

## **Oracle® Fusion Middleware**

Application Developer's Guide for Oracle Identity Management

11g Release 1 (11.1.1)

**E56470-02**

August 2018

Documentation for developers that explains how to modify applications to work with the old Oracle LDAP APIs, 10g Oracle Delegated Administration Services, and the Directory Integration Platform.

Oracle Fusion Middleware Application Developer's Guide for Oracle Identity Management, 11g Release 1 (11.1.1)

E56470-02

Copyright © 1999, 2018, Oracle and/or its affiliates. All rights reserved.

Primary Author: Devanshi Mohan

Contributing Author: John Spencer

This software and related documentation are provided under a license agreement containing restrictions on use and disclosure and are protected by intellectual property laws. Except as expressly permitted in your license agreement or allowed by law, you may not use, copy, reproduce, translate, broadcast, modify, license, transmit, distribute, exhibit, perform, publish, or display any part, in any form, or by any means. Reverse engineering, disassembly, or decompilation of this software, unless required by law for interoperability, is prohibited.

The information contained herein is subject to change without notice and is not warranted to be error-free. If you find any errors, please report them to us in writing.

If this is software or related documentation that is delivered to the U.S. Government or anyone licensing it on behalf of the U.S. Government, then the following notice is applicable:

U.S. GOVERNMENT END USERS: Oracle programs, including any operating system, integrated software, any programs installed on the hardware, and/or documentation, delivered to U.S. Government end users are "commercial computer software" pursuant to the applicable Federal Acquisition Regulation and agency-specific supplemental regulations. As such, use, duplication, disclosure, modification, and adaptation of the programs, including any operating system, integrated software, any programs installed on the hardware, and/or documentation, shall be subject to license terms and license restrictions applicable to the programs. No other rights are granted to the U.S. Government.

This software or hardware is developed for general use in a variety of information management applications. It is not developed or intended for use in any inherently dangerous applications, including applications that may create a risk of personal injury. If you use this software or hardware in dangerous applications, then you shall be responsible to take all appropriate fail-safe, backup, redundancy, and other measures to ensure its safe use. Oracle Corporation and its affiliates disclaim any liability for any damages caused by use of this software or hardware in dangerous applications.

Oracle and Java are registered trademarks of Oracle and/or its affiliates. Other names may be trademarks of their respective owners.

Intel and Intel Xeon are trademarks or registered trademarks of Intel Corporation. All SPARC trademarks are used under license and are trademarks or registered trademarks of SPARC International, Inc. AMD, Opteron, the AMD logo, and the AMD Opteron logo are trademarks or registered trademarks of Advanced Micro Devices. UNIX is a registered trademark of The Open Group.

This software or hardware and documentation may provide access to or information about content, products, and services from third parties. Oracle Corporation and its affiliates are not responsible for and expressly disclaim all warranties of any kind with respect to third-party content, products, and services unless otherwise set forth in an applicable agreement between you and Oracle. Oracle Corporation and its affiliates will not be responsible for any loss, costs, or damages incurred due to your access to or use of third-party content, products, or services, except as set forth in an applicable agreement between you and Oracle.



2.2.3	Functional Model.....	2-3
2.2.4	Security Model .....	2-4
2.2.4.1	Authentication .....	2-4
2.2.4.1.1	Anonymous Authentication .....	2-4
2.2.4.1.2	Simple Authentication .....	2-4
2.2.4.1.3	Authentication Using Secure Sockets Layer (SSL) .....	2-5
2.2.4.2	Access Control and Authorization.....	2-5
2.2.4.3	Data Integrity .....	2-6
2.2.4.4	Data Privacy .....	2-6
2.2.4.5	Password Policies .....	2-6
2.3	About the Standard LDAP APIs.....	2-6
2.3.1	API Usage Model.....	2-7
2.3.2	Getting Started with the C API.....	2-7
2.3.3	Getting Started with the DBMS_LDAP Package.....	2-7
2.3.4	Getting Started with the Java API .....	2-8
2.4	Initializing an LDAP Session.....	2-8
2.4.1	Initializing the Session by Using the C API.....	2-8
2.4.2	Initializing the Session by Using DBMS_LDAP .....	2-9
2.4.3	Initializing the Session by Using JNDI .....	2-9
2.5	Authenticating an LDAP Session .....	2-10
2.5.1	Authenticating an LDAP Session by Using the C API.....	2-10
2.5.2	Authenticating an LDAP Session by Using DBMS_LDAP.....	2-11
2.6	Searching the Directory.....	2-11
2.6.1	Program Flow for Search Operations .....	2-12
2.6.2	Search Scope .....	2-13
2.6.3	Filters .....	2-14
2.6.4	Searching the Directory by Using the C API .....	2-15
2.6.5	Searching the Directory by Using DBMS_LDAP .....	2-16
2.7	Terminating the Session.....	2-17
2.7.1	Terminating the Session by Using the C API .....	2-17
2.7.2	Terminating the Session by Using DBMS_LDAP .....	2-18

### 3 Extensions to the LDAP Protocol

3.1	SASL Authentication.....	3-1
3.1.1	SASL Authentication by Using DIGEST-MD5 .....	3-1
3.1.1.1	Steps Involved in SASL Authentication by Using DIGEST-MD5 .....	3-2
3.1.2	SASL Authentication by Using External Mechanism.....	3-3
3.2	Using Controls .....	3-3
3.3	Proxying on Behalf of End Users.....	3-11
3.4	Creating Dynamic Password Verifiers .....	3-12
3.4.1	Request Control for Dynamic Password Verifiers .....	3-13
3.4.2	Syntax for DynamicVerifierRequestControl.....	3-13
3.4.3	Parameters Required by the Hashing Algorithms.....	3-14
3.4.4	Configuring the Authentication APIs.....	3-14
3.4.4.1	Parameters Passed If ldap_search Is Used.....	3-14
3.4.4.2	Parameters Passed If ldap_compare Is Used.....	3-14
3.4.5	Response Control for Dynamic Password Verifiers .....	3-15

3.4.6	Obtaining Privileges for the Dynamic Verifier Framework .....	3-15
3.5	Performing Hierarchical Searches .....	3-15
3.5.1	New Features of the CONNECT_BY Control.....	3-15
3.5.2	Value Fields in the CONNECT_BY Control .....	3-15
3.6	Sorted LDAP Search Results .....	3-16
3.7	Paged LDAP Search Results.....	3-16
3.8	Password Policies.....	3-17
3.8.1	User Provisioning .....	3-17
3.8.2	User Authentication .....	3-18
3.8.2.1	LDAP Bind/Compare Operation-Based Authentication .....	3-18
3.8.2.2	LDAP Search Operation-Based Authentication.....	3-18
3.8.2.2.1	Ability to Check and Enforce State Policies at Authentication Time.....	3-19
3.8.2.2.2	Ability to Inform the Directory of Authentication Success/Failure.....	3-19
3.8.3	User Account Maintenance .....	3-20

## 4 Developing Applications With Oracle Extensions to the Standard APIs

4.1	Using Oracle Extensions to the Standard APIs .....	4-1
4.2	Creating an Application Identity in the Directory.....	4-2
4.2.1	Creating an Application Identity.....	4-2
4.2.2	Assigning Privileges to an Application Identity .....	4-2
4.3	Managing Users .....	4-3
4.4	Managing Groups .....	4-3
4.5	Managing Realms .....	4-3
4.6	Discovering a Directory Server .....	4-3
4.6.1	Benefits of Oracle Internet Directory Discovery Interfaces .....	4-4
4.6.2	Usage Model for Discovery Interfaces.....	4-4
4.6.3	Determining Server Name and Port Number From DNS .....	4-5
4.6.3.1	Mapping the DN of the Naming Context .....	4-5
4.6.3.2	Search by Domain Component of Local Machine .....	4-6
4.6.3.3	Search by Default SRV Record in DNS .....	4-6
4.6.4	Environment Variables for DNS Server Discovery .....	4-6
4.6.5	Programming Interfaces for DNS Server Discovery .....	4-7

## 5 Using the Java API Extensions to JNDI

5.1	Installing the Java Extensions.....	5-1
5.2	Using the oracle.ldap.util Package to Model LDAP Objects .....	5-1
5.3	The Classes PropertySetCollection, PropertySet, and Property.....	5-2
5.4	Managing Users .....	5-2
5.5	Authenticating Users.....	5-3
5.6	Creating Users .....	5-3
5.7	Retrieving User Objects.....	5-4
5.8	Retrieving Objects from Realms .....	5-4
5.9	Example: Search for Oracle Single Sign-On Login Name .....	5-5
5.10	Discovering a Directory Server .....	5-6
5.11	Example: Discovering a Directory Server .....	5-7
5.12	Using DIGEST-MD5 to Perform SASL Authentication.....	5-8

5.13	Example: Using SASL Digest-MD5 auth-int and auth-conf Modes .....	5-8
5.14	Using LDAP Transactions .....	5-10
5.15	Example: Using LDAP Transactions .....	5-12
5.15.1	Start Transaction Request interface implementation (LdapStartTxnReq.java) .....	5-12
5.15.2	Start Transaction Response interface implementation (LdapStartTxnRes.java) .....	5-13
5.15.3	End Transaction Request interface implementation (LdapEndTxnReq.java).....	5-14
5.15.4	End Transaction Response interface implementation (LdapEndTxnRes.java) .....	5-15
5.15.5	Java and Pseudocode Sample of Interfaces in LDAP Update Operations Within Transaction Semantics (LdapTxnOperation.java).....	5-16

## 6 Using the API Extensions in PL/SQL

6.1	Installing the PL/SQL Extensions .....	6-1
6.2	Using Handles to Access Directory Data .....	6-1
6.3	Managing Users .....	6-2
6.4	Authenticating Users.....	6-2
6.5	Dependencies and Limitations of the PL/SQL LDAP API.....	6-2

## 7 Developing Provisioning-Integrated Applications

### Part II Oracle Internet Directory Programming Reference

## 8 C API Reference

8.1	About the Oracle Internet Directory C API.....	8-1
8.1.1	Oracle Internet Directory SDK C API SSL Extensions .....	8-1
8.1.1.1	SSL Interface Calls .....	8-2
8.1.1.2	Wallet Support .....	8-2
8.2	Functions in the C API .....	8-2
8.2.1	The Functions at a Glance.....	8-3
8.2.2	Initializing an LDAP Session .....	8-5
8.2.2.1	ldap_init and ldap_open.....	8-5
8.2.3	LDAP Session Handle Options.....	8-6
8.2.3.1	ldap_get_option and ldap_set_option.....	8-6
8.2.4	Getting Bind Credentials for Chasing Referrals.....	8-10
8.2.4.1	ldap_set_rebind_proc.....	8-10
8.2.5	Authenticating to the Directory.....	8-11
8.2.5.1	ldap_sasl_bind, ldap_sasl_bind_s, ldap_simple_bind, and ldap_simple_bind_s .....	8-11
8.2.6	SASL Authentication Using Oracle Extensions.....	8-13
8.2.6.1	ora_ldap_init_SASL.....	8-13
8.2.6.2	ora_ldap_create_cred_hdl, ora_ldap_set_cred_props, ora_ldap_get_cred_props, and ora_ldap_free_cred_hdl .....	8-14
8.2.7	Working With Controls.....	8-15
8.2.8	Closing the Session .....	8-17
8.2.8.1	ldap_unbind, ldap_unbind_ext, and ldap_unbind_s.....	8-17
8.2.9	Performing LDAP Operations .....	8-17
8.2.9.1	ldap_search_ext, ldap_search_ext_s, ldap_search, and ldap_search_s .....	8-17
8.2.9.2	Reading an Entry .....	8-20

8.2.9.3	Listing the Children of an Entry.....	8-20
8.2.9.4	ldap_compare_ext, ldap_compare_ext_s, ldap_compare, and ldap_compare_s.....	8-21
8.2.9.5	ldap_modify_ext, ldap_modify_ext_s, ldap_modify, and ldap_modify_s.....	8-22
8.2.9.6	ldap_rename and ldap_rename_s.....	8-24
8.2.9.7	ldap_add_ext, ldap_add_ext_s, ldap_add, and ldap_add_s.....	8-26
8.2.9.8	ldap_delete_ext, ldap_delete_ext_s, ldap_delete, and ldap_delete_s.....	8-27
8.2.9.9	ldap_extended_operation and ldap_extended_operation_s.....	8-29
8.2.10	Abandoning an Operation.....	8-30
8.2.10.1	ldap_abandon_ext and ldap_abandon.....	8-30
8.2.11	Obtaining Results and Peeking Inside LDAP Messages.....	8-31
8.2.11.1	ldap_result, ldap_msgtype, and ldap_msgid.....	8-31
8.2.12	Handling Errors and Parsing Results.....	8-33
8.2.12.1	ldap_parse_result, ldap_parse_sasl_bind_result, ldap_parse_extended_result, and ldap_err2string.....	8-33
8.2.13	Stepping Through a List of Results.....	8-35
8.2.13.1	ldap_first_message and ldap_next_message.....	8-35
8.2.14	Parsing Search Results.....	8-36
8.2.14.1	ldap_first_entry, ldap_next_entry, ldap_first_reference, ldap_next_reference, ldap_count_entries, and ldap_count_references.....	8-36
8.2.14.2	ldap_first_attribute and ldap_next_attribute.....	8-37
8.2.14.3	ldap_get_values, ldap_get_values_len, ldap_count_values, ldap_count_values_len, ldap_value_free, and ldap_value_free_len.....	8-38
8.2.14.4	ldap_get_dn, ldap_explode_dn, ldap_explode_rdn, and ldap_dn2ufn.....	8-39
8.2.14.5	ldap_get_entry_controls.....	8-40
8.2.14.6	ldap_parse_reference.....	8-40
8.3	Sample C API Usage.....	8-41
8.3.1	C API Usage with SSL.....	8-41
8.3.2	C API Usage Without SSL.....	8-42
8.3.3	C API Usage for SASL-Based DIGEST-MD5 Authentication.....	8-42
8.3.4	Setting and Using a Callback Function to Get Credentials When Chasing Referrals.....	8-45
8.4	Required Header Files and Libraries for the C API.....	8-47
8.5	Dependencies and Limitations of the C API.....	8-47

## 9 DBMS\_LDAP PL/SQL Reference

9.1	Summary of Subprograms.....	9-1
9.2	Exception Summary.....	9-3
9.3	Data Type Summary.....	9-4
9.4	Subprograms.....	9-5
9.4.1	FUNCTION init.....	9-5
9.4.2	FUNCTION simple_bind_s.....	9-6
9.4.3	FUNCTION bind_s.....	9-7
9.4.4	FUNCTION unbind_s.....	9-8
9.4.5	FUNCTION compare_s.....	9-9
9.4.6	FUNCTION search_s.....	9-10
9.4.7	FUNCTION search_st.....	9-11

9.4.8	FUNCTION first_entry .....	9-13
9.4.9	FUNCTION next_entry.....	9-14
9.4.10	FUNCTION count_entries.....	9-15
9.4.11	FUNCTION first_attribute .....	9-16
9.4.12	FUNCTION next_attribute.....	9-17
9.4.13	FUNCTION get_dn .....	9-18
9.4.14	FUNCTION get_values.....	9-19
9.4.15	FUNCTION get_values_len .....	9-20
9.4.16	FUNCTION delete_s .....	9-21
9.4.17	FUNCTION modrdn2_s .....	9-21
9.4.18	FUNCTION err2string .....	9-22
9.4.19	FUNCTION create_mod_array.....	9-23
9.4.20	PROCEDURE populate_mod_array (String Version).....	9-24
9.4.21	PROCEDURE populate_mod_array (Binary Version).....	9-25
9.4.22	PROCEDURE populate_mod_array (Binary Version. Uses BLOB Data Type).....	9-26
9.4.23	FUNCTION get_values_blob.....	9-27
9.4.24	FUNCTION count_values_blob .....	9-28
9.4.25	FUNCTION value_free_blob .....	9-28
9.4.26	FUNCTION modify_s.....	9-29
9.4.27	FUNCTION add_s.....	9-30
9.4.28	PROCEDURE free_mod_array .....	9-31
9.4.29	FUNCTION count_values .....	9-31
9.4.30	FUNCTION count_values_len.....	9-32
9.4.31	FUNCTION rename_s.....	9-32
9.4.32	FUNCTION explode_dn.....	9-33
9.4.33	FUNCTION open_ssl .....	9-34
9.4.34	FUNCTION msgfree .....	9-35
9.4.35	FUNCTION ber_free .....	9-36
9.4.36	FUNCTION nls_convert_to_utf8 .....	9-37
9.4.37	FUNCTION nls_convert_to_utf8 .....	9-37
9.4.38	FUNCTION nls_convert_from_utf8 .....	9-38
9.4.39	FUNCTION nls_convert_from_utf8 .....	9-39
9.4.40	FUNCTION nls_get_dbcharset_name.....	9-39

## 10 Java API Reference

## 11 DBMS\_LDAP\_UTL PL/SQL Reference

11.1	Summary of Subprograms.....	11-1
11.2	Subprograms.....	11-2
11.2.1	User-Related Subprograms .....	11-3
11.2.1.1	Function authenticate_user .....	11-3
11.2.1.2	Function create_user_handle .....	11-5
11.2.1.3	Function set_user_handle_properties.....	11-5
11.2.1.4	Function get_user_properties .....	11-6
11.2.1.5	Function set_user_properties.....	11-7
11.2.1.6	Function get_user_extended_properties.....	11-9
11.2.1.7	Function get_user_dn.....	11-10



11.2.1.8	Function check_group_membership .....	11-11
11.2.1.9	Function locate_subscriber_for_user .....	11-11
11.2.1.10	Function get_group_membership .....	11-12
11.2.2	Group-Related Subprograms .....	11-13
11.2.2.1	Function create_group_handle .....	11-14
11.2.2.2	Function set_group_handle_properties .....	11-15
11.2.2.3	Function get_group_properties .....	11-16
11.2.2.4	Function get_group_dn .....	11-17
11.2.3	Subscriber-Related Subprograms .....	11-18
11.2.3.1	Function create_subscriber_handle .....	11-19
11.2.3.2	Function get_subscriber_properties .....	11-19
11.2.3.3	Function get_subscriber_dn .....	11-20
11.2.3.4	Function get_subscriber_ext_properties .....	11-21
11.2.4	Property-Related Subprograms .....	11-23
11.2.5	Miscellaneous Subprograms .....	11-23
11.2.5.1	Function normalize_dn_with_case .....	11-23
11.2.5.2	Function get_property_names .....	11-24
11.2.5.3	Function get_property_values .....	11-25
11.2.5.4	Function get_property_values_len .....	11-26
11.2.5.5	Procedure free_propertyset_collection .....	11-27
11.2.5.6	Function create_mod_propertyset .....	11-28
11.2.5.7	Function populate_mod_propertyset .....	11-28
11.2.5.8	Procedure free_mod_propertyset .....	11-29
11.2.5.9	Procedure free_handle .....	11-29
11.2.5.10	Function check_interface_version .....	11-30
11.2.5.11	Function get_property_values_blob .....	11-30
11.2.5.12	Procedure property_value_free_blob .....	11-31
11.3	Function Return Code Summary .....	11-32
11.4	Data Type Summary .....	11-33

## 12 Oracle Directory Integration and Provisioning Java API Reference

12.1	Application Configuration .....	12-1
12.1.1	Application Registration and Provisioning Configuration .....	12-2
12.1.1.1	Application Registration .....	12-2
12.1.1.2	Provisioning Configuration .....	12-4
12.1.1.2.1	Application Identity Information .....	12-7
12.1.1.2.2	Application Identity Realm Information .....	12-7
12.1.1.2.3	Application Provisioning and Default Policy .....	12-7
12.1.1.2.4	Application User Data Location .....	12-8
12.1.1.2.5	Event Interface Configuration .....	12-8
12.1.1.2.6	Application User Attribute and Defaults Configuration .....	12-10
12.1.1.2.7	Application Provisioning Plug-in Configuration .....	12-11
12.1.1.2.8	Application Propagation Configuration .....	12-11
12.1.1.2.9	Application Event Propagation Run Time Status .....	12-13
12.1.2	Application Configuration Classes .....	12-13
12.2	User Management .....	12-14
12.2.1	Creating a User .....	12-14

12.2.2	Modifying a User .....	12-15
12.2.3	Deleting a User .....	12-15
12.2.4	Looking Up a User .....	12-15
12.3	Debugging .....	12-15
12.4	Sample Code .....	12-16

## 13 Oracle Directory Integration Platform PL/SQL API Reference

13.1	Versioning of Provisioning Files and Interfaces .....	13-1
13.2	Extensible Event Definition Configuration .....	13-1
13.3	Inbound and Outbound Events .....	13-4
13.4	PL/SQL Bidirectional Interface (Version 3.0) .....	13-4
13.5	PL/SQL Bidirectional Interface (Version 2.0) .....	13-8
13.6	Provisioning Event Interface (Version 1.1) .....	13-9
13.6.1	Predefined Event Types .....	13-11
13.6.2	Attribute Type .....	13-11
13.6.3	Attribute Modification Type .....	13-11
13.6.4	Event Dispositions Constants .....	13-11
13.6.5	Callbacks .....	13-11
13.6.5.1	GetAppEvent() .....	13-12
13.6.5.2	PutAppEventStatus() .....	13-12
13.6.5.3	PutOIDEvent() .....	13-12

## Part III Appendices

### A Java Plug-ins for User Provisioning

A.1	Provisioning Plug-in Types and Their Purpose .....	A-1
A.2	Provisioning Plug-in Requirements .....	A-2
A.3	Data Entry Provisioning Plug-in .....	A-2
A.3.1	Pre-Data-Entry Provisioning Plug-in .....	A-4
A.3.2	Post-Data-Entry Provisioning Plug-in .....	A-5
A.4	Data Access Provisioning Plug-in .....	A-6
A.5	Event Delivery Provisioning Plug-in .....	A-7
A.6	Provisioning Plug-in Return Status .....	A-10
A.7	Configuration Template for Provisioning Plug-ins .....	A-10
A.8	Sample Code for a Provisioning Plug-in .....	A-11

### B DSML Syntax

B.1	Capabilities of DSML .....	B-1
B.2	Benefits of DSML .....	B-1
B.3	DSML Syntax .....	B-2
B.3.1	Top-Level Structure .....	B-2
B.3.2	Directory Entries .....	B-2
B.3.3	Schema Entries .....	B-3
B.4	Tools Enabled for DSML .....	B-3

## **C Migrating from Netscape LDAP SDK API to Oracle LDAP SDK API**

C.1	Features .....	C-1
C.2	Functions .....	C-2
C.3	Macros .....	C-2



## List of Figures

1-1	A Directory-Enabled Application.....	1-4
1-2	An Application Leveraging APIs and Services .....	1-6
2-1	A Directory Information Tree .....	2-2
2-2	Attributes of the Entry for Anne Smith .....	2-3
2-3	Steps in Typical DBMS_LDAP Usage.....	2-7
2-4	Flow of Search-Related Operations.....	2-13
2-5	The Three Scope Options.....	2-14
4-1	Programmatic Flow for API Extensions .....	4-2
12-1	The Directory Information Tree for Provisioning Configuration Data .....	12-6

## List of Tables

1-1	Interactions During Application Lifecycle .....	1-4
1-2	Services and APIs for Integrating with Oracle Internet Directory .....	1-5
1-3	Services for Modifying Existing Applications .....	1-6
2-1	LDAP Functions .....	2-3
2-2	SSL Authentication Modes .....	2-5
2-3	Parameters for ldap_init() .....	2-9
2-4	Arguments for ldap_simple_bind_s() .....	2-11
2-5	Options for search_s() or search_st() Functions .....	2-13
2-6	Search Filters .....	2-14
2-7	Boolean Operators .....	2-15
2-8	Arguments for ldap_search_s() .....	2-16
2-9	Arguments for DBMS_LDAP.search_s() and DBMS_LDAP.search_st() .....	2-16
3-1	Request Controls Supported by Oracle Internet Directory .....	3-5
3-2	Response Controls Supported by Oracle Internet Directory .....	3-10
3-3	Parameters in DynamicVerifierRequestControl .....	3-14
3-4	Parameters Required by the Hashing Algorithms .....	3-14
4-1	Environment Variables for DNS Discovery .....	4-7
5-1	Methods for Directory Server Discovery .....	5-6
8-1	Arguments for SSL Interface Calls .....	8-2
8-2	Functions and Procedures in the C API .....	8-3
8-3	Parameters for Initializing an LDAP Session .....	8-6
8-4	Parameters for LDAP Session Handle Options .....	8-7
8-5	Constants for LDAP Session Handle Options .....	8-8
8-6	Parameters for Callback Function and for Setting Callback Function .....	8-10
8-7	Parameters for Authenticating to the Directory .....	8-12
8-8	Parameters passed to ora_ldap_init_sasl() .....	8-13
8-9	Parameters for Managing SASL Credentials .....	8-15
8-10	Fields in ldapcontrol Structure .....	8-15
8-11	Parameters for Closing the Session .....	8-17
8-12	Parameters for Search Operations .....	8-19
8-13	Parameters for Compare Operations .....	8-22
8-14	Parameters for Modify Operations .....	8-23
8-15	Fields in LDAPMod Structure .....	8-24
8-16	Parameters for Rename Operations .....	8-25
8-17	Parameters for Add Operations .....	8-27
8-18	Parameters for Delete Operations .....	8-28
8-19	Parameters for Extended Operations .....	8-29
8-20	Parameters for Abandoning an Operation .....	8-31
8-21	Parameters for Obtaining Results and Peeking Inside LDAP Messages .....	8-32
8-22	Parameters for Handling Errors and Parsing Results .....	8-34
8-23	Parameters for Stepping Through a List of Results .....	8-35
8-24	Parameters for Retrieving Entries and Continuation References from a Search Result Chain, and for Counting Entries Returned .....	8-36
8-25	Parameters for Stepping Through Attribute Types Returned with an Entry .....	8-37
8-26	Parameters for Retrieving and Counting Attribute Values .....	8-38
8-27	Parameters for Retrieving, Exploding, and Converting Entry Names .....	8-39
8-28	Parameters for Extracting LDAP Controls from an Entry .....	8-40
8-29	Parameters for Extracting Referrals and Controls from a SearchResultReference Message .....	8-41
9-1	DBMS_LDAP API Subprograms .....	9-1
9-2	DBMS_LDAP Exception Summary .....	9-3
9-3	DBMS_LDAP Data Type Summary .....	9-4
9-4	INIT Function Parameters .....	9-5

9-5	INIT Function Return Values .....	9-6
9-6	INIT Function Exceptions .....	9-6
9-7	SIMPLE_BIND_S Function Parameters .....	9-6
9-8	SIMPLE_BIND_S Function Return Values.....	9-7
9-9	SIMPLE_BIND_S Function Exceptions.....	9-7
9-10	BIND_S Function Parameters.....	9-7
9-11	BIND_S Function Return Values .....	9-8
9-12	BIND_S Function Exceptions .....	9-8
9-13	UNBIND_S Function Parameters .....	9-8
9-14	UNBIND_S Function Return Values.....	9-8
9-15	UNBIND_S Function Exceptions.....	9-9
9-16	COMPARE_S Function Parameters .....	9-9
9-17	COMPARE_S Function Return Values .....	9-9
9-18	COMPARE_S Function Exceptions .....	9-10
9-19	SEARCH_S Function Parameters .....	9-10
9-20	SEARCH_S Function Return Value.....	9-11
9-21	SEARCH_S Function Exceptions .....	9-11
9-22	SEARCH_ST Function Parameters.....	9-12
9-23	SEARCH_ST Function Return Values .....	9-12
9-24	SEARCH_ST Function Exceptions .....	9-13
9-25	FIRST_ENTRY Function Parameters .....	9-13
9-26	FIRST_ENTRY Return Values.....	9-13
9-27	FIRST_ENTRY Exceptions.....	9-14
9-28	NEXT_ENTRY Function Parameters .....	9-14
9-29	NEXT_ENTRY Function Return Values .....	9-14
9-30	NEXT_ENTRY Function Exceptions .....	9-14
9-31	COUNT_ENTRY Function Parameters .....	9-15
9-32	COUNT_ENTRY Function Return Values .....	9-15
9-33	COUNT_ENTRY Function Exceptions .....	9-15
9-34	FIRST_ATTRIBUTE Function Parameters.....	9-16
9-35	FIRST_ATTRIBUTE Function Return Values .....	9-16
9-36	FIRST_ATTRIBUTE Function Exceptions .....	9-16
9-37	NEXT_ATTRIBUTE Function Parameters .....	9-17
9-38	NEXT_ATTRIBUTE Function Return Values .....	9-17
9-39	NEXT_ATTRIBUTE Function Exceptions .....	9-17
9-40	GET_DN Function Parameters .....	9-18
9-41	GET_DN Function Return Values .....	9-18
9-42	GET_DN Function Exceptions .....	9-18
9-43	GET_VALUES Function Parameters.....	9-19
9-44	GET_VALUES Function Return Values .....	9-19
9-45	GET_VALUES Function Exceptions .....	9-19
9-46	GET_VALUES_LEN Function Parameters.....	9-20
9-47	GET_VALUES_LEN Function Return Values .....	9-20
9-48	GET_VALUES_LEN Function Exceptions .....	9-20
9-49	DELETE_S Function Parameters .....	9-21
9-50	DELETE_S Function Return Values .....	9-21
9-51	DELETE_S Function Exceptions .....	9-21
9-52	MODRDN2_S Function Parameters.....	9-22
9-53	MODRDN2_S Function Return Values .....	9-22
9-54	MODRDN2_S Function Exceptions .....	9-22
9-55	ERR2STRING Function Parameters .....	9-23
9-56	ERR2STRING Function Return Values.....	9-23
9-57	CREATE_MOD_ARRAY Function Parameters.....	9-23
9-58	CREATE_MOD_ARRAY Function Return Values .....	9-24
9-59	POPULATE_MOD_ARRAY (String Version) Procedure Parameters .....	9-24

9-60	POPULATE_MOD_ARRAY (String Version) Procedure Exceptions .....	9-24
9-61	POPULATE_MOD_ARRAY (Binary Version) Procedure Parameters .....	9-25
9-62	POPULATE_MOD_ARRAY (Binary Version) Procedure Exceptions .....	9-25
9-63	POPULATE_MOD_ARRAY (Binary) Parameters .....	9-26
9-64	POPULATE_MOD_ARRAY (Binary) Exceptions .....	9-26
9-65	GET_VALUES_BLOB Parameters .....	9-27
9-66	get_values_blob Return Values.....	9-27
9-67	get_values_blob Exceptions.....	9-27
9-68	COUNT_VALUES_BLOB Parameters .....	9-28
9-69	COUNT_VALUES_BLOB Return Values.....	9-28
9-70	VALUE_FREE_BLOB Parameters .....	9-28
9-71	MODIFY_S Function Parameters .....	9-29
9-72	MODIFY_S Function Return Values .....	9-29
9-73	MODIFY_S Function Exceptions .....	9-29
9-74	ADD_S Function Parameters .....	9-30
9-75	ADD_S Function Return Values .....	9-30
9-76	ADD_S Function Exceptions .....	9-30
9-77	FREE_MOD_ARRAY Procedure Parameters .....	9-31
9-78	COUNT_VALUES Function Parameters .....	9-31
9-79	COUNT_VALUES Function Return Values.....	9-31
9-80	COUNT_VALUES_LEN Function Parameters.....	9-32
9-81	COUNT_VALUES_LEN Function Return Values .....	9-32
9-82	RENAME_S Function Parameters .....	9-33
9-83	RENAME_S Function Return Values.....	9-33
9-84	RENAME_S Function Exceptions.....	9-33
9-85	EXPLODE_DN Function Parameters.....	9-34
9-86	EXPLODE_DN Function Return Values .....	9-34
9-87	EXPLODE_DN Function Exceptions .....	9-34
9-88	OPEN_SSL Function Parameters.....	9-34
9-89	OPEN_SSL Function Return Values.....	9-35
9-90	OPEN_SSL Function Exceptions.....	9-35
9-91	MSGFREE Function Parameters .....	9-35
9-92	MSGFREE Return Values .....	9-36
9-93	BER_FREE Function Parameters .....	9-36
9-94	Parameters for nls_convert_to_utf8 .....	9-37
9-95	Return Values for nls_convert_to_utf8.....	9-37
9-96	Parameters for nls_convert_to_utf8 .....	9-38
9-97	Return Values for nls_convert_to_utf8.....	9-38
9-98	Parameter for nls_convert_from_utf8.....	9-38
9-99	Return Value for nls_convert_from_utf8.....	9-38
9-100	Parameter for nls_convert_from_utf8.....	9-39
9-101	Return Value for nls_convert_from_utf8.....	9-39
9-102	Return Value for nls_get_dbcharset_name .....	9-40
11-1	DBMS_LDAP_UTL User-Related Subprograms .....	11-1
11-2	DBMS_LDAP_UTL Group-Related Subprograms.....	11-1
11-3	DBMS_LDAP_UTL Subscriber-Related Subprograms.....	11-2
11-4	DBMS_LDAP_UTL Miscellaneous Subprograms.....	11-2
11-5	authenticate_user Function Parameters .....	11-4
11-6	authenticate_user Function Return Values .....	11-4
11-7	CREATE_USER_HANDLE Function Parameters.....	11-5
11-8	CREATE_USER_HANDLE Function Return Values .....	11-5
11-9	SET_USER_HANDLE_PROPERTIES Function Parameters.....	11-6
11-10	SET_USER_HANDLE_PROPERTIES Function Return Values .....	11-6
11-11	GET_USER_PROPERTIES Function Parameters .....	11-6
11-12	GET_USER_PROPERTIES Function Return Values .....	11-7



11-13	SET_USER_PROPERTIES Function Parameters .....	11-8
11-14	SET_USER_PROPERTIES Function Return Values .....	11-8
11-15	GET_USER_EXTENDED_PROPERTIES Function Parameters .....	11-9
11-16	GET_USER_EXTENDED_PROPERTIES Function Return Values .....	11-9
11-17	GET_USER_DN Function Parameters .....	11-10
11-18	GET_USER_DN Function Return Values .....	11-10
11-19	CHECK_GROUP_MEMBERSHIP Function Parameters .....	11-11
11-20	CHECK_GROUP_MEMBERSHIP Function Return Values .....	11-11
11-21	LOCATE_SUBSCRIBER_FOR_USER Function Parameters .....	11-12
11-22	LOCATE SUBSCRIBER FOR USER Function Return Values .....	11-12
11-23	GET_GROUP_MEMBERSHIP Function Parameters .....	11-13
11-24	GET_GROUP_MEMBERSHIP Function Return Values .....	11-13
11-25	CREATE_GROUP_HANDLE Function Parameters .....	11-14
11-26	CREATE_GROUP_HANDLE Function Return Values .....	11-15
11-27	SET_GROUP_HANDLE_PROPERTIES Function Parameters .....	11-15
11-28	SET_GROUP_HANDLE_PROPERTIES Function Return Values .....	11-16
11-29	GET_GROUP_PROPERTIES Function Parameters .....	11-16
11-30	GET_GROUP_PROPERTIES Function Return Values .....	11-16
11-31	GET_GROUP_DN Function Parameters .....	11-17
11-32	GET_GROUP_DN Function Return Values .....	11-18
11-33	CREATE_SUBSCRIBER_HANDLE Function Parameters .....	11-19
11-34	CREATE_SUBSCRIBER_HANDLE Function Return Values .....	11-19
11-35	GET_SUBSCRIBER_PROPERTIES Function Parameters .....	11-20
11-36	GET_SUBSCRIBER_PROPERTIES Function Return Values .....	11-20
11-37	GET_SUBSCRIBER_DN Function Parameters .....	11-21
11-38	GET_SUBSCRIBER_DN Function Return Values .....	11-21
11-39	GET_SUBSCRIBER_EXT_PROPERTIES Function Parameters .....	11-22
11-40	GET_USER_EXTENDED_PROPERTIES Function Return Values .....	11-22
11-41	NORMALIZE_DN_WITH_CASE Function Parameters .....	11-24
11-42	NORMALIZE_DN_WITH_CASE Function Return Values .....	11-24
11-43	GET_PROPERTY_NAMES Function Parameters .....	11-25
11-44	GET_PROPERTY_NAMES Function Return Values .....	11-25
11-45	GET_PROPERTY_VALUES Function Parameters .....	11-25
11-46	GET_PROPERTY_VALUES Function Return Values .....	11-26
11-47	GET_PROPERTY_VALUES_LEN Function Parameters .....	11-26
11-48	GET_PROPERTY_VALUES_LEN Function Return Values .....	11-27
11-49	FREE_PROPERTYSET_COLLECTION Procedure Parameters .....	11-27
11-50	CREATE_MOD_PROPERTYSET Function Parameters .....	11-28
11-51	CREATE_MOD_PROPERTYSET Function Return Values .....	11-28
11-52	POPULATE_MOD_PROPERTYSET Function Parameters .....	11-29
11-53	POPULATE_MOD_PROPERTYSET Function Return Values .....	11-29
11-54	FREE_MOD_PROPERTYSET Procedure Parameters .....	11-29
11-55	FREE_HANDLE Procedure Parameters .....	11-30
11-56	CHECK_INTERFACE_VERSION Function Parameters .....	11-30
11-57	CHECK_VERSION_INTERFACE Function Return Values .....	11-30
11-58	GET_PROPERTY_VALUES_BLOB Function Parameters .....	11-31
11-59	GET_PROPERTY_VALUES_BLOB Return Values .....	11-31
11-60	PROPERTY_VALUE_FREE_BLOB Function Parameters .....	11-31
11-61	Function Return Codes .....	11-32
11-62	DBMS_LDAP_UTL Data Types .....	11-33
12-1	Some Useful Privilege Groups .....	12-3
12-2	Interfaces and Their Configuration .....	12-8
12-3	Information Formats Supported by the PLSQL Interface .....	12-9
12-4	Properties Stored as Attributes in the Attribute Configuration Entry .....	12-10
12-5	Event propagation parameters .....	12-12

13-1	Predefined Event Definitions .....	13-2
13-2	Attributes of the Provisioning Subscription Profile.....	13-4

---

---

# Preface

The *Oracle Fusion Middleware Application Developer's Guide for Oracle Identity Management* explains how to modify applications to work with Oracle Identity Management, including Oracle Application Server Single Sign-On, Oracle Internet Directory, Oracle Delegated Administration Services, and the Directory Integration Platform.

This preface contains these topics:

- [Audience](#)
- [Documentation Accessibility](#)
- [Related Documents](#)
- [Conventions](#)

## Audience

The following readers can benefit from this book:

- Developers who want to integrate applications with Oracle Identity Management. This process involves storing and updating information in an Oracle Internet Directory server. It also involves modifying applications to work with `mod_osso`, an authentication module on the Oracle HTTP Server.
- Anyone who wants to learn about the LDAP APIs and Oracle extensions to these APIs.

## Documentation Accessibility

For information about Oracle's commitment to accessibility, visit the Oracle Accessibility Program website at

<http://www.oracle.com/pls/topic/lookup?ctx=acc&id=docacc>.

### Access to Oracle Support

Oracle customers that have purchased support have access to electronic support through My Oracle Support. For information, visit

<http://www.oracle.com/pls/topic/lookup?ctx=acc&id=info> or visit

<http://www.oracle.com/pls/topic/lookup?ctx=acc&id=trs> if you are hearing impaired.

## Related Documents

For more information, see these Oracle resources:

- *Oracle Fusion Middleware Installation Guide for Oracle Identity Management*
- *Oracle Fusion Middleware Administrator's Guide for Oracle Internet Directory*
- *Oracle Fusion Middleware Administrator's Guide for Oracle Directory Integration Platform*

For additional information, see:

- Chadwick, David. *Understanding X.500—The Directory*. Thomson Computer Press, 1996.
- Howes, Tim and Mark Smith. *LDAP: Programming Directory-enabled Applications with Lightweight Directory Access Protocol*. Macmillan Technical Publishing, 1997.
- Howes, Tim, Mark Smith and Gordon Good, *Understanding and Deploying LDAP Directory Services*. Macmillan Technical Publishing, 1999.
- Internet Assigned Numbers Authority home page, <http://www.iana.org>, for information about object identifiers
- Internet Engineering Task Force (IETF) documentation available at: <http://www.ietf.org>, especially:
  - The LDAPEXT charter and LDAP drafts
  - The LDUP charter and drafts
  - RFC 2251, "Lightweight Directory Access Protocol (v3)"
  - RFC 2254, "The String Representation of LDAP Search Filters"
  - RFC 1823, "The LDAP Application Program Interface"
- The OpenLDAP Community, <http://www.openldap.org>

## Conventions

The following text conventions are used in this document:

Convention	Meaning
<b>boldface</b>	Boldface type indicates graphical user interface elements associated with an action, or terms defined in text or the glossary.
<i>italic</i>	Italic type indicates book titles, emphasis, or placeholder variables for which you supply particular values.
monospace	Monospace type indicates commands within a paragraph, URLs, code in examples, text that appears on the screen, or text that you enter.

# What's New in the SDK?

This chapter describes the new features of the Software Developer's Kit (SDK) for Oracle Identity Management—both in the current release and in previous releases. Use the links provided in each section to learn more about each feature.

This chapter includes the following sections:

- [New Features in the 11g Release 1 \(11.1.1.9.0\) SDK](#)
- [New Features in the 11g Release 1 \(11.1.1.7.0\) SDK](#)
- [New Features in the 11g Release 1 \(11.1.1.6\) SDK](#)
- [New Features in the 11g Release 1 \(11.1.1\) SDK](#)
- [New Features in the 10g \(10.1.4.0.1\) SDK](#)
- [New Features in the Release 10.1.2 SDK](#)
- [New Features in the Release 9.0.4 SDK](#)

---

---

**Note:** As of Release 11g Release 1 (11.1.1), the recommended security API for Fusion Middleware application developers is Oracle Platform Security for Java, which is documented in the *Oracle Fusion Middleware Application Security Guide*. The Oracle Identity Management interfaces described in the current book are supported for developers who maintain and extend existing solutions already integrated with the SDK.

Oracle Fusion Middleware 11g Release 1 (11.1.1) does not include Oracle Single Sign-On or Oracle Delegated Administration Services. Oracle Internet Directory 11g Release 1 (11.1.1), however, is compatible with Oracle Single Sign-On 10g (10.1.4.3.0) or later and Oracle Delegated Administration Services 10g (10.1.4.3.0) or later.

---

---

## New Features in the 11g Release 1 (11.1.1.9.0) SDK

The 11g Release 1 (11.1.1.9.0) SDK includes the following new features:

- New controls:
  - The Proxy Authorization control allows an LDAP operation (ldapsearch, ldapadd, ldapdelete, ldapmodify, ldapmoddn, or ldapcompare) to be performed by a proxy user on behalf of a single or multiple users without requiring the proxy user to rebind to Oracle Internet Directory server.
  - The Password Policy request and response controls allow an LDAP client application to request information from Oracle Internet Directory server about the current password policy state for a user entry.
  - The Persistent Search controls allows an LDAP client to send a persistent search request to Oracle Internet Directory server to communicate the changes made on the server.

See [Using Controls](#).

## New Features in the 11g Release 1 (11.1.1.7.0) SDK

The 11g Release 1 (11.1.1.7.0) SDK adds the following new controls:

- The Virtual List View (VLV) request and response controls allow a client to specify that the server return, for a given LDAP search, a contiguous subset of a large search result set.
- The Computed Attribute Value Uniqueness control allows computed attribute values to be unique across a directory.

See [Using Controls](#).

## New Features in the 11g Release 1 (11.1.1.6) SDK

The 11g Release 1 (11.1.1.6) SDK adds support for transactions. See [Using LDAP Transactions](#).

## New Features in the 11g Release 1 (11.1.1) SDK

The 11g Release 1 (11.1.1) SDK adds support for Internet Protocol version 6 (IPv6). The C and Java APIs now support both IPv6 and IPv4 addresses.

## New Features in the 10g (10.1.4.0.1) SDK

The 10g (10.1.4.0.1) SDK adds:

- Java plug-in support.  
Server plug-ins can now be written in Java and in PL/SQL. For more information, please see *Oracle Fusion Middleware Administrator's Guide for Oracle Internet Directory* for more information.
- Paging and sorting of LDAP search results.  
You can now obtain paged and sorted results from LDAP searches. For more information, please see "Sorted LDAP Search Results" and "Paged LDAP Search Results" in Chapter 3, "Extensions to the LDAP Protocol".
- Added functionality for hierarchical searches.  
You can now traverse the hierarchy in either direction and specify the number of levels of the hierarchy to search. For more information, please see "Performing Hierarchical Searches" in Chapter 3, "Extensions to the LDAP Protocol".
- Support for all three modes of SASL Digest-MD5 authentication.  
Oracle Internet Directory now supports all three modes with the Java Naming and Directory Interface (JNDI) of jdk1.4 API or with the OpenLDAP Java API. For more information, please see "SASL Authentication" in Chapter 3, "Extensions to the LDAP Protocol" and "Example: Using SASL Digest-MD5 auth-int and auth-conf Modes" in Chapter 5, "Using the Java API Extensions to JNDI".

## New Features in the Release 10.1.2 SDK

The release 10.1.2 SDK adds:

- Centralized user provisioning.

This feature enables you to provision application users into the Oracle Identity Management infrastructure. To learn more, see [Chapter 12, "Oracle Directory Integration and Provisioning Java API Reference"](#).

- **Dynamic password verifiers**

This feature addresses the needs of applications that provide parameters for password verifiers only at runtime. To learn more, see "[Creating Dynamic Password Verifiers](#)" in [Chapter 3](#).
- **Binary support for `ldapmodify`, `ldapadd`, and `ldapcompare` plug-ins**

Directory plug-ins can now access binary attributes in the directory database. To learn more, see "[Binary Support in the PL/SQL Plug-in Framework](#)" in *Oracle Fusion Middleware Administrator's Guide for Oracle Internet Directory*.
- **Plug-in support for the Oracle Directory Integration and Provisioning Server**

These Java hooks enable an enterprise to incorporate its own business rules and to tailor footprint creation to its needs. To learn more, see [Appendix A](#).

## New Features in the Release 9.0.4 SDK

The following features made their debut in the release 9.0.4 SDK:

- **URL API for Oracle Delegated Administration Services**

This API enables you to build administrative and self-service consoles that delegated administrators can use to perform directory operations.
- **PL/SQL API Enhancements:**
  - New functions in the LDAP v3 standard. Previously available only in the C API, these functions are now available in PL/SQL.
  - Functions that enable proxy access to middle-tier applications.
  - Functions that create and manage provisioning profiles in the Oracle Directory Integration and Provisioning.

To learn more, see [Chapter 7](#).
- **Plug-in support for external authentication**

This feature enables administrators to use Microsoft Active Directory to store and manage security credentials for Oracle components. [Chapter 12](#)
- **Server discovery using DNS**

This feature enables directory clients to discover the host name and port number of a directory server. It reduces the cost of maintaining directory clients in large deployments. To learn more, see "[Discovering a Directory Server](#)" in [Chapter 4.6](#).
- **XML support for the directory SDK and directory tools**

This feature enables LDAP tools to process XML and LDIF notation. Directory APIs can manipulate data in a DSML 1.0 format.
- **Caching for client-side referrals**

This feature enables clients to cache referral information, speeding up referral processing.





# Part I

---

## Programming for Oracle Identity Management

Part I shows you how to modify your applications to work with the different components of Oracle Identity Management. This section begins with an introduction to the Oracle Internet Directory SDK and to LDAP programming concepts. You then learn how to use the three LDAP APIs and their extensions to enable applications for Oracle Internet Directory.

Part I contains these chapters:

- Chapter 1, "Developing Applications for Oracle Identity Management"
- Chapter 2, "Developing Applications with Standard LDAP APIs"
- Chapter 3, "Extensions to the LDAP Protocol"
- Chapter 4, "Developing Applications With Oracle Extensions to the Standard APIs"
- Chapter 5, "Using the Java API Extensions to JNDI"
- Chapter 6, "Using the API Extensions in PL/SQL"
- Chapter 7, "Developing Provisioning-Integrated Applications"



---

# Developing Applications for Oracle Identity Management

This chapter describes the interfaces for developing applications for Oracle Identity Management and recommends application development best practices in the Oracle Identity Management environment.

As of Release 11g Release 1 (11.1.1), the recommended security API for Fusion Middleware application developers is Oracle Platform Security for Java, which is documented in the *Fusion Middleware Security Guide*. The Oracle Identity Management interfaces described in the current book are not part of Oracle Platform Security for Java.

Oracle Identity Management provides a shared infrastructure for all Oracle applications. It also provides services and interfaces that facilitate third-party enterprise application development. These interfaces are useful for application developers who need to incorporate identity management into their applications.

This chapter includes the following sections:

- [Section 1.1, "Oracle Identity Management Services Available for Application Integration"](#)
- [Section 1.2, "Integrating Existing Applications with Oracle Identity Management"](#)
- [Section 1.3, "Oracle Identity Management Programming: An Overview"](#)

## 1.1 Oracle Identity Management Services Available for Application Integration

Custom applications can use Oracle Identity Management through a set of documented and supported services and APIs. For example:

- Oracle Internet Directory provides LDAP APIs for C, Java, and PL/SQL, and is compatible with other LDAP SDKs.
- Oracle Delegated Administration Services provides a core self-service console that can be customized to support third-party applications. In addition, they provide several services for building customized administration interfaces that manipulate directory data.
- Oracle Directory Integration Services facilitate the development and deployment of custom solutions for synchronizing Oracle Internet Directory with third-party directories and other user repositories.

- Oracle Provisioning Integration Services provide a mechanism for provisioning third-party applications, and a means of integrating the Oracle environment with other provisioning systems.
- Oracle Single Sign-On provides APIs for developing and deploying partner applications that share a single sign-on session with other Oracle Web applications.
- JAZN is the Oracle implementation of the Java Authentication and Authorization Service (JAAS) Support standard. JAZN allows applications developed for the Web using the Oracle J2EE environment to use the identity management infrastructure for authentication and authorization.

---

**Note:** Oracle Fusion Middleware 11g Release 1 (11.1.1) does not include Oracle Single Sign-On or Oracle Delegated Administration Services. Oracle Internet Directory 11g Release 1 (11.1.1), however, is compatible with Oracle Single Sign-On and Oracle Delegated Administration Services 10g (10.1.4.3.0) or later.

---

## 1.2 Integrating Existing Applications with Oracle Identity Management

For new applications, use Oracle Platform Security for Java, which is documented in the *Fusion Middleware Security Guide*.

An enterprise may have already deployed certain applications to perform critical business functions. Oracle Identity Management provides the following services that can be leveraged by the deployment to modify existing applications:

- **Automated User Provisioning:** The deployment can develop a custom provisioning agent that automates the provisioning of users in the existing application in response to provisioning events in the Oracle Identity Management infrastructure. This agent must be developed using the interfaces of Oracle Provisioning Integration Service.

**See Also:** *Oracle Fusion Middleware Administrator's Guide for Oracle Internet Directory* for more information about developing automated user provisioning.

- **User Authentication Services:** If the user interface of the existing application is based on HTTP, integrating it with Oracle HTTP Server and protecting its URL using `mod_ossso` authenticates all incoming user requests using the Oracle Single Sign-On service.
- **Centralized User Profile Management:** If the user interface of the existing application is based on HTTP, and it is integrated with Oracle Single Sign-On for authentication, the application can use the self-service console of Oracle Delegated Administration Services to enable centralized user profile management. The self-service console can be customized by the deployment to address the specific needs of the application.

## 1.3 Oracle Identity Management Programming: An Overview

This section introduces you to the Oracle Identity Management Software Developer's Kit. It provides an overview of how an application can use the kit to integrate with the directory. You are also acquainted with the rest of the directory product suite.

The section contains these topics:

- Section 1.3.1, "Programming Languages Supported by the Oracle Internet Directory SDK"
- Section 1.3.2, "Oracle Identity Management SDK Components"
- Section 1.3.3, "Application Development in the Oracle Identity Management Environment"

### 1.3.1 Programming Languages Supported by the Oracle Internet Directory SDK

The SDK is for application developers who use C, C++, and PL/SQL. Java developers must use the JNDI provider to integrate with the directory.

### 1.3.2 Oracle Identity Management SDK Components

The Oracle Identity Management Software Developer's Kit 11g Release 1 (11.1.1) consists of the following:

- A C API compliant with LDAP Version 3
- A PL/SQL API contained in a PL/SQL package called `DBMS_LDAP`
- *Oracle Identity Management Application Developer's Guide* (this document)
- Command-line tools

### 1.3.3 Application Development in the Oracle Identity Management Environment

This section contains these topics:

- Section 1.3.3.1, "Architecture of an Oracle Identity Management Application"
- Section 1.3.3.2, "Oracle Identity Management Interactions During the Application Life Cycle"
- Section 1.3.3.3, "Services and APIs for Integrating Applications with Oracle Identity Management"
- Section 1.3.3.4, "Integrating Existing Applications with Oracle Identity Management"

#### 1.3.3.1 Architecture of an Oracle Identity Management Application

Most Oracle Identity Management applications are back-end programs that simultaneously handle multiple requests from multiple users. [Figure 1–1](#) shows how a directory is used by such applications.

**Figure 1-1 A Directory-Enabled Application**

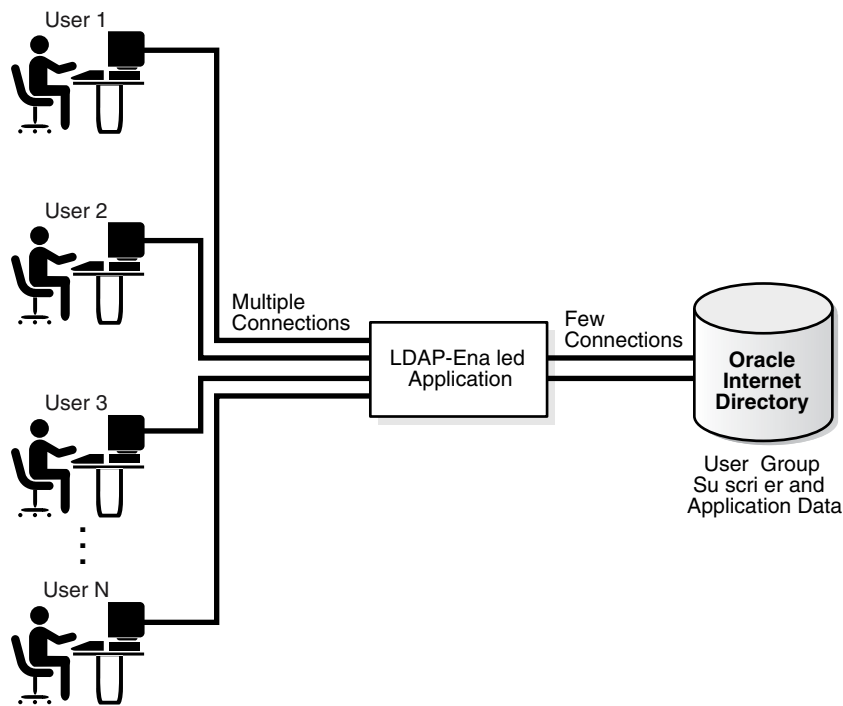

As Figure 1-1 shows, when a user request involves an LDAP-enabled operation, the application processes the request using a smaller set of pre-created directory connections.

### 1.3.3.2 Oracle Identity Management Interactions During the Application Life Cycle

Table 1-1 on page 1-4 walks you through the directory operations that an application typically performs during its lifecycle.

**Table 1-1 Interactions During Application Lifecycle**

Point in Application Lifecycle	Logic
Application Installation	<ol style="list-style-type: none"> <li>1. Create an application identity in the directory. The application uses this identity to perform most of its LDAP operations.</li> <li>2. Give the application identity LDAP authorizations by making it part of the correct LDAP groups. These authorizations enable the application to accept user credentials and authenticate them against the directory. The directory can also use application authorizations to proxy for the user when LDAP operations must be performed on the user's behalf.</li> </ol>
Application Startup and Bootstrap	<p>The application must retrieve credentials that enable it to authenticate itself to the directory.</p> <p>If the application stores configuration metadata in Oracle Internet Directory, it can retrieve that metadata and initialize other parts of the application.</p> <p>The application can then establish a pool of connections to serve user requests.</p>

**Table 1–1 (Cont.) Interactions During Application Lifecycle**

Point in Application Lifecycle	Logic
Application Runtime	<p>For every end-user request that needs an LDAP operation, the application can:</p> <ul style="list-style-type: none"> <li>▪ Pick a connection from the pool of LDAP connections.</li> <li>▪ Switch the user to the end-user identity if the LDAP operation must be performed with the effective rights of the end-user.</li> <li>▪ Perform the LDAP operation by using either the regular API or the API enhancements described in this chapter.</li> <li>▪ Ensure that the effective user is now the application identity when the LDAP operation is complete.</li> <li>▪ Return the LDAP connection back to the pool of connections.</li> </ul>
Application Shutdown	Abandon any outstanding LDAP operations and close all LDAP connections.
Application Deinstallation	Remove the application identity and the LDAP authorizations granted to it.

### 1.3.3.3 Services and APIs for Integrating Applications with Oracle Identity Management

Application developers can integrate with Oracle Identity Management by using the services and APIs listed and described in [Table 1–2](#) on page 1-5.

**Table 1–2 Services and APIs for Integrating with Oracle Internet Directory**

Service/API	Description	More Information
Standard LDAP APIs in C, PL/SQL and Java	These provide basic LDAP operations. The standard LDAP API used in Java is the JNDI API with the LDAP service provider.	<a href="#">Chapter 2, "Developing Applications with Standard LDAP APIs"</a>
Oracle Extensions to Standard C, PL/SQL and Java APIs	These APIs provide programmatic interfaces that model various concepts related to identity management.	<a href="#">Chapter 4, "Developing Applications With Oracle Extensions to the Standard APIs"</a>
Oracle Delegated Administration Services	Oracle Delegated Administration Services consists of a self-service console and administrative interfaces. You can modify the administrative interfaces to support third-party applications.	The 10g (10.1.4.0.1) Library.
Oracle Directory Provisioning Integration Service	You can use the Oracle Provisioning Integration System to provision third-party applications and integrate other provisioning systems.	<ul style="list-style-type: none"> <li>▪ <a href="#">Chapter 7, "Developing Provisioning-Integrated Applications"</a></li> <li>▪ <i>Oracle Fusion Middleware Administrator's Guide for Oracle Directory Integration Platform</i></li> </ul>

[Figure 1–2](#) shows an application leveraging some of the services illustrated in [Table 1–2](#) on page 1-5.

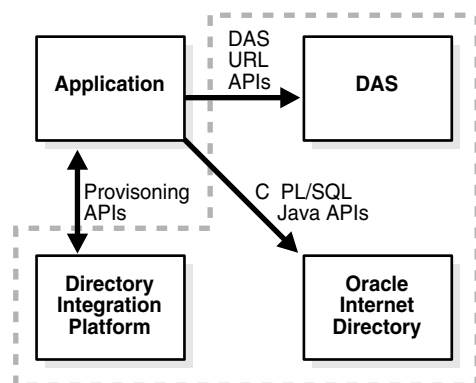
**Figure 1–2 An Application Leveraging APIs and Services**

As [Figure 1–2](#) shows, the application integrates with Oracle Internet Directory as follows:

- Using PL/SQL, C, or Java APIs, it performs LDAP operations directly against the directory.
- In some cases, it directs users to self-service features of Oracle Delegated Administration Services.
- It is notified of changes to entries for users or groups in Oracle Internet Directory. The Oracle Directory Provisioning Integration Service provides this notification.

### 1.3.3.4 Integrating Existing Applications with Oracle Identity Management

Your enterprise may already have deployed applications that you may have wanted to integrate with the Oracle identity management infrastructure. You can integrate these applications using the services presented in [Table 1–3](#).

**Table 1–3 Services for Modifying Existing Applications**

Service	Description	More Information
Automated User Provisioning	You can develop an agent that automatically provisions users when provisioning events occur in the Oracle identity management infrastructure. You use interfaces of the Oracle Directory Provisioning Integration Service to develop this agent.	<a href="#">Chapter 7, "Developing Provisioning-Integrated Applications"</a>
User Authentication Services	If your user interface is based on HTTP, you can integrate it with the Oracle HTTP Server. This enables you to use <code>mod_osso</code> and OracleAS Single Sign-On to protect the application URL.	<i>Oracle Application Server Single Sign-On Administrator's Guide</i>
Centralized User Profile Management	If your user interface is based on HTTP and is integrated with OracleAS Single Sign-On, you can use the Oracle Internet Directory Self-Service Console to manage user profiles centrally. You can tailor the console to the needs of your application.	<ul style="list-style-type: none"> <li>■ The 10g (10.1.4.0.1) library.</li> <li>■ The chapter about the delegated administration services framework in <i>Oracle Identity Management Guide to Delegated Administration</i>.</li> </ul>



---

---

# Developing Applications with Standard LDAP APIs

This chapter provides an overview of the operations that the standard LDAP API enables, including how to integrate your applications with the API.

This chapter includes the following sections:

- Section 2.1, "History of LDAP"
- Section 2.2, "LDAP Models"
- Section 2.3, "About the Standard LDAP APIs"
- Section 2.4, "Initializing an LDAP Session"
- Section 2.5, "Authenticating an LDAP Session"
- Section 2.6, "Searching the Directory"
- Section 2.7, "Terminating the Session"

## 2.1 History of LDAP

LDAP began as a lightweight front end to the X.500 Directory Access Protocol. LDAP simplifies the X.500 Directory Access Protocol in the following ways:

- It uses TCP/IP connections. These are lightweight compared to the OSI communication stack required by X.500 implementations
- It eliminates little-used and redundant features of the X.500 Directory Access Protocol
- It uses simple formats to represent data elements. These formats are easier to process than the complicated and highly structured representations in X.500.
- It uses a simplified version of the X.500 encoding rules used to transport data over networks.

## 2.2 LDAP Models

LDAP uses four basic models to define its operations, described in the following sections:

- Section 2.2.1, "Naming Model"
- Section 2.2.2, "Information Model"
- Section 2.2.3, "Functional Model"

- Section 2.2.4, "Security Model"

## 2.2.1 Naming Model

The LDAP naming model enables directory information to be referenced and organized. Each entry in a directory is uniquely identified by a distinguished name (DN). The DN tells you exactly where an entry resides in the directory hierarchy. A directory information tree (DIT) is used to represent this hierarchy.

Figure 2–1 illustrates the relationship between a distinguished name and a directory information tree.

**Figure 2–1 A Directory Information Tree**

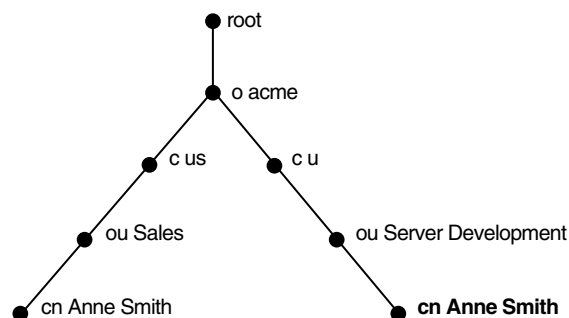

The DIT in Figure 2–1 shows entries for two employees of Example Corporation who are both named Anne Smith. It is structured along geographical and organizational lines. The Anne Smith represented by the left branch works in the Sales division in the United States. Her counterpart works in the Server Development division in the United Kingdom.

The Anne Smith represented by the right branch has the common name (cn) Anne Smith. She works in an organizational unit (ou) named Server Development, in the country (c) of United Kingdom of Great Britain and Northern Ireland (uk), in the organization (o) Example. The DN for this Anne Smith entry looks like this:

```
cn=Anne Smith,ou=Server Development,c=uk,o=example
```

Note that the conventional format for a distinguished name places the lowest DIT component at the left. The next highest component follows, on up to the root.

Within a distinguished name, the lowest component is called the relative distinguished name (RDN). In the DN just presented, the RDN is cn=Anne Smith. The RDN for the entry immediately above Anne Smith's RDN is ou=Server Development. And the RDN for the entry immediately above ou=Server Development is c=uk, and so on. A DN is thus a sequence of RDNs separated by commas.

To locate a particular entry within the overall DIT, a client uniquely identifies that entry by using the full DN—not simply the RDN—of that entry. To avoid confusion between the two Anne Smiths in the global organization depicted in Figure 2–1, you use the full DN for each. If there are two employees with the same name in the same organizational unit, you can use other mechanisms. You may, for example, use a unique identification number to identify these employees.

## 2.2.2 Information Model

The LDAP information model determines the form and character of information in the directory. This model uses the concept of entries as its defining characteristic. In a directory, an entry is a collection of information about an object. A telephone directory,

for example, contains entries for people. A library card catalog contains entries for books. An online directory may contain entries for employees, conference rooms, e-commerce partners, or shared network resources such as printers.

In a typical telephone directory, a person entry contains an address and a phone number. In an online directory, each of these pieces of information is called an attribute. A typical employee entry contains attributes for a job title, an e-mail address, and a phone number.

In [Figure 2-2](#), the entry for Anne Smith in Great Britain (uk) has several attributes. Each provides specific information about her. Those listed in the balloon to the right of the tree are `emailaddr`, `printername`, `jpegPhoto`, and `app preferences`. Note that the rest of the bullets in [Figure 2-2](#) are also entries with attributes, although these attributes are not shown.

**Figure 2-2 Attributes of the Entry for Anne Smith**

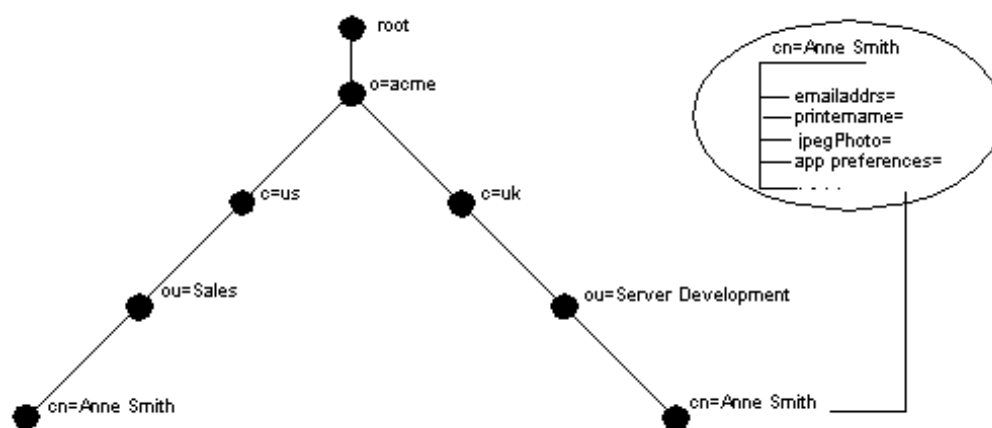

Each attribute consists of an attribute type and one or more attribute values. The attribute type is the kind of information that the attribute contains—`jobTitle`, for instance. The attribute value is the actual information. The value for the `jobTitle` attribute, for example, might be `manager`.

## 2.2.3 Functional Model

The LDAP functional model determines what operations can be performed on directory entries. [Table 2-1](#) on page 2-3 lists and describes the three types of functions:

**Table 2-1 LDAP Functions**

Function	Description
Search and read	The read operation retrieves the attributes of an entry whose name is known. The list operation enumerates the children of a given entry. The search operation selects entries from a defined area of the tree based on some selection criteria known as a search filter. For each matching entry, a requested set of attributes (with or without values) is returned. The searched entries can span a single entry, an entry's children, or an entire subtree. Alias entries can be followed automatically during a search, even if they cross server boundaries. An abandon operation is also defined, allowing an operation in progress to be canceled.

**Table 2–1 (Cont.) LDAP Functions**

Function	Description
Modify	<p>This category defines four operations that modify the directory:</p> <ul style="list-style-type: none"> <li>■ Modify—change existing entries. You can add and delete values.</li> <li>■ Add—insert entries into the directory</li> <li>■ Delete—remove entries from the directory</li> <li>■ Modify RDN—change the name of an entry</li> </ul>
Authenticate	<p>This category defines a bind operation. A bind enables a client to initiate a session and prove its identity to the directory. Oracle Internet Directory supports several authentication methods, from simple clear-text passwords to public keys. The unbind operation is used to terminate a directory session.</p>

## 2.2.4 Security Model

The LDAP security model enables directory information to be secured. This model has several parts:

- **Authentication**  
Ensuring that the identities of users, hosts, and clients are correctly validated
- **Access Control and Authorization**  
Ensuring that a user reads or updates only the information for which that user has privileges
- **Data Integrity**: Ensuring that data is not modified during transmission
- **Data Privacy**  
Ensuring that data is not disclosed during transmission
- **Password Policies**  
Setting rules that govern how passwords are used

### 2.2.4.1 Authentication

Authentication is the process by which the directory server establishes the identity of the user connecting to the directory. Directory authentication occurs when an LDAP bind operation establishes an LDAP session. Every session has an associated user identity, also referred to as an authorization ID.

Oracle Internet Directory provides three authentication options: anonymous, simple, and SSL.

**2.2.4.1.1 Anonymous Authentication** If your directory is available to everyone, users may log in anonymously. In anonymous authentication, users leave the user name and password fields blank when they log in. They then exercise whatever privileges are specified for anonymous users.

**2.2.4.1.2 Simple Authentication** In simple authentication, the client uses an unencrypted DN and password to identify itself to the server. The server verifies that the client's DN and password match the DN and password stored in the directory.

**2.2.4.1.3 Authentication Using Secure Sockets Layer (SSL)** Secure Sockets Layer (SSL) is an industry standard protocol for securing network connections. It uses a certificate exchange to authenticate users. These certificates are verified by trusted certificate authorities. A certificate ensures that an entity's identity information is correct. An entity can be an end user, a database, an administrator, a client, or a server. A Certificate Authority (CA) is an application that creates public key certificates that are given a high level of trust by all parties involved.

You can use SSL in one of the three authentication modes presented in [Table 2–2](#).

**Table 2–2 SSL Authentication Modes**

SSL Mode	Description
No authentication	Neither the client nor the server authenticates itself to the other. No certificates are sent or exchanged. In this case, only SSL encryption and decryption are used.
One-way authentication	Only the directory server authenticates itself to the client. The directory server sends the client a certificate verifying that the server is authentic.
Two-way authentication	Both client and server authenticate themselves to each other, exchanging certificates.

In an Oracle Internet Directory environment, SSL authentication between a client and a directory server involves three basic steps:

1. The user initiates an LDAP connection to the directory server by using SSL on an SSL port. The default SSL port is 3131.
2. SSL performs the handshake between the client and the directory server.
3. If the handshake is successful, the directory server verifies that the user has the appropriate authorization to access the directory.

**See Also:** *Oracle Advanced Security Administrator's Guide* for more information about SSL.

### 2.2.4.2 Access Control and Authorization

The authorization process ensures that a user reads or updates only the information for which he or she has privileges. The directory server ensures that the user—identified by the authorization ID associated with the session—has the requisite permissions to perform a given directory operation. Absent these permissions, the operation is disallowed.

The mechanism that the directory server uses to ensure that the proper authorizations are in place is called access control. And an access control item (ACI) is the directory metadata that captures the administrative policies relating to access control.

An ACI is stored in Oracle Internet Directory as user-modifiable operational attributes. Typically a whole list of these ACI attribute values is associated with a directory object. This list is called an access control list (ACL). The attribute values on that list govern the access policies for the directory object.

ACIs are stored as text strings in the directory. These strings must conform to a well-defined format. Each valid value of an ACI attribute represents a distinct access control policy. These individual policy components are referred to as ACI Directives or ACIs and their format is called the ACI Directive format.

Access control policies can be prescriptive: their security directives can be set to apply downward to all entries at lower positions in the directory information tree (DIT). The

point from which an access control policy applies is called an access control policy point (ACP).

#### **2.2.4.3 Data Integrity**

Oracle Internet Directory uses SSL to ensure that data is not modified, deleted, or replayed during transmission. This feature uses cryptographic checksums to generate a secure message digest. The checksums are created using either the MD5 algorithm or the Secure Hash Algorithm (SHA). The message digest is included in each network packet.

#### **2.2.4.4 Data Privacy**

Oracle Internet Directory uses public key encryption over SSL to ensure that data is not disclosed during transmission. In public-key encryption, the sender of a message encrypts the message with the public key of the recipient. Upon delivery, the recipient decrypts the message using his or her private key. The directory supports two levels of encryption:

- **DES40**

The DES40 algorithm, available internationally, is a DES variant in which the secret key is preprocessed to provide forty effective key bits. It is designed for use by customers outside the USA and Canada who want to use a DES-based encryption algorithm.

- **RC4\_40**

Oracle is licensed to export the RC4 data encryption algorithm with a 40-bit key size to virtually all destinations where Oracle products are available. This makes it possible for international corporations to safeguard their entire operations with fast cryptography.

#### **2.2.4.5 Password Policies**

A password policy is a set of rules that govern how passwords are used. When a user attempts to bind to the directory, the directory server uses the password policy to ensure that the password provided meets the various requirements set in that policy.

When you establish a password policy, you set the following types of rules, to mention just a few:

- The maximum length of time a given password is valid
- The minimum number of characters a password must contain
- The ability of users to change their passwords

## **2.3 About the Standard LDAP APIs**

The standard LDAP APIs enable you to perform the fundamental LDAP operations described in "[LDAP Models](#)". These APIs are available in C, PL/SQL, and Java. The first two are part of the directory SDK. The last is part of the JNDI package. All three use TCP/IP connections. They are based on LDAP Version 3, and they support SSL connections to Oracle Internet Directory.

This section contains these topics:

- [Section 2.3.1, "API Usage Model"](#)
- [Section 2.3.2, "Getting Started with the C API"](#)

- [Section 2.3.4, "Getting Started with the Java API"](#)
- [Section 2.3.3, "Getting Started with the DBMS\\_LDAP Package"](#)

### 2.3.1 API Usage Model

Typically, an application uses the functions in the API in four steps:

1. Initialize the library and obtain an LDAP session handle.
2. Authenticate to the LDAP server if necessary.
3. Perform some LDAP operations and obtain results and errors, if any.
4. Close the session.

[Figure 2–3](#) illustrates these steps.

**Figure 2–3 Steps in Typical DBMS\_LDAP Usage**

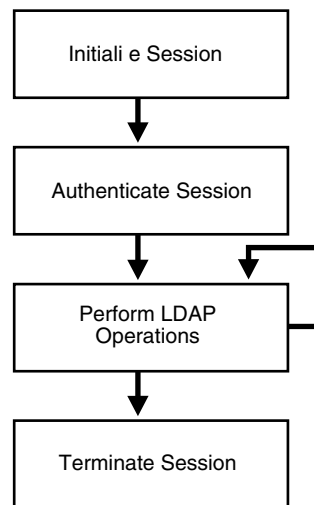

### 2.3.2 Getting Started with the C API

When you build applications with the C API, you must include the header file `ldap.h`, located at `$ORACLE_HOME/ldap/public`. In addition, you must dynamically link to the library located at `$ORACLE_HOME/lib/libclntsh.so.10.1`.

**See Also:** [Section 8.3, "Sample C API Usage"](#) to learn how to use the SSL and non-SSL modes.

### 2.3.3 Getting Started with the DBMS\_LDAP Package

The `DBMS_LDAP` package enables PL/SQL applications to access data located in enterprise-wide LDAP servers. The names and syntax of the function calls are similar to those of the C API. These functions comply with current recommendations of the Internet Engineering Task Force (IETF) for the C API. Note though that the PL/SQL API contains only a subset of the functions available in the C API. Most notably, only synchronous calls to the LDAP server are available in the PL/SQL API.

To begin using the PL/SQL LDAP API, use this command sequence to load `DBMS_LDAP` into the database:

1. Log in to the database, using SQL\*Plus. Run the tool in the Oracle home in which your database is present. Connect as SYSDBA.

```
SQL> CONNECT / AS SYSDBA
```

2. Load the API into the database, using this command:

```
SQL> @?/rdbs/admin/catldap.sql
```

### 2.3.4 Getting Started with the Java API

Java developers can use the Java Naming and Directory Interface (JNDI) to gain access to information in Oracle Internet Directory. The JNDI is found at this link:

<http://www.oracle.com/technetwork/java/jndi/index.html>

Although no Java APIs are provided in this chapter, [Section 2.4.3, "Initializing the Session by Using JNDI"](#) shows you how to use wrapper methods for the JNDI to establish a basic connection.

## 2.4 Initializing an LDAP Session

All LDAP operations based on the C API require clients to establish an LDAP session with the LDAP server. For LDAP operations based on the PL/SQL API, a database session must first initialize and open an LDAP session. Most Java operations require a Java Naming and Directory Interface (JNDI) connection. The `oracle.ldap.util.jndi` package, provided here, simplifies the work involved in achieving this connection.

The section contains the following topics:

- [Section 2.4.1, "Initializing the Session by Using the C API"](#)
- [Section 2.4.2, "Initializing the Session by Using DBMS\\_LDAP"](#)
- [Section 2.4.3, "Initializing the Session by Using JNDI"](#)

### 2.4.1 Initializing the Session by Using the C API

The C function `ldap_init()` initializes a session with an LDAP server. The server is not actually contacted until an operation is performed that requires it, allowing options to be set after initialization.

`ldap_init` has the following syntax:

```
LDAP *ldap_init
(
  const char      *hostname,
  int             portno
);
```

[Table 2–3](#) lists and defines the function parameters.



**Table 2–3 Parameters for ldap\_init()**

Parameter	Description
hostname	<p>Contains a space-separated list of directory host names or IP addresses represented by dotted strings. You can pair each host name with a port number if you use a colon to separate the two.</p> <p>The hosts are tried in the order listed until a successful connection is made.</p> <p>Note: A suitable representation for including a literal IPv6[10] address in the host name parameter is desired, but has not yet been determined or implemented in practice.</p>
portno	<p>Contains the TCP port number of the directory you would like to connect to. The default LDAP port of 3060 can be obtained by supplying the constant LDAP_PORT. If a host includes a port number, this parameter is ignored.</p>

ldap\_init() and ldap\_open() both return a session handle, or pointer, to an opaque structure that must be passed to subsequent calls to the session. These routines return NULL if the session cannot be initialized. You can check the error reporting mechanism for your operating system to determine why the call failed.

## 2.4.2 Initializing the Session by Using DBMS\_LDAP

In the PL/SQL API, the function DBMS\_LDAP.init() initiates an LDAP session. This function has the following syntax:

```
FUNCTION init (hostname IN VARCHAR2, portnum IN PLS_INTEGER )
RETURN SESSION;
```

The function init requires a valid host name and port number to establish an LDAP session. It allocates a data structure for this purpose and returns a handle of the type DBMS\_LDAP.SESSION to the caller. The handle returned from the call should be used in all subsequent LDAP operations defined by DBMS\_LDAP for the session. The API uses these session handles to maintain state about open connections, outstanding requests, and other information.

A single database session can obtain as many LDAP sessions as required, although the number of simultaneous active connections is limited to 64. One database session typically has multiple LDAP sessions when data must be obtained from multiple servers simultaneously or when open sessions that use multiple LDAP identities are required.

---

**Note:** The handles returned from calls to DBMS\_LDAP.init() are dynamic constructs. They do not persist across multiple database sessions. Attempting to store their values in a persistent form, and to reuse stored values at a later stage, can yield unpredictable results.

---

## 2.4.3 Initializing the Session by Using JNDI

The oracle.ldap.util.jndi package supports basic connections by providing wrapper methods for the JNDI implementation. If you want to use the JNDI to establish a connection, see the following link:

<http://www.oracle.com/technetwork/java/jndi/index.html>

Here is an implementation of oracle.ldap.util.jndi that establishes a non-SSL connection:

```
import oracle.ldap.util.jndi
import javax.naming.*;

public static void main(String args[])
{
    try{
        InitialDirContext ctx = ConnectionUtil.getDefaultDirCtx(args[0], // host
                                                                args[1], // port
                                                                args[2], // DN
                                                                args[3]; // password)

        // Do work
    }
    catch(NamingException ne)
    {
        // javax.naming.NamingException is thrown when an error occurs
    }
}
```

---

**Note:**

- *DN* and *password* represent the bind DN and password. For anonymous binds, set these to "".
  - You can use `ConnectionUtil.getSSLDirCtx()` to establish a no-authentication SSL connection.
- 

## 2.5 Authenticating an LDAP Session

Individuals or applications seeking to perform operations against an LDAP server must first be authenticated. If the `dn` and `passwd` parameters of these entities are null, the LDAP server assigns a special identity, called anonymous, to these users. Typically, the anonymous user is the least privileged user of the directory.

When a bind operation is complete, the directory server remembers the new identity until another bind occurs or the LDAP session terminates (`unbind_s`). The LDAP server uses the identity to enforce the security model specified by the enterprise in which it is deployed. The identity helps the LDAP server determine whether the user or application identified has sufficient privileges to perform search, update, or compare operations in the directory.

Note that the password for the bind operation is sent over the network in clear text. If your network is not secure, consider using SSL for authentication and other LDAP operations that involve data transfer.

This section contains these topics:

- [Section 2.5.1, "Authenticating an LDAP Session by Using the C API"](#)
- [Section 2.5.2, "Authenticating an LDAP Session by Using DBMS\\_LDAP"](#)

### 2.5.1 Authenticating an LDAP Session by Using the C API

The C function `ldap_simple_bind_s()` enables users and applications to authenticate to the directory server using a DN and password.

The function `ldap_simple_bind_s()` has this syntax:

```
int ldap_simple_bind_s
(
    LDAP* ld,
```

```
char* dn,
char* passwd
);
```

Table 2–4 lists and describes the parameters for this function.

**Table 2–4 Arguments for `ldap_simple_bind_s()`**

Argument	Description
ld	A valid LDAP session handle
dn	The identity that the application uses for authentication
passwd	The password for the authentication identity

If the `dn` and `passwd` parameters for are `NULL`, the LDAP server assigns a special identity, called `anonymous`, to the user or application.

## 2.5.2 Authenticating an LDAP Session by Using `DBMS_LDAP`

The PL/SQL function `simple_bind_s` enables users and applications to use a DN and password to authenticate to the directory. `simple_bind_s` has this syntax:

```
FUNCTION simple_bind_s ( ld IN SESSION, dn IN VARCHAR2, passwd IN VARCHAR2)
RETURN PLS_INTEGER;
```

Note that this function requires as its first parameter the LDAP session handle obtained from `init`.

The following PL/SQL code snippet shows how the PL/SQL initialization and authentication functions just described might be implemented.

```
DECLARE
retval PLS_INTEGER;
my_session DBMS_LDAP.session;
BEGIN
retval:= -1;
-- Initialize the LDAP session
my_session:= DBMS_LDAP.init('yow.example.com',3060);
--Authenticate to the directory
retval:=DBMS_LDAP.simple_bind_s(my_session,'cn=orcladmin', 'welcome');
```

In the previous example, an LDAP session is initialized on the LDAP server `yow.example.com`. This server listens for requests at TCP/IP port number 3060. The identity `cn=orcladmin`, whose password is `welcome`, is then authenticated. After authentication is complete, regular LDAP operations can begin.

## 2.6 Searching the Directory

Searches are the most common LDAP operations. Applications can use complex search criteria to select and retrieve entries from the directory.

This section contains these topics:

- Section 2.6.1, "Program Flow for Search Operations"
- Section 2.6.2, "Search Scope"
- Section 2.6.3, "Filters"
- Section 2.6.4, "Searching the Directory by Using the C API"
- Section 2.6.5, "Searching the Directory by Using `DBMS_LDAP`"

---

---

**Note:** This release of the DBMS\_LDAP API provides only synchronous search capability. This means that the caller of the search functions is blocked until the LDAP server returns the entire result set.

---

---

## 2.6.1 Program Flow for Search Operations

The programming required to initiate a typical search operation and retrieve results can be broken down into the following steps:

1. Decide what attributes must be returned; then place them into an array.
2. Initiate the search, using the scope options and filters of your choice.
3. Obtain an entry from result set.
4. Obtain an attribute from the entry obtained in step 3.
5. Obtain the values of the attributes obtained in step 4; then copy these values into local variables.
6. Repeat step 4 until all attributes of the entry are examined.
7. Repeat Step 3 until there are no more entries

Figure 2–4 on page 2-13 uses a flowchart to represent these steps.

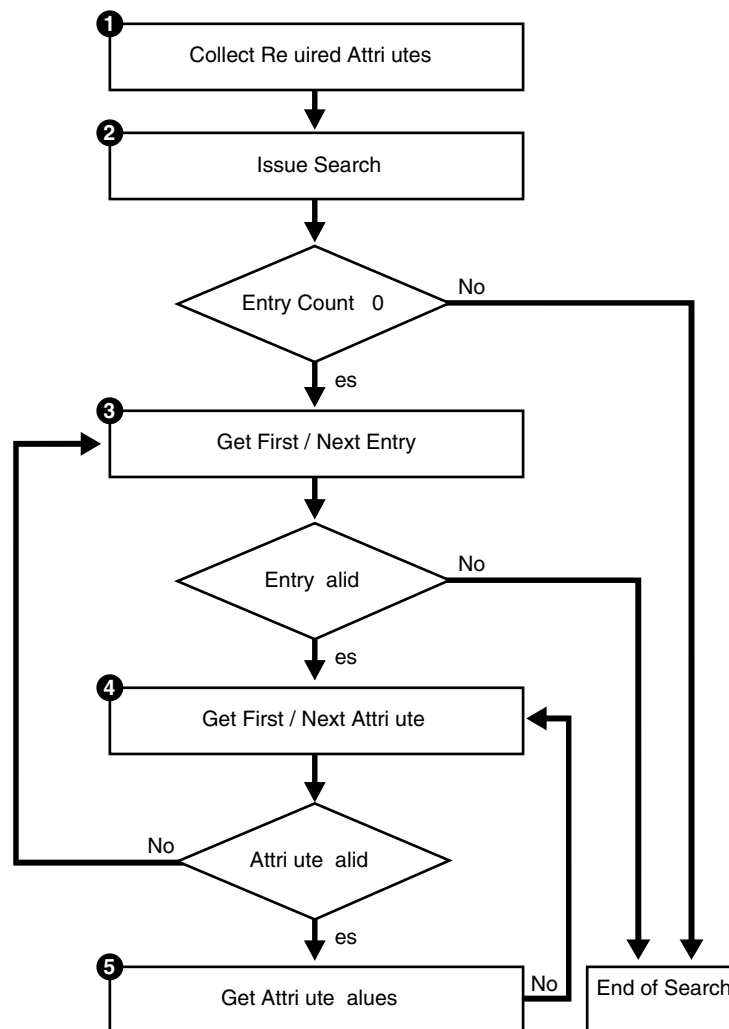
**Figure 2-4** Flow of Search-Related Operations

## 2.6.2 Search Scope

The scope of a search determines how many entries the directory server examines relative to the search base. You can choose one of the three options described in [Table 2-5](#) and illustrated in [Figure 2-5](#) on page 2-14.

**Table 2-5** Options for `search_s()` or `search_st()` Functions

Option	Description
SCOPE_BASE	The directory server looks only for the entry corresponding to the search base.
SCOPE_ONELEVEL	The directory server confines its search to the entries that are the immediate children of the search base entry.
SCOPE_SUBTREE	The directory server looks at the search base entry and the entire subtree beneath it.

**Figure 2-5 The Three Scope Options**

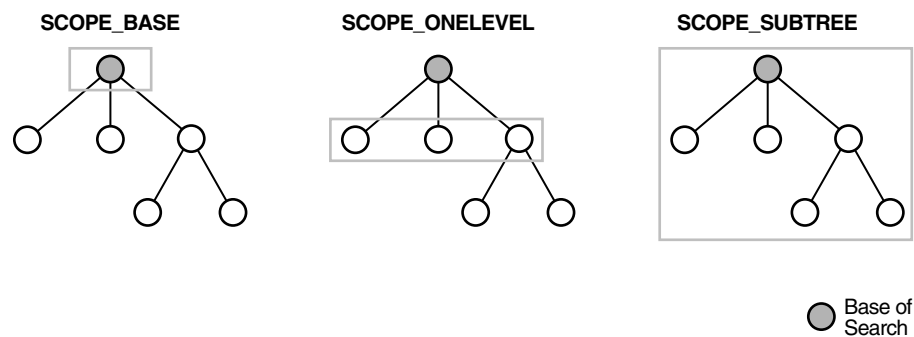

In Figure 2-5, the search base is the shaded circle. The shaded rectangle identifies the entries that are searched.

### 2.6.3 Filters

A search filter is an expression that enables you to confine your search to certain types of entries. The search filter required by the `search_s()` and `search_st()` functions follows the string format defined in RFC 1960 of the Internet Engineering Task Force (IETF). As Table 2-6 shows, there are six kinds of search filters. These are entered in the format *attribute operator value*.

**Table 2-6 Search Filters**

Filter Type	Format	Example	Matches
Equality	(att=value)	(sn=Keaton)	Surnames exactly equal to Keaton.
Approximate	(att~=value)	(sn~=Ketan)	Surnames approximately equal to Ketan.
Substring	(attr=[leading]*[any]*[trailing])	(sn=*keaton*)	Surnames containing the string keaton.
		(sn=keaton*)	Surnames starting with keaton.
		(sn=*keaton)	Surnames ending with keaton.
		(sn=ke*at*on)	Surnames starting with ke, containing at and ending with on.
Greater than or equal	attr>=value	(sn>=Keaton)	Surnames lexicographically greater than or equal to Keaton.
Less than or equal	(attr<=value)	(sn<=Keaton)	Surnames lexicographically less than or equal to Keaton.
Presence	(attr=*)	(sn=*)	All entries having the sn attribute.
Extensible	attr[:dn]:=value	(sn:dn:=Mary Smith)	All entries with a surname attribute in the entry or in the DN of the entry matching "Mary Smith".

**Note:**

- While Oracle Internet Directory supports extensible filters, `ldapsearch` and the Oracle LDAP API do not. You must use a different API, such as JNDI, to use this type of filter.
- Oracle Internet Directory does not support extensible matching using matching rules specified in the filter.

You can use boolean operators and prefix notation to combine these filters to form more complex filters. Table 2-7 on page 2-15 provides examples. In these examples, the `&` character represents AND, the `|` character represents OR, and the `!` character represents NOT.

**Table 2-7 Boolean Operators**

Filter Type	Format	Example	Matches
AND	<code>(&amp;(filter1)(filter2)). . .)</code>	<code>(&amp;(sn=keaton)(objectclass=inetOrgPerson))</code>	Entries with surname of Keaton and object class of InetOrgPerson.
OR	<code>( (filter1)(filter2)). . .)</code>	<code>( (sn~=ketan)(cn=*keaton))</code>	Entries with surname approximately equal to ketan or common name ending in keaton.
NOT	<code>(!(filter))</code>	<code>(!(mail=*))</code>	Entries without a mail attribute.

The complex filters in Table 2-7 can themselves be combined to create even more complex, nested filters.

**See Also:**

- The LDAP Filter Definition appendix in *Oracle Fusion Middleware Administrator's Guide for Oracle Internet Directory*
  - RFC 2254 at: <http://www.ietf.org>
- for more information about LDAP filters.

## 2.6.4 Searching the Directory by Using the C API

The C function `ldap_search_s()` performs a synchronous search of the directory.

The syntax for `ldap_search_s()` looks like this:

```
int ldap_search_s
(
    LDAP*      ld,
    char*      base,
    int        scope,
    char*      filter,
    int        attrsonly,
    LDAPMessage** res
);
```

`ldap_search_s` works with several supporting functions to refine the search. The steps that follow show how all of these C functions fit into the program flow of a search operation. [Chapter 8, "C API Reference"](#), examines all of these functions in depth.

1. Decide what attributes must be returned; then place them into an array of strings. The array must be null terminated.
2. Initiate the search, using `ldap_search_s()`. Refine your search with scope options and filters.
3. Obtain an entry from the result set, using either the `ldap_first_entry()` function or the `ldap_next_entry()` function.
4. Obtain an attribute from the entry obtained in step 3. Use either the `ldap_first_attribute()` function or the `ldap_next_attribute()` function for this purpose.
5. Obtain all the values for the attribute obtained in step 4; then copy these values into local variables. Use the `ldap_get_values()` function or the `ldap_get_values_len()` function for this purpose.
6. Repeat step 4 until all attributes of the entry are examined.
7. Repeat step 3 until there are no more entries.

**Table 2–8 Arguments for `ldap_search_s()`**

Argument	Description
<code>ld</code>	A valid LDAP session handle
<code>base</code>	The DN of the search base.
<code>scope</code>	The breadth and depth of the DIT to be searched.
<code>filter</code>	The filter used to select entries of interest.
<code>attrs</code>	The attributes of interest in the entries returned.
<code>attrso</code>	If set to 1, only returns attributes.
<code>res</code>	This argument returns the search results.

## 2.6.5 Searching the Directory by Using `DBMS_LDAP`

You use the function `DBMS_LDAP.search_s()` to perform directory searches if you use the PL/SQL API.

Here is the syntax for `DBMS_LDAP.search_s()`:

```
FUNCTION search_s
(
  ld      IN  SESSION,
  base    IN  VARCHAR2,
  scope   IN  PLS_INTEGER,
  filter  IN  VARCHAR2,
  attrs   IN  STRING_COLLECTION,
  attronly IN PLS_INTEGER,
  res     OUT MESSAGE
)
RETURN PLS_INTEGER;
```

The function takes the arguments listed and described in [Table 2–9](#) on page 2-16.



**Table 2–9 Arguments for `DBMS_LDAP.search_s()` and `DBMS_LDAP.search_st()`**

Argument	Description
<code>ld</code>	A valid session handle
<code>base</code>	The DN of the base entry in the LDAP server where search should start
<code>scope</code>	The breadth and depth of the DIT that must be searched
<code>filter</code>	The filter used to select entries of interest
<code>attrs</code>	The attributes of interest in the entries returned
<code>attronly</code>	If set to 1, only returns the attributes
<code>res</code>	An <code>OUT</code> parameter that returns the result set for further processing

`search_s` works with several supporting functions to refine the search. The steps that follow show how all of these PL/SQL functions fit into the program flow of a search operation.

1. Decide what attributes need to be returned; then place them into the `DBMS_LDAP.STRING_COLLECTION` data-type.
2. Perform the search, using either `DBMS_LDAP.search_s()` or `DBMS_LDAP.search_st()`. Refine your search with scope options and filters.
3. Obtain an entry from the result set, using either `DBMS_LDAP.first_entry()` or `DBMS_LDAP.next_entry()`.
4. Obtain an attribute from the entry obtained in step 3. Use either `DBMS_LDAP.first_attribute()` or `DBMS_LDAP.next_attribute()` for this purpose.
5. Obtain all the values for the attribute obtained in step 4; then copy these values into local variables. Use either `DBMS_LDAP.get_values()` or `DBMS_LDAP.get_values_len()` for this purpose.
6. Repeat step 4 until all attributes of the entry are examined.
7. Repeat step 3 until there are no more entries.

## 2.7 Terminating the Session

This section contains these topics:

- [Section 2.7.1, "Terminating the Session by Using the C API"](#)
- [Section 2.7.2, "Terminating the Session by Using `DBMS\_LDAP`"](#)

### 2.7.1 Terminating the Session by Using the C API

After an LDAP session handle is obtained and all directory-related work is complete, the LDAP session must be destroyed. In the C API, the `ldap_unbind_s()` function is used for this purpose.

`ldap_unbind_s()` has this syntax:

```
int ldap_unbind_s
(
LDAP* ld
);
```

A successful call to `ldap_unbind_s()` closes the TCP/IP connection to the directory. It de-allocates system resources consumed by the LDAP session. Finally it returns the integer `LDAP_SUCCESS` to its callers. After `ldap_unbind_s()` is invoked, no other LDAP operations are possible. A new session must be started with `ldap_init()`.

## 2.7.2 Terminating the Session by Using DBMS\_LDAP

The `DBMS_LDAP.unbind_s()` function destroys an LDAP session if the PL/SQL API is used. `unbind_s` has the following syntax:

```
FUNCTION unbind_s (ld IN SESSION ) RETURN PLS_INTEGER;
```

`unbind_s` closes the TCP/IP connection to the directory. It de-allocates system resources consumed by the LDAP session. Finally it returns the integer `DBMS_LDAP.SUCCESS` to its callers. After the `unbind_s` is invoked, no other LDAP operations are possible. A new session must be initiated with the `init` function.

---

---

## Extensions to the LDAP Protocol

This chapter describes extensions to the LDAP protocol that are available in Oracle Internet Directory 11g Release 1 (11.1.1).

This chapter includes the following sections:

- Section 3.1, "SASL Authentication"
- Section 3.2, "Using Controls"
- Section 3.3, "Proxying on Behalf of End Users"
- Section 3.4, "Creating Dynamic Password Verifiers"
- Section 3.5, "Performing Hierarchical Searches"
- Section 3.6, "Sorted LDAP Search Results"
- Section 3.7, "Paged LDAP Search Results"
- Section 3.8, "Password Policies"

### 3.1 SASL Authentication

Oracle Internet Directory supports two mechanisms for SASL-based authentication. This section describes the two methods. It contains these topics:

- SASL Authentication by Using the DIGEST-MD5 Mechanism
- SASL Authentication by Using External Mechanism

#### 3.1.1 SASL Authentication by Using DIGEST-MD5

SASL Digest-MD5 authentication is the required authentication mechanism for LDAP Version 3 servers (RFC 2829). LDAP Version 2 does not support Digest-MD5.

To use the Digest-MD5 authentication mechanism, you can use either the Java API or the C API to set up the authentication. The C API supports only `auth` mode.

**See Also:**

- Java-specific information in Section 5.12, "Using DIGEST-MD5 to Perform SASL Authentication" and Section 5.13, "Example: Using SASL Digest-MD5 `auth-int` and `auth-conf` Modes."
- C-specific information in Section 8.2.5, "Authenticating to the Directory" and Section 8.2.6, "SASL Authentication Using Oracle Extensions."

The SASL Digest-MD5 mechanism includes three modes, each representing a different security level or "Quality of Protection." They are:

- `auth`—Authentication only. Authentication is required only for the initial bind. After that, information is passed in clear text.
- `auth-int`—Authentication plus integrity. Authentication is required for the initial bind. After that, check sums are used to guarantee the integrity of the data.
- `auth-conf`—Authentication plus confidentiality. Authentication is required for the initial bind. After that, encryption is used to protect the data. Five cipher choices are available:
  - DES
  - 3DES
  - RC4
  - RC4-56
  - RC4-40

These are all symmetric encryption algorithms.

Prior to 10g (10.1.4.0.1), Oracle Internet Directory supported only the `auth` mode of the Digest-MD5 mechanism. As of 10g (10.1.4.0.1), Oracle Internet Directory supports all three modes with the Java Naming and Directory Interface (JNDI) of `jdk1.4` API or with the OpenLDAP Java API. The Oracle LDAP SDK supports only `auth` mode.

Out of the box, Oracle Internet Directory SASL Digest-MD5 authentication supports generation of static SASL Digest-MD5 verifiers based on user or password, but not based on realm. If you want to use SASL Digest-MD5 with realms, you must enable reversible password generation by changing the value of the `orclpasswordencryptionenable` attribute to 1 in the related password policy before provisioning new users. The LDIF file for modifying the value should look like this:

```
dn: cn=default,cn=pwdPolicies,cn=Common,cn=Products,cn=OracleContext
changetype: modify
replace: orclpasswordencryptionenable
orclpasswordencryptionenable: 1
```

The Digest-MD5 mechanism is described in RFC 2831 of the Internet Engineering Task Force. It is based on the HTTP Digest Authentication (RFC 2617).

**See Also:**

- Internet Engineering Task Force Web site, at <http://www.ietf.org>.
- Open LDAP class libraries <http://www.openldap.org>.

### 3.1.1.1 Steps Involved in SASL Authentication by Using DIGEST-MD5

SASL Digest-MD5 authenticates a user as follows:

1. The directory server sends data that includes various authentication options that it supports and a special token to the LDAP client.
2. The client responds by sending an encrypted response that indicates the authentication options that it has selected. The response is encrypted in such a way that proves that the client knows its password.
3. The directory server then decrypts and verifies the client's response.

### 3.1.2 SASL Authentication by Using External Mechanism

The following is from section 7.4 of RFC 2222 of the Internet Engineering Task Force.

The mechanism name associated with external authentication is "EXTERNAL". The client sends an initial response with the authorization identity. The server uses information, external to SASL, to determine whether the client is authorized to authenticate as the authorization identity. If the client is so authorized, the server indicates successful completion of the authentication exchange; otherwise the server indicates failure.

The system providing this external information may be, for example, IPsec or SSL/TLS.

If the client sends the empty string as the authorization identity (thus requesting the authorization identity be derived from the client's authentication credentials), the authorization identity is to be derived from authentication credentials that exist in the system which is providing the external authentication.

Oracle Internet Directory provides the SASL external mechanism over an SSL mutual connection. The authorization identity (DN) is derived from the client certificate during the SSL network negotiation.

## 3.2 Using Controls

The LDAPv3 Protocol, as defined by RFC 2251, allows extensions by means of controls. Oracle Internet Directory supports several controls. Some are standard and described by RFCs. Other controls, such as the CONNECT\_BY control for hierarchical searches are Oracle-specific. You can use controls with either Java or C.

Controls can be sent to a server or returned to the client with any LDAP message. These controls are referred to as server controls. The LDAP API also supports a client-side extension mechanism through the use of client controls. These controls affect the behavior of the LDAP API only and are never sent to a server.

For information about using LDAP controls in C, see [Section 8.2.7, "Working With Controls."](#)

For information about using LDAP controls in Java, see the documentation for the JNDI package `javax.naming.ldap` at:  
<http://www.oracle.com/technetwork/java/jndi/index.html>

The controls supported by Oracle Internet Directory 11g Release 1 (11.1.1) are listed in [Table 3-1, "Request Controls Supported by Oracle Internet Directory"](#) and [Section 3-2, "Response Controls Supported by Oracle Internet Directory."](#)



**Table 3–1 Request Controls Supported by Oracle Internet Directory**

Object Identifier	Name	Description
2.16.840.1.113730.3.4.18	Proxy Authorization	<p data-bbox="797 260 1446 365">Allows an LDAP client application to bind to Oracle Internet Directory server with its own identity and then to perform operations on behalf of another user or on behalf of multiple users.</p> <p data-bbox="797 380 1446 459">This control can improve performance especially for proxy operations performed on behalf of multiple users. The LDAP operation does not require a rebind for each user.</p> <p data-bbox="797 474 1175 501">For example, consider this scenario:</p> <ol data-bbox="797 516 1446 926" style="list-style-type: none"> <li data-bbox="797 516 1446 569">1. A client application named <code>proxy-app</code> binds to Oracle Internet Directory server.</li> <li data-bbox="797 583 1446 663">2. A user named John Doe sends a request to the <code>proxy-app</code> client application. The client must be a member of the proxy authorization group.</li> <li data-bbox="797 678 1446 783">3. Instead of passing the request to the Oracle Internet Directory server as <code>proxy-app</code>, the client passes the Proxy Authorization control along with the proxy DN (John Doe) to the server.</li> <li data-bbox="797 798 1446 926">4. The server performs the LDAP request for John Doe using John Doe's privileges (ACLs). The server can access only the information or perform only the operations that John Doe has privileges to access or perform.</li> </ol> <p data-bbox="797 940 1382 968">Considerations for the Proxy Authorization control are:</p> <ul data-bbox="797 982 1446 1409" style="list-style-type: none"> <li data-bbox="797 982 1446 1087">■ If the control is not accompanied by a proxy dn, the server throws an exception and returns an error to the client. If the criticality flag is not set to <code>TRUE</code>, the request is rejected with a protocol error.</li> <li data-bbox="797 1102 1446 1207">■ If the proxy user has the privileges to perform the operation as per the ACLs, the server executes the request; otherwise, the server returns the result code "123".</li> <li data-bbox="797 1222 1446 1299">■ Oracle Internet Directory server determines if a Proxy Authorization request is to be honored. Anonymous users are not allowed to assume the identity of others.</li> <li data-bbox="797 1314 1446 1409">■ If the server receives more than one Proxy Authorization control in the same operation, an error is returned to the client application and the operation attempt is unsuccessful.</li> </ul>

**Table 3–1 (Cont.) Request Controls Supported by Oracle Internet Directory**

Object Identifier	Name	Description
1.3.6.1.4.1.42.2.27.8.5.1	Password Policy	<p>Allows an LDAP client to request information from Oracle Internet Directory server about the current password policy state for a user. If a password policy is applicable, a client can send this control with these operations:</p> <ul style="list-style-type: none"> <li>▪ ldapbind, ldapmodify, ldapadd, or ldapcompare</li> <li>▪ ldapsearch</li> </ul> <p>Other operations such as ldapunbind and ldapabandon are not supported. Also, this control does not apply to a replication bind.</p> <p>The password policy request control does not have a <code>controlValue</code>, but the response control has return values, which are described in Table 3–2.</p> <p>The password policy is typically applied to the single-valued attribute <code>userPassword</code> for the LDAP simple authentication method or password-based Simple Authentication and Security Layer (SASL) authentication.</p> <p>For more information, see "Password Policy for LDAP Directories" at this location:</p> <p><a href="http://tools.ietf.org/html/draft-behera-ldap-password-policy-09">http://tools.ietf.org/html/draft-behera-ldap-password-policy-09</a></p>
2.16.840.1.113730.3.4.3	Persistent Search	<p>Allows an LDAP client to send a persistent search request to Oracle Internet Directory server.</p> <p>A persistent search operation is an enhanced search that continues after the initial search results are returned by the server to the client. After the initial search is finished, the connection to the server is kept alive until the client unbinds or abandons the operation. The client can track changes for entries in the search scope and receive an Entry Change Notification response control if an entry is modified.</p> <p>The definition for this control is:</p> <pre>PersistentSearch ::= SEQUENCE {     controlType 2.16.840.1.113730.3.4.3     changeTypes INTEGER,     changesOnly BOOLEAN,     returnECs BOOLEAN }</pre> <p>For a description of these fields, see:</p> <p><a href="http://tools.ietf.org/id/draft-ietf-ldapext-psearch-03.txt">http://tools.ietf.org/id/draft-ietf-ldapext-psearch-03.txt</a></p>



**Table 3-1 (Cont.) Request Controls Supported by Oracle Internet Directory**

Object Identifier	Name	Description
2.16.840.1.113894.1.8.39	Computed Attribute Value Uniqueness	<p>Allows computed attribute value uniqueness for an entry-based combination of multiple attribute values. Usually, attribute uniqueness is configured only for a single attribute. An application that requires uniqueness for a combination of attribute values can send this control, and Oracle Internet Directory server ensures that the computed attribute value is unique across the directory during an operation such as <code>ldapadd</code>, <code>ldapmodify -add</code>, or <code>ldapmodify -replace</code>.</p> <p>If an entry with the computed value already exists, Oracle Internet Directory server returns the LDAP error code: <code>LDAP_ALREADY_EXISTS = 0x44</code>.</p> <p>For example, in a multi-tenant environment, the UID attribute of a user must be unique for a specific tenant but not necessarily unique across the directory. An application creates an LDAP entry with a computed attribute named <code>TenantID_UID</code>, where <code>TenantID</code> is the identifier of the tenant and <code>UID</code> is the attribute. The application that creates the LDAP entry sends this control, and if an entry with the computed attribute already value already exists, Oracle Internet Directory server returns the <code>LDAP_ALREADY_EXISTS</code> error code.</p>
2.16.840.1.113730.3.4.9	OID_SEARCH_VLV_REQ_CONTROL	<p>Allows a client to specify that the server return, for a given LDAP search, a contiguous subset of a large search result set. It can be used to go through the search results one page at a time, which allows a client to retrieve results more quickly and prevents the client from needing to store too many search results at a time.</p> <p>The server returns the <code>OID_SEARCH_VLV_RES_CONTROL 2.16.840.1.113730.3.4.10</code>.</p> <p>The <code>OID_SEARCH_VLV_REQ_CONTROL</code> works only in conjunction with the <code>SORT</code> control (<code>ldapsearch -T</code> argument). If you do not include a <code>SORT</code> control, the request returns LDAP error code 53 - Search operation with VLV request control is missing <code>SORT</code> request control.</p> <p>The <code>SORT</code> control can contain any sort specification valid for the server. When the <code>SORT</code> control is used with the <code>OID_SEARCH_VLV_REQ_CONTROL</code>, the server does not return the complete set of sorted search results, but instead returns a contiguous subset of those entries specified in the control using a target entry as a reference point for results.</p> <p>For more information, see "LDAP Extensions for Scrolling View Browsing of Search Results" at <a href="http://tools.ietf.org/html/draft-ietf-ldapext-ldapv3-ylv-09">http://tools.ietf.org/html/draft-ietf-ldapext-ldapv3-ylv-09</a>.</p>
1.2.840.113556.1.4.319	OID_SEARCH_PAGING_CONTROL	See "Paged LDAP Search Results" on page 3-16.
1.2.840.113556.1.4.473	OID_SEARCH_SORTING_REQUEST_CONTROL	See "Sorted LDAP Search Results" on page 3-16.
2.16.840.1.113730.3.4.2	GSL_MANAGE_DSA_CONTROL	Used to manage referrals, dynamic groups, and alias objects in Oracle Internet Directory. For more information, please see RFC 3296, "Named Subordinate References in Lightweight Directory Access Protocol (LDAP) Directories," at <a href="http://www.ietf.org">http://www.ietf.org</a> .

**Table 3–1 (Cont.) Request Controls Supported by Oracle Internet Directory**

Object Identifier	Name	Description
2.16.840.1.113894.1.8.1	OID_RESET_PROXYCONTROL_IDENTITY	Used to perform a proxy switch of an identity on an established LDAP connection. For example, suppose that Application A connects to the directory server and then wishes to switch to Application B. It can simply do a rebind by supplying the credentials of Application B. However, there are times when the proxy mechanism for the application to switch identities could be used even when the credentials are not available. With this control, Application A can switch to Application B provided Application A has the privilege in Oracle Internet Directory to proxy as Application B.
2.16.840.1.113894.1.8.2	OID_APPLYUSEPASSWORD_POLICY	Sent by applications that require Oracle Internet Directory to check for account lockout before sending the verifiers of the user to the application. If Oracle Internet Directory detects this control in the verifier search request and the user account is locked, then Oracle Internet Directory does not send the verifiers to the application. It sends an appropriate password policy error.
2.16.840.1.113894.1.8.3	CONNECT_BY	See Section 3.5, "Performing Hierarchical Searches."
2.16.840.1.113894.1.8.4	OID_CLIENT_IP_ADDRESS	Intended for a client to send the end user IP address if IP lockout is to be enforced by Oracle Internet Directory.
2.16.840.1.113894.1.8.5	GSL_REQDATTR_CONTROL	Used with dynamic groups. Directs the directory server to read the specific attributes of the members rather than the membership lists.
2.16.840.1.113894.1.8.6	PasswordStatusRequestControl	When packaged as part of the LDAP Bind/Compare operation request, this control causes the server to generate a password policy response control. The actual response control depends on the situation. Cases include imminent password expiration, number of grace logins remaining, password expired, and account locked.
2.16.840.1.113894.1.8.14	OID_DYNAMIC_VERIFIER_REQUEST_CONTROL	The request control that the client sends when it wants the server to create a dynamic password verifier. The server uses the parameters in the request control to construct the verifier.
2.16.840.1.113894.1.8.16	AccountStatusRequestControl	When packaged with the LDAP search operation associated with the authentication process, the Oracle Internet Directory returns a password policy response control to inform the client application of account state related information like account lockout, password expiration etc. The application can then parse and enforce the results.
2.16.840.1.113894.1.8.23	GSL_CERTIFICATE_CONTROL"	Certificate search control. The request control that the client sends to specify how to search for a user certificate. See the appendix "Searching the Directory for User Certificates" in <i>Oracle Fusion Middleware Administrator's Guide for Oracle Internet Directory</i> .

**Table 3–1 (Cont.) Request Controls Supported by Oracle Internet Directory**

<b>Object Identifier</b>	<b>Name</b>	<b>Description</b>
2.16.840.1.113894.1.8.29	EffectivePolicyControl	This control is packaged as part of an LDAP base search, where the base DN is that of the user entry being tested. The entry need not exist in the directory at the time. Passing this control results in the return of the LDAP entry describing the applicable password policy, assuming the entity performing the search has the access rights to view the password policy entry. If the desired password is provided as the optional testPassword parameter, the directory server returns the response control 2.16.840.1.113894.1.8.32.
2.16.840.1.113894.1.8.36	DelSubtreeControl	When this control is sent with a delete operation, it causes the deletion of the entire subtree below the DN provided. Any user having necessary privileges can perform this operation.
1.3.6.1.1.21.2	TransactionSpecification Control	This is an LDAPControl indicating association of an operation to a transaction by means of the transaction identifier, which is the value of this control. Its criticality is TRUE.

**Table 3–2 Response Controls Supported by Oracle Internet Directory**

Object Identifier	Name	Description
1.3.6.1.4.1.42.2.27.8.5.1	Password Policy	<p>Response control that the Oracle Internet Directory server returns to an LDAP client in response to the Password Policy request control. The response control value is encoded as follows:</p> <pre> PasswordPolicyResponseValue ::= SEQUENCE {   warning [0] CHOICE {     timeBeforeExpiration [0] INTEGER (0 .. maxInt),     graceAuthNsRemaining [1] INTEGER (0 .. maxInt) } OPTIONAL,   error [1] ENUMERATED {     passwordExpired (0),     accountLocked (1),     changeAfterReset (2),     passwordModNotAllowed (3),     mustSupplyOldPassword (4), /*currently not supported*/     insufficientPasswordQuality (5),     passwordTooShort (6),     passwordTooYoung (7),     passwordInHistory (8) } OPTIONAL } </pre> <p>The Password Policy response control does not offer the <code>mustSupplyOldPassword</code> error code, because Oracle Internet Directory does not support the <code>pwdsafemodify</code> functionality.</p> <p>The server sends either an error or warning in the password policy response control (but not both). Error codes are described in: <a href="http://tools.ietf.org/html/draft-behera-ldap-password-policy-09">http://tools.ietf.org/html/draft-behera-ldap-password-policy-09</a></p> <p>Control criticality is not returned in the response. For a non violation of the password policy, the server does not send a response.</p>
2.16.840.1.113730.3.4.7	Entry Change Notification	<p>Returned by the Oracle Internet Directory server to an LDAP client in response to a Persistent Search control that has the <code>returnECs</code> field set to <code>TRUE</code>. This control is returned for each changed entry that matches the persistent search criteria and describes the change made to the specific search entry.</p> <p>The definition for this control is:</p> <pre> EntryChangeNotification ::= SEQUENCE {   controlType 2.16.840.1.113730.3.4.7   changeType ENUMERATED {     add (1),     delete (2),     modify (4),     modDN (8)   },   previousDN LDAPDN OPTIONAL, -- modifyDN ops. only   changeNumber INTEGER OPTIONAL -- if supported } </pre> <p>For a description of these fields, see: <a href="http://tools.ietf.org/id/draft-ietf-ldapext-psearch-03.txt">http://tools.ietf.org/id/draft-ietf-ldapext-psearch-03.txt</a></p>
2.16.840.1.113730.3.4.10	OID_SEARCH_VLV_RES_CONTROL	The server sends this control in response to an <code>OID_SEARCH_VLV_REQ_CONTROL</code> 2.16.840.1.113730.3.4.9.
2.16.840.1.113894.1.8.7	OID_PASSWORD_EXPWARNING_CONTROL	Password policy control. Response control that the server sends when the <code>pwdExpireWarning</code> attribute is enabled and the client sends the request control. The response control value contains the time in seconds to password expiration.
2.16.840.1.113894.1.8.8	OID_PASSWORD_GRACE_LOGIN_CONTROL	Password policy control. The response control that the server sends when grace logins are configured and the client sends a request control. The response control value contains the remaining number of grace logins.
2.16.840.1.113894.1.8.20	OID_PWDEXPIRED_CONTROL	Password policy control. The response control that the server sends when the password has expired, there are no grace logins remaining, and the client sends a request control.

**Table 3–2 (Cont.) Response Controls Supported by Oracle Internet Directory**

Object Identifier	Name	Description
2.16.840.1.113894.1.8.9	OID_PASSWORD_MUSTCHANGE_CONTROL	Password policy control. The response control that the server sends when forced password reset is enabled and the client sends the request control. The client must force the user to change the password upon receipt of this control.
2.16.840.1.113894.1.8.15	OID_DYNAMIC_VERIFY_RESPONSE_CONTROL	The response control that the server sends to the client when an error occurs. The response control contains the error code.
2.16.840.1.113894.1.8.32	PasswordValidationControl	The server sends this in response to control 2.16.840.1.113894.1.8.29 when the desired password is provided as the optional testPassword parameter. A client application can parse the validationResult to determine whether the password can be accepted by the server ("Success") or the reason it has been rejected. The same type of error message generated during a failed LDAP modify operation on userpassword is returned as the value.

To find out what controls are available in your Oracle Internet Directory installation, type:

```
ldapsearch -p port -b "" -s base "objectclass=*
```

Look for entries that begin with supportedcontrol=.

### 3.3 Proxying on Behalf of End Users

Often applications must perform operations that require impersonating an end user. An application may, for example, want to retrieve resource access descriptors for an end user. (Resource access descriptors are discussed in the concepts chapter of *Oracle Fusion Middleware Administrator's Guide for Oracle Internet Directory*.)

A proxy switch occurs at run time on the JNDI context. An LDAP v3 feature, proxying can only be performed using `InitialLdapContext`, a subclass of `InitialDirContext`. If you use the Oracle extension `oracle.ldap.util.jndi.ConnectionUtil` to establish a connection (the example following), `InitialLdapContext` is always returned. If you use JNDI to establish the connection, make sure that it returns `InitialLdapContext`.

---

**Note:** To perform the proxy switch to an end user, you need the user's DN.

If there is a `User` object already available fetched from `Subscriber`, then the user's DN is available as shown in this fragment:

```
//User user = subscriber.getUser(...);
user.getDn();
```

If you do not have the `User` object, you can create it if you have the user's name, UID, SAM account name, or Kerberos principal are available, as shown in the following fragment:

```
User user = new User(dirCtx, idType, userIdValue, subscriber,
true);
// idType can be Util.IDTYPE_SIMPLE / Util.IDTYPE_GUID /
Util.IDTYPE_WINDOWS / Util.IDTYPE_KERB_PRINCIPAL
user.getDn();
```

---

This code shows how the proxy switch occurs:

```
import oracle.ldap.util.jndi.*;
```

```
import javax.naming.directory.*;
import javax.naming.ldap.*;
import javax.naming.*;

public static void main(String args[])
{
    try{
        InitialLdapContext appCtx=ConnectionUtil.getDefaultDirCtx(args[0], // host
                                                                    args[1], // port
                                                                    args[2], // DN
                                                                    args[3]; // pass)

        // Do work as application
        // . . .
        String userDN=null;
        // assuming userDN has the end user DN value
        // Now switch to end user
        ctx.addToEnvironment(Context.SECURITY_PRINCIPAL, userDN);
        ctx.addToEnvironment("java.naming.security.credentials", "");
        Control ctls[] = {
            new ProxyControl()
        };
        ((LdapContext)ctx).reconnect(ctls);
        // Do work on behalf of end user
        // . . .
    }
    catch(NamingException ne)
    {
        // javax.naming.NamingException is thrown when an error occurs
    }
}
```

The `ProxyControl` class in the code immediately preceding implements a `javax.naming.ldap.Control`. To learn more about LDAP controls, see the LDAP control section of *Oracle Fusion Middleware Reference for Oracle Identity Management*. Here is an example of what the `ProxyControl` class might look like:

```
import javax.naming.*;
import javax.naming.ldap.Control;
import java.lang.*;

public class ProxyControl implements Control {

    public byte[] getEncodedValue() {
        return null;
    }

    public String getID() {
        return "2.16.840.1.113894.1.8.1";
    }

    public boolean isCritical() {
        return false;
    }
}
```

## 3.4 Creating Dynamic Password Verifiers

You can modify the LDAP authentication APIs to generate application passwords dynamically—that is, when users log in to an application. This feature has been

designed to meet the needs of applications that provide parameters for password verifiers only at runtime.

This section contains the following topics:

- Section 3.4.1, "Request Control for Dynamic Password Verifiers"
- Section 3.4.2, "Syntax for DynamicVerifierRequestControl"
- Section 3.4.3, "Parameters Required by the Hashing Algorithms"
- Section 3.4.4, "Configuring the Authentication APIs"
- Section 3.4.5, "Response Control for Dynamic Password Verifiers"
- Section 3.4.6, "Obtaining Privileges for the Dynamic Verifier Framework"

### 3.4.1 Request Control for Dynamic Password Verifiers

Creating a password verifier dynamically involves modifying the LDAP authentication APIs `ldap_search` or `ldap_modify` to include parameters for password verifiers. An LDAP control called `DynamicVerifierRequestControl` is the mechanism for transmitting these parameters. It takes the place of the password verifier profile used to create password verifiers statically. Nevertheless, dynamic verifiers, like static verifiers, require that the directory attributes `orclrevpwd` (synchronized case) and `orclunsyncrevpwd` (unsynchronized case) be present and that these attributes be populated.

Note that the `orclpwdencryptionenable` attribute of the password policy entry in the user's realm must be set to 1 if `orclrevpwd` is to be generated. If you fail to set this attribute, an exception is thrown when the user tries to authenticate. To generate `orclunsyncrevpwd`, you must add the `crypto` type 3DES to the entry `cn=defaultSharedPINProfileEntry,cn=common,cn=products,cn=oraclecontext`.

### 3.4.2 Syntax for DynamicVerifierRequestControl

The request control looks like this:

```
DynamicVerifierRequestControl
controlOid: 2.16.840.1.113894.1.8.14
criticality: FALSE
controlValue: an OCTET STRING whose value is the BER encoding of the following
type:
```

```
ControlValue ::= SEQUENCE {
    version [0]
    crypto [1] CHOICE OPTIONAL {
        SASL/MD5 [0] LDAPString,
        SyncML1.0 [1] LDAPString,
        SyncML1.1 [2] LDAPString,
        CRAM-MD5 [3] LDAPString },
    username [1] OPTIONAL LDAPString,
    realm [2] OPTIONAL LDAPString,
    nonce [3] OPTIONAL LDAPString,
}
```

Note that the parameters in the control structure must be passed in the order in which they appear. [Table 3–3](#) defines these parameters.

**Table 3–3 Parameters in DynamicVerifierRequestControl**

Parameter	Description
controlOID	The string that uniquely identifies the control structure.
crypto	The hashing algorithm. Choose one of the four identified in the control structure.
username	The distinguished name (DN) of the user. This value must always be included.
realm	A randomly chosen realm. It may be the identity management realm that the user belongs to. It may even be an application realm. Required only by the SASL/MD5 algorithm.
nonce	An arbitrary, randomly chosen value. Required by SYNCML1.0 and SYNCML1.1.

### 3.4.3 Parameters Required by the Hashing Algorithms

Table 3–4 lists the four hashing algorithms that are used to create dynamic password verifiers. The table also lists the parameters that each algorithm uses as building blocks. Note that, although all algorithms use the user name and password parameters, they differ in their use of the `realm` and `nonce` parameters.

**Table 3–4 Parameters Required by the Hashing Algorithms**

Algorithm	Parameters Required
SASL/MD5	username, realm, password
SYNCML1.0	username, password, nonce
SYNCML1.1	username, password, nonce
CRAM-MD5	username, password

### 3.4.4 Configuring the Authentication APIs

Applications that require password verifiers to be generated dynamically must include `DynamicVerifierRequestControl` in their authentication APIs. Either `ldap_search` or `ldap_compare` must incorporate the `controlOID` and the control values as parameters. They must BER-encode the control values as shown in [Section 3.4.2, "Syntax for DynamicVerifierRequestControl."](#) Then they must send both `controlOID` and the control values to the directory server.

#### 3.4.4.1 Parameters Passed If `ldap_search` Is Used

If you want the application to authenticate the user, use `ldap_search` to pass the control structure. If `ldap_search` is used, the directory passes the password verifier that it creates to the client.

`ldap_search` must include the DN of the user, the `controlOID`, and the control values. If the user's password is a single sign-on password, the attribute passed is `authpassword`. If the password is a numeric pin or another type of unsynchronized password, the attribute passed is `orclpasswordverifier;orclcommonpin`.

#### 3.4.4.2 Parameters Passed If `ldap_compare` Is Used

If you want Oracle Internet Directory to authenticate the user, use `ldap_compare` to pass the control structure. In this case, the directory retains the verifier and authenticates the user itself.



Like `ldap_search`, `ldap_compare` must include the DN of the user, the `controlOID`, the control values, and the user's password attribute. For `ldap_compare`, the password attribute is `orclpasswordverifier;orclcommonpin` (unsynchronized case).

### 3.4.5 Response Control for Dynamic Password Verifiers

When it encounters an error, the directory sends the LDAP control `DynamicVerifierResponseControl` to the client. This response control contains the error code. To learn about the error codes that the response control sends, see the troubleshooting chapter in *Oracle Fusion Middleware Administrator's Guide for Oracle Internet Directory*.

### 3.4.6 Obtaining Privileges for the Dynamic Verifier Framework

If you want the directory to create password verifiers dynamically, you must add your application identity to the `VerifierServices` group of directory administrators. If you fail to perform this task, the directory returns an `LDAP_INSUFFICIENT_ACCESS` error.

## 3.5 Performing Hierarchical Searches

One of the server controls you can pass to an LDAP search function is `CONNECT_BY`. This is an Oracle-specific control that causes the search to traverse a hierarchy. For example, if you search for all the users in `group1`, without the `CONNECT_BY` control, the search function returns only users who are direct members of `group1`. If you pass the `CONNECT_BY` control, however, the search function traverses the hierarchy. If `group2` is a member of `group1`, the search also returns users in `group2`. If `group3` is a member of `group2`, the search also returns users in `group3`, and so forth.

### 3.5.1 New Features of the `CONNECT_BY` Control

In 10g (10.1.4.0.1), the `CONNECT_BY` control was enhanced in two ways:

- You can now traverse the hierarchy in either direction. That is, you can search through all containers in which an entry is contained, and through all containers contained within an entry.
- You can now specify the number of levels of the hierarchy to search.

### 3.5.2 Value Fields in the `CONNECT_BY` Control

In previous releases, the `CONNECT_BY` control required no values. Because of the new functionality, you can now pass one or both of the following values to `CONNECT_BY`:

- **Hierarchy-establishing attribute**—A string representing the attribute to be searched. This value is necessary only when searching through all containers in which an entry is contained. When searching through containers contained within an entry, you need not provide this value because the search filter provides that information.
- **Number of levels**—An integer representing the number of levels to traverse. If the value is 0, the search traverses all levels. The default value is 0, so you need not pass this value if you want the search to traverse all levels.

#### **Example 1: Find All the Groups to Which a User Belongs**

Using a filter such as `(member=cn=jsmith)`, you do not need to provide the hierarchy-establishing attribute `member` because it is in the search filter. You do not need to pass a value for the number of levels because 0 is the default.

**Example 2: Find Only the Groups to Which a User Directly Belongs**

Using the same filter as in Example 1, you would pass the integer control value 1. The result would be the same as if you did not use the `CONNECT_BY` control at all.

**Example 3: Find All Members of a Group**

In this case, your search filter would specify `(objectclass=*)`, but if you want to find all members of `group1`, the attribute for traversing the hierarchy is `member`. For this search, you must pass the string "member" as the hierarchy-establishing attribute. You do not need to pass a value for the number of levels because 0 is the default.

**Example 4: Finding all Managers of a User**

This is similar to Example 3, except that you want to find all managers of the user `jsmith`, so `manager` is the attribute for traversing the hierarchy. For this search, you would pass the string "manager". You do not need to pass a value for the number of levels because 0 is the default.

**See Also:**

- [Section 8.2.9.1, "ldap\\_search\\_ext, ldap\\_search\\_ext\\_s, ldap\\_search, and ldap\\_search\\_s"](#)
- [Section 8.2.7, "Working With Controls"](#)

## 3.6 Sorted LDAP Search Results

As of Oracle Internet Directory 10g (10.1.4.0.1), you can obtain sorted results from an LDAP search, as described by IETF RFC 2891. You request sorted results by passing a control of type 1.2.840.113556.1.4.473 to the search function. The server returns a response control is of type 1.2.840.113556.1.4.474. Error processing and other details are described in RFC 2891.

**See Also:** IETF RFC 2891, "LDAP Control Extension for Server Side Sorting of Search Results," at <http://www.ietf.org>.

Sorting and paging may be used together.

The Oracle Internet Directory implementation of RFC 2891 has the following limitations:

- It supports only one `attributeType` in the control value.
- It uses the default ordering rule defined in the schema for each attribute.
- Linguistic sorting is not supported.
- The default sorting order is ascending.
- If a sort key is a multi-valued attribute, and an entry has multiple values for that attribute, and there are no other controls that affect the sorting order, then the server uses the least value, according to the ordering rule for that attribute.
- The sort attribute must be searchable. That is, it must be a cataloged attribute in Oracle Internet Directory.

## 3.7 Paged LDAP Search Results

As of Oracle Internet Directory 10g (10.1.4.0.1), you can obtain paged results from an LDAP search, as described by IETF RFC 2696. You request sorted results by passing a

control of type 1.2.840.113556.1.4.319 to the search function. Details are described in RFC 2696.

**See Also:** IETF RFC 2696, "LDAP Control Extension for Simple Paged Results Manipulation," at <http://www.ietf.org>.

Sorting and paging may be used together.

The Oracle Internet Directory implementation of RFC 2696 has the following limitations:

- The number of entries in a page might be less than the page size if an ACI partially blocks some entries from the search results.
- The paging response control does not contain the total entry count estimation. The return value is always 0.

## 3.8 Password Policies

The Oracle Internet Directory natively supports a rich set of policies governing passwords. See "Managing Password Policies" in *Oracle Fusion Middleware Administrator's Guide for Oracle Internet Directory*. You should design your applications to interact with the directory's password policies at runtime and handle any resulting events gracefully. Oracle Internet Directory provides several mechanisms to allow clients to interact with the server's password policies.

This section contains the following topics:

- [Section 3.8.1, "User Provisioning"](#)
- [Section 3.8.2, "User Authentication"](#)
- [Section 3.8.3, "User Account Maintenance"](#)

### 3.8.1 User Provisioning

If your application provisions its own users in the directory, you should test passwords for acceptability by the server before committing the new user entry into the directory. You can test a password by using the following custom control:

```
EffectivePolicyControl
 ::= SEQUENCE {
           controlType      2.16.840.1.113894.1.8.29,
           criticality      BOOLEAN DEFAULT FALSE,
           controlValue     testPassword
         }
testPassword ::= OCTET STRING (optional)
```

Package this control as part of an LDAP base search, where the base DN is that of the user entry being tested. The entry does not need to exist in the directory at the time. The server returns the LDAP entry describing the applicable password policy, assuming the entity performing the search has the access rights to view the password policy entry. Providing the desired password as the optional testPassword parameter results in the directory server returning the following response control:

```
PasswordValidationControl
 ::= SEQUENCE {
           controlType      2.16.840.1.113894.1.8.32,
           criticality      BOOLEAN DEFAULT FALSE,
           controlValue     validationResult
         }
```

```
validationResult ::= OCTET STRING
```

Your client application can parse the `validationResult` to determine whether the password is accepted by the server ("Success") or the reason it has been rejected. The error message is the same as that generated during a failed LDAP modify operation on `userpassword`.

## 3.8.2 User Authentication

User authentication use-cases broadly fall into two main categories:

1. [LDAP Bind/Compare Operation-Based Authentication](#)
2. [LDAP Search Operation-Based Authentication](#)

The former refers to authentication performed on the standard `userpassword` attribute. The entire authentication process is performed within the directory server, and appropriate internal events are generated to update various account states as necessary.

The latter refers to authentication performed against other authentication tokens, such as password verifiers, maintained as part of a user entry. The token may be retrieved by the application. The authentication process occurs within the application and outside the scope of the directory server. Therefore in LDAP search-based authentications, the directory does not implicitly know the result of the authentication attempt.

The following two subsections describe the best practices for application integration when dealing with these two types of authentication scenarios.

### 3.8.2.1 LDAP Bind/Compare Operation-Based Authentication

The traditional use of this type of authentication is in an unsophisticated protocol. The application performs either an LDAP bind or compare operation against the server and checks for success. It handles all other cases as authentication failures.

When an authentication attempt fails, an application can determine the cause and either take action to remedy the situation or to expose the cause to the end user so that the end user can take an action to remedy the situation. This enhances the user experience and reduces administrative overhead. To retrieve such cause information during an LDAP Bind/Compare operation, you use the following LDAP control:

```
PasswordStatusRequestControl
 ::= SEQUENCE {
           controlType      2.16.840.1.113894.1.8.6,
           criticality      BOOLEAN DEFAULT FALSE,
           }

```

When packaged as part of the LDAP Bind/Compare operation request, this control is processed by the server and causes the generation of a response control. The actual response control depends on the situation. See the password response controls in [Table 3–2, "Response Controls Supported by Oracle Internet Directory"](#) on page 3-10. Cases include imminent password expiration, number of grace logins remaining, password expired, and account locked.

### 3.8.2.2 LDAP Search Operation-Based Authentication

If an application performs its own authentication after retrieving an authentication token from the directory, then none of the state-related policies are effective. Without

these policies, scenarios such as locked accounts aren't enforceable, and users with expired accounts can still authenticate against the application.

The Oracle Internet Directory provides two mechanism that allow such an application to leverage the state related policy framework already present in the directory server. They are described in the following sections:

- [Section 3.8.2.2.1, "Ability to Check and Enforce State Policies at Authentication Time"](#)
- [Section 3.8.2.2.2, "Ability to Inform the Directory of Authentication Success/Failure"](#)

**3.8.2.2.1 Ability to Check and Enforce State Policies at Authentication Time** This ability is enabled through the following custom control:

```
AccountStatusRequestControl
 ::= SEQUENCE {
                                controlType      2.16.840.1.113894.1.8.16,
                                criticality      BOOLEAN DEFAULT FALSE,
                                }

```

When this control is packaged with the LDAP search operation associated with the authentication process, Oracle Internet Directory processes this control and returns a response control to inform the client application of account state related information like account lockout, password expiration etc. See the password response controls in [Table 3–2, "Response Controls Supported by Oracle Internet Directory"](#) on page 3-10. The application can then parse and enforce the results.

While this addresses the issue of how the policies can be enforced by the client application, another fundamental application requirement is as follows:

**3.8.2.2.2 Ability to Inform the Directory of Authentication Success/Failure** Oracle Internet Directory provides this ability through the virtual attribute: `orclAccountStatusEvent`.

This attribute is available on all user entries as a virtual attribute. That is, it has no disk footprint. However, modify operations can be applied on it. By default, a directory ships with restricted access to this attribute, so you must ask the directory administrator to grant your application identity write access on the attribute for the relevant user population.

You communicate authentication success or failure to the directory by modifying this attribute to hold `UserAccountEvent`. The following LDIF illustrates this.

```
dn: UserDN
changetype: modify
replace: orclAccountStatusEvent
orclAccountStatusEvent: UserAccountEvent

```

The Oracle Internet Directory understands the following values for `UserAccountEvent`:

```
UserAccountEvent = 1 (Authentication Success)
UserAccountEvent = 2 (Authentication Failure)

```

Upon receipt of these events, the Oracle Internet Directory invokes the same logic that is invoked during an authentication/success failure of an LDAP bind or compare operation, thereby updating the necessary account states.

In this way, you can leverage the existing account state related infrastructure available in the Oracle Internet Directory to secure your application.

### 3.8.3 User Account Maintenance

User account maintenance and its interaction with password policies occur mostly around periodic password modifications. We recommend that applications utilize the `EffectivePolicyControl` described above to retrieve the effective policy and parse it to generate a message guiding the end user to the password construction requirements. Furthermore, we encourage the usage of the "test" capabilities encapsulated in this control to direct the end user towards the cause behind a modification failure. Handling these situations within the application reduces administrative overhead.

Secondly, there are a multitude of use-cases requiring a user to change his or her password upon next logon. The Oracle Internet Directory natively triggers this requirement when the `pwdmustchange` password policy element is enabled and a `userpassword` undergoes a non-self modification. However, in the event that an explicit trigger of this requirement is needed, the Oracle Internet Directory supports it also via the `orclAccountStatusEvent` attribute described above. The relevant events are:

```
UserAccountEvent = 3 (Require Password Reset on next Logon)
UserAccountEvent = 4 (Clear Password Reset Requirement)
```

If the application has an administrative interface, this functionality may be desirable and can be exposed to the administrator.

---

---

## Developing Applications With Oracle Extensions to the Standard APIs

This chapter introduces the Oracle extensions to the Java and PL/SQL LDAP APIs.

Chapter 5 explains how the Java extensions are used, and chapter 6 describes the PL/SQL extensions. Oracle does not support extensions to the C API.

This chapter includes the following sections:

- Section 4.1, "Using Oracle Extensions to the Standard APIs"
- Section 4.2, "Creating an Application Identity in the Directory"
- Section 4.3, "Managing Users"
- Section 4.4, "Managing Groups"
- Section 4.5, "Managing Realms"
- Section 4.6, "Discovering a Directory Server"

### 4.1 Using Oracle Extensions to the Standard APIs

The APIs that Oracle has added to the existing APIs fulfill these functions:

- User management  
Applications can set or retrieve various user properties
- Group management  
Applications can query group properties
- Realm management  
Applications can set or retrieve properties about identity management realms
- Server discovery management  
Applications can locate a directory server in the Domain Name System (DNS)

Subsequent sections examine each of these functions in detail. Note that applications must use the underlying APIs for such common tasks as establishing and closing connections and looking up directory entries not searchable with the API extensions.

Figure 4–1 shows what program flow looks like when the API extensions are used.

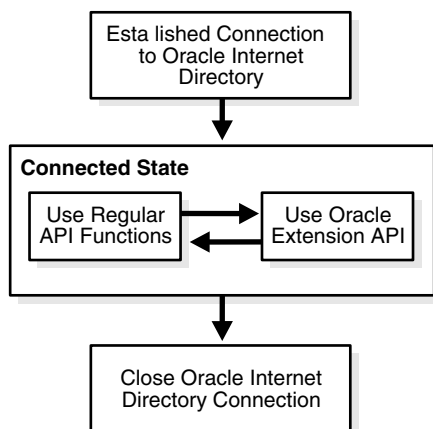
**Figure 4–1 Programmatic Flow for API Extensions**

As [Figure 4–1](#) shows, an application first establishes a connection to Oracle Internet Directory. It can then use the standard API functions and the API extensions interchangeably.

## 4.2 Creating an Application Identity in the Directory

Before an application can use the LDAP APIs and their extensions, it must establish an LDAP connection. After it establishes a connection, it must have permission to perform operations. But neither task can be completed if the application lacks an identity in the directory.

### 4.2.1 Creating an Application Identity

Creating an application identity in the directory is relatively simple. Such an entry requires only two object classes: `orclApplicationEntity` and `top`. You can use either Oracle Directory Services Manager or an LDIF file to create the entry. In LDIF notation, the entry looks like this:

```

dn: orclapplicationcommonname=application_name
changetype: add
objectclass:top
objectclass: orclApplicationEntity
userpassword: password
  
```

The value provided for `userpassword` is the value that the application uses to bind to the directory.

### 4.2.2 Assigning Privileges to an Application Identity

To learn about the privileges available to an application, see the chapter about delegating privileges for an Oracle technology deployment in *Oracle Fusion Middleware Administrator's Guide for Oracle Internet Directory*. After identifying the right set of privileges, add the application entity DN to the appropriate directory groups. The reference just provided explains how to perform this task using either Oracle Directory Services Manager or the `ldapmodify` command.

## 4.3 Managing Users

This section describes user management features of the LDAP APIs.



Directory-enabled applications need to perform the following operations:

- Retrieve properties of user entries  
These properties are stored as attributes of the user entry itself—in the same way, for example, that a surname or a home address is stored.
- Retrieve extended user preferences  
These preferences apply to a user but are stored in a DIT different from the DIT containing user entries. Extended user preferences are either user properties common to all applications or user properties specific to an application. Those of the first type are stored in a common location in the Oracle Context. Those of the second type are stored in the application-specific DIT.
- Query the group membership of a user
- Authenticate a user given a simple name and credential  
Typically an application uses a fully qualified DN, GUID, or simple user name to identify a user. In a hosted environment, the application may use both a user name and a realm name for identification.

## 4.4 Managing Groups

Groups are modeled in Oracle Internet Directory as a collection of distinguished names. Directory-enabled applications must access Oracle Internet Directory to obtain the properties of a group and to verify that a given user is a member of that group.

A group is typically identified by one of the following:

- A fully qualified LDAP distinguished name
- A global unique identifier
- A simple group name along with a subscriber name

## 4.5 Managing Realms

An identity management realm is an entity or organization that subscribes to the services offered in the Oracle product stack. Directory-enabled applications must access Oracle Internet Directory to obtain realm properties such as user search base or password policy.

A realm is typically identified by one of the following:

- A fully qualified LDAP distinguished name
- A global unique identifier
- A simple enterprise name

## 4.6 Discovering a Directory Server

Directory server discovery (DSD) enables automatic discovery of the Oracle directory server by directory clients. It enables deployments to manage the directory host name and port number information in the central DNS server. All directory clients perform a DNS query at runtime and connect to the directory server. Directory server location information is stored in a DNS service location record (SRV).

An SRV contains:

- The DNS name of the server providing LDAP service

- The port number of the corresponding port
- Any parameters that enable the client to choose an appropriate server from multiple servers

DSD also allows clients to discover the directory host name information from the `ldap.ora` file itself.

This section contains these topics:

- [Section 4.6.1, "Benefits of Oracle Internet Directory Discovery Interfaces"](#)
- [Section 4.6.2, "Usage Model for Discovery Interfaces"](#)
- [Section 4.6.3, "Determining Server Name and Port Number From DNS"](#)
- [Section 4.6.4, "Environment Variables for DNS Server Discovery"](#)
- [Section 4.6.5, "Programming Interfaces for DNS Server Discovery"](#)

**See Also:**

- "Discovering LDAP Services with DNS" by Michael P. Armijo at [this URL](http://www.ietf.org):  
<http://www.ietf.org>.
- "A DNS RR for specifying the location of services (DNS SRV)", Internet RFC 2782 at the same URL.

## 4.6.1 Benefits of Oracle Internet Directory Discovery Interfaces

Typically, the LDAP host name and port information is provided statically in a file called `ldap.ora` which is located on the client in `$ORACLE_HOME/network/admin`. For large deployments with many clients, this information becomes very cumbersome to manage. For example, each time the host name or port number of a directory server is changed, the `ldap.ora` file on each client must be modified.

Directory server discovery eliminates the need to manage the host name and port number in the `ldap.ora` file. Because the host name information resides on one central DNS server, the information must be updated only once. All clients can then discover the new host name information dynamically from the DNS when they connect to it.

DSD provides a single interface to obtain directory server information without regard to the mechanism or standard used to obtain it. Currently, Oracle directory server information can be obtained either from DNS or from `ldap.ora` using a single interface.

## 4.6.2 Usage Model for Discovery Interfaces

The first step in discovering host name information is to create a discovery handle. A discovery handle specifies the source from which host name information is discovered. In case of the Java API, the discovery handle is created by creating an instance of the `oracle.ldap.util.discovery.DiscoveryHelper` class.

```
DiscoveryHelper disco = new DiscoveryHelper(DiscoveryHelper.DNS_DISCOVER);
```

The argument `DiscoveryHelper.DNS_DISCOVER` specifies the source. In this case the source is DNS.

Each source may require some inputs to be specified for discovery of host name information. In the case of DNS these inputs are:

- domain name
- discover method
- SSL mode

Detailed explanation of these options is given in ["Determining Server Name and Port Number From DNS"](#).

```
// Set the property for the DNS_DN
disco.setProperty(DiscoveryHelper.DNS_DN, "dc=us,dc=fiction,dc=com");
// Set the property for the DNS_DISCOVER_METHOD
disco.setProperty(DiscoveryHelper.DNS_DISCOVER_METHOD
    ,DiscoveryHelper.USE_INPUT_DN_METHOD);
// Set the property for the SSLMODE
disco.setProperty(DiscoveryHelper.SSLMODE, "0");
```

Now the information can be discovered.

```
// Call the discover method
disco.discover(reshdl);
```

The discovered information is returned in a result handle (reshdl). Now the results can be extracted from the result handle.

```
ArrayList result =
(ArrayList)reshdl.get(DiscoveryHelper.DIR_SERVERS);
if (result != null)
{
    if (result.size() == 0) return;
    System.out.println("The hostnames are :-");
    for (int i = 0; i < result.size(); i++)
    {
        String host = (String)result.get(i);
        System.out.println((i+1)+"."+host+"");
    }
}
```

### 4.6.3 Determining Server Name and Port Number From DNS

Determining a host name and port number from a DNS lookup involves obtaining a domain and then searching for SRV resource records based on that domain. If there is more than one SRV resource record, they are sorted by weight and priority. The SRV resource records contain host names and port numbers required for connection. This information is retrieved from the resource records and returned to the user.

There are three approaches for determining the domain name required for lookup:

- Mapping the distinguished name (DN) of the naming context
- Using the domain component of local machine
- Looking up the default SRV record in the DNS

#### 4.6.3.1 Mapping the DN of the Naming Context

The first approach is to map the distinguished name (DN) of naming context into domain name using the algorithm given here.

The output domain name is initially empty. The DN is processed sequentially from right to left. An RDN is able to be converted if it meets the following conditions:

- It consists of a single attribute type and value

- The attribute type is `dc`
- The attribute value is non-null

If the RDN can be converted, then the attribute value is used as a domain name component (label).

The first such value becomes the right most, and the most significant, domain name component. Successive converted RDN values extend to the left. If an RDN cannot be converted, then processing stops. If the output domain name is empty when processing stops, then the DN cannot be converted into a domain name.

For the DN `cn=John Doe,ou=accounting,dc=example,dc=net`, the client converts the `dc` components into the DNS name `example.net`.

#### 4.6.3.2 Search by Domain Component of Local Machine

Sometimes a DN cannot be mapped to a domain name. For example, the DN `o=Oracle IDC,Bangalore` cannot be mapped to a domain name. In this case, the second approach uses the domain component of the local machine on which the client is running. For example, if the client machine domain name is `mc1.example.com`, the domain name for the lookup is `example.com`.

#### 4.6.3.3 Search by Default SRV Record in DNS

The third approach looks for a default SRV record in the DNS. This record points to the default server in the deployment. The domain component for this default record is `_default`.

After the domain name has been determined, it is used to send a query to DNS. The DNS is queried for SRV records specified in Oracle Internet Directory-specific format. For example, if the domain name obtained is `example.net`, the query for non-SSL LDAP servers is for SRV resource records having the owner name `_ldap._tcp._oid.example.net`.

It is possible that no SRV resource records are returned from the DNS. In such a case the DNS lookup is performed for the SRV resource records specified in standard format. For example, the owner name would be `_ldap._tcp.example.net`.

The result of the query is a set of SRV records. These records are then sorted and the host information is extracted from them. This information is then returned to the user.

---

---

**Note:** The approaches mentioned here can also be tried in succession, stopping when the query lookup of DNS is successful. Try the approaches in the order as described in this section. DNS is queried only for SRV records in Oracle Internet Directory-specific format. If none of the approaches is successful, then all the approaches are tried again, but this time DNS is queried for SRV records in standard format.

---

---

### 4.6.4 Environment Variables for DNS Server Discovery

The following environment variables override default behavior for discovering a DNS server.

**Table 4–1 Environment Variables for DNS Discovery**

Environment Variable	Description
ORA_LDAP_DNS	IP address of the DNS server containing the SRV records. If the variable is not defined, then the DNS server address is obtained from the host machine.
ORA_LDAP_DNSPORT	Port number on which the DNS server listens for queries. If the variable is not defined, then the DNS server is assumed to be listening at standard port number 53.
ORA_LDAP_DOMAIN	Domain of the host machine. If the variable is not defined, then the domain is obtained from the host machine itself.

### 4.6.5 Programming Interfaces for DNS Server Discovery

The programming interface provided is a single interface to discover directory server information without regard to the mechanism or standard used to obtain it. Information can be discovered from various sources. Each source can use its own mechanism to discover the information. For example, the LDAP host and port information can be discovered from the DNS acting as the source. Here DSD is used to discover host name information from the DNS.

**See Also:** For detailed reference information and class descriptions, refer to the Javadoc located on the product CD.



---

## Using the Java API Extensions to JNDI

This chapter describes how to use Java API extensions to the Java Naming and Directory Interface (JNDI) to perform many of the operations introduced in Chapter 3.

The Oracle extensions to the standard APIs are documented in detail in the *Oracle Fusion Middleware Java API Reference for Oracle Internet Directory*.

This chapter includes the following sections:

- Section 5.1, "Installing the Java Extensions"
- Section 5.2, "Using the oracle.ldap.util Package to Model LDAP Objects"
- Section 5.3, "The Classes PropertySetCollection, PropertySet, and Property"
- Section 5.4, "Managing Users"
- Section 5.5, "Authenticating Users"
- Section 5.6, "Creating Users"
- Section 5.7, "Retrieving User Objects"
- Section 5.8, "Retrieving Objects from Realms"
- Section 5.9, "Example: Search for Oracle Single Sign-On Login Name"
- Section 5.10, "Discovering a Directory Server"
- Section 5.11, "Example: Discovering a Directory Server"
- Section 5.12, "Using DIGEST-MD5 to Perform SASL Authentication"
- Section 5.13, "Example: Using SASL Digest-MD5 auth-int and auth-conf Modes"
- Section 5.14, "Using LDAP Transactions"
- Section 5.15, "Example: Using LDAP Transactions"

### 5.1 Installing the Java Extensions

The Java extensions are installed along with the standard Java APIs when the LDAP client is installed. The APIs and their extensions are found at `ORACLE_HOME/jlib/ldapjclnt10.jar`.

### 5.2 Using the oracle.ldap.util Package to Model LDAP Objects

In Java, LDAP entities—users, groups, realms, and applications—are modeled as Java objects instead of as handles. This modeling is done in the `oracle.java.util` package.

All other utility functionality is modeled either as individual objects—as, for example, GUID—or as static member functions of a utility class.

For example, to authenticate a user, an application must follow these steps:

1. Create `oracle.ldap.util.User` object, given the user DN.
2. Create a `DirContext` JNDI object with all of the required properties, or get one from a pool of `DirContext` objects.
3. Invoke the `User.authenticateUser` method, passing in a reference to the `DirContext` object and the user credentials.
4. If the `DirContext` object was retrieved from a pool of existing `DirContext` objects, return it to that pool.

Unlike their C and PL/SQL counterparts, Java programmers do not have to explicitly free objects. The Java garbage collection mechanism performs this task.

### 5.3 The Classes `PropertySetCollection`, `PropertySet`, and `Property`

Many of the methods in the `user`, `subscriber`, and `group` classes return a `PropertySetCollection` object. The object represents a collection of one or more LDAP entries. Each of these entries is represented by a `PropertySet` object, identified by a DN. A property set can contain attributes, each represented as a property. A property is a collection of one or more values for the particular attribute it represents. An example of the use of these classes follows:

```
PropertySetCollection psc = Util.getGroupMembership( ctx,
                                                    myuser,
                                                    null,
                                                    true );

    // for loop to go through each PropertySet
    for (int i = 0; i < psc.size(); i++) {

        PropertySet ps = psc.getPropertySet(i);

        // Print the DN of each PropertySet
        System.out.println("dn: " + ps.getDN());

        // Get the values for the "objectclass" Property
        Property objectclass = ps.getProperty( "objectclass" );

        // for loop to go through each value of Property "objectclass"
        for (int j = 0; j < objectclass.size(); j++) {

            // Print each "objectclass" value
            System.out.println("objectclass: " + objectclass.getValue(j));
        }
    }
}
```

The entity `myuser` is a user object. The `psc` object contains all the nested groups that `myuser` belongs to. The code loops through the resulting entries and prints out all the object class values of each entry.

### 5.4 Managing Users

All user-related functionality is abstracted in a Java class called `oracle.ldap.util.User`. The process works like this:



1. Construct a `oracle.ldap.util.User` object based on a DN, GUID, or simple name.
2. Invoke `User.authenticateUser(DirContext, int, Object)` to authenticate the user if necessary.
3. Invoke `User.getProperties(DirContext)` to get the attributes of the user entry.
4. Invoke `User.getExtendedProperties(DirContext, int, String[])` to get the extended properties of the user. `int` is either `shared` or `application-specific`. `String[]` is the object that represents the type of property desired. If `String[]` is null, all properties in a given category are retrieved.
5. Invoke `PropertySetCollection.getProperties(int)` to get the metadata required to parse the properties returned in step 4.
6. Parse the extended properties and continue with application-specific logic. This parsing is also performed by application-specific logic.

## 5.5 Authenticating Users

User authentication is a common LDAP operation that compares the credentials that a user provides at login with the user's credentials in the directory. Oracle Internet Directory supports the following:

- Arbitrary attributes can be used during authentication
- Appropriate password policy exceptions are returned by the authentication method. Note, however, that the password policy applies only to the `userpassword` attribute.

The following code fragment shows how the API is used to authenticate a user:

```
// User user1 - is a valid User Object
try
{
    user1.authenticateUser(ctx,
        User.CREDTYPE_PASSWD, "welcome");

    // or
    // user1.authenticateUser(ctx, <any
attribute>, <attribute value>);
}
catch (UtilException ue)
{
    // Handle the password policy error
    accordingly
    if (ue instanceof PasswordExpiredException)
        // do something
    else if (ue instanceof GraceLoginException)
        // do something
}
```

## 5.6 Creating Users

The subscriber class uses the `createUser()` method to programmatically create users. The object classes required by a user entry are configurable through Oracle Delegated Administration Services. The `createUser()` method assumes that the client understands the requirement and supplies the values for the mandatory attributes during user creation. If the programmer does not supply the required information the server returns an error.

The following snippet of sample code demonstrates the usage.

```
// Subscriber sub is a valid Subscriber object
// DirContext ctx is a valid DirContext

// Create ModPropertySet object to define all the attributes and their values.
ModPropertySet mps = new ModPropertySet();
mps.addProperty(LDIF.ATTRIBUTE_CHANGE_TYPE_ADD, "cn", "Anika");
mps.addProperty(LDIF.ATTRIBUTE_CHANGE_TYPE_ADD, "sn", "Anika");
mps.addProperty(LDIF.ATTRIBUTE_CHANGE_TYPE_ADD, "mail",
"Anika@example.com");

// Create user by specifying the nickname and the ModPropertySet just defined
User newUser = sub.createUser( ctx, mps, true);

// Print the newly created user DN
System.out.println( newUser.getDN(ctx) );

// Perform other operations with this new user
```

## 5.7 Retrieving User Objects

The subscriber class offers the `getUser()` method to replace the public constructors of the `User` class. A user object is returned based on the specified information.

The following is a piece of sample code demonstrating the usage:

```
// DirContext ctx is contains a valid directory connection with
sufficient privilege to perform the operations

// Creating RootOracleContext object
RootOracleContext roc = new RootOracleContext(ctx);

// Obtain a Subscriber object representing the default
subscriber
Subscriber sub = roc.getSubscriber(ctx,
Util.IDTYPE_DEFAULT, null, null);

// Obtain a User object representing the user whose
nickname is "Anika"
User user1 = sub.getUser(ctx, Util.IDTYPE_SIMPLE, "Anika",
null);
// Do work with this user
```

The `getUser()` method can retrieve users based on DN, GUID and simple name. A `getUsers()` method is also available to perform a filtered search to return more than one user at a time. The returned object is an array of `User` objects. For example,

```
// Obtain an array of User object where the user's nickname
starts with "Ani"
User[] userArr = sub.getUsers(ctx, Util.IDTYPE_SIMPLE,
"Ani", null);
// Do work with the User array
```

## 5.8 Retrieving Objects from Realms

This section describes how the Java API can be used to retrieve objects in identity management realms.

The `RootOracleContext` class represents the root Oracle Context. Much of the information needed for identity management realm creation is stored within the root Oracle Context. The `RootOracleContext` class offers the `getSubscriber()` method. It replaces the public constructors of the subscriber class and returns an identity management realm object based on the specified information.

The following is a piece of sample code demonstrating the usage:

```
// DirContext ctx contains a valid directory
// connection with sufficient privilege to perform the
// operations

// Creating RootOracleContext object
RootOracleContext roc = new RootOracleContext(ctx);

// Obtain a Subscriber object representing the
// Subscriber with simple name "Oracle"
Subscriber sub = roc.getSubscriber(ctx,
Util.IDTYPE_SIMPLE, "Oracle", null);

// Do work with the Subscriber object
```

## 5.9 Example: Search for Oracle Single Sign-On Login Name

The following example shows how to find a user's login name when you have the simple name, GUID, or DN. The Oracle Single Sign-On login name is also referred to as nickname.

There are two parts to this example:

1. Determine which attribute is used to store the nickname in this realm.
2. Retrieve the User object and determine the value of the nickname attribute.

```
import javax.naming.*;
import javax.naming.directory.*;
import javax.naming.ldap.*;
import oracle.ldap.util.jndi.*;
import oracle.ldap.util.*;
import java.io.*;

public class NickNameSearch {

    public static void main(String[] args)
        throws Exception
    {
        InitialLdapContext ctx = ConnectionUtil.getDefaultDirCtx( args[0],
            args[1], args[2], args[3]);

        RootOracleContext roc=new RootOracleContext(ctx);
        Subscriber sub = null;
        sub = roc.getSubscriber(ctx, Util.IDTYPE_DEFAULT, null, null) ;

        PropertySetCollection psc = sub.getProperties(ctx,
            Subscriber.USER_NAMING_PROPERTIES, null);

        String nickNameAttribute = null;
        try
        {
            nickNameAttribute = (String)
psc.getPropertySet(0).getProperty(Subscriber.USER_NAMING_ATTR_SIMPLE).getValue(0);
```

```

    }
    catch (Exception e)
    {
        // unable to retrieve the attribute name
        System.exit(0);
    }
    System.out.println("Nickname attribute: " + nickNameAttribute);

    // Retrieve user using simple name, guid or DN
    User user = sub.getUser(ctx, Util.IDTYPE_SIMPLE,"orcladmin", null);
    System.out.println("user DN: " + user.getDN(ctx));

    // Retrieve nickname value using User object
    psc = user.getProperties(ctx, new String[]{ nickNameAttribute });

    String nickName = null;
    try
    {
        nickName = (String)
psc.getPropertySet(0).getProperty(nickNameAttribute).getValue(0);
    }
    catch (Exception e)
    {
        // unable to retrieve the attribute value
        System.exit(0);
    }
    System.out.println("Nickname : " + nickName);
}
}

```

## 5.10 Discovering a Directory Server

A new Java class, the public class, has been introduced:

```
public class oracle.ldap.util.discovery.DiscoveryHelper
```

This class provides a method for discovering specific information from the specified source.

**Table 5–1** *Methods for Directory Server Discovery*

Method	Description
discover	Discovers the specific information from a given source
setProperty	Sets the properties required for discovery
getProperty	Accesses the value of properties

Two new methods are added to the existing Java class

```
oracle.ldap.util.jndi.ConnectionUtil:
```

- `getDefaultDirCtx`: This overloaded function determines the host name and port information of non-SSL ldap servers by making an internal call to `oracle.ldap.util.discovery.DiscoveryHelper.discover()`.
- `getSSLDirCtx`: This overloaded function determines the host name and port information of SSL ldap servers by making an internal call to `oracle.ldap.util.discovery.DiscoveryHelper.discover()`.

## 5.11 Example: Discovering a Directory Server

The following is a sample Java program for directory server discovery:

```
import java.util.*;
import java.lang.*;
import oracle.ldap.util.discovery.*;
import oracle.ldap.util.jndi.*;

public class dsdtest
{
    public static void main(String s[]) throws Exception
    {
        HashMap reshdl = new HashMap();
        String result = new String();
        Object resultObj = new Object();
        DiscoveryHelper disco = new
DiscoveryHelper(DiscoveryHelper.DNS_DISCOVER);

        // Set the property for the DNS_DN
disco.setProperty(DiscoveryHelper.DNS_DN, "dc=us,dc=fiction,dc=com")
;

        // Set the property for the DNS_DISCOVER_METHOD
disco.setProperty(DiscoveryHelper.DNS_DISCOVER_METHOD,
DiscoveryHelper.USE_INPUT_DN_METHOD);

        // Set the property for the SSLMODE
disco.setProperty(DiscoveryHelper.SSLMODE, "0");

        // Call the discover method
int res=disco.discover(reshdl);
if (res!=0)
    System.out.println("Error Code returned by the discover method is :"+res) ;

        // Print the results
printReshdl(reshdl);
}

public static void printReshdl(HashMap reshdl)
{
    ArrayList result = (ArrayList)reshdl.get(DiscoveryHelper.DIR_SERVERS);

    if (result != null)
    {
        if (result.size() == 0) return;
        System.out.println("The hostnames are :-");
        for (int i = 0; i< result.size();i++)
        {
            String host = (String)result.get(i);
            System.out.println((i+1)+".
"+host+"");
        }
    }
}
}
```

## 5.12 Using DIGEST-MD5 to Perform SASL Authentication

When using JNDI to create a SASL connection, you must set these `javax.naming.Context` properties:

- `Context.SECURITY_AUTHENTICATION = "DIGEST-MD5"`
- `Context.SECURITY_PRINCIPAL`

The latter sets the principal name. This name is a server-specific format. It can be either of the following:

- The DN—that is, `dn:`—followed by the fully qualified DN of the entity being authenticated
- The string `u:` followed by the user identifier.

The Oracle directory server accepts just a fully qualified DN such as `cn=user,ou=my department,o=my company`.

---



---

**Note:** The SASL DN must be normalized before it is passed to the API that calls the SASL bind. To generate SASL verifiers, Oracle Internet Directory supports only normalized DNs.

---



---

## 5.13 Example: Using SASL Digest-MD5 auth-int and auth-conf Modes

The following code provides an example of Java LDAP/JNDI using SASL Digest-MD5.

```

/* $Header: LdapSasl.java 27-oct-2005.11:26:59 qdinh Exp $ */

/* Copyright (c) 2003, 2005, Oracle. All rights reserved. */

/*
DESCRIPTION
<short description of component this file declares/defines>

PRIVATE CLASSES
<list of private classes defined - with one-line descriptions>

NOTES
<other useful comments, qualifications, and so on.>

MODIFIED      (MM/DD/YY)
qdinh         04/23/03 - Creation
*/

/**
 * @version $Header: LdapSasl.java 27-oct-2005.11:26:59 qdinh Exp $
 * @author qdinh * @since release specific (what release of product did this
 * appear in)
 */

package oracle.ldap.util.jndi;

import javax.naming.*;
import javax.naming.directory.*;
import javax.naming.ldap.*;
import oracle.ldap.util.jndi.*;
import oracle.ldap.util.*;
import java.lang.*;

```

```

import java.util.*;
public class LdapSasl
{
    public static void main( String[] args)
        throws Exception
    {

        int numofargs;

        numofargs = args.length;

        Hashtable hashtable = new Hashtable();

        // Look through System Properties for Context Factory if it is available
        // then set the CONTEXT factory only if it has not been set
        // in the environment -
        // set default to com.sun.jndi.ldap.LdapCtxFactory

        hashtable.put(Context.INITIAL_CONTEXT_FACTORY,
            "com.sun.jndi.ldap.LdapCtxFactory");
        // possible valid arguments
        // args[0] - hostname
        // args[1] - port number
        // args[2] - Entry DN
        // args[3] - Entry Password
        // args[4] - QoP [ auth | auth-int | auth-conf ]
        // args[5] - SASL Realm
        // args[6] - Cipher Choice
        //   If QoP == "auth-conf" then args[6] cipher choice can be
        //   - des
        //   - 3des
        //   - rc4
        //   - rc4-56
        //   - rc4-40

        hashtable.put(Context.PROVIDER_URL, "ldap://" + args[0] + ":" + args[1]);
        hashtable.put(Context.SECURITY_AUTHENTICATION, "DIGEST-MD5");
        System.out.println("hash put security dn: " + args[2]);
        hashtable.put(Context.SECURITY_PRINCIPAL, args[2] );
        hashtable.put(Context.SECURITY_CREDENTIALS, args[3] );

        // For Quality of Protection modes
        // 1. Authentication and Data Integrity Mode - "auth-int"
        // 2. Authentication and Data Confidentiality Mode "auth-conf"

        //
        // hashtable.put("javax.security.sasl.qop", args[4]);
        hashtable.put("javax.naming.security.sasl.realm", args[5]);

        // Setup Quality of Protection
        //
        // System.out.println("hash sasl.qop: " + args[4]);

        hashtable.put("javax.security.sasl.qop", args[4]);

        if (numofargs > 4)
        {
            if (args[4].equalsIgnoreCase("AUTH-CONF"))
            {

```

```

        // Setup a cipher choice only if QoP == "auth-conf"
        String strength = "high";
        String cipher = new String(args[6]);
        if (cipher.compareToIgnoreCase("rc4-40") == 0)
            strength = "low";
        else if (cipher.compareToIgnoreCase("rc4-56") == 0 ||
            cipher.compareToIgnoreCase("des")== 0 )
            strength = "medium";
        else if (cipher.compareToIgnoreCase("3des") == 0 ||
            cipher.compareToIgnoreCase("rc4") == 0)
            strength = "high";

        // setup cipher choice
        System.out.println("hash sasl.strength:"+strength);
        hashtable.put("javax.security.sasl.strength", strength);
    }

    // set maxbuffer length if necessary
    if (numofargs > 7 && !" ".equals(args[6]))
        hashtable.put("javax.security.sasl.maxbuf", args[5].toString());
    }

    // Enable Debug --
    // hashtable.put("com.sun.jndi.ldap.trace.ber", System.err);

    LdapContext ctx = new InitialLdapContext(hashtable, null);

    // At this stage - SASL Digest -MD5 has been successfully

    System.out.println("sasl bind successful");

    // Ldap Search Scope Options
    //
    // - Search base - OBJECT_SCOPE
    // - One Level   - ONELEVEL_SCOPE
    // - Sub Tree    - SUBTREE_SCOPE
    //
    // Doing an LDAP Search
    PropertySetCollection psc =
    Util.ldapSearch(ctx, "o=oracle,dc=com", "objectclass=*", SearchControls.OBJECT_SCOPE,
        new String[] {"*"});
    // Print out the search result
    Util.printResults(psc);

    System.exit(0);
}
}

```

## 5.14 Using LDAP Transactions

As of 11g Release 1 (11.1.1.6), the Oracle Internet Directory SDK supports transactions, as defined in RFC 5805.

**See Also:** RFC 5805 on Lightweight Directory Access Protocol (LDAP) Transactions at: <http://www.ietf.org>



Transactions are necessary to support a number of applications, including provisioning. When a transaction is committed, either all operations within the transaction update succeed or all fail. Oracle Internet Directory publishes the Object Identifiers of the extended operations and the control as `supportedExtension` and `supportedControl` in the root DSE.

Oracle Internet Directory LDAP transactions use the following entities.

- **Start Transaction Request (Object Identifier 1.3.6.1.1.21.1):** This is an LDAP extended operation that facilitates grouping of related operations for starting a transaction. It is an LDAPMessage of CHOICE `extendedReq` where `requestName` is 1.3.6.1.1.21.1 and the `requestValue` is absent.
- **Start Transaction Response:** This is sent by Oracle Internet Directory server in response to a Start Transaction Request. It is an LDAPMessage of CHOICE `extendedRes`. Its `responseName` is absent. Upon success, `resultCode` (0), `responseValue` is present and contains the transaction identifier. Upon failure, for example a malformed request, the `responseValue` is absent.
- **Transaction Specification Control (Object Identifier 1.3.6.1.1.21.2):** This is an LDAPControl indicating association of an operation to a transaction by means of the transaction identifier, which is the value of this control. Its `criticality` is TRUE.
- **End Transaction Request (Object Identifier 1.3.6.1.1.21.3):** This is another LDAP extended operation used to indicate the end of a transaction. This indicates the settling of the transaction, resulting in a commit or abort of the transaction. This LDAPMessage has a CHOICE `extendedReq` where the `requestName` is 1.3.6.1.1.21.3 and the `requestValue` is present and contains BER-encoded transaction request.

A commit value of TRUE indicates a request to commit the transaction identified by the identifier. A commit value of FALSE indicates a request to abort the identified transaction.

- **End Transaction Response:** This is an LDAPMessage response of Oracle Internet Directory server to an End Transaction Request. Its response name is absent. The `responseValue`, when present, contains a BER-encoded transaction response.
- **Aborted Transaction Notice (Object Identifier 1.3.6.1.1.21.4):** This is an Unsolicited Notification message where `responseName` is 1.3.6.1.1.21.4 and `responseValue` is present and contains a transaction identifier.

The following is the sequence of requests and responses between the Oracle Internet Directory server and its client in an LDAP transaction.

1. A client issues a Start Transaction Request to Oracle Internet Directory server.
2. Oracle Internet Directory server responds to this request with a Start Transaction Response providing a transaction identifier and with a `resultCode` of success (0). Upon failure, for example, in the case of a malformed request, the server responds with a Start Transaction Response with a `resultCode` other than success indicating the nature of the error.

This transaction identifier generated and sent to client in a success case is used in subsequent protocol messages to identify this transaction.

3. If the client receives a success result code from the server, it then attaches a Transaction Specification Control containing the transaction identifier to each of the update operations to indicate that they are to be processed as part of a single transaction. For a valid response, Oracle Internet Directory sends a success. Otherwise it sends to its client an appropriate response to the request with a `resultCode` along with a detailed nature of the failure.

4. After the client is done sending all the update operations of the transaction, accompanied by the Transaction Specification Control containing the transaction identifier to Oracle Internet Directory server, it sends an End Transaction Request including the transaction identifier to Oracle Internet Directory server, indicating that it wants to settle the transaction. A commit value of TRUE indicates a request to commit the transaction while a value of FALSE indicates a request to abort the transaction.
5. Upon receiving a request to abort the transaction, Oracle Internet Directory server aborts the identified transaction by abandoning all the operations that were part of the transaction and indicates that it has done so by returning an End Transaction Response with a resultCode of success (0). Upon receiving a request to commit the transaction, Oracle Internet Directory server applies commit to DB for the updates it performed for all the operations in the transaction. If it succeeds, the server returns an End Transaction Response with a resultCode of success (0). Otherwise, it returns an End Transaction Response with a non-success resultCode, indicating the nature of the failure.

There is no requirement that the server serialize transactions or updates requested outside of the transaction. That is, the server may process multiple commit requests, from one or more clients, acting upon different sets of entries concurrently.

6. If, at any time during the above exchange between the client and server, the server is unable to continue the specification of a transaction, the server issues an Aborted Transaction Notice. Upon receiving this notice, the client must discontinue all use of the transaction identifier and the transaction is null and void. All operations that were to be processed as part of the transaction are implicitly abandoned. Any further use of the identifier by the client results in a response containing a failure resultCode from Oracle Internet Directory server.
7. If, at any time during the above exchange between the client and server, the client closes the connection to Oracle Internet Directory server, the server performs the necessary connection-related clean up.

## 5.15 Example: Using LDAP Transactions

This section provides a brief outline of the steps required to develop a JNDI-based LDAP transaction Java client module using LDAP extended operations. The steps include implementing four interfaces: Start Transaction Request, Start Transaction Response, End Transaction Request, and End Transaction Response. The classes implementing these four interfaces must be used in code performing LDAP update operations within transaction semantics. The following sample code snippets show the four implemented interfaces and their use in a sample LDAP update operations with transaction semantics.

### 5.15.1 Start Transaction Request interface implementation (LdapStartTxnReq.java)

```
import java.lang.*;
import java.util.*;
import java.io.*;
import javax.naming.*;
import javax.naming.directory.*;
import javax.naming.ldap.*;

public class LdapStartTxnReq implements ExtendedRequest
{
```

```

public static final String TXN_REQ_OID = "1.3.6.1.1.21.1";

// constructor
public LdapStartTxnReq()
{
}

// Method for getting the request ID

public String getID() {

    return TXN_REQ_OID;

}

public byte[] getEncodedValue() {

    return null; // No value is needed for Start Txn request
}

public ExtendedResponse createExtendedResponse(String id, byte[] berValue,
                                               int offset, int length)
    throws NamingException

{
    return new LdapStartTxnRes(id, berValue, offset, length);
}
}

```

### 5.15.2 Start Transaction Response interface implementation (LdapStartTxnRes.java)

```

import java.lang.*;
import java.util.*;
import java.io.*;
import javax.naming.*;
import javax.naming.directory.*;
import javax.naming.ldap.*;

public class LdapStartTxnRes implements ExtendedResponse
{
    public String txnID;

    // Called by LdapStartTxnReq.createExtendedResponse()
    protected LdapStartTxnRes(String id, byte[] berValue, int offset, int length)
        throws NamingException
    {
        byte[] buff2 = new byte[length];

        System.arraycopy(berValue, offset, buff2, 0, length);

        try
        {
            this.txnID = new String(berValue, "UTF8");
        }
        catch (Exception e)
        {
            System.out.println(e);
        }
    }
}

```

```
    }

    public String getTxnID()
    {
        return txnID;
    }

    // No op for our case
    public byte[] getEncodedValue()
    {
        return null;
    }

    public String getID()
    {
        return null; // as have no response ID.
    }
}
```

### 5.15.3 End Transaction Request interface implementation (LdapEndTxnReq.java)

```
import java.lang.*;
import java.util.*;
import java.io.*;
import javax.naming.*;
import javax.naming.ldap.*;
import oracle.ldap.util.ber.*;

public class LdapEndTxnReq implements ExtendedRequest
{
    public static final String TXN_END_REQ_OID = "1.3.6.1.1.21.3";
    private int sequenceTag = 0x30;
    private boolean commitValue;
    private String controlValue;

    // constructor
    public LdapEndTxnReq(boolean commitVal, String controlVal)
    {
        this.commitValue = commitVal;
        this.controlValue = controlVal;
    }

    // Method to get End Txn Request ID
    public String getID() {
        return TXN_END_REQ_OID;
    }

    public byte[] getEncodedValue()
    {
        boolean encodeUTF8 = true;
        byte[] bytes = null;

        try
        {
            BEREncoder berElement = new BEREncoder();

            berElement.beginSeq(sequenceTag);
```

```

        berElement.encodeBoolean(this.commitValue);

        berElement.encodeString(this.controlValue, encodeUTF8);

        berElement.endSeq();
        bytes = berElement.getTrimmedBuf();

        return bytes;
    }
    catch (EncodeException e)
    {
        return null;
    }
}

public ExtendedResponse createExtendedResponse(String id, byte[] berValue,
                                               int offset, int length)
    throws NamingException
{
    return null;
}
}

```

#### 5.15.4 End Transaction Response interface implementation (LdapEndTxnRes.java)

```

import java.lang.*;
import java.util.*;
import java.io.*;
import javax.naming.*;
import javax.naming.directory.*;
import javax.naming.ldap.*;

public class LdapEndTxnRes implements ExtendedResponse
{
    // constructor
    LdapEndTxnRes(String id, byte[] berValue, int offset, int length)
        throws NamingException
    {
        ;
    }

    public String getTxnID()
    {
        return null;
    }

    public byte[] getEncodedValue()
    {
        return null;
    }

    public String getID()
    {
        return null;
    }
}

```

## 5.15.5 Java and Pseudocode Sample of Interfaces in LDAP Update Operations Within Transaction Semantics (LdapTxnOperation.java)

```

import java.lang.*;
import java.util.*;
import java.io.*;
import javax.naming.*;
import javax.naming.directory.*;
import javax.naming.ldap.*;

    .
    .
    .

public class LdapTxnOperation implements .....
{
    public static void main( String[] args )
    {
        try
        {
            LdapContext ctx;

            Perform ldapbind against OID server on the LDAP context ctx;

            If bind is successful
            {
                /* Issue LDAP Start Transaction Request to OID server and
                receive its response */
                LdapStartTxnRes startResp =
(LdapStartTxnRes)ctx.extendedOperation(new
LdapStartTxnReq());
                /* Extract the transaction ID sent by OID server */
                String txnID = startResp.getTxnID();

                Issue LDAP update operations (add, delete, modify) to OID server each containing
                the Transaction Control with ID 1.3.6.1.1.21.2 and value of the transaction ID;

                /* Vendor's technical doc link is provided in Reference section below */

                /* After done sending all update operations, issue LDAP End Transaction Request
                to OID server with your intention to either commit or abort the transaction and
                receive its response. */

                If want to commit the transaction
                { /* commit request */
                    LdapEndTxnRes endResp = (LdapEndTxnRes)ctx.extendedOperation(new
LdapEndTxnReq(true, txnID));
                }
                Else
                { /* abort request */
                    LdapEndTxnRes endResp = (LdapEndTxnRes)ctx.extendedOperation(new
LdapEndTxnReq(false, txnID));
                }
            }
            catch( Exception e)
            {
                e.printStackTrace();
                return;
            }
        }
        return ;
    }
}

```

```
}
```





---

---

## Using the API Extensions in PL/SQL

This chapter explains how to use PL/SQL extensions to the standard directory APIs to manage and authenticate users.

The Oracle extensions do not include PL/SQL APIs that create users. The Oracle extensions to the standard APIs are documented in full in [Chapter 11](#).

This chapter includes the following sections:

- [Section 6.1, "Installing the PL/SQL Extensions"](#)
- [Section 6.2, "Using Handles to Access Directory Data"](#)
- [Section 6.3, "Managing Users"](#)
- [Section 6.4, "Authenticating Users"](#)
- [Section 6.5, "Dependencies and Limitations of the PL/SQL LDAP API"](#)

### 6.1 Installing the PL/SQL Extensions

The PL/SQL extensions are installed with the `DBMS_LDAP` package when the Oracle database is installed. You must run the script `$ORACLE_HOME/rdbms/admin/catldap.sql`.

### 6.2 Using Handles to Access Directory Data

Most of the extensions described in this chapter are helper functions. They access data about specific LDAP entities such as users, groups, realms, and applications. In many cases, these functions must pass a reference to one of these entities to the standard API functions. To do this, the API extensions use opaque data structures called handles. The steps that follow show an extension creating a user handle:

1. Establish an LDAP connection or get one from a pool of connections.
2. Create a user handle from user input. This could be a DN, a GUID, or a single sign-on user ID.
3. Authenticate the user with the LDAP connection handle, user handle, or credentials.
4. Free the user handle.
5. Close the LDAP connection, or return the connection back to the connection pool.

## 6.3 Managing Users

The steps that follow show how the `DBMS_LDAP_UTL` package is used to create and use a handle that retrieves user properties from the directory.

1. Invoke `DBMS_LDAP_UTL.create_user_handle(user_hd, user_type, user_id)` to create a user handle from user input. The input can be a DN, a GUID, or a single sign-on user ID.
2. Invoke `DBMS_LDAP_UTL.set_user_handle_properties(user_hd, property_type, property)` to associate a realm with the user handle.
3. Invoke `DBMS_LDAP_UTL.get_user_properties(ld, user_handle, attrs, ptype, ret_pset_coll)` to place the attributes of a user entry into a result handle.
4. Invoke `DBMS_LDAP_UTL.get_property_names(pset, property_names)` and `DBMS_LDAP_UTL.get_property_values(pset, property_name, property_values)` to extract user attributes from the result handle that you obtained in step 3.

## 6.4 Authenticating Users

Use `DBMS_LDAP_UTL.authenticate_user(session, user_handle, auth_type, cred, binary_cred)` to authenticate a user to the directory. This function compares the password provided by the user with the password attribute in the user's directory entry.

## 6.5 Dependencies and Limitations of the PL/SQL LDAP API

The PL/SQL LDAP API for this release has the following limitations:

- The LDAP session handles obtained from the API are valid only for the duration of the database session. The LDAP session handles cannot be written to a table and reused in other database sessions.
- Only synchronous versions of LDAP API functions are supported in this release.

The PL/SQL LDAP API requires a database connection to work. It cannot be used in client-side PL/SQL engines (like Oracle Forms) without a valid database connection.

---

---

## Developing Provisioning-Integrated Applications

In the 10g (10.1.4.0.1) release, new APIs were added for developing provisioning-integrated applications.

Nothing has changed for 11g Release 1 (11.1.1). For more information, see *Oracle Fusion Middleware Administrator's Guide for Oracle Directory Integration Platform*.



# Part II

---

## Oracle Internet Directory Programming Reference

Part II presents the standard APIs and the Oracle extensions to these APIs. It contains these chapters:

- Chapter 8, "C API Reference"
- Chapter 9, "DBMS\_LDAP PL/SQL Reference"
- Chapter 10, "Java API Reference"
- Chapter 11, "DBMS\_LDAP\_UTL PL/SQL Reference"
- Chapter 12, "Oracle Directory Integration and Provisioning Java API Reference"
- Chapter 13, "Oracle Directory Integration Platform PL/SQL API Reference"



This chapter introduces the Oracle Internet Directory C API and provides examples of how to use this API.

This chapter includes the following sections:

- [Section 8.1, "About the Oracle Internet Directory C API"](#)
- [Section 8.2, "Functions in the C API"](#)
- [Section 8.3, "Sample C API Usage"](#)
- [Section 8.4, "Required Header Files and Libraries for the C API"](#)
- [Section 8.5, "Dependencies and Limitations of the C API"](#)

### 8.1 About the Oracle Internet Directory C API

The Oracle Internet Directory SDK C API is based on LDAP Version 3 C API and Oracle extensions to support SSL.

You can use the Oracle Internet Directory API 11g Release 1 (11.1.1) in the following modes:

- **SSL**—All communication secured by using SSL
- **Non-SSL**—Client/server communication not secure

The API uses TCP/IP to connect to a directory server. When it does this, it uses, by default, an unencrypted channel. To use the SSL mode, you must use the Oracle SSL call interface. You determine which mode you are using by the presence or absence of the SSL calls in the API usage. You can easily switch between SSL and non-SSL modes.

**See Also:** [Section 8.3, "Sample C API Usage"](#) for more details on how to use the two modes.

This section contains these topics:

- [Section 8.1.1, "Oracle Internet Directory SDK C API SSL Extensions"](#)
- [Section 8.2.1, "The Functions at a Glance"](#)

#### 8.1.1 Oracle Internet Directory SDK C API SSL Extensions

Oracle SSL extensions to the LDAP API are based on standard SSL protocol. The SSL extensions provide encryption and decryption of data over the wire and authentication.

There are three modes of authentication:

- None—Neither client nor server is authenticated, and only SSL encryption is used
- One-way—Only the server is authenticated by the client
- Two-way—Both the server and the client are authenticated by each other

The type of authentication is indicated by a parameter in the SSL interface call.

### 8.1.1.1 SSL Interface Calls

There is only one call required to enable SSL:

```
int ldap_init_SSL(Socketbuf *sb, char *sslwallet, char *sslwalletpasswd, int
sslauthmode)
```

The `ldap_init_SSL` call performs the necessary handshake between client and server using the standard SSL protocol. If the call is successful, then all subsequent communication happens over a secure connection.

**Table 8–1 Arguments for SSL Interface Calls**

Argument	Description
<code>sb</code>	Socket buffer handle returned by the <code>ldap_open</code> call as part of LDAP handle.
<code>sslwallet</code>	Location of the user wallet.
<code>sslwalletpasswd</code>	Password required to use the wallet.
<code>sslauthmode</code>	SSL authentication mode user wants to use. Possible values are: <ul style="list-style-type: none"> <li>■ <code>GSLC_SSL_NO_AUTH</code>—No authentication required</li> <li>■ <code>GSLC_SSL_ONWAY_AUTH</code>—Only server authentication required.</li> <li>■ <code>GSLC_SSL_TWOWAY_AUTH</code>—Both server and client authentication required.</li> </ul> <p>A return value of 0 indicates success. A nonzero return value indicates an error. The error code can be decoded by using the function <code>ldap_err2string</code>.</p>

**See Also:** [Section 8.3, "Sample C API Usage"](#).

### 8.1.1.2 Wallet Support

depending on which authentication mode is being used, both the server and the client may require wallets to use the SSL feature. 11g Release 1 (11.1.1) of the API supports only the Oracle Wallet. You can create wallets by using Oracle Wallet Manager.

## 8.2 Functions in the C API

This section examines each of the functions and procedures in the C API. It explains their purpose and syntax. It also provides tips for using them.

The section contains the following topics:

- [Section 8.2.1, "The Functions at a Glance"](#)
- [Section 8.2.2, "Initializing an LDAP Session"](#)
- [Section 8.2.3, "LDAP Session Handle Options"](#)
- [Section 8.2.4, "Getting Bind Credentials for Chasing Referrals"](#)
- [Section 8.2.5, "Authenticating to the Directory"](#)



- Section 8.2.6, "SASL Authentication Using Oracle Extensions"
- Section 8.2.7, "Working With Controls"
- Section 8.2.8, "Closing the Session"
- Section 8.2.9, "Performing LDAP Operations"
- Section 8.2.10, "Abandoning an Operation"
- Section 8.2.11, "Obtaining Results and Peeking Inside LDAP Messages"
- Section 8.2.12, "Handling Errors and Parsing Results"
- Section 8.2.13, "Stepping Through a List of Results"
- Section 8.2.14, "Parsing Search Results"

## 8.2.1 The Functions at a Glance

Table 8–2 lists all of the functions and procedures in the C API and briefly explains their purpose.

**Table 8–2** *Functions and Procedures in the C API*

Function or Procedure	Description
<code>ber_free</code>	Free the memory allocated for a <code>BerElement</code> structure
<code>ldap_abandon_ext</code> <code>ldap_abandon</code>	Cancel an asynchronous operation
<code>ldap_add_ext</code> <code>ldap_add_ext_s</code> <code>ldap_add</code> <code>ldap_add_s</code>	Add a new entry to the directory
<code>ldap_compare_ext</code> <code>ldap_compare_ext_s</code> <code>ldap_compare</code> <code>ldap_compare_s</code>	Compare entries in the directory
<code>ldap_count_entries</code>	Count the number of entries in a chain of search results
<code>ldap_count_values</code>	Count the string values of an attribute
<code>ldap_count_values_len</code>	Count the binary values of an attribute
<code>ora_ldap_create_clientctx</code>	Create a client context and returns a handle to it.
<code>ora_ldap_create_cred_hdl</code>	Create a credential handle.
<code>ldap_delete_ext</code> <code>ldap_delete_ext_s</code> <code>ldap_delete</code> <code>ldap_delete_s</code>	Delete an entry from the directory
<code>ora_ldap_destroy_clientctx</code>	Destroy the client context.
<code>ora_ldap_free_cred_hdl</code>	Destroy the credential handle.
<code>ldap_dn2ufn</code>	Converts the name into a more user friendly format
<code>ldap_err2string</code>	Get the error message for a specific error code
<code>ldap_explode_dn</code> <code>ldap_explode_rdn</code>	Split up a distinguished name into its components
<code>ldap_first_attribute</code>	Get the name of the first attribute in an entry

**Table 8–2 (Cont.) Functions and Procedures in the C API**

<b>Function or Procedure</b>	<b>Description</b>
ldap_first_entry	Get the first entry in a chain of search results
ora_ldap_get_cred_props	Retrieve properties associated with credential handle.
ldap_get_dn	Get the distinguished name for an entry
ldap_get_option	Access the current value of various session-wide parameters
ldap_get_values	Get the string values of an attribute
ldap_get_values_len	Get the binary values of an attribute
ldap_init ldap_open	Open a connection to an LDAP server
ora_ldap_init_SASL	Perform SASL authentication
ldap_memfree	Free memory allocated by an LDAP API function call
ldap_modify_ext ldap_modify_ext_s ldap_modify ldap_modify_s	Modify an entry in the directory
ldap_msgfree	Free the memory allocated for search results or other LDAP operation results
ldap_first_attribute ldap_next_attribute	Get the name of the next attribute in an entry
ldap_next_entry	Get the next entry in a chain of search results
ldap_perror (Deprecated)	Prints the message supplied in message.
ldap_rename ldap_rename_s	Modify the RDN of an entry in the directory
ldap_result2error (Deprecated)	Return the error code from result message.
ldap_result ldap_msgfree ldap_msgtype ldap_msgid	Check the results of an asynchronous operation
ldap_sasl_bind ldap_sasl_bind_s	General authentication to an LDAP server
ldap_search_ext ldap_search_ext_s ldap_search ldap_search_s	Search the directory
ldap_search_st	Search the directory with a timeout value
ldap_get_option ldap_set_option	Set the value of these parameters
ldap_set_rebind_proc	Set the callback function to be used to get bind credential to a new server when chasing referrals.
ora_ldap_set_clientctx	Add properties to the client context handle.
ora_ldap_set_cred_props	Add properties to credential handle.

**Table 8–2 (Cont.) Functions and Procedures in the C API**

Function or Procedure	Description
ldap_simple_bind ldap_simple_bind_s ldap_sasl_bind ldap_sasl_bind_s	Simple authentication to an LDAP server
ldap_unbind_ext ldap_unbind ldap_unbind_s	End an LDAP session
ldap_value_free	Free the memory allocated for the string values of an attribute
ldap_value_free ldap_value_free_len	Free the memory allocated for the binary values of an attribute

This section lists all the calls available in the LDAP C API found in RFC 1823.

**See Also:** The following URL for a more detailed explanation of these calls:

<http://www.ietf.org>

## 8.2.2 Initializing an LDAP Session

The calls in this section initialize a session with an LDAP server.

### 8.2.2.1 ldap\_init and ldap\_open

ldap\_init() initializes a session with an LDAP server, but does not open a connection. The server is not actually contacted until an operation is performed that requires it, allowing various options to be set after initialization. ldap\_open() initializes a session and opens a connection. The two fulfill the same purpose and have the same syntax, but the first is preferred.

#### Syntax

```
LDAP *ldap_init
(
    const char    *hostname,
    int           portno
)
;
```

## Parameters

**Table 8–3 Parameters for Initializing an LDAP Session**

Parameter	Description
hostname	<p>Contains a space-separated list of host names or dotted strings representing the IP address of hosts running an LDAP server to connect to. Each host name in the list may include a port number. The two must be separated by a colon. The hosts are tried in the order listed until a successful connection occurs.</p> <p>IPv6 addresses must be enclosed in brackets ([]). The following are examples of valid <code>hostname</code> values:</p> <pre>host1.example.com 192.168.1.10 [2002:ae5:4000:1::8c57:352] host1.example.com:3060 192.168.1.10:3060 [2002:ae5:4000:1::8c57:352]:3060</pre>
portno	<p>Contains the TCP port number to connect to. The default LDAP port of 3060 can be obtained by supplying the constant <code>LDAP_PORT</code>. If <code>hostname</code> includes a port number, <code>portno</code> is ignored.</p>

## Usage Notes

`ldap_init()` and `ldap_open()` both return a session handle. This is a pointer to an opaque structure that must be passed to subsequent calls pertaining to the session. These routines return `NULL` if the session cannot be initialized. If the session cannot be initialized, check the error reporting mechanism for the operating system to see why the call failed.

Note that if you connect to an LDAPv2 server, one of the LDAP bind calls described later SHOULD be completed before other operations can be performed on the session. LDAPv3 does not require that a bind operation be completed before other operations are performed.

The calling program can set various attributes of the session by calling the routines described in the next section.

## 8.2.3 LDAP Session Handle Options

The LDAP session handle returned by `ldap_init()` is a pointer to an opaque data type representing an LDAP session. In RFC 1823 this data type was a structure exposed to the caller, and various fields in the structure could be set to control aspects of the session, such as size and time limits on searches.

In the interest of insulating callers from inevitable changes to this structure, these aspects of the session are now accessed through a pair of accessor functions, described in this section.

### 8.2.3.1 `ldap_get_option` and `ldap_set_option`

`ldap_get_option()` is used to access the current value of various session-wide parameters. `ldap_set_option()` is used to set the value of these parameters. Note that some options are read only and cannot be set; it is an error to call `ldap_set_option()` and attempt to set a read only option.

Note that if automatic referral following is enabled (the default), any connections created during the course of following referrals inherit the options associated with the session that sent the original request that caused the referrals to be returned.

### Syntax

```
int ldap_get_option
(
LDAP          *ld,
int           option,
void         *outvalue
)
;

int ldap_set_option
(
LDAP          *ld,
int           option,
const void   *invalue
)
;

#define LDAP_OPT_ON      ((void *)1)
#define LDAP_OPT_OFF    ((void *)0)
```

### Parameters

Table 8–4 lists and describes the parameters for LDAP session handle options.

**Table 8–4 Parameters for LDAP Session Handle Options**

Parameters	Description
ld	The session handle. If this is NULL, a set of global defaults is accessed. New LDAP session handles created with <code>ldap_init()</code> or <code>ldap_open()</code> inherit their characteristics from these global defaults.
option	The name of the option being accessed or set. This parameter should be one of the constants listed and described in Table 8–5 on page 8-8. The hexadecimal value of the constant is listed in parentheses after the constant.
outvalue	The address of a place to put the value of the option. The actual type of this parameter depends on the setting of the option parameter. For outvalues of type <code>char **</code> and <code>LDAPControl **</code> , a copy of the data that is associated with the LDAP session ld is returned. Callers should dispose of the memory by calling <code>ldap_memfree()</code> or <code>ldap_controls_free()</code> , depending on the type of data returned.
invalue	A pointer to the value the option is to be given. The actual type of this parameter depends on the setting of the option parameter. The data associated with invalue is copied by the API implementation to allow callers of the API to dispose of or otherwise change their copy of the data after a successful call to <code>ldap_set_option()</code> . If a value passed for invalue is invalid or cannot be accepted by the implementation, <code>ldap_set_option()</code> should return -1 to indicate an error.

### Constants

Table 8–5 on page 8-8 lists and describes the constants for LDAP session handle options.

**Table 8–5 Constants for LDAP Session Handle Options**

Constant	Type for invalue parameter	Type for outvalue parameter	Description
LDAP_OPT_API_INFO(0x00)	Not applicable. Option is read only.	LDAPAPIInfo*	Used to retrieve some basic information about the LDAP API implementation at execution time. Applications need to be able to determine information about the particular API implementation they are using both at compile time and during execution. This option is read only and cannot be set.
ORA_LDAP_OPT_RFRL_CACHE	void* (LDAP_OPT_ON) void* (LDAP_OPT_OFF)	int *	This option determines whether referral cache is enabled or not. If this option is set to LDAP_OPT_ON, the cache is enabled; otherwise, the cache is disabled.
ORA_LDAP_OPT_RFRL_CACHE_SZ	int *	int *	This option sets the size of referral cache. The size is maximum size in terms of number of bytes the cache can grow to. It is set to 1MB by default.
LDAP_OPT_DEREF (0x02)	int *	int *	Determines how aliases are handled during search. It should have one of the following values: LDAP_DEREF_NEVER (0x00), LDAP_DEREF_SEARCHING (0x01), LDAP_DEREF_FINDING (0x02), or LDAP_DEREF_ALWAYS (0x03). The LDAP_DEREF_SEARCHING value means aliases are dereferenced during the search but not when locating the base object of the search. The LDAP_DEREF_FINDING value means aliases are dereferenced when locating the base object but not during the search. The default value for this option is LDAP_DEREF_NEVER.
LDAP_OPT_SIZELIMIT(0x03)	int *	int *	A limit on the number of entries to return from a search. A value of LDAP_NO_LIMIT (0) means no limit. The default value for this option is LDAP_NO_LIMIT.
LDAP_OPT_TIMELIMIT(0x04)	int *	int *	A limit on the number of seconds to spend on a search. A value of LDAP_NO_LIMIT (0) means no limit. This value is passed to the server in the search request only; it does not affect how long the C LDAP API implementation itself waits locally for search results. The timeout parameter passed to ldap_search_ext_s() or ldap_result()—both of which are described later in this document—can be used to specify both a local and server side time limit. The default value for this option is LDAP_NO_LIMIT.
LDAP_OPT_REFERRALS(0x08)	void *(LDAP_OPT_ON) void *(LDAP_OPT_OFF)	int *	Determines whether the LDAP library automatically follows referrals returned by LDAP servers or not. It may be set to one of the constants LDAP_OPT_ON or LDAP_OPT_OFF. Any non-null pointer value passed to ldap_set_option() enables this option. When the current setting is read using ldap_get_option(), a zero value means off and any nonzero value means on. By default, this option is turned on.
LDAP_OPT_RESTART(0x09)	void *(LDAP_OPT_ON) void *(LDAP_OPT_OFF)	int *	Determines whether LDAP input and output operations are automatically restarted if they stop prematurely. It may be set to either LDAP_OPT_ON or LDAP_OPT_OFF. Any non-null pointer value passed to ldap_set_option() enables this option. When the current setting is read using ldap_get_option(), a zero value means off and any nonzero value means on. This option is useful if an input or output operation can be interrupted prematurely—by a timer going off, for example. By default, this option is turned off.

**Table 8–5 (Cont.) Constants for LDAP Session Handle Options**

Constant	Type for invalue parameter	Type for outvalue parameter	Description
LDAP_OPT_PROTOCOL_VERSION(0x11)	int *	int *	This option indicates the version of the LDAP protocol used when communicating with the primary LDAP server. The option should be either LDAP_VERSION2 (2) or LDAP_VERSION3 (3). If no version is set, the default is LDAP_VERSION2 (2).
LDAP_OPT_SERVER_CONTROLS(0x12)	LDAPControl**	LDAPControl***	A default list of LDAP server controls to be sent with each request.  <b>See Also:</b> <a href="#">Section 8.2.7, "Working With Controls."</a>
LDAP_OPT_CLIENT_CONTROLS(0x13)	LDAPControl**	LDAPControl***	A default list of client controls that affect the LDAP session.  <b>See Also:</b> <a href="#">Section 8.2.7, "Working With Controls."</a>
LDAP_OPT_API_FEATURE_INFO(0x15)	Not applicable. Option is read only.	LDAPAPIFeatureInfo *	Used to retrieve version information about LDAP API extended features at execution time. Applications need to be able to determine information about the particular API implementation they are using both at compile time and during execution. This option is read only. It cannot be set.
LDAP_OPT_HOST_NAME(0x30)	char *	char **	The host name (or list of hosts) for the primary LDAP server. See the definition of the <code>hostname</code> parameter for <code>ldap_init()</code> to determine the syntax.
LDAP_OPT_ERROR_NUMBER(0x31)	int *	int *	The code of the most recent LDAP error during this session.
LDAP_OPT_ERROR_STRING(0x32)	char *	-	The message returned with the most recent LDAP error during this session.
LDAP_OPT_MATCHED_DN(0x33)	char *	char **	The matched DN value returned with the most recent LDAP error during this session.
LDAP_OPT_CONNECT_TIMEOUT(0xD2)	int *	int *	This option sets the LDAP connection timeout value in seconds. The connection timeout must be set before calling <code>ldap_open</code> . Valid values are 0 – 300 seconds. If the value is set to 0, then the timeout defaults to TCP timeout. If this option is not set, then <code>ldap_open()</code> call times out in 15 sec if the host is not reachable.

### Usage Notes

Both `ldap_get_option()` and `ldap_set_option()` return 0 if successful and -1 if an error occurs. If -1 is returned by either function, a specific error code may be retrieved by calling `ldap_get_option()` with an option value of `LDAP_OPT_ERROR_NUMBER`. Note that there is no way to retrieve a more specific error code if a call to `ldap_get_option()` with an option value of `LDAP_OPT_ERROR_NUMBER` fails.

When a call to `ldap_get_option()` succeeds, the API implementation **MUST NOT** change the state of the LDAP session handle or the state of the underlying implementation in a way that affects the behavior of future LDAP API calls. When a call to `ldap_get_option()` fails, the only session handle change permitted is setting the LDAP error code (as returned by the `LDAP_OPT_ERROR_NUMBER` option).

When a call to `ldap_set_option()` fails, it must not change the state of the LDAP session handle or the state of the underlying implementation in a way that affects the behavior of future LDAP API calls.

Standards track documents that extend this specification and specify new options should use values for option macros that are between 0x1000 and 0x3FFF inclusive. Private and experimental extensions should use values for the option macros that are between 0x4000 and 0x7FFF inclusive. All values less than 0x1000 and greater than 0x7FFF that are not defined in this document are reserved and should not be used. The following macro must be defined by C LDAP API implementations to aid extension implementers:

```
#define LDAP_OPT_PRIVATE_EXTENSION_BASE 0x4000 /* to 0x7FFF inclusive */
```

## 8.2.4 Getting Bind Credentials for Chasing Referrals

The functions in this section are used to get the bind credentials of a new server while chasing referrals.

### 8.2.4.1 ldap\_set\_rebind\_proc

The `ldap_set_rebind_proc()` function is used to set the callback function that the library uses to get the bind credentials for connecting to a new server while chasing LDAP referrals. The library uses the callback function only if `LDAP_OPT_REFERRALS` is set using `ldap_set_option()`. If `ldap_set_rebind_proc()` is not called, then the library uses an anonymous bind to connect to the new server while chasing LDAP referrals.

**See Also:** [Section 8.2.3, "LDAP Session Handle Options."](#)

#### Syntax

```
void ldap_set_rebind_proc
(
LDAP          *ld,
int(*rebindproc) (LDAP  *ld,
                  char  **dnp,
                  char  **passwdp,
                  int   *authmethodp,
                  int   freeit)
)
```

The `reprocbind()` function is the function to be called to get the bind credentials of the new server.

**Table 8–6 Parameters for Callback Function and for Setting Callback Function**

Parameter	Description
<code>ld</code>	The session handle
<code>rebindproc</code>	The callback function to be used to get the bind credentials for connecting to a new server while chasing LDAP referrals
<code>ld</code>	The session handle to the new server
<code>dnp</code>	Pointer to bind dn for new server
<code>passwdp</code>	Pointer to bind password for new server
<code>authmethodp</code>	Pointer to authentication method for new server
<code>freeit</code>	0 - returns bind dn pointer, bind password pointer, and bind authentication method pointer for new server 1 - frees any memory allocated in previous call



When the `freeit` parameter value is 0, then `rebindproc` must return `bind dn` pointer, `bind password` pointer, and `bind authentication method` pointer. When the `freeit` parameter value is 1, then `rebindproc` must free any memory allocated in the previous call. The LDAP library call this function twice, first to get the bind credentials and second time to free the memory.

**See Also:** [Section 8.3.4, "Setting and Using a Callback Function to Get Credentials When Chasing Referrals."](#)

## 8.2.5 Authenticating to the Directory

The functions in this section are used to authenticate an LDAP client to an LDAP directory server.

### 8.2.5.1 `ldap_sasl_bind`, `ldap_sasl_bind_s`, `ldap_simple_bind`, and `ldap_simple_bind_s`

The `ldap_sasl_bind()` and `ldap_sasl_bind_s()` functions can be used to do general and extensible authentication over LDAP through the use of the Simple Authentication Security Layer. The routines both take the DN to bind as, the method to use, as a dotted-string representation of an object identifier (OID) identifying the method, and a `struct berval` holding the credentials. The special constant value `LDAP_SASL_SIMPLE` (NULL) can be passed to request simple authentication, or the simplified routines `ldap_simple_bind()` or `ldap_simple_bind_s()` can be used.

#### Syntax

```
int ldap_sasl_bind
(
LDAP                *ld,
const char          *dn,
const char          *mechanism,
const struct berval *cred,
LDAPControl         **serverctrls,
LDAPControl         **clientctrls,
int                 *msgidp
);

int ldap_sasl_bind_s(
LDAP                *ld,
const char          *dn,
const char          *mechanism,
const struct berval *cred,
LDAPControl         **serverctrls,
LDAPControl         **clientctrls,
);

int ldap_simple_bind(
LDAP                *ld,
const char          *dn,
const char          *passwd
);

int ldap_simple_bind_s(
LDAP                *ld,
const char          *dn,
const char          *passwd
);
```

The use of the following routines is deprecated and more complete descriptions can be found in RFC 1823:

- `int ldap_bind( LDAP *ld, const char *dn, const char *cred, int method );`
- `int ldap_bind_s( LDAP *ld, const char *dn, const char *cred, int method );`
- `int ldap_kerberos_bind( LDAP *ld, const char *dn );`
- `int ldap_kerberos_bind_s( LDAP *ld, const char *dn );`

### Parameters

Table 8–7 lists and describes the parameters for authenticating to the directory.

**Table 8–7 Parameters for Authenticating to the Directory**

Parameter	Description
<code>ld</code>	The session handle
<code>dn</code>	The name of the entry to bind as
<code>mechanism</code>	Either <code>LDAP_SASL_SIMPLE</code> (NULL) to get simple authentication, or a text string identifying the SASL method
<code>cred</code>	The credentials with which to authenticate. Arbitrary credentials can be passed using this parameter. The format and content of the credentials depends on the setting of the mechanism parameter.
<code>passwd</code>	For <code>ldap_simple_bind()</code> , the password to compare to the entry's <code>userPassword</code> attribute
<code>serverctrls</code>	List of LDAP server controls
<code>clientctrls</code>	List of client controls
<code>msgidp</code>	This result parameter is set to the message id of the request if the <code>ldap_sasl_bind()</code> call succeeds

### Usage Notes

Additional parameters for the deprecated routines are not described. Interested readers are referred to RFC 1823.

The `ldap_sasl_bind()` function initiates an asynchronous bind operation and returns the constant `LDAP_SUCCESS` if the request was successfully sent, or another LDAP error code if not. If successful, `ldap_sasl_bind()` places the message id of the request in `*msgidp`. A subsequent call to `ldap_result()` can be used to obtain the result of the bind.

The `ldap_simple_bind()` function initiates a simple asynchronous bind operation and returns the message id of the operation initiated. A subsequent call to `ldap_result()`, described in, can be used to obtain the result of the bind. In case of error, `ldap_simple_bind()` returns `-1`, setting the session error parameters in the LDAP structure appropriately.

The synchronous `ldap_sasl_bind_s()` and `ldap_simple_bind_s()` functions both return the result of the operation, either the constant `LDAP_SUCCESS` if the operation was successful, or another LDAP error code if it was not.

Note that if an LDAPv2 server is contacted, no other operations over the connection can be attempted before a bind call has successfully completed.

Subsequent bind calls can be used to re-authenticate over the same connection, and multistep SASL sequences can be accomplished through a sequence of calls to `ldap_sasl_bind()` or `ldap_sasl_bind_s()`.

**See Also:** Section 8.2.12, "Handling Errors and Parsing Results" for more information about possible errors and how to interpret them.

## 8.2.6 SASL Authentication Using Oracle Extensions

This section contains the following topics:

- Section 8.2.6.1, "ora\_ldap\_init\_SASL"
- Section 8.2.6.2, "ora\_ldap\_create\_cred\_hdl, ora\_ldap\_set\_cred\_props, ora\_ldap\_get\_cred\_props, and ora\_ldap\_free\_cred\_hdl"

### 8.2.6.1 ora\_ldap\_init\_SASL

The function `ora_ldap_init_SASL()` can be used for SASL based authentication. It performs authentication based on the mechanism specified as one of its input arguments.

This function encapsulates the SASL handshake between the client and the directory server for various standard SASL mechanisms thereby reducing the coding effort involved in establishing a SASL-based connection to the directory server.

#### Syntax

```
int ora_ldap_init_SASL
(
OraLdapClientCtx * clientCtx,
LDAP*ld,
char* dn,
char* mechanism,
OraLdapHandle cred,
LDAPControl**serverctrls,
LDAPControl**clientctrls
);
```

#### Parameters

**Table 8–8** Parameters passed to `ora_ldap_init_sasl()`

Parameter	Description
<code>clientCtx</code>	C API Client context. This can be managed using <code>ora_ldap_init_clientctx()</code> and <code>ora_ldap_free_clientctx()</code> functions.
<code>ld</code>	Ldap session handle.
<code>dn</code>	User DN to be authenticated.
<code>mechanism</code>	SASL mechanism.
<code>cred</code>	Credentials needed for SASL authentication.
<code>serverctrls</code>	List of LDAP server controls
<code>clientctrls</code>	List of client controls

The cred parameter is a SASL credential handle for the user. This handle can be managed using `ora_ldap_create_cred_hdl()`, `ora_ldap_set_cred_props()` and `ora_ldap_free_cred_hdl()` functions.

Supported SASL mechanisms:

- DIGEST-MD5

The Oracle Internet Directory SASL API supports the authentication-only mode of DIGEST-MD5. The other two authentication modes addressing data privacy and data integrity are yet to be supported.

While authenticating against Oracle Internet Directory, the DN of the user has to be normalized before it is sent across to the server. This can be done either outside the SASL API using the `ora_ldap_normalize_dn()` function before the DN is passed on to the SASL API or with the SASL API by setting the `ORA_LDAP_CRED_SASL_NORM_AUTHDN` option in SASL credentials handle using `ora_ldap_set_cred_handle()`.

- EXTERNAL:

The SASL API and SASL implementation in Oracle Internet Directory use SSL authentication as one of the external authentication mechanisms.

Using this mechanism requires that the SSL connection (mutual authentication mode) be established to the directory server by using the `ora_ldap_init_SSL()` function. The `ora_ldap_init_SASL()` function can then be invoked with the mechanism argument as `EXTERNAL`. The directory server would then authenticate the user based on the user credentials in SSL connection.

### 8.2.6.2 `ora_ldap_create_cred_hdl`, `ora_ldap_set_cred_props`, `ora_ldap_get_cred_props`, and `ora_ldap_free_cred_hdl`

Use these functions to create and manage SASL credential handles. The `ora_ldap_create_cred_hdl` function should be used to create a SASL credential handle of certain type based on the type of mechanism used for SASL authentication. The `ora_ldap_set_cred_props()` function can be used to add relevant credentials to the handle needed for SASL authentication. The `ora_ldap_get_cred_props()` function can be used for retrieving the properties stored in the credential handle, and the `ora_ldap_free_cred_hdl()` function should be used to destroy the handle after its use.

#### Syntax

```
OraLdapHandle ora_ldap_create_cred_hdl
(
    OraLdapClientCtx * clientCtx,
    int               credType
);
```

```
OraLdapHandle ora_ldap_set_cred_props
(
    OraLdapClientCtx * clientCtx,
    OraLdapHandle    cred,
    int               String[],
    void             * inProperty
);
```

```
OraLdapHandle ora_ldap_get_cred_props
(
    OraLdapClientCtx * clientCtx,
    OraLdapHandle    cred,
```

```

        int          String[],
        void         *   outProperty
    );

OraLdapHandle ora_ldap_free_cred_hdl
(
    OraLdapClientCtx *   clientCtx,
    OraLdapHandle      cred
);

```

**Parameters**

**Table 8–9 Parameters for Managing SASL Credentials**

Parameter	Description
clientCtx	C API Client context. This can be managed using ora_ldap_init_clientctx() and ora_ldap_free_clientctx() functions.
credType	Type of credential handle specific to SASL mechanism.
cred	Credential handle containing SASL credentials needed for a specific SASL mechanism for SASL authentication.
String[]	Type of credential, which must be added to credential handle.
inProperty	One of the SASL Credentials to be stored in credential handle.
outProperty	One of the SASL credentials stored in credential handle.

**8.2.7 Working With Controls**

LDAPv3 operations can be extended through the use of controls. Controls can be sent to a server or returned to the client with any LDAP message. These controls are referred to as server controls.

The LDAP API also supports a client-side extension mechanism through the use of client controls. These controls affect the behavior of the LDAP API only and are never sent to a server. A common data structure is used to represent both types of controls:

```

typedef struct ldapcontrol
{
    char          *ldctl_oid;
    struct berval ldctl_value;
    char          ldctl_iscritical;
} LDAPControl;

```

The fields in the ldapcontrol structure are described in [Table 8–10](#).

**Table 8–10 Fields in ldapcontrol Structure**

Field	Description
ldctl_oid	The control type, represented as a string.
ldctl_value	The data associated with the control (if any). To specify a zero-length value, set ldctl_value.bv_len to zero and ldctl_value.bv_val to a zero-length string. To indicate that no data is associated with the control, set ldctl_value.bv_val to NULL.
ldctl_iscritical	Indicates whether the control is critical of not. If this field is nonzero, the operation is only carried out if the control is recognized by the server or the client. Note that the LDAP unbind and abandon operations have no server response. Clients should not mark server controls critical when used with these two operations.

**See Also:** [Chapter 3, "Extensions to the LDAP Protocol"](#) for more information about controls.

Some LDAP API calls allocate an `ldapcontrol` structure or a NULL-terminated array of `ldapcontrol` structures. The following routines can be used to dispose of a single control or an array of controls:

```
void ldap_control_free( LDAPControl *ctrl );
void ldap_controls_free( LDAPControl **ctrls );
```

If the `ctrl` or `ctrls` parameter is NULL, these calls do nothing.

A set of controls that affect the entire session can be set using the `ldap_set_option()` function described in [Section 8.2.3.1, "ldap\\_get\\_option and ldap\\_set\\_option."](#) A list of controls can also be passed directly to some LDAP API calls such as `ldap_search_ext()`, in which case any controls set for the session through the use of `ldap_set_option()` are ignored. Control lists are represented as a NULL-terminated array of pointers to `ldapcontrol` structures.

Server controls are defined by LDAPv3 protocol extension documents; for example, a control has been proposed to support server-side sorting of search results.

One client control is defined in this chapter (described in the following section).

**Client-Controlled Referral Processing** As described previously in [Section 8.2.3, "LDAP Session Handle Options,"](#) applications can enable and disable automatic chasing of referrals on a session-wide basis by using the `ldap_set_option()` function with the `LDAP_OPT_REFERRALS` option. It is also useful to govern automatic referral chasing on per-request basis. A client control with an object identifier (OID) of 1.2.840.113556.1.4.616 exists to provide this functionality.

```
/* OID for referrals client control */
#define LDAP_CONTROL_REFERRALS          "1.2.840.113556.1.4.616"

/* Flags for referrals client control value */
#define LDAP_CHASE_SUBORDINATE_REFERRALS 0x00000020U
#define LDAP_CHASE_EXTERNAL_REFERRALS   0x00000040U
```

To create a referrals client control, the `ldctl_oid` field of an `LDAPControl` structure must be set to `LDAP_CONTROL_REFERRALS` ("1.2.840.113556.1.4.616") and the `ldctl_value` field must be set to a four-octet value that contains a set of flags. The `ldctl_value.bv_len` field must always be set to 4. The `ldctl_value.bv_val` field must point to a four-octet integer flags value. This flags value can be set to zero to disable automatic chasing of referrals and LDAPv3 references altogether. Alternatively, the flags value can be set to the value `LDAP_CHASE_SUBORDINATE_REFERRALS` (0x00000020U) to indicate that only LDAPv3 search continuation references are to be automatically chased by the API implementation, to the value `LDAP_CHASE_EXTERNAL_REFERRALS` (0x00000040U) to indicate that only LDAPv3 referrals are to be automatically chased, or the logical OR of the two flag values (0x00000060U) to indicate that both referrals and references are to be automatically chased.

**See Also:** "Directory Schema Administration" in *Oracle Fusion Middleware Administrator's Guide for Oracle Internet Directory* for more information about object identifiers.

## 8.2.8 Closing the Session

Use the functions in this section to unbind from the directory, to close open connections, and to dispose of the session handle.

### 8.2.8.1 ldap\_unbind, ldap\_unbind\_ext, and ldap\_unbind\_s

`ldap_unbind_ext()`, `ldap_unbind()`, and `ldap_unbind_s()` all work synchronously in the sense that they send an unbind request to the server, close all open connections associated with the LDAP session handle, and dispose of all resources associated with the session handle before returning. Note, however, that there is no server response to an LDAP unbind operation. All three of the unbind functions return `LDAP_SUCCESS` (or another LDAP error code if the request cannot be sent to the LDAP server). After a call to one of the unbind functions, the session handle `ld` is invalid and it is illegal to make any further LDAP API calls using `ld`.

The `ldap_unbind()` and `ldap_unbind_s()` functions behave identically. The `ldap_unbind_ext()` function allows server and client controls to be included explicitly, but note that since there is no server response to an unbind request there is no way to receive a response to a server control sent with an unbind request.

#### Syntax

```
int ldap_unbind_ext( LDAP *ld, LDAPControl **serverctrls,
LDAPControl **clientctrls );
int ldap_unbind( LDAP *ld );
int ldap_unbind_s( LDAP *ld );
```

#### Parameters

**Table 8–11 Parameters for Closing the Session**

Parameter	Description
<code>ld</code>	The session handle
<code>serverctrls</code>	List of LDAP server controls
<code>clientctrls</code>	List of client controls

## 8.2.9 Performing LDAP Operations

Use the functions in this section to search the LDAP directory and to return a requested set of attributes for each entry matched.

### 8.2.9.1 ldap\_search\_ext, ldap\_search\_ext\_s, ldap\_search, and ldap\_search\_s

The `ldap_search_ext()` function initiates an asynchronous search operation and returns the constant `LDAP_SUCCESS` if the request was successfully sent, or another LDAP error code if not. If successful, `ldap_search_ext()` places the message id of the request in `*msgidp`. A subsequent call to `ldap_result()` can be used to obtain the results from the search. These results can be parsed using the result parsing routines described in detail later.

Similar to `ldap_search_ext()`, the `ldap_search()` function initiates an asynchronous search operation and returns the message id of the operation initiated. As for `ldap_search_ext()`, a subsequent call to `ldap_result()` can be used to obtain the result of the bind. In case of error, `ldap_search()` returns `-1`, setting the session error parameters in the LDAP structure appropriately.

The synchronous `ldap_search_ext_s()`, `ldap_search_s()`, and `ldap_search_st()` functions all return the result of the operation, either the constant `LDAP_SUCCESS` if the operation was successful, or another LDAP error code if it was not. Entries returned from the search, if any, are contained in the `res` parameter. This parameter is opaque to the caller. Entries, attributes, values, and so on, can be extracted by calling the parsing routines described in this section. The results contained in `res` should be freed when no longer in use by calling `ldap_msgfree()`, which is described later.

The `ldap_search_ext()` and `ldap_search_ext_s()` functions support LDAPv3 server controls, client controls, and allow varying size and time limits to be easily specified for each search operation. The `ldap_search_st()` function is identical to `ldap_search_s()` except that it takes an additional parameter specifying a local timeout for the search. The local search timeout is used to limit the amount of time the API implementation waits for a search to complete. After the local search timeout expires, the API implementation sends an abandon operation to stop the search operation.

**See Also:** [Section 8.2.12, "Handling Errors and Parsing Results"](#) for more information about possible errors and how to interpret them.

### Syntax

```
int ldap_search_ext
(
    LDAP          *ld,
    const char    *base,
    int           scope,
    const char    *filter,
    char          **attrs,
    int          attrsonly,
    LDAPControl   **serverctrls,
    LDAPControl   **clientctrls,
    struct timeval *timeout,
    int           sizelimit,
    int           *msgidp
);
```

```
int ldap_search_ext_s
(
    LDAP          *ld,
    const char    *base,
    int           scope,
    const char    *filter,
    char          **attrs,
    int          attrsonly,
    LDAPControl   **serverctrls,
    LDAPControl   **clientctrls,
    struct timeval *timeout,
    int           sizelimit,
    LDAPMessage   **res
);
```

```
int ldap_search
(
    LDAP          *ld,
    const char    *base,
    int           scope,
    const char    *filter,
    char          **attrs,
    int          attrsonly
```



```

);

int ldap_search_s
(
LDAP          *ld,
const char    *base,
int           scope,
const char    *filter,
char          **attrs,
int           attrsonly,
LDAPMessage  **res
);

int ldap_search_st
);

LDAP          *ld,
const char    *base,
int           scope,
const char    *filter,
char          **attrs,
int           attrsonly,
struct timeval *timeout,
LDAPMessage  **res
);

```

## Parameters

Table 8–12 lists and describes the parameters for search operations.

**Table 8–12 Parameters for Search Operations**

Parameter	Description
ld	The session handle.
base	The DN of the entry at which to start the search.
scope	One of LDAP_SCOPE_BASE (0x00), LDAP_SCOPE_ONELEVEL (0x01), or LDAP_SCOPE_SUBTREE (0x02), indicating the scope of the search.
filter	A character string representing the search filter. The value NULL can be passed to indicate that the filter "(objectclass=*)" which matches all entries is to be used. Note that if the caller of the API is using LDAPv2, only a subset of the filter functionality can be successfully used.
attrs	A NULL-terminated array of strings indicating which attributes to return for each matching entry. Passing NULL for this parameter causes all available user attributes to be retrieved. The special constant string LDAP_NO_ATTRS ("1.1") may be used as the only string in the array to indicate that no attribute types are to be returned by the server. The special constant string LDAP_ALL_USER_ATTRS ("*") can be used in the attrs array along with the names of some operational attributes to indicate that all user attributes plus the listed operational attributes are to be returned.
attrsonly	A boolean value that must be zero if both attribute types and values are to be returned, and nonzero if only types are wanted.

**Table 8–12 (Cont.) Parameters for Search Operations**

Parameter	Description
timeout	For the <code>ldap_search_st()</code> function, this specifies the local search timeout value (if it is <code>NULL</code> , the timeout is infinite). If a zero timeout (where <code>tv_sec</code> and <code>tv_usec</code> are both zero) is passed, API implementations should return <code>LDAP_PARAM_ERROR</code> . For the <code>ldap_search_ext()</code> and <code>ldap_search_ext_s()</code> functions, the timeout parameter specifies both the local search timeout value and the operation time limit that is sent to the server within the search request. Passing a <code>NULL</code> value for timeout causes the global default timeout stored in the LDAP session handle (set by using <code>ldap_set_option()</code> with the <code>LDAP_OPT_TIMELIMIT</code> parameter) to be sent to the server with the request but an infinite local search timeout to be used. If a zero timeout (where <code>tv_sec</code> and <code>tv_usec</code> are both zero) is passed in, API implementations should return <code>LDAP_PARAM_ERROR</code> . If a zero value for <code>tv_sec</code> is used but <code>tv_usec</code> is nonzero, an operation time limit of 1 should be passed to the LDAP server as the operation time limit. For other values of <code>tv_sec</code> , the <code>tv_sec</code> value itself should be passed to the LDAP server.
sizelimit	For the <code>ldap_search_ext()</code> and <code>ldap_search_ext_s()</code> calls, this is a limit on the number of entries to return from the search. A value of <code>LDAP_NO_LIMIT (0)</code> means no limit.
res	For the synchronous calls, this is a result parameter which contains the results of the search upon completion of the call. If no results are returned, <code>*res</code> is set to <code>NULL</code> .
serverctrls	List of LDAP server controls.
clientctrls	List of client controls.
msgidp	This result parameter is set to the message id of the request if the <code>ldap_search_ext()</code> call succeeds. There are three options in the session handle <code>ld</code> which potentially affect how the search is performed. They are: <ul style="list-style-type: none"> <li>▪ <code>LDAP_OPT_SIZELIMIT</code>—A limit on the number of entries to return from the search. A value of <code>LDAP_NO_LIMIT (0)</code> means no limit. Note that the value from the session handle is ignored when using the <code>ldap_search_ext()</code> or <code>ldap_search_ext_s()</code> functions.</li> <li>▪ <code>LDAP_OPT_TIMELIMIT</code>—A limit on the number of seconds to spend on the search. A value of <code>LDAP_NO_LIMIT (0)</code> means no limit. Note that the value from the session handle is ignored when using the <code>ldap_search_ext()</code> or <code>ldap_search_ext_s()</code> functions.</li> <li>▪ <code>LDAP_OPT_DEREF</code>—One of <code>LDAP_DEREF_NEVER (0x00)</code>, <code>LDAP_DEREF_SEARCHING (0x01)</code>, <code>LDAP_DEREF_FINDING (0x02)</code>, or <code>LDAP_DEREF_ALWAYS (0x03)</code>, specifying how aliases are handled during the search. The <code>LDAP_DEREF_SEARCHING</code> value means aliases are dereferenced during the search but not when locating the base object of the search. The <code>LDAP_DEREF_FINDING</code> value means aliases are dereferenced when locating the base object but not during the search.</li> </ul>

### 8.2.9.2 Reading an Entry

LDAP does not support a read operation directly. Instead, this operation is emulated by a search with base set to the DN of the entry to read, scope set to `LDAP_SCOPE_BASE`, and filter set to `"(objectclass=*)"` or `NULL`. The `attrs` parameter contains the list of attributes to return.

### 8.2.9.3 Listing the Children of an Entry

LDAP does not support a list operation directly. Instead, this operation is emulated by a search with base set to the DN of the entry to list, scope set to `LDAP_SCOPE_ONELEVEL`, and filter set to `"(objectclass=*)"` or `NULL`. The parameter `attrs` contains the list of attributes to return for each child entry.

### 8.2.9.4 ldap\_compare\_ext, ldap\_compare\_ext\_s, ldap\_compare, and ldap\_compare\_s

Use these routines to compare an attribute value assertion against an LDAP entry.

The `ldap_compare_ext()` function initiates an asynchronous compare operation and returns the constant `LDAP_SUCCESS` if the request was successfully sent, or another LDAP error code if not. If successful, `ldap_compare_ext()` places the message id of the request in `*msgidp`. A subsequent call to `ldap_result()` can be used to obtain the result of the compare.

Similar to `ldap_compare_ext()`, the `ldap_compare()` function initiates an asynchronous compare operation and returns the message id of the operation initiated. As for `ldap_compare_ext()`, a subsequent call to `ldap_result()` can be used to obtain the result of the bind. In case of error, `ldap_compare()` returns `-1`, setting the session error parameters in the LDAP structure appropriately.

The synchronous `ldap_compare_ext_s()` and `ldap_compare_s()` functions both return the result of the operation, either the constant `LDAP_SUCCESS` if the operation was successful, or another LDAP error code if it was not.

The `ldap_compare_ext()` and `ldap_compare_ext_s()` functions support LDAPv3 server controls and client controls.

**See Also:** [Section 8.2.12, "Handling Errors and Parsing Results"](#) for more information about possible errors and how to interpret them.

#### Syntax

```
int ldap_compare_ext
(
LDAP                *ld,
const char          *dn,
const char          *attr,
const struct berval *bvalue,
LDAPControl         **serverctrls,
LDAPControl         **clientctrls,
int                 *msgidp
);

int ldap_compare_ext_s
(
LDAP                *ld,
const char          *dn,
const char          *attr,
const struct berval *bvalue,
LDAPControl         **serverctrls,
LDAPControl         **clientctrls
);

int ldap_compare
(
LDAP                *ld,
const char          *dn,
const char          *attr,
const char          *value
);
int ldap_compare_s
(
LDAP                *ld,
const char          *dn,
```

```
const char      *attr,
const char      *value
);
```

**Parameters**

Table 8–13 lists and describes the parameters for compare operations.

**Table 8–13 Parameters for Compare Operations**

Parameter	Description
ld	The session handle.
dn	The name of the entry to compare against.
attr	The attribute to compare against.
bvalue	The attribute value to compare against those found in the given entry. This parameter is used in the extended routines and is a pointer to a struct berval so it is possible to compare binary values.
value	A string attribute value to compare against, used by the ldap_compare() and ldap_compare_s() functions. Use ldap_compare_ext() or ldap_compare_ext_s() if you need to compare binary values.
serverctrls	List of LDAP server controls.
clientctrls	List of client controls.
msgidp	This result parameter is set to the message id of the request if the ldap_compare_ext() call succeeds.

**8.2.9.5 ldap\_modify\_ext, ldap\_modify\_ext\_s, ldap\_modify, and ldap\_modify\_s**

Use these routines to modify an existing LDAP entry.

The ldap\_modify\_ext() function initiates an asynchronous modify operation and returns the constant LDAP\_SUCCESS if the request was successfully sent, or another LDAP error code if not. If successful, ldap\_modify\_ext() places the message id of the request in \*msgidp. A subsequent call to ldap\_result() can be used to obtain the result of the modify.

Similar to ldap\_modify\_ext(), the ldap\_modify() function initiates an asynchronous modify operation and returns the message id of the operation initiated. As for ldap\_modify\_ext(), a subsequent call to ldap\_result() can be used to obtain the result of the modify. In case of error, ldap\_modify() returns -1, setting the session error parameters in the LDAP structure appropriately.

The synchronous ldap\_modify\_ext\_s() and ldap\_modify\_s() functions both return the result of the operation, either the constant LDAP\_SUCCESS if the operation was successful, or another LDAP error code if it was not.

The ldap\_modify\_ext() and ldap\_modify\_ext\_s() functions support LDAPv3 server controls and client controls.

**See Also:** [Section 8.2.12, "Handling Errors and Parsing Results"](#) for more information about possible errors and how to interpret them.

**Syntax**

```
typedef struct ldapmod
{
int      mod_op;
char     *mod_type;
union mod_vals_u
```

```

    {
        char          **modv_strvals;
        struct berval **modv_bvals;
    } mod_vals;
} LDAPMod;
#define mod_values      mod_vals.modv_strvals
#define mod_bvalues     mod_vals.modv_bvals

int ldap_modify_ext
(
    LDAP          *ld,
    const char    *dn,
    LDAPMod       **mods,
    LDAPControl   **serverctrls,
    LDAPControl   **clientctrls,
    int           *msgidp
);

int ldap_modify_ext_s
(
    LDAP          *ld,
    const char    *dn,
    LDAPMod       **mods,
    LDAPControl   **serverctrls,
    LDAPControl   **clientctrls
);

int ldap_modify
(
    LDAP          *ld,
    const char    *dn,
    LDAPMod       **mods
);

int ldap_modify_s
(
    LDAP          *ld,
    const char    *dn,
    LDAPMod       **mods
);

```

### Parameters

Table 8–14 lists and describes the parameters for modify operations.

**Table 8–14 Parameters for Modify Operations**

Parameter	Description
ld	The session handle
dn	The name of the entry to modify
mods	A NULL-terminated array of modifications to make to the entry
serverctrls	List of LDAP server controls
clientctrls	List of client controls
msgidp	This result parameter is set to the message id of the request if the <code>ldap_modify_ext()</code> call succeeds

Table 8–15 lists and describes the fields in the LDAPMod structure.

**Table 8–15 Fields in LDAPMod Structure**

Field	Description
mod_op	The modification operation to perform. It must be one of LDAP_MOD_ADD (0x00), LDAP_MOD_DELETE (0x01), or LDAP_MOD_REPLACE (0x02). This field also indicates the type of values included in the mod_vals union. It is logically ORed with LDAP_MOD_BVALUES (0x80) to select the mod_bvalues form. Otherwise, the mod_values form is used.
mod_type	The type of the attribute to modify.
mod_vals	The values (if any) to add, delete, or replace. Only one of the mod_values or mod_bvalues variants can be used, selected by ORing the mod_op field with the constant LDAP_MOD_BVALUES. mod_values is a NULL-terminated array of zero-terminated strings and mod_bvalues is a NULL-terminated array of berval structures that can be used to pass binary values such as images.

### Usage Notes

For LDAP\_MOD\_ADD modifications, the given values are added to the entry, creating the attribute if necessary.

For LDAP\_MOD\_DELETE modifications, the given values are deleted from the entry, removing the attribute if no values remain. If the entire attribute is to be deleted, the mod\_vals field can be set to NULL.

For LDAP\_MOD\_REPLACE modifications, the attribute has the listed values after the modification, having been created if necessary, or removed if the mod\_vals field is NULL. All modifications are performed in the order in which they are listed.

### 8.2.9.6 ldap\_rename and ldap\_rename\_s

Use these routines to change the name of an entry.

The ldap\_rename() function initiates an asynchronous modify DN operation and returns the constant LDAP\_SUCCESS if the request was successfully sent, or another LDAP error code if not. If successful, ldap\_rename() places the DN message id of the request in \*msgidp. A subsequent call to ldap\_result() can be used to obtain the result of the rename.

The synchronous ldap\_rename\_s() returns the result of the operation, either the constant LDAP\_SUCCESS if the operation was successful, or another LDAP error code if it was not.

The ldap\_rename() and ldap\_rename\_s() functions both support LDAPv3 server controls and client controls.

**See Also:** [Section 8.2.12, "Handling Errors and Parsing Results"](#) for more information about possible errors and how to interpret them.

### Syntax

```
int ldap_rename
(
LDAP          *ld,
const char    *dn,
const char    *newrdn,
const char    *newparent,
int           deleteoldrdn,
LDAPControl  **serverctrls,
LDAPControl  **clientctrls,
```

```

int          *msgidp
);

int ldap_rename_s
(
LDAP        *ld,
const char  *dn,
const char  *newrdn,
const char  *newparent,
int         deleteoldrdn,
LDAPControl **serverctrls,
LDAPControl **clientctrls
);

```

The use of the following routines is deprecated and more complete descriptions can be found in RFC 1823:

```

int ldap_modrdn
(
LDAP        *ld,
const char  *dn,
const char  *newrdn
);

int ldap_modrdn_s
(
LDAP        *ld,
const char  *dn,
const char  *newrdn
);

int ldap_modrdn2
(
LDAP        *ld,
const char  *dn,
const char  *newrdn,
int         deleteoldrdn
);

int ldap_modrdn2_s
(
LDAP        *ld,
const char  *dn,
const char  *newrdn,
int         deleteoldrdn
);

```

### Parameters

Table 8–16 lists and describes the parameters for rename operations.

**Table 8–16** Parameters for Rename Operations

Parameter	Description
ld	The session handle.
dn	The name of the entry whose DN is to be changed.
newrdn	The new RDN to give the entry.

**Table 8–16 (Cont.) Parameters for Rename Operations**

Parameter	Description
newparent	The new parent, or superior entry. If this parameter is <code>NULL</code> , only the RDN of the entry is changed. The root DN should be specified by passing a zero length string, <code>"</code> . The newparent parameter should always be <code>NULL</code> when using version 2 of the LDAP protocol; otherwise the server's behavior is undefined.
deleteoldrdn	This parameter only has meaning on the rename routines if newrdn is different than the old RDN. It is a boolean value, if nonzero indicating that the old RDN value is to be removed, if zero indicating that the old RDN value is to be retained as non-distinguished values of the entry.
serverctrls	List of LDAP server controls.
clientctrls	List of client controls.
msgidp	This result parameter is set to the message id of the request if the <code>ldap_rename()</code> call succeeds.

### 8.2.9.7 ldap\_add\_ext, ldap\_add\_ext\_s, ldap\_add, and ldap\_add\_s

Use these functions to add entries to the LDAP directory.

The `ldap_add_ext()` function initiates an asynchronous add operation and returns the constant `LDAP_SUCCESS` if the request was successfully sent, or another LDAP error code if not. If successful, `ldap_add_ext()` places the message id of the request in `*msgidp`. A subsequent call to `ldap_result()` can be used to obtain the result of the add.

Similar to `ldap_add_ext()`, the `ldap_add()` function initiates an asynchronous add operation and returns the message id of the operation initiated. As for `ldap_add_ext()`, a subsequent call to `ldap_result()` can be used to obtain the result of the add. In case of error, `ldap_add()` returns `-1`, setting the session error parameters in the LDAP structure appropriately.

The synchronous `ldap_add_ext_s()` and `ldap_add_s()` functions both return the result of the operation, either the constant `LDAP_SUCCESS` if the operation was successful, or another LDAP error code if it was not.

The `ldap_add_ext()` and `ldap_add_ext_s()` functions support LDAPv3 server controls and client controls.

**See Also:** [Section 8.2.12, "Handling Errors and Parsing Results"](#) for more information about possible errors and how to interpret them.

#### Syntax

```
int ldap_add_ext
(
    LDAP          *ld,
    const char    *dn,
    LDAPMod       **attrs,
    LDAPControl   **serverctrls,
    LDAPControl   **clientctrls,
    int           *msgidp
);

int ldap_add_ext_s
(
    LDAP          *ld,
    const char    *dn,
```



```

LDAPMod      **attrs,
LDAPControl  **serverctrls,
LDAPControl  **clientctrls
);

int ldap_add
(
LDAP         *ld,
const char   *dn,
LDAPMod      **attrs
);

int ldap_add_s
(
LDAP         *ld,
const char   *dn,
LDAPMod      **attrs
);

```

### Parameters

Table 8–17 lists and describes the parameters for add operations.

**Table 8–17 Parameters for Add Operations**

Parameter	Description
ld	The session handle.
dn	The name of the entry to add.
attrs	The entry attributes, specified using the LDAPMod structure defined for <code>ldap_modify()</code> . The <code>mod_type</code> and <code>mod_vals</code> fields must be filled in. The <code>mod_op</code> field is ignored unless ORed with the constant <code>LDAP_MOD_BVALUES</code> , used to select the <code>mod_bvalues</code> case of the <code>mod_vals</code> union.
serverctrls	List of LDAP server controls.
clientctrls	List of client controls.
msgidp	This result parameter is set to the message id of the request if the <code>ldap_add_ext()</code> call succeeds.

### Usage Notes

Note that the parent of the entry being added must already exist or the parent must be empty—that is, equal to the root DN—for an add to succeed.

#### 8.2.9.8 `ldap_delete_ext`, `ldap_delete_ext_s`, `ldap_delete`, and `ldap_delete_s`

Use these functions to delete a leaf entry from the LDAP directory.

The `ldap_delete_ext()` function initiates an asynchronous delete operation and returns the constant `LDAP_SUCCESS` if the request was successfully sent, or another LDAP error code if not. If successful, `ldap_delete_ext()` places the message id of the request in `*msgidp`. A subsequent call to `ldap_result()` can be used to obtain the result of the delete.

Similar to `ldap_delete_ext()`, the `ldap_delete()` function initiates an asynchronous delete operation and returns the message id of the operation initiated. As for `ldap_delete_ext()`, a subsequent call to `ldap_result()` can be used to obtain the result of the delete. In case of error, `ldap_delete()` returns `-1`, setting the session error parameters in the LDAP structure appropriately.

The synchronous `ldap_delete_ext_s()` and `ldap_delete_s()` functions both return the result of the operation, either the constant `LDAP_SUCCESS` if the operation was successful, or another LDAP error code if it was not.

The `ldap_delete_ext()` and `ldap_delete_ext_s()` functions support LDAPv3 server controls and client controls.

**See Also:** [Section 8.2.12, "Handling Errors and Parsing Results"](#) for more information about possible errors and how to interpret them.

### Syntax

```
int ldap_delete_ext
(
    LDAP          *ld,
    const char    *dn,
    LDAPControl   **serverctrls,
    LDAPControl   **clientctrls,
    int           *msgidp
);
```

```
int ldap_delete_ext_s
(
    LDAP          *ld,
    const char    *dn,
    LDAPControl   **serverctrls,
    LDAPControl   **clientctrls
);
```

### int ldap\_delete

```
(
    LDAP          *ld,
    const char    *dn
);
```

```
int ldap_delete_s
(
    LDAP          *ld,
    const char    *dn
);
```

### Parameters

[Table 8–18](#) lists and describes the parameters for delete operations.

**Table 8–18 Parameters for Delete Operations**

Parameter	Description
<code>ld</code>	The session handle.
<code>dn</code>	The name of the entry to delete.
<code>serverctrls</code>	List of LDAP server controls.
<code>clientctrls</code>	List of client controls.
<code>msgidp</code>	This result parameter is set to the message id of the request if the <code>ldap_delete_ext()</code> call succeeds.

## Usage Notes

Note that the entry to delete must be a leaf entry—that is, it must have no children. Deletion of entire subtrees in a single operation is not supported by LDAP.

### 8.2.9.9 ldap\_extended\_operation and ldap\_extended\_operation\_s

These routines enable extended LDAP operations to be passed to the server, providing a general protocol extensibility mechanism.

The `ldap_extended_operation()` function initiates an asynchronous extended operation and returns the constant `LDAP_SUCCESS` if the request was successfully sent, or another LDAP error code if not. If successful, `ldap_extended_operation()` places the message id of the request in `*msgidp`. A subsequent call to `ldap_result()` can be used to obtain the result of the extended operation which can be passed to `ldap_parse_extended_result()` to obtain the object identifier (OID) and data contained in the response.

The synchronous `ldap_extended_operation_s()` function returns the result of the operation, either the constant `LDAP_SUCCESS` if the operation was successful, or another LDAP error code if it was not. The `retoid` and `retdata` parameters are filled in with the OID and data from the response. If no OID or data was returned, these parameters are set to `NULL`.

The `ldap_extended_operation()` and `ldap_extended_operation_s()` functions both support LDAPv3 server controls and client controls.

**See Also:** [Section 8.2.12, "Handling Errors and Parsing Results"](#) for more information about possible errors and how to interpret them.

## Syntax

```
int ldap_extended_operation
(
    LDAP                *ld,
    const char          *requestoid,
    const struct berval *requestdata,
    LDAPControl         **serverctrls,
    LDAPControl         **clientctrls,
    int                 *msgidp
);

int ldap_extended_operation_s
(
    LDAP                *ld,
    const char          *requestoid,
    const struct berval *requestdata,
    LDAPControl         **serverctrls,
    LDAPControl         **clientctrls,
    char                **retoidp,
    struct berval       *retdatap
);
```

## Parameters

Table 8–19 lists and describes the parameters for extended operations.

**Table 8–19 Parameters for Extended Operations**

Parameter	Description
<code>ld</code>	The session handle

**Table 8–19 (Cont.) Parameters for Extended Operations**

Parameter	Description
requestoid	The dotted-OID text string naming the request
requestdata	The arbitrary data needed by the operation (if NULL, no data is sent to the server)
serverctrls	List of LDAP server controls
clientctrls	List of client controls
msgidp	This result parameter is set to the message id of the request if the <code>ldap_extended_operation()</code> call succeeds.
retoidp	Pointer to a character string that is set to an allocated, dotted-OID text string returned by the server. This string should be disposed of using the <code>ldap_memfree()</code> function. If no OID was returned, <code>*retoidp</code> is set to NULL.
retdatap	Pointer to a <code>berval</code> structure pointer that is set an allocated copy of the data returned by the server. This <code>struct berval</code> should be disposed of using <code>ber_bvfree()</code> . If no data is returned, <code>*retdatap</code> is set to NULL.

## 8.2.10 Abandoning an Operation

Use the functions in this section to abandon an operation in progress:

### 8.2.10.1 `ldap_abandon_ext` and `ldap_abandon`

`ldap_abandon_ext()` abandons the operation with message id `msgid` and returns the constant `LDAP_SUCCESS` if the abandon was successful or another LDAP error code if not.

`ldap_abandon()` is identical to `ldap_abandon_ext()` except that it does not accept client or server controls and it returns zero if the abandon was successful, -1 otherwise.

After a successful call to `ldap_abandon()` or `ldap_abandon_ext()`, results with the given message id are never returned from a subsequent call to `ldap_result()`. There is no server response to LDAP abandon operations.

#### Syntax

```
int ldap_abandon_ext
(
    LDAP          *ld,
    int           msgid,
    LDAPControl   **serverctrls,
    LDAPControl   **clientctrls
);

int ldap_abandon
(
    LDAP          *ld,
    int           msgid
);
```

#### Parameters

Table 8–20 lists and describes the parameters for abandoning an operation.

**Table 8–20 Parameters for Abandoning an Operation**

Parameter	Description
ld	The session handle.
msgid	The message id of the request to be abandoned.
serverctrls	List of LDAP server controls.
clientctrls	List of client controls.

**See Also:** [Section 8.2.12, "Handling Errors and Parsing Results"](#) for more information about possible errors and how to interpret them.

## 8.2.11 Obtaining Results and Peeking Inside LDAP Messages

Use the functions in this section to return the result of an operation initiated asynchronously. They identify messages by type and by ID.

### 8.2.11.1 ldap\_result, ldap\_msgtype, and ldap\_msgid

`ldap_result()` is used to obtain the result of a previous asynchronously initiated operation. Note that depending on how it is called, `ldap_result()` can actually return a list or "chain" of result messages. The `ldap_result()` function only returns messages for a single request, so for all LDAP operations other than search only one result message is expected; that is, the only time the "result chain" can contain more than one message is if results from a search operation are returned.

After a chain of messages has been returned to the caller, it is no longer tied in any caller-visible way to the LDAP request that produced it. Therefore, a chain of messages returned by calling `ldap_result()` or by calling a synchronous search routine is never affected by subsequent LDAP API calls (except for `ldap_msgfree()` which is used to dispose of a chain of messages).

`ldap_msgfree()` frees the result messages (possibly an entire chain of messages) obtained from a previous call to `ldap_result()` or from a call to a synchronous search routine.

`ldap_msgtype()` returns the type of an LDAP message. `ldap_msgid()` returns the message ID of an LDAP message.

#### Syntax

```
int ldap_result
(
LDAP          *ld,
int           msgid,
int           all,
struct timeval *timeout,
LDAPMessage  **res
);
int ldap_msgfree( LDAPMessage *res );
int ldap_msgtype( LDAPMessage *res );
int ldap_msgid( LDAPMessage *res );
```

#### Parameters

[Table 8–21](#) on page 8-32 lists and describes the parameters for obtaining results and peeling inside LDAP messages.

**Table 8–21 Parameters for Obtaining Results and Peeking Inside LDAP Messages**

Parameter	Description
ld	The session handle.
msgid	The message id of the operation whose results are to be returned, the constant <code>LDAP_RES_UNSOLICITED</code> (0) if an unsolicited result is desired, or the constant <code>LDAP_RES_ANY</code> (-1) if any result is desired.
all	Specifies how many messages is retrieved in a single call to <code>ldap_result()</code> . This parameter only has meaning for search results. Pass the constant <code>LDAP_MSG_ONE</code> (0x00) to retrieve one message at a time. Pass <code>LDAP_MSG_ALL</code> (0x01) to request that all results of a search be received before returning all results in a single chain. Pass <code>LDAP_MSG_RECEIVED</code> (0x02) to indicate that all messages retrieved so far are to be returned in the result chain.
timeout	A timeout specifying how long to wait for results to be returned. A <code>NULL</code> value causes <code>ldap_result()</code> to block until results are available. A timeout value of zero seconds specifies a polling behavior.
res	For <code>ldap_result()</code> , a result parameter that contains the result of the operation. If no results are returned, <code>*res</code> is set to <code>NULL</code> . For <code>ldap_msgfree()</code> , the result chain to be freed, obtained from a previous call to <code>ldap_result()</code> , <code>ldap_search_s()</code> , or <code>ldap_search_st()</code> . If <code>res</code> is <code>NULL</code> , nothing is done and <code>ldap_msgfree()</code> returns zero.

### Usage Notes

Upon successful completion, `ldap_result()` returns the type of the first result returned in the `res` parameter. This is one of the following constants.

`LDAP_RES_BIND` (0x61)

`LDAP_RES_SEARCH_ENTRY` (0x64)

`LDAP_RES_SEARCH_REFERENCE` (0x73) -- new in LDAPv3

`LDAP_RES_SEARCH_RESULT` (0x65)

`LDAP_RES_MODIFY` (0x67)

`LDAP_RES_ADD` (0x69)

`LDAP_RES_DELETE` (0x6B)

`LDAP_RES_MODDN` (0x6D)

`LDAP_RES_COMPARE` (0x6F)

`LDAP_RES_EXTENDED` (0x78) -- new in LDAPv3

`ldap_result()` returns 0 if the timeout expired and -1 if an error occurs, in which case the error parameters of the LDAP session handle is set accordingly.

`ldap_msgfree()` frees each message in the result chain pointed to by `res` and returns the type of the last message in the chain. If `res` is `NULL`, then nothing is done and the value zero is returned.

`ldap_msgtype()` returns the type of the LDAP message it is passed as a parameter. The type is one of the types listed previously, or -1 on error.

`ldap_msgid()` returns the message ID associated with the LDAP message passed as a parameter, or -1 on error.

## 8.2.12 Handling Errors and Parsing Results

Use the functions in this section to extract information from results and to handle errors returned by other LDAP API routines.

### 8.2.12.1 `ldap_parse_result`, `ldap_parse_sasl_bind_result`, `ldap_parse_extended_result`, and `ldap_err2string`

Note that `ldap_parse_sasl_bind_result()` and `ldap_parse_extended_result()` must typically be used in addition to `ldap_parse_result()` to retrieve all the result information from SASL Bind and Extended Operations respectively.

The `ldap_parse_result()`, `ldap_parse_sasl_bind_result()`, and `ldap_parse_extended_result()` functions all skip over messages of type `LDAP_RES_SEARCH_ENTRY` and `LDAP_RES_SEARCH_REFERENCE` when looking for a result message to parse. They return the constant `LDAP_SUCCESS` if the result was successfully parsed and another LDAP error code if not. Note that the LDAP error code that indicates the outcome of the operation performed by the server is placed in the `errcodep` `ldap_parse_result()` parameter. If a chain of messages that contains more than one result message is passed to these routines they always operate on the first result in the chain.

`ldap_err2string()` is used to convert a numeric LDAP error code, as returned by `ldap_parse_result()`, `ldap_parse_sasl_bind_result()`, `ldap_parse_extended_result()` or one of the synchronous API operation calls, into an informative zero-terminated character string message describing the error. It returns a pointer to static data.

#### Syntax

```
int ldap_parse_result
(
LDAP          *ld,
LDAPMessage  *res,
int           *errcodep,
char         **matcheddn,
char         **errmsgp,
char         ***referralsp,
LDAPControl  ***serverctrlsp,
int           freeit
);

int ldap_parse_sasl_bind_result
(
LDAP          *ld,
LDAPMessage  *res,
struct berval **servercredp,
int           freeit
);

int ldap_parse_extended_result
(
LDAP          *ld,
LDAPMessage  *res,
char         **retoidp,
struct berval **retdatap,
int           freeit
);
#define LDAP_NOTICE_OF_DISCONNECTION "1.3.6.1.4.1.1466.20036"
```

```
char *ldap_err2string( int err );
```

The routines immediately following are deprecated. To learn more about them, see RFC 1823.

```
int ldap_result2error
(
    LDAP          *ld,
    LDAPMessage   *res,
    int           freeit
);
void ldap_perror( LDAP *ld, const char *msg );
```

### Parameters

Table 8–22 lists and describes parameters for handling errors and parsing results.

**Table 8–22 Parameters for Handling Errors and Parsing Results**

Parameter	Description
ld	The session handle.
res	The result of an LDAP operation as returned by <code>ldap_result()</code> or one of the synchronous API operation calls.
errcodep	This result parameter is filled in with the LDAP error code field from the <code>LDAPMessage</code> message. This is the indication from the server of the outcome of the operation. <code>NULL</code> should be passed to ignore this field.
matcheddn	In the case of a return of <code>LDAP_NO_SUCH_OBJECT</code> , this result parameter is filled in with a DN indicating how much of the name in the request was recognized. <code>NULL</code> should be passed to ignore this field. The matched DN string should be freed by calling <code>ldap_memfree()</code> which is described later in this document.
errmsgp	This result parameter is filled in with the contents of the error message field from the <code>LDAPMessage</code> message. The error message string should be freed by calling <code>ldap_memfree()</code> which is described later in this document. <code>NULL</code> should be passed to ignore this field.
referralsp	This result parameter is filled in with the contents of the referrals field from the <code>LDAPMessage</code> message, indicating zero or more alternate LDAP servers where the request is to be retried. The referrals array should be freed by calling <code>ldap_value_free()</code> which is described later in this document. <code>NULL</code> should be passed to ignore this field.
serverctrlsp	This result parameter is filled in with an allocated array of controls copied out of the <code>LDAPMessage</code> message. The control array should be freed by calling <code>ldap_controls_free()</code> which was described earlier.
freeit	A Boolean that determines whether the <code>res</code> parameter is disposed of or not. Pass any nonzero value to have these routines free <code>res</code> after extracting the requested information. This is provided as a convenience; you can also use <code>ldap_msgfree()</code> to free the result later. If <code>freeit</code> is nonzero, the entire chain of messages represented by <code>res</code> is disposed of.
servercredp	For SASL bind results, this result parameter is filled in with the credentials passed back by the server for mutual authentication, if given. An allocated <code>ber_val</code> structure is returned that should be disposed of by calling <code>ber_bvfree()</code> . <code>NULL</code> should be passed to ignore this field.
retoidp	For extended results, this result parameter is filled in with the dotted-OID text representation of the name of the extended operation response. This string should be disposed of by calling <code>ldap_memfree()</code> . <code>NULL</code> should be passed to ignore this field. The <code>LDAP_NOTICE_OF_DISCONNECTION</code> macro is defined as a convenience for clients that wish to check an OID to see if it matches the one used for the unsolicited Notice of Disconnection (defined in RFC 2251[2] section 4.4.1).



**Table 8–22 (Cont.) Parameters for Handling Errors and Parsing Results**

Parameter	Description
retdatap	For extended results, this result parameter is filled in with a pointer to a struct <code>berval</code> containing the data in the extended operation response. It should be disposed of by calling <code>ber_bvfree()</code> . <code>NULL</code> should be passed to ignore this field.
err	For <code>ldap_err2string()</code> , an LDAP error code, as returned by <code>ldap_parse_result()</code> or another LDAP API call.

**Usage Notes**

See RFC 1823 for a description of parameters peculiar to the deprecated routines.

**8.2.13 Stepping Through a List of Results**

Use the routines in this section to step through the list of messages in a result chain returned by `ldap_result()`.

**8.2.13.1 ldap\_first\_message and ldap\_next\_message**

The result chain for search operations can include referral messages, entry messages, and result messages.

`ldap_count_messages()` is used to count the number of messages returned. The `ldap_msgtype()` function, described previously, can be used to distinguish between the different message types.

```
LDAPMessage *ldap_first_message( LDAP *ld, LDAPMessage *res );
LDAPMessage *ldap_next_message( LDAP *ld, LDAPMessage *msg );
int ldap_count_messages( LDAP *ld, LDAPMessage *res );
```

**Parameters**

Table 8–23 lists and describes the parameters for stepping through a list of results.

**Table 8–23 Parameters for Stepping Through a List of Results**

Parameter	Description
ld	The session handle.
res	The result chain, as obtained by a call to one of the synchronous search routines or <code>ldap_result()</code> .
msg	The message returned by a previous call to <code>ldap_first_message()</code> or <code>ldap_next_message()</code> .

**Usage Notes**

`ldap_first_message()` and `ldap_next_message()` returns `NULL` when no more messages exist in the result set to be returned. `NULL` is also returned if an error occurs while stepping through the entries, in which case the error parameters in the session handle `ld` is set to indicate the error.

If successful, `ldap_count_messages()` returns the number of messages contained in a chain of results; if an error occurs such as the `res` parameter being invalid, `-1` is returned. The `ldap_count_messages()` call can also be used to count the number of messages that remain in a chain if called with a message, entry, or reference returned by `ldap_first_message()`, `ldap_next_message()`, `ldap_first_entry()`, `ldap_next_entry()`, `ldap_first_reference()`, `ldap_next_reference()`.

## 8.2.14 Parsing Search Results

Use the functions in this section to parse the entries and references returned by `ldap_search` functions. These results are returned in an opaque structure that may be accessed by calling the routines described in this section. Routines are provided to step through the entries and references returned, step through the attributes of an entry, retrieve the name of an entry, and retrieve the values associated with a given attribute in an entry.

### 8.2.14.1 `ldap_first_entry`, `ldap_next_entry`, `ldap_first_reference`, `ldap_next_reference`, `ldap_count_entries`, and `ldap_count_references`

The `ldap_first_entry()` and `ldap_next_entry()` routines are used to step through and retrieve the list of entries from a search result chain. The `ldap_first_reference()` and `ldap_next_reference()` routines are used to step through and retrieve the list of continuation references from a search result chain. `ldap_count_entries()` is used to count the number of entries returned. `ldap_count_references()` is used to count the number of references returned.

```
LDAPMessage *ldap_first_entry( LDAP *ld, LDAPMessage *res );
LDAPMessage *ldap_next_entry( LDAP *ld, LDAPMessage *entry );
LDAPMessage *ldap_first_reference( LDAP *ld, LDAPMessage *res );
LDAPMessage *ldap_next_reference( LDAP *ld, LDAPMessage *ref );
int ldap_count_entries( LDAP *ld, LDAPMessage *res );
int ldap_count_references( LDAP *ld, LDAPMessage *res );
```

#### Parameters

Table 8–24 lists and describes the parameters or retrieving entries and continuation references from a search result chain, and for counting entries returned.

**Table 8–24 Parameters for Retrieving Entries and Continuation References from a Search Result Chain, and for Counting Entries Returned**

Parameter	Description
<code>ld</code>	The session handle.
<code>res</code>	The search result, as obtained by a call to one of the synchronous search routines or <code>ldap_result()</code> .
<code>entry</code>	The entry returned by a previous call to <code>ldap_first_entry()</code> or <code>ldap_next_entry()</code> .
<code>ref</code>	The reference returned by a previous call to <code>ldap_first_reference()</code> or <code>ldap_next_reference()</code> .

#### Usage Notes

`ldap_first_entry()`, `ldap_next_entry()`, `ldap_first_reference()`, and `ldap_next_reference()` all return `NULL` when no more entries or references exist in the result set to be returned. `NULL` is also returned if an error occurs while stepping through the entries or references, in which case the error parameters in the session handle `ld` is set to indicate the error.

`ldap_count_entries()` returns the number of entries contained in a chain of entries; if an error occurs such as the `res` parameter being invalid, `-1` is returned. The `ldap_count_entries()` call can also be used to count the number of entries that remain in a chain if called with a message, entry or reference returned by `ldap_first_message()`, `ldap_next_message()`, `ldap_first_entry()`, `ldap_next_entry()`, `ldap_first_reference()`, or `ldap_next_reference()`.

`ldap_count_references()` returns the number of references contained in a chain of search results; if an error occurs such as the `res` parameter being invalid, `-1` is returned. The `ldap_count_references()` call can also be used to count the number of references that remain in a chain.

### 8.2.14.2 `ldap_first_attribute` and `ldap_next_attribute`

Use the functions in this section to step through the list of attribute types returned with an entry.

#### Syntax

```
char *ldap_first_attribute
(
    LDAP          *ld,
    LDAPMessage   *entry,
    BerElement    **ptr
);

char *ldap_next_attribute
(
    LDAP          *ld,
    LDAPMessage   *entry,
    BerElement    *ptr
);
void ldap_memfree( char *mem );
```

#### Parameters

Table 8–25 lists and describes the parameters for stepping through attribute types returned with an entry.

**Table 8–25 Parameters for Stepping Through Attribute Types Returned with an Entry**

Parameter	Description
<code>ld</code>	The session handle.
<code>entry</code>	The entry whose attributes are to be stepped through, as returned by <code>ldap_first_entry()</code> or <code>ldap_next_entry()</code> .
<code>ptr</code>	In <code>ldap_first_attribute()</code> , the address of a pointer used internally to keep track of the current position in the entry. In <code>ldap_next_attribute()</code> , the pointer returned by a previous call to <code>ldap_first_attribute()</code> . The <code>BerElement</code> type itself is an opaque structure.
<code>mem</code>	A pointer to memory allocated by the LDAP library, such as the attribute type names returned by <code>ldap_first_attribute()</code> and <code>ldap_next_attribute</code> , or the DN returned by <code>ldap_get_dn()</code> . If <code>mem</code> is <code>NULL</code> , the <code>ldap_memfree()</code> call does nothing.

#### Usage Notes

`ldap_first_attribute()` and `ldap_next_attribute()` returns `NULL` when the end of the attributes is reached, or if there is an error. In the latter case, the error parameters in the session handle `ld` are set to indicate the error.

Both routines return a pointer to an allocated buffer containing the current attribute name. This should be freed when no longer in use by calling `ldap_memfree()`.

`ldap_first_attribute()` allocates and returns in `ptr` a pointer to a `BerElement` used to keep track of the current position. This pointer may be passed in subsequent calls to `ldap_next_attribute()` to step through the entry's attributes. After a set of calls to `ldap_first_attribute()` and `ldap_next_attribute()`, if `ptr` is non-null, it should be

freed by calling `ber_free(ptr, 0)`. Note that it is very important to pass the second parameter as 0 (zero) in this call, since the buffer associated with the `BerElement` does not point to separately allocated memory.

The attribute type names returned are suitable for passing in a call to `ldap_get_values()` and friends to retrieve the associated values.

### 8.2.14.3 `ldap_get_values`, `ldap_get_values_len`, `ldap_count_values`, `ldap_count_values_len`, `ldap_value_free`, and `ldap_value_free_len`

`ldap_get_values()` and `ldap_get_values_len()` are used to retrieve the values of a given attribute from an entry. `ldap_count_values()` and `ldap_count_values_len()` are used to count the returned values.

`ldap_value_free()` and `ldap_value_free_len()` are used to free the values.

#### Syntax

```
char **ldap_get_values
(
    LDAP          *ld,
    LDAPMessage   *entry,
    const char    *attr
);

struct berval **ldap_get_values_len
(
    LDAP          *ld,
    LDAPMessage   *entry,
    const char    *attr
);

int ldap_count_values( char **vals );
int ldap_count_values_len( struct berval **vals );
void ldap_value_free( char **vals );
void ldap_value_free_len( struct berval **vals );
```

#### Parameters

Table 8–26 lists and describes the parameters for retrieving and counting attribute values.

**Table 8–26 Parameters for Retrieving and Counting Attribute Values**

Parameter	Description
<code>ld</code>	The session handle.
<code>entry</code>	The entry from which to retrieve values, as returned by <code>ldap_first_entry()</code> or <code>ldap_next_entry()</code> .
<code>attr</code>	The attribute whose values are to be retrieved, as returned by <code>ldap_first_attribute()</code> or <code>ldap_next_attribute()</code> , or a caller-supplied string (for example, "mail").
<code>vals</code>	The values returned by a previous call to <code>ldap_get_values()</code> or <code>ldap_get_values_len()</code> .

#### Usage Notes

Two forms of the various calls are provided. The first form is only suitable for use with non-binary character string data. The second `_len` form is used with any kind of data.

`ldap_get_values()` and `ldap_get_values_len()` return `NULL` if no values are found for `attr` or if an error occurs.

`ldap_count_values()` and `ldap_count_values_len()` return `-1` if an error occurs such as the `vals` parameter being invalid.

If a `NULL` `vals` parameter is passed to `ldap_value_free()` or `ldap_value_free_len()`, nothing is done.

Note that the values returned are dynamically allocated and should be freed by calling either `ldap_value_free()` or `ldap_value_free_len()` when no longer in use.

#### 8.2.14.4 `ldap_get_dn`, `ldap_explode_dn`, `ldap_explode_rdn`, and `ldap_dn2ufn`

`ldap_get_dn()` is used to retrieve the name of an entry. `ldap_explode_dn()` and `ldap_explode_rdn()` are used to break up a name into its component parts.

`ldap_dn2ufn()` is used to convert the name into a more user friendly format.

#### Syntax

```
char *ldap_get_dn( LDAP *ld, LDAPMessage *entry );
char **ldap_explode_dn( const char *dn, int notypes );
char **ldap_explode_rdn( const char *rdn, int notypes );
char *ldap_dn2ufn( const char *dn );
```

#### Parameters

Table 8–27 lists and describes the parameters for retrieving, exploding, and converting entry names.

**Table 8–27** *Parameters for Retrieving, Exploding, and Converting Entry Names*

Parameter	Description
<code>ld</code>	The session handle.
<code>entry</code>	The entry whose name is to be retrieved, as returned by <code>ldap_first_entry()</code> or <code>ldap_next_entry()</code> .
<code>dn</code>	The DN to explode, such as returned by <code>ldap_get_dn()</code> .
<code>rdn</code>	The RDN to explode, such as returned in the components of the array returned by <code>ldap_explode_dn()</code> .
<code>notypes</code>	A Boolean parameter, if nonzero indicating that the DN or RDN components are to have their type information stripped off: <code>cn=Babs</code> would become <code>Babs</code> .

#### Usage Notes

`ldap_get_dn()` returns `NULL` if a DN parsing error occurs. The function sets error parameters in the session handle `ld` to indicate the error. It returns a pointer to newly allocated space that the caller should free by calling `ldap_memfree()` when it is no longer in use.

`ldap_explode_dn()` returns a `NULL`-terminated `char *` array containing the RDN components of the DN supplied, with or without types as indicated by the `notypes` parameter. The components are returned in the order they appear in the DN. The array returned should be freed when it is no longer in use by calling `ldap_value_free()`.

`ldap_explode_rdn()` returns a `NULL`-terminated `char *` array containing the components of the RDN supplied, with or without types as indicated by the `notypes` parameter. The components are returned in the order they appear in the `rdn`. The array returned should be freed when it is no longer in use by calling `ldap_value_free()`.

`ldap_dn2ufn()` converts the DN into a user friendly format. The UFN returned is newly allocated space that should be freed by a call to `ldap_memfree()` when no longer in use.

### 8.2.14.5 ldap\_get\_entry\_controls

`ldap_get_entry_controls()` is used to extract LDAP controls from an entry.

#### Syntax

```
int ldap_get_entry_controls
(
LDAP          *ld,
LDAPMessage   *entry,
LDAPControl   ***serverctrlsp
);
```

#### Parameters

Table 8–28 lists and describes the parameters for extracting LDAP control from an entry.

**Table 8–28 Parameters for Extracting LDAP Controls from an Entry**

Parameters	Description
<code>ld</code>	The session handle.
<code>entry</code>	The entry to extract controls from, as returned by <code>ldap_first_entry()</code> or <code>ldap_next_entry()</code> .
<code>serverctrlsp</code>	This result parameter is filled in with an allocated array of controls copied out of entry. The control array should be freed by calling <code>ldap_controls_free()</code> . If <code>serverctrlsp</code> is NULL, no controls are returned.

#### Usage Notes

`ldap_get_entry_controls()` returns an LDAP error code that indicates whether the reference could be successfully parsed (LDAP\_SUCCESS if all goes well).

### 8.2.14.6 ldap\_parse\_reference

Use `ldap_parse_reference()` to extract referrals and controls from a SearchResultReference message.

#### Syntax

```
int ldap_parse_reference
(
LDAP          *ld,
LDAPMessage   *ref,
char          ***referralsp,
LDAPControl   ***serverctrlsp,
int           freeit
);
```

#### Parameters

Table 8–29 lists and describes parameters for extracting referrals and controls from a SearchResultReference message.

**Table 8–29 Parameters for Extracting Referrals and Controls from a SearchResultReference Message**

Parameter	Description
ld	The session handle.
ref	The reference to parse, as returned by <code>ldap_result()</code> , <code>ldap_first_reference()</code> , or <code>ldap_next_reference()</code> .
referralsp	This result parameter is filled in with an allocated array of character strings. The elements of the array are the referrals (typically LDAP URLs) contained in <code>ref</code> . The array should be freed when no longer in use by calling <code>ldap_value_free()</code> . If <code>referralsp</code> is <code>NULL</code> , the referral URLs are not returned.
serverctrlsp	This result parameter is filled in with an allocated array of controls copied out of <code>ref</code> . The control array should be freed by calling <code>ldap_controls_free()</code> . If <code>serverctrlsp</code> is <code>NULL</code> , no controls are returned.
freeit	A Boolean that determines whether the <code>ref</code> parameter is disposed of or not. Pass any nonzero value to have this routine free <code>ref</code> after extracting the requested information. This is provided as a convenience. You can also use <code>ldap_msgfree()</code> to free the result later.

**Usage Notes**

`ldap_parse_reference()` returns an LDAP error code that indicates whether the reference could be successfully parsed (`LDAP_SUCCESS` if all goes well).

## 8.3 Sample C API Usage

The first three examples show how to use the C API both with and without SSL and for SASL authentication. More complete examples are given in RFC 1823. The sample code for the command-line tool to perform an LDAP search also demonstrates use of the API in both the SSL and the non-SSL mode.

This section contains these topics:

- [Section 8.3.1, "C API Usage with SSL"](#)
- [Section 8.3.2, "C API Usage Without SSL"](#)
- [Section 8.3.3, "C API Usage for SASL-Based DIGEST-MD5 Authentication"](#)
- [Section 8.3.4, "Setting and Using a Callback Function to Get Credentials When Chasing Referrals"](#)

### 8.3.1 C API Usage with SSL

```
#include <stdio.h>
#include <ldap.h>

main()
{
    LDAP      *ld;
    int       ret = 0;
    ...
    /* open a connection */
    if ((ld = ldap_open("MyHost", 3131)) == NULL)
        exit( 1 );

    /* SSL initialization */
    ret = ldap_init_SSL(&ld->ld_sb, "file:/sslwallet", "welcome",
                      GSLC_SSL_ONEWAY_AUTH );
```

```

if(ret != 0)
{
printf(" %s \n", ldap_err2string(ret));
exit(1);
}

/* authenticate as nobody */
if ( ldap_bind_s( ld, NULL, NULL ) != LDAP_SUCCESS ) {
    ldap_perror( ld, "ldap_bind_s" );
    exit( 1 );
}

.
.
.
}

```

Because the user is making the `ldap_init_SSL` call, the client/server communication in the previous example is secured by using SSL.

### 8.3.2 C API Usage Without SSL

```

#include <stdio.h>
#include <ldap.h>

main()
{
LDAP          *ld;
int           ret = 0;
.
.
.
/* open a connection */
if ( (ld = ldap_open( "MyHost", LDAP_PORT )) == NULL )
    exit( 1 );

/* authenticate as nobody */
if ( ldap_bind_s( ld, NULL, NULL ) != LDAP_SUCCESS ) {
    ldap_perror( ld, "ldap_bind_s" );
    exit( 1 );
}

.
.
.
}

```

In the previous example, the user is not making the `ldap_init_SSL` call, and the client-to-server communication is therefore not secure.

### 8.3.3 C API Usage for SASL-Based DIGEST-MD5 Authentication

This sample program illustrates the usage of LDAP SASL C-API for SASL-based DIGEST-MD5 authentication to a directory server.

```

/*
EXPORT FUNCTION(S)
    NONE

INTERNAL FUNCTION(S)
    NONE

STATIC FUNCTION(S)

```



NONE

#### NOTES

##### Usage:

```
saslbind -h ldap_host -p ldap_port -D authentication_identity_dn \
-w password
```

##### options

```
-h    LDAP host
-p    LDAP port
-D    DN of the identity for authentication
-p    Password
```

Default SASL authentication parameters used by the demo program

SASL Security Property : Currently only "auth" security property is supported by the C-API. This demo program uses this security property.

SASL Mechanism : Supported mechanisms by OID  
 "DIGEST-MD5" - This demo program illustrates it's usage.  
 "EXTERNAL" - SSL authentication is used.  
 (This demo program does not illustrate it's usage.)

Authorization identity : This demo program does not use any authorization identity.

```
MODIFIED (MM/DD/YY)
***** 06/12/03 - Creation
```

\*/

```
/*-----
PRIVATE TYPES AND CONSTANTS
-----*/
```

```
/*-----
STATIC FUNCTION DECLARATIONS
-----*/
```

```
#include <stdio.h>
#include <stdlib.h>
#include <ldap.h>
```

```
static int ldap_version = LDAP_VERSION3;
```

```
main (int argc, char **argv)
```

```
{
LDAP*      ld;
extern char* optarg;
char*      ldap_host = NULL;
char*      ldap_bind_dn = NULL;
char*      ldap_bind_pw = NULL;
int        authmethod = 0;
char        ldap_local_host[256] = "localhost";
int        ldap_port = 3060;
char*      authcid = (char *)NULL;
char*      mech = "DIGEST-MD5"; /* SASL mechanism */
char*      authzid = (char *)NULL;
char*      sasl_secprops = "auth";
char*      realm = (char *)NULL;
```

```
int          status = LDAP_SUCCESS;
OraLdapHandle sasl_cred = (OraLdapHandle )NULL;
OraLdapClientCtx *cctx = (OraLdapClientCtx *)NULL;
int          i = 0;

while (( i = getopt( argc, argv,
"D:h:p:w:E:P:U:V:W:O:R:X:Y:Z"
)) != EOF ) {
switch( i ) {

case 'h':/* ldap host */
    ldap_host = (char *)strdup( optarg );
    break;
case 'D':/* bind DN */
    authcid = (char *)strdup( optarg );
    break;

case 'p':/* ldap port */
    ldap_port = atoi( optarg );
    break;
case 'w':/* Password */
    ldap_bind_pw = (char *)strdup( optarg );
    break;

    default:
        printf("Invalid Arguments passed\n" );
}
}

/* Get the connection to the LDAP server */
if (ldap_host == NULL)
    ldap_host = ldap_local_host;

if ((ld = ldap_open( ldap_host, ldap_port)) == NULL)
{
    ldap_perror( ld, "ldap_init");
    exit( 1);
}

/* Create the client context needed by LDAP C-API Oracle Extension functions*/
status = ora_ldap_init_clientctx(&cctx);

if(LDAP_SUCCESS != status) {
    printf("Failed during creation of client context \n");
    exit(1);
}

/* Create SASL credentials */
sasl_cred = ora_ldap_create_cred_hdl(cctx, ORA_LDAP_CRED_HANDLE_SASL_MD5);

ora_ldap_set_cred_props(cctx, sasl_cred, ORA_LDAP_CRED_SASL_REALM,
    (void *)realm);
ora_ldap_set_cred_props(cctx, sasl_cred, ORA_LDAP_CRED_SASL_AUTH_PASSWORD,
    (void *)ldap_bind_pw);
ora_ldap_set_cred_props(cctx, sasl_cred, ORA_LDAP_CRED_SASL_AUTHORIZATION_ID,
    (void *)authzid);
ora_ldap_set_cred_props(cctx, sasl_cred, ORA_LDAP_CRED_SASL_SECURITY_PROPERTIES,
    (void *)sasl_secprops);
```

```

/* If connecting to the directory using SASL DIGEST-MD5, the Authentication ID
   has to be normalized before it's sent to the server,
   the LDAP C-API does this normalization based on the following flag set in
   SASL credential properties */
ora_ldap_set_cred_props(cctx, sasl_cred, ORA_LDAP_CRED_SASL_NORM_AUTHDN, (void
*)NULL);

/* SASL Authentication to LDAP Server */
status = (int)ora_ldap_init_SASL(cctx, ld, (char *)authcid, (char
*)ORA_LDAP_SASL_MECH_DIGEST_MD5,
    sasl_cred, NULL, NULL);

if(LDAP_SUCCESS == status) {
    printf("SASL bind successful \n" );
}else {
    printf("SASL bind failed with status : %d\n", status);
}

/* Free SASL Credentials */
ora_ldap_free_cred_hdl(cctx, sasl_cred);

status = ora_ldap_free_clientctx(cctx);

/* Unbind from LDAP server */
ldap_unbind (ld);

return (0);
}

/* end of file saslbinding.c */

```

### 8.3.4 Setting and Using a Callback Function to Get Credentials When Chasing Referrals

To set the callback function, you use `ldap_set_rebind_proc()`. The callback function is used only if `LDAP_OPT_REFERRALS` is set using `ldap_set_option()`. If `ldap_set_rebind_proc()` is not called, then the library uses anonymous bind to connect to a new server while chasing LDAP referrals.

```

/* referralsample.c - Sample program to demonstrate the usage of
ldap_set_rebind_proc() for referrals */

#include <stdio.h>
#include <stdlib.h>
#include <ldap.h>

/*
 * Prints the Entry DNs of the search result
 */
void print_entry_dns( LDAP *ld, LDAPMessage *result )
{
    LDAPMessage *e;
    char *dn;

    for ( e = ldap_first_entry( ld, result ); e != NULL;
          e = ldap_next_entry(ld, e) )
    {
        if ( (dn = ldap_get_dn( ld, e )) != NULL ) {

```

```

        printf( "dn: %s\n\n", dn );
        ldap_memfree( dn );
    }
    else {
        ldap_perror( ld, "ldap_get_dn" );
    }
}

/*
 * Rebind function for providing the credentials to bind referral servers
 */
int getbindcredentials(LDAP *ld, char **binddn, char **bindpwd, int *authmethod,
int freeit)
{
    if (freeit == 0) {
        /* In this example bind credentials are static. Typically, Bind credentials
are fetched from wallet or
some other means for the server information in input session handle */

        *binddn = "cn=orcladmin";
        *bindpwd = "xyz";
        *authmethod = LDAP_AUTH_SIMPLE;
    }
    else {
        /* In this example there is no memory allocation.
        If the memory is allocated for binddn/bindpwd/authmehod, they should be
freed here */

        *binddn = NULL;
        *bindpwd = NULL;
        *authmethod = 0;
    }

    return 0;
}

main()
{
    char        ldaphost[] = "localhost";
    char        binddn[] = "cn=orcladmin";
    char        bindpwd[] = "password";
    int         ldapport = 3060;
    char        searchbase[] = "dc=oracle,dc=com";
    char        filter[] = "objectclass=*";
    int         scope = LDAP_SCOPE_SUBTREE;

    LDAP        *ld;
    LDAPMessage *result;
    int         ret = 0;

    if ( (ld = ldap_open( ldaphost, ldapport )) == NULL) {
        printf( "ldap_open: Connection failed\n" );
        exit( 1 );
    }

    if ( ldap_simple_bind_s(ld, binddn, bindpwd) != LDAP_SUCCESS ) {
        ldap_perror(ld, "ldap_simple_bind_s");
        exit( 1 );
    }
}

```

```

}

/* Set this option to connect to the referrals */
ldap_set_option (ld, LDAP_OPT_REFERRALS, (void *)1);

/* set the function pointer which provides the bind credentials for referral
server */
ldap_set_rebind_proc(ld, (int (*)(LDAP*, char**, char**, int*,
int))getbindcredentials);

ret = ldap_search_s( ld, searchbase, scope, filter, NULL, 0, &result );
if(LDAP_SUCCESS != ret) {
    ldap_perror(ld, "ldap_search_s");
    exit( 1 );
}

print_entry_dns(ld, result);

ldap_unbind(ld);
return(0);
}

```

## 8.4 Required Header Files and Libraries for the C API

To build applications with the C API, you need to:

- Include the header file located at `$ORACLE_HOME/ldap/public/ldap.h`
- Dynamically link to the library located at:
  - `$ORACLE_HOME/lib/libclntsh.so.11.1` on UNIX and Linux operating systems
  - `%ORACLE_HOME%\bin\oraldapclnt11.lib` on Windows operating systems

## 8.5 Dependencies and Limitations of the C API

This API can work against any release of Oracle Internet Directory. It requires either an Oracle environment or, at minimum, globalization support and other core libraries.

To use the different authentication modes in SSL, the directory server requires corresponding configuration settings.

**See Also:** *Oracle Fusion Middleware Administrator's Guide for Oracle Internet Directory* for details about how to set the directory server in various SSL authentication modes.

Oracle Wallet Manager is required for creating wallets if you are using the C API in SSL mode.

TCP/IP Socket Library is required.

The following Oracle libraries are required:

- Oracle SSL-related libraries
- Oracle system libraries

Sample libraries are included in the release for the sample command line tool. You should replace these libraries with your own versions of the libraries.

The product supports only those authentication mechanisms described in LDAP SDK specifications (RFC 1823).

All strings input to the C API must be in UTF-8 format. If the strings are not in the UTF-8 format, you can use the OCI function `OCINlsCharSetConvert` to perform the conversion. Please see the *Oracle Call Interface Programmer's Guide* in the Oracle Database Library at <http://www.oracle.com/technology/documentation>.

---



---

## DBMS\_LDAP PL/SQL Reference

This chapter describes the `DBMS_LDAP`, which contains the functions and procedures that enable PL/SQL programmers to access data from LDAP servers. This chapter also examines all of the API functions in detail.

This chapter includes the following sections:

- Section 9.1, "Summary of Subprograms"
- Section 9.2, "Exception Summary"
- Section 9.3, "Data Type Summary"
- Section 9.4, "Subprograms"

### 9.1 Summary of Subprograms

**Table 9–1** *DBMS\_LDAP API Subprograms*

Function or Procedure	Description
FUNCTION <code>init</code>	<code>init()</code> initializes a session with an LDAP server. This actually establishes a connection with the LDAP server.
FUNCTION <code>simple_bind_s</code>	The function <code>simple_bind_s()</code> can be used to perform simple user name and password authentication to the directory server.
FUNCTION <code>bind_s</code>	The function <code>bind_s()</code> can be used to perform complex authentication to the directory server.
FUNCTION <code>unbind_s</code>	The function <code>unbind_s()</code> is used for closing an active LDAP session.
FUNCTION <code>compare_s</code>	The function <code>compare_s()</code> can be used to test if a particular attribute in a particular entry has a particular value.
FUNCTION <code>search_s</code>	The function <code>search_s()</code> performs a synchronous search in the LDAP server. It returns control to the PL/SQL environment only after all of the search results have been sent by the server or if the search request is 'timed-out' by the server.
FUNCTION <code>search_st</code>	The function <code>search_st()</code> performs a synchronous search in the LDAP server with a client side time out. It returns control to the PL/SQL environment only after all of the search results have been sent by the server or if the search request is 'timed-out' by the client or the server.
FUNCTION <code>first_entry</code>	The function <code>first_entry</code> is used to retrieve the first entry in the result set returned by either <code>search_s()</code> or <code>search_st</code> .
FUNCTION <code>next_entry</code>	The function <code>next_entry()</code> is used to iterate to the next entry in the result set of a search operation.

**Table 9–1 (Cont.) DBMS\_LDAP API Subprograms**

Function or Procedure	Description
FUNCTION <code>count_entries</code>	This function is used to count the number of entries in the result set. It can also be used to count the number of entries remaining during a traversal of the result set using a combination of the functions <code>first_entry()</code> and <code>next_entry</code> .
FUNCTION <code>first_attribute</code>	The function <code>first_attribute()</code> fetches the first attribute of a given entry in the result set.
FUNCTION <code>next_attribute</code>	The function <code>next_attribute()</code> fetches the next attribute of a given entry in the result set.
FUNCTION <code>get_dn</code>	The function <code>get_dn()</code> retrieves the X.500 distinguished name of a given entry in the result set.
FUNCTION <code>get_values</code>	The function <code>get_values()</code> can be used to retrieve all of the values associated with a given attribute in a given entry.
FUNCTION <code>get_values_len</code>	The function <code>get_values_len()</code> can be used to retrieve values of attributes that have a 'Binary' syntax.
FUNCTION <code>delete_s</code>	This function can be used to remove a leaf entry in the LDAP Directory Information Tree.
FUNCTION <code>modrdn2_s</code>	The function <code>modrdn2_s()</code> can be used to rename the relative distinguished name of an entry.
FUNCTION <code>err2string</code>	The function <code>err2string()</code> can be used to convert an LDAP error code to a string in the local language in which the API is operating.
FUNCTION <code>create_mod_array</code>	The function <code>create_mod_array()</code> allocates memory for array modification entries that are applied to an entry using the <code>modify_s()</code> functions.
PROCEDURE <code>populate_mod_array</code> (String Version)	Populates one set of attribute information for add or modify operations. This procedure call has to happen after <code>DBMS_LDAP.create_mod_array()</code> is called.
PROCEDURE <code>populate_mod_array</code> (Binary Version)	Populates one set of attribute information for add or modify operations. This procedure call has to occur after <code>DBMS_LDAP.create_mod_array()</code> is called.
PROCEDURE <code>populate_mod_array</code> (Binary Version. Uses BLOB Data Type)	Populates one set of attribute information for add or modify operations. This procedure call has to happen after <code>DBMS_LDAP.create_mod_array()</code> is called.
FUNCTION <code>get_values_blob</code>	The function <code>get_values_blob()</code> can be used to retrieve larger values of attributes that have a binary syntax.
FUNCTION <code>count_values_blob</code>	Counts the number of values returned by <code>DBMS_LDAP.get_values_blob()</code> .
FUNCTION <code>value_free_blob</code>	Frees the memory associated with the <code>BLOB_COLLECTION</code> returned by <code>DBMS_LDAP.get_values_blob()</code> .
FUNCTION <code>modify_s</code>	Performs a synchronous modification of an existing LDAP directory entry. Before calling <code>add_s</code> , you must call <code>DBMS_LDAP.creat_mod_array()</code> and <code>DBMS_LDAP.populate_mod_array()</code> .
FUNCTION <code>add_s</code>	Adds a new entry to the LDAP directory synchronously. Before calling <code>add_s</code> , you must call <code>DBMS_LDAP.creat_mod_array()</code> and <code>DBMS_LDAP.populate_mod_array()</code> .
PROCEDURE <code>free_mod_array</code>	Frees the memory allocated by <code>DBMS_LDAP.create_mod_array()</code> .



**Table 9–1 (Cont.) DBMS\_LDAP API Subprograms**

Function or Procedure	Description
FUNCTION <code>count_values</code>	Counts the number of values returned by <code>DBMS_LDAP.get_values()</code> .
FUNCTION <code>count_values_len</code>	Counts the number of values returned by <code>DBMS_LDAP.get_values_len()</code> .
FUNCTION <code>rename_s</code>	Renames an LDAP entry synchronously.
FUNCTION <code>explode_dn</code>	Breaks a DN up into its components.
FUNCTION <code>open_ssl</code>	Establishes an SSL (Secure Sockets Layer) connection over an existing LDAP connection.
FUNCTION <code>msgfree</code>	This function frees the chain of messages associated with the message handle returned by synchronous search functions.
FUNCTION <code>ber_free</code>	This function frees the memory associated with a handle to <code>BER_ELEMENT</code> .
FUNCTION <code>nls_convert_to_utf8</code>	The <code>nls_convert_to_utf8</code> function converts the input string containing database character set data to UTF-8 character set data and returns it.
FUNCTION <code>nls_convert_from_utf8</code>	The <code>nls_convert_from_utf8</code> function converts the input string containing UTF-8 character set data to database character set data and returns it.
FUNCTION <code>nls_get_dbcharset_name</code>	The <code>nls_get_dbcharset_name</code> function returns a string containing the database character set name.

**See Also:**

- Section 2.6, "Searching the Directory" for more about `DBMS_LDAP.search_s()` and `DBMS_LDAP.search_st()`.
- Section 2.7.2, "Terminating the Session by Using DBMS\_LDAP" for more about `DBMS_LDAP.unbind_s()`.

## 9.2 Exception Summary

DBMS\_LDAP can generate the exceptions described in Table 9–2 on page 9-3.

**Table 9–2 DBMS\_LDAP Exception Summary**

Exception Name	Oracle Error Number	Cause of Exception
<code>general_error</code>	31202	Raised anytime an error is encountered that does not have a specific PL/SQL exception associated with it. The error string contains the description of the problem in the user's language.
<code>init_failed</code>	31203	Raised by <code>DBMS_LDAP.init()</code> if there are problems.
<code>invalid_session</code>	31204	Raised by all functions and procedures in the <code>DBMS_LDAP</code> package if they are passed an invalid session handle.
<code>invalid_auth_method</code>	31205	Raised by <code>DBMS_LDAP.bind_s()</code> if the authentication method requested is not supported.
<code>invalid_search_scope</code>	31206	Raised by all search functions if the scope of the search is invalid.

**Table 9–2 (Cont.) DBMS\_LDAP Exception Summary**

<b>Exception Name</b>	<b>Oracle Error Number</b>	<b>Cause of Exception</b>
invalid_search_time_val	31207	Raised by DBMS_LDAP.search_st() if it is given an invalid value for a time limit.
invalid_message	31208	Raised by all functions that iterate through a result-set for getting entries from a search operation if the message handle given to them is invalid.
count_entry_error	31209	Raised by DBMS_LDAP.count_entries if it cannot count the entries in a given result set.
get_dn_error	31210	Raised by DBMS_LDAP.get_dn if the DN of the entry it is retrieving is NULL.
invalid_entry_dn	31211	Raised by all functions that modify, add, or rename an entry if they are presented with an invalid entry DN.
invalid_mod_array	31212	Raised by all functions that take a modification array as an argument if they are given an invalid modification array.
invalid_mod_option	31213	Raised by DBMS_LDAP.populate_mod_array if the modification option given is anything other than MOD_ADD, MOD_DELETE or MOD_REPLACE.
invalid_mod_type	31214	Raised by DBMS_LDAP.populate_mod_array if the attribute type that is being modified is NULL.
invalid_mod_value	31215	Raised by DBMS_LDAP.populate_mod_array if the modification value parameter for a given attribute is NULL.
invalid_rdn	31216	Raised by all functions and procedures that expect a valid RDN and are provided with an invalid one.
invalid_newparent	31217	Raised by DBMS_LDAP.rename_s if the new parent of an entry being renamed is NULL.
invalid_deleteoldrdn	31218	Raised by DBMS_LDAP.rename_s if the deleteoldrdn parameter is invalid.
invalid_notypes	31219	Raised by DBMS_LDAP.explode_dn if the notypes parameter is invalid.
invalid_ssl_wallet_loc	31220	Raised by DBMS_LDAP.open_ssl if the wallet location is NULL but the SSL authentication mode requires a valid wallet.
invalid_ssl_wallet_password	31221	Raised by DBMS_LDAP.open_ssl if the wallet password given is NULL.
invalid_ssl_auth_mode	31222	Raised by DBMS_LDAP.open_ssl if the SSL authentication mode is not 1, 2 or 3.

## 9.3 Data Type Summary

The DBMS\_LDAP package uses the data types described in [Table 9–3](#).

**Table 9–3 DBMS\_LDAP Data Type Summary**

<b>Data-Type</b>	<b>Purpose</b>
SESSION	Used to hold the handle of the LDAP session. Nearly all of the functions in the API require a valid LDAP session to work.

**Table 9–3 (Cont.) DBMS\_LDAP Data Type Summary**

<b>Data-Type</b>	<b>Purpose</b>
MESSAGE	Used to hold a handle to the message retrieved from the result set. This is used by all functions that work with entry attributes and values.
MOD_ARRAY	Used to hold a handle to the array of modifications being passed to either <code>modify_s()</code> or <code>add_s()</code> .
TIMEVAL	Used to pass time limit information to the LDAP API functions that require a time limit.
BER_ELEMENT	Used to hold a handle to a BER structure used for decoding incoming messages.
STRING_COLLECTION	Used to hold a list of VARCHAR2 strings that can be passed on to the LDAP server.
BINVAL_COLLECTION	Used to hold a list of RAW data, which represent binary data.
BERVAL_COLLECTION	Used to hold a list of BERVAL values that are used for populating a modification array.
BLOB_COLLECTION	Used to hold a list of BLOB data, which represent binary data.

## 9.4 Subprograms

This section takes a closer look at each of the DBMS\_LDAP subprograms.

### 9.4.1 FUNCTION init

`init()` initializes a session with an LDAP server. This actually establishes a connection with the LDAP server.

#### Syntax

```
FUNCTION init
(
  hostname IN VARCHAR2,
  portnum  IN PLS_INTEGER
)
RETURN SESSION;
```

#### Parameters

**Table 9–4 INIT Function Parameters**

<b>Parameter</b>	<b>Description</b>
hostname	Contains a space-separated list of host names or dotted strings representing the IP address of hosts running an LDAP server to connect to. Each host name in the list may include a port number, which is separated from the host by a colon. The hosts are tried in the order listed, stopping with the first one to which a successful connection is made.
portnum	Contains the TCP port number to connect to. If the port number is included with the host name, this parameter is ignored. If the parameter is not specified, and the host name does not contain the port number, a default port number of 3060 is assumed.

## Return Values

**Table 9–5** *INIT Function Return Values*

Value	Description
SESSION	A handle to an LDAP session that can be used for further calls to the API.

## Exceptions

**Table 9–6** *INIT Function Exceptions*

Exception	Description
init_failed	Raised when there is a problem contacting the LDAP server.
general_error	For all other errors. The error string associated with the exception describes the error in detail.

## Usage Notes

DBMS\_LDAP.init() is the first function that should be called because it establishes a session with the LDAP server. Function DBMS\_LDAP.init() returns a session handle, a pointer to an opaque structure that must be passed to subsequent calls pertaining to the session. This routine returns NULL and raises the INIT\_FAILED exception if the session cannot be initialized. After init() has been called, the connection has to be authenticated using DBMS\_LDAP.bind\_s or DBMS\_LDAP.simple\_bind\_s().

## See Also

DBMS\_LDAP.simple\_bind\_s(), DBMS\_LDAP.bind\_s().

## 9.4.2 FUNCTION simple\_bind\_s

The function simple\_bind\_s can be used to perform simple user name and password authentication to the directory server.

### Syntax

```
FUNCTION simple_bind_s
(
  ld      IN SESSION,
  dn      IN VARCHAR2,
  passwd  IN VARCHAR2
)
RETURN PLS_INTEGER;
```

### Parameters

**Table 9–7** *SIMPLE\_BIND\_S Function Parameters*

Parameter	Description
ld	A valid LDAP session handle.
dn	The Distinguished Name of the User that we are trying to login as.
passwd	A text string containing the password.

## Return Values

**Table 9–8** *SIMPLE\_BIND\_S Function Return Values*

Value	Description
PLS_INTEGER	DBMS_LDAP.SUCCESS on a successful completion. If there was a problem, one of the following exceptions are raised.

## Exceptions

**Table 9–9** *SIMPLE\_BIND\_S Function Exceptions*

Exception	Description
invalid_session	Raised if the session handle ld is invalid.
general_error	For all other errors. The error string associated with this exception explains the error in detail.

## Usage Notes

DBMS\_LDAP.simple\_bind\_s() can be used to authenticate a user whose directory distinguished name and directory password are known. It can be called only after a valid LDAP session handle is obtained from a call to DBMS\_LDAP.init().

### 9.4.3 FUNCTION bind\_s

The function bind\_s can be used to perform complex authentication to the directory server.

#### Syntax

```
FUNCTION bind_s
(
  ld      IN SESSION,
  dn      IN VARCHAR2,
  cred    IN VARCHAR2,
  meth    IN PLS_INTEGER
)
RETURN PLS_INTEGER;
```

#### Parameters

**Table 9–10** *BIND\_S Function Parameters*

Parameter	Description
ld	A valid LDAP session handle.
dn	The distinguished name of the user.
cred	A text string containing the credentials used for authentication.
meth	The authentication method. The only valid value is DBMS_LDAP_UTL.AUTH_SIMPLE.

**Return Values****Table 9–11 BIND\_S Function Return Values**

Value	Description
PLS_INTEGER	DBMS_LDAP.SUCCESS upon successful completion. One of the following exceptions is raised if there is a problem.

**Exceptions****Table 9–12 BIND\_S Function Exceptions**

Exception	Description
invalid_session	Raised if the session handle ld is invalid.
invalid_auth_method	Raised if the authentication method requested is not supported.
general_error	For all other errors. The error string associated with this exception explains the error in detail.

**Usage Notes**

DBMS\_LDAP.bind\_s() can be used to authenticate a user. It can be called only after a valid LDAP session handle is obtained from a call to DBMS\_LDAP.init().

**See Also**

DBMS\_LDAP.init(), DBMS\_LDAP.simple\_bind\_s().

**9.4.4 FUNCTION unbind\_s**

The function unbind\_s is used for closing an active LDAP session.

**Syntax**

```
FUNCTION unbind_s
(
  ld IN OUT SESSION
)
RETURN PLS_INTEGER;
```

**Parameters****Table 9–13 UNBIND\_S Function Parameters**

Parameter	Description
ld	A valid LDAP session handle.

**Return Values****Table 9–14 UNBIND\_S Function Return Values**

Value	Description
PLS_INTEGER	DBMS_LDAP.SUCCESS on proper completion. One of the following exceptions is raised otherwise.

## Exceptions

**Table 9–15 UNBIND\_S Function Exceptions**

Exception	Description
invalid_session	Raised if the sessions handle ld is invalid.
general_error	For all other errors. The error string associated with this exception explains the error in detail.

## Usage Notes

The `unbind_s()` function sends an unbind request to the server, closes all open connections associated with the LDAP session, and disposes of all resources associated with the session handle before returning. After a call to this function, the session handle `ld` is invalid.

## See Also

`DBMS_LDAP.bind_s()`, `DBMS_LDAP.simple_bind_s()`.

## 9.4.5 FUNCTION compare\_s

The function `compare_s` can be used to test if a particular attribute in a particular entry has a particular value.

### Syntax

```
FUNCTION compare_s
(
  ld      IN SESSION,
  dn      IN VARCHAR2,
  attr    IN VARCHAR2,
  value   IN VARCHAR2
)
RETURN PLS_INTEGER;
```

### Parameters

**Table 9–16 COMPARE\_S Function Parameters**

Parameter	Description
ld	A valid LDAP session handle.
dn	The name of the entry to compare against.
attr	The attribute to compare against.
value	A string attribute value to compare against.

### Return Values

**Table 9–17 COMPARE\_S Function Return Values**

Value	Description
PLS_INTEGER	COMPARE_TRUE if the given attribute has a matching value. COMPARE_FALSE if the given attribute does not have a matching value.

## Exceptions

**Table 9–18 COMPARE\_S Function Exceptions**

Exception	Description
<code>invalid_session</code>	Raised if the session handle <code>ld</code> is invalid.
<code>general_error</code>	For all other errors. The error string associated with this exception explains the error in detail.

## Usage Notes

The function `compare_s` can be used to assert that an attribute in the directory has a certain value. This operation can be performed only on attributes whose syntax enables them to be compared. The `compare_s` function can be called only after a valid LDAP session handle has been obtained from the `init()` function and authenticated by the `bind_s()` or `simple_bind_s()` functions.

## See Also

`DBMS_LDAP.bind_s()`.

## 9.4.6 FUNCTION `search_s`

The function `search_s` performs a synchronous search in the directory. It returns control to the PL/SQL environment only after all of the search results have been sent by the server or if the search request is timed out by the server.

## Syntax

```
FUNCTION search_s
(
  ld          IN  SESSION,
  base       IN  VARCHAR2,
  scope      IN  PLS_INTEGER,
  filter     IN  VARCHAR2,
  attrs      IN  STRING_COLLECTION,
  attronly  IN  PLS_INTEGER,
  res        OUT MESSAGE
)
RETURN PLS_INTEGER;
```

## Parameters

**Table 9–19 SEARCH\_S Function Parameters**

Parameter	Description
<code>ld</code>	A valid LDAP session handle.
<code>base</code>	The DN of the entry at which to start the search.
<code>scope</code>	One of <code>SCOPE_BASE</code> (0x00), <code>SCOPE_ONELEVEL</code> (0x01), or <code>SCOPE_SUBTREE</code> (0x02), indicating the scope of the search.
<code>filter</code>	A character string representing the search filter. The value <code>NULL</code> can be passed to indicate that the filter "(objectclass=*)", which matches all entries, is to be used.



**Table 9–19 (Cont.) SEARCH\_S Function Parameters**

Parameter	Description
<code>attrs</code>	A collection of strings indicating which attributes to return for each matching entry. Passing <code>NULL</code> for this parameter causes all available user attributes to be retrieved. The special constant string <code>NO_ATTRS</code> ("1.1") may be used as the only string in the array to indicate that no attribute types are to be returned by the server. The special constant string <code>ALL_USER_ATTRS</code> ("*") can be used in the <code>attrs</code> array along with the names of some operational attributes to indicate that all user attributes plus the listed operational attributes are to be returned.
<code>attrsonly</code>	A boolean value that must be zero if both attribute types and values are to be returned, and nonzero if only types are wanted.
<code>res</code>	This is a result parameter that contains the results of the search upon completion of the call. If no results are returned, <code>*res</code> is set to <code>NULL</code> .

**Return Values****Table 9–20 SEARCH\_S Function Return Value**

Value	Description
<code>PLS_INTEGER</code>	<code>DBMS_LDAP.SUCCESS</code> if the search operation succeeded. An exception is raised in all other cases.
<code>res</code>	If the search succeeded and there are entries, this parameter is set to a non-null value which can be used to iterate through the result set.

**Exceptions****Table 9–21 SEARCH\_S Function Exceptions**

Exception	Description
<code>invalid_session</code>	Raised if the session handle <code>ld</code> is invalid.
<code>invalid_search_scope</code>	Raised if the search scope is not one of <code>SCOPE_BASE</code> , <code>SCOPE_ONELEVEL</code> , or <code>SCOPE_SUBTREE</code> .
<code>general_error</code>	For all other errors. The error string associated with this exception explains the error in detail.

**Usage Notes**

The function `search_s()` issues a search operation and does not return control to the user environment until all of the results have been returned from the server. Entries returned from the search, if any, are contained in the `res` parameter. This parameter is opaque to the caller. Entries, attributes, and values can be extracted by calling the parsing routines described in this chapter.

**See Also**

`DBMS_LDAP.search_st()`, `DBMS_LDAP.first_entry()`, `DBMS_LDAP.next_entry()`.

**9.4.7 FUNCTION search\_st**

The function `search_st()` performs a synchronous search in the LDAP server with a client-side time out. It returns control to the PL/SQL environment only after all of the search results have been sent by the server or if the search request is timed out by the client or the server.

**Syntax**

```

FUNCTION search_st
(
  ld      IN  SESSION,
  base   IN  VARCHAR2,
  scope  IN  PLS_INTEGER,
  filter IN  VARCHAR2,
  attrs  IN  STRING_COLLECTION,
  attronly IN PLS_INTEGER,
  tv     IN  TIMEVAL,
  res    OUT MESSAGE
)
RETURN PLS_INTEGER;

```

**Parameters****Table 9–22** *SEARCH\_ST Function Parameters*

Parameter	Description
ld	A valid LDAP session handle.
base	The DN of the entry at which to start the search.
scope	One of <code>SCOPE_BASE</code> (0x00), <code>SCOPE_ONELEVEL</code> (0x01), or <code>SCOPE_SUBTREE</code> (0x02), indicating the scope of the search.
filter	A character string representing the search filter. The value <code>NULL</code> can be passed to indicate that the filter "(objectclass=*)", which matches all entries, is to be used.
attrs	A collection of strings indicating which attributes to return for each matching entry. Passing <code>NULL</code> for this parameter causes all available user attributes to be retrieved. The special constant string <code>NO_ATTRS</code> ("1.1") may be used as the only string in the array to indicate that no attribute types are to be returned by the server. The special constant string <code>ALL_USER_ATTRS</code> ("*") can be used in the <code>attrs</code> array along with the names of some operational attributes to indicate that all user attributes plus the listed operational attributes are to be returned.
attrsonly	A boolean value that must be zero if both attribute types and values are to be returned, and nonzero if only types are wanted.
tv	The time out value, expressed in seconds and microseconds, that should be used for this search.
res	This is a result parameter which contains the results of the search upon completion of the call. If no results are returned, *res is set to <code>NULL</code> .

**Return Values****Table 9–23** *SEARCH\_ST Function Return Values*

Value	Description
PLS_INTEGER	<code>DBMS_LDAP.SUCCESS</code> if the search operation succeeded. An exception is raised in all other cases.
res	If the search succeeded and there are entries, this parameter is set to a non-null value which can be used to iterate through the result set.

## Exceptions

**Table 9–24** *SEARCH\_ST Function Exceptions*

Exception	Description
<code>invalid_session</code>	Raised if the session handle <code>ld</code> is invalid.
<code>invalid_search_scope</code>	Raised if the search scope is not one of <code>SCOPE_BASE</code> , <code>SCOPE_ONELEVEL</code> or <code>SCOPE_SUBTREE</code> .
<code>invalid_search_time_value</code>	Raised if the time value specified for the time out is invalid.
<code>general_error</code>	For all other errors. The error string associated with this exception explains the error in detail.

## Usage Notes

This function is very similar to `DBMS_LDAP.search_s()` except that it requires a time out value to be given.

## See Also

`DBMS_LDAP.search_s()`, `DBML_LDAP.first_entry()`, `DBMS_LDAP.next_entry`.

## 9.4.8 FUNCTION `first_entry`

The function `first_entry()` is used to retrieve the first entry in the result set returned by either `search_s()` or `search_st()`.

## Syntax

```
FUNCTION first_entry
(
  ld IN SESSION,
  msg IN MESSAGE
)
RETURN MESSAGE;
```

## Parameters

**Table 9–25** *FIRST\_ENTRY Function Parameters*

Parameter	Description
<code>ld</code>	A valid LDAP session handle.
<code>msg</code>	The search result, as obtained by a call to one of the synchronous search routines.

## Return Values

**Table 9–26** *FIRST\_ENTRY Return Values*

Value	Description
<code>MESSAGE</code>	A handle to the first entry in the list of entries returned from the LDAP server. It is set to <code>NULL</code> if there was an error and an exception is raised.

## Exceptions

**Table 9–27** *FIRST\_ENTRY Exceptions*

Exception	Description
<code>invalid_session</code>	Raised if the session handle <code>ld</code> is invalid.
<code>invalid_message</code>	Raised if the incoming <code>msg</code> handle is invalid.

## Usage Notes

The function `first_entry()` should always be the first function used to retrieve the results from a search operation.

## See Also

`DBMS_LDAP.next_entry()`, `DBMS_LDAP.search_s()`, `DBMS_LDAP.search_st()`.

## 9.4.9 FUNCTION `next_entry`

The function `next_entry()` is used to iterate to the next entry in the result set of a search operation.

## Syntax

```
FUNCTION next_entry
(
  ld IN SESSION,
  msg IN MESSAGE
)
RETURN MESSAGE;
```

## Parameters

**Table 9–28** *NEXT\_ENTRY Function Parameters*

Parameter	Description
<code>ld</code>	A valid LDAP session handle.
<code>msg</code>	The search result, as obtained by a call to one of the synchronous search routines.

## Return Values

**Table 9–29** *NEXT\_ENTRY Function Return Values*

Value	Description
<code>MESSAGE</code>	A handle to the next entry in the list of entries returned from the LDAP server. It is set to null if there was an error and an exception is raised.

## Exceptions

**Table 9–30** *NEXT\_ENTRY Function Exceptions*

Exception	Description
<code>invalid_session</code>	Raised if the session handle, <code>ld</code> is invalid.
<code>invalid_message</code>	Raised if the incoming <code>msg</code> handle is invalid.

**Usage Notes**

The function `next_entry()` should always be called after a call to the function `first_entry()`. Also, the return value of a successful call to `next_entry()` should be used as `msg` argument used in a subsequent call to the function `next_entry()` to fetch the next entry in the list.

**See Also**

`DBMS_LDAP.first_entry()`, `DBMS_LDAP.search_s()`, `DBMS_LDAP.search_st()`.

**9.4.10 FUNCTION count\_entries**

This function is used to count the number of entries in the result set. It can also be used to count the number of entries remaining during a traversal of the result set using a combination of the functions `first_entry()` and `next_entry()`.

**Syntax**

```
FUNCTION count_entries
(
  ld IN SESSION,
  msg IN MESSAGE
)
RETURN PLS_INTEGER;
```

**Parameters****Table 9–31 COUNT\_ENTRY Function Parameters**

Parameter	Description
<code>ld</code>	A valid LDAP session handle.
<code>msg</code>	The search result, as obtained by a call to one of the synchronous search routines.

**Return Values****Table 9–32 COUNT\_ENTRY Function Return Values**

Value	Description
<code>PLS_INTEGER</code>	Nonzero if there are entries in the result set. -1 if there was a problem.

**Exceptions****Table 9–33 COUNT\_ENTRY Function Exceptions**

Exception	Description
<code>invalid_session</code>	Raised if the session handle <code>ld</code> is invalid.
<code>invalid_message</code>	Raised if the incoming <code>msg</code> handle is invalid.
<code>count_entry_error</code>	Raised if there was a problem in counting the entries.

**Usage Notes**

`count_entries()` returns the number of entries contained in a chain of entries; if an error occurs such as the `res` parameter being invalid, -1 is returned. The `count_entries()` call can also be used to count the number of entries that remain in a

chain if called with a message, entry, or reference returned by `first_message()`, `next_message()`, `first_entry()`, `next_entry()`, `first_reference()`, `next_reference()`.

### See Also

`DBMS_LDAP.first_entry()`, `DBMS_LDAP.next_entry()`.

## 9.4.11 FUNCTION `first_attribute`

The function `first_attribute()` fetches the first attribute of a given entry in the result set.

### Syntax

```
FUNCTION first_attribute
(
  ld          IN  SESSION,
  ldapentry  IN  MESSAGE,
  ber_elem   OUT BER_ELEMENT
)
RETURN VARCHAR2;
```

### Parameters

**Table 9–34** *FIRST\_ATTRIBUTE Function Parameters*

Parameter	Description
<code>ld</code>	A valid LDAP session handle.
<code>ldapentry</code>	The entry whose attributes are to be stepped through, as returned by <code>first_entry()</code> or <code>next_entry()</code> .
<code>ber_elem</code>	A handle to a <code>BER_ELEMENT</code> that is used to keep track of attributes in the entry that have already been read.

### Return Values

**Table 9–35** *FIRST\_ATTRIBUTE Function Return Values*

Value	Description
<code>VARCHAR2</code>	The name of the attribute if it exists. NULL if no attribute exists or if an error occurred.
<code>ber_elem</code>	A handle used by <code>DBMS_LDAP.next_attribute()</code> to iterate over all of the attributes

### Exceptions

**Table 9–36** *FIRST\_ATTRIBUTE Function Exceptions*

Exception	Description
<code>invalid_session</code>	Raised if the session handle <code>ld</code> is invalid.
<code>invalid_message</code>	Raised if the incoming <code>msg</code> handle is invalid.

### Usage Notes

The handle to the `BER_ELEMENT` returned as a function parameter to `first_attribute()` should be used in the next call to `next_attribute()` to iterate

through the various attributes of an entry. The name of the attribute returned from a call to `first_attribute()` can in turn be used in calls to the functions `get_values()` or `get_values_len()` to get the values of that particular attribute.

### See Also

`DBMS_LDAP.next_attribute()`, `DBMS_LDAP.get_values()`,  
`DBMS_LDAP.get_values_len()`, `DBMS_LDAP.first_entry()`, `DBMS_LDAP.next_entry()`.

## 9.4.12 FUNCTION `next_attribute`

The function `next_attribute()` retrieves the next attribute of a given entry in the result set.

### Syntax

```
FUNCTION next_attribute
(
  ld          IN SESSION,
  ldapentry  IN MESSAGE,
  ber_elem   IN BER_ELEMENT
)
RETURN VARCHAR2;
```

### Parameters

**Table 9–37** *NEXT\_ATTRIBUTE Function Parameters*

Parameter	Description
<code>ld</code>	A valid LDAP session handle.
<code>ldapentry</code>	The entry whose attributes are to be stepped through, as returned by <code>first_entry()</code> or <code>next_entry()</code> .
<code>ber_elem</code>	A handle to a <code>BER_ELEMENT</code> that is used to keep track of attributes in the entry that have been read.

### Return Values

**Table 9–38** *NEXT\_ATTRIBUTE Function Return Values*

Value	Description
<code>VARCHAR2</code> (function return)	The name of the attribute if it exists.

### Exceptions

**Table 9–39** *NEXT\_ATTRIBUTE Function Exceptions*

Exception	Description
<code>invalid_session</code>	Raised if the session handle <code>ld</code> is invalid.
<code>invalid_message</code>	Raised if the incoming <code>msg</code> handle is invalid.

### Usage Notes

The handle to the `BER_ELEMENT` returned as a function parameter to `first_attribute()` should be used in the next call to `next_attribute()` to iterate through the various attributes of an entry. The name of the attribute returned from a

call to `next_attribute()` can in turn be used in calls to the functions `get_values()` or `get_values_len()` to get the values of that particular attribute.

### See Also

`DBMS_LDAP.first_attribute()`, `DBMS_LDAP.get_values()`,  
`DBMS_LDAP.get_values_len()`, `DBMS_LDAP.first_entry()`, `DBMS_LDAP.next_entry()`.

## 9.4.13 FUNCTION `get_dn`

The function `get_dn()` retrieves the X.500 distinguished name of given entry in the result set.

### Syntax

```
FUNCTION get_dn
(
  ld IN SESSION,
  ldapentrymsg IN MESSAGE
)
RETURN VARCHAR2;
```

### Parameters

**Table 9–40** *GET\_DN Function Parameters*

Parameter	Description
<code>ld</code>	A valid LDAP session handle.
<code>ldapentry</code>	The entry whose DN is to be returned.

### Return Values

**Table 9–41** *GET\_DN Function Return Values*

Value	Description
<code>VARCHAR2</code>	The X.500 Distinguished name of the entry as a PL/SQL string. NULL if there was a problem.

### Exceptions

**Table 9–42** *GET\_DN Function Exceptions*

Exception	Description
<code>invalid_session</code>	Raised if the session handle <code>ld</code> is invalid.
<code>invalid_message</code>	Raised if the incoming <code>msg</code> handle is invalid.
<code>get_dn_error</code>	Raised if there was a problem in determining the DN.

### Usage Notes

The function `get_dn()` can be used to retrieve the DN of an entry as the program logic is iterating through the result set. This can in turn be used as an input to `explode_dn()` to retrieve the individual components of the DN.

### See Also

`DBMS_LDAP.explode_dn()`.



## 9.4.14 FUNCTION `get_values`

The function `get_values()` can be used to retrieve all of the values associated with a given attribute in a given entry.

### Syntax

```
FUNCTION get_values
(
  ld      IN SESSION,
  ldapentry IN MESSAGE,
  attr   IN VARCHAR2
)
RETURN STRING_COLLECTION;
```

### Parameters

**Table 9–43** *GET\_VALUES Function Parameters*

Parameter	Description
<code>ld</code>	A valid LDAP session handle.
<code>ldapentry</code>	A valid handle to an entry returned from a search result.
<code>attr</code>	The name of the attribute for which values are being sought.

### Return Values

**Table 9–44** *GET\_VALUES Function Return Values*

Value	Description
<code>STRING_COLLECTION</code>	A PL/SQL string collection containing all of the values of the given attribute. NULL if there are no values associated with the given attribute.

### Exceptions

**Table 9–45** *GET\_VALUES Function Exceptions*

Exception	Description
<code>invalid_session</code>	Raised if the session handle <code>ld</code> is invalid.
<code>invalid_message</code>	Raised if the incoming entry handle is invalid.

### Usage Notes

The function `get_values()` can only be called after the handle to entry has been first retrieved by call to either `first_entry()` or `next_entry()`. The name of the attribute may be known beforehand or can be determined by a call to `first_attribute()` or `next_attribute()`. The function `get_values()` always assumes that the data type of the attribute it is retrieving is a string. For retrieving binary data types, `get_values_len()` should be used.

### See Also

`DBMS_LDAP.first_entry()`, `DBMS_LDAP.next_entry()`, `DBMS_LDAP.count_values()`, `DBMS_LDAP.get_values_len()`.

## 9.4.15 FUNCTION `get_values_len`

The function `get_values_len()` can be used to retrieve values of attributes that have a binary syntax.

### Syntax

```
FUNCTION get_values_len
(
  ld      IN SESSION,
  ldapentry IN MESSAGE,
  attr   IN VARCHAR2
)
RETURN BINVAL_COLLECTION;
```

### Parameters

**Table 9–46** *GET\_VALUES\_LEN Function Parameters*

Parameter	Description
<code>ld</code>	A valid LDAP session handle.
<code>ldapentrymsg</code>	A valid handle to an entry returned from a search result.
<code>attr</code>	The string name of the attribute for which values are being sought.

### Return Values

**Table 9–47** *GET\_VALUES\_LEN Function Return Values*

Value	Description
<code>BINVAL_COLLECTION</code>	A PL/SQL 'Raw' collection containing all the values of the given attribute.
	NULL if there are no values associated with the given attribute.

### Exceptions

**Table 9–48** *GET\_VALUES\_LEN Function Exceptions*

Exception	Description
<code>invalid_session</code>	Raised if the session handle <code>ld</code> is invalid.
<code>invalid_message</code>	Raised if the incoming entry handle is invalid.

### Usage Notes

The function `get_values_len()` can only be called after the handle to an entry has been retrieved by a call to either `first_entry()` or `next_entry()`. The name of the attribute may be known beforehand or can also be determined by a call to `first_attribute()` or `next_attribute()`. This function can be used to retrieve both binary and non-binary attribute values.

### See Also

`DBMS_LDAP.first_entry()`, `DBMS_LDAP.next_entry()`,  
`DBMS_LDAP.count_values_len()`, `DBMS_LDAP.get_values()`.

## 9.4.16 FUNCTION delete\_s

The function `delete_s()` can be used to remove a leaf entry in the DIT.

### Syntax

```
FUNCTION delete_s
(
  ld      IN SESSION,
  entrydn IN VARCHAR2
)
RETURN PLS_INTEGER;
```

### Parameters

**Table 9–49 DELETED\_S Function Parameters**

Parameter Name	Description
ld	A valid LDAP session.
entrydn	The X.500 distinguished name of the entry to delete.

### Return Values

**Table 9–50 DELETED\_S Function Return Values**

Value	Description
PLS_INTEGER	DBMS_LDAP.SUCCESS if the delete operation was successful. An exception is raised otherwise.

### Exceptions

**Table 9–51 DELETED\_S Function Exceptions**

Exception	Description
invalid_session	Raised if the session handle <code>ld</code> is invalid.
invalid_entry_dn	Raised if the distinguished name of the entry is invalid.
general_error	For all other errors. The error string associated with this exception explains the error in detail.

### Usage Notes

The function `delete_s()` can be used to remove only leaf entries in the DIT. A leaf entry is an entry that does not have any entries under it. This function cannot be used to delete non-leaf entries.

### See Also

`DBMS_LDAP.modrdn2_s()`.

## 9.4.17 FUNCTION modrdn2\_s

The function `modrdn2_s()` can be used to rename the relative distinguished name of an entry.

### Syntax

```
FUNCTION modrdn2_s
(
```

```

ld IN SESSION,
entrydn IN VARCHAR2
newrdn IN VARCHAR2
deleteoldrdn IN PLS_INTEGER
)
RETURN PLS_INTEGER;

```

### Parameters

**Table 9–52 MODRDN2\_S Function Parameters**

Parameter	Description
ld	A valid LDAP session handle.
entrydn	The distinguished name of the entry (This entry must be a leaf node in the DIT).
newrdn	The new relative distinguished name of the entry.
deleteoldrdn	A boolean value that, if nonzero, indicates that the attribute values from the old name should be removed from the entry.

### Return Values

**Table 9–53 MODRDN2\_S Function Return Values**

Value	Description
PLS_INTEGER	DBMS_LDAP.SUCCESS if the operation was successful. An exception is raised otherwise.

### Exceptions

**Table 9–54 MODRDN2\_S Function Exceptions**

Exception	Description
invalid_session	Raised if the session handle ld is invalid.
invalid_entry_dn	Raised if the distinguished name of the entry is invalid.
invalid_rdn	Invalid LDAP RDN.
invalid_deleteoldrdn	Invalid LDAP deleteoldrdn.
general_error	For all other errors. The error string associated with this exception explains the error in detail.

### Usage Notes

The function `nodrdn2_s()` can be used to rename the leaf nodes of a DIT. It simply changes the relative distinguished name by which they are known. The use of this function is being deprecated in the LDAP v3 standard. Please use `rename_s()`, which fulfills the same purpose.

### See Also

DBMS\_LDAP.rename\_s().

## 9.4.18 FUNCTION err2string

The function `err2string()` can be used to convert an LDAP error code to a string in the local language in which the API is operating.

**Syntax**

```
FUNCTION err2string
(
  ldap_err IN PLS_INTEGER
)
RETURN VARCHAR2;
```

**Parameters****Table 9–55** *ERR2STRING Function Parameters*

Parameter	Description
ldap_err	An error number returned from one of the API calls.

**Return Values****Table 9–56** *ERR2STRING Function Return Values*

Value	Description
VARCHAR2	A character string translated to the local language. The string describes the error in detail.

**Exceptions**

err2string() raises no exceptions.

**Usage Notes**

In this release, the exception handling mechanism automatically invokes this function if any of the API calls encounter an error.

**9.4.19 FUNCTION create\_mod\_array**

The function create\_mod\_array() allocates memory for array modification entries that are applied to an entry using the modify\_s() or add\_s() functions.

**Syntax**

```
FUNCTION create_mod_array
(
  num IN PLS_INTEGER
)
RETURN MOD_ARRAY;
```

**Parameters****Table 9–57** *CREATE\_MOD\_ARRAY Function Parameters*

Parameter	Description
num	The number of the attributes that you want to add or modify.

## Return Values

**Table 9–58 CREATE\_MOD\_ARRAY Function Return Values**

Value	Description
MOD_ARRAY	The data structure holds a pointer to an LDAP mod array. Returns NULL if there was a problem.

## Exceptions

`create_mod_array()` raises no exceptions.

## Usage Notes

This function is one of the preparation steps for `DBMS_LDAP.add_s` and `DBMS_LDAP.modify_s`. It calls `DBMS_LDAP.free_mod_array` to free memory after the calls to `add_s` or `modify_s` have completed.

## See Also

`DBMS_LDAP.populate_mod_array()`, `DBMS_LDAP.modify_s()`, `DBMS_LDAP.add_s()`, and `DBMS_LDAP.free_mod_array()`.

## 9.4.20 PROCEDURE populate\_mod\_array (String Version)

Populates one set of attribute information for add or modify operations.

### Syntax

```
PROCEDURE populate_mod_array
(
  modptr    IN DBMS_LDAP.MOD_ARRAY,
  mod_op    IN PLS_INTEGER,
  mod_type  IN VARCHAR2,
  modval    IN DBMS_LDAP.STRING_COLLECTION
);
```

### Parameters

**Table 9–59 POPULATE\_MOD\_ARRAY (String Version) Procedure Parameters**

Parameter	Description
<code>modptr</code>	The data structure holds a pointer to an LDAP mod array.
<code>mod_op</code>	This field specifies the type of modification to perform, <code>MOD_ADD</code> , <code>MOD_DELETE</code> or <code>MOD_REPLACE</code> .
<code>mod_type</code>	This field indicates the name of the attribute type to which the modification applies.
<code>modval</code>	This field specifies the attribute values to add, delete, or replace. It is for string values only.

### Exceptions

**Table 9–60 POPULATE\_MOD\_ARRAY (String Version) Procedure Exceptions**

Exception	Description
<code>invalid_mod_array</code>	Invalid LDAP mod array
<code>invalid_mod_option</code>	Invalid LDAP mod option

**Table 9–60 (Cont.) POPULATE\_MOD\_ARRAY (String Version) Procedure Exceptions**

Exception	Description
invalid_mod_type	Invalid LDAP mod type
invalid_mod_value	Invalid LDAP mod value

**Usage Notes**

This function is one of the preparation steps for `DBMS_LDAP.add_s` and `DBMS_LDAP.modify_s`. It has to happen after `DBMS_LDAP.create_mod_array` is called.

**See Also**

`DBMS_LDAP.create_mod_array()`, `DBMS_LDAP.modify_s()`, `DBMS_LDAP.add_s()`, and `DBMS_LDAP.free_mod_array()`.

**9.4.21 PROCEDURE populate\_mod\_array (Binary Version)**

Populates one set of attribute information for add or modify operations. This procedure call occurs after `DBMS_LDAP.create_mod_array()` is called.

**Syntax**

```
PROCEDURE populate_mod_array
(
  modptr   IN DBMS_LDAP.MOD_ARRAY,
  mod_op   IN PLS_INTEGER,
  mod_type IN VARCHAR2,
  modbval  IN DBMS_LDAP.BERVAL_COLLECTION
);
```

**Parameters****Table 9–61 POPULATE\_MOD\_ARRAY (Binary Version) Procedure Parameters**

Parameter	Description
modptr	This data structure holds a pointer to an LDAP mod array.
mod_op	This field specifies the type of modification to perform, <code>MOD_ADD</code> , <code>MOD_DELETE</code> or <code>MOD_REPLACE</code> .
mod_type	This field indicates the name of the attribute type to which the modification applies.
modbval	This field specifies the attribute values to add, delete, or replace. It is for the binary values.

**Exceptions****Table 9–62 POPULATE\_MOD\_ARRAY (Binary Version) Procedure Exceptions**

Exception	Description
invalid_mod_array	Invalid LDAP mod array.
invalid_mod_option	Invalid LDAP mod option.
invalid_mod_type	Invalid LDAP mod type.
invalid_mod_value	Invalid LDAP mod value.

**Usage Notes**

This function is one of the preparation steps for `DBMS_LDAP.add_s` and `DBMS_LDAP.modify_s`. It is invoked after `DBMS_LDAP.create_mod_array` is called.

**See Also**

`DBMS_LDAP.create_mod_array()`, `DBMS_LDAP.modify_s()`, `DBMS_LDAP.add_s()`, and `DBMS_LDAP.free_mod_array()`.

**9.4.22 PROCEDURE populate\_mod\_array (Binary Version. Uses BLOB Data Type)**

Populates one set of attribute information for add or modify operations. This procedure call occurs after `DBMS_LDAP.create_mod_array()` is called.

**Syntax**

```
PROCEDURE populate_mod_array
(
  modptr IN DBMS_LDAP.MOD_ARRAY,
  mod_op IN PLS_INTEGER,
  mod_type IN VARCHAR2,
  modbval IN DBMS_LDAP.BLOB_COLLECTION
);
```

**Parameters****Table 9–63 POPULATE\_MOD\_ARRAY (Binary) Parameters**

Parameter	Description
<code>modptr</code>	This data structure holds a pointer to an LDAP mod array.
<code>mod_op</code>	This field specifies the type of modification to perform, <code>MOD_ADD</code> , <code>MOD_DELETE</code> or <code>MOD_REPLACE</code> .
<code>mod_type</code>	This field indicates the name of the attribute type to which the modification applies.
<code>modbval</code>	This field specifies the binary attribute values to add, delete, or replace.

**Exceptions****Table 9–64 POPULATE\_MOD\_ARRAY (Binary) Exceptions**

Exception	Description
<code>invalid_mod_array</code>	Invalid LDAP mod array.
<code>invalid_mod_option</code>	Invalid LDAP mod option.
<code>invalid_mod_type</code>	Invalid LDAP mod type.
<code>invalid_mod_value</code>	Invalid LDAP mod value.

**Usage Notes**

This function is one of the preparation steps for `DBMS_LDAP.add_s` and `DBMS_LDAP.modify_s`. It is invoked after `DBMS_LDAP.create_mod_array` is called.

**See Also**

`DBMS_LDAP.create_mod_array()`, `DBMS_LDAP.modify_s()`, `DBMS_LDAP.add_s()`, and `DBMS_LDAP.free_mod_array()`.



### 9.4.23 FUNCTION `get_values_blob`

The function `get_values_blob()` can be used to retrieve larger values of attributes that have a binary syntax.

#### Syntax

```
Syntax
FUNCTION get_values_blob
(
  ld IN SESSION,
  ldapentry IN MESSAGE,
  attr IN VARCHAR2
)
RETURN BLOB_COLLECTION;
```

#### Parameters

**Table 9–65** *GET\_VALUES\_BLOB Parameters*

Parameter	Description
<code>ld</code>	A valid LDAP session handle.
<code>ldapentrymsg</code>	A valid handle to an entry returned from a search result.
<code>attr</code>	The string name of the attribute for which values are being sought.

#### Return Values

**Table 9–66** *get\_values\_blob Return Values*

Value	Description
<code>BLOB_COLLECTION</code>	A PL/SQL BLOB collection containing all the values of the given attribute.
<code>NULL</code>	No values are associated with the given attribute.

#### Exceptions

**Table 9–67** *get\_values\_blob Exceptions*

Exception	Description
<code>invalid_session</code>	Raised if the session handle <code>ld</code> is invalid.
<code>invalid message</code>	Raised if the incoming entry handle is invalid.

#### Usage Notes

The function `get_values_blob()` can only be called after the handle to an entry has been retrieved by a call to either `first_entry()` or `next_entry()`. The name of the attribute may be known beforehand or can also be determined by a call to `first_attribute()` or `next_attribute()`. This function can be used to retrieve both binary and nonbinary attribute values.

#### See Also

`DBMS_LDAP.first_entry()`, `DBMS_LDAP.next_entry()`,  
`DBMS_LDAP.count_values_blob()`, `DBMS_LDAP.get_values()`.

## 9.4.24 FUNCTION count\_values\_blob

Counts the number of values returned by `DBMS_LDAP.get_values_blob()`.

### Syntax

```
FUNCTION count_values_blob
(
  values IN DBMS_LDAP.BLOB_COLLECTION
)
RETURN PLS_INTEGER;
```

### Parameters

**Table 9–68** COUNT\_VALUES\_BLOB Parameters

Parameter	Description
values	The collection of large binary values.

### Return Values

**Table 9–69** COUNT\_VALUES\_BLOB Return Values

Values	Description
PLS_INTEGER	Indicates the success or failure of the operation.

### Exceptions

The function `count_values_blob()` raises no exceptions.

### See Also

`DBMS_LDAP.count_values()`, `DBMS_LDAP.get_values_blob()`.

## 9.4.25 FUNCTION value\_free\_blob

Frees the memory associated with `BLOB_COLLECTION` returned by `DBMS_LDAP.get_values_blob()`.

### Syntax

```
PROCEDURE value_free_blob
(
  vals IN OUT DBMS_LDAP.BLOB_COLLECTION
);
```

### Parameters

**Table 9–70** VALUE\_FREE\_BLOB Parameters

Parameter	Description
vals	The collection of large binary values returned by <code>DBMS_LDAP.get_values_blob()</code> .

### Exceptions

`value_free_blob()` raises no exceptions.

**See Also**

DBMS\_LDAP.get\_values\_blob().

**9.4.26 FUNCTION modify\_s**

Performs a synchronous modification of an existing LDAP directory entry.

**Syntax**

```
FUNCTION modify_s
(
  ld      IN DBMS_LDAP.SESSION,
  entrydn IN VARCHAR2,
  modptr  IN DBMS_LDAP.MOD_ARRAY
)
RETURN PLS_INTEGER;
```

**Parameters****Table 9–71 MODIFY\_S Function Parameters**

Parameter	Description
ld	This parameter is a handle to an LDAP session returned by a successful call to DBMS_LDAP.init().
entrydn	This parameter specifies the name of the directory entry whose contents are to be modified.
modptr	This parameter is the handle to an LDAP mod structure, as returned by successful call to DBMS_LDAP.create_mod_array().

**Return Values****Table 9–72 MODIFY\_S Function Return Values**

Value	Description
PLS_INTEGER	Indicates the success or failure of the modification operation.

**Exceptions****Table 9–73 MODIFY\_S Function Exceptions**

Exception	Description
invalid_session	Invalid LDAP session.
invalid_entry_dn	Invalid LDAP entry dn.
invalid_mod_array	Invalid LDAP mod array.

**Usage Notes**

This function call has to follow successful calls of DBMS\_LDAP.create\_mod\_array() and DBMS\_LDAP.populate\_mod\_array().

**See Also**

DBMS\_LDAP.create\_mod\_array(), DBMS\_LDAP.populate\_mod\_array(), DBMS\_LDAP.add\_s(), and DBMS\_LDAP.free\_mod\_array().

## 9.4.27 FUNCTION add\_s

Adds a new entry to the LDAP directory synchronously. Before calling `add_s`, `DBMS_LDAP.create_mod_array()` and `DBMS_LDAP.populate_mod_array()` must be called.

### Syntax

```
FUNCTION add_s
(
  ld      IN DBMS_LDAP.SESSION,
  entrydn IN VARCHAR2,
  modptr  IN DBMS_LDAP.MOD_ARRAY
)
RETURN PLS_INTEGER;
```

### Parameters

**Table 9–74 ADD\_S Function Parameters**

Parameter	Description
<code>ld</code>	This parameter is a handle to an LDAP session, as returned by a successful call to <code>DBMS_LDAP.init()</code> .
<code>entrydn</code>	This parameter specifies the name of the directory entry to be created.
<code>modptr</code>	This parameter is the handle to an LDAP mod structure, as returned by successful call to <code>DBMS_LDAP.create_mod_array()</code> .

### Return Values

**Table 9–75 ADD\_S Function Return Values**

Value	Description
<code>PLS_INTEGER</code>	Indicates the success or failure of the modification operation.

### Exceptions

**Table 9–76 ADD\_S Function Exceptions**

Exception	Description
<code>invalid_session</code>	Invalid LDAP session.
<code>invalid_entry_dn</code>	Invalid LDAP entry dn.
<code>invalid_mod_array</code>	Invalid LDAP mod array.

### Usage Notes

The parent entry of the entry to be added must already exist in the directory. This function call has to follow successful calls to `DBMS_LDAP.create_mod_array()` and `DBMS_LDAP.populate_mod_array()`.

### See Also

`DBMS_LDAP.create_mod_array()`, `DBMS_LDAP.populate_mod_array()`, `DBMS_LDAP.modify_s()`, and `DBMS_LDAP.free_mod_array()`.

## 9.4.28 PROCEDURE free\_mod\_array

Frees the memory allocated by `DBMS_LDAP.create_mod_array()`.

### Syntax

```
PROCEDURE free_mod_array
(
  modptr IN DBMS_LDAP.MOD_ARRAY
);
```

### Parameters

**Table 9–77** *FREE\_MOD\_ARRAY Procedure Parameters*

Parameter	Description
modptr	This parameter is the handle to an LDAP mod structure returned by a successful call to <code>DBMS_LDAP.create_mod_array()</code> .

### Exceptions

`free_mod_array` raises no exceptions.

### See Also

`DBMS_LDAP.populate_mod_array()`, `DBMS_LDAP.modify_s()`, `DBMS_LDAP.add_s()`, and `DBMS_LDAP.create_mod_array()`.

## 9.4.29 FUNCTION count\_values

Counts the number of values returned by `DBMS_LDAP.get_values()`.

### Syntax

```
FUNCTION count_values
(
  values IN DBMS_LDAP.STRING_COLLECTION
)
RETURN PLS_INTEGER;
```

### Parameters

**Table 9–78** *COUNT\_VALUES Function Parameters*

Parameter	Description
values	The collection of string values.

### Return Values

**Table 9–79** *COUNT\_VALUES Function Return Values*

Value	Description
PLS_INTEGER	Indicates the success or failure of the operation.

### Exceptions

`count_values` raises no exceptions.

**See Also**

DBMS\_LDAP.count\_values\_len(), DBMS\_LDAP.get\_values().

**9.4.30 FUNCTION count\_values\_len**

Counts the number of values returned by DBMS\_LDAP.get\_values\_len().

**Syntax**

```
FUNCTION count_values_len
(
  values IN DBMS_LDAP.BINVAL_COLLECTION
)
RETURN PLS_INTEGER;
```

**Parameters****Table 9–80 COUNT\_VALUES\_LEN Function Parameters**

Parameter	Description
values	The collection of binary values.

**Return Values****Table 9–81 COUNT\_VALUES\_LEN Function Return Values**

Value	Description
PLS_INTEGER	Indicates the success or failure of the operation.

**Exceptions**

count\_values\_len raises no exceptions.

**See Also**

DBMS\_LDAP.count\_values(), DBMS\_LDAP.get\_values\_len().

**9.4.31 FUNCTION rename\_s**

Renames an LDAP entry synchronously.

**Syntax**

```
FUNCTION rename_s
(
  ld          IN SESSION,
  dn          IN VARCHAR2,
  newrdn     IN VARCHAR2,
  newparent  IN VARCHAR2,
  deleteoldrdn IN PLS_INTEGER,
  serverctrls IN LDAPCONTROL,
  clientctrls IN LDAPCONTROL
)
RETURN PLS_INTEGER;
```

## Parameters

**Table 9–82** *RENAME\_S Function Parameters*

Parameter	Description
ld	This parameter is a handle to an LDAP session returned by a successful call to <code>DBMS_LDAP.init()</code> .
dn	This parameter specifies the name of the directory entry to be renamed or moved.
newrdn	This parameter specifies the new RDN.
newparent	This parameter specifies the DN of the new parent.
deleteoldrdn	This parameter specifies whether the old RDN should be retained. If this value is 1, the old RDN is removed.
serverctrls	Currently not supported.
clientctrls	Currently not supported.

## Return Values

**Table 9–83** *RENAME\_S Function Return Values*

Value	Description
PLS_INTEGER	The indication of the success or failure of the operation.

## Exceptions

**Table 9–84** *RENAME\_S Function Exceptions*

Exception	Description
invalid_session	Invalid LDAP Session.
invalid_entry_dn	Invalid LDAP DN.
invalid_rdn	Invalid LDAP RDN.
invalid_newparent	Invalid LDAP newparent.
invalid_deleteoldrdn	Invalid LDAP deleteoldrdn.

## See Also

`DBMS_LDAP.modrdn2_s()`.

## 9.4.32 FUNCTION `explode_dn`

Breaks a DN up into its components.

### Syntax

```
FUNCTION explode_dn
(
  dn          IN VARCHAR2,
  notypes    IN PLS_INTEGER
)
RETURN STRING_COLLECTION;
```

**Parameters****Table 9–85** *EXPLODE\_DN Function Parameters*

Parameter	Description
dn	This parameter specifies the name of the directory entry to be broken up.
notypes	This parameter specifies whether the attribute tags are returned. If this value is not 0, no attribute tags are returned.

**Return Values****Table 9–86** *EXPLODE\_DN Function Return Values*

Value	Description
STRING_COLLECTION	An array of strings. If the DN cannot be broken up, NULL is returned.

**Exceptions****Table 9–87** *EXPLODE\_DN Function Exceptions*

Exception	Description
invalid_entry_dn	Invalid LDAP DN.
invalid_notypes	Invalid LDAP notypes value.

**See Also**

DBMS\_LDAP.get\_dn().

**9.4.33 FUNCTION open\_ssl**

Establishes an SSL (Secure Sockets Layer) connection over an existing LDAP connection.

**Syntax**

```
FUNCTION open_ssl
(
  ld          IN SESSION,
  sslwrl     IN VARCHAR2,
  sslwalletpasswd IN VARCHAR2,
  sslauth    IN PLS_INTEGER
)
RETURN PLS_INTEGER;
```

**Parameters****Table 9–88** *OPEN\_SSL Function Parameters*

Parameter	Description
ld	This parameter is a handle to an LDAP session that is returned by a successful call to DBMS_LDAP.init().
sslwrl	This parameter specifies the wallet location. The format is file:path. Required for one-way or two-way SSL connections.



**Table 9–88 (Cont.) OPEN\_SSL Function Parameters**

Parameter	Description
sslwalletpasswd	This parameter specifies the wallet password. Required for one-way or two-way SSL connections.
sslauth	This parameter specifies the SSL Authentication Mode. (1 for no authentication, 2 for one-way authentication required, 3 for two-way authentication).

**Return Values****Table 9–89 OPEN\_SSL Function Return Values**

Value	Description
PLS_INTEGER	Indicates the success or failure of the operation.

**Exceptions****Table 9–90 OPEN\_SSL Function Exceptions**

Exception	Description
invalid_session	Invalid LDAP Session.
invalid_ssl_wallet_location	Invalid LDAP SSL wallet location.
invalid_ssl_wallet_password	Invalid LDAP SSL wallet password.
invalid_ssl_auth_mode	Invalid LDAP SSL authentication mode.

**Usage Notes**

Need to call `DBMS_LDAP.init()` first to acquire a valid ldap session.

**See Also**

`DBMS_LDAP.init()`.

**9.4.34 FUNCTION msgfree**

This function frees the chain of messages associated with the message handle returned by synchronous search functions.

**Syntax**

```
FUNCTION msgfree
(
  res          IN MESSAGE
)
RETURN PLS_INTEGER;
```

**Parameters****Table 9–91 MSGFREE Function Parameters**

Parameter	Description
res	The message handle obtained by a call to one of the synchronous search routines.

## Return Values

**Table 9–92 MSGFREE Return Values**

Value	Description
PLS_INTEGER	<p>Indicates the type of the last message in the chain.</p> <p>The function might return any of the following values:</p> <ul style="list-style-type: none"> <li>■ DBMS_LDAP.LDAP_RES_BIND</li> <li>■ DBMS_LDAP.LDAP_RES_SEARCH_ENTRY</li> <li>■ DBMS_LDAP.LDAP_RES_SEARCH_REFERENCE</li> <li>■ DBMS_LDAP.LDAP_RES_SEARCH_RESULT</li> <li>■ DBMS_LDAP.LDAP_RES_MODIFY</li> <li>■ DBMS_LDAP.LDAP_RES_ADD</li> <li>■ DBMS_LDAP.LDAP_RES_DELETE</li> <li>■ DBMS_LDAP.LDAP_RES_MODDN</li> <li>■ DBMS_LDAP.LDAP_RES_COMPARE</li> <li>■ DBMS_LDAP.LDAP_RES_EXTENDED</li> </ul>

## Exceptions

`msgfree` raises no exceptions.

## See Also

`DBMS_LDAP.search_s()`, `DBMS_LDAP.search_st()`.

## 9.4.35 FUNCTION `ber_free`

This function frees the memory associated with a handle to `BER_ELEMENT`.

## Syntax

```
FUNCTION ber_free
(
  ber_elem IN BER_ELEMENT,
  freebuf  IN PLS_INTEGER
)
```

## Parameters

**Table 9–93 BER\_FREE Function Parameters**

Parameter	Description
<code>ber_elem</code>	A handle to <code>BER_ELEMENT</code> .
<code>freebuf</code>	<p>The value of this flag should be 0 while the <code>BER_ELEMENT</code> returned from <code>DBMS_LDAP.first_attribute()</code> is being freed. For any other case, the value of this flag should be 1.</p> <p>The default value of this parameter is zero.</p>

## Return Values

`ber_free` returns no values.

## Exceptions

`ber_free` raises no exceptions.

**See Also**

DBMS\_LDAP.first\_attribute(),DBMS\_LDAP.next\_attribute().

**9.4.36 FUNCTION nls\_convert\_to\_utf8**

The `nls_convert_to_utf8()` function converts the input string containing database character set data to UTF-8 character set data and returns it.

**Syntax**

```
Function nls_convert_to_utf8
(
  data_local IN VARCHAR2
)
RETURN VARCHAR2;
```

**Parameters****Table 9–94 Parameters for nls\_convert\_to\_utf8**

Parameter	Description
data_local	Contains the database character set data.

**Return Values****Table 9–95 Return Values for nls\_convert\_to\_utf8**

Value	Description
VARCHAR2	UTF-8 character set data string.

**Usage Notes**

The functions in DBMS\_LDAP package expect the input data to be UTF-8 character set data if the `UTF8_CONVERSION` package variable is set to `FALSE`. The `nls_convert_to_utf8()` function converts database character set data to UTF-8 character set data.

If the `UTF8_CONVERSION` package variable of the DBMS\_LDAP package is set to `TRUE`, functions in the DBMS\_LDAP package expect input data to be database character set data.

**See Also**

DBMS\_LDAP.nls\_convert\_from\_utf8(),DBMS\_LDAP.nls\_get\_dbcharset\_name().

**9.4.37 FUNCTION nls\_convert\_to\_utf8**

The `nls_convert_to_utf8()` function converts the input string collection containing database character set data to UTF-8 character set data. It then returns the converted data.

**Syntax**

```
Function nls_convert_to_utf8
(
  data_local IN STRING_COLLECTION
)
RETURN STRING_COLLECTION;
```

**Parameters****Table 9–96 Parameters for `nls_convert_to_utf8`**

Parameter	Description
<code>data_local</code>	Collection of strings containing database character set data.

**Return Values****Table 9–97 Return Values for `nls_convert_to_utf8`**

Value	Description
<code>STRING_COLLECTION</code>	Collection of strings containing UTF-8 character set data.

**Usage Notes**

The functions in the `DBMS_LDAP` package expect the input data to be in the UTF-8 character set if the `UTF8_CONVERSION` package variable is set to `FALSE`. The `nls_convert_to_utf8()` function converts the input data from the database character set to the UTF-8 character set.

If the `UTF8_CONVERSION` package variable of the `DBMS_LDAP` package is set to `TRUE`, functions in the `DBMS_LDAP` package expect the input data to be in the database character set.

**See Also**

`DBMS_LDAP.nls_convert_from_utf8()`, `DBMS_LDAP.nls_get_dbcharset_name()`.

**9.4.38 FUNCTION `nls_convert_from_utf8`**

The `nls_convert_from_utf8()` function converts the input string containing UTF-8 character set to database character set data. It then returns this data.

**Syntax**

```
Function nls_convert_from_utf8
(
  data_utf8 IN VARCHAR2
)
RETURN VARCHAR2;
```

**Parameters****Table 9–98 Parameter for `nls_convert_from_utf8`**

Parameter	Description
<code>data_utf8</code>	Contains UTF-8 character set data.

**Return Values****Table 9–99 Return Value for `nls_convert_from_utf8`**

Value	Description
<code>VARCHAR2</code>	Data string in the database character set.

**Usage Notes**

The functions in the DBMS\_LDAP package return UTF-8 character set data if the UTF8\_CONVERSION package variable is set to FALSE. The nls\_convert\_from\_utf8() function converts the output data from the UTF-8 character set to the database character set.

If the UTF8\_CONVERSION package variable of the DBMS\_LDAP package is set to TRUE, functions in the DBMS\_LDAP package return database character set data.

**See Also**

DBMS\_LDAP.nls\_convert\_to\_utf8(), DBMS\_LDAP.nls\_get\_dbcharset\_name().

**9.4.39 FUNCTION nls\_convert\_from\_utf8**

The nls\_convert\_from\_utf8() function converts the input string collection containing UTF-8 character set data to database character set data. It then returns this data.

**Syntax**

```
Function nls_convert_from_utf8
(
  data_utf8 IN STRING_COLLECTION
)
RETURN STRING_COLLECTION;
```

**Parameters****Table 9–100 Parameter for nls\_convert\_from\_utf8**

Parameter	Description
data_utf8	Collection of strings containing UTF-8 character set data.

**Return Values****Table 9–101 Return Value for nls\_convert\_from\_utf8**

Value	Description
VARCHAR2	Collection of strings containing database character set data.

**Usage Notes**

The functions in the DBMS\_LDAP package return UTF-8 character set data if the UTF8\_CONVERSION package variable is set to FALSE. nls\_convert\_from\_utf8() converts the output data from the UTF-8 character set to the database character set. If the UTF8\_CONVERSION package variable of the DBMS\_LDAP package is set to TRUE, functions in the DBMS\_LDAP package return database character set data.

**See Also**

DBMS\_LDAP.nls\_convert\_to\_utf8(), DBMS\_LDAP.nls\_get\_dbcharset\_name().

**9.4.40 FUNCTION nls\_get\_dbcharset\_name**

The nls\_get\_dbcharset\_name() function returns a string containing the database character set name.

**Syntax**

Function `nls_get_dbcharset_name`

RETURN VARCHAR2;

**Parameters**

None.

**Return Values**

**Table 9–102** *Return Value for `nls_get_dbcharset_name`*

Value	Description
VARCHAR2	String containing the database character set name.

**See Also**

`DBMS_LDAP.nls_convert_to_utf8()`, `DBMS_LDAP.nls_convert_from_utf8()`.

# 10

---

---

## Java API Reference

The standard Java APIs for Oracle Internet Directory are available as the Java Naming and Directory Interface (JNDI).

For reference information about the JNDI, see:

<http://www.oracle.com/technetwork/java/jndi/index.html>.

For the Oracle extensions to the standard APIs, see the *Oracle Fusion Middleware Java API Reference for Oracle Internet Directory*.





---



---

## DBMS\_LDAP\_UTL PL/SQL Reference

This chapter provides reference information for the `DBMS_LDAP_UTL` package, which contains Oracle Extension utility functions.

This chapter includes the following sections:

- Section 11.1, "Summary of Subprograms"
- Section 11.2, "Subprograms"
- Section 11.3, "Function Return Code Summary"
- Section 11.4, "Data Type Summary"

### 11.1 Summary of Subprograms

**Table 11–1** *DBMS\_LDAP\_UTL User-Related Subprograms*

Function or Procedure	Purpose
Function <code>authenticate_user</code>	Authenticates a user against an LDAP server.
Function <code>create_user_handle</code>	Creates a user handle.
Function <code>set_user_handle_properties</code>	Associates the given properties to the user handle.
Function <code>get_user_properties</code>	Retrieves user properties from an LDAP server.
Function <code>set_user_properties</code>	Modifies the properties of a user.
Function <code>get_user_extended_properties</code>	Retrieves user extended properties.
Function <code>get_user_dn</code>	Retrieves a user DN.
Function <code>check_group_membership</code>	Checks whether a user is member of a given group.
Function <code>locate_subscriber_for_user</code>	Retrieves the subscriber for the given user.
Function <code>get_group_membership</code>	Retrieves a list of groups of which the user is a member.

**Table 11–2** *DBMS\_LDAP\_UTL Group-Related Subprograms*

Function or Procedure	Purpose
Function <code>create_group_handle</code>	Creates a group handle.
Function <code>set_group_handle_properties</code>	Associates the given properties with the group handle.
Function <code>get_group_properties</code>	Retrieves group properties from an LDAP server.

**Table 11–2 (Cont.) DBMS\_LDAP\_UTL Group-Related Subprograms**

Function or Procedure	Purpose
Function <code>get_group_dn</code>	Retrieves a group DN.

**Table 11–3 DBMS\_LDAP\_UTL Subscriber-Related Subprograms**

Function or Procedure	Purpose
Function <code>create_subscriber_handle</code>	Creates a subscriber handle.
Function <code>get_subscriber_properties</code>	Retrieves subscriber properties from an LDAP server.
Function <code>get_subscriber_dn</code>	Retrieves a subscriber DN.

**Table 11–4 DBMS\_LDAP\_UTL Miscellaneous Subprograms**

Function or Procedure	Purpose
Function <code>normalize_dn_with_case</code>	Normalizes the DN string.
Function <code>get_property_names</code>	Retrieves a list of property names in a <code>PROPERTY_SET</code> .
Function <code>get_property_values</code>	Retrieves a list of values for a property name.
Function <code>get_property_values_blob</code>	Retrieves a list of large binary values for a property name.
Procedure <code>property_value_free_blob</code>	Frees the memory associated with <code>BLOB_COLLECTION</code> returned by <code>DBMS_LDAP_UTL.get_property_values_blob()</code> .
Function <code>get_property_values_len</code>	Retrieves a list of binary values for a property name.
Procedure <code>free_propertyset_collection</code>	Frees <code>PROPERTY_SET_COLLECTION</code> .
Function <code>create_mod_propertyset</code>	Creates a <code>MOD_PROPERTY_SET</code> .
Function <code>populate_mod_propertyset</code>	Populates a <code>MOD_PROPERTY_SET</code> structure.
Procedure <code>free_mod_propertyset</code>	Frees a <code>MOD_PROPERTY_SET</code> .
Procedure <code>free_handle</code>	Frees handles.
Function <code>check_interface_version</code>	Checks for support of the interface version.

## 11.2 Subprograms

This section contains the following topics:

- Section 11.2.1, "User-Related Subprograms"
- Section 11.2.2, "Group-Related Subprograms"
- Section 11.2.3, "Subscriber-Related Subprograms"
- Section 11.2.4, "Property-Related Subprograms"
- Section 11.2.5, "Miscellaneous Subprograms"

## 11.2.1 User-Related Subprograms

A user is represented by the `DBMS_LDAP_UTL.HANDLE` data type. You can create a user handle by using a DN, GUID, or simple name, along with the appropriate subscriber handle. When a simple name is used, additional information from the root Oracle Context and the subscriber Oracle Context is used to identify the user. This example shows a user handle being created:

```
retval := DBMS_LDAP_UTL.create_user_handle(
user_handle,
DBMS_LDAP_UTL.TYPE_DN,
"cn=user1,cn=users,o=example,dc=com"
);
```

This user handle must be associated with an appropriate subscriber handle. If, for example, `subscriber_handle` is `o=example,dc=com`, the subscriber handle can be associated in the following way:

```
retval := DBMS_LDAP_UTL.set_user_handle_properties(
user_handle,
DBMS_LDAP_UTL.SUBSCRIBER_HANDLE,
subscriber_handle
);
```

Common uses of user handles include setting and getting user properties and authenticating the user. Here is a handle that authenticates a user:

```
retval := DBMS_LDAP_UTL.authenticate_user(
my_session
user_handle
DBMS_LDAP_UTL.AUTH_SIMPLE,
"welcome"
NULL
);
```

In this example, the user is authenticated using a clear text password `welcome`.

Here is a handle that retrieves a user's telephone number:

```
--my_attrs is of type DBMS_LDAP.STRING_COLLECTION
my_attrs(1) := 'telephonenumber';
retval := DBMS_LDAP_UTL.get_user_properties(
my_session,
my_attrs,
DBMS_LDAP_UTL.ENTRY_PROPERTIES,
my_pset_coll
);
```

### 11.2.1.1 Function `authenticate_user`

The function `authenticate_user()` authenticates the user against Oracle Internet Directory.

#### Syntax

```
FUNCTION authenticate_user
(
ld IN SESSION,
user_handle IN HANDLE,
auth_type IN PLS_INTEGER,
credentials IN VARCHAR2,
binary_credentials IN RAW
```

```
)
RETURN PLS_INTEGER;
```

## Parameters

**Table 11–5** *authenticate\_user Function Parameters*

Parameter Name	Parameter Type	Parameter Description
ld	SESSION	A valid LDAP session handle.
user_handle	HANDLE	The user handle.
auth_type	PLS_INTEGER	Type of authentication. The only valid value is <code>DBMS_LDAP_UTL.AUTH_SIMPLE</code>
credentials	VARCHAR2	The user credentials.
binary_credentials	RAW	The binary credentials. This parameter is optional. It can be <code>NULL</code> by default.

## Return Values

**Table 11–6** *authenticate\_user Function Return Values*

Value	Description
<code>DBMS_LDAP_UTL.SUCCESS</code>	On a successful completion.
<code>DBMS_LDAP_UTL.PARAM_ERROR</code>	Invalid input parameters.
<code>DBMS_LDAP_UTL.GENERAL_ERROR</code>	Authentication failed.
<code>DBMS_LDAP_UTL.NO_SUCH_USER</code>	User does not exist.
<code>DBMS_LDAP_UTL.MULTIPLE_USER_ENTRIES</code>	The user has multiple DN entries.
<code>DBMS_LDAP_UTL.INVALID_SUBSCRIBER_ORCL_CTX</code>	Invalid Subscriber Oracle Context.
<code>DBMS_LDAP_UTL.NO_SUCH_SUBSCRIBER</code>	Subscriber doesn't exist.
<code>DBMS_LDAP_UTL.MULTIPLE_SUBSCRIBER_ENTRIES</code>	The subscriber has multiple DN entries.
<code>DBMS_LDAP_UTL.INVALID_ROOT_ORCL_CTX</code>	Invalid Root Oracle Context.
<code>DBMS_LDAP_UTL.ACCT_TOTALLY_LOCKED_EXCP</code>	User account is locked.
<code>DBMS_LDAP_UTL.AUTH_PASSWD_CHANGE_WARN</code>	This return value is deprecated.
<code>DBMS_LDAP_UTL.AUTH_FAILURE_EXCP</code>	Authentication failed.
<code>DBMS_LDAP_UTL.PWD_EXPIRED_EXCP</code>	User password has expired.
<code>DBMS_LDAP_UTL.PWD_GRACELOGIN_WARN</code>	Grace login for user.
<code>DBMS_LDAP</code> error codes	Return proper <code>DBMS_LDAP</code> error codes for unconditional failures that occurred when LDAP operations were carried out.

## Usage Notes

This function can be called only after a valid LDAP session is obtained from a call to `DBMS_LDAP.init()`.

## See Also

`DBMS_LDAP.init()`, `DBMS_LDAP_UTL.create_user_handle()`.

### 11.2.1.2 Function create\_user\_handle

The function `create_user_handle()` creates a user handle.

#### Syntax

```
FUNCTION create_user_handle
(
  user_hd OUT HANDLE,
  user_type IN PLS_INTEGER,
  user_id IN VARCHAR2,
)
RETURN PLS_INTEGER;
```

#### Parameters

**Table 11–7 CREATE\_USER\_HANDLE Function Parameters**

Parameter Name	Parameter Type	Parameter Description
<code>user_hd</code>	HANDLE	A pointer to a handle to a user.
<code>user_type</code>	PLS_INTEGER	The type of user ID that is passed. Valid values for this argument are as follows: <ul style="list-style-type: none"> <li>■ <code>DBMS_LDAP_UTL.TYPE_DN</code></li> <li>■ <code>DBMS_LDAP_UTL.TYPE_GUID</code></li> <li>■ <code>DBMS_LDAP_UTL.TYPE_NICKNAME</code></li> </ul>
<code>user_id</code>	VARCHAR2	The user ID representing the user entry.

#### Return Values

**Table 11–8 CREATE\_USER\_HANDLE Function Return Values**

Value	Description
<code>DBMS_LDAP_UTL.SUCCESS</code>	On a successful completion.
<code>DBMS_LDAP_UTL.PARAM_ERROR</code>	Invalid input parameters.
<code>DBMS_LDAP_UTL.GENERAL_ERROR</code>	Other error.

#### See Also

`DBMS_LDAP_UTL.get_user_properties()`,  
`DBMS_LDAP_UTL.set_user_handle_properties()`.

### 11.2.1.3 Function set\_user\_handle\_properties

The function `set_user_handle_properties()` configures the user handle properties.

#### Syntax

```
FUNCTION set_user_handle_properties
(
  user_hd IN HANDLE,
  property_type IN PLS_INTEGER,
  property IN HANDLE
)
RETURN PLS_INTEGER;
```

## Parameters

**Table 11–9 SET\_USER\_HANDLE\_PROPERTIES Function Parameters**

Parameter Name	Parameter Type	Parameter Description
user_hd	HANDLE	A pointer to a handle to a user.
property_type	PLS_INTEGER	The type of property that is passed. Valid values for this argument are as follows: - DBMS_LDAP_UTL.SUBSCRIBER_HANDLE.
property	HANDLE	The property describing the user entry.

## Return Values

**Table 11–10 SET\_USER\_HANDLE\_PROPERTIES Function Return Values**

Value	Description
DBMS_LDAP_UTL.SUCCESS	On a successful completion.
DBMS_LDAP_UTL.PARAM_ERROR	Invalid input parameters.
DBMS_LDAP_UTL.RESET_HANDLE	When a caller tries to reset the existing handle properties.
DBMS_LDAP_UTL.GENERAL_ERROR	Other error.

## Usage Notes

The subscriber handle does not have to be set in User Handle Properties if the user handle is created with TYPE\_DN or TYPE\_GUID as the user type.

## See Also

DBMS\_LDAP\_UTL.get\_user\_properties().

### 11.2.1.4 Function get\_user\_properties

The function get\_user\_properties() retrieves the user properties.

## Syntax

```
FUNCTION get_user_properties
(
  ld IN SESSION,
  user_handle IN HANDLE,
  attrs IN STRING_COLLECTION,
  ptype IN PLS_INTEGER,
  ret_pset_coll OUT PROPERTY_SET_COLLECTION
)
RETURN PLS_INTEGER;
```

## Parameters

**Table 11–11 GET\_USER\_PROPERTIES Function Parameters**

Parameter Name	Parameter Type	Parameter Description
ld	SESSION	A valid LDAP session handle.
user_handle	HANDLE	The user handle.
attrs	STRING_COLLECTION	The list of user attributes to retrieve.

**Table 11–11 (Cont.) GET\_USER\_PROPERTIES Function Parameters**

Parameter Name	Parameter Type	Parameter Description
ptype	PLS_INTEGER	Type of properties to return. These are valid values: <ul style="list-style-type: none"> <li>▪ DBMS_LDAP_UTL.ENTRY_PROPERTIES</li> <li>▪ DBMS_LDAP_UTL.NICKNAME_PROPERTY</li> </ul>
ret-pset_collection	PROPERTY_SET_COLLECTION	User details contained in attributes requested by the caller.

### Return Values

**Table 11–12 GET\_USER\_PROPERTIES Function Return Values**

Value	Description
DBMS_LDAP_UTL.SUCCESS	On a successful completion.
DBMS_LDAP_UTL.PARAM_ERROR	Invalid input parameters.
DBMS_LDAP_UTL.NO_SUCH_USER	User does not exist.
DBMS_LDAP_UTL.MULTIPLE_USER_ENTRIES	The user has multiple DN entries.
DBMS_LDAP_UTL.INVALID_ROOT_ORCL_CTX	Invalid root Oracle Context.
DBMS_LDAP_UTL.GENERAL_ERROR	Other error.
DBMS_LDAP error codes	Return proper DBMS_LDAP error codes for unconditional failures that occur when LDAP operations are carried out.

### Usage Notes

This function requires the following:

- A valid LDAP session handle, which must be obtained from the `DBMS_LDAP.init()` function.
- A valid subscriber handle to be set in the group handle properties if the user type is of `DBMS_LDAP_UTL.TYPE_NICKNAME`.

This function does not identify a NULL subscriber handle as a default subscriber. The default subscriber can be obtained from `DBMS_LDAP_UTL.create_subscriber_handle()`, where a NULL `subscriber_id` is passed as an argument.

If the group type is either `DBMS_LDAP_UTL.TYPE_GUID` or `DBMS_LDAP_UTL.TYPE_DN`, the subscriber handle need not be set in the user handle properties. If the subscriber handle is set, it is ignored.

### See Also

`DBMS_LDAP.init()`, `DBMS_LDAP_UTL.create_user_handle()`.

#### 11.2.1.5 Function set\_user\_properties

The function `set_user_properties()` modifies the properties of a user.

### Syntax

```
FUNCTION set_user_properties
(
ld IN SESSION,
```

```

user_handle IN HANDLE,
pset_type IN PLS_INTEGER,
mod_pset IN PROPERTY_SET,
mod_op IN PLS_INTEGER
)
RETURN PLS_INTEGER;

```

## Parameters

**Table 11–13 SET\_USER\_PROPERTIES Function Parameters**

Parameter Name	Parameter Type	Description
ld	SESSION	A valid LDAP session handle.
user_handle	HANDLE	The user handle.
pset_type	PLS_INTEGER	The type of property set being modified. A valid value is ENTRY_PROPERTIES.
mod_pset	PROPERTY_SET	Data structure containing modify operations to perform on the property set.
mod_op	PLS_INTEGER	The type of modify operation to be performed on the property set. Here are valid values: <ul style="list-style-type: none"> <li>■ ADD_PROPERTYSET</li> <li>■ MODIFY_PROPERTYSET</li> <li>■ DELETE_PROPERTYSET</li> </ul>

## Return Values

**Table 11–14 SET\_USER\_PROPERTIES Function Return Values**

Value	Description
DBMS_LDAP_UTL.SUCCESS	On a successful completion.
DBMS_LDAP_UTL.NO_SUCH_USER	User does not exist.
DBMS_LDAP_UTL.MULTIPLE_USER_ENTRIES	The user has multiple DN entries.
DBMS_LDAP_UTL.INVALID_ROOT_ORCL_CTX	Invalid root Oracle Context.
DBMS_LDAP_UTL.PWD_MIN_LENGTH_ERROR	Password length is less than the minimum required length.
DBMS_LDAP_UTL.PWD_NUMERIC_ERROR	Password must contain numeric characters.
DBMS_LDAP_UTL.PWD_NULL_ERROR	Password cannot be NULL.
DBMS_LDAP_UTL.PWD_INHISTORY_ERROR	Password cannot be the same as the one that is being replaced.
DBMS_LDAP_UTL.PWD_ILLEGALVALUE_ERROR	Password contains illegal characters.
DBMS_LDAP_UTL.GENERAL_ERROR	Other error.
DBMS_LDAP error codes	Return proper DBMS_LDAP error codes for unconditional failures while carrying out LDAP operations by the LDAP server.

## Usage Notes

This function can only be called after a valid LDAP session is obtained from a call to `DBMS_LDAP.init()`.



**See Also**

DBMS\_LDAP.init(), DBMS\_LDAP\_UTL.get\_user\_properties().

**11.2.1.6 Function get\_user\_extended\_properties**

The function get\_user\_extended\_properties() retrieves user extended properties.

**Syntax**

```
FUNCTION get_user_extended_properties
(
  ld IN SESSION,
  user_handle IN HANDLE,
  attrs IN STRING_COLLECTION
  ptype IN PLS_INTEGER,
  filter IN VARCHAR2,
  rep_pset_coll OUT PROPERTY_SET_COLLECTION
)
RETURN PLS_INTEGER;
```

**Parameters****Table 11–15 GET\_USER\_EXTENDED\_PROPERTIES Function Parameters**

Parameter Name	Parameter Type	Parameter Description
ld	SESSION	A valid LDAP session handle.
user_handle	HANDLE	The user handle.
attrs	STRING_COLLECTION	A list of attributes to fetch for the user.
ptype	PLS_INTEGER	The type of properties to return. Here is a valid value: - DBMS_LDAP_UTL.EXTPROPTYPE_RAD
filter	VARCHAR2	An LDAP filter to further refine the user properties returned by the function.
ret_pset_collection	PROPERTY_SET_COLLECTION	The user details containing the attributes requested by the caller.

**Return Values****Table 11–16 GET\_USER\_EXTENDED\_PROPERTIES Function Return Values**

Value	Description
DBMS_LDAP_UTL.SUCCESS	On a successful completion.
DBMS_LDAP_UTL.PARAM_ERROR	Invalid input parameters.
DBMS_LDAP_UTL.NO_SUCH_USER	User does not exist.
DBMS_LDAP_UTL.MULTIPLE_USER_ENTRIES	The user has multiple DN entries.
USER_PROPERTY_NOT_FOUND	User extended property does not exist.
DBMS_LDAP_UTL.INVALID_ROOT_ORCL_CTX	Invalid root Oracle Context.
DBMS_LDAP_UTL.GENERAL_ERROR	Other error.
DBMS_LDAP error codes	Return proper DBMS_LDAP error codes for unconditional failures that occur when LDAP operations are carried out.

**Usage Notes**

This function can be called only after a valid LDAP session is obtained from a call to `DBMS_LDAP.init()`.

**See Also**

`DBMS_LDAP.init()`, `DBMS_LDAP_UTL.get_user_properties()`.

**11.2.1.7 Function `get_user_dn`**

The function `get_user_dn()` returns the user DN.

**Syntax**

```
FUNCTION get_user_dn
(
  ld IN SESSION,
  user_handle IN HANDLE,
  dn OUT VARCHAR2
)
RETURN PLS_INTEGER;
```

**Parameters****Table 11–17 GET\_USER\_DN Function Parameters**

Parameter Name	Parameter Type	Parameter Description
<code>ld</code>	SESSION	A valid LDAP session handle.
<code>user_handle</code>	HANDLE	The user handle.
<code>dn</code>	VARCHAR2	The user DN.

**Return Values****Table 11–18 GET\_USER\_DN Function Return Values**

Value	Description
<code>DBMS_LDAP_UTL.SUCCESS</code>	On a successful completion.
<code>DBMS_LDAP_UTL.PARAM_ERROR</code>	Invalid input parameters.
<code>DBMS_LDAP_UTL.GENERAL_ERROR</code>	Authentication failed.
<code>DBMS_LDAP_UTL.NO_SUCH_USER</code>	User does not exist.
<code>DBMS_LDAP_UTL.MULTIPLE_USER_ENTRIES</code>	The user has multiple DN entries.
<code>DBMS_LDAP_UTL.INVALID_ROOT_ORCL_CTX</code>	Invalid root Oracle Context.
<code>DBMS_LDAP_UTL.GENERAL_ERROR</code>	Other error.
<code>DBMS_LDAP</code> error codes	Return proper <code>DBMS_LDAP</code> error codes for unconditional failures that occur when LDAP operations are carried out.

**Usage Notes**

This function can be called only after a valid LDAP session is obtained from a call to `DBMS_LDAP.init()`.

**See Also**

`DBMS_LDAP.init()`.

### 11.2.1.8 Function `check_group_membership`

The function `check_group_membership()` checks whether the user belongs to a group.

#### Syntax

```
FUNCTION check_group_membership
(
  ld IN SESSION,
  user_handle IN HANDLE,
  group_handle IN HANDLE,
  nested IN PLS_INTEGER
)
RETURN PLS_INTEGER;
```

#### Parameters

**Table 11–19** *CHECK\_GROUP\_MEMBERSHIP Function Parameters*

Parameter Name	Parameter Type	Parameter Description
<code>ld</code>	SESSION	A valid LDAP session handle.
<code>user_handle</code>	HANDLE	The user handle.
<code>group_handle</code>	HANDLE	The group handle.
<code>nested</code>	PLS_INTEGER	The type of membership the user holds in groups. Here are valid values: <ul style="list-style-type: none"> <li>▪ <code>DBMS_LDAP_UTL.NESTED_MEMBERSHIP</code></li> <li>▪ <code>DBMS_LDAP_UTL.DIRECT_MEMBERSHIP</code></li> </ul>

#### Return Values

**Table 11–20** *CHECK\_GROUP\_MEMBERSHIP Function Return Values*

Value	Description
<code>DBMS_LDAP_UTL.SUCCESS</code>	If user is a member.
<code>DBMS_LDAP_UTL.PARAM_ERROR</code>	Invalid input parameters.
<code>DBMS_LDAP_UTL.NO_GROUP_MEMBERSHIP</code>	If user is not a member.

#### Usage Notes

This function can be called only after a valid LDAP session is obtained from a call to `DBMS_LDAP.init()`.

#### See Also

`DBMS_LDAP.get_group_membership()`.

### 11.2.1.9 Function `locate_subscriber_for_user`

The function `locate_subscriber_for_user()` retrieves the subscriber for the given user and returns a handle to it.

#### Syntax

```
FUNCTION locate_subscriber_for_user
(
  ld IN SESSION,
  user_handle IN HANDLE,
```

```

subscriber_handle OUT HANDLE
)
RETURN PLS_INTEGER;

```

### Parameters

**Table 11–21 LOCATE\_SUBSCRIBER\_FOR\_USER Function Parameters**

Parameter Name	Parameter Type	Parameter Description
ld	SESSION	A valid LDAP session handle.
user_handle	HANDLE	The user handle.
subscriber_handle	HANDLE	The subscriber handle.

### Return Values

**Table 11–22 LOCATE SUBSCRIBER FOR USER Function Return Values**

Value	Description
DBMS_LDAP_UTL.SUCCESS	On a successful completion.
DBMS_LDAP_UTL.NO_SUCH_SUBSCRIBER	Subscriber doesn't exist.
DBMS_LDAP_UTL.MULTIPLE_SUBSCRIBER_ENTRIES	Multiple number of subscriber DN entries exist in the directory for the given subscriber.
DBMS_LDAP_UTL.NO_SUCH_USER	User doesn't exist.
DBMS_LDAP_UTL.MULTIPLE_USER_ENTRIES	Multiple number of user DN entries exist in the directory for the given user.
DBMS_LDAP_UTL.SUBSCRIBER_NOT_FOUND	Unable to locate subscriber for the given user.
DBMS_LDAP_UTL.INVALID_ROOT_ORCL_CTX	Invalid Root Oracle Context.
DBMS_LDAP_UTL.ACCT_TOTALLY_LOCKED_EXCP	User account is locked.
DBMS_LDAP_UTL.GENERAL_ERROR	Other error.
DBMS_LDAP error codes	Return proper DBMS_LDAP error codes for unconditional failures while carrying out LDAP operations by the LDAP server.

### Usage Notes

This function can be called only after a valid LDAP session is obtained from a call to `DBMS_LDAP.init()`.

### See Also

`DBMS_LDAP.init()`, `DBMS_LDAP_UTL.create_user_handle()`.

#### 11.2.1.10 Function `get_group_membership`

The function `get_group_membership()` returns the list of groups to which the user is a member.

### Syntax

```

FUNCTION get_group_membership
(
  user_handle IN HANDLE,
  nested IN PLS_INTEGER,
  attr_list IN STRING_COLLECTION,

```

```

ret_groups OUT PROPERTY_SET_COLLECTION
)
RETURN PLS_INTEGER;

```

### Parameters

**Table 11–23** *GET\_GROUP\_MEMBERSHIP Function Parameters*

Parameter Name	Parameter Type	Parameter Description
ld	SESSION	A valid LDAP session handle.
user_handle	HANDLE	The user handle.
nested	PLS_INTEGER	The type of membership the user holds in groups. Here are valid values: <ul style="list-style-type: none"> <li>■ DBMS_LDAP_UTL.NESTED_MEMBERSHIP</li> <li>■ DBMS_LDAP_UTL.DIRECT_MEMBERSHIP</li> </ul>
attr_list	STRING_COLLECTION	A list of attributes to be returned.
ret_groups	PROPERTY_SET_COLLECTION	A pointer to a pointer to an array of group entries.

### Return Values

**Table 11–24** *GET\_GROUP\_MEMBERSHIP Function Return Values*

Value	Description
DBMS_LDAP_UTL.SUCCESS	On a successful completion.
DBMS_LDAP_UTL.PARAM_ERROR	Invalid input parameters.
DBMS_LDAP_UTL.GENERAL_ERROR	Other error.

### Usage Notes

This function can be called only after a valid LDAP session is obtained from a call to `DBMS_LDAP.init()`.

### See Also

`DBMS_LDAP.init()`.

## 11.2.2 Group-Related Subprograms

A group is represented using by using the `DBMS_LDAP_UTL.HANDLE` data type. A group handle represents a valid group entry. You can create a group handle by using a DN, GUID or a simple name, along with the appropriate subscriber handle. When a simple name is used, additional information from the Root Oracle Context and the Subscriber Oracle Context is used to identify the group. Here is an example of a group handle creation:

```

retval := DBMS_LDAP_UTL.create_group_handle(
group_handle,
DBMS_LDAP_UTL.TYPE_DN,
"cn=group1,cn=Groups,o=example,dc=com"
);

```

This group handle has to be associated with an appropriate subscriber handle. For example, given a subscriber handle: `subscriber_handle` representing `o=example,dc=com`, the subscriber handle can be associated in the following way:

```

retval := DBMS_LDAP_UTL.set_group_handle_properties(
group_handle,
DBMS_LDAP_UTL.SUBSCRIBER_HANDLE,
subscriber_handle
);

```

A sample use of group handle is getting group properties. Here is an example:

```

my_attrs is of type DBMS_LDAP.STRING_COLLECTION
my_attrs(1) := 'uniquemember';
retval := DBMS_LDAP_UTL.get_group_properties(
my_session,
my_attrs,
DBMS_LDAP_UTL.ENTRY_PROPERTIES,
my_pset_coll
);

```

The group-related subprograms also support membership-related functionality. Given a user handle, you can find out if it is a direct or a nested member of a group by using the `DBMS_LDAP_UTL.check_group_membership()` function. Here is an example:

```

retval := DBMS_LDAP_UTL.check_group_membership(
session,
user_handle,
group_handle,
DBMS_LDAP_UTL.DIRECT_MEMBERSHIP
);

```

You can also obtain a list of groups that a particular group belongs to, using the `DBMS_LDAP_UTL.get_group_membership()` function. For example:

```

my_attrs is of type DBMS_LDAP.STRING_COLLECTION
my_attrs(1) := 'cn';
retval := DBMS_LDAP_UTL.get_group_membership(
my_session,
user_handle,
DBMS_LDAP_UTL.DIRECT_MEMBERSHIP,
my_attrs
my_pset_coll
);

```

### 11.2.2.1 Function `create_group_handle`

The function `create_group_handle()` creates a group handle.

#### Syntax

```

FUNCTION create_group_handle
(
group_hd OUT HANDLE,
group_type IN PLS_INTEGER,
group_id IN VARCHAR2
)
RETURN PLS_INTEGER;

```

#### Parameters

**Table 11–25** *CREATE\_GROUP\_HANDLE Function Parameters*

Parameter Name	Parameter Type	Parameter Description
group_hd	HANDLE	A pointer to a handle to a group.

**Table 11–25 (Cont.) CREATE\_GROUP\_HANDLE Function Parameters**

Parameter Name	Parameter Type	Parameter Description
group_type	PLS_INTEGER	The type of group ID that is passed. Valid values for this argument are as follows: <ul style="list-style-type: none"> <li>■ DBMS_LDAP_UTL.TYPE_DN</li> <li>■ DBMS_LDAP_UTL.TYPE_GUID</li> <li>■ DBMS_LDAP_UTL.TYPE_NICKNAME</li> </ul>
group_id	VARCHAR2	The group ID representing the group entry.

### Return Values

**Table 11–26 CREATE\_GROUP\_HANDLE Function Return Values**

Value	Description
DBMS_LDAP_UTL.SUCCESS	On a successful completion.
DBMS_LDAP_UTL.PARAM_ERROR	Invalid input parameters.
DBMS_LDAP_UTL.GENERAL_ERROR	Other error.

### See Also

DBMS\_LDAP\_UTL.get\_group\_properties(),  
DBMS\_LDAP\_UTL.set\_group\_handle\_properties().

#### 11.2.2.2 Function set\_group\_handle\_properties

The function set\_group\_handle\_properties() configures the group handle properties.

### Syntax

```
FUNCTION set_group_handle_properties
(
  group_hd IN HANDLE,
  property_type IN PLS_INTEGER,
  property IN HANDLE
)
RETURN PLS_INTEGER;
```

### Parameters

**Table 11–27 SET\_GROUP\_HANDLE\_PROPERTIES Function Parameters**

Parameter Name	Parameter Type	Parameter Description
group_hd	HANDLE	A pointer to the handle to the group.
property_type	PLS_INTEGER	The type of property that is passed. Valid values for this argument are as follows: DBMS_LDAP_UTL.GROUP_HANDLE
property	HANDLE	The property describing the group entry.

## Return Values

**Table 11–28 SET\_GROUP\_HANDLE\_PROPERTIES Function Return Values**

Value	Description
DBMS_LDAP_UTL.SUCCESS	On a successful completion.
DBMS_LDAP_UTL.PARAM_ERROR	Invalid input parameters.
DBMS_LDAP_UTL.RESET_HANDLE	When a caller tries to reset the existing handle properties.
DBMS_LDAP_UTL.GENERAL_ERROR	Other error.

## Usage Notes

The subscriber handle doesn't need to be set in Group Handle Properties if the group handle is created with TYPE\_DN or TYPE\_GUID as the group type.

## See Also

DBMS\_LDAP\_UTL.get\_group\_properties().

### 11.2.2.3 Function get\_group\_properties

The function get\_group\_properties() retrieves the group properties.

## Syntax

```
FUNCTION get_group_properties
(
  ld IN SESSION,
  group_handle IN HANDLE,
  attrs IN STRING_COLLECTION,
  ptype IN PLS_INTEGER,
  ret_pset_coll OUT PROPERTY_SET_COLLECTION
)
RETURN PLS_INTEGER;
```

## Parameters

**Table 11–29 GET\_GROUP\_PROPERTIES Function Parameters**

Parameter Name	Parameter Type	Parameter Description
ld	SESSION	A valid LDAP session handle.
group_handle	HANDLE	The group handle.
attrs	STRING_COLLECTION	A list of attributes that must be fetched for the group.
ptype	PLS_INTEGER	The type of properties to be returned. The valid value is DBMS_LDAP_UTL.ENTRY_PROPERTIES
ret_pset_coll	PROPERTY_SET_COLLECTION	The group details containing the attributes requested by the caller.

## Return Values

**Table 11–30 GET\_GROUP\_PROPERTIES Function Return Values**

Value	Description
DBMS_LDAP_UTL.SUCCESS	On a successful completion.



**Table 11–30 (Cont.) GET\_GROUP\_PROPERTIES Function Return Values**

Value	Description
DBMS_LDAP_UTL.PARAM_ERROR	Invalid input parameters.
DBMS_LDAP_UTL.NO_SUCH_GROUP	Group doesn't exist.
DBMS_LDAP_UTL.MULTIPLE_GROUP_ENTRIES	Multiple number of group DN entries exist in the directory for the given group.
DBMS_LDAP_UTL.INVALID_ROOT_ORCL_CTX	Invalid Root Oracle Context.
DBMS_LDAP_UTL.GENERAL_ERROR	Other error.
DBMS_LDAP error codes	Return proper DBMS_LDAP error codes for unconditional failures while carrying out LDAP operations by the LDAP server.

**Usage Notes**

This function requires the following:

- A valid LDAP session handle which must be obtained from the `DBMS_LDAP.init()` function.
- A valid subscriber handle to be set in the group handle properties if the group type is of: `DBMS_LDAP_UTL.TYPE_NICKNAME`.

This function does not identify a NULL subscriber handle as a default subscriber. The default subscriber can be obtained from `DBMS_LDAP_UTL.create_subscriber_handle()`, where a NULL `subscriber_id` is passed as an argument.

If the group type is either `DBMS_LDAP_UTL.TYPE_GUID` or `DBMS_LDAP_UTL.TYPE_DN`, the subscriber handle does not have to be set in the group handle properties. If the subscriber handle is set, it is ignored.

**See Also**

`DBMS_LDAP.init()`, `DBMS_LDAP_UTL.create_group_handle()`.

**11.2.2.4 Function get\_group\_dn**

The function `get_group_dn()` returns the group DN.

**Syntax**

```
FUNCTION get_group_dn
(
  ld IN SESSION,
  group_handle IN HANDLE
  dn OUT VARCHAR2
)
RETURN PLS_INTEGER;
```

**Parameters****Table 11–31 GET\_GROUP\_DN Function Parameters**

Parameter Name	Parameter Type	Parameter Description
ld	SESSION	A valid LDAP session handle.
group_handle	HANDLE	The group handle.

**Table 11–31 (Cont.) GET\_GROUP\_DN Function Parameters**

Parameter Name	Parameter Type	Parameter Description
dn	VARCHAR2	The group DN.

**Return Values****Table 11–32 GET\_GROUP\_DN Function Return Values**

Value	Description
DBMS_LDAP_UTL.SUCCESS	On a successful completion.
DBMS_LDAP_UTL.PARAM_ERROR	Invalid input parameters.
DBMS_LDAP_UTL.NO_SUCH_GROUP	Group doesn't exist.
DBMS_LDAP_UTL.MULTIPLE_GROUP_ENTRIES	Multiple number of group DN entries exist in the directory for the given group.
DBMS_LDAP_UTL.INVALID_ROOT_ORCL_CTX	Invalid Root Oracle Context.
DBMS_LDAP_UTL.GENERAL_ERROR	Other error.
DBMS_LDAP error codes	Return proper DBMS_LDAP error codes for unconditional failures that are encountered when LDAP operations are carried out.

**Usage Notes**

This function can only be called after a valid LDAP session is obtained from a call to `DBMS_LDAP.init()`.

**See Also**

`DBMS_LDAP.init()`.

**11.2.3 Subscriber-Related Subprograms**

A subscriber is represented by using `dbms_ldap_util.handle` data type. You can create a subscriber handle by using a DN, GUID or simple name. When a simple name is used, additional information from the root Oracle Context is used to identify the subscriber. This example shows a subscriber handle being created:

```
retval := DBMS_LDAP_UTL.create_subscriber_handle(
subscriber_handle,
DBMS_LDAP_UTL.TYPE_DN,
"o=example,dc=com"
);
```

`subscriber_handle` is created by it's DN: `o=oracle,dc=com`.

Getting subscriber properties is one common use of a subscriber handle. Here is an example:

```
my_attrs is of type DBMS_LDAP.STRING_COLLECTION
my_attrs(1) := 'orclguid';
retval := DBMS_LDAP_UTL.get_subscriber_properties(
my_session,
my_attrs,
DBMS_LDAP_UTL.ENTRY_PROPERTIES,
my_pset_coll
```

```
);
```

### 11.2.3.1 Function create\_subscriber\_handle

The function `create_subscriber_handle()` creates a subscriber handle.

#### Syntax

```
FUNCTION create_subscriber_handle
(
  subscriber_hd OUT HANDLE,
  subscriber_type IN PLS_INTEGER,
  subscriber_id IN VARCHAR2
)
RETURN PLS_INTEGER;
```

#### Parameters

**Table 11–33 CREATE\_SUBSCRIBER\_HANDLE Function Parameters**

Parameter Name	Parameter Type	Parameter Description
<code>subscriber_hd</code>	HANDLE	A pointer to a handle to a subscriber.
<code>subscriber_type</code>	PLS_INTEGER	The type of subscriber ID that is passed. Valid values for this argument are: <ul style="list-style-type: none"> <li>▪ <code>DBMS_LDAP_UTL.TYPE_DN</code></li> <li>▪ <code>DBMS_LDAP_UTL.TYPE_GUID</code></li> <li>▪ <code>DBMS_LDAP_UTL.TYPE_NICKNAME</code></li> <li>▪ <code>DBMS_LDAP_UTL.TYPE_DEFAULT</code></li> </ul>
<code>subscriber_id</code>	VARCHAR2	The subscriber ID representing the subscriber entry. This can be NULL if <code>subscriber_type</code> is <code>DBMS_LDAP_UTL.TYPE_DEFAULT</code> . In this case, the default subscriber is retrieved from the root Oracle Context.

#### Return Values

**Table 11–34 CREATE\_SUBSCRIBER\_HANDLE Function Return Values**

Value	Description
<code>DBMS_LDAP_UTL.SUCCESS</code>	On a successful completion.
<code>DBMS_LDAP_UTL.PARAM_ERROR</code>	Invalid input parameters.
<code>DBMS_LDAP_UTL.GENERAL_ERROR</code>	Other error.

#### See Also

`DBMS_LDAP_UTL.get_subscriber_properties()`.

### 11.2.3.2 Function get\_subscriber\_properties

The function `get_subscriber_properties()` retrieves the subscriber properties for the given subscriber handle.

#### Syntax

```
FUNCTION get_subscriber_properties
(
  ld IN SESSION,
```

```

subscriber_handle IN HANDLE,
attrs IN STRING_COLLECTION,
ptype IN PLS_INTEGER,
ret_pset_coll OUT PROPERTY_SET_COLLECTION
)
RETURN PLS_INTEGER;

```

## Parameters

**Table 11–35** *GET\_SUBSCRIBER\_PROPERTIES Function Parameters*

Parameter Name	Parameter Type	Parameter Description
ld	SESSION	A valid LDAP session handle.
subscriber_handle	HANDLE	The subscriber handle.
attrs	STRING_COLLECTION	A list of attributes that must be retrieved for the subscriber.
ptype	PLS_INTEGER	Properties of the subscriber's Oracle Context to return. These are valid values: <ul style="list-style-type: none"> <li>■ DBMS_LDAP_UTL.ENTRY_PROPERTIES</li> <li>■ DBMS_LDAP_UTL.COMMON_PROPERTIES</li> </ul>
ret_pset_coll	PROPERTY_SET_COLLECTION	The subscriber details containing the attributes requested by the caller.

## Return Values

**Table 11–36** *GET\_SUBSCRIBER\_PROPERTIES Function Return Values*

Value	Description
DBMS_LDAP_UTL.SUCCESS	On a successful completion.
DBMS_LDAP_UTL.PARAM_ERROR	Invalid input parameters.
DBMS_LDAP_UTL.NO_SUCH_SUBSCRIBER	Subscriber doesn't exist.
DBMS_LDAP_UTL.MULTIPLE_SUBSCRIBER_ENTRIES	Subscriber has a multiple number of DN entries.
DBMS_LDAP_UTL.INVALID_ROOT_ORCL_CTX	Invalid root Oracle Context.
DBMS_LDAP_UTL.GENERAL_ERROR	Other error.
DBMS_LDAP error codes	Return proper DBMS_LDAP error codes for unconditional failures encountered while LDAP operations are carried out.

## Usage Notes

This function can only be called after a valid LDAP session is obtained from a call to `DBMS_LDAP.init()`.

## See Also

`DBMS_LDAP.init()`, `DBMS_LDAP_UTL.create_subscriber_handle()`.

### 11.2.3.3 Function `get_subscriber_dn`

The function `get_subscriber_dn()` returns the subscriber DN.

**Syntax**

```

FUNCTION get_subscriber_dn
(
  ld IN SESSION,
  subscriber_handle IN HANDLE,
  dn OUT VARCHAR2
)
RETURN PLS_INTEGER;

```

**Parameters****Table 11–37** *GET\_SUBSCRIBER\_DN Function Parameters*

Parameter Name	Parameter Type	Parameter Description
ld	SESSION	A valid LDAP session handle.
subscriber_handle	HANDLE	The subscriber handle.
dn	VARCHAR2	The subscriber DN.

**Return Values****Table 11–38** *GET\_SUBSCRIBER\_DN Function Return Values*

Value	Description
DBMS_LDAP_UTL.SUCCESS	On a successful completion.
DBMS_LDAP_UTL.PARAM_ERROR	Invalid input parameters.
DBMS_LDAP_UTL.NO_SUCH_SUBSCRIBER	Subscriber doesn't exist.
DBMS_LDAP_UTL.MULTIPLE_SUBSCRIBER_ENTRIES	Multiple number of subscriber DN entries exist in the directory for the given subscriber.
DBMS_LDAP_UTL.INVALID_ROOT_ORCL_CTX	Invalid root Oracle Context.
DBMS_LDAP_UTL.GENERAL_ERROR	Other error.
DBMS_LDAP error codes	Return proper DBMS_LDAP error codes for unconditional failures encountered when LDAP operations are carried out.

**Usage Notes**

This function can only be called after a valid LDAP session is obtained from a call to `DBMS_LDAP.init()`.

**See Also**

`DBMS_LDAP.init()`.

**11.2.3.4 Function get\_subscriber\_ext\_properties**

The function `get_subscriber_ext_properties()` retrieves the subscriber extended properties. Currently this can be used to retrieve the subscriber-wide default Resource Access Descriptors.

**Syntax**

```

FUNCTION get_subscriber_ext_properties
(

```

```

ld IN SESSION,
subscriber_handle IN HANDLE,
attrs IN STRING_COLLECTION,
ptype IN PLS_INTEGER,
filter IN VARCHAR2,
rep_pset_coll OUT PROPERTY_SET_COLLECTION
)
RETURN PLS_INTEGER;

```

## Parameters

**Table 11-39** *GET\_SUBSCRIBER\_EXT\_PROPERTIES* Function Parameters

Parameter Name	Parameter Type	Parameter Description
ld	SESSION	A valid LDAP session handle.
subscriber_handle	HANDLE	The subscriber handle.
attrs	STRING_COLLECTION	A list of subscriber attributes to retrieve.
ptype	PLS_INTEGER	The type of properties to return. A valid value is <code>DBMS_LDAP_UTL.DEFAULT_RAD_PROPERTIES</code> .
filter	VARCHAR2	An LDAP filter to further refine the subscriber properties returned by the function.
ret_pset_collection	PROPERTY_SET_COLLECTION	The subscriber details containing the attributes requested by the caller.

## Return Values

**Table 11-40** *GET\_USER\_EXTENDED\_PROPERTIES* Function Return Values

Value	Description
<code>DBMS_LDAP_UTL.SUCCESS</code>	On a successful completion.
<code>DBMS_LDAP_UTL.PARAM_ERROR</code>	Invalid input parameters.
<code>DBMS_LDAP_UTL.NO_SUCH_USER</code>	User does not exist.
<code>DBMS_LDAP_UTL.INVALID_ROOT_ORCL_CTX</code>	Invalid root Oracle Context.
<code>DBMS_LDAP_UTL.GENERAL_ERROR</code>	Other error.
<code>DBMS_LDAP</code> error codes	Return proper <code>DBMS_LDAP</code> error codes for unconditional failures encountered when LDAP operations are carried out.

## Usage Notes

This function can be called only after a valid LDAP session is obtained from a call to `DBMS_LDAP.init()`.

See Also `DBMS_LDAP.init()`, `DBMS_LDAP_UTL.get_subscriber_properties()`.

## 11.2.4 Property-Related Subprograms

Many of the user-related, subscriber-related, and group-related subprograms return `DBMS_LDAP_UTL.PROPERTY_SET_COLLECTION`, which is a collection of one or more LDAP entries representing results. Each of these entries is represented by a `DBMS_LDAP_UTL.PROPERTY_SET`. A `PROPERTY_SET` may contain attributes—that is, properties—and its values. Here is an example that illustrates the retrieval of properties from `DBMS_LDAP_UTL.PROPERTY_SET_COLLECTION`:

```
my_attrs is of type DBMS_LDAP.STRING_COLLECTION
my_attrs(1) := 'cn';

retval := DBMS_LDAP_UTL.get_group_membership(
my_session,
user_handle,
DBMS_LDAP_UTL.DIRECT_MEMBERSHIP,
my_attrs,
my_pset_coll
);

IF my_pset_coll.count > 0 THEN
  FOR i in my_pset_coll.first .. my_pset_coll.last LOOP
    -- my_property_names is of type DBMS_LDAP.STRING_COLLECTION
    retval := DBMS_LDAP_UTL.get_property_names(
pset_coll(i),
property_names
  IF my_property_names.count > 0 THEN
    FOR j in my_property_names.first .. my_property_names.last LOOP
      retval := DBMS_LDAP_UTL.get_property_values(
pset_coll(i),
property_names(j),
property_values
      if my_property_values.COUNT > 0 then
        FOR k in my_property_values.FIRST..my_property_values.LAST LOOP
          DBMS_OUTPUT.PUT_LINE(my_property_names(j) || ':'
          ||my_property_values(k));
        END LOOP; -- For each value
      else
        DBMS_OUTPUT.PUT_LINE('NO VALUES FOR' || my_property_names(j));
      end if;
    END LOOP; -- For each property name
  END IF; -- IF my_property_names.count > 0
END LOOP; -- For each propertyset
END IF; -- If my_pset_coll.count > 0
```

`use_handle` is a user handle. `my_pset_coll` contains all the nested groups that `use_handle` belongs to. The code loops through the resulting entries and prints out the `cn` of each entry.

## 11.2.5 Miscellaneous Subprograms

The miscellaneous subprograms in the `DBMS_LDAP_UTL` package perform a variety of different functions.

### 11.2.5.1 Function `normalize_dn_with_case`

The function `normalize_dn_with_case()` removes unnecessary white space characters from a DN and converts all characters to lowercase based on a flag.

**Syntax**

```

FUNCTION normalize_dn_with_case
(
  dn IN VARCHAR2,
  lower_case IN PLS_INTEGER,
  norm_dn OUT VARCHAR2
)
RETURN PLS_INTEGER;

```

**Parameters****Table 11-41** *NORMALIZE\_DN\_WITH\_CASE* Function Parameters

Parameter Name	Parameter Type	Parameter Description
dn	VARCHAR2	The DN.
lower_case	PLS_INTEGER	If set to 1: The normalized DN returns in lowercase. If set to 0: The case is preserved in the normalized DN string.
norm_dn	VARCHAR2	The normalized DN.

**Return Values****Table 11-42** *NORMALIZE\_DN\_WITH\_CASE* Function Return Values

Value	Description
DBMS_LDAP_UTL.SUCCESS	On a successful completion.
DBMS_LDAP_UTL.PARAM_ERROR	Invalid input parameters.
DBMS_LDAP_UTL.GENERAL_ERROR	On failure.

**Usage Notes**

This function can be used while comparing two DN's.

**11.2.5.2 Function get\_property\_names**

The function `get_property_names()` retrieves the list of property names in the property set.

**Syntax**

```

FUNCTION get_property_names
(
  pset IN PROPERTY_SET,
  property_names OUT STRING_COLLECTION
)
RETURN PLS_INTEGER;

```



## Parameters

**Table 11–43** *GET\_PROPERTY\_NAMES Function Parameters*

Parameter Name	Parameter Type	Parameter Description
pset	PROPERTY_SET	The property set in the property set collection returned from any of the following functions: <ul style="list-style-type: none"> <li>■ DBMS_LDAP_UTL.get_group_membership()</li> <li>■ DBMS_LDAP_UTL.get_subscriber_properties()</li> <li>■ DBMS_LDAP_UTL.get_user_properties()</li> <li>■ DBMS_LDAP_UTL.get_group_properties()</li> </ul>
property_names	STRING_COLLECTION	A list of property names associated with the property set.

## Return Values

**Table 11–44** *GET\_PROPERTY\_NAMES Function Return Values*

Value	Description
DBMS_LDAP_UTL.SUCCESS	On a successful completion.
DBMS_LDAP_UTL.PARAM_ERROR	Invalid input parameters.
DBMS_LDAP_UTL.GENERAL_ERROR	On error.

## See Also

DBMS\_LDAP\_UTL.get\_property\_values().

### 11.2.5.3 Function get\_property\_values

The function `get_property_values()` retrieves the property values (the strings) for a given property name and property.

## Syntax

```
FUNCTION get_property_values
(
  pset IN PROPERTY_SET,
  property_name IN VARCHAR2,
  property_values OUT STRING_COLLECTION
)
RETURN PLS_INTEGER;
```

## Parameters

**Table 11–45** *GET\_PROPERTY\_VALUES Function Parameters*

Parameter Name	Parameter Type	Parameter Description
property_name	VARCHAR2	The property name.

**Table 11–45 (Cont.) GET\_PROPERTY\_VALUES Function Parameters**

Parameter Name	Parameter Type	Parameter Description
pset	PROPERTY_SET	The property set in the property set collection obtained from any of the following function returns: <ul style="list-style-type: none"> <li>■ DBMS_LDAP_UTL.get_group_membership()</li> <li>■ DBMS_LDAP_UTL.get_subscriber_properties()</li> <li>■ DBMS_LDAP_UTL.get_user_properties()</li> <li>■ DBMS_LDAP_UTL.get_group_properties()</li> </ul>
property_values	STRING_COLLECTION	A list of property values (strings).

**Return Values****Table 11–46 GET\_PROPERTY\_VALUES Function Return Values**

Value	Description
DBMS_LDAP_UTL.SUCCESS	On a successful completion.
DBMS_LDAP_UTL.PARAM_ERROR	Invalid input parameters.
DBMS_LDAP_UTL.GENERAL_ERROR	On failure.

**See Also**

DBMS\_LDAP\_UTL.get\_property\_values\_len().

**11.2.5.4 Function get\_property\_values\_len**

The function `get_property_values_len()` retrieves the binary property values for a given property name and property.

**Syntax**

```
FUNCTION get_property_values_len
(
  pset IN PROPERTY_SET,
  property_name IN VARCHAR2,
  auth_type IN PLS_INTEGER,
  property_values OUT BINVAL_COLLECTION
)
RETURN PLS_INTEGER;
```

**Parameters****Table 11–47 GET\_PROPERTY\_VALUES\_LEN Function Parameters**

Parameter Name	Parameter Type	Parameter Description
property_name	VARCHAR2	A property name.

**Table 11–47 (Cont.) GET\_PROPERTY\_VALUES\_LEN Function Parameters**

Parameter Name	Parameter Type	Parameter Description
pset	PROPERTY_SET	The property set in the property set collection obtained from any of the following function returns: <ul style="list-style-type: none"> <li>■ DBMS_LDAP_UTL.get_group_membership()</li> <li>■ DBMS_LDAP_UTL.get_subscriber_properties()</li> <li>■ DBMS_LDAP_UTL.get_user_properties()</li> <li>■ DBMS_LDAP_UTL.get_group_properties()</li> </ul>
property_values	BINVAL_COLLECTION	A list of binary property values.

### Return Values

**Table 11–48 GET\_PROPERTY\_VALUES\_LEN Function Return Values**

Value	Description
DBMS_LDAP_UTL.SUCCESS	On a successful completion.
DBMS_LDAP_UTL.PARAM_ERROR	Invalid input parameters.
DBMS_LDAP_UTL.GENERAL_ERROR	On failure.

### See Also

DBMS\_LDAP\_UTL.get\_property\_values().

#### 11.2.5.5 Procedure free\_propertyset\_collection

The procedure free\_propertyset\_collection() frees the memory associated with property set collection.

### Syntax

```
PROCEDURE free_propertyset_collection
(
  pset_collection IN OUT PROPERTY_SET_COLLECTION
);
```

### Parameters

**Table 11–49 FREE\_PROPERTYSET\_COLLECTION Procedure Parameters**

Parameter Name	Parameter Type	Parameter Description
pset_collection	PROPERTY_SET_COLLECTION	The property set collection returned from one of the following functions: <ul style="list-style-type: none"> <li>■ DBMS_LDAP_UTL.get_group_membership()</li> <li>■ DBMS_LDAP_UTL.get_subscriber_properties()</li> <li>■ DBMS_LDAP_UTL.get_user_properties()</li> <li>■ DBMS_LDAP_UTL.get_group_properties()</li> </ul>

**See Also**

DBMS\_LDAP\_UTL.get\_group\_membership(),  
 DBMS\_LDAP\_UTL.get\_subscriber\_properties(),  
 DBMS\_LDAP\_UTL.get\_user\_properties(), DBMS\_LDAP\_UTL.get\_group\_properties().

**11.2.5.6 Function create\_mod\_propertyset**

The function create\_mod\_propertyset() creates a MOD\_PROPERTY\_SET data structure.

**Syntax**

```
FUNCTION create_mod_propertyset
(
  pset_type IN PLS_INTEGER,
  pset_name IN VARCHAR2,
  mod_pset OUT MOD_PROPERTY_SET
)
RETURN PLS_INTEGER;
```

**Parameters****Table 11–50 CREATE\_MOD\_PROPERTYSET Function Parameters**

Parameter Name	Parameter Type	Parameter Description
pset_type	PLS_INTEGER	The type of property set being modified. Here is a valid value: ENTRY_PROPERTIES
pset_name	VARCHAR2	The name of the property set. This can be NULL if ENTRY_PROPERTIES are being modified.
mod_pset	MOD_PROPERTY_SET	The data structure to contain modify operations to be performed on the property set.

**Return Values****Table 11–51 CREATE\_MOD\_PROPERTYSET Function Return Values**

Value	Description
DBMS_LDAP_UTL.SUCCESS	On a successful completion.
DBMS_LDAP_UTL.GENERAL_ERROR	Other error.

**See Also**

DBMS\_LDAP\_UTL.populate\_mod\_propertyset().

**11.2.5.7 Function populate\_mod\_propertyset**

The function populate\_mod\_propertyset() populates the MOD\_PROPERTY\_SET data structure.

**Syntax**

```
FUNCTION populate_mod_propertyset
(
  mod_pset IN MOD_PROPERTY_SET,
  property_mod_op IN PLS_INTEGER,
  property_name IN VARCHAR2,
  property_values IN STRING_COLLECTION
)
RETURN PLS_INTEGER;
```

## Parameters

**Table 11–52** *POPULATE\_MOD\_PROPERTYSET Function Parameters*

Parameter Name	Parameter Type	Parameter Description
mod_pset	MOD_PROPERTY_SET	Mod-PropertySet data structure.
property_mod_op	PLS_INTEGER	The type of modify operation to perform on a property. These are valid values: <ul style="list-style-type: none"> <li>■ ADD_PROPERTY</li> <li>■ REPLACE_PROPERTY</li> <li>■ DELETE_PROPERTY</li> </ul>
property_name	VARCHAR2	The name of the property
property_values	STRING_COLLECTION	Values associated with the property.

## Return Values

**Table 11–53** *POPULATE\_MOD\_PROPERTYSET Function Return Values*

Value	Description
DBMS_LDAP_UTL.SUCCESS	On a successful completion.
DBMS_LDAP_UTL.GENERAL_ERROR	Authentication failed.
DBMS_LDAP_UTL.PWD_GRACELOGIN_WARN	Grace login for user.

## See Also

DBMS\_LDAP\_UTL.create\_mod\_propertyset().

### 11.2.5.8 Procedure free\_mod\_propertyset

The procedure free\_mod\_propertyset() frees the MOD\_PROPERTY\_SET data structure.

## Syntax

```
PROCEDURE free_mod_propertyset
(
  mod_pset IN MOD_PROPERTY_SET
);
```

## Parameters

**Table 11–54** *FREE\_MOD\_PROPERTYSET Procedure Parameters*

Parameter Name	Parameter Type	Parameter Description
mod_pset	PROPERTY_SET	Mod_PropertySet data structure.

## See Also

DBMS\_LDAP\_UTL.create\_mod\_propertyset().

### 11.2.5.9 Procedure free\_handle

The procedure free\_handle() frees the memory associated with the handle.

## Syntax

```
PROCEDURE free_handle
```

```
(
handle IN OUT HANDLE
);
```

### Parameters

**Table 11–55** *FREE\_HANDLE Procedure Parameters*

Parameter Name	Parameter Type	Parameter Description
handle	HANDLE	A pointer to a handle.

### See Also

DBMS\_LDAP\_UTL.create\_user\_handle(),  
 DBMS\_LDAP\_UTL.create\_subscriber\_handle(),  
 DBMS\_LDAP\_UTL.create\_group\_handle().

### 11.2.5.10 Function check\_interface\_version

The function check\_interface\_version() checks the interface version.

#### Syntax

```
FUNCTION check_interface_version
(
interface_version IN VARCHAR2
)
RETURN PLS_INTEGER;
```

### Parameters

**Table 11–56** *CHECK\_INTERFACE\_VERSION Function Parameters*

Parameter Name	Parameter Type	Parameter Description
interface_version	VARCHAR2	Version of the interface.

### Return Values

**Table 11–57** *CHECK\_VERSION\_INTERFACE Function Return Values*

Value	Description
DBMS_LDAP_UTL.SUCCESS	Interface version is supported.
DBMS_LDAP_UTL.GENERAL_ERROR	Interface version is not supported.

### 11.2.5.11 Function get\_property\_values\_blob

The function get\_property\_values\_blob() retrieves large binary property values for a given property name and property.

#### Syntax

```
FUNCTION get_property_values_blob
(
pset IN PROPERTY_SET,
property_name IN VARCHAR2,
auth_type IN PLS_INTEGER,
property_values OUT BLOB_COLLECTION
)
RETURN PLS_INTEGER;
```

## Parameters

**Table 11–58** *GET\_PROPERTY\_VALUES\_BLOB Function Parameters*

Parameters	Parameter Type	Description
property_name	VARCHAR2	A property name.
pset	PROPERTY_SET	The property set in the property set collection obtained from any of the following function returns: <ul style="list-style-type: none"> <li>■ DBMS_LDAP_UTL.get_group_membership()</li> <li>■ DBMS_LDAP_UTL.get_subscriber_properties( )</li> <li>■ DBMS_LDAP_UTL.get_user_properties()</li> <li>■ DBMS_LDAP_UTL.get_group_properties()</li> </ul>
property_values	BLOB_COLLECTION	A list of binary property values.

## Return Values

**Table 11–59** *GET\_PROPERTY\_VALUES\_BLOB Return Values*

Value	Description
DBMS_LDAP_UTL.SUCCESS	On a successful completion.
DBMS_LDAP_UTL.PARAM_ERROR	Invalid input parameters.
DBMS_LDAP_UTL.GENERAL_ERROR	On failure.

## See Also

DBMS\_LDAP\_UTL.get\_property\_values().

### 11.2.5.12 Procedure property\_value\_free\_blob

Frees the memory associated with BLOB\_COLLECTION returned by DBMS\_LDAP.get\_property\_values\_blob().

## Syntax

```
Syntax
PROCEDURE property_value_free_blob
(
vals IN OUT DBMS_LDAP.BLOB_COLLECTION
);
```

## Parameters

**Table 11–60** *PROPERTY\_VALUE\_FREE\_BLOB Function Parameters*

Parameter	Description
vals	The collection of large binary values returned by DBMS_LDAP.get_property_values_blob().

## See Also

DBMS\_LDAP.get\_property\_values\_blob().

## 11.3 Function Return Code Summary

The DBMS\_LDAP\_UTL functions can return the values in the following table.

**Table 11–61** *Function Return Codes*

Name	Return Code	Description
SUCCESS	0	Operation successful.
GENERAL_ERROR	-1	This error code is returned on failure conditions other than those conditions listed here.
PARAM_ERROR	-2	Returned by all functions when an invalid input parameter is encountered.
NO_GROUP_MEMBERSHIP	-3	Returned by user-related functions and group functions when the user is not a member of a group.
NO_SUCH_SUBSCRIBER	-4	Returned by subscriber-related functions when the subscriber does not exist in the directory.
NO_SUCH_USER	-5	Returned by user-related functions when the user does not exist in the directory.
NO_ROOT_ORCL_CTX	-6	Returned by most functions when the root oracle context does not exist in the directory.
MULTIPLE_SUBSCRIBER_ENTRIES	-7	Returned by subscriber-related functions when multiple subscriber entries are found for the given subscriber nickname.
INVALID_ROOT_ORCL_CTX	-8	Root Oracle Context does not contain all the required information needed by the function.
NO_SUBSCRIBER_ORCL_CTX	-9	Oracle Context does not exist for the subscriber.
INVALID_SUBSCRIBER_ORCL_CTX	-10	Oracle Context for the subscriber is invalid.
MULTIPLE_USER_ENTRIES	-11	Returned by user-related functions when multiple user entries exist for the given user nickname.
NO_SUCH_GROUP	-12	Returned by group related functions when a group does not exist in the directory.
MULTIPLE_GROUP_ENTRIES	-13	Multiple group entries exist for the given group nickname in the directory.
ACCT_TOTALLY_LOCKED_EXCEPTION	-14	Returned by DBMS_LDAP_UTL.authenticate_user() function when a user account is locked. This error is based on the password policy set in the subscriber oracle context.
AUTH_PASSWD_CHANGE_WARN	-15	This return code is deprecated.
AUTH_FAILURE_EXCEPTION	-16	Returned by DBMS_LDAP_UTL.authenticate_user() function when user authentication fails.
PWD_EXPIRED_EXCEPTION	-17	Returned by DBMS_LDAP_UTL.authenticate_user() function when the user password has expired. This is a password policy error.
RESET_HANDLE	-18	Returned when entity handle properties are being reset by the caller.
SUBSCRIBER_NOT_FOUND	-19	Returned by DBMS_LDAP_UTL.locate_subscriber_for_user() function when it is unable to locate the subscriber.



**Table 11–61 (Cont.) Function Return Codes**

<b>Name</b>	<b>Return Code</b>	<b>Description</b>
PWD_EXPIRE_WARN	-20	Returned by <code>DBMS_LDAP_UTL.authenticate_user()</code> function when the user password is about to expire. This is a password policy error.
PWD_MINLENGTH_ERROR	-21	Returned by <code>DBMS_LDAP_UTL.set_user_properties()</code> function while changing the user password and the new user password is less than the minimum required length. This is a password policy error.
PWD_NUMERIC_ERROR	-22	Returned by <code>DBMS_LDAP_UTL.set_user_properties()</code> function while changing the user password and the new user password does not contain at least one numeric character. This is a password policy error.
PWD_NULL_ERROR	-23	Returned by <code>DBMS_LDAP_UTL.set_user_properties()</code> function while changing the user password and the new user password is an empty password. This is a password policy error.
PWD_INHISTORY_ERROR	-24	Returned by <code>DBMS_LDAP_UTL.set_user_properties()</code> function while changing the user password and the new user password is the same as the previous password. This is a password policy error.
PWD_ILLEGALVALUE_ERROR	-25	Returned by <code>DBMS_LDAP_UTL.set_user_properties()</code> function while changing the user password and the new user password has an illegal character. This is a password policy error.
PWD_GRACELOGIN_WARN	-26	Returned by <code>DBMS_LDAP_UTL.authenticate_user()</code> function to indicate that the user password has expired and the user has been given a grace login. This is a password policy error.
PWD_MUSTCHANGE_ERROR	-27	Returned by <code>DBMS_LDAP_UTL.authenticate_user()</code> function when user password must be changed. This is a password policy error.
USER_ACCT_DISABLED_ERROR	-29	Returned by <code>DBMS_LDAP_UTL.authenticate_user()</code> function when user account has been disabled. This is a password policy error.
PROPERTY_NOT_FOUND	-30	Returned by user-related functions while searching for a user property in the directory.

## 11.4 Data Type Summary

The `DBMS_LDAP_UTL` package uses the data types in the following table

**Table 11–62 DBMS\_LDAP\_UTL Data Types**

<b>Data Type</b>	<b>Purpose</b>
HANDLE	Used to hold the entity.
PROPERTY_SET	Used to hold the properties of an entity.
PROPERTY_SET_COLLECTION	List of <code>PROPERTY_SET</code> structures.
MOD_PROPERTY_SET	Structure to hold modify operations on an entity.



---

# Oracle Directory Integration and Provisioning Java API Reference

This chapter provides reference information for the Oracle Directory Integration and Provisioning Java APIs.

As of 10g (10.1.4.0.1), Oracle offers two complementary provisioning products, optimized for different use cases.

- Oracle Identity Manager, formerly known as Oracle Xellerate IP, is an enterprise provisioning platform designed to manage complex environments with highly heterogeneous technologies that can include directories, databases, mainframes, proprietary technologies, and flat files. Oracle Identity Manager offers full-functioned workflow and policy capabilities along with a rich set of audit and compliance features.
- Oracle Directory Integration and Provisioning, a component of the Identity Management infrastructure, is a meta-directory technology designed to perform directory synchronization and provisioning tasks in a directory-centric environment. Oracle Directory Integration and Provisioning is designed to manage a more homogeneous environment consisting of directories and compatible Oracle products. Oracle Directory Integration and Provisioning performs provisioning tasks by using data synchronization. Oracle Directory Integration and Provisioning offers a small deployment footprint when workflow and a full feature policy engine are not required.

The Oracle Internet Directory SDK includes an Oracle Directory Integration and Provisioning user provisioning API, which enables you to manage users and their application properties in the Oracle Identity Management infrastructure. This chapter describes the main features of the API and explains how to use them.

This chapter includes the following sections:

- [Section 12.1, "Application Configuration"](#)
- [Section 12.2, "User Management"](#)
- [Section 12.3, "Debugging"](#)
- [Section 12.4, "Sample Code"](#)

## 12.1 Application Configuration

Applications must register with the provisioning system in order to be recognized as provisionable. They must also create their own configuration in Oracle Internet Directory using the command-line interface. Java classes exist for viewing application configurations.

This section contains the following topics:

- [Section 12.1.1, "Application Registration and Provisioning Configuration"](#)
- [Section 12.1.2, "Application Configuration Classes"](#)

## 12.1.1 Application Registration and Provisioning Configuration

In order to register with the provisioning system, an application must create a provisioning configuration. After the provisioning configuration exists, the provisioning system identifies the application as directory-enabled and provisionable.

The application must perform the following steps to create a provisioning configuration:

1. [Application Registration](#)
2. [Provisioning Configuration](#)

### 12.1.1.1 Application Registration

Oracle applications typically register themselves by using the repository APIs in the `repository.jar` file under `$ORACLE_HOME/jlib`. This file is provided during installation specifically for application registration. In addition to creating an application entry in Oracle Internet Directory, repository APIs can be used to add the application to privileged groups.

Applications written by customers, however, cannot use the `repository.jar` APIs to perform application registration. So application developers must use LDIF templates and create application entries in Oracle Internet Directory using LDAP commands.

An application must create a container for itself under one of these containers:

- `"cn=Products,cn=OracleContext"`—for applications that service users in multiple realms
- `"cn=Products,cn=OracleContext,RealmDN"`—for applications that service users in a specific realm

If an application is configured for a specific realm, then that application cannot manage users in other realms. In most cases, you should create the application outside any identity management realm so that the application is not tied to a specific realm in Oracle Internet Directory.

Whenever a new instance of the application installs, a separate entry for the application instance is created under the application's container. Some of the provisioning configuration is common to all the instances of a particular type and some is specific to the instance. When multiple instances of an application are deployed in an enterprise, each instance is independent of the others. Each instance is defined as a separate provisionable application. Users can be provisioned for one or more instances of this application, so that the user can get access to one or more instances of this application.

The examples in this section are for a sample application similar to Oracle Files. When the first instance of this application installs, specific entries must be created in Oracle Internet Directory. In the following example, the name of this application, chosen at run time, is `Files-App1` and the type of the application is `FILES`. The application can have LDIF templates that can be instantiated if required and then uploaded to Oracle Internet Directory. In this example, the application identity is outside any realm. That is, it is under the `"cn=Products,cn=OracleContext"` container.

```
dn: cn=FILES,cn=Products,cn=OracleContext
```

```

changetype: add
objectclass: orclContainer

dn: orclApplicationCommonName=Files-App1,cn=FILES,cn=Products,cn=OracleContext
changetype: add
orclappfullname: Files Application Instance 1
userpassword: welcome123
description: This is a test Application instance.
protocolInformation: xxxxx
orclVersion: 1.0
orclaci: access to entry by group="cn=odisgroup,cn=DIPAdmins,
cn=Directory Integration Platform,cn=Products,
cn=OracleContext" (browse,proxy) by group="cn=User Provisioning Admins,
cn=Groups,cn=OracleContext" (browse,proxy)
orclaci: access to attr=(*) by group="cn=odisgroup,cn=DIPAdmins,
cn=Directory Integration Platform,cn=Products,
cn=OracleContext" (search,read,write,compare)
by group="cn=User Provisioning Admins,
cn=Groups,cn=OracleContext" (search,read,write,compare)

```

The ACLs shown in the example are discussed in the "[Application User Data Location](#)" section.

The application is expected to grant certain privileges to some provisioning services and provisioning administrators.

When the second instance of this application installs, the following entries must be created in Oracle Directory Integration and Provisioning, assuming the name of this application, decided at run time, is Files-App2.

```

dn: orclApplicationCommonName=Files-App2,cn=FILES,cn=Products,cn=OracleContext
changetype: add
orclappfullname: Files Application Instance 2
userpassword: welcome123
description: This is a test Application instance.
orclVersion: 1.0
orclaci: access to entry by group="cn=odisgroup,
cn=DIPAdmins,cn=Directory Integration Platform,cn=Products,
cn=OracleContext" (browse,proxy) by group="cn=User Provisioning Admins,
cn=Groups,cn=OracleContext" (browse,proxy)
orclaci: access to attr=(*) by group="cn=odisgroup,cn=DIPAdmins,
cn=Directory Integration Platform,cn=Products,
cn=OracleContext" (search,read,write,compare) by
group="cn=User Provisioning Admins,cn=Groups,cn=OracleContext"
(search,read,write,compare)

```

After the application creates its entries successfully, the application's identity is registered in Oracle Internet Directory. At this point, the application can add itself to certain privileged groups in Oracle Internet Directory, if it needs specific privileges. [Table 12-1, "Some Useful Privilege Groups"](#) shows some of the privileged groups that an application can add itself to. Each of these groups exists in every realm and also in the RootOracleContext. The RootOracleContext Group is a member of the group in all the realms

**Table 12-1 Some Useful Privilege Groups**

Group Name	Privilege
OracleDASCreateUser	Create a public user
OracleDASEditUser	Edit a public user

**Table 12–1 (Cont.) Some Useful Privilege Groups**

Group Name	Privilege
OracleDASDeleteUser	Delete a public user
OracleDASCreateGroup	Create a new public group
OracleDASEditGroup	Edit a public group
OracleDASDeleteGroup	Delete a public group

For example, the following LDIF file adds the Files-App1 application to `cn=OracleCreateUser`, which gives it the privilege to create users in all realms.

```
dn:cn=OracleCreateUser,cn=Groups,cn=OracleContext
changetype: modify
add: uniquemember
uniquemember:
orclApplicationCommonName=Files-App1,cn=FILES,cn=Products,cn=OracleContext
```

### 12.1.1.2 Provisioning Configuration

An application's provisioning configuration is maintained in its provisioning profile. The provisioning system supports three different provisioning profile versions: Versions 1.1, 2.0 and 3.0. The provisioning service provides different service for the different profile version. Some generic configuration details are common to all applications, regardless of version.

#### Differences Between Provisioning Configuration Versions

The differences between the Version 3.0 profile and the Version 2.0 and Version 1.1 profiles are as follows:

- The new provisioning framework recognizes only Version 3.0 applications. Therefore, only applications with provisioning profile Version 3.0 show up as target applications to be provisioned in Oracle Provisioning Console. Applications with Version 2.0 and Version 1.1 profiles do not show them up as applications to be provisioned in the Provisioning Console. Still, the applications are notified about the events that the applications have configured for.
- Creating the provisioning configuration of an application is a multi step process for Version 3.0 profiles. For the earlier version profiles, provisioning registration requires only a single step, running the `oidprovtool` command.
- Applications can subscribe for provisioning events using different interfaces. Two of the interfaces, Java and OID-LDAP, are available only for interface Version 3.0, which is coupled with provisioning configuration Version 3.0. See [Table 12–2, "Interfaces and Their Configuration"](#).
- An application can specify its application-specific user attributes configuration in an LDIF file. This is supported only for interface Version 3.0, which is coupled with provisioning configuration Version 3.0. See [Section 12.1.1.2.6, "Application User Attribute and Defaults Configuration"](#).
- The provisioning status of the user, discussed in the *Oracle Fusion Middleware Administrator's Guide for Oracle Directory Integration Platform*, is maintained only for Version 3.0 applications. It is not maintained for applications having profiles earlier than Version 3.0.
- Event propagation configuration parameters vary from one version to another. See [Table 12–5, "Event propagation parameters"](#).

### Version 3.0-Specific Provisioning Configuration

Unless otherwise stated, the remainder of this section describes the Version 3.0-specific provisioning configuration. [Figure 12–1](#) shows the DIT in Oracle Internet Directory used to store the provisioning configuration. All the provisioning configuration information is located under the following container:

```
cn=Provisioning,cn=Directory Integration Platform,cn=Products,cn=OracleContext
```

Common provisioning configuration information is stored in entries under the container:

```
cn=Profiles,cn=Provisioning,cn=Directory Integration Platform,  
cn=Products,cn=OracleContext
```

The rest of the provisioning configuration for an application is located under:

```
cn=ApplicationType,cn=Applications,cn=Provisioning,  
cn=Directory Integration Platform,cn=Products,cn=OracleContext
```

All the instances of a specific application type share the configuration under this container. That is, whenever a second instance of an existing application type creates a provisioning profile, all the configuration information under the "cn=*ApplicationType*" container is shared.

**Figure 12-1 The Directory Information Tree for Provisioning Configuration Data**

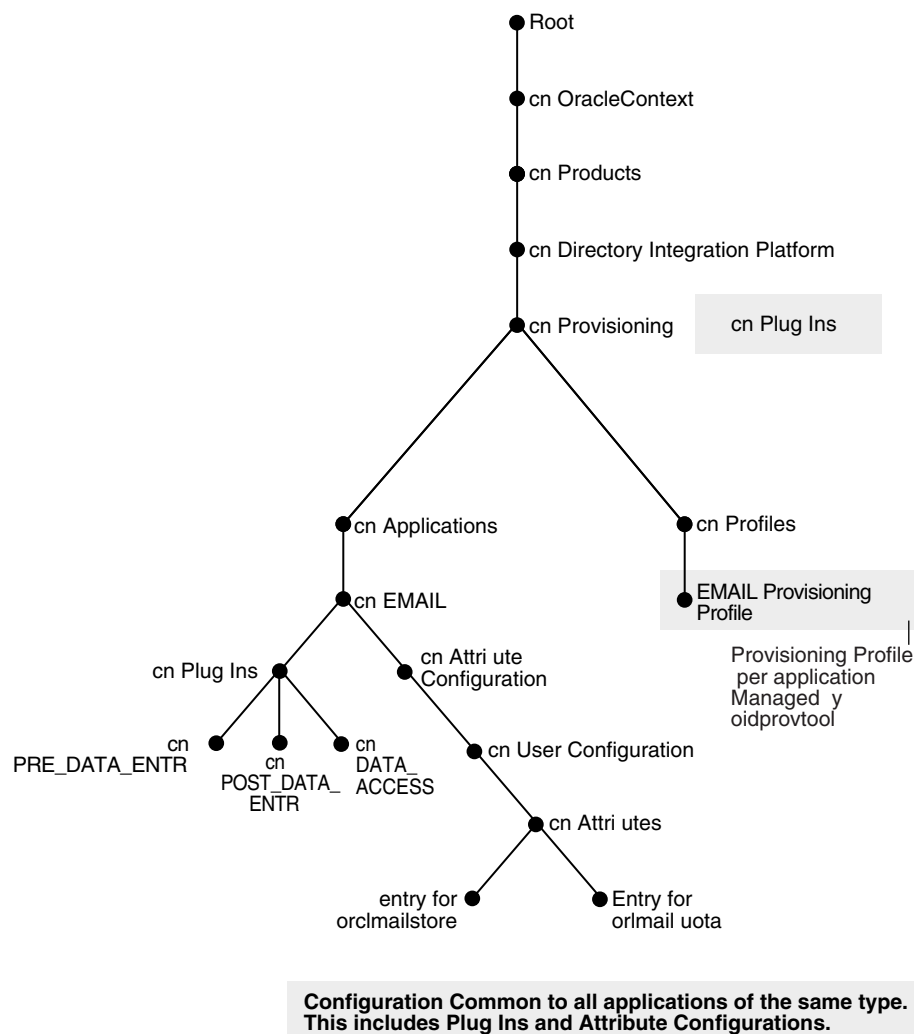

The Profiles container contains the following types of configuration information:

- Section 12.1.1.2.1, "Application Identity Information"
- Section 12.1.1.2.2, "Application Identity Realm Information"
- Section 12.1.1.2.3, "Application Provisioning and Default Policy"
- Section 12.1.1.2.4, "Application User Data Location"
- Section 12.1.1.2.5, "Event Interface Configuration"
- Section 12.1.1.2.6, "Application User Attribute and Defaults Configuration"
- Section 12.1.1.2.7, "Application Provisioning Plug-in Configuration"
- Section 12.1.1.2.8, "Application Propagation Configuration"
- Section 12.1.1.2.9, "Application Event Propagation Run Time Status"

Whenever an instance of an application creates a profile, the new profile is stored as a separate entry under the Profiles container in the following naming format:

`orclODIPProfileName=GUID_of_the_Realm_Entry_GUID_of_the_Application_Identity,...`



An application must specify the following information when creating a provisioning configuration:

**12.1.1.2.1 Application Identity Information** An instance of an application is uniquely identified by the following parameters:

- Application DN—A unique DN in the Oracle Internet Directory representing the application. This is a mandatory parameter.
- Application Type— A parameter that is common to all instances of the same application. Multiple instances of a particular type can share some configuration. This is a mandatory parameter.
- Application Name—This can be separately specified. If not specified, it is extracted from the DN. This is an optional parameter.
- Application Display Name—A user-friendly name for the application. This shows up on the Provisioning Console as a target provisionable application. This is an optional parameter.

You provide these application identity parameters while creating the provisioning profile by using the following arguments to the `$ORACLE_HOME/bin/oidprovtool` command line utility, respectively:

- `application_type`
- `application_dn`
- `application_name`
- `application_display_name`

**See Also:** The `oidprovtool` command-line tool reference in *Oracle Fusion Middleware Reference for Oracle Identity Management*.

**12.1.1.2.2 Application Identity Realm Information** An application registers for a specific realm in order to provide services to the users of that realm only. An application must create a separate provisioning profile for each of the realms it provides services for. In a multi realm scenario, such as a hosted Oracle Portal scenario, applications must register for individual realms.

Whenever a provisioning administrator for a realm accesses the Provisioning Console, only the applications that are registered for that realm are shown as provisionable target applications.

The application specifies realm information while creating the provisioning profile by using the `$ORACLE_HOME/bin/oidprovtool` command line utility with the argument `organization_dn`.

**See Also:** The `oidprovtool` command-line tool reference in *Oracle Fusion Middleware Administrator's Guide for Oracle Internet Directory*.

**12.1.1.2.3 Application Provisioning and Default Policy** While creating a provisioning profile, an application can specify whether the Provisioning Console should manage provisioning to that application or not. If not, the application does not show up on the Provisioning Console as an application to be provisioned. However, Oracle Directory Integration and Provisioning still processes this profile and propagates the events as expected.

An application specifies this information while creating the provisioning profile by using the `application_isdasvisible` argument to the `$ORACLE_HOME/bin/oidprovtool` command line utility. The default value is `TRUE`.

An application can configure a default policy determining whether all the users in that realm should be provisioned for that application by default or no users should be provisioned by default. The valid values are

- `PROVISIONING_REQUIRED`—all users are provisioned by default
- `PROVISIONING_NOT_REQUIRED`—no users are provisioned by default

The default is set to `PROVISIONING_REQUIRED`

You can override the default policy with application-provided policy plug-ins at run time. In addition, an administrator can override both the default policy and the decision of the policy plug-in.

An application provides the default policy information by using the `default_provisioning_policy` argument to the `$ORACLE_HOME/bin/oidprovtool` command line utility.

**12.1.1.2.4 Application User Data Location** Application-specific user information is stored in the application-specific containers. If this data is to be managed by the provisioning system, the application must specify the location of these containers during provisioning registration. An application specifies its user data location by using the `user_data_location` argument to the `$ORACLE_HOME/bin/oidprovtool` command line utility. The application must ensure that the ACLs on this container allow Oracle Delegated Administration Services and Oracle Directory Integration and Provisioning to manage the information in this container.

**12.1.1.2.5 Event Interface Configuration** Applications can subscribe for provisioning events using different interfaces: PLSQL, Java, and OID-LDAP. [Table 12–2, "Interfaces and Their Configuration"](#) lists the supported interfaces and their associated configuration. Note that `INTERFACE_VERSION` is coupled with provisioning profile version.

**Table 12–2 Interfaces and Their Configuration**

Configuration Parameter	PLSQL	Java	OID-LDAP
<code>INTERFACE_VERSION</code>	1.1, 2.0, 3.0	3.0	3.0
<code>INTERFACE_NAME</code>	The name of the PLSQL package that implements the Interface	Not used	Not used
<code>INTERFACE_CONNECT_INFO</code>	The Database Connect String. Multiple formats supported for all versions.	Not used	Not used
<code>INTERFACE_ADDITIONAL_INFO</code>	Not used	Not used	Not used
Plugin types	<code>PRE_DATA_ENTRY</code> , <code>POST_DATA_ENTRY</code> , <code>DATA_ACCESS</code>	<code>PRE_DATA_ENTRY</code> , <code>POST_DATA_ENTRY</code> , <code>DATA_ACCESS</code> , <code>EVENT_DELIVERY</code> (MUST)	<code>PRE_DATA_ENTRY</code> , <code>POST_DATA_ENTRY</code> , <code>DATA_ACCESS</code>

**Table 12–2 (Cont.) Interfaces and Their Configuration**

Configuration Parameter	PLSQL	Java	OID-LDAP
Description	Mainly for applications that have an Oracle Database back end. The DIP Server pushes the event to the remote Database by invoking the PLSQL procedure.	If the Interface Type is JAVA, an event delivering plug-in must be configured or the server gives errors. The plug-in configuration determines the rest of the configuration. See <a href="#">Section 12.1.1.2.7, "Application Provisioning Plug-in Configuration."</a>	Mainly used in cases where the application is very tightly bound to Oracle Internet Directory and event delivery through the PLSQL interface or the JAVA Event Delivery Plug-in is unnecessary. This interface is deprecated in future. Please use the JAVA Interface instead.

Applications can use the following arguments to `$ORACLE_HOME/bin/oidprovtool` when specifying an event interface configuration:

- `interface_type` (Default is PLSQL)
- `interface_version` (Default is 2.0)
- `interface_name`
- `interface_connect_info`
- `interface_additional_info`

[Table 12–3, "Information Formats Supported by the PLSQL Interface"](#) lists the interface connection information formats that the PL/SQL interface supports when it connects to a remote database. All the formats are supported for all interface versions.

**Table 12–3 Information Formats Supported by the PLSQL Interface**

Format	Description
<code>dbHost:dbPort:dbSID:username:password</code>	Old format, not recommended. Oracle Directory Integration and Provisioning passes this to the thin JDBC Driver.
<code>dbHost:dbPort:dbServiceName:username:password</code>	Newer format. Not Recommended for High Availability implementations, as the database host and port might change in such scenarios. DIP passes this to the thin JDBC Driver.
<code>DBSVC=DB_TNS_Connect_Sring_Alias:username:password</code>	Used by JDBC thick OCI Driver. The local <code>tnsnames.ora</code> file must contain this alias on the node where DIP is running.
<code>DBURL=ldap://LDAP_host:LDAP_port/ServiceName,cn=OracleContext</code>	Recommended format, as it takes care of High Availability requirements. DIP passes this to the thin JDBC Driver and the driver looks up the Database Registration entry in Oracle Internet Directory to get the actual Database connection information.

Some examples of supported formats are:

```
localhost:1521:iasdb:scott:tiger
```

```
localhost:1521:iasdbsvc:scott:tiger
```

```
DBSVC=TNSALIAS:scott:tiger
```

```
DBURL=ldap://example.com:3060/sampleldbname:scott:tiger
```

**12.1.1.2.6 Application User Attribute and Defaults Configuration** An application can specify its application-specific user attributes configuration in an LDIF file. This is supported only for interface version 3.0.

As shown in [Figure 12–1, "The Directory Information Tree for Provisioning Configuration Data"](#), the configuration for a particular attribute is stored as a separate entry under the container:

```
"cn=Attributes,cn=User Configuration,cn=Attribute configuration,
cn=Application_Type,cn=Applications,cn=Provisioning,
cn=Directory Integration Platform,cn=Products,cn=OracleContext"
```

There is no argument to `oidprovtool` for uploading this information. The application must use an LDAP file and command-line tools to upload its attribute configuration information to Oracle Internet Directory.

Each application-specific attribute is represented as a separate entry. The following example is for the attribute `orclFilesDomain`:

```
dn: cn=orclFilesDomain,cn=Attributes,cn=User configuration,cn=Attribute
configuration,.....
changetype: add
orclDasAdminModifiable: 1
orclDasViewable: 1
displayname: Files Domain
orclDasMandatory: 1
orclDasUIType: LOV
orclDasLOV: us.example.com
orclDasLOV: uk.example.com
orclDASAttrIsUIField: 1
orclDASAttrIsFieldForCreate: 1
orclDASAttrIsFieldForEdit: 1
orclDASAttrToDisplayByDefault: 1
orclDASSelfModifiable: 1
orclDASAttrDisplayOrder: 1
orclDASAttrDefaultValue: us.example.com
orclDASAttrObjectClass: orclFILESUser
objectclass: orclDASConfigAttr
objectclass: orclcontainer
```

[Table 12–4, "Properties Stored as Attributes in the Attribute Configuration Entry"](#) explains the significance of each of the properties that are stored as attributes in the attribute configuration entry.

**Table 12–4 Properties Stored as Attributes in the Attribute Configuration Entry**

Property Name	Description	Comments
<code>orclDASIsUIField</code>	Whether this property is to be shown in the DAS Console or not	Not Used in 11g Release 1 (11.1.1). All attributes are shown.
<code>orclDASUIType</code>	The Type of the UI Field: singletext, multitext, LOV, DATE, Number, password	Used by Oracle Internet Directory Self-Service Console only
<code>orclDASAdminModifiable</code>	Whether the field is modifiable by the administrator or not	Not Used in 11g Release 1 (11.1.1). All attributes are modifiable by administrator.

**Table 12–4 (Cont.) Properties Stored as Attributes in the Attribute Configuration Entry**

Property Name	Description	Comments
orclDASViewAble	Whether this attribute is a read-only attribute in the Oracle Internet Directory Self-Service Console	Not Used in 11g Release 1 (11.1.1)
displayName	The Localized Name of the attribute as it shows on the Oracle Internet Directory Self-Service Console	
orclDASIsMandatory	Whether this attribute is mandatory or not	If a mandatory attribute is not populated, the Oracle Internet Directory Self-Service Console complains
orclDASAttrIsFieldForCreate	Whether to expose this attribute only during user creation	Not Used in 11g Release 1 (11.1.1)
orclDASAttrIsFieldForEdit	Whether to expose this attribute only during user editing	Not Used in 11g Release 1 (11.1.1)
orclDASAttrToDisplayByDefault	Whether to hide the attribute by default under a collapsed section	Not Used in 11g Release 1 (11.1.1)
orclDASSelfModifiable	Whether this attribute is modifiable by the user or not	Not Used in 11g Release 1 (11.1.1), as Oracle Internet Directory Self-Service Console is only for application-specific attributes. Users cannot change their user preferences from the Oracle Internet Directory Self-Service Console.
OrclDASAttrDisplayOrder	The order is which the attribute is to be displayed in the application-specific section	Not Used in 11g Release 1 (11.1.1)
OrclDASAttrDefaultValue	The initial default value for the attribute that is used by the provisioning components: Oracle Internet Directory Self-Service Console, Oracle Directory Integration and Provisioning, Bulk Provisioning Tool	Can be changed using the Oracle Internet Directory Self-Service Console <i>Application Management</i> Page. The Plug-ins or the administrator can override the initial default values.
OrclDASAttrObjectClass	The LDAP object class that the attribute belongs to.	Used to create the application-specific user entries that the provisioning system maintains.

If an application has application-specific attributes, you can specify that the provisioning system manage its attributes defaults. You do that by using the `manage_application_defaults` argument to `$ORACLE_HOME/bin/oidprovtool`. This argument is `TRUE` by default.

**12.1.1.2.7 Application Provisioning Plug-in Configuration** Application provisioning plug-ins are discussed in

[Appendix A, "Java Plug-ins for User Provisioning"](#).

**12.1.1.2.8 Application Propagation Configuration** Event propagation configuration parameters vary from one profile version to another. [Table 12–5, "Event propagation parameters"](#) lists and describes configuration parameters for event propagation.

**Table 12–5 Event propagation parameters**

Parameter	Supported Provisioning Profile Version	Description
profile_mode	2.0,,3.0	Whether the application is to receive outbound provisioning events from Oracle Internet Directory, to send inbound events, or both. Values are OUTBOUND (default), INBOUND, and BOTH.
Schedule	1.1, 2.0, 3.0	The scheduling interval after which pending events are propagated
enable_bootstrap	3.0	Enables events for application bootstrapping. This specifies that the application should be notified of users that existed in Oracle Internet Directory before the application created its provisioning profile.
enable_upgrade	3.0	Enables events for application user upgrade. This specifies that the application should be notified of users that existed in Oracle Internet Directory before the upgrade. If the application was present before the upgrade, users might already exist in the application. For such users, Oracle Directory Integration and Provisioning sends an Upgrade Event to the application so that the user is handled differently from a normal new user.
lastchangenumber	3.0	The change number in Oracle Internet Directory from which the events need to be sent to the application.
max_prov_failure_limit	3.0	The maximum number of retries that the Oracle Directory Integration and Provisioning server attempts when provisioning a user for that application.
max_events_per_invocation	2.0, 3.0	For bulk event propagation, this specifies the maximum number of events that can be packaged and sent during one invocation of the event interface.
max_events_per_schedule	2.0	Maximum number of events that Oracle Directory Integration and Provisioning sends to an application in one execution of the profile. The default is 25. In deployments with many profiles and applications, this enables Oracle Directory Integration and Provisioning, which is multithreaded, to execute threads for multiple profiles.
event_subscription	1.1, 2.0, 3.0	<p>Defines the types of OUTBOUND events an application is to receive from the event propagation service. The format is:</p> <pre>Object_Type:Domain:Operation(Attributes,...)</pre> <p>For example:</p> <pre>USER:cn=users,dc=example,dc=com:ADD(*)</pre> <p>specifies that USER_ADD event should be sent if the user that was created is under the specified domain and that all attributes should also be sent.</p> <pre>USER:cn=users,dc=example,dc=com:MODIFY(cn,sn.mail,telephonenumber)</pre> <p>specifies that USER_MODIFY event should be sent if the user that was modified is under the specified domain and any of the listed attributes were modified</p> <pre>USER:cn=users,dc=example,dc=com:DELETE</pre> <p>specifies that USER_DELETE event should be sent if a user under the specified domain was deleted</p>

**Table 12-5 (Cont.) Event propagation parameters**

Parameter	Supported Provisioning Profile Version	Description
event_permitted_operations	2.0	<p>Defines the types of INBOUND events an application is privileged to send to the Oracle Directory Integration and Provisioning server. The format is:</p> <pre>Object_Type:Domain:Operation(Attributes,...)</pre> <p>For example:</p> <pre>IDENTITY:cn=users,dc=example,dc=com:ADD(*)</pre> <p>specifies that IDENTITY_ADD event is allowed for the specified domain and all attributes are also allowed. This means that the application is allowed to create users in Oracle Internet Directory.</p> <pre>IDENTITY:cn=users,dc=example,dc=com:MODIFY(cn,sn.mail,telephonenumber)</pre> <p>Specifies that IDENTITY_MODIFY is allowed for only the attributes in the list. Other attributes are silently ignored. This means that the application is allowed to modify the listed attributes of the users in Oracle Internet Directory.</p> <pre>IDENTITY:cn=users,dc=example,dc=com:DELETE</pre> <p>Specifies that the application is allowed to delete users in Oracle Internet Directory</p>
event_mapping_rules	2.0	<p>For INBOUND profiles, this specifies the type of object received from an application and a qualifying filter condition to determine the domain of interest for this event. Multiple rules are allowed. The format is:</p> <pre>Object_Type: Filter_condition: Domain_Of_Interest</pre> <p>For example:</p> <pre>EMP::cn=users,dc=example,dc=com</pre> <p>specifies that if the object type received is EMP, the event is meant for the domain "cn=users,dc=example,dc=com".</p> <pre>EMP:l=AMERICA:l=AMER,cn=users,dc=example,dc=com</pre> <p>specifies that if the object type received is EMP, and the event has the attribute l (locality) and its value is AMERICA, the event is meant for the domain "l=AMER,cn=users,dc=example,dc=com".</p>

**12.1.1.2.9 Application Event Propagation Run Time Status** The Oracle Provisioning Service records a user's provisioning status in Oracle Internet Directory for each provisioning-integrated application. This is described in the Deploying and Configuring Provisioning chapter of *Oracle Fusion Middleware Administrator's Guide for Oracle Directory Integration Platform*.

## 12.1.2 Application Configuration Classes

The `oracle.idm.user.provisioning.configuration.Configuration` class enables you to obtain provisioning schema information. The `oracle.idm.user.provisioning.configuration.Application` class enables you to obtain metadata for registered applications. These classes are documented under the package `oracle.idm.provisioning.configuration`.

The `Configuration` class provides access to application configurations. To construct a `Configuration` object, you must specify the realm. For example:

```
Configuration cfg = new Configuration ("us");
```

Then you use `Configuration` class methods to get one or all application configurations in a realm. You must supply the LDAP context of the realm.

The `Configuration` object is a fairly heavy weight object, as its creation requires access to the Oracle Internet Directory metadata. Best practice is to create a `Configuration` object once during initialization of an application, then to reuse it for all operations that require it.

The `Application` object represents an application instance. Its methods provide metadata about a registered application in the infrastructure.

## 12.2 User Management

When Oracle Directory Integration and Provisioning or Oracle Delegated Administration Services invokes a provisioning plug-in, it passes information about the user being provisioned. A deployed application can use the user object to modify the user.

The user management provisioning classes provide the following operations:

- Create, modify, and delete a base user
- Create, modify, and delete application-specific user information
- Search base users
- Retrieve user provisioning status for applications

This section includes the following topics:

- [Section 12.2.1, "Creating a User"](#)
- [Section 12.2.2, "Modifying a User"](#)
- [Section 12.2.3, "Deleting a User"](#)
- [Section 12.2.4, "Looking Up a User"](#)

### 12.2.1 Creating a User

Creating a user in the Oracle Identity Management repository consists of two steps:

1. Creating basic user information in the specified realm. This information is referred to as the base user.
2. Creating the application-specific user attributes, or footprint. This information is referred to as the application user.

The combination of the base user and application user in the repository is referred to as the Oracle Identity Management user. Some methods create only the base user and other create both components of the Oracle Identity Management user.

The minimum information required to create a user is a set of attributes representing the base user. The attributes are in the form of name-value pairs. These user attributes are represented as Java objects using the class `oracle.ldap.util.ModPropertySet`.

Some user creation methods require you to specify the DN of the entry that you want to create in the Oracle Identity Management user repository. Other methods do not



require the DN. Instead, they construct the Oracle Identity Management user using the metadata configuration information from the Realm in which the user is created.

If the creation of the base user and application user succeeds, then the creation method returns an `IdmUser` object. You use this object to manage the attributes of the base user and application user.

## 12.2.2 Modifying a User

Modifying a base user in the Oracle Identity Management repository results in

- Modifying the base user information
- Creating or modifying application user information

You must supply the following information in order to modify an Oracle Identity Management user:

1. The user's DN, GUID, or `IdmUser` object reference
2. The desired changes to the base user attributes, represented as an `oracle.ldap.util.ModPropertySet`

Some user modification methods modify only the base user attributes. Others modify the application user attributes as well.

## 12.2.3 Deleting a User

Deleting a base user in the Oracle Identity Management repository produces the following results:

- Deleting the base user information
- Deleting the application user information

To modify an Oracle Identity Management user, you must supply the DN, GUID, or `IdmUser` object reference.

As result of this operation, the base user and the application user attributes are deleted.

## 12.2.4 Looking Up a User

The lookup methods provide two lookup options:

- Look up a specific Oracle Identity Management user using GUID or DN
- Look up a set of Oracle Identity Management users using a search filter

In order to look up Oracle Identity Management users, you must provide the DN or GUID.

The output of a lookup method is one of the following:

- A single `IdmUser` object
- A list of `IdmUser` objects

## 12.3 Debugging

Set `UtilDebug.MODE_PROVISIONING_API` mode to enable debugging and trace information. If you do not specify an output stream for the log messages, they are written to standard output.

The following snippet shows how to set `UtilDebug.MODE_PROVISIONING_API` mode and specify an output stream:

```
import oracle.ldap.util.UtilDebug;
FileOutputStream logStream = new FileOutputStream("ProvAPI.log")
...
UtilDebug.setDebugMode(UtilDebug.MODE_PROVISIONING_API);
UtilDebug.setPrintStream(logStream);
```

## 12.4 Sample Code

The following code example shows how to create, modify, and look up a user and how to get user provisioning status for an application.

```
UtilDebug.setDebugMode(UtilDebug.MODE_PROVISIONING_API);
...
Configuration cfg = new Configuration(realm);
try {
    debug("Connecting...");
    InitialLdapContext ctx =
        ConnectionUtil.getDefaultDirCtx(hostName, port, bindDn, passwd);
    debug("Connected...");
    UserFactory factory = UserFactoryBuilder.createUserFactory(ctx, cfg);

    // Create
    ModPropertySet mpSet = new ModPropertySet();
    mpSet.addProperty("cn", "Heman");
    mpSet.addProperty("sn", "The Master");
    mpSet.addProperty("uid", "Heman");
    IdmUser idmUser = factory.createUser(mpSet);

    // Modify
    mpSet = new ModPropertySet();
    mpSet.addProperty(LDIF.ATTRIBUTE_CHANGE_TYPE_REPLACE, "sn",
        "Heman The Master");
    mpSet.addProperty("givenName", "Master of the Universe");
    factory.modifyUser(idmUser, mpSet);

    // Lookup      List users = factory.searchUsers(Util.IDTYPE_SIMPLE, "Hema*",
null);
    ...

    // Get user provisioning status for an application.
    Application app = cfg.getApplication(lCtx, "Files", "FilesInstance");
    String status = idmUser.getProvisioningStatus(app);

    // Another way to get user provisioning status
    String userDn = idmUser.getDn();
    String status = ProvUtil.getUserProvisioningStatus(dirctx,
        Util.IDTYPE_DN, userDn, app.getType(), app.getName());
} catch (Exception ex) {
    ex.printStackTrace();
    //
}
```

---

# Oracle Directory Integration Platform PL/SQL API Reference

This chapter describes the registration API for the Oracle Directory Provisioning Integration Service.

This chapter includes the following sections:

- Section 13.1, "Versioning of Provisioning Files and Interfaces"
- Section 13.2, "Extensible Event Definition Configuration"
- Section 13.3, "Inbound and Outbound Events"
- Section 13.4, "PL/SQL Bidirectional Interface (Version 3.0)"
- Section 13.5, "PL/SQL Bidirectional Interface (Version 2.0)"
- Section 13.6, "Provisioning Event Interface (Version 1.1)"

## 13.1 Versioning of Provisioning Files and Interfaces

In release 9.0.2, the default interface version was version 1.1. In releases 9.0.4 and 10.1.2.0.0, the interface version defaults to version 2.0. Release 10.1.2.0.1 adds yet a third version. The administrator can use any one of these.

## 13.2 Extensible Event Definition Configuration

This feature is only for outbound events. It addresses the ability to define a new event at run time so that the provisioning integration service can interpret a change in Oracle Internet Directory and determine whether an appropriate event is to be generated and propagated to an application. The following events are the only configured events at installation time.

An event definition (entry) consists of the following attributes.

- Event object type (`orclODIPProvEventType`): This specifies the type of object the event is associated with. For example, the object could be a `USER`, `GROUP`, or `IDENTITY`.
- LDAP change type (`orclODIPProvEventChangeType`): This indicates that all kinds of LDAP operations can generate an event for this type of object. (e.g `ADD`, `MODIFY`, `DELETE`)
- Event criteria (`orclODIPProvEventCriteria`): The additional selection criteria that qualify an LDAP entry to be of a specific object type. For example, `Objectclass=orclUserV2` means that any LDAP entry that satisfies this criteria

can be qualified as this Object Type and any change to this entry can generate appropriate events.

The object class that holds these attributes is `orclODIPProvEventTypeConfig`. The container `cn=ProvisioningEventTypeConfig,cn=odi,cn=oracle internet directory` is used to store all the event type configurations.

Table 13–1 lists the event definitions predefined as a part of the installation.

**Table 13–1 Predefined Event Definitions**

Event Object Type	LDAP Change Type	Event Criteria
ENTRY	ADD MODIFY DELETE	objectclass=*
USER	ADD MODIFY DELETE	objectclass=interorgperson objectclass=orcluserv2
IDENTITY	ADD MODIFY DELETE	objectclass=interorgperson objectclass=orcluserv2
GROUP	ADD MODIFY DELETE	objectclass=orclgroup objectclass=groupofuniquenames
SUBSCRIPTION	ADD MODIFY DELETE	objectclass=orclservicereceptient
SUBSCRIBER	ADD MODIFY DELETE	objectclass=orclsubscriber

The container `cn=ProvisioningEventTypeConfig,cn=odi,cn=oracle internet directory` is used to store all the event definition configurations. LDAP configuration of the predefined event definitions is as follows:

```
dn: orclODIPProvEventObjectType=ENTRY,cn=ProvisioningEventTypeConfig,cn=odi,
cn=oracle internet directory
orclODIPProvEventObjectType: ENTRY
orclODIPProvEventLDAPChangeType: Add
orclODIPProvEventLDAPChangeType: Modify
orclODIPProvEventLDAPChangeType: Delete
orclODIPProvEventCriteria: objectclass=*
objectclass: orclODIPProvEventTypeConfig
```

```
dn:
orclODIPProvEventObjectType=USER,cn=ProvisioningEventTypeConfig,cn=odi,cn=oracle
internet directory
orclODIPProvEventObjectType: USER
orclODIPProvEventLDAPChangeType: Add
orclODIPProvEventLDAPChangeType: Modify
orclODIPProvEventLDAPChangeType: Delete
orclODIPProvEventCriteria: objectclass=InetOrgPerson
orclODIPProvEventCriteria: objectclass=orcluserv2
objectclass: orclODIPProvEventTypeConfig
```

```
dn: orclODIPProvEventObjectType=IDENTITY,cn=ProvisioningEventTypeConfig,cn=odi,
cn=oracle internet directory
```

```

orclODIPProvEventObjectType: IDENTITY
orclODIPProvEventLDAPChangeType: Add
orclODIPProvEventLDAPChangeType: Modify
orclODIPProvEventLDAPChangeType: Delete
orclODIPProvEventCriteria: objectclass=inetorgperson
orclODIPProvEventCriteria: objectclass=orcluser2
objectclass: orclODIPProvEventTypeConfig

```

```

dn: orclODIPProvEventObjectType=GROUP,cn=ProvisioningEventTypeConfig,cn=odi,
cn=oracle internet directory
orclODIPProvEventObjectType: GROUP
orclODIPProvEventLDAPChangeType: Add
orclODIPProvEventLDAPChangeType: Modify
orclODIPProvEventLDAPChangeType: Delete
orclODIPProvEventCriteria: objectclass=orclgroup
orclODIPProvEventCriteria: objectclass=groupofuniquenames
objectclass: orclODIPProvEventTypeConfig

```

```

dn:
orclODIPProvEventObjectType=SUBSCRIPTION,cn=ProvisioningEventTypeConfig,cn=odi,
cn=oracle internet directory
orclODIPProvEventObjectType: SUBSCRIPTION
orclODIPProvEventLDAPChangeType: Add
orclODIPProvEventLDAPChangeType: Modify
orclODIPProvEventLDAPChangeType: Delete
orclODIPProvEventCriteria: objectclass=orclservicerecipient
objectclass: orclODIPProvEventTypeConfig

```

```

dn: orclODIPProvEventObjectType=SUBSCRIBER,cn=ProvisioningEventTypeConfig,cn=odi,
cn=oracle internet directory
orclODIPProvEventObjectType: SUBSCRIBER
orclODIPProvEventLDAPChangeType: Add
orclODIPProvEventLDAPChangeType: Modify
orclODIPProvEventLDAPChangeType: Delete
orclODIPProvEventCriteria: objectclass=orclsubscriber
objectclass: orclODIPProvEventTypeConfig

```

To define a new event of Object type XYZ (which is qualified with the object class objXYZ), create the following entry in Oracle Internet Directory. The DIP server recognizes this new event definition and propagates events if necessary to applications that subscribe to this event.

```

dn: orclODIPProvEventObjectType=XYZ,cn=ProvisioningEventTypeConfig,cn=odi,
cn=oracle internet directory
orclODIPProvEventObjectType: XYZ
orclODIPProvEventLDAPChangeType: Add
orclODIPProvEventLDAPChangeType: Modify
orclODIPProvEventLDAPChangeType: Delete
orclODIPProvEventCriteria: objectclass=objXYZ
objectclass: orclODIPProvEventTypeConfig

```

This means that if an LDAP entry with the object class objXYZ is added, modified, or deleted, DIP propagates the XYZ\_ADD, XYZ\_MODIFY, or XYZ\_DELETE event to any application concerned.

## 13.3 Inbound and Outbound Events

An application can register as a supplier as and as a consumer of events. The provisioning subscription profile has the attributes described in Table 13–2 on page 13-4.

**Table 13–2 Attributes of the Provisioning Subscription Profile**

Attribute	Description
EventSubscriptions	<p>Outbound events only (multivalued).</p> <p>Events for which DIP should send notification to this application. The format of this string is  <code>[USER]GROUP]:[domain_of_interest]:[DELETE ADD MODIFY(list_of_attributes_separated_by_comma)]</code></p> <p>Multiple values may be specified by listing the string multiple times, each time with different values. If parameters are not specified, the following defaults are assumed: <code>USER:organization_DN:DELETEGROUP:organization_DN:DELETE</code>—that is, send user and group delete notifications under the organization DN.</p>
MappingRules	<p>Inbound events Only (multivalued).</p> <p>This attribute is used to map the type of object received from an application and a qualifying filter condition to determine the domain of interest for this event. The mapping takes this form:</p> <p><code>OBJECT_TYPE: Filter_condition: domain_of_interest</code></p> <p>Multiple rules are allowed. In the mapping <code>EMP:cn=users,dc=example,dc=com</code>, the object type received is EMP. The event is meant for the domain <code>cn=users,dc=example,dc=com</code>. In the mapping <code>EMP:l=AMERICA:l=AMER,cn=users,dc=example,dc=com</code>, the object type received is EMP. The event is meant for the domain <code>l=AMER,cn=users,dc=example,dc=com</code>.</p>
permittedOperations	<p>Inbound events only (multi valued).</p> <p>This attribute is used to define the types of events an application is privileged to send to the provisioning integration service. The mapping takes this form:</p> <p><code>Event_Object: affected_domain:operation(attributes, . . .)</code></p> <p>In the mapping <code>IDENTITY:cn=users,dc=example,dc=com:ADD(*)</code> the <code>IDENTITY_ADD</code> event is allowed for the specified domain and all attributes are also allowed. In the mapping <code>IDENTITY:cn=users,dc=example,dc=com:MODIFY(cn,sn.mail,telephonenumber)</code>, the <code>IDENTITY_MODIFY</code> event is allowed only for the attributes in the list. Any extra attributes are silently ignored.</p>

## 13.4 PL/SQL Bidirectional Interface (Version 3.0)

Before attempting to use Version 3.0 of the PL/SQL interface, please refer to:

- [Appendix A, "Java Plug-ins for User Provisioning"](#)
- The chapter "Understanding Oracle Directory Integration Platform for Provisioning" in *Oracle Fusion Middleware Administrator's Guide for Oracle Directory Integration Platform*
- The chapter "Deploying Provisioning-Integrated Applications" in *Oracle Fusion Middleware Administrator's Guide for Oracle Directory Integration Platform*

The PL/SQL callback interface requires you to develop a PL/SQL package that Oracle Directory Provisioning Integration Service invokes in the application specific database. Choose any name for the package, but be sure to use the same name when you register the package at subscription time. Implement the package by using the following PL/SQL package specification:

```

DROP TYPE LDAP_EVENT_LIST_V3;
DROP TYPE LDAP_EVENT_V3;
DROP TYPE LDAP_EVENT_STATUS_LIST_V3;
DROP TYPE LDAP_ATTR_LIST_V3;
DROP TYPE LDAP_ATTR_V3;
DROP TYPE LDAP_ATTR_VALUE_LIST_V3;
DROP TYPE LDAP_ATTR_VALUE_V3;
-----
-----
-- Name: LDAP_ATTR_VALUE_V3
-- Data Type: OBJECT
-- DESCRIPTION: This structure contains values of an attribute. A list of one or
more of this object is passed in any event.
-----
-----

CREATE TYPE LDAP_ATTR_VALUES_V3 AS OBJECT (
    attr_value      VARCHAR2(4000),
    attr_bvalue     RAW(2048),
    attr_value_len  INTEGER
);

GRANT EXECUTE ON LDAP_ATTR_VALUE_V3 to public;

CREATE TYPE LDAP_ATTR_VALUE_LIST_V3 AS TABLE OF LDAP_ATTR_VALUE_V3;
/
GRANT EXECUTE ON LDAP_ATTR_VALUE_LIST_V3 to public;
-----
-----
-- Name: LDAP_ATTR_V3
-- Data Type: OBJECT
-- DESCRIPTION: This structure contains details regarding an attribute. A list of
one or more of this object is passed in any event.
-----
-----

CREATE TYPE LDAP_ATTR_V3 AS OBJECT (
    attr_name      VARCHAR2(256),
    attr_type      INTEGER ,
    attr_mod_op    INTEGER,
    attr_values    LDAP_ATTR_VALUE_LIST_V3
);

GRANT EXECUTE ON LDAP_ATTR_V3 to public;

CREATE TYPE LDAP_ATTR_LIST_V3 AS TABLE OF LDAP_ATTR_V3;
/
GRANT EXECUTE ON LDAP_ATTR_LIST_V3 to public;
-----
-----
-- Name: LDAP_EVENT_V3
-- Data Type: OBJECT
-- DESCRIPTION: This structure contains event information plus the attribute List.
-----
-----

CREATE TYPE LDAP_EVENT_V3 AS OBJECT (
    event_type     VARCHAR2(32),
    event_id       VARCHAR2(32),
    event_src      VARCHAR2(1024),
    event_time     VARCHAR2(32),

```

```

        object_name VARCHAR2(1024),
        object_type VARCHAR2(32),
        object_guid VARCHAR2(32),
        object_dn   VARCHAR2(1024),
        profile_id  VARCHAR2(1024),
        attr_list   LDAP_ATTR_LIST_V3 ) ;
/

GRANT EXECUTE ON LDAP_EVENT_V3 to public;
CREATE TYPE LDAP_EVENT_LIST_V3 AS TABLE OF LDAP_EVENT_V3;
/
GRANT EXECUTE ON LDAP_EVENT_LIST_V3 to public;
-----
-----
-- Name: LDAP_EVENT_STATUS_V3
-- Data Type: OBJECT
-- DESCRIPTION: This structure contains information that is sent by the consumer
of an event to the supplier in response to the actual event.
-----
-----

CREATE TYPE LDAP_EVENT_STATUS_V3 AS OBJECT (
        event_id      VARCHAR2(32),
        status        VARCHAR2(32),
        status_msg    VARCHAR2(2048),
        object_guid   VARCHAR(32)
) ;
/

GRANT EXECUTE ON LDAP_EVENT_STATUS_V3 to public;
CREATE TYPE LDAP_EVENT_STATUS_LIST_V3 AS TABLE OF LDAP_EVENT_STATUS_V3;
/
GRANT EXECUTE ON LDAP_EVENT_STATUS_LIST_V3 to public;
-----
-----
-- Name: LDAP_NTIFY
-- DESCRIPTION: This is the interface to be implemented by provisioning integrated
applications to send information to and receive information from the directory.
The name of the package can be customized as needed. The function and procedure
names within this package should not be changed.
-----
-----

CREATE OR REPLACE PACKAGE LDAP_NTIFY AS

    -- The Predefined Event Types

    ENTRY_ADD      CONSTANT VARCHAR2 (32) := 'ENTRY_ADD';
    ENTRY_DELETE   CONSTANT VARCHAR2 (32) := 'ENTRY_DELETE';
    ENTRY_MODIFY   CONSTANT VARCHAR2 (32) := 'ENTRY_MODIFY';

    USER_ADD       CONSTANT VARCHAR2 (32) := 'USER_ADD';
    USER_DELETE    CONSTANT VARCHAR2 (32) := 'USER_DELETE';
    USER_MODIFY    CONSTANT VARCHAR2 (32) := 'USER_MODIFY';

    IDENTITY_ADD   CONSTANT VARCHAR2 (32) := 'IDENTITY_ADD';
    IDENTITY_DELETE CONSTANT VARCHAR2 (32) := 'IDENTITY_DELETE';
    IDENTITY_MODIFY CONSTANT VARCHAR2 (32) := 'IDENTITY_MODIFY';

```



```

GROUP_ADD      CONSTANT VARCHAR2 (32) := 'GROUP_ADD';
GROUP_DELETE   CONSTANT VARCHAR2 (32) := 'GROUP_DELETE';
GROUP_MODIFY   CONSTANT VARCHAR2 (32) := 'GROUP_MODIFY';

SUBSCRIPTION_ADD      CONSTANT VARCHAR2 (32) := 'SUBSCRIPTION_ADD';
SUBSCRIPTION_DELETE   CONSTANT VARCHAR2 (32) := 'SUBSCRIPTION_DELETE';
SUBSCRIPTION_MODI     CONSTANT VARCHAR2 (32) := 'SUBSCRIPTION_MODIFY';

SUBSCRIBER_ADD      CONSTANT VARCHAR2 (32) := 'SUBSCRIBER_ADD';
SUBSCRIBER_DELETE   CONSTANT VARCHAR2 (32) := 'SUBSCRIBER_DELETE';
SUBSCRIBER_MODIFY   CONSTANT VARCHAR2 (32) := 'SUBSCRIBER_MODIFY';

-- The Attribute Type

ATTR_TYPE_STRING      CONSTANT NUMBER := 0;
ATTR_TYPE_BINARY      CONSTANT NUMBER := 1;
ATTR_TYPE_ENCRYPTED_STRING  CONSTANT NUMBER := 2;

-- The Attribute Modification Type

MOD_ADD      CONSTANT NUMBER := 0;
MOD_DELETE   CONSTANT NUMBER := 1;
MOD_REPLACE  CONSTANT NUMBER := 2;

-- The Event dispositions constants

EVENT_SUCCESS      CONSTANT VARCHAR2 (32) := 'EVENT_SUCCESS';
EVENT_IN_PROGRESS  CONSTANT VARCHAR2 (32) := 'EVENT_IN_PROGRESS';
EVENT_USER_NOT_REQUIRED  CONSTANT VARCHAR2 (32) := 'EVENT_USER_NOT_REQUIRED';
EVENT_ERROR        CONSTANT VARCHAR2 (32) := 'EVENT_ERROR';
EVENT_ERROR_ALERT  CONSTANT VARCHAR2 (32) := 'EVENT_ERROR_ALERT';
EVENT_ERROR_ABORT  CONSTANT VARCHAR2 (32) := 'EVENT_ERROR_ABORT';

-- The Actual Callbacks

FUNCTION GetAppEvents (events OUT LDAP_EVENT_LIST_V3)
RETURN NUMBER;

-- Return CONSTANTS
EVENT_FOUND      CONSTANT NUMBER:= 0;
EVENT_NOT_FOUND  CONSTANT NUMBER:= 1403;

```

If the provisioning server is unable to process an inbound event, it triggers an `EVENT_ERROR_ALERT` status, which generates a trigger in Oracle Enterprise Manager.

If the provisioning server is able to process the event, but finds that the event cannot be processed—for example, the user to be modified, subscribed, or deleted does not exist—it responds with `EVENT_ERROR` to indicate to the application that something is wrong. It is again up to the application to handle the status event.

`EVENT_ERROR` means no errors in directory operations. The event cannot be processed for other reasons.

-- `PutAppEventStatus()` : DIP Server invokes this callback in the remote Data base after processing an event it had received using the `GetAppEvents()` callback. For every event received, the DIP server sends the status event back after processing the event. This API will NOT be required by the Oracle Collaboration Suite release 3.0 components.

```
PROCEDURE PutAppEventStatus (event_status IN LDAP_EVENT_STATUS_LIST_V3);
```

```
-- PutOIDEvents() : DIP Server invokes this API in the remote Database. DIP
server sends event to applications using this callback. It also expects a status
event object in response as an OUT parameter. This API needs to be implemented
by all the Oracle Collaboration Suite release 3.0 components.
```

```
PROCEDURE PutOIDEvents (event          IN LDAP_EVENT_LIST_V3,
                        event_status OUT LDAP_EVENT_STATUS_LIST_V3);
```

```
END LDAP_NTIFY;
/
```

## 13.5 PL/SQL Bidirectional Interface (Version 2.0)

The PL/SQL callback interface requires that you develop a PL/SQL package that the provisioning integration service invokes in the application-specific database. Choose any name for the package, but be sure to use the same name when you register the package at subscription time. Implement the package using the following PL/SQL package specification:

```
DROP TYPE LDAP_EVENT;
DROP TYPE LDAP_EVENT_STATUS;
DROP TYPE LDAP_ATTR_LIST;
DROP TYPE LDAP_ATTR;
-----
-- Name: LDAP_ATTR
-- Data Type: OBJECT

DESCRIPTION: This structure contains details regarding an attribute. A list of one
--           or more of this object is passed in any event.
-----
-----
CREATE TYPE LDAP_ATTR AS OBJECT (
    attr_name      VARCHAR2(256),
    attr_value     VARCHAR2(4000),
    attr_bvalue    RAW(2048),
    attr_value_len INTEGER,
    attr_type      INTEGER ,
    attr_mod_op    INTEGER
);

GRANT EXECUTE ON LDAP_ATTR to public;

CREATE TYPE LDAP_ATTR_LIST AS TABLE OF LDAP_ATTR;
/
GRANT EXECUTE ON LDAP_ATTR_LIST to public;

-----
-- Name: LDAP_EVENT
-- Data Type: OBJECT
-- DESCRIPTION: This structure contains event information plus the attribute
--             list.
-----
-----
CREATE TYPE LDAP_EVENT AS OBJECT (
    event_type VARCHAR2(32),
    event_id   VARCHAR2(32),
    event_src  VARCHAR2(1024),
```

```

        event_time VARCHAR2(32),
        object_name VARCHAR2(1024),
        object_type VARCHAR2(32),
        object_guid VARCHAR2(32),
        object_dn VARCHAR2(1024),
        profile_id VARCHAR2(1024),
        attr_list LDAP_ATTR_LIST );
/

GRANT EXECUTE ON LDAP_EVENT to public;

-----
-----
-- Name: LDAP_EVENT_STATUS
-- Data Type: OBJECT
-- DESCRIPTION: This structure contains information that is sent by the
--               consumer of an event to the supplier in response to the
--               actual event.
-----
-----

CREATE TYPE LDAP_EVENT_STATUS AS OBJECT (
        event_id          VARCHAR2(32),
        orclguid          VARCHAR(32),
        error_code         INTEGER,
        error_String       VARCHAR2(1024),
        error_disposition VARCHAR2(32));
/

GRANT EXECUTE ON LDAP_EVENT_STATUS to public;

```

## 13.6 Provisioning Event Interface (Version 1.1)

You must develop logic to consume events generated by the provisioning integration service. The interface between the application and the provisioning integration service can be table-based, or it can use PL/SQL callbacks.

The PL/SQL callback interface requires that you develop a PL/SQL package that the provisioning integration service invokes in the application-specific database. Choose any name for the package, but be sure to use the same name when you register the package at subscription time. Implement the package using the following PL/SQL package specification:

```

Rem
Rem      NAME
Rem      ldap_ntfy.pks - Provisioning Notification Package Specification.
Rem

DROP TYPE LDAP_ATTR_LIST;
DROP TYPE LDAP_ATTR;

-- LDAP ATTR
-----
--
-- Name      : LDAP_ATTR
-- Data Type : OBJECT
-- DESCRIPTION : This structure contains details regarding
--               an attribute.
--

```

```

-----
CREATE TYPE LDAP_ATTR AS OBJECT (
    attr_name      VARCHAR2(255),
    attr_value     VARCHAR2(2048),
    attr_bvalue    RAW(2048),
    attr_value_len INTEGER,
    attr_type      INTEGER -- (0 - String, 1 - Binary)
    attr_mod_op    INTEGER
);
/
GRANT EXECUTE ON LDAP_ATTR to public;

-----
--
-- Name          : LDAP_ATTR_LIST
-- Data Type     : COLLECTION
-- DESCRIPTION   : This structure contains collection
--                of attributes.
--
-----
CREATE TYPE LDAP_ATTR_LIST AS TABLE OF LDAP_ATTR;
/
GRANT EXECUTE ON LDAP_ATTR_LIST to public;

-----
--
-- NAME          : LDAP_NTIFY
-- DESCRIPTION   : This is a notifier interface implemented by Provisioning System
--                clients to receive information about changes in Oracle Internet
--                Directory. The name of package can be customized as needed.
--                The function names within this package should not be changed.
--
-----
CREATE OR REPLACE PACKAGE LDAP_NTIFY AS

--
-- LDAP_NTIFY data type definitions
--

-- Event Types
USER_DELETE     CONSTANT VARCHAR2(256) := 'USER_DELETE';
USER_MODIFY     CONSTANT VARCHAR2(256) := 'USER_MODIFY';
GROUP_DELETE   CONSTANT VARCHAR2(256) := 'GROUP_DELETE';
GROUP_MODIFY   CONSTANT VARCHAR2(256) := 'GROUP_MODIFY';

-- Return Codes (Boolean)
SUCCESS        CONSTANT NUMBER := 1;
FAILURE       CONSTANT NUMBER := 0;

-- Values for attr_mod_op in LDAP_ATTR object.
MOD_ADD       CONSTANT NUMBER := 0;
MOD_DELETE   CONSTANT NUMBER := 1;
MOD_REPLACE  CONSTANT NUMBER := 2;

-----
-- Name: LDAP_NTIFY
-- DESCRIPTION: This is the interface to be implemented by Provisioning System
--                clients to send information to and receive information from

```

```
--          Oracle Internet Directory. The name of the package can be
--          customized as needed. The function names within this package
--          should not be changed.
```

```
-----
-----
CREATE OR REPLACE PACKAGE LDAP_NTIFY AS
```

### 13.6.1 Predefined Event Types

```
ENTRY_ADD          CONSTANT VARCHAR2 (32)  := 'ENTRY_ADD';
ENTRY_DELETE       CONSTANT VARCHAR2 (32)  := 'ENTRY_DELETE';
ENTRY_MODIFY       CONSTANT VARCHAR2 (32)  := 'ENTRY_MODIFY';

USER_ADD           CONSTANT VARCHAR2 (32)  := 'USER_ADD';
USER_DELETE        CONSTANT VARCHAR2 (32)  := 'USER_DELETE';
USER_MODIFY        CONSTANT VARCHAR2 (32)  := 'USER_MODIFY';

IDENTITY_ADD       CONSTANT VARCHAR2 (32)  := 'IDENTITY_ADD';
IDENTITY_DELETE    CONSTANT VARCHAR2 (32)  := 'IDENTITY_DELETE';
IDENTITY_MODIFY    CONSTANT VARCHAR2 (32)  := 'IDENTITY_MODIFY';

GROUP_ADD          CONSTANT VARCHAR2 (32)  := 'GROUP_ADD';
GROUP_DELETE       CONSTANT VARCHAR2 (32)  := 'GROUP_DELETE';
GROUP_MODIFY       CONSTANT VARCHAR2 (32)  := 'GROUP_MODIFY';

SUBSCRIPTION_ADD   CONSTANT VARCHAR2 (32)  := 'SUBSCRIPTION_ADD';
SUBSCRIPTION_DELETE CONSTANT VARCHAR2 (32)  := 'SUBSCRIPTION_DELETE';
SUBSCRIPTION_MODI  CONSTANT VARCHAR2 (32)  := 'SUBSCRIPTION_MODIFY';

SUBSCRIBER_ADD     CONSTANT VARCHAR2 (32)  := 'SUBSCRIBER_ADD';
SUBSCRIBER_DELETE  CONSTANT VARCHAR2 (32)  := 'SUBSCRIBER_DELETE';
SUBSCRIBER_MODIFY  CONSTANT VARCHAR2 (32)  := 'SUBSCRIBER_MODIFY';
```

### 13.6.2 Attribute Type

```
ATTR_TYPE_STRING   CONSTANT NUMBER      := 0;
ATTR_TYPE_BINARY   CONSTANT NUMBER      := 1;
ATTR_TYPE_ENCRYPTED_STRING CONSTANT NUMBER  := 2;
```

### 13.6.3 Attribute Modification Type

```
MOD_ADD            CONSTANT NUMBER      := 0;
MOD_DELETE         CONSTANT NUMBER      := 1;
MOD_REPLACE        CONSTANT NUMBER      := 2;
```

### 13.6.4 Event Dispositions Constants

```
EVENT_SUCCESS      CONSTANT VARCHAR2 (32) := 'EVENT_SUCCESS';
EVENT_ERROR         CONSTANT VARCHAR2 (32) := 'EVENT_ERROR';
EVENT_RESEND       CONSTANT VARCHAR2 (32) := 'EVENT_RESEND';
```

### 13.6.5 Callbacks

A callback is a function invoked by the provisioning integration service to send or receive notification events. While transferring events for an object, the related attributes can also be sent along with other details. The attributes are delivered as a

collection (array) of attribute containers, which are in unnormalized form: if an attribute has two values, two rows are sent in the collection.

### 13.6.5.1 GetAppEvent()

The Oracle Directory Integration and Provisioning server invokes this API in the remote database. It is up to the application to respond with an event. The Oracle Directory Integration and Provisioning processes the event and sends the status back using the `PutAppEventStatus()` callback. The return value of `GetAppEvent()` indicates whether an event is returned or not.

```
FUNCTION GetAppEvent (event OUT LDAP_EVENT)
RETURN NUMBER;

-- Return CONSTANTS
EVENT_FOUND          CONSTANT NUMBER := 0;
EVENT_NOT_FOUND      CONSTANT NUMBER := 1403;
```

If the provisioning server is not able to process the event—that is, it runs into some type of LDAP error—it responds with `EVENT_RESEND`. The application is expected to resend that event when `GetAppEvent()` is invoked again.

If the provisioning server is able to process the event, but finds that the event cannot be processed—for example, the user to be modified does not exist, or the user to be subscribed does not exist, or the user to be deleted does not exist—then it responds with `EVENT_ERROR` to indicate to the application that something was wrong. Resending the event is not required. It is up to the application to handle the event.

Note the difference between `EVENT_RESEND` and `EVENT_ERROR` in the previous discussion. `EVENT_RESEND` means that it was possible to apply the event but the server could not. If it gets the event again, it might succeed.

`EVENT_ERROR` means there is no error in performing directory operations, but the event could not be processed due to other reasons.

### 13.6.5.2 PutAppEventStatus()

The Oracle Directory Integration and Provisioning server invokes this callback in the remote database after processing an event it has received using the `GetAppEvent()` callback. For every event received, the Oracle Directory Integration and Provisioning server sends the status event back after processing the event.

```
PROCEDURE PutAppEventStatus (event_status IN LDAP_EVENT_STATUS);
```

### 13.6.5.3 PutOIDEvent()

The Oracle Directory Integration and Provisioning server invokes this API in the remote database. It sends event to applications using this callback. It also expects a status event object in response as an `OUT` parameter. If a valid event status object is not sent back, or it indicates a `RESEND`, the Oracle Directory Integration and Provisioning server resends the event. In case of `EVENT_ERROR`, the server does not resend the event.

```
PROCEDURE PutOIDEvent (event IN LDAP_EVENT, event_status OUT
LDAP_EVENT_STATUS);
END LDAP_NTFY;
/
```

# Part III

---

## Appendixes

Part III presents plug-ins that can be used to customize provisioning in Oracle Collaboration Suite. In addition, this section contains an appendix about DSML syntax and usage.

- [Appendix A, "Java Plug-ins for User Provisioning"](#)
- [Appendix B, "DSML Syntax"](#)
- [Appendix C, "Migrating from Netscape LDAP SDK API to Oracle LDAP SDK API"](#)





---

---

## Java Plug-ins for User Provisioning

This appendix describes how to use Java plug-ins to customize provisioning policy evaluation, data validation, data manipulation, and event delivery in typical deployments of Oracle Directory Integration and Provisioning Provisioning Service version 3.0.

The Oracle provisioning server cannot support all of the provisioning needs of a deployment. Hence, hooks are provided at various stages of user creation, modification, and deletion. These hooks enable an enterprise to incorporate its own business rules and to tailor information creation to its needs. The hooks take the form of Java plug-ins.

This appendix includes the following sections:

- Section A.1, "Provisioning Plug-in Types and Their Purpose"
- Section A.2, "Provisioning Plug-in Requirements"
- Section A.3, "Data Entry Provisioning Plug-in"
- Section A.4, "Data Access Provisioning Plug-in"
- Section A.5, "Event Delivery Provisioning Plug-in"
- Section A.6, "Provisioning Plug-in Return Status"
- Section A.7, "Configuration Template for Provisioning Plug-ins"
- Section A.8, "Sample Code for a Provisioning Plug-in"

### A.1 Provisioning Plug-in Types and Their Purpose

There are three types of provisioning plug-ins:

- Data entry plug-ins
- Data manipulation and data access plug-ins
- Event Delivery plug-ins

The data entry plug-ins can be used by applications that integrate with the provisioning framework using either synchronous or asynchronous provisioning. The data access plug-ins are used only by applications that are integrated with the provisioning framework for synchronous provisioning. The event delivery plug-ins are used only by applications that integrate with the provisioning framework using asynchronous provisioning.

Oracle Provisioning Console, Oracle Directory Integration and Provisioning server, and other mechanisms that affect the base user information in the directory invoke

these plug-ins when the information is created. By configuring a data entry plug-in, a deployment can do any of the following:

- Validate attribute values for application users
- Validate attribute values for base users
- Enhance attribute values for application users
- Enhance attribute values for base users
- Evaluate provisioning policies

If you want the deployed application to maintain application user information you must configure a data access plug-in for it. This type of plug-in enables you to maintain the application information either outside of the directory or within it as several entries.

Data entry and data access plug-ins are typically invoked from one of these environments:

- User provisioning console for Oracle Delegated Administration Services
- Oracle Directory Integration and Provisioning server
- Provisioning API
- Bulk Provisioning Tools

The event delivery plug-ins are required by applications that have the JAVA interface type and that subscribe for provisioning events. Applications that have synchronous provisioning should not implement event delivery plug-ins.

## A.2 Provisioning Plug-in Requirements

All of the plug-ins that you provide for an application must be in a JAR file that can be uploaded to the directory with the standard LDIF template. See the section [Section A.7, "Configuration Template for Provisioning Plug-ins"](#) for an example. The plug-in interface definitions are found in `$ORACLE_HOME/jlib/ldapjclnt10.jar`. Refer to *Oracle Fusion Middleware Java API Reference for Oracle Internet Directory* and the public interfaces for a more detailed description. If the application requires additional jar files, you can upload them too.

Place the files in the directory:

```
$MW_HOME/user_projects/domains/DOMAIN_NAME/servers/MANAGED_SERVER_NAME/tmp/  
/_WL_user/DIP_VERSION_NUMBER/RANDOM_CHARACTERS/APP-INF/lib/
```

## A.3 Data Entry Provisioning Plug-in

Data entry plug-ins take two forms:

- Pre-data-entry plug-ins
- Post-data-entry plug-ins

If you want to use either of these plug-ins, you must implement the `oracle.idm.provisioning.plugin.IdataEntryPlugin` interface. This interface has three methods. Here it is:

```
/**  
 * The applications can perform a post data entry operation by  
 * implementing this method.  
 */
```

```

    * @param appCtx the application context
    * @param idmUser the IdmUser object
    * @param baseUserAttr Base user properties
    * @param appUserAttr App user properties
    * @throws PluginException when an exception occurs.
    */
public PluginStatus process(ApplicationContext appCtx,
    IdmUser idmUser, ModPropertySet baseUserAttr,
    ModPropertySet appUserAttr) throws PluginException;
/**
 * Returns the Modified Base User properties
 *
 * @return ModPropertySet modified base user properties.
 */
public ModPropertySet getBaseAttrMods();

/**
 * Returns the Modified App User properties
 *
 * @return ModPropertySet modified app user properties.
 */
public ModPropertySet getAppAttrMods();

```

Typically the plug-in implementer uses these methods for data validation or policy evaluation. In the latter case, a base user attribute is used to make the decision.

The application context object contains this information:

- LDAP directory context
 

If you want the application to perform a directory operation, you can have it obtain the LDAP context from the application object. Note that this LDAP context should not be closed in the plug-in.
- Plug-in call mode
 

The plug-in is called from Oracle Provisioning Console, Oracle Directory Integration and Provisioning server, or another environment that invokes the provisioning API. If the calling environment is Oracle Directory Integration and Provisioning, the provisioning service calls the plug-in. The two possible values are `INTERACTIVE_MODE` and `AUTOMATIC_MODE`. The first indicates that the plug-in was invoked through interaction between Oracle Delegated Administration Services and a client application. The second indicates that the plug-in was invoked by Oracle Directory Integration and Provisioning, where user intervention does not occur.
- Client locale
 

The plug-in may want to know what the client locale is, especially if it is invoked from Oracle Delegated Administration Services.
- Plug-in call operation
 

You may decide to have data entry plug-ins for both create and modify user operations. You may even implement these plug-ins in the same class. Under these conditions, the plug-in must determine which operation is invoked. The application context object uses the values `OP_CREATE` and `OP_MODIFY` to identify the operation.
- Plug-in invocation point
 

The data entry plug-in is typically used to determine whether a user must be provisioned for an application. The policy evaluation and data validation that

occurs can be performed in either a pre-data-entry plug-in or a post-data-entry plug-in. You may choose either or both. If you choose both, you can implement them in the same class. The application context object specifies which one is actually invoked. It uses the values `PRE_DATA_ENTRY` and `POST_DATA_ENTRY` to do this.

- **Callback context**

If you decide to have both pre and post plug-ins for an operation and you want the pre plug-in to share information with the post plug-in, you can set the callback context in the application context object of the pre-data-entry plug-in. The post-data-entry plug-in can then obtain and use this callback context.

- **Logging**

You can use the log methods provided in the application context object to log information for the plug-in.

The calling sequence looks like this:

1. Download and instantiate a plug-in object based on the configuration information object in Oracle Internet Directory
2. Construct an application context object that is passed to the plug-in.
3. Call `process` method()
4. Call `getBaseAttrMods()` to obtain base user attributes that are modified in `process()`.
5. Merge the base user attributes returned by `getBaseAttrMods()` with the base user attributes, depending on the plug-in execution status. The execution status can be either `success` or `failure`. The plug-in implementer must return a valid plug-in execution status object. If null is returned, the execution status is considered a failure. Merging of the base user is only done if the plug-in execution status is successful.
6. Call `getAppAttrMods()` for the plug-in. This method obtains application user attributes that are modified in `process()`.
7. Merge the application user attributes returned by `getAppAttrMods()` with the application user attributes, depending on the user provisioning status returned by the plug-in.

### A.3.1 Pre-Data-Entry Provisioning Plug-in

The pre-data-entry plug-in generates values for application attributes. The attribute defaults specified during application registration are passed to this plug in along with the current base user attributes. The returned values are displayed in the UI if the invocation environment is interactive like Oracle Delegated Administration Services.

The pre-data-entry plug-in can decide whether the user should be provisioned for an application. The plug-in examines base user attributes to make the decision. It is invoked during create and modify operations. You can support both operations with one plug-in class, or you can assign one class to each.

If the application decides to have pre-data-entry plug-ins for create and modify operations, two configuration entries must be created in Oracle Internet Directory under the application container. The first entry is for the create operation:

```
dn: cn=PRE_DATA_ENTRY_CREATE, cn=Plugins, cn=FILES, cn=Applications,
cn=Provisioning, cn=Directory Integration Platform, cn=Products,
cn=OracleContext
```

```

changetype: add
objectClass: orclODIPPlugin
orclStatus: ENABLE
orclODIPPluginExecName: oracle.myapp.provisioning.UserCreatePlugin
orclODIPPluginAddInfo: Pre Data Entry Plugin for CREATE operation

```

The second entry is for the modify operation:

```

dn: cn=PRE_DATA_ENTRY_MODIFY, cn=Plugins, cn=FILES, cn=Applications,
   cn=Provisioning, cn=Directory Integration Platform, cn=Products,
   cn=OracleContext
changetype: add
objectClass: orclODIPPlugin
orclStatus: ENABLE
orclODIPPluginExecName: oracle.myapp.provisioning.UserModifyPlugin
orclODIPPluginAddInfo: Pre Data Entry Plugin for MODIFY operation

```

In this example, separate classes for create and modify plug-ins are shown.

### A.3.2 Post–Data-Entry Provisioning Plug-in

The post–data-entry plug-in validates data entered by the user in the UI. In addition, it generates derived attribute values. If the plug in fails for any one application, the UI does not proceed. All applications must successfully validate the data before a user entry can be created in the directory. However, in the case of non-UI environment or automatic route, the plug-in implementer can decide to raise an error or continue, based on the plug-in call mode (`INTERACTIVE_MODE` or `AUTOMATIC_MODE`).

Like the pre–data-entry plug-in, the post–data-entry plug-in is invoked during create and modify operations. The application can decide to implement one plug-in class for both operations or a separate class for each.

If you decide to have post–data-entry plug-ins for create and modify operations, create two configuration entries in Oracle Internet Directory under the application container. The first entry is for the create operation:

```

dn: cn=POST_DATA_ENTRY_CREATE, cn=Plugins, cn=FILES, cn=Applications,
   cn=Provisioning, cn=Directory Integration Platform, cn=Products,
   cn=OracleContext
changetype: add
objectClass: orclODIPPlugin
orclStatus: ENABLE
orclODIPPluginExecName: oracle.myapp.provisioning.UserMgmtPlugin
orclODIPPluginAddInfo: Post Data Entry Plugin for CREATE and MODIFY
operations

```

The second entry is for the modify operation:

```

dn: cn=POST_DATA_ENTRY_MODIFY, cn=Plugins, cn=FILES, cn=Applications,
   cn=Provisioning, cn=Directory Integration Platform, cn=Products,
   cn=OracleContext
changetype: add
objectClass: orclODIPPlugin
orclStatus: ENABLE
orclODIPPluginExecName: oracle.myapp.provisioning.UserMgmtPlugin
orclODIPPluginAddInfo: Post Data Entry Plugin for MODIFY and CREATE operation

```

In this example, too, separate classes for create and modify plug-ins are shown.

## A.4 Data Access Provisioning Plug-in

The primary purpose of the data access plug-in is to manage the application-specific information of the user in the directory. You can use this plug-in to create and retrieve the information.

The data access plug-in is invoked whenever a user is created and is requesting provisioning for an application—whether by Oracle Delegated Administration Services, by Oracle Directory Integration and Provisioning, or by bulk provisioning tools.

The data access plug-in is invoked during modify and delete operations as well. It can update the application information or remove it.

If you want to use the data access plug-in, implement the interface `oracle.idm.provisioning.plugin.IDataAccessPlugin`. Here is the interface:

```
/**
 * The applications can create/modify/delete the user footprint by
 * implementing this method.
 *
 * @param appCtx the application context
 * @param idmUser IdmUser object
 * @param baseUserAttr Base user properties
 * @param appUserAttr App user properties
 *
 * @return PluginStatus a plugin status object, which must contain
 * the either <code>IdmUser.PROVISION_SUCCESS</CODE> or
 * <code>IdmUser.PROVISION_FAILURE</CODE> provisioning status
 *
 * @throws PluginException when an exception occurs.
 */
public PluginStatus process(ApplicationContext appCtx,
    IdmUser idmUser, ModPropertySet baseUserAttr,
    ModPropertySet ppUserAttr) throws PluginException;

/**
 * The applications can return their user footprint by
 * implementing this method. Use <CODE>
 * oracle.ldap.util.VarPropertySet </CODE>
 * as the return object
 *
 * <PRE>
 * For Ex.
 * PropertySet retPropertySet = null;
 * retPropertySet = new VarPropertySet();
 *
 * //Fetch the App data and add it to retPropertySet
 * retPropertySet.addProperty("name", "value");
 * ..
 * return retPropertySet;
 * </PRE>
 *
 * @throws PluginException when an exception occurs.
 */
public PropertySet getAppUserData(ApplicationContext appCtx,
    IdmUser user, String reqAttrs[]) throws PluginException;
```

If you want to manage the user information for an application, create a plug-in configuration entry in the directory under the application container. The example that follows shows what this entry looks like:

```

dn: cn=DATA_ACCESS, cn=Plugins, cn=FILES, cn=Applications,
   cn=Provisioning, cn=Directory Integration Platform, cn=Products,
   cn=OracleContext
changetype: add
objectClass: orclODIPPlugin
orclStatus: ENABLE
orclODIPPluginExecName: oracle.myapp.provisioning.UserDataAccPlugin
orclODIPPluginAddInfo: Data Access Plugin

```

## A.5 Event Delivery Provisioning Plug-in

The primary purpose of the event delivery plug-in is to use the events notified by the Oracle Directory Integration and Provisioning server. Events are delivered to the plug-in by the Oracle Directory Integration and Provisioning server. Based on the event type and the action to be performed in the application repository, the plug-in performs the required operations. The interface definitions for this plug-in are as follows:

```

/* $Header: IEventPlugin.java 09-jun-2005.12:45:53 *
/* Copyright (c) 2004, 2005, Oracle. All rights reserved. */
/*
DESCRIPTION
  All of the plug-in interfaces must extend this common interface.
PRIVATE CLASSES
  None
NOTES
  None
*/
package oracle.idm.provisioning.plugin;
/**
 * This is the base interface
 */
public interface IEventPlugin
{
  /**
   * The applications can perform the initialization logic in this method.
   *
   * @param Object For now it is the provisioning Profile that is passed.
   *       look at oracle.ldap.odip.engine.ProvProfile for more details.
   *
   * @throws PluginException when an exception occurs.
   */
  public void initialize(Object profile) throws PluginException;
  /**
   * The applications can perform the termination logic in this method.
   *
   * @param void Provisioning Profile Object is sent.
   *       refer to oracle.ldap.odip.engine.ProvProfile for more details
   * @throws PluginException when an exception occurs.
   */
  public void terminate(Object profile) throws PluginException;
  /**
   * Set Additional Info.
   * Since we pass on the complete profile, there is no requirement to set
   * the additiona
   * @param addInfo Plugin additional info
   */
  //public void setAddInfo(Object addInfo);
}

```

```

/* $Header: IEventsFromOID.java 09-jun-2005.12:45:53 */
/* Copyright (c) 2004, 2005, Oracle. All rights reserved. */
/*
    DESCRIPTION
    Applications interested in receiving changes from OID should
implement this interface.
    PRIVATE CLASSES
    <None>
    NOTES
*/
package oracle.idm.provisioning.plugin;
import oracle.idm.provisioning.event.Event;
import oracle.idm.provisioning.event.EventStatus;

/**
 * Applications interested in receiving changes from OID should implement this
 * interface. The applications register with the OID for the changes occurring
 * at OID. The DIP engine would instantiate an object of this class and invoke
 * the initialize(), sendEventsToApp(), and truncate() method in the same
 * sequence. The initialize method would provide the appropriate information
 * from the profile in the form of a java.util.Hashtable object.
 * The property names, that is, the hash table key that could be used by the
 * interface implementer is defined as constants in this interface.
 *
 * @version $Header: IEventsFromOID.java 09-jun-2005.12:45:53 $
 */
public interface IEventsFromOID extends IEventPlugin
{
    /**
     * Initialize. The application would provide any initialization logic
     * through method. The DIP engine after instantiating a class that
     * implements this interface will first invoke this method.
     *
     * @param prop A HashMap that would contain necessary information exposed
     * to the applications
     * @throws EventInitializationException the applications must throw this
     * exception in case of error.
     */
    public void initialize(Object provProfile)
        throws EventPluginInitException;

    /**
     * OID Events are delivered to the application through this method.
     *
     * @param evts an array of LDATEvent objects returned by the DIP engine
     * @return the application logic must process these events and return the
     * status of the processed events
     * @throws EventDeliveryException the applications must throw this exception
     * in case of any error.
     */
    public EventStatus[] sendEventsToApp(Event [] evts)
        throws EventDeliveryException;
}

/* $Header: IEventsToOID.java 09-jun-2005.12:45:53 $ */
/* Copyright (c) 2004, 2005, Oracle. All rights reserved. */

/*

```



```

DESCRIPTION
Applications interested in sending changes to OID should implement this
interface.
*/
package oracle.idm.provisioning.plugin;
import oracle.idm.provisioning.event.Event;
import oracle.idm.provisioning.event.EventStatus;

/**
 * Applications interested in sending changes to OID should implement this
 * interface. The applications must register with the OID for the sending
 * changes at their end to DIP. The DIP engine would instantiate an object
 * of this class and invoke the initialize(), sendEventsFromApp(), and
 * truncate() method in the same sequence. The initialize method would
 * provide the appropriate information from the profile in the form of
 * a java.util.Hashtable object. The property names, that is, the hash table key
 * that could be used by the interface implementer is defined as
 * constants in this interface.
 *
 */
public interface IEventsToOID extends IEventPlugin
{
    /**
     * Initialize. The application would provide any initialization logic
     * through method. The DIP engine after instantiating a class that
     * implements this interface will first invoke this method.
     *
     * @param prop ProvProfile
     *          oracle.ldap.odip.engine.ProvProfile
     * @throws EventPluginInitException the applications must throw this
     * exception in case of error.
     */
    public void initialize(Object profile) throws EventPluginInitException;

    /**
     * Application Events are delivered to OID through this method.
     *
     * @return an array of Event objects returned to be processed by the
     * DIP engine.
     * @throws EventDeliveryException the applications must throw this exception
     * in case of any error.
     */
    public Event[] receiveEventsFromApp()
        throws EventDeliveryException;

    /**
     * Application can let the DIP engine know whether there are more event to
     * follow through this method
     *
     * @return true if there are more events to be returned and false otherwise
     * @throws PluginException the applications must throw this exception
     * in case of any error.
     */
    public boolean hasMore() throws PluginException;

    /**
     * The status of the application events are intimated through this method.
     * i.e the DIP engine after processing the events calls this method to set
     * the event status.
     *
     * @param an array of Event status objects describing the processed event

```

```

    * status by the DIP engine.
    * @throws EventDeliveryException the applications must throw this exception
    * in case of any error.
    */
    public void setAppEventStatus(EventStatus[] evtStatus)
        throws EventDeliveryException;
}

```

To perform directory operations from a plug-in, you need the application context. You can use `ProvProfile.getApplicationContext()` in the event delivery plug-in `initialize()` method to get an instance of `oracle.idm.provisioning.plugin.ApplicationContext`. You can use this `applicationContext` to perform any directory operation in any plug-in method.

## A.6 Provisioning Plug-in Return Status

Each of the provisioning plug-ins must return an object of the appropriate class.

`IDataEntryPlugin` and `IDataAccessPlugins` return an object of the class `oracle.idm.provisioning.plugin.PluginStatus`. The `EventDeliveryPlugins` (`IEventFromOID` and `IEventToOID`) return an array of objects of the class `'oracle.idm.provisioning.event.EventStatus'`.

The returned object indicates the execution status, which is either success or failure. The object can return the user provisioning status as well.

## A.7 Configuration Template for Provisioning Plug-ins

The LDIF template provided here is used in Oracle Internet Directory 11g Release 1 (11.1.1) to specify the application plug-in. You must create a directory entry for the application and upload the JAR file that contains the classes that implement the plug-in.

```

dn: cn=Plugins, cn=APPTYPE, cn=Applications, cn=Provisioning,
   cn=Directory Integration Platform, cn=Products, cn=OracleContext
changetype: add
add: orclODIPPluginExecData
orclODIPPluginExecData: full_path_name_of_the_JAR_file
objectclass: orclODIPPluginContainer

```

```

dn: cn=PRE_DATA_ENTRY_CREATE, cn=Plugins, cn=APPTYPE, cn=Applications,
   cn=Provisioning, cn=Directory Integration Platform, cn=Products,
   cn=OracleContext
changetype: add
objectClass: orclODIPPlugin
orclStatus: ENABLE
orclODIPPluginExecName: Name_of_the_class_that_implements_the_plug-in
orclODIPPluginAddInfo: Pre Data Entry Plugin for CREATE operation

```

```

dn: cn=PRE_DATA_ENTRY_MODIFY, cn=Plugins, cn=APPTYPE, cn=Applications,
   cn=Provisioning, cn=Directory Integration Platform, cn=Products,
   cn=OracleContext
changetype: add
objectClass: orclODIPPlugin
orclStatus: ENABLE
orclODIPPluginExecName: Name_of_the_class_that_implements_the_plug-in
orclODIPPluginAddInfo: Pre Data Entry Plugin for MODIFY operation

```

```

dn: cn=POST_DATA_ENTRY_CREATE, cn=Plugins, cn=APPTYPE, cn=Applications,
   cn=Provisioning, cn=Directory Integration Platform, cn=Products,
   cn=OracleContext
changetype: add
objectClass: orclODIPPlugin
orclStatus: ENABLE
orclODIPPluginExecName: Name_of_the_class_that_implements_the_plug-in
orclODIPPluginAddInfo: Post Data Entry Plugin for CREATE and modify operations

dn: cn=POST_DATA_ENTRY_MODIFY, cn=Plugins, cn=APPTYPE, cn=Applications,
   cn=Provisioning, cn=Directory Integration Platform, cn=Products,
   cn=OracleContext
changetype: add
objectClass: orclODIPPlugin
orclStatus: ENABLE
orclODIPPluginExecName: Name_of_the_class_that_implements_the_plug-in
orclODIPPluginAddInfo: Post Data Entry Plugin for MODIFY and CREATE operation

dn: cn=DATA_ACCESS, cn=Plugins, cn=APPTYPE, cn=Applications,
   cn=Provisioning, cn=Directory Integration Platform, cn=Products,
   cn=OracleContext
changetype: add
objectClass: orclODIPPlugin
orclStatus: ENABLE
orclODIPPluginExecName: Name_of_the_class_that_implements_the_plug-in
orclODIPPluginAddInfo: Data Access Plugin

dn: cn=EVENT_DELIVERY_OUT, cn=Plugins, cn=APPTYPE, cn=Applications,
   cn=Provisioning, cn=Directory Integration Platform, cn=Products, cn=OracleContext
changetype: add
objectClass: orclODIPPlugin
orclStatus: ENABLE
orclODIPPluginExecName: Name_of_the_class_that_implements_the_plug-in
orclODIPPluginAddInfo: Event Delivery Plugin for Outbound

dn: cn=EVENT_DELIVERY_IN, cn=Plugins, cn=APPTYPE, cn=Applications,
   cn=Provisioning, cn=Directory Integration Platform, cn=Products, cn=OracleContext
changetype: add
objectClass: orclODIPPlugin
orclStatus: ENABLE
orclODIPPluginExecName: Name_of_the_class_that_implements_the_plug-in
orclODIPPluginAddInfo: Event Delivery Plugin for Inbound

```

## A.8 Sample Code for a Provisioning Plug-in

```

/* Copyright (c) 2004, Oracle. All rights reserved. */
/**
DESCRIPTION
Sample PRE DATA Entry Plugin for CREATE operation that
validates the attribute.
PRIVATE CLASSES
None.
NOTES
This class implements the PRE_DATA_ENTRY_CREATE plugin ONLY
MODIFIED (MM/DD/YY)
12/15/04 \226 Creation
*/
package oracle.ldap.idm;

```

```

import java.util.*;
import javax.naming.*;
import javax.naming.ldap.*;
import javax.naming.directory.*;
import oracle.ldap.util.*;
import oracle.idm.provisioning.plugin.*;
/**
 * This class implements the PRE_DATA_ENTRY_CREATE plugin ONLY
 *
 */
public class SamplePreDataEntryCreatePlugin implements IDataEntryPlugin
{
    public ModPropertySet mpBaseUser = null;
    public ModPropertySet mpAppUser = null;

    public PluginStatus process(ApplicationContext appCtx, IdmUser idmuser,
        ModPropertySet baseUserAttr, ModPropertySet appUserAttr)
        throws PluginException
    {
        PluginStatus retPluginStatus = null;
        String retProvStatus = null;
        String retProvStatusMsg = null;

        LDIFRecord lRec = null;
        LDIFAttribute lAttr = null;
        String val = null;
        if(null == baseUserAttr.getModPropertyValue("\223departmentNumber\224))
        {
            mpBaseUser = new ModPropertySet();
            mpBaseUser.addProperty("departmentNumber", "ST");
            appCtx.log("\223Base user attribute \226 departmentNumber missing\224 +
                \223Setting default - ST\224);
        }
        else if ( baseUserAttr.getModPropertyValue("\223departmentNumber\224)
            .notin("\223ST\224, \223APPS\224, \224CRM\224) )
        {
            throw new PluginException("\223Invalid department Number\224);
        }
        if((null == appUserAttr) ||
            null == appUserAttr.getModPropertyValue("\223emailQouta\224))
        {
            mpAppUser = new ModPropertySet();
            mpAppUser.addProperty("emailQouta", "50M");
            appCtx.log("\223Application user attribute - email Qouta missing \224 +
                \223Setting default - 50M\224);
        }
        return new PluginStatus(PluginStatus.SUCCESS, null, null);
    }

    public ModPropertySet getBaseAttrMods()
    {
        return mpBaseUser;
    }

    public ModPropertySet getAppAttrMods()
    {
        return mpAppUser;
    }
}

```

```

/* Copyright (c) 2004, Oracle. All rights reserved. */
/**
DESCRIPTION
Sample POST DATA Entry Plugin for CREATE operation. Implementing a
policy check to provision only those users who belong to \223SALES\224.
PRIVATE CLASSES
None.
NOTES
This class implements the POST_DATA_ENTRY_CREATE plugin ONLY
MODIFIED (MM/DD/YY)
12/15/04 \226 Creation
*/
package oracle.ldap.idm;

import java.util.*;
import javax.naming.*;
import javax.naming.ldap.*;
import javax.naming.directory.*;
import oracle.ldap.util.*;
import oracle.idm.provisioning.plugin.*;
/**
 * This class implements the POST_DATA_ENTRY_CREATE plugin ONLY
 *
 */
public class SamplePostDataEntryCreatePlugin implements IDataEntryPlugin
{
    public ModPropertySet mpBaseUser = null;
    public ModPropertySet mpAppUser = null;

    public PluginStatus process(ApplicationContext appCtx, IdmUser idmuser,
        ModPropertySet baseUserAttr, ModPropertySet appUserAttr)
        throws PluginException
    {
        PluginStatus retPluginStatus = null;
        String retProvStatus = null;
        String retProvStatusMsg = null;

        if(null == baseUserAttr.getModPropertyValue(\223departmentNumber\224))
        {
            mpBaseUser = new ModPropertySet();
            mpBaseUser.addProperty("departmentNumber ", "SALES");
            appCtx.log("Base user attribute \221c\222 is missing");

            retProvStatus = IdmUser.PROVISION_ REQUIRED;
            retProvStatusMsg = "Provision policy: Only \221SALES\222\224.
        }
        else if (baseUserAttr.getModPropertyValue(\223departmentNumber\224)
            .equals(\223SALES\224))
        {
            retProvStatus = IdmUser.PROVISION_ REQUIRED;
            retProvStatusMsg = "Provision policy: Only \221SALES\222\224.
        }
        else
        {
            // do not provision those users who do not belong to SALES.
            retProvStatus = IdmUser.PROVISION_NOT_REQUIRED;
            retProvStatusMsg =
                "Do not provision the person who is not from \221SALES\222";
        }
    }
}

```

```

        return new PluginStatus(PluginStatus.SUCCESS, retProvStatusMsg,
                                retProvStatus);
    }

    public ModPropertySet getBaseAttrMods()
    {
        return mpBaseUser;
    }

    public ModPropertySet getAppAttrMods()
    {
        return mpAppUser;
    }
}

/* Copyright (c) 2004, Oracle. All rights reserved. */
/**
 * DESCRIPTION
 * Sample DATA Access Plugin.
 * NOTES
 * This class implements the DATA_ACCESS plugin
 * MODIFIED (MM/DD/YY)
 * 12/15/04 \226 Creation
 */
package oracle.ldap.idm;

import javax.naming.*;
import javax.naming.ldap.*;
import javax.naming.directory.*;
import oracle.ldap.util.*;
import oracle.idm.provisioning.plugin.*;
/**
 * This class implements the DATA_ACCESS plugin ONLY
 *
 */
public class SampleDataAccessPlugin implements IDataAccessPlugin
{
    public PluginStatus process(ApplicationContext appCtx, IdmUser idmuser,
                               ModPropertySet baseUserAttr, ModPropertySet appUserAttr)
        throws PluginException
    {
        try {
            DirContext dirCtx = appCtx.getDirCtx();
            if ( appCtx.getCallOp().equals(ApplicationContext.OP_CREATE )
                {
                    // Use the directory context and create the entry.
                }
            elseif ( appCtx.getCallOp().equals(ApplicationContext.OP_MODIFY)
                {
                    // Use the directory context and modify the entry.
                }
        } catch (Exception e) {
            throw new PluginException(e);
        }
        return new PluginStatus(PluginStatus.SUCCESS, null, null);
    }

    public PropertySet getAppUserData(ApplicationContext appCtx,
                                       IdmUser idmuser, String [] reqAttrs) throws PluginException
    {

```

```
VarPropertySet vpSet = null;
DirContext dirCtx = appCtx.getDirCtx();

try {
    Attributes attrs= dirCtx.getAttributes("\223myAppContainer\224");
    vpSet = new VarPropertySet(); // Populate the VarPropertySet from attrs
} catch(Exception ne) {
    throw new PluginException(e);
}
return vpSet; }
}
```





---

---

## DSML Syntax

This appendix describes syntax for the Directory Services Mark-up Language (DSML). DSML is deprecated in Oracle Fusion Middleware 11g Release 1 (11.1.1) and might not be supported in future releases.

This appendix includes the following sections:

- [Section B.1, "Capabilities of DSML"](#)
- [Section B.2, "Benefits of DSML"](#)
- [Section B.3, "DSML Syntax"](#)
- [Section B.4, "Tools Enabled for DSML"](#)

### B.1 Capabilities of DSML

Directory services form a core part of distributed computing. XML is becoming the standard markup language for Internet applications. As directory services are brought to the Internet, there is a pressing and urgent need to express the directory information as XML data. This caters to the growing breed of applications that are not LDAP-aware yet require information exchange with a LDAP directory server.

Directory Services Mark-up Language (DSML) defines the XML representation of LDAP information and operations. The LDAP Data Interchange Format (LDIF) is used to convey directory information, or a set of changes to be applied to directory entries. The former is called Attribute Value Record and the latter is called Change Record.

### B.2 Benefits of DSML

Using DSML with Oracle Internet Directory and Internet applications makes it easier to flexibly integrate data from disparate sources. Also, DSML enables applications that do not use LDAP to communicate with LDAP-based applications, easily operating on data generated by an Oracle Internet Directory client tool or accessing the directory through a firewall.

DSML is based on XML, which is optimized for delivery over the Web. Structured data in XML is uniform and independent of application or vendors, thus making possible numerous new flat file type synchronization connectors. After it is in XML format, the directory data can be made available in the middle tier and have more meaningful searches performed on it.

## B.3 DSML Syntax

A DSML version 1 document describes either directory entries, a directory schema or both. Each directory entry has a unique name called a distinguished name (DN). A directory entry has several property-value pairs called directory attributes. Every directory entry is a member of several object classes. An entry's object classes constrain the directory attributes the entry can take. Such constraints are described in a directory schema, which may be included in the same DSML document or may be in a separate document.

The following subsections briefly explain the top-level structure of DSML and how to represent the directory and schema entries.

### B.3.1 Top-Level Structure

The top-level document element of DSML is of the type `dsml`, which may have child elements of the following types:

```
directory-entries
directory-schema
```

The child element `directory-entries` may in turn have child elements of the type `entry`. Similarly the child element `directory-schema` may in turn have child elements of the types `class` and `attribute-type`.

At the top level, the structure of a DSML document looks like this:

```
<!-- a document with directory & schema entries -->
<dsml:directory-entries>
  <dsml:entry dn="...">...</dsml:entry>
  .
  .
  .
</dsml:directory-entries>
.
.
.
<dsml:directory-schema>
  <dsml:class id="..." ...>...</dsml:class>
  <dsml:attribute-type id="..." ...>...</dsml:attribute-type>
  .
  .
  .
</dsml:directory-schema> </dsml:dsml>
```

### B.3.2 Directory Entries

The element type `entry` represents a directory entry in a DSML document. The entry element contains elements representing the entry's directory attributes. The distinguished name of the entry is indicated by the XML attribute `dn`.

Here is an XML entry to describe the directory entry:

```
<dsml:entry dn="uid=Heman, c=in, dc=oracle, dc=com">
<dsml:objectclass>
  <dsml:oc-value>top</dsml:oc-value>
  <dsml:oc-value ref="#person">person</dsml:oc-value>
  <dsml:oc-value>organizationalPerson</dsml:oc-value>
  <dsml:oc-value>inetOrgPerson</dsml:oc-value>
</dsml:objectclass>
```

```

<dsml:attr name="sn">
<dsml:value>Siva</dsml:value></dsml:attr>
<dsml:attr name="uid">
<dsml:value>Heman</dsml:value></dsml:attr>
<dsml:attr name="mail">
<dsml:attr name="givenname">
<dsml:value>Siva V. Kumar</dsml:value></dsml:attr>
<dsml:attr name="cn">
<dsml:value>SVK@example.com</dsml:value></dsml:attr>
<dsml:value>Siva Kumar</dsml:value></dsml:attr>

```

The `oc-value's ref` is a URI Reference to a class element that defines the object class. In this case it is a URI [9] Reference to the element that defines the person object class. The child elements `objectclass` and `attr` are used to specify the object classes and the attributes of a directory entry.

### B.3.3 Schema Entries

The element type `class` represents a schema entry in a DSML document. The `class` element takes an XML attribute `id` to make referencing easier.

For example, the object class definition for the person object class might look like the following:

```

<dsml:class id="person" superior="#top" type="structural">
  <dsml:name>person</dsml:name>
  <dsml:description>...</dsml:description>
  <dsml:object-identifier>2.5.6.6</object-identifier>
  <dsml:attribute ref="#sn" required="true"/>
  <dsml:attribute ref="#cn" required="true"/>
  <dsml:attribute ref="#userPassword" required="false"/>
  <dsml:attribute ref="#telephoneNumber" required="false"/>
  <dsml:attribute ref="#seeAlso" required="false"/>
  <dsml:attribute ref="#description" required="false"/>
</dsml:class>

```

The directory attributes are described in a similar way. For example, the attribute definition for the `cn` attribute may look like this:

```

<dsml:attribute-type id="cn">
  <dsml:name>cn</dsml:name>
  <dsml:description>...</dsml:description>
  <dsml:object-identifier>2.5.4.3</object-identifier>
  <dsml:syntax>1.3.6.1.4.1.1466.115.121.1.44</dsml:syntax>
</dsml:attribute-type>

```

## B.4 Tools Enabled for DSML

With the XML framework, you can now use non-ldap applications to access directory data. The XML framework broadly defines the access points and provides the following tools:

- `ldapadd`
- `ldapaddmt`
- `ldapsearch`

**See Also:** "Oracle Internet Directory Server Administration Tools" in *Oracle Fusion Middleware Reference for Oracle Identity Management* for information about syntax and usage.

The client tool `ldifwrite` generates directory data and schema LDIF files. If you convert these LDIF files to XML, you can store the XML file on an application server and query it. The query and response time is small compared to performing an LDAP operation against an LDAP server.

---

# Migrating from Netscape LDAP SDK API to Oracle LDAP SDK API

This Appendix describes differences between the Netscape LDAP SDK and the Oracle Internet Directory LDAP SDK that are important when migrating code.

The Oracle Internet Directory SDK C API is described in [Chapter 8, "C API Reference"](#).

This appendix includes the following sections:

- [Section C.1, "Features"](#)
- [Section C.2, "Functions"](#)
- [Section C.3, "Macros"](#)

## C.1 Features

The following features of the Oracle Internet Directory LDAP SDK are different from Netscape's SDK.

- In the Netscape SDK, a client must register an LDAP Rebind Call Back to handle a referral. This is automatically handled in the Oracle LDAP SDK.
- Access to the LDAP Structure is different. The LDAP handle in Netscape LDAP SDK is type opaque. Accessory functions are required to access individual fields within this handle. In the Oracle Internet Directory LDAP SDK, the LDAP structure is exposed and a client can modify individual fields within the structure.
- Use `ldap_open()` instead of `ldap_init()` with the Oracle LDAP SDK.
- SSL connection initialization requires different function calls and procedures in the Oracle LDAP SDK. See [Chapter 8, "C API Reference"](#) for information about Oracle Internet Directory function calls for SSL.
- The Oracle Internet Directory C API depends on the Oracle environment, including libraries and other files. You must install Oracle Application Server or Oracle Database and set the environment variable `$ORACLE_HOME` to an appropriate location before you build your application.
- An LDAP SDK user must use an allocation function that clears memory, such as `calloc()`, to allocate an `LDAPMod` structure().
- The Oracle Internet Directory API is not thread-safe.

## C.2 Functions

The following functions are available in Netscape LDAP SDK and not in Oracle LDAP SDK:

- The Oracle LDAP SDK does not have the function `ldap_ber_free()`. Use `ber_free()` instead.
- The Oracle LDAP SDK does not have the function `ldap_get_lderrno()` for retrieving the ld error and matched string. You can retrieve this information directly by accessing the field `LDAP.ld_matched` and `LDAP.ld_error`. These are the only fields of the LDAP structure that you should ever need to access.

## C.3 Macros

- `LDAPS_PORT` is not defined in the Oracle LDAP SDK. Use `LDAP_SSL_PORT` instead.
- `LDAP_AFFECT_MULTIPLE_DSA` is not defined in the Oracle LDAP SDK. This is a Netscape-specific macro.