

# Oracle® Fusion Middleware

## Using Oracle WebCenter Content



14c (14.1.2.0.0)

F89687-01

December 2024

The Oracle logo, consisting of a solid red square with the word "ORACLE" in white, uppercase, sans-serif font centered within it.

ORACLE®

Oracle Fusion Middleware Using Oracle WebCenter Content, 14c (14.1.2.0.0)

F89687-01

Copyright © 1997, 2024, Oracle and/or its affiliates.

Primary Author: Oracle Corporation

This software and related documentation are provided under a license agreement containing restrictions on use and disclosure and are protected by intellectual property laws. Except as expressly permitted in your license agreement or allowed by law, you may not use, copy, reproduce, translate, broadcast, modify, license, transmit, distribute, exhibit, perform, publish, or display any part, in any form, or by any means. Reverse engineering, disassembly, or decompilation of this software, unless required by law for interoperability, is prohibited.

The information contained herein is subject to change without notice and is not warranted to be error-free. If you find any errors, please report them to us in writing.

If this is software, software documentation, data (as defined in the Federal Acquisition Regulation), or related documentation that is delivered to the U.S. Government or anyone licensing it on behalf of the U.S. Government, then the following notice is applicable:

U.S. GOVERNMENT END USERS: Oracle programs (including any operating system, integrated software, any programs embedded, installed, or activated on delivered hardware, and modifications of such programs) and Oracle computer documentation or other Oracle data delivered to or accessed by U.S. Government end users are "commercial computer software," "commercial computer software documentation," or "limited rights data" pursuant to the applicable Federal Acquisition Regulation and agency-specific supplemental regulations. As such, the use, reproduction, duplication, release, display, disclosure, modification, preparation of derivative works, and/or adaptation of i) Oracle programs (including any operating system, integrated software, any programs embedded, installed, or activated on delivered hardware, and modifications of such programs), ii) Oracle computer documentation and/or iii) other Oracle data, is subject to the rights and limitations specified in the license contained in the applicable contract. The terms governing the U.S. Government's use of Oracle cloud services are defined by the applicable contract for such services. No other rights are granted to the U.S. Government.

This software or hardware is developed for general use in a variety of information management applications. It is not developed or intended for use in any inherently dangerous applications, including applications that may create a risk of personal injury. If you use this software or hardware in dangerous applications, then you shall be responsible to take all appropriate fail-safe, backup, redundancy, and other measures to ensure its safe use. Oracle Corporation and its affiliates disclaim any liability for any damages caused by use of this software or hardware in dangerous applications.

Oracle®, Java, MySQL, and NetSuite are registered trademarks of Oracle and/or its affiliates. Other names may be trademarks of their respective owners.

Intel and Intel Inside are trademarks or registered trademarks of Intel Corporation. All SPARC trademarks are used under license and are trademarks or registered trademarks of SPARC International, Inc. AMD, Epyc, and the AMD logo are trademarks or registered trademarks of Advanced Micro Devices. UNIX is a registered trademark of The Open Group.

This software or hardware and documentation may provide access to or information about content, products, and services from third parties. Oracle Corporation and its affiliates are not responsible for and expressly disclaim all warranties of any kind with respect to third-party content, products, and services unless otherwise set forth in an applicable agreement between you and Oracle. Oracle Corporation and its affiliates will not be responsible for any loss, costs, or damages incurred due to your access to or use of third-party content, products, or services, except as set forth in an applicable agreement between you and Oracle.

# Contents

## Preface

---

Audience	xix
Documentation Accessibility	xix
Keyboard Accessibility	xix
Related Documents	xix
Conventions	xix

## Part I Getting Started with Oracle WebCenter Content

---

### 1 Introduction to Oracle WebCenter Content

---

1.1	About This Guide	1-1
1.2	What is Oracle WebCenter Content	1-1
1.3	Benefits of Using WebCenter Content	1-2
1.4	Basic WebCenter Content Concepts	1-2
1.4.1	Useful vocabulary	1-3
1.4.2	What are document libraries?	1-7
1.4.3	What are folders?	1-8
1.4.4	What are shortcuts?	1-8
1.4.5	What are favorites?	1-8
1.4.6	How do I find content?	1-9
1.4.7	Can I manage images and videos?	1-9
1.4.8	Can I manage content through office applications?	1-9
1.4.9	What are folios and how are they used to group content?	1-10
1.4.10	What are workflows and how are they used to route content?	1-10
1.5	Basic WebCenter Content Tasks	1-10

### 2 Accessing and Navigating Oracle WebCenter Content

---

2.1	Understanding How to Access Oracle WebCenter Content	2-1
2.1.1	How do I access Oracle WebCenter Content using a web browser?	2-1
2.1.2	Can I access Oracle WebCenter Content outside of a web browser?	2-1
2.2	Navigating Oracle WebCenter Content Using a Standard Web Browser	2-1

2.2.1	How do I browse and search for content?	2-3
-------	---	-----

## 3 Understanding Content Management

---

3.1	Managing Unstructured Documents	3-1
3.2	Understanding Uploading, Checking In, and Checking Out Documents	3-1
3.2.1	Uploading documents	3-1
3.2.2	Can I upload documents to Oracle Content Management Cloud Service?	3-2
3.2.3	Checking out documents	3-2
3.2.4	Checking in documents	3-2
3.3	Understanding Document Metadata Properties	3-2
3.3.1	When do I use document metadata properties?	3-3
3.4	Understanding How to Find Documents	3-3
3.4.1	Library and folder context	3-3
3.4.2	Metadata search	3-3
3.4.3	Metadata search operators for a database metadata search	3-4
3.4.4	Metadata search case sensitivity	3-4
3.4.5	What is full-text searching?	3-5
3.4.6	Full-text search rules	3-5
3.4.7	Full-text search case sensitivity	3-6
3.4.8	Oracle database full-text search operators	3-6
3.5	Understanding How a Document is Processed Within Oracle WebCenter Content	3-7
3.5.1	Revision status	3-8
3.5.2	What is a revision history?	3-9
3.5.3	What is expired content?	3-9
3.6	Understanding Document Security	3-9
3.7	Understanding Library and Folder Security	3-9

## 4 Understanding Documents and Document Properties

---

4.1	About Documents	4-1
4.2	Finding Documents	4-1
4.3	Viewing and Annotating Documents	4-1
4.4	Understanding Document Properties	4-2
4.4.1	How do I define document metadata values?	4-2
4.4.2	Can document profiles be used to control metadata fields?	4-3
4.5	Understanding Document Security	4-3
4.5.1	Library and folder security	4-4
4.6	Understanding Document Renditions	4-4

## 5 Understanding Libraries

---

5.1	About Document Libraries	5-1
5.2	Understanding Enterprise Libraries	5-2
5.2.1	What are the benefits of using enterprise libraries?	5-2
5.2.2	How do I set security for enterprise libraries and folders?	5-2
5.2.3	How do I resolve upload conflicts and track revision history?	5-3
5.2.4	How do I manage document access using enterprise libraries and folders?	5-3
5.3	Understanding Shortcuts, Favorites, and Following	5-4

## 6 Understanding Folders

---

6.1	About Folders	6-1
6.2	Folder Differences Between the WebCenter Content and Native User Interfaces	6-1
6.3	Browsing the Folder Hierarchy	6-2
6.4	Searching For Folders	6-3
6.5	Working With Folders	6-3
6.6	Understanding Folder Security	6-4
6.7	Saved Searches and Shortcuts	6-5

## 7 Understanding Document Workflows

---

7.1	About Workflows	7-1
7.2	Workflow Types	7-1
7.3	Workflow Steps	7-1
7.4	Workflow Process	7-2
7.5	Postprocess Workflow Options	7-2
7.6	Authentication	7-2

## Part II Using the WebCenter Content User Interface with Oracle WebCenter Content

---

### 8 Getting Started with the WebCenter Content User Interface

---

8.1	Working with Oracle WebCenter Content	8-1
8.2	Accessing Oracle WebCenter Content	8-1
8.3	Understanding the WebCenter Content User interface	8-1
8.3.1	Find Documents page	8-2
8.3.2	Search box	8-3
8.3.3	Side bar	8-4
8.3.4	Results list	8-5
8.3.5	Results list toolbar and contextual menu	8-7

8.3.6	Searching and browsing	8-8
8.3.6.1	Searching metadata	8-8
8.3.6.2	Browsing	8-9
8.3.7	View Documents page	8-10
8.4	Personalizing WebCenter Content Preferences	8-14

## 9 Finding Libraries, Folders, and Documents

---

9.1	About Finding Libraries, Folders, and Documents	9-1
9.2	Using the Find Documents Page	9-1
9.3	Browsing Using the Side Bar	9-2
9.3.1	How do I browse through libraries?	9-2
9.3.2	How do I browse through favorites?	9-3
9.3.3	How do I browse through folders in the side bar?	9-3
9.3.4	Browsing versus searching	9-4
9.3.5	How do I switch between searching and browsing?	9-4
9.4	Searching Using the Banner Search Box	9-5
9.4.1	Understanding text entry	9-7
9.4.1.1	How do I search metadata when browsing?	9-7
9.4.2	How do I use predefined filters to refine results?	9-7
9.4.3	How do I clear filters?	9-8
9.4.4	Supported wildcards	9-8
9.5	Searching for Folders	9-9
9.5.1	How do I search for folders using the search box?	9-9
9.5.2	How do I search for folders using the side bar?	9-9
9.6	Using System Libraries to Find Documents in a Process State	9-10
9.7	Using Advanced Search Capabilities	9-10
9.7.1	What is a metadata search?	9-11
9.7.2	What is a full-text search?	9-11
9.7.3	How do I use an advanced search form?	9-11
9.8	Saving Searches	9-11
9.8.1	How do I use a saved search?	9-13
9.8.2	How do I modify saved search properties and criteria?	9-13
9.9	Working with the Results List	9-14
9.9.1	Results view	9-15
9.9.1.1	When should a results list be refreshed?	9-15
9.9.2	How do I sort results?	9-16
9.9.3	How do I change the number of items displayed per page?	9-16
9.9.4	How do I pin a view?	9-16
9.9.5	How do I set a favorite?	9-16
9.9.6	How do I follow items?	9-17
9.9.7	How do I view library contents?	9-18

9.10	Modifying Items Using the Results Toolbar	9-18
------	---	------

## 10 Viewing and Annotating Documents

---

10.1	About Viewing and Annotating Documents	10-1
10.1.1	Banner section	10-2
10.1.2	Preview area	10-2
10.1.3	Properties section	10-3
10.2	Viewing Documents on the Document Page	10-3
10.3	Changing the Document View	10-3
10.4	Viewing Alternate Renditions	10-4
10.4.1	How do I view and work with digital asset renditions?	10-5
10.4.2	How do I use the renditions clipboard?	10-6
10.5	Viewing the Native File	10-6
10.6	Viewing Previous Document Revisions	10-6
10.7	Annotating Documents	10-7
10.7.1	About annotation security	10-7
10.7.2	How do I view and hide annotations?	10-8
10.7.3	How do I create annotations?	10-9
10.7.4	How do I modify annotations?	10-11
10.7.5	How do I delete annotations?	10-12
10.7.6	How do I download annotated documents?	10-12
10.8	Using Links	10-12

## 11 Uploading and Checking In Documents

---

11.1	About Uploading and Checking In Documents	11-1
11.2	Uploading Documents from a Web Browser	11-2
11.2.1	How do I change access to uploaded documents?	11-4
11.2.1.1	How do I change access to unfiled or enterprise library documents?	11-7
11.3	Checking In New Revisions from a Web Browser	11-8
11.4	Uploading and Checking In Documents from WebCenter Content: Desktop	11-9
11.5	Uploading and Checking In Documents from a Mobile Device	11-10

## 12 Checking Out and Downloading Documents

---

12.1	About Checking Out and Downloading Documents	12-1
12.2	Checking Out Documents	12-1
12.3	Downloading Documents	12-1
12.3.1	How do I download native files?	12-2
12.3.2	How do I download a web-viewable rendition?	12-2
12.4	Checking Out and Downloading Documents from WebCenter Content: Desktop	12-2

12.5	Checking Out and Downloading Documents from a Mobile Device	12-2
------	---	------

## 13 Working with Libraries

---

13.1	About Document Libraries	13-1
13.2	Creating an Enterprise Library	13-2
13.3	Viewing and Editing Document Library Properties	13-3
13.4	Propagating Library Metadata	13-5
13.5	Sharing Document Libraries	13-7
13.6	Following Document Libraries	13-7
13.7	Creating Library Shortcuts	13-7
13.8	Using System Libraries to Find Content	13-9

## 14 Working with Content Folders

---

14.1	About Folders	14-1
14.2	Working With Folders	14-1
14.3	Finding Folders	14-2
14.4	Creating Folders	14-3

## 15 Deleting Libraries, Folders, and Documents

---

15.1	About Deleting Libraries, Folders, and Documents	15-1
15.2	About Trash	15-2
15.3	Moving Items to Trash	15-2
15.4	Viewing Trash	15-3
15.5	Working with Items in Trash	15-4
15.5.1	How do I delete an item permanently?	15-4
15.5.2	How do I restore an item?	15-5
15.5.3	How do I view revisions of a document in Trash?	15-5
15.5.4	How do I empty Trash?	15-5

## 16 Using Workflows

---

16.1	About Workflows	16-1
16.2	Workflow Types	16-1
16.3	Entering a File to a Workflow	16-1
16.4	Reviewing Workflow Items Assigned to You	16-3
16.5	Viewing Workflow Information	16-4
16.5.1	How do I view a list of my workflow assignments?	16-5
16.5.2	How do I view a list of all documents in active workflows?	16-5
16.5.3	How do I view a list of documents in a specific workflow?	16-5



16.5.4	How do I view workflow details and history?	16-5
--------	---	------

## 17 Working with Oracle Content Management Cloud Service

---

17.1	About Content Management Cloud Service	17-1
17.2	Uploading Content to Oracle Content Management Cloud Service	17-1
17.3	Copying Content to Oracle Content Management Cloud Service	17-2
17.3.1	How do I copy content to a top-level cloud folder?	17-3
17.3.2	How do I copy content to a child cloud folder?	17-5
17.4	Copying Content from Oracle Content Management Cloud Service	17-6
17.5	Sharing Cloud Folders	17-6
17.5.1	How do I share a cloud folder with my Oracle Content Management Cloud Service account?	17-6
17.5.1.1	How do I enable sharing while creating a cloud folder?	17-7
17.5.1.2	How do I share a cloud folder to which I have access?	17-9
17.5.2	How do I stop sharing a cloud folder with my Oracle Content Management Cloud Service account?	17-9
17.5.3	How do I share a cloud folder with other users?	17-10
17.6	Deleting Cloud Folders	17-10

## Part III Using the Native User Interface with Oracle WebCenter Content

---

### 18 Getting Started with the Native User Interface

---

18.1	Working with Oracle WebCenter Content	18-1
18.2	Accessing WebCenter Content Server	18-2
18.3	Understanding the Native User Interface	18-2
18.3.1	Home Page	18-2
18.3.2	Toolbar	18-3
18.3.3	Trays	18-4
18.3.4	My Content Server Tray	18-5
18.3.5	Content Management Tray	18-6
18.3.6	Quick Search Field	18-7

### 19 Finding Documents

---

19.1	Search Pages	19-1
19.1.1	Quick Search Field	19-1
19.1.2	Home Page Search Fields	19-2
19.1.3	Search Tray	19-2
19.1.4	Advanced Search Page	19-2
19.1.5	Query Builder Form	19-3

19.2	Working with Search Results	19-3
19.2.1	Displaying Search Results	19-4
19.2.2	Viewing Documents on the Search Results Page	19-4
19.2.3	Changing the Search Results View	19-4
19.3	Search Result Templates	19-4
19.3.1	Classic View Template	19-5
19.3.2	Headline View Template	19-6
19.3.3	Thumbnail View Template	19-6
19.3.4	Creating a Custom Search Result Template	19-7
19.4	Saving Queries	19-8
19.4.1	About Saved Queries	19-8
19.4.2	Saving a Query	19-8
19.4.3	Rerunning a Recent Query	19-9
19.4.4	Clearing Recent Queries	19-9
19.4.5	Creating Quick Search Queries	19-9
19.5	Searching with Oracle Text Search	19-10
19.5.1	Searching with the Expanded Form	19-11
19.5.2	Filtering Search Results	19-12
19.5.3	Searching with the Query Builder Form	19-13
19.5.4	Metadata Search Operators for Oracle Text Search	19-15
19.6	Searching with Database Metadata Search	19-15
19.6.1	About Metadata Searching	19-15
19.6.2	Performing a Metadata Search	19-16
19.7	Searching with Database Full-Text Search	19-16
19.7.1	Performing a Full-Text Search	19-16
19.8	Searching with Elasticsearch	19-17
19.8.1	Searching with the Expanded Form	19-17
19.8.2	Filtering Search Results	19-19
19.8.3	Searching with the Query Builder Form	19-20
19.8.4	Metadata Search Operators for Elasticsearch	19-22
19.9	Searching for Expired or Expiring Content	19-22
19.10	Using Additional Search Capabilities	19-23
19.10.1	Metadata Wildcards	19-23
19.10.2	Internet-Style Search Syntax	19-23
19.10.3	Complex Queries and Alternate Query Formats	19-25
19.11	Searching Referenced Links (optional)	19-25
19.11.1	About Searching Links	19-26
19.11.2	Link References on the Content Information Page	19-26
19.11.3	Notification of Expiration	19-27
19.11.4	Performing a Link Search	19-28
19.11.5	Checking Content Item Link References	19-28
19.11.5.1	Checking Link References from the Search Results Page	19-28

19.11.5.2	Checking Link References from the Link Manager's Search Links page	19-28
19.11.6	Checking the Link Information About Specific Links	19-29
19.11.6.1	Checking Link Information from the Content Information Page	19-29
19.11.6.2	Checking Link Information from the Search Links Page	19-29
19.12	Content Data Tracking	19-29
19.12.1	About Content Tracker	19-29

## 20 Viewing Documents

---

20.1	Viewing a Content Item	20-1
20.1.1	Viewing a Web-Viewable File	20-1
20.1.2	Viewing a Native File	20-1
20.2	Discussing Content	20-2
20.2.1	About Discussion Posts and Threads	20-2
20.2.2	Initiating a Discussion from the Content Information Page	20-4
20.2.3	Initiating a Discussion from the Search Results Page	20-4
20.2.4	Initiating a Discussion from the Workflow Review Page	20-4
20.2.5	Viewing and Replying to a Threaded Discussion	20-4
20.2.6	Printing a Threaded Discussion	20-5
20.2.7	Deleting a Threaded Discussion	20-5
20.2.8	Searching with the Discussion Type Field	20-6
20.3	Subscribing to New Revisions of a Content Item	20-6
20.3.1	About Subscriptions	20-6
20.3.2	Subscribing to a Content Item	20-7
20.3.3	Viewing Your Current Subscriptions	20-7
20.3.4	Unsubscribing from a Content Item	20-7
20.3.5	Unsubscribing from a Criteria Group	20-7
20.4	Signing Content Electronically	20-7
20.4.1	About Electronic Signatures	20-8
20.4.2	Signable Objects	20-8
20.4.3	Signature Metadata	20-9
20.4.4	Signature Verification	20-9
20.4.5	Signing a Content Item Electronically	20-9
20.4.6	Viewing Electronic Signature Information	20-10
20.4.7	Search for a File in Revisions	20-10
20.4.8	Search for a File in the Repository	20-11

## 21 Uploading Documents

---

21.1	About Manual File Check-In	21-1
21.2	Primary and Alternate Files	21-1
21.3	Watermarks and File Check-In	21-2

21.3.1	About PDF Watermark	21-2
21.3.2	Watermark Templates	21-2
21.3.3	Content Check-In Form	21-2
21.4	Checking In Single Files	21-3
21.4.1	Checking In a New File	21-3
21.4.2	Checking In a Similar File	21-5
21.4.3	Checking In a Revised File	21-5
21.5	Checking In Multiple Files	21-5
21.5.1	About Multiple File Check-In	21-5
21.5.2	Upload Applet Requirements	21-6
21.5.3	Checking In Multiple Files Using Upload	21-6
21.6	Important Considerations	21-8
21.6.1	Multibyte Characters	21-8
21.6.2	Content Profiles	21-8

## 22 Checking Out and Downloading Files

---

22.1	About Manual File Check-Out	22-1
22.2	Checking Out Single Files	22-1
22.3	Checking Out Multiple Files	22-2
22.3.1	About Multiple File Check-Out	22-2
22.3.2	Download Applet Requirements	22-2
22.3.3	Download Options on Search Results Pages	22-3
22.3.4	Downloading Multiple Files	22-3

## 23 Working with Content Folders

---

23.1	Introduction	23-1
23.1.1	Browsing to Content	23-2
23.1.1.1	Browse Content Tray	23-2
23.1.1.2	Browsing Content to Find a File	23-2
23.1.2	About Folders	23-2
23.1.2.1	The Folders Interface	23-3
23.1.2.2	Folders and Files	23-3
23.1.2.3	Shortcuts	23-4
23.1.2.4	Query Folders and Folder Search	23-6
23.1.2.5	Folders Retention	23-6
23.1.2.6	Personal Folder	23-7
23.1.2.7	Security and User Access	23-7
23.1.2.8	Content Item Versioning	23-7
23.1.2.9	Folder and Content Item Metadata	23-8
23.1.2.10	Migrating Contribution Folder Content	23-9

23.1.3	About Contribution Folders	23-9
23.1.3.1	Content Item Security	23-9
23.1.3.2	Folder Metadata Inheritance	23-10
23.1.3.3	Default Metadata Values	23-10
23.1.3.4	Trash Bin	23-11
23.1.3.5	Metadata Propagation	23-11
23.1.3.6	Folder Content Item Revisions	23-11
23.1.4	About WebDAV	23-12
23.1.4.1	What is WebDAV?	23-12
23.1.4.2	WebDAV Clients	23-12
23.1.4.3	Oracle WebCenter Content: Desktop	23-12
23.2	Working with Folders	23-13
23.2.1	Folder Navigation	23-13
23.2.2	Working with Folders	23-13
23.2.2.1	Create a Folder	23-14
23.2.2.2	Specify Default Folder Metadata	23-15
23.2.2.3	Propagate Folder Metadata	23-15
23.2.3	Working with Content Items	23-16
23.2.3.1	Add a New Content Item to a Folder	23-16
23.2.3.2	Add an Existing Content Item to a Folder	23-17
23.2.3.3	Create a Folder or File Shortcut	23-17
23.2.3.4	Copy or Move Folders and Files	23-18
23.2.3.5	Check Out and Check in Files	23-19
23.2.3.6	Delete Folders and Files	23-19
23.2.4	About Expired Items	23-19
23.2.5	Working with Search Options and Query Folders	23-21
23.2.5.1	Search for a Folder or File	23-21
23.2.5.2	Save a Search as a Query Folder	23-22
23.2.5.3	Create or Modify a Query Folder	23-22
23.2.6	Folder Access Example	23-23
23.3	Working with Contribution Folders	23-24
23.3.1	Naming Folders	23-25
23.3.2	Defining User Configuration Settings	23-25
23.3.3	Defining User Metadata Defaults for New Content	23-26
23.3.4	Defining User Metadata Defaults for Revised Content	23-26
23.3.5	Viewing Contribution Folders	23-27
23.3.6	Viewing Content Items	23-27
23.3.7	Checking In Content	23-27
23.3.8	Adding Contribution Folders	23-28
23.3.9	Modifying Contribution Folders	23-28
23.3.10	Moving Contribution Folders and Content	23-29
23.3.11	Creating a Shortcut	23-29

23.3.11.1	Creating a Shortcut from an Exploring Page	23-29
23.3.11.2	Creating a Shortcut from a Folder Information or Content Information Page	23-30
23.3.12	Deleting Contribution Folders and Their Content	23-30
23.3.12.1	About Deleting Folders and Content	23-30
23.3.12.2	Deleting a Folder or Content Item	23-31
23.3.12.3	Permanently Deleting Folders and Content from Trash	23-31
23.3.13	Restoring Folders and Content from Trash	23-32
23.3.14	Propagating Metadata	23-32
23.3.15	Searching for Content in Folders	23-33
23.4	Working with WebDAV	23-33
23.4.1	Working with Folders	23-33
23.4.1.1	WebDAV Folders	23-33
23.4.1.2	Connecting to a WebDAV Folder	23-34
23.4.1.3	Viewing Folders	23-34
23.4.1.4	Creating a New Folder	23-34
23.4.2	Working with Content	23-35
23.4.2.1	Checking In Content	23-35
23.4.2.2	Check-In Troubleshooting	23-35
23.4.2.3	Checking Out Content	23-36
23.4.2.4	Viewing Content	23-36
23.4.2.5	Modifying Content	23-37
23.4.2.6	Deleting a Folder or Content Item	23-37
23.4.2.7	Restoring a Contribution Folder or Content Item	23-38
23.4.2.8	Copying Content	23-38
23.4.2.9	Moving Content	23-38
23.4.3	Displaying Web Pages	23-39
23.4.3.1	Configuring Windows Explorer	23-39
23.4.3.2	Displaying a Web Page	23-39

## 24 Grouping Documents Using Folios

---

24.1	About Content Folios	24-1
24.1.1	What a Folio Is	24-1
24.1.2	The Folio Structure	24-1
24.1.3	When to Use a Folio	24-2
24.2	Working with Folios	24-4
24.2.1	Creating a Simple Folio	24-5
24.2.2	Creating an Advanced Folio	24-5
24.2.3	Modifying Folio Structure and Content	24-6
24.2.3.1	Editing a Simple Folio	24-6
24.2.3.2	Editing an Advanced Folio	24-8

24.2.4	Taking Snapshots	24-12
24.2.5	Locking and Unlocking Folios	24-13
24.2.6	Downloading Folio Renditions	24-13
24.2.7	Finding Existing Folios	24-14
24.2.8	Viewing Folios	24-14
24.2.9	Viewing Folio Information	24-14
24.2.10	Subscribing to Folios	24-14
24.2.11	Using Digital Asset Baskets	24-15
24.2.11.1	Managing Digital Asset Baskets	24-15
24.2.11.2	Working with Digital Asset Baskets	24-16
24.2.12	Understanding Folio Workflows	24-17

## 25 Using Workflows

---

25.1	About Workflows	25-1
25.2	Entering a File to a Workflow	25-1
25.3	Reviewing Revisions in a Workflow	25-2
25.4	Working with a Rejected Revision	25-3
25.5	Viewing Workflow Information	25-3
25.5.1	Viewing a List of Active Workflows	25-4
25.5.2	Viewing a List of Your Workflows	25-4
25.5.3	Viewing Workflow History and Information About a Workflow Step	25-4
25.5.4	Viewing Content Information	25-4

## 26 Working with Images and Videos

---

26.1	About Digital Asset Management with Oracle WebCenter Content	26-1
26.2	Supported Input Formats	26-3
26.3	Supported Video Output Formats	26-4
26.4	Checking In a Digital Asset	26-5
26.5	Finding Renditions and Information	26-6
26.6	Rendition Information Page	26-6
26.7	Image Data Page	26-7
26.7.1	Accessing the Image Data Page	26-9
26.8	Rendition Parameters Page	26-9
26.9	Video Preferences Page	26-11
26.9.1	Accessing the Video Preferences Page	26-12
26.9.2	No Format Option	26-13
26.9.3	No Player Option	26-14
26.10	Working with Renditions	26-14
26.10.1	Storing Renditions in Your Digital Asset Basket	26-15
26.10.2	Viewing Items in Your Digital Asset Basket	26-16

26.10.3	Removing Items from Your Digital Asset Basket	26-17
26.10.4	Adding and Removing Renditions in a Rendition Set	26-18
26.10.5	Downloading Multiple Items	26-19
26.10.6	Creating Renditions	26-20
26.10.7	Updating Renditions	26-20
26.11	Working with Standard Content Items	26-21
26.12	Managing Digital Assets on a Macintosh Client	26-22

## 27 Working with Records

---

27.1	Understanding Retention Management	27-1
27.1.1	The Retention Process	27-2
27.1.2	Physical Content Management	27-3
27.1.3	Understanding Roles and Permissions	27-3
27.1.4	Interface Overview	27-4
27.1.4.1	Dashboards	27-4
27.1.4.2	My Favorites	27-6
27.2	Creating Records and Physical Content	27-7
27.2.1	Checking In From the Main Menu	27-7
27.2.1.1	Checking in Items Using DIS	27-8
27.2.2	Checking In Through a Retention Schedule	27-9
27.2.3	Checking In a Classified Item	27-9
27.2.4	Folios and Content Basket	27-10
27.2.4.1	Creating, Updating, or Deleting a Basket	27-11
27.2.4.2	Setting an Active Basket	27-11
27.2.4.3	Adding or Removing Items	27-11
27.2.4.4	Sorting Items	27-12
27.2.4.5	Creating Reservation Requests for Items	27-12
27.2.4.6	Downloading Items	27-12
27.2.4.7	Creating E-Mail Links to Items in the Content Basket	27-13
27.2.5	Folios and Cloned Content	27-14
27.2.5.1	Creating a Fixed Clone	27-14
27.2.5.2	Adding a Folio to a Restricted Revision Category	27-15
27.2.6	Creating a Physical Item	27-15
27.2.6.1	Using the Storage Page	27-15
27.2.6.2	Within a Retention Schedule	27-16
27.2.6.3	Creating a Physical Item Within Another Item	27-17
27.3	Finding Records and Physical Items	27-17
27.3.1	Searching for Content	27-18
27.3.1.1	Using the Search Forms Option	27-18
27.3.1.2	Using Auxiliary Metadata Sets	27-18
27.3.2	Searching for Physical Content	27-19



27.3.3	Screening for Content	27-19
27.3.3.1	Performing Screenings	27-20
27.3.3.2	Scheduling a Screening Report	27-21
27.3.3.3	Setting Default Metadata For Reports	27-21
27.3.4	Browsing the Retention Schedule	27-22
27.3.5	Browsing the PCM Storage Space	27-22
27.3.5.1	Browsing the Storage Tree	27-23
27.3.5.2	Using Exploring Pages	27-23
27.3.5.3	Viewing Information about a Storage Location	27-23
27.3.6	Generating a Retention Schedule Report	27-24
27.4	Reservations and Chargebacks	27-24
27.5	Creating a Records Profile	27-24
27.5.1	Creating a Profile	27-25
27.5.1.1	Trigger Fields	27-25
27.5.1.2	Rules	27-26
27.5.1.3	Profile Pages	27-26
27.5.2	Designing a Simple Profile	27-27
27.5.2.1	Adding a New Profile	27-27
27.5.2.2	Using the Create/Update Profile Pages	27-29
27.5.3	Profile Management	27-35
27.5.3.1	Viewing Profile Information	27-36
27.5.3.2	Updating a Simple Profile	27-36
27.5.3.3	Copying a Profile	27-37
27.5.3.4	Deleting a Profile	27-37
27.5.3.5	Moving a Profile	27-38
27.5.3.6	Changing a Trigger Field (Administrators Only)	27-38
27.5.3.7	Troubleshooting (Administrators Only)	27-38

## Part IV Using Other Ways to Work with WebCenter Content

---

### 28 Accessing Managed Content Directly from Within Your Desktop Applications

---

28.1	About Oracle WebCenter Content: Desktop	28-1
28.2	Managing Content Through Windows Explorer	28-2
28.3	Working With Managed Content Within Microsoft Word, Microsoft Excel, and Microsoft PowerPoint	28-3
28.4	Working With Managed Content Within Microsoft Outlook and Lotus Notes	28-4
28.5	Using Web Browser Search Fields to Search for Managed Content	28-6

## 29 Working with WebCenter Content from Mobile Devices

---

29.1	About the Mobile App	29-1
29.2	Everyday Tasks Using the Mobile App	29-1
29.3	Installing and Connecting to Oracle WebCenter Content	29-2
29.4	Navigating the Mobile App	29-2
29.5	Finding Documents	29-3
29.6	Viewing Files	29-3
29.6.1	Viewing a File	29-3
29.6.2	Viewing Information about a File, Folder, or Library	29-3
29.7	Downloading Files	29-3
29.8	Sharing Files	29-4

## A Metadata Fields in Records Management

---

A.1	Checkin Page Metadata Fields	A-1
A.2	Date, Format, and Audit Fields	A-2
A.3	Security Fields	A-2
A.4	Subject to Review Fields	A-3
A.5	Correspondence Fields	A-4

# Preface

This user's guide provides concepts and procedures for people who use Oracle WebCenter Content.

## Audience

This document is intended for people who view or update documents and document information stored by Oracle WebCenter Content through a web browser, mobile device, or desktop integration. People using Oracle WebCenter Content should have skills similar to those necessary for web browsing and using office applications.

## Documentation Accessibility

For information about Oracle's commitment to accessibility, visit the Oracle Accessibility Program website at <http://www.oracle.com/pls/topic/lookup?ctx=acc&id=docacc>.

### Access to Oracle Support

Oracle customers that have purchased support have access to electronic support through My Oracle Support. For information, visit <http://www.oracle.com/pls/topic/lookup?ctx=acc&id=info> or visit <http://www.oracle.com/pls/topic/lookup?ctx=acc&id=trs> if you are hearing impaired.

## Keyboard Accessibility

For information on keyboard shortcuts that can be used to navigate the Oracle WebCenter Content User Interface, see Keyboard Shortcuts in *Developing Web User Interfaces with Oracle ADF Faces*.

## Related Documents

The complete Oracle WebCenter Content documentation set is available from the Oracle Help Center at the [Oracle WebCenter Content](#) page.

## Conventions

The following text conventions are used in this document:

Convention	Meaning
<b>boldface</b>	Boldface type indicates graphical user interface elements associated with an action, or terms defined in text or the glossary.
<i>italic</i>	Italic type indicates book titles, emphasis, or placeholder variables for which you supply particular values.

<b>Convention</b>	<b>Meaning</b>
monospace	Monospace type indicates commands within a paragraph, URLs, code in examples, text that appears on the screen, or text that you enter.

# Part I

## Getting Started with Oracle WebCenter Content

You can access Oracle WebCenter Content through the completely redesigned WebCenter Content user interface or the native user interface. The enhanced, redesigned interface retains all features previously available in the native user interface.

This part contains the following chapters:

- [Introduction to Oracle WebCenter Content](#)
- [Accessing and Navigating Oracle WebCenter Content](#)
- [Understanding Content Management](#)
- [Understanding Documents and Document Properties](#)
- [Understanding Libraries](#)
- [Understanding Folders](#)
- [Understanding Document Workflows](#)

# 1

## Introduction to Oracle WebCenter Content

With Oracle WebCenter Content, you can house all unstructured content within your organization under a unified repository. In addition, you can manage the life cycle of all your content from creation to archival.

This chapter provides a general introduction to Oracle WebCenter Content and describes some of the many benefits it provides to your organization. This chapter covers the following topics:

- [About This Guide](#)
- [What is Oracle WebCenter Content](#)
- [Benefits of Using WebCenter Content](#)
- [Basic WebCenter Content Concepts](#)
- [Basic WebCenter Content Tasks](#)

### 1.1 About This Guide

This guide details how to use Oracle WebCenter Content. It is divided into the following parts:

- Part I: [Getting Started with Oracle WebCenter Content](#)
- Part II: [Using the WebCenter Content User Interface with Oracle WebCenter Content](#)
- Part III: [Using the Native User Interface with Oracle WebCenter Content](#)
- Part IV: [Using Other Ways to Work with WebCenter Content](#)

Part I provides overview information about Oracle WebCenter Content and content management and includes concepts common to all ways of working with WebCenter Content. Part II includes information on using the features available in the WebCenter Content user interface, while Part III details how to use the features available in the native user interface. Lastly, Part IV provides information about accessing Oracle WebCenter Content through desktop applications or through a mobile device.

The information contained in this document is subject to change as the product technology evolves and as hardware, operating systems, and third-party software are created and modified. Due to the technical nature of browsers, databases, web servers, and operating systems, Oracle cannot warrant compatibility with all versions and features of third-party products.

### 1.2 What is Oracle WebCenter Content

Oracle WebCenter Content manages information you use every day. Information found in e-mails, reports, memos, slide presentations, and more. Oracle WebCenter Content stores it, organizes it, and secures it so that only the people needing the information have access to it. And most importantly, it helps you find it quickly when you need it and view it through a standard web browser, even if you do not have the software that created the document.

## 1.3 Benefits of Using WebCenter Content

Communication fuels organizations and helps them effectively coordinate and execute everything from global business plans to personal task lists. Necessary information in today's organizations is captured in office documents, personal e-mail, memos, video conferences, and a variety of other types of unstructured content. Left unmanaged, critical information is lost, business processes become strained, the right people don't have the right access to documents, and you make poor decisions based on inaccurate and outdated information. Oracle WebCenter Content lets you find critical information in a comfortable environment, with applications you already use every day.

### Designed for You

You can contribute documents using a standard web browser, but also through Windows Explorer and familiar desktop applications such as Microsoft Word, Excel, and Outlook. You can route a critical contract through a workflow, allow others to see the latest design specifications, or upload a training video for your team. Oracle WebCenter Content brings you drag-and-drop convenience for uploading documents, and you have the choice to find and view content in a variety of ways using Windows Explorer, your favorite web browser, or even your Apple iPad, iPhone or Android device.

### Saves You Time

How many hours have you spent trying to find one critical bit of information about a project, customer, or legal challenge? Was it in an e-mail? Did you see it in a slide presentation? Oracle WebCenter Content brings a powerful way of searching to help you filter and retrieve the information you need quickly.

### Reduces Your Risk

With the increase of documentation-intensive compliance mandates, the need to store and retrieve compliance evidence has also increased. Using Oracle WebCenter Content records management capabilities enables you to manage records and retention policies and easily retrieve the information, saving you time and reducing your risk.

### Meets Your Needs

If your content management needs extend into rich media industries such as advertising, distance learning, web development, or other lines of business requiring use of images and video, Oracle WebCenter Content allows you to manage such digital assets simply and effectively. Store high-resolution source videos on one server while resized conversions are served out of a separate streaming server. Or group advertising collateral for a catalog in a folio, route it through a workflow, then zip it into a compressed file for distribution to a vendor. All these options are possible with Oracle WebCenter Content using the native user interface.

## 1.4 Basic WebCenter Content Concepts

Oracle WebCenter Content provides an automated system for sharing, managing, and distributing business information. This information can be in documents or some other type of content, and in this guide the terms *document*, *content*, and *file* are often used interchangeably. In some cases, for example if image conversion is enabled, multiple files may be managed together as one document. Whatever term is used, the information is being stored electronically and is managed as a single item. Oracle WebCenter Content manages the item by providing a means for you to find the information you are looking for while controlling access to the document so that only authorized people can use it.

You can access current information quickly and securely from any standard web browser. You can manage letters, reports, engineering drawings, spreadsheets, manuals, sales literature, and more, in one powerful content management system.

For typical business document management, Oracle WebCenter Content offers an easy and intuitive user interface with drag-and-drop convenience and sophisticated searching capabilities through the WebCenter Content user interface. If your needs require a more specific feature, such as managing videos, images, or records, then the native user interface provides a fully featured and familiar user experience. In addition to accessing your content through a web browser, Oracle WebCenter Content provides several alternatives for those who want an experience more integrated with their office applications, or for those on the go. Desktop and WebDAV interfaces allow you to perform primary content management actions from your desktop using folders and files to represent documents, and applications are available for accessing your documents from your Apple iPad, iPhone, or Android device.

## 1.4.1 Useful vocabulary

The following terms are used throughout this guide and it is useful to understand their definitions.

Term	Definition
WebCenter Content user interface	An easy and intuitive user interface offering drag-and-drop convenience and sophisticated searching capabilities. This user interface was introduced in Oracle WebCenter Content 11gR1 (11.1.1.8.0). For more information, see <a href="#">Part II</a> .
native user interface	A feature-rich user interface offering a familiar user experience for those who need to manage rich media beyond traditional office documents, including images, records, and videos. For more information, see <a href="#">Part III</a> .
content server	Oracle WebCenter Content uses a content server as a repository for storing and managing your documents. Multiple content servers can be used to help your company manage performance or to separate content to provide additional security or features.
document, content item, file	Any file uploaded to Oracle WebCenter Content is referred to as a document or content item interchangeably. They are discreet items tracked by the content server even though they consist of metadata and one or more files, revisions, or renditions.
metadata	<p><i>Metadata</i> is information about a document, such as the title, author, release date, and so on. You can use metadata to find documents in WebCenter Content, much as you would search for books in a library by author or subject. When you upload a document, you assign some metadata values, while Oracle WebCenter Content assigns some metadata values automatically. The metadata is stored in a database that works with Oracle WebCenter Content.</p> <p>To simplify metadata entry and selection, libraries and folders have metadata predefined. When you upload a document to a particular library or folder, the document is assigned the predefined metadata, as well as any metadata you specify. In some cases, your system administrator can create <i>Profiles</i> that specify which metadata values are displayed when you upload, search for, or view documents and document properties.</p> <p>It is important that you understand your organization's metadata fields and always assign metadata carefully. Proper metadata makes documents easier to find, and ensures that only users who have the proper permissions can access a document.</p>



Term	Definition
document properties, content information	Document properties and content information are used interchangeably in this guide. They refer to the metadata associated with a file uploaded to Oracle WebCenter Content as well as other associated information. Associated information can include additional renditions, revision history, security and sharing options and any file attachments, among others. The terms are specific to the information in Oracle WebCenter Content and do not refer to document properties associated with a file outside of WebCenter Content, such as those assigned by Microsoft Word, Excel, and other applications.
search	Search for documents using metadata. If full-text indexing has been configured by your system administrator, it also allows you to search for text within documents. In the WebCenter Content user interface, you can apply filters when searching to refine your results. For example, you can enter search terms then limit the search to libraries only, documents you are following, just images or a variety of other filter options.
browse	Browse through libraries and folders to find documents. As with searching, in the WebCenter Content user interface various filter options are available to you when browsing.
content repository	<p>When you upload a document, the electronic file is stored in a content repository. The original, or <i>native</i>, file is stored in a central repository for native files. If your system has conversion features installed and enabled, a <i>web-viewable</i> version of the file (such as PDF) is created and stored in a special repository for web-viewable files. If you are not using conversion, or if a particular file type cannot be converted, a copy of the native file is placed in the repository for web-viewable files.</p> <p>Any user with the correct security permissions can view the web-viewable version of a document or get a copy of the original file from the repository of native files. Security permissions determine who can view, revise, and delete a particular document.</p> <p>The native file and any web-viewable files associated with a document are called <i>renditions</i>. For example, the PDF version of a document is a rendition of that document, as are the HTML and XML versions.</p>
revision control	<p>To change a document that is uploaded to Oracle WebCenter Content, you must check in a new revision to the repository. It is good practice to check out a document prior to making changes. Checking out the document locks it from being checked out by anyone else, alerting them that you are making changes. Only one person can have a document checked out at any given time, but others can view the released version of the file.</p> <p>When you upload the modified file back into Oracle WebCenter Content, it is automatically stored as a new revision of the document. You can view or copy previous revisions, but the latest revision is displayed by default.</p>
workflow	In some cases you may need someone to review or approve a document before it is released for others to see. A workflow specifies how to route content for review and approval before it is released to the system. Each workflow can include multiple review and notification steps, and multiple reviewers to approve or reject the file at each step.
persistent URL	Every document in the repository for web-viewable files keeps a permanent web address that does not change from one revision to the next. The most current version is always displayed when you point your browser to the persistent URL of a document.

Term	Definition
Users	<p>Content Server defines two types of users:</p> <ul style="list-style-type: none"> <li>• <b>Consumers:</b> These are users who find, view, and print files from the content repository. They do not have permission to create, modify, or delete files.</li> <li>• <b>Contributors:</b> These are users who create and revise files in the content repository. They also have permission to find, view, and print files.</li> </ul> <p>In many Oracle WebCenter Content Server systems, the majority of users are consumers. To safeguard the integrity of files in the system, contributors must have a user name and password to check documents in to or out of the content repository.</p> <p>Users who have full administrative permissions are referred to as <i>system administrators</i>. Your organization may also assign limited administrative permission, such as the ability to set up user logins and create workflow templates, to certain users. These users are referred to as <i>subadministrators</i>.</p> <p>As of 11g Release 1 (11.1.1), user logins are managed with the Oracle WebLogic Server Administration Console. Although an administrator can manage user logins in Content Server for special purposes, the logins are not valid for authentication to Content Server until they are created with the Oracle WebLogic Server Administration Console.</p>
security groups and accounts	<p>You can set Oracle WebCenter Content security to control which users can view, edit, and delete particular documents. In some cases when you upload a file, you may have to specify a value for the following security-related metadata fields:</p> <ul style="list-style-type: none"> <li>• <b>Security group:</b> All users belong to one or more security groups. They also have a specific level of access within each security group determined by their role and the permissions the role grants. The security group is a required metadata field for all documents and may be assigned by default. Only the users who have permission to that security group can work with the document.</li> <li>• <b>Account:</b> Accounts are an optional feature that your system administrator can use to define a more flexible security model. As with security groups, only users who have permission to a particular account can work with documents that belong to that account.</li> </ul>
roles	<p>A role is a set of permissions (Read, Write, Delete, Admin). For example, as a team member, you can view a schedule (Read access), but as the team leader, you may also have to update the schedule (Read and Write access).</p> <p>The system administrator assigns roles to users to define their level of access within a security group. Available roles depend on your company needs and are created by your system administrator. Examples of typical roles are:</p> <ul style="list-style-type: none"> <li>• <b>guest:</b> The <i>guest</i> role has Read permission to the Public security group. Users can search for and view content in the Public security group.</li> <li>• <b>contributor:</b> The <i>contributor</i> role has Read and Write permission to the Public security group. Users can search for, view, upload, and download content.</li> <li>• <b>sysmanager:</b> The <i>sysmanager</i> role has privileges to access the Admin Server links under the Administration menu in the native user interface.</li> </ul>

Term	Definition
permissions	<p>Each role can have the following permissions for each security group:</p> <ul style="list-style-type: none"> <li>• <b>read (R):</b> The person can view and copy files in that security group.</li> <li>• <b>write (W):</b> The person can view, upload, download, and get a copy of documents in that security group. Authors can change the security settings of a document if the author has admin permission in the new security group.</li> <li>• <b>delete (D):</b> The person can view, upload, download, get a copy, and delete files in that security group.</li> <li>• <b>admin (A):</b> The person can view, upload, download, get a copy, and delete files in that security group. If this person has Workflow rights, they can start or edit a workflow in that security group. The person can also upload documents in that security group with another person specified as the Author. Non-authors of a document with document admin permission can change the security settings of a document if the non-author has admin permission in the new security group and optionally, account.</li> <li>• <b>Annotation Privileges:</b> Based on the annotation privileges granted here, the person can view, modify, and add annotations on all the documents in that security group. The usual options available are <b>Standard (S)</b>, <b>Restricted (T)</b>, and <b>Hidden (H)</b>.</li> </ul> <p>For more information on annotation security, see <a href="#">About annotation security</a>.</p> <p>The permissions for a security group are the highest permission defined by any of the roles <i>for that group</i>. For example, if you are assigned Guest and Contributor roles, where guest is given Read permission and Contributor is given Write permission to the Public security group, you have Write permission to content in the Public security group.</p>

Term	Definition
access control list (ACL) security	<p>An access control list is an explicit list of individuals or groups with permission to access or interact with a specific document.</p> <p>Depending on how access control list security is configured, up to three additional fields are available for use when adding, modifying, or searching for documents:</p> <ul style="list-style-type: none"> <li>• User Access List</li> <li>• Group Access List</li> <li>• Role Access List</li> </ul> <p><b>Important:</b> To use an access control list on a document, the document must be uploaded to a security group that supports access control lists, or the added security does not work. If you are uncertain if the security group you are using supports access control lists, check with your system administrator.</p> <p>To use access control lists with documents, you assign one or more predefined users, groups, or roles to the document. In addition, you assign the permissions (Read (R), Write (W), Delete (D), or Admin (A)) to each of the access list entries you specify.</p> <p>For example, suppose you add a document and you want guests to have read access and you want all logged-in users to have read and write access. First, add the <i>guest</i> role to the document and click the <b>R</b> (Read) permission icon. Then, add the <i>authenticated</i> user role to the document and click the <b>W</b> (Write) permission icon to grant both the read and write permissions.</p> <p>If either role is valid for the user, they have the access specified for the valid role. If both roles are valid for the user, they have the greater of the two permission sets. If a user has admin level access to a security group, then an ACL does not apply.</p> <p><b>Important:</b> If no access control list is enabled for a document, then the document is available to any user whose security group and account permissions allow them access. However, once a user or group has been added to the access control list of a document, then users not explicitly added lose access to the document.</p>
Oracle Content and Experience Cloud Service	The cloud-based content management product from Oracle.

## 1.4.2 What are document libraries?

When using the Oracle WebCenter Content user interface, documents in the content server are organized into libraries that can also contain folders and subfolders. There are the following types of libraries:

- **System Libraries**, created and managed by Oracle WebCenter Content to organize documents that are in a system process, such as checked-out or expired documents. Documents cannot be uploaded to a system library.
- **Enterprise Libraries**, created by individuals to provide flexible security and comprehensive document management used by an entire organization.

Documents are uploaded to WebCenter Content in the context of a library or folder. To upload documents to a specific library or folder, you must navigate to the library or folder first, and then upload the document. Doing so applies the correct metadata to a document and organizes it in Oracle WebCenter Content so that you and others can find it. For detailed information on libraries and folders, see [Understanding Libraries](#) and [Understanding Folders](#).

## 1.4.3 What are folders?

Folders in Oracle WebCenter Content are used to organize documents so that you can find them quickly by browsing the folder structure. There are three main types of folders in Oracle WebCenter Content:

- Traditional folders, which are similar to folders you use to organize your files in your computer file system.
- Cloud folders, which are a special kind of folders, allow you to copy content to and from Oracle Content Management Cloud Service.
- Saved searches, which are collections of documents based on search criteria you have saved.

Traditional folders in Oracle WebCenter Content are like folders on your computer with one important distinction: they have metadata associated with them. They can automatically assign default folder metadata to the documents organized in them, and you can easily change metadata for multiple documents by propagating metadata assigned at the folder level to documents in them. Having default metadata or being able to change metadata to a group of documents through propagation saves you time. You can upload documents to a folder and know that they are secure and easily found without having to manually assign security and other metadata, and you can change the metadata of multiple documents easily when information changes.

Cloud folders are a special kind of folders created to allow copying of content to and from the cloud server. They act as a link to a folder in Oracle Content Management Cloud Service. If your company has integrated with Oracle Content Management Cloud Service, you can copy or upload files to the cloud using a cloud folder, and you can access content on the go through the cloud user interface.

Saved searches aren't actually folders in the traditional sense, but rather they are search criteria you have saved that are executed when you click a saved search. They give you the experience of browsing through a file system while in reality searching for content using metadata. For example, a saved search can be created titled *Documents Released Since October 2015* that when clicked displays all documents released since the first day of October 2015 till the current date. The contents change every day without people having to upload documents to a specific folder, because clicking the folder tells Oracle WebCenter Content to find all documents released since October 2015 and display them in a list.

## 1.4.4 What are shortcuts?

You can create shortcuts to any item (library, folder, or document) to which you have access in Oracle WebCenter Content. A shortcut points to an item, allowing you a way to quickly organize how you access items pertinent to you. For example, you may work on several projects, each requiring a specification document, and each specification document is stored in the associated project folder. You can create a folder containing shortcuts to each specification document. So instead of having to search through multiple project folders to find the documents you want, you can click your folder and have shortcuts to all specification documents listed there for quick, convenient access.

## 1.4.5 What are favorites?

Each person's Favorites listing is private and always available in the side bar. You can easily add to your Favorites folder by clicking the star on a document list or from a document

properties page. Favorites provide a quick and easy way to navigate to those items you use frequently or those items you want to quickly find later.

## 1.4.6 How do I find content?

There are two ways of finding documents in Oracle WebCenter Content:

- Browsing
- Searching

In the WebCenter Content user interface, find content using the **Search**, **Browse**, and **Favorites** links in the side bar. The first time you log in to Oracle WebCenter Content, the Search link is active in the side bar and the latest revision of all documents in Oracle WebCenter Content to which you have access are displayed in the content area. In this view, all documents are displayed in a single flat list regardless of what library or folder they may be in. You can review the documents in the content area or filter the results using the search box above the content area. You can personalize this page to display all documents, all libraries, or your favorites the next time you log in.

In the native interface, browse for content using the Browse Content or Content Management trays in the side bar, or search for content using the Search tray, Quick Search field, or other search form.

You can search for a document by its metadata, by full-text, or by a combination of the two. Only the documents you have permission to view are displayed in the results list.

You can specify search terms for one or more metadata fields. Depending on how your system is configured, you can use search operators that specify if the search term is a whole word or part of a word, or if it appears at the start or the end of the field. You can also use wildcard characters to match one more characters in a search term.

To simplify or customize the search form, an administrator can create one or more metadata *profiles* that specify the metadata fields that are included on the form.

With the Quick Search function, you can search at any time from the home page. You can specify a search term for a selected field or for all supported fields. If your system is configured for full-text search, Quick Search also searches for the search term in the text of documents.

## 1.4.7 Can I manage images and videos?

If Oracle WebCenter Content is configured to manage digital assets such as images or videos, you can use the native user interface to quickly find, group, convert, and download images and videos of various sizes, formats, and resolutions to meet your business needs. This helps maintain a consistency of use across your organization. For example, an organization's logo can be available in a variety of sizes for advertisements, web pages, and presentation, or a company training video can be available in a variety of formats for streaming on an intranet, presenting to an audience, or copying to tape.

## 1.4.8 Can I manage content through office applications?

Oracle also offers Oracle WebCenter Content: Desktop, which can enhance the WebDAV client environment by more closely integrating with Windows Explorer, Microsoft Outlook, Lotus Notes, and other applications. For more information, see [Accessing Managed Content Directly from Within Your Desktop Applications](#).

## 1.4.9 What are folios and how are they used to group content?

A *folio* is a logical grouping or framework to organize content stored in Oracle WebCenter Content. Folios are available through the native user interface and useful when you want to organize groups of documents, such as contracts or sales information, that include some common components and some unique components, and assemble them in a standardized sequence and hierarchy. Folios are also useful when you want to create and review a group of documents as part of one or more workflow processes.

With a *simple folio*, you collect one or more items in a single level. With an *advanced folio*, you can organize content in a hierarchy of folders.

An advanced folio can contain folders, called nodes, placeholders for content, called slots, and documents. These elements are displayed by default in a hierarchical structure, similar to a standard file system.

## 1.4.10 What are workflows and how are they used to route content?

In Oracle WebCenter Content, the workflow process routes a file for review and approval before it is released to the content repository. Users are notified by e-mail when they have a file to review.

You can optionally sign and approve a file with an electronic signature which uniquely identifies the contents of the file at a particular revision and associates the signature with a particular reviewer.

You can create two types of workflows in Oracle WebCenter Content:

- In a *criteria* workflow, files automatically go into a workflow if the values entered in the metadata fields upon check-in meet certain criteria. Criteria workflows are useful for individual documents that are approved by the same reviewers on a regular basis (newsletter articles, for example).
- In a *basic* workflow, files are specifically identified in the workflow, along with the contributors, reviewers, and steps. This type of workflow requires an administrator to initiate the process, and is best suited for groups of documents that go through a workflow or individual documents with unique workflow requirements.

## 1.5 Basic WebCenter Content Tasks

Regardless of whether you access Oracle WebCenter Content from your desktop, mobile device, or web browser using either the WebCenter Content interface or the native user interface, managing your documents has several common factors:

- Logging in to gain access to your documents
- Finding the documents you need
- Viewing documents and their properties
- Uploading documents you want managed
- Downloading documents you need
- Organizing documents in useful ways
- Sharing documents with others through workflows



# 2

## Accessing and Navigating Oracle WebCenter Content

With Oracle WebCenter Content, you can use a number of ways to access and navigate through content within your organization. You can choose from several options, such as, a standard web browser, a mobile device, Microsoft Office applications, or Windows Explorer to find and view content.

This chapter covers the following topics:

- [Understanding How to Access Oracle WebCenter Content](#)
- [Navigating Oracle WebCenter Content Using a Standard Web Browser](#)

### 2.1 Understanding How to Access Oracle WebCenter Content

Oracle WebCenter Content offers a number of ways to find and view content, including through office applications such as Microsoft Word and Windows Explorer, and even through your Apple iPad, iPhone or Android device. The features available to you depend on the device you use to connect and how you access Oracle WebCenter Content. When accessing documents through a standard web browser, Oracle WebCenter Content offers two distinct interfaces, each with their own unique features, options, and web address:

To access Oracle WebCenter Content, a system administrator provides you with the proper web address, user name, and password. The web address for accessing the WebCenter Content user interface is different than the one used for the native user interface. Typically you are given the web address for the interface that has the features you need.

#### 2.1.1 How do I access Oracle WebCenter Content using a web browser?

This chapter provides an overview to the basic user interface options for Oracle WebCenter Content. Specific details of how to use each interface are in [Getting Started with WCC UI](#) and [Getting Started with Native UI](#).

#### 2.1.2 Can I access Oracle WebCenter Content outside of a web browser?

This guide focuses on accessing Oracle WebCenter Content through a standard web browser but you can also access documents through Microsoft Office applications, Windows Explorer, and mobile devices. For an overview of alternate ways to accessing Oracle WebCenter Content, including links to specific documentation, see [Part IV](#).

### 2.2 Navigating Oracle WebCenter Content Using a Standard Web Browser

Both default user interfaces used to access Oracle WebCenter Content share common features:

1. A top banner with links to preferences and searching



2. A side bar, called the tray area in the native user interface, with links for folders and other navigation options
3. A main content area used to display documents and results lists

Figure 2-1 WebCenter Content User Interface

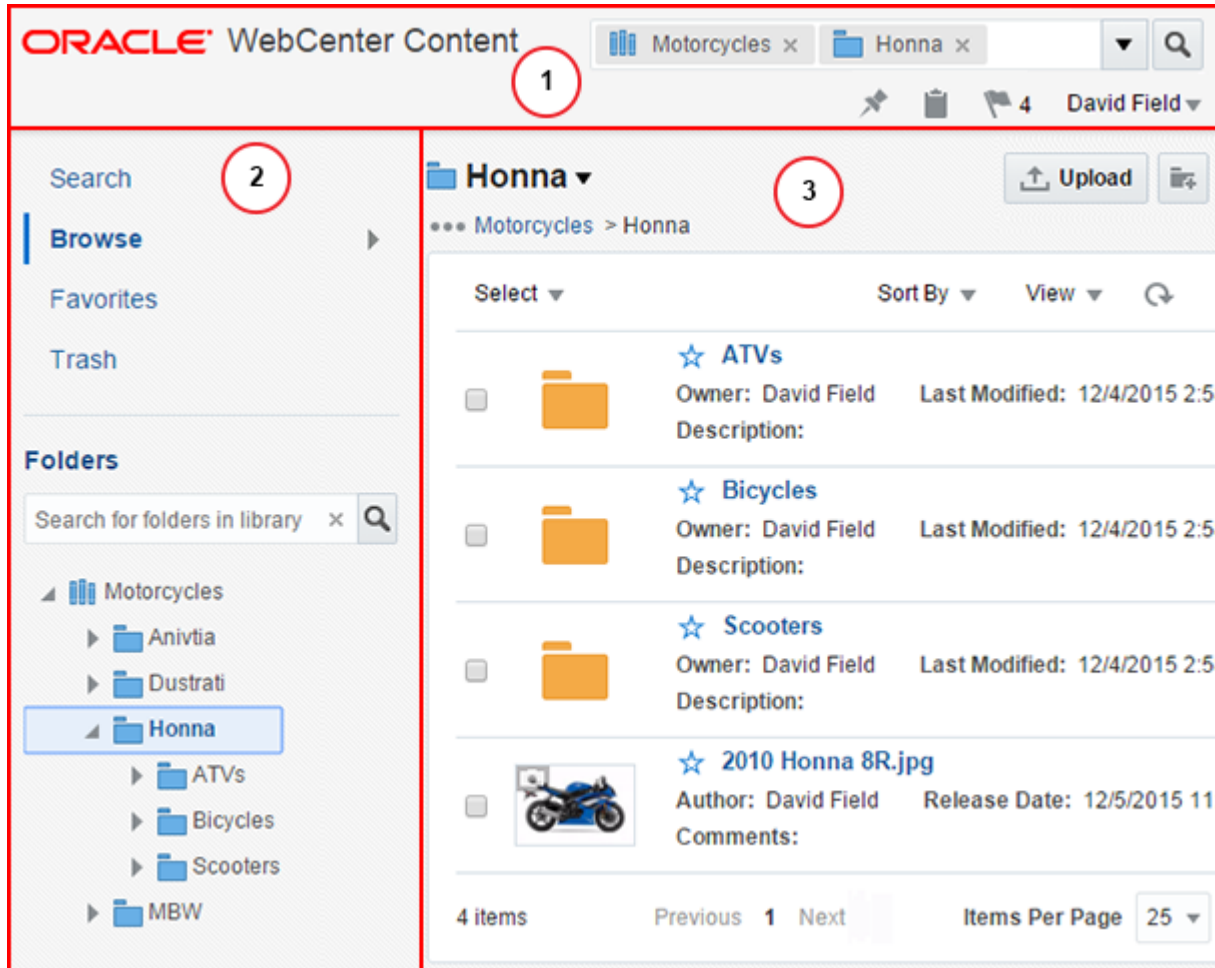
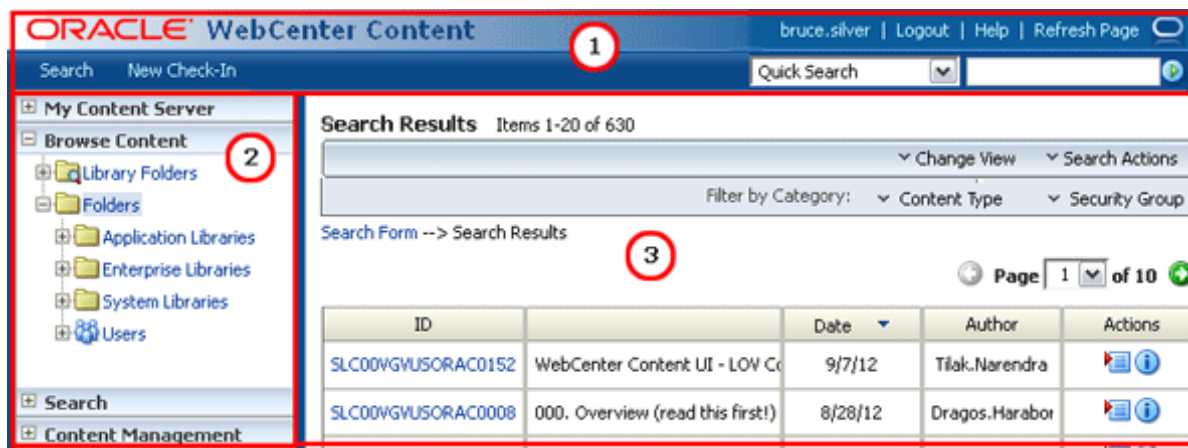

Figure 2-2 Native User Interface



## 2.2.1 How do I browse and search for content?

The navigation links in the side bar and tray area are used to browse through libraries and folders to help you find documents. These links are useful when you have an idea of how the document is organized in Oracle WebCenter Content.

If you are uncertain of the context in which a document was uploaded to Oracle WebCenter Content, then it may be faster to search for it using the search box in the banner area. The search box can be used for either metadata search or full-text search, depending on how Oracle WebCenter Content is configured by your system administrator.

### Searching in the WebCenter Content Interface

The search box works differently in the WebCenter Content interface than it does in the native user interface. In the WebCenter Content interface, the search box works in combination with your browsing, searching within the context of the folder or library you are browsing. For example, if you browse to a folder called *My Motorcycles* in the *Motorcycles* library, then tags for the library and folder are displayed in the search box and Oracle WebCenter Content searches the titles of documents in the *My Motorcycles* folder for any terms entered in the search box. Selecting the **Search <Folder> and Subfolders** option from the folder drop-down menu allows you to search within the context of the *My Motorcycles* folder. Closing the tags in the search box clears the filter and changes the context of the search.

Figure 2-3 Search Box in WebCenter Content Interface with Contextual Tags



### Filtering Results Using the WebCenter Content User interface Search Box

You can apply filters using the search box to refine your search. Options to filter results by library or folder are displayed below the search box as you type. Options to filter the results based on specific metadata are displayed by selecting the filter menu next to the search box.

Figure 2-4 Search Box with Metadata Filters



### Searching in the native user interface

The search box in the native user interface does not work in combination with your browsing to filter your search. Instead, it offers a variety of search options called quick searches. Quick searches look through the entire repository, performing a substring search of the title and

content ID metadata, and the indexed full-text if it is supported on your system. Quick searches can support Internet-style search syntax, complex construction, and alternate query formats. They can be predefined by a system administrator or you can define your own. For detailed information about defining quick searches, see [Creating Quick Search Queries](#). For information on additional search capabilities of the native user interface, see [Using Additional Search Capabilities](#).

**Figure 2-5 Search Box in Native User Interface with Quick Searches**

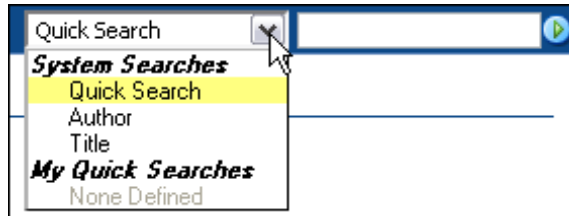

### Search Forms

You can provide detailed search criteria using search forms in either user interface. Search forms allow you to enter criteria in most available metadata fields or use special query syntax to create powerful ways of searching. The standard search form can often include many metadata fields that you may not use, and so a system administrator may have set up profile forms to display metadata fields that are useful for finding certain types of documents. For example, one profile may be set to display fields useful to finding legal contracts, while another profile may be set to display fields useful to finding account invoices. For details on profiles, see [Content Profiles](#).

Figure 2-6 Search Form in WebCenter Content User interface

The screenshot shows a 'Standard Search' dialog box with the following fields and options:

- Name: Starts (dropdown) [text input]
- Document ID: Starts (dropdown) [text input]
- Type: Matches (dropdown) [dropdown]
- Title: Starts (dropdown) [text input]
- Author: Starts (dropdown) [dropdown]
- Security Group: Matches (dropdown) [dropdown]
- Account: Matches (dropdown) [dropdown]
- Release Date: Between [calendar icon] And [calendar icon] [text input]
- Expiration Date: Between [calendar icon] And [calendar icon] [text input]
- Comments: Starts (dropdown) [text area]
- User Access List: Starts (dropdown) [text area] [Add Users dropdown]
- Group Access List: Starts (dropdown) [text area] [Add Aliases dropdown]
- Role Access List: Starts (dropdown) [text area] [Add Roles dropdown]
- Profile: Matches (dropdown) [dropdown]
- Image Rendition Set: Matches (dropdown) [dropdown]
- Video Rendition Set: Matches (dropdown) [dropdown]

Buttons: Search, Cancel

Figure 2-7 Search Form in Native User Interface

**Search: Expanded Form** [quick help](#)

Switch Profile Search Forms

Search Reset Save

---

**Metadata Search**

Content ID Substring

Title Substring

Type Substring

Security Group Substring

Author Substring

Release Date From   To

Expiration Date From   To

Comments Substring

---

**Results Options**

Results Per Page:  Sort By: Release Date  Descending

Search Reset Save

# 3

## Understanding Content Management

Content management is a process that helps you administer content within your organization from creation to archival or deletion. The content can be of any format, such as, documents, images, video, audio, and so on. Different aspects of content management are detailed here.

This chapter covers the following topics:

- [Managing Unstructured Documents](#)
- [Understanding Uploading, Checking In, and Checking Out Documents](#)
- [Understanding Document Metadata Properties](#)
- [Understanding How to Find Documents](#)
- [Understanding How a Document is Processed Within Oracle WebCenter Content](#)
- [Understanding Document Security](#)
- [Understanding Library and Folder Security](#)

### 3.1 Managing Unstructured Documents

Unstructured documents are all the documents, files, e-mails, memos, images, videos, slide presentations or other work product that fill your inbox and clutter your desk. Filing them in a drawer or letting them sit in your e-mail might get them out of your way, but often they are filled with critical information. Oracle WebCenter Content allows you to take those documents and the information they contain and organize them, making them easy to find, access, and share.

### 3.2 Understanding Uploading, Checking In, and Checking Out Documents

To organize unstructured content, you upload documents to Oracle WebCenter Content. Many times a document that has been uploaded to Oracle WebCenter Content needs to be revised. Oracle WebCenter Content controls access and tracks changes to documents, providing access to a history of document revisions.

#### 3.2.1 Uploading documents

*Uploading* is the process of getting new documents into Oracle WebCenter Content. You can upload an electronic file by browsing a file system or upload a physical document by scanning it in. Documents are uploaded into the context of a library or folder already set up in Oracle WebCenter Content. When it is uploaded, the document is assigned information, or metadata, that is associated with the folder or library. The metadata becomes the document properties, and can be used to find documents in Oracle WebCenter Content.

## 3.2.2 Can I upload documents to Oracle Content Management Cloud Service?

If your Oracle WebCenter Content Server is integrated with Oracle Content Management Cloud Service, you can upload documents to the cloud server directly. For more information, see [Uploading Content to Oracle Content Management Cloud Service](#).

## 3.2.3 Checking out documents

*Check-out* is the process of locking a document so that no other users can revise it. Only one user at a time can check out a file; however, multiple users can continue to view the released file. There are two approaches to checking out files manually:

- For content items that could be revised by other users, it is a good idea to check out the file as soon as you know that you must edit it to prevent other users from checking in a new revision with potentially conflicting changes.
- For content items that are unlikely to be revised by other users, you can make revisions to a copy of the file, check out the content item, and immediately check it back in with the edited file.

### Note:

You must have write permission to the document to check it out or undo a check-out.

### Checking out from Oracle Content Management Cloud Service

If your Oracle WebCenter Content Server is integrated with Oracle Content Management Cloud Service, you can copy or move documents between the two content servers, but you cannot check content out from the Oracle Content Management Cloud Service directly. However, you can upload new revisions of a document directly from Oracle Content Management Cloud user interface.

## 3.2.4 Checking in documents

*Check-in* is the process of uploading a new revision of a document already in Oracle WebCenter Content. You upload new documents and check in new revisions of existing documents.

## 3.3 Understanding Document Metadata Properties

*Metadata*, also called document *properties*, or *content information*, is information about a document, such as the title, author, release date, who can access the document and its metadata, and so on. You can use metadata to find documents in Oracle WebCenter Content, much as you would search for books in a library by author or subject. When you upload a document, you assign some metadata values, while Oracle WebCenter Content assigns some metadata values automatically. The metadata is stored in a database that works with Oracle WebCenter Content.

### 3.3.1 When do I use document metadata properties?

You use document properties for the following reasons:

- To secure documents to control access. Security Group is a required metadata field anytime you upload a document. In some cases, the security group may be set for you automatically.
- To refine access. Access control lists are optional metadata that can control who has access to folders or documents at the folder or document level.
- To categorize documents. Document type is a required field that helps you organize documents.
- To track multiple revisions of documents. A revision history is useful when you need to see how a document has changed.
- To track who uploaded or edited the document and when.
- To find documents. Metadata associated with a document can be easily searched and used to filter documents so that you can find the one document you need out of many managed by Oracle WebCenter Content.

For more information about document metadata properties, see [Understanding Document Properties](#).

## 3.4 Understanding How to Find Documents

A critical reason for managing unstructured content is so that you can find pertinent information quickly. To do this, Oracle WebCenter Content uses a powerful combination of browsing through libraries, searching for metadata and filtering results. If your system is configured to do so, Oracle WebCenter Content also indexes the full text of a document, making it available for searching.

### 3.4.1 Library and folder context

Documents uploaded to Oracle WebCenter Content can be unfiled, meaning that they are not uploaded to any library or folder, or organized in the context of a library and folder. If you know in what context documents are organized, it is easy to browse for them using the Library and Folder options in the side bar. For more information on libraries, see [Understanding Libraries](#).

### 3.4.2 Metadata search

You can search for documents using the metadata values associated with the documents. This is useful when:

- The documents you are looking for are not filed in the context of a library or folder.
- You do not know how the documents are organized.
- You want to refine your search within the context of how the documents are organized.

When searching using metadata values, you can use a search operator to narrow or broaden your search criteria.



### 3.4.3 Metadata search operators for a database metadata search

If you use a search form rather than the search box, you can use search operators to refine the search criteria. These operators are listed as options in lists to the left of each field.

The following table describes the search terms used and provides examples for use.

Operator	Description	Example
Substring	Finds content items with the specified string anywhere in the metadata field. This operator has the same effect as placing a wildcard before and after the search term. This is the default operator.  This operator is not available for implementations that use Oracle Text Search.	When you enter <code>form</code> in the Title field, the search returns items with words such as <code>forms</code> , <code>performance</code> , and <code>reform</code> in their title.
Matches	Finds items with the exact specified value in the metadata field.	When you enter <code>address change form</code> in the Title field, the search returns items with the exact title of <code>address change form</code> .
Starts	Finds items with the specified value at the beginning of the metadata field. This operator has the same effect as placing a wildcard after the search term when using the Matches operator.	When you enter <code>form</code> in the Title field, the search returns all items with a title that begins with <code>form</code> , including <code>forms</code> , <code>forming</code> , and so on.
Contains	Finds items with the specified whole word or phrase in the metadata field. This operator is available only for Oracle Text Search, or for Oracle Database and Microsoft SQL Server database with the optional <code>DBSearchContainsOpSupport</code> component enabled. For more information, see your administrator.	When you enter <code>form</code> in the Title field, the search returns items with the word <code>form</code> in their title but does not return items with the word <code>performance</code> or <code>reform</code> .
Ends	Finds items with the specified value at the end of the metadata field. This operator has the same effect as placing a wildcard before the search term when using the Matches operator.	When you enter <code>form</code> in the Title field, the search returns all items with titles that end with <code>form</code> , such as <code>form</code> , <code>perform</code> , and <code>chloroform</code> .
Not Substring	Finds content items that do not have the specified string anywhere in the metadata field.	When you enter <code>form</code> in the Title field, the search returns items without words such as <code>forms</code> , <code>performance</code> , and <code>reform</code> in their title.
Not Matches	Finds items that do not have the exact specified value in the metadata field.	When you enter <code>address change form</code> in the Title field, the search returns items without the exact title of <code>Address Change Form</code> .

### 3.4.4 Metadata search case sensitivity

Case sensitivity for metadata searches varies depending on how your system administrator has configured Content Server.

**Note:**

For information about your specific configuration, see your system administrator.

- Microsoft SQL Server: If Content Server is using database searching with Microsoft SQL Server, metadata searches can be case sensitive or insensitive, depending on how the database is set up.
- Oracle Database: If Content Server is using database searching with Oracle Database, metadata searches are always case sensitive and full-text searches are not case-sensitive.
- IBM DB2: If Content Server is using database searching with IBM DB2, metadata searches are case sensitive.

### 3.4.5 What is full-text searching?

*Full-text* searching enables you to find a content item based on the text contained in the file itself. When you check in a content item into Content Server, the indexer stores all of the words in the Web-viewable version of the content item (PDF, HTML, text, or other supported file formats) in an index. A full-text search compares the search expression with the index and returns any content items and discussions that contain the search text.

You can include the following in a full-text search expression:

- Strings: partial words (such as *addr*)
- Words: individual whole words (such as *addresses*)
- Phrases: multiple-word phrases (such as *new addresses*)
- Operators: logic applied to words and phrases (such as *news AND addresses*)

For more information, see [Full-text search rules](#).

Search terms can be highlighted in the returned text, provided Content Server is using Oracle Database full-text search and your administrator has enabled the functionality. Forward (>>) and back (<<) navigation links bracket the highlighted text. Click the links to go to the next and previous result in the text.

### 3.4.6 Full-text search rules

To refine your full-text search criteria:

- You can use wildcards in full-text search queries.
- You can use search operators in full-text search queries.

For more information, see [Oracle database full-text search operators](#).

- You can use [Internet-Style Search Syntax](#).
- When you perform a full-text search, the search finds the word you specify *and* words that have the same *stem*. For example, searching for the word *address* finds files with the word *address*, *addressing*, *addresses*, or *addressed* in them. To limit the search to the word you specify, place the word in double quotation marks (for example, "address").
- You can sort full-text search results by the number of occurrences of the search terms and the proximity of the search terms when you use an operator such as <NEAR>. Select the **Score** option from the **Sort By** list on the Oracle WebCenter Content.

 **Note:**

You can sort the results using the **Score** option only if you are using the Oracle 11g database search solution and have installed the Oracle Text Search option.

### 3.4.7 Full-text search case sensitivity

Case sensitivity for full-text searches varies depending on how your system administrator has configured Content Server. By default, full-text searches with Oracle Database are not case sensitive. Full-text searches with Microsoft SQL Server vary based on how the database is set up.

If your Content Server configuration includes an optional search engine, case sensitivity depends on the search engine. For information about your specific configuration, see your system administrator.

 **Note:**

Generally, you should use all lowercase search strings to find all of the files that match your search expression. Use mixed-case search strings *only* if you are looking for a specific combination of lowercase and uppercase.

### 3.4.8 Oracle database full-text search operators

Use the following operators to refine your Oracle Database full-text search expression.

 **Note:**

For clarity, the operators are shown in uppercase, but they can also be in lowercase.

Operator	Description	Example
AND	Finds content items that contain all of the specified terms.	<code>address AND name</code> returns content items that contain both specified words.
OR	Finds content items that contain at least one of the specified terms.	<code>safety OR security OR protection</code> returns content items that contain at least one of the specified words.
NOT	Finds content items that contain the term that precedes the operator (if any), and ignores content items that contain the term that follows it.	<code>NOT server</code> returns content items that do not contain the word <code>server</code> . <code>internet NOT server</code> returns content items that contain the word <code>internet</code> but do not contain the word <code>server</code> .

Operator	Description	Example
NEAR(term1, term2)	Finds content items that contain the specified terms near to each other. Terms that are closer receive a higher score.	NEAR(internet, server) returns content items that contain the specified words close to one another.
ISABOUT(phrase)	Finds content items that contain the phrase specified in the parenthesis.	ISABOUT(changed address) returns content items that contain the specified phrase.

## 3.5 Understanding How a Document is Processed Within Oracle WebCenter Content

Oracle WebCenter Content must process documents when they are uploaded or checked in. This process includes:

1. Determining the metadata options based on the document context.
2. Assigning values to the metadata that are either provided automatically by the system or manually by the person who uploaded the document.
3. Converting the document if necessary using the conversion options specified by a system administrator. Conversion options may provide one or more types of web-viewable options for the document so that people throughout the organization have access to see it even though they may not have the native application that created the document.
4. Storing the documents and web-viewable conversions based on rules defined by a system administrator. Native and converted documents can be stored in a database, on a file system, or using a combination of the two.
5. Routing a document through a workflow if it meets the criteria to do so. Workflow criteria are defined by a system administrator and documents that meet the defined criteria are automatically routed.

### Releasing a Document

Once a document has been processed successfully, it is indexed by Oracle WebCenter Content so that others with proper access can find the document. The document or its metadata only are indexed when the document meets all of the following criteria:

- The document converts successfully or passes through without conversion if no conversion is necessary
- The document is approved at all steps of a workflow (if any)
- The document reaches its release date

Once a document is released, you can:

- Find the document by browsing or searching
- Retrieve the web-viewable file, the native file, the metadata, or any combination of these

Figure 3-1 Revision Process

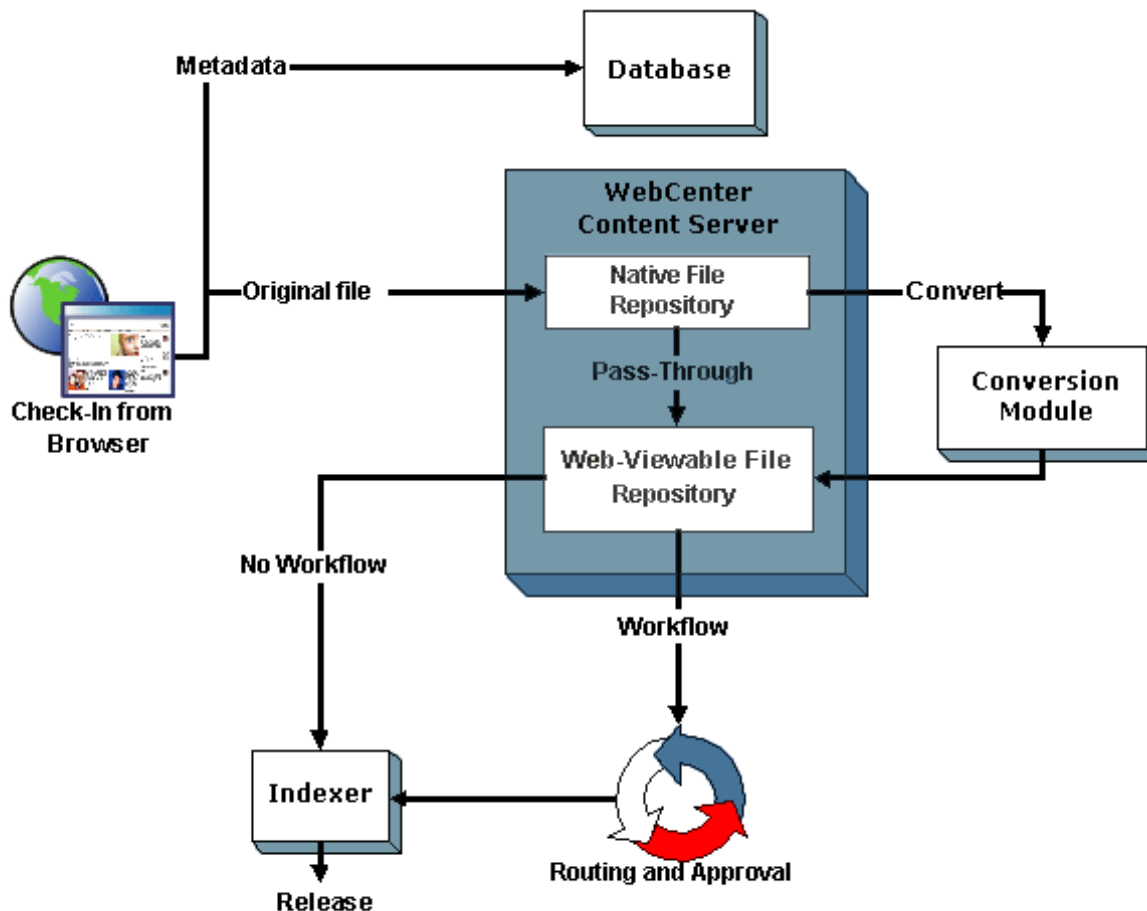

### 3.5.1 Revision status

A document changes status several times when it is uploaded or revised. It is useful to know what types of status there are in case you have difficulty finding a document or need to locate a document that is not yet released.

Status	Description
Waiting	The document has a revision in the system but has not been sent for conversion.
GenWWW	The document is being converted to web-viewable format or is being indexed, or has failed conversion or indexing.
Done	The document is waiting to be released on its specified release date.
Released	The revision is available in Oracle WebCenter Content.
Review	The revision is in a workflow and is being reviewed.
Edit	The revision is at the initial contribution step of a workflow.
Pending	The revision is in a basic workflow and is waiting for approval of all revisions in the workflow.

---

Status	Description
Expired	The revision is no longer available for viewing in Oracle WebCenter Content. (The revision is not removed from the repository, but only an administrator can access it.)
Deleted	The revision has been deleted and is waiting to be completely removed from Oracle WebCenter Content during the next indexing cycle.

---

## 3.5.2 What is a revision history?

Each time you check out a document and check it back in, Oracle WebCenter Content creates a new revision of that document. The new revision has the same content ID as the previous revision, but the native file and the metadata can be the same or different. The system stores the previous versions of a document, so you can review them as necessary.

## 3.5.3 What is expired content?

A document can have an expiration date that specifies when the document is no longer accessible through the standard interface for searching or viewing. All revisions of the document expire when the document expires.

To determine if a document has expired, use the Expired Content page in the Content Management tray.

When a document expires, it and its revisions are not deleted from the repository, but they can be accessed only from the Repository Manager by an administrator unless Notification of Expiration is in use.

## 3.6 Understanding Document Security

Document security determines who can view a document, who can edit it, and who can modify the document properties. Access is controlled by a combination of roles and security groups created by a system administrator, and access control lists you define when uploading a document. Optionally, an account can be set up to refine security. For more information, see [Understanding Document Security](#).

## 3.7 Understanding Library and Folder Security

Security can be set at library and folder levels as well as the document level. Security is inherited from the containing library unless it is set independently. For more information, see [Library and folder security](#).

# 4

## Understanding Documents and Document Properties

Regardless of how you access a document, the tasks you can perform on it remain same. Here you learn about various tasks, properties, and options associated with documents. This chapter covers the following topics:

- [About Documents](#)
- [Finding Documents](#)
- [Viewing and Annotating Documents](#)
- [Understanding Document Properties](#)
- [Understanding Document Security](#)
- [Understanding Document Renditions](#)

### 4.1 About Documents

Documents are uploaded to Oracle WebCenter Content into a library, folder, or subfolder. Libraries and folders give a document context and provide a structure that helps you easily find a document. As documents in Oracle WebCenter Content are updated, document revisions are tracked so that you always have access to the current version while still being able to review document history.

### 4.2 Finding Documents

Oracle WebCenter Content provides an innovative way of finding documents through a combination of browsing and searching. In the WebCenter Content user interface you can browse through libraries and folders using the side bar, or search using the Quick Search box or the expanded search form access through the banner then enter search criteria into the search box to filter the contents.

### 4.3 Viewing and Annotating Documents

When a document is uploaded to Oracle WebCenter Content, the document is converted to a web-viewable version. This allows the document to be shared and viewed by anyone with permission using a standard web browser, regardless of whether or not they have the software application used to create the document. A large variety of file formats are supported for conversion, and the source files can include business documents, CAD drawings, multiple page TIFFs and PDFs, photographs, and video, among others. Documents are viewed in different ways depending on whether you access Oracle WebCenter Content through the desktop, a mobile device, or one of the web browser user interfaces.

Provided you have the permissions to do so, you can add or modify annotations to documents. Among other things, documents can be stamped *Approved*, have a particular text highlighted, or have a note addressing a specific issue added.

## 4.4 Understanding Document Properties

*Document properties*, also called *metadata*, or *content information*, is information about a document, such as the title, author, release date, who can access the document and its metadata, and so on. When you upload a document, you assign some metadata values, while Oracle WebCenter Content assigns some metadata values automatically. The metadata is stored in a database that works with Oracle WebCenter Content.

In some cases an organization may have many different types of metadata to track, not all of which are useful to you. For example, you may be uploading resumes to an HR folder where the document properties must track the applicant name and department to which they are applying. Another person may be uploading photos to an Advertising folder and tracking the subject of the photo and the name of the photographer. Neither of you needs the metadata being used by the other, so profiles are created which display only a small part of the available metadata fields. When you upload the resumes, you select the HR profile and see only the metadata fields you need. When the other person uploads the photos, she selects the Advertising profile and only sees the metadata fields she uses.

You can use metadata to find documents in Oracle WebCenter Content, much as you would search for books in a library by author or subject.

### 4.4.1 How do I define document metadata values?

The values of document properties can initially be set when you first upload a document in the following ways:

- You enter metadata values manually. For example, when you upload a document, the default title of the document is the file name, such as *document1.txt*. You can change that to a more meaningful title, such as *November Expense Report*. Any metadata values you enter can be changed at a later time.
- The folder or library context into which you upload a document determines some of the values. When a folder or library is created, values can be defined that get applied to any documents uploaded to the folder or library.
- Oracle WebCenter Content defines values for some metadata. These values are considered system metadata. System metadata cannot be modified by you.

The values of document properties can also be changed after you upload a document in the following ways:

- You change metadata values manually using the metadata tab of the View Documents page. For more information about the View Documents page, see [View Documents page](#).
- You change the metadata of the folder or library the document is in and propagate the changes to the documents in the folder or library.

#### Note:

Metadata values of a document can be modified individually or through propagation, but any modification may be overwritten if the folder metadata is propagated again. For information on propagating metadata, see [Propagating Library Metadata](#).



## 4.4.2 Can document profiles be used to control metadata fields?

The available metadata fields for documents managed by Oracle WebCenter Content are determined by a combination of required system fields and fields defined by your system administrator for your organization. Not all available fields are useful to all business situations. For example, a customer call center may need a field to track customer call tickets, but have no use for a vendor ID field needed by an accounting department. Document profiles can be defined by a system administrator and selected by you when uploading a document to filter what fields are available when uploading. For detailed information about document profiles, see [Content Profiles](#).

## 4.5 Understanding Document Security

Document security determines who can view a document, who can edit it, and who can modify the document properties. Access is controlled by a combination of roles and security groups created by a system administrator, and access control lists you define when uploading a document. Optionally, an account can be set up to refine security.

- **Roles** are permissions assigned to users and determine what rights you have within a security group. Available permissions are Read (R), Write (W), Delete (D), Admin (A), or Annotation Privileges. For more information on annotation privileges, see [About annotation security](#).
- **Security groups** are assigned to a document when it is uploaded and determine who has access to the document. If you are in the assigned security group, you have access to the document with the permissions set by your role, unless filtered out by an account or an access control list.
- **Accounts** are optional and are assigned to a document when it is uploaded, similar to security groups. Accounts give an additional level of security. If a document is assigned a specific account that you do not have access to, you cannot access the document even though you may be part of the security group.
- **Access control lists** are a way for you to override the other security options when you upload a document, within limits. For example, even though hundreds of people may have Read rights to the documents in the security group, you can confine access to a certain few people, give them Write permission to your specific document, and collaborate on it. When you are ready, you can remove the access control list so all people in the security group can see the document.

The limitations of an access control list are these:

- When permissions differ between what is set in a security group or account and what is set in an access control list, the permissions will be the lesser of the two. For example, if you have Read permission in the HR security group but are set to have Write permission on an access control list in the HR security group, you will have Read permission.
- When permissions differ between what is set in a role and what is set in an access control list, the permissions will be the greater of the two. For example, if you are a contributor and the contributor role is set to have Write permission but an access control list is set to have Admin permission, then you will have Admin permission.

 **Note:**

In some situations, using an access control list without including yourself as a user can cause you to lose access to the document, folder, or library. It is a good idea to always add yourself when setting access control.

## 4.5.1 Library and folder security

Security can be set at library and folder levels as well as the document level. Security is inherited from the containing library unless it is set independently. For example, if the security group set for a library is *HR*, then all folders and documents in the library also have the security group set to *HR* unless changed.

If you specify a security group to be different from the containing library when you create a folder, then all documents checked into the folder inherit the folder security unless you change it.

If you change security on a folder or library with documents inside of it, the security on the documents does not change unless you specify the changes be propagated. If you specify the changes be propagated, then you can choose to change the security on all contained documents or only the contained folders.

### Conflicting document and folder rights

It is possible that you can have rights set to a document in a folder that you do not have access to. In this case, you can find the document by searching but not by browsing. You cannot browse to the folder it is in because you do not have rights to the folder. Once you have found the document, mark it as a favorite or create a shortcut in a folder to which you do have access in order to find the document quickly.

## 4.6 Understanding Document Renditions

Uploaded documents are processed by Oracle WebCenter Content and are rendered so that you can view them in a standard web browser without having to have the native application that created them. Depending on how Oracle WebCenter Content is set up, different renditions may be available to you. The following rendering options are typical:

### Web-Viewable Rendition

The web-viewable rendition is converted when you upload a document based on rules created by your system administrator. It is displayed on the Document page when you view the document or document properties. The Document page provides navigation for multi-page renditions and options for zooming, printing, and e-mailing documents.

### Dynamic Conversion

A dynamic conversion option is also available from the document properties that converts the document when you click the link. The dynamic conversion displays in a new web page, outside of Oracle WebCenter Content user interface.

### Special Renditions

If configured to work with Oracle WebCenter Content's digital asset management, there may be other rendition options available to you. A system administrator may have set options to convert documents into many different renditions that may include different formats, document

sizes, applied watermarks, or even video renditions for video files. Links to special renditions and rendition metadata are available on the View Documents page in Oracle WebCenter Content. For detailed information about working with special renditions in the native user interface, see [Working with Images and Videos](#).

For information to better understand how documents are processed in Oracle WebCenter Content, see [Understanding How a Document is Processed Within Oracle WebCenter Content](#).

# 5

## Understanding Libraries

Use libraries to organize and control access to documents. Using libraries, you can also associate appropriate metadata to documents, which aids in easy retrieval of content.

### Note:

Libraries are used differently in the native and WebCenter Content user interfaces. In the native interface, the Browse Content tray lists Library Folders, which can be set up by your system administrator as links to custom web sites for your organization. This is very different from how libraries are used in the WebCenter Content user interface. Libraries in the WebCenter Content user interface behave as the top level of folder hierarchies. In fact, if Oracle WebCenter Content is configured to do so, what show up as libraries in the WebCenter Content user interface are displayed under **Folders** in the **Browse Content** tray of the native interface. This chapter focuses on how libraries work and are displayed in the WebCenter Content user interface. For more information on the differences between interfaces, see [Understanding Folders](#).

This chapter has the following topics:

- [About Document Libraries](#)
- [Understanding Enterprise Libraries](#)
- [Understanding Shortcuts, Favorites, and Following](#)

### 5.1 About Document Libraries

Libraries provide structure and organization to documents in Oracle WebCenter Content. They are the top level of a folder tree in which all folders and documents should be stored. This is important to note because libraries as used in the WebCenter Content interface are listed as folders in the Browse Content tray of the native user interface.

When a document is uploaded to a library, the library provides context to the document, helping to determine what metadata fields are associated with it and in some cases assigning values to the metadata automatically.

Documents can be uploaded to Oracle WebCenter Content outside of a library context as an unfiled document. However, organizing documents in libraries helps to ensure documents are secure, can be shared, and are easily found by yourself and others. In addition to containing documents, libraries can also contain folders and shortcuts to other libraries, folders, and documents. This provides a secure, fast and familiar way to navigate Oracle WebCenter Content.

There are two types of libraries:

- **Enterprise Libraries**, created by individuals to provide flexible security and comprehensive document management used by an entire organization.

- **System Libraries**, created and managed by Oracle WebCenter Content to organize documents that are in a system process, such as checked-out or expired documents. Documents cannot be uploaded to a system library.

### Library Ownership

Libraries are owned by the people who create them. Enterprise library owners can transfer ownership, but as system libraries are created by Oracle WebCenter Content, they cannot have their properties edited.

## 5.2 Understanding Enterprise Libraries

Enterprise libraries are a robust way to secure, manage and share content that is accessed by many people in your organization. In an enterprise library you can set access at the document level, lock documents while editing, and maintain a comprehensive revision history of documents. You can create and share any number of enterprise libraries and folders or shortcuts within enterprise libraries.

### 5.2.1 What are the benefits of using enterprise libraries?

Enterprise libraries provide a secure area in Oracle WebCenter Content to store documents that need to be seen and accessed by many people. For example, you can create an enterprise library for a project team to use as a workspace for shared documents. Or a Human Resources department can use an enterprise library as a place to store forms that are used by all employees. In both cases, many people can access the documents and any changes can be managed by checking documents in and out while tracking revision history.

Uploading documents to an enterprise library offers the following benefits:

- Available to many people unless you choose otherwise. An enterprise library gives you the ability to control access at all levels: library, folder, and document. Only an enterprise library lets you define different access permissions to different folders or documents in the same library.
- Full choice of metadata options through profiles and the ability to enter and modify values for all necessary metadata fields.
- The ability to control changes to documents by checking it out. Checking out a document locks the document while you make changes, keeping others from accidentally overwriting your changes.
- The ability to access documents from mobile devices. Enterprise libraries can be easily accessed from an Apple or Android device using the Oracle WebCenter Content mobile app.
- Ability to share enterprise libraries and folders with others. You can collaborate with others on documents in a shared enterprise library or folder.

### 5.2.2 How do I set security for enterprise libraries and folders?

When you set security permissions for an enterprise library or folder, you allow people access to the documents contained in the enterprise library or folder based on the library or folder access permissions, or you explicitly define different access for the documents in them.

You can allow access to individual documents in an enterprise library. This can be done in different ways:

- By explicitly defining access rights to each document, either as it is uploaded or by modifying the document properties after the documents has been uploaded or revised. For more information on uploading documents, see [Uploading and Checking In Documents](#).
- By creating a folder and defining the access rights you need at the folder level, then moving documents into the new folder and propagating the folder access down to the contained documents. For more information on propagating metadata, see [Propagating Library Metadata](#).

### 5.2.3 How do I resolve upload conflicts and track revision history?

If two people have modified a document in an enterprise library or folder and then try to upload the documents, the changes may conflict. In this case, the first revision checked in will be overwritten by the last. However, Oracle WebCenter Content maintains revision history. This allows you to manually compare each document revision and merge changes.

### 5.2.4 How do I manage document access using enterprise libraries and folders?

Access to documents in an enterprise library can be managed at the document level, but access is controlled initially at the library or folder level. All documents uploaded into the context of a library or folder use the permissions for that library or folder by default unless an access control list is defined.

For example, consider that:

- All legal documents are stored in a library titled *Legal*.
- All documents pertinent to pending litigation are stored in subfolders of the *Litigation* folder in the *Legal* library.
- All engineering documents are stored in a library called *Engineering*.
- All engineering specifications are stored in subfolders of the *Specifications* folder in the *Engineering* library.

**Figure 5-1 Legal Library Hierarchy**

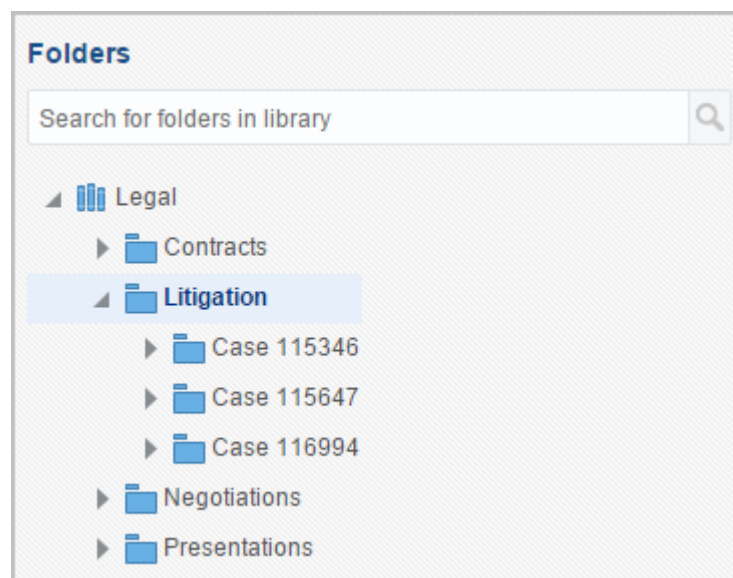

There are many lawyers with access to the *Legal* library, but only a few who are qualified to review technical specifications. The security group for all lawyers is assigned to the *Legal* library when it is created. All documents uploaded to the *Legal* library and its subfolders can be accessed by all lawyers unless limited by an access control list, which can limit other security. For example, a shortcut to the *Engineering Specifications* folder can be created in the *Legal* library and an access control list can be used to set security for the *Specifications* folder to allow only those few lawyers who are qualified to review specifications.

Now consider that engineers must also review technical data included in legal presentations and pending litigation documents. The engineer that needs access varies depending on the document, but no engineer should have access to legal documents outside of what they need to review. When a document in the *Legal* library is ready for technical review, the document properties can be modified and an access control list defined for that document that gives read permission to a specific engineer.

**Table 5-1 Enterprise Library Structure Example**

Folder Name	Security Group	Access Control Lists	People
<b>Legal</b>	legal (R, W, D)		tjimenez (lawyer)
<i>Contracts</i>			tjimenez (lawyer)
<i>Litigation</i>			tjimenez (lawyer)
<i>Case X</i>			tjimenez (lawyer)
<i>Document X</i>		R	tjimenez (lawyer), jmarshall (engineer)
<b>Engineering</b>	technical (R, W, D)		jmarshall (engineer)
<i>Specifications</i>			jmarshall (engineer)
<i>Product Y</i>		R	tmano (lawyer)
<i>Document Y</i>			tmano (lawyer)
<i>Product Z</i>		R	tjimenez (lawyer)
<i>Document Z</i>			tjimenez (lawyer)

Note that in this case, [Table 5-1](#) shows the access control list is set at the document level for giving engineering access to legal documents, but it is set at the folder level when giving lawyers access to the engineering specifications. In this example, one engineer is reviewing only the one document, but each lawyer reviews all specifications for a specific product.

## 5.3 Understanding Shortcuts, Favorites, and Following

You can easily access and follow libraries, folders, and documents in several ways. Setting any item as a favorite adds it to your Favorites list for quick access by clicking Favorites in the side bar. You can create a shortcut to a library, folder, or document and put it in a convenient location for quick access. You can also follow items so you are notified by e-mail when they change.

# 6

## Understanding Folders

Like libraries, use folders to organize documents. You can create a folder within or outside a library.

This chapter covers the following topics:

- [About Folders](#)
- [Folder Differences Between the WebCenter Content and Native User Interfaces](#)
- [Browsing the Folder Hierarchy](#)
- [Searching For Folders](#)
- [Working With Folders](#)
- [Understanding Folder Security](#)
- [Saved Searches and Shortcuts](#)

### 6.1 About Folders

Folders in Oracle WebCenter Content are used to organize documents. In the WebCenter Content user interface, folders can be created in the context of a library or outside a library (ad hoc folders). However, folders should be created within the context of a library for better organization of content. Folders, like libraries, can be shared, followed, copied, moved, and secured. By using folders to organize content, you can:

- Find content quickly by browsing the folder structure.
- Create a saved search to organize content associated by search criteria.
- Share groups of content easily with co-workers.

### 6.2 Folder Differences Between the WebCenter Content and Native User Interfaces

The folders in the WebCenter Content user interface are not visible in the native user interface by default but can be enabled. If enabled, folders as used in the WebCenter Content interface are displayed in the **Browse Content** tray under **Folders**. Using folders differs between the WebCenter Content and native user interfaces. This chapter focuses on common features. Where features differ, this chapter focuses on the WebCenter Content interface. For details about understanding and using folders in the native user interface, see [About Folders](#).

 **Note:**

The native user interface uses query folders instead of saved searches.





**Note:**

Cloud folders are enabled only in the WebCenter Content user interface and not in the native user interface.

**Figure 6-1 Folder Comparison Between Interfaces**

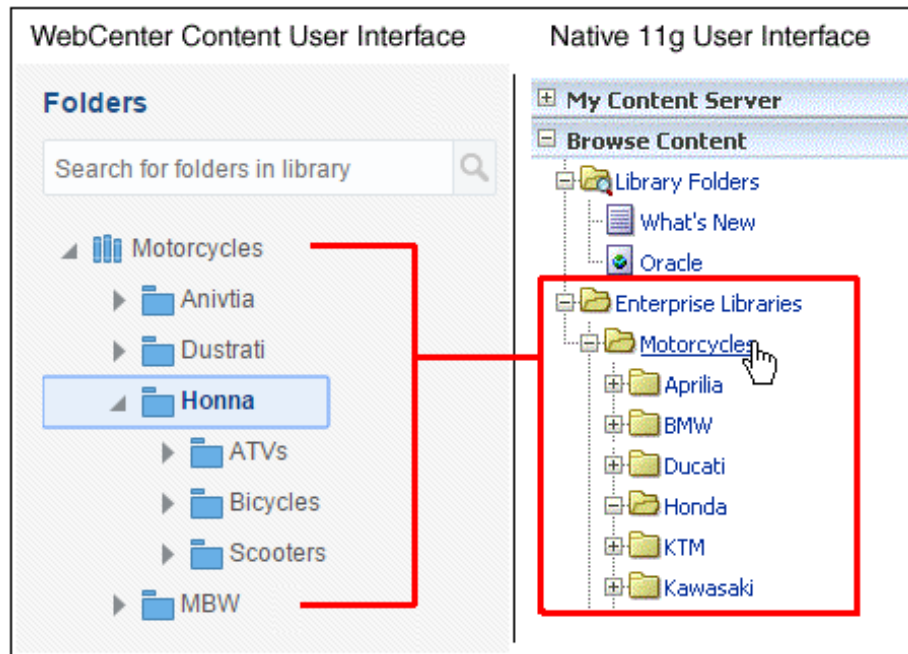

## 6.3 Browsing the Folder Hierarchy

When you open a library from a results list in the WebCenter Content interface, a hierarchy of folders is displayed in the side bar. Like traditional folder hierarchies, you can expand folders to display subfolders, also called child folders. Selecting a folder in the hierarchy displays the contents of the folder in a results list, including any subfolders, folder shortcuts, query or retention folders.

When you expand the Browse Content tray in the native user interface, several folder options are available and are listed in [Table 6-1](#). If the folder option has been enabled in the native user interface, then virtual folders can be created and used to help organize content.

**Table 6-1 Folder Options**

Name	Description
Library Folders	Library folders in the native user interface are not organizational folders in the traditional sense. Instead they refer to web pages predefined by your system administrator.
Folders	Folders are virtual folders that organize content. These are not available by default and must be enabled by your system administrator.

**Table 6-1 (Cont.) Folder Options**

Name	Description
Cloud Folders	Cloud folders are a special kind of folders, which allow you to copy content to and from the cloud server. They act as a link to a folder in Oracle Content Management Cloud Service. If your company has integrated with Oracle Content Management Cloud Service, you can copy or upload files to the cloud using a cloud folder, and you can access content on the go through the cloud user interface. Cloud folders are enabled only in the WebCenter Content user interface and not in the native user interface.
Saved Searches	Saved searches are virtual folders that contain the items returned by a search criteria; each time you access a saved search, you initiate the search criteria associated with that folder. The contents of saved searches can change dynamically as the contents of the repository change.
Retention Folders	A type of saved search with rules for retaining content.

## 6.4 Searching For Folders

In the WebCenter Content user interface, you can search for folders using either the search field above the hierarchy in the side bar, or using the search box in the banner area. Results are displayed in the side bar if using the search field, and in the results list area if using the search box.

## 6.5 Working With Folders

In the WebCenter Content interface, either right-click the folder in the side bar hierarchy and use the contextual menu, or select the folder in a results list and use the tool bar to create new folders, modify folder properties, set the folder as a favorite, or make other changes to the folder.

Figure 6-2 Folder Contextual Menu

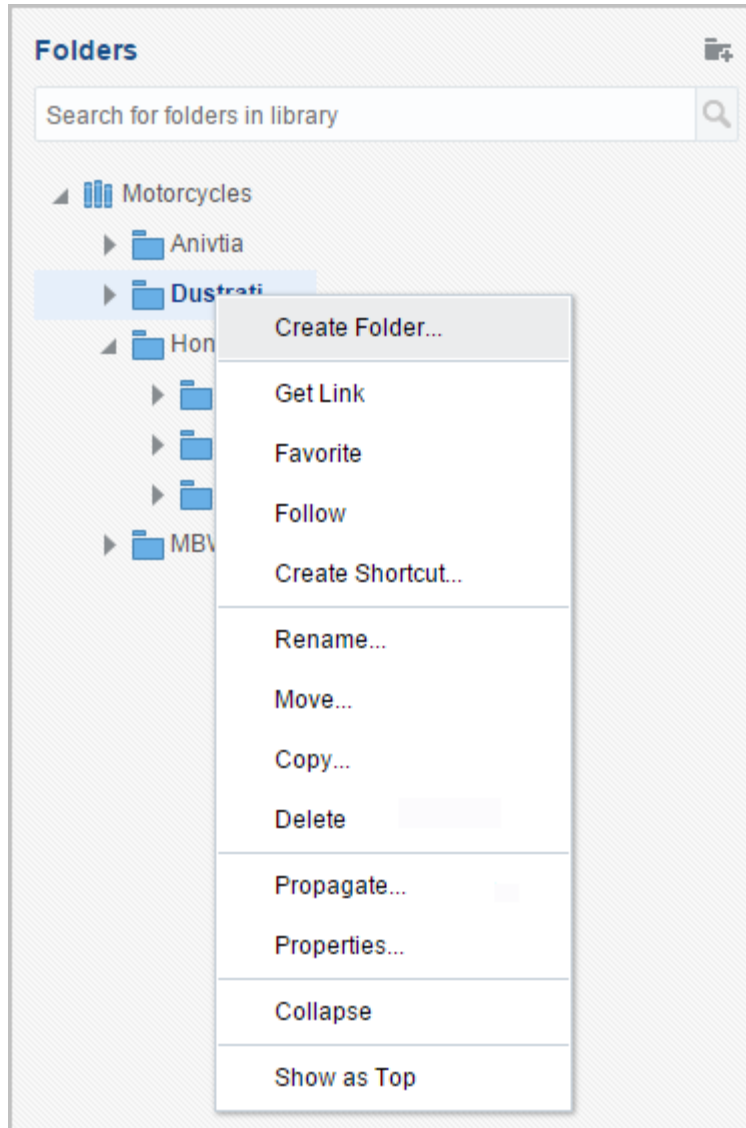

## 6.6 Understanding Folder Security

In the WebCenter Content user interface, security can be set at library and folder levels as well as the document level. Security is inherited from the containing library unless it is set independently. For more information, see [Library and folder security](#).

 **Note:**

It is possible that you can have rights set to a folder in a library or containing folder that you do not have access to. In this case, you can find the folder by searching but not by browsing. You cannot browse to the library or folder it is in because you do not have rights to do so. Once you have found the folder, mark it as a favorite or create a shortcut in a folder to which you do have access in order to find the document quickly.

## 6.7 Saved Searches and Shortcuts

In addition to folders, any saved search or shortcut you create in a folder is displayed in the folder hierarchy. To use them, you must click a saved search or shortcut.

# 7

## Understanding Document Workflows

Use workflows to route content items through a collaborative review process before releasing them into the system.

This chapter covers the following topics:

- [About Workflows](#)
- [Workflow Types](#)
- [Workflow Steps](#)
- [Workflow Process](#)
- [Postprocess Workflow Options](#)
- [Authentication](#)

### 7.1 About Workflows

A workflow specifies how to route content for review and approval before it is released to the system. The workflow notifies users by e-mail when they have a file to review, and when using the Oracle WebCenter Content user interface, a notification flag is displayed next to the user name in the banner.

### 7.2 Workflow Types

From a workflow participant's point of view, there are two types of workflows:

- A *basic* workflow defines the review process for specific content items, and must be initiated manually.
- In a *criteria* workflow, a file enters the workflow automatically upon check-in when its metadata matches predefined criteria.

### 7.3 Workflow Steps

Each workflow can include multiple review and notification steps, and multiple reviewers to approve or reject the file at each step. For each step in a workflow, a set of users and a step type must be defined. The users defined for a step can perform only the tasks allowed for that step type.

Step Type	Description
Contribution	This step is the initial step of a basic workflow. The workflow defines who the contributors are.
Auto-Contribution	This step is the initial step of a criteria workflow. There are no predefined users involved in this step.
Review	Users can only approve or reject the file. Editing is not allowed.
Review/Edit Revision	Users can edit the file if necessary and then approve or reject it, maintaining the existing revision number.

---

Step Type	Description
Review/New Revision	Users can edit the file if necessary and then approve or reject it, creating a new revision.

---

## 7.4 Workflow Process

The workflow process is as follows:

- When the required number of approvers for a particular step approves a revision, the revision goes to the next step in the workflow.
- If any reviewer rejects a revision, it goes back to the most recent review step that allows editing.
- When reviewers approve a revision in the last step in the workflow, the content item is released to the system.
- A basic workflow containing multiple content items can release some items in the workflow to the system before all of the revisions have completed the workflow.

## 7.5 Postprocess Workflow Options

Workflows or individual workflow steps can allow for items in review to be released into the system for indexing, searching, and viewing, even though the workflow to which they belong is not completed. For example, items in a workflow process can be made available to others not in the workflow, or a workflow can update the content information of an item without advancing the revision of that item.

## 7.6 Authentication

Workflows provide authentication options for individual steps and for the content item itself.

When you approve a revision, you also have the option of providing an electronic signature for the content item itself (not the step). The electronic signature uniquely identifies the contents of the file at a particular revision and associates the revision with a particular reviewer.

An electronic signature is a unique identifier computed from the content of the item and associated with other metadata such as the user name of the reviewer. Multiple reviewers can *sign* a particular content item revision. Modifications to the content item itself result in a different identifier. By comparing electronic signatures, Content Server can determine whether a content item has changed and whether existing approvals are valid.

For more information about electronic signatures, see [Signing Content Electronically](#).

# Part II

## Using the WebCenter Content User Interface with Oracle WebCenter Content

The WebCenter Content user interface is a modern, intuitive user interface with drag-and-drop convenience and sophisticated searching capabilities. Using this interface, you can manage rich media beyond traditional office documents, including images, records, and videos.

This part contains the following chapters:

- [Getting Started with the WebCenter Content User Interface](#)
- [Finding Libraries, Folders, and Documents](#)
- [Viewing and Annotating Documents](#)
- [Uploading and Checking In Documents](#)
- [Checking Out and Downloading Documents](#)
- [Working with Libraries](#)
- [Working with Content Folders](#)
- [Deleting Libraries, Folders, and Documents](#)
- [Using Workflows](#)
- [Working with Oracle Content Management Cloud Service](#)

# 8

## Getting Started with the WebCenter Content User Interface

You can use the WebCenter Content user interface with nearly zero training because it is that intuitive and simple. With this interface, you can easily store, secure, retrieve, and share any type of document.

This chapter has the following topics:

- [Working with Oracle WebCenter Content](#)
- [Accessing Oracle WebCenter Content](#)
- [Understanding the WebCenter Content User interface](#)
- [Personalizing WebCenter Content Preferences](#)

### 8.1 Working with Oracle WebCenter Content

You work with Oracle WebCenter Content to upload documents to the repository and search for and view documents that others have uploaded. The two main pages used in Oracle WebCenter Content are the Find Documents page and the View Documents page.

#### **Find Documents page**

The Find Documents page is displayed when you first log in to Oracle WebCenter Content. You can personalize this page to display all documents, all libraries, or your favorites the next time you log in. The page also provides ways to filter what documents are displayed to help you find specific documents more quickly. Detailed information about the Find Documents page is in [Find Documents page](#).

#### **View Documents page**

The View Documents page is displayed when you open a document from a results list. The page allows you to view the contents of a document, the metadata properties of the document, and provides ways to update the document to a new revision, update the document metadata properties, or download the document. Detailed information about the View Documents page is in [View Documents page](#).

### 8.2 Accessing Oracle WebCenter Content

To access Oracle WebCenter Content using a standard web browser, enter the web address and log in. The web address is configured when Oracle WebCenter Content is installed. You must be given rights to log in. Rights may be shared with other systems in your organization. If you are uncertain if you have rights to log in or what user name and password to use, contact a system administrator for Oracle WebCenter Content.

### 8.3 Understanding the WebCenter Content User interface

The WebCenter Content user interface is focused on helping you find and view documents. The Find Documents page and View Documents page provide access to the most common



features necessary for managing documents. This section describes the main pages and features of the WebCenter Content user interface.

### 8.3.1 Find Documents page

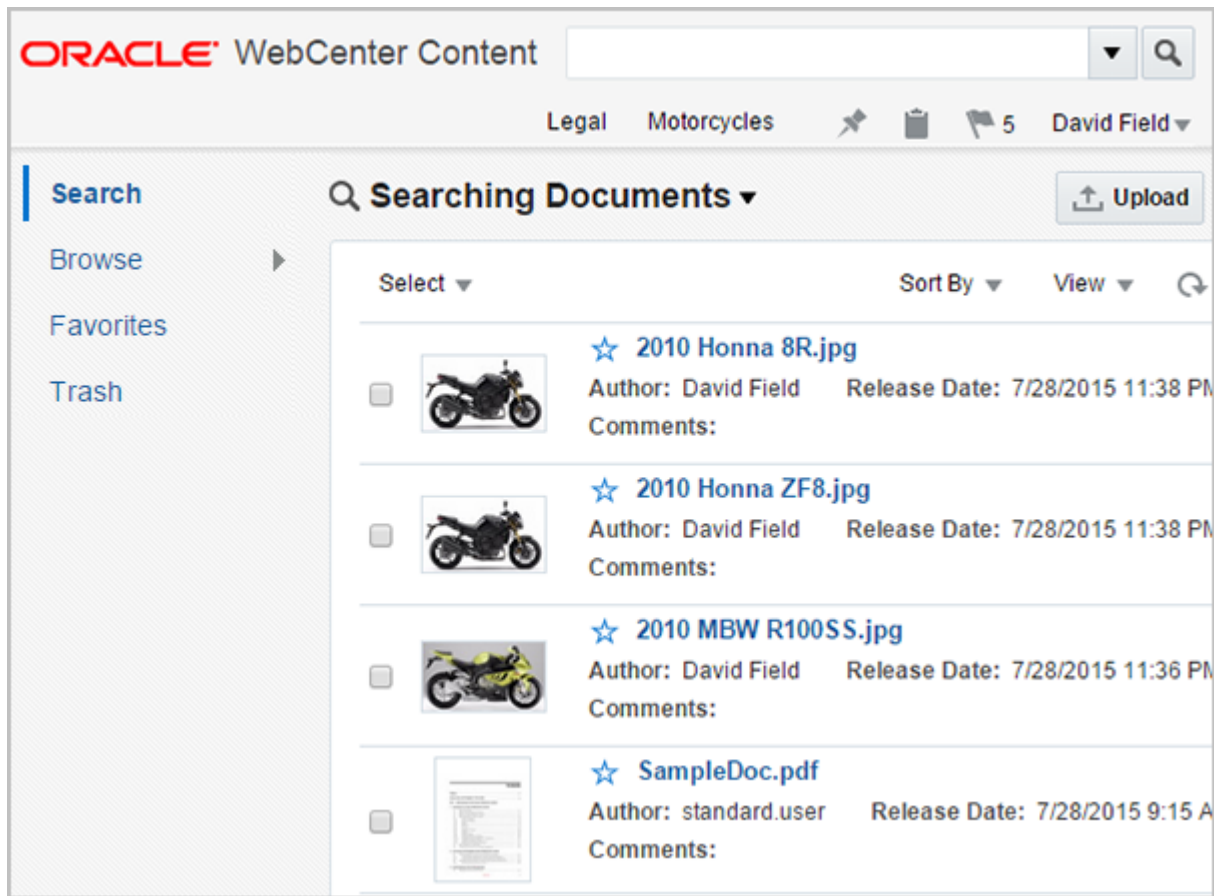

The Find Documents page is displayed when you first log in to Oracle WebCenter Content. You can personalize this page to display all documents, all libraries, or your favorites when you log in.

Figure 8-1 Oracle WebCenter Content Find Documents Page



The following areas of the Find Documents page are used to quickly find documents:

- **Banner:** Located at the top of the page, the banner contains the following items:
  - **Search box:** The search box is a field that expands as you enter text to show instant results organized by libraries, folders, and documents. Selecting an option helps narrow the displayed results so you can find documents more quickly. Steps for using the search box are detailed in [Searching Using the Banner Search Box](#).
  - **User Name and Preferences:** Selecting the user name in the banner displays a menu allowing you to set preferences for working with Oracle WebCenter Content, access help files, view version information of WebCenter Content, or log out of the system.
  - **Workflow Notification Icon:**  If you have pending workflows, the workflow notification icon is displayed next to your user name. Click the icon to display a list of documents in workflow that are currently assigned to you.

- **View Rendition Clipboard Icon:**  The view rendition clipboard icon displays a listing of renditions you have added to the rendition clipboard. You add a rendition to the clipboard by selecting an item in a result list when searching or browsing and using the toolbar or contextual menu **Add to Rendition Clipboard** option. You are prompted to choose what renditions of the selected item you want to add. You can also add renditions to the clipboard from the summary tab of the View Documents properties section, in which case you select what renditions to add first, then use the rendition tool bar to add them to the clipboard. The rendition clipboard lets you store specific renditions of documents and even specific revisions for quick access. For example, you can save a web-viewable rendition of the first revision of a document as well as a native version of the current revision so that you can quickly compare them.
- **Pin This View Icon:**  The Pin This View icon saves the current view with a name you specify. The saved view includes any search and filter criteria, any library and folder selections, and the current sort and view selections. The name appears in the banner with the oldest pin nearest to the icon. In [Figure 8-1](#), Legal and Motorcycles are saved or pinned views. Click the name of the view to return to it.
- **Side bar:** Located to the side of the page, the side bar provides a way to browse through libraries and items you've marked as favorites. Once you've selected a library, an additional option to search for and browse through folders is also displayed in the side bar. Steps for using the side bar are detailed in [Browsing Using the Side Bar](#).
- **Results list:** The results when you search or browse are displayed in the main content area of the Find Documents page. The results may come from a search using the search box, through browsing using the side bar, or a combination of the two. Steps for working with results are detailed in [Working with the Results List](#).

## 8.3.2 Search box

When searching for documents using [Searching metadata](#), entering text into the search box expands the box to display libraries, documents, or folders whose names are close matches to what you enter. It does not only show exact matches. This means that you may see results in the expanded search box that won't be displayed in a results list. For example, entering *moto* in the search box may show suggestions for documents with *motorcycle* or *photo* in the name, and a folder called *Notes*.

Any filters applied to the search are displayed in the search box. Closing the filters in the search box removes the filter and broadens the search to a larger context.

**Figure 8-2 Oracle WebCenter Content Search Box**

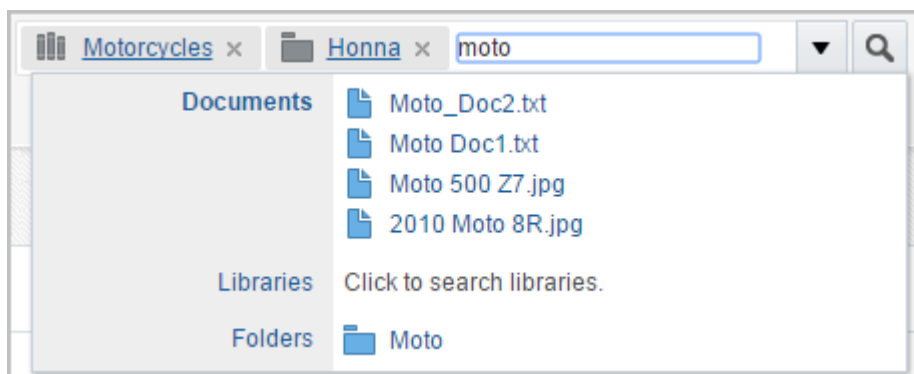

Filters predefined by a system administrator based on document properties are available by clicking the arrow next to the search box. Depending on how the filter list is configured, some filters in the list may display the number of documents within each filter.

Figure 8-3 Predefined Filter Choices in Search Box



 **Note:**

- When browsing for documents, entering text into the search box searches only the names of documents in the library or folder you are browsing, not any other metadata or full-text. For example, if you browse to a library called *WebCenter Content Documentation* then to a folder called *Administration* and enter **report** into the search box, the results list displays documents in the administration folder whose names contain the word report, such as *Q3 2011 Report*, *Bob's Status Report*, or *New Financial Reporting Procedures*. To search for metadata within the folder you have browsed to, you must first select the **Search <Folder> and Subfolders** option from the folder drop-down menu.
- If the Auto Suggest feature is disabled, the **Search Box** doesn't automatically prompt results when you enter a search term. The categories in the pop-up window—Documents, Libraries, and Folders—are displayed with no results. Contact your system administrator to enable the Auto Suggest feature.

### 8.3.3 Side bar

The library and folder features in the side bar provide an easy way to organize documents and navigate document storage in Oracle WebCenter Content.

Use the **Search** link to search for documents using metadata and display all documents in Oracle WebCenter Content to which you have access.

Use the **Browse** link to perform the default browse action, that is, to list all libraries in the main area of the page. Click on the attached arrow in the **Browse** button to see a list of specific options. Navigate to the list of enterprise libraries or to the folder root using these options.

In addition to navigating libraries and folders, the side bar gives you a quick access to all items you have marked as favorites. Click the **Favorites** link to view the list of items that you previously marked as favorites, they can be documents, folders, or libraries.

If Trash is enabled on your content server, you can view the list of items that you previously moved to Trash using the **Trash** link.

Figure 8-4 Oracle WebCenter Content Side Bar

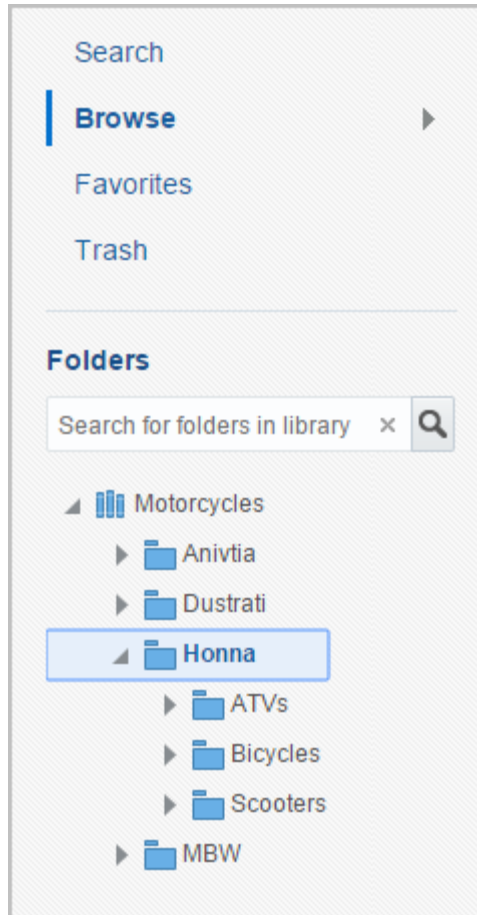

**Note:**

If the Auto Suggest feature is disabled, the **Folder Search Box** isn't displayed in the side bar. Contact your system administrator to enable this feature.

### 8.3.4 Results list

The results list displays documents and folders in the main content area based on the filters you use when browsing and searching. The **Create Library** option in the results list area allows you to create a new library. It is only available when browsing at the top level of libraries. The **Upload** option in the results list enables you to upload documents using the profile options available in the **Upload** menu. The **Upload** menu is not available when browsing at the top level of libraries. After you have opened a library or folder, then the option to create folders is also available in the results list.

The title of the results list shows the context of the listed documents. For example, if you click **Search** in the sidebar, the results list displays all documents in Oracle WebCenter Content to which you have access, with no filtering by library or folder, and the title displayed is *Searching Documents*.

If you navigate to a folder within the library and select the **Search <Folder> and Subfolders** option from the folder drop-down menu, then the title changes to *Searching <Folder> and Subfolders*. This is important because the title tells you the context in which you are searching for a document. If you want to browse after searching but remain in the library or folder you are in, click the title of the library or folder tab in the search box or select the **Return to Browsing <Folder>** option from the search title drop-down menu. For more information on the differences between browsing and searching, see [Browsing versus searching](#).

**Figure 8-5 Results List from Searching with the Search Box**

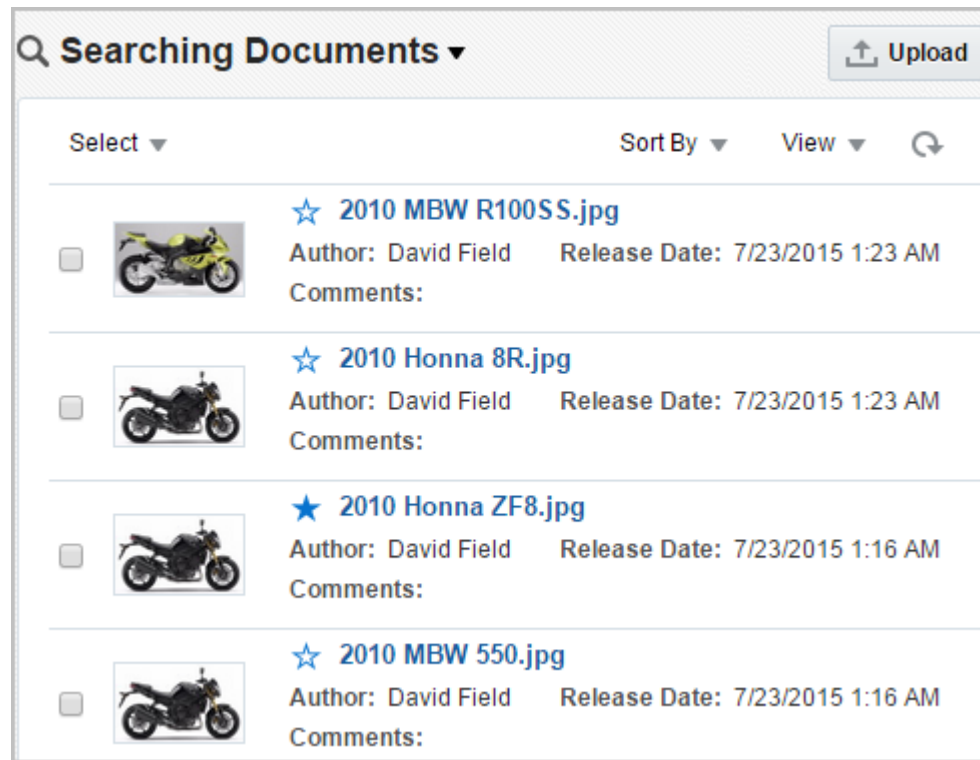

Once you click **Browse** and open a library or folder, though, the title changes to the name of the library or folder. In addition, there is a drop-down menu associated with each library or folder title with the following options:

Option	Description
Search <Folder/Library> and Subfolders	Click to use the search box to search metadata or the full-text of documents within the folder or library you are browsing, rather than only the name of the document or folder.
Get Link	Displays a URL to the library or folder in which you are browsing.
Folder/Library Properties	Displays properties of the library or folder you are browsing in.

Oracle WebCenter Content behaves differently depending on if you search for content using the search box or browse for content within libraries or folders. Consequently, the results list is also slightly different. For example, if you search using the search box without first navigating to a specific folder or library, the results list displays the documents that match your search criteria regardless of what library or folder context the documents are in. [Figure 8-5](#) shows an example of results listing documents regardless of what library or folder the documents are in.

If instead of searching using the search bar, you browse to a particular folder in the Motorcycle library, then the results list displays only those documents within that folder and location links show the path of the folder hierarchy. [Figure 8-6](#) shows an example of results returned when browsing through libraries and folders. Additional differences between searching and browsing are detailed in [Searching and browsing](#).

**Figure 8-6 Results List from Browsing Using the Side Bar**

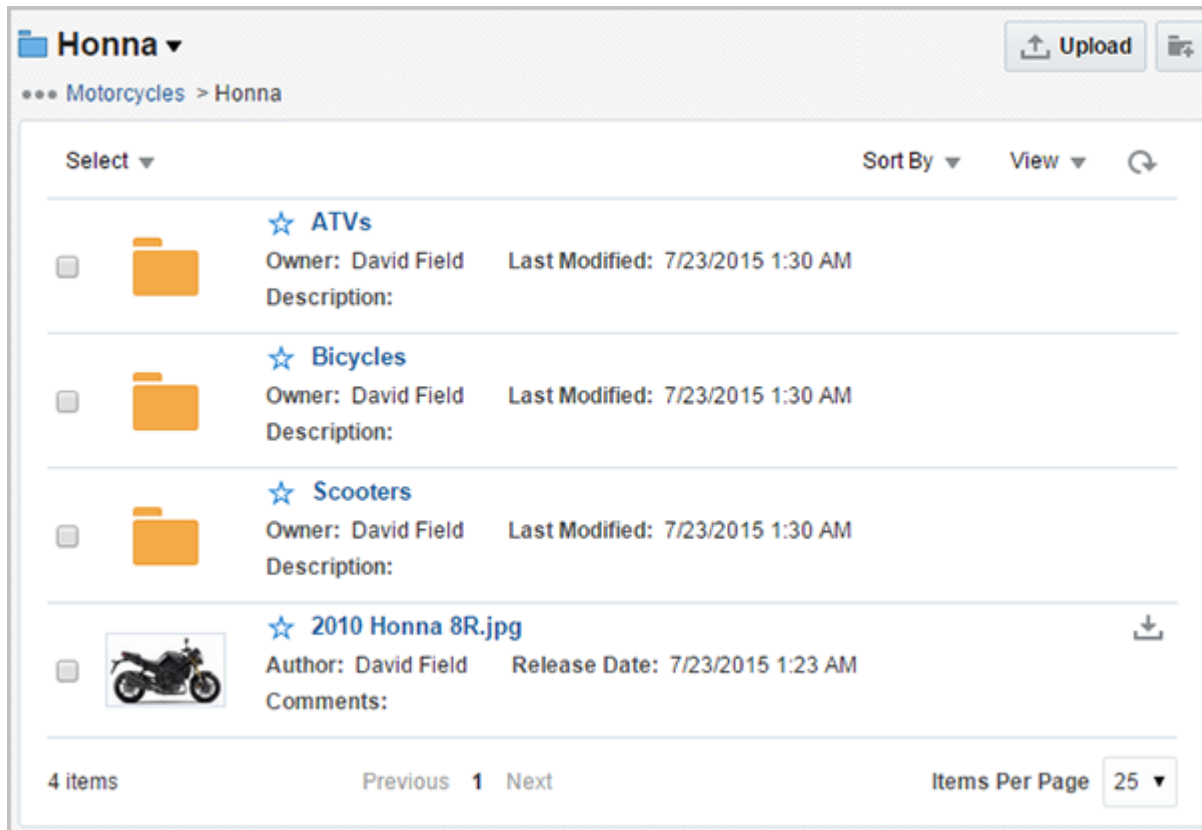

 **Note:**

When browsing, entering text into the search box searches only the names of documents in the library or folder you are browsing, not any other metadata or full-text. To search for metadata within the folder you have browsed to, you must first select the **Search <Folder> and Subfolders** option from the folder drop-down menu.

### 8.3.5 Results list toolbar and contextual menu

You can change how results are sorted and also how they are displayed using the options in the toolbar below the results list title. Selecting one or more documents in the results list adds options to the toolbar, such as letting you add a rendition to your rendition clipboard, copy or move one or more documents to different folders or libraries, or do a variety of other tasks.

Figure 8-7 Results List Toolbar



Selecting a single document displays the results list toolbar. Right-clicking on a document displays a contextual menu. Both provide a convenient way to do a variety of functions which vary depending on the permissions you have. Functions you do not have permissions to are not displayed or grayed out. The full extent of the options available are detailed in the online help system and also in the procedures throughout this guide.

## 8.3.6 Searching and browsing

Oracle WebCenter Content provides two powerful ways to find content: searching metadata and browsing content. They can be used separately or in combination, and have slightly different behavior and appearance.

### 8.3.6.1 Searching metadata

When you log in to Oracle WebCenter Content the first time, you see a list of all released documents to which you have access on the Find Documents page. When searching, the search box searches all indexed metadata of the documents within the library or folder you are searching, including subfolders. If your system administrator has configured full-text indexing, then the full text of each document is searched as well. If you are not in the context of a library or folder, then all documents in the system are searched.

#### Note:

Only the latest released documents are returned in a results list when searching metadata. Unreleased documents and shortcuts are not displayed.

Figure 8-8 shows an example of the Find Document page with the following features specific to searching metadata noted:

1. **Search** in the side bar is highlighted.
2. There is no folder hierarchy in the side bar.
3. There are no locator links below the title.
4. Library and folder tags in the search bar display the context you are in. Clicking the title of a library or folder tag switches you from searching metadata back to browsing documents in that context.
5. The **Return to Browsing <Folder/Library>** option and the **Create New Saved Search** option are displayed in the search title drop-down menu.



- The **Upload** button is disabled.

Figure 8-8 Searching Metadata with Search Features Noted

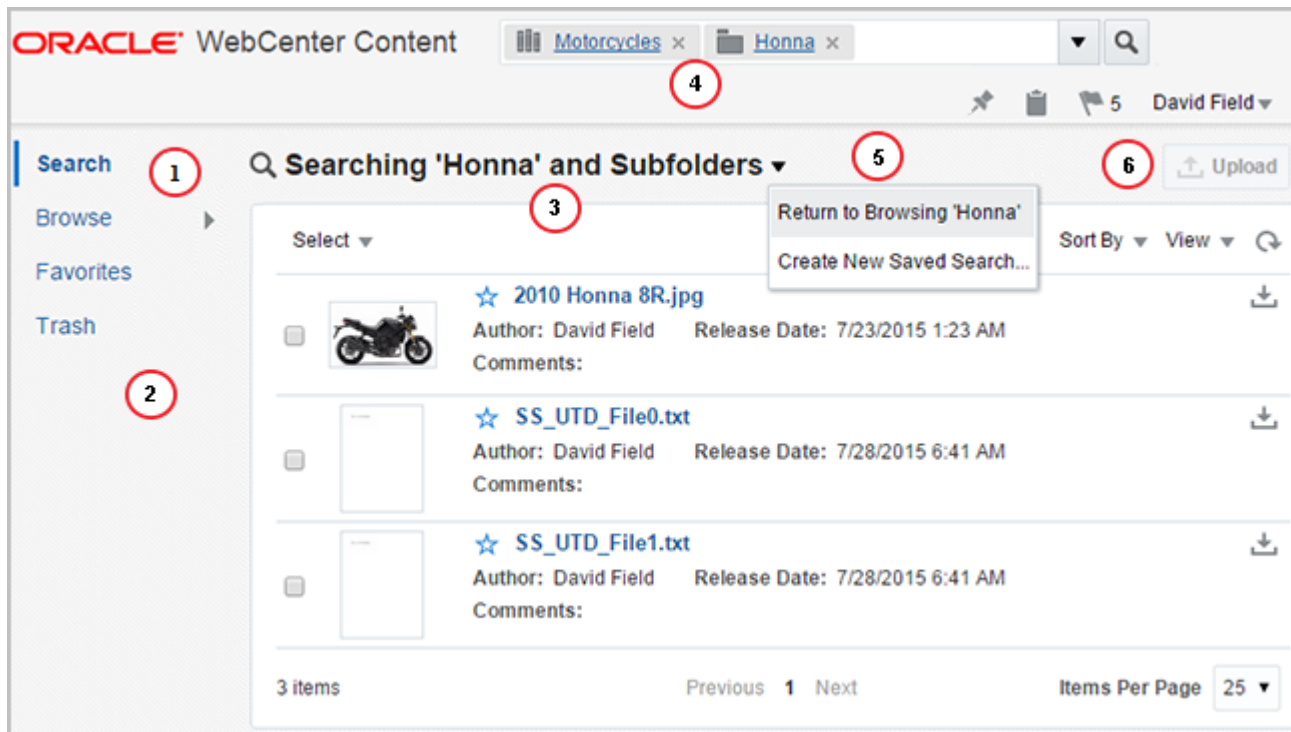

### 8.3.6.2 Browsing

Click **Browse** in the side bar of the Oracle WebCenter Content user interface to perform the default browse action, that is, to list all libraries in the main area of the page. Click on the attached arrow in the **Browse** button to see a list of specific options. Navigate to the list of libraries or to the folder root using these options.

In the library listing, click a library to see a listing of documents and folders within the library to which you have access. The hierarchy of folders in the library are also displayed in the side bar. When browsing, the search box no longer searches through document metadata by default, but rather searches through names of documents in the particular library or folder you are browsing.

If you want to search metadata and optional full-text within the context of the library or folder you are browsing, select the **Search <Folder> and Subfolders** option from the drop-down menu next to the library or folder title. Doing so lets you search metadata within the context of the library or folder you are browsing, including subfolders. To return to browsing, click the title of the library or folder tag listed in the search box or select the **Return to Browsing <Folder/Library>** option from the search title drop-down menu (see 4 in Figure 8-8).

#### Note:

Both released and unreleased documents are returned in a results list when using browsing, as well as any shortcuts.



Note that when browsing system libraries or favorites, you do not have all of the options available when browsing enterprise libraries. Figure 8-9 shows an example of the Find Documents page when browsing through enterprise libraries, with the following features specific to browsing noted:

1. **Browse** in the side bar is highlighted.
2. There is a folder hierarchy in the side bar.
3. There are locator links below the title. Use the links in the breadcrumb popup to navigate to the library listing or the root folder.
4. Library and folder tags in the search bar display the context you are in. Clicking the **X** in the tag closes the tag and backs you out of that context.
5. Folder tools are available in the library or folder drop-down menu allowing you to switch to searching, as well as see properties and links for the library or folder you are in. Also, the **Create New Saved Search** option is not displayed in this menu.
6. The **Upload** button is enabled.

Figure 8-9 Browsing with Browse Features Noted

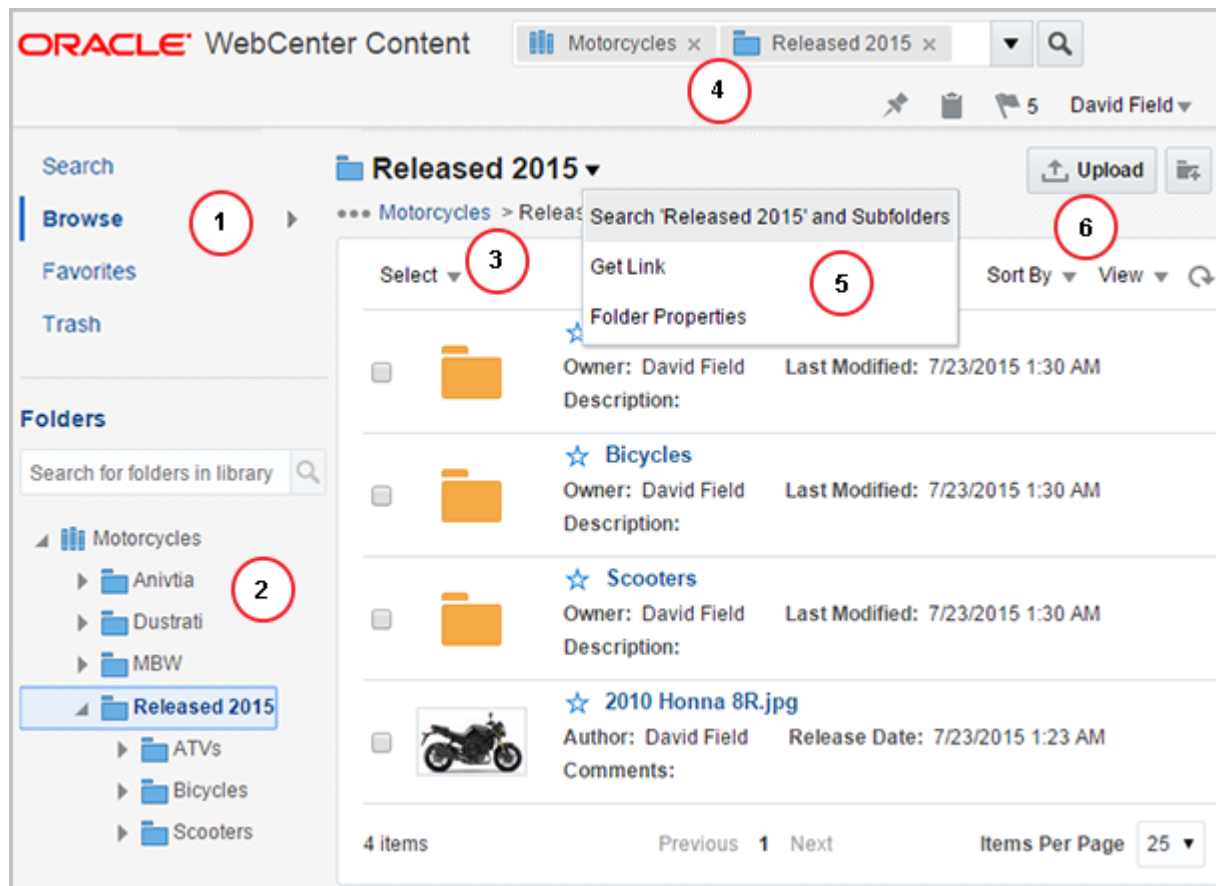

### 8.3.7 View Documents page

Depending on the document format and how your system is configured, Oracle WebCenter Content can convert many uploaded documents into formats that are viewable using a standard web browser. In addition to the current released version of the document, all previous

revisions are easily accessed, as well as all the metadata properties of the current and previous revisions of the document.

Figure 8-10 Oracle WebCenter Content Document Page

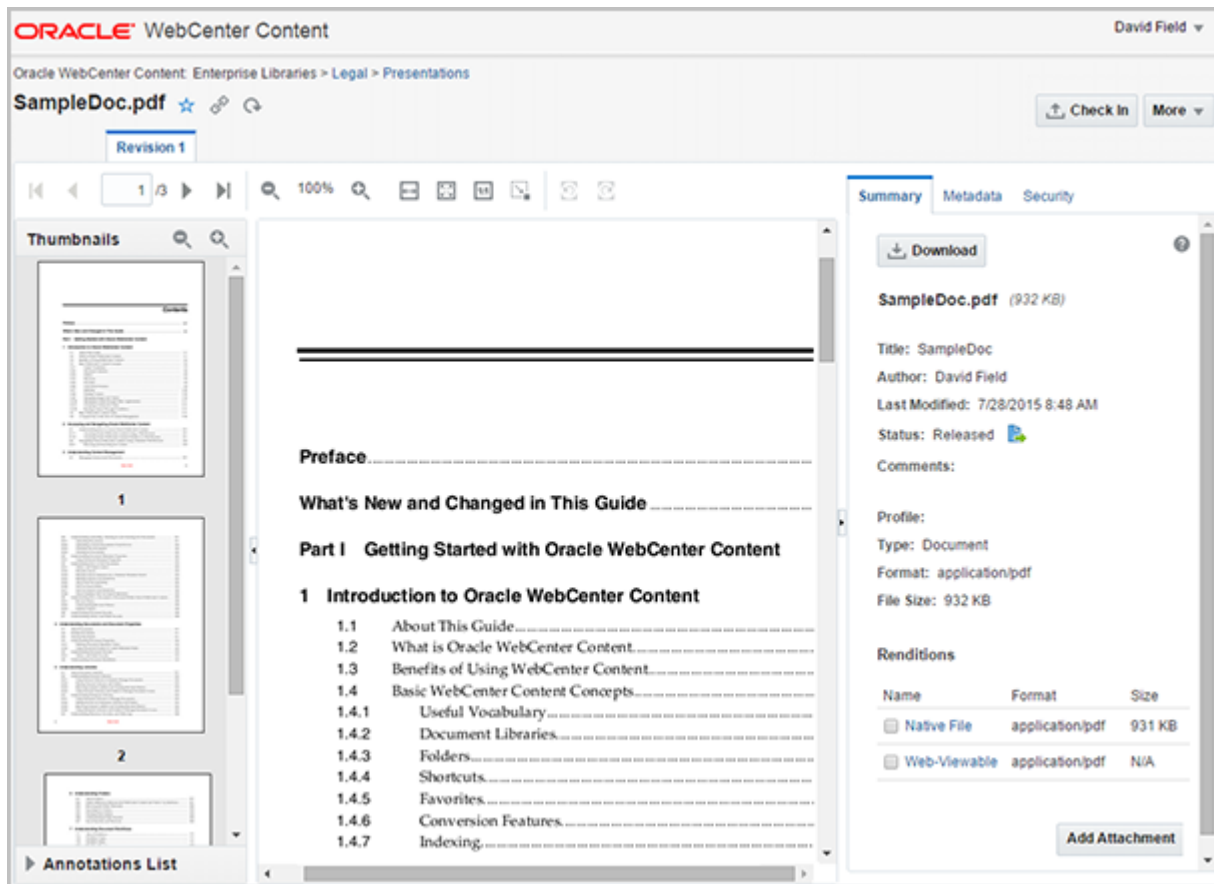

The following areas of the Document page are used to quickly view and update documents and document properties:

- **Banner:** Located at the top of the page, the banner displays the path to the document location in the context of Oracle WebCenter Content. Click on a step in the path to navigate to the step's location.

 **Note:**

If a document is unfiled, the document is listed as Unfiled and a link allows you to file the document.

Additionally, the banner is used to log out, mark a document as a favorite, provide links to documents, and open a menu that provides various options for working with a document.

Figure 8-11 Oracle WebCenter Content Document Page Banner

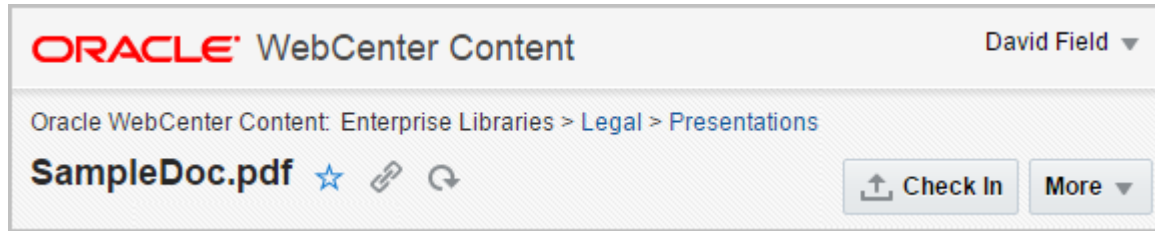

- **Properties section:** Located to the side of the page, the properties section provides a summary of document properties at a glance. Use the **Add Rendition** icon  to add additional renditions, and select a rendition to display a toolbar with various additional tasks. If the document has annotations, an Annotations section is included in the summary page. This section lists downloadable versions of the document that have the annotations applied. Click on a particular version to download it. Click the **Add Attachment** button to attach additional items that may be useful only when associated with the document revision. For example, you can attach a photo of a job candidate with the candidate's résumé. The photo does not have to be managed as a separate document in WebCenter Content, but instead provides support for the revision being managed. Note that attachments are specific to a revision.

If a document is in a workflow, an additional section is added to the summary tab. If the document has been assigned to you, the section provides options to review workflow details, contribute to the workflow, and approve or reject a document. See [Reviewing Workflow Items Assigned to You](#) for more information on reviewing workflow items assigned to you.

Use the tabs in the properties section to display all document metadata and change the security access to a document, if you have the rights to do so.

Figure 8-12 Oracle WebCenter Content Document Properties

Summary

Metadata

Security

↓ Download

?

**Tulips.jpg** (607 KB)

Title: Tulips

Author: David Field

Last Modified: 7/30/2015 1:48 PM

Status: Released

Comments:

Profile:

Type: Document

Format: image/jpeg

File Size: 607 KB

Rendition Set: BasicRenditions

**Renditions**

Name	Format	Size	Dimensions	Resolution
<input type="checkbox"/> <a href="#">Native File</a>	image/jpeg	606 KB	N/A	N/A
<input type="checkbox"/> <a href="#">Web-Viewable</a>	image/jpeg	N/A	N/A	N/A
<input type="checkbox"/> <a href="#">Thumbnail</a>	image/png	19 KB	106 x 80	96 dpi
<input type="checkbox"/> <a href="#">Preview</a>	image/gif	17 KB	250 x 187	N/A

**Annotations**

Name	Format
<a href="#">Annotated PDF</a>	application/pdf
<a href="#">Annotated TIFF</a>	image/tiff

Add Attachment

- **Document preview area:** The document is displayed in the body of the View Documents page. The document preview area has a toolbar that provides various options for manipulating the document view such as zooming in and out or changing pages. It also provides options to show, hide, filter, and add annotations to a document. Above the view toolbar are the revision history tabs. Clicking a tab quickly displays a view of that revision, including the metadata of that revision. Steps for working with document preview area are detailed in [Viewing Documents on the Document Page](#).

Figure 8-13 Oracle WebCenter Content Document Page Toolbar



## 8.4 Personalizing WebCenter Content Preferences

Clicking your user name in the banner opens a menu allowing you to set several preferences. When the preferences page is displayed, the general preferences tab typically has the option to use an external user directory to control preferences enabled. This means your name, e-mail address, locale and time zone are specified by information managed externally by your system administrator. In some cases you may want to manage these yourself, for example by adding a nickname to your full name or changing your locale. If so, disable **Use external user directory settings**. It is a good idea to check with your system administrator before doing so.

Figure 8-14 Oracle WebCenter Content General Preferences

The image shows a 'Preferences' dialog box with three tabs: 'General', 'Personalization', and 'Accessibility'. The 'General' tab is active. It contains a checked checkbox for 'Use external user directory settings'. Below this are four input fields: 'Full Name' with the value 'David Field', 'E-mail Address' with 'david.field@email.com', 'Locale' with a dropdown menu showing 'English-US', and 'Time Zone' with a dropdown menu showing '<No Selection>'. At the bottom right are 'Save' and 'Cancel' buttons. A note at the bottom states: 'Note: If you have a personal account for Oracle Documents Cloud Service, the e-mail setting above must match the e-mail/user-name of your Oracle Documents account in order to enable personal sharing of cloud folders in WebCenter Content.'

Oracle WebCenter Content offers extensive guidance messages throughout the product. As you do something for the first time, a message is often displayed on the page beneath the title bar to help you with the task. You can leave these messages open so that they are displayed each time you do the task, or you can hide each message by enabling **Do not show this message again**. If you hide messages and would like to have them display again at another time, you can reset the guidance messages preference under the personalization preferences tab.

Also under the personalization preferences tab, you can set the home page preference to always show a list of libraries, recent documents, or your favorites each time you log in. You can also enable WebCenter Content to clear recent and pinned items or from selection lists, and any pinned views.

Figure 8-15 Oracle WebCenter Content Personalization Preferences

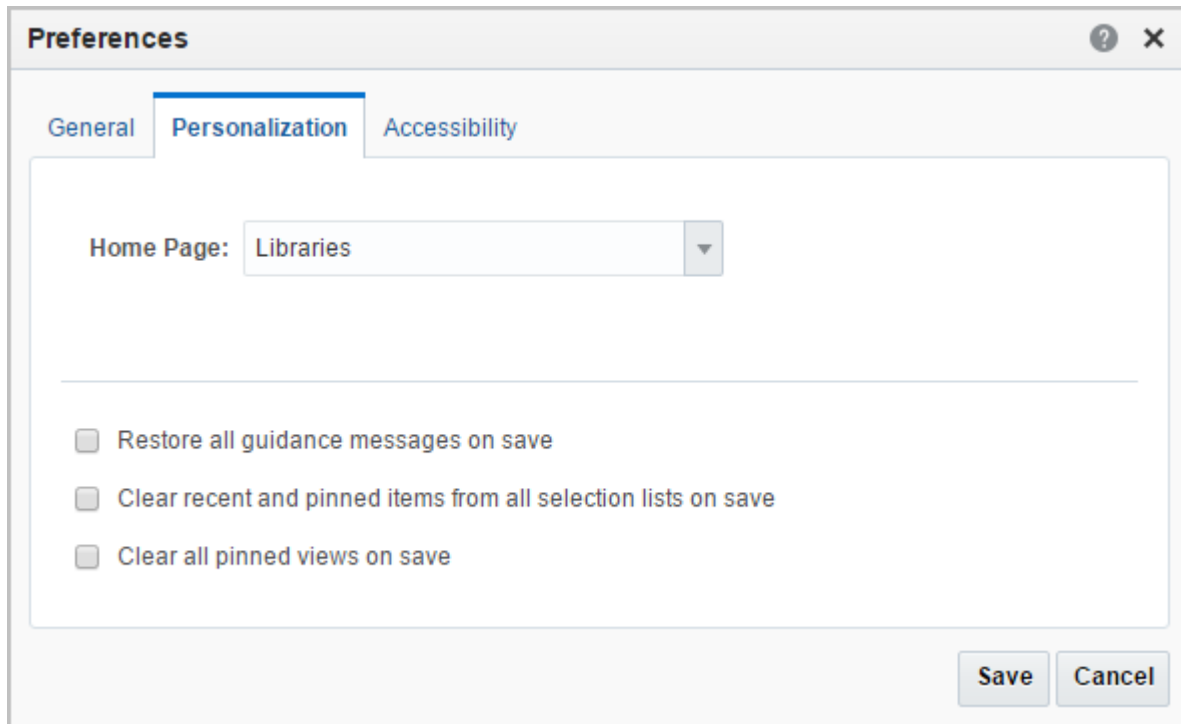

Oracle WebCenter Content also lets you adjust accessibility settings to your preference. If you prefer to use a screen reader or like to see the **Accessibility Preference** page as soon as you login, you can set these options using your preference settings.

Figure 8-16 Oracle WebCenter Content Accessibility Preferences

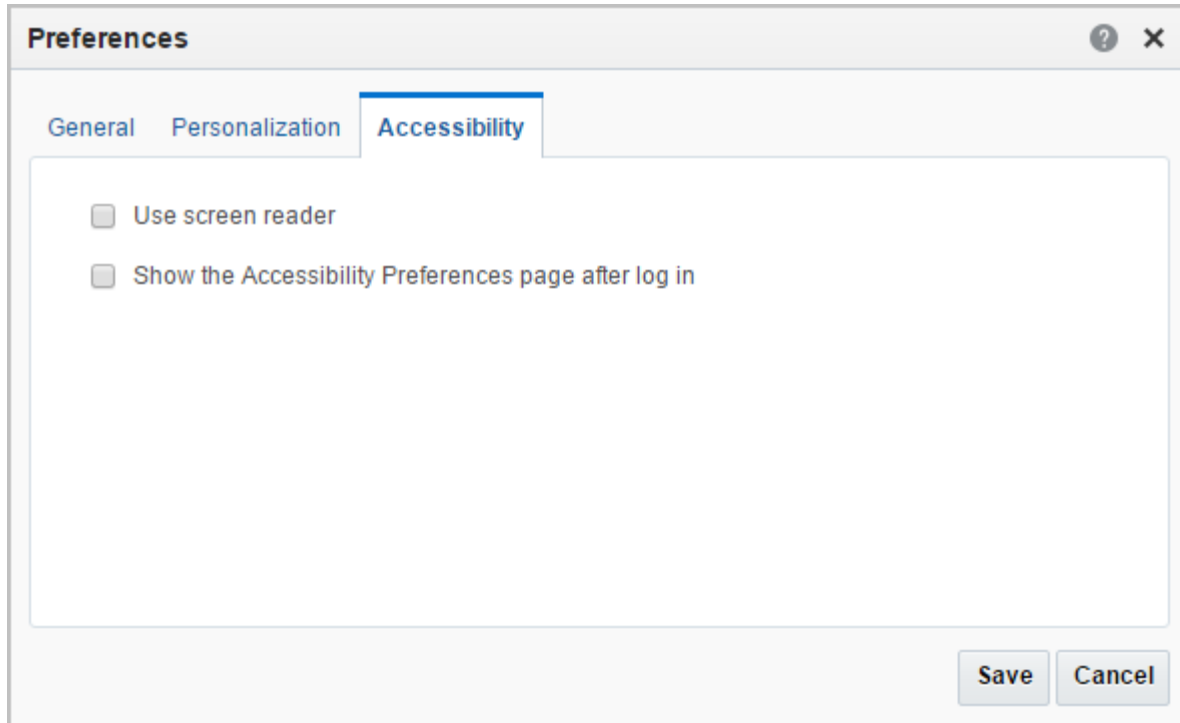

# 9

## Finding Libraries, Folders, and Documents

Organizing documents into libraries and folders provides a familiar way to browse for content. Additionally, information associated with each library, folder, and document provides an easy way to search for content. When you combine browsing and searching, you have a powerful way to quickly find content that you need.

This chapter details the steps to browse and search for documents. It covers the following topics:

- [About Finding Libraries, Folders, and Documents](#)
- [Using the Find Documents Page](#)
- [Browsing Using the Side Bar](#)
- [Searching Using the Banner Search Box](#)
- [Searching for Folders](#)
- [Using System Libraries to Find Documents in a Process State](#)
- [Using Advanced Search Capabilities](#)
- [Saving Searches](#)
- [Working with the Results List](#)
- [Modifying Items Using the Results Toolbar](#)

### 9.1 About Finding Libraries, Folders, and Documents

Documents are stored in Oracle WebCenter Content and organized into libraries. There are two types of libraries:

- **System Libraries**, created and managed by Oracle WebCenter Content to organize documents that are in a system process, such as checked-out or expired documents. Documents cannot be uploaded to a system library.
- **Enterprise Libraries**, created by individuals to provide flexible security and comprehensive document management used by an entire organization.

Each library can have folders and each folder can have subfolders. Just like you browse to documents on your computer using folders, you can also browse to documents in the libraries of Oracle WebCenter Content using folders. Folders provide a familiar way of navigating. However, folders in Oracle WebCenter Content are virtual, meaning that they are collections of like metadata that tell Oracle WebCenter Content how to filter documents when you browse. Because of this, you can use a combination of searching and browsing to quickly filter your results to find the documents you need.

### 9.2 Using the Find Documents Page

The [Find Documents page](#) is displayed when you first log in to Oracle WebCenter Content. The main sections of the Find Documents page are:

- Side bar



- Search box in the banner area
- Folder search box and folder listing in the side bar (active when browsing and a library has been selected)
- Results list

When you log in to Oracle WebCenter Content the first time, the **Search** link is active in the side bar and the latest released revision of all documents in Oracle WebCenter Content to which you have access are displayed in the results list. In this view, all documents are displayed in a single flat list regardless of what library or folder they may be in. You can review the results in the content area or filter the results using the search box above the content area. For information about using the search box,

See [Searching Using the Banner Search Box](#).

Click **Browse** in the side bar to navigate through libraries and folders much like you browse folders on your local computer. Documents and folders in the library or folder you are browsing display in the results list, and the folder hierarchy you are browsing is displayed in the side bar. When browsing, the search box in the banner searches only the names of documents within the library or folder you are browsing, and a secondary search field is available above the folder hierarchy to use when searching for folders.

You can personalize this page to display all documents, all libraries, or your favorites the next time you log in.

## 9.3 Browsing Using the Side Bar

Clicking **Browse** in the side bar allows you to browse documents, and all libraries to which you have access are displayed in the results list. The type of library is noted by the icon used. For additional information on browsing, see [Browsing](#).

### 9.3.1 How do I browse through libraries?

To find content in a library:

1. Click **Browse** in the side bar.
2. In the results list, click the library you want to browse. The library opens and displays the folder hierarchy for the library in the side bar. Only documents at the top level of the library are displayed in the results list.
3. Do one of the following:
  - Review the documents in the list for the document you are looking for.
  - Enter text in the search box to filter the list by name.
  - Use the folder hierarchy in the side bar or click on any folder in the results list to navigate to a different folder in the library.
  - Use the folder search box in the side bar to search for a folder in the library. Note that the folder search box searches all folders in a library.
  - Select the **Search <Library> and Subfolders** option in the library drop-down menu to switch to searching metadata and then filter the results using the search box (see [Searching Using the Banner Search Box](#)).

Note that the results list differs depending on if you are browsing documents or searching metadata. For more information, see [Browsing versus searching](#).

## 9.3.2 How do I browse through favorites?

Click **Favorites** in the side bar to display all items you have specified as favorites. Unlike browsing libraries, a Favorites results list can display folders, libraries, saved searches, and any documents set as a favorite. Note that if you set a shortcut as a favorite, the target item is displayed when browsing favorites.

1. Click **Favorites** in the side bar. The results list of favorites is displayed with the items you've most recently specified as a favorite at the top.
2. Do one of the following:
  - Review the items in the list for the desired library, folder, or document.
  - Enter text in the search box to filter the list by name.
  - Open a folder in the list to continue to browse for the right item. Once you open a folder or library, the results list behaves as it does when browsing folders (see [How do I browse through folders in the side bar?](#)) or libraries (see [How do I browse through libraries?](#)).

## 9.3.3 How do I browse through folders in the side bar?

Folders, subfolders, and saved searches are displayed in the side bar once a library has been opened from the results list, or by searching using the search box at the top of the page (see [Searching Using the Banner Search Box](#)). To browse through a folder:

1. Click **Browse** in the side bar.
2. In the results list, click the library you want to browse. A list of folders in the library, if any, is displayed in the side bar.
3. Do one of the following:
  - Review the folders in the side bar list to find a specific folder. Expand each folder to see subfolders.
  - Filter the results using the Folders search box in the side bar to find a specific folder. Note that the folder search box searches all folders in a library.
4. Select the folder you want to browse. A list of documents and folders at the top level of the folder is displayed, with folders at the top of the list. If necessary, select the **Search <Folder> and Subfolders** option in the folder drop-down menu to switch to searching metadata. Searching metadata flattens the view, displaying documents in subfolders and filters out any document shortcuts and unreleased revisions. For more information, see [Browsing versus searching](#).

Figure 9-1 Changing Search Behavior with the Search &lt;Folder&gt; and Subfolders Option

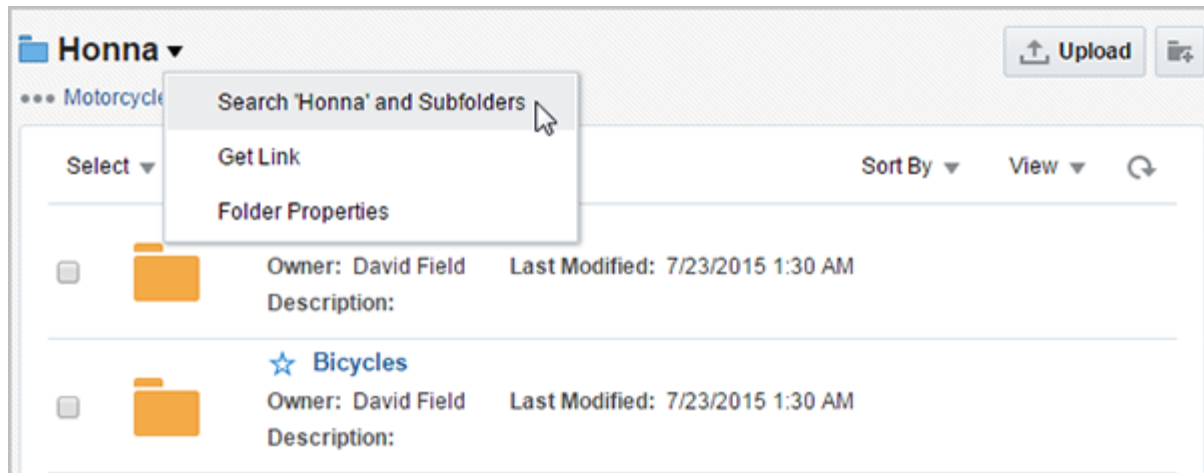

### 9.3.4 Browsing versus searching

You can find documents by browsing through libraries and folders, by searching for key words or phrases in document text and metadata, or a combination of both. The results displayed in the results list change depending on whether you are browsing or searching. [Table 9-1](#) describes how the results differ between browsing content and searching metadata. For information about the differences in search behavior, see [Searching and browsing](#).

**Table 9-1 Results Differences Between Browsing Documents and Searching Metadata**

Option	Description
Browse	When browsing: <ul style="list-style-type: none"> <li>• Folders (including query and retention folders), and shortcuts to folders are displayed at the top of the list.</li> <li>• The latest revisions of documents to which you have access at the top level of a library or folder are displayed, including unreleased revisions.</li> <li>• No documents in subfolders within the library or folder are displayed.</li> <li>• Shortcuts to documents are displayed.</li> <li>• The folder search box and folder hierarchy are displayed in the side bar.</li> </ul>
Search	When searching metadata and full-text: <ul style="list-style-type: none"> <li>• The latest released revisions of all documents to which you have access in the library or folder are displayed as a flat list, even those in subfolders. This list does not include unreleased revisions.</li> <li>• No document shortcuts are displayed.</li> <li>• The title of the filter tag in the search box can be clicked to return to browsing in the library or folder.</li> </ul>

### 9.3.5 How do I switch between searching and browsing?

When you log in to Oracle WebCenter Content the first time, you are outside the context of any library or folder. Use the search box to search metadata and full-text, if enabled, or click **Browse** in the side bar to navigate through libraries and folders to find the content you need.

Note that you can personalize this page to display all documents, all libraries, or your favorites the next time you log in.

If you want to search within an entire library or folder easily, you can browse to the library or folder you want to search, then search within the library or folder by selecting the **Search <Library/Folder> and Subfolders** option in the library or folder drop-down menu (see [Figure 9-1](#)). This enables you to search all the released documents in the library or folder you are browsing.

If you want to switch back to browsing after searching but remain in the library or folder you are in, click the title of the library or folder tab in the search box or select the **Return to Browsing <Library/Folder>** option from the search title drop-down menu (see [Figure 9-2](#)).

Figure 9-2 Switching from Searching Back to Browsing

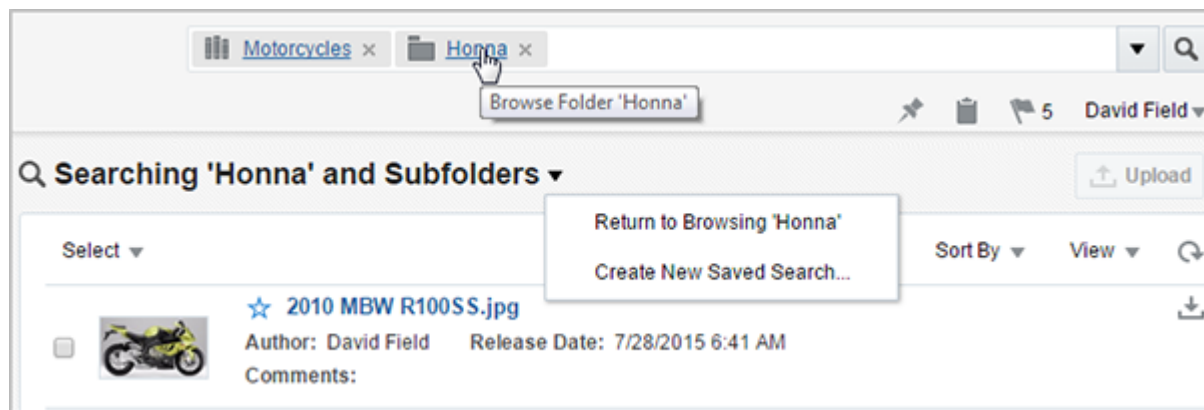

## 9.4 Searching Using the Banner Search Box

Searching for documents, folders, and libraries is done using the search box in the banner at the top of the page. As you enter text in the search box, it expands to provide suggestions based on close matches to what you enter. It does not only show exact matches. This means that you may see results in the expanded search box that won't be displayed in a results list when you execute the search by pressing **Enter** or clicking the search icon  next to the search box. For example, entering **Hon** in the search box may display a suggestion for the folder **Honna** as well as **On Hold**, both of which are close matches. However, once you execute the search, neither are displayed in the results list, because they do not exactly match the entered text of **Hon**.

### Note:

If the Auto Suggest feature is disabled, the **Search Box** doesn't automatically prompt results when you enter a search term. The categories in the pop-up window—Documents, Libraries, and Folders—are displayed with no results. Contact your system administrator to enable the Auto Suggest feature.

Figure 9-3 Expanded Search Box

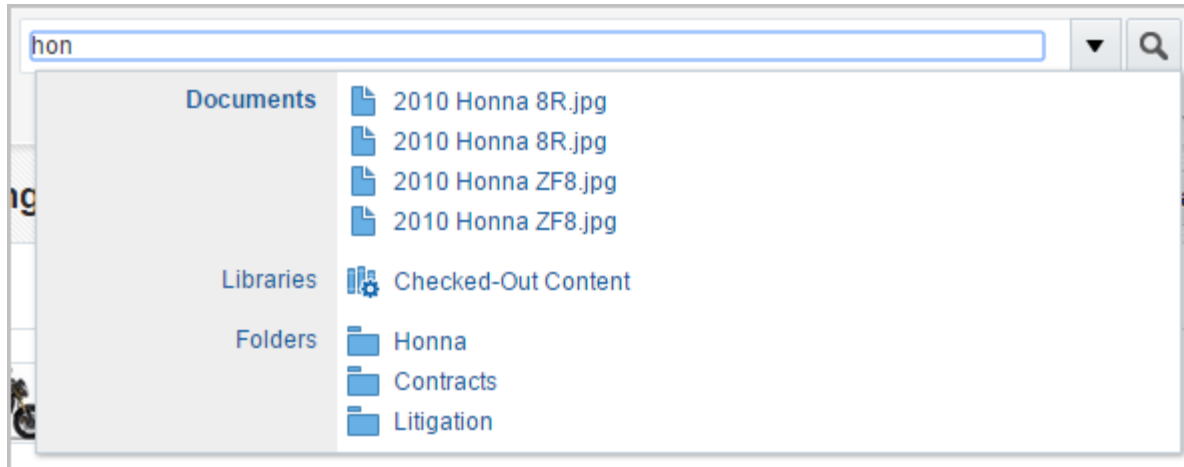

To search using the search box in the banner area:

1. Enter the name or part of the name for the document, folder, or library in the search box in the banner area. The search box expands, showing you result options available for documents, libraries, or folders.
2. Do one of the following:
  - On the left side of the expanded search box, select **Documents, Libraries, or Folders** to see a results listing of all documents, libraries, or folders that meet the criteria you entered.
  - On the right side of the expanded search box, select the specific document, folder, or library.

 **Note:**

If you browse to a particular library or folder before you search with the banner search box, your search is confined to the names of the documents or folders in the library or folder you are browsing. To search the folder or library using metadata, you must select the **Search <Library/Folder> and Subfolders** option in the library or folder drop-down menu (see [Browsing versus searching](#)). To widen your search to all documents to which you have access, click **Search** in the side bar.

- Click the **Search for documents** icon next to the search box to display a results list.
- Press **Enter** after entering the text to display a result list. Click the **Filter** icon next to the search box to display and select filter options to refine the results (see [How do I use predefined filters to refine results?](#)).

 **Note:**

The search box expands and displays filter options as you enter text. The entered text does not have to be at the beginning of the name of the document, folder, or library to be displayed in the filter options (see [Understanding text entry](#).) In fact, the suggested options are considered close matches, so entering *capabil* in the search box may display *capabilities worksheet.xls* as a close match under the Documents section of the filter.

However, when clicking the **Search for documents** icon next the search box, the search box looks for items that match the text entered. It does not search for parts of words or phrases unless you use wildcards. For example, even though entering *capabil* in the search box suggested *capabilities worksheet.xls* as a document option, it does not find a file named *capabilities worksheet.xls* when you click the **Search for documents** icon, because *capabil* is not an exact match. Entering *capabilities*, *capabi\**, or *??pabil\** does. For a list of supported wildcards and their behavior, see [Table 9-2](#).

## 9.4.1 Understanding text entry

When searching, text entered into the search box creates a custom filter based on the text you enter. When you press **Enter**, the text in the search box is compared to indexed metadata such as document, folder, and library titles as well as the full-text of each document if Oracle WebCenter Content is configured to index full-text.

When you begin entering text into the search box before pressing **Enter**, the box expands to display a list of possible result options organized into sections by Documents, Folders, and Libraries. For example, entering *HR* would show documents named *HR Vacation Policy* and *HR Employees*, folders named *HR Forms* and *HR Policies*, and a library named *HR*.

Continuing to enter text immediately filters the results. In this example, if you continued typing *HR P*, the search box result options would change to show only the folder named *HR Policies*. Note that the document named *HR Vacation Policy* would not be displayed, even though it has both *HR* and *P* in the title. The entered text must be sequential in the returned result.

The entered text does not have to be at the beginning of the name of the document, folder, or library. It can be anywhere in the title and is not case sensitive. For example, entering *POL* would display result options for the *HR Vacation Policy* document and the *HR Policies* folder, even though the names do not begin with what was entered.

### 9.4.1.1 How do I search metadata when browsing?

If you browse to a particular library or folder before you search with the banner search box, your search is confined to the titles of the documents or folders in the library or folder you are browsing. To search the folder or library using metadata, you must select the **Search <Library/Folder> and Subfolders** option in the library or folder drop-down menu (see [Browsing versus searching](#)).

### 9.4.2 How do I use predefined filters to refine results?

Predefined filters are created by a system administrator as a way of refining what documents are included in a search by selecting to search only documents that meet the specified criteria, such as a specific content type or within a specific security group. The Favorites link in the side bar is a predefined filter. You can display additional predefined filters by clicking the **Filter** icon

next to the search box. One or more filters can be selected and are displayed as tags in the search box. Predefined filters can be used along with text entered into the search box to better refine your search.

 **Note:**

When browsing, predefined filters for documents are limited to documents authored, favorited, followed, or checked out by you. Predefined filters when browsing libraries are limited to libraries created, favorited, and followed by you, enterprise and system libraries.

To use filters when searching:

1. Click the **Filter** icon next to the search box to display and select filter options to refine the results. The applied filter is displayed as a tag in the search box and the results list refreshes to display documents meeting the filter criteria.
2. Enter text into the **search box** to refine your search within the context of the applied filter.

Figure 9-4 Search Box and Filter Menu



### 9.4.3 How do I clear filters?

Once you apply a filter, the filter tag is displayed in the search box and remains active until you clear it. To clear a filter, click the **X** in the filter tag to close it. If you want to quickly clear all tags, click the **Search** link in the side bar. Clicking the Search link takes you to the top-level of Oracle WebCenter Content, outside of any library context.

### 9.4.4 Supported wildcards

The following wildcard behavior is supported in the search box:

Table 9-2

Wildcard	Behavior
*	Enter to represent an infinite number of unknown characters
?	Enter to represent a single unknown character. Enter multiple times to represent a specific number of unknown characters.

**Note:**

To search for an asterisk (\*) or a question mark (?) without treating it as wildcard, you must escape the wildcard character by putting a backslash (\) before it; for example:  
here\\*

## 9.5 Searching for Folders

You can search for folders using either the search box at the top of the Find Documents page, or by browsing to a library or folder first, then using the search box in the side bar.

### 9.5.1 How do I search for folders using the search box?

To search for a folder using the search box at the top of the Find Documents page:

1. Enter the folder name or part of the folder name in the search box. The search box expands to show a list of suggestions.
2. Select a folder from the list of suggestions, or click **Folders** to display a result list of folders from which to choose.

**Note:**

Selecting Folders applies the Folders filter. The Folders filter allows you to search for folders across all libraries.

**Figure 9-5 Search Box with Folder Options Displayed**

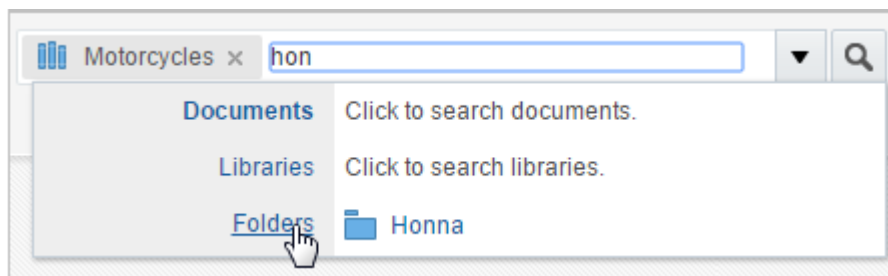

### 9.5.2 How do I search for folders using the side bar?

Once you browse to a library, folders within the library are listed in the side bar. There you can browse the folder hierarchy or use the folder search box above the hierarchy to find a specific folder in the library. The folder search box always searches in the context of whatever library or folder you are in, as opposed to the search box in the banner area, which can search across multiple libraries.

To search for a folder using the search box above the folder list in the side bar:

1. Navigate to the library or folder you want to search. A folder hierarchy is displayed in the side bar.



2. Enter the folder name or part of the folder name in the folder search box and press **Enter** or click the search icon next to the box. A list of close matches is displayed.

 **Note:**

- The search box returns suggestions based on close matches to what you enter. It does not only show exact matches. For example, entering **Hon** in the search box may display a suggestion for the folder **Honna** as well as **On Hold** once you execute the search.
- If the Auto Suggest feature is disabled, the **Folder Search Box** isn't displayed in the side bar. Contact your system administrator to enable this feature.

**Figure 9-6 Folder Search Box and Folder Hierarchy**

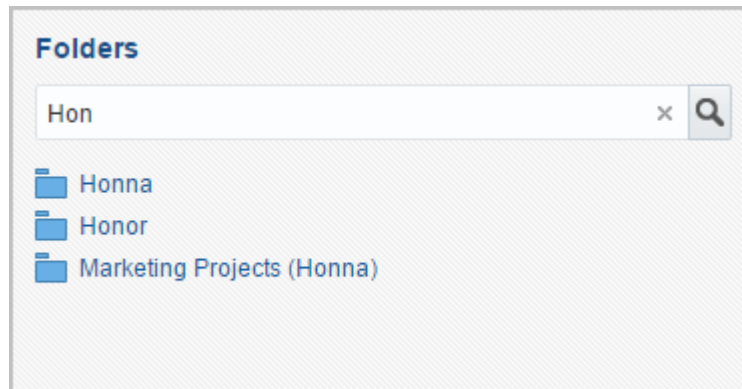

## 9.6 Using System Libraries to Find Documents in a Process State

System libraries can be used to quickly find documents that are being processed by Oracle WebCenter Content but not yet released. For example, documents that are checked out, expired, or being converted into different formats. For details on using system libraries to find unreleased content, see [Using System Libraries to Find Content](#).

## 9.7 Using Advanced Search Capabilities

Advanced search forms provide more flexibility for entering search criteria. To use an advanced search form, you select it from the search box menu. Advanced search forms are only available when searching. They include the standard form listing all metadata fields, or profile forms listing only those metadata fields used in a specific profile set up by your system administrator. Using an advanced search form you can search for metadata, full-text if it is configured, or a combination of both on all available fields.

Figure 9-7 Search Box Menu Showing Advanced Search Form Links

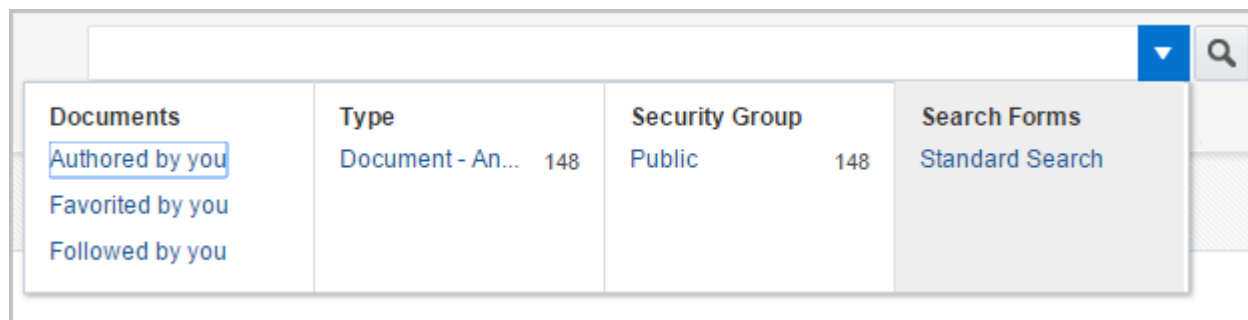

## 9.7.1 What is a metadata search?

With the advanced search form, you can search for document properties such as security group, author, title, or other defining criteria.

### Note:

Searches built using an advanced search form separate the metadata fields with the <AND> operator, meaning that each value entered into each field must be met in order to find a document. For example, if you enter `January` into the **Title** field and `presentation` into the **Type** field, then a search finds content only if it has a `presentation` type and has `January` in the title.

## 9.7.2 What is a full-text search?

You can also search for text used in a document if your system administrator has configured Oracle WebCenter Content to index full-text. If configured to search full-text, the additional search field **Full-Text Search** is added to the standard advanced search form and may be available in profile searches.

## 9.7.3 How do I use an advanced search form?

To search using an advanced search form:

1. When searching, select a form from the Search Forms section of the search box menu.
2. Enter values in the fields you want to search and click **OK**. For example, you can search for a document title, security group, or if configured for full-text search, then for text in a document. For information on using wildcards to help search, see [Supported wildcards](#). For information on how to use search operators, see [Metadata search operators for a database metadata search](#).

## 9.8 Saving Searches

Some search criteria can be saved and executed quickly using a saved search. Saved searches give you the experience of browsing through a file system while in reality searching for content using metadata. For example, a saved search can be created titled *1st Quarter Documents* that when clicked displays all documents checked in during the months of January

through March. The contents change every day without people having to upload documents to a specific folder, because clicking the saved search folder tells Oracle WebCenter Content to find all documents uploaded in January through March and display them in a list.

Some ways of searching cannot be saved. If you are browsing, the **Create New Saved Search** option is not available in the library or folder drop-down menu. To save the search, you would first have to select the **Search <Library/Folder> and Subfolders** option from the library or folder drop-down menu. For information on how to change between searching and browsing, see [Browsing versus searching](#).

To save a search:

1. Search for documents by browsing, using the banner search box, or using a search form.
2. When the results are displayed, select the **Create New Saved Search** option from the search title drop-down menu. If the **Create New Saved Search** option is not available in the menu, click the **Search <Library/Folder> and Subfolders** option from the library or folder drop-down menu. For more information, see [How do I switch between searching and browsing?](#)
3. In the Save Search screen, enter a name for the search and an optional description.
4. Search for a folder location where you want the search to be saved. You can search for a folder in all libraries or narrow your search by library.
5. Click **Save**. The search is saved to the location you specified.

Figure 9-8 Saving a Search

**Create Saved Search** [?] [X]

\* Name:  
1st Quarter Document

Description:  
All Docs in A/P Jan through Mar

< Contracts Search in This Folder [Q]

... Legal > Contracts

- Quarterly

Save Cancel

 **Note:**

If the Auto Suggest feature is disabled, the **Folder or Library Search Box** isn't displayed within the **Create Saved Search** dialog. Contact your system administrator to enable this feature.

## 9.8.1 How do I use a saved search?

Saved searches are displayed in the folder hierarchy in the side bar as well as in the results list. To use a saved search, navigate to the folder in which the search is saved, and click on the saved search to view the search results.

## 9.8.2 How do I modify saved search properties and criteria?

If you have the permissions to do so, you can modify the properties of a saved search, such as title and sharing options, in the same way that you modify library and folder properties. For

more information on folder types and modifying library and folder properties, see [Viewing and Editing Document Library Properties](#).

To modify a saved search, navigate to the folder in which the search is saved and do the following:

1. Run the saved search.
2. Change the search criteria.
3. Select the **Update Saved Search <Name>** option from the saved search drop-down menu.

**Figure 9-9 Update Saved Search Option in Save Search Menu**

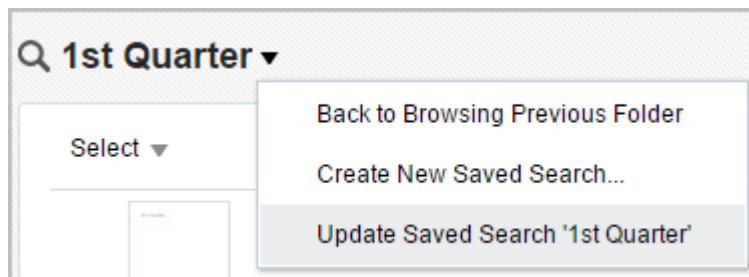

## 9.9 Working with the Results List

When searching or browsing, results are displayed in the content area as a results list. All results lists, except the Rendition Clipboard results list, can be viewed as lists, thumbnails, or tables as detailed in [Results view](#). Some results lists can be sorted. There are six types of results:

- **Favorites** results are displayed with the most recently marked items listed first and cannot be sorted.
- **Library** results are displayed when you click **Browse** in the side bar. Library results cannot be sorted.
- **Folders** results are similar to library results and cannot be sorted. Folder results differ from library results in that their contextual menus have options available to folders but not libraries.
- **Documents and Folders** results can be sorted (see section [How do I sort results?.](#)) Document results can also be filtered when searching to show documents in all subfolders, or when browsing to show documents and folders only at the top level of the selected library or folder, as well as unreleased revisions and document shortcuts. For detailed information on changing between searching and browsing, see [Browsing versus searching](#).
- **Rendition Clipboard** results are displayed when you click the **Rendition Clipboard** icon (🗑️) in the banner area. You cannot sort or change the view of this results list.
- **Trash** results are displayed when you click **Trash** in the side bar. Trash results can be sorted.

In a results list, browsing a library or folder displays the latest revision of all documents at the top level of the library or folder as well as any subfolders. Browsing does not display documents in subfolders within the library. To display documents in all folders and subfolders of a library or folder, browse to the folder then select the **Search <Folder> and Subfolders** option in the folder drop-down menu.

To open a library, click the library thumbnail image, or the library title if in the list view. To open a document, click the document title in the results view. Opening the document from a results list displays the document in the View Documents page.

## 9.9.1 Results view

In a results list, the name of each item and its corresponding icon are displayed. Some results lists also provide the option to set an item as a favorite. In such results lists, the **Favorite/Unfavorite** icon is displayed next to the item. There is also a check box present next to each item in a results list (except for the Favorites results list). Selecting the check box enables the results toolbar (see [Modifying Items Using the Results Toolbar](#)).

You can change how a results list is displayed using the View menu. To change the results view:

1. Browse or search for documents (see [Browsing Using the Side Bar](#) and [Searching Using the Banner Search Box](#)). Libraries and Favorites cannot be sorted.
2. With the results list displayed in the content area, select an option from the **View** menu. Options and their behavior are listed and described in [Table 9-3](#). The chosen option remains as the default view until it is changed, although library and document display options are specified individually.

**Table 9-3 Results List Display Options**

Option	Document Behavior	Library Behavior
List	Displays a document thumbnail, the document author, release date and comments. Clicking a document expands the line to include a subset of document properties.	Displays an icon identifying the type of library it is, a description of the library and the library owner.
Thumbnail	Displays a document thumbnail. Clicking the information icon opens a window with a subset of the document properties.	Displays an icon identifying the type of library it is. Clicking the information icon opens a window with a description of the library and the library owner.
Tabular	Name, Title, Author, and Release date are listed in the table.	Displays a small icon identifying the type of library it is. Name, Description, and Owner are listed in the table.

### 9.9.1.1 When should a results list be refreshed?

Due to the need to index documents as they or their metadata are modified, changes to the results list when in searching are not displayed until the search index is refreshed in these cases:

- When a document is uploaded
- When a new revision is uploaded
- When a document name is changed
- When a document is moved to a different library or folder
- When a document is deleted
- When a document is removed from a library

## 9.9.2 How do I sort results?

Documents, folder, and trash results lists can be sorted, but library, favorites, and renditions clipboard results lists cannot. To sort a results list, select the sort option from the **Sort By** menu. The sort options are:

- Release Date
- Name

Options can be sorted in Ascending or Descending order and folders are always displayed before documents.

## 9.9.3 How do I change the number of items displayed per page?

You can specify the number of items displayed in a results list by using the **Items Per Page** menu in the content area of a results list. Libraries items per page and document items per page can be specified individually. The chosen option remains as the default view until it is changed.

## 9.9.4 How do I pin a view?

Click the **Pin This View Icon**  to save a current view. You are prompted to enter a name for the saved view, and the name appears in the banner with the oldest pin nearest to the icon.

Click the name of the view in the banner to return to it. The saved view includes any search and filter criteria, any library and folder selections, and the current sort and view selections.

## 9.9.5 How do I set a favorite?

To mark a document or library as a favorite, click the Favorite icon next to the item in a results view. Click again to clear the favorite.

### Note:

Marking a shortcut as a favorite also sets the target library, folder, or document as a favorite. Unmarking either the shortcut or target item clears both the shortcut and target item.

To mark a folder as a favorite, do one of the following:

- Navigate to the folder you want to mark so that it is listed in the side bar, then right-click the folder and select Favorite. Repeat the process to clear the folder.
- Begin searching for the folder you want using the banner search box and select **Folders** from the suggestion list in the expanded search box. Locate the folder in the results list and click the Favorite icon next to the folder in the content area.

### Note:

You cannot mark a cloud folder as a favorite.

Figure 9-10 Filtering Results to List Folders

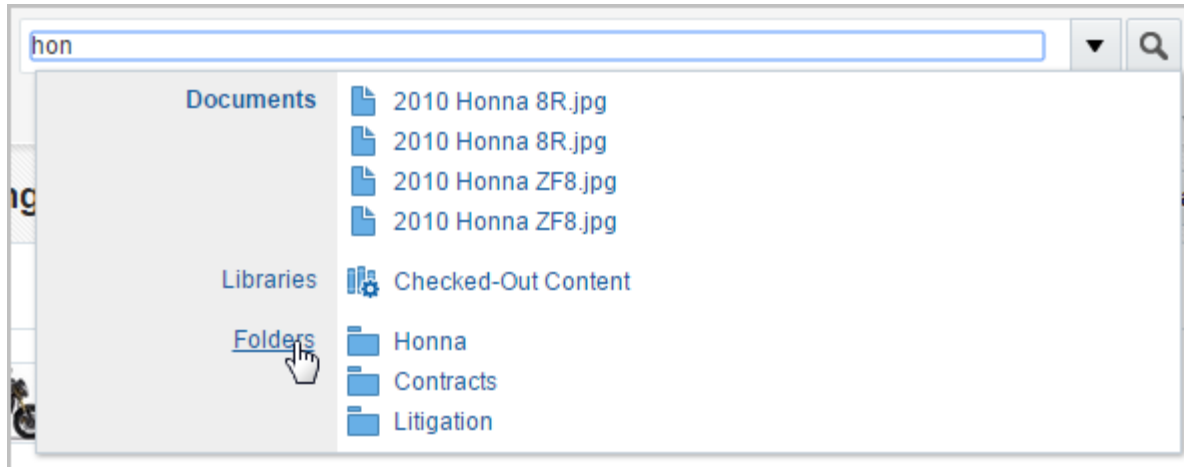
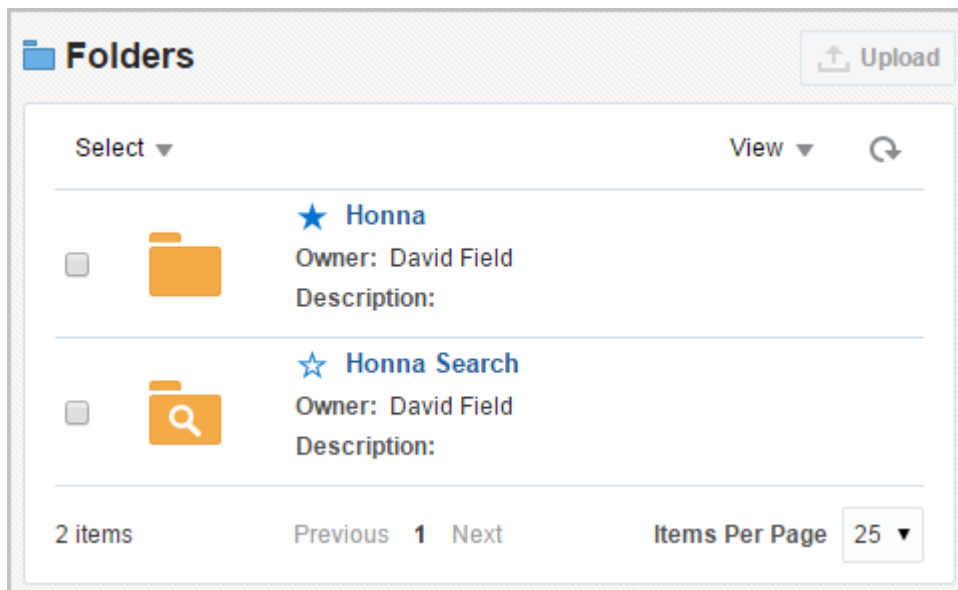

Figure 9-11 Folder Results List with Favorite Marked



## 9.9.6 How do I follow items?

You can follow a library, folder, or document and be notified when documents are added and modified. To follow an item, do one of the following:

- Select the item on a results list and choose **Follow** from the **More** menu in the results toolbar.
- Right-click an item in a results list or in the Folders list of the side bar and select **Follow** from the contextual menu.





**Note:**

Followed items are noted with a check mark next to Follow in the More or contextual menus. Clear the check mark to no longer follow an item.

To quickly display a list of all documents you are following:

1. Click **Search** in the side bar to clear all filters from the search box.
2. Select **Followed by you** from the filter menu in the document list of the search box.



**Note:**

When using the **Followed by you** filter when searching, libraries that you are following are not displayed in the results list. If browsing libraries, libraries are displayed when using the **Followed by you** filter.

If you want to limit the list of documents you are following to those in a specific library or folder:





1. Browse to the library or folder.
2. Select **Followed by you** from the filter menu in the document list of the search box.



## 9.9.7 How do I view library contents?

To open a library and view the contents, click the library thumbnail image or the library title. The latest released revisions of all documents at the top level of the library are displayed.

## 9.10 Modifying Items Using the Results Toolbar

Selecting an item or items in a results list enables the results toolbar. Note that the available options in the toolbar depend on your permissions to the selected item or items. The following table lists the actions available for items in a document, folder or library results list. For actions available in renditions clipboard and trash results lists, see [How do I use the renditions clipboard?](#) and [Working with Items in Trash](#) respectively.

Icon	Option	Description
	Check In New Revision	Checks out the selected item and prompts you to check in a new revision. This option is not available if multiple items are selected.
	Get Link	Displays links to view the document properties page and to the native file of the latest released revision or optionally the specific revision in the result list. This option is not available if multiple items are selected.
	Move	Prompts you to move the selected item or items. Available when single or multiple items are selected.
	Copy	Prompts you to copy the selected item or items. Available when single or multiple items are selected.

Icon	Option	Description
	Delete	Prompts you to delete the selected item or items. Available when single or multiple items are selected and you have rights to delete the items.
	Properties	Displays the Library or Folder Properties page.
More	Has the following possible options (note that some may be unavailable depending on your permissions):	Lists options for modifying documents. This option is not available if multiple items are selected.
	Propagate (folder only)	Displays the Propagate page.
	Check Out/Cancel Check Out	Checks out the selected item. After checking out an item, you must either check in a new revision or undo the check-out before the item can be revised again.
	Download	Prompts you to download the selected item.
	Launch Web Rendition	Displays the web rendition of the selected item.
	Launch Dynamic Conversion	Displays the HTML conversion of the selected item.
	Add to Rendition Clipboard	Prompts you to choose what renditions of the selected item you want to add to the rendition clipboard. The rendition clipboard stores specific renditions of specific document revisions for quick access. For example, you can save a web-viewable rendition of the first revision of a document as well as a native version of the current revision so that you can quickly compare them.  Click the rendition clipboard icon  to display a list of renditions saved to the clipboard.
	Follow	Starts tracking of the selected item so you can follow it.
	Create a Shortcut	Prompts you to create a shortcut of the selected item.
	Rename	Prompts you to rename the selected item.  Renaming a cloud folder results in a rename of the corresponding Oracle Content Management Cloud Service folder.
	File/Unfile Document	Allows you to file the selected unfiled document in a library or folder, or remove the selected filed document from a library.
	Upload Similar document	Prompts you to upload a similar item. Selecting this option prepopulates the metadata values of the Document Upload form with those of the selected document.
	Properties	Opens the Document Properties page.

# 10

## Viewing and Annotating Documents

Using the WebCenter Content user interface, you can easily view single or multipage documents and their associated metadata or revisions without having to leave the interface. This chapter has the following sections:

- [About Viewing and Annotating Documents](#)
- [Viewing Documents on the Document Page](#)
- [Changing the Document View](#)
- [Viewing Alternate Renditions](#)
- [Viewing the Native File](#)
- [Viewing Previous Document Revisions](#)
- [Annotating Documents](#)
- [Using Links](#)

### 10.1 About Viewing and Annotating Documents

Oracle WebCenter Content converts many document formats to versions that are displayed on the Document page within a standard web browser. This means that even if someone does not have the native software that created a document, they can still view and share the document.

In addition to viewing documents, you can annotate documents and perform a variety of tasks from the Document page, which has the following main sections:

1. [Banner section](#)
2. [Preview area](#)
3. [Properties section](#)

Figure 10-1 Oracle WebCenter Content Document Page

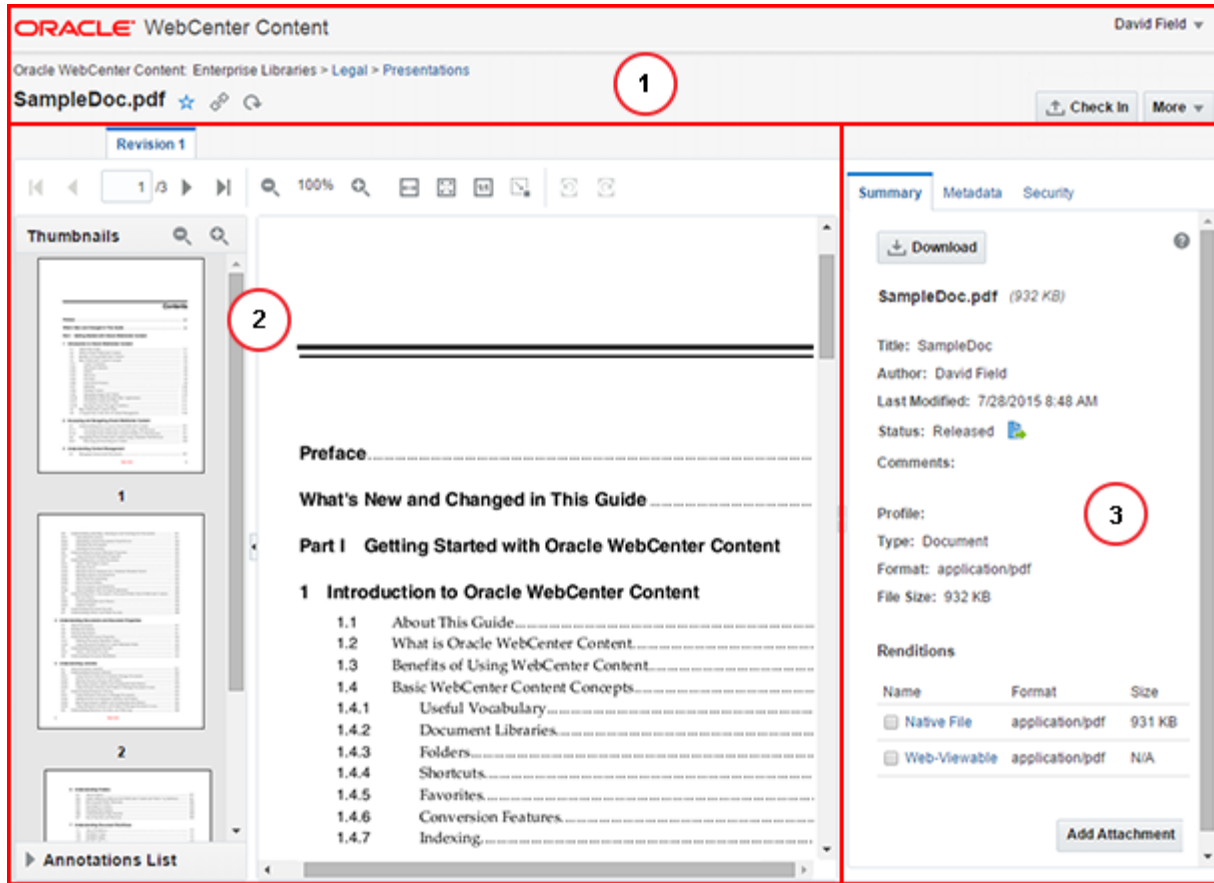

### 10.1.1 Banner section

In the banner section, you can perform the following tasks:

- File an unfiled document or view the path to a filed document's location in the context of Oracle WebCenter Content
- Mark a document as a favorite
- View links to the document
- Check in new revisions of documents
- Access more tasks from the More menu
- Log out of Oracle WebCenter Content

### 10.1.2 Preview area

Depending on the document format and how your system is configured, Oracle WebCenter Content converts uploaded documents into formats that are viewable using a standard web browser or document viewer. If your system can display a viewable rendition of the document, it is displayed in the preview area. You can perform the following tasks using the toolbar in the preview area:

- Going to specific pages

- Zooming the page view
- Adjusting the document width
- Rotating the document
- Viewing/hiding, filtering, and adding annotations.

Certain types of documents provide additional viewing and navigation tools, if enabled. The side of the preview area can expand to display thumbnail images of the document pages and the annotations list. You can navigate to specific pages of the document using thumbnails and to specific annotations using the annotations list.

 **Note:**

If a particular document format (for example, *.indd* or *.indt*) cannot be converted to a web-viewable version, a blank page is displayed in the preview area.

### 10.1.3 Properties section

The properties section displays a summary of document properties with the option to display all properties, including security metadata. From the document properties area you can do these tasks:

- Download a copy of the native file
- View or download any generated rendition
- Download annotated versions of the document if the document has annotations.
- Add attachments to the document
- View and edit metadata and security properties
- View workflow details of documents in a workflow and check in, approve, or reject items assigned to you.

## 10.2 Viewing Documents on the Document Page

Documents can be accessed from the [Find Documents page](#) and viewed on the [View Documents page](#). How to access the documents depends on if the results list is set to display as List, Thumbnail, or Tabular:

- If set to List or thumbnail, click either the thumbnail or document name to view the document
- If set to Tabular, click the View icon or document name to view the document

## 10.3 Changing the Document View

The View Documents page toolbar allows you to change how a document is displayed in the preview area. Using the toolbar, you can:

1. Navigate multipage documents
2. Increase or decrease the display size of the document
3. Rotate the document page displayed in the viewer

4. View/hide, filter, and add annotations (If you do not have annotation privileges, the annotation related options do not appear in the toolbar.)

Additionally, the side pane of the preview area can expand to display thumbnail images of each page of the document and the annotations list. Click a page in the thumbnail pane to go to that page.

Figure 10-2 Oracle WebCenter Content Document Page Toolbar



## 10.4 Viewing Alternate Renditions

Alternate renditions are available for most documents when converted to HTML dynamically or when converted to some other web-viewable format at the time a document is uploaded. Dynamic conversions are not available for some native document formats, and also must be converted each time you select it. Web-viewable renditions are typically available for a wide range of native document formats and are converted once when a document is uploaded.

Dynamic conversions of documents can be viewed in a standard web browser outside of the View Documents page by:

- Selecting **Launch Dynamic Conversion** from a contextual menu. To access the contextual menu, right-click a document in a results list.
- Clicking **Dynamic Conversion** under the Renditions area in the Properties section of a [View Documents page](#).

Web-viewable renditions of documents can be viewed in a standard web browser outside of the Document page by:

- Selecting **Launch Web Rendition** from the list toolbar menu. To access the list toolbar menu, select a document in a results list.
- Clicking **Web-Viewable** under the Renditions area in the Properties section of a View Documents page.

Summary
Metadata
Security

Download
?

**Tulips.jpg** (607 KB)

Title: Tulips

Author: David Field

Last Modified: 7/30/2015 1:48 PM

Status: Released

Comments:

Profile:

Type: Document

Format: image/jpeg

File Size: 607 KB

Rendition Set: BasicRenditions

**Renditions**

Name	Format	Size	Dimensions	Resolution
<input type="checkbox"/> <a href="#">Native File</a>	image/jpeg	606 KB	N/A	N/A
<input type="checkbox"/> <a href="#">Web-Viewable</a>	image/jpeg	N/A	N/A	N/A
<input type="checkbox"/> <a href="#">Thumbnail</a>	image/png	19 KB	106 x 80	96 dpi
<input type="checkbox"/> <a href="#">Preview</a>	image/gif	17 KB	250 x 187	N/A

Add Attachment

### 10.4.1 How do I view and work with digital asset renditions?

Some digital assets such as images and videos may be set to have additional renditions created automatically. Select a digital asset rendition to display a tool bar next to the rendition title that allows you to download a rendition, copy a rendition to the rendition clipboard, get links to a rendition, or delete the rendition if you have rights to do so.

## 10.4.2 How do I use the renditions clipboard?

### What is on the renditions clipboard?

Renditions of files that you put here. These are one or more of the following:

- The native file. This is the one that you or someone else first uploaded to the server.
- The web-viewable rendition. This is nearly always created when you first upload the native file to the server.
- Other renditions of this file that may have been created, usually by a process set up by the system administrator.

### How did these renditions get onto this clipboard?

You added a rendition to the clipboard by selecting an item in a search result list and choosing the **Add to Rendition Clipboard** option. Or you did so using the rendition tool bar on the View Documents Summary tab.

### What can I do with the renditions on the clipboard?

- **View a native file on a page within WebCenter Content:** Click the item's thumbnail image, or select **Open in New Tab** from the context menu of the Native File link.
- **View the web-viewable file in a web browser:** Click the Web-Viewable link or select **Open in New Tab** from its context menu.
- **View other renditions in their associated application:** Click the rendition's link [or select **Open** from its context menu].
- **Download the renditions:** Check the boxes for the renditions you want to download, then click the **Download Renditions** icon. Files are downloaded as a zip file through the Save As dialog.
- **Get links to renditions:** Check the boxes for the renditions you want to get links to, then select the **Get Link to Renditions** icon. The links are listed in a pop-up box. You can copy and paste the links from here yourself, or you can use the special feature to send them in an email.

You can also remove a rendition from the clipboard by checking its box and selecting the **Remove Renditions from Clipboard** icon, or you can empty the clipboard of all renditions by clicking **Empty**.

## 10.5 Viewing the Native File

If you have the software to open a native version of a document, you can download a copy and view it using the native software by clicking **Native File** in the Renditions area on the Summary tab of a View Documents page. See [Checking Out and Downloading Documents](#) for information on downloading a document.

## 10.6 Viewing Previous Document Revisions

The preview area of the [View Documents page](#) provides access to all previous revisions of a document. Revision numbers are listed above the View Documents page toolbar. Clicking a revision number displays that revision of the document in the preview area and the metadata of that revision in the document properties section.



Figure 10-3 Revision Tabs in Document View

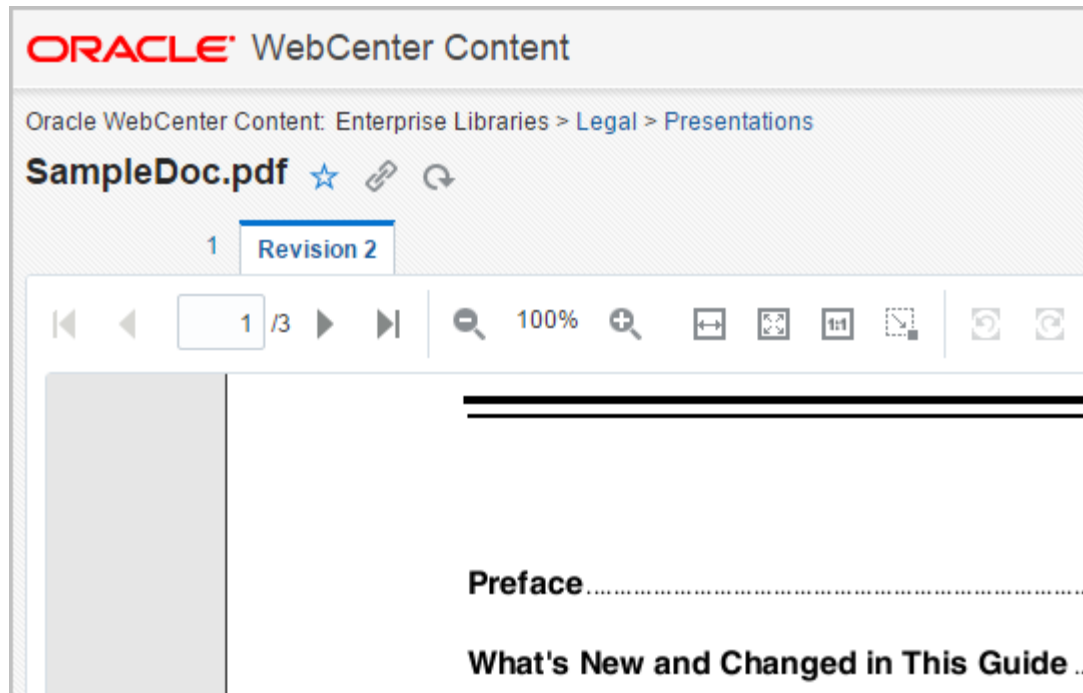

## 10.7 Annotating Documents

Provided you have the permissions to do so, you can add or modify annotations to documents. Among other things, documents can be stamped *Approved*, have a particular text highlighted, or have a note addressing a specific issue added.

This section has the following topics:

- [About annotation security](#)
- [How do I view and hide annotations?](#)
- [How do I create annotations?](#)
- [How do I modify annotations?](#)
- [How do I delete annotations?](#)
- [How do I download annotated documents?](#)

### 10.7.1 About annotation security

In some cases, not all annotations should be seen or allowed to be modified by all people. For example, upper management may annotate a request for proposal with pertinent information regarding an upcoming merger. Legally they may not be able to share that information with others in an organization who need access to that proposal, so the annotation permission is set to hide the annotation from those without proper permissions. Or perhaps a manager annotates a raise request denying the raise. The annotation can be restricted so the person who made the request can not approve it by modifying the annotation. Or a document may contain personal information such as Social Security numbers or health issues that need to be redacted and protected. Redaction annotation can be set to restricted to prevent others from hiding or modifying them to see the information.

When you create an annotation, you can set permissions for the annotation using the annotation toolbar. The permissions you can set, and the annotations you can modify or see, are determined by the permissions you have been given by the system administrator. Generally, the following options are available in the toolbar:

- **Standard (S):** Annotations appear on the document page for all users. They may be applied and changed only by users granted Standard annotation security permissions.
- **Restricted (T):** Annotations are visible to all users but can be modified only by a user granted the restricted permission. If you do not have the restricted permission (permission to change restricted documents), you can view the annotation but cannot alter it or change the permissions.
- **Hidden (H):** Annotations are visible only to users that have been granted the hidden permission. Only users having the hidden permission can mark an annotation as hidden or modify existing hidden annotations.

 **Note:**

If no annotation security is assigned to a person, they cannot create new or modify existing annotations. However, they still can view all Standard and Restricted annotations. This ensures that redaction annotations are applied for all people with rights to view a document.

Users must be granted the security level they assign to an annotation. For example, users assigned only the *restricted* security level can grant only the *restricted* security level to any annotation they create. Users that have been assigned the *standard* and *restricted* security levels by an administrator can specify a security level of *standard* or *restricted*, but not *hidden*.

 **Note:**

Redaction annotations cannot be marked hidden.

## 10.7.2 How do I view and hide annotations?

 **Note:**

A change in viewer technology starting with Imaging version 11.1.1.6.0 may cause stamp, sticky note, or text annotations created in earlier Imaging versions to be resized when first opened in the 11.1.1.6.0 version of the viewer. Redactions, line, and highlight annotations should not be affected. The change in size is caused by the ability of the new viewer to size annotations based on the resolution (in dots per inch) of the document image.

In some cases when viewing a document, annotations may get in the way of seeing information on the document you need to see. Click the **Hide Annotations** icon in the Document Page toolbar to hide annotations on a document. Alternatively, click the **Show Annotations** icon to view all annotations on a document.

## 10.7.3 How do I create annotations?

Select the type of annotation you want to create from the annotation toolbar. After you select, click on the document to create annotations such as Text, Sticky Note or Stamp, or drag the mouse cursor over the document to create other annotation types. An editing toolbar appears as soon as you create an annotation. Typical options on the editing toolbar include rotating the annotation, changing annotation color, and setting annotation permissions. Additional options are determined by the type of annotation. For example, the stamp annotation tool lets you choose from several stamps, and the note annotation toolbar lets you open a rich text editor.



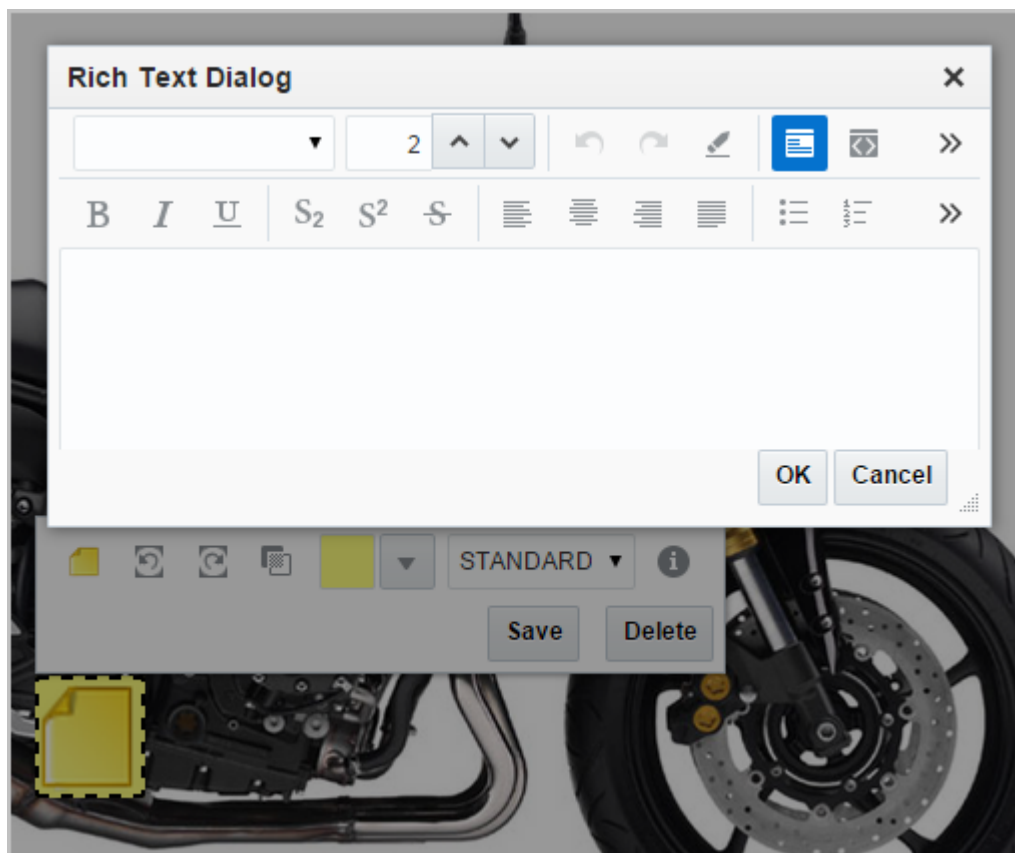



Figure 10-4 Note Annotation with Annotation Toolbar and Rich Text Editor Displayed



After you have finished creating an annotation, save it using the **Save** button on the editing toolbar. Navigating away from a viewed document without saving changes may cause changes to be lost.

The following table lists and describes the types of annotations available.

Table 10-1

Annotation Style	Icon	Description
Text		Select then click on document to display the editing toolbar. Enter the content in the description field of the toolbar.
Highlight		Select then drag on the current page to highlight a portion of the current page. Opacity and color are controlled by the accompanying toolbar.
Sticky Note		Select then click on the current page to display the editing toolbar. Click the <b>Edit Note</b> icon in the accompanying toolbar to open the rich text dialog.
Redaction		Select then drag on the current page to cover a portion of the current page.  Redaction annotations are placed based on coordinates and may shift with inconsistent use of fonts. If your redaction annotation has shifted, talk to your system administrator about ensuring that a consistent set of fonts is used across the server and clients.
Box		Select then drag on the current page to enclose a portion of the page in a box. The box color and border are controlled by the accompanying toolbar.
Stamp		Select then click the current page to add a predefined watermark annotation to the page. There are four default stamp options: <ul style="list-style-type: none"> <li>• Approved</li> <li>• On Hold</li> <li>• Received</li> <li>• Rejected</li> </ul> The stamp message, size, orientation, and opacity is controlled by the accompanying toolbar.
Line		Select then drag on the current page to add a line notation for underlining or striking through a word or image on the current page. Color, line width, and inclusion of arrowheads are controlled by the accompanying toolbar.

### How do I create annotations using the keyboard?

To create an annotation using the keyboard:

1. Use the **Tab** key to navigate through screen controls and focus on the **Annotation Edit**

**Mode** menu button () in the Document Page toolbar.

2. Press the **Down** key to view the annotations menu.
3. Use the **Up** and **Down** keys to focus on an annotation type in the menu.
4. Press **Shift+Enter** to create the annotation at the default location on the document.  
Along with the annotation, the annotation toolbar (in the keyboard mode) appears.

 **Tip:**

You can **Tab** through to **Edit Mode Selector** button () in the Document Page toolbar and press **Shift+Enter** to create a text annotation without using the annotations menu.

5. Use the controls in the toolbar to edit the annotation. Use the **Tab** key to navigate through and focus on controls in the toolbar. Use the **Up** and **Down** keys to alter values. Use the **Enter** key to make a selection.

 **Note:**

The size and position controls (Left, Top, Width, and Height) are available in the annotation toolbar only when you use the keyboard to create or modify an annotation.

## 10.7.4 How do I modify annotations?

After you create an annotation, you can modify aspects of the annotation using the same toolbar that you used to create the annotation. To display the toolbar, click the annotation and

select the **Edit** () button that appears on the annotation. Use the toolbar to modify the annotation in variety of ways, including:

- Change the text in a text annotation by editing the description field in the annotation toolbar.
- Change the text in a note annotation by clicking the **Edit Note** icon in the annotation toolbar to display the rich text editor.
- Cut, copy, paste, reorganize and undo changes to content within a note annotation using the rich text editor.
- Change an annotation background and border color using the background fill color and border color tools.
- Change the opacity of a highlight or stamp annotation using the **Annotation Opacity Level** icon and the slider to fade or darken the annotation.
- Rotate a stamp annotation.
- Change permissions to an annotation using the permissions drop-down menu in the annotation toolbar.

Click on an annotation to:

- Move it to a different location on the page by dragging it.
- Resize it by dragging the edges.

 **Note:**

To modify an annotation, you must have appropriate permissions. See, [About annotation security](#) for details.

### How do I modify annotations using the keyboard?

To modify an annotation using the keyboard:

1. Open the **Annotations List** in the side pane of the preview area.
2. Use the **Tab** key to navigate through screen controls and focus on one of the cells of the Annotations List table.
3. Press **F2** to get the Annotations List table into actionable mode.
4. **Tab** through the table listing to focus on a particular annotation and press **Shift+Enter**.  
The associated annotation is made active in the viewer, and the annotation toolbar (in the keyboard mode) appears.
5. Use the controls in the toolbar to modify the annotation. Use the **Tab** key to navigate through and focus on controls in the toolbar. Use the **Up** and **Down** keys to alter values. Use the **Enter** key to make a selection.

## 10.7.5 How do I delete annotations?

Select the annotation and click the **Edit** () button that appears on it to open the editing toolbar. Select **Delete** in the toolbar to delete the annotation.

## 10.7.6 How do I download annotated documents?

If the document has annotations, an Annotations section is included in the Summary Properties page. This section lists downloadable versions of the document that have the annotations applied. Click on a particular version to download it.

The annotations you see on the downloaded document will depend on the permissions you have been given by the system administrator.

 **Note:**

If a document has redactions and if you do not have the permission to see the content under redactions, you can download only the annotated version of the document. The options to download the native file and other rendition types are disabled.

## 10.8 Using Links

Links to view a document can be easily shared with others. If a person does not have rights to view a document, it remains secure and is not displayed. Document links can be displayed in these ways:

- Clicking the **Link** icon in the View Documents page banner section

- Selecting **Get Links** from the **More** menu in the View Documents page banner area
- Clicking the **Get Links** icon in the results list toolbar on the Find Documents page
- Right-clicking a document in a results list and select **Get Link** from the contextual menu

Links can also be displayed for folders and libraries.

# 11

## Uploading and Checking In Documents

Learn how to upload one or more documents to Oracle WebCenter Content so that they can be secured, viewed, and shared with others.

This chapter has the following sections:

- [About Uploading and Checking In Documents](#)
- [Uploading Documents from a Web Browser](#)
- [Checking In New Revisions from a Web Browser](#)
- [Uploading and Checking In Documents from WebCenter Content: Desktop](#)
- [Uploading and Checking In Documents from a Mobile Device](#)

### 11.1 About Uploading and Checking In Documents

You upload a document to have it managed by Oracle WebCenter Content. Uploading a document copies the document into a repository and if WebCenter Content is set to do so, converts the document to a version viewable in a web browser. Once the document is in a repository, it can be checked out, revised, and checked back in. Oracle WebCenter Content controls access to the document, tracks revisions to the document, and maintains metadata information associated with the document.

When you upload documents to a specific library or folder, you must navigate to the library first and then upload the document. Doing so applies the correct metadata to a document and organizes it in Oracle WebCenter Content so that you and others can find it. For detailed information on Libraries and Folders, see [Understanding Libraries](#) and [Understanding Folders](#).

Figure 11-1 Document Context

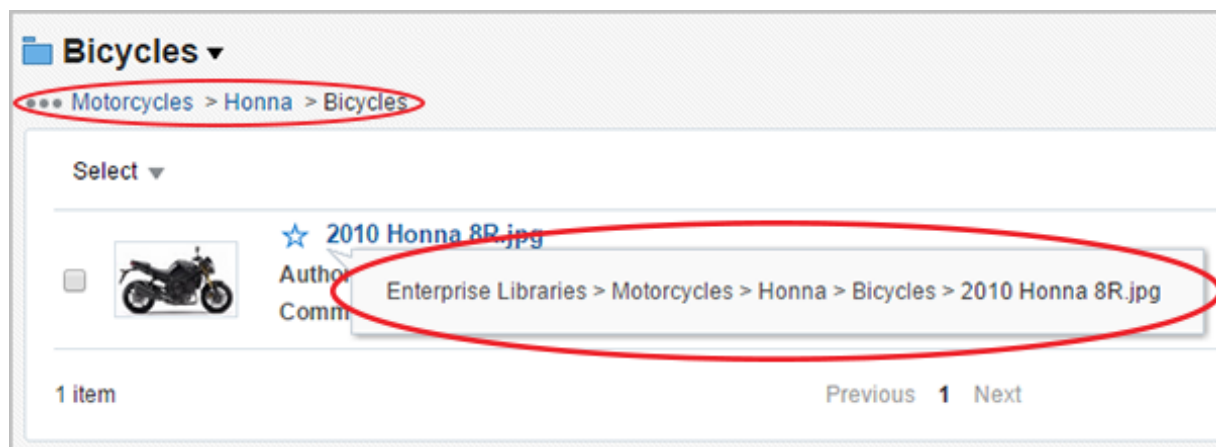



## 11.2 Uploading Documents from a Web Browser

Uploading documents to Oracle WebCenter Content is similar to uploading documents in many other applications. Once you begin, you navigate to the file you want to upload and then provide information about the document.

The information asked for when uploading a document is determined by the profile used when uploading. Profiles are configured by a system administrator to organize what metadata fields are available. For example, uploading a presentation using a profile configured for Marketing may require different metadata fields than when uploading a job application for Human Resources.

Much of the necessary information is automatically assigned based on the context of the library or folder used when uploading the document. For example, security access to a library automatically gets applied to a document uploaded to that library. If uploading to a folder in the library and the folder has different security properties, then they override the library security properties. If you want, you can see and change the metadata information when uploading a document.

You begin uploading documents in one of the following ways:

- Select a profile from the **Upload** menu on the Find Documents page. This option uses the metadata fields of the selected profile and the default information from the library or folder context used when uploading.
- Select **Upload Similar Document** from the **More** menu on either the Find Documents or View Documents page, or from the contextual menu when you right-click a document on a results list. This option uses the profile and default information of a document already uploaded to Oracle WebCenter Content.

### Note:

When uploading a document, it is recommended that you navigate to the library or folder you want the document in and select the default profile used by the library or folder to ensure that all metadata options are available during upload. The default profile for a library or folder is listed in bold face at the top of the Upload menu.

Note that profiles can set default values for some metadata fields, but the library or folder used to upload the document can override the profile.

To upload documents:

1. Select a profile from the **Upload** menu on the Find Documents page, or select **Upload Similar Document** from the **More** menu or a contextual menu. The Document Upload page is displayed.

### Note:

The **More** menu is available on the Find Documents page when a single document is selected and is also available on the View Documents page.

2. Add one or more files to the documents section of the Document Upload page. You can add files in one of the following ways:
  - Drag-and-drop one or more files from your file system to the documents section. Note that not all browsers support the ability to drag-and-drop.
  - Click **Browse** and navigate your file system to the file or files you want to add.

To remove a file from the list of documents, click the **X** next to the file.

3. Expand the **Metadata** section to review and edit any information for the document that you want to change. Metadata options are available only if at least one file is added to the documents section. If multiple documents are added, the displayed metadata is for the selected document.

 **Note:**

Metadata options are dependent on the profile selected. Default values are provided by the profile as well as the library and folder context. Some information is required as noted by an asterisk (\*).

Do not change the selected profile on the Document Upload Metadata form. If you need to use a different profile, cancel the upload and select the correct profile from the upload menu to begin again.

The **Name** field must be unique in the library or folder context being used or the upload fails. If the Name field is not available as a metadata option in the Document Upload form, then the file name of the file being uploaded must be unique in the library or folder context.

When uploading multiple files there is an option to copy a given metadata value to all files being uploaded. For example, you can enter *Status Report* in the name field and copy it to 12 other status reports to be uploaded, then add the month to the name value for each report separately: *Status Report - Jan*, *-Feb*, *-Mar*, etc. However, as the Name field value must be unique, you must make sure to change each value or the upload process will fail.

4. Click **Upload**.

Figure 11-2 The Document Upload Page

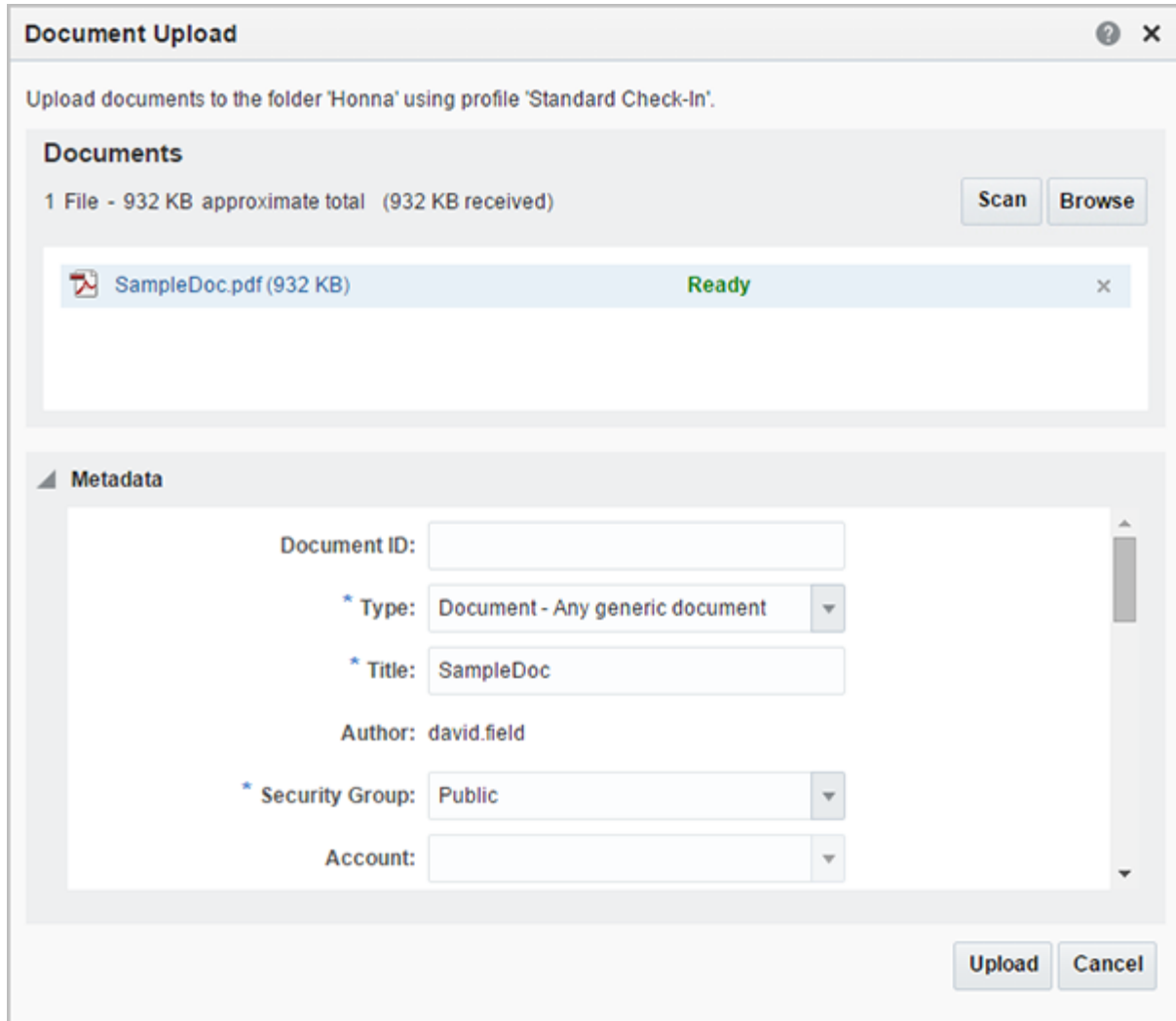

### 11.2.1 How do I change access to uploaded documents?

Access to documents uploaded to Oracle WebCenter Content is initially determined by the profile used to upload the document and the document context. This means that the library or folder to which the document is uploaded can set the default security metadata values. For example, if you upload a document to an enterprise library folder accessible by everyone without changing security settings, then everyone initially has access to the document.

You can change the access to unfiled documents or documents uploaded to an enterprise library using security groups, accounts, and access control lists. The following table lists and describes the security options available when uploading an unfiled document, or adding a document to an enterprise library in Oracle WebCenter Content.

**Table 11-1 Security Options For Unfiled Documents and Enterprise Libraries**

Option	Description
security groups	<p>Security groups control access to documents. Roles assigned to people within the security group are used to grant permissions to view, edit, and delete particular documents. The security group is a required metadata field for all documents and may be assigned by default. Only those who belong to that security group can work with the document. When you upload a file, you may be able to specify or change the security group metadata value.</p>
accounts	<p>Accounts are an optional feature that a system administrator can set up to define a more flexible security model. As with security groups, only users who have permission to a particular account can work with documents that belong to that account. When you upload a file, you may be able to specify or change the account metadata values.</p>
permissions	<p>Each role can have the following permissions for each security group:</p> <ul style="list-style-type: none"> <li>• <b>read (R):</b> The person can view and download files in that security group.</li> <li>• <b>write (W):</b> The person can view, upload, download, and get a copy of documents in that security group. Authors can change the security settings of a document if the author has write permission in the new security group.</li> <li>• <b>delete (D):</b> The person can view, upload, download, get a copy, and delete files in that security group.</li> <li>• <b>admin (A):</b> The person can view, upload, download, get a copy, and delete files in that security group. If this person has Workflow rights, they can start or edit a workflow in that security group. The person can also upload documents in that security group with another person specified as the Author. Non-authors of a document with document admin permission can change the security settings of a document if the non-author has write permission in the new security group and optionally, account.</li> <li>• <b>Annotation Privileges:</b> Based on the annotation privileges granted here, the person can view, modify, and add annotations on all the documents in that security group. The usual options available are <b>Standard (S)</b>, <b>Restricted (T)</b>, and <b>Hidden (H)</b>.        For more information on annotation security, see <a href="#">About annotation security</a>.</li> </ul> <p>The permissions for a security group are the highest permission defined by any of the roles <i>for that group</i>. For example, if you are assigned Guest and Contributor roles, where guest is given Read permission and Contributor is given Write permission to the Public security group, you have Write permission to content in the Public security group.</p>

**Table 11-1 (Cont.) Security Options For Unfiled Documents and Enterprise Libraries**

Option	Description
access control list (ACL) security	<p>An access control list is an explicit list of individuals or groups with permission to access or interact with a specific document.</p> <p>Depending on how access control list security is configured, up to three additional fields are available for use when adding, modifying, or searching for documents:</p> <ul style="list-style-type: none"> <li>• User Access List</li> <li>• Group Access List</li> <li>• Role Access List</li> </ul> <p><b>Important:</b> To use an access control list on a document, the document must be uploaded to a security group that supports access control lists, or the added security does not work. If you are uncertain if the security group you are using supports access control lists, check with your system administrator.</p> <p>To use access control lists with documents, you assign one or more predefined users, groups, or roles to the document. In addition, you assign the permissions (Read (R), Write (W), Delete (D), Admin (A), or Annotation Privileges) to each of the access list entries you specify.</p> <p>For example, suppose you add a document and you want guests to have read access with standard annotation privileges and you want all logged-in users to have read/write access with hidden annotation privileges. First, add the <i>guest</i> role to the document, click the <b>R</b> (Read) permission icon, and select Standard Annotations from the Annotations Privileges drop-down menu. Then, add the <i>authenticated</i> user role to the document, click the <b>W</b> (Write) permission icon to grant both the read and write permissions, and select Hidden Annotations from the Annotations Privileges drop-down menu.</p> <p>If either role is valid for the user, they have the access specified for the valid role. If both roles are valid for the user, they have the greater of the two permission sets.</p> <p><b>Important:</b> If there are no entries in the access control list fields for a document, then the document is available to any user whose security group and account permissions allow them access. However, once a user or group has been added to the access control list of a document, then users not explicitly added lose access to the document.</p> <p>The Access Control List metadata associated with a document can include multiple entries and permissions. When searching for content using Access Control List metadata, use the <i>Contains</i> or the <i>Substring</i> option (depending on your search engine) to help ensure that you find all instances of the specified metadata.</p>

Figure 11-3 Security Tab of the View Documents Page Properties Section

Summary Metadata **Security**

**General Security**

\* Security Group: Libraries

Account:

**Access Control Lists**

David Field R W D A [Permissions] x

Add Users

guest R W D A [Permissions] x

Add Roles

**Options**

Inhibit propagation of security values

Reset Save Cancel

### 11.2.1.1 How do I change access to unfiled or enterprise library documents?

Changing access to an unfiled document or document uploaded to an enterprise library is done using the document properties section of the View Documents page. To change access:

1. On the View Documents page of the document you want to modify, click **Security** in the Document Properties section.

2. In the Security area of the Document Properties section, select the security group or account you want to use.
3. If you want to define rights for specific people, add them using the Add User field in the Users area of the Access Control Lists section and set the rights you want them to have.
4. If you want to modify the rights given to certain roles, add the role using the Add Roles field in the Roles area of the Access Control Lists section and set the rights you want for that role for this document. Modifying the rights a role has for a specific document does not change the rights it has for other documents.

Remember, you can restrict permissions using an access control list within a security group, but not expand them beyond the permissions of the security group. For example, if everyone in the Authenticated role is set to have Write access to a document, you cannot specify Delete access to a person. You can, however, specify Read access for a specific person and they are limited to Read access.

However, if a person has two valid roles set in an Access Control List, then they have the greater of the two permissions. In other words, if an Access Control List is set to give Write access to all people with the Contributor role and Read access to all people with the Guest role, and a person is both Contributor and Guest, then they have Write access to the document.

## 11.3 Checking In New Revisions from a Web Browser

After a document is uploaded to Oracle WebCenter Content, any changes to the document must be checked in as a new revision. You can manually check in new revisions in the following ways:

- Using the **Check In** button on a View Documents page
- Adding a revision tab on the View Documents page
- Right-clicking on a document in a results list on the Find Documents page and selecting **Check In New Revision** from the contextual menu
- Selecting a document in a results list on the Find Documents page and clicking the **Check In New Revision** icon in the tool bar

If a document is checked out by someone else, the document is locked and a new revision can be checked in only by the person who has checked it out unless they undo the check-out. If a document is not checked out, you can check it out to lock it while you edit it before checking it back in, or add an edited revision to the View Documents page without first checking out the document. For more information on the options available for checking out and editing documents, see [Checking Out Documents](#).

To check in a new revision:

1. Click **Check In** on the View Documents page or use one of the other options listed above to begin. The Check In New Revision page is displayed.
2. Add a file to the documents section of the Check In New Revision page. You can add files in one of the following ways:
  - Drag-and-drop a file from your file system to the documents section. Not all browser are able to use drag-and-drop.
  - Click **Browse** and navigate your file system to the file you want to add.

To remove a file from the list of documents, click the **X** next to the file.

3. Expand the **Metadata** section to review and edit any information for the document that you want to change. Metadata options are available after a file is added to the documents section.

 **Note:**

The metadata profile and default options are based on the previous revision of the document.

4. Click **Upload**.

Figure 11-4 Check In New Revision Page

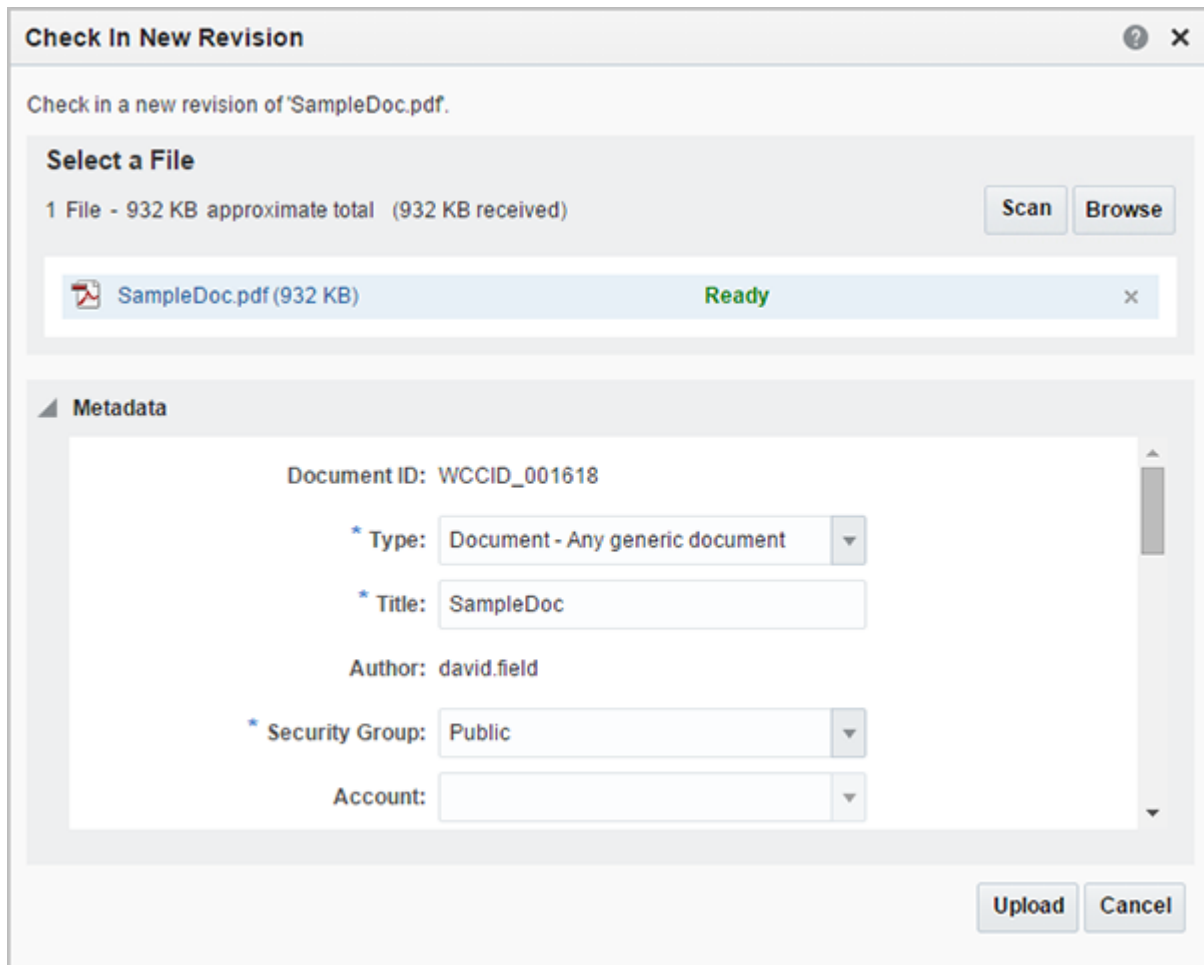

## 11.4 Uploading and Checking In Documents from WebCenter Content: Desktop

Oracle WebCenter Content: Desktop provides quick access to Oracle WebCenter through a standard Microsoft Windows files system or through Microsoft Office products such as Outlook and Word. When integrated with Oracle WebCenter Content: Desktop, uploading files to Oracle WebCenter Content is as simple as copying a file to a folder in Windows Explorer or



saving a file from a Microsoft Office Application. See [How do I integrate Microsoft File Explorer with content servers?](#) and subsequent sections in *Using Oracle WebCenter Content: Desktop*.

## 11.5 Uploading and Checking In Documents from a Mobile Device

You can upload documents to Oracle WebCenter Content using your Apple iPad, iPhone, or Android device. See [Uploading Documents Using the Apple iPad or iPhone App](#) and [Uploading Documents Using the Android Mobile App](#) in *Using Oracle WebCenter Content on Mobile Devices*.

# 12

## Checking Out and Downloading Documents

You can check out one or more documents from Oracle WebCenter Content to revise them. You can also download copies of documents.

This chapter has the following sections:

- [About Checking Out and Downloading Documents](#)
- [Checking Out Documents](#)
- [Downloading Documents](#)
- [Checking Out and Downloading Documents from WebCenter Content: Desktop](#)
- [Checking Out and Downloading Documents from a Mobile Device](#)

### 12.1 About Checking Out and Downloading Documents

You check out a document to lock it so that no other users can revise it. Only one user at a time can check out a file, but multiple users can continue to view the released document even when it is checked out. After checking out a document, you must either check in a new revision or undo the check-out before the document can be revised again. You must have write permission to the document to check it out or check in a revision. To undo a check-out, you must be the person who has the document checked out or have admin permissions to the document.

### 12.2 Checking Out Documents

You check out a document to lock it while you make changes. To check out a document, select a document then select **Check Out** from the **More** menu on either the Find Documents or View Documents page, or select **Check Out** from the contextual menu on the Find Documents page.

### 12.3 Downloading Documents

You download a document to copy a version to a file system. A copy can be the native file version, a web-viewable rendition, or an annotated version. You need read permission to download a document.

Some reasons you might download a document:

- To edit the document after you check it out
- To send a copy to someone else
- To review a document when not connected to Oracle WebCenter Content, for example while traveling
- To compare different revisions

For information on downloading annotated documents, see [How do I download annotated documents?](#)

### 12.3.1 How do I download native files?

To download a copy of a document in its native file format:

1. Do one of the following:
  - Click **Download** on the View Documents page.
  - Click **Native File** on the summary tab of the Properties section of a specified revision on the View Documents page.
  - Select **Download** from the More menu on a Find Documents page.
  - Click the document size on the Find Documents page when in List view.
2. When prompted, navigate to where you want the file stored and save the file.

### 12.3.2 How do I download a web-viewable rendition?

To download a web-viewable rendition of a document:

1. Right-click **Web-Viewable** on the summary tab of the Properties section of the View Documents page and select the appropriate option from the contextual menu for saving the file.
2. When prompted, navigate to where you want the file stored and save the file.

## 12.4 Checking Out and Downloading Documents from WebCenter Content: Desktop

Oracle WebCenter Content: Desktop provides quick access to Oracle WebCenter through a standard Microsoft Windows files system or through Microsoft Office products such as Outlook and Word. When integrated with Oracle WebCenter Content: Desktop, files can be checked out automatically and downloaded through your desktop application. See *How do I integrate Microsoft File Explorer with content servers?* and subsequent sections in *Using Oracle WebCenter Content: Desktop*.

## 12.5 Checking Out and Downloading Documents from a Mobile Device

Documents can be downloaded from Oracle WebCenter Content using your Apple iPad, iPhone, or Android device for review when you are not online, or for sending to others.

# 13

## Working with Libraries

Use libraries to organize and control access to documents, as well as associate appropriate metadata with documents. Here you learn how to create, secure, modify, and delete libraries. This chapter has the following sections:

- [About Document Libraries](#)
- [Creating an Enterprise Library](#)
- [Viewing and Editing Document Library Properties](#)
- [Propagating Library Metadata](#)
- [Sharing Document Libraries](#)
- [Following Document Libraries](#)
- [Creating Library Shortcuts](#)
- [Using System Libraries to Find Content](#)

### 13.1 About Document Libraries

Libraries and folders provide the context of a document, helping to determine what metadata fields are associated with a document and in some cases assigning values to the metadata automatically. Organizing documents in libraries helps to ensure documents are secure, can be shared, and are easily found by yourself and others. For detailed information on Libraries and Folders, see [Understanding Libraries](#) and [Understanding Folders](#).

There are two types of libraries:

- **Enterprise Libraries**, created by individuals to provide flexible security and comprehensive document management used by an entire organization.
- **System Libraries**, created and managed by Oracle WebCenter Content to organize documents that are in one of the following system processes:
  - Checked-Out Content (content locked for editing.)
  - Expired Content (documents that are no longer actively managed by Oracle WebCenter Content. Expired content can be filtered to also display documents set to expire within a specified date range.)
  - Work In Progress (documents that are in a conversion or indexing process and not yet ready for release.)
  - Content In Workflow (documents that are in one or more workflows.)

System libraries offer the ability to quickly find documents that are not currently released. You cannot upload documents to a system library.

 **Note:**

The permissions you have to a library determine the options available to you when working with that library.

## 13.2 Creating an Enterprise Library

Enterprise libraries provide flexible security and comprehensive document management used by an entire organization. To create an enterprise library:

1. Click **Browse** on the Find Documents page to display a list of all libraries.
2. Click **Create Library** in the results list.
3. Enter a unique name and description for the enterprise library on the Create Enterprise Library page and click **OK**.

 **Note:**

It is a good idea to select a unique name for any enterprise library that you create as in most cases you cannot have multiple enterprise libraries with the same name.

**Figure 13-1** Create Enterprise Library Window

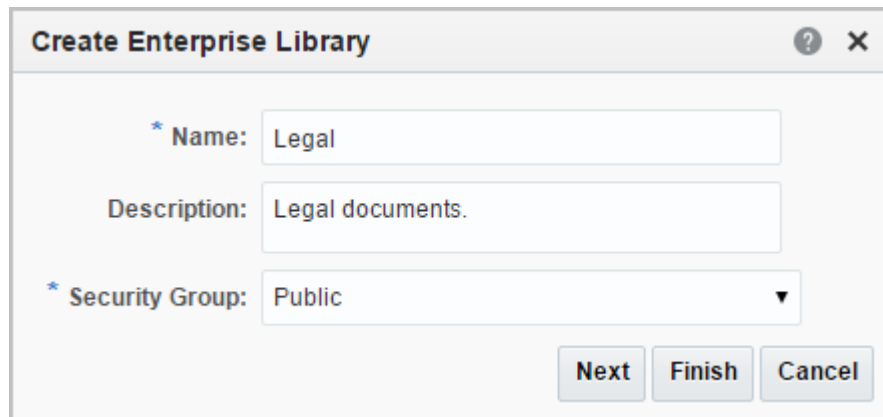

The screenshot shows a dialog box titled "Create Enterprise Library". It has a title bar with a question mark icon and a close button (X). The dialog contains three input fields: "Name" with the value "Legal", "Description" with the value "Legal documents.", and "Security Group" with a dropdown menu showing "Public". At the bottom right are three buttons: "Next", "Finish", and "Cancel".

4. Enter a security group for a library. For information on security groups, see [Understanding Document Security](#).

 **Note:**

To use an access control list on a document uploaded to the library, the security group selected for the library must support access control lists, or the added security does not work. If you are uncertain if the security group you are using supports access control lists, check with your system administrator.

5. Click **Finish** if done, or continue to set additional options if they are enabled.
6. If configured to use Accounts, click **Next** to optionally select an account for additional security. Use of accounts in Oracle WebCenter Content is optional and determined by your system administrator. You can begin typing to filter the list of any available accounts. For information on accounts, see [Understanding Document Security](#).
7. If configured to use access control lists, optionally set additional security in the **Access Control Lists** section. ACLs must also be enabled by your system administrator in order to be available.

Access control lists let you choose who has very specific access to items in the library. For example, if the authenticated role is set to Read access with Standard Annotation privileges, everyone with that role has rights to read content and also to create or modify standard annotations on documents uploaded to that library. But you can use an access control list to grant specific people rights to modify the library content, delete it, or even modify the library properties. For more information on access control lists, see [Understanding Document Security](#).

8. Once all options are set, click **Finish**.

**Figure 13-2 Create Enterprise Library Optional Security Options**

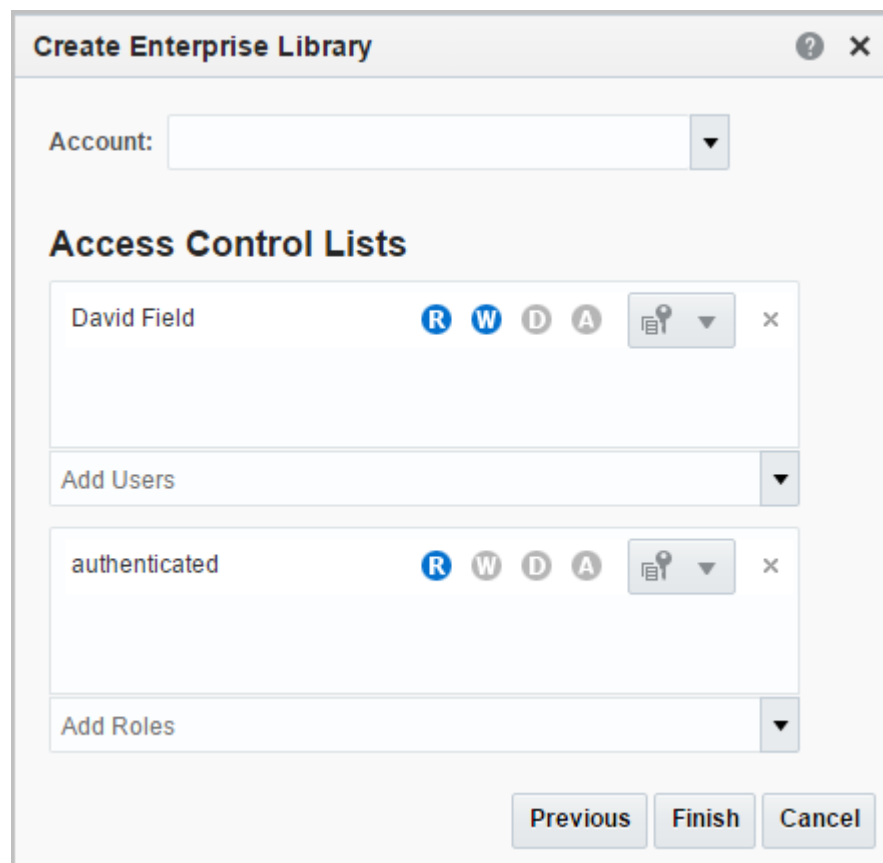

## 13.3 Viewing and Editing Document Library Properties

Libraries are owned by the people who create them, however:

- Enterprise library owners can transfer ownership to someone else, as can anyone with admin permissions to the library, even if they are not the owner.
- Enterprise library properties can usually be edited by anyone with Delete permission to the library, or the library owner if they have Read and Write permissions. If access control lists are used, then a person must have admin permission in the access control list. See your system administrator if you have questions regarding your permissions.
- System libraries are created by Oracle WebCenter Content and cannot have their properties edited.

Limited property information such as the library owner and description is displayed on a results list next to the library listing, or by clicking the Information icon (  ) next to a library in Thumbnail view.

To view or edit additional library properties, use the Library Properties window.

**Table 13-1 Library Property Options**

Tab	Page Options
General	<ul style="list-style-type: none"> <li>• Name</li> <li>• Description</li> <li>• Owner</li> </ul>
Security	<ul style="list-style-type: none"> <li>• Set security group</li> <li>• Set accounts</li> <li>• Specify users and roles in access control lists</li> </ul>
Metadata	<ul style="list-style-type: none"> <li>• Prompt user to enter metadata</li> <li>• Set default metadata values</li> </ul> <p>Note that library property metadata options and folder property metadata options are alike except for the following two options, which are available only for folders:</p> <ul style="list-style-type: none"> <li>• <b>Inhibit propagation of metadata values through this folder</b></li> <li>• <b>Inhibit propagation of security values through this folder</b></li> </ul>
Shortcuts	Displays a list of shortcuts pointing to the library. This information cannot be modified.
Advanced	Displays system information about a library that cannot be modified, such as the Library ID and the creation date.

To view and edit library properties:

1. Open the library properties window by one of the following ways:
  - Select the library on a results list and click the Library Properties icon (  ) in the List toolbar.
  - Open a library and select the **Library Properties** option from the library drop-down menu.
  - Right-click a library on a results list or in the Folders list of the side bar and select **Properties** from the contextual menu.
2. Select the appropriate tab for the information you want to view and edit.
3. When finished editing the library properties, click **Save**.

## 13.4 Propagating Library Metadata

If you move or copy documents or folders from a library into a different enterprise library with predefined values for metadata, you may want to change or add the metadata values associated with the item to the default values of the new library.



### Note:

While propagating metadata, all subfolders and documents in subfolders are affected. However, propagation does not affect shortcuts, saved searches, and cloud folders.

To propagate metadata and security values to items in a library:

1. Open the Propagate window by one of the following ways:
  - Select the library on a results list and choose **Propagate** from the More menu in the List toolbar.
  - Right-click a library on a results list or in the Folders list of the side bar and select **Propagate** from the contextual menu.
2. Optionally enable **Propagate to folders only** to limit propagation to folders and not to documents in the library or folder.
3. Optionally enable **Force propagation** to ignore inhibit propagation settings on descendants of the library or folder.
4. Select the fields to use when propagating and specify the values. The default values can be used or modified. The metadata or security fields of the documents or folders will be populated with the specified values. If any fields contain values prior to being propagated, the values will be overwritten. For example, selecting a field with a blank default value in the library will overwrite and therefore clear any fields that contain a value in the document or folder.
5. When finished selecting the fields, click **Propagate**.



Figure 13-3 Propagate Window

The screenshot shows a window titled "Propagate" with a close button and a help icon. The main text reads: "Propagate to the contents of 'Legal' and its subfolders." Below this, there are two sections: "Options" and "Fields".

**Options**

- Propagate to folders only
- Force propagation

**Fields**

Select fields to propagate by checking the box next to the field name. The values of these fields will overwrite existing values for documents and folders in the propagation path.

Fields listed include:

- Type:  <No Selection>
- Title:  [Text input]
- Author:  [Text input]
- Security Group:  Public
- Account:  [Text input]
- Expiration Date:  [Date picker]
- Comments:  [Text area]
- User Access List:  [List area] with "Add Users" button
- Group Access List:  [List area] with "Add Aliases" button
- Profile:  <No Selection>
- Template Type:  <No Selection>
- Image Rendition Set:  <No Selection>
- Video Rendition Set:  <No Selection>

Buttons at the bottom right: "Propagate" and "Cancel".

## 13.5 Sharing Document Libraries

To share enterprise libraries you must have Read, Write, and Delete permissions to the library, or be the library owner and have Read and Write permissions. Set access using security groups, optional accounts, and access control lists. For detailed information about these items, see [Understanding Document Security](#).

Share access to enterprise libraries using the library properties window:

1. Open the library properties window by one of the following ways:
  - Select the library on a results list and click the Properties icon (  ) in the List toolbar.
  - Right-click a library on a results list or in the Folders list of the side bar and select **Properties** from the contextual menu.
  - Select the **Library Properties** option from the library drop-down menu when browsing at the root level of a library .
2. Select the **Security** tab.
3. Set access levels by first specifying the security group. All members of the security group are given access to the documents in the library based on their role in the group. See [Understanding Document Security](#) for information about security groups.
4. Optionally specify an account. Accounts can limit access to a subset of people in a security group. They are an optional level of security that must be enabled by a system administrator before they are available for use. See [Understanding Document Security](#) for information about accounts.
5. Optionally select users or roles in the Access Control Lists section. Access control lists provide the most granular way of limiting access to libraries. Using access control lists, you can specify the rights that are assigned to roles or individual users. See [Understanding Document Security](#) for information about access control lists.
6. When finished, click **Save**.

## 13.6 Following Document Libraries

You can follow a document library and be notified when the library is modified. To follow a document library, do one of the following:

- Select the library on a results list and choose **Follow** from the **More** menu in the List toolbar.
- Right-click a library on a results list or in the Folders list of the side bar and select **Follow** from the contextual menu.

## 13.7 Creating Library Shortcuts

Create shortcuts to libraries to make navigating Oracle WebCenter Content easier. Library shortcuts can be added to any folder or other library and are displayed in the folders section of the side bar.

To create a library shortcut:

1. Open the Create Shortcut window by one of the following ways:

- Select the library on a results list and choose **Create Shortcut** from the More menu in the List toolbar.
  - Right-click a library on a results list or in the Folders list of the side bar and select **Create Shortcut** from the contextual menu.
2. Name the shortcut or accept the default name.
  3. Choose where the shortcut will be located. Shortcuts must be created in the context of a library or folder. They cannot be unfiled.
  4. When finished, click **Save**.

**Figure 13-4 Create Shortcut Window**

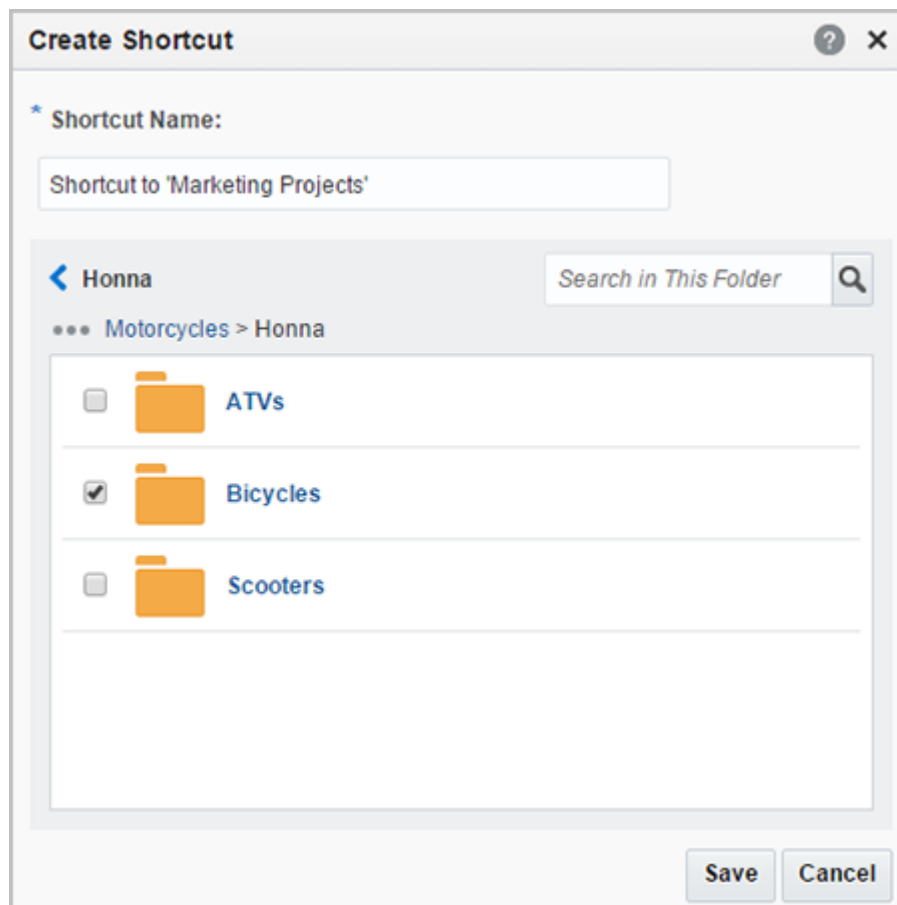

 **Note:**

If the Auto Suggest feature is disabled, the **Folder or Library Search Box** isn't displayed within the **Create Shortcut** dialog. Contact your system administrator to enable this feature.

## 13.8 Using System Libraries to Find Content

System libraries offer the ability to quickly find documents that are not currently released or are checked out and locked for editing. There are several system libraries in Oracle WebCenter Content:

- Checked-Out Content (content locked for editing).
- Expired Content (documents that are no longer actively managed by Oracle WebCenter Content. Expired content can be filtered to also display documents set to expire within a specified date range).
- Work In Progress (documents that are in a conversion or indexing process and not yet ready for release).
- Content In Workflow (documents that are in a workflow process, initially filtered by those documents assigned to you).

To search for documents in a system library:

1. Click **Browse** in the side bar.
2. Click the Filter icon next to the search box and select the **System Libraries** filter from the Library type list. This filters the library results list so that only system libraries are displayed.
3. Open the system library that contains the documents in the desired process state. For example, you would open the **Checked-Out Content** library if you are looking for documents you have checked out.
4. Filter your results using the filter menu to refine your search.

### **Note:**

By default, Checked-Out Content and Work In Progress libraries filter the results to include only documents checked out or authored by you. Similarly, the Content in Workflow library filters results by default to workflow content assigned to you. To expand the results list to include other documents to which you have rights, clear the filter by closing the appropriate filter tag in the search box.

The Expired Content library lists all expired content by default. Use the filter menu to display documents expired or set to expire within a specified date range.

If searching for content in workflow assigned to you, go directly to a filtered list by clicking the workflow notification icon () in the banner. If no filter notification icon is displayed in the banner, then you do not have pending workflows assigned to you.

Figure 13-5 Expired Content Filter Options



# 14

## Working with Content Folders

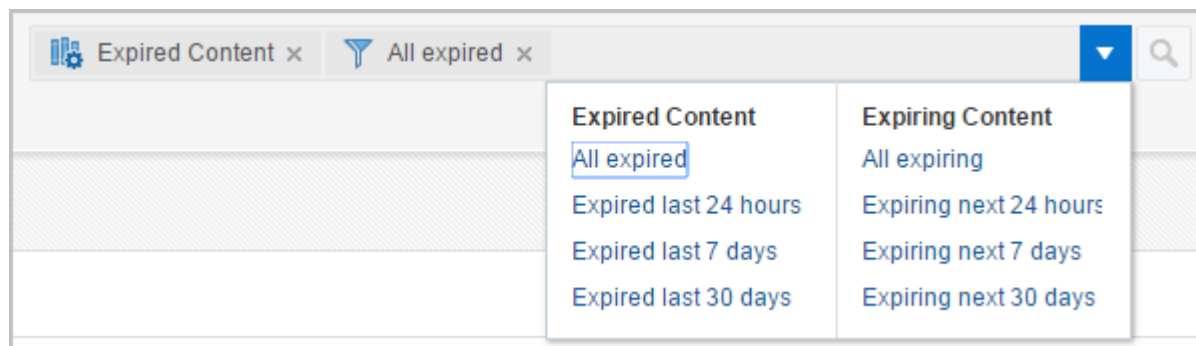
Like libraries, use folders to organize and control access to documents, as well as associate appropriate metadata with documents. Here you learn how to create, secure, modify, and delete folders.

This chapter has the following sections:

- [About Folders](#)
- [Working With Folders](#)
- [Finding Folders](#)
- [Creating Folders](#)

### 14.1 About Folders

Folders and subfolders are created to provide additional levels of organization and security within the context of a library. Like libraries, folders help to determine what metadata fields are associated with a document, can help in assigning values to the metadata automatically, and can add a layer of security. For detailed information on Libraries and Folders, see [Understanding Libraries](#) and [Understanding Folders](#).

Cloud folders are a special kind of folders created to allow copying of content to and from the cloud server. They act as a link to a folder in Oracle Content and Experience Cloud Service. If your company has integrated with Oracle Content and Experience Cloud Service, you can copy or upload files to the cloud using a cloud folder, and you can access content on the go through the cloud user interface.

Folders mimic the behavior of the library they are in. By default, documents uploaded to a folder inherit the metadata fields and security defined for a folder, as well as any default metadata values defined for the folder.





### 14.2 Working With Folders

Folders behave much like libraries, as libraries are the top-most level of a folder hierarchy. Some tasks are identical when working with folders or libraries. The following table lists the appropriate sections necessary to do the specified tasks. What tasks are available to you is dependent on the permissions you have for a folder.

**Table 14-1 Links to Procedures for Libraries**

To do this...	...see this section
Create a folder	<a href="#">Creating Folders</a>

**Table 14-1 (Cont.) Links to Procedures for Libraries**

To do this...	...see this section
View and edit folder properties	<a href="#">Viewing and Editing Document Library Properties</a>
<div style="border: 1px solid #ccc; background-color: #e6f2ff; padding: 10px;"> <b>Note:</b> For a cloud folder, the Metadata tab and the Shortcuts tab are not available in the Folder Properties window.</div>	
Propagate folder metadata	<a href="#">Propagating Library Metadata</a>
<div style="border: 1px solid #ccc; background-color: #e6f2ff; padding: 10px;"> <b>Note:</b> You cannot propagate metadata to a cloud folder.</div>	
Share a folder	<a href="#">Sharing Document Libraries</a>
Follow a folder	<a href="#">Following Document Libraries</a>
<div style="border: 1px solid #ccc; background-color: #e6f2ff; padding: 10px;"> <b>Note:</b> You cannot follow a cloud folder.</div>	
Create folder shortcuts	<a href="#">Creating Library Shortcuts</a>
<div style="border: 1px solid #ccc; background-color: #e6f2ff; padding: 10px;"> <b>Note:</b> You cannot create shortcuts to a cloud folder. Also, the parent folder for any folder shortcut must be a regular folder (cannot be a cloud folder or its descendants).</div>	

## 14.3 Finding Folders

Folders typically exist in Oracle WebCenter Content within the context of a library. Once a library is selected, folders within the library are listed in the side bar and you can browse to the folder you need.

You can also enter search criteria to search for specific folders. For information on searching for specific folders, see [Searching Using the Banner Search Box](#) and [Searching for Folders](#).

 **Note:**

The folder search box in the side bar always searches the selected library. In contrast, the banner search box can search for folders across multiple libraries.

## 14.4 Creating Folders

Folders are created within the context of a library, inheriting the properties of the parent library by default. Once a folder is created, you can update the folder properties. To create a folder:

1. On the Find Documents page, navigate to the library in which you want the folder. The folder list is displayed in the side bar.
2. Right-click the library or folder in which you want to create a new folder, and select **Create Folder** from the contextual menu, or click the **Create Folder** icon above the results list, towards the right corner of your screen.
3. Enter a unique name and description for the folder on the Create Folder page.

 **Note:**

It is a good idea to select a unique name for any folder that you create as in most cases you cannot have multiple folders with the same name. The name of a folder should be unique within the context of the library or folder in which it is created.

4. Select the type of folder to create from the type select list. The default option, **Local WebCenter Content Folder**, creates a local folder on Oracle WebCenter Content Server. To create a folder on Oracle Content and Experience Cloud Service that can be accessed from the WebCenter Content user interface, select the **Oracle Content and Experience Cloud Folder** option from the type list and click **Save**.

 **Note:**

When you select the **Oracle Content and Experience Cloud Folder** option from the type list, a check box to enable sharing of the cloud folder with your Oracle Content and Experience Cloud Service account and an associated message may be displayed. For more information, see [How do I enable sharing while creating a cloud folder?](#)



# Deleting Libraries, Folders, and Documents

Learn how to delete a library, folder, or file in Oracle WebCenter Content. When you delete a content item, it may be permanently deleted or moved to the Trash folder, depending on the content server configuration.

This chapter contains following topics:

- [About Deleting Libraries, Folders, and Documents](#)
- [About Trash](#)
- [Moving Items to Trash](#)
- [Viewing Trash](#)
- [Working with Items in Trash](#)

## 15.1 About Deleting Libraries, Folders, and Documents

You can delete items managed by the content server in one of the following ways:

- Select multiple items or a particular item on the results list and click the **Delete** icon (  ) in the results list toolbar, see [Modifying Items Using the Results Toolbar](#).
- Right-click an item on the results list and select **Delete** from the contextual menu.
- Right-click a folder in the Folders list of the side bar and select **Delete** from the contextual menu (applicable only for folders).

You can delete a single item or multiple items depending on the context you are in.

You can select multiple items to delete in the following contexts:

- Browse mode within a library or folder
- Libraries page
- Folders page
- Search mode within a library or folder

You can select only a single item to delete in the following contexts:

- Global search
- System libraries, except the Expired Content library

Deleting a library or folder, deletes all its contents, including all shortcuts to it. To delete an enterprise library or folder, you must have Read, Write, and Delete permissions to that particular library or folder.

In addition to having the permission to delete a library or folder, you must also have permissions to delete each item within the library or folder. When deleting a library or folder, Oracle WebCenter Content begins by deleting the items (folders, documents, shortcuts, and saved searches) in the library or folder. If you don't have the permission to delete an item, the item is not deleted, and consequently, the library or folder that item is in remains as well.

For information on deleting cloud folders, see [Deleting Cloud Folders](#).

Deleting a document deletes all revisions of the document. You can delete multiple documents or a single document depending on the context you are in. However, you cannot delete a document that is in a workflow.

You can also delete a particular revision of a document. To delete a particular revision, choose **View And Manage Revisions...** from the **More** menu in the [Banner section](#) of the Documents page.

 **Note:**

You can delete a library shortcut using the same procedure for deleting libraries. Deleting a shortcut does not delete the library, but deleting a library deletes all shortcuts to it. This applies to folder and document shortcuts as well.

## 15.2 About Trash

The Trash function is an optional feature that sends deleted items to the Trash folder, rather than permanently deleting the items. Items in the Trash folder can then be permanently deleted or restored to their original location in the folder hierarchy. This enables users to recover files and folders that have been unintentionally deleted.

The Trash folder works much like a normal folder except that the items deleted from the Trash folder are permanently deleted.

## 15.3 Moving Items to Trash

If the Trash functionality is enabled in the content server, all libraries, folders, and documents that you delete are moved to the Trash folder. When you perform the delete operation, the confirmation dialog notifies that the items will be moved to the Trash folder. A link to the Trash folder is provided after the delete operation is complete.

**Figure 15-1** Moved to Trash Notice

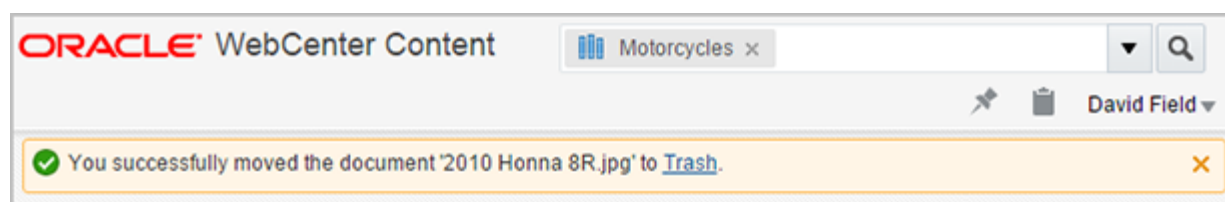

In the case of documents, deleting a filed document or its revision, moves the document or revision to the Trash folder and assigns the *Expired* status to it. Deleting the latest revision of a filed document, marks all revisions as *Expired* and moves the entire document to the Trash folder. However, deleting an unfiled document or its revision results in a permanent delete of that document or revision, even if the Trash functionality is enabled. Deleting the latest revision of an unfiled document does not alter other revisions of the document.

You cannot move documents from the Expired Content system library to the Trash folder because these documents are already in the *Expired* state. Deleting documents from the Expired Content system library results in a permanent delete of those documents.

**Note:**

When you move a content item (library, folder, or document) into Trash, all shortcuts to it are automatically moved to Trash as well. Shortcuts moved in this way are not visible in the Trash view. However, when you restore the item, all shortcuts to it are also restored to their original locations.

For details on the Trash view and the actions that can be performed on the items in Trash, see [Viewing Trash](#) and [Working with Items in Trash](#).

## 15.4 Viewing Trash

Click **Trash** in the side bar of the Oracle WebCenter Content user interface to navigate to the Trash page. You can select a single item or multiple items from the Trash page and delete them permanently or restore them back to the file repository.

The Trash page has the same areas as on the [Find Documents](#) page. The following figure shows the Trash page with the features specific to Trash noted:

**Figure 15-2** Trash Page

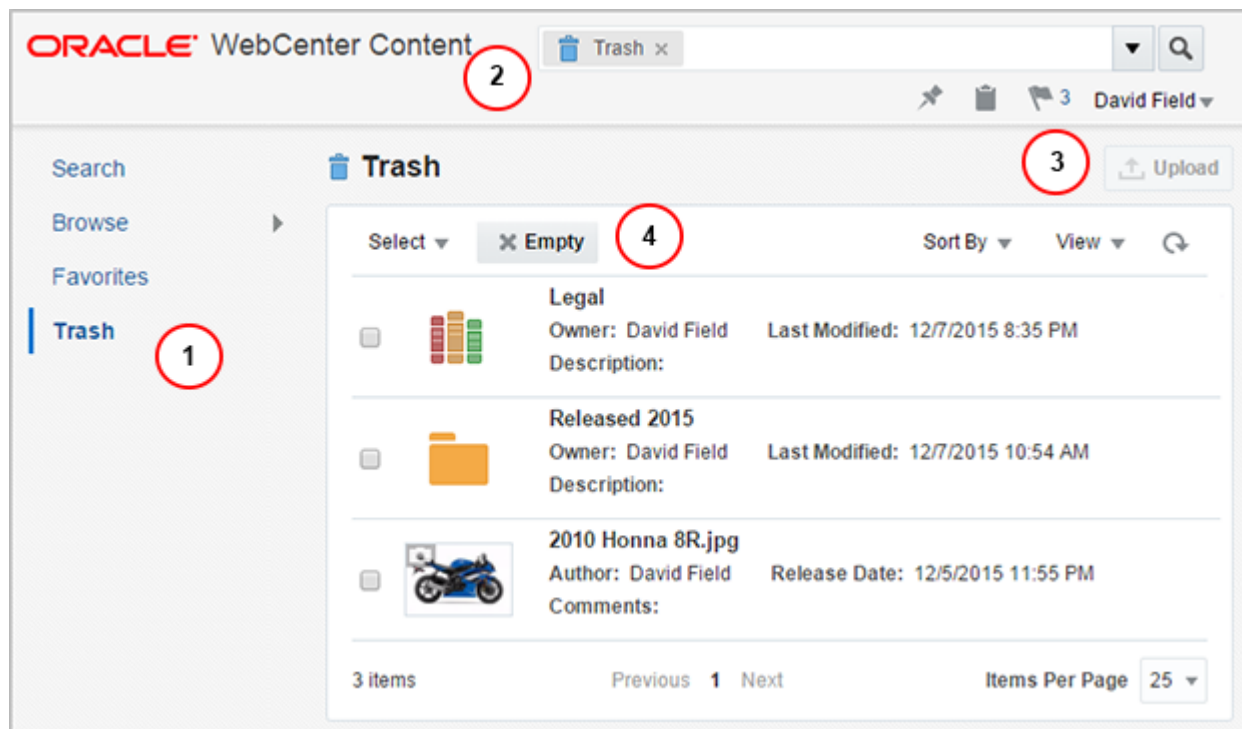

1. **Trash** in the side bar is highlighted.
2. The **Trash** tag in the search bar indicates that you are in the Trash context. Clicking the **X** in the tag, closes the tag and takes you to the Searching Documents page.
3. The **Upload** button is disabled.
4. The **Empty** button is present in the results list toolbar. Use this button to permanently delete all items on the Trash page.

**Note:**

Items listed on the Trash page are non-navigable.

## 15.5 Working with Items in Trash

To view the actions available for items in Trash, select a single item or multiple items from the Trash results list. The actions available are displayed in the results list toolbar. You can also right-click on an item in Trash to view the actions available for that item in the contextual menu.

The following figure shows the results list toolbar on the Trash page:

**Figure 15-3** Trash Toolbar

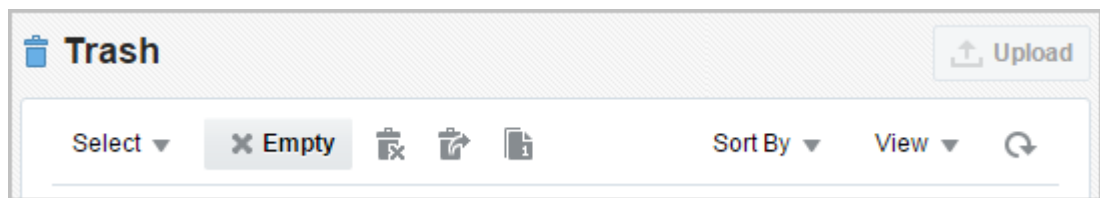

For more information on the results list, see [Working with the Results List](#).

You can perform the following actions on the Trash page:

- [Delete an item permanently](#)
- [Restore an item](#)
- [View revisions of a document in Trash](#)
- [Empty Trash](#)

**Note:**

For multiple selections, only **Permanently Delete** () and **Restore** () actions are available in the results list toolbar on the Trash page. The **Revisions in Trash** () action is available only for documents on single selection. Other actions, such as Download and Mark as a Favorite, are not available for items in Trash.

### 15.5.1 How do I delete an item permanently?

Select an item in the Trash results list, and click the **Permanently Delete** icon () to permanently delete the item. You can select multiple items in the results list and delete them together. Click **Yes** to confirm.

## 15.5.2 How do I restore an item?

Select a single item or multiple items from the Trash results list, and click the **Restore** icon (  ) to restore items back to their original location.

After an item has been restored, a message is displayed confirming the restore operation.

If you restore a document using its context menu, a path to the restored document is provided as a link.

**Figure 15-4** Restore Notice

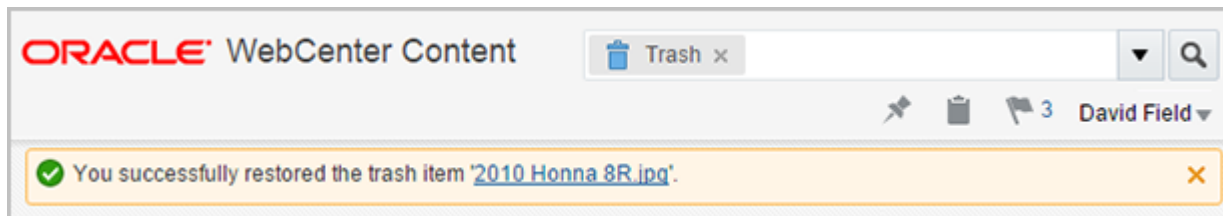

### Note:

If a folder is moved to Trash, you must restore the folder before restoring its contents (that is, its subfolders or documents within it). If a parent folder is permanently deleted, you cannot restore its contents.

## 15.5.3 How do I view revisions of a document in Trash?

Each document may be revised multiple times, and when you delete a document, all revisions of the document are moved into Trash. From Trash, you can choose to permanently delete or restore a particular revision of the document.

Select a document in Trash and click the **Revisions in Trash** icon (  ) to view all revisions of the document present in Trash.

In the Revisions in Trash window, select a revision and click **Restore** to restore that particular revision of the document or click **Delete** to permanently delete that revision. You can also select multiple revisions and choose to restore or delete them.

The **Revisions in Trash** option is available in the results list toolbar only for documents on single selection. This option is also available from the context menu of a document.

## 15.5.4 How do I empty Trash?

Click **Empty** in the results list toolbar to empty the Trash folder and to delete all items permanently. Click **Yes** to confirm.

# 16

## Using Workflows

Learn how to participate in and manage the workflows to which you belong. This chapter has the following topics:

- [About Workflows](#)
- [Workflow Types](#)
- [Entering a File to a Workflow](#)
- [Reviewing Workflow Items Assigned to You](#)
- [Viewing Workflow Information](#)

### 16.1 About Workflows

A workflow specifies how to route content for review and approval before it is released to the system. The workflow notifies users by e-mail when they have a file to review, and by displaying a workflow notification icon in the banner next to their user name.

### 16.2 Workflow Types



From a workflow participant's point of view, there are two types of workflows:

- A *basic* workflow defines the review process for specific content items, and must be initiated manually.
- In a *criteria* workflow, a file enters the workflow automatically upon check-in when its metadata matches predefined criteria.

### 16.3 Entering a File to a Workflow

If you have been assigned as a contributor to a basic workflow, it notifies you that you have an item in workflow both by e-mail and by notification flag on the banner of the WebCenter Content home page. To start the workflow, you must check in the designated files as the first step.

To check in a file to begin a basic workflow:

1. Click the **Items in Workflow** notification icon (  ) on the home page banner to display a listing of all workflow items assigned to you.
2. Do one of the following:
  - Right-click on the item in the result list to check in and select **Check In** from the contextual menu.
  - Select the item in the result list to check in and click the **Check In** icon (  ) in the toolbar.
  - Open the document in the View Documents page to display the document properties and click **Check In**.

 **Note:**

Document properties of workflow items also link to workflow details and subsequently to workflow history. From the document properties tab in the View Documents page you can also approve, reject, or check in workflow items assigned to you. You can access document properties in a number of ways, including right-clicking an item in a result list and selecting **Properties** from the contextual menu.

3. Select a destination and profile to use and click **Continue**.

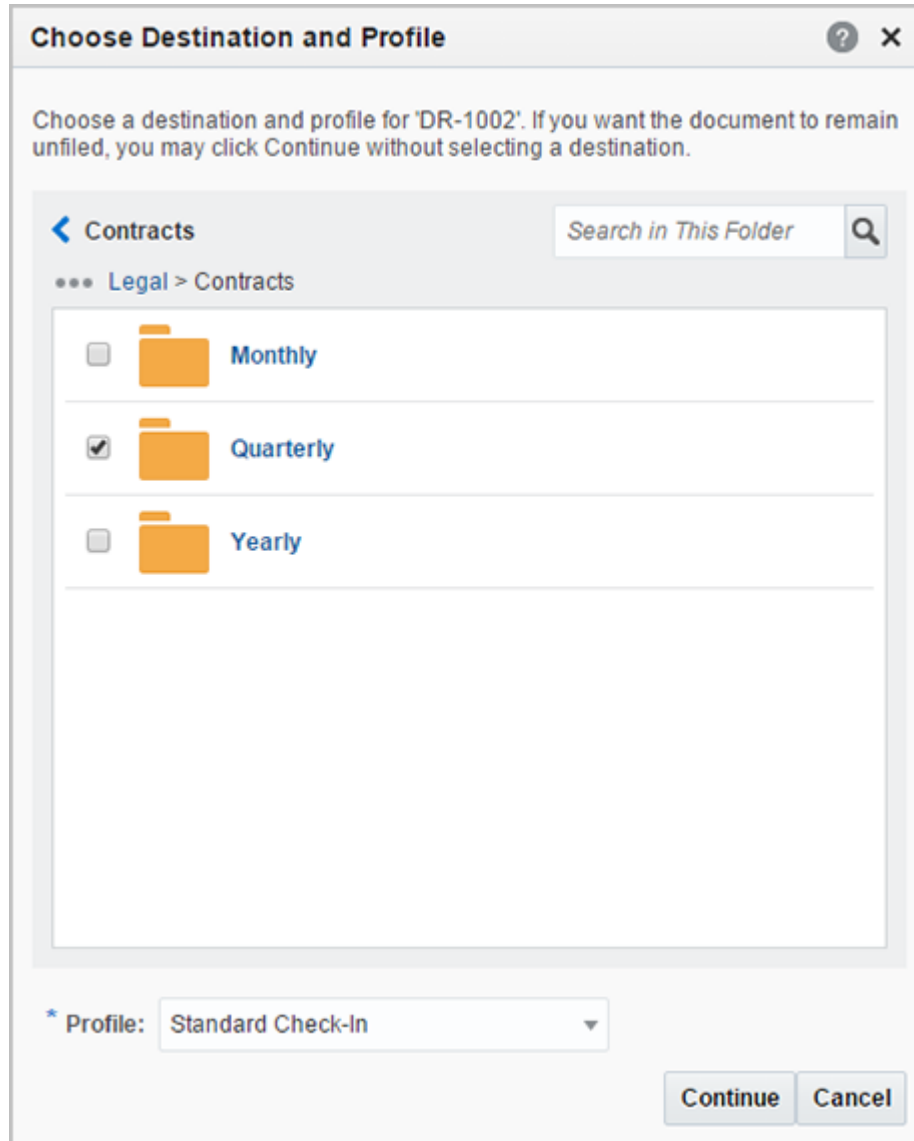

**Choose Destination and Profile** ? X

Choose a destination and profile for 'DR-1002'. If you want the document to remain unfiled, you may click Continue without selecting a destination.

< Contracts Search in This Folder

... Legal > Contracts

- Monthly
- Quarterly
- Yearly

\* Profile: Standard Check-In

Continue Cancel





4. For detailed information about checking in a file, see [Uploading Documents from a Web Browser](#).
5. Select a file to check in and fill in the check-in form, then click **Upload**, noting the following:
  - By default, **Submit document to workflow** is enabled and any item checked in moves to the next step in the workflow.

- Disabling **Submit document to workflow** and clicking **Upload** checks in the file but keeps it in edit status. It does not move to the next step in the workflow.

## 16.4 Reviewing Workflow Items Assigned to You

When you are assigned to the current step in a workflow, you receive an e-mail message and a notification flag on the banner of the WebCenter Content home page. When the required number of reviewers approve the revision, the content item goes to the next step in the workflow.

To review a file in a workflow:

1. Click the **Items in Workflow** notification icon () on the home page banner to display a listing of all workflow items assigned to you. Workflow items are assigned to you when you have a responsibility to check in or review the item.
2. Select one of the following options pertaining to workflow items on the listing toolbar when an item is selected, or on the summary tab of the document properties on the View Documents page:
  - **Approve**  : Approves the item in a review step. There are three types of review steps: review, review/edit revision, and review/new revision. Once the required number of reviewers approves the item, it moves to the next step in the workflow. The option to approve is not available for an item in a contribution step.
  - **Reject**  : Rejects the item in a review step and returns it to the most recent review step that allows editing. If there is no previous review step that allows editing, then it returns to the original contribution step.
  - **Check In**  : Uploads a revised document for an item in a review or contribution step. If you check in a document in a review/new revision step, the revision number increments with each check in. This allows you to manage changed revisions to a document throughout the workflow process.

If you check in a document in a review/edit revision step, then the revision number stays the same throughout the step. If it is the final step in the workflow, it stays at that revision even when the document is released at the end of the workflow. This allows you or others to change the document several times and only manage approved and released revisions.

Note that you have the option to approve the document when you check it in.

- **Remove From Your Assignments:** Removes the document from the Content in Workflow list results when the Assigned to you filter is applied. Selecting this option does not change the document's workflow status or the operations you can perform on the document. If a subsequent workflow step assigns the document to you, it will again appear in the list generated by the Assigned to you filter. This option is available only if the Assigned to you filter is applied.

### Note:

If you remove a workflow from your assignments but need to contribute to the workflow, you can find the workflow by browsing the Content In Workflow system library without the **Assigned to you** filter applied.



Figure 16-1 Summary Tab Showing Workflow Options in Document Properties

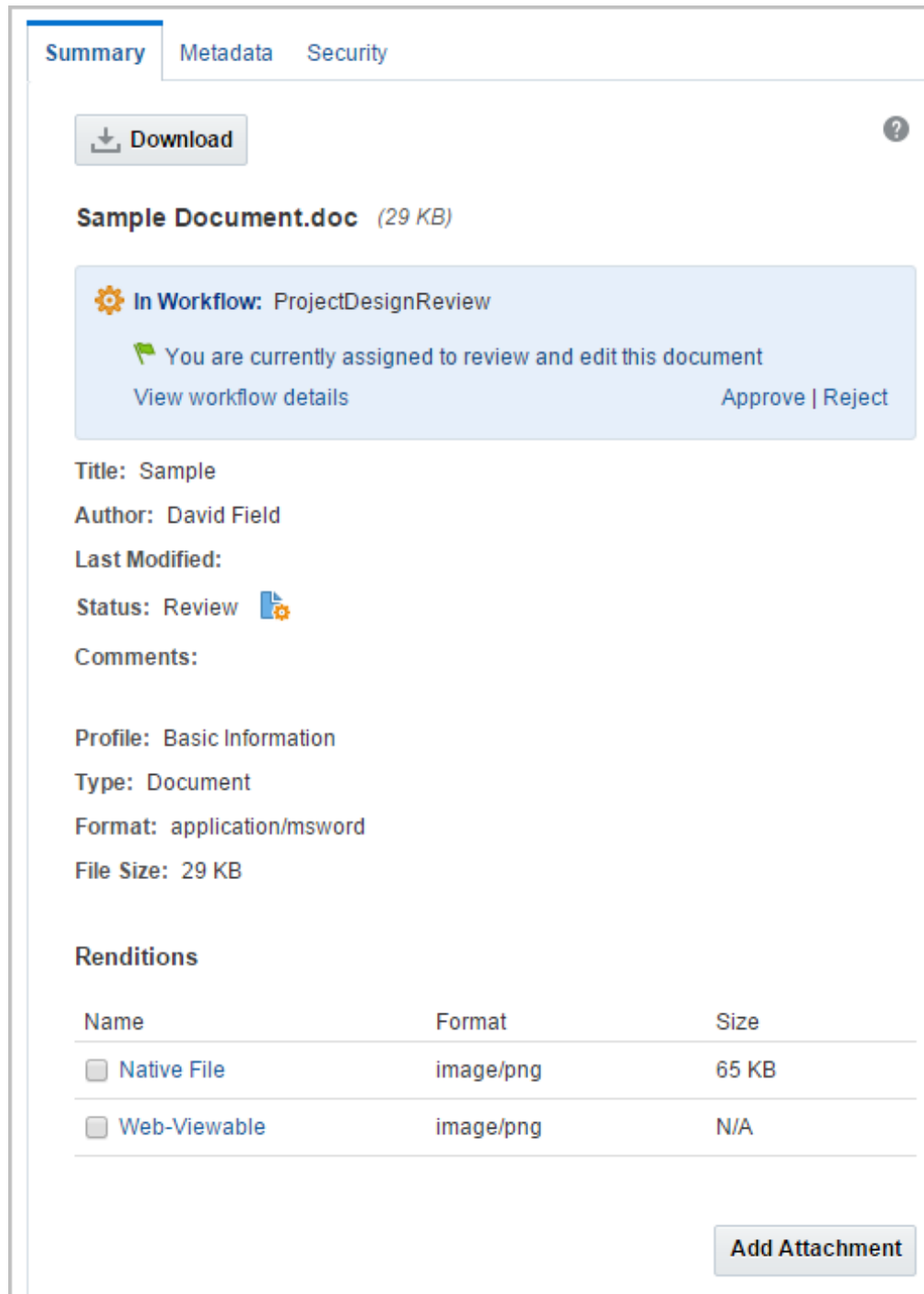

## 16.5 Viewing Workflow Information

There are several ways to view information about a content item in a workflow. With links between workflow pages you can perform the following tasks:

- [View a list of your workflow assignments](#)

- [View a list of all documents in active workflows](#)
- [View a list of documents in a specific workflow](#)
- [View workflow details and history](#)

## 16.5.1 How do I view a list of my workflow assignments?

To view a list of workflows that require action from you, do one of the following:

- Click the **Items in Workflow** notification icon (  ) on the home page banner to display a listing of all workflow items, filtered by default to those assigned to you.
- Navigate to the **Content in Workflow** system library:
  1. Click **Browse** in the side bar.
  2. Select the **System Libraries** filter from the Library type list in the search box to filter the library results list so that only system libraries are displayed.
  3. Click **Content in Workflow** in the result list. By default, only those workflow items assigned to you are displayed.

## 16.5.2 How do I view a list of all documents in active workflows?

To view a list of all active workflows in the system, follow the steps in [How do I view a list of my workflow assignments?](#) to view all items assigned to you, then expand the results to include all active workflows by clearing the **Assigned to you** filter in the search box.

## 16.5.3 How do I view a list of documents in a specific workflow?

To view a list of documents within a specific workflow, first view a list of all documents in active workflows (see [How do I view a list of all documents in active workflows?](#)) and select the workflow name from the filter list of the search box.

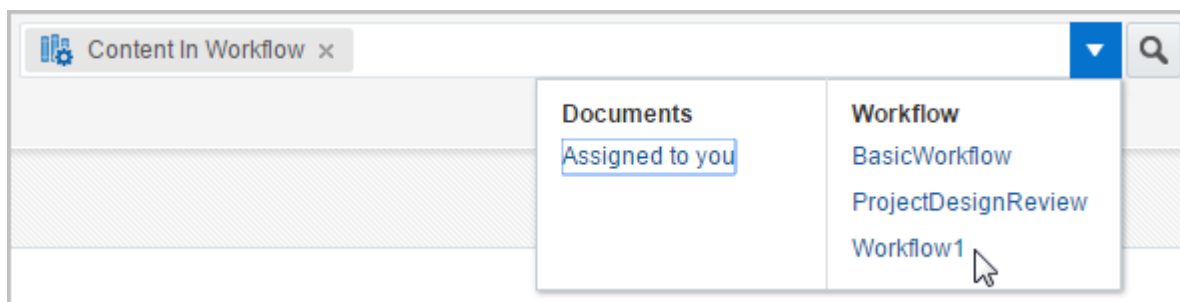

## 16.5.4 How do I view workflow details and history?

Workflow details are accessed from the properties page of a document in workflow by clicking the **View workflow details** link under the properties summary tab or by selecting it from the **More** menu on the View Documents page. Workflow details include information about the current step and any completed steps in the workflow. This option is available only if the document is currently in a workflow.

Workflow history lists the workflows that a document has been part of and provides details about the steps and actions in each workflow. Workflow history is available on any document whether or not it is in an active workflow. For documents in an active workflow, access

workflow history by clicking the **View Workflow Details** in the document properties summary section and then **View Workflow History** on the Workflow Details page. For documents not in an active workflow, access workflow history by selecting **View Workflow History** from the **More** menu of the View Documents page.

# 17

## Working with Oracle Content Management Cloud Service

If WebCenter Content Server is integrated with Oracle Content Management Cloud Service, you can share content between these servers. You can upload content to the cloud server and copy content to and from the cloud server. In addition, you can share a cloud folder or item with specific Oracle Documents users or with external users using the cloud user interface.

This chapter contains the following topics:

- [About Content Management Cloud Service](#)
- [Uploading Content to Oracle Content Management Cloud Service](#)
- [Copying Content to Oracle Content Management Cloud Service](#)
- [Copying Content from Oracle Content Management Cloud Service](#)
- [Sharing Cloud Folders](#)
- [Deleting Cloud Folders](#)

### 17.1 About Content Management Cloud Service

Content Management Cloud Service is a cloud-based content management product from Oracle. If Oracle WebCenter Content Server is integrated with Oracle Content Management Cloud Server, you can upload or copy content to the cloud server to maintain a secure, easy access to content on the go through the cloud user interface.

### 17.2 Uploading Content to Oracle Content Management Cloud Service

Using Oracle Content Management Cloud Service you can keep all your work in the cloud.

To upload content to Oracle Content Management Cloud Service:

1. Navigate to a cloud folder.
2. Click the folder thumbnail image or the folder title to open the cloud folder in the embedded cloud user interface.
3. Click the **Upload** button in the embedded cloud user interface, and select the item or items you want to upload from your physical drive.

Figure 17-1 View Cloud Folder

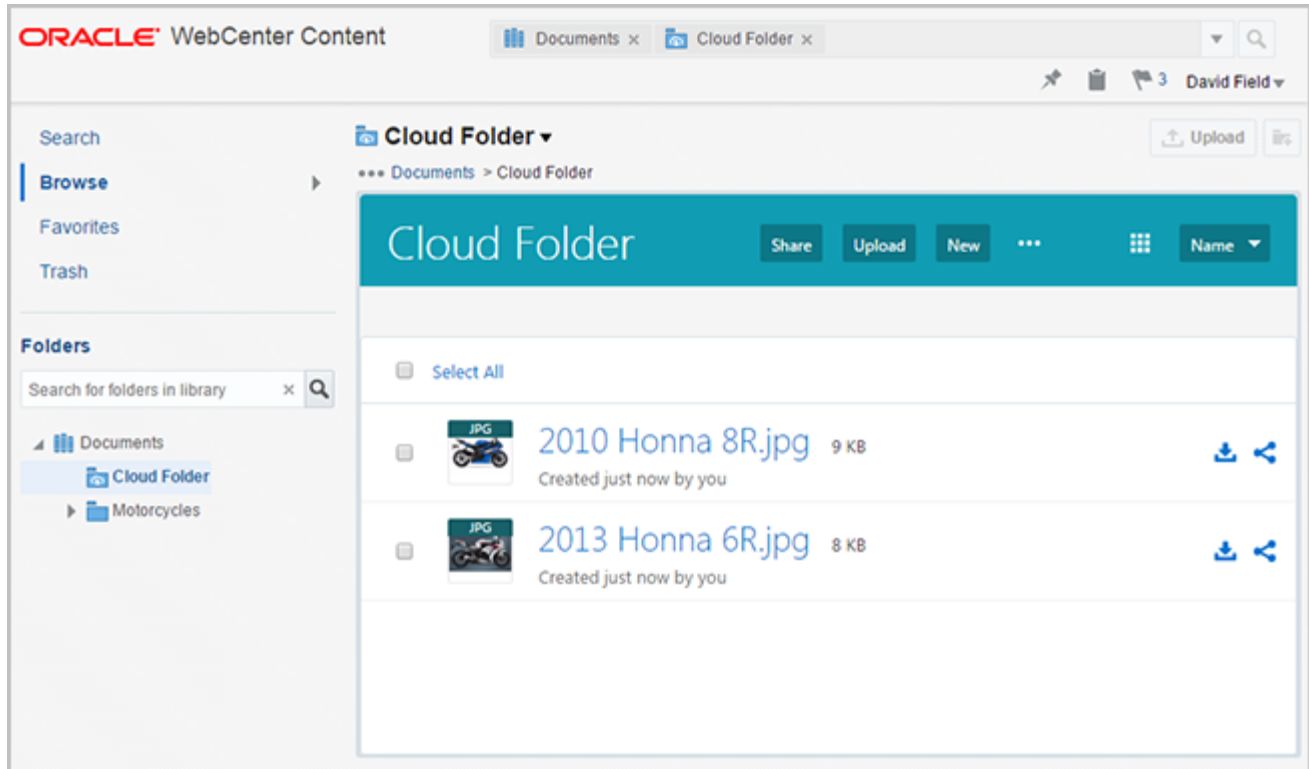

**Note:**

In the View Cloud Folder screen, the following buttons or fields are disabled or hidden:

- The **Upload** button and the **Create Folder** button in the context of Oracle WebCenter Content Server.
- The search box, including the **Filter** icon and the **Search** icon, in the banner area.
- The **Search <Folder> and Subfolders** option in the folder drop-down menu.

## 17.3 Copying Content to Oracle Content Management Cloud Service

This section describes how to copy content items between Oracle WebCenter Content Server and Oracle Content Management Cloud Service. It contains the following sections:

- [How do I copy content to a top-level cloud folder?](#)
- [How do I copy content to a child cloud folder?](#)



**Note:**

You cannot copy the following items from WebCenter Content Server to Content Management Cloud Server:

- Saved search
- Retention folder
- Shortcuts of any type

### 17.3.1 How do I copy content to a top-level cloud folder?

To copy a regular folder or an item from Oracle WebCenter Content Server to a top-level cloud folder:

1. Select the folder or items to copy, and click the **Copy** icon ().
2. Select the target folder in the Copy window. If you select a top-level cloud folder, the **Next** button in the Copy window is disabled.
3. Click **Finish** to complete the copy operation.

Figure 17-2 Copying to a Top-Level Cloud Folder



 **Note:**

If the Auto Suggest feature is disabled, the **Folder or Library Search Box** isn't displayed within the **Copy** dialog. Contact your system administrator to enable this feature.

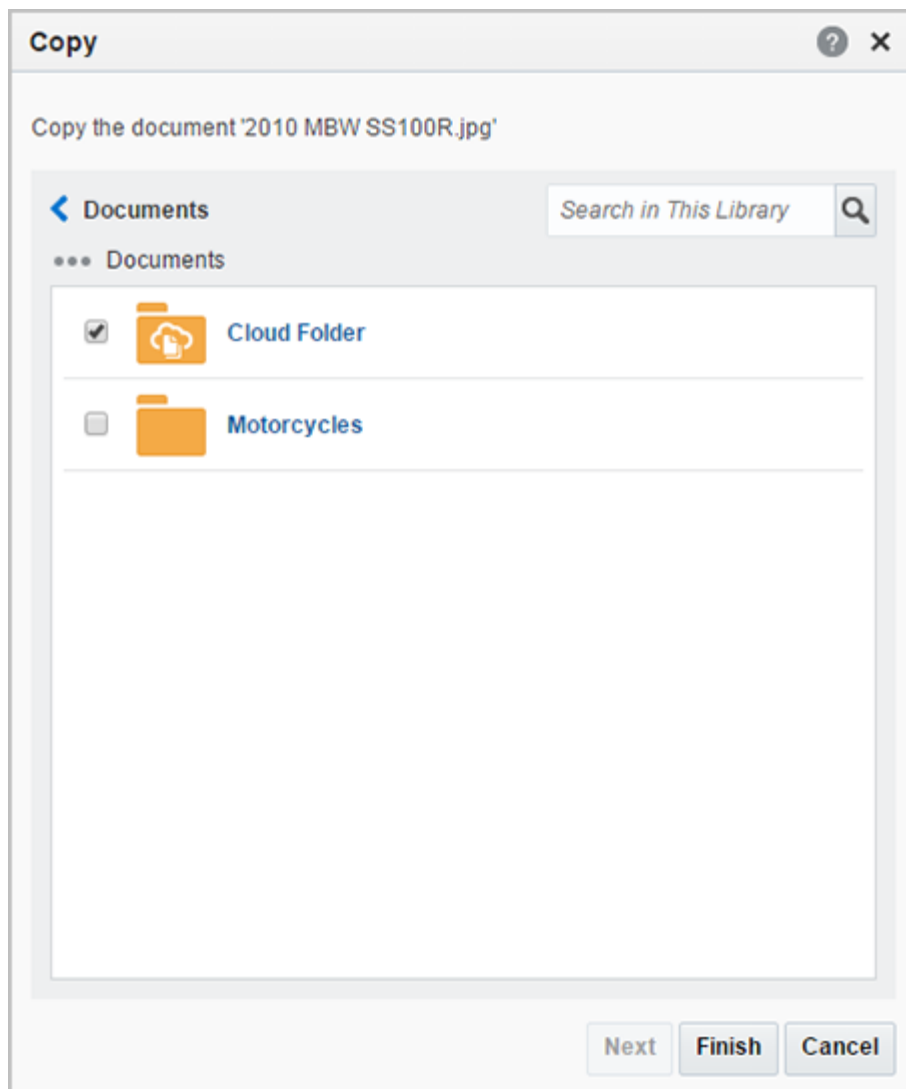
After the items are copied into the target folder, a success message provides a link to the top-level cloud folder within Oracle WebCenter Content Server.

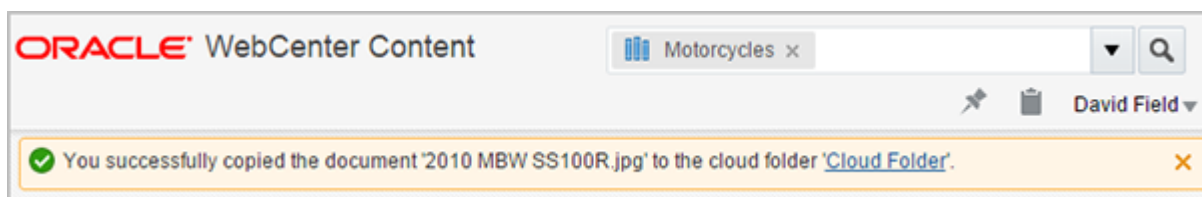

## 17.3.2 How do I copy content to a child cloud folder?

To copy a regular folder or an item from Oracle WebCenter Content Server to a descendant of a top-level cloud folder:

1. Select the folder or items to copy, and click the **Copy** icon (  ).
2. Click on the desired top-level cloud folder to display its descendants.  
**Note:** The Copy window displayed here is from the context of Oracle Content and Experience Cloud Service.
3. Select a child cloud folder and click **OK** to complete the copy operation.

**Figure 17-3 Copying to a Child Cloud Folder**

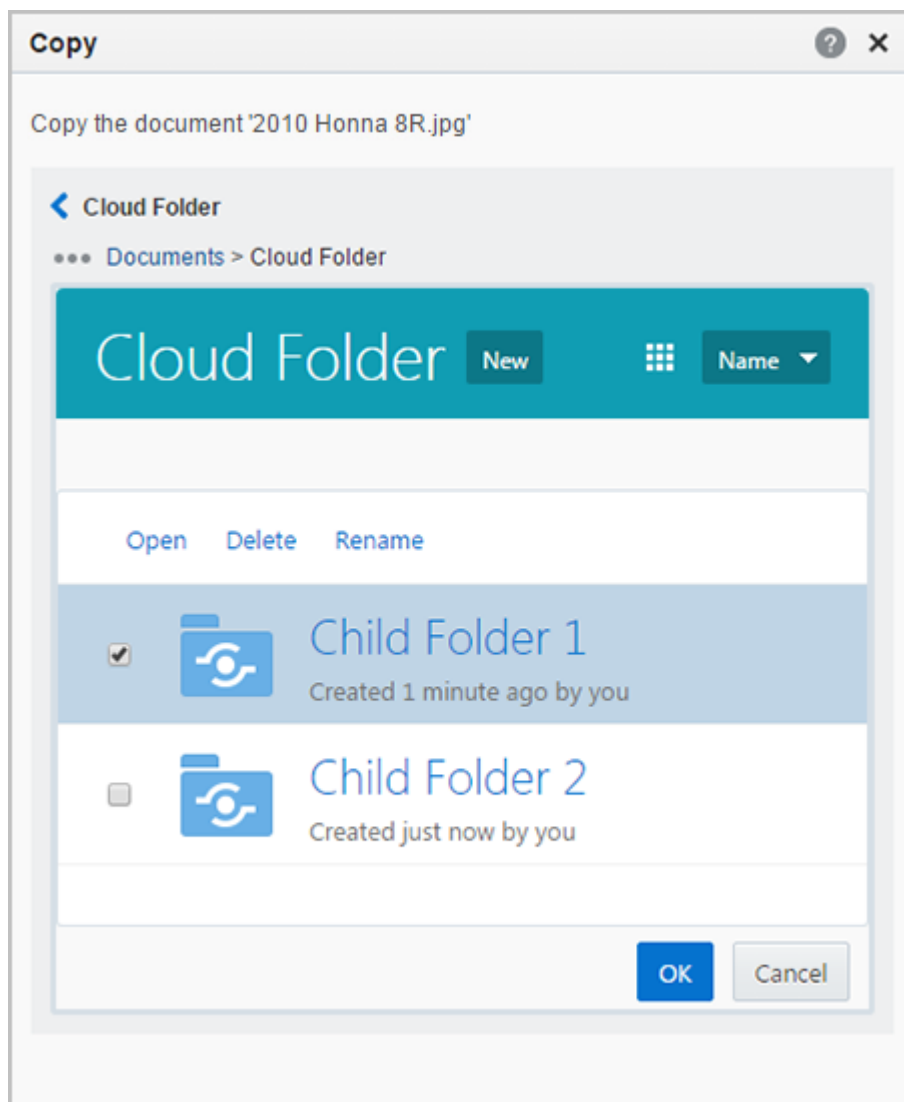

After the items are copied into the target folder, a success message is displayed with the name of the target. No link is provided to the target folder because it is out of the context of Oracle WebCenter Content Server.



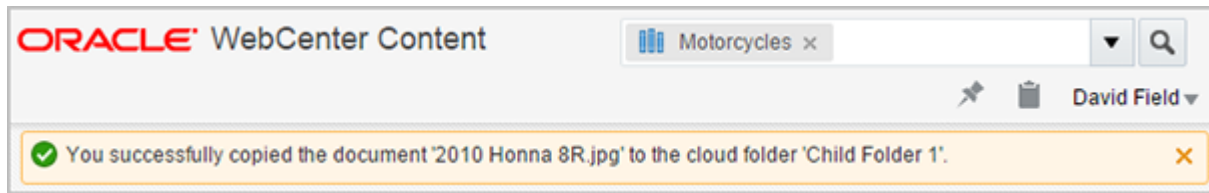

## 17.4 Copying Content from Oracle Content Management Cloud Service

You can copy a top-level cloud folder from Oracle Content Management Cloud Service to Oracle WebCenter Content Server. The top-level cloud folder and its descendants are copied as regular folders into Oracle WebCenter Content Server.

### Note:

If you copy a regular folder containing cloud folders into another regular folder within Oracle WebCenter Content Server, for each cloud folder descendant a new cloud folder is created at the destination with duplicate content.

## 17.5 Sharing Cloud Folders

If your system administrator has granted you with appropriate privileges, you can share a cloud folder with your Oracle Content Management Cloud Service account.

In addition, you can also share a cloud folder or its contents with specific Oracle Content Management Cloud Service users or external users from the embedded cloud user interface within a cloud folder.

This section covers the following topics:

- [How do I share a cloud folder with my Oracle Content Management Cloud Service account?](#)
- [How do I stop sharing a cloud folder with my Oracle Content Management Cloud Service account?](#)
- [How do I share a cloud folder with other users?](#)

### 17.5.1 How do I share a cloud folder with my Oracle Content Management Cloud Service account?

You can share a cloud folder with your Oracle Content Management Cloud Service account, provided that:

- Your system administrator has enabled sharing of cloud folders on the Content Server for your WebCenter Content account.
- You have a valid Oracle Content Management Cloud Service account.
- You have an e-mail address defined on the WebCenter Content system and linked to your Oracle Content Management Cloud Service account.

To define an e-mail address, see [Personalizing WebCenter Content Preferences](#).

You can share a cloud folder with your Oracle Content Management Cloud Service account from the following scenarios:

- Create Folder dialog. See [How do I enable sharing while creating a cloud folder?](#).
- Context menu of a cloud folder. See [How do I share a cloud folder to which I have access?](#).

 **Note:**

The system administrator determines when you can share cloud folders by selecting from the following available options on the Content Server:

- **Creation:** You will be able to share a cloud folder only during its creation.
- **Always:** You will be able to share a cloud folder during its creation or any time after its creation. In addition, you will also be able to share all cloud folders to which you have access.
- **Never:** You will not be able to share cloud folders because options to share will not appear on the user interface.

### 17.5.1.1 How do I enable sharing while creating a cloud folder?

To enable sharing of a cloud folder from the Create Folder dialog:

1. Fill out the name and description fields, and select the **Oracle Content and Experience Cloud Folder** option from the type list to create a cloud folder.

A check box to enable sharing of the cloud folder with your Oracle Content Management Cloud Service account and an associated message is displayed.

2. Select the check box and click **Save**.

Figure 17-4 Sharing a Cloud Folder from the Create Folder Dialog

**Create Folder** [?] [X]

\* Name

Description

\* Type

Share with my Oracle Documents account

If you have an account on Oracle Documents, you can check the sharing option above to make this folder visible under your Oracle Documents Home.

After you create the folder, you can share it with members of Oracle Documents, assign security privileges, and more.

[Save] [Cancel]

 **Note:**

The check box and the associated message appear in the Create Folder dialog if all of the following conditions are true:

- The system administrator has set the cloud folder sharing option on the Content Server to either *Creation* or *Always* for your account.
- You have an e-mail address defined on the WebCenter Content system.
- You have selected the **Oracle Content and Experience Cloud Folder** option from the type list in the Create Folder dialog.

If the cloud folder is successfully shared with your Oracle Content Management Cloud Service account, the following confirmation message is displayed.

Figure 17-5 Successful Share with Oracle Content Management Cloud Service

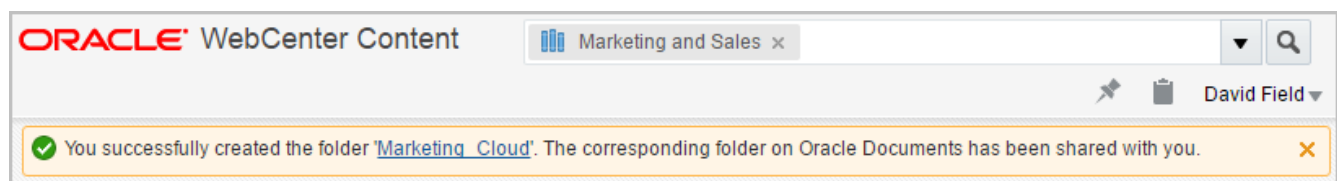

If the share operation is unsuccessful, the following notification is displayed.

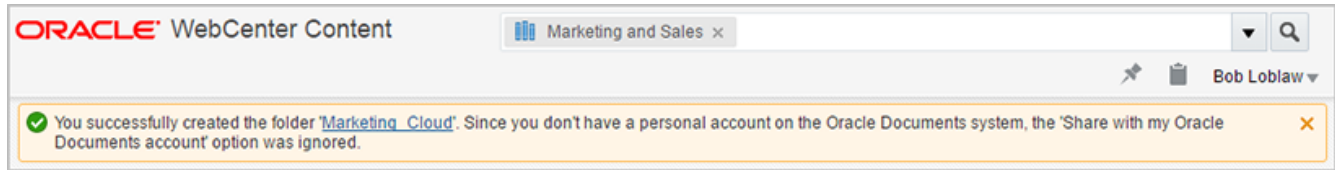
**Figure 17-6 Unsuccessful Share with Oracle Content Management Cloud Service**

### 17.5.1.2 How do I share a cloud folder to which I have access?

You can share any cloud folder to which you have access with your Oracle Content Management Cloud Service account.

To share a cloud folder:

1. Right-click on the cloud folder in the results list or in the folder hierarchy in the side bar.
2. From the context menu, select the **Share With My Cloud Account** option.

A notification indicates if the cloud folder has been successfully shared with your Oracle Content Management Cloud Service account or not.

#### **Note:**

The **Share With My Cloud Account** option is also available from the **More** menu in the results toolbar upon selecting a single cloud folder.

The option to share a cloud folder with your Oracle Content Management Cloud Service account appears in the context menu or **More** menu of a cloud folder if all of the following conditions are true:

- The system administrator has set the cloud folder sharing option on the Content Server to *Always* for your account.
- You have an e-mail address defined on the WebCenter Content system.
- The cloud folder that you select is not currently being shared with your Oracle Content Management Cloud Service account.

If the cloud folder is currently being shared with your Oracle Content Management Cloud Service account, the context menu and **More** menu display the option to stop sharing of the cloud folder. See, [How do I stop sharing a cloud folder with my Oracle Content Management Cloud Service account?](#)

### 17.5.2 How do I stop sharing a cloud folder with my Oracle Content Management Cloud Service account?

To stop sharing a cloud folder that is currently being shared with your Oracle Content Management Cloud Service account:

1. Right-click on the cloud folder in the results list or in the folder hierarchy in the side bar.
2. From the context menu, select the **Stop Sharing With My Cloud Account** option.

A notification indicates if the sharing has been successfully stopped or not.

 **Note:**

The **Stop Sharing With My Cloud Account** option is also available from the **More** menu in the results toolbar upon selecting a single cloud folder that is currently being shared with your Oracle Content Management Cloud Service account.

## 17.5.3 How do I share a cloud folder with other users?

You can share a cloud folder or its contents with specific Oracle Documents users or with external users.

To share cloud content, click the **Share** button () in the embedded cloud user interface in the View Cloud Folder screen (see [Figure 17-1](#)) to share an entire cloud folder or select Share from the menu bar or the right-click menu of a content item in the cloud folder to share the item.

The Share dialog contains the following tabs:

- **Members:** In this tab, click the **Add Members** button to add Oracle Documents users and assign roles to each member. This tab is available only if you have administration privileges on a particular cloud folder.

 **Important:**

Only the Oracle Content Management Cloud Service accounts added to the members' list of a particular cloud folder or item are able to access the cloud folder or item from the cloud user interface.

- **Public Links:** In this tab, click the **Create Link** button to create a public link to a cloud folder or item. Assign a link name, link permissions, link expiry date (optional), and a code to access the public link (optional), and share the link with external users.

 **Note:**

The Public Links feature can be enabled or disabled by the Oracle Content Management Cloud Server administrator in the cloud user interface.

For more information on sharing, see [How do I share folders?](#) in *Using Oracle Content Management Cloud*.

## 17.6 Deleting Cloud Folders

You can delete a cloud folder using the same procedure for deleting a normal WebCenter Content folder, see [About Deleting Libraries, Folders, and Documents](#).

Permanently deleting a cloud folder deletes the corresponding folder and all its documents from Oracle Content Management Cloud Service. If the Trash functionality is enabled in the content server, deleting a cloud folder moves it to Trash, but the corresponding folder and its contents in Oracle Content Management Cloud Service remain active.

 **Note:**

A user with only a write privilege (without a delete privilege) to a cloud folder is able to delete contents of that folder in the Oracle Content Management Cloud user interface. This is the expected behavior.

# Part III

## Using the Native User Interface with Oracle WebCenter Content

The Oracle WebCenter Content native user interface is a feature-rich interface that offers a familiar user experience. Using this interface, you can manage rich media beyond traditional office documents, including images, records, and videos.

This part contains the following chapters:

- [Getting Started with the Native User Interface](#)
- [Finding Documents](#)
- [Viewing Documents](#)
- [Uploading Documents](#)
- [Checking Out and Downloading Files](#)
- [Working with Content Folders](#)
- [Grouping Documents Using Folios](#)
- [Using Workflows](#)
- [Working with Images and Videos](#)
- [Working with Records](#)

# Getting Started with the Native User Interface

The native user interface provides a fully-featured and familiar user experience. It offers simple ways to store, secure, and retrieve content items.

This chapter covers the following topics:

- [Working with Oracle WebCenter Content](#)
- [Accessing WebCenter Content Server](#)
- [Understanding the Native User Interface](#)

## 18.1 Working with Oracle WebCenter Content

You work with Oracle WebCenter Content to upload documents to the repository and search for and view documents that others have uploaded. Several pages are used in Oracle WebCenter Content:

- [Home Page](#)
- [Search Page](#)
- [Check-In Page](#)
- [Content Information Page](#)

### Home Page

The Home page is displayed when you first log in to Oracle WebCenter Content. The content of the home page can be configured by a system administrator to display content pertinent to your company and often includes a simplified search form for finding documents. Detailed information about the Search page is in [Home Page](#).

### Search Page

The search page is one of several options for finding documents available in the native user interface. The search page uses criteria you specify in a search form to find documents. The search form may vary depending on Oracle Content Server is configured, but offers the most flexible way of searching for content. Detailed information about the search page is in [Advanced Search Page](#).

### Check-In Page

The check-in page is used to check files in to Content Server. The standard check-in page displays all available metadata fields in Content Server. If profiles are set by your system administrator, different profiles can be selected when checking in content to limit the displayed metadata fields to only those needed by the type of content being checked in. Required fields on the check-in page are indicated by an asterisk (\*).

### Content Information Page

The Content Information page is displayed when you open a document from a search results list. The page allows you to view the contents of a document, the metadata properties of the



document, and provides ways to update the document to a new revision, update the document metadata properties, or download the document.

Depending on how Oracle WebCenter Content is configured, you also have additional options when using the native user interface. They include:

- grouping content into folios
- managing and converting digital assets
- integrating with desktop applications
- managing records, either electronic or physical

## 18.2 Accessing WebCenter Content Server

To access Content Server, enter its Web address (Uniform Resource Locator or URL) in a supported browser and log in. The URL specifies the host name and port number for Oracle WebCenter Content Server.

The host name is the name of the computer that is running the Oracle WebCenter Content Managed Server. The default port number for Content Server is 16200.

### To access WebCenter Content Server:

1. Browse to your Content Server instance with a Web URL in this format:

```
http://host_name:port_number/cs/
```

For example:

```
http://example.com:16200/cs/
```

2. On the Content Server home page, click **Login**.
3. Enter your user name and password, and click **Sign In**.

## 18.3 Understanding the Native User Interface

The native user interface is a feature-rich interface offering a familiar user experience for those who need to manage rich media beyond traditional office documents, including images, records, and videos. The following sections describe the main interface features:

- [Home Page](#)
- [Toolbar](#)
- [Trays](#)
- [My Content Server Tray](#)
- [Content Management Tray](#)
- [Quick Search Field](#)

### 18.3.1 Home Page

The home page opens when you first log in. The home page typically includes the tray navigation, the top toolbar, and other page content and functions as determined by your system administrator. To return to the home page at any time, click the **Oracle WebCenter Content** in the upper left.

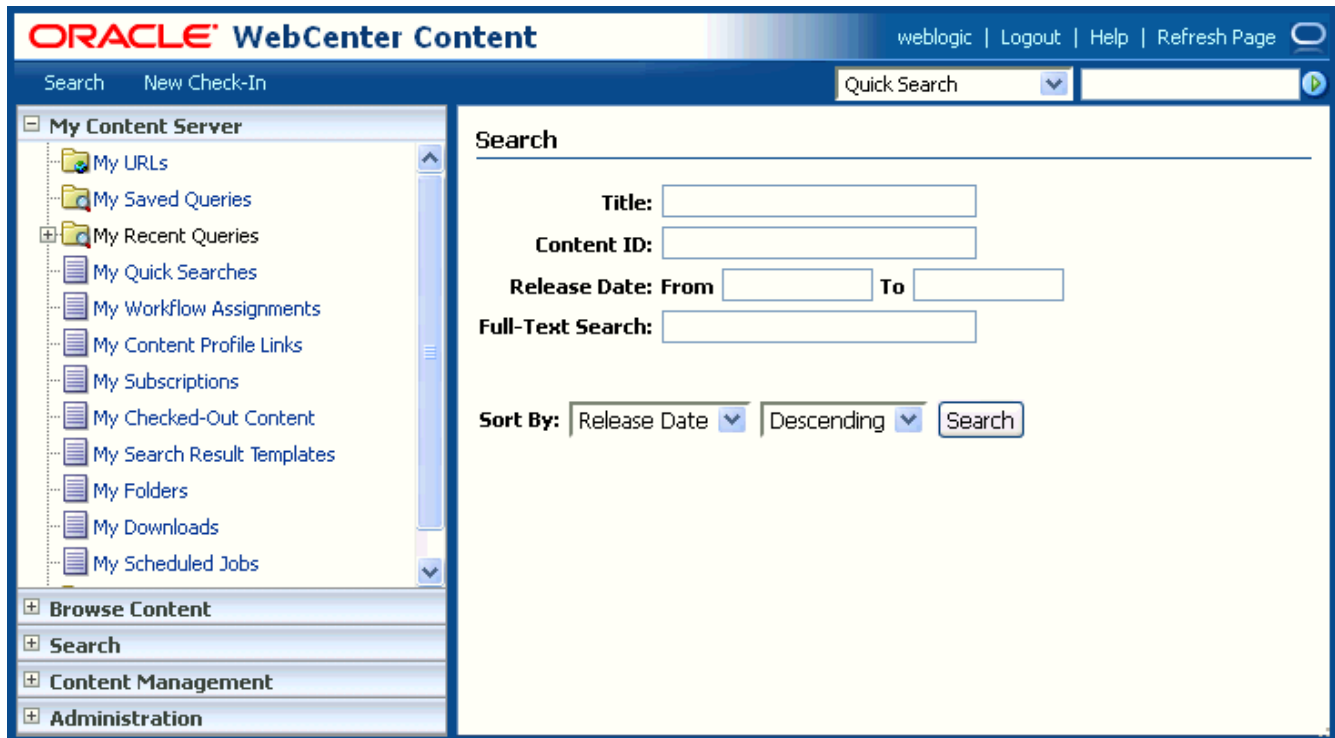

If you set up a default saved query, the results are displayed on this page (you may have to scroll down to view them).

## 18.3.2 Toolbar

The toolbar at the top of Content Server Web pages contains navigation links, online help, and the Quick Search feature.



### Note:

The Search and New Check-In links may list multiple options if your system administrator creates and enables Content Profiles to provide alternative metadata forms.

Link	Description
<b>WebCenter Content</b>	Displays the Home Page.
<b>Search</b>	Displays the Advanced Search Page, which you can use to perform metadata and full-text searches to find specific files.
<b>New Check-In</b>	Displays the Content Check-In Form, which you can use to check new files in to Content Server.

Link	Description
User profile link	Displays the User Profile Page and provides information for editing your user profile. The link is either a user name or the user's full name.
<b>Logout</b>	Logs out of Content Server.
<b>Help</b>	Displays the online help system.
<b>Refresh Page</b>	Updates the current page.
Quick Search	Searches for the specified term in the supported metadata fields and in the content item text if supported by your system. For more information, see <a href="#">Quick Search Field</a>

### 18.3.3 Trays

The trays on the left side of Content Server Web pages provide quick access to most of the functional areas in Content Server. You can add functions you use often, such as predefined searches and links to your favorite web sites.



**Note:**

Trays are part of the frame-based Trays layout option, and are the default navigation tool for Content Server. If you select Top Menus on the User Profile Page, then you can access Content Server functionality from a series of menus located above the main content area.

Link	Description
<b>Microsoft Login</b>	If you are logged in to your Microsoft network, click this link to log in to Content Server.  This link is present only if your organization is using Microsoft Network security to log in to Content Server. Many browsers, such as Mozilla Firefox, support logging in with this security.  Your Content Server instance may be integrated with your enterprise login system. For more information, ask your system administrator.
<b>My Content Server</b>	Displays the My Content Server Tray with options to view URLs and queries you have saved, content you have checked out, open workflow assignments, available metadata profiles, personal folders, and so on.
<b>Browse Content</b>	Expands to display a hierarchy of folders. You can expand and collapse the levels of folders in the tray and click a folder to show the content of the folder in the work area.
<b>Search</b>	Displays the Search Tray. From this page, you can perform metadata and full-text searches to find specific files.
<b>Content Management</b>	Displays the Content Management Tray with options to view content items that are checked out or expired, or that are active in workflow.

## 18.3.4 My Content Server Tray

Use this tray to display URLs and queries you have saved, content you have checked out, open workflow assignments, available metadata profiles, personal folders, and so on. To open this tray, click **My Content Server** in the trays area.

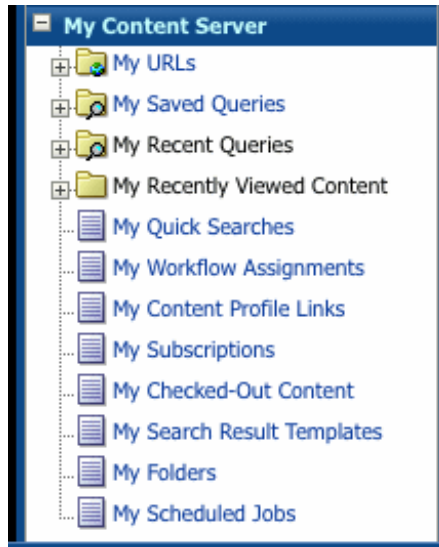

Link	Description
<b>My URLs</b>	Expand <b>My URLs</b> to display previously saved URLs. Click a URL to open the target address in the work area. Click <b>My URLs</b> to specify and save links you want to make readily available: <b>Title:</b> The displayed name of the link. <b>URL:</b> The complete Uniform Resource Locator (URL) of the website; for example: <code>http://www.example.com</code> .
<b>My Saved Queries</b>	Opens the Saved Queries Page page to modify or delete previously saved queries. Expand <b>My Saved Queries</b> to display previously saved queries. Click a query to execute the associated search. To save a query, choose <b>Save Search</b> from the Actions menu on the Search Results page.
<b>My Recent Queries</b>	Expand <b>My Recent Queries</b> to display the text form of the queries you performed recently. Click a query to execute the associated search. Click <b>Clear</b> to remove all queries from the list.
<b>My Recently Viewed Content</b>	Expand <b>My Recently Viewed Content</b> to display the most recent Content Information Pages you have viewed. Click a list item to open Content Information Page for that item.
<b>My Quick Searches</b>	Displays the Quick Searches Page which lists both the quick searches your administrator creates and the quick searches you explicitly create with the <b>Create New</b> option on this page.
<b>My Workflow Assignments</b>	Displays the Workflow in Queue Page which lists of all content items currently in a workflow for which you have responsibility.

Link	Description
<b>My Content Profile Links</b>	Displays a list of your defined content profiles. Click a link to display the profile.
<b>My Subscriptions</b>	Displays the Subscriptions Page which lists of all content items to which you subscribe.
<b>My Checked-Out Content</b>	Displays the Checked-Out Content for User Page which lists of all content you have checked out.
<b>My Search Result Templates</b>	Displays the Search Result Templates for User Page, from which you can build custom search results views.
<b>My Folders</b>	Displays a list of personal folders. Expand or collapse a particular level in the folder hierarchy to view folders contained within that folder. Click a folder name to display the contents of the folder in the work area. For more information about folders, see <a href="#">About Folders</a> .
<b>My Downloads</b>	Displays a list of recent content items that you have downloaded from Content Server.
<b>My Scheduled Jobs</b>	Displays a list of jobs requiring your attention.

## 18.3.5 Content Management Tray

Use this tray to manage content in Content Server. You must be a Contributor to access this tray. To open this tray, click **Content Management** in the trays area.

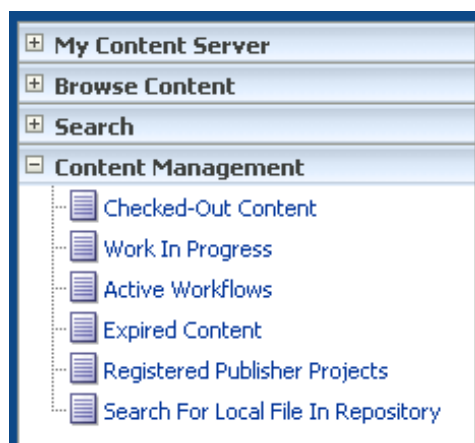

Link	Description
<b>Checked Out Content</b>	Opens the Checked-Out Content for User Page that lists all files currently checked out of Content Server.
<b>Work In Progress</b>	Opens the Work in Progress Page that lists files that have been checked in, but not released.
<b>Active Workflows</b>	Opens the Active Workflows Page that lists the currently active workflows.
<b>Expired Content</b>	Opens the Expired Content Page that lists files that have expired or that are set to expire soon.

Link	Description
<b>Registered Publisher Projects</b>	Opens the Registered Publisher Projects page that registers Content Publisher projects. (To use this feature, you must have the Content Publisher product.)
<b>Search For Local File In Repository</b>	Opens the Search for Local File Page that lets you select and compare a file from a local file system against all electronically signed content to which you have access. You can validate an external file against a single content item from the Content Information - Signatures Tab.

### 18.3.6 Quick Search Field

Use this field to perform a search at any time. By default, the Quick Search field searches for the specified search terms in the title, content ID metadata, and text indexed for full-text search if your system supports it. You can also create custom search queries that incorporate the specified search terms.



**Note:**

If you have changed your layout to the Classic layout, you can select **Quick Search** on your Adding Links to Favorites page to enable the Quick Search field.

Item	Description
Quick Search	Displays available search queries. The default query (labeled Quick Search) searches for the specified search terms in the title, content ID metadata, and text indexed for full-text search if your system supports it. The name of the selected query persists until you select another query.  The list can contain queries created by your administrator (listed under System Searches), and queries that you create (listed under My Quick Searches) with the Quick Searches Page.
Text entry field	Enter search terms for use with the selected query.
<b>Search</b> icon	Initiates the search and displays a search results list for specified query and search terms.

# 19

## Finding Documents

In Oracle WebCenter Content, the metadata you enter when you check in a content item is stored in a database set up by your system administrator. You can search for content items using these metadata values. If your system administrator has configured the Oracle Text Search option or the database full-text search capability, then the text of content items is indexed and made available for searching as well.

Check with your system administrator to see which search solution or database is used and to see if full-text indexing is enabled.

This chapter covers the following topics:

- [Search Pages](#)
- [Working with Search Results](#)
- [Search Result Templates](#)
- [Saving Queries](#)
- [Searching with Oracle Text Search](#)
- [Searching with Database Metadata Search](#)
- [Searching with Database Full-Text Search](#)
- [Searching with Elasticsearch](#)
- [Searching for Expired or Expiring Content](#)
- [Using Additional Search Capabilities](#)
- [Searching Referenced Links \(optional\)](#)
- [Content Data Tracking](#)

### 19.1 Search Pages

You can search for content using one of the following ways:

- [Quick Search Field](#)
- [Home Page Search Fields](#)
- [Search Tray](#)
- [Advanced Search Page](#)
- [Query Builder Form](#)

#### 19.1.1 Quick Search Field

With the Quick Search field, you can perform a search regardless of the page in the content area. The Quick Search field performs a substring search of the title and content ID metadata, and the indexed full-text if it is supported on your system.

A substring search is equivalent to including a wildcard at the beginning and end of the search term. For example, if you enter `form` in the Quick Search field, the search returns items with

words such as `forms`, `performance`, and `reform` in the title or content ID metadata, or in the indexed full-text if it is supported on your system.

You or your system administrator can also build custom searches targeted to search one or more metadata fields you specify, and make them available through the Quick Search field. You can create targeted searches with either the [Query Builder Form](#) or Expanded Form.

The Quick Search field supports Internet-style search syntax, complex construction, and alternate query formats. For more information, see [Using Additional Search Capabilities](#).

## 19.1.2 Home Page Search Fields

With the search fields on the Home page, you can perform a metadata search, a full-text search, or a combination of both. Only the most commonly used search fields are available from the home page.

### Note:

Your home page may have a different appearance than the default *out-of-the-box* content server home page, which includes search fields. If search functionality is not available from your home page or to search on additional metadata fields, use the [Search Tray](#) or [Advanced Search Page](#).

## 19.1.3 Search Tray

With the Search tray, you can perform a metadata, full-text, or combination search. Only the most commonly used search fields are available from the Search tray.

The Criteria tab on the Search tray displays a form where you can enter your criteria. The Results tab displays the search results.

## 19.1.4 Advanced Search Page

With the Advanced Search page, you can perform a metadata search, full-text search, or a combination of both on all available fields.

To access this page, click the **Advanced** link in the [Search Tray](#) or use the Search menu on the Toolbar.

The expanded form on the [Advanced Search Page](#) displays all search fields available to you on a single page. You can alternate between the expanded form and the query builder form using the Search Forms menu at the top of the search page.

You can also select a different search profile from the Switch Profile menu, if your system administrator has defined them for you. You can specify the default search form to use the Advanced Search page.



 **Note:**

Queries built using the Expanded Form separate the metadata fields with the <AND> operator. Each search criterion entered into each field must be met for a result to be returned. For example, if you enter `January` into the Title field and `presentation` into the Type field, then a search finds content only if it has a `presentation` type and has `January` in the title.

 **Note:**

When using Oracle Text Search with your Content Server instance, you cannot enter complex search queries into the Full-Text Search field on the Expanded Form of the Advanced Search page. Instead, you must use the Query Builder form.

## 19.1.5 Query Builder Form

The Query Builder form creates and saves complex queries by selecting options from a series of lists. After a query is built, you can edit the query directly, perform the search, or save the query for easy access from **My Saved Queries**.

With the Query Builder form, you can separate the metadata fields with either the <AND> operator or the <OR> operator. If you use the <AND> operator, then each search criteria entered into each field must be met to return a result.

If you use the <OR> operator, then only one of each field's criteria must be met. For example, if you enter `January` into the Title field and `presentation` into the Type field separated by <OR>, then results include content that has either `presentation` as the type or has `January` in the title.

 **Note:**

When using Oracle Text Search with your Content Server instance, you cannot enter complex search queries into the Full-Text Search field on the Expanded Form of the Advanced Search page. Instead, you must use the Query Builder form.

## 19.2 Working with Search Results

You can specify how to display the results of your search based on the number of content items returned per page and the order of the content items. For example, to find the most recent files that match your criteria, sort the results by release date. If you are searching for specific text such as `changed address`, sort your search results by score.

Use the Results Options area of the [Advanced Search Page](#) to control the display of the Search Results page:

- [Displaying Search Results](#)
- [Changing the Search Results View](#)

## 19.2.1 Displaying Search Results

To specify how to display the search results:

1. Display the home page search fields or the Advanced Search page.
2. Scroll down to the Results Options.
3. Set Results Per Page to the maximum number of content items to display on each Search Results page.
4. Specify the Sort By method and order.
5. Click **Search**.
6. From the Content Actions menu on a Search Results page, choose the view option to specify the search results view.

### Note:

- The **Clear** button clears the search fields, but does not clear the Results Options settings.
- The system administrator can use the Content Server Configuration Manager to add or remove sortable fields. To change the fields available for sorting, see your system administrator.

## 19.2.2 Viewing Documents on the Search Results Page

To view documents on the search results page:

1. On the **Find Documents** page, select a single document and then open the **More** menu.
2. In the **More** menu, select the **Open Document** option.

## 19.2.3 Changing the Search Results View

To change the default search results view:

1. Display the User Profile page.
2. Scroll down to the **Search Template** option.
3. Click **Search Template**, and select the search result view.
4. Click **Update**.







## 19.3 Search Result Templates

You can customize the metadata information you want to see on a search result. You can even specify different search results templates to be used for different saved queries. To personalize how search results are displayed, select an option from the list on the User Profile Page, or from the Search Results page. There are three templates available by default, and you have the option to create new views based on the three provided templates using the Search Results Templates for *User* page to identify the information and specify display options:

- [Classic View Template](#)
- [Headline View Template](#)
- [Thumbnail View Template](#)
- [Creating a Custom Search Result Template](#)

## 19.3.1 Classic View Template









The Classic template lists content items sequentially in single rows, based on the default sort field and order set on the User Profile page.

	Description	Rev.	Actions
	<p><b>System Log</b> [ 0007 ]</p> <p><b>Author:</b> sysadmin <b>Revision:</b> 1</p> <p><b>Release Date:</b> 6/7/06 1:36 PM</p> <p>System Log detailing crash info.</p>	<u>1</u>	 
		text/plain 5K	
	<p><b>Resume - Oliver</b> [ 0008 ]</p> <p><b>Author:</b> sysadmin <b>Revision:</b> 1</p> <p><b>Release Date:</b> 6/7/06 1:36 PM</p>	<u>1</u>	 
		text/plain 1K	

Column	Description
Content icon or Thumbnail image	Displays an icon based on the content type. Optionally, if your system administrator has set up Content Server to create a thumbnail image of the content, then it displays the thumbnail image.
<b>Description</b>	<p><b>Title and Content ID:</b> The title and unique identifier of the content item, linked to display a Web-viewable version of the content, if it is available. If no Web-viewable version is available, it links to the native file.</p> <p>The title and content ID are displayed in all custom search result templates based on the Classic View, even if those fields are not specifically selected from the <a href="#">Classic View Template</a> section of the Create/Edit Classic View Search Result Template page.</p> <p><b>Author:</b> The person who checked in the content item.</p> <p><b>Revision:</b> Identifies the revision number of the content item.</p> <p><b>Release Date:</b> The date the content item was released.</p> <p><b>Comments:</b> Comments entered when the item was checked in, if any.</p> <p><b>Content Format:</b> The format of the native file.</p>
<b>Rev.</b>	Displays the revision number of the content item.
<b>Actions</b>	<p>Displays the Actions menu for an item and the <b>Content Info</b> icon.</p> <p><b>Actions</b> icon: Click this icon to open a menu of actions for the selected content item.</p> <p><b>Content Info</b> icon: Click this icon to display the Content Information page.</p>

## 19.3.2 Headline View Template

The Headline template by default lists items in a single line, with a minimum of information. The Headline template uses the sort field, sort order, and result count fields on the User Profile page to arrange the results.

ID	Title	Date	Author	Actions
000066	Ref Test 10	1/22/07	sysadmin	 
000065	BMP Image	12/5/06	sysadmin	 
000064	Word Document	12/5/06	sysadmin	 
000060	Word Document	12/5/06	sysadmin	 

Column	Description
<b>ID</b>	A unique identifier of the content item, linked to a Web-viewable version of the content item, if it is available. If no Web-viewable version is available, it links to the native file.
<b>Title</b>	Displays the title of the content item without any associated link.
<b>Date</b>	Displays the date the content item was released.
<b>Author</b>	Displays the user name of the person who last checked in the content item.
<b>Actions</b>	Displays the Actions menu for an item and the <b>Content Info</b> icon. <b>Actions</b> icon: Click this icon to open a menu of actions for the selected content item. <b>Content Info</b> icon: Click this icon to display the Content Information page of the selected content item.

## 19.3.3 Thumbnail View Template

The Thumbnail template by default lists items in a grid from left-to-right and top-to-bottom and displays an icon based on the content type, or a thumbnail image of the content if your system administrator has set up Content Server to create one. This template is particularly suited for displaying images and other graphic content. The grid arranges results based on the sort field and order set on the User Profile page.



Item	Description
Icons	Displays the Actions menu for an item and the <b>Content Info</b> icon. <b>Actions</b> icon: Click this icon to open a menu of actions for the selected content item. <b>Content Info</b> icon: Click this icon to display the Content Information page of the selected content item.
Thumbnail Icon or Image	Displays an icon based on the content type or a thumbnail image of the content if your system administrator has set up Content Server to create one, linked to a Web-viewable version of the content item, if it is available. If no Web-viewable version is available, it links to the native file.
Title	Displays the title of the content item without any associated link. To maintain the grid structure, long titles are truncated to a single line. Rolling the mouse over the title expands the text to display the full title.

## 19.3.4 Creating a Custom Search Result Template

To create a custom search result template:

### Note:

If you have Oracle WebCenter Content: Records installed with Department of Defense (DoD) functionality enabled, the Security Classification field must always be displayed in a search result. If you do not include the Security Classification field when you customize a search result template, the Security Classification field is included automatically.

1. Navigate to the Search Result Templates for User page.
  - From a search results page, choose **Customize** from the Actions menu.
  - Open the My Content Server tray and click **My Search Result Templates**.

2. Click the **Add Template** icon in the **Actions** column next to the provided List template on which you want to base your custom template.
3. If your custom template is not based on the provided Headline View template, skip to the next step. If your custom template is based on the Headline View template, on the Create Custom Template page, select a metadata field to display as a column from the **Available Fields** box, and click the right arrow. The selected metadata field is added to the **Columns** field. You must select and move each field separately.

To reorder the column display, use the up and down arrows next to the **Columns** field. Click the up arrow to move the selected column to the left in the results template. Click the down arrow to move the selected column to the right in the results template.

4. Select a metadata field to display in the **Description** column from the **Available Fields** box, and click **Move Here** beneath the **Description** box. The metadata field is added to the **Description** box. You must select and move each field separately.

To reorder the column display, use the up and down arrows next to the **Main Information** field. Click the up arrow to move the selected item up in the **Description** column. Click the down arrow to move the selected column down in the **Description** column.

 **Note:**

To display the selected fields, you must also display the **Description** metadata field as a column.

5. Click **Save**.

## 19.4 Saving Queries

You can save and reuse search queries:

- [About Saved Queries](#)
- [Saving a Query](#)
- [Rerunning a Recent Query](#)
- [Clearing Recent Queries](#)
- [Creating Quick Search Queries](#)

### 19.4.1 About Saved Queries

To quickly display results for a search that you perform often, you can save the search in the My Saved Queries folder in the My Content Server tray.

After you save a query link, you can modify or delete the link from your Saved Queries page.

You or your system administrator can also build custom searches targeted to search one or more metadata fields you specify, and make them available through the Quick Search field.

### 19.4.2 Saving a Query

To save a search as a query link on the Saved Queries page:

1. Specify the search criteria you want to save.

- On the [Search Tray](#), [Home Page Search Fields](#), or [Advanced Search Page](#), enter the search criteria in the associated fields.
  - On the Search Results page, the criteria saved are the criteria that were used to display the results.
2. Choose **Save Search** from the Actions menu on the Search Results page.
  3. In the prompt dialog, enter a title to use as the link name for the saved query.
  4. Click **OK**.
- The new link is shown under the My Saved Queries tray.

### 19.4.3 Rerunning a Recent Query

To rerun a recent query:

1. Open the My Recent Queries folder in the My Content Server tray.
2. Double-click the link for the query you want to run.

The output from the query displays on your Search Results page.

### 19.4.4 Clearing Recent Queries

To clear all recent queries from your My Recent Queries tray:

1. Open My Recent Queries in the My Content Server tray.
2. Double-click the **Clear** link.

Content Server deletes all links except **Clear** from the My Recent Queries folder.

### 19.4.5 Creating Quick Search Queries

You can create targeted searches with either the Query Builder Form or Expanded Form. To customize the query string directly, you must use the [Query Builder Form](#) as shown in this procedure.

To build a targeted search available through the Quick Search field:

1. Click **My Quick Searches** in the My Content Server tray.
2. On the Quick Searches page, click **Create New** beneath the My Quick Searches area.

To edit an existing Quick Search, choose **Edit** from the associated Actions menu. You must be an administrator to modify the quick searches defined by administrators.

3. From the Search form menu on the Create/Edit Targeted Quick Search page, select the form to use to create the search query.

The form you select when you create the quick search is the form you must use when you edit the quick search (the Search form menu is not available when you edit an existing quick search.)

The Expanded Form is selected by default. If you want to manually edit the query text, use the Query Builder form.

4. Specify a Quick Search Key to select the search from the Quick Search list. Use lower case letters or numbers. Searches are listed in ascending order based on this key.

Duplicate keys within the My Quick Searches table are not allowed. Although it is best to use a single character, you can use multiple character keys to avoid duplicate key names.

Only the first character acts as the shortcut. For example, if you have keys a1, a2, and a3, the first time you press "a", you select the search associated with key a1. The next time you press "a", you select the search associated with key a2, and so on.

5. Specify the Quick Search Label to display in the Quick Search list.
6. Enter **#s** in one or more fields to represent the search terms entered by the user in the Quick Search field. To further restrict the search, you can provide specific values for one or more search fields, but you must include **#s** in at least one field.

If you use the Query Builder form, you can manually edit the query when you click **show advanced query builder options** and then select **Modify Query Text**.

For example, if you select the date field, the On or After operator, and specify #s to represent the user input, the resulting query text is:

```
dInDate >= `#s`
```

To create a query that shows check-ins within the last specified period of days, subtract the number of days entered by the user from the current date returned by the dateCurrent function:

```
dInDate > `<$dateCurrent(-#s)$>`
```

7. Specify the number of results to show on each page, or use the default.
8. Specify how to sort the results, or use the defaults.
9. Specify the template to use to format the results, or use the default.
10. Click **Save**.

The searches you create are displayed under My Quick Searches in the Quick Search menu.

## 19.5 Searching with Oracle Text Search

If you have a license to use Oracle Text Search (in Oracle Database 11g) or Oracle Secure Enterprise Search 11g, the Oracle Text Search option enables the use of those technologies as the primary full-text search engine for Oracle WebCenter Content Server.

Oracle Text Search can filter and extract content from different document formats in different languages. It supports a large number of document formats, including Microsoft Office file formats, Adobe PDF, HTML, and XML. It can render search results in various formats, including unformatted text, HTML with term highlighting, and original document format.

If the system administrator configured Oracle Text Search, this option enables you to find a content item or items based on information about the file, actual text in the file, or both. The system administrator can also configure Oracle Secure Enterprise Search (Oracle SES) as the back-end search engine for Oracle Text Search.

If your system administrator has configured the Oracle Text Search option, you can specify full-text and metadata searches and select options to filter the results of a search by categories:

- [Searching with the Expanded Form](#)
- [Filtering Search Results](#)
- [Searching with the Query Builder Form](#)
- [Metadata Search Operators for Oracle Text Search](#)



## 19.5.1 Searching with the Expanded Form

On the Expanded Form, you can specify a metadata search, a full-text search, or both to identify a content item or items to search for. Also, you can specify result options.

Figure 19-1 shows part of the Expanded Form for specifying Oracle Text Search queries.

**Figure 19-1 Expanded Form for Oracle Text Search**

The screenshot shows the 'Search: Expanded Form' interface. At the top, there is a 'quick help' link and a 'Search Forms' dropdown menu. Below this is a 'Full-Text Search' section with a search bar and 'Search', 'Reset', and 'Save' buttons. The 'Metadata Search' section follows, containing several rows of search criteria. Each row has a dropdown menu set to 'Contains' and an input field. The criteria include Content ID, Title, Type, Security Group, Collaboration Project, Account, Author, Date (with 'From' and 'To' date pickers), Expiration Date (with 'From' and 'To' date pickers), User Access List (with an 'Add User' button), Comments, and Group Access List. There are also large empty rectangular boxes for additional input.

### To specify a search on the Expanded Form:

1. On the Content Server home page, display the [Home Page Search Fields](#) from the Search menu or the [Search Tray](#).
2. In the Metadata Search area of the Expanded Form, you can enter one or more search criteria for metadata fields:
  - Select the appropriate search operators.  
For more information, see [Metadata Search Operators for Oracle Text Search](#).
  - Use Metadata Wildcards as necessary.  
For more information, see [Metadata Wildcards](#).
  - Oracle Text Search is always case insensitive.

- In the Full-Text Search area, you can enter text to search for in a content item or items, to refine your search.

 **Note:**

When using Oracle Text Search with your Content Server instance, you cannot enter free-form metadata queries into the Full-Text Search field on the Expanded Form. Instead, you must use the advanced options on the Query Builder Form. For more information, see [Searching with the Query Builder Form](#).

- In the Results Options area, you can change the Results Options for displaying the results.
- To save the search query under **My Saved Queries**, click **Save**.
- To run the search query, click **Search**.

The content item or items that match your search criteria are displayed on the Search Results page.











## 19.5.2 Filtering Search Results

The Search Results page displays a menu bar with metadata categories you can use to filter the search results. Each category lists values that are valid for the particular search results. The system administrator can add or remove categories. The default set of categories include **Content Type**, **Security Group**, and **Account**.

**Figure 19-2 Search Results with Oracle Text Search Default Menu**

**Search Results** Found 11 items

Filter by Category: [Content Type:ADACCT](#) [Security Group](#) [Account](#)

Actions					
<input type="checkbox"/>	ID	Title	Date	Author	Actions
<input type="checkbox"/>	<a href="#">PPT_TEST1</a>	PPTTestDoc1	6/6/08	sysadmin	 
<input type="checkbox"/>	<a href="#">SEARCHINDEX_000021</a>	TestDoc19	9/4/02	sysadmin	 
<input type="checkbox"/>	<a href="#">SEARCHINDEX_000010</a>	TestDoc8	9/4/02	sysadmin	 
<input type="checkbox"/>	<a href="#">SEARCHINDEX_000013</a>	TestDoc11	9/4/02	user1	 
<input type="checkbox"/>	<a href="#">SEARCHINDEX_000011</a>	TestDoc9	9/4/02	sysadmin	 

An arrow next to the category name indicates that the search results include multiple values for that category. When you move your cursor over the option name, a menu displays the list of the values found in the search results for that category and the number of content items for each value. Click a value to filter the Search Results page to list only the items that have the selected value in the selected category.

[Figure 19-3](#) shows a list of categories under **Security Group** and the number of items found in each category.

Figure 19-3 Search Results with Expanded Oracle Text Search Menu

Search Results Found 24 items			
Filter by Category: Content Type Security Group Account Author:sysadmin			
Administration- (3) Marketing- (1) Public- (14) Secure- (5)			
Production- (:)			
Actions	Description	Content ID	Actions
<input type="checkbox"/>	<b>Title:</b> Chinese Test <b>Author:</b> sysadmin <b>Content Type:</b> ADACCT - Acme Accounting Department <b>Account:</b> MSP <b>Security Group:</b> Administration <b>Native File Extension:</b> doc <b>Release Date:</b> 6/19/08 4:20 PM <b>Snippet:</b> idcnnull SEARCHINDEX_000026 idcnnull sysadmin idcnnull N/A idcnnull idcnnull <b>Score:</b> 3	SEARCHINDEX_000026	
<input type="checkbox"/>	<b>Title:</b> Contemporary Resume RTF <b>Author:</b> sysadmin <b>Content Type:</b> ADACCT - Acme Accounting Department <b>Account:</b> MSP <b>Security Group:</b> Administration <b>Native File Extension:</b> rtf <b>Release Date:</b> 6/16/08 11:10 AM <b>Snippet:</b> idcnnull SEARCHINDEX_000025 idcnnull sysadmin idcnnull N/A idcnnull idcnnull <b>Score:</b> 3	SEARCHINDEX_000025	
<input type="checkbox"/>	<b>Title:</b> errortext <b>Author:</b> sysadmin <b>Content Type:</b> ADACCT - Acme Accounting Department <b>Account:</b> MSP <b>Security Group:</b> Public <b>Native File Extension:</b> txt	SEARCHINDEX_000024	

### 19.5.3 Searching with the Query Builder Form

On the Query Builder form, you can select search criteria from menus as required. You can build and save complex queries by selecting options from a series of lists. You can also manually edit the query text.

**Note:**

When using Oracle Text Search with your Content Server instance, you cannot enter free-form metadata queries into the Full-Text Search field on the Expanded Form. Instead, you must use the advanced options on the Query Builder Form. For more information, see [Searching with the Query Builder Form](#).

Figure 19-4 shows the Query Builder Form for specifying Oracle Text Search queries.

Figure 19-4 Query Builder Form for Oracle Text Search

**To specify a search on the Query Builder Form:**

1. On the Content Server home page, display the [Home Page Search Fields](#) from the Search menu or the [Search Tray](#).
2. On the Search Forms menu, choose **Query Builder Form**.
3. To edit the query, click **show advanced query builder options**, and then choose **Modify Query Text**.

For example, if you select the date field, the On or After operator, and specify a date, the resulting query text is similar to the following:

```
dInDate >= `9/22/11 12:00 AM`
```

To create a search that shows check-ins within the last specified period of days, subtract the number of days (7 in the example below) from the current date returned by the `dateCurrent` function:

```
dInDate > `<$dateCurrent(-7)$>`
```

4. In the Results Options area, you can change the Results Options for displaying the results.
5. To save the search query under **My Saved Queries**, click **Save**.
6. To run the search query, click **Search**.

## 19.5.4 Metadata Search Operators for Oracle Text Search

On the [Advanced Search Page](#), you can use search operators to refine the search criteria. These operators are listed as options in lists to the left of each field.

The following table describes the search terms used and provides examples for use.

Operator	Description	Example
CONTAINS	Finds content items with the specified whole word or phrase in the metadata field.  This operator is available only for Oracle Text Search, or for Oracle Database and Microsoft SQL Server database with the optional DBSearchContainsOpSupport component enabled. For more information, see your system administrator.	If you enter <code>form</code> in the Title field, the search returns items with the whole word <code>form</code> in their title, but does not return items with the word <code>performance</code> , <code>reform</code> , or <code>format</code> .
MATCHES	Finds items with the exact specified value in the metadata field.	When you enter <code>address change form</code> in the Title field, the search returns items with the exact title of <code>address change form</code> .  A query that uses the MATCHES operator on a nonoptimized field behaves the same as a query that uses the CONTAINS operator.  For example, if the <code>xDepartment</code> field is not optimized, then the query <code>xDepartment MATCHES 'Marketing'</code> behaves like <code>xDepartment CONTAINS 'Marketing'</code> , returning documents that have an <code>xDepartment</code> value of <code>'Marketing Services'</code> or <code>'Product Marketing'</code> .
HAS WORD PREFIX	Finds all content items with the specified prefix at the beginning of at least one word in the metadata field.	If you enter <code>form</code> in the Title field, the search finds all content items whose title includes the words <code>form</code> and <code>format</code> , but does not find the words <code>performance</code> or <code>reform</code> .

## 19.6 Searching with Database Metadata Search

Database metadata search enables you to find a content item or items based on information about the file. The metadata search functionality is installed by default and is available even if other search engines are configured.

### 19.6.1 About Metadata Searching

Metadata searching is similar to finding a book in a library by searching for its author, title, or subject. When you search by metadata, you specify as much information as you know about a file or a group of files. For example, to find all files written by your supervisor for your department that were released on or after 1/1/2002, specify the following on the search page:

- Author: *supervisor's user name*
- Department: *department name*
- Release Date From: *1/1/2002*

 **Note:**

When you search for metadata, case sensitivity varies depending on how your system administrator has configured Content Server. For your specific configuration, see your system administrator.

When you use full-text searching, a search is case sensitive for metadata and case insensitive for full text. For Content ID, however, lowercase letters are converted to uppercase letters, so you cannot search Content ID with lowercase letters.

## 19.6.2 Performing a Metadata Search

To search for files using metadata as the search criteria:

1. Display the [Home Page Search Fields](#) or the [Search Tray](#).
2. Enter your search criteria in the Expanded Form.
  - Select the appropriate search operators.  
For more information, see [Metadata search operators for a database metadata search](#)
  - Use [Metadata Wildcards](#) as necessary.
  - Keep the case sensitivity of metadata searches in mind.  
For more information, see [Metadata search case sensitivity](#).
3. Select the Results Options for displaying the results.
4. Click **Search**.

The files that match your search criteria are displayed on the Search Results page.

## 19.7 Searching with Database Full-Text Search

Database full-text search enables you to find a content item or items based on the actual text in the file. The database full-text search is available if the system administrator configured it.

### 19.7.1 Performing a Full-Text Search

To perform a full-text search:

1. Display the [Quick Search Field](#), [Home Page Search Fields](#), [Search Tray](#), or [Advanced Search Page](#).
2. Enter your search terms in the full-text search field.
  - Take the [Full-text search rules](#) into account.
  - Keep the case sensitivity of full-text searches in mind.  
For more information, see [Full-text search case sensitivity](#)

3. Select the Results Options for displaying the results.
4. Click **Search**.

The files that match your search criteria are displayed on the Search Results page or in the Results tab in the Search Tray.

## 19.8 Searching with Elasticsearch

WebCenter Content supports a variety of search indexer engines including `DATABASE.METADATA`, `DATABASE.FULLTEXT`, and `ORACLETEXTSEARCH`. Out of these, `ORACLETEXTSEARCH` provides a rich searching capability including full-text searches with relevancy ranking, complex query structures, and improved performance compared to `DATABASE.FULLTEXT`. However, in a large enterprise setup where content items run into millions and ingestion is quite high, customers find rebuilding the `ORACLETEXTSEARCH` index to be time-consuming.

WebCenter Content communicates with Elasticsearch through REST APIs provided by Elasticsearch. WebCenter Content APIs/services exposed to users remain the same. While the APIs and user interfaces remain mostly untouched in Elasticsearch, rebuild time has reduced significantly. Users will also experience an improved and near real-time search response.

- [Searching with the Expanded Form](#)
- [Filtering Search Results](#)
- [Searching with the Query Builder Form](#)
- [Metadata Search Operators for Elasticsearch](#)

### 19.8.1 Searching with the Expanded Form

On the Expanded Form, you can specify a metadata search, a full-text search, or both to identify a content item or items to search for. Also, you can specify result options.

The figure given below shows part of the Expanded Form for specifying Elasticsearch queries.

**Figure 19-5 Expanded Form for Elasticsearch**

**To specify a search on the Expanded Form:**

1. On the Content Server home page, display the [Home Page Search Fields](#) from the Search menu or the [Search Tray](#).
2. In the Metadata Search area of the Expanded Form, you can enter one or more search criteria for metadata fields:
  - Select the appropriate search operators.  
For more information, see [Metadata Search Operators for Elasticsearch](#).
  - Use Metadata Wildcards as necessary.  
For more information, see [Metadata Wildcards](#).
  - Elasticsearch is always case insensitive.
3. In the Full-Text Search area, you can enter text to search for in a content item or items, to refine your search.



 **Note:**

When using Elasticsearch with your Content Server instance, you can perform search based on the combination of the metadata operators and Full-Text Search field on the Expanded Form.

4. In the Results Options area, you can change the Results Options for displaying the results.
5. To save the search query under **My Saved Queries**, click **Save**.
6. To run the search query, click **Search**.

The content item or items that match your search criteria are displayed on the Search Results page.

## 19.8.2 Filtering Search Results











The Search Results page displays a menu bar with metadata categories you can use to filter the search results. Each category lists values that are valid for the particular search results. The system administrator can add or remove categories. The default set of categories include **Content Type**, **Security Group**, and **Account**.

**Figure 19-6 Search Results with Elasticsearch Default Menu**

**Search Results** Found 11 items

▼ Change View   ▼ Query Actions

Filter by Category: Content Type:ADACCT   ▼ Security Group   ▼ Account

▼ Actions					
<input type="checkbox"/>	ID	Title	Date	Author	Actions
<input type="checkbox"/>	<a href="#">PPT_TEST1</a>	PPTTestDoc1	6/6/08	sysadmin	 
<input type="checkbox"/>	<a href="#">SEARCHINDEX_000021</a>	TestDoc19	9/4/02	sysadmin	 
<input type="checkbox"/>	<a href="#">SEARCHINDEX_000010</a>	TestDoc8	9/4/02	sysadmin	 
<input type="checkbox"/>	<a href="#">SEARCHINDEX_000013</a>	TestDoc11	9/4/02	user1	 
<input type="checkbox"/>	<a href="#">SEARCHINDEX_000011</a>	TestDoc9	9/4/02	sysadmin	 

An arrow next to the category name indicates that the search results include multiple values for that category. When you move your cursor over the option name, a menu displays the list of the values found in the search results for that category and the number of content items for each value. Click a value to filter the Search Results page to list only the items that have the selected value in the selected category.

The figure below shows a list of categories under **Security Group** and the number of items found in each category.

Figure 19-7 Search Results with Expanded Elasticsearch Menu

Search Results Found 24 items			
Filter by Category: Content Type Security Group Account Author:sysadmin			
Administration- (3) Marketing- (1) Public- (14) Secure- (5)			
Production- (:) Actions			
<input type="checkbox"/>	Description	Content ID	Actions
<input type="checkbox"/>	<b>Title:</b> Chinese Test <b>Author:</b> sysadmin <b>Content Type:</b> ADACCT - Acme Accounting Department <b>Account:</b> MSP <b>Security Group:</b> Administration <b>Native File Extension:</b> doc <b>Release Date:</b> 6/19/08 4:20 PM <b>Snippet:</b> idnull SEARCHINDEX_000026 idnull sysadmin idnull N/A idnull idnull <b>Score:</b> 3	SEARCHINDEX_000026	
<input type="checkbox"/>	<b>Title:</b> Contemporary Resume RTF <b>Author:</b> sysadmin <b>Content Type:</b> ADACCT - Acme Accounting Department <b>Account:</b> MSP <b>Security Group:</b> Administration <b>Native File Extension:</b> rtf <b>Release Date:</b> 6/16/08 11:10 AM <b>Snippet:</b> idnull SEARCHINDEX_000025 idnull sysadmin idnull N/A idnull idnull <b>Score:</b> 3	SEARCHINDEX_000025	
<input type="checkbox"/>	<b>Title:</b> errortext <b>Author:</b> sysadmin <b>Content Type:</b> ADACCT - Acme Accounting Department <b>Account:</b> MSP <b>Security Group:</b> Public <b>Native File Extension:</b> txt	SEARCHINDEX_000024	

### 19.8.3 Searching with the Query Builder Form

On the Query Builder form, you can select search criteria from menus as required. You can build and save complex queries by selecting options from a series of lists. You can also manually edit the query text.



**Note:**

When using Elasticsearch with your Content Server instance, you cannot enter free-form metadata queries into the Full-Text Search field on the Expanded Form. Instead, you must use the advanced options on the Query Builder Form.

The figure below shows the Query Builder Form for specifying Elasticsearch queries.

Figure 19-8 Query Builder Form for Elasticsearch

**To specify a search on the Query Builder Form:**

1. On the Content Server home page, display the [Home Page Search Fields](#) from the Search menu or the [Search Tray](#).
2. On the Search Forms menu, choose **Query Builder Form**.
3. To edit the query, click **show advanced query builder options**, and then choose **Modify Query Text**.

For example, if you select the date field, the On or After operator, and specify a date, the resulting query text is similar to the following:

```
dInDate >= `9/22/11 12:00 AM`
```

To create a search that shows check-ins within the last specified period of days, subtract the number of days (7 in the example below) from the current date returned by the `dateCurrent` function:

```
dInDate > `<$dateCurrent(-7)$>`
```

4. In the Results Options area, you can change the Results Options for displaying the results.
5. To save the search query under **My Saved Queries**, click **Save**.
6. To run the search query, click **Search**.

## 19.8.4 Metadata Search Operators for Elasticsearch

The following table describes the search terms used and provides examples for use:

Operator	Description	Example
CONTAINS	Finds content items with the specified whole word or phrase in the metadata field.	If you enter <code>form</code> in the Title field, the search returns items with the whole word <code>form</code> in their title, but does not return items with the word <code>performance</code> or <code>reform</code> .
MATCHES	Finds items with the exact specified value in the metadata field.	When you enter <code>address change form</code> in the Title field, the search returns items with the exact title of <code>address change form</code> .
HAS WORD PREFIX	Finds all content items with the specified word at the beginning of the metadata field. No wildcard character is placed before or after the specified value.	If you enter <code>form</code> in the Title field, the search finds all content items with the word <code>form</code> at the beginning of their title but does not return any item whose title begins with the word <code>performance</code> or <code>reform</code> .
STARTS	Finds items with the specified value at the beginning of the metadata field. This operator has the same effect as placing a wildcard after the search term when using the MATCHES operator.	When you enter <code>form</code> in the Title field, the search returns all items with a title that begins with <code>form</code> , <code>forms</code> , or <code>forming</code> and so on.
ENDS	Finds items with the specified value at the end of the metadata field. This operator has the same effect as placing a wildcard before the search term when using the MATCHES operator.	When you enter <code>form</code> in the Title field, the search returns all items with titles that end with <code>form</code> , such as <code>forms</code> , <code>perform</code> , and <code>chloroform</code> .
SUBSTRING	Finds content items with the specified string anywhere in the metadata field. This operator has the same effect as placing a wildcard before and after the search term.	When you enter <code>form</code> in the Title field, the search returns items with words such as <code>forms</code> , <code>performance</code> , and <code>reform</code> in their title.
NOT MATCHES	Finds items that do not have the exact specified value in the metadata field or the documents that have empty field for that metadata field.	When you enter <code>address change form</code> in the Title field, the search returns items without the exact title of <code>Address Change Form</code> .

## 19.9 Searching for Expired or Expiring Content

By default, if you have write permission to any security group, you can access the Expired Content page and perform a search for expired content. The search results include only the content for which you have at least read permission.

To search for content that has expired or is set to expire:

1. Log in to Content Server.
2. Click **Content Manager** in the left navigation bar and click **Expired Content**.
3. To search for content within a particular date and time range, on the Expired Content page, specify dates and times in the **Before** and **After** fields or select a value from the associated list that is a day, a week, or a month before or after the current date and time.

By default, if you leave the **Before** and **After** fields blank, the search effectively returns all content set to expire after the current date and time.

4. To restrict the search results to expired content only, select **Expired Content**.

If you select **Expired Content** and leave the **Before** and **After** fields blank, the search effectively returns all content that expired before the current date and time.

5. The Expired Content page displays the date range applied and the expired or expiring content items that match the specified criteria.

## 19.10 Using Additional Search Capabilities

This section covers the following topics:

- [Metadata Wildcards](#)
- [Internet-Style Search Syntax](#)
- [Complex Queries and Alternate Query Formats](#)

### 19.10.1 Metadata Wildcards

A wildcard substitutes for unknown or nonspecific characters in the search term. You can use wildcards in metadata searches, even when using the Quick Search field.

Available wildcard characters and behavior are dependent on the search engine being used and how Content Server is configured. Check with your system administrator for guidance on what wildcards are available and how they behave. Asterisks (\*) and question marks (?) are often used as wildcard characters, but not always. When available as wildcard characters, asterisks and question marks typically behave as follows when entered into metadata search fields:

- An asterisk (\*) indicates zero or more alphanumeric characters. For example:
  - `form*` matches `form` and `formula`
  - `*orm` matches `form` and `reform`
  - `*form*` matches `form`, `formula`, `reform`, and `performance`
- A question mark (?) indicates one alphanumeric character. For example:
  - `form?` matches `forms` and `form1`, but not `form` or `formal`
  - `??form` matches `reform` but not `perform`

#### Note:

Because asterisks and question marks are often used as wildcards, it is not recommended that they be used in metadata fields such as title or Content ID when checking in a document.

### 19.10.2 Internet-Style Search Syntax

Search techniques common to the popular Internet search engines are supported in Content Server. For example, `new product` entered in the Quick Search field searches for `new <AND>`

product, while new, product searches for new <OR> product. The following table lists how Content Server interprets common characters.

Character	Interpreted As
Space ( )	AND
Comma (,)	OR
Minus (-)	NOT
Phrases enclosed in double-quotes (" <i>any phrase</i> ")	Exact match of entered phrase

The following table lists examples of how Content Server interprets Internet-style syntax in a full-text search.

Query	Interpreted As
new product	new <AND> product
(new, product) images	(new <OR> product) <AND> images
new product -images	(new <AND> product) <AND> <NOT> images
"new product", "new images"	"new product" <OR> "new images"

The following table lists examples of how Content Server interprets Internet-style syntax when searching title metadata using the substring operator.

Query	Interpreted As
new product	dDocTitle <substring> 'new' <AND> dDocTitle <substring> 'product'
new, product	dDocTitle <substring> 'new' <OR> dDocTitle <substring> 'product'
new -product	dDocTitle <substring> 'new' <AND> <NOT> 'product'
"new product"	dDocTitle <substring> 'new product'

 **Note:**

Internet-style search syntax is enabled by default, but your system administrator can disable it. Check with your system administrator if you have questions.

## 19.10.3 Complex Queries and Alternate Query Formats

Content Server allows for the use of parentheses for complex query construction and *field:value* and *site:value* formats when creating a query. By using these alternatives, you can more easily search the metadata field you want across multiple servers, if necessary, and refine your results. For example, to search only the title metadata for new product without having to go to the Advanced Search page, enter `dDocTitle:"new product"` into the Quick Search field. The search looks only in the field you specified before the colon. You must know the Content Server identifier for the metadata field you want to search.

### Note:

When using Oracle Text Search with your Content Server instance, you cannot enter complex search queries into the Full-Text Search field on the Expanded Form of the Advanced Search page. Instead, you must use the advanced options on the Query Builder Form.

The following table lists some examples of complex and alternate query formats.

Query	Interpreted As
<code>dDocTitle:New</code>	<code>dDocTitle &lt;contains&gt; `New`</code>
<code>dDocTitle:New product</code>	<code>(dDocTitle &lt;contains&gt; `New`) &lt;AND&gt; &lt;ftx&gt;`product`&lt;/ftx&gt;</code>
<code>dDocTitle:New dDocTitle:product</code>	<code>dDocTitle &lt;contains&gt; `New` &lt;AND&gt; dDocTitle &lt;contains&gt; `product`</code>
<code>dDocTitle:New, dDocTitle:product</code>	<code>dDocTitle &lt;contains&gt; `New` &lt;OR&gt; dDocTitle &lt;contains&gt; `product`</code>
<code>dDocTitle:New dDocType:Presentations</code>	<code>dDocTitle &lt;contains&gt; `New` &lt;AND&gt; dDocType &lt;contains&gt; `Presentations`</code>
<code>dDocTitle:New, dDocType:Presentations</code>	<code>dDocTitle &lt;contains&gt; `New` &lt;OR&gt; dDocType &lt;contains&gt; `Presentations`</code>

## 19.11 Searching Referenced Links (optional)

If your administrator installed the optional Link Manager component, it evaluates, filters, and parses the URL links of indexed documents and then extracts the links for storage in a database table, making them available for searching. After the Link Manager component populates the table with the extracted URL links, it references this table to generate link search results, lists of link references for the Content Information page, and the resource information for the Link Info page. The Link Manager component shows these items:

- Lists of links using specific search criteria

- Detailed information about a specific link
- The links to other documents for a specific content item, and any documents that reference this item

The search results, link references lists, and Link Info pages are useful to determine what documents are affected by content additions, changes, or revision deletions. For example, before deleting a content item, you can verify that any URL references contained in it are insignificant. Another use might be to monitor how content items are used.

 **Note:**

Because the Link Manager component extracts the URL links during the Content Server indexing cycle, only the URL links of released documents are extracted. For content items with multiple revisions, only the most current released revision is available for searching.

This section covers the following topics:

- [About Searching Links](#)
- [Link References on the Content Information Page](#)
- [Notification of Expiration](#)
- [Performing a Link Search](#)
- [Checking Content Item Link References](#)
- [Checking the Link Information About Specific Links](#)

## 19.11.1 About Searching Links

Use the Search Links page to search for links, using criteria stored in the repository database. Use this page to validate links, to determine where a resource is used, to determine if deleting a content item affects other documents, and so on.

The Link Search Results page displays items matching your search criteria. Invalid or broken links are listed in bold font. Each item has an Link Item Actions Menu and an Info icon which displays a Link Info page.

## 19.11.2 Link References on the Content Information Page

Use the **References** options to see whether the content item references or is referenced by other content items. **References** provides two options:

- **Show:** By default, the links are hidden when the Content Information page opens. Click **Show** to display all applicable links. If this content item contains one or more references to other documents, then these links are listed in the *Links contained in this content item* section. If other documents reference this content item, then those references are listed in the *Links to this content item* section.

Links that are invalid or broken are listed using bold font. Click the **Info** link in the Actions column to display the Link Info page for that particular link.

- **Hide:** Click **Hide** to hide the link information.

To access the available link information for content items, click any Content Information icon, which displays the Content Information page and the **References** options. Or, you can choose



either **Content Information** or **Target Content Info** from the Link Item Actions Menu, which also displays the Content Information page and the **References** options.

 **Note:**

You cannot delete a content item revision if other content items reference it unless the system administrator has set the *AllowForceDelete* configuration variable to true. When you delete a content item revision, the message indicates if another content item references the content item and asks if you are sure you want to delete it. In this case, deleting a content item that is referenced by another content item breaks those links and makes them invalid.

### 19.11.3 Notification of Expiration

With Link Manager installed, the Notification of Expiration page includes additional information for each content item that is expiring soon. The e-mail notification specifies if the expiring content item is referenced by another content item:

- Is Referenced: Yes
- Is Referenced: No

The e-mail does not provide a list of the content items that reference the soon-to-expire document. This information is available in the References section on the Content Information page. For more information, see [Checking Content Item Link References](#).

If the Content Server configuration variable (*EnableExpirationNotifier*) has been enabled, an e-mail notification is sent to each author when content expires. For more information about setting this configuration variable, see *EnableExpirationNotifier* in the *Configuration Reference for Oracle WebCenter Content*.

 **Note:**

When a content item expires, it still exists in the Content Server. Expiration only removes the item from the index. Therefore, all links associated with an expired content item are functional if they involve a valid document.

**Figure 19-9 Notification of Expiration E-mail for Author**

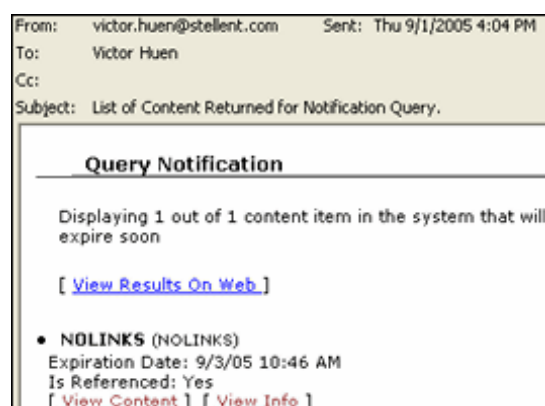

## 19.11.4 Performing a Link Search

To search for links in content items:

1. Click the **Managed Links Search** link in the Content Management tray.
2. On the Search Links page, enter the applicable values in the field(s).
3. Click **Search**. The Link Manager component generates and displays the search results, as shown in the Link Search Results page.

## 19.11.5 Checking Content Item Link References

Use the Content Information page to display, check, and verify all the link references associated with a specific content item. You can access the Content Information page for a content item from either of two pages, as described in these topics:

- [Checking Link References from the Search Results Page](#)
- [Checking Link References from the Link Manager's Search Links page](#)

### 19.11.5.1 Checking Link References from the Search Results Page

1. Search for the specific content item using the Content Server Search page.
2. Select a content item from the Search Results page, and click the corresponding **Content Info** icon in the Actions column.
3. On the Content Information page, click **References Show**.

**References Show** is displayed only if the content item contains links or has links that reference it.

All applicable links are displayed. The *Links contained in this content item* section lists all the links included in this content item that reference other documents. The *Links to this content item* section lists all the links in other documents that reference this content item.

### 19.11.5.2 Checking Link References from the Link Manager's Search Links page

1. Open the Search Links page and search for links. For more information, see [Performing a Link Search](#).
2. Select a link from the Search Results section.
3. Click the **Content Info** icon in the Actions column.
4. On the Content Information page, click **References Show**.

**References Show** is displayed only if the content item contains links or has links that reference it.

All applicable links are displayed. The *Links contained in this content item* section lists all the links included in this content item that reference other documents. The *Links to this content item* section lists all the links in other documents that reference this content item.

 **Note:**

To display the Link Info page for any link listed in the References sections (either *Links contained in this content item* or *Links to this content item*), click the corresponding **Info** link in the Actions column.

## 19.11.6 Checking the Link Information About Specific Links

Use the Link Info page to view additional information about a specific link. You can access the Link Info page for any link from either of two pages, as described in these topics:

- [Checking Link Information from the Content Information Page](#)
- [Checking Link Information from the Search Links Page](#)

### 19.11.6.1 Checking Link Information from the Content Information Page

1. Open the Content Information page for a specific content item and display the applicable links. For more information, see [Checking Content Item Link References](#).
2. Select a link from a list in the References sections (either *Links contained in this content item* or *Links to this content item*).
3. Click the corresponding **Content Info** link in the Actions column.

### 19.11.6.2 Checking Link Information from the Search Links Page

1. Open the Search Links page and search for links. For more information, see [Performing a Link Search](#).
2. Select a link from the Search Results section.
3. Click the Actions icon in the Actions column.
4. From the Link Item Actions Menu, choose **Link Info**.

## 19.12 Content Data Tracking

Content Tracker is an optional component that provides information about system usage:

- [About Content Tracker](#)

### 19.12.1 About Content Tracker

Content Tracker monitors your system and records information about various activities. Content Tracker collects this information from various sources, then merges and writes the information to a set of tables in your Content Server database. You can customize Content Tracker to change or expand the types of information it collects. Content Tracker monitors activity based on:

- Content item accesses:

Content Tracker gathers information about content item usage from Web filter log files, the Content Server database, and other external applications such as portals and websites. Content item access data includes dates, times, content IDs, current metadata, user names, and profile information about users.

- Content Server services:

Content Tracker tracks all services that return content and services that handle search requests. And, with a simple configuration change, Content Tracker can monitor literally any Content Server service, even custom services.

# 20

## Viewing Documents

In Oracle WebCenter Content, you can view content items and their associated revisions and metadata in several ways. You can also download copies of native files. In addition, you can sign content items electronically, participate in a discussion about a content item, and subscribe to content item revisions.

This chapter has the following sections:

- [Viewing a Content Item](#)
- [Discussing Content](#)
- [Subscribing to New Revisions of a Content Item](#)
- [Signing Content Electronically](#)

### 20.1 Viewing a Content Item

After you find a content item, you can view it in several ways, depending on the available renditions of the content item, the conversion setup for your system, and the configuration of your Web browser. Depending on your access permissions, you may also be able to open or get a copy of the native file.

This section covers the following topics:

- [Viewing a Web-Viewable File](#)
- [Viewing a Native File](#)

#### 20.1.1 Viewing a Web-Viewable File

To view the Web-viewable rendition of a content item, you must have the appropriate helper application or Web browser plug-in installed. For example, to view the PDF version of a content item, you must have the Adobe Acrobat plug-in.

You can view a Web-viewable file as follows:

- From a Content Information page, click the **Web Location** link.
- From a Search Results page, click the **Content ID** link in the ID column (Headline view) or Description column (Classic View), or the thumbnail (Classic and Thumbnail views).

If a Web-viewable file does not exist, or you do not have the correct helper application or plug-in installed, you are prompted to either save the file or open it in its native application. For more information, see [Viewing a Native File](#).

#### 20.1.2 Viewing a Native File

When you view the native file of a content item, you are prompted to either save a copy of the file or open it in its native application. If you choose to open the file, you are actually opening a copy of the native file that is stored in a temporary location on your hard drive. You are not opening the native file that is stored in Content Server repository.

You can access a native file as follows:

- From a Content Information page, click the **Native File** link.
- From a Check-Out Confirmation page, click the **Download *native file*** button.
- From a workflow review notification message, click the **Review workflow item** link to open the Workflow Review page, and then click the **Native File** link under Renditions.

## 20.2 Discussing Content

Content Server comes with the ThreadedDiscussions component. If enabled, it allows contributors to post questions and comments about the content item throughout multiple revisions. This component must be installed and enabled by your system administrator for this functionality to be available.

This section covers the following topics:

- [About Discussion Posts and Threads](#)
- [Initiating a Discussion from the Content Information Page](#)
- [Initiating a Discussion from the Search Results Page](#)
- [Initiating a Discussion from the Workflow Review Page](#)
- [Viewing and Replying to a Threaded Discussion](#)
- [Printing a Threaded Discussion](#)
- [Deleting a Threaded Discussion](#)
- [Searching with the Discussion Type Field](#)

### 20.2.1 About Discussion Posts and Threads

Threaded discussions provide question and answer feedback about a content item and help record how and why changes were made to a content item. Because threaded discussion posts follow content through multiple revisions and refer to the revision for which the comment was made, threaded discussions help contributors keep track of enhancement requests or other recommendations for future changes to the content. Each discussion post conveniently lists the revision number of the content to which it refers, so you do not have to view the content information of previous revisions to post to a discussion item.

Discussions are managed content items. When you begin a discussion thread about a content item, an .hscp form for the discussion is created, given the same ID as the content with `_d` appended to the end, associated with the content item, and automatically checked in to Content Server.



#### Note:

If you have a content item that has a document name that is within one character of the database storage maximum, which is 30 by default, you cannot create a threaded discussion for it.

Unlike other content items, edits to a discussion do not create new revisions of the discussion content itself. Instead, the .hscp form that contains the discussion is modified. The Revision History for discussion content is always Revision 1. The revision number does not increment for discussion content. The number of the post represents the chronological order in which the comments were posted.

In [Figure 20-1](#), each top-level post represents a thread. Posting number one (#1) and posting number two (#2) are threads. The reply (#3) to thread number two represents a post within a thread.

**Figure 20-1 Threads and Posts**

<b>Brief Content Info:</b>	<a href="#">[Print View]</a> <a href="#">[Discussion Info]</a> <a href="#">[Original Content Info]</a>
Title: <b>This is a test word document</b>	Type: <b>Document</b>
Content ID: <b>ADC2101139USOR000031</b>	Release Date: <b>4/6/10 10:50 AM</b>
Author: <b>weblogic</b>	Revision: <b>1</b>

**Need to Change Test Document (#1)**  
 by weblogic at 4/9/10 8:45 AM ADC2101139USOR000031(comment on revision [1](#))  
 We need to change the initial paragraph in the test document.  
[\[Reply To This\]](#)

**I will alter the text. Thanks for the feedback. (#2)**  
 by weblogic at 4/9/10 8:46 AM ADC2101139USOR000031(comment on revision [1](#))  
 Here's the new text. The next available iteration is slated for tomorrow.  
[\[Reply To This\]](#)

**RE: I will alter the text. Thanks for the feedback. (#3)**  
 by weblogic at 4/9/10 8:47 AM ADC2101139USOR000031(comment on revision [1](#))  
 Confirmed. This is good.  
[\[Reply To This\]](#)

[Figure 20-2](#) shows posts #1, #2, #3 and #4. The reply to "Change to Introduction (#1)," "RE: Change to Introduction (#3)" was made after "Change to Conclusion (#2)."

**Figure 20-2 Posting Order**

<b>Brief Content Info:</b>	<a href="#">[Print View]</a> <a href="#">[Discussion Info]</a> <a href="#">[Original Content Info]</a>
Title: <b>Evan's Static WM Test</b>	Type: <b>Document</b>
Content ID: <b>STATIC_WM</b>	Release Date: <b>4/9/10 7:30 AM</b>
Author: <b>weblogic</b>	Revision: <b>1</b>

**Change to Introduction (#1)**  
 by weblogic at 4/9/10 8:51 AM STATIC\_WM(comment on revision [1](#))  
 We need to change the first paragraph.  
[\[Reply To This\]](#)

**RE: Change to Introduction (#3)**  
 by weblogic at 4/9/10 8:53 AM STATIC\_WM(comment on revision [1](#))  
 How about: The start date will be upon receipt (as opposed to upon completion).  
[\[Reply To This\]](#)

**Change to Conclusion (#2)**  
 by weblogic at 4/9/10 8:51 AM STATIC\_WM(comment on revision [1](#))  
 We need to update the conclusion to match our new goals.  
[\[Reply To This\]](#)

**RE: Change to Conclusion (#4)**  
 by weblogic at 4/9/10 8:54 AM STATIC\_WM(comment on revision [1](#))  
 I agree. We'll add information about the new product.  
[\[Reply To This\]](#)

## 20.2.2 Initiating a Discussion from the Content Information Page

To initiate a discussion from the content information page of a content item:

1. Browse or search to locate the content item and open the Content Information page for the item.

If you are checking in a new content item, you can access the Content Information page by clicking the **Content Info** link on the Check-In Confirmation page. For more information about checking in content items, see [Checking In a New File](#).

2. In the Links area, click the **Create Discussion** link.
3. On the Post Comment form, enter a subject for the posting in the Subject box.
4. Enter your discussion question or comment in the comment text box.
5. Click **New Post**. The Post Comment form (Brief Content Info page) displays the new post.

## 20.2.3 Initiating a Discussion from the Search Results Page

You must be using a search results view that provides access to the Content Actions menu, such as the Headline or Thumbnail views. If you are using the thumbnail view, then you can click the discussion icon to access the discussion.

To initiate or enter a discussion in progress from the Search Results page:

1. From the main menu, choose **Search**.
2. On the Advanced Search page, enter any search metadata fields to narrow your search, and click **Search**. For example, to exclude content items that are discussions, select **Discussion Type=Not applicable**. Your search results are displayed.
3. In the Content Actions menu for the content you want to discuss, click **Create Discussion**.
4. On the Post Comment form, enter a subject for the posting in the Subject box.
5. Enter your discussion in the comment text box.
6. Click **New Post**. The Post Comment form (Brief Content Info page) displays the new post.

## 20.2.4 Initiating a Discussion from the Workflow Review Page

To initiate a discussion about a workflow document:

1. Open your My Content Server tray and click the **My Workflow Assignments** link.
2. In the Actions column on the Workflow in Queue page, click the **Workflow Review** icon.
3. In the Links list on The Workflow Review page, click the **Create Discussion** link.
4. In the Subject box on the Post Comment form, enter a subject for the posting.
5. Enter your discussion in the comment text box.
6. Click **New Post**. The Post Comment form (Brief Content Info page) displays the new post.

## 20.2.5 Viewing and Replying to a Threaded Discussion

Users with read permissions can view the messages within a threaded discussion, but only those who can edit the content can post messages. You can access an existing discussion from the following links:



- On the Content Information page, click the **ID of the content item to discuss** link.
- On the Workflow Review page or Search Results page, click the **Discuss This Item** link.
- On the Discussion Info page, click the **Web Location** link.
- On the Search Results page of a discussion, click the **Content ID** link.

The Discussion link indicates how many discussion posts have been created for the document. The Discussion Count custom information field generates the number of items.

To view and reply to a discussion thread:

1. On the navigation bar, click **Search**.
2. On the Advanced Search page, specify the search criteria for the content you want to discuss. In the Discussion Type field, select **N/A**.
3. Click **Search**.
4. On the Search Results page, click the **Content Info** link or icon for the item you want to discuss.
5. To view the discussion, in the Links area on the Content Information page, click the **Go to Discussion** link.
6. To reply to a post, beneath the post to which you want to reply, click **Reply To This**.
7. Enter your reply in the comments text box, and click **Post Reply**. Your post is added to the discussion.

## 20.2.6 Printing a Threaded Discussion

To print a threaded discussion.

1. On the navigation bar, click **Search**.
2. On the Advanced Search page, specify the search criteria for the discussion thread. In the Discussion Type field, select **Single Content**, and click **Search**.
3. In the ID column of the Search Results page, click the ID of the discussion thread. The ID should have an *underscore d* (**\_d**) suffix.
4. In the discussion thread, click the **Print View** option.
5. On the print view page, click the **Printer** icon or use any of the print options supported by your browser.

## 20.2.7 Deleting a Threaded Discussion

To delete a threaded discussion. You must have delete permission for the content to delete the discussion.

To delete a discussion:

1. In the Search Results page, click the **Content Item info** link for the discussion you want to delete.
2. On the Discussion Info page, click **OK**. A message indicates the revision has been successfully deleted from Content Server.

## 20.2.8 Searching with the Discussion Type Field

You can use the Discussion Type metadata field to narrow your search criteria when searching documents. The Discussion Type search field enables you to refine a search for content associated with discussions. The discussion type options are:

- **N/A:** A search applies to all documents including those without associated discussions. A search returns content both with and without a discussion, but does not return any content that is a discussion itself. That is, content IDs with an underscore "\_d" are excluded from the search.
- **Single Content:** A search applies to documents that have a discussion focused on a single content item. A search using this option returns the discussion content itself (it returns only content that is a discussion). Only content IDs with an underscore "\_d" are included in the search results.

 **Note:**

If you do not select any criteria for Discussion Type, all content with or without discussions are displayed, including the discussion content itself.

## 20.3 Subscribing to New Revisions of a Content Item

This section covers the following topics:

- [About Subscriptions](#)
- [Subscribing to a Content Item](#)
- [Viewing Your Current Subscriptions](#)
- [Unsubscribing from a Content Item](#)
- [Unsubscribing from a Criteria Group](#)

### 20.3.1 About Subscriptions

Subscriptions notify you automatically whenever a content item is revised. There are two types of subscriptions:

- **Content item subscription:** Users manually subscribe to individual content items.
- **Criteria subscription:** The system administrator sets up a subscription based on one or more metadata fields. When a user subscribes to the Criteria subscription, they are automatically subscribed to all content items that match a particular value of those metadata fields.

For example, the system administrator sets up a criteria subscription with **Author** values as the criteria. Whenever you view a Content Information page, you can choose to subscribe to all content items checked in by the author of the current content item.

The system administrator can subscribe users to specific content items or to criteria subscriptions, but users have the ability to cancel these subscriptions.

## 20.3.2 Subscribing to a Content Item

To subscribe to a content item:

1. Display the Content Information page for the content item.
2. From the Content Actions menu, choose **Subscribe**.
3. If the item is part of a criteria group, on the Subscribe to "*content\_item*" page, click **Subscribe** under the Subscribe To This Item section.
4. If no e-mail address has been specified in your User Profile page, you are prompted to enter an e-mail address for this subscription. Enter an e-mail address, and click **OK**.

## 20.3.3 Viewing Your Current Subscriptions

To view your current subscriptions, Open the My Content Server tray, and click **My Subscriptions**.

## 20.3.4 Unsubscribing from a Content Item

To unsubscribe from a content item:

1. Open the My Content Server tray, and click **My Subscriptions**.
2. From the Actions menu on the Subscriptions page, choose **Unsubscribe**.

## 20.3.5 Unsubscribing from a Criteria Group

To unsubscribe from a criteria group:

1. Open the My Content Server tray, and click **My Subscriptions**.
2. From the Actions menu on the Subscriptions page, choose **Unsubscribe**.

## 20.4 Signing Content Electronically

If the Electronic Signatures component is enabled, you can optionally sign a content item with an electronic signature that uniquely identifies the contents of the file at a particular revision and associates the revision with a particular user.

This section covers the following topics:

- [About Electronic Signatures](#)
- [Signable Objects](#)
- [Signature Metadata](#)
- [Signature Verification](#)
- [Signing a Content Item Electronically](#)
- [Viewing Electronic Signature Information](#)
- [Search for a File in Revisions](#)
- [Search for a File in the Repository](#)

## 20.4.1 About Electronic Signatures

An electronic signature is a unique identifier computed from the binary content of a content item and associated with other metadata such as the name of the user who signs the content item. Unlike a digital signature, which uniquely identifies both the document and the signer and encrypts the information with the document, an electronic signature is not stored with the document.

When you check in a content item, Content Server generates the identifier and stores it with the revision metadata for the content item. When you *sign* a content item, a copy of the identifier is stored with the electronic signature metadata. When you check in a modified revision of the content item, a new identifier is calculated.

Content Server can compare the identifier stored with the content item to the identifier stored with the electronic signature to help you determine if a signed content item has changed and if existing signatures for a content item are valid.



### Note:

The identifier is computed from the content only, not the associated metadata. A change in the metadata for a content item does not invalidate the electronic signature for the content item.

Because electronic signatures are stored separately from both the content item and from its metadata, multiple users can sign a particular content item revision. For example, in a workflow approval process, multiple reviewers may sign a revision of a content item.

Any user with access to the Document Information page for a content item can sign the content item. You can also provide an electronic signature as part of a workflow approval step. For more information, see [Reviewing Revisions in a Workflow](#).

You can access signature information for a signed content item from the Content Information - Signatures tab. For more information about signing a content item, see [Signing a Content Item Electronically](#).

## 20.4.2 Signable Objects

The following table describes the restrictions on objects that you can sign electronically:

Object	Description
Content Items	You can sign any content item, such as a document, an image, a zip file, and so on. You can sign the native file, but not other renditions, such as web-viewable versions of the native file.
Folios	You can sign a folio, provided it has been frozen.
Metadata-only	You cannot sign items that do not have an associated content item, such as metadata profiles or Content Server folders. Because metadata itself is not used to calculate the signature ID, a change to the metadata for a content item does not constitute a change to the electronic signature for the content item.

## 20.4.3 Signature Metadata

When you sign a content item electronically, the signature is automatically associated with your user name and certain information about the content item such as the content name and revision ID. You must provide your user name and password to sign a content item revision, and you typically provide additional information such as the reason for signing the document.

Your system administrator may also define additional metadata fields that are stored as part of the metadata for the electronic signature.

 **Note:**

Because signature metadata is stored separately from content item metadata, you cannot search for electronic signature metadata with the standard search options provided.

A system administrator can use signature metadata in a watermark to indicate that a PDF document has been electronically signed. For more information, see *Types of Watermark* in *Managing Oracle WebCenter Content*.

## 20.4.4 Signature Verification

When a content item itself is modified, it produces a different computed identifier. By comparing the identifier of a content item with the stored signature, Content Server can determine whether the signature for a particular revision is still valid.

Because identical files produce the same calculated identifier, you can compare a file in a local file system to a particular content item revision to determine if the files are identical. For more information, see [Search for a File in Revisions](#).

You can also verify a file from a local file system against all signed or unsigned content to which you have access. For more information, see [Search for a File in the Repository](#).

## 20.4.5 Signing a Content Item Electronically

To electronically sign a content item:

1. Display the Content Information page for the revision you want to sign.
2. From the Content Actions menu, choose **Sign Content**.
3. On the login page, specify your user name and password to provide signature authentication.
4. On the Sign Content Item page, your user name is preselected. Specify additional metadata fields as necessary.

 **Note:**

The **Reset** button returns the fields to their original values.

5. Click **Sign**.

6. To view signature information for the current revision, on the Electronic Signature Confirmation page, click the **View Signature Information** link.

The Content Information - Signatures tab opens. This page is also accessible as a tab on the Content Information page.

## 20.4.6 Viewing Electronic Signature Information

To view signature information for an electronically signed content item:

1. Display the Content Information page for the content item.
2. In the Revision column, click the revision for which you want to view signature information.

If the selected revision of the content item has one or more electronic signatures, a **Signatures** tab is included at the top of the page.

3. Click the **Signatures** tab.
4. To view complete signature metadata for a signature, on the Content Information - Signatures tab, click the Signature Details icon in the left-most column for the associated signature.

The Content Information - Signatures tab provides information about the all signatures for the selected content item revision, including any associated workflows the validation status of each signature.

5. To view signature information for all revisions of the current content item, choose **All Revisions** from the Change View menu.

The **Signatures** tab updates to show signature information for all revisions of the current content item.

### Note:

The column with validation status is replaced by the revision number in this view with the currently selected revision in bold and surrounded by brackets. Validation of signatures is provided for a single revision only.

6. To view complete signature metadata for a signature, click the Signature Details icon in the left-most column for the associated signature.

## 20.4.7 Search for a File in Revisions

To compare a file in a local file system to the signed revisions of a content item:

### Note:

The external file is compared to signed revisions only.

1. Display the Content Information - Signatures tab for the signed content item you want to compare with the external file.
2. Click **Search For Local File In Repository** in the menu area.
3. To select an external file, on the Search for Local File page, click **Browse**.

4. In the File Upload window, navigate to the location of the external file, select the file, and click **Open**.

The file path for the selected file is shown in the **File Path** field. Click **Reset** to clear the field.

5. Click **Validate**.
6. If the external file matches a signed revision, in the signature validation window, you can click the **View Content Info** link to display the Content Information page with the matching revision selected.

If the external file matches a signed revision other than the most current revision, you can click the **newer signed revision** link to display the Content Information page with the newer revision selected.

## 20.4.8 Search for a File in the Repository

To compare a file in a local file system to all signed or unsigned content in the system to which you have access:

 **Note:**

The external file is compared only to revisions to which you have access.

1. In the **Content Management** tray, click **Search For Local File In Repository**.
2. To select an external file, on the Search for Local File page, click **Browse**.
3. In the File Upload window, navigate to the location of the external file, select the file, and click **Open**.  
  
The file path for the selected file is shown in the **File Path** field. Click **Reset** to clear the field.
4. Click **Validate**.
5. If the external file matches a signed revision, in the signature validation window, you can click the **View Content Info** link to display the Content Information page with the matching revision selected.

If the external file matches more than one signed revision, the results are displayed in a table format. You can click the Information icon to the left of the matching item to display the Content Information page for that item.

If there are multiple matches, the window remains open until you click **Close Window**.

# 21

## Uploading Documents

Learn how to check in one or more content items to Oracle WebCenter Content Server. You can also include watermarks and web-viewable renditions of content items. This chapter has the following sections:

- [About Manual File Check-In](#)
- [Primary and Alternate Files](#)
- [Watermarks and File Check-In](#)
- [Checking In Single Files](#)
- [Checking In Multiple Files](#)
- [Important Considerations](#)

### 21.1 About Manual File Check-In

*Manual File Check-in* is the process of submitting a file to the Content Server repository. You must have the correct permission to check a file in to Content Server. The system administrator assigns permissions to users. During the check-in process, you specify metadata for your file to help identify and locate the file. You can check in files and have metadata automatically applied through your desktop application by using Oracle WebCenter Content: Desktop. For more information, see *Adding and Managing Your Content Server Connections* in *Using Oracle WebCenter Content: Desktop*.

 **Note:**

It is extremely important to know your organization's standards before you enter the metadata. The metadata helps users find the content item and determines where Content Server stores the file.

### 21.2 Primary and Alternate Files

When you check in a file, the native file is the *primary* file. You have the option to also specify an *alternate* file, such as the following:

- A Web-viewable version of the native file: Use this when the native file cannot be converted by Content Server, or you want to convert the native file manually.
- A file in a format that can be converted to a Web-viewable file: Use this when the native file cannot be converted by Content Server, and you have an alternate file format that can be converted by the system (such as PostScript).
- A file explaining what the native file contains: Typical uses include providing a text file that describes the contents of a compressed file (such as a ZIP file) and supplying documentation for an executable file.



For example, if you are checking in a Word document that has several graphics, you could compress the Word file and all the original graphics into a ZIP file and then check in that ZIP file as the primary file. As the alternate file, you could specify the Word document itself (which could be converted to PDF by the Content Server), a text file that describes the contents of the ZIP file, or a PDF file that you created manually.

 **Note:**

The file extension of the alternate file (after the period) cannot be the same as that of the primary file (for example, both files cannot end in `.doc`).

## 21.3 Watermarks and File Check-In

This section covers the following topics:

- [About PDF Watermark](#)
- [Watermark Templates](#)
- [Content Check-In Form](#)

### 21.3.1 About PDF Watermark

PDF Watermark is an optional component that is automatically installed with Content Server. If enabled, this component allows watermarks to be applied to PDF files generated by the PDFConverter component of Oracle WebCenter Content: Inbound Refinery, or to native PDF content in the `WebLayout` directory.

There are two types of watermarks: Static and Dynamic. A PDF file receives a static watermark during content check-in as a follow-on step to the Inbound Refinery conversion. Only documents that Inbound Refinery converts to PDF can receive a static watermark. After a document receives a watermark, all viewers of the document see the same watermark.

Dynamic watermarks are generated when a user requests the document for viewing or downloading and can contain variable information (for example, the user name, date, and time of download). System administrators define rules and set up specific conditions for determining which requested content gets a dynamic watermark. Different users may see the same content with different watermarks.

### 21.3.2 Watermark Templates

A special kind of template determines the appearance of a watermark that gets applied to a PDF document. A watermark template defines the text fields and images used for the watermark and to which pages each field and image can be applied. The template may also enforce certain security measures, such as requiring a password for viewing or printing the watermarked content. The system administrator creates and manages watermark templates.

### 21.3.3 Content Check-In Form

When you check in certain document formats to the system, they may be automatically converted to PDF for viewing on the Web. In such cases, you may be allowed to specify a template used to apply the static watermark.

To request that a document receive a static watermark, enter the content ID of the template to be used. Your system administrator provides you with a list of templates that are available and appropriate for your use.

## 21.4 Checking In Single Files

This section covers the following topics:

- [Checking In a New File](#)
- [Checking In a Similar File](#)
- [Checking In a Revised File](#)

### 21.4.1 Checking In a New File

To check in a new file:

1. Click the New Check-In link.
2. On the Content Check-In Form, if applicable, enter a unique name in the Content ID field. Content ID values are generated automatically by Content Server if your system administrator has enabled this feature. However, you can override an automatically generated content ID by entering a new value.

 **Note:**

If your content server uses an Oracle database, all content IDs are converted to uppercase letters automatically.

3. From the Type list, select the option that best describes the file.
4. Enter a descriptive title in the Title field. The title you enter must be 249 or fewer characters in length.
5. From the Security Group list, select the security group for the content item. Keep in mind that this content item is available to users who have permission to the specified security group.
6. If accounts are enabled for your system, select an option from the Account list, or enter a new account name. Keep in mind that this content item is available to users who have permission to the specified account.
7. Specify a *primary file* in one of two ways:
  - Click **Browse** next to the Primary File field. Navigate to and select the native file, then click **Open**.
  - Enter the complete path name and file name of the native file in the Primary File field (for example, *c:/My Documents/ABC Project/MyFile.doc*).

 **Note:**

You can check in a metadata placeholder without specifying a primary file by entering an invalid path in the Primary File field. For example, entering the word `placeholder` into the Primary File field creates a content item within Content Server with the specified metadata, but no indexed primary file. Placeholders are useful for initiating workflows or making metadata available for searching and discussion.

 **Note:**

If you are checking in a placeholder using Internet Explorer version 6.0 on the Windows XP operating system with Service Pack 2 installed, the path used in the Primary File field must be valid, but end with an invalid file. In the following example, `c:/` is a valid drive, but `placeholder` is not a valid file:

```
c:/placeholder
```

If you do not specify a valid drive, an error message is displayed.

8. If the Format field is displayed under the Primary File field, select the conversion format for the file.
  - If you select the **Use Default** option, Content Server converts the file format based on its file name extension.
  - If you select any other option, Content Server ignores the file extension and uses the selected format to determine how to convert the file.
9. (Optional) Specify an *alternate file* by browsing or entering the path name and file name.
  - The alternate file must have a different file extension than the primary file.
  - The alternate file is typically in a Web-viewable format or a format that can be converted to a Web-viewable file, such as *.pdf*, *.txt*, *.doc*, and so on.
10. If the Format field is displayed under the Alternate File field and you specified an alternate file, select a conversion format for the file.
  - If you select the **Use Default** option, Content Server converts the file format based on its file name extension.
  - If you select any other option, Content Server ignores the file extension and uses the selected format to determine how to convert the file.
11. Accept the default revision in the Revision field. (You should change the revision only if there is a specific reason to do so.)
12. Enter any notes about the file in the Comments field.
13. Use the default release date, or enter a future release date in the Release Date field.
14. If you want the file to be unavailable as of a particular date, enter a date in the Expiration Date field.
15. If applicable, fill in any of your organization's custom metadata fields.
16. After you enter all the appropriate metadata values, click **Check In**.

Upon successful check-in, the Check-In Confirmation page opens.

 **Note:**

Depending on the type of file you checked in and how your system is configured, it may take a few minutes for the file to be converted and indexed before it is available through a search or by drilling down.

## 21.4.2 Checking In a Similar File

If you have a new file to check in that has similar metadata to an existing content item, you can use an existing content item as a model for the new file. The system then pre-fills metadata fields in the content check-in form with values from the *model* content item.

To check in a similar file:

1. From the Check-In Confirmation page or the Content Information page of the existing content item, click **Check In Similar**.

Most of the metadata fields in the Content Check-In Form display the same values as those assigned to the existing content item.

2. Continue with Step 2 of the procedure for Checking In a New File, changing or adding metadata values and member permissions as necessary.

## 21.4.3 Checking In a Revised File

To check in a revised file:

1. Click the **My Content Server** tray.
2. Click **My Checked-Out Content**.
3. On the Checked-Out Content for User page, click the **Actions** icon for the appropriate content item to display a contextual menu, and choose **Check In**. You can now check in the revised file. For more information, see [Checking In a New File](#).

Please note:

- The content ID that was assigned to the original file cannot be changed.
- The name of the original file is displayed for reference; however, the revised file that you are checking is not required to have the same name.
- The revision has been incremented by one.

## 21.5 Checking In Multiple Files

This section covers the following topics:

- [About Multiple File Check-In](#)
- [Upload Applet Requirements](#)
- [Checking In Multiple Files Using Upload](#)

### 21.5.1 About Multiple File Check-In

You can check in multiple files as a compressed ZIP file that is stored as a single content item. Checking in multiple files is useful for a variety of situations, including:

- Publishing software, such as FrameMaker: You can check in an entire book that contains multiple chapters.
- Page layout software, such as QuarkXpress: You can check in the Quark file and all its supporting files (fonts, pictures, and so on).
- CAD software, such as Solidworks: You can check in an assembly made of several files.
- Related files: You can check in a group of related files, such as a set of JPG files for a website.

There are two ways to check in multiple files:

- Create a compressed ZIP file *outside* of Content Server, using a compression program such as WinZip or PKZIP, then check in this ZIP file as a single file. For more information, see [Checking In a New File](#).
- Create a compressed ZIP file *within* Content Server by selecting the **Upload Multiple Files** check box in the Content Check-In Form. Checking in multiple files using this method is possible if all of the following conditions are true:
  - The system administrator has enabled the upload applet on Content Server.
  - You select the **Enable upload applet** check box in your User Profile page.
  - You are using a Web browser that runs Java.

For more information, see [Checking In Multiple Files Using Upload](#).

## 21.5.2 Upload Applet Requirements

You can use the upload applet to check in multiple files only if the following conditions are true:

- The system administrator has enabled the upload applet on Content Server.
- You selected the **Enable upload applet** check box in your User Profile page.
- You are using a Web browser that runs Java.

The upload applet requires permission to access the local drive. When you access the Content Check-In Form for the first time after enabling this applet, you may see a Java security warning:

- If your system is using the Oracle Java plug-in, when you encounter this message box, click **Run**. If you do not want to be prompted again with this message box, select **Always trust content from this publisher**, then click **Run**.
- If your system is using the Microsoft plug-in for Internet Explorer, click **Yes** to give full permissions. If you do not want to be prompted again with this message box, select **Always trust software from Oracle**, and click **Yes**.

## 21.5.3 Checking In Multiple Files Using Upload

To check in multiple files as a single content item in a compressed ZIP format using the upload applet:

 **Note:**

You can also check in multiple files by creating a compressed ZIP file *outside* of Content Server using a compression program such as WinZip or PKZIP, and then checking in the ZIP file as a single file. For more information, see [Checking In a New File](#).

1. Enable the upload applet in your user profile.
2. Follow the general procedure for [Checking In a New File](#), [Checking In a Similar File](#), or [Checking In a Revised File](#).
3. Before specifying the primary file or alternate file, select the corresponding **Upload Multiple Files** check box.
4. Click the corresponding **Browse** button.
5. (Optional) In the Upload Files window, change the default Zip Name value to a more descriptive file name. Include the `.zip` extension.
6. Select the files to be checked in.
  - To select individual files:
    - a. Click **Select File**.
    - b. In the Select File window, navigate to the file to add, and click **Open**.

The Files to Upload list displays the file.
    - c. Repeat the previous two steps as necessary to select individual files.
  - To select multiple files:
    - a. Click **Select Multiple**.
    - b. To select the drive where the files are located, in the Select Files window, click **Change Drive**, select the drive on the Change Drive window, and click **OK**.
    - c. Navigate to the directory or files to add. The Subdirectories list shows the contents of the directory where you are currently located. To navigate to the parent directory, double-click the `..` entry in the Subdirectories list.
    - d. To select multiple files in the Files list:
      - To select noncontiguous files, press and hold the Ctrl key, and click each file name.
      - To select contiguous files, press and hold the Shift key and click the first and last file names.
    - e. To narrow the selection of files, use the File Filter field. For example, the filter `*.doc` selects all files with a `.doc` extension.
    - f. To select all files in all subdirectories of the current directory, select the **Recurse through subdirectories** check box.
    - g. To store path information (from the parent folder) with the files you are adding, select the **Include parent folder in file path** check box.
    - h. Click the button appropriate to your selection: **Add Selected** or **Add with Filter**.
    - i. The selected files are displayed in the Files to Upload list.
    - j. Repeat these steps as necessary to add files from other directories or drives.

7. Verify that the correct files are shown in the Files to Upload list, and click **OK**.  
The ZIP file name appears in the Primary File or Alternate File field.
8. Follow the general check-in procedure to complete the check-in. For more information, see [Checking In a New File](#).  
If the chunking function is enabled, the Upload Message window displays a progress bar during upload.

## 21.6 Important Considerations

This section covers the following topics:

- [Multibyte Characters](#)
- [Content Profiles](#)

### 21.6.1 Multibyte Characters

You should not use multibyte characters (for example, Japanese or Korean) in content IDs and content types, even if Content Server is to be used in a multibyte environment. The values of these fields are included in the URLs of content items, and limitations in current Web technology prevent Web servers and browsers from handling URLs with multibyte characters correctly.

To use multibyte characters in content IDs, content types, or both, you must ask your content server system administrator if the *entire* content server environment (all servers and *all* clients) runs on operating systems that support multibyte languages (for example, Japanese or Korean versions of Microsoft Windows). Otherwise, errors may occur, such as links to PDF renditions of content items not working or Dynamic Converter failing to find content items.

### 21.6.2 Content Profiles

Content profiles, defined by your system administrator, determine what metadata fields are displayed and how they are grouped and titled on the associated check in, search, and information pages, based on rules established by the system administrator. By default, all content profiles are displayed as links under both the Search and New Check-In lists on the Toolbar.

**Figure 21-1** Content Profile Links Under the Search and New Check-In Lists on the Toolbar

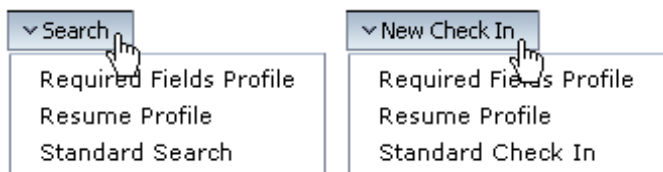

If you access a search or check-in page using a content profile link, you may not have access to all available metadata fields, either for searching or use when checking in a content item. Also, if you access the Content Information page of a content item that meets criteria established by the system administrator, the initial information displayed may not be the full information available.

Figure 21-2 Content Information Page Streamlined by Content Profiles

**Content Information** [Show]

Content Actions E-mail

**Content ID :** 000002  
**Type:** ADACCT - Acme Accounting Department  
**Title:** SecondContent  
**Author:** sysadmin  
**Security Group:** Public  
**Checked Out By:**  
**Status:** Released  
**Links Formats:** Application/jpg

---

**Web Location:** http://bsilvernote1/stellent\_75/groups/adacct/000002.jpg  
**Native File:** stitches.jpg

Revision	Release Date	Expiration Date	Status	Actions
[ 1 ]	9/7/04 1:54 PM	None	Released	Delete



# 22

## Checking Out and Downloading Files

You can check out one or more documents from Oracle WebCenter Content to revise them. You can also download copies of documents. This chapter has the following sections:

- [About Manual File Check-Out](#)
- [Checking Out Single Files](#)
- [Checking Out Multiple Files](#)

### 22.1 About Manual File Check-Out

*Check-out* is the process of locking a content item so that no other users can revise it. You must have write permission to the content item to check out a file or undo a check-out. Only one user at a time can check out a file; however, multiple users can continue to view the released file.

There are two approaches to checking out files manually:

- For content items that could be revised by other users, it is a good idea to check out the file as soon as you know that you must edit it to prevent other users from checking in a new revision with potentially conflicting changes.
- For content items that are unlikely to be revised by other users, you can make revisions to a copy of the file, check out the content item, and immediately check it back in with the edited file.

After you have checked out a content item, you can either check in a revision or undo the check-out.

You can check out files automatically through your desktop application by using Oracle WebCenter Content Desktop. For more information, see *Checking Out Files in Using Oracle WebCenter Content: Desktop*.

### 22.2 Checking Out Single Files

**To check out single files from a Content Information page:**

1. Display the Content Information page of the content item you want to check out.
2. Choose **Check Out** from the Content Actions menu.
3. If applicable, on the Check-Out Confirmation page, click **Native File Link** to get a copy of the native file.
4. If a dialog window opens before the Save As window, choose to save the file to disk.
5. In the Save As dialog box, navigate to the location where you want to save the file, and click **Save**.
6. Start the native application (for example, Word or PowerPoint) and locate the file where you saved it in Step 5.
7. Edit the file in its native application and then save the file.

**To check out single files from a Search Results Page:**

1. Search for content to view a search results list.
2. Choose **Headline View** or **Thumbnail View** from the Content Actions menu.
3. Click the **Actions** icon, and choose **Check Out** from the contextual menu.
4. If applicable, on the Check-Out Confirmation page, click **Native File Link** to get a copy of the native file.
5. If a dialog box opens before the Save As window, choose to save the file to disk.
6. On the Save As window, navigate to the location where you want to save the file, and click **Save**.
7. Start the native application (for example, Word or PowerPoint), and locate the file where you saved it in Step 6.
8. Edit the file in its native application, and then save the file.

## 22.3 Checking Out Multiple Files

This section covers the following topics:

- [About Multiple File Check-Out](#)
- [Download Applet Requirements](#)
- [Download Options on Search Results Pages](#)
- [Downloading Multiple Files](#)

### 22.3.1 About Multiple File Check-Out

To get copies of multiple content items, use the download applet. When you download files, you also have the option to check out the content items and uncompress any compressed ZIP files.

### 22.3.2 Download Applet Requirements

You can use the download applet to check out multiple files if the following conditions are true:

The system administrator has enabled the download applet on Content Server.

- You selected the **Enable download applet** check box in your User Profile page.
- You are using a Java-enabled Web browser.

The download applet requires permission to access the local drive. When you run a search for the first time after enabling this applet, you may see a Java security warning:

- If your system is using the Oracle Java plug-in, when you encounter this message box, click **Run**. If you do not want to be prompted again with this message box, select **Always trust content from this publisher**, then click **Run**.
- If your system is using the Microsoft plug-in for Internet Explorer, click **Yes** to give full permissions. If you do not want to be prompted again with this message box, select **Always trust software from Oracle Incorporated**, and click **Yes**.

## 22.3.3 Download Options on Search Results Pages

When the download applet is enabled, it adds the following features to search results pages.

Element	Description
<b>Download</b>	This link downloads the selected content items.
<b>Select All</b> check box	Selects all items in the search results list.
<b>Select</b> check boxes	Selects content items to be downloaded when you click the <b>Download Selected</b> button.

## 22.3.4 Downloading Multiple Files

To download and check out multiple content items using the download applet:

1. Browse or search to locate the files to download. For more information, see [Finding Documents](#).
2. To download all content items on the Search Results page, click **Download All**.
3. To download selected content items, select the corresponding **Select** check boxes, and click **Download Selected**.
4. In the Download Files window, select the type of file to download: **Web Viewable** or **Native**.
5. To uncompress ZIP files during the download process, select the **Extract zip file contents** check box.
6. If you selected the **Native** option and you want to check out the content items upon download, select the **Check out file** check box.
7. In the Download Location field, enter the path where you want the files to be copied. You can click **Browse** and navigate to the directory to select it.
8. If you want a different file name for the downloaded file, change the file name in the Download Location field. This applies only to the current file. If you click **Download All**, all other files retain their default file names.
9. Click a button:
  - **Download**: to download the current file only.
  - **Download All**: to download all selected files that have not been skipped (you are not prompted for each file that was selected).
  - **Skip**: to not download the current file and go to the next selected file.
  - **Cancel**: to cancel the download.
10. If a file with the same file name exists in the target location, you are asked whether you want to overwrite it. Click a button to indicate whether you want to overwrite one or more files.
11. In the Download Results Summary, click **OK**.

# 23

## Working with Content Folders

You can use alternative folders and WebDAV interfaces, similar to a conventional file system, to organize and manage some or all of the content in Oracle WebCenter Content Server. This chapter has the following sections:

- [Introduction](#)
- [Working with Folders](#)
- [Working with Contribution Folders](#)
- [Working with WebDAV](#)

### 23.1 Introduction

Content Server includes components that provide a hierarchical folder interface, similar to a conventional file system, for organizing and managing some or all of the content in the repository.

- **Folders:** This component (FrameworkFolders component) provides a hierarchical folder interface within the browser, similar to a conventional file system, for organizing, locating, and managing repository content and content item metadata. The Folders functionality is installed but disabled by default. Folders is a scalable, enterprise solution and is intended to replace the earlier Contribution Folder interface.
- **Contribution Folders:** Contribution Folders is an optional feature. The component is installed but disabled by default. The newer, Folders component is meant to be a replacement for Contribution Folders.

 **Note:**

Running both Folders and Contribution Folders is not a supported configuration. Content in Contribution Folders should be migrated to the Folders interface.

- **WebDAV (Web-Based Distributed Authoring and Versioning):** Both folder components work with Content Server's built-in WebDAV functionality to allow users to remotely manage and author content using clients that support the WebDAV protocol. The WebDAV interface provides a subset of the options available through the browser interface. In general, you can create, delete, move, and copy both folders and content items, and you can modify and check in content items. To check out content items through the WebDAV interface, you must use a WebDAV client that can open the file. To perform other management tasks, such as specifying or propagating metadata values, you must use the standard browser interface.

Oracle also offers Oracle WebCenter Content: Desktop, which can enhance the WebDAV client environment by more closely integrating with Windows Explorer, Microsoft Outlook, Lotus Notes, and other applications. See [How do I integrate Microsoft File Explorer with content servers?](#) and subsequent sections in *Using Oracle WebCenter Content: Desktop*.

This section covers the following topics:

- [Browsing to Content](#)
- [About Folders](#)
- [About Contribution Folders](#)
- [About WebDAV](#)

## 23.1.1 Browsing to Content

This section covers the following topics:

- [Browse Content Tray](#)
- [Browsing Content to Find a File](#)

### 23.1.1.1 Browse Content Tray

*Browsing content* in Content Server is similar to looking for a paper document in your organization's file cabinets. In a file cabinet, you find the file drawer, then the folder, then the document. In Content Server, you find documents and links to websites in folders in the Browse Content tray.

The Browse Content tray is a hierarchical link structure (the *Library*), where metadata define the folders in the hierarchy. The folder, `Library Folders`, is set up by default. Your system administrator determines the hierarchy of any folders within `Library Folders`. Click the plus sign (+) next to a collapsed folder to expand the contents of the folder. Click the minus sign (-) next to an expanded folder to collapse it.

Click a link in the last folder of a hierarchy to display:

- A list of content items that match the folder's metadata and that you have permission to view
- A website
- A report that provides information about content items, users, metadata fields, or other content server elements.

### 23.1.1.2 Browsing Content to Find a File

To find information by browsing content:

1. Click [Browse Content Tray](#) to expand the tray.
2. Scan the list of folders until you find the one you are looking for.
3. Click the plus sign (+) next to the folder to expand the folder contents and continue drilling down through the folders until you reach a link to the following:
  - A search results page
  - A different website
  - A content server report

## 23.1.2 About Folders

Folders is an optional component (Framework Folders component) for use with Content Server that, when enabled, provides a hierarchical folder interface, similar to a conventional file system, for organizing and locating some or all of the content in the repository.

Folders is a scalable, enterprise solution and is intended to be a replacement for the earlier Contribution Folders component. Some of the benefits that Folders provides include:

- No practical limits on the number of folders or files (content items) in the Folders interface
- Default metadata for content items added to a folder
- Metadata inheritance for newly created folders
- Metadata propagation for new or modified metadata values
- Query-based folders for dynamically retrieving content items from the repository
- Query-based retention folders for specifying basic retention rules for the items returned by the query
- Folder-level security using the standard Content Server security model
- Integration with the WebDAV interface for local folder and file authoring and management
- Integration with Oracle WebCenter Content: Desktop for enhanced local folder and file authoring and management

This section covers the following topics:

- [The Folders Interface](#)
- [Folders and Files](#)
- [Shortcuts](#)
- [Query Folders and Folder Search](#)
- [Folders Retention](#)
- [Personal Folder](#)
- [Security and User Access](#)
- [Content Item Versioning](#)
- [Folder and Content Item Metadata](#)
- [Migrating Contribution Folder Content](#)

### 23.1.2.1 The Folders Interface

The Folders hierarchy is accessible through both the standard content management pages and the WebDAV interface.

The familiar folder and file model provides a framework for organizing and accessing content stored in the repository. Functionally, folders and files are very similar to those in a conventional file system. You can copy, move, rename, and delete folders and files. You can also create shortcuts to folders or files so you can access a content item from multiple locations in the hierarchy.

You can think of the files in the Folders interface as symbolic links or pointers to content items in the repository. The operations you perform in the Folders interface, such as searching or propagating metadata, effectively operate on the associated content items.

### 23.1.2.2 Folders and Files

As with a conventional file system, Folders offers a convenient way to organize content. Users can easily view the relationship between folders and subfolders and can browse to a group of content items.

Using Folders, users can perform the following actions with the privileges defined by Content Server's standard security model:

- Browse to locate content items for check-in, check-out, and to view and change folder and item information.
- Create new folders and subfolders.
- Create new content items in a folder or add existing repository content to a folder.
- Add shortcuts to folders or content items in one or more locations. Shortcuts act as placeholders for the referenced content item.
- Move or copy folders or files to other locations.
- Rename a folder or file.
- Remove a file from the folders hierarchy. This does not affect the associated content item.
- Delete a folder or file. When you delete a folder or file, the folder or file and any shortcuts to it are removed from the folders hierarchy. Any content items associated with the files are set to *expired* in the repository.
- Create a query folder that contains content items returned by the query associated with the folder. For more information about query folders, see [Query Folders and Folder Search](#).
- Create a retention query folder and assign retention rules for the content items returned by the query. For more information about query folders and retention scheduling, see [Folders Retention](#).
- Assign folder security and default metadata values for content items created in the folder. You can also propagate specified metadata values to the contents of a folder or block propagation for a given folder. For more information, see [Folder and Content Item Metadata](#).

The Folders interface follows several conventions familiar to users of file systems:





- Use standard Windows naming conventions when creating folders. Do not use the following characters:  
`? / \ * " | < > :`
- Content Server can store multiple files of the same name as separate content items. However, in the Folders interface, file names in a given folder must be unique (in the same way that a folder in Windows cannot contain two files with the same name).

### 23.1.2.3 Shortcuts

With Folders, you can reference the same folder or content item in multiple locations using shortcuts that act as placeholders for the referenced folder or file. You can create shortcuts to folders or files to help you locate and manage the target content items within the folder hierarchy.



#### 23.1.2.3.1 Folders and Shortcuts

Folders and folder shortcuts are identified with different icons:

Icon	Description
	Folder: Folders can contain other folders, content items, and shortcuts to other folders and content items. Folders are identified by a standard folder icon.
	Folder Shortcut: A folder shortcut includes the contents of the associated folder in the hierarchy at the point where the shortcut is stored. Folder shortcuts are identified by a folder icon with an arrow and can reference either a folder or a query folder. Folder shortcuts are excluded from metadata propagation actions.
	Query Folder: The contents of a query folder are the repository content items returned by the query associated with the folder. Query folders are identified by a folder icon with a magnifying glass.
	Retention Query Folder: Similar to a query folder, the contents of a retention query folder are the repository content items returned by the query associated with the folder. You can additionally specify retention rules for the content items returned by the query. Retention query folders are identified by a folder icon with a magnifying glass and a clock.

### 23.1.2.3.2 Content Item Links

You can think of content items in the Folders interface as links to items in the repository. There are two types of links for content items:

Icon	Description
	File (primary link): There can be only one primary link to a content item in the Folders interface. The primary link represents the content item in the repository and is identified by a standard document icon. In most respects, working with a file (or primary link) is the same as working directly with the content item in the repository. For example, if you delete a file, the status of the associated content item in the repository is set to <i>expired</i> .
	Shortcut (secondary link): There can be any number of file shortcuts in the Folders interface to an associated content item. A file shortcut is identified by a document icon with an arrow indicating that it is a reference to the actual content item. Shortcuts are excluded from metadata propagation actions. Changes you make by means of the shortcut (such as metadata changes) are made to the underlying content item. Changes you make to the shortcut itself (such as deleting the shortcut) do not affect the underlying content item.
	Query result: The contents of a query folder are the repository content items returned by the query associated with the folder. Query content items are identified by a document icon with a magnifying glass.



## 23.1.2.4 Query Folders and Folder Search

A query folder functions much like a saved search; each time you access the folder, you initiate the query associated with the folder. The contents of a query folder are the content items returned by the query. The contents of query folders can change dynamically as the contents of the repository change.

Query folders contain the actual repository content items returned by the query. That is, folders and shortcuts are not included in the contents of query folders.

With the contents of a query folder, you can copy the associated content items, view and update metadata information for individual items, or propagate metadata changes through all items in the query folder.

Folders also expands the standard search results options to include the **Create Query Folder** option to save a search query as a query folder. For more information, see [Save a Search as a Query Folder](#).

To search for folders or files from within in the Folders hierarchy, use the options in the Search menu in a given folder. You can search any or all folder metadata fields to find folders or files within the folders hierarchy that match the specified search criteria.

## 23.1.2.5 Folders Retention

With Folders, you can perform basic content retention scheduling by creating a retention query folder, assigning retention attributes to the folder, and then configuring the retention schedule. You can assign retention rules based on the age of the content item or on the number of revisions. If you have a license for Oracle WebCenter Content: Records, you can also define retention rules based on categories defined in Records.

You must be an administrator to specify retention rules or schedules. For information about specifying retention scheduling, see Understanding Retention Schedules in *Managing Oracle WebCenter Content*.

### Considerations

The following considerations apply to retention query folders:

- Retention rules are associated with the retention query folder but are stored separately from the standard folder metadata. For this reason, you cannot search for a query folder based on the folder's retention attributes.
- Unlike standard query folders, retention query folders search only database values and cannot perform full-text searches even if full-text search is supported on your system.
- If you specify multiple retention rules for a particular retention query folder, all the rules must be satisfied for the disposition to occur. For example, if you specify the age as 1 calendar year and the number of revisions to keep as 3, only those items that are more than 1 year old and that are older than the last three revisions are deleted.
- Different queries can include the same content item in their results. In this case, the retention rules for each retention query folder are applied independently from one another. For example, if one query folder specifies the number of revisions to keep as 2 and another specifies the revisions to keep as 3, only two revisions of the item are retained.
- Folders retention is treated differently than that in Oracle WebCenter Content: Records. When using Records, if multiple delete actions are called, the retention with the longest interval is used. In Folders, the shortest interval always runs first.

### Considerations with Oracle WebCenter Content: Records

If you use both Folders and Oracle WebCenter Content: Records on the same system, the following additional considerations apply:

- If you have Records installed, it is possible to have two retention schedules (as well as multiple rules) for the same item. If a content item has retention rules defined in both Content Server and in Oracle WebCenter Content: Records, only the retention and schedule defined by the Records system are used.
- If you have Records installed with a level of DoD Baseline or higher, retention query folder options are not available in the Content Server interface. Any existing retention query folders retain their icon and (inactive) retention attributes, but function as a standard query folder.

If the level is then set to Standard or lower, then retention query folder options are enabled in Content Server and the rules for any existing retention query folders become active.

### 23.1.2.6 Personal Folder

In the root folder of the Folders hierarchy is a Users folder that contains a folder defined for you as an authenticated user. You can create subfolders and content items in the same way you do with other folders in the hierarchy. Every authenticated user can have a personal folder.

 **Note:**

You can only add folders and content items to your personal folder. Changes you make within the /Users folder are not maintained.

Folders provides menu options to quickly add folders, files, and shortcuts to your personal folder, referred to in menus as **Add to My Folder**. Although your personal folder is visible only to you, the items in the folder are governed by the security settings for the item itself and not necessarily those of the enclosing folder. Some items may be accessible to other users, for example, in search results.

To access your personal folder, click **My Content Server** in the trays area and then click **My Folders**.

### 23.1.2.7 Security and User Access

Users can create and edit folders, shortcuts to folders, and links to documents as allowed by Content Server's standard security model. Folders are assigned security attributes in the same way they are assigned to content items, including security group, account, and Access Control List attributes, if enabled.

By default, folders inherit the security settings and other default metadata defined for the parent folder. You can, however, explicitly set security and metadata values for a given folder and propagate those values to folders and content items within the folder.

### 23.1.2.8 Content Item Versioning

You can check out content items and check in new versions of those content items through the Folders interface in much the same way you do through the standard content management

pages. When you view or edit the metadata information for a particular content item, you can choose menu options to check out the item and then check in a new version of that item.

Folders provides three modes for viewing content item versions:

- **Published Items (consumption mode):** The latest released revisions of documents are displayed. These are the same revisions that are returned in search results listings.
- **All Items (contribution mode):** The latest revision of each document is displayed, regardless of its state. These can include the revisions of documents that are still in workflow.
- **Expired Items:** The expired items belonging to the selected folder are displayed.

As a user, you can switch between the two modes to see released content items only or to see content items that require work before being released. The selection you make remains in effect until you explicitly change it.

### 23.1.2.9 Folder and Content Item Metadata

Every folder has a set of metadata values that can be applied to content items added to the folder. You can configure folders to enforce metadata rules on their content items or allow any or all values to be modified. For example, a folder could be configured to enforce 'Secure' as the value for the Security Group metadata field. Then, when a content item is added to that folder, the Security Group value automatically updates to Secure.

Folders inherit the default metadata assigned to their parent folders unless the folder is explicitly configured otherwise. Subsequent changes to a parent folder's metadata do not affect the metadata for existing subfolders unless explicitly propagated down through the hierarchy.

Folder metadata inheritance and propagation make it easy to apply metadata to content items. Whether you are an administrator managing all folders and files or a user managing your own folders and files, it is a good idea to plan your metadata strategy before you start creating folders and adding content items. Your strategy should include the following basic steps:

1. Determine whether specific folders or branches in the hierarchy have unique metadata requirements and how best to identify and manage those requirements.
2. Determine which metadata fields (if any) a user should specify when adding or checking in a content item through a particular folder.
3. Determine which metadata fields (if any) should have a default value or an enforced value for a particular folder.
4. Determine which subfolders (if any) are eligible to be changed when propagating metadata through a folder.
5. Determine whether to use profiles to manage metadata requirements. An administrator can create one or more profiles to organize, selectively display, and control access to metadata fields based on rules associated with the profile.

#### 23.1.2.9.1 Default Metadata

Default metadata values are automatically applied to new content items created in or checked in to a folder. To modify the default metadata values for a folder, you must have Delete permission to the folder or be the Author and have Write permission.

If default values are not provided for all required fields, you are prompted to provide them when you create or check in the content item. If the folder has the **Prompt for Metadata** option selected, you are prompted to provide metadata values for the item rather than relying on the folder's default metadata settings.

Default metadata values are also used as the default values when propagating metadata.

### 23.1.2.9.2 Metadata Propagation

With proper permissions, you can propagate metadata values from a folder to its subfolders and content items. To propagate metadata to the content items in a particular folder, you must have Write permission for the folder and the content items themselves. To propagate to any folders below the folder in the hierarchy, you must have Delete permission the folders.

Content items in a folder do not necessarily have the same security settings. To propagate metadata to content items, you must also have Write permission for the content item. To restrict changes to folders only, you can optionally select the **Propagate To Folders Only** option.

When you propagate metadata, you select the metadata fields and can specify the values to propagate from the metadata available for the current folder. You can propagate any metadata value that you can change. For example, you can propagate the Security Group or Owner values, but you cannot propagate the Content ID. You can also propagate a blank field, such as the Comment or Expiration Date fields, to clear the associated values from content items.

You can configure folders to prevent propagation by selecting **Inhibit Propagation** in the folder information for that folder. You can optionally override a folder's inhibit setting using the **Force Propagation** setting on the Propagate window. For more information about propagation, see [Propagate Folder Metadata](#).

### 23.1.2.9.3 Metadata Profiles

An administrator can create sets of metadata as one or more profiles that the administrator or other users can easily apply to folders when specifying folder defaults or when propagating metadata. For more information about using profiles, see *Creating and Using Content Profiles* in *Managing Oracle WebCenter Content*.

### 23.1.2.10 Migrating Contribution Folder Content

If you have content in an existing Contribution Folders hierarchy (folders\_g component) and want to migrate the folders and files to the Folders interface, you can use the Folders Migration utility to replicate the folder hierarchy and selectively migrate folder content. For more information about the Folders Migration Utility, see *Understanding Folders\_g Migration to Folders* in *Administering Oracle WebCenter Content*.

## 23.1.3 About Contribution Folders

Contribution Folders is an optional component for use with Content Server that, when enabled, provides a hierarchical folder interface to content in Content Server in the form of *contribution folders*. With contribution folders, you can create a multilevel folder structure.

Users can use the familiar folder and file interface to organize and manage content items. Users can create, delete, copy, and move content items. Users can check content items in, and out, and apply default metadata to content items by checking them in through a particular folder.

### 23.1.3.1 Content Item Security

The user logins and security controls in Content Server also apply to content that you manage through contribution folders. For example, if you have Read permission for a content item, you are able to view the file, but you are not able to check in a revision to the file.

### 23.1.3.2 Folder Metadata Inheritance

When you create a new folder, the metadata from the parent folder populates the fields for the new folder. The folder initially *inherits* metadata, but you can change its values without affecting the parent folder. A folder has the same metadata as a content item.

 **Note:**

Specifying a default value for the Author field will limit the users who can check documents into the folder. Only users with Admin permission to at least one group will be able to check documents into a folder for which a default author is specified.

Subsequent changes to a parent folder's metadata do not affect the metadata for existing subfolders. To apply a parent folder's metadata to subfolders and content items, you can use the metadata propagation function. For more information, see [Metadata Propagation](#).

### 23.1.3.3 Default Metadata Values

When a file is checked in to Content Server through a contribution folder, default metadata values are entered on the content check-in form automatically. Default metadata values are evaluated in the following order:

1. Contribution folder default values: When you choose **New Folder** from the New Item menu, any content default metadata values defined for that contribution folder are entered on the content check-in form. These values are defined on the Hierarchy Folder Configuration page.
2. User default metadata values: If any content metadata defaults are not defined for the contribution folder, the user's default metadata values are applied. These values are defined by each user for new content items on their Default Information Field Configuration page, and for revised content items on their Revision Information Field Configuration page.

 **Note:**

User default metadata values are only applicable when creating new content items using WebDAV. They are not applicable when using the Content Server web browser user interface.

3. System default metadata values: The system default values are applied to any fields that are not defined by the contribution folder or the user's default metadata. These values are defined by the system administrator.

 **Note:**

System default metadata values are only applicable when creating new content items using WebDAV. They are not applicable when using the Content Server web browser user interface.

4. None: You can leave a metadata field blank if it is not a required field. If you leave a required field blank, an error occurs and the content item is not checked in.

### 23.1.3.4 Trash Bin

The *Trash Bin* function is an optional feature that sends deleted items to a Trash folder, rather than permanently deleting the items. Items in the Trash folder can then be permanently deleted or restored to their original location in the folder hierarchy. This enables users to recover files and folders that have been mistakenly deleted.

Please note:

- The Trash folder works much like a normal folder except that items deleted from the Trash folder are permanently deleted.
- Deleting a revision from a content information page bypasses the Trash folder and permanently deletes the revision.
- Users can select whether to make use of the Trash folder or permanently delete items immediately. They can also select whether to see all deleted items in the Trash folder or just the items they deleted themselves.
- Deleting an item from the Exploring page puts the item into the Trash folder.
- Deleting an item from WebDAV puts it into the Trash folder.

### 23.1.3.5 Metadata Propagation

The *metadata propagation* function enables contributors to copy default metadata values from a folder to its subfolders and content items. Typical uses for this function include:

- After moving a large number of content items to a new folder structure, you want to apply the top-level folder's default metadata to all subfolders and content items.
- You revised the default metadata for a folder, and you want to apply it to subfolders and content items within that folder.

Please note:

- The propagation function applies each folder's metadata to all *uninhibited* subfolders and content items within those folders. Each uninhibited subfolder and content item inherits the metadata of the folder from which propagation was launched.
- When you inhibit a folder, it is not affected by metadata propagation from a higher-level folder. However, you can still launch metadata propagation *from* an inhibited folder.
- The system administrator selects which metadata fields are included in propagation. (This setting is systemwide.) By default, no metadata fields are included until they are specifically selected for metadata propagation.
- If a folder metadata field does not have a value defined, subfolders and content items within that folder may not inherit the *blank* value during propagation and any existing metadata values may stay intact for these items. The system administrator specifies how the system handles blank fields.
- When you launch metadata propagation, only folders and content items for which you have Write permission to the security group are affected.

### 23.1.3.6 Folder Content Item Revisions

When documents are edited and checked in to Content Server, the revised document must be converted, indexed, and released. Before this process is complete, the system considers the

revised document to be the *latest* version. After the process is complete, the system considers the revised document to be the *latest released* version.

Depending on how Folders has been set up, users with read access to the content item see either the latest version or nothing at all if the item is not released. Authors, however, always see the latest version. By default, the latest version is available to all users with read access.

## 23.1.4 About WebDAV

WebDAV (Web-Based Distributed Authoring and Versioning) provides a way to remotely author and manage your content using clients that support the WebDAV protocol. For example, you can use Microsoft Windows Explorer to manage content in the repository rather than using the browser interface.

### 23.1.4.1 What is WebDAV?

WebDAV is an extension to the HTTP/1.1 protocol that allows clients to perform remote Web content authoring operations. The WebDAV protocol is specified by RFC 2518.0. For more information, see the WebDAV Resources website at

<http://www.webdav.org>

When a content management system such as Oracle WebCenter Content uses WebDAV, the WebDAV client serves as an alternate user interface to the native files in the content repository. The same versioning and security controls apply, whether an author uses the Web browser interface or a WebDAV client.

The WebDAV interface provides a subset of the options available through the browser interface. In general, you can create, delete, move, and copy both folders and content items, and you can modify and check in content items. To check out content items through the WebDAV interface, you must use a WebDAV client that can open the file. To perform other management tasks, such as specifying or propagating metadata values, you must use the standard browser interface.

You can use the WebDAV interface in Content Server with either the Contribution Folders interface or the Folders interface. For more information about the Contribution Folders interface, see [About Contribution Folders](#). For more information about the Folders interface, see [About Folders](#).

### 23.1.4.2 WebDAV Clients

A WebDAV client is an application that can send requests and receive responses using the WebDAV protocol. With a WebDAV client, you can check content out of the e Content Server repository, modify the content item, and check in a new revision using the native application menus.

You can use WebDAV folders in Windows Explorer to manage files that are created non-WebDAV application, but you must check content out of the Content Server repository using the Content Server browser interface rather than the native application.

### 23.1.4.3 Oracle WebCenter Content: Desktop

Oracle WebCenter Content: Desktop provides a set of embedded applications that help you seamlessly integrate your desktop experience with the WebDAV-based Content Server repository. Desktop provides convenient access to Content Server directly from Microsoft Windows Explorer, Microsoft Office applications (Word, Excel, and PowerPoint), and supported e-mail clients (Microsoft Outlook and Lotus Notes). Integrating Content Server with your



desktop applications improves your ability to work with files on Content Server. You can easily manage files on the server and share files with other users directly from your desktop in addition to logging in to Content Server and using the Web browser interface. For more information about Desktop, see *What is Oracle WebCenter Content: Desktop?* in *Using Oracle WebCenter Content: Desktop*.

## 23.2 Working with Folders

Folders provides a hierarchical folder interface, similar to a conventional file system, for organizing and locating some or all of the content in the repository.

This chapter provides information about using Folders:

- [Folder Navigation](#)
- [Working with Folders](#)
- [Working with Content Items](#)
- [About Expired Items](#)
- [Working with Search Options and Query Folders](#)
- [Folder Access Example](#)

### 23.2.1 Folder Navigation

To view the folder hierarchy, click **Browse Content** in the trays area and click **Folders**. The Browse Content tray shows a tree view of the folder hierarchy. The basic hierarchy includes standard folders, such as the Users folder and any other folders created by your administrator.

To expand or collapse a particular level in the folder hierarchy, click the plus or minus icon next to the folder name in the Browse Content tray. To view the contents of a folder, click the folder name.



#### Note:

Individual folders are displayed only if you have Read privileges for that folder.

When you open a folder, its contents are displayed in the folder content area with folders in the top portion and content items in the bottom portion. Page menus provide options for adding folders and content items and for managing the current folder. Folder content menus provide options for managing selected items (folders or content items) in the current folder. Individual folder and content item menus provide options for managing the associated item.

The path to the current folder is displayed at the top of the page. You can click any folder in the path to open the contents of that folder.

### 23.2.2 Working with Folders

Working with folders in the Folders interface is similar to working with folders in a conventional file system. You can copy, move, rename, and delete folders and files. You can also create shortcuts to folders or files so you can access a content item from multiple locations in the hierarchy. Additionally, you can use folder to apply and manage metadata for the content items contained in the folder.



This section covers the following topics:

- [Create a Folder](#)
- [Specify Default Folder Metadata](#)
- [Propagate Folder Metadata](#)

For information about copying or moving folders, see [Copy or Move Folders and Files](#). For information about deleting folders, see [Delete Folders and Files](#).

### 23.2.2.1 Create a Folder

Use this procedure to:

- Create a folder
  - View and change folder information
  - Rename a folder
1. Navigate to the folder where you want to create the new folder. You must have write permission in the folder where you want to create the new folder.
  2. Choose **New Folder** from the Add menu on the folder page.
  3. On the The Folder Creation form, specify a name for the folder.

Use standard Windows naming conventions when naming folders. Do not use the following characters:

? / \ \* " | < > :

4. To specify **Additional Fields**, click **show advanced options** if the fields are not displayed.
5. Choose an **Owner** for the folder from the list of defined users. By default, the current user is the owner.
6. Choose a **Security Group** from the list of defined security groups. By default, the folder uses the security group of its parent folder.
7. To prevent the folder from having its metadata modified unintentionally, select **Inhibit Propagation**.

You can override this setting by selecting Force Propagation during metadata propagation. For more information, see [Propagate Folder Metadata](#).

8. To prompt the user to specify metadata rather than relying on the folder's default metadata settings when they create new content items in the folder select **Prompt For Metadata**.
9. Click **Create**. The folder page shows the new folder and its associated Actions menu.  
If a folder with the specified name already exists in this location, the newly created folder is named Copy of *name*.
10. To rename the folder, choose **Rename** from the folder Actions menu, specify the new name and click **OK**.

Use standard Windows naming conventions when naming folders. Do not use the following characters:

? / \ \* " | < > :

For more information about copying and moving folders, see [Copy or Move Folders and Files](#).

11. To change other metadata values, including the name, choose **Update Folder Information** from the folder Actions menu, change the values outlined in the steps above and click **OK**.

To change metadata values for the folder when you are viewing the contents of the folder, choose **Folder Information** from the Edit menu on the page.

### 23.2.2.2 Specify Default Folder Metadata

This procedure shows you how to define default metadata values to apply to new content items added to a folder. Default metadata values are also used as the default values when propagating metadata.

To change folder metadata, you must have Delete permission for the folder or be the Author and have Write permission.

1. Click **Browse Content** in the trays area, then locate and open the folder for which you want to define default metadata.
2. From the page Edit menu, choose **Metadata Values**.
3. On the Editing Default Metadata Values page, specify the metadata values you want to apply to new items added to the folder.

#### Note:

Specifying a default value for the Author field will limit the users who can check documents into the folder. Only users with Admin permission to at least one group will be able to check documents into a folder for which a default author is specified.

These values apply only to new repository content items. They are not applied to content items defined in the repository when they are added to a folder. Although you can modify the values before propagation, these values also act as the default values for propagation (described later in this section).

4. Click **Save**.

### 23.2.2.3 Propagate Folder Metadata

This procedure shows you how to propagate metadata values to the items in a query folder or to a folder and its subfolders.

To change folder metadata, you must have Delete permission for the folder or be the Author and have Write permission. To change content item metadata, you must have Write permission for the content item.

#### Note:

Depending on the contents of a folder, propagation can change metadata values for a significant number of folders and content items. Before you begin, make sure you know what the consequences of propagation are.

1. Click **Browse Content** in the trays area, then locate and open the folder or query folder in which you want to propagate metadata.
2. From the page Edit menu, choose **Propagate**.  
The fields on the Propagate page are initially populated with the metadata values defined for the folder. Query folders show general defaults.
3. On the Propagate page, select the check box next to a field you want to propagate.
4. If necessary, specify the value to propagate in the associated field. If you propagate an empty field, it clears the field for all affected items.
5. Repeat steps 3 and 4 for each field you want to propagate.
6. To exclude content items and propagate metadata changes to subfolders only, select **Propagate To Folders Only**.
7. To override the Inhibit Propagation setting specified for all subfolders, select **Force Propagation**.

 **Caution:**

Propagation is recursive through all subfolders in the propagation folder. Propagation can change metadata values for a significant number of folders and content items. Use caution when propagating metadata and when using the **Force Propagation** option in particular.

8. Click **Propagate**.

## 23.2.3 Working with Content Items

Working with content items in the Folders interface is similar to working with files in a conventional file system, except that the *files* represent content items stored in the repository.

This section covers the following topics:

- [Add a New Content Item to a Folder](#)
- [Add an Existing Content Item to a Folder](#)
- [Create a Folder or File Shortcut](#)
- [Copy or Move Folders and Files](#)
- [Check Out and Check in Files](#)
- [Delete Folders and Files](#)

### 23.2.3.1 Add a New Content Item to a Folder

To check in a new content item through the folder interface:

1. Navigate to the folder to which you want to add the content item.
2. Choose **New Content Item** from the page Add menu.
3. On the Content Check-In Form, provide metadata information as necessary. The form is populated with the default metadata values defined for the enclosing folder. Required fields are indicated with an asterisk (\*).

For more information about checking content items, see [Checking In a New File](#).

4. After you enter all the appropriate metadata values, click **Check In**.
5. If the check-in is successful, and you are working with published items only, the Check-In Confirmation page opens. If you are working with all items, the new revision is added to the list of available revisions.  
  
The content item is checked in and is represented by a file in the current folder. The name of the file in the folder is the name of the native file you checked in.  
  
If an item with the specified name already exists in this location, the newly created folder is named Copy of *name*.
6. To rename the file, choose **Rename** from the file item menu. To change other metadata, choose **Update Content Information** from the file item menu.

### 23.2.3.2 Add an Existing Content Item to a Folder

To add a content item that is already in the repository to the folders interface:

1. Navigate to the folder to which you want to add the content item.
2. Choose **Existing Content Item** from the page Add menu.
3. In the Add Existing Content Item window, provide metadata search information to locate the content item using any of the supported forms.

For more information about the expanded search form, see [Advanced Search Page](#). For more information about the query builder form, see [Query Builder Form](#).

4. After you enter all the appropriate metadata values, click **Search**.
5. The Search Results page displays the repository content items, if any, that match your search criteria. To add an item to the folder hierarchy, click **Select** next to the associated item.

If the **Select** button is not available for a particular item, it is because there is already a file representing the item in the folder hierarchy.

6. The content item is represented by a file in the current folder. The name of the file in the folder is the name of the native file you checked in.

If an item with the specified name already exists in this location, the newly created folder is named Copy of *name*.

7. To rename the file, choose **Rename** from the file item menu. To change other metadata, choose **Update Content Information** from the file item menu.

### 23.2.3.3 Create a Folder or File Shortcut

To create a shortcut to a target folder or file listed in the current folder and store the shortcut in a selected destination folder:

1. Navigate to the folder that contains the folder or file for which you want to create a shortcut.
2. Choose **Create Shortcut** from the folder or file item menu.
3. In the Create Shortcut window, **Browse** to the destination folder where the shortcut will be stored and select the folder.
4. Verify the selected path in the Folder box at the bottom of the page and click **OK**.
5. Specify a name for the shortcut.

Use standard Windows naming conventions when creating folders and files. If a shortcut with the specified name already exists in this location, the newly created shortcut is named Copy of *name*.

6. Click **OK**. If the shortcut is successfully created in a destination folder other than the current folder, click **Yes** to view the destination folder and click **No** to return to the current folder.

Folder shortcuts are identified by a folder icon with an arrow. File shortcuts are identified by a document icon with an arrow.

### 23.2.3.4 Copy or Move Folders and Files

This procedure shows you how to copy or move folders or content items to another location:

1. To copy or move an entire folder, navigate to the parent folder of the folder you want to copy.  
To copy or move one or more selected items, navigate to the folder containing the items.
2. To copy or move a single item, choose **Copy** or **Move** from the associated item menu.  
To copy or move multiple items, select the items and choose **Copy** or **Move** from the folder Actions menu.
3. In the Choose a Destination window, **Browse** to the target folder, select the folder, and click **OK**.
4. To specify how naming conflicts are resolved, click **Show Advanced Options**.
5. Copied files inherit the default metadata defined by the enclosing folder. By default, moved items retain their metadata values, including security metadata.

If your administrator enabled the **Auto propagate destination's metadata to folder** option, you can select this option to have the moved items inherit the metadata defined by the enclosing folder in the same way that copied items do.

6. Specify how to resolve duplicate names when you copy or move folders or files. After the copy or move operation completes, a window lists any conflicts and their resolutions.
  - **Resolve conflicts if file/folder exists:** Folders or files with name conflicts are renamed in the destination with a prefix of "copy of". If more than one copy is created, each subsequent copy is given a numeric increment (1, 2, 3, and so on.)
  - **Override file/folder if exists:** For one or more files, delete the duplicate file in the destination and replace it with the source file.

For folders, merge the contents of the source and destination folders and replace the security attributes and metadata of destination folder with those of the source folder. For file conflicts within folders, delete the duplicate file in the destination and replace it with the source file.

Deleted files are expired in the repository and removed from the folders hierarchy. Any shortcuts to deleted items are also removed from the folders hierarchy.

- **Skip copy/moves if file/folder exists:** Skip individual items with folder or file name conflicts, but continue with the remainder of the copy or move operation. Folders with name conflicts are skipped in their entirety, including their contents.
7. Click **OK**. The items are copied (or moved) to the destination folder.
  8. A window opens confirming the copy or move operation and any naming conflicts and resolutions. Click **OK**.

As with any content item created in a folder, any new content items in the repository are created with the default metadata values assigned by the parent folder according to the rules of inheritance define for the chain of folders.

### 23.2.3.5 Check Out and Check in Files

The folder interface does not provide special options for checking out content. Use the check-out options provided by the Content Information and Search Results pages.

For more information about standard content check-out, see [Checking Out Single Files](#).

Files in the folder interface always point to the most current revision available. When you check in a new version of a content item using the standard check-in options, the file and any shortcuts reference the new version.

For more information about standard content check in, see [Checking In a Revised File](#).

### 23.2.3.6 Delete Folders and Files

Use this procedure to:

- Remove a content item from the folder structure while leaving it in the repository
- Delete a content item from both the folder structure and the repository

#### **Caution:**

When you delete a folder, all files within the folder and its subfolders are also deleted. All deleted files and associated shortcuts are removed from the folders interface and expired in the repository. Use caution when deleting folders.

1. Navigate to the folder that contains the folder or file you want to delete.
2. To remove a single file from the folders interface but leave it intact in the repository, choose **Remove From Folder** from the item action menu.  
Alternatively, select one or more files in the folder and choose, **Remove From Folder** from the folder Actions menu.
3. To delete a single folder or file from the folders interface and expire the related content item in the repository, choose **Delete** from the item action menu.  
Alternatively, select one or more items in the folder and choose, **Delete** from the folder Actions menu.

## 23.2.4 About Expired Items

Content items in “Expired” status can be accessed by clicking **Content Management** and then clicking **Expired Content** menu.

Users can perform the following actions for expired content items within a folder:

- Update Content Information
- Rename
- Move

- Delete
- Remove From Folder

### Expiration of Framework Folder's Content Items

The metadata field **dOutDate** decides when a content item will be expired. A content item whose **dOutDate** has gone past becomes an expired content item.

- When an item is expired, it is set to the status "Expired". The item will remain in the same folder itself and will not be moved to trash folder.
- When the latest revision of a content item is expired, the entire document is marked as expired.
- When a user performs propagate metadata operation on a folder, depending on the **fldBrowsingMode** set, the metadata values are propagated. For example,
  - If **fldBrowsingMode=expiration**, then the metadata values are propagated only to items part of 'expiration' view.
  - If **fldBrowsingMode=consumption**, then the metadata values are propagated only to the items part of 'consumption' view.
  - The **fldBrowsingMode** is applicable only for content items and does not apply for folders. So, irrespective of the **fldBrowsingMode**, the metadata values are propagated to folder(s) depending on the propagation flags set on it.
- When a user performs copy of a folder consisting of expired content items,
  - System performs the copy operation but the expired content items will not be copied to the new location when the **fldBrowsingMode** is set to 'contribution' and/or 'consumption'.
  - If the **fldBrowsingMode** is set to 'expiration', the system does not perform copy operation.
- When a user performs move operation on a folder consisting of expired content items, the folder along with all its content items (including expired content items) is moved under the new parent folder.
- You cannot create shortcuts on expired content items.
- You cannot perform 'add to favorites' and/or 'add to my folders' on expired content items.

### Deletion of Folder with Expired Content Items

You cannot delete a folder consisting of expired items when the **fldBrowsingMode** is set to 'consumption' and 'contribution'. If you want to delete a folder consisting of expired items, then **fldBrowsingMode=expiration** should be set. On the native UI, you should select the "Expired Items" view to perform delete on a folder consisting of expired items.

### Restore of Content Items from Trash

When an "Expired" item is restored, the content item (latest revision) will be put back to "Released" status.

 **Note:**

- When a content item is in “Expired” status, if a user performs un-expiry (and/or update) on a revision, only that revision will be put back to “Released” status and all other revisions of the content item will still be in “Expired” status.
- **Browse expired items via service:** To browse expired items within a given folder, any integrating client application can make a call to FLD\_BROWSE with **fldBrowsingMode=expiration**.
- **Delete folders with expired items via service:** To delete a folder consisting of expired items, any integrating client application can make a call to FLD\_DELETE with **fldBrowsingMode=expiration** to delete a folder consisting of expired items and move the folder along with all the content items into user’s trash.

## 23.2.5 Working with Search Options and Query Folders

This section covers the following topics:

- [Search for a Folder or File](#)
- [Save a Search as a Query Folder](#)
- [Create or Modify a Query Folder](#)

### 23.2.5.1 Search for a Folder or File

Folders and shortcuts are not included in standard search or query folder results. To search for a folder, file, or shortcut in a given folder:

 **Note:**

Folder and file searches search the specified folder only. They do not search subfolders.

1. Navigate to the folder you want to search.
2. To search for a folder within the current folder, choose **Folder** from the page Search menu. To search for a file, choose **File** from the page Search menu.
3. For a selected field on the Folder/File Search form, choose a comparison operator that specifies whether the value matches exactly, is a substring within the actual value, and so on.

For more information about search field operators, see [Metadata search operators for a database metadata search](#)

4. For a selected field, specify a search value. If you leave a field blank, it effectively matches all values.

Some fields allow you to directly enter a full or partial value. Other fields require that you choose a value from a list of values or through another selection process.

5. Repeat steps 3 and 4 for each field you want to specify search criteria.



6. Under Results Options, specify how to sort the search results. Choose a sort value from the **Sort By** list and choose whether the results are sorted in **Ascending** or **Descending** order.
7. To initiate the search, click **Search**. To cancel the search, navigate away from the Folder/File Search form.

### 23.2.5.2 Save a Search as a Query Folder

With Folders, you also have the option to save a standard search query as a query folder.

1. Enter your search criteria in the Quick Search field or the Expanded Form and click **Search**.  
  
Search options vary depending on system configuration. You can save any search you create as a query folder. For more information about creating and performing searches, see [Finding Documents](#).
2. On the Search Results page, choose **Create Query Folder** from the Search Actions menu.
3. In the Create Query Folder window, **Browse** to the **Parent Folder**, or destination, where the query folder will be stored, select the folder, and click **OK**.
4. Specify a **Folder Name** for the query folder.  
  
Use standard Windows naming conventions when creating folders.
5. Click **OK**. The query folder is created in the destination folder.  
  
Query folders are identified by a folder icon with an magnifying glass.
6. To modify the search criteria associated with a query folder, choose **Folder Information** from the associated item or page menus and click **Edit** next to the Query Text field.  
  
The Expanded Search form opens and displays the criteria currently defined for the query folder. Modify the criteria and click **Save**. Click **Save** to save the changes to the query folder information.

### 23.2.5.3 Create or Modify a Query Folder

To create or modify a query folder:

1. Navigate to the folder where you want to create the new folder. You must have write permission in the folder where you want to create the new folder.
2. Choose **New Query Folder** from the Add menu on the folder page.
3. On the Query Folder Creation Form, specify a name for the folder.  
  
Use standard Windows naming conventions when naming folders. Do not use the following characters:  
  
? / \ \* " | < > :
4. To specify the search criteria, click **Edit** next to the Query Text field.  
  
Search options vary depending on system configuration. For more information about creating and performing searches, see [Finding Documents](#).
5. To specify **Additional Fields**, click **Show** if the fields are not displayed.
6. Choose an **Owner** for the folder from the list of defined users. By default, the current user is the owner.
7. Choose a **Security Group** from the list of defined security groups. By default, the folder uses the security group of its parent folder.

- Click **Create**. The folder page shows the new folder and its associated Actions menu.
- To rename the folder, choose **Rename** from the Actions menu, specify the new name and click **OK**.

Use standard Windows naming conventions when naming folders. Do not use the following characters:

? / \ \* " | < > :

For more information about copying and moving folders, see [Copy or Move Folders and Files](#).

- To change search criteria or other metadata values you specified when you created the folder, choose **Update Folder Information** from the folder Actions menu, change the values and click **OK**.

To change metadata values for the folder when you are viewing the contents of the folder, choose **Folder Information** from the Edit menu on the page.

## 23.2.6 Folder Access Example

Folders are a convenient way to grant access to certain content items. You assign security attributes to folders in the same way that you assign them to content items, including security group, account, and Access Control List attributes, if enabled. By default, content items inherit the security settings and other default metadata defined for the enclosing folder.

For example, assume you have a number of projects that members of your team are working on. You want each project to have its own folder (Project\_1, Project\_2, and so on) and separate folders to store project-related documents (Documents folder) and status documents (Status folder).

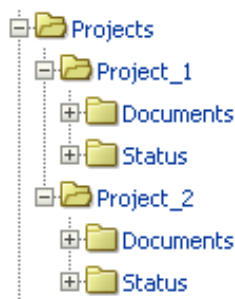

The security considerations for the folder structure are as follows:

- You want only members of your team to be able to add or modify the documents within the Projects folder.
- You want project team members to be able to read status documents for each project, but you want only project leads to be able to add and modify status documents.
- You want team members to be able to add and modify documents for a specific project. Some individuals may work on more than one project.
- Within each project, you may want to restrict the number of team members who can modify a given document. This requires Access Control Lists (ACL) to be enabled.

To accomplish this, ask your administrator to set up the following group, roles, and accounts and to enable Access Control List functionality. For more information about groups, accounts,

and Access Control Lists, see Overview of Content Server Security in *Administering Oracle WebCenter Content*.

- Roles: Have your administrator create the following roles:
  - **Team\_Lead**
  - **Team\_Member**
- Group: Have your administrator create a group called **Projects** and designate it as a special authorization group so you can use Access Control Lists. Have your administrator assign permissions to the roles in the group as follows:
  - **Team\_Lead**: Assign Read (R), Write (W), Delete (D), and Admin (A) permissions.
  - **Team\_Member**: Assign Read (R), Write (W), and Delete (D) permissions.
- Accounts: Have your administrator create the following accounts for each project:
  - **Project\_1**
  - **Project\_1/Documents**
  - **Project\_1/Status**
- Users: Have your administrator assign roles and accounts to users as follows:
  - Team lead: Assign the **Team\_Lead** role and the **Project** account with Read (R), Write (W), Delete (D), and Admin (A) permissions.
  - Team members: Assign the **Team\_Member** role, the **Project\_1/Documents** account with Read (R), Write (W), and Delete (D) permissions, and the **Project\_1/Status** account with Read (R) permission.

Create the folder structure and assign security as follows:

Projects folder:

- Group: **Projects**

Projects/Project\_1 folder:

- Group: **Projects** (inherited default)
- Account: **Project\_1**

Projects/Project\_1/Documents folder:

- Group: **Projects** (inherited default)
- Account: **Project\_1/Documents**

Projects/Project\_1/Status folder:

- Group: **Projects** (inherited default)
- Account: **Project\_1/Status**

The **Team\_Lead** role has the additional option of specifying Access Control List security on any content item in the **Project\_1** folder or its subfolders, further restricting access to those items.

## 23.3 Working with Contribution Folders

Contribution Folders is an optional component (Folders\_g component) that provides a hierarchical folder interface within the browser, similar to a conventional file system, for organizing repository content. The newer, Folders component is meant to be a replacement for Contribution Folders. For more information about Folders, see [Working with Folders](#).

If you have content in an existing Contribution Folders hierarchy and want to migrate the folders and files to the Folders interface, you can use the Folders Migration utility to replicate the folder hierarchy and selectively migrate folder content. For more information about the Folders Migration Utility, see Understanding Folders\_g Migration to Folders in *Administering Oracle WebCenter Content*.

 **Note:**

WebCenter Portal 11.1.1.8.0 and earlier supports the folders\_g component only. For information about configuring Content Server with WebCenter Portal, see Configuring Oracle WebCenter Content Server in *Administering Oracle WebCenter Portal*.

This section covers the following topics:

- [Naming Folders](#)
- [Defining User Configuration Settings](#)
- [Defining User Metadata Defaults for New Content](#)
- [Defining User Metadata Defaults for Revised Content](#)
- [Viewing Contribution Folders](#)
- [Viewing Content Items](#)
- [Checking In Content](#)
- [Adding Contribution Folders](#)
- [Moving Contribution Folders and Content](#)
- [Creating a Shortcut](#)
- [Deleting Contribution Folders and Their Content](#)
- [Restoring Folders and Content from Trash](#)
- [Propagating Metadata](#)
- [Searching for Content in Folders](#)

This guide assumes that your Content Server instance is using the Trays layout with the Oracle skin, which is the default for Content Server.

## 23.3.1 Naming Folders

The Folders component mimics the Windows file system. Therefore, when you create a folder, you are not allowed to use double quotation marks in the name (for example, "doublequotedfolder"). Using double quotation marks causes an error. You must use the standard naming conventions for Windows when creating folders.

## 23.3.2 Defining User Configuration Settings

To define your contribution folder configuration settings:

1. Click the **My Content Server** tray.
2. Click **My Folder Configuration**.
3. On the Folder Configuration page, Select a Content Style option.

4. If the Hide/Unhide feature is enabled, select or deselect the **Show hidden when browsing** check box.
5. If the Trash Bin function is enabled, select or deselect the following check boxes:
  - **Remove items immediately when deleted**
  - **Show only items that user has deleted in trash virtual folder**
6. Click **Update**.

### 23.3.3 Defining User Metadata Defaults for New Content

To define default metadata values for new content checked in by a particular user.

These defaults are applied to any new content item checked in through a contribution folder *only* if a value is not defined for the folder. For more information, see [Default Metadata Values](#).

These metadata values are applied only on initial check-in of a content item. These settings do not affect revisions to existing content. For information about how to set metadata defaults for revisions, see [Defining User Metadata Defaults for Revised Content](#).

#### **Note:**

Each user should follow this procedure to define their default metadata before using WebDAV to check in content through a contribution folder. Defined defaults help ensure that content items do not all have the same metadata, and that content can be checked in if required values are not defined for the folder or in the system defaults. Each WebDAV contributor should repeat this procedure after a required metadata field is added or after accounts are enabled.

#### **To define user metadata defaults for new content:**

1. Click the **My Content Server** tray.
2. Expand the **My Folder Configuration** link.
3. Click **Default Information Field Configuration for user**.
4. On the Default Information Field Configuration page, specify the default values to be applied to new content upon check-in. Use Idoc Script in any information field.
5. Click **Update**.

### 23.3.4 Defining User Metadata Defaults for Revised Content

These defaults are applied to any content item revision checked in through a contribution folder *only* if a value is not defined for the folder. For more information, see [Default Metadata Values](#).

These metadata values are applied only upon check-in of a revision; these settings do not affect new content items. For information about how to set metadata defaults for new content, see [Defining User Metadata Defaults for New Content](#).

To define default metadata values for revised content checked in by a particular user:

#### **To define user metadata defaults for revised content:**

1. Click the **My Content Server** tray.

2. Expand the **My Folder Configuration** link.
3. Click **Revision Information Field Configuration for User**.
4. On the Revision Information Field Configuration page, specify the default values to be applied to revised content upon check-in. Use Idoc Script in any information field.
5. Click **Update**.

## 23.3.5 Viewing Contribution Folders

To view a contribution folder from a content server Web page:

1. Click the **Browse Content** tray.
2. Click the **Contribution Folders** link.
3. On the Exploring Contribution Folders page, click folder links to drill down to the folder you want.

Depending on how the system administrator set up the system, long display lists may be truncated and spread out over multiple pages. Navigation links are then provided to move between pages.

4. To view the Hierarchical Folder Information page for a folder, click the Folder Information icon, choose **Folder Information** from the Action menu, or explore the folder and click the Info link.
5. If the Web Folder feature is enabled and you are using Internet Explorer 5.0 or higher, choose **Open Web Folder** from the Content Actions menu to view the folder in Windows Explorer.

## 23.3.6 Viewing Content Items

To view content items from a contribution folder:

1. View the Exploring page for the contribution folder that contains the content item.

Depending on how the system administrator set up the system, long display lists may be truncated and spread out over multiple pages. Navigation links are then provided to move between pages.

2. To view the content information for a content item, click the **Information** icon, or choose **Content Information** from the item Actions menu.
3. To view a file, click the file link in the Name column.
  - If you selected the **Native** option under **Content Style** on the Folder Configuration page, you can optionally open or save the file.
  - If you selected the **Web Viewable (Browse only)** option under **Content Style** on the Folder Configuration page, the Web-viewable file opens.

## 23.3.7 Checking In Content

To check in a file through a contribution folder:

1. View the Exploring page for the contribution folder you want to check the content item into.
2. Display the content check-in form using one of the following methods:
  - Choose **New Content** from the Actions menu.
  - Click the **Actions** icon for an existing content item, and then choose **Check In Similar**.

- Click **New Check-In** on the top menu, and then specify a folder in the **Folder** field on the check-in form.
- 3. On the content check-in form, enter the required metadata and any optional metadata for the content item.
- 4. Enter the path and file name of the **Primary File**. You cannot check two files with the same file name into the same folder.
- 5. In the **Inhibit Propagation** field, specify whether the content item receives propagated metadata.
  - Set the value to *false* to apply propagated metadata to the content item.
  - Set the value to *true* if the content item's metadata should remain unchanged during metadata propagation.
- 6. Click **Check In**.

If the number of content items in the folder exceeds the limit set by the system administrator, you receive an error message and cannot check in the new content item.

## 23.3.8 Adding Contribution Folders

To add a contribution folder, you must be a contributor.

To add a contribution folder:

1. Choose **New Folder** from the **New Item** link on the Exploring Folder page:
2. Specify an owner for the contribution folder.
3. Specify any additional metadata values for the folder.
  - These metadata values are applied to content items upon initial check-in to this folder.
  - These metadata values override any values inherited from the parent folder.
  - Use Idoc Script in any information field.
4. In the Inhibit Propagation field, specify whether the folder receives metadata propagated from a higher-level folder.
  - Set the value to *false* if the folder receives propagated metadata.
  - Set the value to *true* if the folder's metadata remains unchanged during metadata propagation.
5. Click **Save**.

The Exploring Contribution Folders pages shows the new contribution folder.

If the number of folders exceeds the limit set by the system administrator, you receive an error message and cannot check in the new folder.

## 23.3.9 Modifying Contribution Folders

To modify a contribution folder, you must have Write permission to the folder's security group. Folders without security metadata can be modified by all users.

To modify a contribution folder:

1. Open the Hierarchical Folder Information page.
2. Choose **Update** from the folder Actions menu.

3. On the Hierarchy Folder Configuration page, revise one or more metadata values for the folder.
  - These metadata values are applied to content items upon initial check-in to this folder; these settings do not affect revisions to existing content in the folder.
  - These metadata values override any values inherited from the parent folder.
  - Use Idoc Script in any information field.
4. In the Inhibit Propagation field, specify whether the folder receives metadata propagated from a higher-level folder.
  - Set the value to *false* if the folder receives propagated metadata.
  - Set the value to *true* if the folder's metadata remains unchanged during metadata propagation.
5. Click **Submit Update**.

The Exploring Contribution Folders pages shows the modified contribution folder.

If the number of folders exceeds the limit set by the system administrator, you receive an error message and cannot check in the new folder.

## 23.3.10 Moving Contribution Folders and Content

To move contribution folders and content items from one contribution folder to another:

1. View the Exploring page for the contribution folder that contains the folders, content items, or both to move.
2. Select the check boxes next to the folders and content items to be moved.
3. Click the item **Actions** icon, and choose **Move**.
4. Click the folder to move the selected items to. (You may have to navigate to a higher-level folder to display its subfolders.) The target folder is the open folder.
5. Click **OK**.

The selected items are moved to the target folder.

If local folder mapping is setup, if you move a file from one folder to another (either through the Folders user interface or WebDAV), the copy of that file in the local folder associated with the source folder is not deleted. For example, if you have a folder *WebSite*, files in this folder are automatically copied to its local folder, *C:/Website/*. If you now move a file from the folder *WebSite* to another folder, say, *Intranet*, with *Z:/Intranet/* as the local folder, then the file copy in *C:/Website/* is not deleted.

## 23.3.11 Creating a Shortcut

You can create a shortcut link to a contribution folder or content item in the folder hierarchy in two ways:

- [Creating a Shortcut from an Exploring Page](#)
- [Creating a Shortcut from a Folder Information or Content Information Page](#)

### 23.3.11.1 Creating a Shortcut from an Exploring Page

To create a shortcut from an exploring page:



1. View the Exploring page for the contribution folder that contains the folder or content item for which you want to create a shortcut.
2. Choose the folder or item Actions menu, and then choose **Create Shortcut**.
3. In the Browsing window, click the folder where you want to create the shortcut link. (You may have to navigate to a higher-level folder to display its subfolders.) The target folder is the open folder.
4. Click **OK**.

A shortcut link is created in the target folder.

### 23.3.11.2 Creating a Shortcut from a Folder Information or Content Information Page

To create a shortcut from a folder information page or content information page:

1. View the Hierarchical Folder Information page or Content Information page for the folder or content item for which you want to create a shortcut.
2. Choose **Create Shortcut** from the Content Actions menu.
3. In the Browsing window, click the folder where you want to create the shortcut link. (You may have to navigate to a higher-level folder to display its subfolders.) The target folder is the open folder.
4. Click **OK**.

A shortcut link is created in the target folder.

### 23.3.12 Deleting Contribution Folders and Their Content

This section covers the following topics:

- [About Deleting Folders and Content](#)
- [Deleting a Folder or Content Item](#)
- [Permanently Deleting Folders and Content from Trash](#)

#### 23.3.12.1 About Deleting Folders and Content

 **Note:**

When you delete a folder, all subfolders and all revisions of all content items in the folders are also deleted. When you delete a content item, all revisions of that content item are deleted. Be extremely careful when deleting folders and content items so that you do not accidentally delete content.

Keep the following in mind when deleting contribution folders and content items:

- When you delete folders and content items from the Folders hierarchy, the action that occurs depends on whether the Trash Bin function is enabled and whether you have chosen to use the Trash Bin function in your user profile:

Trash Bin Function Enabled by System Administrator	"Remove items immediately when deleted" Check Box on the Folder Configuration Page	Result of Delete Action
Enabled	Cleared	Deleting a folder or content item moves it to the Trash folder. Items can be permanently deleted or restored from the Trash folder.
Enabled	Selected	Deleting a folder or content item permanently deletes it. <i>Items cannot be restored.</i>
Disabled	Selected or cleared	Deleting a folder or content item permanently deletes it. <i>Items cannot be restored.</i>

- To delete a content item, you must have Delete permission to the content item's security group. If accounts are enabled, you must have Delete permission to the account as well.
- To delete a contribution folder, you must be the owner of the folder or a user with Delete permission to the folder's security group. If accounts are enabled, you must have Delete permission to the account as well.
- If a folder contains any content items or subfolders that you do not have permission to delete, you cannot delete the folder.

### 23.3.12.2 Deleting a Folder or Content Item

#### Note:

When you delete a folder, all subfolders and all revisions of all content items in the folders are also deleted. When you delete a content item, all revisions of that content item are deleted. *Be extremely careful when deleting folders and content items so that you do not accidentally delete content.*

To delete a content item, you must have Delete permission for the security group of that content item. To delete a folder, you must be the Owner of the folder or have Delete permission for the folder's security group, and you must have Delete permission for the security groups of all subfolders and content items within the folder.

To delete folders and content items:

1. View the Exploring page for the contribution folder that contains the folder or content item you want to delete.
2. Select the check box next to each folder and content item to be deleted.
3. For multiple selections, choose **Delete** from the Actions menu. For an individual selection, choose **Delete** from the item Actions menu.

You are asked to confirm the action.

4. Click **OK**.

All revisions of selected content items, any selected folders, any subfolders of selected folders, and all revisions of content items in these folders are deleted. Whether they can be restored depends on how Folders has been set up.

### 23.3.12.3 Permanently Deleting Folders and Content from Trash

To permanently delete items from the Trash folder:

1. View the Exploring page for the Trash folder.
2. Select the check box next to each folder and content item to be permanently deleted.
3. For multiple selections, choose **Delete** from the Actions menu. For an individual selection, choose **Delete** from the item Actions menu.

You are asked to confirm the action.

4. Click **OK**.

All revisions of selected content items, any selected folders, any subfolders of selected folders, and all revisions of content items in these folders are permanently deleted from Content Server. *They cannot be restored.*

### 23.3.13 Restoring Folders and Content from Trash

If you delete a folder or content item from the Trash folder, the folder or item is permanently deleted from Content Server. To prevent permanent deletion of folders and content, you can restore them from the Trash folder to their original parent folders. Items that remain in the Trash folder are still searchable.

To restore an item from the Trash folder to its original parent folder:

1. View the Exploring page for the Trash folder.
2. Click the **Actions** icon and choose **Restore**. (You can restore only one item at a time.)
3. Click **OK**.

The item is restored to its original parent folder.

#### **Note:**

If the original parent folder has been deleted and is still in the Trash folder, the restored item is moved to the original folder. If the original folder has been permanently deleted, you cannot restore the item.

### 23.3.14 Propagating Metadata

This procedure replaces metadata values for folders and content items that are not identified as *inhibited*, and there is no *undo*. *Be extremely careful when propagating metadata so that you do not accidentally change values you meant to keep.*

The system administrator selects which metadata fields are included in propagation. This setting is systemwide. Be certain that you know which metadata fields are enabled for propagation before launching the process.

You can only propagate metadata for a folder if you are the owner or administrator of that folder. Empty metadata field values may not be propagated, depending on how the system has been set up.

To copy metadata from a folder to its subfolders and content items:

1. Display the Hierarchical Folder Information page for the folder from which you want to propagate metadata.
2. Choose **Propagate** from the Folder Actions menu.

The metadata values defined for the current folder are copied to any uninhibited subfolders and content items within those folders. Only content items and folders for which you have Write permission to the security group are affected.

### 23.3.15 Searching for Content in Folders

Your Content Server instance might or might not be configured for subfolders. If it is not, then you can still search for items in a single folder. Otherwise, you have the choice to search for content in a folder or the folder and everything below. If there are many subfolders, you might be limited in how many are actually searched.

If Folders supports searching in a folder and its subfolders, then follow this procedure to search for content items in Folders:

1. Click **Search**.
2. On the Search page, click **Browse** to find and select the folder, including its subfolders, to search.
3. Specify any other parameters on the Search page and click **Search**.

## 23.4 Working with WebDAV

You can use the WebDAV interface in Content Server with either the Contribution Folders interface (Folders\_g component) or the Folders interface (FrameworkFolders component). Except where noted, the topics in this section apply to both components.

This section covers the following topics:

- [Working with Folders](#)
- [Working with Content](#)
- [Displaying Web Pages](#)

### 23.4.1 Working with Folders

This section covers these topics:

- [WebDAV Folders](#)
- [Connecting to a WebDAV Folder](#)
- [Viewing Folders](#)
- [Creating a New Folder](#)

#### 23.4.1.1 WebDAV Folders

You connect to WebDAV folder as you would a networked location. The credentials you use are the same as those you use for the standard browser interface for Oracle WebCenter Content Server. You can work with folders and folder content as defined by your user permissions. For example, if you have Read permission for a content item, you can view the file, but you cannot check in a revision to the file.

The WebDAV interface provides a subset of the options available through the browser interface. In general, you can create, delete, move, and copy both folders and content items, and you can modify and check in content items. To check out content items through the WebDAV interface, you must use a WebDAV client that can open the file. To perform other

management tasks, such as specifying or propagating metadata values, you must use the standard browser interface.

### 23.4.1.2 Connecting to a WebDAV Folder

You connect to a WebDAV folder as you would connect to a networked location. For example, to connect to a WebDAV folder in the Windows XP operating system:

1. In Windows Explorer, click **My Network Places** in the Folders (left) pane.
2. Double-click **Add Network Place**.
3. In the Add Network Place Wizard window, click **Next**.
4. Click **Choose another network location** and click **Next**.
5. Enter the Web address of the WebDAV component using the following syntax:

```
http[s]://host-name:[port]/web-root/idcplg/webdav
```

For example:

```
http://server.example.com/cs/idcplg/webdav
```

If you are not sure which protocol, host name, or root folder to enter, see your system administrator.

6. Click **Next**. You are prompted to enter a user name and password.
7. Enter the user name and password that you use to access Content Server and click **OK**.
8. Enter a name for the WebDAV folder to display in My Network Places and click **Next**.
9. Optionally select **Open this network place when I click Finish**, and click **Finish**.

A shortcut with the name you specified is displayed in My Network Places. With Windows Explorer, you can navigate the folder hierarchy, create, move, copy, paste, and delete folders and files.

### 23.4.1.3 Viewing Folders

To view folders in Windows Explorer or from the Open or Save As dialog in a WebDAV client:

- Click the Web folder under the My Network Places node
- Expand the Web Folders node under the My Computer node, and then select the Web folder

### 23.4.1.4 Creating a New Folder

You can create a new folder in Windows Explorer or from the Open or Save As dialog in a WebDAV client. Right-click an existing Web folder, choose **New**, and then choose **Folder**.

- The newly created folder has the same default metadata as its parent folder. For information about how to modify the default metadata for Contribution Folders, see [Defining User Metadata Defaults for New Content](#). For information about how to modify the default metadata for Folders, see [Specify Default Folder Metadata](#).
- You cannot create a new folder at the root level.
- You can create folders within your personal folder (*/Users/username/*), however you typically cannot create a new folder in the Users directory itself.

- You cannot create a new query folder. To specify the associated query, you must have access to the folder metadata which is only accessible through the Folders browser interface.
- Do not use the following characters in the folder name:  
? / \ \* " | < > :

## 23.4.2 Working with Content

This section covers the following topics:

- [Check-In Troubleshooting](#)
- [Checking Out Content](#)
- [Viewing Content](#)
- [Modifying Content](#)
- [Deleting a Folder or Content Item](#)
- [Restoring a Contribution Folder or Content Item](#)
- [Copying Content](#)
- [Moving Content](#)

With WebDAV folders in Windows Explorer, you can check in, view, delete, copy, and move files that were not created in a supported WebDAV client, but you must check them out through the browser interface.

### 23.4.2.1 Checking In Content

To check in a content item through Windows Explorer, use either of the following methods:

- Drag and drop a file from your hard drive or another network drive into a folder.
- Copy a file from your hard drive or another network drive and paste it into a folder.

To check in a content item through a Microsoft Office application (Word, Excel, PowerPoint, and so on), Save a file in a folder and then close the file.

### 23.4.2.2 Check-In Troubleshooting

Placing a file in a folder checks the file in to the Content Server repository. Keep the following points in mind when checking in files through WebDAV.

#### General Check-In Considerations

- You can use Windows Explorer to manage files that were created in a non-WebDAV client, but to check content out of the Content Server repository, you must use a WebDAV client.
- You cannot check two files with the same file name into the same folder.
- Make sure you define default values for required metadata fields for a folder or an error will occur when you try to check in content.

For information about how to modify the default metadata for Contribution Folders, see [Defining User Metadata Defaults for New Content](#). For information about how to modify the default metadata for Folders, see [Specify Default Folder Metadata](#).

- If the Save As window opens when you attempt to place a file in a folder, you do not have Write privileges to the security group defined for that folder. You must select a different

folder, or save the file on your hard drive and then check in the file through a Web browser where you can select the appropriate metadata.

- If your file has double-byte characters (for example, Chinese, Japanese, or Korean) in the file name and Content Server is running on a Western European operating system, you may not be able to check in the file through WebDAV due to a limitation in Microsoft's WebDAV clients. Eliminate double-byte characters from the file name or check in the file through the Web browser interface of Content Server.
- Do not use the number sign (#) in your file name. The number sign (#) is an illegal WebDAV character.
- If you use a shortcut to open a folder, the folder might not show recent changes to content items until you refresh the display by pressing **F5** or selecting **Refresh** from the View menu. This is a known cache problem with folder shortcuts in Microsoft Windows.

#### Check-In Considerations for Contribution Folders

- The title of the checked-in content item depends on the value of the WebDAV title allocation configuration parameter as set by the system administrator. The title is either the file name (with or without the file extension) or the default title metadata value defined for the folder where the content item resides. Content item titles are assigned as follows:
  - If the WebDAV title inheritance configuration setting is disabled (the default value), the title is the file name *without* the file extension (for example, "monthly\_report"). This naming convention is applied even if a default title metadata value is defined for the folder.
  - If the WebDAV title inheritance configuration setting is enabled and no default title metadata value has been defined for the folder, the title is the file name *with* the file extension (for example, "monthly\_report.doc").
  - If the WebDAV title inheritance configuration setting is enabled and a default title metadata value is defined for the folder, the title is the defined name (for example, "Monthly Report").
- In most WebDAV configurations, an open file is not checked in to Content Server repository until the file is closed, so you can save the file repeatedly without affecting the revision number. Your system administrator can change this so that each save creates a new revision in Content Server.

### 23.4.2.3 Checking Out Content

Opening a file from a folder either through Windows Explorer or through a WebDAV client such as a Microsoft Office application checks out the file from the Content Server repository and locks the file so that other users can only view it.

The Undo Check Out option cancels the content item check-out. This option is displayed only if the content item is checked out, and it is only available to the user who checked out the content item.

### 23.4.2.4 Viewing Content

You can view a content item without affecting the revision number by opening the content item and then closing the file without saving it. This action results in an *undo check-out* rather than a check-in of a new revision.

**Note:**

If you save any changes to a file opened from a WebDAV folder, you create a new revision.

## 23.4.2.5 Modifying Content

Use one of the following procedures to modify and check a new revision of a content item.

### 23.4.2.5.1 Modifying a File in a WebDAV Client Format

To modify a file that is in a WebDAV client supported format (Word, Excel, PowerPoint, and so on):

1. Open the file from a folder, either through Windows Explorer or from a WebDAV client.  
The file is checked out of the Content Server repository.
2. Make changes to the file.
3. Save the changes.
4. Close the file.

The file is checked in as a new revision.

In most WebDAV configurations, an open file is not checked in to the Content Server repository until the file is closed, so you can save the file repeatedly without affecting the revision number. Your system administrator can change this so that each save, including automatic saves, creates a new revision in Content Server.

### 23.4.2.5.2 Modifying a File in a Non-WebDAV Client Format

To modify a file that is not in a WebDAV client supported format:

1. Copy the file from a folder to a temporary location. Do not change the file name.
2. Modify the file.
3. Save the changes to the temporary file and close the file.
4. Move or copy the file to its original folder, and replace the existing file.

The file is checked in as a new revision.

## 23.4.2.6 Deleting a Folder or Content Item

You can delete a folder or content item from Windows Explorer or from the Open or Save As window in a WebDAV client. Browse to the folder or content item you want to delete, right-click and choose **Delete** from the menu (or press the Delete key).

**Caution:**

When you delete a folder, all files within the folder and its subfolders are also deleted. All deleted files and associated shortcuts are removed from the folders interface and expired in the repository. Use caution when deleting folders or content items.



For more information on security and the Trash Bin function for Contribution Folders, see [Deleting Contribution Folders and Their Content](#). For information about the effects of deleting content in Folders, see [Delete Folders and Files](#).

### 23.4.2.7 Restoring a Contribution Folder or Content Item

If you are working with Contribution Folders and the Trash Bin function is enabled, you can restore a folder or content item from Windows Explorer using one of the following methods:

- Drag and drop the folder or file from the Trash folder to another contribution folder.
- Cut the folder or file from the Trash folder and paste it into another contribution folder.

### 23.4.2.8 Copying Content

Copying a file from one folder to another checks in the copied file as a new content item. If the file has the same file name as an existing file in the target folder, a new revision is checked in. The new content item or new revision is stored with the file name and metadata of the latest revision of the source.

#### 23.4.2.8.1 Copying Through Windows Explorer

Use one of the following methods to copy a content item through Windows Explorer:

- Right-drag a file from a folder to another, release, and choose **Copy Here**.
- Copy a file from a folder and paste it into another folder.

#### 23.4.2.8.2 Copying Through Microsoft Office

To copy a content item through a Microsoft Office application (Word, Excel, PowerPoint, and so on):

- Open a file from a folder, from the File menu, choose **Save As**, select a different folder, click **OK**, and close the file.

#### Note:

If the Save As dialog opens twice, you do not have Write privileges to the security group defined for the folder. You must select a different folder, or save the file on your hard drive and then check in the file through a Web browser where you can select the appropriate metadata.

### 23.4.2.9 Moving Content

Use any of the following methods to move a content item from one folder to another:

#### 23.4.2.9.1 Moving Through Windows Explorer

Use one of the following methods to move a content item through Windows Explorer:

- Drag and drop a file from one folder to another.
- Cut a file from a folder and paste it into another folder.

### 23.4.2.9.2 Moving Through Microsoft Office

To move a content item through a Microsoft Office application (Word, Excel, PowerPoint, and so on):

- Open a file from a folder, from the File menu, choose **Save As**, select a different folder, click **OK**, and close the file.

Moving a file to a different folder does not change the metadata. To apply the new parent folder's metadata, you can use the metadata propagation function. For more information, see [Metadata Propagation](#).

## 23.4.3 Displaying Web Pages

You can access Content Server folder Web pages through Windows Explorer rather than through a Web browser.

### 23.4.3.1 Configuring Windows Explorer

To be able to display Web pages through Windows Explorer, the application must be set to display the full path in the title bar:

1. In Windows Explorer, from the Tools menu, choose **Folder Options**.
2. In the Folder Options window, click the **View** tab.
3. Under Files and Folders, select the **Display the full path in title bar** check box.
4. Click **OK**.

### 23.4.3.2 Displaying a Web Page

To display a content server Web page from Windows Explorer:

1. Access the Web Folders folder in Windows Explorer. This folder is usually under My Computer.

If the Web Folders folder is not displayed, access your folders under My Network Places. You might have to do this a few times for Web Folders to appear.

2. In Windows Explorer, double-click the folder on the right for which you want to display the Web page.
3. Click the Address bar at the top of the window.
4. Press the Enter key.

The exploring page for the folder opens.

# 24

## Grouping Documents Using Folios

In Oracle WebCenter Content, you can use folios to organize content in a consistent and repeatable structure.

- [About Content Folios](#)
- [Working with Folios](#)

### 24.1 About Content Folios

Oracle WebCenter Content Server provides a quick and effective way to assemble, track, and access logical groupings of multiple content items from within the secure environment of Oracle WebCenter Content Server. For example, you can assemble all items relevant to an upcoming brochure, such as images, logos, legal disclosures, and ad copy, and send them through a workflow process. Or perhaps a new project requires a virtual place to assemble all relevant content items in a particular hierarchy, whenever they are checked in, with restricted access to particular areas of the hierarchy. Or a video may have to be associated and tracked with release waivers and narration text.

This section contains the following topics:

- [What a Folio Is](#)
- [The Folio Structure](#)
- [When to Use a Folio](#)

#### 24.1.1 What a Folio Is

Technically, a content folio is an XML file checked in to Content Server that uses elements to define a hierarchical structure of nodes, slots, and specified content items in Content Server. In practice, a content folio is a logical grouping or a framework to structure content stored in Content Server.

*A simple folio* is a flat container, while an *advanced folio* can nest content in a hierarchy within folders. In an advanced folio, you can establish the hierarchy before, during, or after you assemble the content items.

You can add content to existing folios or lock them so changes cannot be made. You can add content items folio by searching the repository. You can add content items to an advanced folio by checking new items into the repository or by searching for existing content. An advanced folio can also contain hyperlinks to outside resources such as websites or shared network drives.

#### 24.1.2 The Folio Structure

Within Content Server, a folio opens starting at the root, or top level. Each simple folio contains content items displayed in a table similar to a standard Search Results page. You can add content to a simple folio by searching through Content Server.

Each advanced folio can contain folders, called nodes, placeholders for content, called slots, and content items, displayed by default in a hierarchical structure, similar to a standard file

system. Slots in an advanced folio are populated with content items by either checking in a new item, or searching for an existing item in Content Server and inserting it into the slot.

**Figure 24-1 Simple Folio Structure**

	Name	Description	Created	Modified	Content Item
	Item 1	This is the first item.	10/10/2007	10/10/2007	CS003_000022
	Item 2	This is the second item.	10/10/2007	10/10/2007	CS003_000023
	Item 3	This item is being reordered by dragging and dropping.			
	Item 4	This is the fourth item.	10/10/2007	10/10/2007	CS003_000025

**Figure 24-2 Advanced Folio Structure**

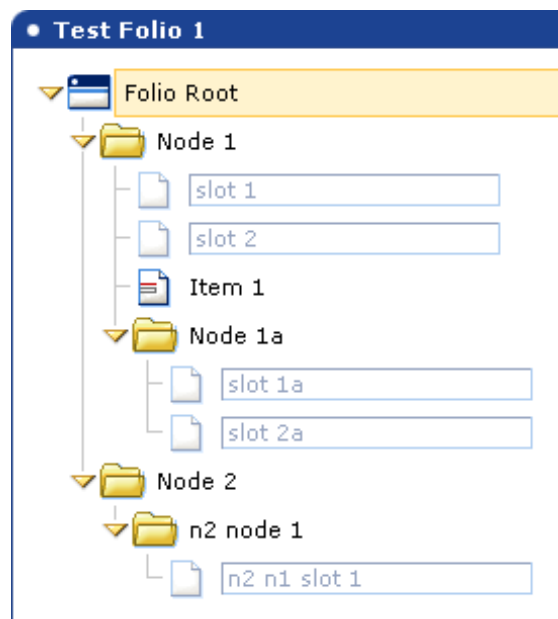

### 24.1.3 When to Use a Folio

Use a folio any time you want to create a logical grouping of content, or when you want to provide a structure for other people to create a logical grouping of content. Use folios to associate content with a project or vendor, or to group multiple content items in a hierarchy.

## Structured Organization of Content

Use Folios to organize content. For example, a company has a consistent way of giving sales presentations to prospective clients, with existing content items used in each new presentation, along with new content specific to the prospective client. Each presentation includes printed material with current background information on the company, printed material of recent press coverage, a slide presentation pertinent to the prospective client, and comments by members of several different departments. Create a folio template that includes content items of the most recent background and press coverage automatically, and has empty slots for the new slide presentation and new comments from each department. When you develop a presentation for a new client, use the template to create a folio that and route it in workflow. The background information and press coverage reflects the most recent information automatically, and the necessary people insert the required slide presentation and comments as it passes to them in the workflow.

## Management of Records and Reports

Folios are useful when you want to create and review a group of documents as part of one or more workflow processes. For example, an agency generates intelligence reports on various topics. Each report typically has many documents arranged in a particular hierarchy, and every report has the same hierarchy. A system administrator creates a template with nodes in the correct hierarchy. In the appropriate nodes of the hierarchy, a system administrator clones required forms, inserts current versions of standard content items included in each report, and creates slots where new content items must be inserted, with labels for the slots indicating what each is for.

When an agent begins a new report, the agent creates a new folio based on the template created by the system administrator. After the agent collects and enters certain crucial information, other agents contribute additional information. After agents contribute all the required parts of the report, meaning that all slots in the folio are filled, the folio is sent through one or more workflow processes. The processes may involve further editing and analysis of the data. There may also be processes where one or more the documents contained in the report must be translated. The translated documents may be added as part of the report if required, or a link could be inserted in the folio to the translations, stored separately.

Security is maintained throughout the creation, review, and translation process based on existing Content Server permissions, meaning that not all contents of the folio are visible to all participants of the workflow. For example, certain employees with *Secret* clearance cannot see documents or nodes that require *Top Secret* clearance. In such cases, the agents with *Secret* clearance also remain unaware of the existence of *Top Secret* items in the folio. Employees who have *Top Secret* clearance see all *Top Secret* and *Secret* documents in the folio. At any stage in the creation or workflow process, an authorized agent can easily collect all the items in the folio and download them as a compressed file. Similarly, an authorized user can compile PDFs or content converted to PDF (with PDF Converter) as a single PDF file for easy printing.

## Management of Digital Assets and Production

Often catalogs, technical manuals, and other collateral material require many separate files that must be managed, reviewed, and sent to a vendor for production. A folio is an ideal way of organizing such content.

For example, a large retail chain produces advertising biweekly flyers distributed with newspapers, quarterly catalogs distributed by mail, and an online website. The three products, flyer, catalog, and website, share images and text. Each flyer has 8 pages of products, the catalog has 120 pages, and the website lists the entire inventory.

An advertising/marketing manager at the company begins a new flyer by selecting the Flyer template from the folio template options, and begins a new catalog by selecting the Catalog template.

The new flyer folio contains a slot for the design file, and 8 nodes representing each page. Each node contains a sub-node for images and slots for ad copy. Depending on how the template is set up, the slots could be blank or filled with cloned versions of the previous flyer copy and images as a starting point.

The new catalog folio contains a slot for the catalog design file, a slot for discussion of the catalog design, a node for global images, and 7 nodes representing each section of the catalog. Each section node has a slot for the section design file, a sub-node for images, and another sub-node for ad copy.

The folios are sent into workflow to others who create content for the empty slots or modify the existing content. As items are checked in to Content Server, a single item is added to each of the folios. When all items are checked in to a folio, the folio continues on in the workflow to the layout designers, who create the flyer and catalog designs. When each folio is done, it is locked and future flyers and catalogs are started by copying these or beginning fresh using the appropriate template.

### Custom Uses

The preceding examples are only a few ways in which you can use folios in Oracle Content Server. If you would like help implementing Content Server within your organization, contact Oracle Consulting Services.

## 24.2 Working with Folios

Like any other item in Content Server, you create folios and check them in to the repository. You can search for and review associated metadata. You can track folio revisions and lock or unlock folios to control changes to the folio.

This section covers the following topics:

- [Creating a Simple Folio](#)
- [Creating an Advanced Folio](#)
- [Modifying Folio Structure and Content](#)
- [Taking Snapshots](#)
- [Locking and Unlocking Folios](#)
- [Downloading Folio Renditions](#)
- [Finding Existing Folios](#)
- [Viewing Folios](#)
- [Viewing Folio Information](#)
- [Subscribing to Folios](#)
- [Using Digital Asset Baskets](#)
- [Understanding Folio Workflows](#)

## 24.2.1 Creating a Simple Folio

A simple folio creates a flat folio with no additional hierarchy. A simple folio displays content in a table, similar to a search results page. You can convert a simple folio to an advanced folio later if you require additional structure, however you cannot convert an advanced folio to a simple folio.

Although a simple folio displays content in a manner similar to a standard Content Server search results page, there is an important difference. A standard search results page displays content information from a content item's metadata. The Edit Simple Folio page displays element information from the XML file stored in Content Server that defines the folio. This element information is unique to the folio, and can be changed in the folio without affecting the content item's metadata. For more information, see [Updating Simple Folio Element Information](#).

**To create a simple folio after you have logged in to Content Server:**

1. Click the **Content Management** tray.
2. Click **New Folio**.
3. On the Pick Folio Type page, accept the default, Simple Folio.
4. Click **Load folio**.
5. On the Edit Simple Folio page, choose **Save folio** from the Actions menu.

 **Note:**

You must save the folio before navigating away from it. Saving the folio checks the folio into Content Server. If you do not save the folio, it and any changes to it are lost.

6. On the Set Folio Profile page, select the profile to be used with the folio, if any, and click **Next**.
7. On the Folio Check In page, enter the required information and click **Check in**.
8. On the Folio Check In Confirmation page, select how to proceed and click **Finish**. Options are:
  - Use the Edit Folio page to continue editing the folio to add content.
  - Use the Content Information page to view content information for the folio.
  - Use the View Folio page to view the folio.

## 24.2.2 Creating an Advanced Folio

An advanced folio is a folio that allows for a hierarchical structure. The system administrator may define the structure in a template. If the folio has no template associated with it, you can modify the folio structure dynamically as you create and edit the folio. The structure of a template-based folio may or may not be modifiable, depending on the template.

**To create an advanced folio after you have logged in:**

1. Click the **Content Management** tray.
2. Click **New Folio**.

3. On the Pick Folio Type page, select **Advanced Folio** and optionally select a template.
4. Click **Load folio**. If a content item associated with a selected folio template is set to be cloned, then the Set Folio Profile page opens and you are prompted to first check in the folio and skip to Step 6.
5. On the Edit Folio page, choose **Save folio** from the Actions menu.

 **Note:**

You must save the page before navigating away from it. Saving the folio checks the folio into Content Server. If you do not save the folio, it and any changes to it are lost.

6. On the Set Folio Profile page, select the profile to be used with the folio, if any, and click **Next**.
7. On the Folio Check In page, enter the required information and click **Check in**.
8. On the Folio Check In Confirmation page, select how to proceed and click **Finish**. Options are:
  - Use the Edit Folio page to continue editing the folio to add content.
  - Use the Content Information page to view content information for the folio.
  - Use the View Folio page to view the folio.

## 24.2.3 Modifying Folio Structure and Content

Simple folios have a flat structure displayed as a table. You can change the order of the content with the Edit Simple Folio page. You can add or delete content, but you cannot add hierarchical structure to a simple folio. You can convert a simple folio to an advanced folio later if you require additional structure, however you cannot convert an advanced folio to a simple folio.

Advanced folios have a hierarchical structure. If a predefined template is selected when the folio is created, the folio may or may not be modified, depending on the properties defined for the template by the system administrator. If no template is selected when the folio is created, the folio has a single, root node. You can add, modify, move, and delete nodes, slots, and content items within an advanced folio's structure and set the associated properties with the Edit Folio page.

This section covers the following topics:

- [Editing a Simple Folio](#)
- [Editing an Advanced Folio](#)

### 24.2.3.1 Editing a Simple Folio

Simple folios have a flat structure. You can add, delete, or reorder items within a simple folio. Unlike advanced folios, items added to a simple folio must be checked in to Content Server.

#### 24.2.3.1.1 Adding Items to a Simple Folio

To add items to a simple folio:



1. On the Edit Simple Folio page, click the **Add Row** icon in the table heading above the thumbnail column.
2. On the search profile page, select a search profile, if necessary, and click **Next**.
3. Enter your search criteria and click **Search**.
4. On the search results page, select the item or items you want to add to the simple folio and click **Next**. The selected items are added to the content listed in the simple folio.
5. Choose **Save changes** from the Actions menu to save the content to the folio.

 **Note:**

You must save the page before navigating away from it. If you do not save the folio, it and any changes to it are lost.

### 24.2.3.1.2 Deleting Items from a Simple Folio

To delete items from a simple folio:

1. On the Edit Simple Folio page, click the row of the item to be deleted. The row is highlighted.

 **Note:**

To select multiple, sequential items, press and hold the Shift key and click the first and last items. To select multiple, non-sequential items, press and hold the Ctrl key and click each item.

2. Click the **Delete Row** icon in the table heading above the thumbnail column. The item or items are removed from the displayed list of items in the folio.
3. Choose **Save changes** from the Actions menu to save the content to the folio.

 **Note:**

You must save the page before navigating away from it. If you do not save the folio, it and any changes to it are lost.

### 24.2.3.1.3 Reordering Items in a Simple Folio

To reorder items in a simple folio:

1. Click and hold on the row you want to move and drag it to the new position, then release.
2. Choose **Save changes** from the Actions menu to save the content to the folio.

### 24.2.3.1.4 Updating Simple Folio Element Information

The content of a simple folio is specified in an XML file stored in Content Server. This folio information is displayed in the table of the Edit Simple Folio page. Because this information is

specific to the folio, you can change the folio information without affecting the metadata of the content item or the information in any other folio with which a content item may be associated.

To update the element information in a simple folio:

1. On the Edit Simple Folio page, double-click the information you want to update. An editable text field opens above the information. By default, you can update only the name and description.
2. Modify the information and press the Enter key, or click anywhere outside of the text field. The changes are applied.
3. Choose **Save changes** from the page Actions menu. The element information is updated.

## 24.2.3.2 Editing an Advanced Folio

An advanced folio is a folio that allows for a hierarchical structure and the insertion of *Hypertexts*, which are hyperlinks to websites. Like a simple folio, you can add, delete, or reorder items within an advanced folio. Unlike simple folios, you can nest items in folders (nodes), create empty slots as placeholders for content items, search for and add items, and check in new content through the folio interface.

The structure and content associated with an advanced folio is specified in an XML file stored in Content Server. This information is displayed in the Element Info tray area of the Edit Folio page. Because this information is specific to the folio, you can change the folio information without affecting the metadata of the content item or the information in any other folio with which a content item may be associated.

The structure of an advanced folio may be predefined in a template by the system administrator. The structure of a template-based folio may or may not be modified later, depending on the template.

### 24.2.3.2.1 Adding and Organizing Nodes and Slots

You can add, move, and delete nodes and slots from folios with the Edit Folio page. Working with the folio hierarchy and organizing items within it is similar to working with folders and files in other environments, such as a computer file system. For example, you can drag-and-drop content items into a folder or slot from the Source Items tray, and drag-and-drop nodes, slots, and items within the folio hierarchy area to reorganize them. Additionally, right-click a node, slot, or item in the folio hierarchy section to display a contextual menu with options for the selection identical to those in the contextual menu of the Element Info area.

To add nodes or slots to a folio:

1. Navigate to the Edit Folio page of the folio to modify.
2. Select the node in which to add a new node or slot. You can select a root node, or a node within another node.
3. Right-click the selected node or click the contextual menu icon in the Element Info area to open an element contextual menu.
4. Choose **Create Node** or **Create Slot** from the contextual menu. A new node or slot is displayed.
5. Choose **Save changes** from the Actions menu to save the changes to the folder hierarchy.

 **Note:**

If you do not save changes before navigating away from the folio, any changes are lost.

### 24.2.3.2.2 Adding Content Items to an Advanced Folio

Content items are added to an advanced folio by using the Source Items tray on the Edit Folio page, the Element Info contextual menu, a Search Result page, or a digital asset basket. For example, content items are added to a folio by one of the following ways:

- By using the Source Items area on the Edit Folio page to search for existing content, and then dragging the items into the folio hierarchy  
For more information, see [Adding Items from the Source Items Area](#).
- By displaying a digital asset basket in the Source Items area on the Edit Folio page, and then dragging the items into the folio hierarchy  
For more information, see [Adding Items from the Source Items Area](#).
- By choosing **Insert Item by Search** from the Element Info contextual menu to search for existing content and add it to the folio  
For more information, see [Inserting an Existing Item Using a Contextual Menu](#).
- By choosing *Insert Item by Checkin* from the Element Info contextual menu to check a new content item and add it to the folio  
For more information, see [Inserting a New Item Using a Contextual Menu](#).
- By using a Search Result page to add existing content to the Source Items area of a new or existing advanced folio  
For more information, see [Adding Items from a Search Result page](#).
- By publishing content gathered in a digital asset basket to a new folio created during the publishing process  
For more information, see [Adding Items from a Digital Asset Basket](#).

### 24.2.3.2.3 Adding Items from the Source Items Area

The Source Items area of an Edit Folio page displays content checked in to Content Server. The content may be collected in a digital asset basket that is displayed in the Source Items area, or collected using the Source Items area search feature. The source items contextual menu lists each set of items that can be displayed in the Source Items area.

**To add items to a folio from the Source Items area:**

1. Navigate to the Edit Folio page of the folio where you want to add content.
2. From the Source Items area contextual menu, choose the content set containing the items to add.
3. Select the appropriate item in the Source Items area, and drag it to the node or slot in the folio to which to add the item.
4. From the Edit Folio page Actions menu, choose **Save changes**.

 **Note:**

If you do not save changes before navigating away from the folio, any changes are lost.

If no items have been collected into a digital asset basket or into the Source Items area, you can search for items using the Source Items area search function.

**To collect items into the Source Items area using the search function:**

1. Navigate to the Edit Folio page of the folio where you want to add content.
2. Click **Search** in the Source Items area.
3. On the Search for Items page, select a profile to use for searching, if any, and click **Next**.
4. On the search form, select the criteria appropriate to the item for which you are searching, and click **Search**.
5. On the Content Listing page, select the check box next to the item or items in the search results to collect, then click **Next**. The items are listed in the Source Items area.
6. From the Edit Folio page Actions menu, choose **Save changes**.

 **Note:**

You cannot select items across multiple pages of search results.

#### 24.2.3.2.4 Inserting an Existing Item Using a Contextual Menu

Items that have been checked in can be searched for and inserted directly into a folio node or slot by choosing **Insert Item by Search** from the Element Info contextual menu. You can also right-click the appropriate node or slot to access this contextual menu.

To search for and insert a content item directly into a folio node or slot:

1. Navigate to the Edit Folio page of the folio where you want to add content.
2. Select the node or slot into which the content goes.
3. Right-click the node or slot, or click the contextual menu in the Element Info area and choose **Insert Item by Search**.
4. On the Search for Item page, choose the criteria appropriate to the item for which you are searching, and click **Search**.
5. On the Content Listing page, click **Select** next to the item to insert. The item is inserted into the folio.

#### 24.2.3.2.5 Inserting a New Item Using a Contextual Menu

New items that have not yet been checked in can be inserted directly into a folio node or slot by using **Insert Item by Checkin** in the Element Info contextual menu. You can also right-click the appropriate node or slot to access this contextual menu.

To search for and insert a content item directly into a folio node or slot:

1. Navigate to the Edit Folio page of the folio where you want to add content.

2. Select the node or slot into which the content goes.
3. Right-click the node or slot, or click the contextual menu in the Element Info area and choose Insert Item by Checkin.
4. On the Item Check In page, fill in the appropriate criteria for the item you are checking in, and click **Check In**.
5. On the check-in confirmation page, click **Add Item to Folio**. The item is inserted into the folio.
6. From the Edit Folio page Actions menu, choose **Save changes**.

#### 24.2.3.2.6 Adding Items from a Search Result page

You can add items from a Search Result page either directly to a new folio, or to the Source Items area of an existing folio or new template-based folio. When listed in the Source Items area, content can be added to the folio by dragging it to the appropriate node or slot. For more information, see [Adding Items from the Source Items Area](#).

##### To add items from a Search Result page to a new folio:

1. From a Search Result page, select the check box next to the item or items you want to add to the folio.
2. From the table Actions menu, choose **Add items to folio**.
3. On the Add Items to Folio page, select **New folio** and click **Next**.
4. On the Pick Folio Type page, select **Simple Folio**, or select **Advanced Folio** and choose an appropriate template, if any.
  - Selecting **Simple Folio** inserts the selected content items in the root node of a flat, single node folio.
  - Selecting **Advanced Folio** enables the Folio Template list, providing access to folio templates with structure predefined by a system administrator.
5. Click **Load folio**.

If you selected **Simple Folio** in Step 4, the Edit Simple Folio page opens with the selected elements listed. If you selected **Advanced Folio** in Step 4, then the Edit Folio page opens with the selected content items inserted into the root node of the advanced folio.

6. From the Actions menu, choose **Save changes**.

 **Note:**

If you do not save changes before navigating away from the folio, any changes are lost.

##### To add items from a Search Result page to an existing folio:

1. From a Search Result page, select the check box next to the item or items you want to add to the folio.
2. From the table Actions menu, choose **Add items to folio**.
3. On the Add Items to Folio page, select **Existing folio**, and click **Next**.
4. On the Select Folio Profile page, select the appropriate profile, if any, and click **Next**.

5. On the Search for Existing Folio page, choose the criteria appropriate to the folio for which you are searching, and click **Search**.
6. On the Folio Listing page, click **Select** by the folio to which the content items are to be added.
7. On the Edit Folio page of the selected folio, drag content from the Source Items area to the appropriate node or slot. For more information, see [Adding Items from the Source Items Area](#).
8. From the Edit Folio page Actions menu, choose **Save changes**.

#### 24.2.3.2.7 Adding Items from a Digital Asset Basket

Digital asset baskets are used to manage collected items. Items in digital asset baskets are displayed in the Source Items area of a folio when a digital asset basket is chosen from the Source Items contextual menu. When displayed in the Source Items area, content in a digital asset basket can be added to the folio by dragging it to the appropriate node or slot. For more information, see [Adding Items from the Source Items Area](#).

Additionally, items in a digital asset basket can be published to a new folio from the Digital Asset Basket page.

To publish content in a digital asset basket:

1. Open **My Baskets** in the **My Content Server** tray and select the digital asset basket that contains the items to be published to a new folio.
2. From the Actions menu, choose **Publish to folio**.
3. On the Edit Folio page, the published items are inserted at the root level of a new folio.
4. From the page Actions menu, choose **Save folio**.
5. Continue with Step 6 of [Creating an Advanced Folio](#).

 **Note:**

If you do not save changes before navigating away from the folio, any changes are lost.

#### 24.2.3.2.8 Updating Advanced Folio Element Information

To update the element information in an advanced folio:

1. On the Folio Structure tray of the Edit Folio page, select the node, slot, or item you want to update.
2. In the Element Info tray, modify the information and press the Enter key, or click anywhere outside of the text field. The changes are applied.
3. From the page Actions menu, choose **Save changes**. The element information is updated.

### 24.2.4 Taking Snapshots

A folio's hierarchy is defined in an XML file checked in to Content Server as a content item. Like any content item, a folio can have multiple revisions. Unlike other content items, however, new revisions of a folio are created by taking a snapshot of the folio using the Edit Folio page Actions menu, rather than explicitly checking out the content and checking in a new revision.

When a snapshot is taken, the current hierarchy is saved and duplicated as a new revision. The new revision can continue to be edited. The previous revision maintains the folio hierarchy at the point the snapshot was taken. Like any content item, you can access the revision history of the folio from the folio content information page.

**To take a snapshot of a folio:**

1. Navigate to the Edit Folio page for the folio.
2. Choose **Create snapshot** from the Actions menu. The Edit Folio page refreshes.

 **Note:**

You can verify that a new revision has been created by choosing **Content Item Info** from the Actions menu on the Edit Folio page and reviewing the revision history on the Content Information page.

## 24.2.5 Locking and Unlocking Folios

Locking a folio takes a snapshot of a folio and locks it, preventing it from being edited. After a folio is locked, people who have rights to edit the folio are directed to the View Folio page instead of the Edit Folio page.

**To lock a folio:**

1. Navigate to the Edit Folio page of the folio.
2. Choose **Lock folio** from the Actions menu.

If required, you can unlock a locked folio for additional edits. Unlocking a folio duplicates the locked folios hierarchy as a new revision available for editing.

**To unlock a folio:**

1. Navigate to the Edit Folio page of the folio.
2. Choose **Create editable revision** from the Actions menu.

## 24.2.6 Downloading Folio Renditions

Your system administrator defines renditions and can make them available in a variety of forms. For example, a single ZIP file rendition could contain all folio content to which you have access. A PDF rendition could assemble all folio content to which you have access into a single PDF file suitable for printing.

**To download renditions of a folio:**

1. Navigate to the Edit Folio page of the folio.
2. Choose the rendition you require from the Renderers menu.
3. In the dialog box, specify the location for the download.

 **Note:**

A PDF rendition is only possible if the content associated with the folio has a PDF Web-viewable file. That is, either the associated content item is a PDF file, or that your system administrator has set up PDF Converter to generate a PDF version.

 **Note:**

Only folio items that have a PDF version become part of the PDF rendition.

## 24.2.7 Finding Existing Folios

Because Content Server manages a folio as a single XML file, you can find folios by searching Content Server in the same way you would find any content item. You can use the search tray, the Advanced Search page, or the Quick Search field to search for folio titles or other associated metadata. Only folios for which you have permissions are displayed in the search results. A folio icon is displayed in the Actions column of the search results field. Click the icon to display the folio. If you can edit the folio, the Edit Folio page opens, otherwise, the View Folio page opens.

On the content info page of a content item that is in a folio, there is a Folio Membership section (above the Revision table) with a *show* link which lists the folios to which the content is a member. There are also action icons next to the listed folios with the option to View the Folio or see it's content info.

## 24.2.8 Viewing Folios

You can view Folios in the following ways:

- The Edit Folio page displays the folio hierarchy and allows you to edit the folio, provided you have the rights to do so.
- The View Folio page shows, by default, the folio hierarchy but does not allow you to edit it. Your system administrator can define additional views that may not resemble the default folder hierarchy view.
- View the native XML file (file extension .xcsr) from a content information page link.

## 24.2.9 Viewing Folio Information

Folio information, including revision history, is displayed on the content information page of the XML file checked in to Content Server. To access folio information, click the Info icon next to a folio in the Actions column on a Search Result page, or choose **Content Item info** from the Actions menu on the Edit Simple Folio page, Edit Folio page, or View Folio page.

## 24.2.10 Subscribing to Folios

You can subscribe to simple and advanced folios like any other item in Content Server. Because changes can be made to folios and folio items without causing a new revision to the folio, however, you can choose the types of changes that cause you to be notified using the Subscribe to *folio\_name* page.



**To subscribe to changes made to a folio or folio items:**

1. Choose **Subscribe** from the Content Actions menu on the content information page of the folio to which you want to subscribe.
2. On the Subscribe to folio\_name page, select the check box next to one or more of the actions for which to be notified:
  - **Child update:** Any change to content linked to by this folio sends notification
  - **Add:** Additions to this folio sends notification
  - **Modify:** Modifications to the attributes in this folio sends notification
  - **Delete:** Deletions from this folio sends notification
3. Click **Subscribe**. The standard content information page for the folio opens.

## 24.2.11 Using Digital Asset Baskets

Digital asset baskets are a useful way to collect items checked in to Content Server. You add content to a digital asset basket from the Search Result page. When collected in a digital asset basket, items can be published to new folios or easily accessed from within existing folios in the Source Items tray of the Edit Folio page. You can create multiple baskets with the Manage Content Baskets page to help organize content by project, author, date, type, or any other way that you find useful.

Content added to digital asset baskets still resides in the repository. It does not change physical locations. Instead, the metadata for items in a digital asset basket updates to reflect the basket or baskets to which a content item is added. Click a digital asset basket link to execute a search for the metadata reflecting that digital asset basket, and return a search result page listing the content items. The same content can be collected in multiple baskets.

### 24.2.11.1 Managing Digital Asset Baskets

Digital asset baskets are created and deleted using the Manage Content Baskets page. You can create multiple baskets, but only one basket is active at a time. You can only add content to the active basket.

**To create a digital asset basket:**

1. In the **My Content Server** tray, click **My Baskets**.
2. On the Manage Content Baskets page, click **Append basket**. A new field is displayed on the page.
3. Enter a name for the basket in the new field.
4. Select **Active** next to the new basket to make it the active basket, otherwise leave disabled. Only the active basket can have content added to it.
5. Click **Update**. The new basket is displayed under **My Baskets** in the **My Content Server** tray.

**To delete a digital asset basket:**

1. Click **My Baskets** in the **My Content Server** tray.
2. On the Manage Content Baskets page, select **Delete** next to the basket to delete and click **Update**. The basket is removed from the Manage digital asset baskets page and from under **My Baskets** in the **My Content Server** tray.

## 24.2.11.2 Working with Digital Asset Baskets

You can create multiple digital asset baskets to help organize collected content. Only the active basket can have content added to it. Content is added to the active basket from a Search Result page. You can move content between baskets, copy content into another basket, and reorder content within a basket.

### 24.2.11.2.1 Setting the Active Basket

You can set the active basket on the Manage Digital Asset Baskets page.

**To set the active basket:**

1. Click **My Baskets** in the **My Content Server** tray.
2. On the Manage Content Baskets page, select **Active** next to the basket and click **Update**. The Basket Icon changes, and *Active* is displayed next to the newly active basket under **My Baskets** in the **My Content Server** tray.

### 24.2.11.2.2 Adding Content to the Active Basket

You can add content to the active basket from a Search Result page.

**To add content to the active basket:**

1. From a Search Result page, select the check box next to the item or items you want to add to the active basket.
2. Choose **Add to active basket** from the table Actions menu above the check boxes.
3. To verify that the content is added to the active basket, open **My Baskets** in the **My Content Server tray** and click the active basket icon.

### 24.2.11.2.3 Moving and Copying Content Items

If you inadvertently add content to the wrong basket and want to move it, or to reorganize your content into different baskets, you can do so. Also, you can copy content in one basket into another basket, so that it is displayed in both.

**To move or copy content items from one basket to another:**

1. Open **My Baskets** in the **My Content Server tray** and click the basket link of the basket from which you want to move or copy content.
2. Select the check box next to the item or items you want to move or copy.
3. Choose **Move selected items** or **Copy selected items** from the table Actions menu.
4. On the Move/Copy Basket Items page, click the basket to which the items are to be moved or copied.

### 24.2.11.2.4 Removing Content Items

You can remove items from any digital asset basket.

**To remove content items from a basket:**

1. Open **My Baskets** in the **My Content Server tray** and click the basket link of the basket from which you want to remove content.

2. Select the check box next to the item or items to remove.
3. Choose **Remove selected items** from the Actions menu.

## 24.2.12 Understanding Folio Workflows

When working with folios in a workflow, it is important to remember that technically a folio is an XML file checked in to Content Server that lists associated content in a meaningful way. When a folio is routed in a workflow, it is the associated XML file that is routed. It is the structure of the folio that is reviewed and edited. The items themselves are not routed.

Think of the folio as a list of items. When a folio is routed in a workflow, you are asked to review the list of items, and possibly to update, add to, or rearrange the items. In the examples in [The Folio Structure](#), a company used a template to create a folio to include information for a sales presentation. The new folio has the latest press releases and company background associated with it automatically, based on the template, and empty slots for slide presentations from several departments pertinent to the prospective client.

In this case, when the folio gets routed through a workflow, the appropriate people are asked to create slide presentations and insert them into the appropriate slots on the folio. The slide presentations they work on can go through any number of separate workflows and be checked in and out any number of times, but the folio won't move on in the workflow until content is associated with the specified empty slots. After that is done and the folio moves out of workflow, the folio is associated with the latest revisions of the content items listed in the folio, until a snapshot of the folio is taken or the folio is locked.

# 25

## Using Workflows

Learn how to participate in and manage the workflows to which you belong. This chapter has the following topics:

- [About Workflows](#)
- [Entering a File to a Workflow](#)
- [Reviewing Revisions in a Workflow](#)
- [Working with a Rejected Revision](#)
- [Viewing Workflow Information](#)

### 25.1 About Workflows

A workflow specifies how to route content for review and approval before it is released to the system. The workflow notifies users by e-mail when they have a file to review. For information about workflow types and uses, see [Understanding Document Workflows](#).

### 25.2 Entering a File to a Workflow

When a basic workflow starts, it sends an e-mail message to the contributors, who must check in the designated files as the first step in the workflow.

To check in a file to begin a basic workflow:

1. Read the Workflow Started Notification message.
2. On the Workflow Content Items page, click the **Review Workflow Content** link.
3. Choose **Check Out** from the contextual menu in the **Actions** column.
4. On the Check-Out Confirmation page, check the content item into the system using one of the following methods:
  - If the check-out confirmation page is still displayed, click **Check In**.
  - Choose **Check In** from the contextual menu in the **Actions** column on the Workflow Content Items page.
  - Open the Content Management tray, click **Active Workflows**, click the name of the workflow, then choose **Check In** from the contextual menu in the **Actions** column on the Workflow Content Items page.
5. Fill in the content check-in form.
  - If you select the **Revision Finished Editing** check box, the revision moves from Edit status to GenWWW status and goes to the next step in the workflow.
  - If you leave the **Revision Finished Editing** check box unselected, the file is checked in but remains in Edit status instead of moving to GenWWW status. Return to Step 3 to check out the file and check it back in.

 **Note:**

If a document included in a workflow fails to convert in the check-in process, the content item is set to Edit status automatically. For this reason, include documents in the workflow that are valid for conversion.

6. Click **Check In** and provide user credentials if prompted.

## 25.3 Reviewing Revisions in a Workflow

When the next step in a workflow is a review step, the reviewers receive an e-mail message. When the appropriate number of reviewers approve the revision, the content item goes to the next step in the workflow.

To review a file in a workflow:

1. Read the Workflow Review Notification Message.
2. Click the **Review Workflow Item** link.

 **Note:**

For a reviewer step, you can choose to *Sign and Approve*, *Approve* or *Reject* the content item. For a reviewer/contributor step, you can choose to *Check Out*, *Approve*, or *Reject* the content item.

3. On the Workflow Review page:
  - Review the file in the area to the right of the Workflow Review panel.
  - Click the **Web Viewable** link to see a version of the content in your browser.
  - Click the **Native File** link to save a copy of the file in its original format.
  - Click the **HTML Rendition** link to view the file as HTML in your browser.
4. If you have reviewer/contributor permission and you would like to edit the file, click the **Check out** link in the Workflow Review panel to check out the content item for editing. Otherwise, continue with Step 12.
5. On the Check-Out Confirmation page, get a copy of the original file and edit it.
6. Check the content item back in to the system using one of the following methods:
  - If the check-out confirmation page is still displayed, click **Check In**.
  - Choose **Check In** from the contextual menu in the **Actions** column on the Workflow Content Items page.
  - Open the Content Management tray, click **Active Workflows**, click the name of the workflow, then choose **Check In** from the contextual menu in the **Actions** column on the Workflow Content Items page.
7. Fill in the Checked-Out Content page.
  - If you select the **Approve Revision** box, the revision moves from Edit status to GenWWW status and goes to the next step in the workflow when the required number of reviewers approve. Step 8 is not required.

- If you leave the **Approve Revision** box unselected, the revision is checked in but remains in Review status instead of moving to GenWWW status. You must still approve or reject the revision.
8. Click **Check In**.
  9. To reject the revision, click the **Reject** link in the Workflow Review panel.
  10. On the Reject Content Item page, enter a message explaining the reason for rejecting the content item. When you reject a content item, it is sent back to the most recent workflow step that permitted contribution.
  11. To approve the revision, click the **Approve** or the **Sign and Approve** link in the Workflow Review panel.
  12. If you click **Sign and Approve**, on the Sign Workflow Content Item page, specify your password and any additional metadata values and click **Sign and Approve**.
  13. Review the information in the confirmation window and click **Close Window**.

## 25.4 Working with a Rejected Revision

When a revision is rejected, the users assigned to the most recent contribution step receive an e-mail message.

To edit a rejected file:

1. Read the Workflow Content Item Reject Notification message.
2. Click the **Review Workflow Content** link.
3. On the Workflow Content Items page, choose **Check Out** from the contextual menu in the **Actions** column.
4. On the Check-Out Confirmation page, get a copy of the original file and edit it.
5. Check the content item back into the system using one of the following methods:
  - If the check-out confirmation page is still displayed, click **Check In**.
  - Choose **Check In** from the contextual menu in the **Actions** column on the Workflow Content Items page.
  - Open the Content Management tray, click **Active Workflows**, click the name of the workflow, and then choose **Check In** from the contextual menu in the **Actions** column on the Workflow Content Items page.
6. Fill in the Checked-Out Content page.
  - If you select the **Revision Finished Editing** box, the file moves from Review status to GenWWW status and goes to the next step in the workflow.
  - If you leave the **Revision Finished Editing** box unselected, the file is checked in but remains in Review status instead of moving to GenWWW status. You must still approve the file.
7. Click **Check In**.

## 25.5 Viewing Workflow Information

There are several ways to view information about a content item in a workflow. With links between workflow pages you can perform the following tasks:

- [Viewing a List of Active Workflows](#)

- [Viewing a List of Your Workflows](#)
- [Viewing Workflow History and Information About a Workflow Step](#)
- [Viewing Content Information](#)

## 25.5.1 Viewing a List of Active Workflows

To view a list of all active workflows in the system:

1. Open the Content Management tray.
2. Click **Active Workflows**.

The Active Workflows page opens.

## 25.5.2 Viewing a List of Your Workflows

To view a list of workflows that require action from you:

1. Open the My Content Server tray.
2. Click **My Workflow Assignments**.
3. To remove content items from the Workflow in Queue page, choose **Remove from Queue** from the contextual menu in the Actions column. (The content item is not deleted from the workflow.)

## 25.5.3 Viewing Workflow History and Information About a Workflow Step

To view workflow history and information about a workflow step:

1. Display either the Workflow Content Items page or the Workflow in Queue page.
2. Choose **Workflow Info** from the contextual menu in the Actions column.

The Workflow Info for Item page opens.

## 25.5.4 Viewing Content Information

To view content information for a revision in a workflow:

1. Open the My Content Server tray.
2. Click **My Workflow Assignments**.
3. On the Workflow in Queue page, choose **Content Info** from the contextual menu in the Actions column.

The Content Information page opens.

# 26

## Working with Images and Videos

Using Oracle WebCenter Content, you can effectively manage digital assets and quickly find, group, convert, and download images and videos of various sizes, formats, and resolutions. This functionality is installed but disabled by default. Your system administrator chooses whether to enable this functionality for your site. The chapter covers the following topics:

- [About Digital Asset Management with Oracle WebCenter Content](#)
- [Supported Input Formats](#)
- [Supported Video Output Formats](#)
- [Checking In a Digital Asset](#)
- [Finding Renditions and Information](#)
- [Rendition Information Page](#)
- [Image Data Page](#)
- [Rendition Parameters Page](#)
- [Video Preferences Page](#)
- [Working with Renditions](#)
- [Working with Standard Content Items](#)
- [Managing Digital Assets on a Macintosh Client](#)

### 26.1 About Digital Asset Management with Oracle WebCenter Content

Using Oracle WebCenter Content to manage digital assets enables you to quickly find, group, convert, and download images and videos of various sizes, formats, and resolutions to meet your business requirements, while maintaining a consistency of use across your organization. For example, an organization may have a logo in a variety of sizes for advertisements, Web pages, and presentation, or a training video in a variety of formats for streaming on an intranet, presenting to an audience, or copying to tape.

Work with your system administrator and other contributors to define the appropriate size and output. At check-in, the digital asset is automatically converted into the defined formats and sizes, known as renditions. You can then search for the asset using standard metadata or closed-caption text if it is a video asset. From the Rendition Information page you can add renditions to a digital asset basket and download a single compressed file that contains all of the renditions.



Figure 26-1 Overview

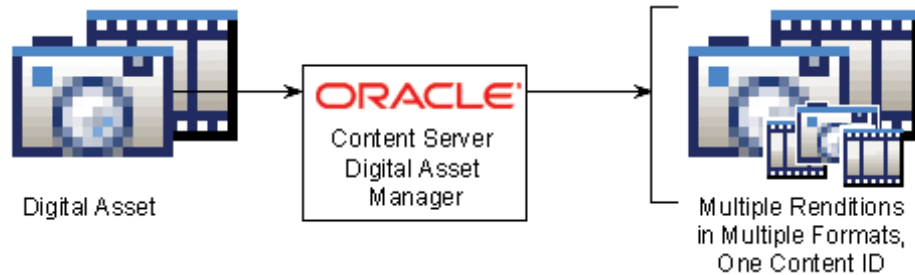

When enabled, the ability to manage digital assets adds the following pages to Oracle WebCenter Content Server:

- [Rendition Information Page](#)
- [Video Preferences Page](#)
- [Digital Asset Basket Page](#)
- [Add a Rendition Page](#)
- [Rendition Parameters Page](#)
- [Image Data Page](#)
- [Add/Edit Attachments](#) page

The ability to manage digital assets also adds functionality to the Content Check-In, Content Information, Content Information Update pages, all search result pages, and the **My Content Server** tray.

The ability to manage digital assets enables you to create and find images and videos in specified formats and sizes. This helps your organization maintain consistent standards for branding and asset use, while providing the right content to the right people in the right format.

Managing digital assets allows you to create multiple formats of digital assets automatically when they are checked in to Oracle WebCenter Content Server, and lists the formats under one content ID. Digital assets, such as a corporate artwork or commercial videos, maintain a standard size and quality in each format required by your organization. The content management and workflow features of Oracle WebCenter Content Server uses only approved versions because assets are created from a single source managed by Oracle WebCenter Content Server.

Managing digital assets with Oracle WebCenter Content Server gives you the confidence that you are using the approved asset in the proper format. For example, an image of the logo in a format for use on a Web-site can be bundled and downloaded with other formats of the logo for use in office presentations or print collateral, all from a single digital asset checked in to Oracle WebCenter Content Server. Or, a low-bandwidth version of a training video can be posted to a streaming server while a high-bandwidth version can be provided to a vendor for replication to tape or DVD.

Each format created of a digital asset is called a rendition. Each image rendition includes information about size, color, format, and other criteria defined by your system administrator. Each video rendition includes information about display size, bandwidth, and expected use. Renditions are grouped into rendition sets. When you check in a digital asset, you choose a rendition set, which then determines what renditions are created for the asset. When finding a digital asset for use, all renditions of the asset are listed on the asset's Rendition Information page, and are available for download.

Figure 26-2 Example Image Rendition Set and Resulting Rendition Listing

**Digital Asset**

**Selected Rendition Set**

Format	Size	Dimensions	Resolution
JPEG	20 KB	800 x 281	72 dpi
GIF	1 KB	102 x 36	N/A
Windows BMP	2.2 MB	2550 x 897	600 dpi
EPS / PostScript	528 KB	2550 x 3300	300 dpi

**Created Renditions**

Figure 26-3 Example Video Rendition Set and Resulting Rendition Listing

**Digital Asset**

**Selected Rendition Set**

Format	Size	Dimensions	Frame Rate
Quicktime	1.5 MB	320 x 240	15 fps
RealMedia	1.8 MB	320 x 240	15 fps
WindowsMedia	2.2 MB	320 x 240	15 fps
MPEG	2.1 MB	320 x 240	15 fps

**Created Renditions**

## 26.2 Supported Input Formats

Supported input formats are determined by the graphic or video conversion application as set up by your system administrator.

### Image Input Formats

Common image input formats include the following:

- JPG/JPEG (Joint Photographic Expert Group)
- GIF (Graphics Interchange Format)
- BMP (Bitmap)

- PNG (Portable Network Graphics)
- TIFF (Tag Image File Format)
- PSD (Adobe Photoshop)
- AI (Adobe Illustrator)
- PDF (Portable Document Format)

### Image Video Formats

Common video input formats include the following:

- Flash Media Format
- MPEG Layer 3 and 4 Elementary Stream Media Format
- PacketVideo MPEG4 Format
- QuickTime Media Format
- QuickTime Streaming Format
- Windows Media Format
- AVI Media Format
- DVD Stream Media Format
- MPEG1 System Stream Media Format
- MPEG2 Program Stream Media Format
- MPEG2 Transport Stream Format
- MPEG4 Media Format
- Pinnacle MediaStream Media Format

For a comprehensive listing of supported format, see the conversion application documentations.

Formats supported by the conversion application must also be associated with the conversion process within Oracle WebCenter Content Server by the system administrator using the Oracle WebCenter Content Server Configuration Manager. If a supported format is not rendering, see your system administrator.

## 26.3 Supported Video Output Formats

Output formats are limited to what your browser displays effectively. Only output formats supported by Windows Media Player, Real Player, Flash Player, or Quicktime Player are available for viewing in your Web browser. Any assets rendered in a format not supported by those players is still be managed by Oracle WebCenter Content Server, but is available only for download only.

Oracle WebCenter Content currently supports the following video output formats:

- MPEG Layers 1, 2, and 4 (.mpg, .mpeg, .mp2, .mp4)
- Quicktime (.mov)
- Audio Video Interleave (.avi)
- Flash Video (.flv)

Other output formats not listed here but supported by your media player may work when set up properly by your system administrator. For additional format requests, see your system

administrator. For information on formats supported by your media player, see the player's help system.

## 26.4 Checking In a Digital Asset

When the ability to manage digital assets is added to Oracle WebCenter Content Server, the Rendition Set list is displayed on the content check in form.

**Figure 26-4** Content Check-In Form with Rendition Set List

The screenshot shows a web form titled "Content Check In Form". The form is divided into two main sections. The top section contains the following fields: "Image Rendition Set" with a dropdown menu showing "CorporatImage"; "Type" with a dropdown menu showing "ADACCT - Acme Accounting De"; "Title" with an empty text input field; "Author" with a text input field containing "sysadmin" and a dropdown menu also showing "sysadmin"; and "Security Group" with a dropdown menu showing "Public". The bottom section contains two rows: "Primary File" with an empty text input field and a "Browse..." button; and "Alternate File" with an empty text input field and a "Browse..." button.

To check in a digital asset, perform these steps:

1. Open the content check-in form.
2. Choose a rendition set from the Rendition Set list.
3. Enter a title and any additional metadata for the asset. The title you enter must be 249 or fewer characters in length.
4. Click **Browse** to locate the primary file.
5. Click **Check In**.

Oracle WebCenter Content Server uses the file extension, such as .psd, .jpg, .mov, or .avi, to determine if an item is a digital asset. Digital assets checked in to Oracle WebCenter Content Server must have the correct file extension appended to the file name. For example, a Photoshop file named CorporateLogo.psd is correctly identified by Oracle WebCenter Content Server as a digital asset, but one named CorporateLogo is not.









Do not select an alternate file when checking in a digital asset. Doing so prevents the primary file from rendering.

## 26.5 Finding Renditions and Information

Searching for digital assets is identical to searching for other types of content. Digital assets have an additional icon displayed in the standard Search Result page. The Rendition Information icon links to the Rendition Information page of the asset.

**Figure 26-5 Search Result Page with Rendition Information Icon**

**Search Results** Found 12 items matching the query.

Select	ID	Title	Date	Author	Actions
<input type="checkbox"/>	000_000094	Stellent Logo	2/24/07	sysadmin	  
<input type="checkbox"/>	000_000090	Japanese Symbol	2/2/07	edmonton	 
<input type="checkbox"/>	000_000088	Wizard image	12/23/06	tenelt	  

Rendition Information Icon

Because you are working with images and videos, you may want to set your default search result view to Thumbnail View. To do so, choose **Thumbnail View** from the Content Actions menu on a Search Result page.

**Figure 26-6 Thumbnail View Search Result Page.**

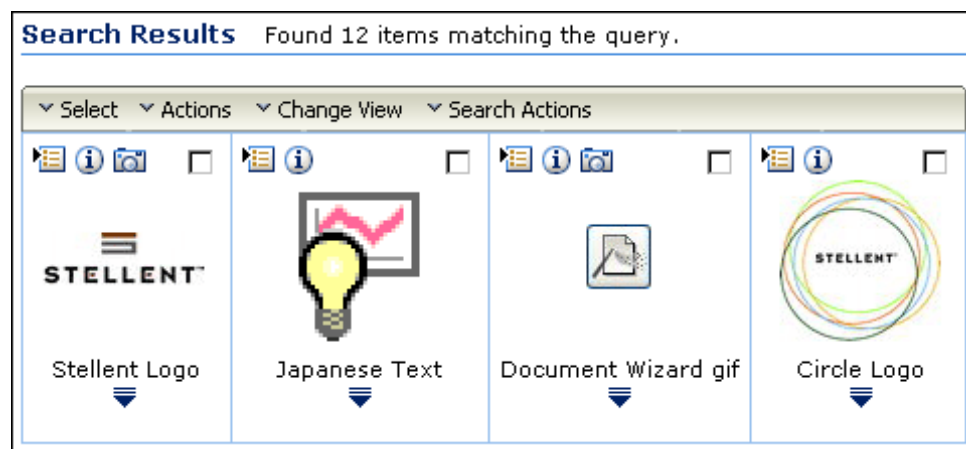

## 26.6 Rendition Information Page

When a digital asset is checked in to Oracle WebCenter Content Server, multiple renditions are created based on the rendition set chosen at the time of check-in. Just like with standard content, information about the original content item is indexed and displayed on the Content Information page. However, with a digital asset, information about the created renditions is also

displayed on the Rendition Information page, and on the story board and any closed-captioned text for video assets.

To access the Rendition Information page, click the associated link on the Content Information page, or from a search result page using the **Rendition Information** icon or the **Rendition information** link in the item Actions menu.

### Accessing The Rendition Information Page

To access the Rendition Information page of a digital asset from any page in Oracle WebCenter Content Server, perform one of these steps:

1. Search for the digital asset for which to view rendition information.
2. Click the **Rendition Information** icon next to the appropriate digital asset on a Search Result page, or choose **Rendition Information** from the item Action menu.

Alternately, you can access the Rendition Information page from the digital asset basket by performing these steps:

1. Click the **My Content Server** tray, click **My Baskets**, and then click **Digital Asset Basket**.
2. Click the **Rendition Information** icon next to the appropriate digital asset in your digital asset basket.

When the Rendition Information page opens, click the tabs at the top of the page to switch between the Content Information page, the Rendition Information page, and the Image Data page for the asset.

## 26.7 Image Data Page

The Image Data page displays information about the native image file checked in to Content Server. However, what that information is and how it is displayed is contingent on:

- The specific information the camera or application captures, and
- Whether the image is generated by a digital camera or an application (such as Photoshop).

### Image Information

The specific information that is displayed is dependent on the type of camera or application used to generate the image. Different digital cameras collect different information, depending on the camera features and capabilities.

Additionally, one camera might have a built-in GPS system and can record GPS coordinates into the image file. Another camera might not have that capability, and so wouldn't be able to output that information to the Image Data page. Similarly, an application such as Photoshop may generate information specific to its feature set while Paint Shop Pro would generate different information specific to its different feature set.

### Display Formats

How the information is displayed on the **Image Data** tab is dependent on whether the native image file is a JPEG from a digital camera or if it is from an application. Digital cameras store information using the EXIF standard (Exchangeable Image File format), which is a subset of the XMP standard (Extensible Metadata Platform). Both methods use the Oracle Outside In filters to generate XML to structure the data.

If the image is a JPEG from a digital camera, Outside In specifies the document type as JPEG File Interchange, and the EXIF data is displayed on the **Image Data** tab in a flat listing. If the image is from an application such as Adobe Photoshop, Outside In specifies the document

type as coming from the application (for example, `document type="Adobe Photoshop"`), and the XMP data is displayed on the **Image Data** tab with some hierarchical structure.

 **Note:**

If the image is a digital photograph that has been manipulated in Photoshop, the EXIF data gets aggregated and formatted as part of the XMP data, because EXIF is a subset of XMP.

Figure 26-7 shows the contents of the **Image Data** tab for a checked in digital photo. In this case, the information includes the image thumbnail and the photo's digital properties.

**Figure 26-7 Image Data Page of a Digital Photo**

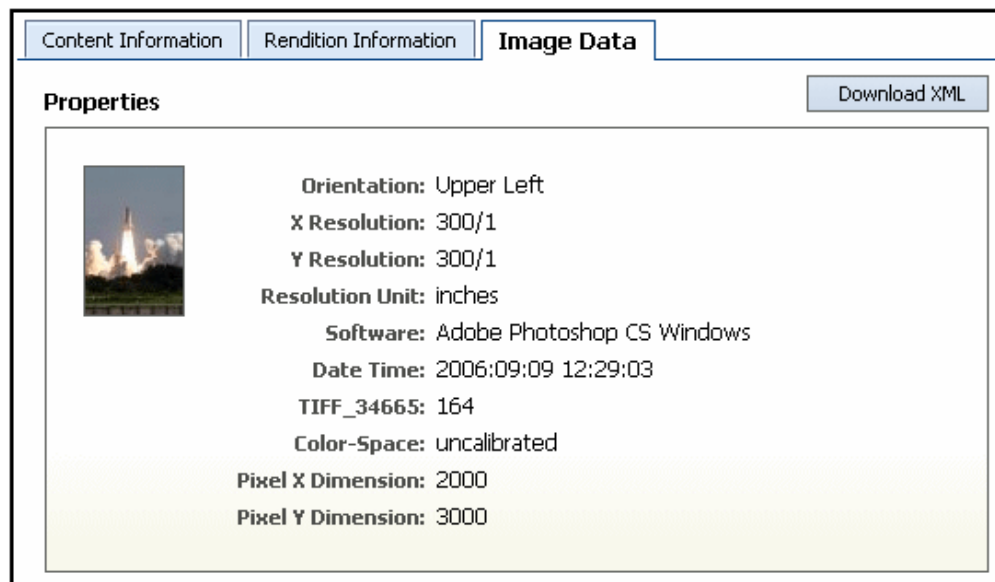
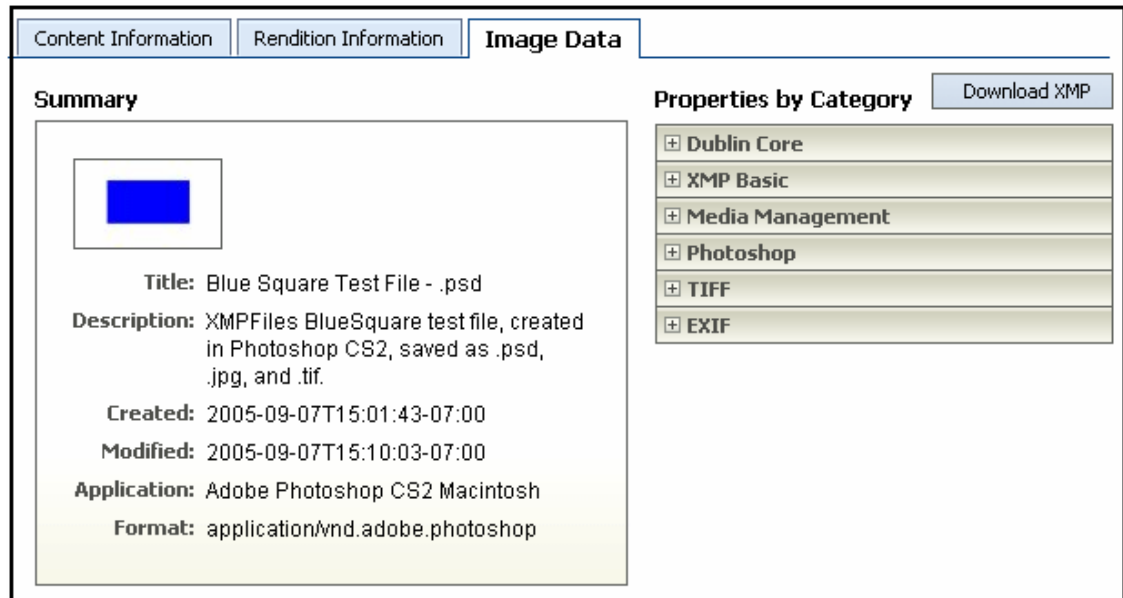

Figure 26-8 shows the contents of the **Image Data** tab for a Photoshop document with the XMP data displayed in a hierarchy.

Figure 26-8 Image Data Page of a Photoshop Image



### 26.7.1 Accessing the Image Data Page

To access the Image Data page of a digital asset from any page in Oracle WebCenter Content Server, perform one of these steps:

1. Search for the digital asset for which to view rendition information.
2. Navigate to either the Rendition Information page or the Content Information pages, and click the **Image Data** tab
3. Click the **Image Data** tab.

Alternately, you can access the Image Data page from the digital asset basket by performing these steps:

1. Click the **My Content Server** tray, click **My Baskets**, and then click **Digital Asset Basket**.
2. Click the **Rendition Information** icon next to the appropriate digital asset in your digital asset basket.

When the Image Data page opens, click the links at the top of the page to switch between the Content Information page, the Rendition Information page, and the Image Data page for the asset.

## 26.8 Rendition Parameters Page

To access the Rendition Parameters page, click the **Rendition Name Information** icon next to a rendition name on the Rendition Information page.

If an image rendition fails, the format column in the Renditions section of the Rendition Information page displays `Not Converted` for that rendition. In the case of a failed rendition, the Rendition Parameters page displays information about the cause of the failure.



Figure 26-9 Example of an image Rendition Parameters page.

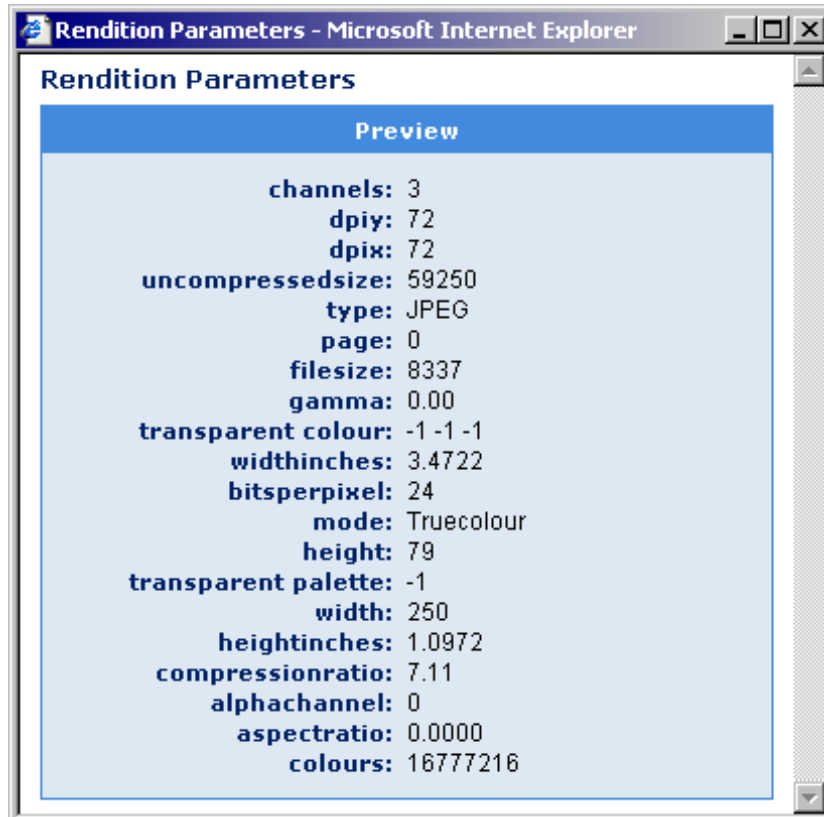
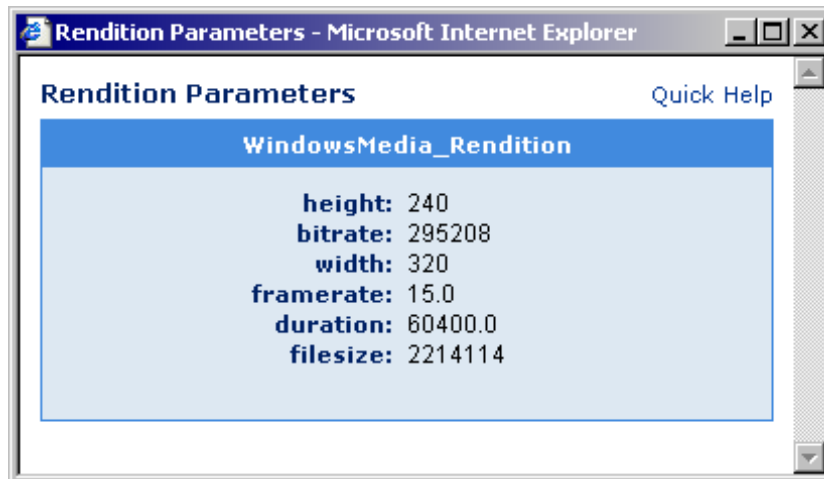

Figure 26-10 Example of a Video Rendition Parameters Page.



### Accessing The Rendition Parameters Page

To access the parameters of each specific rendition, perform these steps:

1. Access the Rendition Information page.
2. Click the **Rendition Name Info** icon.

## 26.9 Video Preferences Page

To play a video rendition, use the preview section of the Rendition Information page or click a Web-viewable link on the Content Information, digital asset basket, or Search Result pages. Oracle WebCenter Content determines what format to use as the default for the preview window based on information you specify on the Video Preferences page. You can also specify the number of keyframes displayed in the storyboard on the Rendition Information page, and your preferred bandwidth for the preview.

Other features of the Video Preferences page enable you to specify a video player for each rendition format and to set a [No Player Option](#) and a [No Format Option](#) for both that affect the preview display on the [Rendition Information Page](#). To open and play renditions in a standalone player, click the rendition name in the rendition section of the Rendition Information page. The player chosen is then determined by file format and helper application settings unique to your computer and browser, outside of Video Manager.

**Video Preferences for bsilver**

**Video Format Preference Order:**

1 - Flash	<input type="button" value="Move Up"/>  <input type="button" value="Move Down"/>
2 - WindowsMedia	
3 - Quicktime	
4 - MPEG	
5 - Real	
6 - NoPlayer	

**Video Bandwidth Preference:**

**Max Keyframe Segment Length:**

**Player Preference By Format:**

Real (rm)	<input type="button" value="Real Player"/>
Real (ra)	<input type="button" value="Real Player"/>
WindowsMedia (wmv)	<input type="button" value="No Player"/>
WindowsMedia (wm)	<input type="button" value="Windows Media Player"/>
WindowsMedia (wmx)	<input type="button" value="Windows Media Player"/>
WindowsMedia (wmd)	<input type="button" value="Windows Media Player"/>
WindowsMedia (wmz)	<input type="button" value="Windows Media Player"/>
WindowsMedia (avi)	<input type="button" value="Windows Media Player"/>
WindowsMedia (wma)	<input type="button" value="Windows Media Player"/>
WindowsMedia (wav)	<input type="button" value="Windows Media Player"/>
Quicktime (mov)	<input type="button" value="QuickTime Player"/>
Quicktime (qt)	<input type="button" value="QuickTime Player"/>
Quicktime (aif)	<input type="button" value="Real Player"/>
Quicktime (aiff)	<input type="button" value="Windows Media Player"/>
Quicktime (aifc)	<input type="button" value="Flash Player"/>
MPEG (mpeg)	<input type="button" value="No Player"/>
MPEG (mpg)	<input type="button" value="QuickTime Player"/>

## 26.9.1 Accessing the Video Preferences Page

To access the Video Preferences page, perform these steps:

1. Access the Rendition Information page, or click the **My Content Server** tray.
2. Click **Video Preferences**.

Page Item	Description
Video Format Preference Order	Specifies the preferred media format used in the Rendition Information page preview section for renditions, and with a rendition's Web-viewable link in a search result, digital asset basket, or content information page. Because a rendition set may not have a rendition in the preferred format, Video Manager plays the rendition using the first available format found in the order listed here.  The NoPlayer option enables you to suppress one or more of the media formats here, depending on your preference. The placement of the NoPlayer option determines what media format is available. For example, if you move the NoPlayer option immediately following WindowsMedia, then all other formats are ignored. For more information, see <a href="#">No Format Option</a> .
Move Up	Moves a selected media format up in the preference order.
Move Down	Moves a selected media format down in the preference order.
Video Bandwidth Preference	Specifies the preferred size of streaming and local videos by using the size information from the rendition listing.  Low: Smaller video best suited when connecting to Video Manager using a modem to dial in.  High: Larger video best suited when connecting to Video Manager through a high speed connection, such a corporate network or broadband internet connection.
Max Keyframe Segment Length	Specifies the maximum number of keyframes displayed at each drill-down level in the storyboard section of a Rendition Information page.
Player Preference By Format	Enables you to specify a video player for each media format included in the list. For more information, see <a href="#">No Player Option</a> .
Update	Submits changes made to the Video Preferences page.

## 26.9.2 No Format Option

Depending on what priority you have assigned to the No Format option in the Video Format Preference Order section on the [Video Preferences Page](#), the preview area of the [Rendition Information Page](#) may or may not display the video preview player. For example, the following graphic illustrates that this rendition set does not contain any preferred video format. That is, all formats available in this set appear below the No Format option in the Video Format Preference Order which means that they have been suppressed.

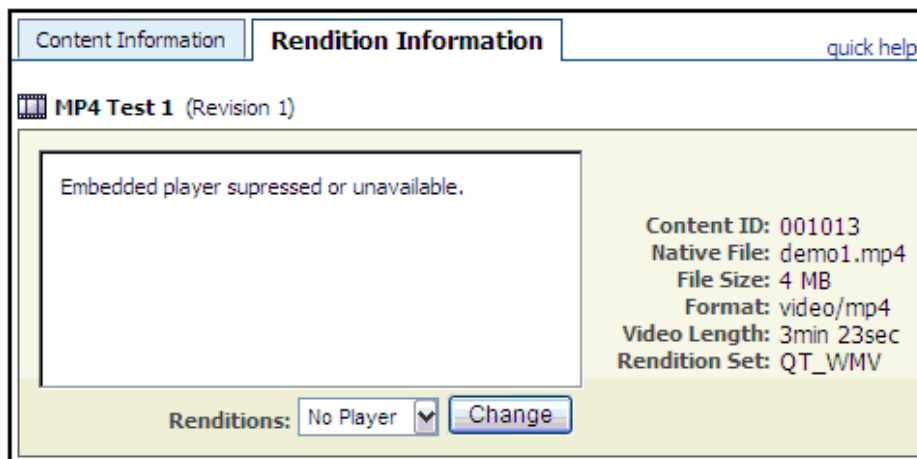

## 26.9.3 No Player Option

The Player Preference By Format section of the [Video Preferences Page](#) enables you to set a video player for each media format included in the list. For example, if you set the preference for Quicktime to be No Format, then this option suppresses that format in the preview area of the [Rendition Information Page](#) as illustrated in the following graphic. Click **Access this rendition directly** to open a new window and play the video using the applicable default player.

 **Note:**

The [No Format Option](#) placement always overrides the selected settings for media formats listed in the Player Preference By Format section.

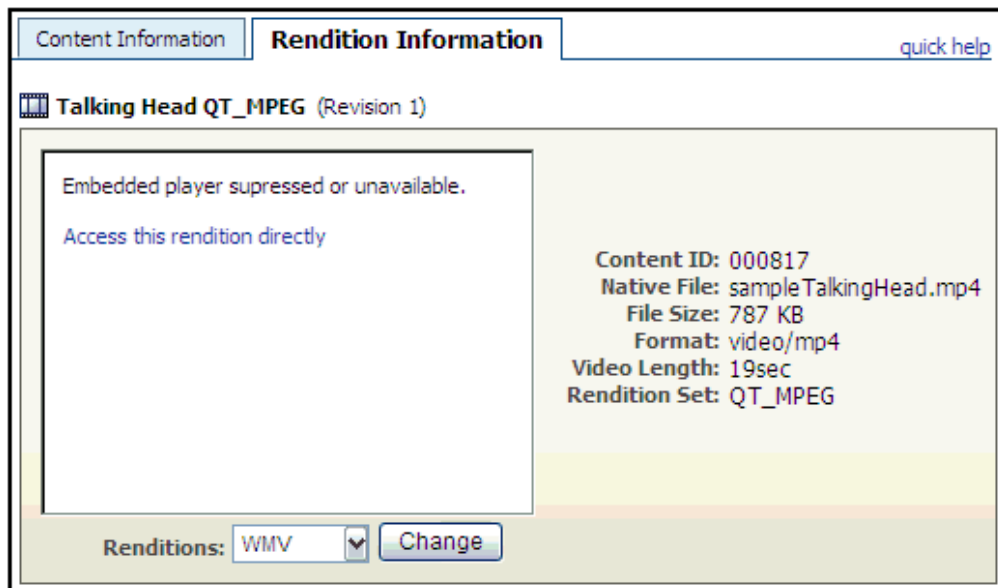

## 26.10 Working with Renditions

The ability to manage digital assets not only creates renditions automatically, it provides a personal space where you can store renditions you are currently working on, called the digital asset basket. Your digital asset basket is unique to you, and contains only the renditions you choose to include.

You can add items to your digital asset basket from a Search Result page, from the Rendition Information page, or from the Content Information page. To view the items in your digital asset basket, click **My Baskets** and then **Digital Asset Basket** in the My Content Server tray.

By design, the digital asset basket can contain renditions from different revisions of the same digital asset. If you use your basket to quickly find a rendition of an asset, such as a corporate logo or video, remember that you may not be accessing the most recent revision of the asset. If a newer revision has been checked in to Oracle WebCenter Content Server, a notification is displayed next to the revision number in the Description column. Click the notification to display the Content Information page of the latest revision.

You can do the following tasks with renditions:

- [Storing Renditions in Your Digital Asset Basket](#)
- [Viewing Items in Your Digital Asset Basket](#)
- [Removing Items from Your Digital Asset Basket](#)
- [Adding and Removing Renditions in a Rendition Set](#)
- [Downloading Multiple Items](#)
- [Creating Renditions](#)
- [Updating Renditions](#)

## 26.10.1 Storing Renditions in Your Digital Asset Basket

You can store any rendition from any revision of a digital asset in your digital asset basket, and the Web-viewable or native file from any revision of a content item, provided the revision is released by Oracle WebCenter Content Server.

From the digital asset basket, you can select renditions from one or multiple assets to be compressed into a single file and downloaded to a local or networked drive, or send links to selected renditions in an e-mail. You can also use the digital asset basket to access the content information and rendition information pages of content items and digital assets.

You can add items to your digital asset basket from the following pages:

- Rendition Information page (native file and all renditions)
- Content Information page (native and Web-viewable files only)
- Search Result page (native and Web-viewable files only)

When you add a rendition to the digital asset basket, it may not be listed at the top of the digital asset basket page. Items in the digital asset basket are listed in descending order first by content ID and then by revision number. If a rendition of a content item revision is in the digital asset basket, additional renditions are added to that revision's listing. Additionally, if a newer revision of a content item in your digital asset basket has been checked in to Oracle WebCenter Content Server, a notification is displayed next to the revision number in the Description column. Click the notification to display the Content Information page of the latest revision.

To add renditions to your digital asset basket from the Rendition Information page, perform these steps:

1. Access the rendition information page of an asset.
2. On the Rendition Information page, select the check box next to a rendition to add the rendition to your digital asset basket.
3. From the **Renditions** list, choose **Add to Basket**. The Digital Asset Basket page opens with the renditions you selected listed in the Selected Renditions column of the item.

To add all renditions to your digital asset basket, select all items. You do not have to select the check box next to any rendition if using this option.

To add the native or Web-viewable file to your digital asset basket from the Content Information page:

1. Access the Content Information page of an item.
2. From the Content Actions menu, choose one of these:

- **Add Native File to Digital Asset Basket**
- **Add Web-Viewable File to Digital Asset Basket**

The Digital Asset Basket page opens with the selected items listed in the Selected Renditions column of the item.

You cannot add both the native file and the Web-viewable file to the digital asset basket at the same time using the Content Information page. If the item is a digital asset and has a Rendition Information page, use it to add multiple items to the digital asset basket at the same time.

To add the native or Web-viewable file to your digital asset basket from a Search Result page:

1. From a Search Result page, select the check box next to the item or items you want to add to your digital asset basket.
2. From the Content Actions menu, choose either of these items:
  - **Add Native Files to Digital Asset Basket**
  - **Add Web-Viewable Files to Digital Asset Basket**

The Digital Asset Basket page opens with the selected items listed in the Selected Renditions column of the item.

To add all native or Web-viewable items on a Search Result page to your digital asset basket, choose **All** from the Select menu. You do not have to select the check box next to any item if using this option. Also, Web-viewable files of video renditions added to the digital asset basket are suitable for viewing only from the digital asset basket. You cannot download them from the digital asset basket. To download a rendition, use the Rendition Information page.

## 26.10.2 Viewing Items in Your Digital Asset Basket

To access the digital asset basket, click **My Basket** and then **Digital Asset Basket** in the **My Content Server** tray. From the digital asset basket, you can select renditions from one or multiple assets to be compressed into a single file and downloaded to a local or networked drive, or send links to selected renditions in an e-mail. You can also use the digital asset basket to access the content information and rendition information pages of content items and digital assets.

To access the Digital Asset Basket page, perform these steps:

1. Click the **My Content Server** tray.
2. Click **My Baskets**.
3. Click **Digital Asset Basket**.

**Digital Asset Basket Page**

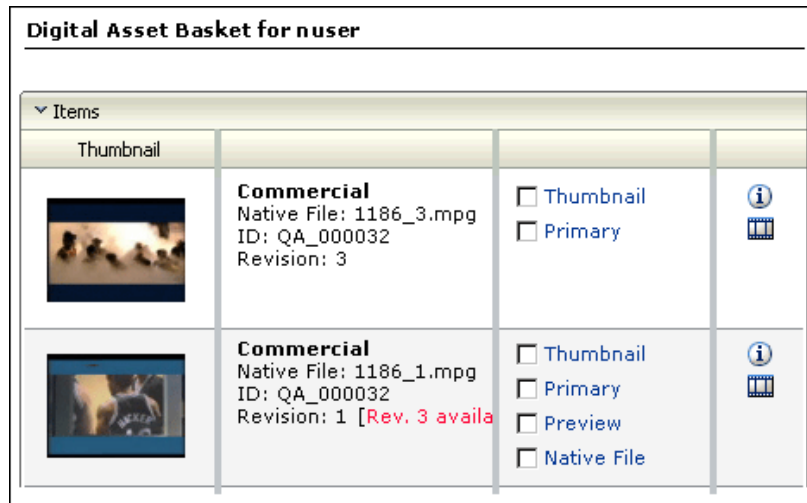

Page Item	Description
Thumbnail	Opens the Web-viewable rendition in a separate window. Your system administrator specifies the Web-viewable rendition. It is typically larger than the thumbnail or preview renditions. For video assets, you determine the Web-viewable rendition based on the choices you make on the <a href="#">Video Preferences Page</a> .
Description	Title, native file, Content ID, and Revision metadata of the content item. If a newer revision of the content item has been checked in to Oracle WebCenter Content Server, a notification is displayed next to the revision number. Click the notification to display the Content Information page of the latest revision.
Selected Renditions	Listing of all renditions of a content item saved to the digital asset basket.
<b>Content Info</b> icon	Links to the Content Information page of an item.
<b>Rendition Info</b> icon	Links to the <a href="#">Rendition Information Page</a> of an item.
Items menu	<ul style="list-style-type: none"> <li>Download: Bundles the selected items into a single compressed file and copies the file to a local or networked storage space. Web-viewable files of video renditions added to the digital asset basket are suitable for viewing only from the digital asset basket. You cannot download them from the digital asset basket. To download a rendition, use the Rendition Information Page.</li> <li>E-mail Links: Opens a prompt that enables the user to enter one or more e-mail addresses. Then the e-mail is generated and sent from within the server, after which a confirmation page is shown that displays the format of the e-mail. The URL links to the selected items are copied into the body of a new message.</li> <li>Remove: Removes the selected items from the digital asset basket.</li> <li>Empty Basket: Removes all items from the digital asset basket.</li> </ul>

Items in the digital asset basket are listed in descending order first by content ID and then by revision number. If a rendition of a content item revision is in the digital asset basket, additional renditions are added to that revision's listing.

### 26.10.3 Removing Items from Your Digital Asset Basket

Because you can store renditions from different revisions of a digital asset in the digital asset basket, renditions listed in the digital asset basket are not necessarily the latest revision. It is a



good idea to remove the renditions from your digital asset basket when you no longer require them.

You can store a link to the most recent revision of any content item in Oracle WebCenter Content Server by searching for the item's content ID, then choosing **Save Search** from the Content Actions menu on the search result page. The link is saved in the My Saved Queries folder in your **My Content Server** tray. Click the saved search link to always access the most recent revision of a content item.

**To remove individual renditions from your digital asset basket:**

1. Click the **My Content Server** tray, click **My Baskets**, and then click **Digital Asset Basket**.
2. Select the check box next to the renditions to be removed in the Selected Renditions column on the digital asset basket page.
3. Choose **Remove** from the Items menu.

The items are removed from the digital asset basket.

**To remove all items from your digital asset basket:**

1. Click the **My Content Server** tray, click **My Baskets**, and then click **Digital Asset Basket**.
2. Choose **Empty Basket** from the Items menu.

All items in the digital asset basket are removed. You do not have to select the check box next renditions when removing them all from your basket.

Removing renditions and other items from your digital asset basket does not remove them from Oracle WebCenter Content Server. You can remove renditions and other items from Oracle WebCenter Content Server using the Rendition or Content Information pages. Renditions and other items listed in your digital asset basket are not available if they have been removed from Oracle WebCenter Content Server.

## 26.10.4 Adding and Removing Renditions in a Rendition Set

The ability to manage digital assets automatically creates multiple renditions of digital assets and manages them in Oracle WebCenter Content Server under one content ID. Oracle WebCenter Content provides the content management and workflow benefits of Oracle WebCenter Content Server while ensuring that you have access to all the types of renditions you need. One content ID provides single-point access to all items relevant to the digital asset.

In some situations, you may want to associate an additional rendition or other file to a digital asset, or remove a rendition that is no longer useful. For example, you may need a rendition that is a slightly different size than the one created by the rendition set, or uses a different color palette, so you want to add the new one and remove the old one. Or, you may have a text file with instructions to a vendor on how they are to use a logo. Files such as these can be added to a digital asset's existing set of renditions using the Add a Rendition page, accessed from the Rendition Information page, and removed directly from the Rendition Information page.

### Add a Rendition Page

You can access the Add a Rendition page from the Renditions menu on the Rendition Information page of an asset. An added rendition is assumed to be a graphic file, and metadata fields on the Add a Rendition page allow you to manually add information pertinent to graphic renditions. Added renditions can be any type of file, however. For example, if you have a text file with instructions on how to output a PDF file, you can attach the text file as a rendition of the original asset. You should note, though, that Oracle WebCenter Content Server does not manipulate added renditions. It does not modify a rendition based on information

entered into the metadata fields, nor does it convert an added rendition to a Web-viewable format, nor index it for searching.

- Metadata on the Add a Rendition page is for information only. It does not change the size of an added graphic file, and it does not get indexed for searching.
- You can add any type of file as a rendition. It does not have to be a graphic file. To view added renditions, you must have the native application or suitable viewer for the added rendition's file format.

**To add a rendition to an existing rendition set:**

1. Access the Rendition Information page.
2. Choose **Add New Rendition** from the Renditions menu.
3. On the Add a Rendition page, enter a name for the rendition in the Name field (required). The name is displayed in the Rendition Name column of the Rendition Information page.
4. Enter a description for the rendition in the Description field (optional). To display the description, click the **Rendition Name Description** icon in the Rendition Name column of the Rendition Information page.
5. Click **Browse** to locate the rendition or other file you want to add to the rendition set (required). You can select any type of file.
6. Fill in the pixel dimensions and resolution information in the Width, Height, and Resolution fields (optional).
7. Click **Add Rendition**.

Metadata on the Add a Rendition page is for information only. It does not change the size of an added graphic file, and it is not indexed for searching.

**To delete a rendition from an existing rendition set:**

1. Access the Rendition Information page.
2. Select the check box next to the rendition you want to delete. You can select multiple renditions to delete.
3. Choose **Delete** from the Renditions menu.

Renditions and other items are not available if they have been removed from Oracle WebCenter Content Server. When you delete a rendition from the system, it disappears from the basket display.

## 26.10.5 Downloading Multiple Items

You can compress renditions and other content items into a single file and downloaded to a local or networked drive, for example, when you want to send multiple renditions or native files to others. You can do this from the Digital Asset Basket page or Rendition Information page.

**To download multiple renditions:**

1. Access the digital asset basket or Rendition Information page.
2. Select the check box next to the renditions you want to download. The renditions are listed in the Selected Renditions column of the Digital Asset Basket page, or the Rendition Name column of the Renditions Information page.
3. Choose **Download** from the Renditions menu on the Rendition Information page or from the Items menu on the Digital Asset Basket page.
4. Follow the download instructions as they are displayed on screen.

 **Note:**

- To download all renditions in your digital asset basket, or on the Rendition Information page, select all items, and then choose the Download menu option. You do not have to select the check box next to any rendition if using this option.
- Web-viewable files of video renditions added to the digital asset basket are suitable for viewing only from the digital asset basket. You cannot download them from the digital asset basket. To download a rendition, use the Rendition Information page.
- You can remove renditions and other items from Oracle WebCenter Content Server using the Rendition or Content Information pages.

## 26.10.6 Creating Renditions

Renditions are created automatically when a digital asset is checked in. The types of renditions created are determined by criteria defined in the selected rendition set.

**To create renditions:**

1. Access the Content Check-In Form.
2. Choose a rendition set from the Rendition Set list.
3. Enter a title and any additional metadata for the asset. The title you enter must be 249 or fewer characters in length.
4. Click **Browse** to locate the primary file.
5. Click **Check In**.

**Notes**

- Oracle WebCenter Content Server uses the file extension, such as .psd, .jpg, .mov, or .avi, to determine if an item is a digital asset. You must append the correct extension to the file name for all digital assets checked in to Oracle WebCenter Content Server. For example, a Photoshop file named CorporateLogo.psd is correctly identified by Oracle WebCenter Content Server as a digital asset, but one named CorporateLogo is not.
- Do not select an alternate file when checking in a digital asset. Doing so prevents the primary file from rendering.

## 26.10.7 Updating Renditions

If an incorrect rendition set was selected when a digital asset was checked in, or if a new rendition set has been created, you may want to update the renditions created for a digital asset.

To update to a different rendition set, perform these steps:

1. Choose **Update** from the Content Actions menu on the Content Information page.
2. Choose a different rendition set from the Rendition Set list.
3. Click **Submit Update**.

**Notes**

- You cannot display rendition information while an asset is being processed by Oracle WebCenter Content Server. If an asset is being processed, the status in the revision history on the Content Information page is GenWWW, and the Rendition Information page displays a message saying the content item is not released yet.
- Updating a rendition set replaces the previous renditions with a new set, effectively removing the previous set from Oracle WebCenter Content Server.

## 26.11 Working with Standard Content Items

The ability to manage digital assets adds functionality to Oracle WebCenter Content Server that extends to content items that are not digital assets. You can add native and Web-viewable versions of content items to your digital asset basket, and add or delete attachments to content items from the Content Information page.

### Add/Edit Attachments

In some situations, you may want to associate an additional rendition or other file to a content item that is not a digital asset, or remove an attachment that is no longer useful. For example, you may attach a customer's new logo to a piece of collateral that uses it and remove the old one, or you may attach a text file with project contact information to a project plan. You can add files such as these to a content item using the Add/Edit Attachments page, accessed from the Content Actions menu on the Content Information page. Attached files are not converted to a Web-viewable format, and are not indexed for searching by Oracle WebCenter Content Server.

**Figure 26-11** Adding or Editing an attachment with the Edit Attachments page

**Edit Attachments in Content Item 'Text File'**

---

**Select Attachments to Delete**

Select	Attachment	Description
<input type="checkbox"/>	Picture	For ad campaign [eidanNlynx.jpg] (graphic 22K)
<input type="checkbox"/>	Icon Files	Icon options for the new product [trayicons.zip] (zip 8K)

**Append New Attachments**

Name 1:

Description 1:

File 1:

Page Item	Description
Attachment column	Lists the name given to an existing attached file at the time it was attached.
Description column	Lists the description given to an existing attached file at the time it was attached.

Page Item	Description
Name field	Used to enter the name of the file to be attached. Displayed in the Attachments section of the Content Information page.
Description field	Used to enter the description of the file to be attached. Displayed in the Attachments section of the Content Information page.
File field	Used to locate the file to be attached.
<b>Add/Edit Attachment</b> Button	Submits the information to Oracle WebCenter Content Server.

#### To add an attachment to a content item:

1. Access the Content Information page.
2. Choose **Add/Edit Attachments** from the Content Actions menu.
3. On the Add/Edit Attachments page, enter a name for the attachment in the Name field (required). The name is displayed in the Attachments section of the Content Information page.
4. Enter a description for the rendition in the Description field (optional). The description is displayed in the Attachments section of the Content Information page.
5. Click **Browse** to locate the rendition or other file you want to attach to the content item (required). It can be any type of file.
6. Click **Add/Edit Attachments**.

Metadata on the Add/Edit Attachments page is for information only. It does not get indexed for searching.

#### To delete an attachment from a content item:

1. Access the Content Information page.
2. Choose **Add/Edit Attachments** from the Content Actions menu.
3. On the Add/Edit Attachments page, select the check box next to the attachment you want to delete. You can select multiple attachments to delete.
4. Click **Edit Attachments**.

## 26.12 Managing Digital Assets on a Macintosh Client

Oracle WebCenter Content Server renders digital assets when checked in using a Macintosh client provided the file name of the asset has a valid file extension. However, files created on Macintosh operating systems before OS X may have information stored in a file resource fork. Information in a resource fork may include custom fonts used by the file and is not transferred.

Depending on your organization's requirements, removing the resource fork generally does not create a problem. One exception to this is if the asset uses custom fonts and the rendition set includes a PDF rendition.

# Working with Records

Usually, you manage a record with a retention schedule and assign a life cycle according to disposition rules for the content. The record administrator develops the retention schedule and life cycle.

This chapter provides an overview of common tasks involved in managing content that is designated as a record. It covers the following topics:

- [Understanding Retention Management](#)
- [Creating Records and Physical Content](#)
- [Finding Records and Physical Items](#)
- [Reservations and Chargebacks](#)
- [Creating a Records Profile](#)

## 27.1 Understanding Retention Management

The Records software managed content items that are on a retention schedule. The focus of records management tends to be the preservation of content for historical, legal, or archival purposes while also performing retention management functions. The focus of retention management tends to be the scheduled elimination of content based on a schedule designed by a record administrator.

This software combines both record and retention management into one software system. It can track and preserve content as needed, or dispose of content when it is no longer required.

The following terms are used when explaining retention management:

- **Record administrator:** individuals who set up and maintain the retention schedule and other aspects of the management system.
- **Record user:** individuals who uses the software to check content in and out of the system, to search for records, and to perform other non-administrative tasks.
- **Record officer:** individuals who have limited administrative responsibility in addition to the responsibilities of a record user.
- The **retention schedule** is an organized hierarchy of series, categories, and record folders, which allows users to cluster content into similar groups, each with its own retention and disposition characteristics.
- A **series** is an organizational construct in the retention schedule that assists in organizing categories into functional groups. Series are normally static and are used at a high level in an organization hierarchy.
- A **retention category** is a set of security settings and disposition instructions in the retention schedule hierarchy, below a series. It is not an organization construct but rather a way to group items with the same dispositions.
- A **disposition** is the set of actions taken on items. Disposition instructions are created that define how the content should be handled all revisions.
- A **period** is the segment of time that must pass before a review or disposition action can be performed.

- A **trigger** is an event that must occur before a disposition instruction is processed.
- A **link** is a defined relationship between items.
- A **classification** specifies the security level of a classified item. It is used in the process of identifying and safeguarding content containing sensitive information. Typical classification levels are *Top Secret*, *Secret*, and *Confidential*, and *Unclassified*.
- A **classification guide** is used to define default values for several classification-related fields on the content check-in pages for content.
- **Freezing** inhibits disposition processing for an item. Frozen content cannot be altered in any way nor can it be deleted or destroyed.
- **Federation, Federated Search, Federated Freeze** are functionality used to manage the process of legal discovery. Using Federated Search or Freeze, a legal officer can search content across all repositories to gather information needed for legal proceedings.

## 27.1.1 The Retention Process

The following steps outline the basic workflow of retained content:

1. The retention schedule and any required components, such as triggers, periods, classifications, and custom security or metadata fields are created by an administrator.
2. Items are filed into the retention schedule by users. The filed items assume the disposition schedules of their assigned category.
3. Disposition rules are processed in accordance with the defined disposition schedules, which usually have a retention period. The processing is activated by either a system-derived trigger or custom trigger. The trigger could affect one or more items simultaneously.
4. Whenever a disposition event is due for action (as activated by a trigger), an e-mail notification is sent to the person responsible for processing the events. The same is true for review. The pending events and reviews are displayed in the pages accessed from the Retention Assignments links within the user interface.
5. The Records Administrator or privileged user performs the review process. This is a manual process.
6. The Records Administrator processes the disposition actions on the pending dispositions approval page. This is a manual process.
7. A batch process is run to process an approval.

Many disposition schedules are **time-based** according to a predictable schedule. For example, content is often filed then destroyed after a certain number of years. The system tracks when the affected content is due for action. A notification e-mail is sent to reviewers with links to the pages where reviewers can review and approve content and folders that are due for dispositions.

In contrast, **time-event** and **event-based** dispositions must be triggered with a non-system-derived trigger (a trigger that was defined for a particular scenario). For example, when a pending legal case starts litigation, the Records Administrator must enable the custom trigger and set its activation date because the start date information is external. Custom triggers can define event and time-event based disposition actions based on the occurrence of a particular event.

## 27.1.2 Physical Content Management

While the Records system enables organizations to manage the retention and disposition of content, PCM provides the capability of managing physical content that is not stored in electronic form.

All items, internal and external regardless of their source or format, are managed in a single, consistent, manageable infrastructure using one central application and a single user interface. The same retention schedules are used for both electronic and physical content.

PCM tracks the storage locations and retention schedules of the physical content. The functionality provides the following main features:

- **Space management**, including definition of warehouse layout, searching for empty space, reserving space, and tracking occupied and available space.
- **Circulation services**, including handling reservation requests for items, checking out items, and maintaining a due date for checked-out items.
- **Chargeback services**, including invoicing, for the use of storage facilities and/or actions performed on physical items.
- **Barcode file processing**, including uploading barcode information directly into the system, or processing barcode files manually.
- **Label creation and printing**, including labels for users, storage locations, or individual physical items.
- **Retention management**, including periodic reviews, freezes and litigation holds, and e-mail notifications for pending events.

## 27.1.3 Understanding Roles and Permissions

The Records functionality contains several default roles which allow users to access specific parts of the product. Administrators can customize these roles by including specific rights, providing a fine level of access to tasks.

The following list describes default predefined roles. Consult your administrator to see what additional roles may be in use at your site:

- **rma**, or the Record User. This role is usually assigned to basic users and allows them to perform basic management tasks.
- **rlocalrecordsofficer**, or the Records Officer. This role is usually assigned to *privileged* users, who have all the permissions assigned to basic users (rma role) but are also granted rights to perform additional functions.
- **rmaadmin**, or the Records Administrator. This role is usually assigned to administrators who are responsible for setting up and maintaining the management infrastructure and environment. These users have the widest range of rights to perform management tasks.
- **pcmrequestor**, or PCM Requestor. This role is usually assigned to users who have all the permissions assigned to basic users without a Physical Content Management role but are also granted additional rights to perform some functions not allowed for basic users.
- **pcmadmin**, or the PCM Administrator. This role is usually assigned to administrators who are responsible for setting up and maintaining the physical content management infrastructure and environment.

Each of these predefined roles comes with a default set of permissions and rights, but these can be modified. New roles with assigned management rights can also be created.



To view assigned roles and rights, click the user name in the top right portion of the window. The roles assigned to the logged-in user appear at the top of the My Profile information.

To see rights assigned, choose **Records** then **Rights**. The Assigned Rights shows the rights assigned to the current user for the enabled components. To view details about each component, click the **Show** link for that component. To view details about all rights, click the **Show All Rights** link at the top of the window. To hide rights again, click the **Hide** link in the component section or at the top of the window.

## 27.1.4 Interface Overview

Four main menus are used to access functionality; however, this product is highly configurable, so the options seen on any menu may vary depending on what options have been enabled.

The following four primary menu locations are available:

- **Top menu:** This menu contains a **Records** option as well as a **Physical** option (if Physical Content Management is enabled). This menu can be used to quickly access different parts of the Records system and Physical Content Management (PCM) products.
- **Page Actions menu or Page menu:** On many pages, an **Actions** menu (a small box with horizontal lines in it) appears at the top of the page. Options in this menu pertain to the items at that level in the hierarchy. For example, an **Actions** menu appears on the Exploring Retention Schedule page. At that level of the product hierarchy, reports about the retention schedules can be created.
- **Table menu:** On most pages that list items (triggers, retention categories, content items) a menu appears at the top of the listing. By selecting a box next to an item, multiple items can be affected at one time. For example, on an Exploring Retention Category page, options appear above the listing of items in that category.
- **Individual Actions menus:** Items listed on a page will often have an individual **Actions** menu. The options on these menus vary depending on the item and its location in the retention hierarchy.

The following list summarizes the most commonly seen individual **Actions** menu options:

- **Information:** Used to access information pages for folders, life cycle of the item, recent reviews, metadata history, and retention schedule reports. On some Information pages, additional options appear to edit or revise the displayed information.
- **Edit:** Provides quick links to edit pages for folders or reviews, and options to alter an item's status by moving, closing, freezing, or unfreezing an item.
- **Set Dates:** Provides quick links to actions associated with dates, such as marking items for review, canceling, rescinding, and expiring items.
- **Delete:** Provides options to delete the item or perform a recursive delete (delete an entire tree if multiple items are checked).
- **Create:** Provides options to create items appropriate to the location in the hierarchy. For example, if this is the **Actions** menu for a retention category, Create sub-options include **Series** and **Retention Category**.

### 27.1.4.1 Dashboards

Dashboards allow immediate access to frequently used aspects of the software. Each dashboard is composed of panes that hold different types of functionality, such as search boxes, lists of information, or access to other websites. The dashboard can be customized so frequently performed tasks, such as pending reviews, pending approvals, and so on, are easily accessible.

If actions can be taken in a dashboard pane, icons appear in the top right corner of the pane. Those icons can be used to perform actions directly from the dashboard. For example, if you have a Pending Review list in one pane, you can select the check box for a review then click the **Approve** icon (a green checkmark). The review will be approved directly from the dashboard.

Default dashboards are provided. To access this functionality, choose **Records** then **Dashboards**. Choose **User** to access the user dashboard. If you are assigned administrative privileges, another dashboard is available. To view it, choose **Admin**.

To select a dashboard for use:

1. Choose **Records** then **Dashboards**.
2. Select the dashboard to use from the list.
3. On the Dashboard page, choose **Actions** then **Set as Home Page** to use the dashboard as a home page at login. To remove the dashboard as the home page, click the user name in the top right corner of the window. On the My Profile page, select **Remove Dashboard Home Page**.

To edit the default dashboards or other personal dashboards:

1. Choose **Records** then **Dashboards**. Select the dashboard to edit.
2. On the Dashboard page, choose **Save As** from the **Actions** menu. The default dashboard must be saved under a new name before it can be edited. Enter a new dashboard name and a dashboard title. Click **OK** when done.
3. The dashboard opens in edit mode.
  - To move a pane from one location to another, put the cursor on the border of the pane. Hold down the left mouse button and drag the pane to another location.
  - To delete a pane, click the X in the upper corner of the pane.
  - To set individual options for each pane, click the **Options** menu in the upper corner of the pane. Note that not all panes have an option list.
  - To replace a pane, first delete the pane. An empty pane is displayed. Click **Other Dashboards** to populate the search list. The Search for Items dialog opens. Use this search form to find panes to use in the dashboard.

Select metadata fields for searching or click **Search** to search the entire database.

The Dashboard Results page opens, showing those items that can be used in the dashboard.

Select the box next to the items to include and click **Next**. The Select Dashboard list is populated with the items that were selected. Click an item from the list to include in the pane and click **OK**.
4. When done, choose **Save Changes** or **Save As** from the **Actions** menu to save the dashboard under a new name.

To create a personal dashboard:

1. Choose **Records** then **Dashboards** then **Create New** from the Top menu or choose **New Dashboard** from the **Content Management** menu.
2. On the Create/Edit Dashboard page, choose the number of columns to appear on the dashboard by selecting a number from the list.
3. In the first pane, click **Other Dashboards** to populate the list of dashboards for use.

Use the displayed search form to find panes to use in the dashboard. Select metadata fields for searching or click **Search** to search the entire database.

4. On the Dashboard Results page, select the box next to the items to include and click **Next**. The Select Dashboard list is populated with the selected items.
5. Select an item from the list for the pane and click **Ok**. Repeat this process for the other panes in the other columns. To delete a pane click the **X** in the corner of the pane window.
6. When done selecting panes for use, click **Actions** then **Save Dashboard**.
7. To use a Simple Profile to associate with the dashboard, select it from the list. Click **Next** when done.
8. Enter the necessary metadata on the check-in page to save the dashboard. Click **Checkin** when done.

## 27.1.4.2 My Favorites

Users can create a listing, similar to bookmarked browser Favorites and add series, categories, folders, reports, report templates, users, and aliases to this listing. Users with administrative privileges can add other objects such as freezes to the listing.

If an item can be added to a Favorites listing, the **Add to Favorites** menu option is displayed on a page. To add items to these lists, select the box next to an item and click **Add to Favorites**.

Favorites can be shared with other users. To make a Favorites list available for sharing, click the user name in the top right corner of the window. On the My Profile page, click **Yes** in the **Share RMA Favorites** box. Click **Update** when done. The Favorites list will then be available to other users to select from.

To share an item in that list, select the check box for the item then choose **Sharing** and **Share** from the Table menu. To prevent sharing, choose **Sharing** then **Unshare**.

To add a favorite from another user, choose **Records** then **Favorites** from the Top menu. If a favorite list is available from another user, the **Import From User** table option is available in the list of favorites. Choose the **Import From User** option and select the name of a user from the list. All of that user's favorites for that particular Favorite type (for example, a Series or a Category) appear on the Favorites list.

Sharing favorite items is based on assigned rights. If a user does not have rights to share items then the **Import From User** option does not appear on that user's My Favorite list. For example, if you do not have the category.freeze, folder.freeze, or record.freeze right, you cannot access favorite freezes from other users.

To view items in the Favorites list, choose **Records** then **Favorites** from the Top menu. On the My Favorites page, click the indicated tabs to quickly find the favorites of a specific type (for example, Categories or Series).

Use the Up or Down arrow on the My Favorites page to rearrange the favorites in the list. The reordering in the list is not saved until the **Save Now** button is clicked, which appears when reordering begins.

Favorites items are used to populate option lists, such as when creating freezes or when checking in content. For example, if an item is on a Favorites list, it appears on the list when a freeze name is selected or when a category is selected during content checkin. This helps to narrow down the choices on large option lists.

## 27.2 Creating Records and Physical Content

Content can be created from the Main menu, from within retention schedules, or existing content can be marked as usable for retention. For example, if you work with Oracle WebCenter Content to manage content outside of a retention schedule, you can file content into a retention schedule without moving outside of the Content Server. You do this by accessing the content check-in form from the Main menu.

If you work mostly within retention schedules and are within a schedule hierarchy, you can create the content item at your current position in the hierarchy by choosing **Check in New Content Item** from the **Actions** menu for the retention object.

### 27.2.1 Checking In From the Main Menu

If profiles have been created by the administrator, those profiles appear on the **New Check In** menu. A profile *hides* fields so only those fields essential for check-in are shown. This makes the process faster and less prone to error.

 **Note:**

The fields on the check-in pages are dependent on the profiles used for the check-in and the configuration of the system. See the Records Administrator for details about what triggers are used for profiles and what fields are to be expected on the check-in pages.

Content can be checked into a category or a record folder. To check in content:

 **Note:**

Use this method of filing content items when filing items to disparate locations and to navigate to a different location within the retention schedule with each checkin.

1. Choose **New Check In**. If profiles are available, several different options may be available. Select the profile or type of check-in to do.
2. Enter or choose information pertinent to the item. The following list describes some of the common fields on the checkin page:
  - Type: File type chosen from a list.
  - Title: Descriptive name for the item. Maximum: 80 characters.
  - Filer: User checking in the item. Administrators can choose a user name from a list.
  - Security Group: Security group associated with the item. Default: RecordsGroup.
  - Primary File: Path and file name of the item. Maximum: 80 characters for file name, 8 characters for extension. Click **Browse** to select the item.
  - User, Group, Role Access List: if Access Control Lists are enabled, this is used to set permissions for specific users or groups.

- **Alternate File:** Path and file name of a web-viewable file or one that can be converted to be web-viewable. The file extension cannot be same as that used in the Primary file. Maximum: 80 characters for the file name, 8 characters for the extension. Click **Browse** to find and select the item.
  - **Content ID:** Identifier for the item. Maximum: 30 characters. No special characters can be used. If this field is filled in, the system is automatically configured to assign IDs.
  - **Revision:** Generated automatically with each iteration of the item. Do not change this value.
  - **Comments:** Additional notes. Maximum: 255 characters.
  - **Date, Format and Audit Information:** Date a record is activated or expired in the system, as well as information about the auditing of the item.
  - **Security information:** Classification information, supplemental marking information, and classification topic information.
  - **Subject to Review information:** Fields indicating if an item is subject to review, and the reviewers and review period.
  - **Correspondence Information:** Information pertaining to e-mail.
3. If an auxiliary metadata set has been created, click that option in the top right corner of the page. Additional metadata fields appear containing information for the item.
  4. To associate the item with a category or folder, click **Browse** next to the **Category or Folders** field at the bottom of the page.
  5. In the Select Category or Folder dialog, choose the category or folder in which to file the item. If categories or folders were added to a My Favorites list, they appear on the list and are easily selected.
  6. Assign a supplemental marking to the item. A user must be assigned a supplemental marking in order for markings to appear on the list of supplemental markings that can be used at checkin.
  7. Click **Life Cycle Preview** to view the disposition actions associated with the category selected earlier.
  8. After entering all the appropriate metadata values, click **Check In**. A confirmation page is displayed.

### 27.2.1.1 Checking in Items Using DIS

If Desktop Integration Suite is installed, new files can be checked in from Microsoft Office by using the **Copy** and **Paste** options in the right-click menu. If an item is currently checked out, a user can check it in using the Offline Content Manager or by choosing the **Check In** option on the right-click menu.

To check in an existing file from Microsoft Office, click **File** then **Save** and select the server option in the Save dialog. The content check-in form opens for the last instance used.

If the DoD component is enabled, files may not be able to be checked by copying and pasting or dragging and dropping them into contribution folders. When using DoD features, the Category or Folder field is required. This means an item cannot be checked in if that field is empty. The actions of copying and pasting or dragging and dropping into a contribution folder often doesn't require further user intervention, so often the check-in cannot complete successfully.

## 27.2.2 Checking In Through a Retention Schedule

The proper security privileges are required to access the category or records folder in use. To create an item from within a retention schedule:

### Note:

To save time when filing multiple content items into the same category or folder, check in the content from within the retention schedule this way. It eliminates the need to select the **Category** or **Records Folder ID** fields to navigate to the location each time because the check-in form is presented in context to its location as shown in the Retention Schedule locator links. To further expedite the filing process, use the **Check In Similar** feature.

1. Click **Browse Content** then **Retention Schedules**.
2. On the Exploring page, choose a Retention Category for use. From the item's **Actions** menu, choose **Create** then the type of content: **Record**, **Folder**, **New Content Item**, or **New Physical Item**.
3. Click **Life Cycle Preview** to view the disposition actions associated with the category selected earlier.
4. After entering all the appropriate metadata values, click **Create**.
5. If similar content is available to check in, click **Check In Similar** on the confirmation page to pre-populate the form and expedite the process.

## 27.2.3 Checking In a Classified Item

Classified items require protection against unauthorized disclosure (for example, because they contain information regarding security or insider information). Unclassified content is not and has never been classified. Declassified items were formerly classified, but the classified status has been lifted.

Classification is an optional security feature certified to comply with the Chapter 4 requirements of the DoD 5015.2 specification. A site administrator can choose whether to enable this functionality and make it available.

### Note:

Executive Order 12958: Classified National Security Information describes in detail the system for classifying, safeguarding, and declassifying national security information. If you are using this product to comply with that order, you should be familiar with proper classification protocols.

To check in content from the Main menu:

1. Access the content check-in form as described previously.
2. Enter optional information pertinent to the item.

3. To associate the item with a retention schedule, click **Browse** next to the **Category or Folders** field at the bottom of the page.
4. In the Select Category or Folder dialog, choose the category or folders in which to file the item. The file pathname is displayed under the field.
5. Specify information pertinent to classifications:
  - The agency classifying the content (optional).
  - The person classifying the content. This is mandatory unless the data is derived from a specific topic, in which case it is optional.
  - What the classification is derived from. This is mandatory unless there is a specific *classified by* person identified.
  - The topic derived from unless there is a specific person classifying the item.
  - The classification at the time of record creation. For example, Top Secret, Secret, Confidential, and so forth.
  - The type of classification. For example, military plans, foreign government information, cryptology, and so forth.
  - A declassification exemption category. For example, reveal intelligence source, reveal military plans, and so forth.
  - The event triggering the declassification of the item.
  - A date triggering the declassification of the item.
  - Enable automatic declassification. If this functionality is enabled the **Is Auto Declassification Date** option appears. Select this option to allow automatic declassification of the item.
  - How the item can be downgraded. Choose date, event, or date and event.
  - An event triggering the downgrading of the item classification. This is mandatory if it was specified how the item can be downgraded.
6. After entering all the appropriate metadata values, click **Check In**. A confirmation page is displayed.

## 27.2.4 Folios and Content Basket

Content Folio is an optional component automatically installed with the Records system. It can be used to assemble and track groupings of content items in a virtual container such as a content basket. The Content Basket can contain any number of items managed by Oracle WebCenter Content, the Records system, Physical Content Management, or other add-on products.

Folio configuration is performed by administrators and can include custom template design and the creation of specific folio hierarchies designed to help manage content. This chapter does not discuss the details of folio use except how it interacts with the Content Basket. For more details about the use of folios at the organization, see the site administrator.

Items can be added to the Content Basket from the item's information page or Search Result page using options from the menus on those pages. The information in the Content Basket page includes a thumbnail depicting the type of item, the content ID for the item, the item's title, native file name (if any), and source name. If the item is a physical item, source will always be Physical.

The default order for items in the content basket is the order in which they were added. Any new items are added to the bottom of the list. If adding multiple items at the same time (from a



Search Result page), then the items are added in the order in which they were displayed on the Search Result page. The order of the items in the basket can later be changed.

In previous versions of this product, each user was automatically assigned a content basket. In the current version of the software, users must create their own content baskets. Any items in the user's basket prior to upgrading are not retained.

### 27.2.4.1 Creating, Updating, or Deleting a Basket

To create a basket or update an existing basket:

1. Choose **My Content Server** then **My Baskets**.
2. To create a new basket, click **Append Content Basket** on the Content Basket Manager page and enter the name of the new basket.
3. To delete a basket, select the **Delete** check box next to the basket name. If items are in the basket, they must first be removed before it can be deleted.
4. To change a basket, edit the information.
5. When done making all changes, click **Update**. The Content Basket Manager page opens again with the changes in place.

### 27.2.4.2 Setting an Active Basket

Before using content baskets, set one basket as the default to be used for activities involving content.

1. Choose **My Content Server** then **My Baskets**. A list of defined content baskets appears on the menu.
2. Select the name of the basket to be made active.

A user can also navigate to the Content Basket Manager page and click **Active** next to a content basket name. Click **Update** to make that basket the active basket.

Only one basket can be active at a time and it can be changed at any time.

### 27.2.4.3 Adding or Removing Items

To add items to a content basket:

1. Search for the item(s) to add to the content basket.
2. On the Search Result page, select the check box of each item to add to the content basket.
3. Choose **Actions** then **Add to Active Content Basket** in the Table menu. Items can only be added to a basket designated as active. The Content Basket page opens, with the new item(s) added at the bottom of the list.

When items are removed, they are only removed from the content basket. They are not deleted from the system. To remove items from the basket:

1. Choose **My Content Server** then select the name of the basket to use.
2. On the Content Basket page, select the check box of the items to remove. Choose **Actions** then **Remove Selected Items** from the Table menu.
3. To remove all items, choose **Actions** then **Empty Content Basket** from the Page menu.



## 27.2.4.4 Sorting Items

The order of the items can be changed by modifying the numbers in the Order Priority column.

1. Click **My Content Server** then the name of the basket to reorder.
2. On the Content Basket page, click **Actions** then **Toggle Row Reorder**. Click the Up or Down arrows on individual rows to move the item upward or downward.

## 27.2.4.5 Creating Reservation Requests for Items

To make a reservation request for one or more physical items in a content basket:



### Note:

You can only make reservation requests for physical items.

If the content basket does not contain the item(s) to reserve, add them first.

1. Click **My Content Server** then the name of the basket to use.
2. On the Content Basket page, select the check box of each physical item and choose **Request** then **Request Selected Items** from the Table menu. To reserve all items in a content basket, choose **Request** then **Request All Items**.

A prompt is displayed asking if the selected items should be removed from the content basket after they are reserved.

3. Click **Yes** or **No**. Click **Cancel** to stop the reservation request.
4. On the Create or Edit Request page, specify the properties of the new reservation request, such as the transfer method, priority, and delivery location.
5. Click **Create** when done. The items are now reserved, and the administrator is notified of the reservation request. After the administrator processes the reservation request, it can be fulfilled in accordance with the procedures in an organization. If a reserved item is already checked out, the user is placed on a waiting list for that item.

## 27.2.4.6 Downloading Items

To download a zip file with one or more items in a content basket:



### Note:

You can only download items in a zip file if the system has been set up to support this feature.

1. Click **My Content Server** then the name of the basket to use.
2. On the Content Basket page, select the check box of each item to download, and choose a download option from the **Download** menu on the Table menu.

Selecting to download to a workspace stores items in the user's workspace location. A workspace is defined on the user's profile page. It can be an FTP or WebDAV server, a

path on the local file system to a location, or Other (which downloads a zip file to be saved at a specified location). Selecting to download to the workspace stores the items in the user's workspace location. If the location is an FTP or WebDAV server and authentication is needed, a dialog is displayed and credentials must be entered.

- **Download Selected Items**
- **Download All Items**
- **Download Selected Items to Workspace**
- **Download All Items to Workspace**

A zip file named `Bundle.zip` is created and a dialog is displayed with a prompt for the location to open or save the file.

The contents of the zip file depends on the type of item:

- **Internal (electronic) items:** The zip file contains the selected rendition file for the item. The file name for the item is built up as follows:  
`<Item_Title> (Primary|Web) [<Content_ID> Revision-<Rev. No.>].<File_Extension>`  
where *Primary* refers to the native file rendition, and *Web* to the web-viewable rendition. For example: *Report2005 (Primary) [CS12025 Revision-2].doc*.
- **External (physical items):** The zip file contains a file with the metadata, location, and retention information about the physical item, in the archive metadata format as specified on the Configure Records Management page. The file name is built up as follows:  
`<Random_Number> (External Item) [<Item_Name>].<File_Extension>`  
where the file extension depends on the configured format setting. For example: *810871584 (External Item) [Contracts2009].hda*.

### 27.2.4.7 Creating E-Mail Links to Items in the Content Basket

To create a new e-mail message in the default e-mail client, with information and links for one or more items in a content basket:

1. Click **My Content Server** then **My Content Basket**.
2. On the Content Basket page, select the check box of each item (rendition) to include in the e-mail message, and choose **E-Mail Links** then **E-Mail Links to Selected Items** from the **Email Links** menu at the top of the page. To include all items in the e-mail message, choose **E-Mail Links** then **E-Mail Links to All Items**.

A new e-mail message window for the default e-mail client is displayed, with Content Item Rendition Links as the subject line and links and information for the items in the message body.

Some e-mail clients have limitations regarding the number of characters used in the body of a message. Adding a large number of items as links to an e-mail may exceed the limitation, resulting in some links not being listed.

#### 27.2.4.7.1 Contents of E-Mail Message

What is included in the e-mail message for an item depends on the type of that item:

- **Internal (electronic) items:** The e-mail message contains the content ID and title of each selected item, links to the selected rendition file(s) for the item.
- **External (physical) items:** The e-mail message contains the name and title of each selected physical item, a link to the item's information page.

## 27.2.5 Folios and Cloned Content

Automatic cloning occurs when working with folios that are filed into restricted categories. A default rule in the Records system is followed that states all folios must be editable, revisionable, and deletable. If a folio is filed into a category that restricts any of these actions, it is cloned when a new revision is checked in.

If a folio is frozen, a clone is created because freezing restricts deletions and edits. If folio content is filed into a category that restricts edits, deletions, or revisions, it is cloned.

You can also manually create a copy of a specific revision of a content item by cloning the item. Unlike a simple copy of a content item, a **fixed cloned copy** is linked to the original version. A newly cloned copy can also replace (supersede) any previous cloned versions. The functionality to manually create a fixed clone is only available if the `RmaEnableFixedClones` configuration variable has been set to TRUE.

When creating a fixed clone, specify which category or folder will hold the item. The clone name is created with the title of the current revision with a suffix appended. Administrators can change the value of the suffix by changing a configuration variable. See Understanding Content Folios in *Managing Oracle WebCenter Content* for details.

Cloning rules can be customized to override record restrictions. This process is not discussed in this documentation. See Consulting Services for more details.

The fixed clone appears in the original content item's Revision History Section with the Fixed Clone Icon designating its status. It also appears in a separate section in the Exploring page for the category or folder where the item was stored. If the clone has been frozen, the Frozen Fixed Clone Icon is displayed. Click either icon to view the Content Information page for that clone.

A new metadata field, **Working Copy**, is added to the Information page of the fixed clone. The name of the original content item or folio appears next to this field with a link to that item.

If a user has permissions to freeze an item (assigned to the Records Administrator role by default) the user can freeze fixed clones and freeze the revision associated with the fixed clone. Freezing is done by searching for the folio then selecting a **Freeze** option from the Table menu on the Search Result page. See Freezing Search Results in *Managing Oracle WebCenter Content* for details.

### 27.2.5.1 Creating a Fixed Clone

To create a fixed clone (this menu option is only available when a content item matches the criteria for cloning):

1. Use searching or screening to find the content item to clone.
2. Click the **Info** icon for the item.
3. On the Content Information page, select the revision to clone by clicking the revision number in the Revision History Section.
4. Choose **Content Actions** then **Create Fixed Clone** from the Page menu to create a fixed clone of the revision. Choose to supersede previous clones with this version by selecting the appropriate box. A prompt appears for the clone name and the location for storage (folder or category). Enter the name of the category or click **Browse** to choose an item from the Select Category or Folder dialog.
5. Click **OK** when done. The Content Information page opens with the fixed clone icon in the Revision History Section indicating the action taken.

## 27.2.5.2 Adding a Folio to a Restricted Revision Category

To create a folio that is cloned for use in a restricted revision category:

1. Choose **Content Management** then **New Folio**.
2. Choose the type of folio to create and choose **Load Folio**.
3. Click the plus icon to add a folio. Click **Next**. Select items from the search results for inclusion and click **Next**.
4. On the folio page, choose **Actions** then **Save Folio** from the Page menu.
5. Click **Next** in the dialog. Choose a title for the folio and a security group for the folio.
6. In the Category or Folders field, choose a category that restricts revisions.
7. Click **OK** and check in the folio.
8. Browse to the category with restricted revisions. Note that the folio and a folio clone are listed.

## 27.2.6 Creating a Physical Item

When creating a new physical item, you check in its metadata, storage information, and retention schedule in the repository. This information is subsequently used to track the physical item and manage its life cycle.

You can also create a new physical item by choosing **New Checkin** then **Electronic/Physical Checkin**. Use that option to check in an item that is stored on another repository (such as an adapter system). The procedure is the same as that described here. Only the menu option is different.

A physical item can be created by simply checking in the item as a physical item. Other methods can also be used to create a physical item:

- [Using the Storage Page](#)
- [Within a Retention Schedule](#)
- [Creating a Physical Item Within Another Item](#)

### 27.2.6.1 Using the Storage Page

 **Note:**

The PCM.Physical.Create right is required and the Record.Create right is needed in the Records system to perform this task. The PCM.Physical.Create right is assigned by default to the PCM Requestor and PCM Administrator roles. The Record.Create right is assigned by default to the predefined Records Privileged and Records Administrator roles.

Use this option when creating a record for an item which has no electronic equivalent (such as a tape or a CD).

1. Choose **Physical** then **Storage**.

2. On the Exploring Storage page, choose **Create Physical Item** from the **Actions** menu for the location to store the item.
3. On the Create or Edit Physical Item page, provide the information for the new physical item as required, including its storage and record-related information:
  - Title: Item's title. Maximum characters is 80.
  - Filer (author): Person submitting the item. The default is the current user. Administrators can select an alternative filer.
  - Security Group: Group where the item should be assigned.
  - Object Type: Select a type matching the object type of the storage location, if one is specified.
  - Media Type: Available media types depend on the object type.
  - Permanent Location, Current Location: Enter a location or click **Browse** to open a dialog used to browse the storage space hierarchy. Use the plus and minus symbols in front of a storage location to unfold or collapse all child locations. After selecting the desired location, click **OK** to return to the Create or Edit Physical Item page. Click **Clear** to delete the current storage path and select a new one.

After selecting a location, the Permanent Location field contains a reference to that location. This is the barcode for the location or if no barcode is specified, it is a 19-digit number. Below the Permanent Location field, the full hierarchical storage path to the selected location is displayed.

If a current location isn't set, it is set to OTHER. To set the location to a user, select **Set Current Location to a User**. If needed, enter a comment about the current location (for example, handling instructions).

If a permanent location isn't provided, it is set to the current location.
4. Click **Create** to submit the information about the new physical item to the repository.

## 27.2.6.2 Within a Retention Schedule

### Note:

The PCM.Physical.Create right and the Record.Create right is required in the Records system to perform this task. The PCM.Physical.Create right is assigned by default to the PCM Requestor and PCM Administrator roles. The Record.Create right is assigned by default to the predefined Records Privileged and Records Administrator roles.

To create a new physical item in a retention category or records folder:

1. Choose **Browse Content** then **Retention Schedules**.
2. Navigate to the records retention category or records folder in the hierarchy to store the physical item.

3. Choose **Create** then **Check In New Physical Item** from the **Actions** menu of the location where the item will be stored.
4. Provide the information for the new physical item as required.  
The page does not contain the Life Cycle field because the physical item is automatically assigned the retention and disposition rules of the current (or inherited) retention category.
5. Click **Create** to submit the information about the physical item to the repository. The Physical Item Information page for the new physical item opens with the **Is Record** field set to Yes.

### 27.2.6.3 Creating a Physical Item Within Another Item

 **Note:**

The PCM.Physical.Create right is required to perform this task. This right is assigned by default to the PCM Requestor and PCM Administrator roles.

To create a new physical item within an existing physical item:

1. Choose **Physical** then **Storage**.
2. On the Exploring Storage page, choose **Create Physical Item Within** from the **Actions** menu for the location where the item will be stored.
3. On the Create or Edit Physical Item page, provide the information for the new physical item as required, including its storage and record-related information.
4. Click **Create** to submit the information about the new physical item to the repository.

## 27.3 Finding Records and Physical Items

The **Search** option can be used to search for records, just as any type of content can be searched.

When using Oracle Text Search the system does not index external items, including physical items. Therefore those items and other items stored externally (for example, on an adapter system) are not available for searching.

For details about using Federated Search for legal discovery purposes, see Federated Searches in *Managing Oracle WebCenter Content*.

In addition to search-like functionality, screening can isolate retention categories, record folders, and content by their attributes. Screening enables a user to see what has happened or what could happen within a retention schedule.

If more results are returned than are configured in the User Profile page, the page navigation menu will change, indicating other pages of information available for viewing. The list of page numbers is updated as the user navigates through the pages. If there are fewer search results than are configured in the User Profile, no page navigation is displayed.

 **Note:**

Depending on a user's role, rights associated with that role, and profile, different menu options may appear on a search or screening page. In general, system administrative users will see menus similar to those used to configure the system while end users will see menus containing typical functionality for users.

## 27.3.1 Searching for Content

To search for content:

1. Choose **Search** then the repository for searching.
2. On the Standard Search page, enter the criteria to use for the search. When searching folders, it is best to use Substring as an operand instead of Matches. Using the Matches operand narrows the search results considerably. Using Substring returns all internal content items as expected.
3. To create a query for later use, select the search criteria and click **Save**. A prompt appears for a query name. Enter a name and click **OK**. The query is saved in the user's My Saved Query list in the **My Content Server** menu.
4. To run the search immediately, specify the search criteria and click **Search** when done. The Search Result page opens, which lists all items meeting the search criteria.

### 27.3.1.1 Using the Search Forms Option

An expanded version of the search form can also be used or a custom search query can be constructed. To access these options, choose **Search Forms** from the Page menu of the Standard Search page.

- **Expanded form:** By default, several sections of each search form are displayed using the collapsed format (for example, Correspondence Fields). When the expanded version of a search form is selected, all of the sections on the form are displayed.
- **Query builder:** The Query Builder form is available from the Search Forms menu at the top of the page on any of the search pages. It enables a user to easily build and save complex queries by selecting options from a series of lists and operator fields. After a query is built using the Query Builder form, the user can edit the query directly, perform the search, or save the query for easy access from the saved queries list or through a targeted quick search.

The Query Builder form displays the **Include Child Records Folders** box. If selected, the search function returns any matching results within child record folders. For comprehensive information about the Query Builder form, see [Searching with the Query Builder Form](#).

### 27.3.1.2 Using Auxiliary Metadata Sets

If an auxiliary metadata set has been created, the **Auxiliary Metadata Set** option appears next to the **Search Forms** option on the Page menu.

To search using metadata from that auxiliary set, click **Auxiliary Metadata Set** then click the name of the set before performing a search. Click **OK**. The search page is populated with the additional metadata fields, which can then be used for searching.

## 27.3.2 Searching for Physical Content

Physical content metadata (including storage information and retention schedules, if any) are stored in the repository. Information about physical items managed by PCM can be found using the basic search page or the advanced search page.



### Note:

The search functionality for physical content items is case-sensitive.

To search for physical items:

1. Choose **Search** then **Physical**.  
To use the advanced search page, choose **Search** then **Advanced Search** on the Page menu.
2. To create a query for later use, select the search criteria and click **Save**. A prompt appears for a query name. Enter a name and click **OK**. The query is saved in the user's My Saved Query list in the **My Content Server** menu.
3. To run the search immediately, specify the search criteria and click **Search** when done. The Physical Search Result page opens, which lists all items meeting the search criteria.

## 27.3.3 Screening for Content



### Note:

Depending on a user's role, the rights associated with that role, and the user profile, different menu options may appear on search or screening pages. In general, administrative users will see menus similar to those used to configure the system while end users will see menus containing typical functionality for users.

After installation, an additional **Screening** menu is available on the **Search** menu. In addition to search-like functionality, screening enables a user to isolate retention categories, folders, and content by their attributes. Screening enables the user to see what has happened or what could happen within a retention schedule.

Screening reports can be created immediately or they can be scheduled to be generated at a later time. This is especially useful for screening reports affecting large sets of content. Creating the screening report immediately might put a heavy load on the system, which could diminish its responsiveness and/or result in browser time-outs. To avoid the load on the system, schedule screening reports to be performed at midnight, an off-peak time in most environments.



### Note:

Scheduling reports is usually limited to those users with administrative privileges.



The screening interface may use user-friendly captions or may use standard retention terminology. The interface depictions in this documentation show user-friendly captions.

The following screening topics are discussed in this section:

- [Performing Screenings](#)
- [Scheduling a Screening Report](#)
- [Setting Default Metadata For Reports](#)

### 27.3.3.1 Performing Screenings

This section describes a general procedure to perform screenings. A search can be done by retention categories, record folders, and content by disposition, disposition event criteria, record folder and/or retention category criteria. Click **Search** without entering any criteria, and all items are returned in the results. Different repositories can also be searched (physical and electronic).



#### Note:

The Admin.Screening right is required to perform screening actions. This right is assigned by default to the Records Administrator role.

To screen data:

1. Choose **Search** then **Screening**. Select the screening type (Categories, Folders, or Content).
2. When screening content and records, you can select the sources to use for the screening on the Screen for topic page. If additional repositories are available (for example, physical content or an adapter repository), you can select the source from the list. If an additional repository is chosen, you should verify that the screening criteria used is also available in that repository. If a field is used for screening and it is not used in the external repository, an error is displayed.
3. Depending on the type of screening chosen, different screening options are available. Select the criteria for the search from the provided menus.

When screening content and records, the **Update Sort Fields** button is displayed. Click this button to open a dialog where the user can select multiple fields to use for sorting. For each field selected and moved to the **Search Fields** pane, a check box appears below the fields section. Select the box to further refine if the sorting for that field should be in ascending order. If not checked, sort order is descending.

4. (Optional) if screening for a review or due date, specify the date in the **Review Due By** box or **Due for Action** box.
5. Select a **Freeze Status** to filter by items that are frozen or not frozen.
6. Select sorting preferences in the **Results Options** area.
  - a. Sort by the default or select another option from the **Sort By** list.
  - b. Sort in the default descending order or select the ascending order.
7. Click **Search**. Any results matching the screening criteria appear in the Screening Results.

## 27.3.3.2 Scheduling a Screening Report

 **Note:**

You must have Records Administrator or PCM Administrator rights to schedule screening reports.

You may be able to only schedule screening reports and not execute them immediately, depending on the setting of the **Only allow scheduled screening** option on the Configure Retention Administration page. See *Configuring Retention Definitions and Options* in *Managing Oracle WebCenter Content* for details about configuring the system.

To schedule a screening report:

1. Choose **Search** then **Screening** then the screening type.
2. On the Screen for Topic page, select the criteria for the screening and click **Schedule**.
3. On the Schedule Screening Report page, provide a **name** for the screening report.
4. Provide the **start date** of the screening report. This is the date the scheduled screening report will be generated. If the screening report is recurring, the first screening report will be generated for the first time on this date, and all subsequent reports at the end of each recurring period after this date.
5. To create the report periodically rather than just once, select **Is Recurring**. Specify the interval at which the recurring screening report will be created (for example, every 2 weeks).
6. Click **OK** when done.

The Scheduled Screening Reports page opens, which now includes the newly created scheduled screening report.

## 27.3.3.3 Setting Default Metadata For Reports

 **Note:**

You must have Records Administrator or PCM Administrator rights to schedule screening reports.

Recurring screening reports are automatically checked into the repository. To set the default metadata for these checked-in reports:

1. Choose **Records** then **Configure**. Choose **Metadata** then **Screening Metadata Defaults**.
2. On the Default Metadata for Checked-In Screening Reports page, specify the default metadata for checked-in screening reports.
3. Click **Submit Update** when done.

## 27.3.4 Browsing the Retention Schedule

Browsing content and navigating the hierarchy in the retention schedule can be done using various techniques. A user's permissions and security configuration determine what portions of the schedule the user can view. A user can navigate using these methods:

- Accessing retention schedules using the **Browse Content** menu: When an object is clicked in the Browse Content area, the tree expands or collapses. By default, retained items can be accessed in the retention schedule object.
- Accessing retention schedules using a search result: Click the link in the Name column on a Search Result page to navigate to child objects. Hover the mouse pointer over the name of a category or record folder to quickly view its description. Descriptions over 100 characters are truncated in the popup for easier viewing. The full description of a category or folder can be viewed on the relevant information page.
- Accessing retention schedules using locator links: The locator link provides a convenient means of navigating a retention schedule. It shows the location in the schedule hierarchy, and provides links to click to quickly move between parent and child levels.

To view the contents of a retention object (a category or series):

1. Choose **Browse Content** then **Retention Schedules**.
2. On the Exploring page, click the name of the object to view.
3. The appropriate object page opens. For example, if you elect to view the contents of a category, the Category or Series Content page opens.

To view information about a series or retention categories:

1. Choose **Browse Content** then **Retention Schedules**.
2. On the Exploring page, navigate to the item for which to see information.
3. In the row for the item, do either of the following:
  - Click the **Info** icon.
  - Click the item's **Actions** menu and choose **Information**, then select the type of information to view:
    - **Series**: Information about a series.
    - **Category**: Information about a category.
    - **Metadata History**: A list of changes to the metadata of the item.
    - **Disposition Information**: Disposition instructions, defining how items in the category are handled.

The appropriate information page opens (for example, the Series Information page or the Category Information Page). The page shows relevant information about the selected item.

## 27.3.5 Browsing the PCM Storage Space

PCM uses a defined physical space environment to keep track of the storage and retention of physical items. When working with a physical item, the item is assigned to a storage location, so PCM knows where it is stored and can track it.

Storage space in PCM is set up hierarchically. Storage locations contain other, smaller storage locations that contain still smaller storage locations, and so on. The default PCM functionality comes with the following storage space hierarchy (from large to small).

This section describes browsing the defined storage environment in PCM. It covers the following topics:

- [Browsing the Storage Tree](#)
- [Using Exploring Pages](#)
- [Viewing Information about a Storage Location](#)

### 27.3.5.1 Browsing the Storage Tree

The **Browse Content** menu contains an item called **Storage**. This option enables a user to browse the defined storage space environment in a tree view with all defined storage locations in their hierarchical order. Note the following considerations:

- The icons indicate the location type of the storage locations.
- All storage locations include a percentage that shows how much of the available storage space in the location (and all its children) is currently occupied. For example, 25% means one-quarter of the maximum allowed number of stored items is currently assigned to the storage location (and all its children). The percentage of a storage location is automatically updated. However, the percentages of the parent storage location(s) are not updated automatically. This is done automatically daily (see next note).
- By default, the available storage space for the entire hierarchy is recalculated daily at midnight. Therefore, the storage availability information may not be entirely up to date as the day progresses because it still reflects the situation from the night before.
- The Browse Storage tree will always include a storage location called Other at the bottom. This is the default storage location for any physical items not explicitly assigned to another storage location.
- Click any linked item in the storage space tree to see its Location page.

### 27.3.5.2 Using Exploring Pages

The Exploring [Location] pages show the child storage location of a defined storage location. A list of all physical items stored in it can also be shown.

1. Click **Browse Content** then **Storage**.
2. The Exploring page for the top level (called Storage) opens. Use the links on this page to drill down in the storage space hierarchy. In the default Trays layout, navigate to a storage location in the tree view and click its link in the tree.

At the top of the page are locator links showing the current location in the storage space hierarchy. This trail allows a user to easily navigate between the levels in the hierarchy. Click any linked item in the trail to go to that level and show its Exploring page.

### 27.3.5.3 Viewing Information about a Storage Location

To view information about a storage location:

1. Choose **Browse Content** then **Storage**.
2. On the Location page, navigate to the storage location and click the **Info** icon.

You can also choose **Information** then **Storage** from the **Actions** menu for a storage location in the list to view that location's properties.

3. Click **OK** when done viewing information.

## 27.3.6 Generating a Retention Schedule Report

A report can be generated at any time for any portion of the retention schedule to which a user has permissions. To generate reports for retained items:

To generate a report:

1. Choose **Browse Content** then **Retention Schedules**.
2. On the Exploring page, select the box corresponding to the item to use for the report. Choose **Reports** then **Retention Schedule** on the Page menu.

A retention schedule report is generated. Open the report and view it or choose to save the report as a file.

3. Close the browser window when done.

### Note:

The report is generated in either PDF or HTML form, depending on how the system is configured. If the generated file is in PDF format, it must be viewed using Adobe Acrobat version 6.0 or later.

## 27.4 Reservations and Chargebacks

Reservations are used to manage physical items. Items can be checked out to users, reserved for later use, or requested. A user can put a hold on items that are currently unavailable (for example, someone else has the item). If others also made a reservation request for an item, that reservation is put on a waiting list, which specifies the order in which people made a reservation for the item. A reservation request may comprise multiple items.

Chargebacks are fees charged to people or businesses for the use of storage facilities or actions performed on physical items in the storage facilities. They can also be used to provide an explanation for storage actions.

Invoices can be generated for the storage, use, reservation, and destruction of the managed content. The invoices can then be sent to internal or external customers in accordance with applicable business procedures.

For complete details about creating customers, charges, and reservations, see Understanding the Chargeback Process and Processing Reservations in *Managing Oracle WebCenter Content*.

## 27.5 Creating a Records Profile

Profiles limit information shown on often-used pages, thus making it easier for users to see or enter only information that is directly relevant. Profiles can be considered a type of filter for what information is displayed.

Simple Profiles are based on Content Profile functionality. Content Profiles is a field-based approach to customizing content pages. Simple Profiles is a form-based application. A software wizard tool steps the user through the process of creating a profile. Users can customize the forms by choosing what fields will appear, the order of the fields, and can create tool tips and prompts to remind the user of needed actions and valid entries.

Most users do not have the security privileges required to use the Content Profile tool in the Configuration Manager applet, but all users are able to use Simple Profiles, regardless of their security privileges.

The Simple Profile functionality meets Department of Defense 5015 certification requirements and enables individual users to set their own defaults for a personal profile.

## 27.5.1 Creating a Profile

*System* profiles are created by an administrator and can be accessed by any user. *Personal* profiles are created and configured by a user for personal use. If a administrator sets up a personal profile, it is available for use only by the administrator, not to others in the enterprise.

### Note:

The Records User right is required to create a personal profile. To perform any administrative functions, the Record Administrator or PCM Administrator role is required.

A profile is composed of *rules* and a *trigger value*, based on a *trigger field*. Select the trigger field in the initial step of setting up the profile then use the Simple Profiles interface to set the rules to control the trigger.

The following topics are discussed in this section:

- [Trigger Fields](#)
- [Rules](#)
- [Profile Pages](#)

### 27.5.1.1 Trigger Fields

The first step in the profile process is to determine a trigger field. The trigger must match the following criteria:

- It must be an option list metadata field. The fields that are defined as option list fields are the only fields that appear in the list for trigger selection.
- After a trigger field has been defined for a system profile, it cannot be deleted from the system. (A user can delete a trigger field defined for a personal profile.)
- A trigger field can be disabled by a administrator using the Profiles tab of the Configuration Manager applet. Click **Select**, then select **none specified** from the Add Profile page, then click **OK**.

### Caution:

If a trigger field is disabled, all profiles are disabled but they remain listed on the **Search** and **New Check In** menu. If a trigger field is changed after profiles have been created that use that field, the existing profiles could become invalid.

If a metadata field in a document matches a trigger value for a profile that profile is used for the document. You can have an unlimited number of profiles, but only one trigger *value* per profile. For example, if a trigger field is dDocType, Profile 1 can use a trigger value of ADACCT. Profile 2 can use a trigger value of ADSALES.

## 27.5.1.2 Rules

A *rule* is a set of metadata fields that determine how the fields are shown on the Check In, Update, Content Information, and Search pages. It also determines if fields are editable, required, hidden, excluded, or read-only. A rule can be evaluated for every profile (global) or can be evaluated for a specific profile.

A *global profile* is one that is always evaluated. Because profile rules are evaluated after global profiles, global profiles can be superseded by profile rules. However, administrators can set the priority for the global profile and increase its precedence.

### Note:

Global system profiles affect all personal profiles that other users create. The defaults, descriptions, and labels that an administrator creates in this type of profile are used on the personal profiles other users create if the profile is made global.

## 27.5.1.3 Profile Pages

After determining the trigger value, set up the following elements in Simple Profile pages by using either the profile configuration Wizard (when creating a new simple profile) or the following page menu options.

### Note:

Some of these elements are restricted to use by administrators only at a site. Available elements also may be limited by the configuration for a site.

- **Configure fields:** Used to choose the fields to appear on forms and whether those fields are excluded, hidden, un-editable (read-only) or required.
- **Set field formats:** Used to specify the formats for fields.
- **Set default values:** Used to set the default values for fields.
- **Set derived values:** Used to set the derived values for fields.
- **Group fields:** Used to determine how the fields are grouped, the headings used, and any other descriptive information about the groups.
- **Set labels:** Used to change the display names for the fields used in the profile.
- **Set descriptions:** Used to add a field label tool tip for a field to explain the field usage.
- **Restrict options:** Used to restrict what appears on a form or to determine the order of options in a list, depending on the field choice.
- **Set activation condition:** Used to set the activation condition that changes profile behavior based on different inputs.

- **Limit access (Administrators Only):** Used to limit access to a system profile based on a security group.
- **Set search order:** Used to set the search order for search results and the direction of a search (ascending or descending).

Include as many of these elements as needed in the profile.

Designing a profile consists of a number of steps. The exact number and order of the steps depends on the elements to be included in the profile. This document describes all the steps. Choose the steps needed for the profile.

## 27.5.2 Designing a Simple Profile

System profiles are profiles that can be used by all users. These are typically created by administrators. Personal profiles are profiles that are created by individual users for their own personal use. The following sections describe how to create and configure a profile.

- [Adding a New Profile](#)
- [Using the Create/Update Profile Pages](#)



### Note:

Some tasks are restricted to administrators.



### Tip:

When creating a new profile, you can test the effects of the profile and then edit the functionality. You can exit the Wizard at various points in the profile creation process and view the effect of the profile. To return to editing the profile, choose **Edit**, then **Update Profile** from the Page menu bar for the profile. If you have closed the profile, from the Profile Listing page choose **Edit**, then **Update Profile** from the **ACTIONS** menu for the desired profile. Use the Wizard page menu to quickly navigate to the specific page you need to update.

### 27.5.2.1 Adding a New Profile

Follow these steps to create a new system or personal profile using Simple Profiles. Add as many elements to the profile as needed. The pages shown in the Wizard depend on the elements selected in the Wizard fields.

1. Access the Simple Profile functionality on the system depending on the type of profile to be created:
  - To create a personal profile, choose **My Content Server** then **My Simple Profiles** then choose the profile type. Select **Create** then **Create Profile**. Profiles created in this fashion will appear as a menu selection on the Check-in and the Search menus.
  - Administrators: To create a system profile that can be used by all users, choose **Records** then **Configure** then **Simple Profiles**. Choose the profile type. Select **Create** then **Create Profile**.



- To create a system profile for Physical Content Management, choose **Physical**, then **Configure** then **Physical Profiles**. Select **Create** then **Create Profile**.
  - To create a global profile that will be applied to every profile, choose **Create Global Profile** instead of the **Create Profile** option. A global profile is one that is applied to every profile and which may override other profile behavior. Global profiles are applied in order of the priority assigned to the profile. Use this option with caution.
2. Enter a name for the profile. This name can be a maximum field length of 50 characters and cannot contain special characters (; @ &, and so on).
  3. Enter a label for the profile. This name appears in the New Check In menu list and in the Search menu list.
  4. Enter a description for the profile.
  5. Choose the trigger value for the profile. When the trigger field matches this trigger value, the profile is used. Depending on the type of trigger chosen, a list may be available where a value can be selected.
  6. If the rules in a profile should be used globally, select **Is Global**. Global rules are those that are always evaluated, regardless of the criteria selected for the profile. An administrator can apply global rules to a system profile, which will affect all users. A user can apply global rules, but those rules apply only to the user's personal profiles.

 **Note:**

Global rules for a system profile may affect personal profiles. The defaults, descriptions, and labels created in the system profile may affect pages used in creating personal profiles.

7. If global rule is selected, choose a priority number. A low priority number gives a lower precedence. The rule is executed before other higher priority rules, which means any changes made by higher priority rules may override those made by this rule.
8. Leave **Clear Search Trigger Value** unselected to prevent pre-populating the trigger value specified in step 6. Default behavior is to allow the trigger value to be inserted on the Search pages that use the profile. By selecting this option, the trigger value is not used.
9. Select the auxiliary metadata set or sets to use as a source for field values.
10. Select the elements to include by selecting the appropriate check boxes in the Wizard Fields list.
11. When finished selecting elements to include, click **Save**.  
The first page chosen for configuration opens.
12. Make any configuration choices for each page in the Wizard. After specifying the configuration for each page, click **Save**, and the Wizard will continue with the next page in the sequence.

To avoid saving the configuration for a page, click **Reset** to return the settings to their original values. At any time during this process the user can click **Exit Wizard** and the configuration is saved in the new profile, even if the user has not completed all the pages.

 **Note:**

In some pages, if you choose a field but don't specify a value for it, a message will appear to tell you to specify a value.

13. When you finish configuring the last page in the profile Wizard sequence, click **Save**. The Simple Profile Information page opens. From this page the user can update, delete, or copy the profile.

## 27.5.2.2 Using the Create/Update Profile Pages

The profile pages available for configuring a new simple profile depend on the options selected on the Create/Update Simple Profile page.

The following general procedure can be used to manage the information on any of the pages:

- Click a field name to designate it for use. To designate a block of fields, click the first field, then press the Shift key and click the final field in the block.
- Click the arrows to move the field from one location to another. A field can only be used in one location at a time. On some pages, arrows also can be used to sort the order of fields.
- If a field has an additional element, such as a label to be associated with the field or a value that can be selected, that information appears at the bottom of the page.
- To save the page and move to the next page in the Wizard sequence, click **Save**.
- To exit the process and save the profile at any point, click **Exit Wizard**.
- To reset the values on the page, click **Reset**.
- To receive help information for the page, click **Quick Help**.

### Actions Menu

The **Actions** for the individual profiles lists the following frequently used actions:

- **Profile Information:** Opens the Simple Profile Information page for the profile.
- **Update Profile:** Opens the Create/Update Simple Profile page where elements can be selected to include in the profile.
- **Delete Profile:** Deletes the current profile.

### Wizard Page Menu

The **Wizard** page menu shows the pages available for use in the profile using the configuration wizard. Move between pages in the profile by choosing a page from this menu.

### Saving and Exiting

To exit the profile design process, click **Exit Wizard** on any design page. A message is displayed, indicating the configuration wizard has been exited. Click **OK**.

 **Note:**

When you click **Exit Wizard** while using the configuration wizard, your profile is saved temporarily and does not appear on **New Check In** or **Search** menus for use. You must complete the design process and click **Save** in order to use the profile.

To reset the current page and lose all changes made to it, click **Reset**.

When finished the configuration on the page, click **Save**. The next page in the profile design sequence opens. When a user reaches the final page and clicks **Save**, the process is complete.

### 27.5.2.2.1 Selecting Fields for Inclusion

To select fields for inclusion, select **Field Configurations** from the Wizard Fields section on the Create/Update Simple Profile page. The Simple Profile Field Configuration page opens. Use this page to determine actions for the specified fields.

- **Excluded Fields:** These fields are not available for use on any future pages used in the profile design process.
  - **Hidden Fields:** These fields can continue to be used even though they are not displayed. This allows a user to set defaults, descriptions, and other useful information for those fields that will remain on the form when the document is checked in.
  - **Uneditable Fields:** These fields cannot be altered during the Check In or Update process.
  - **Required Fields:** These fields must be filled in by the user. If a field is designated as required, a message can be included when prompted at the bottom of the page.
1. Select the available fields to use and move them into the appropriate box on the opposite side of the page. Use the arrows to sort the order of the fields in each box.
  2. If a selected field also has a required message, it is shown in a Required Messages section on the page. Review the information and make modifications.
  3. When done, click **Save**.

The next page in the profile creation process opens.

### 27.5.2.2.2 Set Field Formats

Select **Field Formats** from the Wizard Fields section on the Create/Update Simple Profile page. The Simple Profile Field Formats page opens. Use this page to specify formats for the fields in the profile.

1. Select the available fields to use and move them to the Format Fields box.  
When a format field is selected, a Format Values section is displayed.
2. In the Format Values section, for each format field, click the check box if a format hint is needed on the Check In page.
3. For each selected field, enter a format value for a format different than the existing format. Formats specify the type of information that can be entered by the user when the field appears on a form, usually alphabetic, numeric, or alphanumeric.

Use braces { } around a value to specify a regular expression. Pattern values include the following. All other characters are treated as literal values.

- **N** or **n**: Can be any digit. Example: 0 to 9.
- **L** or **l**: Can be any lowercase alphabet characters. Example: a to z.
- **U** or **u**: Can be any uppercase alphabet characters. Example: A to Z.
- **B** or **b**: Can be any lower- or uppercase alphabetic characters. Examples: a to z; A to Z.
- **A** or **a**: Can be any alpha-numeric characters. Example: a to z; A to Z; or 0 to 9.

4. After setting all the field formats, click **Save**. The next page in the profile creation process opens.

### 27.5.2.2.3 Set Default Values

1. Select the available fields to use and move them to the Default Fields box. When specifying a default field, a Default Values section is displayed.
2. In the Default Values section, for each default field a field value can be entered. Select **Advanced** where Idoc Script can be entered to specify how the default value is used after evaluation for processing.
3. After setting all default values, click **Save**. The next page in the profile creation process opens.

Select **Field Defaults** from the Wizard Fields section on the Create/Update Simple Profile page. The Simple Profile Field Default Values page opens. Use this page to set default values for the fields in the profile.

### 27.5.2.2.4 Set Derived Values

Select **Field Derived Values** from the Wizard Fields section on the Create/Update Simple Profile page. The Simple Profile Field Derived Values page opens. Use this page to set derived values for the fields in the profile.

1. Select the available fields and move them to the Derived Fields box. When a derived field is specified, a Derived Values section is displayed.
2. In the Derived Values section, for each derived field, specify a derived value. Select **Advanced** where Idoc Script can be entered to specify how the derived value is used after evaluation for processing.
3. After setting all derived values, click **Save**. The next page in the profile creation process opens.

### 27.5.2.2.5 Grouping Fields

Select **Field Groups** from the Wizard Fields section on the Create/Update Simple Profile page. The Simple Profile Field Groups page opens. Use this page to group fields together on the Check In, Update, Search, and Content Information pages.

 **Note:**

If you chose to configure fields and excluded some fields on the Simple Profile Field Configuration page, those fields do not appear for use on this page. In addition, if you chose to hide fields, those fields do not appear for use on this page.

1. Select the available fields to use and move them to the Default box or an added group box. The Default box can be used for information that has pre-defined defaults, or for any fields that should appear at the bottom of the form that uses the profile.
2. To create a new group, click **Add Group** then enter the following information on the Edit Profile Group dialog:

- a. Enter a name for the new group. The ID can be a maximum of 50 characters and should not include special characters (#, @, etc.)
  - b. Enter a header for the new group. The header appears on the form when the profile is used.
  - c. Enter a description for the new group. When the user's cursor is placed on the title on the form, this description appears as a field label tooltip.
  - d. Enter any detailed information that identifies the new group.
  - e. Select **Is Allow Collapse** to allow users to collapse the group when viewing the page.
  - f. Select **Is Initially Collapsed** to collapse the group on initial use of the page.
- To exit without saving the group, click **Cancel**. When done creating the new group, click **Save**.
3. To edit any group on the page, including the Default group, click the page icon next to the group title.
  4. To delete a group, click the delete icon in the group title line.  
The fields that were selected for inclusion in the group are returned to the Available Fields box.
  5. To rearrange the order of fields in a group, select a field, then click the Up or Down arrow to move the field into the appropriate position.
  6. When finished arranging the groups on the page, click **Save**. The next page in the profile creation process opens.

#### 27.5.2.2.6 Setting Labels

Select **Field Labels** from the Wizard Fields section on the Create/Update Simple Profile page. The Simple Profile Field Labels page opens. Use this page to add labels to fields on the Check In, Update, Search, and Content Information pages.

 **Note:**

If you chose to configure fields and excluded some fields on the Simple Profile Field Configuration page, those fields do not appear for use on the current page. In addition, if you chose to hide fields, those fields do not appear for use on this page.

1. Select the available fields and move them to the Labeled Fields box. If a labeled field is specified, a Label Values section is displayed.
2. For each specified labeled field, a label can be entered for the field next to the field name.
3. When done, click **Save**. The next page in the profile creation process opens.

#### 27.5.2.2.7 Setting Descriptions

Select **Field Descriptions** from the Wizard Fields section on the Create/Update Simple Profile page. The Simple Profile Field Descriptions page opens. Use this page to add field label tooltips on the Check In, Update, Search, and Content Information pages.

 **Note:**

If you chose to configure fields and excluded some fields on the Simple Profile Field Configuration page, those fields do not appear for use on the current page. In addition, if you chose to hide fields, those fields do not appear for use on this page.

1. Select the available fields and move them to the Description Fields box. When specifying a description field, the Description Values section is displayed.
2. Enter a short description for each field in the Description Values section. This description appears as a field label tool tip when the user places the cursor on the field label.
3. If needed, enter a detailed description for a field. This description appears when the user clicks on the field label.
4. When done, click **Save**. The next page in the profile creation process opens.

### 27.5.2.2.8 Restricting Options

Select **Field Restricted Options** from the Wizard Fields section on the Create/Update Simple Profile page. The Simple Profile Field Restricted Options page opens. Use this page to restrict the choices on any option lists used in the profile.

 **Note:**

Only fields that have option lists associated with them appear for use on this page.

1. Select the available fields and move them to the Restricted Fields box.
2. Select the field to restrict in the Restricted Fields box and click **Update Options**.
3. In the Restricted Options dialog, select values to use in the Available Options box and move them to the Selected Options box.
4. To change the order of the options, click the Up or Down arrows. Use this tool to place more frequently used items at the top of the list.
5. To exit without saving the group, click **Cancel**. When done selecting and arranging the options, click **Save**.
6. When done selecting all option lists, click **Save**. The next page in the system profile creation process opens.

### 27.5.2.2.9 Setting Activation Conditions

Select **Activation Conditions** from the Wizard Fields section on the Create/Update Simple Profile page. The Simple Profile Activation Conditions page opens. Use this page to specify the event, action, or state that triggers the rules in the profile.

 **Note:**

By default all of the conditions are selected. Remove the selection for those conditions you do not want the profile to use.

Not all combinations of activation conditions are valid and some may be mutually exclusive. Be careful when using combinations of condition types.

1. Choose activation conditions by selecting the check box next to the appropriate activation condition:

Event Activation Conditions

- On request: When a search request is initiated.
- On Submit: When a check in is initiated.
- On Import: When an archive is imported.

Action Activation Conditions

- Check In New: When checking in new content.
- Check In Selected: When checking in selected content.
- Info: When accessing content information.
- Update: When updating content information.
- Search: When searching for content.

Flag Activation Conditions

- Is Workflow: When a document is in a workflow.
- Is Not Workflow: When a document is scheduled for a workflow but not active in the workflow.

 **Note:**

If no workflow check box is selected, the workflow state is ignored as a criteria for activation.

2. Advanced box: To have a script activated whenever this profile is submitted, enter the Idoc Script here. See Adding, Editing or Deleting Activation Conditions in Rules in *Managing Oracle WebCenter Content* for details about creating profile scripts.
3. When done, click **Save**. The next page in the profile creation process opens.

### 27.5.2.2.10 Limiting Access (Administrators Only)

Select **Limit Access Values** from the Wizard Fields section on the Create/Update Simple Profile page. The Simple Profile Limit Access Values page opens. Use this page to specify if access to the system profile should be limited according to pre-defined security accounts, roles, and groups for the Check In and Search pages.

 **Note:**

You can limit access based on a security group and an account (if accounts have been enabled). A user must belong to the security group and account in order to use the profile.

If a user is not a member of a security group, or a security group and an account, then the user will not see the profile in the **Search** or **Check In** menus.

1. Limit access to the Check In page by choosing the security group from the menu. Only users in that security group are able to check in content using this profile.
2. If accounts are in place, choose the account from the menu for the Check In page. Only users with that account *and* in the security group specified in step 1 are able to use this profile on the Check In page.
3. If roles are set up, choose the role from the menu for the Check In page. Only users with that role *and* the account *and* in the security group specified in step 2 are able to use this profile on the Check In page.
4. Limit access to the Search page by choosing the security group from the menu. Only users in that security group are able to search for content using this profile.
5. If accounts are set up, enter the account name or choose the account from the menu. Only users with that account *and* in the security group specified in step 4 are able to use this profile on the Search page.
6. If roles are set up, choose the role from the menu. Only users with that role *and* the account *and* in the security group specified in step 5 are able to use this profile on the Search page.
7. When done, click **Save**. The next page in the profile creation process opens.

### 27.5.2.2.11 Setting the Search Order

Select **Search Order** from the Wizard Fields section on the Create/Update Simple Profile page. The Simple Profile Search Order page opens. Use this page to specify the criteria and order for Search fields. Move higher priority fields to the top of the Search Fields list.

1. Select the available fields and move them to the Search Fields box.  
When a search field is selected, it is listed in the Search Criteria section.
2. You can set the search order of fields by using the Up or Down arrows to assign a field a higher or lower sorting priority.
3. In the Search Criteria section, to sort a field by ascending order, select the check box by the Search Field name. Fields are sorted in descending order by default.
4. When done, click **Save**. If no more modifications are needed to the profile, click **Exit Wizard**. The Simple Profile Information page opens.

## 27.5.3 Profile Management

Keep the following points in mind when managing system and personal profiles created with the Simple Profiles component:



- A copied profile contains all of the information in the original profile. Make certain to change any labels, defaults, or security groups in the copied profile.
- All management functionality (updating, copying, deleting) is available from the page menu bar on the Simple Profile Information page and from the **Actions** menu for a profile.
- When creating a profile, if the wizard was exited before finishing the profile by using the **Exit Wizard** option, any changes made up to that point by using the **Save** button are saved. The **Reset** button cannot be used to change them. Edit them using the **Update Profile** option.
- **Administrators Only:** If a profile is moved to the Content Profiles applet it can no longer be modified using Simple Profiles.
- **Administrators Only:** View the details of profiles created with Simple Profiles by using the Rules tab on the Configuration Manager applet. All of the rules created with Simple Profiles appear on that tab.

 **Caution:**

Do not edit any rules created for a simple profile by using the Rules tab. Editing or deleting the rules invalidates the profiles.

The following tasks are typically done when managing profiles:

- [Viewing Profile Information](#)
- [Updating a Simple Profile](#)
- [Copying a Profile](#)
- [Deleting a Profile](#)
- [Moving a Profile](#)
- [Changing a Trigger Field \(Administrators Only\)](#)
- [Troubleshooting \(Administrators Only\)](#)

### 27.5.3.1 Viewing Profile Information

To view information about system and personal profiles:

1. To view personal profiles, choose **My Content Server** then **My Simple Profiles** then the profile type to access the Profile Listing page.  
If you have administrative privileges, to view system profiles, choose **Records** then **Configure** then **Simple Profiles**. Choose the profile type to display the Profile Listing page.
2. Click the **Info** icon for the profile to view.

### 27.5.3.2 Updating a Simple Profile

Updating a simple profile involves accessing a profile and modifying, adding, or deleting information.

1. Access the Profile Listing page.
2. Use one of the following methods to update information for the profile or its fields:

- Click the **Actions** menu for the profile and select **Edit**, then **Update Profile** to access the Create/Update Simple Profile page for the profile.
- Click the **Info** icon for a profile. This opens the Simple Profile Information page. From the Page menu choose any of the Configure Fields or Configure Profile options to configure the profile.

Also, from the Page menu bar a user can choose **Edit** then **Update Profile** to open the Create/Update Simple Profile page.

 **Note:**

A profile can be updated by using the **Actions** menu or a profile's Page menu bar to choose **Edit** then **Update Profile** to open the Create/Update Simple Profile page. When the Update Content Profile page is saved it automatically starts the Wizard for modifying the profile configuration. If you do not want to use the Wizard, use the Page menu bar to directly select a profile configuration type to modify.

3. When finished making changes to a profile, click **Save**.

### 27.5.3.3 Copying a Profile

To copy a system or personal profile:

1. Access the Profile Listing page.
2. Click the **Info** icon for the profile to copy.  
The opens, showing the details of the profile.
3. On the Simple Profile Information page, on the Page menu, choose **Edit**, then select **Copy Profile**.
4. On the Copy Simple Profile page, enter the new profile name and new label.
5. Click **Copy** when done. To change edits, click **Reset** to clear the edits made.
6. Update the profile as needed.

### 27.5.3.4 Deleting a Profile

You must be an administrator to delete a system profile. You can delete your own personal profile. To remove a system or personal profile:

1. Access the Profile Listing page.
2. To delete a specific profile:
  - Click the **Info** icon for the profile to delete. The Simple Profile Information page opens, showing the details of the profile. On the Page menu bar choose **Delete Profile**.
  - Choose the **Actions** menu for the profile and choose **Delete Profile**.
  - Click **Delete** on any profile configuration page.

A message is displayed, prompting to confirm the deletion.

3. Click **OK** to delete the profile, or click **Cancel** to retain the profile.

### 27.5.3.5 Moving a Profile

To move a system profile to the Configuration Manager:



#### Note:

If you move a system profile to the Content Profiles applet in the Configuration Manager, you can no longer modify or work with the profile using the Simple Profiles component. You must use the Configuration Manager Content Profiles functionality instead. Note that physical profiles cannot be moved.

1. Access the Profile Listing page.
2. To move a system content profile to the Configuration Manager, use one of the following methods:
  - Click the **Info** icon for the system profile to be moved. The Simple Profile Information page opens, showing the details of the system profile. On the Page menu bar choose **Edit** then **Move to Configuration Manager**.
  - Click the **Actions** menu for the profile to move, then choose **Edit** then **Move to Configuration Manager**.

A message is displayed, prompting to confirm the move.

3. Click **OK** to move the profile, or **Cancel** to leave the profile as is.

### 27.5.3.6 Changing a Trigger Field (Administrators Only)

To modify the trigger field for content profiles:

1. Access the Profile Listing page.
2. To change the trigger field for content profiles, on the page click **Configure Metadata Set**.
3. On the Simple Profile Information page, select a different trigger field from the list and click **Save**. A confirmation prompt is displayed showing that the profiles configuration has been saved.
4. Click **OK**. The Profile Listing page opens.

### 27.5.3.7 Troubleshooting (Administrators Only)

To temporarily disable the Simple Profiles component to resolve an issue, change the flag to the following setting in the `\config\config.cfg` file:

```
IsSimpleProfilesEnabled=false
```

# Part IV

## Using Other Ways to Work with WebCenter Content

You can access Oracle WebCenter Content through means other than a web browser, such as Windows Explorer or Microsoft Office applications.

This part contains the following chapters:

- [Accessing Managed Content Directly from Within Your Desktop Applications](#)
- [Working with WebCenter Content from Mobile Devices](#)

# Accessing Managed Content Directly from Within Your Desktop Applications

You can manage files in a unified way from all your familiar desktop applications using Oracle WebCenter Content: Desktop.

This chapter has the following topics:

- [About Oracle WebCenter Content: Desktop](#)
- [Managing Content Through Windows Explorer](#)
- [Working With Managed Content Within Microsoft Word\\_ Microsoft Excel\\_ and Microsoft PowerPoint](#)
- [Working With Managed Content Within Microsoft Outlook and Lotus Notes](#)
- [Using Web Browser Search Fields to Search for Managed Content](#)

For more information on using Oracle WebCenter Content: Desktop, see [What is Oracle WebCenter Content: Desktop?](#).

## 28.1 About Oracle WebCenter Content: Desktop

Oracle WebCenter Content: Desktop is optional software that you install on your computer and that allows you to access content servers from within popular desktop applications (for example Microsoft Word).

You can perform content management tasks (checking out, checking in, and many more) directly from your desktop application, without using the content servers' own interfaces.

In addition, you can set up your web browser to search a WebCenter Content repository directly from the browser search field.

You can use the following desktop applications:

- Microsoft Windows Explorer (file management)
- Microsoft Word (word processing)
- Microsoft Excel (spreadsheets)
- Microsoft PowerPoint (presentations)
- Microsoft Outlook (email)
- Lotus Notes (email)
- Internet Explorer (web browsing)
- Mozilla Firefox (web browsing)
- Google Chrome (web browsing)

For more information, including supported versions, see [Supported Client Applications in \*Using Oracle WebCenter Content: Desktop\*](#).

You can use the following content servers (although not all servers support all features):

- Oracle WebCenter Content Server
- Oracle Content Server
- Oracle Content Database
- Generic WebDAV-based repositories

 **Note:**

Administration of the content servers cannot be performed through the supported desktop applications: administrative tasks must be performed through the content servers' own interfaces.

## 28.2 Managing Content Through Windows Explorer

After you install the Oracle WebCenter Content: Desktop client software on your computer, you can see a node named *WebCenter Content Servers* in the folders pane of Windows Explorer. Beneath this node are all the content servers that you can connect to. A hierarchy of libraries, folders, and files is shown for each content server. What the hierarchy looks like depends on the content server type, version, and configuration. Content from the servers can be shown in the content, preview, and details panes.

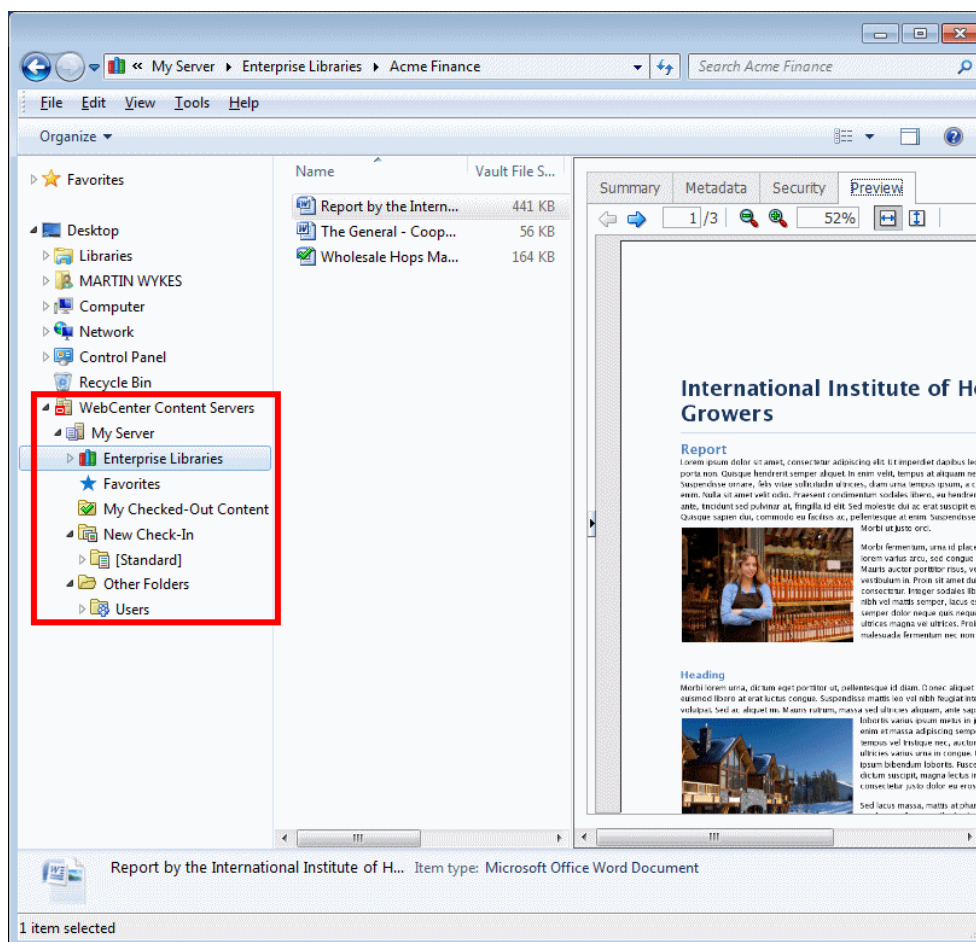

Here is what you can do from within Windows Explorer (if allowed by the content server type and configuration):

- Create and remove certain types of library and folder. (Some types can only be created or removed by administrators.)
- Add new documents to the content server, so that they become managed documents. You can also remove documents from the content server.
- Check out documents from the content server. You can also check them back in or undo a checkout.
- View documents that are on the content server, without checking them out.
- View the properties, metadata, preview, and other information associated with a managed document. You can also change some of this information.

For more information, see Microsoft File Explorer Integration in *Using Oracle WebCenter Content: Desktop*.

## 28.3 Working With Managed Content Within Microsoft Word, Microsoft Excel, and Microsoft PowerPoint

After you install the Oracle WebCenter Content: Desktop client software on your computer, a WebCenter Content menu or ribbon is added to the Microsoft Office application.

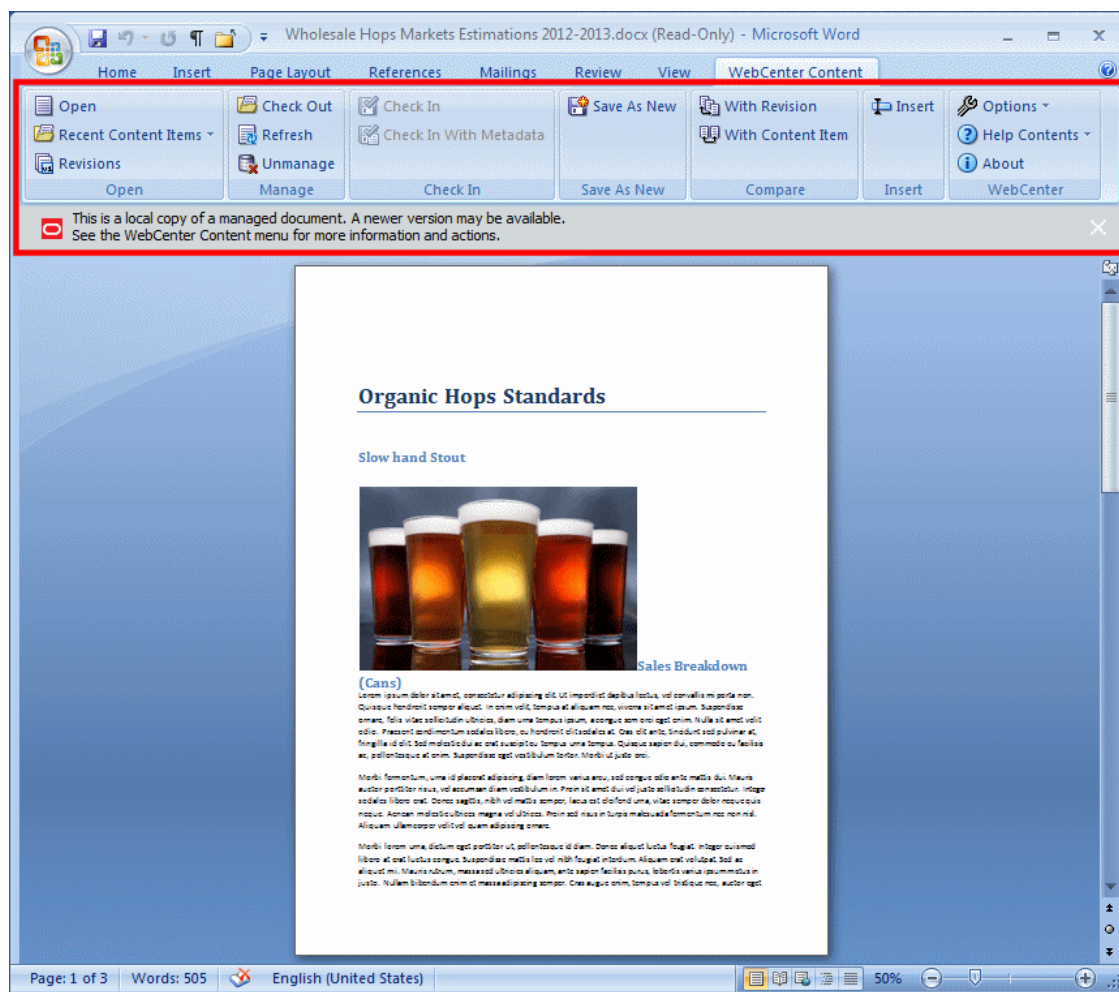

Here is what you can do from within the Microsoft Office application (if allowed by the content server type and configuration):

- View a document on the content server without checking it out. You can also view a document that has already been checked out.
- Open a document on a content server. This will check out the document and lock it from other users.
- Modify documents.
- Update the currently open document to the latest revision on the content server.
- Create an unmanaged version of the of the current managed document.
- Check the current document in to the content server as a new revision.
- Save the current document as a new content item on the server.
- Compare different revisions of managed Microsoft Word documents on a WebCenter Content instance.
- Insert links to files that are on a content server.
- Add document management properties to documents.
- Update document metadata and manage other properties of the document on the content server.

For more information, see Integration into Microsoft Office in *Using Oracle WebCenter Content: Desktop*.

## 28.4 Working With Managed Content Within Microsoft Outlook and Lotus Notes

After you install the Oracle WebCenter Content: Desktop client software on your computer, a number of content management functions become available in your email client (Microsoft Outlook or Lotus Notes).

For more information, see Microsoft Outlook Integration and Lotus Notes Integration in *Using Oracle WebCenter Content: Desktop*.

### Integration into Microsoft Outlook

Content management items are added to menus or ribbons in Microsoft Outlook. Additionally, a node named *WebCenter Content Servers* is optionally added to the mail folders panel. This shows all the content servers to which you can connect, and a hierarchy of libraries, folders, and files for each server. What the hierarchy looks like depends on the content server type, version, and configuration. The preview pane shows tabbed panels for summary information, metadata, security information, and document preview.



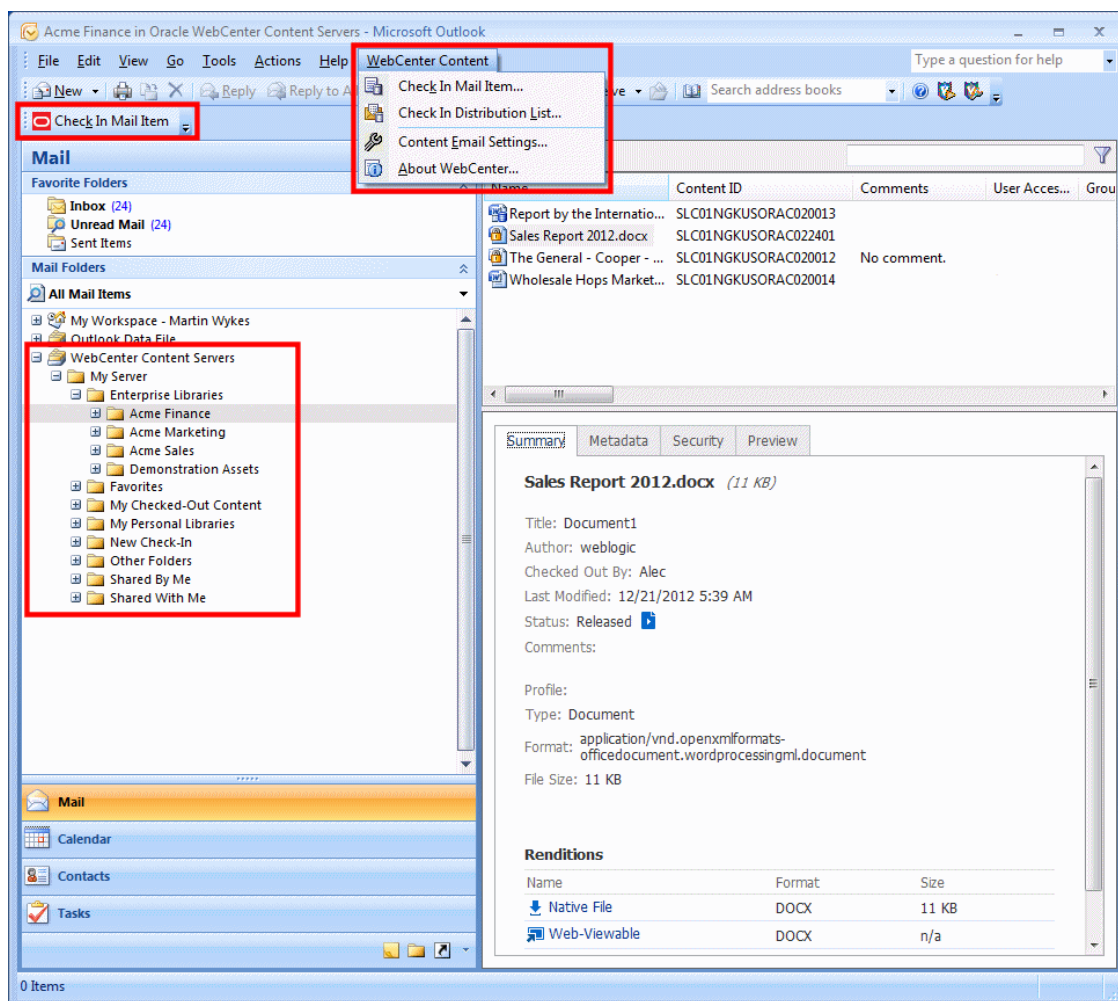

Here is what you can do from within Microsoft Outlook (if allowed by the content server type and configuration):

- Check in email messages and their attachments, to preserve them exactly as they were received, and to share them with others in your organization. Checked-in email messages are not intended to be checked out, modified, and checked back in.
- Open and view email messages managed by a content server.
- Send managed email messages to other people. They become unmanaged email messages when you do this.
- Save copies of managed email messages. Again, they become unmanaged email messages when you do this.
- Check in email distribution lists.

You can make changes to the email messages that you open from a content server, but you cannot then check them back in to the content server.

You can never check in email messages that have been modified since they were checked out.

### Integration into Lotus Notes

Content management items are added to the Actions menu in Lotus Notes.

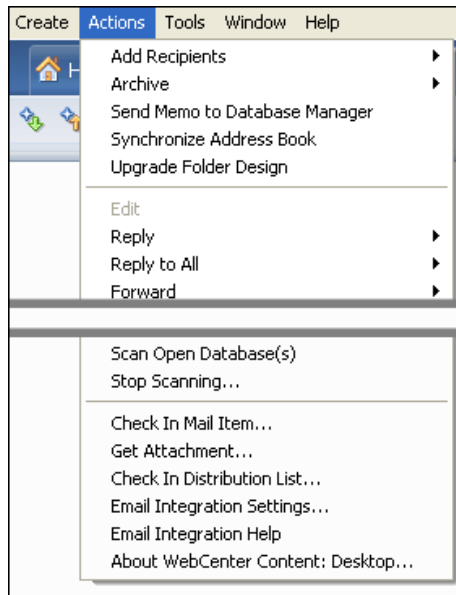

Here is what you can do from within Lotus Notes (if allowed by the content server type and configuration):

- Check in email messages and their attachments, to preserve them exactly as they were received, and to share them with others in your organization. Checked-in email messages are not intended to be checked out, modified, and checked back in.
- Check in email distribution lists.

## 28.5 Using Web Browser Search Fields to Search for Managed Content

If you want, you can set up your web browser to use Oracle WebCenter Content Search as a search provider (instead of, for example, Google). This enables you to search for content on a WebCenter Content instance directly from your browser search field.

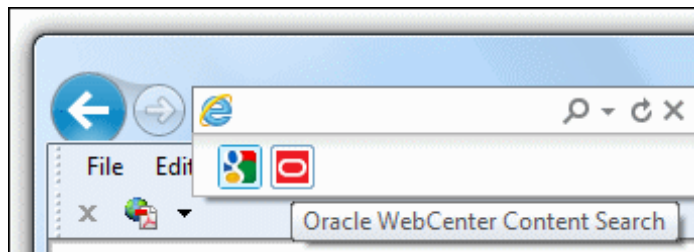

Here is what you can do from within your web browser (Internet Explorer, Mozilla Firefox, or Google Chrome):

- Search for content on an Oracle WebCenter Content Server instance, directly from the search field.
- View the search results in the web browser.

A content server search provider in your web browser is for a specific Oracle WebCenter Content Server instance. You cannot search multiple content servers using a single search provider.

If you are logged in to the content server that you are searching, you will see all content items that meet the search criteria and for which you have access privileges. If you are not logged in, you will see only public content.

For more information, see Web Browser Search Integration in *Using Oracle WebCenter Content: Desktop*.

# 29

## Working with WebCenter Content from Mobile Devices

With Oracle WebCenter Content on your mobile device, you can work securely where and how you want. The mobile application is available for both iOS and Android devices.

This chapter covers the following topics:

- [About the Mobile App](#)
- [Everyday Tasks Using the Mobile App](#)
- [Installing and Connecting to](#)
- [Navigating the Mobile App](#)
- [Finding Documents](#)
- [Viewing Files](#)
- [Downloading Files](#)
- [Sharing Files](#)

### 29.1 About the Mobile App

Have you ever been stuck on a crowded plane and late for a meeting? You need to review a contract but your laptop battery is dead. With Oracle WebCenter Content on your iPad or iPhone, you have access to all your documents no matter where you are. You can review the contract and send notes to your colleague stuck in traffic so you are both better prepared when you get to the meeting. Or download images, text and layouts from your latest ad campaign to review even when you don't have a network connection.

Here are some typical tasks you can do to get things done:

- Access files stored on an Oracle WebCenter Content server.
- Search for files on the server and filter the results to find exactly what you need.
- View a file on your device.
- View information about a file or folder.
- Download a copy of a file and store it on your device.
- Create a link to a file which can then be shared with others.
- Email a copy of a file as an attachment.

### 29.2 Everyday Tasks Using the Mobile App

Using Oracle WebCenter Content on your mobile device is just like using most other apps:

- **Install the application.**

Installation of the app can be done using the information provided by your system administrator or through the App store.

- **Sign in.**  
Enter the user name and password for Oracle WebCenter Content Server. If you are uncertain of the URL for the content server, check with your system administrator. Enable **Save Password** to automatically sign in the next time you launch the application, provided your company policy allows you to sign in automatically.
- **Access libraries, files and folders.**  
When you sign in, a listing of all libraries available to you is displayed. Browse through the libraries and folders or use the search feature to find items.
- **Mark an item as a Favorite.**  
Any library, folder, or document can be set as a favorite for easy access through the **Favorites** feature in the navigation menu.
- **Download a file from the server.**  
Downloading a file to your mobile device allows you to review the file when not connected to the content server.
- **Share a file with other people or applications.**  
Provide access to a file managed by the content server as an attachment through email or messaging, or as a link to Oracle WebCenter Content. You can also share a file with an application other than the default viewing application on your device.

## 29.3 Installing and Connecting to Oracle WebCenter Content

Installing Oracle WebCenter Mobile to your iPad, iPhone, or Android device is just like installing any other app on your device. The application is available in both Google Play and the App store.

When connecting to the Oracle WebCenter Content Server, you are asked for your user name and password. The address for the host computer is a website address where the Oracle WebCenter Content server is installed. Check with your system administrator for the right address. A typical address would resemble the following example: `http://server.example.com:16200`.

### Securing Your Documents

Documents accessed with your mobile device are protected with several layers of security. To connect to the Oracle WebCenter Content server, you must provide a user name and password. Once you connect, permissions within Oracle WebCenter Content protect what content you can access. Any documents you download to your mobile device are encrypted and cannot be accessed outside of the Oracle WebCenter Content mobile application.

For additional security, you can turn on a passcode when you sign in. If you turn on a passcode, you enter it each time you launch the app, or after a time limit you specify. Passcodes are four-digit numbers you create to lock the Oracle WebCenter Content mobile app when you are not using it. This is useful if you leave your mobile device in a public area and want to prevent unauthorized access to Oracle WebCenter Content. Don't worry if you forget the passcode. You can sign out of the app and reset it when you sign back in.

## 29.4 Navigating the Mobile App

Oracle WebCenter Content for Mobile lets you search for, view, download, and share documents already stored in Oracle WebCenter Content. When you start the application, the main screen displays a list of all libraries in Oracle WebCenter Content Server to which you

have access. Tap a library to open it and browse through items and folders. Starting at the left edge of your device and swiping right opens the navigation menu.

The navigation menu in the mobile app is very similar to the side bar in the Oracle WebCenter Content user interface. It has links to search or browse through libraries or folders, to display a list of favorites you specify, and to list items you have downloaded or recently viewed from Oracle WebCenter Content.

## 29.5 Finding Documents

If you know the library or folder a document is in, you can tap libraries and folders to open them and browse for the file you need. You can also filter libraries to show only enterprise libraries or only system libraries.

You can search for documents using a search box like on most other apps. The search box compares the words you enter to the information about documents in Oracle WebCenter Content and text in the documents if your system administrator has set it up to do so.

### Making and Viewing Favorites

You can make any file, folder, or library a favorite. Tapping **Favorites** in the navigation menu displays them in a list, which is useful to find files you use frequently.

## 29.6 Viewing Files

Oracle WebCenter Content Mobile lets you view files stored in Oracle WebCenter Content Server and download them to view on your mobile device if you don't have a connection to the content server.

### 29.6.1 Viewing a File

When you view a document on your mobile device, the file opens if an application is available on your device to view the type of file. For example, if you tap an image file, the file opens in your image viewer. If no app is installed to handle a file type, then you can't open the file.

### 29.6.2 Viewing Information about a File, Folder, or Library

You can view metadata about a document on your mobile device. The type of information you can view depends on the type of file, folder, or library and how Oracle WebCenter Content is set up. Typically the information includes the document, folder, or library title, what revision a document is, when it was last updated and who updated it.

## 29.7 Downloading Files

You might download a file if you want to review it while you cannot connect to Oracle WebCenter Content, for instance if you are on an airplane. Tapping **Downloads** in the navigation menu shows a listing of all files you have downloaded. Remember, all downloaded documents are encrypted and cannot be accessed outside of the Oracle WebCenter Content mobile app.

## 29.8 Sharing Files

Sharing files from a mobile device can mean several things. You can share a link to a file that someone can use with a web browser. You might want to share a link instead of the actual file if the file is very large, or if you aren't sure if the person you are sending it to has rights to see the file. If you send a link, then Oracle WebCenter Content will control the person's access to the file.

You can also send a copy of the file as an attachment to an email, message, or conversation. Or you can even print a physical copy if your mobile device is set up to print.

# A

## Metadata Fields in Records Management

This section describes some of the common fields on a check-in page. This page is used to add content to the repository.

The following sections describe some of the common fields available in the Records system on a checkin page:

- [Checkin Page Metadata Fields](#)
- [Date, Format, and Audit Fields](#)
- [Security Fields](#)
- [Subject to Review Fields](#)
- [Correspondence Fields](#)

### A.1 Checkin Page Metadata Fields

Metadata fields on the check in form are dependent on enabled components and the profiles used.

Metadata fields on the check in form are dependent on enabled components and the profiles used. The metadata fields included and described in the following table are representative of those that may be included in the check in form.

**Table A-1 Metadata Fields**

Field	Description
Type	Type of file. This is required, but is pre-filled.
Title	Descriptive name for the item. Maximum length: 80 characters.
Filer	User who created or revised the content item. This value can be changed by administrators.
Security Group	Security group. Required. Default: RecordsGroup.
Primary File	Path and file name of the native file. Click <b>Browse</b> to find to and select a file.
Alternate File	Path and file name of an alternate web-viewable file or a file that can be converted to web-viewable format. Click <b>Browse</b> to find and select a file.
Content ID	Unique identifier for the content item. Required. If an ID is filled in or this field is not shown, the system is configured to automatically assign IDs.
Revision	Revisions increment automatically with each checkin of the content item, so generally, do not change this value.
Comments	Additional notes about the file. Maximum length: 255 characters.
Security Fields section	For details, see
Subject to Review section	For details, see
Correspondence Fields section	For details, see
Date fields section	For details, see



## A.2 Date, Format, and Audit Fields

Checkin pages may include the following data and format related fields:

**Table A-2 Metadata Fields**

Field	Description
Record Activation Date	Date a record is activated in the system.
Record Expiration Date	Date the record expires in the system.
Originating Organization	Official name or code identifying the office responsible for creating the record. The records administrator must populate this list. Maximum length: 100 characters.
Record Format	Format of the record. Options are designated by the site administrator.
<b>Subject to Audit</b>	If selected, the record is subject to audit and is included in the indirect audit approval trigger.
Audit period	Period used for audits.
Category or Folder	Retention category or folder in which to file the item.

## A.3 Security Fields

The following security-related fields may be included:

**Table A-3 Metadata Fields**

Field	Description
Supplemental Markings	Supplemental markings applied at the content level.
Security Classification	Current classification of the content item (denoted as Current Classification in the DoD 5015.2 specification). If No Markings is set as the lowest classification level in the system and if this field is set to No Markings, then no classification validation is performed.
Classifying Agency	Agency or person classifying the record. For example, an agency head, a corporate CEO, and so forth.
Classified By	Person classifying the item. This is required if <b>Classification Derived from</b> is not populated.
Classification Derived From	Classification guide(s) from which the classification of the item is derived. This is mandatory if the <b>Classified by</b> field is blank. Suggested values for the following fields are shown, but can be changed: <ul style="list-style-type: none"> <li>• Initial classification</li> <li>• Reason(s) for classification</li> <li>• Declassify exemption category</li> <li>• Declassify on event</li> <li>• Declassify on date</li> </ul>
Derived From Topic	Topic associated with a classification guide used to derive classification. This is an option list whose values are dependent on the <b>Classification Derived from</b> field. The information icon to the right of the list presents the description of the selected topic.

**Table A-3 (Cont.) Metadata Fields**

Field	Description
Initial Classification	Classification at time of creation. Required for classified content. This is entered automatically if the classification is derived from a source, multiple sources, or a topic. The available options include: <ul style="list-style-type: none"> <li>• Top Secret</li> <li>• Secret</li> <li>• Confidential</li> <li>• No Markings</li> <li>• Any custom classification as defined by the organization</li> </ul>
Reason(s) for Classification	Specification for classification. Required if <b>Classified</b> by field is populated; otherwise, optional. This is entered automatically if the classification is derived from a source, multiple sources, or a topic. This is an automatically populated custom option list with values varying by organization.
Declassify Exemption Categor	A category that exempts the item from being declassified after the standard declassification period (as defined by the records administrator; typically 10 years). Examples are "reveal an intelligence source," "compromises corporate security," and so on.
Declassify on Event	An event triggering the declassification of an item automatically. Classified content requires <b>Declassify on event, Declassify on date</b> , or both fields to be completed. This may be entered automatically if the classification is derived from a source, multiple sources, or a topic.
Declassify on Date	A date triggering the automatic declassification of an item. This can be entered automatically if the classification is derived from a source, multiple sources, or a topic.
Downgrade Instructions	Instructions on how content can be downgraded if it is subject to downgrading. This is required if there is a Downgrade on event or Downgrade on date or a combination of both.
Downgrade on Event	An event triggering the automatic downgrading of content classification.
Downgrade on Date	A date triggering the automatic downgrading of content classification.
Content Relations	Used to link items to each other. After inserting a link, it can be deleted by clicking the Delete icon (a red X).
Classification Guide Remarks	Text describing the classification guide usage.
Release Date	Date and time the revision is available for viewing. Default: date and time of checkin. If another date is entered, the revision remains in DONE status until that date. Time is optional. This is required but is pre-filled.
Expiration Date	Date and time the revision will no longer be available for viewing in the repository. On expiration, the revision is not deleted.

## A.4 Subject to Review Fields

Checkin forms may include the following review-related fields:

**Table A-4 Metadata Fields**

Field	Description
Subject to Review	If selected, the item is subject to review, enabling the Reviewer and Review Period fields. Review items are defined by an organization as needing to be reviewed by a specified person within a specified time frame. Do not select the checkbox if this is not an item that must be reviewed.
Reviewer	Person doing the review. The reviewer list is defined by a Records Administrator.
Review Period	Period used for reviews, selected from the list.

## A.5 Correspondence Fields

Checkin forms may include the following correspondence-related fields:

**Table A-5 Metadata Fields**

Field	Description
<b>Is Correspondence</b>	If selected, the item is an e-mail being checked in using Outlook Integration.
Author or Originator	Sender of the e-mail. If the <b>Is Correspondence</b> checkbox is unselected, enter the content author or originator.
Addressee(s)	Recipient of the e-mail and others copied on the e-mail.
E-mail Subject	Subject line of the original e-mail.
E-mail To Lists	Alias lists used in the original e-mail.
Received Date, Publication Date	Date an e-mail was received or initially sent.