

# Oracle® Fusion Middleware

## Administering Oracle Identity Governance



14c (14.1.2.1.0)

G19988-01

March 2025

The Oracle logo, consisting of a solid red square with the word "ORACLE" in white, uppercase, sans-serif font centered within it.

ORACLE®

Oracle Fusion Middleware Administering Oracle Identity Governance, 14c (14.1.2.1.0)

G19988-01

Copyright © 2011, 2025, Oracle and/or its affiliates.

Primary Author: Oracle Corporation

This software and related documentation are provided under a license agreement containing restrictions on use and disclosure and are protected by intellectual property laws. Except as expressly permitted in your license agreement or allowed by law, you may not use, copy, reproduce, translate, broadcast, modify, license, transmit, distribute, exhibit, perform, publish, or display any part, in any form, or by any means. Reverse engineering, disassembly, or decompilation of this software, unless required by law for interoperability, is prohibited.

The information contained herein is subject to change without notice and is not warranted to be error-free. If you find any errors, please report them to us in writing.

If this is software, software documentation, data (as defined in the Federal Acquisition Regulation), or related documentation that is delivered to the U.S. Government or anyone licensing it on behalf of the U.S. Government, then the following notice is applicable:

U.S. GOVERNMENT END USERS: Oracle programs (including any operating system, integrated software, any programs embedded, installed, or activated on delivered hardware, and modifications of such programs) and Oracle computer documentation or other Oracle data delivered to or accessed by U.S. Government end users are "commercial computer software," "commercial computer software documentation," or "limited rights data" pursuant to the applicable Federal Acquisition Regulation and agency-specific supplemental regulations. As such, the use, reproduction, duplication, release, display, disclosure, modification, preparation of derivative works, and/or adaptation of i) Oracle programs (including any operating system, integrated software, any programs embedded, installed, or activated on delivered hardware, and modifications of such programs), ii) Oracle computer documentation and/or iii) other Oracle data, is subject to the rights and limitations specified in the license contained in the applicable contract. The terms governing the U.S. Government's use of Oracle cloud services are defined by the applicable contract for such services. No other rights are granted to the U.S. Government.

This software or hardware is developed for general use in a variety of information management applications. It is not developed or intended for use in any inherently dangerous applications, including applications that may create a risk of personal injury. If you use this software or hardware in dangerous applications, then you shall be responsible to take all appropriate fail-safe, backup, redundancy, and other measures to ensure its safe use. Oracle Corporation and its affiliates disclaim any liability for any damages caused by use of this software or hardware in dangerous applications.

Oracle®, Java, MySQL, and NetSuite are registered trademarks of Oracle and/or its affiliates. Other names may be trademarks of their respective owners.

Intel and Intel Inside are trademarks or registered trademarks of Intel Corporation. All SPARC trademarks are used under license and are trademarks or registered trademarks of SPARC International, Inc. AMD, Epyc, and the AMD logo are trademarks or registered trademarks of Advanced Micro Devices. UNIX is a registered trademark of The Open Group.

This software or hardware and documentation may provide access to or information about content, products, and services from third parties. Oracle Corporation and its affiliates are not responsible for and expressly disclaim all warranties of any kind with respect to third-party content, products, and services unless otherwise set forth in an applicable agreement between you and Oracle. Oracle Corporation and its affiliates will not be responsible for any loss, costs, or damages incurred due to your access to or use of third-party content, products, or services, except as set forth in an applicable agreement between you and Oracle.

# Contents

## Preface

---

Audience	xxx
Documentation Accessibility	xxx
Related Documents	xxx
Conventions	xxx

## What's New In This Guide

---

## Part I Overview

---

### 1 Product Overview for Oracle Identity Governance

---

1.1	What is Oracle Identity Governance?	1-1
1.2	What are the Different Modes of Oracle Identity Governance?	1-2
1.3	How does Oracle Identity Governance Interact with Other IT Systems?	1-4
1.4	How does Oracle Identity Governance Interact with Other Oracle Identity and Access Management Products?	1-4
1.5	How do Users Interact with Oracle Identity Governance?	1-5

### 2 Product Architecture of Oracle Identity Governance

---

2.1	Oracle Identity Governance Components	2-1
2.2	Multi-tiered Architecture of Oracle Identity Governance	2-1
2.2.1	About the User Interface Tier	2-2
2.2.2	About the Application Tier	2-2
2.2.3	About the Database Tier	2-5
2.2.4	About the Connector Tier	2-5

### 3 Oracle Identity System Administration Interface

---

3.1	Logging in to Oracle Identity System Administration	3-1
3.2	Oracle Identity System Administration	3-1

3.2.1	Layout of the Oracle Identity System Administration Interface	3-2
3.2.2	Links in the Oracle Identity System Administration Interface	3-2
3.2.2.1	About Accessibility Link	3-2
3.2.2.2	About Sandboxes Link	3-3
3.2.2.3	About Sign Out Link	3-3
3.2.3	Left and Right Panes in the Oracle Identity System Administration Console	3-3
3.2.3.1	About Provisioning Configuration	3-4
3.2.3.2	About System Entities	3-4
3.2.3.3	About System Configuration	3-5
3.2.3.4	About Upgrade	3-6
3.2.3.5	About Workflows	3-6
3.2.4	Help in Oracle Identity System Administration	3-6
3.2.4.1	About Top Pane in the Help Interface	3-6
3.2.4.2	About Lower Left Pane in the Help Interface	3-8
3.2.4.3	About Lower Right Pane in the Help Interface	3-8

## Part II Policy Administration

---

### 4 Managing Workflows

---

4.1	Understanding Workflow Rules	4-1
4.1.1	About Workflow Rules	4-1
4.1.2	About Request Process Flow	4-2
4.1.3	About Request Lifecycle	4-4
4.1.3.1	Various Request Stages	4-4
4.1.3.2	Single Request Lifecycle	4-7
4.1.3.3	Bulk Request Lifecycle	4-8
4.2	Configuring Approval Workflow Rules	4-9
4.2.1	About Approval Workflow Rules	4-10
4.2.2	About Rule Conditions	4-11
4.2.3	About System-Defined Operations and Rules	4-12
4.2.4	Creating Approval Workflow Rules	4-14
4.2.5	About Custom Rule Conditions	4-18
4.2.6	Modifying Approval Workflow Rules	4-25
4.2.7	Deleting Approval Workflow Rules	4-26
4.2.8	About Approval Workflow Rule Evaluation	4-26
4.3	Managing Request Approval in an Upgraded Deployment of Oracle Identity Governance	4-27
4.3.1	About Request Approval in an Upgraded Deployment of Oracle Identity Governance	4-27
4.3.2	About Request Process Flow With Approval Workflow Rules Disabled	4-28
4.3.3	Migrating Approval Policies to Approval Workflow Rules	4-29

4.3.4	Enabling Approval Workflow Rules	4-30
4.3.4.1	Enabling the Approval Workflow Rules Feature	4-30
4.3.4.2	About In-Flight Request Lifecycle	4-31
4.4	Migrating Workflow Rules From Test to Production	4-32
4.4.1	About Migration of Workflow Rules From Test to Production	4-32
4.4.2	Moving Workflow Rules From Test to Production Using the Deployment Manager	4-33
4.5	Running Oracle Identity Governance Without Workflows	4-33
4.5.1	Disabling SOA Server	4-34
4.5.2	About the Impact of Disabling Workflows	4-34
4.6	Use Cases for Disabled or Deleted Proxy Users	4-37

## Part III Form Management

---

### 5 Managing Forms

---

5.1	Creating Forms By Using the Form Designer	5-1
5.2	Searching Forms By Using the Form Designer	5-2
5.3	Modifying Forms By Using the Form Designer	5-3
5.4	Removing or Hiding Form Attributes	5-5

## Part IV System Entities

---

### 6 Configuring Custom Attributes

---

6.1	Creating a Custom Attribute	6-1
6.2	Creating a Custom Child Form	6-5
6.3	Creating a Custom Child Form Attribute	6-6
6.4	Modifying a Custom Attribute	6-9
6.5	Adding a Custom Attribute	6-9
6.5.1	Displaying a UDF in Oracle Identity Self Service Page	6-10
6.5.2	Enabling the Submit Button After Adding a UDF to the Modify User Form	6-15
6.5.3	Adding a Custom Attribute Category into Create User Form	6-16
6.5.4	Customizing Unauthenticated Page	6-17
6.6	Adding a Custom Attribute to an Application Instance Form	6-18
6.6.1	Regenerating View	6-18
6.6.2	Updating the Application Instance Form By Using WebCenter Composer	6-19
6.7	Moving UDFs from Test to Production	6-20
6.7.1	Moving UDFs Added to Entities	6-20
6.7.1.1	Exporting the UDF from the Test Environment	6-21
6.7.1.2	Importing the UDF into the Production Environment	6-21
6.7.2	Moving UDFs Added to Catalog Entities	6-22

6.8	Synchronizing User-Defined Fields Between Oracle Identity Governance and LDAP	6-22
6.9	Creating Cascaded LOVs	6-23
6.10	Specifying Cascaded LOVs Without NULL Value	6-25
6.11	Localizing Display Labels of UDFs	6-26
6.12	Configuring a Field as Mandatory Attribute in the Request Catalog	6-27

## Part V Application Management

---

### 7 Managing IT Resources

---

7.1	Creating IT Resources	7-1
7.2	Searching IT Resources	7-2
7.3	Viewing IT Resources	7-2
7.4	Modifying IT Resources	7-2
7.5	Deleting IT Resources	7-3

### 8 Managing Generic Connectors

---

8.1	Creating Generic Technology Connectors	8-1
8.1.1	Determining Provider Requirements for Creating Generic Technology Connectors	8-1
8.1.2	Selecting the Providers for Creating Generic Technology Connectors	8-2
8.1.3	Addressing the Prerequisites for Creating Generic Technology Connectors	8-2
8.1.4	Creating the Connector Using Identity System Administration	8-3
8.1.5	Configuring Reconciliation	8-3
8.1.6	Configuring Provisioning	8-4
8.1.7	Creating the Form and Publishing the Application Instance	8-5
8.1.8	Enabling Log for the Generic Technology Connector	8-5
8.2	Using Identity System Administration to Create the Connector	8-6
8.2.1	Providing Basic Information for Generic Technology Connector	8-6
8.2.2	Specifying Parameter Values for the Providers	8-8
8.2.2.1	Run-Time Parameters for the Provider	8-8
8.2.2.2	Design Parameters for the Provider	8-8
8.2.2.3	Sample Values for the Run-Time and Design Parameters	8-14
8.2.3	Modifying Connector Configuration	8-16
8.2.3.1	About Metadata for Generic Technology Connector	8-16
8.2.3.2	Data Set for Generic Technology Connectors	8-18
8.2.3.3	Mapping Parameters for Data Sets	8-22
8.2.3.4	About Adding or Editing Fields in Data Sets	8-22
8.2.3.5	Adding or Editing Fields in Data Sets	8-23
8.2.3.6	Removing Fields from Data Sets	8-29
8.2.3.7	Removing Mappings Between Fields	8-29

8.2.3.8	Removing Child Data Sets	8-29
8.2.4	Verifying Connector Form Names	8-30
8.2.5	Verifying Connector Information	8-31
8.3	Managing Generic Technology Connectors	8-32
8.3.1	Modifying Generic Technology Connectors	8-33
8.3.2	Exporting Generic Technology Connectors	8-34
8.3.3	Importing Generic Technology Connectors	8-34
8.3.4	Importing Connector XML File	8-35

## 9 Managing Application Instances

---

9.1	About Application Instances	9-1
9.2	Application Instance Concepts	9-2
9.2.1	Multiple Accounts Per Application Instance	9-2
9.2.2	Entitlements	9-2
9.2.3	Disconnected Application Instances	9-3
9.2.4	Application Instance Security	9-4
9.3	Managing Application Instances	9-4
9.3.1	Creating Application Instances	9-4
9.3.2	Searching Application Instances	9-5
9.3.3	Modifying Application Instances	9-6
9.3.3.1	Modifying Application Instance Attributes	9-6
9.3.3.2	Managing Organizations Associated With Application Instances	9-7
9.3.3.3	Managing Entitlements Associated With Application Instances	9-9
9.3.4	Understanding the Deletion of Application Instances	9-10
9.3.4.1	About Deleting Application Instances	9-10
9.3.4.2	Deleting an Application Instance	9-11
9.3.5	Creating and Modifying Forms Associated With the Application Instances	9-12
9.3.5.1	Creating Forms Associated With Application Instances	9-12
9.3.5.2	Modifying Forms Associated With Application Instances	9-13
9.3.5.3	Localizing Application Instance Form	9-14
9.4	Configuring Application Instances	9-15
9.4.1	Configuring a Resource Object	9-16
9.4.2	Configuring IT Resource	9-16
9.4.3	Configuring Password Policies for Application Instances	9-17
9.5	Developing Entitlements	9-18
9.5.1	About Entitlements	9-18
9.5.2	Available Entitlements and Assigned Entitlements	9-19
9.5.3	Entitlement Data Capture Process	9-20
9.5.4	Marking Entitlement Attributes on Child Process Forms	9-20
9.5.5	Duplicate Validation for Entitlements or Child Data	9-21
9.5.6	Configuring Scheduled Tasks for Working with Entitlement Data	9-22

9.5.6.1	Entitlement List	9-23
9.5.6.2	Entitlement Assignments	9-23
9.5.7	Deleting Entitlements	9-23
9.5.7.1	About Entitlement Deletion	9-23
9.5.7.2	Deleting Entitlement Post-Processing	9-24
9.5.8	Refreshing the Entitlement List Post Delete for New Entries	9-25
9.5.9	Disabling the Capture of Modifications to Assigned Entitlements	9-25
9.5.10	Entitlement-Related Reports	9-26
9.5.10.1	Entitlement Access List	9-26
9.5.10.2	Entitlement Access List History	9-26
9.5.10.3	User Resource Entitlement	9-26
9.5.10.4	User Resource Entitlement History	9-27
9.6	Managing Disconnected Resources	9-27
9.6.1	About Disconnected Resources	9-27
9.6.2	Disconnected Resources Architecture	9-27
9.6.3	Managing Disconnected Application Instance	9-29
9.6.3.1	Creating a Disconnected Application Instance	9-29
9.6.3.2	Creating a Disconnected Application Instance for an Existing Disconnected Resource	9-31
9.6.4	Provisioning Operations on a Disconnected Application Instance	9-31
9.6.5	Configuring Entitlement Grant	9-32
9.6.6	Status Changes in Manual Process Task Action	9-33
9.6.7	Customizing Provisioning SOA Composite	9-34
9.6.7.1	Customizing Human Task Assignment via SOA Composer	9-34
9.6.7.2	Customizing by Modifying the Predefined Composite	9-35
9.6.8	Troubleshooting Disconnected Resources	9-35

## 10 Managing Connector Lifecycle

---

10.1	Lifecycle of a Connector	10-1
10.2	Change Management Terminology	10-4
10.3	Viewing Connector Details	10-5
10.4	Installing Connectors	10-6
10.4.1	Understanding the Connector Deployment Process	10-7
10.4.2	Installing a Connector	10-8
10.4.3	Postinstallation Steps	10-9
10.5	Defining Connectors With Oracle Identity Governance	10-10
10.5.1	About Defining a Connector	10-10
10.5.2	Defining a Connector	10-12
10.6	Cloning Connectors in Oracle Identity Governance	10-14
10.6.1	Guidelines for Cloning a Connector	10-15
10.6.2	Cloning Connector from XML File	10-16



10.6.3	Installing the Clone Connector	10-17
10.6.4	Post-Cloning Steps	10-17
10.7	Exporting Connector Object Definitions in Connector XML Format	10-17
10.7.1	About Exporting Connector Object Definitions in Connector XML Format	10-18
10.7.2	Exporting Connector Object Definitions in Connector XML Format	10-18
10.8	Upgrading Connectors	10-19
10.8.1	About Upgrading Connectors	10-19
10.8.2	Upgrade Use Cases Supported by the Connector Upgrade Feature	10-20
10.8.3	Connector Object Changes Supported by the Upgrade Connectors Feature	10-22
10.8.3.1	Resource Object Changes	10-22
10.8.3.2	Process Definition Changes	10-23
10.8.3.3	Resource Bundle Changes	10-23
10.8.3.4	Process Form Changes	10-24
10.8.3.5	Lookup Definition Changes	10-24
10.8.3.6	Adapter Changes	10-24
10.8.3.7	Rule Changes	10-25
10.8.3.8	IT Resource Type Changes	10-25
10.8.3.9	IT Resource Changes	10-25
10.8.3.10	Scheduled Task Changes	10-26
10.8.4	What Happens When You Upgrade a Connector	10-26
10.8.5	Summary of the Upgrade Procedure	10-26
10.8.5.1	Guidelines for Upgrading Cloned Connectors	10-27
10.8.6	Procedure to Upgrade a Connector	10-28
10.8.6.1	Preupgrade Procedure	10-28
10.8.6.2	Wizard Mode Upgrade in Staging Environment	10-29
10.8.6.3	Silent Mode Upgrade in Staging and Production Environment	10-34
10.8.7	Postupgrade Procedure	10-35
10.8.7.1	Connector Code File Changes	10-35
10.8.7.2	Running the PurgeCache Utility	10-36
10.8.7.3	Running cancelProcessTask Utility	10-36
10.8.7.4	Updating Access Policies	10-36
10.8.7.5	Configuring the IT Resource	10-37
10.8.7.6	Configuring the Scheduled Tasks	10-37
10.8.7.7	Updating Adapters for Changes in IT Resource Type Definition Parameter	10-37
10.8.7.8	Other Postupgrade Steps	10-41
10.8.8	Procedure to Upgrade a 9.x Connector Version to an ICF Based Connector	10-42
10.9	Uninstalling Connectors	10-42
10.9.1	About Uninstalling Connectors Utility	10-43
10.9.2	Use Cases Supported by the Uninstall Connectors Utility	10-43
10.9.3	Overview of the Connector Uninstall Process	10-44
10.9.4	Setting Up the Uninstall Connector Utility	10-45

10.9.5	Uninstalling Connectors and Removing Connector Objects	10-45
10.9.5.1	Uninstalling a Connector	10-45
10.9.5.2	Removing Adapters, Lookup Definitions, Resource Objects, and Scheduled Tasks	10-46
10.9.6	Running the Script to Uninstall Connectors and Connector Objects	10-47
10.9.6.1	Preuninstall the Connectors and Connector Objects	10-47
10.9.6.2	Uninstall the Connectors and Connector Objects	10-48
10.9.6.3	Postuninstall the Connectors and Connector Objects	10-50
10.10	Troubleshooting Connector Management Issues	10-51

## 11 Managing Reconciliation

---

11.1	About Reconciliation	11-1
11.2	Reconciliation Based on the Object Being Reconciled	11-2
11.2.1	Entities that are Reconciled in Oracle Identity Governance	11-3
11.2.2	Trusted Source Reconciliation	11-3
11.2.3	Account Reconciliation	11-4
11.2.3.1	Scenario I: Account Reconciliation From a Target System	11-5
11.2.3.2	Scenario II: Identity and Account Reconciliation	11-5
11.2.4	Reconciliation Process Flow	11-6
11.3	Mode of Reconciliation	11-9
11.4	Approach Used for Reconciliation	11-11
11.5	Managing Reconciliation Events	11-11
11.5.1	About Reconciliation Events	11-11
11.5.2	Searching Events	11-12
11.5.2.1	Performing a Simple Search for Events	11-12
11.5.2.2	Performing an Advanced Search for Events	11-13
11.5.3	Displaying Event Details	11-14
11.5.4	Determining Event Actions	11-15
11.5.5	Re-evaluating Events	11-16
11.5.6	Closing Events	11-17
11.5.7	Linking Reconciliation Events	11-17
11.5.7.1	Ad Hoc Linking	11-18
11.5.7.2	Manual Linking	11-18
11.5.7.3	Linking Orphan Accounts	11-18

## Part VI Requests

---

### 12 Managing the Access Request Catalog

---

12.1	Access Request Catalog	12-1
12.1.1	Access Request Challenges	12-1

12.1.2	Access Request Catalog Concepts	12-2
12.1.3	Access Request Catalog Use Cases	12-3
12.1.4	Features and Benefits of Access Request Catalog	12-6
12.1.5	Access Request Catalog Architecture	12-6
12.2	Configuring the Access Request Catalog	12-7
12.2.1	Adding More Attributes to the Default Search Form	12-7
12.2.2	Configuring Application Selection Limit in Entitlement Search	12-8
12.2.3	Configuring Catalog to Use a Custom Search Form	12-8
12.3	Administering the Access Request Catalog	12-8
12.3.1	Prerequisites of Catalog Administration	12-8
12.3.1.1	Setting Up the Catalog Administrator	12-9
12.3.1.2	Defining the Catalog Metadata	12-9
12.3.1.3	Adding Attributes to the Catalog	12-9
12.3.2	Common Tasks to be Performed by the Catalog Administrator	12-10
12.3.2.1	Onboard Applications and Roles	12-10
12.3.2.2	Bootstrapping the Catalog	12-13
12.3.2.3	Ongoing Synchronization	12-15
12.3.2.4	Enrich the Catalog	12-15
12.3.2.5	Managing Catalog Items	12-18
12.3.3	Catalog Auditing	12-19
12.3.3.1	About Catalog Auditing	12-19
12.3.3.2	Configuring Catalog Auditing	12-19
12.3.4	Configuring Hierarchical Attributes of Entitlements	12-20
12.3.4.1	About Hierarchical Attributes of Entitlements	12-20
12.3.4.2	Enabling the Display of Additional Details of the Entitlements	12-22
12.3.5	Database Best Practices for Access Request Catalog	12-22
12.3.5.1	About Database Best Practices for Access Request Catalog	12-23
12.3.5.2	One-Time Optimizations for Oracle Text Index	12-23
12.3.5.3	Text Index Optimization	12-25
12.3.5.4	Frequently Asked Questions about the Access Request Catalog	12-25
12.4	Managing the Lifecycle of the Catalog	12-30
12.4.1	Overview of Catalog Customization	12-30
12.4.2	Test to Production Procedures for Catalog Customizations	12-33
12.4.2.1	About Test to Production Procedures for Catalog Customizations	12-33
12.4.2.2	Exporting Using the Sandbox and Deployment Manager	12-33
12.4.2.3	Importing Using the Sandbox and Deployment Manager	12-34
12.4.3	Limitations of the Test to Production Procedures	12-35
12.5	Troubleshooting Access Request Catalog	12-36
12.5.1	Catalog Synchronization Issues	12-36
12.5.2	Catalog Security Issues	12-39
12.5.3	Catalog Search Issues	12-41

## Part VII System Configuration

---

### 13 Managing the Home Organization Policy

---

13.1	About Home Organization Policy	13-1
13.2	Use Cases for the Home Organization Policy	13-2
13.2.1	Self-Registration Use Case Using Default Rule	13-2
13.2.2	Self-Registration Use Case Using Simple Rule	13-2
13.2.3	Self-Registration Use Case Using Complex Rule	13-2
13.2.4	Use Case for Rule Evaluation Order	13-3
13.2.5	Self-Registration Use Case When SOA is Off	13-3
13.3	Creating a Rule in Home Organization Policy	13-4
13.4	Modifying a Rule in Home Organization Policy	13-6
13.5	Deleting a Rule in Home Organization Policy	13-7

### 14 Managing Self Service Capability Policy

---

14.1	About Self Service Capability Rule	14-1
14.2	Default Self Service Capability Rule	14-1
14.3	Example of Self Service Capability Rules and Rule Evaluation Order	14-2
14.4	Creating a Rule in Self Service Capability Policy	14-3
14.5	Modifying a Rule in Self Service Capability Policy	14-5
14.6	Deleting a Rule in Self Service Capability Policy	14-5

### 15 Managing Lookups

---

15.1	Searching a Lookup Type	15-1
15.2	Creating a Lookup Type	15-3
15.3	Modifying a Lookup Type	15-5

### 16 Managing Role Categories

---

16.1	About Role Category	16-1
16.2	Creating a Role Category	16-2
16.3	Searching Role Categories	16-2
16.4	Modifying a Role Category	16-3
16.5	Deleting a Role Category	16-3

## 17 Managing the Scheduler

---

17.1	About Scheduler	17-1
17.2	Configuring the oim-config.xml File	17-2
17.3	Start and Stop the Scheduler	17-3
17.3.1	About Enabling and Disabling the Scheduler	17-3
17.3.2	Starting and Stopping the Scheduler	17-4
17.3.3	Controlling Scheduler Start or Stop in a Clustered Environment	17-4
17.3.3.1	Adding the Server Side Property for Oracle Identity Governance	17-5
17.3.3.2	Restarting Oracle Identity Governance Managed Servers from the Node Manager	17-5
17.3.3.3	Modifying the Server Side Property for Oracle Identity Governance	17-6
17.4	Scheduled Tasks	17-6
17.4.1	About Scheduled Tasks	17-6
17.4.2	Predefined Scheduled Tasks	17-7
17.4.3	Creating Custom Scheduled Tasks	17-26
17.5	Managing Jobs	17-27
17.5.1	Creating Jobs	17-28
17.5.2	Searching Jobs	17-30
17.5.2.1	Performing a Simple Search for Jobs	17-30
17.5.2.2	Performing an Advanced Search for Jobs	17-31
17.5.3	Editing and Viewing Jobs	17-32
17.5.4	Modifying Jobs	17-33
17.5.5	About Disabling and Enabling Jobs	17-33
17.5.6	Disabling and Enabling Jobs	17-34
17.5.7	Starting and Stopping Jobs	17-34
17.5.8	Deleting Jobs	17-34
17.6	Diagnosing Scheduled Jobs	17-35
17.6.1	Schedule Job Errors	17-35
17.6.2	Resolving the Schedule Job Errors	17-35

## 18 Managing Notification Service

---

18.1	About Notification Providers	18-1
18.2	Managing Notification Providers	18-2
18.2.1	Using UMS for Notification	18-2
18.2.1.1	About UMS for Notification	18-2
18.2.1.2	Enabling Oracle Identity Governance to Use UMS for Notification	18-2
18.2.1.3	Applying OWSM Policy to the UMS Web Service	18-5
18.2.1.4	Changing UMS Client Connection Pooling	18-7
18.2.2	Using SMTP for Notification	18-8
18.2.2.1	Configuring the SMTP Email Notification Provider Properties	18-8
18.2.2.2	Adding the CSF Key	18-10

18.2.2.3	Enabling SSL for the SMTP Notification Provider	18-10
18.2.3	Using SOA Composite for Notification	18-10
18.2.3.1	Creating a SOA Composite with Notification Activity	18-11
18.2.3.2	Deploying the SOA Composite on the SOA Server Manually	18-11
18.2.3.3	Setting Workflow Notification Properties	18-12
18.2.3.4	Configuring the SOA Email Notification Provider Properties	18-12
18.2.3.5	Configuring the User Messaging Drivers	18-13
18.2.4	Configuring Custom Notification Provider	18-14
18.2.5	Disabling and Enabling Notification Providers	18-15
18.3	Managing Notification Templates	18-15
18.3.1	Default Notification Template	18-16
18.3.2	Searching for a Notification Template	18-16
18.3.2.1	Performing Simple Search for a Notification Template	18-16
18.3.2.2	Performing Advanced Search for a Notification Template	18-17
18.3.3	Creating a Notification Template	18-18
18.3.4	Modifying a Notification Template	18-19
18.3.5	Disabling a Notification Template	18-20
18.3.6	Enabling a Notification Template	18-21
18.3.7	Adding Locales to a Notification Template	18-21
18.3.8	Removing Locales from a Notification Template	18-22
18.3.9	Deleting a Notification Template	18-22
18.3.10	Configuring Notification for a Proxy	18-22
18.4	Configuring Email in Provisioning Workflow	18-23
18.5	Configuring SOA Email Notification	18-23
18.5.1	Configuring Actionable Email Notification on SOA	18-23
18.5.2	Troubleshooting SOA Email Notification	18-25
18.6	Disabling Oracle Identity Governance Email Notifications	18-25
18.6.1	About Disabling Oracle Identity Governance Email Notifications	18-26
18.6.2	Disabling Sending Email Notification by Removing the SelfServiceNotificationHandler	18-27
18.6.3	Disabling Sending Email Notification by Removing the PasswordNotificationHandler	18-27
18.7	Troubleshooting Notification	18-28
18.7.1	Issues Related to Incorrect URL	18-28
18.7.2	Incorrect Outgoing Server EMail Driver Properties	18-30
18.7.3	Error Generated at the SOA Server	18-32
18.7.4	Authentication Failure	18-35
18.7.5	Issues Related to Failed Email Delivery Not Reported Through EM	18-41

## 19 Configuring Oracle Identity Governance

---

19.1	About System Properties	19-1
19.2	Types of System Properties	19-1

19.2.1	Default System Properties in Oracle Identity Governance	19-2
19.2.2	Non-Default System Properties in Oracle Identity Governance	19-20
19.3	Managing System Properties	19-22
19.3.1	Searching for System Properties	19-23
19.3.1.1	Performing a Simple Search for System Properties	19-23
19.3.1.2	Performing an Advanced Search for System Properties	19-23
19.3.2	Editing System Properties	19-24
19.3.3	Purging Cache	19-24
19.4	Configuring Oracle Identity Governance Components	19-25
19.4.1	Configuring Product Options	19-26
19.4.2	Configuring the URL for Challenge Questions	19-26
19.4.3	Configuring the URL for Change Password	19-27
19.4.4	Enabling Challenge Questions	19-27
19.4.5	Configuring User name Generation	19-28
19.4.6	Configuring User ID Reuse	19-28
19.4.7	Configuring Delayed Delete Interval	19-29
19.5	Configuring the Access Request Catalog	19-29
19.5.1	Configuring Additional Information	19-29
19.5.2	Configuring Search Results	19-30
19.5.3	Configuring the Sort By Attributes	19-30
19.5.4	Configuring Custom Search	19-31
19.6	Configuring the Identity Provider	19-31
19.6.1	Configuring Attribute Reservation	19-31
19.6.2	Configuring Common Name Generation	19-31
19.6.3	Configuring LDAP Reservation	19-32
19.6.4	Configuring Referential Integrity	19-32

## 20 Configuration of JCS

---

20.1	Configuration in a Single Node	20-2
20.2	Configuration in a Cluster Setup	20-2
20.3	Manage JCS Logging	20-4
20.4	Troubleshooting	20-4

## 21 Moving From Test to Production

---

21.1	About Test to Production Migration	21-1
21.2	Migrating Incrementally Using the Deployment Manager	21-1
21.2.1	About the Deployment Manager	21-2
21.2.2	Features of the Deployment Manager	21-2
21.2.3	Enabling Deployment Manager in SSL Mode	21-5
21.2.4	About Exporting Deployments	21-5

21.2.5	Exporting Deployments	21-5
21.2.6	About Importing Deployments	21-7
21.2.7	Importing Deployments	21-7
21.2.8	Best Practices for Using the Deployment Manager	21-8
21.2.8.1	Do Not Export System Objects	21-8
21.2.8.2	Exporting Related Groups of Objects	21-9
21.2.8.3	Using Logical Naming Conventions for Versions of a Form	21-9
21.2.8.4	Exporting Root to Preserve a Complete Organizational Hierarchy	21-9
21.2.8.5	Providing Clear Export Descriptions	21-9
21.2.8.6	Checking Dependencies Before Exporting Data	21-10
21.2.8.7	Matching Scheduled Task Parameters	21-10
21.2.8.8	Deployment Manager Actions on Reimported Scheduled Tasks	21-10
21.2.8.9	Compiling Adapters and Enable Scheduled Tasks	21-11
21.2.8.10	Checking Permissions for Roles	21-11
21.2.8.11	Creating a Backup of the Database	21-11
21.2.8.12	Importing Data When the System Is Quiet	21-11
21.2.8.13	Exporting and Importing Data in Bulk	21-12
21.2.8.14	Exporting Entity Publications	21-12
21.2.9	Troubleshooting the Deployment Manager	21-12

## 22 Migrating Application and Database Binaries

---

22.1	Migrating Application Binaries to a New Host With Existing Database	22-1
22.1.1	Moving the Application Binary Files	22-1
22.1.2	Postconfiguration Changes on the Target Host	22-27
22.1.3	Updating EndPoint Address in SOA Composites	22-29
22.2	Migrating the Database and Application Binaries to a New Host	22-31
22.2.1	Moving the Database to Another Environment	22-31
22.2.2	Postconfiguration Changes on the Target Environment	22-34

## Part VIII Auditing and Reporting

---

### 23 Configuring Auditing

---

23.1	About Auditing	23-1
23.2	User Profile Auditing	23-1
23.2.1	Data Collected for User Profile Audits	23-1
23.2.1.1	About Data Collected for User Profile Audits	23-2
23.2.1.2	Capture of User Profile Audit Data	23-2
23.2.1.3	Storage of Snapshots for User Profile Audit	23-4
23.2.1.4	Trigger for Taking Snapshots for User Profile Audit	23-5
23.2.2	Post-Processor Used for User Profile Auditing	23-5



23.2.3	Tables Used for User Profile Auditing	23-5
23.2.4	Archiving User Profile Audit Data	23-7
23.3	Role Profile Auditing	23-7
23.3.1	About Role Profile Auditing	23-7
23.3.2	Capture and Archiving of Role Profile Audit Data	23-8
23.3.3	Storage of Snapshots for Role Profile Auditing	23-8
23.3.4	Trigger for Taking Snapshots for Role Profile Auditing	23-9
23.4	Catalog Auditing	23-9
23.5	Enabling and Disabling Auditing in Oracle Identity Governance	23-9
23.5.1	Disabling Auditing in Oracle Identity Governance	23-10
23.5.2	Enabling Auditing in Oracle Identity Governance	23-10
23.6	Lightweight Audit	23-11
23.6.1	About Lightweight Audit	23-11
23.6.2	Audit Logging Configuration	23-13

## 24 Using Reporting Features

---

24.1	About Reporting in Oracle Identity Governance	24-1
24.2	Supported Output Formats for Reports	24-2
24.3	Classification of Oracle Identity Governance Reports	24-2
24.3.1	Access Policy Reports	24-2
24.3.1.1	Access Policy Details	24-2
24.3.1.2	Access Policy List by Role	24-3
24.3.2	Request and Approval Reports	24-4
24.3.2.1	Approval Activity Report	24-4
24.3.2.2	Request Details Report	24-5
24.3.2.3	Request Summary Report	24-6
24.3.2.4	Task Assignment History	24-7
24.3.3	Role and Organization Reports	24-8
24.3.3.1	Role Membership History	24-8
24.3.3.2	Role Membership Profile	24-9
24.3.3.3	Role Membership	24-10
24.3.3.4	Organization Details	24-10
24.3.3.5	User Membership History	24-11
24.3.4	Password Reports	24-12
24.3.4.1	Password Expiration Summary Report	24-12
24.3.4.2	Password Reset Summary Report	24-13
24.3.4.3	Resource Password Expiration Report	24-14
24.3.5	Resource and Entitlement Reports	24-15
24.3.5.1	Account Activity In Resource	24-15
24.3.5.2	Delegated Admins and Permissions by Resource	24-16
24.3.5.3	Delegated Admins by Resource	24-17

24.3.5.4	Entitlement Access List	24-18
24.3.5.5	Entitlement Access List History	24-19
24.3.5.6	Financially Significant Resource Details	24-19
24.3.5.7	Resource Access List History	24-20
24.3.5.8	Resource Access List	24-21
24.3.5.9	Resource Account Summary	24-22
24.3.5.10	Resource Activity Summary	24-22
24.3.5.11	User Resource Access History	24-23
24.3.5.12	User Resource Access	24-24
24.3.5.13	User Resource Entitlement	24-25
24.3.5.14	User Resource Entitlement History	24-26
24.3.6	User Reports	24-27
24.3.6.1	User Creation	24-28
24.3.6.2	User Profile History	24-28
24.3.6.3	User Summary	24-29
24.3.6.4	Users Deleted	24-30
24.3.6.5	Users Disabled	24-31
24.3.6.6	Users Unlocked	24-32
24.3.7	Certification Reports	24-33
24.3.8	Identity Audit Reports	24-34
24.3.9	Exception Reports	24-35
24.3.9.1	About Exception Reports	24-35
24.3.9.2	Fine Grained Entitlement Exceptions By Resource	24-36
24.3.9.3	Orphaned Account Summary Report	24-37
24.3.9.4	Rogue Accounts By Resource	24-38
24.4	Required Scheduled Tasks for Oracle Analytics Server Reports	24-39
24.5	Best Practices for Running Oracle Identity Governance Reports	24-40

## 25 Using the Archival and Purge Utilities for Controlling Data Growth

---

25.1	About Archival and Purge Utilities	25-1
25.2	Archival and Purge Concepts	25-2
25.2.1	Purge Only Solution Versus Purge and Archive Solution for Entities	25-2
25.2.2	Archival of Data in Oracle Identity Governance	25-3
25.2.3	Purging of Data in Oracle Identity Governance	25-3
25.2.4	Real-Time Purging in Oracle Identity Governance	25-3
25.2.5	Retention Period in Oracle Identity Governance	25-3
25.2.6	Modes of Archival Purge Operations	25-3
25.3	Using Real-Time Purge and Archival Option in Oracle Identity Governance	25-4
25.3.1	About Real-Time Data Purge and Archival	25-4
25.3.2	Configuring Real-Time Purge and Archival	25-5
25.3.3	About the Orchestration Purge Utility	25-8

25.3.4	Collecting Diagnostic Data of the Online Archival and Purge Operations	25-9
25.4	Using Command-Line Option of the Archival Purge Utilities in Oracle Identity Governance	25-12
25.4.1	About Command-Line Utilities	25-12
25.4.2	Using the Reconciliation Archival Utility	25-12
25.4.2.1	About the Reconciliation Archival Utility	25-13
25.4.2.2	Prerequisite for Running the Reconciliation Archival Utility	25-15
25.4.2.3	Archival Criteria for Reconciliation Data	25-15
25.4.2.4	Running the Reconciliation Archival Utility	25-16
25.4.2.5	Log File Generated by the Reconciliation Archival Utility	25-17
25.4.2.6	Troubleshooting Scenario for Reconciliation Archival Utility	25-17
25.4.3	Using the Task Archival Utility	25-18
25.4.3.1	About the Task Archival Utility	25-18
25.4.3.2	Preparing Oracle Database for the Task Archival Utility	25-19
25.4.3.3	Running the Task Archival Utility	25-20
25.4.3.4	Reviewing the Output Files Generated by the Task Archival Utility	25-22
25.4.4	Using the Requests Archival Utility	25-22
25.4.4.1	About the Requests Archival Utility	25-22
25.4.4.2	Prerequisites for Running the Requests Archival Utility	25-23
25.4.4.3	Input Parameters used by the Requests Archival Utility	25-23
25.4.4.4	Running the Requests Archival Utility	25-24
25.4.4.5	Log Files Generated by the Utility	25-26
25.5	Using the Audit Archival and Purge Utility	25-26
25.5.1	About Audit Archival and Purge Utility	25-26
25.5.2	Audit Data Growth Control Measures in Lightweight Audit Framework	25-26
25.5.2.1	About Audit Data Growth Control Measures in Lightweight Audit Framework	25-27
25.5.2.2	Overview of Partition Based Approach	25-28
25.5.2.3	Prerequisites for Partitioning the AUDIT_EVENT Table	25-28
25.5.2.4	Preparing the AUDIT_EVENT Table for Archival and Purge	25-29
25.5.2.5	Archiving or Purging the AUDIT_EVENT Data Using Partitions	25-29
25.5.2.6	Ongoing Partition Maintenance	25-30
25.5.3	Partition-Based Approach for Audit Growth Control Measures in Legacy Audit (UPA) Framework	25-30
25.5.3.1	About Audit Data Growth Control Measures in Legacy Audit Framework	25-31
25.5.3.2	Prerequisites for Using the Utility	25-31
25.5.3.3	Preparing the UPA Table for Archival and Purge	25-32
25.5.3.4	Archiving or Purging the UPA Table	25-36
25.6	Using the Real-Time Certification Purge in Oracle Identity Governance	25-37
25.6.1	Understanding Real-Time Certification Purge Job	25-38
25.6.2	Configuring Real-Time Certification Purge Job	25-40

### 26 Handling Lifecycle Management Changes

---

26.1	URL Changes Related to Oracle Identity Governance	26-1
26.1.1	Oracle Identity Governance Host and Port Changes	26-1
26.1.1.1	Changing OimFrontEndURL in Oracle Identity Governance Configuration	26-2
26.1.1.2	Changing backOfficeURL in Oracle Identity Governance Configuration	26-3
26.1.1.3	Changing Task Details URL in Human Task Configuration	26-4
26.1.1.4	Changing OIG Server Port on WebLogic Administrative Console	26-4
26.1.2	Oracle Identity Governance Database Host and Port Changes	26-4
26.1.2.1	Modifying Datasource oimJMSStoreDS Configuration	26-5
26.1.2.2	Modifying Datasource soaOIMLookupDB Configuration	26-5
26.1.2.3	Modifying Datasource oimOperationsDB Configuration	26-5
26.1.2.4	Modifying Datasource ApplicationDB Configuration	26-6
26.1.2.5	Modifying Datasource Related to Oracle Identity Governance Meta Data Store	26-6
26.1.2.6	Modifying OIMAuthenticationProvider Configuration	26-6
26.1.2.7	Modifying DirectDB Configuration	26-7
26.1.2.8	Modifying the Oracle Identity Governance Database Host and Port in BI Publisher	26-8
26.1.2.9	Changing Incorrect Database Configuration	26-8
26.1.3	Changing Oracle Virtual Directory Host and Port	26-9
26.1.4	Changing BI Publisher Host and Port	26-9
26.1.5	Changing SOA Host and Port	26-10
26.1.6	Changing OAM Host and Port	26-11
26.2	Password Changes Related to Oracle Identity Governance	26-11
26.2.1	Updating Oracle WebLogic Administrator Credentials	26-11
26.2.2	Changing Oracle WebLogic Administrator Password	26-12
26.2.3	Changing Oracle Identity Governance Administrator Password	26-12
26.2.4	Changing Oracle Identity Governance Administrator Database Password	26-13
26.2.4.1	Resetting Oracle Identity Governance Password	26-13
26.2.4.2	Resetting System Administrator Database Password in Oracle Identity Governance Deployment	26-13
26.2.4.3	Resetting System Administrator Database Password When Oracle Identity Governance Deployment is Integrated With Access Manager	26-14
26.2.5	Changing Oracle Identity Governance Database Password	26-16
26.2.5.1	Changing Datasource oimJMSStoreDS Configuration	26-16
26.2.5.2	Changing Datasource ApplicationDB Configuration	26-17
26.2.5.3	Changing Datasource soaOIMLookupDB Configuration	26-17
26.2.5.4	Changing Datasource oimOperationsDB Configuration	26-17
26.2.5.5	Changing Datasource Related to Oracle Identity Governance Meta Data Store	26-17

26.2.5.6	Changing OIMAuthenticationProvider Configuration	26-18
26.2.5.7	Changing Domain Credential Store Configuration	26-18
26.2.5.8	Changing the Oracle Identity Governance Database Password in BI Publisher	26-18
26.2.6	About Credential Store Framework Keys	26-19
26.2.7	Changing Oracle Identity Governance Passwords in the Credential Store Framework	26-19
26.2.8	Changing OVD Password	26-20
26.2.9	Changing Oracle Identity Governance Administrator Password in LDAP	26-20
26.2.10	Unlocking Oracle Identity Governance Administrator Password in LDAP	26-21
26.2.11	Changing Schema Passwords	26-21
26.3	Configuring SSL for Oracle Identity Governance	26-24
26.3.1	Generating Custom Key Stores (Optional)	26-25
26.3.1.1	Creating the Custom Identity Store	26-25
26.3.1.2	Self Signing the Certificates of Custom identity keystore	26-26
26.3.1.3	Exporting the Certificate From Custom Identity Keystore	26-26
26.3.1.4	Importing the Certificate of Custom Identity to Trust Store	26-27
26.3.2	Configuring Custom Key Stores (Optional)	26-27
26.3.3	Enabling SSL for Oracle Identity Governance and SOA Servers	26-29
26.3.3.1	Enabling SSL for Oracle Identity Governance	26-30
26.3.3.2	Changing OimFrontEndURL to Use Oracle Identity Governance SSL Port	26-33
26.3.3.3	Changing backOfficeURL to Use SOA SSL Port	26-34
26.3.3.4	Changing SOA Server URL to Use SOA SSL Port	26-34
26.3.4	Enabling SSL for Oracle Identity Governance DB	26-35
26.3.4.1	Creating KeyStores and Certificates	26-36
26.3.4.2	Setting Up Database in Server-Authentication SSL Mode	26-38
26.3.4.3	Updating Oracle Identity Governance	26-40
26.3.4.4	Updating WebLogic Server	26-41
26.3.5	Enabling SSL for SOA Approval Composites	26-42
26.3.6	Configuring SSL for the Design Console	26-43
26.3.7	Configuring SSL for Oracle Identity Governance Utilities	26-45
26.4	Using Ready App	26-47
26.4.1	About Ready App	26-47
26.4.2	Registering Your Applications with Ready App	26-48
26.4.3	Using Ready App with an EAR	26-48
26.4.4	Using Ready App with a WAR	26-49
26.4.5	Testing Ready App	26-50

## 27 Securing a Deployment

---

27.1	Authorizing and Hardening	27-1
27.2	Configuring Secure Cookies	27-2
27.2.1	About Secure Cookies	27-2

27.2.2	Configuring a New Deployment Plan	27-3
27.2.2.1	Sample Deployment Plans	27-3
27.2.2.2	Configuring the Deployment	27-5
27.2.3	Updating an Existing Deployment Plan	27-6

## Part X Diagnostics and Troubleshooting

---

### 28 Using Enterprise Manager for Managing Oracle Identity Governance

---

28.1	Managing Oracle Identity Governance Configuration	28-1
28.1.1	Using MBeans for Configuration Changes	28-1
28.1.2	Exporting and Importing Configuration Files	28-2
28.2	Using the OrchestrationEngine MBean	28-2
28.2.1	Accessing the OrchestrationEngine MBean	28-3
28.2.2	About the Operations Supported by the MBean	28-3
28.2.3	About Diagnosis of Operation Failures Using the Orchestration Engine	28-4
28.2.4	Diagnosing Operation Failures Using the Orchestration Engine	28-5
28.3	Configuring Log Services for Oracle Identity Governance	28-5
28.3.1	Logging in Oracle Identity Governance By Using ODL	28-6
28.3.1.1	About Oracle Diagnostic Logging	28-6
28.3.1.2	Message Types and Levels in Oracle Identity Governance	28-7
28.3.1.3	Log Handler and Logger Configuration	28-8
28.3.1.4	Configuring Log Handlers	28-8
28.3.1.5	Log Handler Configuration Tools	28-9
28.3.1.6	About Configuring Loggers	28-10
28.3.1.7	Configuring Loggers in Oracle Identity Governance	28-10
28.3.1.8	Sample ODL Log Output	28-14
28.3.2	Logging in Oracle Identity Governance By Using log4j	28-14
28.3.2.1	Log Levels for log4j	28-15
28.3.2.2	Loggers in Third-Party Applications	28-15
28.3.2.3	Configuring and Enabling Logging	28-15
28.3.3	Setting Warning State	28-15
28.3.4	Switching Down the Log Level	28-16
28.4	Handling Cache	28-16

### 29 Using the PL/SQL Unified Diagnostic Logging and Debugging Framework

---

29.1	Understanding the PL/SQL Unified Diagnostic Logging and Debugging Framework	29-1
29.1.1	About the PL/SQL Unified Diagnostic Logging and Debugging Framework	29-1
29.1.2	Features of the Framework	29-2
29.1.3	Configurable Diagnostic Levels Provided in the Framework	29-3
29.1.4	Configurable System Properties to Control Logging	29-3

29.2	Configuring the Diagnostic Level	29-4
29.3	Understanding the Data Captured by PL/SQL Diagnostic Logging Tables	29-4
29.4	Collecting Data Captured by PL/SQL Diagnostic Logging Tables	29-6
29.5	Controlling Data Growth of PL/SQL Diagnostic Logging Tables	29-6

## Part XI Appendixes

---

### A Default User Accounts

---

### B Configuring SSO Providers for Oracle Identity Governance

---

B.1	Common Prerequisites for Integration With Third-Party SSO Solutions	B-1
B.2	Enabling Oracle Identity Governance to Work With OpenSSO	B-2
B.2.1	Prerequisites for Integrating Oracle Identity Governance with OpenSSO	B-2
B.2.2	Integrating Oracle Identity Governance with OpenSSO	B-2
B.2.2.1	Integrating Oracle Identity Governance with OpenSSO Procedure	B-2
B.2.2.2	Adding OpenSSO Agent Filter to Oracle Identity Governance Web-apps	B-4
B.2.2.3	Configuring SSO in Oracle Identity Governance	B-5
B.2.3	Running Validation Tests to Verify the Configuration	B-6
B.3	Enabling Oracle Identity Governance to Work With IBM Tivoli Access Manager	B-7
B.3.1	Prerequisites for Integrating Oracle Identity Governance with IBM Tivoli Access Manager	B-7
B.3.2	Integrating Oracle Identity Governance with IBM Tivoli Access Manager	B-7
B.3.3	Running Validation Tests to Validate the Configuration	B-9
B.4	Enabling Oracle Identity Governance to Work With CA SiteMinder	B-10
B.4.1	Prerequisites for Integrating Oracle Identity Governance with CA SiteMinder	B-10
B.4.2	Integrating Oracle Identity Governance with CA SiteMinder	B-11
B.4.3	Running Validation Tests to Validate the Configuration	B-14
B.5	Configuring Basic SSO Using OAM	B-15
B.5.1	Prerequisites for Configuring SSO Logout and the Authenticator	B-15
B.5.2	Configuring SSO Logout and the Authenticator	B-16
B.5.3	Running Validation Tests to Validate the Configuration	B-17
B.6	Simplifying Third-Party SSO Integration	B-18
B.7	Using Configurable Login ID Support for SSO Integration	B-20
B.8	Configuring Login ID Support for SSO Integration	B-20
B.9	Integrating Oracle Identity Governance with Identity Providers using SAML2 Asserter	B-23
B.9.1	Prerequisites for Integrating Oracle Identity Governance with Identity Providers	B-23
B.9.2	Configuring the SAML2 Asserter in the Oracle Identity Governance Domain	B-26
B.9.3	Configuring Identity Federation Settings on Oracle Identity Governance	B-27
B.9.4	Exporting the Identity Federation Document	B-27
B.9.5	Configuring the Identity Provider Metadata on Oracle Identity Governance	B-28

B.9.6	Updating Identity Self Service, System Administration, and FacadeWebApp to Change the Session Cookie	B-28
B.9.7	Testing the SAML2.0 Flow with Identity Self Service and System Administration Pages	B-33

## C Using Database Roles/Grants for Oracle Identity Governance Database

---

## D Enable Administration Port in Oracle Identity Governance

---

## E Enabling Transparent Data Encryption

---

E.1	Types of Data Encryption	E-1
E.2	Configuring TDE for New Installation of Oracle Identity Governance	E-1
E.3	Configuring TDE for an Existing Installation of Oracle Identity Governance	E-7
E.4	Deconfiguring TDE for Oracle Identity Governance	E-7

## F Troubleshooting Clustered OIM and Eclipselink Cache Coordination

---

F.1	Startup Procedure for Clustered Installation of Oracle Identity Governance	F-1
F.2	Setting Deployment Mode to Cluster	F-2
F.3	Configuring Multicast Addressing for Oracle Identity Governance	F-2
F.4	Multicast Addressing for Eclipselink	F-2
F.5	Testing Multicast Network Testing	F-2
F.6	Enabling Additional Logging for Eclipselink	F-3
F.7	Testing Multicast Connectivity Between Oracle Identity Governance Nodes	F-3

## G Scheduler and System Properties do not come up in the Integrated Environment

---



## List of Figures

---

2-1	Oracle Identity Governance Components	2-1
3-1	Layout of the Oracle Identity System Administration Console	3-2
3-2	Layout of the Help Interface	3-7
4-1	Request Process Flow	4-3
4-2	Single Request Lifecycle	4-8
4-3	Bulk Request Lifecycle	4-9
4-4	Request Process Flow with Disabled Workflow	4-29
4-5	In-Flight Requests Awaiting Request Approval	4-31
4-6	In-Flight Requests Awaiting Operation Approval	4-32
4-7	Disabled Workflows	4-35
6-1	The Create Text Field Page	6-3
6-2	Create User Page in Customization Mode	6-11
6-3	Object Tree Page in Customization Mode	6-11
6-4	Options for Adding a UDF of Text Type	6-14
8-1	Step 3: Modify Connector Configuration Page	8-18
8-2	Step 3: Modify Connector Configuration Page After Addition of a Field	8-30
9-1	Attach Password Policy to Application Instance	9-17
9-2	Disconnected Resource Architecture	9-28
9-3	Create Application Instance Attributes	9-30
10-1	Connector Lifecycle	10-4
10-2	Selected Connector Objects	10-13
10-3	The Variable List Tab of the Adapter Factory Form	10-38
10-4	The Edit Adapter Factory Task Parameters Dialog Box	10-38
10-5	The Integration Tab of the Editing Task Dialog Box	10-39
10-6	The Editing Data Mapping for Variable Dialog Box	10-39
10-7	The Pre-Populate Adapters Dialog Box	10-40
10-8	The Map Adapter Variable Dialog Box	10-40
11-1	Provisioning and Reconciliation	11-2
11-2	Trusted Source Reconciliation from Single and Multiple Authoritative Sources	11-4
11-3	Account Reconciliation From a Target System	11-5
11-4	Identity and Account Reconciliation	11-6
11-5	Reconciliation Process Flow	11-7
12-1	High-Level Catalog Architecture	12-7
12-2	Test to Production Process for Catalog	12-32
12-3	Catalog Synchronization Diagnostic Flowchart	12-37
12-4	Trouble Shooting Synchronization Application Instances Flowchart	12-38

12-5	Trouble Shooting Synchronizing Entitlements Flowchart	12-39
12-6	Diagnostic Flowchart With Security Issues	12-40
12-7	Catalog Search	12-41
13-1	List of Rules defined in Home Organization Policy Page	13-3
13-2	Creating rule with Condition Builder Option	13-4
13-3	Creating rule with Script Option	13-6
14-1	List of Rules defined in Self Service Capabilities page	14-2
14-2	Creating rule with Condition Builder Option for Self Service Capability	14-4
15-1	The Search and Select: Lookup Type Window	15-2
15-2	The Create Lookup Type Dialog Box	15-3
15-3	The Edit Lookup Type Dialog Box	15-5
18-1	UMSEmailNotificationProviderMBean Properties	18-4
18-2	EmailNotificationProviderMBean Properties	18-9
18-3	Sample Mapping of Composite Payload	18-11
18-4	SOAEmailNotificationProviderMBean Properties	18-13
18-5	Notification Search Result	18-17
18-6	The Create Notification Template Page	18-19
18-7	Notification Template Modification	18-20
25-1	Solutions Available to Control Audit Data Growth in Lightweight Audit Framework	25-28
26-1	Setting for OIMAuthenticationProvider	26-7

## List of Tables

---

1-1	Summary of Features	1-3
4-1	Request Stages	4-5
4-2	Operations and Rules	4-12
4-3	Rules for Compliance Use Cases	4-13
4-4	Approval Workflow Rule Syntax and Examples	4-18
4-5	Approval Policies to Approval Workflows	4-28
4-6	Unavailable Features When Workflow is Disabled	4-36
5-1	Options in the Regenerate View Window	5-4
6-1	Fields in the Create Text Field Page	6-4
6-2	Fields in the Create Lookup Field Page	6-8
6-3	Entities and Corresponding Data Components and View Objects	6-12
8-1	Sample Entries for the Step 1: Provide Basic Information Page	8-8
8-2	Sample Entries for the Step 2: Specify Parameter Values Page	8-14
8-3	Display of Data Sets and Fields Under Various Input Conditions	8-21
8-4	Lookup Properties	8-26
9-1	Fields in the Create Application Instance Page	9-5
9-2	Possible Scenarios and Duplicate Validation Basis	9-21
9-3	Duplicate Validation Based on Operation	9-22
9-4	Manual Provisioning SOA Composite Payload Attributes	9-28
9-5	Manual Process Task Action Statuses	9-33
9-6	Troubleshooting Disconnected Resources	9-35
11-1	Types of Reconciliation	11-2
11-2	Regular and Changelog Reconciliation Modes	11-10
11-3	Advanced Search Fields	11-13
11-4	Columns in the Matched Accounts Table	11-15
11-5	Columns in the History Table	11-15
11-6	Actions for Event Status and Types	11-16
12-1	Catalog Metadata Loader Sample	12-17
12-2	Catalog Customization Steps	12-33
17-1	Child Elements of the Scheduler Element	17-2
17-2	Predefined Scheduled Tasks	17-7
17-3	Fields in the Search Results Table	17-31
18-1	Parameters in Attributes Tab	18-3
18-2	UMSEmailNotificationProviderMBean Properties	18-6
18-3	Default SMTP Email Notification Provider Properties	18-9
18-4	SOA Email Notification Provider Properties	18-13

18-5	Default Notification Templates	18-16
19-1	Default System Properties in Oracle Identity Governance	19-2
19-2	Non-Default System Properties	19-21
21-1	Parameter Import Rules	21-10
23-1	User Resource Instance Tables	23-3
23-2	Resource Lifecycle Process Tables	23-4
23-3	Definition of the UPA Table	23-4
23-4	User Profile Audit Tables	23-6
23-5	Definition of the GPA Table	23-8
23-6	Definition of the ARM_AUD Table	23-9
23-7	Entities that are audited in Oracle Identity Manager by Lightweight Audit Engine	23-11
23-8	Definition of the AUDIT_EVENT Table	23-12
23-9	Group Entity Type Actions	23-13
24-1	Default Certification Reports	24-33
24-2	Scheduled Tasks for Oracle Analytics Server Reports	24-39
25-1	Archival and Purge Solutions	25-2
25-2	Purge Configuration Parameters	25-5
25-3	Columns of the OIM_DATAPURGE_TASK_LOG Table	25-9
25-4	Columns of the OIM_DATAPRG_TASKS_LOGDTLS Table	25-10
25-5	Columns of the OIM_DATAPRG_FAILED_KEYS Table	25-11
25-6	Active and Archive Reconciliation Tables	25-13
25-7	Active and Archive Task Tables	25-18
25-8	Output Files Generated by the Task Archival Utility	25-22
25-9	Archival Tables	25-23
25-10	Input Parameters	25-23
25-11	Logs Generated by the DB Archival Utility	25-26
25-12	Possible Scenarios That are Considered For Partitioning	25-29
25-13	Acronyms Used in Archive Certification Tables	25-38
25-14	Active and Archive Certification Tables	25-39
25-15	OIM Certification Purge Job Parameters	25-40
16	Supported Purge Criteria for Oracle Identity Governance Entities	2
17	Configuration Parameters for OIM_OFFLINE_DATAPURGE DBMS Scheduled Job	3
26-1	CSF Keys	26-19
27-1	Securing a Deployment	27-1
28-1	Operations Supported by OrchestrationEngine	28-3
28-2	Oracle Identity Manager Diagnostic Message Types	28-7
28-3	Oracle Identity Manager Loggers	28-11

28-4	Log Levels for log4j	28-15
29-1	Message Types for Diagnostic Levels	29-3
29-2	The DIAG_LOG Table	29-5
29-3	The DIAG_LOG_DTLS Table	29-5
4	Configurable Properties to Control Logging	2
5	Predefined Events and SLA Values	4
6	IDMDF Email Notification	8
7	Detailed Log	8
A-1	Default User Accounts	A-1
B-1	Authentication Chain	B-12
C-1	Role Grants for Database Applications	C-2

# Preface

*Oracle Fusion Middleware Administering Oracle Identity Manager* describes how to perform system administration tasks in Oracle Identity Manager.

## Audience

This guide is intended for system administrators who can perform system configuration tasks, application servers, connectors, and scheduled task management, connector installation and deployment, and archival utility management.

## Documentation Accessibility

For information about Oracle's commitment to accessibility, visit the Oracle Accessibility Program website at <http://www.oracle.com/pls/topic/lookup?ctx=acc&id=docacc>.

### Access to Oracle Support

Oracle customers that have purchased support have access to electronic support through My Oracle Support. For information, visit <http://www.oracle.com/pls/topic/lookup?ctx=acc&id=info> or visit <http://www.oracle.com/pls/topic/lookup?ctx=acc&id=trs> if you are hearing impaired.

## Related Documents

For more information, refer to the following documents:

- *Oracle Fusion Middleware Developing and Customizing Applications for Oracle Identity Governance*
- *Oracle Fusion Middleware Performing Self Service Tasks with Oracle Identity Governance*
- *Oracle Fusion Middleware Installation Guide for Oracle Identity and Access Management*
- *Oracle Fusion Middleware High Availability Guide*
- *Oracle Fusion Middleware Administrator's Guide for Oracle Access Manager*

## Conventions

The following text conventions are used in this document:

Convention	Meaning
<b>boldface</b>	Boldface type indicates graphical user interface elements associated with an action, or terms defined in text or the glossary.
<i>italic</i>	Italic type indicates book titles, emphasis, or placeholder variables for which you supply particular values.

<b>Convention</b>	<b>Meaning</b>
monospace	Monospace type indicates commands within a paragraph, URLs, code in examples, text that appears on the screen, or text that you enter.

# What's New In This Guide

This preface provides a summary of new features and updates to *Administering Oracle Identity Governance 14c* (14.2.1.0).

Oracle Identity Governance 14c (14.1.2.1.0) includes the following new and changed administrative features for this document.

- **JDK Upgrade:** Oracle Identity Governance 14c (14.1.2.1.0) is certified for use with JDK 17 and JDK 21, which introduces new features, optimizations, and bug fixes enhancing the overall performance and stability.
- **FMW Upgrade:** OIG 14.1.2.1.0 is based on the latest FMW version 14.1.2.0.0, which has new security updates and performance optimizations.
- **OJET Uptake:** UI Screens based on OJET now use the version 17.1.0 with redwood theme, providing a fresh look to such UI.
- **JCS Uptake:** Cache has been replaced by JCS which has better distributed caching support, and more advanced memory management.
- **Third Party Software Upgrade:** OIG 14.1.2.1.0 uses the latest and most secure version of third party libraries which make the software more secure.
- **IDS Uptake:** Instead of User/Role API, OIG now uses IDS which is better suited for large enterprises and is optimized for high performance authentication.
- Cache has been replaced by JCS which has better distributed caching support, and more advanced memory management. See [Configuration of JCS](#).
- To enable Administration port in Oracle Identity Governance, refer to [Enable Administration Port in Oracle Identity Governance](#).



# Part I

## Overview

Understand Oracle Identity Governance along with its functions and architecture, and introduce yourself to the Identity System Administration interface.

This part describes the Oracle Identity Governance overview and architecture and provides an overview of the Oracle Identity System Administration interface. It contains the following chapters:

- [Product Overview for Oracle Identity Governance](#)
- [Product Architecture of Oracle Identity Governance](#)
- [Oracle Identity System Administration Interface](#)

# 1

## Product Overview for Oracle Identity Governance

Oracle Identity Governance overview includes understanding the purpose and major features of the product, the different modes in which it can be deployed, and its interaction with other products, IT systems, and users.

This chapter describes the purpose of Oracle Identity Governance and highlights the major features. It includes the following topics:

### Note:

Oracle Identity Governance and Oracle Identity Manager product name references in the documentation mean the same.

- [What is Oracle Identity Governance?](#)
- [What are the Different Modes of Oracle Identity Governance?](#)
- [How does Oracle Identity Governance Interact with Other IT Systems?](#)
- [How does Oracle Identity Governance Interact with Other Oracle Identity and Access Management Products?](#)
- [How do Users Interact with Oracle Identity Governance?](#)

### 1.1 What is Oracle Identity Governance?

Oracle Identity Governance is a solution that provides self service, compliance, provisioning and password management services for applications residing on-premise or on the Cloud.

Oracle Identity Manager is a Governance solution that makes it possible for enterprises to manage the identities and access privileges of their customers, business partners, and employees, all on a single platform. It allows these users to manage their own identities as well as those of others by using delegated administration. It allows enterprises to setup delegated administrators, who are users empowered to manage the identities, passwords, password policies, and access of other users. Business users can create and manage the lifecycle of enterprise roles, which grant access to end-users. These roles can be granted automatically by using rules. With the help of roles and access policies, organizations can ensure that their users are on-boarded and off-boarded in a timely and automated manner.

Oracle Identity Manager enables end-users to get the access they need to do their jobs in a simple and user-friendly manner. End-users use the access catalog, which presents available access in a non-technical, user-friendly manner, to request the access they need. They submit their requests, which are routed to approvers and managers for approval.

Oracle Identity Manager automates the process of creating, updating, and deleting user accounts, provisioning of passwords, and granting/revoking of entitlements across applications hosted on the Cloud or on-premise. This process is known as provisioning and de-provisioning. Oracle Identity Manager makes use of connectors to do provisioning and de-provisioning with connected applications. It also supports manual provisioning and de-provisioning in

applications that do not support a connector. Such applications are called disconnected applications.

Oracle Identity Manager can synchronize identities from authoritative sources, such as HR applications and accounts and access privileges from applications including LDAP and databases. Identity lifecycle events, such as hire, transfer, manager change, and separation from the organization, can be synchronized with Oracle Identity Manager, which can then take appropriate action including revoking access. This mechanism of synchronizing identity information with an authoritative source of identity data is known as trusted reconciliation. Oracle Identity Manager can also synchronize account information, including access privileges, and entitlements from applications that it manages. This mechanism is known as target reconciliation.

Oracle Identity Manager helps managers, authorized users, and compliance administrators to review and certify user access, in a user-friendly manner, by a process known as identity certification. Authorized administrators can create and configure certification campaigns, on a scheduled or ad-hoc basis, by using simple wizards. Certifiers, who have to certify the user access, are presented the information in a simple manner. They can either approve the access or reject it. When a violation is detected and the access is rejected, Oracle Identity Manager initiates a process that enables administrators to correct the violation. It can also directly deprovision the access privileges from the target platform or application, while maintaining a comprehensive trail of the actions taken. This is known as closed-loop remediation. Oracle Identity Manager supports different types of certifications, based on various user personas, such as business managers, role owners, application owners, and entitlement owners.

Oracle Identity Manager makes it possible for organizations to meet their compliance objectives by allowing business users to define audit policies. Audit policies specify what type of access a user may or may not have. For example, a user who has access to both Accounts Payables and Accounts Receivables is violating Sarbanes-Oxley guidelines. This is known as a Segregation of Duties (SoD) violation. Oracle Identity Manager allows organizations to define SoD policies that can be enforced during access request and can also be used to scan existing access to identify toxic combinations of access privileges, known as policy violations. Oracle Identity Manager identifies the violations and initiates a workflow allowing remediators, who could be business manager or administrators to fix these violations. This process is known as remediation. All actions taken by remediators are recorded and a comprehensive audit trail is maintained.

Oracle Identity Manager provides comprehensive auditing capabilities that allow auditors and security staff to keep track of who initiated what change, on whom, when and in what context. It allows the creation of custom audit events. This enables customers to audit their workflows and processes. All audit information is available in a manner that can be reported on using standard reporting tools.

## 1.2 What are the Different Modes of Oracle Identity Governance?

Oracle Identity Governance provides the flexibility to use functionality based on your identity management requirements. You can enable specific functionality by picking specific deployment options.

Oracle Identity Manager can be configured in three deployment modes:

- **Oracle Identity Manager in database mode**

Oracle Identity Manager is a highly scalable identity administration and provisioning solution that is capable of managing millions of identities, roles, and entitlements, and thousands of applications that are stored in a database. This mode should be used when identity administration, access request, account, and entitlement provisioning and

reconciliation is the main business driver and simple Single Sign On (SSO) with a SSO solution is adequate.

- **Oracle Identity Manager with Identity Auditor mode enabled**

Oracle Identity Manager with the Identity Auditor mode enabled provides the ability to run certification campaigns, manage and make use of identity audit policies, and carry out role mining to detect clusters of roles and policies.

Identity Auditor mode enables you to use the role LCM, Segregation of Duties (Identity Audit), and Access Certification features. You must be licensed to use the Identity Auditor features.

 **Note:**

Identity Auditor mode can be enabled after installing Oracle Identity Manager. See "Enabling Identity Audit" in *Performing Self Service Tasks with Oracle Identity Governance* for information about enabling the Identity Auditor mode.

Table 1-1 provides a summary of the features that are available in each deployment mode of Oracle Identity Manager.

**Table 1-1 Summary of Features**

Feature	Oracle Identity Manager in DB mode	Oracle Identity Manager with Identity Auditor mode enabled
Access policy management	Yes	Yes
Access request	Yes	Yes
Approvals	Yes	Yes
Auditing	Yes	Yes
Delegated administration	Yes	Yes
Identity audit (SoD)	No	Yes
Identity certification	No	Yes
Identity store	Database	Database
Lost password, forgot user ID, self registration	Yes	Yes
OAM/OAAM/OMSS integration	Yes	Yes
Organization management	Yes	Yes
Password synchronization	Yes	Yes
Provisioning	Yes	Yes
Reconciliation	Yes	Yes
Reporting	Yes	Yes
Role management	Yes	Yes
User management	Yes	Yes
User password management	Yes	Yes

 **Note:**

- Workflows can be disabled in all modes. However, certain features require workflows. See [Running Oracle Identity Governance Without Workflows](#) for information about disabling workflows and the impact of doing so on various Oracle Identity Manager features.
- See [Configuring Auditing](#) for information about auditing.

## 1.3 How does Oracle Identity Governance Interact with Other IT Systems?

Oracle Identity Governance interacts with various applications and IT systems to manage the application instances and accounts by using connectors.

In Oracle Identity Manager, applications and other IT systems are called *IT resources*. The IT resources expose various objects that can be managed by Oracle Identity Manager. These objects are called *resource objects*. The objects that represent accounts are called *application instances*, and the objects that represent access within an application are known as *entitlements*.

Oracle Identity Manager interacts with various applications and IT systems to manage the application instances and accounts by using connectors. Connectors are installed on the Oracle Identity Manager Server. Oracle provides several connectors for common technologies, such as JDBC, LDAP, SPML, SOAP, and REST, and for common business applications, such as SAP, eBusiness Suite, and PeopleSoft. New connectors can be developed by using the Identity Connector Framework (ICF).

Some IT systems cannot be communicated with directly and require the use of a lightweight component called the Connector Server. Examples of applications that require the use of the Connector Server include Microsoft products, such as Exchange and Active Directory, Novell eDirectory, IBM Lotus Notes, and others. In such scenarios, the connector is deployed on the Connector Server, and it communicates using native protocols with the application. Oracle Identity Manager communicates with the Connector Server, which then communicates with the connector.

## 1.4 How does Oracle Identity Governance Interact with Other Oracle Identity and Access Management Products?

Oracle Identity Governance integrates with other Oracle and third-party Identity and Access Management products via standards-based integration.

When integrated with OAM, Oracle Identity Manager provides forgot user ID, forgot password, challenge questions and responses, password and password policy management, account locking, self registration, and user, role, and organization management services. OAM provides Single Sign On services for Oracle Identity Manager. OAM also provides real-time session kill if the user is locked and auto-unlock features.

Oracle Identity Manager requires the use of the LDAP synchronization feature. This feature allows Oracle Identity Manager to push users, user passwords, and changes to user attributes, groups, and group memberships to the LDAP directory. Oracle Identity Manager reconciles the changes from the LDAP directory including the account lock status.

Oracle Identity Manager supports a reduced and simplified integration with OAM as well, where OAM provides Single Sign On for Oracle Identity Manager. In this approach, there is no synchronization of the state attributes or of OIM users and groups. You can make use of provisioning and connectors to provision and reconcile LDAP users and groups.

 **Note:**

See [Integrating Oracle Access Manager and LDAP](#) in the *Integration Guide for Oracle Identity Management Suite* for information about integration with OAM.

## 1.5 How do Users Interact with Oracle Identity Governance?

Oracle Identity Governance provides an end-user interface, called Identity Self Service, and a system administrator interface, called Identity System Administration. Both end-users and system administrators use the web browser to log on to Oracle Identity Governance.

The interface for end-users is used:

- To manage your user profile, passwords, challenge questions, and account passwords.
- To view, request, and approve access for self and others, certify users, and process policy violations and manual provisioning tasks.
- To setup organizations and administration roles and to configure delegated administration. It is also used by delegated administrators to create and manage users, organizations, and password policies.
- By authorized users to compose roles, create and run certification campaigns, configure SoD rules and policies, and create and run compliance scans.

The interface for system administrators is used:

- To define workflow policies, home organization policies, and user capabilities
- To manage the schema of system entities, such as user, role, and organization
- To manage provisioning end-points and the schema of the supported objects
- To import/export Oracle Identity Manager configuration objects
- To install/uninstall/upgrade connectors

You can also use the REST services to either create your own user interface or to integrate other applications with Oracle Identity Manager.

Developers can also use:

- The JDeveloper IDE to create custom UI by using the Oracle Application Development Framework (ADF) and to create custom workflows by using Business Process Execution Language (BPEL)
- The Design Console, which is a Java thick client, to create provisioning workflows
- The embedded BI Publisher reporting server to create custom reports

# 2

## Product Architecture of Oracle Identity Governance

Understand the various components and multi-tiered architecture of Oracle Identity Governance.

This chapter provides an overview of Oracle Identity Governance product architecture. It consists of the following topics:

- [Oracle Identity Governance Components](#)
- [Multi-tiered Architecture of Oracle Identity Governance](#)

### 2.1 Oracle Identity Governance Components

Oracle Identity Governance is a J2EE web application. The J2EE platforms consists of a set of industry-standard services, APIs, and protocols that provide the functionality for developing multi-tiered and web-based enterprise applications.

Figure 2-1 shows the various components of Oracle Identity Governance.

**Figure 2-1 Oracle Identity Governance Components**

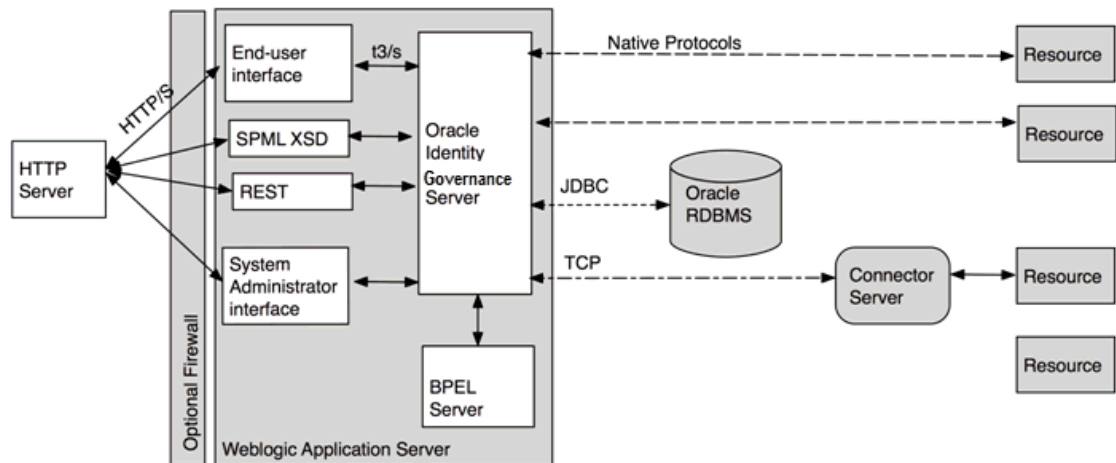

### 2.2 Multi-tiered Architecture of Oracle Identity Governance

The system architecture of Oracle Identity Governance is distributed across logical tiers, namely user interface tier, application tier, database tier, and connector tier.

This section contains the following topics:

- [About the User Interface Tier](#)
- [About the Application Tier](#)

- [About the Database Tier](#)
- [About the Connector Tier](#)

## 2.2.1 About the User Interface Tier

The user-interface tier (or the user tier) consists of administrators and end-users who interact with Oracle Identity Governance through one of the user interfaces.

The main user interface for Oracle Identity Manager is web-based, which communicates with Oracle Identity Manager over HTTP/S. There are two browser-based UIs, the end-user facing Oracle Identity Self Service and the administrator facing Oracle Identity System Administration. These UIs are developed by using the Oracle Application Development Framework (ADF).

Identity Self Service can be customized via the web browser, by system administrators who can add links, add business logic to show/hide form fields, extend shipped forms, and perform several other common UI customization tasks. Administrators perform UI customization tasks in UI sandboxes. These sandboxes can be exported and imported into higher environments. The use of Oracle ADF and UI customization framework allows administrators to customize Identity Self Service in an upgrade-safe manner.

Identity System Administration allows administrators to perform typical system administration functions including scheduling jobs, onboarding applications, and managing schemas. This UI is not customizable.

Developers can use the Design Console to create provisioning workflows and Oracle JDeveloper to create BPEL workflows for manual fulfillment, approval, identity certification, and identity audit.

## 2.2.2 About the Application Tier

Oracle Identity Manager Server is a J2EE application. It is deployed on Oracle WebLogic Server. The server consists of the Identity Self Service and Identity System Administration web applications, SPML XSD, and REST services, and the EJBs and related Java classes that provide the core functionality. Connectors, which interact with other IT systems, are deployed on the Oracle Identity Manager Server.

### Note:

Oracle recommends that you use REST services instead of SPML.

The server comprises of the following functional components:

- **Identity administration**

This includes self-registration, lost password and forgotten user ID, user, role, and organization management, and password management.

The user management engine allows administrators to manage users; reset their passwords and grant/revoke/modify access. When integrated with Oracle Access Manager (OAM), the changes in the user profile are synchronized with the LDAP directory used by OAM using a feature called LDAP synchronization.

The role management engine allows business users and administrators to create static and dynamic roles, associate access via access policies, and make the role available to various organizations. These operations can go through approval. After approval, the



changes are committed to the Oracle Identity Manager repository. This feature is known as role lifecycle management.

The organization management engine allows administrators to create and manage static or rule-based dynamic organizations. Administrators can define password policies and associate them with organizations, which allows different user communities to have different password policies.

- **Authorization**

The authorization engine in Oracle Identity Manager allows granular delegated administration by allowing administrators to define admin roles and associate them with functional capabilities. The authorization engine enforces the policies, which in turn leverage the admin role memberships of the user. Administrators can also define attribute-level permissions for users and specify who can see and modify user attributes.

- **Provisioning**

Oracle Identity Manager provides a highly scalable provisioning engine that provides account management and account password management capabilities. Oracle Identity Manager allows administrators to manage accounts and grant/revoke/modify additional access (entitlements). Administrators and end-users can also reset account passwords or configure Oracle Identity Manager so that the user password is synchronized with the accounts provisioned to a user. The provisioning engine supports two types of provisioning, connected provisioning using connectors and disconnected provisioning (or manual fulfillment) where a user has to take some action.

You can use Oracle Identity Governance to create, maintain, and delete users on target systems. In this configuration, Oracle Identity Governance acts as the front-end entry point for managing user data on the target systems. After accounts are provisioned, the users for whom the accounts have been provisioned can access the target systems without any interaction with Oracle Identity Governance. This is the provisioning configuration of Oracle Identity Governance.

A provisioning operation can be started through any of the following ways:

- **Request-Based Provisioning:** In request-based provisioning, an individual creates a request for a target system account. The provisioning process is completed when an Oracle Identity Governance User with the required privileges approves the request and provisions the target system account to the requester.
- **Policy-Based Provisioning:** This type of provisioning refers to resources being granted to users automatically through access policies. Access policies are used to define the association between user groups (or roles) and target resources.
- **Direct Provisioning:** This type of provisioning is a special administrator-only function in which an Oracle Identity Governance administrator provisions a resource to an OIG User. The workflow for this form of provisioning does not include the request and approval steps. You perform direct provisioning by using the Oracle Identity Self Service interface.
- **Automate and Manual Provisioning:** Oracle Identity Governance provides automated provisioning to managed applications and target systems upon access grant for both standard and privileged access, using a robust set of connectors. If these grants need to be revoked as a result of monitoring controls, then they can be automatically deprovisioned by using the same connectors, while providing a comprehensive audit trail.

Some of the provisioning actions can be automated if a provisioning connector is deployed for the specific target system and others can be completed manually. For manual fulfillment, an administrator will be assigned a provisioning task, make the appropriate changes in the target system, and then mark the task as 'completed' in

Oracle Identity Governance. As approval needs can change over the period of time, policy owners can change the approval routing logic using the Identity Self Service interface.

- **Role-Based Provisioning:** Any organization that implements a role-based platform for automated provisioning and a personalized portal must first implement an integrated identity-management platform to manage risk, protect sensitive information assets, and improve business performance. An identity management suite also can be used to integrate information portals, providing a sophisticated solution for access management, provisioning, and role management.

A solution that implements role-based provisioning should include four key components:

- \* **Provisioning platform:** The provisioning platform pulls identities from a trusted source (often an HR system) and facilitates provisioning by automatically creating accounts on a target system. It is responsible for synchronizing user data between the HR system and target systems where there are changes to user data, such as new-hires, job role changes, or employee termination. When a user is removed from a role and no longer requires access, the provisioning platform automatically deletes the user privileges from the target system.
- \* **Role management:** Role management organizes user-access rights based on similar responsibilities across the enterprise. For instance, a company might formalize job codes or responsibilities into particular roles that carry their own specific system-access rights and security levels. As a user's role changes, so do the user's access permissions. Oracle Identity Governance pushes these changes to the role manager, which derives user role membership and access information based on the user profile sent from the trusted resource. The provisioning platform and role manager should work in tandem to ensure that provisioning events are based on roles.
- \* **Access management:** An access management platform allows users of applications or IT systems to log in once and gain access to IT resources across the enterprise. This allows the organization to create a centralized and automated single sign-on (SSO) solution for managing who has access to what information across the IT infrastructure.
- \* **Portal:** Portals provide unified access to enterprise information in a personalized fashion. Portals can leverage the access-management platform to authenticate and authorize users. Once the user is authenticated and authorized, the portal presents an interface that can be personalized for each user to display only the data and applications that user has access to.

- **Reconciliation**

The reconciliation engine allows changes in target applications to be detected and synchronized with Oracle Identity Manager. It can retrieve changes from an authoritative source or from a target resource. The reconciliation engine allows changes in target applications to be detected and synchronized with Oracle Identity Manager. It can retrieve changes from an authoritative source or from a target resource. In the former scenario, changes are synchronized with the user, while in the latter, with the account.

- **Access request and approvals**

The request engine allows end-users to submit requests for new and modified access, either for themselves or for others. They can use the access catalog to search and browse in a manner similar to online shopping and submit their requests. The requests are routed to the appropriate approvers and fulfilled either in an automated manner by using connectors, or manually by using disconnected provisioning.

- **Identity certification**

The identity certification engine allows administrators to define certification campaigns. These campaigns allow managers and authorized users to review and certify the access granted to users. They can delegate certain users or process them themselves. They can reject a user's access, which can trigger a provisioning action to revoke the access. This is called closed-loop remediation.

- **Identity audit or Segregation of Duties (SoD)**

The SoD engine allows administrators to define rules and group them into policies. These rules and policies, known as identity audit rules and policies, allow Oracle Identity Manager to detect access that violates compliance rules. Administrators can specify which policies should be enforced during access request, while allowing other policies to be enforced retroactively. When a policy violation is found, the engine assigns the violation to a user for remediation.

- **Auditing**

The auditing engine audits (or logs) various actions in Oracle Identity Manager. Administrators can also add custom audit events. The audit data can be reported on using the reporting capabilities of Oracle Identity Manager.

- **Embedded reporting server**

The embedded reporting server, based on Oracle BI Publisher, provides operational and historical reports. Administrators can also use standalone BI Publisher or use the schema information to create reports using any other reporting tool.

- **BPEL workflow engine**

Oracle Identity Manager uses BPEL to provide workflow orchestration for approval, manual fulfillment, identity certification, and identity audit. Administrators or developers can define BPEL workflows or SOA composites and use workflow rules to dynamically invoke these workflows. BPEL provides data-driven approver resolution, task expiration, and escalation and email-based actionable notification. Oracle JDeveloper can be used to create new workflows and register them in Oracle Identity Manager.

## 2.2.3 About the Database Tier

Oracle Identity Manager stores all its information in the Oracle Identity Manager repository. The repository is comprised of tables that store the configuration, state, and other data.

Oracle Identity Manager keeps a copy of the account and entitlement data that is provisioned to the user, allowing it to be the source of truth for identity and account data.

Oracle Identity Manager also makes use of other schemas to store metadata about the workflows, approvals, configuration, and authorization policies.

Because Oracle Identity Manager can accumulate state data, it provides archival and purge utilities to manage data growth. Administrators must follow the product recommendations to manage data growth for optimal performance.

## 2.2.4 About the Connector Tier

The connector tier consists of applications and IT systems to which you provision and deprovision user accounts, change the account password, and grant/revoke entitlements.

The connector tier also includes the connector server, which is a lightweight application that allows Oracle Identity Manager to manage applications that do not provide remote APIs or require native integration.

Typically, Oracle Identity Manager connectors are developed by using the Identity Connector Framework and are deployed with the server. In some cases, where a connector server is required, they are deployed on the connector server.

You can create your own connectors by using the Identity Connector Framework, a lightweight and easy to use framework for developing connectors.

# 3

## Oracle Identity System Administration Interface

Login to Oracle Identity System Administration, access the various links and options available in the interface, and use online help for information on the UI elements.

This chapter discusses the procedure to access and log in to Oracle Identity System Administration, and provides an overview of the Oracle Identity System Administration.

This chapter contains the following topics:

- [Logging in to Oracle Identity System Administration](#)
- [Oracle Identity System Administration](#)

### 3.1 Logging in to Oracle Identity System Administration

Use the correct login ID and password to login to Oracle Identity System Administration.

To log in to Oracle Identity System Administration:

1. Browse to the following URL by using a Web browser:

```
http://HOSTNAME:PORT/sysadmin
```

In this URL, *HOSTNAME* represents the name of the computer hosting the application server and *PORT* refers to the port on which the Oracle Identity Manager server is listening.

#### Note:

The application name, sysadmin, is case-sensitive.

2. After the Oracle Identity System Administration login page is displayed, log in with your user name and password.

### 3.2 Oracle Identity System Administration

The left navigation pane of Oracle Identity System Administration provides links to open various sections of the interface on the right pane.

The interface of the Oracle Identity System Administration is composed of the following areas:

- [Layout of the Oracle Identity System Administration Interface](#)
- [Links in the Oracle Identity System Administration Interface](#)
- [Left and Right Panes in the Oracle Identity System Administration Console](#)
- [Help in Oracle Identity System Administration](#)

## 3.2.1 Layout of the Oracle Identity System Administration Interface

The layout of the Oracle Identity System Administration consists of left and right panes, links, and options.

Figure 3-1 shows a sample page and the layout of the interface.

**Figure 3-1** Layout of the Oracle Identity System Administration Console

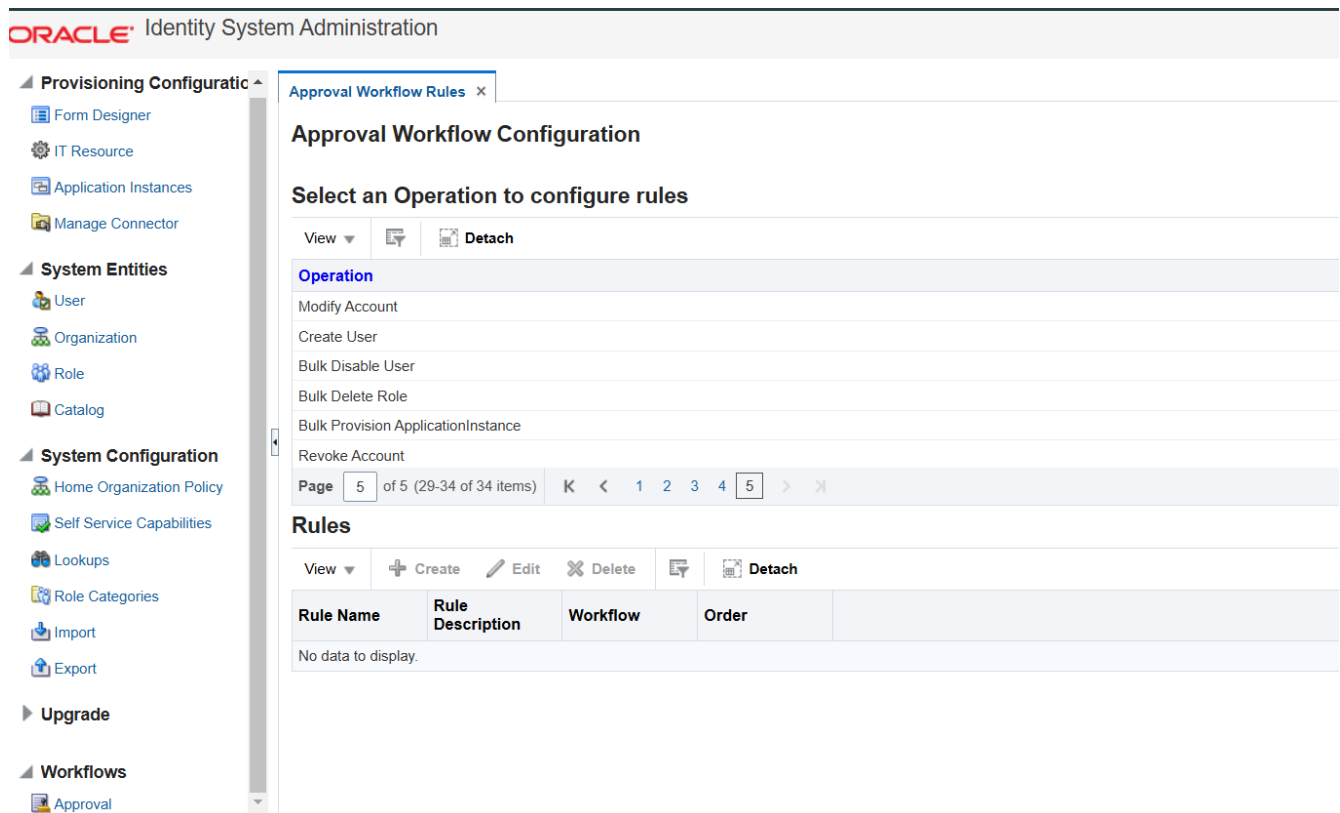

## 3.2.2 Links in the Oracle Identity System Administration Interface

The top pane of Oracle Identity System Administration consists of Accessibility, Sandboxes, and Sign Out.

This area consists of the following links in the upper-right corner of the interface:

- [About Accessibility Link](#)
- [About Sandboxes Link](#)
- [About Sign Out Link](#)

### 3.2.2.1 About Accessibility Link

Oracle Identity System Administration has been designed to adhere to the standards set in Section 508 of the Rehabilitation Act and the World Wide Web Consortium's Web Content Accessibility Guidelines 2.0 AA (WCAG 2.0 'AA').

When you click the Accessibility link in the upper right corner of the page, the Accessibility dialog box is displayed. You can select one of the following options from the Accessibility dialog box:

- **I use a screen reader**  
Select this option if you want to use a screen reader.
- **I use high contrast colors**  
Select this option to use the high-contrast color scheme that you have specified in your operating system, rather than using the default color scheme specified in Oracle Identity System Administration.
- **I use large fonts**  
Select this option if you want to change the font size for easy viewing and readability.

### 3.2.2.2 About Sandboxes Link

A sandbox represents an area where metadata objects can be modified without affecting their mainline usage. In other words, a sandbox is a temporary storage area to save a group of runtime page customizations before they are either saved and published to other users, or discarded.

In the Manage Sandboxes page, you can create, delete, activate, deactivate, and publish sandboxes. See *Managing Sandboxes in Developing and Customizing Applications for Oracle Identity Governance* for detailed information.

### 3.2.2.3 About Sign Out Link

The Sign Out link is available on the top right corner of Oracle Identity System Administration.

Click the Sign Out link to log out of Oracle Identity System Administration.

## 3.2.3 Left and Right Panes in the Oracle Identity System Administration Console

Every page in the Oracle Identity System Administration is divided into two panes. The left pane consists of sections that contain links to regions using which a variety of tasks can be accomplished.

The left pane is the primary navigation tool and is displayed on all web pages of Oracle Identity System Administration. Depending on the link that you click in the left pane, corresponding details are displayed in the right pane.

The left pane consists of these regions:

- [About Provisioning Configuration](#)
- [About System Entities](#)
- [About System Configuration](#)
- [About Upgrade](#)
- [About Workflows](#)

### 3.2.3.1 About Provisioning Configuration

The Provisioning Configuration region consists of Form Designer, IT Resource, Generic Connector, Application Instances, and Manage Connector.

The Provisioning Configuration region contains the following:

- **Form Designer**  
Use this page to create and manage forms of type users, roles, organizations, catalog, and resources that are not predefined in Oracle Identity Manager.  
See "[Managing Forms](#)" for more information.
- **IT Resource**  
Use this page to create and manage IT resources. An IT resource is composed of parameters that store connection information about a target system. Oracle Identity Manager uses this information to connect to a specific installation or instance of the target system.  
See "[Managing IT Resources](#)" for more information.
- **Application Instances**  
Use this page to create and manage application instances. An application instance is a combination of an IT resource instance and resource object. Users have accounts and entitlements that are associated with application instance and not with the IT resource instance or resource object.  
See "[Managing Application Instances](#)" for more information.
- **Manage Connector**  
Use this page to define, install, clone, upgrade, and uninstall predefined connectors in an Oracle Identity Manager environment. A predefined connector is designed for commonly used target systems such as Microsoft Active Directory and PeopleSoft Enterprise Applications.  
See "[Managing Connector Lifecycle](#)" for more information.

### 3.2.3.2 About System Entities

The System Entities region consists of links for customizing forms for the user, organization, role, and catalog entities.

The System Entities region contains the following:

- **User**  
Click to customize the User form, such as to create a UDF for the user entity.
- **Organization**  
Click to customize the Organization form, such as to create a UDF for the organization entity.
- **Role**  
Click to customize the Role form, such as to create a UDF for the role entity.
- **Catalog**  
Click to customize the Catalog form, such as to create a UDF for the catalog entity.



### 3.2.3.3 About System Configuration

The System Configuration region contains of the Home Organization Policy, Self Service Capabilities, Lookups, Role Categories, Scheduler, Notification, Configuration Properties, Import, and Export links.

The System Configuration region contains the following:

- Home Organization Policy  
Use this page to create and manage policies based on which the home organization of a user is determined at the time of self registration.  
See [Managing the Home Organization Policy](#) for more information.
- Self Service Capabilities  
Use this page to define self service capability policies to control what operations a user can perform for self.  
See [Managing Self Service Capability Policy](#) for more information.
- Lookups  
Use this page to create and manage lookup definitions. See [Managing Lookups](#) for more information.
- Role Categories  
Use this page to create and manage role categories for categorizing roles for the purpose of navigation and authorization.  
See [Managing Role Categories](#) for more information.
- Scheduler  
Use this page to create and manage scheduled jobs. Scheduled jobs are jobs that are run at specified time intervals to manage various activities in Oracle Identity Manager.  
See [Managing the Scheduler](#) for more information.
- Notification  
Use this page to create and manage notification templates. A notification template is used to send notifications.  
See [Managing Notification Service](#) for more information.
- Configuration Properties  
Use this page to create and manage system properties. System properties define the characteristics that control the behavior of Oracle Identity Manager.  
See [Configuring Oracle Identity Governance](#) for more information.
- Import  
Use this page to import Oracle Identity Manager configurations by using the Deployment Manager.  
See [Migrating Incrementally Using the Deployment Manager](#) for more information.
- Export  
Use this page to export Oracle Identity Manager configurations by using the Deployment Manager.  
See [Migrating Incrementally Using the Deployment Manager](#) for more information.

### 3.2.3.4 About Upgrade

When you upgrade to this release of Oracle Identity Manager, the custom attributes for entities (such as users, roles, organizations, and application instances) exist in the back-end.

However, if you want to display these attributes as form fields in the Oracle Identity Manager user interface, then you must customize the associated pages on the interface to add the custom form fields. To do so, use the links in the Upgrade region of Identity System Administration.

The Upgrade region contains the following:

- **Upgrade User Form**  
Use this page to create and manage custom form fields for the user entity.
- **Upgrade Role Form**  
Use this page to create and manage custom form fields for the role entity.
- **Upgrade Organization Form**  
Use this page to create and manage custom form fields for the organization entity.
- **Upgrade Application Instances**  
Use this page to create and manage custom form fields for the application instance entity.

For detailed information about upgrading Oracle Identity Manager to 19c (19.1.0.0.0), see [Upgrading Oracle Identity Manager Single Node Environments](#) in *Upgrade Guide for Oracle Identity and Access Management*.

### 3.2.3.5 About Workflows

The Workflows region consists of the Approval Workflow Rules page.

Use this page to manage approval workflow rules that determine whether or not request approval is required for an operation and which workflow is invoked for a specific operation.

See "[Managing Workflows](#)" for more information.

## 3.2.4 Help in Oracle Identity System Administration

The Oracle Identity System Administration interface includes a help system. Clicking the Help link opens the help system in a new window.

The help interface provides context-sensitive help. For example, if you are in the Form Designer page and click the Help link, then help content related to form designer is displayed.

The default view of the help system consists of three panes:

- [About Top Pane in the Help Interface](#)
- [About Lower Left Pane in the Help Interface](#)
- [About Lower Right Pane in the Help Interface](#)

### 3.2.4.1 About Top Pane in the Help Interface

The top pane in the Help interface consists of the Book list, search fields, and buttons for navigation and printing.

Figure 3-2 shows a sample page and default layout of the help interface.

**Figure 3-2 Layout of the Help Interface**

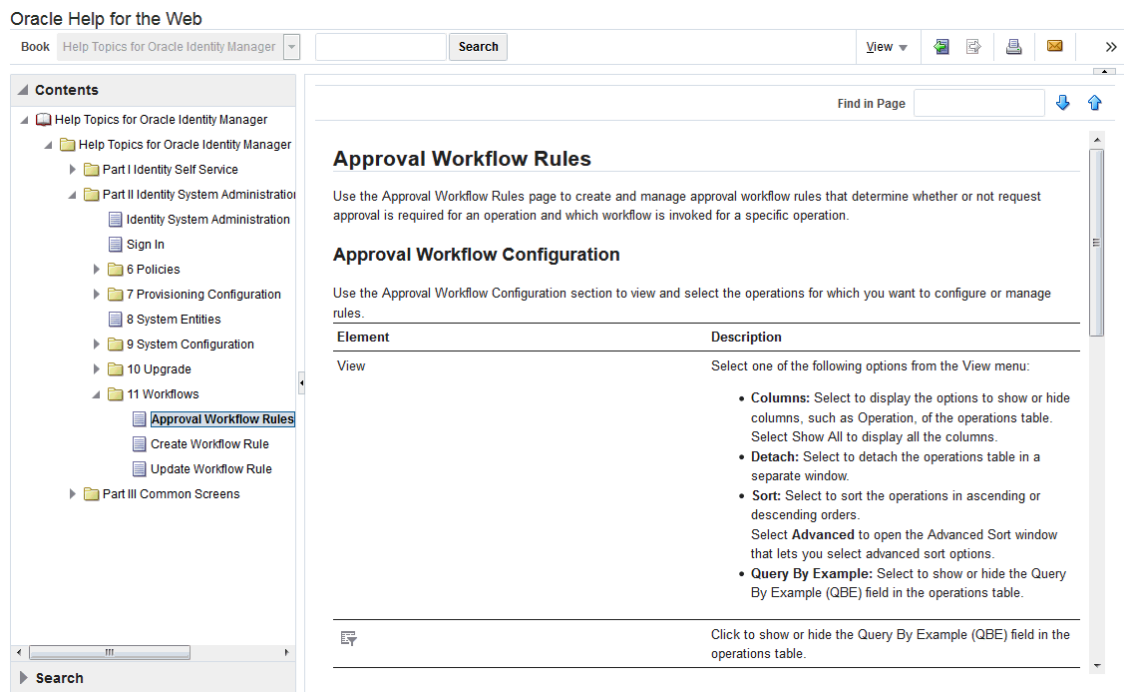

The top pane consists of the following:

- Book drop-down list: From this drop-down list you can select one of the following values:
  - **Help Topics for Oracle Identity Manager:** Select this value to open all help topics for Oracle Identity Manager.
  - **Administrator's Guide for Oracle Identity Manager:** Select this value to open the online help version of *Oracle Fusion Middleware Administrator's Guide for Oracle Identity Manager*.
  - **Developer's Guide for Oracle Identity Manager:** Select this value to open the online help version of *Oracle Fusion Middleware Developing and Customizing Applications for Oracle Identity Manager*.
  - **User's Guide for Oracle Identity Manager:** Select this value to open the online help version of *Oracle Fusion Middleware Performing Self Service Tasks with Oracle Identity Manager*.
  - **Custom Help Topics for Oracle Identity Manager:** Select this value to open any custom help topics.
- Search field: Specify any word or term to search for in the help system.
- View: From the View menu, you can select any one of the following options:
  - **Maximize Reading Pane:** Collapses the lower left pane to maximize the reading pane, which is the lower right pane.
  - **Restore Default Window Layout:** Restores the current layout of the help system to the default layout.

- **Contents:** Restores the lower left pane to display the Contents region along with the help topics, if it is not already being displayed.
- **Search:** Displays the Search region in the lower left pane. In the Search region, you can search for help topic and the search results are displayed in a tabular format. Here are a few guidelines on performing a search:
  - \* Search criterion specified in the Search field can be made case sensitive by selecting the **Case Sensitive** option.
  - \* To define your search precisely, you can specify the boolean operators & (for AND), |(for OR), !(for NOT) in your search criterion, select the **Boolean expression** option, and then click **Search**.
  - \* To search for help topics containing all words specified in the search criterion, select **All words**.
  - \* To search for help topics containing any word specified in the search criterion, select **Any words**.
- **Show permanent link for this topic page:** If you want to save the link to a help topic for future reference, then from the View menu, select **Show permanent link for this topic page**. In the dialog box that is displayed, right-click the link to the help topic and select one of the following options:
  - \* **Bookmark This Link:** Adds the help topic URL to the browser bookmarks.
  - \* **Copy Link Location:** Copies the help topic URL to the clipboard.
- **Toolbar:** The help system contains a toolbar that provides action buttons for certain tasks. You can view the name of the button by moving the mouse pointer over the button. The following buttons are available:
  - **Go back one page:** Takes you back to the page containing the previous help topic.
  - **Go forward one page:** This icon is enabled only if you have clicked the **Go back one page** icon. Clicking the **Go forward one page icon** takes you to the next page in the sequence of topics you visited.
  - **Print this topic page:** Prints the current help topic.
  - **Email this topic page:** Drafts an email with a link to the help topic currently displayed in the help system. This draft can be sent to the desired email recipient.
  - **Link to this topic page:** Saves the link to a help topic for future reference by right-clicking the link to the help topic in the dialog box that is displayed, and then selecting one of the following options:
    - \* **Bookmark This Link:** Adds the help topic URL to the browser bookmarks.
    - \* **Copy Link Location:** Copies the help topic URL to the clipboard.

### 3.2.4.2 About Lower Left Pane in the Help Interface

The lower left pane contains the Contents and Search regions. By default, the Contents region is expanded.

The Contents region displays links to help topics depending on the option you select from the Book drop-down list in the top pane. You can click the arrow icon beside Contents to expand or collapse the Contents region.

### 3.2.4.3 About Lower Right Pane in the Help Interface

The lower right pane is also called the reading pane.

The lower right pane displays any help topic that you search for or open from the Contents and Search regions in the lower left pane. The pages in the reading pane displays a description of each element in the UI page of Oracle Identity System Administration.

# Part II

## Policy Administration

Policy administration includes managing workflows for request generation and approval.

This part contains the following chapter:

- [Managing Workflows](#)

# 4

## Managing Workflows

Managing workflows include understanding and configuring workflow rules, managing request approval in an upgraded deployment, moving workflow policies from test to production, and running Oracle Identity Manager without workflows.

This contains the following sections:

- [Understanding Workflow Rules](#)
- [Configuring Approval Workflow Rules](#)
- [Managing Request Approval in an Upgraded Deployment of Oracle Identity Governance](#)
- [Migrating Workflow Rules From Test to Production](#)
- [Running Oracle Identity Governance Without Workflows](#)
- [Use Cases for Disabled or Deleted Proxy Users](#)

### 4.1 Understanding Workflow Rules

Understand workflow rules, request process flow with or without workflows, and request lifecycle for single and bulk requests.

This sections describes about the approval workflows in the following topics:

- [About Workflow Rules](#)
- [About Request Process Flow](#)
- [About Request Lifecycle](#)

#### 4.1.1 About Workflow Rules

Request generation and approval depends on the usage and configuration of workflow rules.

Request generation and approval is governed by the following:

- Whether Oracle Identity Manager is running with or without workflows. By default, workflows are enabled in Oracle Identity Manager. For information about running Oracle Identity Manager without workflows, see [Running Oracle Identity Governance Without Workflows](#).
- Approval workflow rules defined for the supported operations.

 **Note:**

Approval policies have been removed in favor of workflow policies. Request generation and approval is governed by workflow policies, as described in this document. The removal of approval policies is applied in 14c.release.

Workflow rules determine the following:

- Whether or not approvals are required for an operation
- Which workflow must be invoked for a specific operation

## 4.1.2 About Request Process Flow

The process flow of a request depends on whether or not the operation is allowed, single or bulk operation, and the deployment is with or without workflows.

The process of request generation and approval, which is governed by approval workflow rules, is depicted in [Figure 4-1](#).



Figure 4-1 Request Process Flow

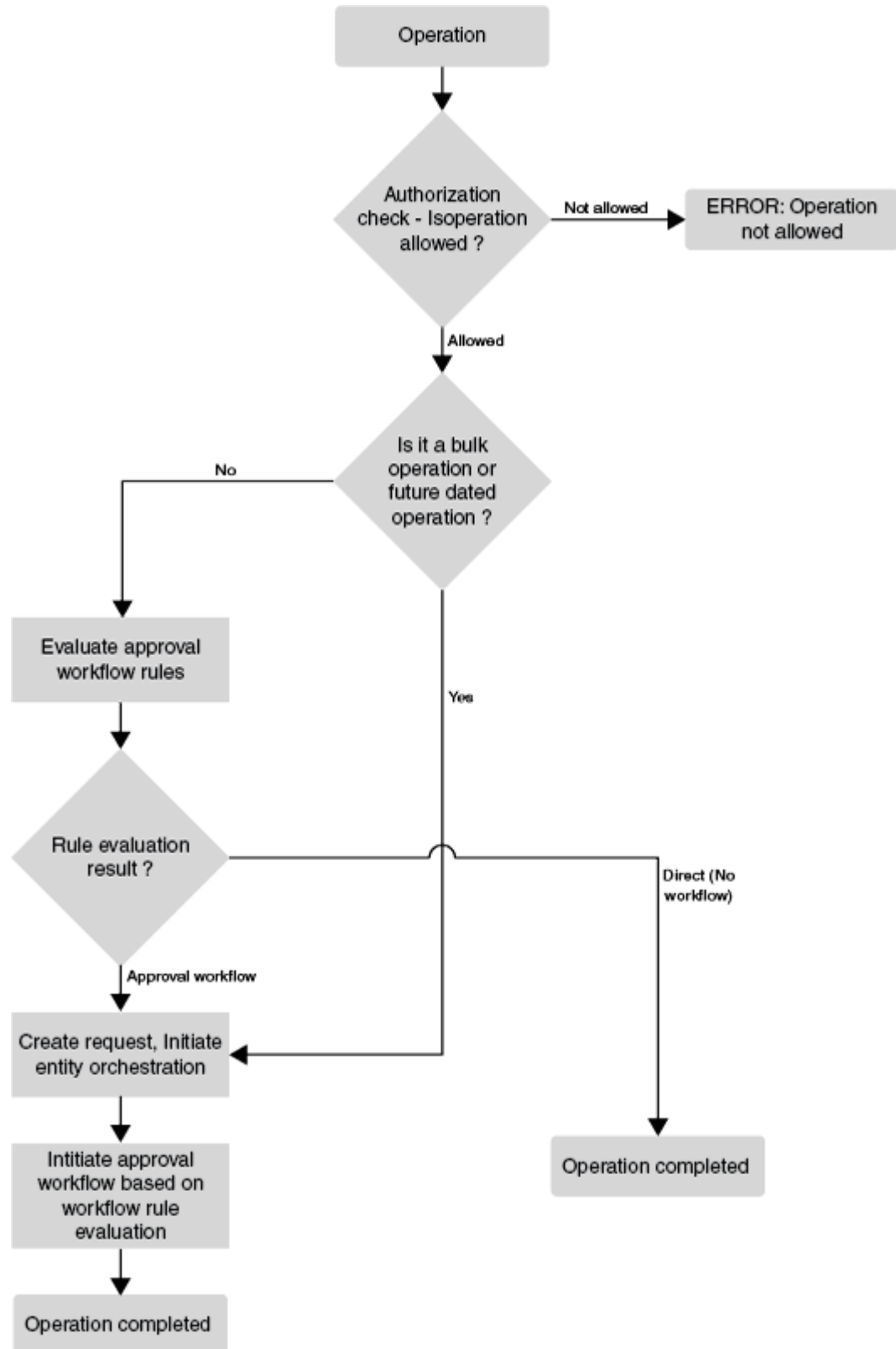

The request process flow is as follows:

1. Authorization checks are performed based on the admin roles granted to the user. This check determines whether or not the user is allowed to perform the operation.
2. If the operation is not authorized, then an error is returned and the flow ends.
3. If the operation is allowed, then it is checked if the operation is a bulk operation or future-dated operation.
4. If it is a bulk or future-dated operation, then a request is created, approval is initiated based on workflow rule evaluation, and the operation is completed after approval.
5. If it is not a bulk or future-dated operation, then approval workflow rules are evaluated. The result of this evaluation determines whether request is created or not.
  - If the result is Direct, then no request is created, and the operation is performed directly.
  - If a SOA Workflow ID is returned as the result, then a request is created, and the workflow returned by the policy evaluation is invoked.

Bulk requests are processed in the following way:

- An allowed bulk operation always results in a request being created.
- Approval workflow rules configured for the bulk operation are evaluated.

If rule evaluation results in a workflow ID, then bulk request is created and corresponding SOA workflow is initiated.

If rule evaluation results in no workflow ID, then bulk request is created and it is auto-approved.
- After the bulk request is approved (auto-approved or SOA workflow approval), child requests are created.
- Child requests go through approval workflow rule evaluation (non-bulk), and are processed based on the outcome.

## 4.1.3 About Request Lifecycle

Each request goes through a specific lifecycle after it is created in the system. The lifecycle transits the request through various stages. The stage a request is in determines what action the controller takes in that step, what operations are available on the request at that time, and what the possible stage transitions are.

Request lifecycle is described in the following sections:

- [Various Request Stages](#)
- [Single Request Lifecycle](#)
- [Bulk Request Lifecycle](#)

### 4.1.3.1 Various Request Stages

[Table 4-1](#) describes how a request functions at various stages through its life cycle and how a request attains these stages.

**Table 4-1 Request Stages**

Request Stage	Description
Request Draft Created	<p>After saving the request as a draft by clicking the <b>Save as Draft</b> button on the Cart Details page, the request moves to the Request Draft Created stage.</p> <p>A requester can save a request for modifying, submitting, or deleting it later. This is useful if the requester is awaiting additional information before submitting the request. The draft request cannot be withdrawn or closed.</p> <p><b>Note:</b> The request data saved in draft mode does not include sensitive information such as passwords, even if they were entered before saving the request as draft.</p>
Request Created	<p>After successful submission of the request, the request moves to the Request Created stage.</p>
Provide Information	<p>This is a task assigned to requester (accessible from Inbox) for the entitlement request to search for and select the account for which the entitlement needs to be provisioned.</p>
Request Awaiting Approval	<p>After the request is created, the request moves to the Request Awaiting Approval stage automatically if there are approvals defined for this request. At this stage, the corresponding approvals are initiated through the request service.</p> <p>If a request is withdrawn or closed at this stage, then the request engine calls cancel workflow on each workflow instance. Notifications are sent to approvers about the withdrawn tasks.</p> <p>After the request successfully completes these statuses, it will attain the Request Approved stage.</p> <p>If an SoD validation check is plugged-in after the request has been successfully created, the request is associated with the following statuses.</p> <ul style="list-style-type: none"> <li>• SoD check not initiated           <p>A request attains this stage, if the SoD validation is not initiated for provisioning resource based request. The request engine moves the request to this stage after submission of request and before Obtaining Approval.</p> </li> <li>• SoD check initiated           <p>A request attains this stage, if the SoD validation is initiated asynchronously for provisioning resource based request. The request engine moves the request to this stage after submission of request and before Obtaining Approval.</p> </li> <li>• SoD check completed           <p>A request attains this stage, if the SoD validation is completed for provisioning resource based request. The request engine moves the request to this stage after submission of request and before Obtaining Approval.</p> </li> </ul> <p><b>Note:</b> These SoD request statuses are possible if the request is any of the following request types:</p> <ul style="list-style-type: none"> <li>• Provision Application Instance</li> <li>• Modify Account</li> <li>• Provision Entitlement</li> <li>• Revoke Entitlement</li> <li>• Assign Roles</li> <li>• Remove from Roles</li> </ul>

**Table 4-1 (Cont.) Request Stages**

Request Stage	Description
Request Approved	Only after a request is approved, it moves to the next stage and is updated with the current status. The outcome is Approved, Rejected, or Pending.
Request Auto Approved	Only after a request is approved, it moves to the next stage and is updated with the current status.
Request Rejected	Each time a workflow instance is updated, request service updates the request engine with the current status of that instance. The outcome that the request engine expects from request service is Approved or Rejected. If any of the workflow instances that are instantiated are rejected, then request engine moves the request to Rejected stage. If any workflow instance is rejected, then the controller calls cancel on all the pending workflows and moves the request to Rejected stage.
Operation Initiated	<p>After the request is approved, the request engine moves the request to the Operation Initiated stage and initiates the operation.</p> <p>The following request statuses are associated with this stage:</p> <ul style="list-style-type: none"> <li>• <b>Operation Completed</b> After completing the actual requested operation, the request engine moves the request to the Operation Completed stage. This happens after Operation Initiated status and is associated with Completed stage.</li> <li>• <b>Post Operation Processing Initiated</b> After the actual requested operation is completed, if there exists any additional operation that needs to be executed as post-processing, the request engine moves the request to the Post Operation Processing Initiated stage, before initiating those operations. This happens after Operation Completed status.</li> </ul> <p><b>Note:</b> In case of a bulk operation, child requests are created after request level approval, and the parent request moves to the "Request Awaiting Child Requests Completion" status.</p>
Request Failed	<p>When the associated operations specified in the request fails to execute, the request cancels any pending operations and moves the request to the Request Failed stage.</p> <p>The following request statuses are associated with this stage:</p> <ul style="list-style-type: none"> <li>• <b>Request Failed</b> When all associated operations specified in a request fail, the request is moved to the Request Failed stage.</li> <li>• <b>Request Partially Failed</b> When any associated operation specified in a request fails, the request is moved to the Request Partially Failed stage.</li> </ul>
Request Withdrawn	<p>A request can be withdrawn by the requester. At this stage, the request is associated to the Request Withdrawn status, and the initiation of all approvals are canceled.</p> <p><b>Note:</b></p> <ul style="list-style-type: none"> <li>• A request can be withdrawn before Operation Initiated stage. After the request attains the Operation Initiated stage, the request cannot be withdrawn.</li> <li>• A request saved in draft mode cannot be withdrawn.</li> <li>• A request can always be withdrawn by a requester only, which is done by using Identity Self Service.</li> <li>• An administrator can close requests, which is similar to the withdraw function.</li> </ul>

**Table 4-1 (Cont.) Request Stages**

Request Stage	Description
Request Closed	<p>A request can be closed by the requester. At this stage, the request is associated to the Request Closed status, and the initiation of all approvals are canceled.</p> <p><b>Note:</b></p> <ul style="list-style-type: none"> <li>• A request saved in draft mode cannot be closed.</li> <li>• An administrator can close requests, which is similar to the withdraw function.</li> </ul>
Request Completed	<p>After the execution of all operations specified in the request are completed, the request engine moves the request to the Request Completed stage.</p> <p>The following request statuses are associated with this stage:</p> <ul style="list-style-type: none"> <li>• Request Completed with Errors A request attains this status, when an actual requested operation executes fine, but fails to execute any of the post-processing operations. The Request Completed with Errors stage is associated with the Failed stage.</li> <li>• Request Completed A request attains this status, when an actual requested operation executes fine without any errors.</li> <li>• Request Awaiting Completion When a request is scheduled to be executed on a future date, the request attains Request Awaiting Completion status till the operation is completed on an effective date.</li> </ul>

The successful attainment of a stage also results in the status of the request being updated to the corresponding status.

Operations can be executed manually or automatically by the system in response to an event. Examples of manual operations are:

- Save request as draft
- Edit/update draft request
- Submit request
- Close/cancel (withdraw) request
- Approve request when the service is notified that the approval workflow is successfully approved

Examples of automatic operations are:

- Start approvals when the request is submitted
- Execute request when the request is approved and execution date is in the future or not specified

### 4.1.3.2 Single Request Lifecycle

Any single or non-bulk request goes through a single level of approval. When the approval workflow is invoked, the request moves to the Request Awaiting Approval stage, and it moves to the Request Approved stage after approval, as shown in [Figure 4-2](#).

Figure 4-2 Single Request Lifecycle

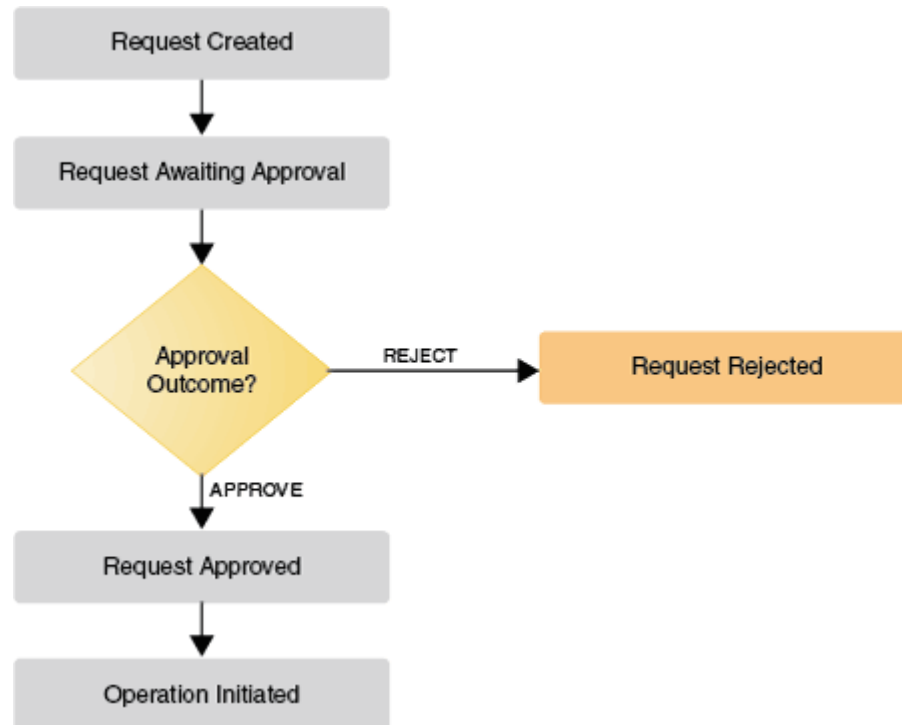

### 4.1.3.3 Bulk Request Lifecycle

The lifecycle of a bulk or parent request is similar to a single or non-bulk request, until the bulk request goes to the `Request Approved` stage. After that, it is split into child requests, and then it moves to the `Request Awaiting Child Requests Completion` status of the `Operation initiated` stage, as shown in [Figure 4-3](#).

Figure 4-3 Bulk Request Lifecycle

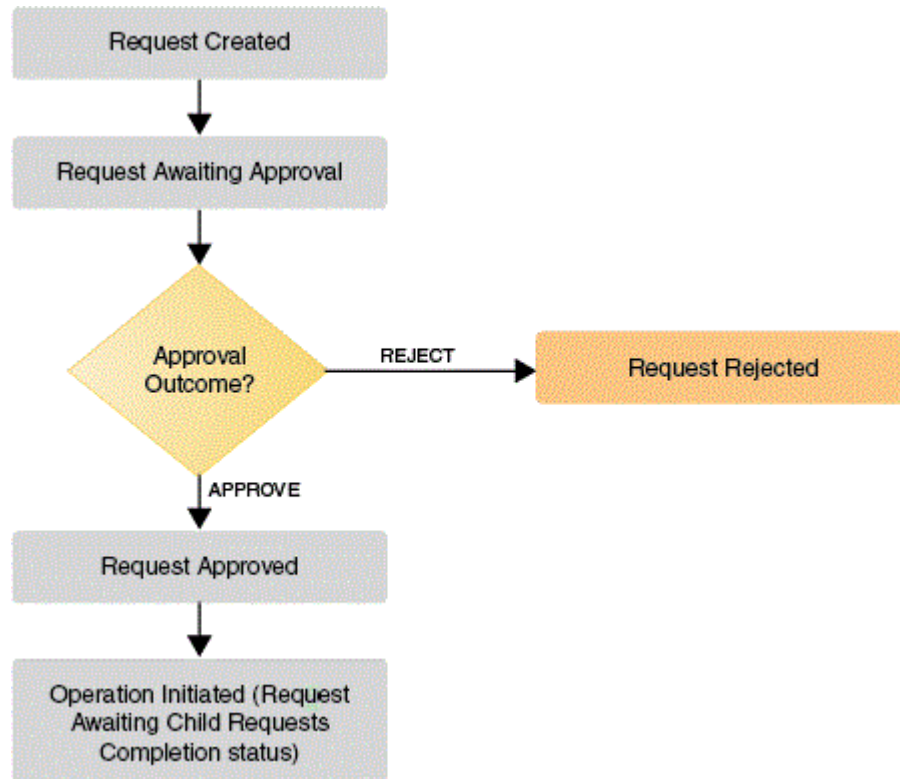

Each child request goes through the lifecycle described in "[Single Request Lifecycle](#)". After the child requests are completed, the bulk or parent request moves to the `Request Completed` stage.

## 4.2 Configuring Approval Workflow Rules

Configuring approval workflow rules involve understanding workflow rules, rule conditions, and system-defined operations and rules; and creating approval workflow rules, configuring custom rule conditions, modifying approval workflow rules, deleting approval workflow rules, and understanding approval workflow rule evaluation.

This sections describes about configuring approval workflow rules in the following topics:

- [About Approval Workflow Rules](#)
- [About Rule Conditions](#)
- [About System-Defined Operations and Rules](#)
- [Creating Approval Workflow Rules](#)
- [About Custom Rule Conditions](#)
- [Modifying Approval Workflow Rules](#)
- [Deleting Approval Workflow Rules](#)
- [About Approval Workflow Rule Evaluation](#)

## 4.2.1 About Approval Workflow Rules

Approval workflow rules can be configured to determine whether an operation requires approval or not. In addition, if approval is required, then the rule also indicates which SOA workflow is to be initiated.

A list of operations and corresponding workflow rules are predefined in Oracle Identity Manager. These system-defined rules determine whether or not approvals are required and the SOA workflow to be initiated. All the non-bulk operations have pre-defined approval workflow rules configured.

For a list of supported operations and corresponding rules, see "[About System-Defined Operations and Rules](#)".

**Note:**

Oracle Identity Manager does not allow you to create new operations and corresponding rules. However, you can create and modify rules for the existing operations.

Approval workflow rules can be configured for all the supported operations, which are:

- Self-Register User
- Create User
- Modify User
- Disable User
- Enable User
- Delete User
- Create Role
- Modify Role
- Delete Role
- Assign Roles
- Remove from Roles
- Modify Role Grant
- Provision Application Instance
- Modify Account
- Disable Account
- Enable Account
- Revoke Account
- Provision Entitlement
- Modify Entitlement
- Revoke Entitlement
- Heterogeneous Request



- Bulk Modify User Profile
- Bulk Disable User
- Bulk Enable User
- Bulk Delete User
- Bulk Delete Role
- Bulk Assign Roles
- Bulk Remove from Roles
- Bulk Provision Application Instance
- Bulk Disable Account
- Bulk Enable Account
- Bulk Revoke Account
- Bulk Provision Entitlement
- Bulk Revoke Entitlement

## 4.2.2 About Rule Conditions

An approval workflow rule consists of rule condition and outcome.

An approval workflow rule consists of:

- **Condition:** Rule condition based on the allowed inputs defined at the operation level
- **Outcome:** Workflow ID, which is the SOA workflow ID to be initiated for the operation

The following is an example of an approval workflow rule for the Modify User operation:

Rule condition:

```
requester.adminroles CONTAINS OrclOIMUserAdmin
```

Rule Outcome:

```
Direct
```

Here, the rule condition checks if the requester is a member of the User Administrator admin role in the beneficiary's organization. If the condition is satisfied, then operation is performed without initiating any approval workflow.

The rule conditions vary from operation to operation. For example, user data is required along with requester data for a Create User operation, and role information and user data is required along with requester data for an Assign Role operation. Requester data is required for all operations. Oracle Identity System Administration enables you to enter the required role conditions based on the operation that you select.

Each approval workflow can have multiple rules associated with it, which must be defined in a certain order. For example, the Create User approval workflow can have rules, such as Create Contractor, Create Supplier, and Create Partner, defined in a sequence. The order in which the rules in an approval workflow are evaluated depends on the order or sequence in which the rules are defined in the policy.

See "[About Custom Rule Conditions](#)" for examples of rule conditions for each operation.

## 4.2.3 About System-Defined Operations and Rules

Each operation/workflow policy has a default rule, whose outcome is DIRECT. This means that if the default rule condition evaluates to true for an operation, then it is a direct operation without approvals.

Table 4-2 lists the system-defined operations and corresponding workflow rules, for which the outcome is DIRECT.



**Note:**

The rules in Table 4-2 are only for backward compatibility. You must remove these and create your own rules.

**Table 4-2 Operations and Rules**

Operation	Rule Name	Rule condition
Assign Roles	Assign Roles Default Rule	requester.adminroles CONTAINS OrclOIMRoleAuthorizer OR requester.adminroles CONTAINS OrclOIMUserAdmin OR requester.adminroles CONTAINS OrclOIMSystemAdministrator
Create Role	Create Role Default Rule	requester.adminroles CONTAINS OrclOIMRoleAdministrator OR requester.adminroles CONTAINS OrclOIMSystemAdministrator
Create User	Create User Default Rule	requester.adminroles CONTAINS OrclOIMUserAdmin OR requester.adminroles CONTAINS OrclOIMSystemAdministrator
Delete Role	Delete Role Default Rule	requester.adminroles CONTAINS OrclOIMRoleAdministrator OR requester.adminroles CONTAINS OrclOIMSystemAdministrator
Delete User	Delete User Default Rule	requester.adminroles CONTAINS OrclOIMUserAdmin OR requester.adminroles CONTAINS OrclOIMSystemAdministrator
Disable Account	Disable Account Default Rule	requester.adminroles CONTAINS OrclOIMApplicationInstanceAuthorizerRole OR requester.adminroles CONTAINS OrclOIMUserAdmin OR requester.adminroles CONTAINS OrclOIMSystemAdministrator
Disable User	Disable User Default Rule	requester.adminroles CONTAINS OrclOIMUserAdmin OR requester.adminroles CONTAINS OrclOIMSystemAdministrator
Enable Account	Enable Account Default Rule	requester.adminroles CONTAINS OrclOIMApplicationInstanceAuthorizerRole OR requester.adminroles CONTAINS OrclOIMUserAdmin OR requester.adminroles CONTAINS OrclOIMSystemAdministrator
Enable User	Enable User Default Rule	requester.adminroles CONTAINS OrclOIMUserAdmin OR requester.adminroles CONTAINS OrclOIMSystemAdministrator
Modify Account	Modify Account Default Rule	requester.adminroles CONTAINS OrclOIMApplicationInstanceAuthorizerRole OR requester.adminroles CONTAINS OrclOIMUserAdmin OR requester.adminroles CONTAINS OrclOIMSystemAdministrator
Modify Entitlement	Modify Entitlement Default Rule	requester.adminroles CONTAINS OrclOIMEntitlementAuthorizer OR requester.adminroles CONTAINS OrclOIMUserAdmin OR requester.adminroles CONTAINS OrclOIMSystemAdministrator
Modify Role	Modify Role Default Rule	requester.adminroles CONTAINS OrclOIMRoleAdministrator OR requester.adminroles CONTAINS OrclOIMSystemAdministrator

**Table 4-2 (Cont.) Operations and Rules**

Operation	Rule Name	Rule condition
Modify User Profile	Modify User Profile Default Rule	requester.adminroles CONTAINS OrclOIMUserAdmin OR requester.adminroles CONTAINS OrclOIMSystemAdministrator
Provision Application Instance	Provision ApplicationInstance Default Rule	requester.adminroles CONTAINS OrclOIMApplicationInstanceAuthorizerRole OR requester.adminroles CONTAINS OrclOIMUserAdmin OR requester.adminroles CONTAINS OrclOIMSystemAdministrator
Provision Entitlement	Provision Entitlement Default Rule	requester.adminroles CONTAINS OrclOIMEntitlementAuthorizer OR requester.adminroles CONTAINS OrclOIMUserAdmin OR requester.adminroles CONTAINS OrclOIMSystemAdministrator
Remove from Roles	Remove from Roles Default Rule	requester.adminroles CONTAINS OrclOIMRoleAuthorizer OR requester.adminroles CONTAINS OrclOIMUserAdmin OR requester.adminroles CONTAINS OrclOIMSystemAdministrator
Revoke Account	Revoke Account Default Rule	requester.adminroles CONTAINS OrclOIMApplicationInstanceAuthorizerRole OR requester.adminroles CONTAINS OrclOIMUserAdmin OR requester.adminroles CONTAINS OrclOIMSystemAdministrator
Revoke Entitlement	Revoke Entitlement Default Rule	requester.adminroles CONTAINS OrclOIMEntitlementAuthorizer OR requester.adminroles CONTAINS OrclOIMUserAdmin OR requester.adminroles CONTAINS OrclOIMSystemAdministrator
Modify Role Grant	Modify Role Grant Default Rule	requester.adminroles CONTAINS OrclOIMRoleAuthorizer OR requester.adminroles CONTAINS OrclOIMUserAdmin OR requester.adminroles CONTAINS OrclOIMSystemAdministrator

In addition, there are a few other system-defined rules that support compliance use cases, which include role lifecycle, identity auditor, and certification, as listed in [Table 4-3](#).

**Table 4-3 Rules for Compliance Use Cases**

Operation	Rule Name	Rule Condition	Rule Outcome
Assign Roles	Assign Roles IdentityAuditorEnabled Rule	identityAuditEnabled EQUAL TRUE	Workflow default/DefaultOperationalApproval!5.0
Create Role	Create Role IdentityAuditorEnabled Rule	identityAuditEnabled Equal TRUE	Workflow default/RoleLCMAApproval!1.0
Delete Role	Delete Role IdentityAuditorEnabled Rule	identityAuditEnabled Equal TRUE	Workflow default/RoleLCMAApproval!1.0
Disable User	Disable User Certification Rule	request.isCertification Equal true	Workflow default/DefaultRequestApproval!6.0
Modify Role	Modify Role IdentityAuditorEnabled Rule	identityAuditEnabled Equal TRUE	Workflow default/RoleLCMAApproval!1.0
Remove from Roles	Remove from Roles IdentityAuditorEnabled Rule	identityAuditEnabled Equal TRUE	Workflow default/DefaultOperationalApproval!5.0

Table 4-3 (Cont.) Rules for Compliance Use Cases

Operation	Rule Name	Rule Condition	Rule Outcome
Remove from Roles	Remove from Roles Certification Rule	request.isCertification Equal TRUE	Workflow default/DefaultRequestApproval!6.0
Revoke Account	Revoke Account Certification Rule	request.isCertification Equal TRUE	Workflow default/DefaultRequestApproval!6.0
Revoke Entitlement	Revoke Entitlement Certification Rule	request.isCertification Equal TRUE	Workflow default/DefaultRequestApproval!6.0
Modify Role Grant	Modify Role Grant IdentityAuditorEnabled Rule	identityAuditorEnabled EQUAL TRUE	Workflow default/DefaultOperationalApproval!5.0

 **See Also:**

Table 4-4 for information about the `request.isCertification` and `identityAuditorEnabled` conditions.

 **Note:**

The workflow rules listed in Table 4-3 are configured ahead (in terms of order) of the default rules listed in Table 4-2. Therefore, these rules would be evaluated before the default rules. See "About Approval Workflow Rule Evaluation" for more information about workflow rule evaluation.

For example, the Assign Roles operation has two rules configured by default in the following order:

1. Assign Roles IdentityAuditorEnabled Rule
2. Assign Roles Default Rule

To determine the approval workflow to be initiated for an Assign Roles operation, the Assign Roles IdentityAuditorEnabled Rule rule is evaluated first. If the rule does not match (evaluates to true), then Assign Roles Default Rule is evaluated.

## 4.2.4 Creating Approval Workflow Rules

Approval workflow rules are configured to determine whether an operation requires approval or not. In addition, if approval is required, then the rule also indicates which SOA workflow is to be initiated.

To create an approval workflow rule:

1. Login to Oracle Identity System Administration.

2. On the left navigation pane, under Workflows, click **Approval**. The Approval Workflow Configuration page is displayed.
3. In the Select an Operation to configure rules section, select an operation to configure rules for the operation. The rules associated with the operation are displayed in the Rules section at the bottom of the page. This section displays the rule name, rule description, and the workflow associated with the operation.

In the Rules section, you can create a new rule, or select an existing rule and update or delete it.

 **Note:**

When multiple rule conditions are specified in an approval workflow policy, the order in which rules are evaluated is based on the order in which they are configured in the policy. The order cannot be changed after the rules have been created. Therefore, the rules must be created in the order in which you want them to be evaluated.

4. In the Rules section, click **Create**. The Create Rule page is displayed.
5. In the Name box, enter a name for the rule. This is a mandatory field.
6. In the Description box, enter a description for the rule.
7. In the Owner box, specify a owner of the rule. To do so, click the search icon adjacent to the Owner field, and then search and select a owner.
8. From the Status list, select a status for the rule. By default, the rule is in Enabled status.
9. In the Condition Builder section, specify the rule conditions in the IF and THEN clauses. To do so, perform the following steps to create a sample rule condition in which if the user is a member of the Top organization, then the Create User operation will be auto-approved:
  - a. Under the IF clause, in the first field of the empty row, to specify an object and attribute, click the search icon adjacent to the field. The Condition Builder dialog box is displayed.

 **Note:**

If you are aware of the exact object and attribute name, then you can enter the condition in the first field, for example `requester.Organization Name`, instead of clicking the search icon.

- b. Click **requester** because you want to specify the condition based on requester data. A list of attributes is displayed that you can specify for the requester object. You can navigate through the attributes by clicking the page number icons and select it. Otherwise, enter the attribute name in the search field and click the search icon.

 **Note:**

From any screen of the Condition Builder dialog box, you can click **Start** to come back to the first screen in which you can start specifying a fresh condition by selecting the object.

- c. Click the Organization Name attribute. The condition `requester.Organization Name` is displayed in the Condition Builder dialog box.
- d. Click **OK**. The condition is added to the first field in the IF clause.
- e. From the Operator list, select **Equal**.

The following operators are available for selection:

- EQUAL
- NOT\_EQUAL
- CONTAINS
- DOES\_NOT\_CONTAIN
- BEGINS\_WITH
- DOES\_NOT\_BEGIN\_WITH
- ENDS\_WITH
- DOES\_NOT\_END\_WITH

- f. To specify the value in the field on the right side, click the search icon. The Condition Builder dialog box is displayed.

 **Note:**

If you are aware of the exact value, then you can enter the value, for example `Top`, instead of clicking the search icon.

- g. Select any one of the following options:
  - **Value:** To specify the value of an attribute.
  - **Expression:** To specify the condition based on an expression.

For the purpose of this example, select the **Value** option. The values for the Organization Name attribute are listed. This is because the object and attribute specified in the rule is `requester.Organization Name`.

- h. Click **Top**. The Top organization is selected.
- i. Click **OK**. The Top organization is populated in the value field.
- j. To add another condition, click **Add Condition**. Another row is added under the IF clause. From the operator list on the right, you can select the **AND** or **OR** operator, and enter another rule condition as described in steps a through i.

To remove a row, you can select the check box to the left of the row, and click **Remove**.

- k. If you have added multiple rule conditions, then you can group the conditions together. To do so, select the check boxes to the left of the conditions, and click **Group**. Similarly, to remove the grouping of the conditions, select the check boxes to the left of the conditions, and click **Ungroup**.

 **Note:**

- You can group only two conditions at a time. If you select more than two conditions, then the **Group** button is disabled. Alternatively, the **Ungroup** button is enabled only when you select one of the conditions that is grouped, but it is disabled when you select more than one group.
- A maximum of two conditions can be grouped together. Therefore, if you create a rule with four conditions that are grouped together with the AND operator, then the conditions are grouped into two sets. But if one of the conditions are grouped with the OR operator, then rule is updated correctly.

- l. In the THEN clause, click the search icon adjacent to the first field to open the Condition Builder dialog box.
- m. Select **workflow** and click **OK**.
- n. In the value field for workflow, select **AutoApproval!1.0**. The request will be auto-approved if you select this workflow.
- o. Click **OK**. The workflow value is populated in the value field.

Therefore, the rule condition you specified is the following:

```
IF
requester.Organization Name EQUALS Top

THEN
workflow default/AutoApproval!1.0
```

10. Click **Create** to create the rule condition. The rule condition is displayed in the table when you select the Operation for which it is created.

 **Note:**

- When Risk attributes are used to define the conditions in a rule, for the rule to be evaluated correctly, the Risk Aggregation Job scheduled job must be run before the request is made.
- For application instances, there is no mechanism to filter out the attributes. All the attributes for application instances are displayed in the Condition Builder with which a rule can be written. For roles, select the role name to display the list of attributes for the role entities. You can select the asterisk (\*) wildcard character to display the list of attributes.

See "[About Custom Rule Conditions](#)" for examples of rule conditions for each workflow operation.



**Note:**

In this release, while creating a workflow rule, use `User Type` instead of `Role`. For example, in the following rule condition, `user.User Type` is used instead of `user.Role`:

```
IF user.User Type=Contractor
THEN capability=selfModifyUser
```

## 4.2.5 About Custom Rule Conditions

Custom rule conditions have a syntax that consist of operation and the corresponding top-level attribute for the condition.

Table 4-4 describes how to specify custom rule conditions with examples.

**Table 4-4 Approval Workflow Rule Syntax and Examples**

Operation	Top-Level Attribute for Condition	Creating Workflow Rule Conditions (based on top-level attribute)
All operations including bulk	operation	<p>This refers to the operation being performed currently, for example:</p> <pre>operation EQUALS Create User</pre> <p><b>Note:</b> Such a condition can be used where the desired outcome is always true.</p>
All operations including bulk and excluding self-register user	requester	<p>This refers to the user profile attributes, roles, and admin role memberships of all the requesters. For example:</p> <pre>requester.Email CONTAINS @example.com requester.adminRoles CONTAINS OrclOIMUserAdmin</pre> <p>This condition means if requester's email ID contains example.com, and requester is a member of OrclOIMUserAdmin admin role.</p>
Create User	user	<p>This refers to all the user entity attributes, which can be specified by the requester while creating a user. For example:</p> <pre>user.Last Name EQUALS Doe</pre>
Modify User	user	<p>This refers to all the user entity attributes of the user being modified, which can be specified by the requester while modifying a user. For example:</p> <pre>user.Organization EQUALS Marketing</pre>
Disable User, Enable User, Delete User	user	<p>This refers to all the user attributes of the user being disabled, enabled, or deleted, which are currently set in the user's profile. For example:</p> <pre>existingUser.Organization EQUALS Marketing</pre>



**Table 4-4 (Cont.) Approval Workflow Rule Syntax and Examples**

Operation	Top-Level Attribute for Condition	Creating Workflow Rule Conditions (based on top-level attribute)
Disable User, Enable User, Delete User	request	<p>This refers to the request metadata, and the only allowed subattribute is <code>isCertification</code>. The only allowed values are <code>true</code> and <code>false</code>, which must be entered manually. This can be used to check if the current operation/request is a certification request. For example:</p> <pre>request.isCertification EQUAL true</pre> <p><b>Note:</b> <code>request.isCertification</code> is used within default rules. It is not recommended to create custom conditions using <code>request.isCertification</code>.</p>
Create Role	role	<p>This refers to all the role entity attributes, which can be specified while creating a role. For example:</p> <pre>role.Name EQUALS ITAdmin</pre> <p>Because catalog metadata attributes can also be specified while creating the role, conditions are allowed based on catalog metadata attributes as well. For example:</p> <pre>role.catalog.Category EQUAL Role</pre>
Create Role	identityAuditEnabled	<p>This can be used to create condition based on the value of the <code>OIG.IsIdentityAuditorEnabled</code> system property. The only allowed values are <code>TRUE</code> and <code>FALSE</code>, which must be entered manually. For example:</p> <pre>identityAuditEnabled EQUALS TRUE</pre> <p><b>Note:</b> <code>identityAuditEnabled</code> is used within default rules. It is not recommended to create custom conditions using <code>identityAuditEnabled</code>.</p>
Modify Role	role	<p>This refers to all the role entity attributes, which can be specified while modifying a role. For example:</p> <pre>role.Name EQUAL ITAdmin</pre> <p>Because catalog metadata attributes can also be specified while modifying the role, conditions are allowed based on catalog metadata attributes as well. For example:</p> <pre>role.catalog.Category EQUAL Role</pre>
Modify Role	existingRole	<p>This refers to all the role entity attributes, which are currently set for the role being modified. For example:</p> <pre>existingRole.DisplayName EQUALS IT Administrator</pre> <p>Because catalog metadata attributes can also be specified while modifying the role, conditions are allowed based on catalog metadata attributes as well. For example:</p> <pre>role.catalog.Category EQUAL Role</pre>

**Table 4-4 (Cont.) Approval Workflow Rule Syntax and Examples**

Operation	Top-Level Attribute for Condition	Creating Workflow Rule Conditions (based on top-level attribute)
Modify Role	identityAuditEnabled	<p>This can be used to create condition based on the value of the <code>OIG.IsIdentityAuditorEnabled</code> system property. The only allowed values are TRUE and FALSE, which must be entered manually. For example:</p> <pre>identityAuditEnabled EQUALS TRUE</pre> <p><b>Note:</b> <code>identityAuditEnabled</code> is used within default rules. It is not recommended to create custom conditions using <code>identityAuditEnabled</code>.</p>
Delete Role	existingRole	<p>This refers to all role entity attributes, which are currently set for the role being deleted. For example:</p> <pre>existingRole.DisplayName EQUALS IT Administrator</pre>
Delete Role	identityAuditEnabled	<p>This can be used to create condition based on the value of the <code>OIG.IsIdentityAuditorEnabled</code> system property. The only allowed values are TRUE and FALSE, which must be entered manually. For example:</p> <pre>identityAuditEnabled EQUALS TRUE</pre> <p><b>Note:</b> <code>identityAuditEnabled</code> is used within default rules. It is not recommended to create custom conditions using <code>identityAuditEnabled</code>.</p>
Assign Roles, Remove from Roles	user	<p>This refers to all user attributes, which are currently set in the profile for the user/beneficiary who is being assigned a role or whose role membership is being revoked. For example:</p> <pre>user.Organization EQUALS Marketing</pre>
Assign Roles, Remove from Roles	role	<p>This refers to all attributes of the role, which is being assigned to or revoked from a user. For example:</p> <pre>role.name EQUAL IT Administrator</pre>
Assign Roles, Remove from Roles	catalogItem	<p>This refers to catalog metadata attributes corresponding to the role for which the access request is being submitted. For example:</p> <pre>catalogItem.Category EQUAL Role</pre>
Assign Roles, Remove from Roles	identityAuditEnabled	<p>This can be used to create condition based on the value of the <code>OIG.IsIdentityAuditorEnabled</code> system property. The only allowed values are TRUE and FALSE, which must be entered manually. For example:</p> <pre>identityAuditEnabled EQUALS TRUE</pre> <p><b>Note:</b> <code>identityAuditEnabled</code> is used within default rules. It is not recommended to create custom conditions using <code>identityAuditEnabled</code>.</p>

**Table 4-4 (Cont.) Approval Workflow Rule Syntax and Examples**

Operation	Top-Level Attribute for Condition	Creating Workflow Rule Conditions (based on top-level attribute)
Assign Roles, Remove from Roles	request	<p>This refers to the request metadata, and the only allowed sub-attribute is <code>isCertification</code>. The only allowed values are <code>true</code> and <code>false</code>, which must be entered manually. This can be used to check if the current operation/request is a certification request. For example:</p> <pre>request.isCertification EQUAL true</pre> <p><b>Note:</b> <code>request.isCertification</code> is used within default rules. It is not recommended to create custom conditions using <code>request.isCertification</code>.</p>
Modify Role Grant	user	<p>This refers to user attributes, which are currently set in the profile for the user/beneficiary whose role membership is being modified. For example:</p> <pre>user.Organization EQUALS Marketing</pre>
Modify Role Grant	role	<p>This refers to attributes of the role whose membership is being modified. For example:</p> <pre>role.name EQUALS IT Administrator</pre>
Modify Role Grant	catalogItem	<p>This refers to catalog metadata attributes corresponding to the role for which the access request is being submitted. For example:</p> <pre>catalogItem.Category EQUAL Role</pre>
Modify Role Grant	identityAuditEnabled	<p>This can be used to create condition based on the value of the <code>OIG.IsIdentityAuditorEnabled</code> system property. The only allowed values are <code>TRUE</code> and <code>FALSE</code>, which must be entered manually. For example:</p> <pre>identityAuditEnabled EQUALS TRUE</pre> <p><b>Note:</b> <code>identityAuditEnabled</code> is used within default rules. It is not recommended to create custom conditions using <code>identityAuditEnabled</code>.</p>
Provision ApplicationInstance	user	<p>This refers to the user profile attributes of the user/beneficiary to whom the account is being provisioned. For example:</p> <pre>user.Organization EQUALS Marketing</pre>

**Table 4-4 (Cont.) Approval Workflow Rule Syntax and Examples**

Operation	Top-Level Attribute for Condition	Creating Workflow Rule Conditions (based on top-level attribute)
Provision ApplicationInstance	appType	<p>This refers to the account which is being provisioned to a user/beneficiary.</p> <p>appType is a top-level attribute that can lead to a hierarchy of sub-attributes, such as appInstance, followed by account, and optionally followed by account-specific child tables or entitlements. Further, account can be followed by the parent form attributes, and child table or entitlement can be followed by their specific attributes.</p> <p><b>Example 1:</b></p> <pre>appType[AD User].appInstance[VisionEmployeesDomain].account[*].Organization Name EQUAL Marketing</pre> <p>This condition means that if an account is being created in the VisionEmployeesDomain appInstance within the Marketing organization.</p> <p><b>Note:</b> Workflow rule evaluation only considers the account that is being requested and does not consider any of the existing accounts that the user/beneficiary might have.</p> <p><b>Example 2:</b></p> <pre>appType[AD User].appInstance[*].account[*].Organization Name EQUAL Marketing</pre> <p>This condition means that if an account is being created in any appInstance pertaining to the AD User target within the Marketing organization.</p>
Provision ApplicationInstance	catalogItem	<p>This refers to catalog metadata attributes set in the catalog item for which the access request is being submitted, for example catalogItem.</p>
Modify Account	user	<p>This refers to user profile attributes of the user/beneficiary whose account is being modified. For example:</p> <pre>user.Organization EQUALS Marketing</pre>
Modify Account	appType	<p>This refers to the account information that is being modified as part of this operation. For example:</p> <pre>existingAppType[AD User].appInstance[*].account[*].Organization Name EQUAL Manufacturing</pre> <p>This condition means that if the user account on any of the AD User targets is being transferred to the Manufacturing organization.</p>

**Table 4-4 (Cont.) Approval Workflow Rule Syntax and Examples**

Operation	Top-Level Attribute for Condition	Creating Workflow Rule Conditions (based on top-level attribute)
Modify Account	existingAppType	<p>This refers to current or existing user account information, which is being modified as part of this operation. For example:</p> <pre>appType[AD User].appInstance[*].account[*].Organization Name EQUAL Marketing</pre> <p>This condition means that if the user account on any of the AD User targets is being transferred from the Marketing organization to some other organization.</p> <p><b>Note:</b> Workflow rule evaluation only considers the account that is being modified and does not consider any of the existing accounts that the user/beneficiary might have.</p>
Modify Account	catalogItem	<p>This refers to the catalog metadata attributes set in the catalog item for which the access request is being submitted. For example:</p> <pre>catalogItem.Category EQUALS Role</pre>
Enable Account, Disable Account, Revoke Account	user	<p>This refers to the user profile attributes of the user/beneficiary whose account is being enabled/disabled/revoked. For example:</p> <pre>user.Organization EQUALS Marketing</pre>
Enable Account, Disable Account, Revoke Account	existingAppType	<p>This refers to current or existing user account information, which is being disabled/enabled/revoked as part of this operation. For example:</p> <pre>existingAppType[AD User].appInstance[*].account[*].Organization Name EQUAL Marketing</pre> <p>This condition means that if the user account being disabled/enabled/revoked belongs to the Marketing Organization of any of the AD User targets.</p> <p><b>Note:</b> Workflow rule evaluation only considers the account which is being disabled/enabled/revoked and does not consider any of the existing accounts that the user/beneficiary might have.</p>
Enable Account, Disable Account, Revoke Account	catalogItem	<p>This refers to catalog metadata attributes set in the catalog item for which the access request is being submitted, for example</p> <pre>catalogItem.</pre>
Enable Account, Disable Account, Revoke Account	request	<p>This refers to the request metadata, and the only allowed sub-attribute is <code>isCertification</code>. The only allowed values are <code>true</code> and <code>false</code>, which must be entered manually. This can be used to check if the current operation/request is a certification request. For example:</p> <pre>request.isCertification EQUAL true</pre> <p><b>Note:</b> <code>request.isCertification</code> is used within default rules. It is not recommended to create custom conditions using <code>request.isCertification</code>.</p>
Provision Entitlement	user	<p>This refers to user profile attributes of the user/beneficiary to whom the entitlement is being provisioned. For example:</p> <pre>user.Organization EQUALS Marketing</pre>

**Table 4-4 (Cont.) Approval Workflow Rule Syntax and Examples**

Operation	Top-Level Attribute for Condition	Creating Workflow Rule Conditions (based on top-level attribute)
Provision Entitlement	appType	<p>This refers to the entitlement information or the data that is being specified while performing the operation. For example:</p> <pre>appType[AD User].appInstance[VisionEmployeesDomain].account [*].UD_ADUSRC[*].Group Name EQUAL PasswordPolicyAdminGrp</pre> <p>This condition means that if the PasswordPolicyAdminGrp entitlement is being granted to the user/beneficiary on VisionEmployeesDomain application instance.</p>
Provision Entitlement	catalogItem	<p>This refers to the catalog metadata attributes set in the catalog item for which the access request is being submitted, for example, catalogItem.</p>
Modify Entitlement	user	<p>This refers to the user profile attributes of the user/beneficiary whose entitlement grant is being modified. For example:</p> <pre>user.Organization EQUALS Marketing</pre>
Modify Entitlement	appType	<p>This refers to the entitlement information or the data that is being specified while performing the operation. For example:</p> <pre>appType[AD User].appInstance[VisionEmployeesDomain].account [*].UD_ADUSRC[*].Group Name EQUAL PasswordPolicyAdminGrp</pre> <p>This condition means that if PasswordPolicyAdminGrp entitlement grant is being modified for the user/beneficiary on VisionEmployeesDomain application instance.</p>
Modify Entitlement	existingAppType	<p>This refers to the entitlement information or the existing entitlement form data, such as start date and end date. For example:</p> <pre>existingAppType[AD User].appInstance[VisionEmployeesDomain].account [*].UD_ADUSRC[*].Group Name EQUAL PasswordPolicyAdminGrp</pre> <p>This condition means that if PasswordPolicyAdminGrp entitlement grant is being modified for the user/beneficiary on VisionEmployeesDomain application instance.</p>
Modify Entitlement	catalogItem	<p>This refers to the catalog metadata attributes set in the catalog item for which the access request is being submitted, for example catalogItem.</p>
Revoke Entitlement	user	<p>User profile attributes of the user/beneficiary whose entitlement grant is being revoked. For example:</p> <pre>user.Organization EQUALS Marketing</pre>

Table 4-4 (Cont.) Approval Workflow Rule Syntax and Examples

Operation	Top-Level Attribute for Condition	Creating Workflow Rule Conditions (based on top-level attribute)
Revoke Entitlement	existingAppType	<p>This refers to the entitlement information or the existing entitlement form data, such as start date and end date. For example:</p> <pre>existingAppType[AD User].appInstance[VisionEmployeesDomain].account [*].UD_ADUSRC[*].Group Name EQUAL PasswordPolicyAdminGrp</pre> <p>This condition means that if PasswordPolicyAdminGrp entitlement grant is being modified for the user/beneficiary on VisionEmployeesDomain application instance.</p>
Revoke Entitlement	catalogItem	<p>This refers to the catalog metadata attributes set in the catalog item for which the access request is being submitted, for example catalogItem.</p>
Revoke Entitlement	request	<p>This refers to the request metadata, and the only allowed sub-attribute is isCertification. The only allowed values are true and false, which must be entered manually. This can be used to check if the current operation/request is a certification request. For example:</p> <pre>request.isCertification EQUAL true</pre> <p><b>Note:</b> request.isCertification is used within default rules. It is not recommended to create custom conditions using request.isCertification.</p>

## 4.2.6 Modifying Approval Workflow Rules

You can modify workflow rules to add, modify, or remove the rule conditions.

To modify the workflow rule that you added in "[Creating Approval Workflow Rules](#)":

1. On the left navigation pane of Identity System Administration, under Workflows, click **Approval**. The Approval Workflow Configuration page is displayed.
2. In the Operation section, select an operation to configure rules for the operation.
3. In the Rules section, click **Edit**. The Edit Rule page is displayed.
4. In the Operation section, search and select the operation for which you want to modify the workflow rule. For the purpose of this example, select **Create User**. The rules for the Create User operation is displayed in a table in the Rules section.
5. In the Rules section, select the rule that you want to edit, and click **Edit**. The Edit Rule page is displayed.
6. If you want to modify any rule attribute, then update the attribute values in the Edit Rule section.
7. In the Condition Builder section, you can modify an existing rule by modifying the object, attribute, or value fields. You can also add conditions to the existing ones, or remove rule conditions. Perform the following steps to add a rule condition that specifies that if the requester has the UserHelpDesk admin role, then the target user manager's approval is required for the Create User Operation:
  - a. In the Condition Builder section, click **Add Condition**. A new row is added.
  - b. From the operators list on the right, select **OR**.

- c. In the first field of the row, specify `requester.adminRole` by using the Condition Builder dialog box. See step 10 of "[Creating Approval Workflow Rules](#)" for information about selecting values in the Condition Builder dialog box.
- d. From the operators list, select **CONTAINS**.
- e. In the value field, select `OrclOIMUserHelpDesk` by using the Condition Builder dialog box.
- f. In the THEN section, specify workflow and default/BeneficiaryManagerApproval!4.0 in the two fields respectively. Therefore, the complete rule condition is:

```
IF
requester.adminRoles CONTAINS OrclOIMUserHelpDesk

THEN
workflow default/BeneficiaryManagerApproval!4.0
```

This rule condition will ensure that if the requester has the UserHelpDesk admin role, then the target user manager's approval is required for creating the user.

8. Click **Update**. The workflow rule is updated with the new rule condition.
9. To remove a rule condition, select the check box to the left of the rule condition row, and click **Remove**. Then, click **Update**.

## 4.2.7 Deleting Approval Workflow Rules

You can delete the workflow rules that you define for all the operations. However, it is recommended that the default rules are not deleted.

To delete a workflow rule:

1. On the left navigation pane of Identity System Administration, under Workflows, click **Approval**. The Approval Workflow Configuration page is displayed.
2. In the Operation section, select an operation whose workflow rule you want to delete.
3. In the Rules section, click **Delete**. A message box is displayed asking for confirmation.
4. Click **Yes**.

## 4.2.8 About Approval Workflow Rule Evaluation

Understand the approval workflow rule evaluation for bulk and non-bulk operations.

When an operation (bulk or non-bulk) is being performed, approval workflow rule evaluation takes place in the following way:

1. The approval workflow rules associated with the operation being performed are evaluated one by one, in the order in which they are configured.
2. Rule evaluation stops, and the outcome, which is workflowID or Direct, of the matched rule is returned.

Approval workflow rule evaluation stops at the first matching rule, which is the rule that evaluates to true, and that rule's outcome is returned as the result.

3. For a Bulk operation, if none of the rules match, then the SOA composite configured in `defaultRequestApprovalComposite` of `SOAConfig` is returned implicitly.
4. For a non-bulk operation, if none of the rules match, then the SOA composite configured in `defaultOperationApprovalComposite` of `SOAConfig` is returned implicitly.



If the approval workflow rule evaluation returns a WorkflowID, for example `UserManagerApproval`, then a request is created and the corresponding ASYNC orchestration is initiated. As part of the orchestration, there is a possibility that some of the data submitted by the user is modified or added. As a result, a different workflow ID than `UserManagerApproval` might be applicable. To handle such scenarios, approval workflow rules are re-evaluated before the workflow is initiated. If the re-evaluation results in a different workflowID, for example `HRManagerApproval`, then `HRManagerApproval` is initiated.

## 4.3 Managing Request Approval in an Upgraded Deployment of Oracle Identity Governance

Managing request approvals in an upgraded deployment involves understanding request approval process in an upgraded deployment, request process flow with disabled workflow rules, migrating approval policies, and enabling workflow rules.

This section describes about managing request approvals in an upgraded deployment of Oracle Identity Governance in the following topics:

- [About Request Approval in an Upgraded Deployment of Oracle Identity Governance](#)
- [About Request Process Flow With Approval Workflow Rules Disabled](#)
- [Migrating Approval Policies to Approval Workflow Rules](#)
- [Enabling Approval Workflow Rules](#)

### 4.3.1 About Request Approval in an Upgraded Deployment of Oracle Identity Governance

In an upgraded deployment of Oracle Identity Manager, the approval workflow rules feature is disabled by default.

As a result, the following occurs when an operation is initiated:

- Authorization policies and admin role assignments determines whether or not an operation requires approval, as described in [Request vs. Direct Operation](#) in the *User's Guide for Oracle Identity Manager*.
- Approval policies are functional and determines which SOA workflow is to be invoked if approval is required.
- There are two levels of approval, and the functionality is as described in [Managing Requests](#) of *User's Guide for Oracle Identity Manager* for 11g Release 2 (11.1.2.2).
- If you enable workflow policies, then request generation and approval takes place in the same manner as in a fresh deployment of Oracle Identity Manager. However, you must migrate approval policies to workflow policies, as described in "[Migrating Approval Policies to Approval Workflow Rules](#)".

#### Note:

After enabling workflow policies, you must not disable it again. Toggling between enabling and disabling workflows is not supported.

Most of the approval policy features can be achieved by using approval workflows. [Table 4-5](#) lists the approval policy features that can be achieved by using approval workflows.

**Table 4-5 Approval Policies to Approval Workflows**

Approval policies	Approval workflow rules
Approval policies for a request type	Approval workflow rule specific to an operation
Approval policy level, which consists of request level and operation level	Single level of approval
Scope type, scope	Approval workflow rule condition
Approval process configuration: auto approval	Approval workflow rule configuration: Select Direct
Approval process configuration: approval process	Workflow rule configuration: Search and select workflow
Approval policy rule	Approval workflow rule condition
Heterogeneous request type	Heterogeneous request policy
Bulk request type	Bulk policy for operation, for example Create User Bulk
Request level approval policies	Approval workflow rules
Operation level approval policy	NA
Priority	Policy order, in which the policies are configured
Hierarchical organization scoping	Policy condition based on organization hierarchy, for example: <pre>user.Organization="VisionMarketing" OR user.parentOrganization="Vision" OR ...</pre>

### 4.3.2 About Request Process Flow With Approval Workflow Rules Disabled

In an upgraded deployment of Oracle Identity Manager, approval workflows is disabled by default.

[Figure 4-4](#) shows the request process flow when approval workflows is disabled.

**Figure 4-4 Request Process Flow with Disabled Workflow**

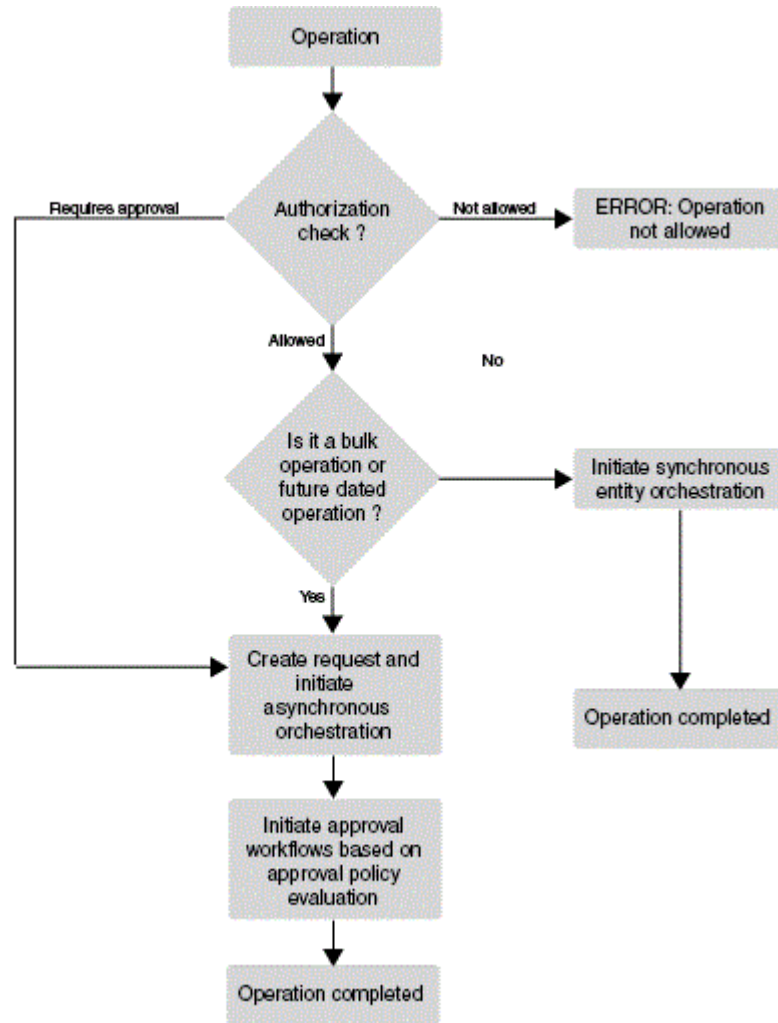

When approval workflow rules feature is disabled, the ApprovalRequired obligation(s) returned as a result of authorization policy evaluation determine whether the operation requires approval(s) or not.

If ApprovalRequired is false, then no request is created, and it is a direct operation.

If ApprovalRequired is true, then a request is created, approval policies are evaluated, and the SOA workflow returned by approval policy evaluation is initiated.

### 4.3.3 Migrating Approval Policies to Approval Workflow Rules

By default, a single workflow policy is available for an operation, whereas, an operation or request type can have multiple approval policies configured at request level and operation level.

To migrate approval policies to approval workflow rules:

1. Identify all the approval policies that are applicable to a request type. Because there can be policies at request level and operation level, some manual analysis is required to identify their priority or order.

An operation or request type can have multiple approval policies configured at request level and operation level. Whereas, by default, there is only a single approval workflow policy available for an operation. This default approval workflow policy cannot be deleted; new rules can be added to the same.

2. Pick the approval policy that comes first or next in the order of priority.
3. Open the default approval policy configuration specific to the request type. If there is a requirement to modify the current approval policy as a bulk workflow policy rule, then open the default bulk policy, for example Bulk Modify User.
4. Model the current approval policy as an approval workflow rule as follows:
  - a. Create a new approval workflow rule with the same name as the approval policy name picked in step 2. Provide a description for the approval workflow rule.

 **See Also:**

"[Creating Approval Workflow Rules](#)" and "[Modifying Approval Workflow Rules](#)" for information about the user interface to work with approval workflow rules

- b. In the Approval Workflow Configuration page of Oracle Identity System Administration, search and select the workflow that is configured in the approval policy as approval process.
  - c. Model the approval policy rule as approval workflow rule condition in the Approval Workflow Configuration page.
5. Repeat steps 2 through 4 for all the approval policies applicable to a request type.
6. Repeat steps 1 through 5 for all the request types.

## 4.3.4 Enabling Approval Workflow Rules

Enabling approval workflow rules in an upgraded deployment involves enabling the workflow rules feature and understanding the in-flight request lifecycle.

This section contains the following topics:

- [Enabling the Approval Workflow Rules Feature](#)
- [About In-Flight Request Lifecycle](#)

### 4.3.4.1 Enabling the Approval Workflow Rules Feature

In an upgraded deployment of Oracle Identity Manager, the approval workflow rules feature is disabled by default. To enable the feature:

1. Ensure that SOA is enabled. To do so, verify that the value of the `Workflows Enabled` system property is `true`.
2. Ensure that migration of approval policies to approval workflows, as described in "[Migrating Approval Policies to Approval Workflow Rules](#)", has been completed.
3. Set the value of the `Workflow Policies Enabled` system property to `true`.
4. Restart Oracle Identity Manager Managed Server.

### 4.3.4.2 About In-Flight Request Lifecycle

When you upgrade Oracle Identity Governance to 19c (19.1.0.0.0), there can be some in-flight requests that must be processed after the upgrade. After the approval workflow policies feature is enabled, the life cycle of all the in-flight requests are the same as in the earlier release of Oracle Identity Manager, except for workflow determination. SOA workflow to be initiated is determined based on the workflow policies and not approval policies. In-flight request go through the existing request stages, which are Obtaining Request Approval, Obtaining Operation Approval, Request Approval Approved, Operation Approval Approved, Request Approval Rejected, and Operation Approval Rejected.

After enabling approval workflows, the in-flight requests are processed in the following manner:

#### For In-Flight Requests Awaiting Request Approval

Figure 4-5 shows the lifecycle of in-flight requests that are awaiting request approval.

Figure 4-5 In-Flight Requests Awaiting Request Approval

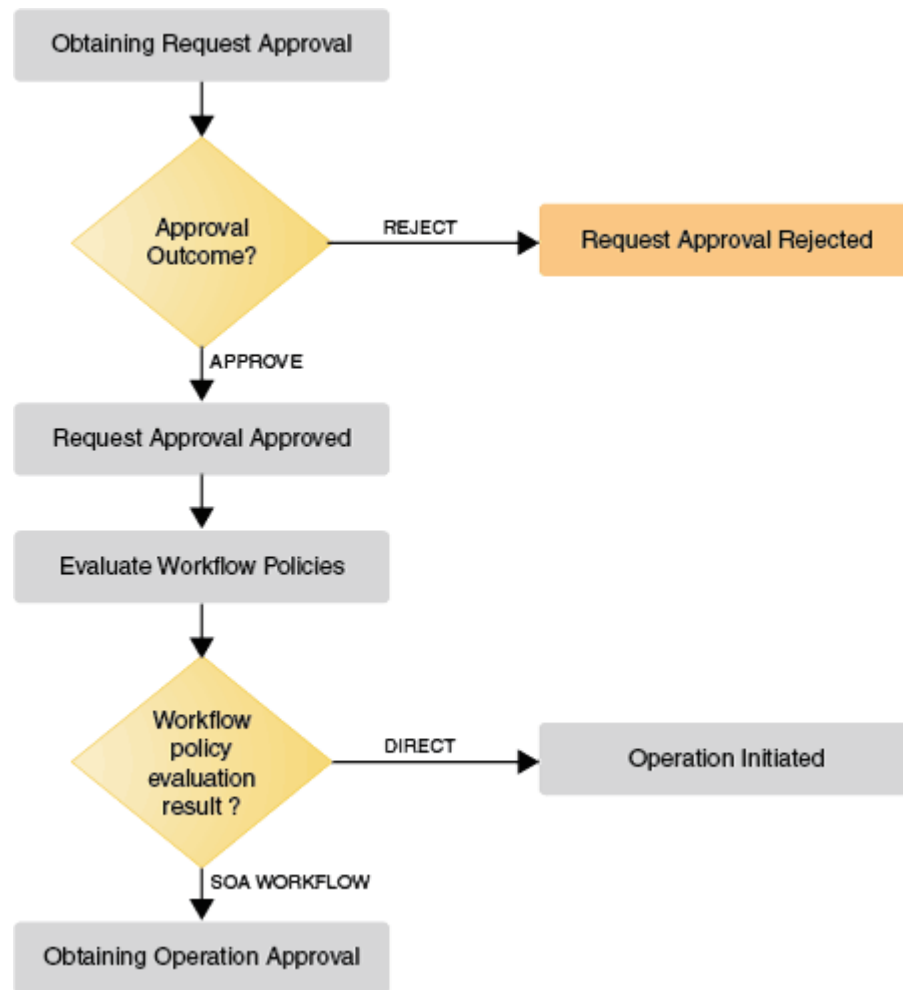

If the request is approved, then approval workflow rule is evaluated to determine the SOA workflow to be initiated at operation level. The request moves to the Obtaining Operation Approval stage.

If the request is rejected, then the request moves to `Request Approval Rejected` stage.

### For In-Flight Requests Awaiting Operation Approval

Figure 4-6 shows the lifecycle of in-flight requests that are awaiting operation approval.

**Figure 4-6 In-Flight Requests Awaiting Operation Approval**

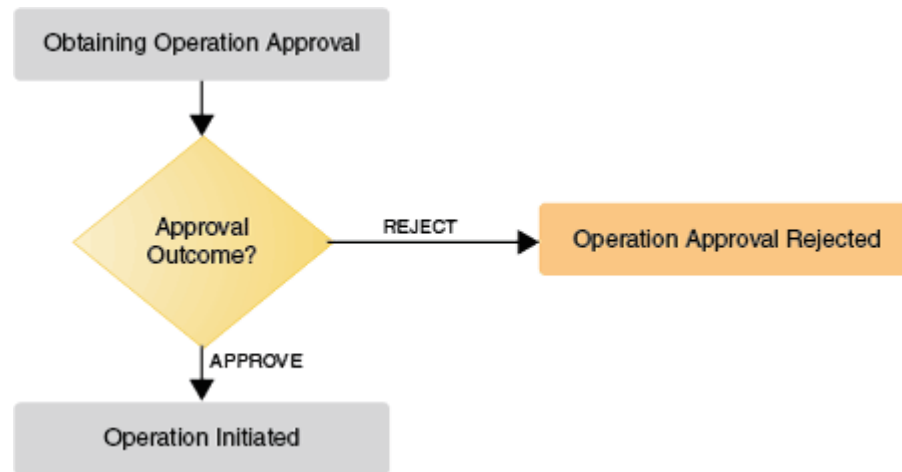

If the request is approved, then the operation is initiated.

If the request is rejected, then the request moves to the `Operation Approval Rejected` stage.

## 4.4 Migrating Workflow Rules From Test to Production

You can migrate workflow rules from a test environment to a production environment.

This section contains the following topics:

- [About Migration of Workflow Rules From Test to Production](#)
- [Moving Workflow Rules From Test to Production Using the Deployment Manager](#)

### 4.4.1 About Migration of Workflow Rules From Test to Production

Workflow rules can be exported from the source environment, such as test environment, and imported to the target environment, such as production environment, by using the Deployment Manager.

Migration of workflow rules and rule to operation/policy relationships come under the category of Policy in the Deployment Manager Wizard. See "[Migrating Incrementally Using the Deployment Manager](#)" for information about the Deployment Manager.

As workflow rules are associated with a specific operation, you must select the operation first, and then select the rules that you want to export.

While exporting/importing workflow rules, the workflow rule configuration in the source environment overrides the workflow rule configuration in the target environment. As a result, when workflow rules for an operation are imported, all rules configured for that operation are deleted, and the exported rules are associated with that operation in the target environment. In addition, the order of the rules in the source environment are carried over to the target environment.

For example, consider that the Create User operation has rules Rule1 and Rule2 configured in the target environment. But the Create User operation on the source environment has rules Rule1 and Rule3, and both are exported. When these rules are imported to the target environment, Rule1 and Rule2 are deleted, and Rule1 and Rule3 are associated with the Create User operation.

Therefore, it is recommended to maintain the source/test environment as the source of truth for workflow rule configuration.

## 4.4.2 Moving Workflow Rules From Test to Production Using the Deployment Manager

Use the Deployment Manager to export the operations and policies and import them to the target environment.

To export/import the workflow rules by using the Deployment Manager:

1. Login to Oracle Identity System Administration of the source/test environment as the system administrator.
2. On the left pane, under System Configuration, click **Export**. The Export Configuration page opens and the Search Objects option is displayed.
3. From the Search Objects page, select Type as **Policy** and click Search icon. Search result is displayed in the **Available Entities** table.
4. From the Available Entities table, select the check box against the policy you want to export the workflow rules. The Policy is moved to the **Selected Entities** table.
5. Click **Next** or click **Export Options** in the train link. The Export Options page is displayed.
6. Set Dependency to **Yes**, select the workflow rules for the selected operations that you want to export.
7. Continue with the remaining steps of the wizard and complete the export.
8. Login to Oracle Identity System Administration of the target/production environment as the system administrator.
9. On the left pane, under System Configuration, click **Import**.
10. Select the file that contains the exported workflow rules (from step 7), and complete the import process. For detailed steps see, [Importing Deployments](#)



### Note:

A workflow rule condition can refer to entities, such as role or application instance. Such dependent entities cannot be migrated as part of workflow rule migration. You must manually configure or migrate such dependent entities in the target/production environment. Otherwise, rule evaluation result might be unpredictable.

## 4.5 Running Oracle Identity Governance Without Workflows

Oracle Identity Manager is dependent on SOA server, which is installed and enabled by default. However, you can manually disable workflows by disabling SOA as a post install configuration step.

This chapter describes the procedure to disable SOA and the functional impact of doing so in the following sections:

- [Disabling SOA Server](#)
- [About the Impact of Disabling Workflows](#)

## 4.5.1 Disabling SOA Server

You can disable the SOA server by setting the value of the `Workflows Enabled` system property.

To disable SOA Server:

1. Shutdown the SOA Managed Server.
2. Set the value of the `Workflows Enabled` system property to `false`. See [Table 19-1](#) for information about this system property.
3. Restart Oracle Identity Manager Managed Server.

SOA Server can be re-enabled by setting the value of the `Workflows Enabled` system property to `true`.



### Note:

Oracle recommends that you do not enable SOA again after disabling it. Toggling between enabling and disabling workflows is not supported.

## 4.5.2 About the Impact of Disabling Workflows

The primary functional impact of disabling workflow is that all operations are auto-approved, which means that the operations are completed without any approvals. Because no approval workflows are initiated, neither approval policies nor approval workflow rules are evaluated.

[Figure 4-7](#) shows the impact of disabling workflows.



Figure 4-7 Disabled Workflows

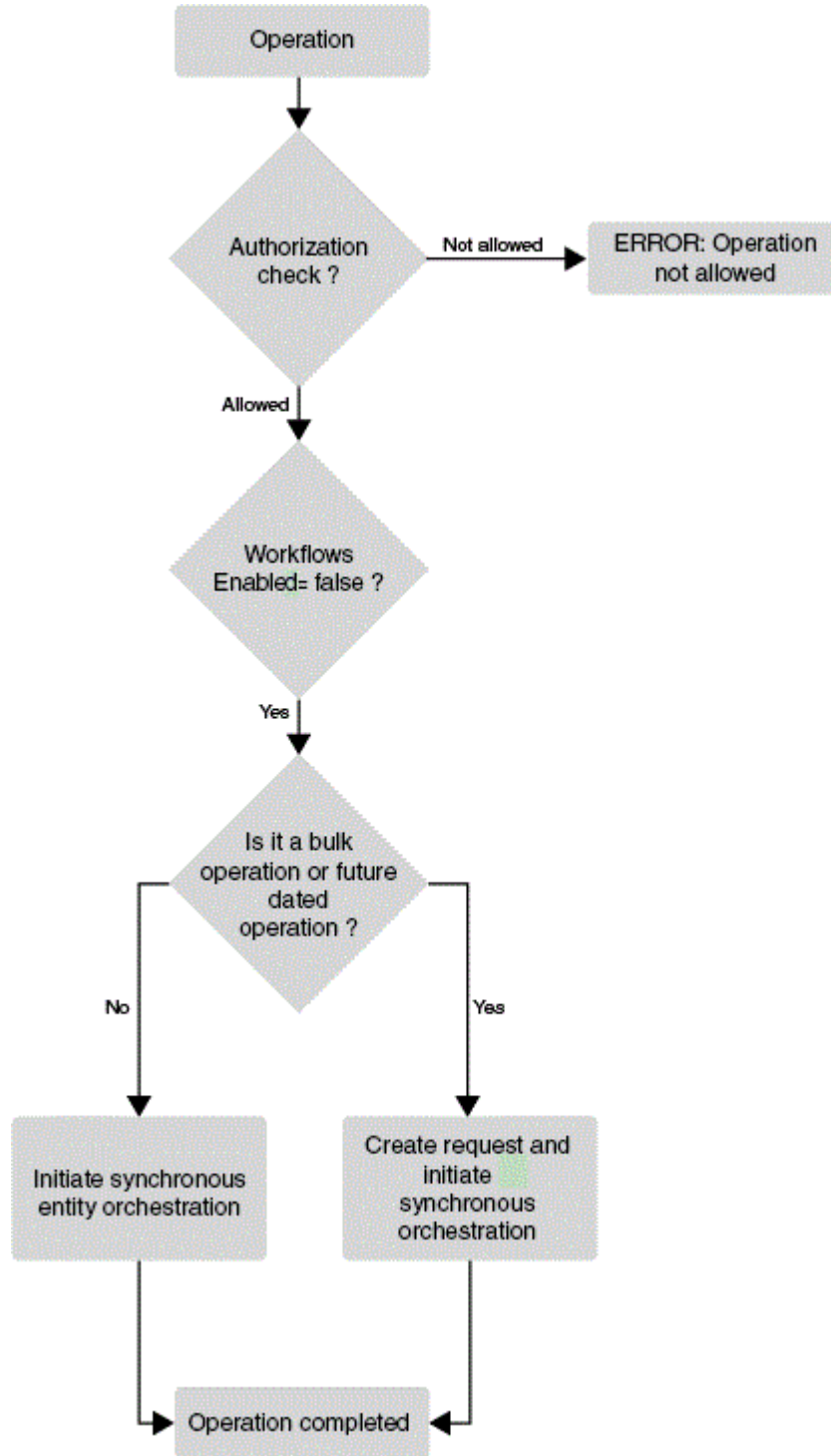

In addition, [Table 4-6](#) lists the features that are not available when workflow is disabled.

**Table 4-6 Unavailable Features When Workflow is Disabled**

Feature	Details
Request approvals	<ul style="list-style-type: none"> <li>• All the operations performed are direct operations and a request is not created, with the following exceptions:               <ul style="list-style-type: none"> <li>– Request is always created for bulk operations. Child requests are created immediately, which are auto-approved.</li> <li>– Request is always created for all operations with future effective date.</li> </ul>               All the newly created requests are auto-approved without involving any human approval. For example, all add access, self profile modification, and account/entitlement modification requests, are direct operations.             </li> <li>• Approval policies or workflow rules are not evaluated. See "<a href="#">About Rule Conditions</a>" for information about workflow rules.</li> </ul>
Provisioning operations	<ul style="list-style-type: none"> <li>• <b>Disconnected application instance:</b> Manual fulfillment tasks for disconnected application instances do not work when workflow is turned off. Provisioning operations for disconnected application instances will fail.</li> <li>• <b>Account-entitlement dependency:</b> Entitlement request with one beneficiary when workflow is turned off works in the following way:               <ul style="list-style-type: none"> <li>– <b>Selected user has one account:</b> The account is preselected, and there is no impact.</li> <li>– <b>Selected user has multiple accounts:</b> It is mandatory to select an account, and there is no impact.</li> <li>– <b>Selected user has no account:</b> Application instance automatically gets added to the cart and a bulk request is created. As SOA is turned off, bulk and child requests will be auto-approved.</li> <li>– <b>Selected user has a pending account request:</b> Newly created entitlement request is set as dependent on the account request. If the account is pending for approval, then as SOA is turned off, the requests are not processed further. If account request is waiting for an effective date, then the entitlement request is processed after the account request is completed.</li> </ul>               Entitlement request with multiple beneficiaries when SOA is turned off results in bulk request. The bulk request is auto-approved and child requests are created. The following are some specific use cases:               <ul style="list-style-type: none"> <li>– <b>User has one account:</b> entitlement request: This is auto-approved and completed.</li> <li>– <b>User has multiple accounts:</b> Corresponding entitlement child requests will fail.</li> <li>– <b>User has no account:</b> Corresponding entitlement child requests will fail.</li> <li>– <b>User has pending account request:</b> Entitlement child request is set as dependent on the account request. If the account is pending for approval, then as SOA is turned off, the requests are not processed further. If account request is waiting for an effective date, then entitlement request is processed after the account request is completed.</li> </ul>               The following account -entitlement use cases that rely on SOA composites will fail:               <ul style="list-style-type: none"> <li>– A multiple beneficiary request for entitlement where one or more beneficiaries have no account, and there is no in-flight account request (for that beneficiary and application instance combination).</li> <li>– A multiple beneficiary request for entitlement where one or more beneficiaries have multiple accounts, and account is not identified.</li> </ul> </li> </ul>
Identity Auditor features	<p>When workflow is turned off, Certification and Identity Auditor features do not work, and the UI links related to Certification and Audit Compliance are not displayed in both Identity Self service and Identity System Administration. This is true when the value of the <code>Identity Auditor Feature Set Availability</code> system property is set to <code>TRUE</code>.</p> <p>When workflow is turned off, any certification-related scheduled job will not be run, and appropriate messages will be logged.</p>

**Table 4-6 (Cont.) Unavailable Features When Workflow is Disabled**

Feature	Details
UMS notification	UMS notification provider works depending on whether workflows are enabled or not. UMS provider does not send notifications when SOA is not available. If UMS provider is kept enabled when SOA is not available, then UMS does not attempt to send notifications and logs an error message. An alternate provider, for example, the EmailServiceProvider must be configured and enabled to continue sending notifications.
Web services connector	Web services connector does not work when SOA is disabled.
SIL-based SoD	SIL-based SoD check do not happen when workflows are disabled even when the operation results in a request. However, SIL-based SoD Checks continue to work at the provisioning level when SOA is unavailable.
User management	<ul style="list-style-type: none"> <li>• <b>User self-registration:</b> User self-registration continue to work when SOA is turned off. Organization is calculated through the home organization determination policy, and the self registration request is auto approved.</li> <li>• <b>Proxy user management:</b> The proxy feature is disabled when SOA is turned off. The panel for managing proxies in the Identity Self Service is not displayed, and all the APIs around proxy throws an exception with the following message:  Proxy functionality is only supported when SOA and workflows are enabled.</li> </ul>
User interface	<p>The following features are disabled (and not displayed) in the default user interface when the <code>Workflows Enabled</code> system property is set to false:</p> <ul style="list-style-type: none"> <li>• <b>In Oracle Identity System Administration:</b> The Approval Policies link</li> <li>• <b>In Oracle Identity Self Service:</b> The Certifications, My open tasks, and Pending Approvals links/icons in the Self Service Home page, and the Approvals tab in the Request Details/Summary pages</li> </ul>

## 4.6 Use Cases for Disabled or Deleted Proxy Users

When users are disabled, Oracle Identity Governance handles tasks without losing the assignments although the target assignee of the task being initiated is already disabled, or the current assignee of the pending tasks is being disabled. The type of tasks can be one of request/approval task, identity audit (IDA) scan violation, or certification.

Applying Oracle Identity Governance Bundle Patch 12.2.1.4.210428 provides the following enhancements:

### Removing Proxy Relationships When a User is Disabled or Deleted

When a user is disabled or deleted, all proxy relationships defined with the user is not effective anymore. If there is an active proxy at the time of disabling the user, the proxy will be terminated. This means that Oracle Identity Governance removes all proxy data of this user from the database and SOA.

For example, User1 and User2 set their proxy to User3, and User3 sets his proxy to User4. When User3 is disabled, those proxy relationships will be removed.

Proxy cleanup actions are done both with Oracle Identity Governance database and SOA. As a result, the proxy data is completely removed from the system.

## Task Assignment with Proxy

When a user has proxy a setup, all tasks are delegated to both the user and its proxy. This means that both the users have the same level of control at the beginning. When a user starts to take actions on the task, modification actions on the same task are limited for the other assignee.

## Reassigning Tasks When Current Assignee is Disabled or Deleted

When a user is disabled or deleted, the existing proxies from/to this user are removed, and all pending tasks are reassigned to the other user or role depending on the configuration of the `OIG.DefaultTaskReassignee` system property. It is important to set this property with an active user or role.

By default, the value of the `OIG.DefaultTaskReassignee` system property is the `SYSTEM ADMINISTRATORS` role so that pending tasks can be reassigned to the `SYSTEM ADMINISTRATORS` role when a user is disabled or deleted.

When the value of the `OIG.DefaultTaskReassignee` system property is a manager, Oracle Identity Governance finds the closest active manager from the hierarchy if the current target assignee is disabled.

When the value of the `OIG.DefaultTaskReassignee` system property is a user, Oracle Identity Governance reassigns the task to the user.

When the value of the `OIG.DefaultTaskReassignee` system property is a role, Oracle Identity Governance reassigns the task to the role. Here, the role name as the value of the `OIG.DefaultTaskReassignee` system property is case-sensitivie.

If Oracle Identity Governance cannot find any valid assignee, then the tasks are reassigned to the System Administrator.

### Note:

This feature works for the disable and delete operations initiated from Oracle Identity Governance user interface or APIs only. Disabling and deleting the users from reconciliation and bulk load does not trigger this new feature.

## Defining the New Initial Task Assignee

If the target assignee of a request being created is already disabled, Oracle Identity Governance looks for the closest manager of the initial target assignee based on the configured approval workflows, as described below:

- `OIG.BeneficiaryManagerApprovalWorkflows` (for request only): When the initial target assignee is already disabled, Oracle Identity Governance looks for the closest manager of the beneficiary of the request with the defined approval workflow, as shown:

```
OIG.BeneficiaryManagerApprovalWorkflows=default/BeneficiaryManagerApproval!  
4.0,default/MyCustomComposite!1.0
```

Multiple composites can be defined with the comma separator.

- `OIG.RequesterManagerApprovalWorkflows` (for Request only): When the initial target assignee is already disabled, Oracle Identity Governance looks for the closest manager of the requester of the request with the defined approval workflow, as shown:

```
OIG.RequesterManagerApprovalWorkflows=default/RequesterManagerApproval!4.0,default/MyCustomComposite2!1.0
```

Multiple composites can be defined with the comma separator.

 **Note:**

The `OIG.BeneficiaryManagerApprovalWorkflows` and `OIG.RequesterManagerApprovalWorkflows` properties are applicable only for requests. By default, `OIG.BeneficiaryManagerApprovalWorkflows` is set to `default/BeneficiaryManagerApproval!4.0`, and `OIG.RequesterManagerApprovalWorkflows` is set to `default/RequesterManagerApproval!4.0`. You can append more approval workflows, such as the following:

```
OIG.BeneficiaryManagerApprovalWorkflows= default/BeneficiaryManagerApproval!4.0,default/DefaultOperationalApproval!5.0
```

- Identity Audit (IDA) scan violations and certifications are assigned to the closest active manager of the initial target assignee if the manager is already disabled.

If a valid assignee is not found, Oracle Identity Governance assigns the IDA scan violations and certifications to the user defined for `OIG.DefaultTaskReassignee`, and then for `SYSTEM ADMINISTRATOR` or the default certification assignee, if defined.

When certifications are created, if there is no valid assignee even after looking up for the active higher manager and the user defined for `OIG.DefaultTaskReassignee` and `XL.AlternativeReviewerIDForManager`, Oracle Identity Governance skips the creation of such certifications. Therefore, make sure that the two system properties are defined with active users with enough privilege for the operations.

### Deploying the New Version of the CertificationProcess Composite

To enable this feature after applying this bundle patch, deploy the new version of the `CertificationProcess` composite. To do so:

1. Create a backup of the current version of the `CertificationProcess` composite from SOA, as shown:
  - a. Login to Oracle Enterprise Manager Fusion Middleware Control.
  - b. Navigate to **SOA, soa-infra, default, CertificationProcess[2.0]**.
  - c. From the SOA Composite menu, select **Export the composite**.
2. Extract the contents of the `OIM_HOME/server/workflows/composites/CertificationProcess.zip` file to a temporary directory.
3. Perform the following steps to deploy the `deploy/sca_CertificationProcess_rev2.1.jar` file:
  - a. In Oracle Enterprise Manager Fusion Middleware Control, navigate to **SOA, soa-infra, default**.
  - b. From the SOA Composite menu, select **SOA Deployment, Deploy**.
  - c. Provide the complete path of the `/deploy/sca_CertificationProcess_rev2.1.jar` file.
  - d. Restart the SOA servers.

# Part III

## Form Management

Form Management is done by using the Form Designer in Identity System Administration.

This part contains the following chapter:

- [Managing Forms](#)

# 5

## Managing Forms

You can use Form Designer in Oracle Identity System Administration to create and manage application instance forms.

This chapter contains the following sections:

- [Creating Forms By Using the Form Designer](#)
- [Searching Forms By Using the Form Designer](#)
- [Modifying Forms By Using the Form Designer](#)
- [Removing or Hiding Form Attributes](#)



### Note:

Before you start performing the procedures described in this section, it is recommended that you review Managing Sandboxes in *Developing and Customizing Applications for Oracle Identity Governance* for information about creating, activating, and publishing sandboxes.

### 5.1 Creating Forms By Using the Form Designer

Creating forms involve creating and activating a sandbox, creating the form by using Form Designer, and exporting and publishing the sandbox.

To create forms by using the Form Designer:

1. Login to Oracle Identity System Administration.
2. Create and activate a sandbox. A warning message is displayed if no sandbox is activated. For detailed instructions on creating and activating a sandbox, see *Managing Sandboxes in Developing and Customizing Applications for Oracle Identity Governance*
3. In the left pane, under Provisioning Configuration, click **Form Designer**. The Form Designer page is displayed.
4. From the Actions menu, select **Create**. Alternatively, click **Create** on the toolbar. The Create Form page is displayed.
5. In the Resource Type field, specify a resource object with which you want to associate the form. To do so:
  - a. Click the lookup icon next to the Name field. The Search and Select: Name dialog box is displayed.
  - b. In the Name field, enter the name of the resource object you want to search. You can leave this field blank if you want to display all resource objects.
  - c. Click **Search**. The resource objects that match the search condition are displayed.
  - d. Select the resource object that you want to associate with the form, and click **OK**. The resource object name is displayed in the Name field of the Create Form page.

6. In the Form Name field, enter a form name.
7. In the Available form fields section, a list of form field names along with description and Display Name are displayed. These fields are available for the form you are creating. For each available form field, you can select the Bulk Update option. Selecting this option makes the form field available for updating the entities in bulk.
8. (Optional) By default, the **Parent Form + Child Tables (Master/Detail)** option is selected. You can select a different **Form Type** option.
9. (Optional) Select the **Generate Entitlement Forms** option if you want to associate the new form with the entitlements. Using this form, users can provide additional information that might help an approver during the approval process. The following is a sample screenshot:

The screenshot shows the Oracle Form Designer interface for creating a new form. The title is "New form for eBusiness Suite User". The "Resource Type" is set to "eBusiness Suite User". The "Form Name" field is empty. Under "Form Type", three options are available: "Parent Form + Child Tables (Master/Detail)" (selected), "Parent Form (Master)", and "Parent Form + Child Tables for Non Entitlement (Master/Detail)". A checkbox labeled "Generate Entitlement Forms" is checked and highlighted with a red box. Below this is the "Available form fields" section, which contains a table with the following data:

#	Display Name	Name	Description	Bulk Update
1	EBS Server	UD_EBS_USER_EBS_ITRES	EBS Server	<input type="checkbox"/>
2	User Name	UD_EBS_USER_USRNAME	User Name	<input type="checkbox"/>
3	Password	UD_EBS_USER_PASSWORD	Password	<input type="checkbox"/>
4	Description	UD_EBS_USER_DESCR	Description	<input type="checkbox"/>
5	Email	UD_EBS_USER_EMAIL	Email	<input type="checkbox"/>
6	Fax	UD_EBS_USER_FAX	Fax	<input type="checkbox"/>
7	Password Expiration Type	UD_EBS_USER_PSWD_EXP_TYPE	Password Expiration Type	<input type="checkbox"/>

**Note:**

The **Generate Entitlement Forms** option is displayed only for complex entitlements. A complex entitlement is represented by child object having at least two attributes, one of them marked as Entitlement attribute.

10. Click **Create**. A message is displayed stating that the form is created.
11. If required, you can export the sandbox to store all the changes made in your sandbox. For detailed instructions on exporting a sandbox, see *Managing Sandboxes in Developing and Customizing Applications for Oracle Identity Governance*
12. Publish the sandbox. For detailed instructions on publishing a sandbox, see *Managing Sandboxes in Developing and Customizing Applications for Oracle Identity Governance*

## 5.2 Searching Forms By Using the Form Designer

Searching forms involve specifying the resource object associated with the form as the search condition.

To search forms by using the Form Designer:



1. In Oracle Identity System Administration, under Provisioning Configuration, click **Form Designer**. The Form Designer page is displayed.
2. From the Resource Type list, select the type of resource object associated with the form.
3. Click **Search**. The forms that match your search condition are displayed. For each form, the search result displays the form name, form type, and resource type.

## 5.3 Modifying Forms By Using the Form Designer

Modifying forms involve creating and activating a sandbox, searching and opening the form in Form Designer, modifying the form attributes, and exporting and publishing the sandbox.

To modify a form by using the Form Designer:

1. Create and activate a sandbox. A warning message is displayed if no sandbox is activated. For detailed instructions on creating and activating a sandbox, see *Managing Sandboxes in Developing and Customizing Applications for Oracle Identity Governance*.
2. In the Form Designer page, search for the form you want to modify.
3. In the Search Results table, select the form you want to modify.
4. From the Actions menu, select **Open**. Alternatively, click **Open** on the toolbar. Otherwise, click the form name in the search results table.

The Manage Form page displays the form attributes in the Object Information section. The Standard and Custom sections list the standard and custom fields of the form. You can edit the standard fields, and create and edit custom fields in these sections.

5. (Optional) If you want to associate a form with the entitlements, then you can regenerate the form to allow users to provide additional information that might help the approver during the approval process. To do so, click **Regenerate View**. In the Regenerate View popup window, select the **Generate Entitlement Forms** checkbox, as shown in the following sample screenshot.

### Note:

- If you have upgraded Oracle Identity Manager, then you must regenerate all the forms to use this feature.
- The Generate Entitlement Forms option is displayed only for complex entitlements. A complex entitlement is represented by child object having at least two attributes, one of them marked as Entitlement attribute.

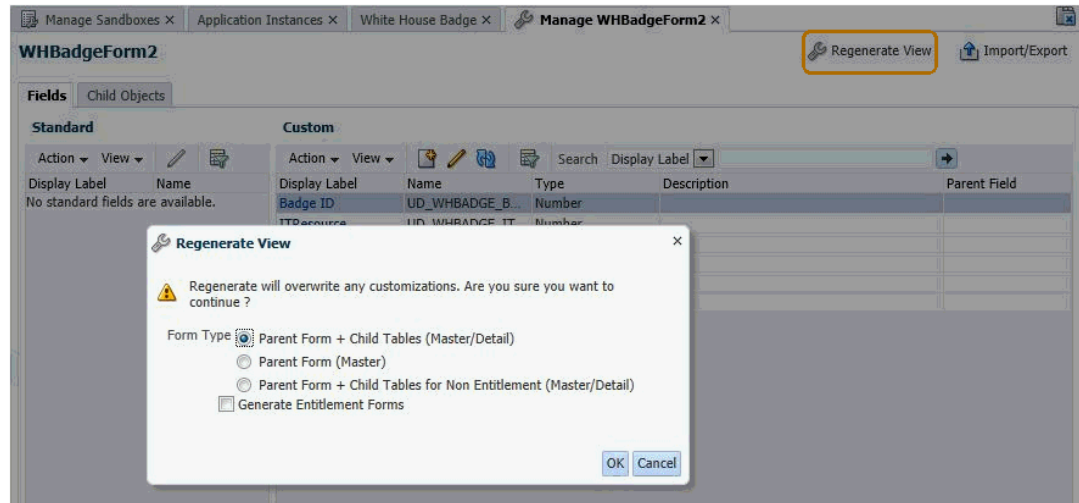

Table 5-1 lists the options in the Regenerate View popup window.

**Table 5-1 Options in the Regenerate View Window**

Option	Description
Parent Form + Child Tables (Master/Detail)	Selecting this option generates the appropriate account form. The account form includes all multi-valued attributes irrespective of whether the forms represent an entitlement or not.
Parent Form (Master)	Selecting this option generates the appropriate account form. The account form does not include any multi-valued attributes.
Parent Form + Child Tables for Non Entitlement (Master/Detail)	Selecting this option generates the appropriate account form. The account form includes all multi-valued attributes that do not represent an entitlement.
Generate Entitlement Forms	Selecting this checkbox generates the appropriate Entitlement forms. The entitlement form is generated only if the multi-valued attribute that represent an entitlement is complex. If the multi-valued attribute that represent an entitlement is scalar, then no form is generated.

6. If required, you can export the sandbox to store all the changes made in your sandbox. For detailed instructions on exporting a sandbox, see *Managing Sandboxes in Developing and Customizing Applications for Oracle Identity Governance*
7. Publish the sandbox. For detailed instructions on publishing a sandbox, see *Managing Sandboxes in Developing and Customizing Applications for Oracle Identity Governance*

 **See Also:**

[Configuring Custom Attributes](#) for information about creating and modifying custom fields or user-defined fields (UDFs)

## 5.4 Removing or Hiding Form Attributes

Removing or hiding form attributes involve creating and activating a sandbox, removing the UI component for the form attribute by customizing the UI, and exporting and publishing the sandbox.

To remove or hide a form attribute in Oracle Identity Self Service:

1. Log in to Oracle Identity Self Service.
2. Create and activate a sandbox. For detailed instructions on creating and activating a sandbox, see *Managing Sandboxes in Developing and Customizing Applications for Oracle Identity Governance*.
3. Open the request catalog.
4. Search for and select the application instance whose resource form page must be updated, and then click **Add to Cart**.
5. Click **Checkout**.
6. On the Cart Details page, under the Details section, the application instance form and its attributes are displayed.
7. Click **Customize** to open WebCenter Composer. The page opens in customization mode.
8. Click **Structure**. The object tree is displayed.
9. If you want to delete a form attribute, select the UI component and click the delete icon in the Composer panel at the top of the page.

If you want to hide a form attribute, click **Edit**. Then, select the UI component and set the Visible property to `false`.

10. Click **Close** to leave customization mode.
11. If required, you can export the sandbox to move the change from the test to production environment. For detailed instructions on exporting a sandbox, see *Managing Sandboxes in Developing and Customizing Applications for Oracle Identity Governance*.
12. Publish the sandbox. For detailed instructions on publishing a sandbox, see *Managing Sandboxes in Developing and Customizing Applications for Oracle Identity Governance*.

# Part IV

## System Entities

You can extend the system entities, such as users, roles, organizations, and request catalogs.

This part contains the following chapter:

- [Configuring Custom Attributes](#)

# 6

## Configuring Custom Attributes

You can configure custom attributes or user-defined fields (UDFs) for the user, role, organization, and catalog entities.

Entity attributes are properties of the entity. The information about the user entity is stored in the form of attributes, such as first name, last name, user login, and password. There are default user attributes in Oracle Identity Manager. However, you can create custom user attributes by using the User form under System Entities in the Oracle Identity System Administration. The custom attributes are referred to as user defined fields (UDFs). Oracle Identity Manager lets you create UDFs for the user, role, resource, organization, and catalog entities.

This chapter describes how to create and manage UDFs in the following sections:

- [Creating a Custom Attribute](#)
- [Creating a Custom Child Form](#)
- [Creating a Custom Child Form Attribute](#)
- [Modifying a Custom Attribute](#)
- [Adding a Custom Attribute](#)
- [Adding a Custom Attribute to an Application Instance Form](#)
- [Moving UDFs from Test to Production](#)
- [Synchronizing User-Defined Fields Between Oracle Identity Governance and LDAP](#)
- [Creating Cascaded LOVs](#)
- [Specifying Cascaded LOVs Without NULL Value](#)
- [Localizing Display Labels of UDFs](#)
- [Configuring a Field as Mandatory Attribute in the Request Catalog](#)



### Note:

Before you start performing the procedures described in this section, it is recommended that you review the Managing Sandboxes section in *Developing and Customizing Applications for Oracle Identity Governance*.

### 6.1 Creating a Custom Attribute

Creating a custom attribute involves activating a sandbox, using the System Entities section of the Identity System Administration to create the UDF for the particular entity, and exporting and publishing the sandbox.

The searchable property controls whether or not the attribute can be used to perform searches. For user defined attributes, setting this property will result in the attribute being shown in the Search form. Default attributes do not support this property.

To create a custom attribute or UDF:



**Note:**

Do *not* use ParentAccountId as a form field name. ParentAccountId is used to store system information.

1. Log in to Oracle Identity System Administration.
2. Create and activate a sandbox. For detailed instructions on creating and activating a sandbox, see *Managing Sandboxes in Developing and Customizing Applications for Oracle Identity Governance*.
3. To create a UDF for the user, organization, role, and catalog entities, click the component under System Entities on the left navigation pane of Identity System Administration.  
  
Catalog UDFs will not be available under Role VO. When ever a catalog UDF is added and customized in access request page, then the new UDF will be available automatically in Role page.
4. In the Custom section of the Fields tab, click the **Create** icon. The Select Field Type dialog box is displayed.
5. Select a field type you want to create. The available field types are:
  - **Text:** Select this option to create a text field.
  - **Number:** Select this option to create a numeric field.
  - **Checkbox:** Select this option to create a checkbox field.
  - **Date:** Select this option to create a date type field.
  - **Lookup:** Select this option to create a lookup field in which users can search and select the value. Note that there are two types of lookups that you can create:
    - A drop-down list from which you can select a value.
    - A searchable picklist (ADF name input list of value), from which users can search and select the value. If you want to create a searchable picklist, then on the Create Lookup Field page, under the Advanced section, select **Searchable Picklist**.

 **Note:**

After you create a UDF for dependent lookups (a lookup field that is created with the **Constrain list by parent field value selection option** selected), you must set the partialTriggers property through WebCenter composer to refresh the values in the dependent lookup. To do so, see the procedure described in [Creating Cascaded LOVs](#).

If you create a UDF in the User Details page, then the UDF is recommended to be in read-only mode. If the UDF is of drop-down or checkbox type, then you must customize it to read-only mode explicitly. To do so:

- a. In the User Details page, click **Customize** to open WebCenter Composer. The page opens in customization mode.
- b. Click the drop-down or checkbox region to edit its properties. In the pop-up window, click **Edit**.
- c. In the Component Properties window, select the **Read Only** checkbox and click **OK**.
- d. Click **Close** to close the page in customization mode.

Do not add drop-down UDF as outputText to a page if the value of the Meaning field has to be displayed.

6. Click **OK**. The page to create a custom field is displayed.

As an example, [Figure 6-1](#) shows the Create Text Field page. The rest of the procedure in this section has been based on creating a custom text field.

**Figure 6-1 The Create Text Field Page**

**Create Text Field** Save and Close Cancel

**Appearance**  
Configure how this field will appear when displayed to your users.

\* Display Label   
Display Width  Characters

**Name**  
Each field requires a unique name in the system. Name and description are for internal use only, and are never displayed to your users.

\* Name   
Description

**Constraints**

Searchable  
Maximum Length  Characters

**Default Value**  
Enter the value you want to set for the field when an object is created. Select Expression if you want to set the default dynamically.

**Advanced**

Encrypt  Certifiable  
 Use in Bulk  
LDAP Attribute

- Enter values in the fields of the Create Text Field page. [Table 6-1](#) lists the fields in the Create Text Field page. Depending on the type of field that you are creating, the fields on the Create Text Field page varies.

**Table 6-1 Fields in the Create Text Field Page**

Section	Field	Description
Appearance	Display Label	The custom field label that is displayed in the form. <b>Note:</b> Display Labels for forms designed by using the Form Designer must be specified in single default language, for example English. If there is a requirement to enter the Display Label in any other language, then the ROOT resource bundle (/xliffBundles/oracle/iam/ui/runtime/BizEditorBundle.xlf) containing the Display Labels specified in the Form Designer can be translated to other languages. The translated labels will be displayed when the form is displayed in the request catalog, Inbox, track requests, and other pages.
Appearance	Display Width	The display width in characters. If you do not specify a value for this field, then the length of the field is taken as default.
Name	Name	The unique custom field name. This field is of internal use only, and the value of this field is not displayed to the user.
<div style="border: 1px solid #0070C0; padding: 10px; background-color: #E6F2FF;"> <p> <b>Note:</b></p> <p>The auto-populated value of the Name field is the first character of the value in the Display Label field. Overwrite the auto-populated value manually with the desired value.</p> </div>		
Name	Description	The description of the custom field. This field is of internal use only, and the value of this field is not displayed to the user.
Constraints	Searchable	The searchable property controls whether or not the attribute can be used to perform searches. For user defined attributes, setting this property will result in the attribute being shown in the Search form. Default attributes do not support this property. <b>Note:</b> If you select the <b>Searchable</b> checkbox, then in the Advanced section, you cannot select <b>Encrypt</b> . A custom field that is marked as searchable cannot be encrypted.
Constraints	Maximum Length	The maximum length of the field in characters. <b>Note:</b> You can increase the maximum length for default and custom attributes by using the User form. However, decreasing the maximum length is not supported.
Default Value	Text field	The default value of the custom field. The value you specify in this field is set for the field when the object is created. <b>Note:</b> The field below the text field is grayed out and is not used.



**Table 6-1 (Cont.) Fields in the Create Text Field Page**

Section	Field	Description
Advanced	Encrypt	Determines whether the custom field must be encrypted. <b>Note:</b> If you select the <b>Encrypt</b> checkbox, then in the Constrains section, you cannot select <b>Searchable</b> . A custom field that is encrypted cannot be searchable.
Advanced	Use in Bulk	Determines whether the attribute is available in bulk operations.
Advanced	LDAP Attribute	Name of the attribute in the LDAP repository to which this custom attribute must map to. <b>Note:</b> Unless LDAP synchronization is enabled, setting a value for this field has no effect. For more information about enabling LDAP synchronization, see <a href="#">Installing and Configuring the Oracle Identity Governance Software</a> in <i>Installation Guide for Oracle Identity and Access Management</i> .
Advanced	Certifiable	Determines whether the attribute is certifiable. A requestable entity is available for certification only if it is marked as certifiable.

8. Click **Save and Close**. The UDF is created in the backend and is displayed in the Custom section of the Form Details page.
9. It is recommended that you export the sandbox to store all the changes made in your sandbox. For detailed instructions on exporting a sandbox, see *Managing Sandboxes in Developing and Customizing Applications for Oracle Identity Governance*.
10. Publish the sandbox. For detailed instructions on publishing a sandbox, see *Managing Sandboxes in the Developing and Customizing Applications for Oracle Identity Governance*.

When you create a UDF by using the Form Designer, it is created in the back-end, and is not available for use. To make it available for use to the user, you must include the UDF in the Oracle Identity Self Service page on which it will be displayed. For information about including a UDF in the Oracle Identity Self Service page, see [Adding a Custom Attribute](#).

## 6.2 Creating a Custom Child Form

Application instance forms can have child forms. Creating custom child forms involve activating a sandbox, using the Form Designer to add the child form to the application instance form, and exporting and publishing the sandbox.

Note that at some places in this guide, the term **resource form** has been used to refer to **application instance forms**.

To create a custom child form:

1. Log in to Oracle Identity System Administration.
2. Create and activate a sandbox. For detailed instructions on creating and activating a sandbox, see *Managing Sandboxes in Developing and Customizing Applications for Oracle Identity Governance*

 **Note:**

You must ensure that sandbox in which the application instance form for which you are creating the child form must be published. If it is not published, then you must perform the procedure described in this section in the same sandbox in which the application instance form was created.

3. In the left pane, under Provisioning Configuration, click **Form Designer**. The Form Designer page is displayed.
4. Search for and open the application instance (resource) form for which you want to create a child form as follows:
  - a. Specify a value for the Resource Type lookup field.
  - b. Click **Search**.

A list of all resource forms (application instance forms) that meet the search criteria is displayed.
  - c. From this list, select the form to open. Alternatively, click **Open** on the toolbar.

The Manage `APP_INSTANCE_FORM_NAME` page is displayed.
5. On the Child Objects tab, click the **Add** icon on the toolbar. The Add dialog box is displayed.
6. In the Name field, enter the name of the child form. In the Description field, enter a description of the child form. Then, click **OK**. The child form is created in the backend and is displayed in the Child Objects tab of the application instance form for which it was created.

For information about adding a new child form attribute, see "[Creating a Custom Child Form Attribute](#)".
7. Click **Regenerate View** to regenerate the application instance form associated with the child form. If you do not regenerate the view the child form will not be available in the page for use on which you want it to be displayed.
8. It is recommended that you export the sandbox to store all the changes made in your sandbox. For detailed instructions on exporting a sandbox, see *Managing Sandboxes in Developing and Customizing Applications for Oracle Identity Governance*.
9. Publish the sandbox. For detailed instructions on publishing a sandbox, see *Managing Sandboxes in Developing and Customizing Applications for Oracle Identity Governance*.

## 6.3 Creating a Custom Child Form Attribute

Creating a custom child form attribute involves activating a sandbox, opening the parent form and the child form in the Form Designer, creating and saving the child form attribute, and exporting and publishing the sandbox.

To create a custom child form attribute:

 **Note:**

Do *not* use `ParentAccountId` as a form field name. `ParentAccountId` is used to store system information.

1. Log in to Oracle Identity System Administration.
2. Create and activate a sandbox. For detailed instructions on creating and activating a sandbox, see *Managing Sandboxes* in *Developing and Customizing Applications for Oracle Identity Governance*

 **Note:**

You must ensure that sandbox in which the child form for which you are creating the attribute must be published. If it is not published, then you must perform the procedure described in this section in the same sandbox in which the child form was created.

3. In the left pane, under Provisioning Configuration, click **Form Designer**. The Form Designer page is displayed.
4. Search for and open the parent form (application instance form) of the child form in which you want to create an attribute. See Step 4 of [Creating a Custom Child Form](#) for information about searching and opening a form.  
The Manage *APP\_INSTANCE\_FORM\_NAME* page is displayed.
5. On the Child Objects tab, from the list of child forms, select the child form in which you want to create the attribute. The Manage *CHILD\_FORM\_NAME* page is displayed.
6. In the Custom section of the Fields tab, click the **Create** icon. The Select Field Type dialog box is displayed.
7. Select a field type you want to create. The available field types are:
  - **Text:** Select this option to create a text field.
  - **Number:** Select this option to create a numeric field.
  - **Checkbox:** Select this option to create a checkbox field.
  - **Date:** Select this option to create a date type field.
  - **Lookup:** Select this option to create a lookup field in which users can search and select the value.
8. Click **OK**. The page to create a custom field is displayed.  
The rest of the procedure in this section has been based on creating a custom lookup field.
9. Enter values in the fields of the Create Lookup Field page. [Table 6-2](#) lists the fields in the Create Lookup Field page:

**Table 6-2 Fields in the Create Lookup Field Page**

Section	Field	Description
Appearance	Display Label	The custom field label that is displayed in the form. <b>Note:</b> Display Labels for forms designed by using the Form Designer must be specified in single default language, for example English. If there is a requirement to enter the Display Label in any other language, then the ROOT resource bundle (/xliffBundles/oracle/iam/ui/runtime/BizEditorBundle.xlf) containing the Display Labels specified in the Form Designer can be translated to other languages. The translated labels will be displayed when the form is displayed in the request catalog, Inbox, track requests, and other pages.
Appearance	Display Width	This attribute will specify the width for LOV UDF on the screen. <b>Note:</b> When creating a Lookup type UDF, the recommended value of Display Width is 40.
Appearance	Help Text	Field-level help text that is displayed to the users as a tooltip.
Name	Name	The unique custom field name. This field is of internal use only, and the value of this field is not displayed to the user.
Name	Description	The description of the custom field. This field is of internal use only, and the value of this field is not displayed to the user.
Constraints	Searchable	Determines if the custom field can be searched by the user.
Constraints	Maximum Length	Determines the maximum length of the value that can be provided.
List of Values	Lookup Type	The lookup whose values are displayed to the user as a list of available values. You can either specify an existing lookup type or create a new one. <b>Note:</b> If you are creating a new lookup, then the name of this new lookup must not be the same as that of the UDF (of type lookup) that you are creating. Otherwise, the lookup is not displayed in the Manager User page.
Default Value	Drop-down list	The default value of the custom field. The value you specify in this field is set for the field when the object is created. <b>Note:</b> The field below the down-down list is grayed out and is not used.
Advanced	Entitlement	Determines whether the custom field is an entitlement. <b>Note:</b> If you are creating a child form with a lookup field for entitlement (in other words, the Entitlement field is selected), then you must select <b>Searchable</b> and <b>Searchable Picklist</b> options too.
Advanced	Use in Bulk	Determines whether the attribute is available in bulk operations.
Advanced	Searchable Picklist	Determines whether the custom field is a input list of values. This is applicable to Lookup field.

10. Click **Save and Close**. The UDF is created in the backend and is displayed in the Custom section of the Form details page.

11. Click **Re-generate View**.
12. It is recommended that you export the sandbox to store all the changes made in your sandbox. For detailed instructions on exporting a sandbox, see *Managing Sandboxes in Developing and Customizing Applications for Oracle Identity Governance*
13. Publish the sandbox. For detailed instructions on publishing a sandbox, see *Managing Sandboxes in Developing and Customizing Applications for Oracle Identity Governance*.

## 6.4 Modifying a Custom Attribute

Modifying a custom attribute involves activating a sandbox, editing the custom attribute, and exporting and publishing the sandbox.

To modify a custom attribute that you created for a form:

1. Create and activate a sandbox. For detailed instructions on creating and activating a sandbox, see *Managing Sandboxes in Developing and Customizing Applications for Oracle Identity Governance*
2. In the Form Designer, search and open the form which contains the custom attribute you want to modify.
3. In the Custom section, select the custom attribute that you want to modify.
4. Click the **Edit** icon on the toolbar. Alternatively, click the Display Name of the attribute. The page to edit the field is displayed.
5. Modify the values in the fields by referring to [Table 6-1](#). Note that all the fields listed in [Table 6-1](#) are editable.
6. Click **Save and Close**.
7. Click **Re-generate View**.
8. It is recommended that you export the sandbox to store all the changes made in your sandbox. For detailed instructions on exporting a sandbox, see *Managing Sandboxes in Developing and Customizing Applications for Oracle Identity Governance*
9. Publish the sandbox. For detailed instructions on publishing a sandbox, see *Managing Sandboxes in Developing and Customizing Applications for Oracle Identity Governance*.

## 6.5 Adding a Custom Attribute

When you create a UDF, it is created only in the backend, and is not available in the page for use on which you want it to be displayed.

 **Note:**

- Adding a custom attribute is always in relation to one of the following entities: User, Organization, Role, or Catalog.
- When catalog UDFs are customized to show in the first page of the Create Role wizard, they are also shown in the summary page of the wizard. But when role UDFs are customized to show in first page of the Create Role wizard, they are not shown in the summary page of the wizard. The summary page must be separately customized for these role UDFs to be displayed.
- The *LOV* attribute (OOTB/CUSTOM) is not supported for unauthenticated pages. For example, in the self-registration UI, the *LOV* attribute is not supported.

Adding a custom attribute involves the following:

- [Displaying a UDF in Oracle Identity Self Service Page](#)
- [Enabling the Submit Button After Adding a UDF to the Modify User Form](#)
- [Adding a Custom Attribute Category into Create User Form](#)
- [Customizing Unauthenticated Page](#)

## 6.5.1 Displaying a UDF in Oracle Identity Self Service Page

You must customize the UI to add the custom attribute and display it in a page in the Identity Self Service.

To display a UDF in a page in Oracle Identity Self Service:

1. Create the UDF by using the User form under System Entities in Identity System Administration. For example, you can create a UDF for the Create User page.

See [Creating a Custom Attribute](#) for information about creating a UDF.

 **Note:**

After adding a UDF through the User form, logout of both Oracle Identity System Administration and Oracle Identity Self Service, and then login again to be able to see the newly added UDF and use it for customization.

2. Log in to Oracle Identity Self Service as the system administrator.
3. Create and activate a sandbox. For detailed instructions on creating and activating a sandbox, see *Managing Sandboxes* in *Developing and Customizing Applications for Oracle Identity Governance*.
4. Click **Manage**. The Home tab displays the different Manage option. Click **Users**. The Manage Users page is displayed.
5. From the Actions menu, select **Create**. Alternatively, you can click **Create** on the toolbar. The Create User page is displayed with input fields for user profile attributes.
6. Click **Customize** at the upper right corner of the page to open WebCenter Composer. The Create User page opens in customization mode as shown in [Figure 6-2](#).

Figure 6-2 Create User Page in Customization Mode

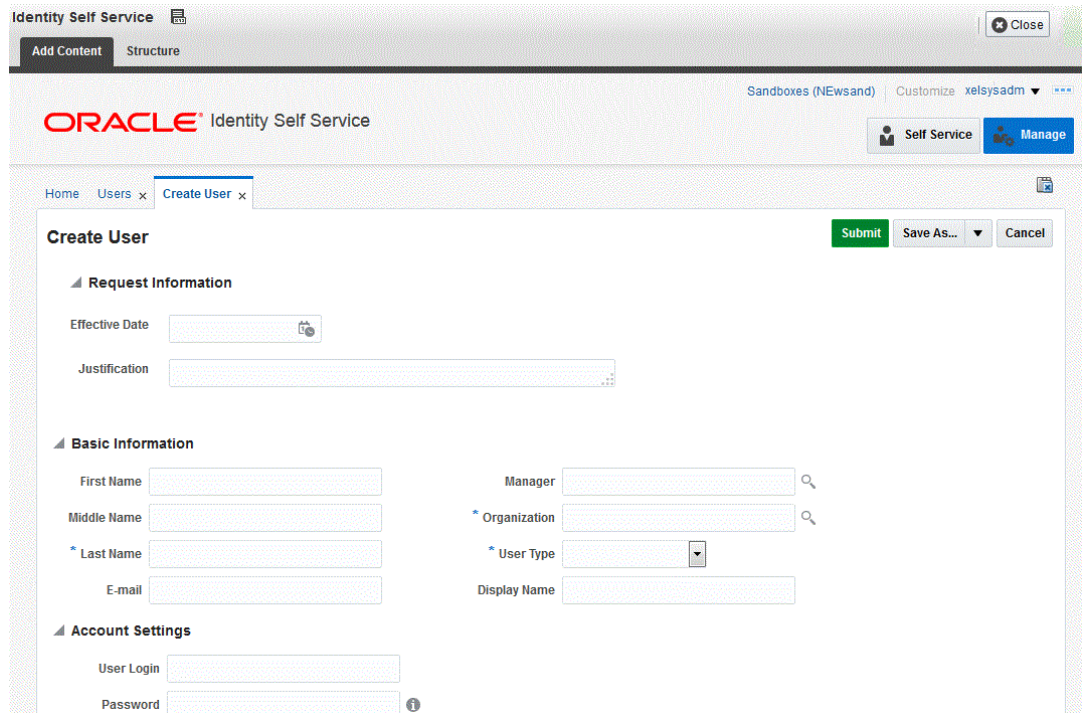

7. Enter values for all mandatory fields.
8. Select **Structure** tab. The object tree is displayed as shown in Figure 6-3.

Figure 6-3 Object Tree Page in Customization Mode

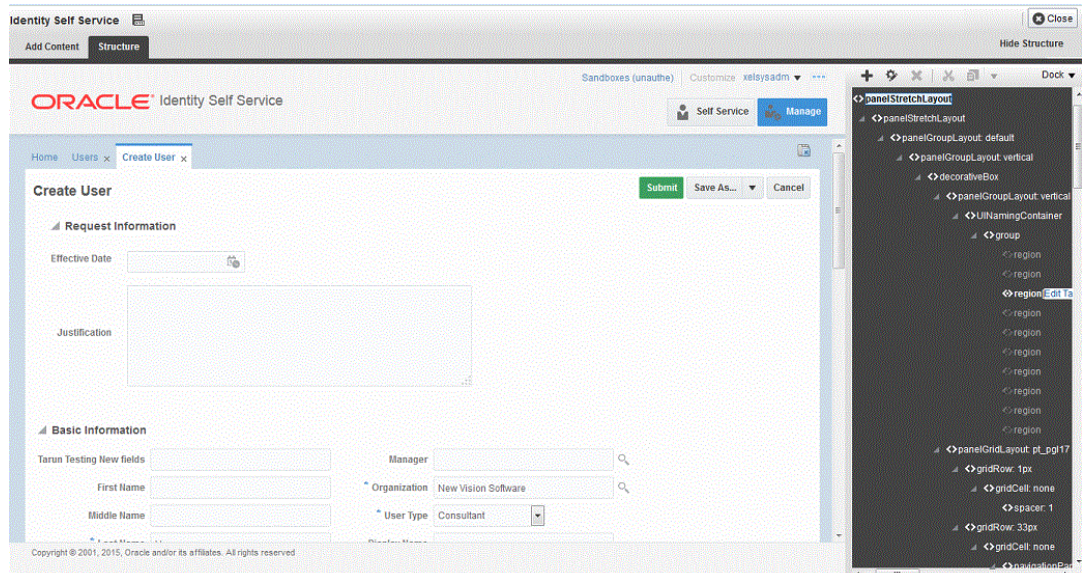

9. Select the section of the page on which you want to add the UDF.
10. In the Confirm Task Flow Edit dialog box, click **Edit** to confirm the edit task. The corresponding ADF component in the object tree is selected.
11. Select the **panelFormLayout** component, and click the **Add** icon. The Add Content dialog box is displayed.

- Depending on the entity or area on which the UDF was added, select the data component, and then the view object. Table 6-3 lists the entities, pages, data components, and view objects that must be selected.

 **Note:**

Adding VO as tables is not supported.

**Table 6-3 Entities and Corresponding Data Components and View Objects**

Entity	Page	Data Component	View Object
User	Create User	Data Component - Catalog	userVO
User	Modify User	Data Component - Catalog	userVO
User	Search Users	Data Component - Manage Users	UserVO1
User	View User Details	Data Component - Manage Users	UserVO1
User	My Information	Data Component - My Information	UserVO1
User	New User Registration	Data Component - User Registration	UserVO1
Role	Create Role	Data Component - Role	RoleDetailsVO
Role	Modify Role	Data Component - Role	RoleDetailsVO
Role	Search Roles	Data Component - Role	RoleVO1
Organization	Create Organization	Data Component - Organization	EditOrgVO
Organization	Modify Organization	Data Component - Organization	EditOrgVO
Organization	Search Organizations	Data Component - Organization	OrganizationVO
Catalog	Access Request	Data Component - Catalog	<ul style="list-style-type: none"> <li>Catalog results table: CartItemsVO1</li> <li>Cart items under Edit Cart Popup: CartItemsVO</li> <li>Catalog details for a selected cart item either under catalog results table or edit cart popup: EditCartItemsVO</li> </ul>
Certification	User Certification	Data Component - Certification	UserCertificationUserVO1
Certification	User Certification	Data Component - Certification	UserCertificationUserEntitlementVO1
Certification	Role Certification	Data Component - Certification	RoleCertificationRoleVO1
Certification	Role Certification	Data Component - Certification	RoleCertificationMemberVO1
Certification	Role Certification	Data Component - Certification	RoleCertificationPolicyVO1
Certification	Application Instance Certification	Data Component - Certification	ApplicationCertificationApplicationVO
Certification	Application Instance Certification	Data Component - Certification	ApplicationCertificationEntitlementVO
Certification	Entitlement Certification	Data Component - Certification	EntitlementCertificationEntitlementVO



**Table 6-3 (Cont.) Entities and Corresponding Data Components and View Objects**

Entity	Page	Data Component	View Object
Certification	Entitlement Certification	Data Component - Certification	EntitlementCertificationEntitlementMemberVO

13. Scroll to find the UDF that you added and click **Add**. If the UDF is not displayed, then refresh the content by clicking the **Refresh** icon at the top right hand corner of the dialog box.
14. Depending on the custom attribute that you created in step 1 and the type of UDF that you want to display, select one of the following items from the menu:

**For a UDF of Text or Number type:**

- ADF Output Text
- ADF Output Text w/Label
- ADF Output Formatted
- ADF Output Formatted w/Label
- ADF Input Text
- ADF Input Text w/Label
- ADF Label
- ADF Readonly Input Text w/Label
- ADF Table Column

**For a UDF of Checkbox type:**

- ADF Select Boolean Checkbox
- ADF Table Column

**For a UDF of Date type:**

- ADF Input Date w/Label
- ADF Table Column

**For a UDF of Lookup type:**

- ADF Input List Of Value (select only for searchable PickList)
- ADF Select One Choice (select only for non-searchable PickList; this option is not visible for a searchable PickList for which you must select ADF Input List of Value)
- ADF Table Column (select when adding a column within an af:table)

For example, if you have created a UDF of Text type, then select **ADF Input Text w/Label**. Similarly, if you created a searchable UDF of Lookup type, then select **ADF Input List of Value**. As an example, [Figure 6-4](#) shows options for a UDF of Text type.

Figure 6-4 Options for Adding a UDF of Text Type

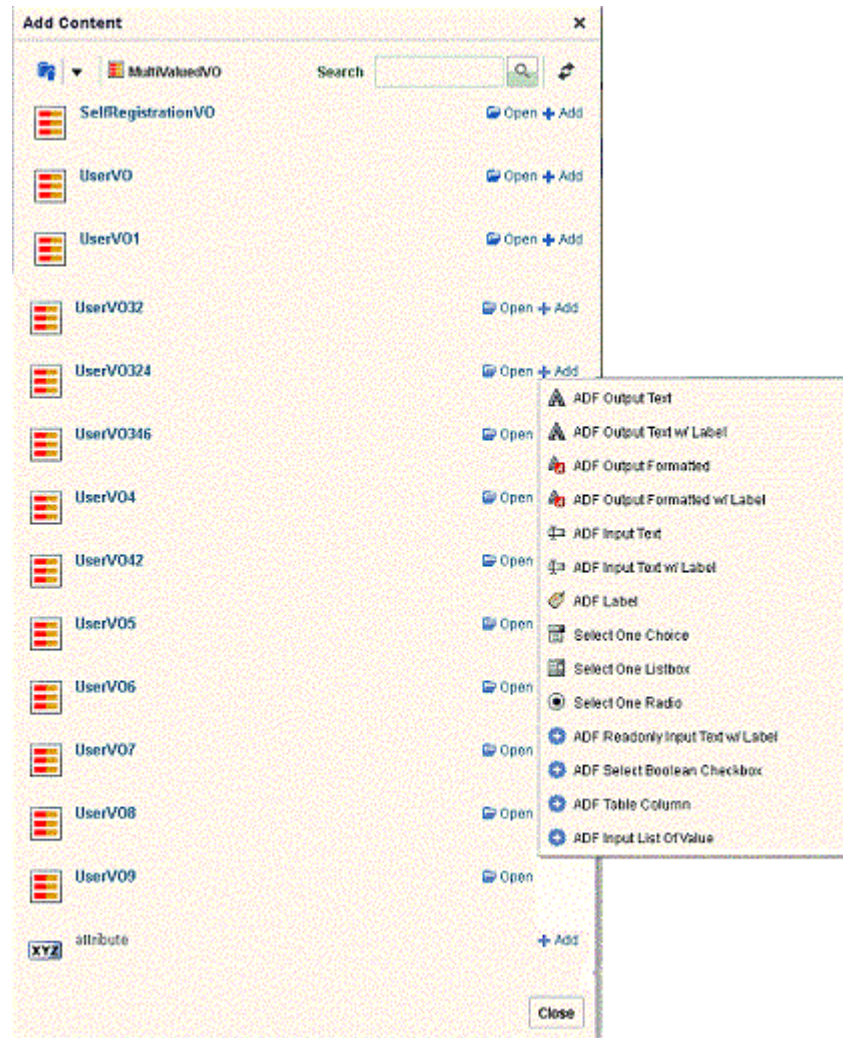

15. Click **Close** to close the Add Content dialog box.

 **Note:**

If two attribute labels are displayed for the same field, then add the attribute that does not end with \_\_C.

16. From the object tree on the Editing Page, select the UDF on the page, and click the **Show properties** icon. The Component Properties page is displayed.
17. On the Display Options tab:
  - a. Select **Auto Submit**.
  - b. If you have added the UDF on the user form, then in the Value Change Listener field, enter `#{pageFlowScope.cartDetailStateBean.attributeValueChangedListener}`.

If you have added the UDF on a form other than the user form, then copy the value of the Value Change Listener field from any of the existing fields on the form and paste it as the value of the Value Change Listener field for the newly added UDF.

- c. If you want to mark this attribute as mandatory, then change the **Required** and **Show Required** properties to `true`. To set the Show Required property, select the **Show Required** option. In the Required field, select **Expression Editor**, and in the Expression Editor field, enter the value as `true`.
- d. If you want to display this attribute as read-only, then select the checkbox for the **Read Only** property.
- e. If you want to bind this attribute to a custom-managed bean method, then change the **Value** property.

The custom-managed bean method must include a call to the original method binding. For more information, see Developing Managed Beans and Task Flows section of *Developing and Customizing Applications for Oracle Identity Governance*.

18. Click **OK**.
19. Click **Close** to leave customization mode.
20. It is recommended that you export the sandbox, in case if you intend to move the change from test to production environment. See Managing Sandboxes in *Developing and Customizing Applications for Oracle Identity Governance* for detailed instructions on exporting a sandbox.
21. Publish the sandbox. For detailed instructions on publishing a sandbox, see Managing Sandboxes in *Developing and Customizing Applications for Oracle Identity Governance*.

To remove a UDF, you can use the customization mode to open the WebCenter Composer. In the customization mode, select the component or UDF that you want to remove, and then delete it or set the rendered property on that UDF to false.

## 6.5.2 Enabling the Submit Button After Adding a UDF to the Modify User Form

After adding a new UDF to the modify user form by customizing the UI using Web Composer, the Submit button of the form is not enabled when you try to modify a user. But modification of other user form fields enables the Submit button.

To avoid this issue, when you add a new UDF to the modify user form for the first time:

1. Create a sandbox and activate it. Open the page that contains the UDF, and click **Customize**.
2. Select **Structure**.
3. Note the value of the `valueChangeListener` property of a predefined or default field. To do so:
  - a. Click the predefined field, and then click **Edit** to open the Component Properties dialog box.
  - b. Copy the value of the `valueChangeListener` property.
4. Add the new UDF to the form, as described in [Adding a Custom Attribute](#).
5. Export the sandbox as a ZIP file.
6. Delete the sandbox without publishing it.
7. Extract the ZIP file, and edit the `jsff.xml` file for the specific screen.
8. Add the following attributes to the ADF tag, for example `af:inputText`, for the UDF field, as shown:

```
valueChangeListener=VALUE_COPIED_IN_STEP3
autoSubmit="true"
```

The resulting XML will look similar to the following:

```
<?xml version='1.0' encoding='UTF-8'?>
<mds:customization version="11.1.1.61.92" xmlns:mds="http://xmlns.oracle.com/mds"
motype_local_name="root" motype_nsuri="http://java.sun.com/JSP/Page">
  <mds:move node="_xg_12" parent="_xg_pfl5" position="last"/>
  <mds:insert parent="_xg_pfl5" position="last">
    <af:inputText xmlns:af="http://xmlns.oracle.com/adf/faces/rich"
value="#{bindings.JobCode__c.inputValue}" label="#{bindings.JobCode__c.hints.label}"
required="#{bindings.JobCode__c.hints.mandatory}"
columns="#{bindings.JobCode__c.hints.displayWidth}"
maximumLength="#{bindings.JobCode__c.hints.precision}"
shortDesc="#{bindings.JobCode__c.hints.tooltip}" id="dtrt_dc_628826708"
autoSubmit="true"
valueChangeListener="#{pageFlowScope.cartDetailStateBean.attributeValueChangedListene
r}">
      <f:validator xmlns:f="http://java.sun.com/jsf/core"
binding="#{bindings.JobCode__c.validator}"/>
    </af:inputText>
  </mds:insert>
  <mds:move node="_xg_19" parent="_xg_pfl5" position="last"/>
  <mds:move node="_xg_20" parent="_xg_pfl5" position="last"/>
  <mds:move node="_xg_27" parent="_xg_pfl5" position="last"/>
  <mds:move node="_xg_23" parent="_xg_pfl5" position="last"/>
  <mds:move node="_xg_41" parent="_xg_pfl5" position="last"/>
</mds:customization>
```

9. Create the ZIP file for the sandbox.
10. Import the sandbox.
11. Publish the sandbox.

### 6.5.3 Adding a Custom Attribute Category into Create User Form

You must customize the Create User or Modify User form to add a new category of fields.

To customize the Create User or Modify User form to add a new category of fields:

1. Log in to Oracle Identity Self Service.
2. Create and activate a sandbox. For detailed instructions on creating and activating a sandbox, see *Managing Sandboxes* in *Developing and Customizing Applications for Oracle Identity Governance*.
3. Click **Manage**. The Home tab displays the different Manage option. Click **Users**. The Manage Users page is displayed.
4. From the Actions menu, select **Create**. Alternatively, you can click **Create** on the toolbar. The Create User page is displayed with input fields for user profile attributes.
5. Click **Customize** at the upper right corner of the page to open WebCenter Composer. The Create User page opens in customization mode.
6. Enter values for all mandatory fields.
7. Select **Structure** tab. The object tree is displayed.
8. Click the first field of the Create User form and select its ancestor **panelGroupLayout** component.
9. Click the **Add Content** icon.

10. In the Add Content dialog box, click **Web Components**.
11. Click **Add** next to the **ShowDetailHeader** component.
12. Click **Close**.
13. Select the newly added **ShowDetailHeader** component and click **Edit** to open the Component Properties dialog box.
14. Modify the value of Size to 2 .
15. Modify the default value of Text with a suitable value.
16. Click **Apply** and **Close**.
17. Click the **Add Content** icon.
18. In the Add Content dialog box, click **Web Components**, if not already open.
19. Click **Add** next to the **PanelFormLayout** component.
20. Click **Close**.
21. Add fields into this new panelFormLayout component as described in step 11 in [Adding a Custom Attribute](#).
22. Click **Close** to leave customization mode.
23. It is recommended that you export the sandbox, in case if you intend to move the change from test to production environment. See *Managing Sandboxes in Developing and Customizing Applications for Oracle Identity Governance* for detailed instructions on exporting a sandbox.
24. Publish the sandbox. For detailed instructions on publishing a sandbox, see *Managing Sandboxes in Developing and Customizing Applications for Oracle Identity Governance*.

## 6.5.4 Customizing Unauthenticated Page

You can customize an unauthenticated page for example New User Login or Self Registration page.

To customize an unauthenticated page for example New User Login or Self Registration page:

1. Log in to Oracle Identity Self Service.
2. Create and activate a sandbox. For detailed instructions on creating and activating a sandbox, see *Managing Sandboxes in Developing and Customizing Applications for Oracle Identity Governance*.
3. Click **Self Service**. The Home tab displays the different Self Service option.
4. Click **Customize** at the upper right corner of the page to open WebCenter Composer. The Home page opens in customization mode.
5. Select **Structure** tab. The object tree is displayed.
6. Select the area on the screen where all other tiles like My Information, My Access and so on are present.
7. In the right hand side panel, select the last *gridRow*, right click and select **Show Component**.

Incase the Unauthenticated box does not immediately appear on the screen, you may have to close the screen and reopen.

8. Unauthenticated option gets added to the screen. This box has a drop-down list of all unauthenticated pages in the Identity Self Service. You can select any one screen that you would like to customize.

For detailed steps on how to add a custom attribute see, [Adding a Custom Attribute](#).

## 6.6 Adding a Custom Attribute to an Application Instance Form

When you create a custom attribute (UDF) on an application instance form, it is created only in the backend, and is not available in the page for use on which you want it to be displayed. The options available to display the UDF in a page in the Identity Self Service are regenerating view and updating the application instance form by using WebCenter Composer.

The following are the options available to display the UDF in a page in Oracle Identity Self Service:

- [Regenerating View](#)
- [Updating the Application Instance Form By Using WebCenter Composer](#)

### 6.6.1 Regenerating View

One of the methods to display a UDF in a page in the Identity Self Service is to use the Regenerate View option in the Child Objects tab of the Form Designer.

To display the UDF in a page in Oracle Identity Self Service:

1. Log in to Oracle Identity System Administration.
2. Create and activate a sandbox. For detailed instructions on creating and activating a sandbox, see *Managing Sandboxes in Developing and Customizing Applications for Oracle Identity Governance*

#### Note:

You must ensure that sandbox in which the application instance form for which you are adding a custom child attribute must be published. If it is not published, then you must perform the procedure described in this section in the same sandbox in which the application instance form was created.

3. In the left pane, under Provisioning Configuration, click **Form Designer**. The Form Designer page is displayed.
4. Search for and open the application instance form whose child form (containing the UDFs that you added) must be displayed in a page in Oracle Identity Self Service.
5. On the Child Objects tab, click **Regenerate View**.

 **Note:**

- The Regenerate View dialog box is displayed. Select the appropriate options for **Form Type** and **Generate Entitlement Forms**. See [Modifying Forms By Using the Form Designer](#) for information about the Form Type and Generate Entitlement Forms options.
- Any customization made to the page will be lost when you click **Regenerate View**.

6. It is recommended that you export the sandbox, in case if you intend to move the change from test to production environment. See *Managing Sandboxes in Developing and Customizing Applications for Oracle Identity Governance* for detailed instructions on exporting a sandbox.
7. Publish the sandbox. For detailed instructions on publishing a sandbox, see *Managing Sandboxes in Developing and Customizing Applications for Oracle Identity Governance*.

## 6.6.2 Updating the Application Instance Form By Using WebCenter Composer

One of the methods to display a UDF in a page in the Identity Self Service is to update the application instance form by using WebCenter Composer.

To display the UDF in a page in Oracle Identity Self Service:

1. Create the UDF by using the Form Designer.
2. Log in to Oracle Identity Self Service.
3. Create and activate a sandbox. For detailed instructions on creating and activating a sandbox, see *Managing Sandboxes in Developing and Customizing Applications for Oracle Identity Governance*
4. In the left pane, under System Entities, click **Catalog**. The Catalog page is displayed.
5. Search for and select the application instance whose resource form page must be updated, and the click **Add to Cart**.
6. Click **Checkout**.
7. On the Cart Details page, under the Details section, the application instance form and its attributes are displayed.
8. Click **Customize** to open WebCenter Composer. The page opens in customization mode.
9. Enter values for all mandatory fields.
10. From the View menu at the upper left corner of the page, select **Structure**. The object tree is displayed.
11. Under the Details section, select and click the attributes of the application instance form. A message confirming whether you want to edit the page is displayed.
12. Click **Edit**. In the object tree, the ADF component corresponding to the selection made in the preceding step is selected.
13. Click **Add Content**. The Add Content dialog box is displayed.
14. Select the data component. To do so:

- a. Select **Data Component - Catalog**.
  - b. Search for **APP\_INSTANCEVO** and then click **Open**. Here, **APP\_INSTANCE** is the name of the application instance for which the attributes are added.
15. Scroll to find the UDF that you added. If the UDF is not displayed, then refresh the page.
  16. Select the UDF on the page, and click **Add**.
  17. Click **Close** to leave customization mode.
  18. It is recommended that you export the sandbox to move the change from the test to production environment. For detailed instructions on exporting a sandbox, see *Managing Sandboxes in Developing and Customizing Applications for Oracle Identity Governance*
  19. Publish the sandbox. For detailed instructions on publishing a sandbox, see *Managing Sandboxes in Developing and Customizing Applications for Oracle Identity Governance*.

## 6.7 Moving UDFs from Test to Production

You can move a UDF that is added to an entity from one deployment, such as test environment, to another, such as production environment.

The following sections discuss the procedure to move a UDF added to entities from test to production:

- [Moving UDFs Added to Entities](#)
- [Moving UDFs Added to Catalog Entities](#)

### See Also:

- [Limitations of the Test to Production Procedures](#) for information about test to production limitations.
- *Handling Concurrency Conflicts in Developing and Customizing Applications for Oracle Identity Governance* for information about handling concurrency conflicts when multiple users customize an application by using sandboxes and troubleshooting concurrency issues

### 6.7.1 Moving UDFs Added to Entities

You can move a UDF that is added to a User, Role, Organization or Application Instance entity from one deployment to another by using the Deployment Manager.

Moving a UDF that is added to a User, Roles, Organization or Application Instance entity from test to production consists of the following steps:

- [Exporting the UDF from the Test Environment](#)
- [Importing the UDF into the Production Environment](#)



 **Note:**

Before you perform these procedures, ensure that you do not have any popup blockers enabled in your browser and that you have a supported Java Runtime Environment (JRE) installed in the browser. This is because the Deployment Manager uses a popup window and it requires JRE to be installed in the browser.

### 6.7.1.1 Exporting the UDF from the Test Environment

To export the UDF from the test environment:

1. Log in to Oracle Identity System Administration.
2. Under System Configuration, click **Export**.
3. Search for the desired metadata, User Metadata, Role Metadata, Organization Metadata, or Application instances. A list of all available metadata is displayed.
4. Select the UDF that you want to move from test to production, and then click **Select Children**.
5. Click **Select Dependencies**, and then click **Confirmation**.
6. Click **Add for Export**.
7. In the confirmation message that is displayed, click **OK** to exit the wizard.
8. Click **Export**. Alternatively, provide description and then click **Export**.
9. Specify the location to which the content must be exported. A message confirming that the export was successful is displayed.
10. Export the sandbox from the test environment to store all the changes made in your sandbox. For detailed instructions on exporting a sandbox, see *Managing Sandboxes in Developing and Customizing Applications for Oracle Identity Governance*.

 **Note:**

- The sandbox exported here must be the same, which has been used while creating and adding custom UDFs.
- The sandbox must not have been published before exporting, because there is no way to export the published sandbox.

### 6.7.1.2 Importing the UDF into the Production Environment

To import UDF into the production environment:

1. In Oracle Identity System Administration, under System Configuration, click **Import**.
2. Specify the path to the XML file that was exported from the test environment by using the Deployment Manager.
3. Click **Add File, Import**, and then confirm the import. A message confirming that the import was successful is displayed.

4. Import the sandbox exported from the test environment. For information about importing a sandbox, see *Managing Sandboxes in Developing and Customizing Applications for Oracle Identity Governance*.
5. Activate the sandbox to verify the changes. For information about activating a sandbox, see *Managing Sandboxes in Developing and Customizing Applications for Oracle Identity Governance*.
6. Publish the sandbox after you verify the changes. For information about publishing a sandbox, see *Managing Sandboxes in Developing and Customizing Applications for Oracle Identity Governance*.

## 6.7.2 Moving UDFs Added to Catalog Entities

Depending upon the type of customization done, moving the catalog definition from test to production involves one or both the steps of exporting and importing using sandbox and Deployment Manager.

The procedure to move a UDF added to a catalog entity from test to production is discussed later in this guide. See [Test to Production Procedures for Catalog Customizations](#) for more information.

## 6.8 Synchronizing User-Defined Fields Between Oracle Identity Governance and LDAP

If you enable LDAP synchronization any time after creating one or more UDFs, then you must synchronize these UDFs with the corresponding LDAP attributes.

To do so, by using the Form Designer, search for and open the form containing the UDF, and then save it (no need to make any other change). Repeat this process of opening the form containing the UDF and then saving it for all UDFs created before enabling LDAP synchronization.

### Note:

- LDAP synchronization works when Oracle Identity Manager is integrated with Access Manager (OAM). The integration is based on LDAP connectors and is available from Release 12.2.1.3 onwards. For more information on LDAP synchronization, see [Enabling LDAP Synchronization in Oracle Identity Manager](#) in the *Integration Guide for Oracle Identity Management Suite*.
- While creating/modifying an attribute using Form Designer, provide a value against LDAP Attribute. This is the value of LDAP attribute name against which the user-defined field (UDF) will be synchronized, and applicable only in LDAP sync enabled environment.
- If you are using an OUD LDAP directory, then the Oracle Identity Manager custom attribute name must not contain a space. OUD does not allow creating a custom attribute with space in the attribute name.

## 6.9 Creating Cascaded LOVs

Creating cascaded LOVs involve activating a sandbox, creating UDFs of Lookup type, exporting the sandbox, and customizing the UI.

To create cascaded LOVs on the My Information page:



### Note:

In this release of Oracle Identity Manager, LOVs cannot be added on the Self-Registration Page.

1. Log in to Oracle Identity System Administration.
2. Create and activate a sandbox, for example `SUJ`. For detailed instructions on creating and activating a sandbox, see *Managing Sandboxes in Developing and Customizing Applications for Oracle Identity Governance*.
3. Under System Entities in the left pane, click **User**.
4. Create the following UDFs of Lookup Type:
  - parent - ParentChoice
  - dependent - DepChoice

While creating DepChoice, make it dependent on the UDF ParentChoice, and map the values. To do so:

- a. In the List of Values section, search for the parent field and select it.  
Select **Constrain list by parent field value selection**. This enables the fields to set the parent dependency details.
- b. Select the required **Parent Choice List** and set the **Value Map**.

5. Click **Save and Close**.
6. Export the sandbox.

The sandbox is stored as `sandbox_SUJ.zip`.

7. Unzip the `sandbox_SUJ.zip` file, and perform the following steps:
  - a. In the file  
`\persdef\sessiondef\oracle\iam\ui\runtime\form\model\user\view\mdssys\cust\site\site\userVO.xml.xml`, under tag `<ViewAttribute Name="DepChoice__c">`, search for the following text:

```
<Property Name="CascadingParentChoiceList" Value="ParentChoice__c"/>
<Property Name="CascadingRelationshipId" Value="100000000002523"/>
```
  - b. Copy the text in Step 7 a to  
`\persdef\oracle\iam\ui\common\model\user\view\mdssys\cust\site\site\UserVO.xml.xml` file under tag `<ViewAttribute Name="DepChoice__c">`.
  - c. In the file  
`\persdef\sessiondef\oracle\iam\ui\runtime\form\model\user\view\mdssys\cust\site\site\userVO.xml.xml`, search for the following text:

```

</mds:insert>
<mds:insert parent=" userVO " position="last">
<ViewAccessor Name="LOVVA_For_DepChoice__c"
ViewObjectName="oracle.adf.businesseditor.model.views.CascadingLookups "
xmlns="http://xmlns.oracle.com/bc4j">

  <ParameterMap>
    <PIMap Variable="Bind_RelationshipId">
      <TransientExpression Name="expression" access="local"><![
CDATA[structureDef.findAttributeDef("DepChoice__c
").getProperty("CascadingRelationshipId")]]></TransientExpression>
    </PIMap>
    <PIMap Variable="Bind_ParentLookupCode">
      <TransientExpression Name="expression" access="local"><![
CDATA[ParentChoice__c]]></TransientExpression>
    </PIMap>
  </ParameterMap>

</ViewAccessor>
</mds:insert>
</ParameterMap>
</ViewAccessor>
</mds:insert>

```

**d. In the file**

\tmp\persdef\oracle\iam\ui\common\model\user\view\mdssys\cust\site\site\UserVO.xml.xml search for the below text and replace it with the text copied in step 7 c. Change userVO to UserVO:

```

</mds:insert>
<mds:insert parent="UserVO" position="last">
<ViewAccessor Name="LOVVA_For_DepChoice__c"
ViewObjectName="oracle.adf.businesseditor.model.views.Lookups"
xmlns="http://xmlns.oracle.com/bc4j">
<ParameterMap>
<PIMap Variable="Bind_LookupType">
<TransientExpression><![CDATA['Lookup.Conditions.Severity']]></TransientExp
ression>
</PIMap>
</ParameterMap>
</ViewAccessor>
</mds:insert>

```

**e. In the file**

\persdef\sessiondef\oracle\iam\ui\runtime\form\model\user\view\mdssys\cust\site\site\userVO.xml.xml, search for the following text:

```

<mds:insert parent="userVO" position="last">
  <Properties xmlns="http://xmlns.oracle.com/bc4j">
    <Property Name="__INTERNAL_EXPR_VALUE_OVERRIDES__" Value="userEO"/>
  </Properties>
</mds:insert>

```

**f. Copy the text from 7 e to file**

persdef\oracle\iam\ui\common\model\user\view\mdssys\cust\site\site\UserVO.xml.xml and change userVO to UserVO and userEO to UserEO.

**8. Recreate the zip file with same name as in Step 6.**

For example, `$zip -r sandbox_SUJ.zip*`

**9. Delete the sandbox SUJ from Oracle Identity System Administration.****10. Import the modified sandbox\_SUJ.zip created in Step 8.**

11. Logout from Oracle Identity System Administration.
12. Log in to Oracle Identity Self Service.
13. Activate the sandbox, `SUJ`.
14. In the left pane, under **My Profile**, click **My Information**. The My Information page is displayed.
15. Click **Customize** to customize the My Information page while the sandbox is active in Oracle Identity Self Service.
16. Add parent UDF and child UDF (created in Step 4) on the page as **Select one choice** component.
17. Select ParentChoice and click **Edit Property** and copy the Id of parent component. Set the **auto submit property to true**.
18. Select DepChoice and click **Edit Property** and paste the id value of ParentChoice UDF copied in Step 17 to the partailTrigger field.
19. Publish the sandbox.

 **Note:**

For any LOV, the user details page displays the lookup code as the output text value. To display the LOV lookup value on the user details page, create a searchable picklist (ADF name input list of value), and then make it read-only.

## 6.10 Specifying Cascaded LOVs Without NULL Value

When you set the value of the required property to true in the attributes on the create user or modify user form, you can still submit a request without selecting a value.

To make the user select a value for the required attribute, you must modify the request dataset to mark the attribute as mandatory. To do so:

1. When the administrative server and at least one Oracle Identity Manager managed server is running, login to Oracle Enterprise Manager Fusion Middleware Control by using the URL in the following format:  
`http://ADMINISTRATION_SERVER:PORT/em`
2. Navigate to **Identity and Access, oim**. Right-click and navigate to **System MBean Browser**.
3. Under Application Defined MBeans, navigate to **oracle.mds.lcm, Server:oim\_server1, Application:OIMAppMetadata, MDSAppRuntime**.
4. To export the request dataset:
  - a. Click the **Operations** tab, and then click **exportMetaData**.
  - b. In the toLocation field, enter `/tmp` or the name of another directory.
  - c. Select createSubDir as **false**.
  - d. Specify the doc location as the following:

`/metadata/iam-features-requestactions/model-data/CreateUserDataSet.xml.`

`/metadata/iam-features-requestactions/model-data//ModifyUserDataset.xml`

 **Note:**

Multiple documents can be set in the doc location while invoking operations `exportMetaData` or `importMetaData`.

- e. Also select **false** for `excludeAllCust`, `excludeBaseDocs`, and `excludeExtendedMetadata`. Then, click **Invoke**.  
This exports the file specified in the `docs` field to the directory specified in the `toLocation` field.
5. Edit the `CreateUserDataSet.xml` file, and change the value of the 'required' property to `true` for the attribute you created.
6. Edit the `ModifyUserDataset.xml` file, and change the value of the 'required' property to `true` for the attribute you created.
7. To import the request dataset:
  - a. Click **importMetaData**.
  - b. In the `fromLocation` field, enter `/tmp` or the name of the directory in which you have the configuration files.
  - c. Select `createSubDir` as **false**.
  - d. Also select **false** for `excludeAllCust`, `excludeBaseDocs`, and `excludeExtendedMetadata`. Then, click **Invoke**.  
This imports the file specified in the `docs` field to MDS in the `toLocation` field.
8. Restart Oracle Identity Manager.

## 6.11 Localizing Display Labels of UDFs

Localizing display labels of UDFs involves localizing the content in the `BizEditorBundle.xlf` file.

To localize display labels of UDFs:

1. Add a new custom field for the user object by referring to [Creating a Custom Attribute](#) and ensure to publish the sandbox.
2. Export the `BizEditorBundle.xlf` file from MDS by referring to [Exporting Metadata Files to MDS](#) in the *Developing and Customizing Applications for Oracle Identity Governance*.
3. Localize the content in `BizEditorBundle.xlf` to the expected locales. To do so:
  - a. Create a copy of the `BizEditorBundle.xlf` file and rename it, for example, `BizEditorBundle_zh_CN.xlf`.
  - b. Edit the `<file>` element from:

```
<file source-language="en" original="/xliffBundles/oracle/iam/ui/runtime/BizEditorBundle.xlf" datatype="x-oracle-adf">
```

To the following sample:

```
<file source-language="en" original="/xliffBundles/oracle/iam/ui/runtime/BizEditorBundle.xlf" datatype="x-oracle-adf" target-language="zh-CN">
```

- c. Translate all the contents in the `BizEditorBundle_zh_CN.xlf` file.

4. Import the BizEditorBundle\_zh\_CN.xlf file to MDS by referring to Importing Metadata Files from MDS in the *Developing and Customizing Applications for Oracle Identity Governance*.
5. Customize the Identity Self Service page to add the custom field label. See [Adding a Custom Attribute](#) for details.
6. Switch the browser language to zh-CN, and log in to the Identity Self Service again.
7. Go to the page on which the custom attribute has been added, and confirm that the customized field label is using its localized value.

## 6.12 Configuring a Field as Mandatory Attribute in the Request Catalog

Configuring a field as mandatory attribute in the request catalog involves customizing the catalog, and setting the value of the Override property to true.

To configure a field as mandatory attribute in the request catalog:

1. In Oracle Identity Self Service, create and activate a sandbox. For detailed instructions on creating and activating a sandbox, see *Managing Sandboxes in Developing and Customizing Applications for Oracle Identity Governance*.
2. On the left pane, under System Entities, click **Catalog**. The Catalog page is displayed.
3. Search for and select the application instance whose form page must be updated, and then click **Add to Cart**.
4. Click **Checkout**.
5. On the Cart Details page, under the Details section, the application instance form and its attributes are displayed.
6. Click **Customize**. The page opens in customization mode.
7. From the View menu, select **Source**. The object tree is displayed.
8. Under the Details section, select and click the attributes of the application instance form. A message confirming whether you want to edit the page is displayed.
9. Click **Edit**. In the object tree, the ADF component corresponding to the selection made in step 8 is selected.
10. Select the input text that is to be marked as mandatory, and click **Edit**. The Component Properties:inputText window opens.
11. Navigate to the required field, click the drop down icon adjacent to the field, select **Override**, and then select **Expression Builder**.
12. In the Expression Builder window, select the **Type a value or expression** option, and enter `true`.
13. Click **OK**, and then click **Apply**.
14. Click **OK** in the Component Properties:inputText. Click **Close** to quit customization mode.
15. Export the sandbox and publish it.

# Part V

## Application Management

Application management includes managing IT resources, application instances, and connector lifecycle, and reconciliation.

This part describes application management in Oracle Identity Manager. It contains the following chapters:

- [Managing IT Resources](#)
- [Managing Application Instances](#)
- [Managing Connector Lifecycle](#)
- [Managing Reconciliation](#)



# 7

## Managing IT Resources

In an application instance, IT resource management includes target connectivity configurations and connector configurations. Using the managing IT resources section, you can create an IT resource, search for existing IT resources, and view and modify IT resources. See [Managing Application Instances](#) for information about application instances.

This chapter describes how to create and manage IT resources in the following sections:

- [Creating IT Resources](#)
- [Searching IT Resources](#)
- [Viewing IT Resources](#)
- [Modifying IT Resources](#)
- [Deleting IT Resources](#)

### 7.1 Creating IT Resources

Oracle Identity Manager associate resource types with resource objects. Users need to create a new IT resource in order to associate this resource type with the corresponding resource object. Creation of IT resource includes steps such as selecting the IT resource type definition and providing parameter values.

To create an IT resource:

 **Note:**

The IT resource type is created before the IT resource can be created. The IT resource type can be created either by using the Design Console, or by importing the IT resource type using the Deployment Manager. See IT Resources Type Definition Form in *Developing and Customizing Applications for Oracle Identity Governance* for information about defining an IT resource type.

1. Login to Oracle Identity System Administration.
2. Under Provisioning Configuration, click **IT Resource**. The Manage IT Resources page is displayed.
3. Click **Create** on the toolbar. The Create IT Resource wizard is displayed.
4. Enter the following information:
  - a. **IT Resource Name:** Enter a name for the IT resource.
  - b. **IT Resource Type:** Select an IT resource type for the IT resource. The Parameter Values information is displayed.
  - c. In the Parameter Values section, specify values for the parameters of the IT resource.
5. Click **Test Connection** to check the connectivity.

 **Note:**

By default, Test connectivity option is available for IT resource types Database and Mails server.

If the test is successful, then click **Finish**. If the test fails, then you can perform one of the following steps:

- a. Check and make changes to the parameter values and then click **Test Connection**.
- b. Click **Cancel** to stop the procedure.
- c. Proceed with the creation process by clicking **Finish**. You can fix the problem later, and then rerun the connectivity test.

## 7.2 Searching IT Resources

You can search IT resources by IT resource name and type in the Manage IT Resources page.

To search an IT resource:

1. In Oracle Identity System Administration, under Provisioning Configuration, click **IT Resource**. The Manage IT Resource page is displayed.
2. On the Manage IT Resources page, you can use one of the following search options to locate the IT resource that you want to view:
  - IT Resource Name: Enter the name of the IT resource, and then click **Search**.
  - IT Resource Type: Select the IT resource type of the IT resource, and then click **Search**.
  - Click **Search**.

On the Manage IT Resource page, the list of IT resources that meet the search criteria is displayed.

To clear selections made in the IT Resource Name or the IT Resource Type fields, click **Reset**.

## 7.3 Viewing IT Resources

You can view IT resources and their parameters in the Manage IT Resources page.

To view an IT resource:

1. From the list of IT resources displayed in the search results, click the IT resource name. The View IT Resource page is displayed. All IT Resource parameter values are listed in this page.
2. Click **Edit** to update the parameters of the IT Resource. The Edit IT Resource page is displayed.

## 7.4 Modifying IT Resources

You can modify IT resource parameters in the Manage IT Resources page.

To modify an IT resource:

1. From the list of IT resources displayed in the search results table, select the IT resource and then click **Edit**. The Edit IT Resource page is displayed.
2. Update the parameter values of the required fields. Click **Save**.

## 7.5 Deleting IT Resources

You can find and delete an IT resource in the Manage IT Resources page. The delete operation is performed as part of the IT Resource lifecycle management process and reduces resource duplication.

To delete an IT resource:

1. From the list of IT resources displayed in the search results, click the Delete icon for the IT resource that you want to delete.
2. To confirm that you want to delete the IT resource, click **Confirm Delete**.



**Note:**

Deleting IT resource instances soft-deletes the corresponding application instances.

# 8

## Managing Generic Connectors

Generic connector management includes various subtasks such as creating, deploying, and managing generic technology connectors.

Generic connectors are managed by using Oracle Identity System Administration. See Predefined Providers for Generic Technology Connectors in *Developing and Customizing Applications for Oracle Identity Governance* for information about generic technology connectors (GTC).

This chapter describes how to create and manage generic connectors in the following sections:

- [Creating Generic Technology Connectors](#)
- [Using Identity System Administration to Create the Connector](#)
- [Managing Generic Technology Connectors](#)

### 8.1 Creating Generic Technology Connectors

While creating a generic connector, you need to consider various connector design aspects, such as provider requirements and selections, address all prerequisites, configure reconciliation and provisioning, create a form, publish a form, and enable logs for the generic create operations.

The procedure to create a generic technology connector is composed of the following steps:

- [Determining Provider Requirements for Creating Generic Technology Connectors](#)
- [Selecting the Providers for Creating Generic Technology Connectors](#)
- [Addressing the Prerequisites for Creating Generic Technology Connectors](#)
- [Creating the Connector Using Identity System Administration](#)
- [Configuring Reconciliation](#)
- [Configuring Provisioning](#)
- [Creating the Form and Publishing the Application Instance](#)
- [Enabling Log for the Generic Technology Connector](#)

#### 8.1.1 Determining Provider Requirements for Creating Generic Technology Connectors

In order to determine provider requirements, first you need to identify various provider-based building blocks. Then, you create data formats and transport mechanism. As a final step, you identify providers to create a generic connector.

The following providers can be used as the building blocks of the generic technology connectors you create:

- Reconciliation Transport Provider
- Reconciliation Format Provider

- Provisioning Transport Provider
- Provisioning Format Provider
- Transformation Provider
- Validation Provider

Based on your knowledge of the data formats and data transport mechanisms supported by the target system, identify the providers that must be included in the generic technology connector that you create. If the target system supports multiple data formats and data transport mechanisms, you must select a single combination of the transport and format providers discussed in the first chapter. You cannot include, for example, multiple reconciliation format providers in a single generic technology connector.

## 8.1.2 Selecting the Providers for Creating Generic Technology Connectors

Selection of providers includes identifying predefined providers. Create a custom provider only to address any special generic connector requirement.

Identify the predefined providers that can be used to meet your provider requirements. See *Predefined Providers for Generic Technology Connectors* in the *Developing and Customizing Applications for Oracle Identity Governance* for information about the predefined providers.

If all your provider requirements are addressed by the predefined providers, you need not create custom providers. You must create custom providers to address only the requirements that are not addressed by the predefined providers.

## 8.1.3 Addressing the Prerequisites for Creating Generic Technology Connectors

Prerequisites for creating generic technology connectors include testing connectivity with the target system, creating the user accounts to be used for creating the generic technology connector, and enabling cache for the `GenericConnector` and `GenericConnectorProviders` cache categories.

You must address the following prerequisites:

- If you are creating the generic technology connector on a production server, enable the cache for the following cache categories:
  - `GenericConnector`
  - `GenericConnectorProviders`
- Testing connectivity between the target system server and the Oracle Identity Manager server

You must take steps to ensure that connectivity can be established between the target system server and the Oracle Identity Manager server. For example, in a UNIX environment, you must enter the fully qualified host name of the Oracle Identity Manager server in the `/etc/hosts` file on the target system server.

- Creating the user account to be used for creating the generic technology connector

All users belonging to the `SYSTEM ADMINISTRATORS` group of Oracle Identity Manager can create generic technology connectors. Alternatively, members of a group to which you assign the required menu items and permissions can create generic technology connectors.

The required menu items are as follows:

- Create Generic Technology Connector menu item
- Manage Generic Technology Connector menu item

The required permissions are as follows:

- Form Designer (Allow Insert, Write Access, Delete Access)
- Structure Utility. Additional Column (Allow Insert, Write Access, Delete Access)
- Meta-Table Hierarchy (Allow Insert, Write Access, Delete Access)

If these permissions are not correctly assigned to the group, an error is thrown when the user clicks the Create button on the final Identity System Administration page for creating generic technology connectors.

 **Note:**

In an Oracle Identity Manager deployment that is integrated with Access Manager (OAM), the OIMSignatureAuthenticator authentication provider is not configured by default. If you use Oracle Identity Manager 9.x connectors, such as GTC, or if your custom code uses signature-based OIMClient login, then you must enable the OIMSignatureAuthenticator authentication provider.

## 8.1.4 Creating the Connector Using Identity System Administration

Creating a new generic connector involves specifying parameter values, defining of datasets and mapping of datasets, along with defining of the forms.

To navigate to the first Identity System Administration page for creating a generic technology connector:

1. Log in to Identity System Administration.
2. Click **Generic Connector** under Provisioning Configuration.
3. In the Manage Connectors page, click **Create**.
4. Provide basic information about the generic technology connector that you want to create in the Provide Basic Information page. Follow procedure in [Providing Basic Information for Generic Technology Connector](#).
5. Enter values for all parameters in Specify Parameter Values Page. Follow procedure in, [Specifying Parameter Values for the Providers](#).
6. Define data sets and mappings between the fields of the data sets in Modify Connector Configuration Page. Follow procedure in, [Modifying Connector Configuration](#).
7. Specify form names for the process forms corresponding to the OIM - Account data set and its child data sets. Follow procedure in, [Verifying Connector Form Names](#).
8. Review information that you have provided up to this point for creating generic technology connectors. Follow procedure in, [Verifying Connector Information](#).

## 8.1.5 Configuring Reconciliation

After successfully creating a generic connector, the next step is to configure reconciliation. Skip the configuration reconciliation step if you have selected only the provisioning option while creating a connector.

A reconciliation scheduled task is created automatically when you create the generic technology connector. To configure and run this scheduled task, follow the instructions in [Managing the Scheduler](#).

 **Note:**

The name of the scheduled task is in the following format:

*GTC\_Name\_GTC*

For example, if the name of the generic technology connector is `WebConn`, the name of the scheduled task is `WebConn_GTC`.

## 8.1.6 Configuring Provisioning

Configure provisioning if you have selected the provisioning configuration option while creating the connector. Skip this step if you have selected only the Reconciliation option on the Step 1: Provide Basic Information page.

A process definition is one of the objects that are automatically created when you create a generic technology connector. The name of the process definition is in the following format:

*GTC\_name\_GTC*

For example, if the name of the generic technology connector is `WebConn`, the name of the process definition is `WebConn_GTC`.

The process tasks that constitute this process definition can be divided into two types:

- System-defined process tasks

System-defined process tasks are included by default in all newly created process definitions.

- Provisioning-specific process tasks

Provisioning-specific process tasks are included in the process definition of a generic technology connector only if you select the Provisioning option on the Step 1: Provide Basic Information page, regardless of whether or not you select the Reconciliation option.

The following are provisioning-specific process tasks:

- Create User
- Delete User
- Enable User
- Disable User
- Updated *Field\_Name* (this task is created for each field of the OIM - Account data set, except the `ID` field)
- For mappings created between fields of the OIM - User data set and the provisioning staging data set, the following process tasks are created:
  - Change *User\_data\_set\_field\_name*
  - Edit *Provisioning\_Staging\_field\_name*

For example, suppose you create a mapping between the Last Name field of the OIM - User data set and the LName field of the provisioning staging data set. The following process tasks are automatically created along with the rest of the provisioning-specific process tasks:

- Change Last Name
- Edit LName

In addition, the following provisioning-specific process tasks are created for each child data set of the OIM - Account data set:

- Child Table *Child\_Form\_Name* row Inserted
- Child Table *Child\_Form\_Name* row Updated
- Child Table *Child\_Form\_Name* row Deleted

All provisioning-specific process tasks have the following default assignments:

- **Target Type:** Group User With Highest Priority
- **Group:** SYSTEM ADMINISTRATORS
- **User:** XELSYSADM

If required, you can modify these default assignments by following the instructions given in *Modifying Process Tasks* in the *Developing and Customizing Applications for Oracle Identity Governance*.

## 8.1.7 Creating the Form and Publishing the Application Instance

You need to create a form and publish the application instance when both provisioning and reconciliation options are selected in the Step 1: Basic Information page.

To create the form and publish the application instance:

1. Create a form specific to the GTC resource object.
2. Attach the form to the GTC application instance.
3. Publish the GTC application instance to the required organizations.



### Note:

To view a provisioned account in the new UI, the process form should have a field for IT resource. The value for this IT resource field should be populated during a reconciliation run.

## 8.1.8 Enabling Log for the Generic Technology Connector

Logging in Oracle Identity Manager generally involves log collection and storage, error reporting, and alerts generation.

This is an optional step. Perform the procedure discussed in this section only if you want to enable logging for the generic technology connector.

See [Configuring Log Services for Oracle Identity Governance](#) for information about enabling logging in Oracle Identity Manager.



## 8.2 Using Identity System Administration to Create the Connector

Creation of a generic connector includes various steps, such as basic information, defining of parameter values, verifying form names, and verifying connector information.

To navigate to the first Identity System Administration page for creating a generic technology connector, login to Identity System Administration, and click **Generic Connector** under Provisioning Configuration. In the Manage Connectors page, click **Create**.

From this point onward, page-wise instructions are provided in the following sections:

- [Providing Basic Information for Generic Technology Connector](#)
- [Specifying Parameter Values for the Providers](#)
- [Modifying Connector Configuration](#)
- [Verifying Connector Form Names](#)
- [Verifying Connector Information](#)

### 8.2.1 Providing Basic Information for Generic Technology Connector

The first step of the connector creation process involves collection of basic information. The Transport provider list and the Format Provider List, provide options for reconciliation and provisioning operations.

To provide basic information about the generic technology connector that you want to create, use this page as follows:

1. In the **Name** field, specify a name for the generic technology connector.

The following are guidelines related to selecting a name for the generic technology connector:

- The name must not be the same as that of any other connector (predefined connector or generic technology connector) on this Oracle Identity Manager installation.
- The name must not be the same as that of any other connector object (such as resource objects, IT resources, and process forms) on this Oracle Identity Manager installation.

#### **Note:**

An error message is displayed if you specify a name that is the same as the name of an existing connector. However, an error message is *not* displayed if you specify a name that is the same as the name of an existing connector object. Therefore, you must ensure that the name you want to specify is not the same as the name of any existing connector object.

- The name must not contain non-ASCII characters, because Oracle Identity Manager does not support non-ASCII characters in connector names. However, you can include the underscore character ( `_` ) in the name.
2. If you want to use the generic technology connector for reconciliation, select **Reconciliation** and perform the following steps:

- From the **Transport Provider** list, select the reconciliation transport provider that you want to use for this connector. This list displays the predefined reconciliation transport providers and the reconciliation transport providers that you create.
- From the **Format Provider** list, select the reconciliation format provider that you want to use for this connector. This list displays the predefined reconciliation format providers and the reconciliation format providers that you create.

 **Note:**

If you select the shared drive reconciliation transport provider, you must also select the CSV reconciliation format provider because all the parameters of this provider are bundled with the parameters of the shared drive reconciliation transport provider.

- If you want to use the connector to perform trusted source reconciliation with the target system, select **Trusted Source Reconciliation**.

 **Note:**

If you select the Trusted Source Reconciliation check box, the Provisioning region of the page is disabled. This is because you cannot provision to a target system that you designate as a trusted source. You can only reconcile data from a trusted source.

3. If you want to use the generic technology connector for provisioning, select **Provisioning** and perform the following steps:

 **Note:**

You can select only Reconciliation, only Provisioning, or both Reconciliation and Provisioning.

- From the **Transport Provider** list, select the provisioning transport provider that you want to use for this connector. This list displays the predefined provisioning transport providers and the provisioning transport providers that you create.  
  
If you select the Web Services provisioning transport provider and if Secure Sockets Layer (SSL) is enabled for the target Web service, you must perform the procedure described in *Configuring SSL Communication Between Oracle Identity Manager and the Target System Web Service* in the *Developing and Customizing Applications for Oracle Identity Governance*.
- From the **Format Provider** list, select the provisioning format provider that you want to use for this connector. This list displays the predefined provisioning format providers and the provisioning format providers that you create.

If you select the SPML provisioning format provider, you must also select the Web Services provisioning transport provider because the parameters of this provider are related to the parameters of the Web Services provisioning transport provider.

4. Click **Continue**.

[Table 8-1](#) lists sample entries for the GUI elements on the Step 1: Provide Basic Information page.

**Table 8-1 Sample Entries for the Step 1: Provide Basic Information Page**

Label on the Step 1: Provide Basic Information Page	Sample Value or Action	Reference Information
Name field	MyGTC2	NA
Reconciliation check box	Check box selected	NA
Transport Provider list	Shared Drive	shared drive reconciliation transport provider
Format Provider list	CSV	CSV Reconciliation format provider
Provisioning check box	Check box selected	NA
Transport Provider list	Web Services	Web Services provisioning transport provider
Format Provider list	SPML	SPML provisioning format provider

## 8.2.2 Specifying Parameter Values for the Providers

The provider parameters are divided into two categories, Run-time parameters and Design parameters.

Use this page to specify values for the parameters of the providers that you select in [Providing Basic Information for Generic Technology Connector](#).

This section contains the following topics:

- [Run-Time Parameters for the Provider](#)
- [Design Parameters for the Provider](#)
- [Sample Values for the Run-Time and Design Parameters](#)

### 8.2.2.1 Run-Time Parameters for the Provider

#### See Also:

Predefined Providers for Generic Technology Connectors in the *Developing and Customizing Applications for Oracle Identity Governance* for detailed information about the run-time parameters of predefined providers that you select on the Step 1: Provide Basic Information page

Run-time parameters are input variables of the providers that you select on the previous page. A run-time parameter represents a value that is not constrained by the design of the provider. For example, the location of the directories containing the data files that you want to reconcile is a run-time parameter.

### 8.2.2.2 Design Parameters for the Provider

This section describes about the design parameters for the provider in the following topics:

- [About Design Parameters for the Provider](#)

- [Reconciliation Specific Design Parameters for the Provider](#)
- [Provisioning Specific Design Parameter for the Provider](#)

### 8.2.2.2.1 About Design Parameters for the Provider

The parameters listed in this section are either design parameters of providers or reconciliation-specific parameters that are common to all generic technology connectors. A design parameter represents a value or set of values that is defined as part of the provider design.

#### See Also:

Predefined Providers for Generic Technology Connectors in *Developing and Customizing Applications for Oracle Identity Governance* for detailed information about the design parameters of predefined providers that you select in the [Providing Basic Information for Generic Technology Connector](#).

For example, the format of data files that can be parsed by a format provider is a design parameter for that provider. While designing the provider, you define the set of formats the provider can parse. In this page, you specify the particular format (from the set of supported formats) that an instance of the format provider must parse.

### 8.2.2.2.2 Reconciliation Specific Design Parameters for the Provider

The following are reconciliation-specific design parameters:

#### Note:

If you do not select the Reconciliation option on the previous page, these reconciliation-specific design parameters are not displayed on this page.

- **Batch Size**

Use this parameter to specify a batch size for the reconciliation run. By using this parameter, you can break into batches the total number of records that the reconciliation engine fetches from the target system during each reconciliation run.

The default value of this parameter is `All`.

- **Stop Reconciliation Threshold**

During reconciliation, data from the reconciliation format provider is accepted as input by the validation provider. Some of the reconciliation data records may not clear the validation checks. You can use the Stop Reconciliation Threshold parameter to automatically stop reconciliation if the percentage of records that fail the validation checks to the total number of reconciliation records processed exceeds the specified value.

The following example illustrates how this parameter works:

Suppose you specify 20 as the value of the Stop Reconciliation Threshold parameter. This means that you want reconciliation to stop if the percentage of failed records to the total number of records processed becomes equal to or greater than 20. Suppose the second and eighth records fail the validation checks. At this stage, the number of failed records is

2 and the total number of records processed is 8. The percentage of failed records is 25, which is greater than the specified threshold of 20. Therefore, reconciliation is stopped after the eighth record is processed.

 **Note:**

- The Stop Reconciliation Threshold parameter is used during reconciliation only if you select validation Providers on the Step 3: Modify Connector Configuration page.
- If reconciliation is stopped because the actual percentage of failed records exceeds the specified percentage, the records that have already been reconciled into Oracle Identity Manager are not removed.

The default value of this parameter is `None`. This default value specifies that during a reconciliation run, you want all the target system records to be processed, regardless of the number of records that fail the checks.

- **Stop Threshold Minimum Records**

If you use the Stop Reconciliation Threshold parameter, there may be a problem if invalid records are encountered right at the beginning of the reconciliation run. For example, suppose you specify 40 as the value of the Stop Reconciliation Threshold parameter. When reconciliation starts, suppose the first record fails the validation checks. At this stage, the percentage of failed records to total records processed is 100. Therefore, reconciliation would stop immediately after the first record is processed.

To avoid such situations, you can use the Stop Threshold Minimum Records parameter in conjunction with the Stop Reconciliation Threshold parameter. The Stop Threshold Minimum Records parameter specifies the number of records that must be processed by the validation provider before the Stop Reconciliation Threshold validation is enabled.

The following example illustrates how this parameter works:

Suppose you specify the following values:

Stop Reconciliation Threshold: 20

Stop Threshold Minimum Records: 80

With these values, from the eighty-first record onward, the Stop Reconciliation Threshold validation is enabled. In other words, after the eightieth record is processed, if any record fails the validation check, the reconciliation engine calculates the percentage of failed records to total records processed.

The default value of this parameter is `None`.

 **Note:**

- The Stop Threshold Minimum Records parameter is used during reconciliation only if you select validation Providers on the Step 3: Modify Connector Configuration page.
- You must specify a value for the Stop Threshold Minimum Records parameter if you specify a value for the Stop Reconciliation Threshold parameter.

- **Reconciliation Type**

Use this parameter to specify whether you want the reconciliation engine to perform incremental or full reconciliation.

 **Note:**

The outcome of both full and incremental reconciliation is the same: target system records that are created or updated after the last reconciliation run are reconciled into Oracle Identity Manager.

In incremental reconciliation, only target system records that are newly added or modified after the last reconciliation run are brought to Oracle Identity Manager. Reconciliation events are created for each of these records.

In full reconciliation, all target system records are brought to Oracle Identity Manager. The optimized reconciliation feature identifies and ignores records that have already been reconciled. Reconciliation events are created for the remaining records.

You must select incremental reconciliation if either one of the following conditions is true:

- The target system time stamps or uniquely marks (in some way) files or individual data records that it generates, and the reconciliation transport provider can recognize records that have been time stamped or marked by the target system.

For example:

Suppose the target system can time stamp the creation of or modifications to user data records. If you can create a custom reconciliation transport provider that can read this time-stamp information, only new or modified data records will be transported to Oracle Identity Manager during reconciliation.

- The target system provides only data records that are newly added or modified after the last reconciliation run.

If *neither* of these conditions is true, you must select full reconciliation.

- **Reconcile Deletion of Multivalued Attribute Data**

Use this parameter to specify whether or not you want to reconcile into Oracle Identity Manager the deletion of multivalued attribute data (child data) on the target system.

The following example explains how this design parameter works:

There is an account for user `John Doe` on the target system. This user is a member of two user groups, `CREATE USERS` and `REVIEW PERMISSIONS`, on the target system. This user account (along with the group membership information) also exists on Oracle Identity Manager.

On the target system, suppose this user is removed from the `REVIEW PERMISSIONS` group. During the next reconciliation run, the action that will be taken in Oracle Identity Manager depends on whether or not you select the **Reconcile Deletion of Multivalued Attribute Data** check box:

- If you select the check box, information about this user being a member of the `REVIEW PERMISSIONS` group on the target system is removed from the Oracle Identity Manager database. All other changes made to this user account on the target system are also reconciled.
- If you do not select the check box, information about this user being a member of the `REVIEW PERMISSIONS` group on the target system is *not* removed from the Oracle

Identity Manager database. However, all other changes made to this user account on the target system are reconciled.

- **Source Date Format**

Use this parameter to specify the format in which date values are stored in the target system.

The format that you specify is used to validate date values fetched during reconciliation and to convert the date values to the format used internally by Oracle Identity Manager.

The Validate Date Format provider is one of the predefined validation providers. During a reconciliation run, the Validate Date Format provider uses the source date format to validate date values fetched from the target system. Only date values that match the source date format are converted to the date format used by Oracle Identity Manager and reconciled. This format validation and conversion applies to all date fields (for example, Date of Birth and Hire Date) of the target system.

For information about the date formats that you can specify, see the following page on the Sun Java Web site:

<http://java.sun.com/docs/books/tutorial/i18n/format/simpleDateFormat.html>

 **Note:**

If you want the source date format to be used in date validation, while performing the procedure described in [Adding or Editing Fields in Data Sets](#), you must:

- Map date fields of the Source data sets to date fields of the reconciliation staging data sets.
- Edit each date field of the reconciliation staging data sets and set its data type to the Date data type.

The default value of the Source Date Format parameter is the date format specified as the value of the `XL.DefaultDateFormat` system property. If you do not specify a value for the Source Date Format parameter, the default date format is used for date validation during reconciliation.

 **See Also:**

[System Properties in Oracle Identity Manager](#) for information about the system properties of Oracle Identity Manager.

The following example illustrates how the Source Date Format parameter is used:

Suppose the following are date values in the target system:

- Date 1: 05/04/2007 06:25:44 PM
- Date 2: 05/06/2007 07:31:44 PM
- Date 3: Thu, Apr 9, '98
- Date 4: 07/03/2008 02:15:55 PM

**Scenario 1:**

While creating the connector, you had entered the following as the value of the Source Date Format parameter:

```
MM/dd/yyyy hh:mm:ss a
```

During a reconciliation run, the record containing the Date 3 value is not reconciled because it does not conform to the specified source date format.

**Scenario 2:**

While creating the connector, you had not entered a value for the Source Date Format parameter. Therefore, during a reconciliation run, all four records are validated against the date format specified as the value of the `XL.DefaultDateFormat` system property.

### 8.2.2.2.3 Provisioning Specific Design Parameter for the Provider

The following is a provisioning-specific design parameter:

 **Note:**

If you do not select the Provisioning option on the previous page, this provisioning-specific design parameter is not displayed.

- **Target Date Format**

Use this parameter to specify the format in which you want to send date values to the target system during provisioning operations.

During a provisioning operation, date values are converted to the format that you specify as the value of the Target Date Format parameter. This format conversion applies to all date fields (for example, Date of Birth and Hire Date) that are used in the provisioning operation.

For information about the date formats that you can specify, see the following page on the Sun Java Web site:

<http://java.sun.com/docs/books/tutorial/i18n/format/simpleDateFormat.html>

If you do not specify a date format, the following date format is used as the default value of this parameter:

```
yyyy/MM/dd hh:mm:ss z
```

The following example illustrates how the Target Date Format parameter is used:

During a provisioning operation, any date value that you enter will be in the `yyyy/MM/dd hh:mm:ss z` format.

**Scenario 1:**

While creating the connector, you had entered the following as the value of the Target Date Format parameter:

```
yyyy.MM.dd G 'at' hh:mm:ss z
```

During a provisioning operation, an Oracle Identity Manager date value (for example, 2007/05/04 06:25:44 IST) will be converted into the target date format (for example, 2007.05.04 AD at 06:25:44 IST) and sent to the target system.

**Scenario 2:**



While creating the connector, you had not entered a value for the Target Date Format parameter. During a provisioning operation, date values are sent to the target system in the (default) `yyyy/MM/dd hh:mm:ss z` format.

### 8.2.2.3 Sample Values for the Run-Time and Design Parameters

After you specify values for the run-time and design parameters, click **Continue**.



**Note:**

If any value that you provide on this page is not correct, an error message is displayed at the top of the page after you click **Continue**. If this happens, fix the parameter value and click **Continue** again.

Table 8-2 lists sample entries for the Specify Parameter Values page. The GUI elements displayed on this page are based on the entries made on the Provide Basic Information page.

**Table 8-2 Sample Entries for the Step 2: Specify Parameter Values Page**

Label on the Step 2: Specify Parameter Values Page	Sample Value or Action	Reference Information
<b>Run-Time Parameters of the Shared Drive Reconciliation Transport Provider</b>		
Staging Directory (Parent Identity Data) field	D:\gctestdata\commaDelimited\parent	NA
Staging Directory (Multivalued Identity Data) field	D:\gctestdata\commaDelimited\child	NA
Archiving Directory field	D:\gctestdata\commaDelimited\archive	NA
File Prefix field	file	NA
Specified Delimiter field	,	NA
Tab Delimiter check box	Check box not selected	NA
Fixed Column Width field		NA
Unique Attribute (Parent Data) field	UserIDTD	NA
<b>Run-Time Parameter of the Web Services Provisioning Transport Provider</b>		
Web Service URL field	http://acme123:8080/spmlws/services/HttpSoap11	NA
<b>Run-Time Parameters of the SPML Provisioning Format Provider</b>		
Target ID field	target	NA
User Name (authentication) field	xelsysadm	NA
User Password (authentication) field		NA

**Table 8-2 (Cont.) Sample Entries for the Step 2: Specify Parameter Values Page**

Label on the Step 2: Specify Parameter Values Page	Sample Value or Action	Reference Information
<b>Design Parameters of the Shared Drive Reconciliation Transport Provider</b>		
File Encoding field	Cp1251	NA
<b>Design Parameters of the Web Services Provisioning Transport Provider</b>		
Web Service SOAP Action field	http://xmlns.oracle.com/OIM/provisioning/processRequest	NA
<b>Design Parameters of the SPML Provisioning Format Provider</b>		
WSSE Configured for SPML Web Service? check box	Check box not selected	NA
Custom Authentication Credentials Namespace field	http://xmlns.oracle.com/OIM/provisioning	NA
Custom Authentication Header Element field	OIMUser	NA
Custom Element to Store User Name field	OIMUserId	NA
Custom Element to Store Password field	OIMUserPassword	NA
SPML Web Service Binding Style (DOCUMENT or RPC) field	RPC	NA
SPML Web Service Complex Data Type field		NA
SPML Web Service Operation Name field	processRequest	NA
SPML Web Service Target Namespace field	http://xmlns.oracle.com/OIM/provisioning	NA
SPML Web Service Soap Message Body Prefix field		NA
ID Attribute for Child Dataset Holding Group Membership Information field		NA
<b>Generic Design Parameters</b>		
Target Date Format field	yyyy-MM-dd hh:mm:ss.ffffff	NA
Batch Size field	All	NA
Stop Reconciliation Threshold field	None	NA
Stop Threshold Minimum Records field	None	NA
Source Date Format field	yyyy/MM/dd hh:mm:ss z	NA
Reconcile Deletion of Multivalued Attribute Data check box	Check box selected	NA
Reconciliation Type list	Incremental	NA

## 8.2.3 Modifying Connector Configuration

The step 3 of the connector creation process involves defining of data sets. After creation of data sets, these data sets need to be associated with the fields. In this step, you specify the user data fields that are required for the generic technology connectors.

You can perform the following actions on the Step 3: Modify Connector Configuration page:

- [About Metadata for Generic Technology Connector](#)
- [Data Set for Generic Technology Connectors](#)
- [Mapping Parameters for Data Sets](#)
- [About Adding or Editing Fields in Data Sets](#)
- [Adding or Editing Fields in Data Sets](#)
- [Removing Fields from Data Sets](#)
- [Removing Mappings Between Fields](#)
- [Removing Child Data Sets](#)

### 8.2.3.1 About Metadata for Generic Technology Connector

Use this page to define data sets and mappings between the fields of the data sets. In other words, you use this page to specify the user data fields that you want to:

- Propagate from the target system to Oracle Identity Manager during reconciliation
- Propagate from Oracle Identity Manager to the target system during provisioning

In the generic technology connector context, the term **metadata** refers to the set of identity fields that constitute the user account information on the target system.

First Name, Last Name, Hire Date, and Department ID are examples of user data fields that constitute metadata. The values assigned to these fields constitute the user data on the target system. For example, the identity information of user John Doe on the target system can be composed of the following fields:

- First Name: John
- Last Name: Doe
- Hire Date: 04-December-2007
- Department ID: Sales
- ...

After you click the **Continue** button on the Step 2: Specify Parameter Values page, the metadata displayed on the Step 3: Modify Connector Configuration page depends on the following factors:

- Input provided on the Step 1: Provide Basic Information and Step 2: Specify Parameter Values pages
- Availability of sample target system data

 **Note:**

In the generic technology connector context, the term **metadata detection** refers to the process in which sample user data is read from the target system and the corresponding metadata (identity field names) is displayed on the Step 3: Modify Connector Configuration page.

Oracle Identity Manager performs the following steps while attempting to detect metadata:

1. The reconciliation transport provider and reconciliation format provider try to fetch and parse metadata from the target system.

Together, the shared drive reconciliation transport provider and CSV reconciliation format provider can detect metadata from the target system. If you want custom providers to perform the same function, you must ensure that:

- The Java code for the reconciliation transport provider contains an implementation of the `getMetadata()` method of the `ReconTransportProvider` interface.
- The Java code for the reconciliation format provider contains an implementation of the `parseMetadata()` method of the `ReconFormatProvider` interface.

If these providers successfully fetch and parse metadata from the target system, Oracle Identity Manager uses information returned by them to display metadata and the following step is not performed.

2. If the reconciliation transport provider and reconciliation format provider cannot fetch and parse metadata from the target system, the provisioning transport provider and provisioning format provider try to perform this function.

The Web Services provisioning transport provider and SPML provisioning format provider cannot detect metadata from the target system. If you want custom providers to be able to detect metadata, you must ensure that:

- The Java code for the provisioning transport provider contains an implementation of the `defineMetadata()` method of the `ProvisioningTransportProvider` interface.
- The Java code for the provisioning format provider contains an implementation of the `parseMetadata()` method of the `ProvisioningFormatProvider` interface.

If the provisioning transport provider and provisioning format provider successfully fetch and parse metadata from the target system, Oracle Identity Manager uses information returned by these providers to display metadata. If these providers are not successful, only the default fields defined for any of the provisioning-specific providers that you select are displayed. For example, the `ID` field of the `OIM - Account` data set and the `objectClass` and `containerID` fields of the provisioning staging data set are displayed by default. These data sets and fields are discussed later in this guide.

Figure 8-1 shows the Step 3: Modify Connector Configuration page for the sample entries listed at the end of the "Step 1: Provide Basic Information Page" and "Step 2: Specify Parameter Values Page" sections.

Figure 8-1 Step 3: Modify Connector Configuration Page

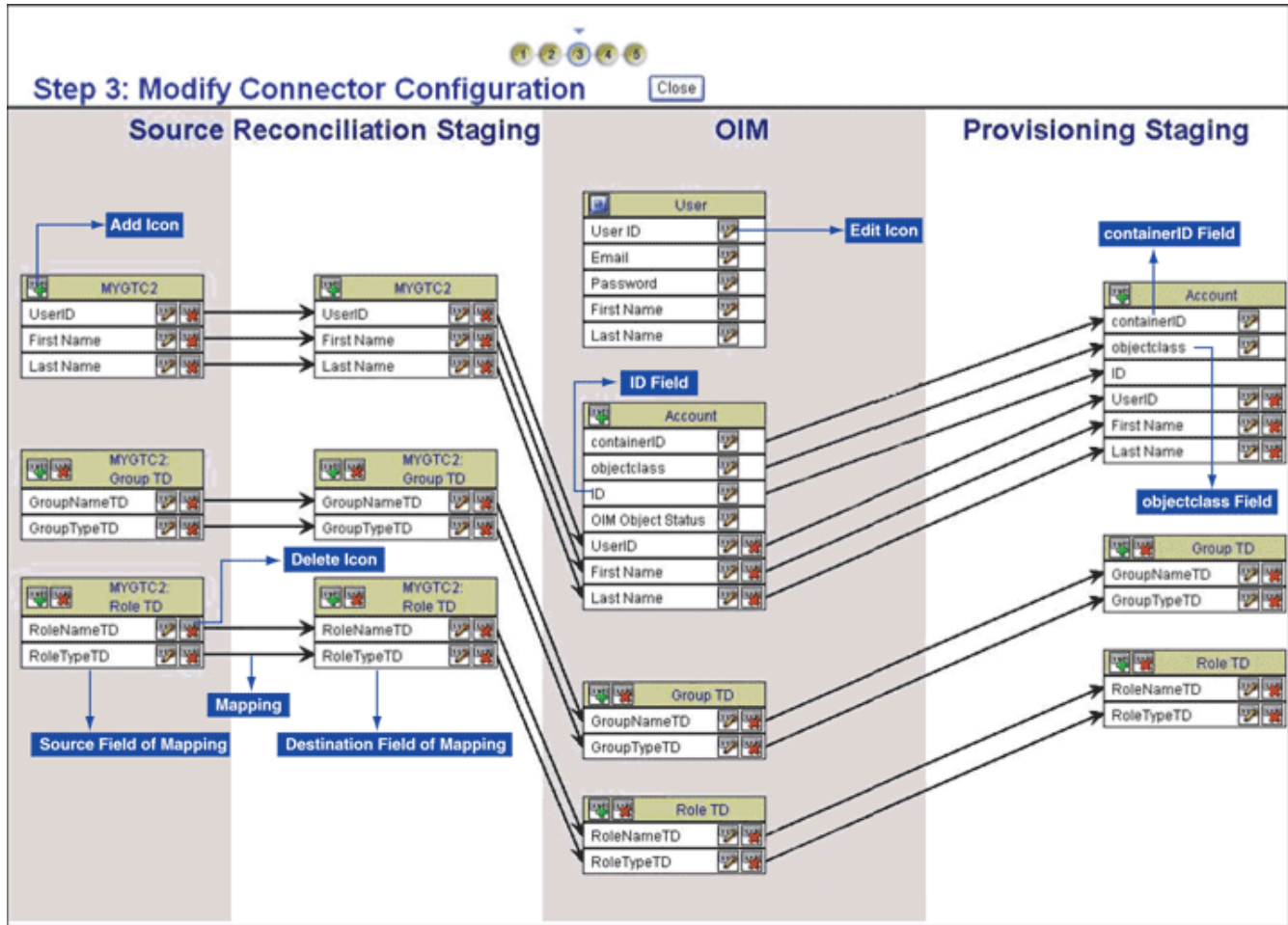

### 8.2.3.2 Data Set for Generic Technology Connectors

The data sets displayed on the Step 3: Modify Connector Configuration page are categorized as follows:

- **Source**  
The Source data sets are displayed only if you select the Reconciliation option on the first page, regardless of whether or not you select the Provisioning option.
- **Reconciliation Staging**  
The reconciliation staging data sets are displayed only if you select the Reconciliation option on the Step 1: Provide Basic Information page, regardless of whether or not you select the Provisioning option.
- **Oracle Identity Manager**  
The Oracle Identity Manager data sets are always displayed, regardless of the options you select on the Step 1: Provide Basic Information page. However, the OIM - Account data set and its child data sets are not displayed if you select the Trusted Source Reconciliation option on the Step 1: Provide Basic Information page. To overcome this issue, you must perform the following steps:
  1. Open the generic technology connector and navigate to Jgraph screen.

2. In the Reconciliation Staging of the Jgraph screen, modify the field data type to **Date** for all the fields which holds date value.
3. Save the connector.

The fields displayed in the OIM - User data set are predefined for the Oracle Identity Manager User. You can show or minimize the full list of OIM - User data set fields by clicking the arrow icon at the top of the data set. The following fields are displayed in the minimized state of the data set:

- User ID
- Email
- Password
- First Name
- Last Name

 **Note:**

If you select the Trusted Source Reconciliation option on the Step 1: Provide Basic Information Page, all the fields of the OIM - User data set are displayed and you cannot use the arrow icon to minimize the display.

These fields constitute the minimum set of Oracle Identity Manager User fields for which values must be defined. You can designate some or all of the remaining OIM - User data set fields as mandatory Oracle Identity Manager User fields for your Oracle Identity Manager installation. You do this by ensuring that these fields always hold values when the Oracle Identity Manager User is created.

 **Note:**

Data set and field names that take up more than a certain amount of space are truncated and dots are displayed after the truncated part of the names. For example, the Deprovisioning Date field of the OIM - User data set is displayed as follows:

Deprovisioning Da..

To view the full name of a field, you can click the edit icon for that field or the field to which that field is mapped. In the pop-up window, the field name that you want to view is on either the first page or the second page, depending on the data set to which the field belongs.

You can add user-defined fields (UDFs) to the list of predefined Oracle Identity Manager User fields by using the Design Console. These UDFs are displayed in the OIM - User data set on the Step 3: Modify Connector Configuration page.

Depending on the options that you select on the Step 1: Provide Basic Information page, some fields are displayed by default on the Step 3: Modify Connector Configuration page:

- ID field

The ID field is displayed by default in the OIM - Account data set, regardless of whether or not you select the Reconciliation option or Provisioning option on the Step

1: Provide Basic Information page. When an account is created, this field is used to store the value that uniquely identifies the account in Oracle Identity Manager and in the target system. For a particular user, this unique field is used to direct other operations, such as modify, delete, enable, disable, and child data operations.

Every target system would have a unique field for tracking the creation of and updates made to a user account. While creating a custom provisioning transport provider, you must ensure that the provider retrieves this unique field value from the target system at the end of a Create User operation. This value must be used to populate the `ID` field of the OIM - Account data set.

During reconciliation, the value of the `ID` field must come from the corresponding unique field of the reconciliation staging data set. To set this up, you must create a mapping between the two fields. The procedure to create a mapping is discussed later in this section.

 **Caution:**

If you select both the Provisioning and Reconciliation options while creating a generic technology connector and if you do not create a mapping between the `ID` field and the unique field of the target system, records that are linked through reconciliation cannot be used for provisioning operations (such as modify, delete, enable, disable, and child data operations). This is because the `ID` field is not populated in the linked records.

– `objectClass` field

The `objectClass` field is displayed by default in the OIM - Account data set and provisioning staging data set only if you select the SPML provisioning format provider on the Step 1: Provide Basic Information page.

– `containerID` field

The `containerID` field is displayed by default in the OIM - Account data set and provisioning staging data set only if you select the SPML provisioning format provider on the Step 1: Provide Basic Information page.

• Provisioning Staging

The provisioning staging data sets are displayed only if you select the Provisioning option on the first page, regardless of whether or not you select the Reconciliation option.

The display of data sets on the Step 3: Modify Connector Configuration page depends on the input that you provide on the Step 1: Provide Basic Information page and Step 2: Specify Parameter Values page. The display of fields within the data sets depends on whether or not metadata detection has taken place.

 **Note:**

Metadata detection does not take place if any of the following conditions are true:

- Sample target system data (including metadata) is not available.
- The Transport and format providers that you select are not capable of detecting metadata from sample target system data.

This is illustrated by the following example:

Suppose you select only the Reconciliation option on the Step 1: Provide Basic Information page. In addition, metadata detection has not taken place. Under these conditions, the display of data sets and fields on the Step 3: Modify Connector Configuration page can be summarized as follows:

The following data sets are displayed:

- Source
- Reconciliation Staging
- Oracle Identity Manager

The fields that constitute the data sets are *not* displayed.

In addition, if you had selected the Trusted Source Reconciliation option on the Step 1: Provide Basic Information page, the OIM - Account data set and its child data sets are not displayed.

In [Table 8-3](#), Scenario 1 shows the outcome of this set of input conditions. The rest of the scenarios in this table describe the display of data sets and fields under the combination of input conditions listed in the first row and first column of the table.

**Table 8-3 Display of Data Sets and Fields Under Various Input Conditions**

Metadata Detection	Only Reconciliation Option Selected	Both Reconciliation and Provisioning Options Selected	Only Provisioning Option Selected
<b>Metadata detection has <i>not</i> taken place</b>	<p><b>Scenario 1</b></p> <p>The following data sets are displayed:</p> <ul style="list-style-type: none"> <li>• Source</li> <li>• Reconciliation Staging</li> <li>• Oracle Identity Manager</li> </ul> <p>The fields that constitute the data sets are <i>not</i> displayed.</p> <p>If you select the Trusted Source Reconciliation option on the Step 1: Provide Basic Information page, the OIM - Account data set and its child data sets are not displayed.</p>	<p><b>Scenario 2</b></p> <p>The following data sets are displayed:</p> <ul style="list-style-type: none"> <li>• Source</li> <li>• Reconciliation Staging</li> <li>• Oracle Identity Manager</li> <li>• Provisioning Staging</li> </ul> <p>The fields that constitute the data sets are <i>not</i> displayed.</p>	<p><b>Scenario 3</b></p> <p>The following data sets are displayed:</p> <ul style="list-style-type: none"> <li>• Oracle Identity Manager</li> <li>• Provisioning Staging</li> </ul> <p>The fields that constitute the data sets are <i>not</i> displayed.</p>
<b>Metadata detection has taken place</b>	<p><b>Scenario 4</b></p> <p>The following data sets are displayed:</p> <ul style="list-style-type: none"> <li>• Source</li> <li>• Reconciliation Staging</li> <li>• Oracle Identity Manager</li> </ul> <p>The fields that constitute the data sets are displayed.</p> <p>If you select the Trusted Source Reconciliation option on the Step 1: Provide Basic Information page, the OIM - Account data set and its child data sets are not displayed.</p>	<p><b>Scenario 5</b></p> <p>The following data sets are displayed:</p> <ul style="list-style-type: none"> <li>• Source</li> <li>• Reconciliation Staging</li> <li>• Oracle Identity Manager</li> <li>• Provisioning Staging</li> </ul> <p>The fields that constitute the data sets are displayed.</p>	<p><b>Scenario 6</b></p> <p>The following data sets are displayed:</p> <ul style="list-style-type: none"> <li>• Oracle Identity Manager</li> <li>• Provisioning Staging</li> </ul> <p>The fields that constitute the data sets are displayed.</p>



### 8.2.3.3 Mapping Parameters for Data Sets

Each flow line displayed on the Step 3: Modify Connector Configuration page represents a mapping (link) between two fields of different data sets. A mapping serves one of the following purposes:

- Establishes a data flow path between fields of two data sets, for either provisioning or reconciliation

A mapping of this type forms the basis for validations or transformations to be performed on data.

- Creates a basis for comparing (matching) field values of two data sets

The following are examples of matching-only mappings:

- Mappings created between fields of the reconciliation staging data set and the OIM - User data set form the basis of a reconciliation rule.
- A mapping between the unique field of the reconciliation staging data set and the ID field of the OIM - Account data set helps identify the key field for reconciliation matching. Along with the ID field, other fields of the OIM - Account data set can be (matching-only) mapped to corresponding fields of the reconciliation staging data set to create a composite key field for reconciliation matching.

### 8.2.3.4 About Adding or Editing Fields in Data Sets

Identity fields detected through metadata detection are displayed on the Step 3: Modify Connector Configuration page. You can modify these fields and the mappings between them. If required, you can also add new fields on this page and create mappings between them.

The following is a summary of the actions that you can perform while adding or editing fields on the Step 3: Modify Connector Configuration page:

 **Note:**

These actions are described in detail in the procedure that follows this list. The procedure also describes the conditions that must be fulfilled before you can perform some of these actions.

- Default attributes (such as the data type and length) are assigned to the fields displayed through metadata detection. You must edit these fields to set the required attributes for them.

 **Note:**

Oracle Identity Manager can recognize date values fetched during reconciliation only if you set the Date data type for fields of the reconciliation staging data sets. In addition, if you have specified a value for the Source Date Format parameter on the Step 2: Specify Parameter Values page, you must map date fields of the Source data sets to the corresponding date fields of the reconciliation staging data sets.

- You can create transformation mappings between fields by using a transformation provider. While performing this action, you can use the predefined concatenation transformation provider or translation transformation provider, or a custom transformation provider that you have created.
- You can create matching-only mappings between fields of the reconciliation staging data set and Oracle Identity Manager data sets. Matching-only mappings that you create between the reconciliation staging data set and the OIM - User data set forms the reconciliation rule. Matching-only mappings that you create between the reconciliation staging data set and the OIM - Account data set identifies the key field for reconciliation matching.
- You can add a child data set to an existing data set.
- You can encrypt the value of a field, both in the process form and in the database.
- You can designate a field as a lookup field and select an input source for the field. The input source can be a lookup definition or a combination of columns from Oracle Identity Manager database tables.
- You can configure user account status reconciliation.

If you want to configure user account status reconciliation, refer to the "Configuring Account Status Reconciliation" section.

### 8.2.3.5 Adding or Editing Fields in Data Sets

To add or edit a field in a data set:

#### Note:

The display of the GUI elements and pages described in the following steps depends on the data set in which you are adding or editing a field. For example, the Required and Encrypted check boxes are not displayed if you are adding or editing a field in a Source data set.

1. Depending on whether you want to add or edit a field, click the Add icon for the data set or the edit icon for the field.
2. On the Step 1: Field Information page, specify values for the following GUI elements:
  - **Field Name:** If you are adding a field, specify a name for the field. The field name that you specify must contain only ASCII characters, because non-ASCII characters are not allowed.
  - **Mapping Action:** Select the type of mapping that you want to create with this field as the destination field of the mapping. You can select one of the following mapping actions:
    - Select **Create Mapping Without Transformation** if you only want to create a one-to-one mapping between a source (input) field and the field that you are adding or editing, and you do not want to use a transformation provider.
    - Select the **Remove Mapping** option if you are editing the field and you want to remove the mapping for which this field is the destination field. The procedure to remove a mapping is covered in detail in the Removing Mapping Between Fields section.

- The transformation mapping options displayed in the Mapping Action list are based on the predefined transformation providers and the custom transformation providers that you create. The following menu options correspond to the predefined transformation providers:

- \* **Create Mapping With Concatenation**

- \* **Create Mapping With Translation**

Apply the following guidelines while selecting a transformation mapping:

- You can create transformation mappings only between fields of the following data sets:
  - Source and Reconciliation Staging
  - Oracle Identity Manager and Provisioning Staging

This means that, for example, you cannot create transformation mappings between a field in a reconciliation staging data set and a field in an Oracle Identity Manager data set.

You cannot create a 1-to-2 mapping with the following source and destination fields:

**Source field:** Unique field of the reconciliation staging data

**Destination fields:** `User ID` field of the OIM - User data set and `ID` field of the OIM - Account data set

This mapping is not supported. Instead, you must create a one-to-one mapping between the unique field of the reconciliation staging data and either the `User ID` field (of the OIM - User data set) or the `ID` field (of the OIM - Account data set).

- Ensure that all the fields of provisioning staging data sets are mapped to corresponding fields of OIM - User and OIM - Account data sets.
- When you create a mapping that has any field of the OIM - User data set as the source or destination field, the display of the OIM - User data set fields list is frozen in the position it was in (expanded or minimized) when the mapping was created. To unfreeze the display of the OIM - User data set so that you are able to use the arrow icon, you must remove all mappings that have any OIM - User data set field as the source or destination field.
- A literal field can be used as one of the input fields of a transformation field. If you select the Literal option, you must enter a value in the field. You must not leave the field blank after selecting it.
- **Matching Only:** Select this check box if the field is to be used as the destination field of a matching-only mapping. As mentioned earlier in this document, you can create the following types of matching-only mappings:

 **Note:**

You must create matching-only mappings for both parent and child data sets.

- To create the reconciliation rule, you create matching-only mappings between fields of the reconciliation staging data set and the OIM - User data set. Each mapping represents a reconciliation rule element. If there are child data sets, you must ensure that the names of fields of the reconciliation staging data set that are

input fields for the matching-only mappings are not used in any of the reconciliation staging child data sets.

- To specify the key field for reconciliation matching, you create a matching-only mapping between the unique field of the reconciliation staging data set and the ID field of the OIM - Account data set. Along with the ID field, other fields of the OIM - Account data set can be (matching-only) mapped to corresponding fields of the reconciliation staging data set to create a composite key field for reconciliation matching.

 **Caution:**

If the name of a reconciliation staging field used in a matching-only mapping were to be reused as the name of a field in a reconciliation staging child data set, matching would not take place during a reconciliation run.

This known issue is explained in the Modify Connector Config Page section.

- **Create End-to-End Mapping:** If you are adding a field, select this check box if you want the same field to be added in all the data sets that are displayed to the right of the data set in which you are adding the field.
- **Multi-Valued Field:** Select this check box if you want to add a child data set. If you select this check box, the name that you specify in the Field Name field is used as the name of the child data set.

 **Note:**

If you select the Trusted Source Reconciliation check box on the Step 1: Provide Basic Information page, this check box (in selected or deselected state) is ignored. This is because the reconciliation of multivalued (child) data is not supported in trusted source reconciliation.

- **Data Type:** Select the data type of the field.  
After metadata detection, the String data type is applied by default to all the fields of the reconciliation staging and OIM - Account data sets. Where required, you must use the Data Type list to specify the actual data type of each field.
- **Length:** Specify the character length of the field.
- **Required:** Select this check box if you want to ensure that the field always contains a value.
- **Encrypted:** Select this check box if the value of the field must be stored in encrypted form in the Oracle Identity Manager database.
- **Password Field:** Select this check box if the value of the field must be encrypted on the process form. Values of fields for which this check box is selected are displayed as asterisks (\*) on the process forms.

 **Note:**

If you select the Encrypted and Password Field check boxes, see "Password-Like Fields" in *Developing and Customizing Applications for Oracle Identity Governance* for information about guidelines that you must follow.

- **Lookup Field:** Select this check box if you want to make the field a lookup field.
3. Click **Continue**.
  4. If you select the **Lookup Field** check box on the Step 1: Field Information page, the Step 2: Lookup Properties page is displayed. On this page, you can select and specify values for any combination of the lookup properties described in [Table 8-4](#).

**Table 8-4 Lookup Properties**

Lookup Property	Value
Column Names	<p>In the <b>Property Value</b> field, enter the name of the database column containing the values that must be displayed in the lookup window. If required, you can enter multiple database column names separated by commas.</p> <p><b>Note:</b> If you select the Lookup Column Name property, you must also select the Column Names property, which is described later in this table.</p> <p>After you enter a value in the <b>Property Value</b> field, click <b>Submit</b>.</p> <p>The following SQL query can be used to illustrate how the Column Names and Lookup Column Name properties are used:</p> <pre>SELECT USR_FIRST_NAME, USR_LOGIN, USR_LAST_NAME FROM USR</pre> <p>Suppose you set the following as the values of the two properties:</p> <ul style="list-style-type: none"> <li>- Column Names: USR_FIRST_NAME, USR_LAST_NAME</li> <li>- Lookup Column Name: USR_LOGIN</li> </ul> <p>When the user selects a particular USR_FIRST_NAME, USR_LAST_NAME combination from the lookup window, the corresponding USR_LOGIN value is stored in the database.</p>
Column Captions	<p>In the <b>Property Value</b> field, enter the name of the column heading that must be displayed in the lookup window. If multiple columns are going to be displayed in the lookup window, enter multiple column captions separated by commas, for example, <b>Organization Name, Organization Status</b>.</p> <p>After you enter a value in the <b>Property Value</b> field, click <b>Submit</b>.</p>
Column Widths	<p>In the <b>Property Value</b> field, enter the character width of the column that must be displayed in the lookup window. This must be the same as the maximum length of the underlying field or column from which data values are drawn to populate the lookup field.</p> <p>If the lookup window is going to display multiple columns, enter multiple column widths separated by commas.</p> <p>After you enter a value in the <b>Property Value</b> field, click <b>Submit</b>.</p>

**Table 8-4 (Cont.) Lookup Properties**

Lookup Property	Value
Lookup Query	<p>To specify a value for the Lookup Query property:</p> <ol style="list-style-type: none"> <li>a. In the <b>Property Value</b> field, enter the SQL query (without the <code>WHERE</code> clause) that must be run when a user double-clicks the lookup field to populate the data columns displayed in the lookup window.</li> <li>b. Click <b>Submit</b>.</li> <li>c. On the Step 2: Add Validation page, select values from the following lists to create a <code>WHERE</code> clause for the <code>SELECT</code> statement that you specify in Step 1: <ul style="list-style-type: none"> <li>- Filter Column</li> <li>- Source</li> <li>- Field Name</li> </ul> <p>From the values that you select, the <code>WHERE</code> clause is created as follows:</p> <pre>WHERE Filter_Column=Source.Field_Name</pre> </li> <li>d. Click <b>Save</b>.</li> </ol> <p>To correctly display the data returned from a query, you must add a <code>lookupfield.header</code> property to the <code>xlWebAdmin_locale.properties</code> file.</p> <p>For example, consider the following SQL query:</p> <pre>SELECT usr_status FROM usr</pre> <p>To view the data returned from the query, you must add the following entry to the <code>xlWebAdmin_locale.properties</code> files:</p> <pre>lookupfield.header.users.status=User Status</pre> <p>If the <code>xlWebAdmin_locale.properties</code> file does not contain a <code>lookupfield.header</code> property for your specified query, the Identity System Administration displays a lookup window after you click the corresponding lookup icon.</p> <p>The syntax for a <code>lookupfield.header</code> property is as follows:</p> <pre>lookupfield.header.column_code=display value</pre> <p>The <code>column_code</code> portion of the entry must be lowercase and any spaces must be replaced by underscore characters (<code>_</code>).</p> <p>By default, the following entries for lookup field column headers are already available in the <code>xlWebAdmin_locale.properties</code> file:</p> <pre>lookupfield.header.lookup_definition.lookup_code_information     .code_key=Value lookupfield.header.lookup_definition.lookup_code_information     .decode=Description lookupfield.header.users.manager_login=User ID lookupfield.header.organizations.organization_name=Name lookupfield.header.it_resources.key=Key lookupfield.header.it_resources.name=Instance Name lookupfield.header.users.user_id=User ID lookupfield.header.users.last_name=Last Name lookupfield.header.users.first_name=First Name lookupfield.header.groups.group_name=Group Name lookupfield.header.objects.name=Resource Name lookupfield.header.access_policies.name=Access Policy Name</pre>

**Table 8-4 (Cont.) Lookup Properties**

Lookup Property	Value
Lookup Code	<p>In the <b>Property Value</b> field, enter the lookup definition code name. This code must generate all information pertaining to the lookup field, including lookup values and the text that is displayed with the lookup field when a lookup value is selected. The classification type of the lookup definition code must be of Lookup Type (that is, the Lookup Type option on the Lookup Definition form must be selected).</p> <p>To enter a lookup code, open the Lookup Definition form, query for the required code, and copy the code into the Property Value field.</p> <p>After you enter a value in the <b>Property Value</b> field, click <b>Submit</b>.</p> <p><b>Note:</b> The Lookup Code property can be used to replace the combination of the <b>Column Captions</b>, <b>Column Names</b>, <b>Column Widths</b>, <b>Lookup Column Name</b>, and <b>Lookup Query</b> properties. In addition, the information contained in the Lookup Code property supersedes any values set in these five lookup properties.</p> <p>If you want to implement lookup fields reconciliation, create a scheduled task that populates the lookup code.</p>
Lookup Column Name	<p>In the <b>Property Value</b> field, enter the name of the database column containing the value that must be stored corresponding to the Column Names value selected by the user in the lookup window. If required, you can enter multiple database column names separated by commas.</p> <p><b>Note:</b> If you select the Column Names property, you must also select the Lookup Column Name property. See the "Lookup Column Name" row in this table for more information about how these two properties are used.</p> <p>After you enter a value in the <b>Property Value</b> field, click <b>Submit</b>.</p>
Auto Complete	<p>If you enter <code>True</code> in the <b>Property Value</b> field, users can filter the values displayed in the lookup window by entering the first few characters of the value they want to select and double-clicking the lookup field. The outcome of this action is that only lookup values that begin with the characters entered by the users are displayed in the lookup window. For example, for the State lookup field, a user can enter <code>New</code> in the field. When the user double-clicks the State lookup field, only states that begin with <code>New</code> (for example, New Hampshire, New Jersey, New Mexico, and New York) are displayed in the lookup window.</p> <p>If you do not want to let users filter the display of values in the lookup field, enter <code>False</code> in the <b>Property Value</b> field.</p> <p>The default value of the <b>Auto Complete</b> property is <code>False</code>.</p> <p>After you enter a value in the <b>Property Value</b> field, click <b>Submit</b>.</p>

If you want to edit the value of a property that is displayed in the table on the Step 2: Lookup Properties page, select the edit option for that property and click **Edit**. If you want to remove a property that is displayed in the table, select the delete option for that property and click **Delete**.

After you specify properties for the lookup field, click **Continue**.

5. If you select a transformation option from the Mapping Action list on the Step 1: Field Information page, the Step 3: Mapping page is displayed. Use this page to define the transformation function that you want to perform on the input data to the field that you are adding. The steps to be performed depend on the transformation provider option (concatenation, translation, or custom transformation provider) that you select on the previous page:

If you select a predefined transformation provider (transformation, concatenation or translation), see Transformation Providers for detailed information about the procedure to specify parameter values for the predefined transformation provider. That section also provides detailed information about configuring user account status reconciliation.

You must use the translation transformation provider if you want to configure the reconciliation of user account status information. This procedure is described in "Translation Transformation Provider" in *Developing and Customizing Applications for Oracle Identity Governance*.

After you specify values for the transformation provider, click **Continue**.

6. If required, select a validation check for the field and click **Add**. In other words, select the validation provider that you want to use.

The validation options displayed in this list are based on the predefined validation Providers and any custom validation Providers that you create.

7. Click **Continue**, and click **Close**.
8. If you do not want to perform any other action on the Step 3: Modify Connector Configuration page, click the **Close** button that is displayed at the top of the page. You must perform the previous step before you click this Close button.

### 8.2.3.6 Removing Fields from Data Sets

To remove a field from a data set:

1. Click the Delete icon for that field.
2. If you do not want to perform any other action on the Step 3: Modify Connector Configuration page, click the **Close** button that is displayed at the top of the page.

### 8.2.3.7 Removing Mappings Between Fields

To remove a mapping:

1. Click the edit icon for the destination field of the mapping that you want to remove.

 **Note:**

If the destination field itself is the source field for another mapping, that mapping is not removed.

2. On the Step 1: Field Information page, select **Remove Mapping** from the **Transformation** list.
3. Click **Continue**.
4. On the last page, click **Close**.
5. If you do not want to perform any other action on the Step 3: Modify Connector Configuration page, click the **Close** button that is displayed at the top of the page.

### 8.2.3.8 Removing Child Data Sets

To remove a child data set:

1. Click the Delete icon for the data set.
2. If you do not want to perform any other action on the Step 3: Modify Connector Configuration page, click the **Close** button that is displayed at the top of the page.

Figure 8-2 shows the Step 3: Specify Connector Configuration page after the `MyField` field was added to the OIM - Account and provisioning staging data sets.



Figure 8-2 Step 3: Modify Connector Configuration Page After Addition of a Field

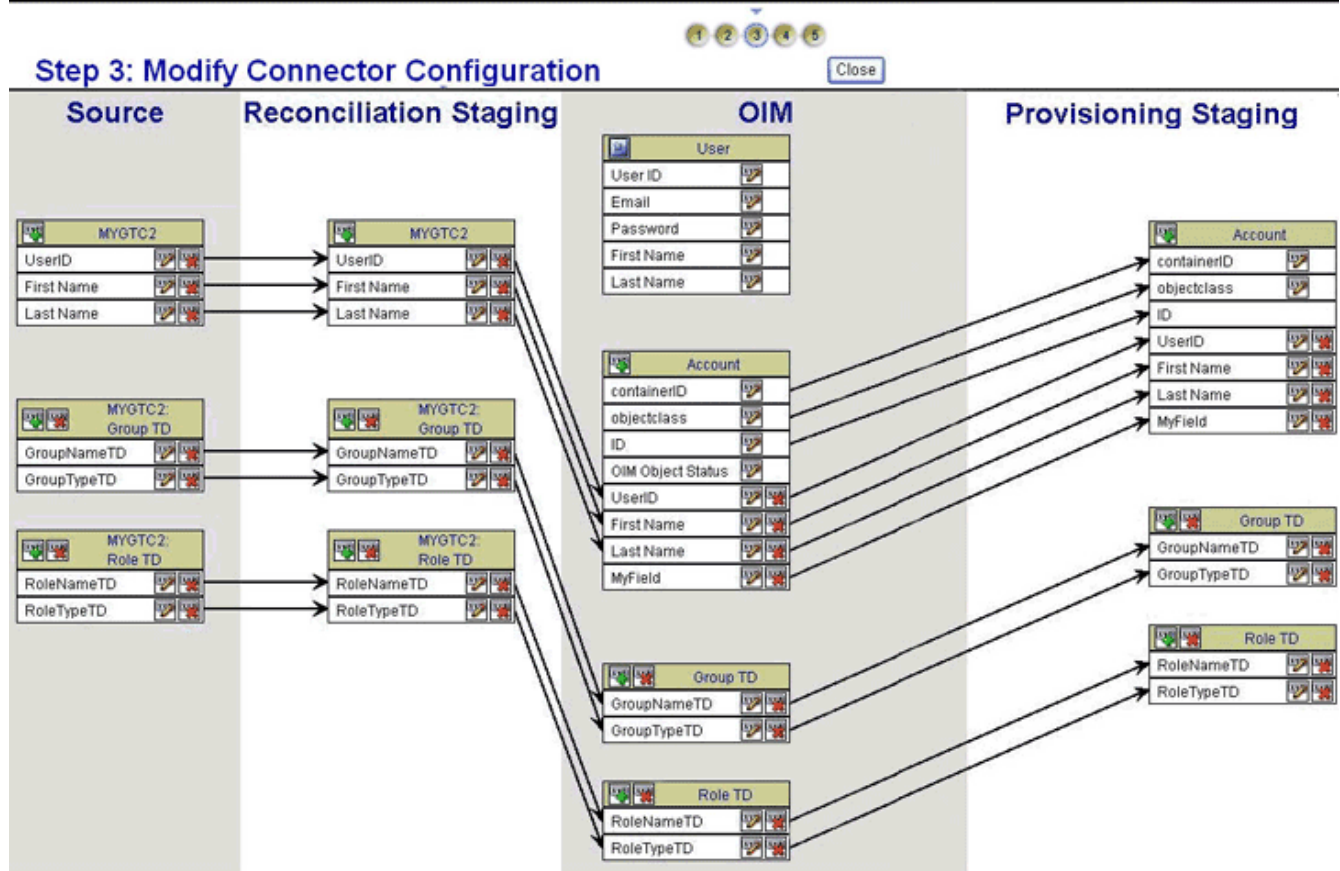

## 8.2.4 Verifying Connector Form Names

In the step 4 of the connector creation process, you specify names for the process form corresponding to the OIM account data sets and its child data sets.

Use this page to specify form names for the process forms corresponding to the OIM - Account data set and its child data sets.

### Note:

If you select the Trusted Source Reconciliation option on the Step 1: Provide Basic Information page, the OIM - Account data set and its child data sets are not created. Therefore, this page is not displayed if you select the Trusted Source Reconciliation option.

The generic technology connector framework automatically creates certain objects after you submit all the information required to create a generic technology connector. Parent and child process forms corresponding to the OIM - Account data sets are examples of objects that are automatically created. Each process form on a particular Oracle Identity Manager installation must have a unique name.

On the Step 4: Verify Connector Form Names page, the generic technology connector framework displays default names for these process forms based on the names of the corresponding data sets. You must verify and, if required, change the names of these forms to ensure that they are unique for this installation of Oracle Identity Manager. While changing the name of a form, you must use only ASCII characters. An error message is displayed if you specify non-unique form names or if any name contains non-ASCII characters.

 **Note:**

You cannot revisit this page, so ensure that the form names that you specify meet all the requirements before you click **Continue**.

After you specify the form names, click **Continue**.

Instead of clicking Continue, you can click **Back** to return to the Step 2: Specify Parameter Values page. However, metadata detection does not take place if you make changes on this page and click the Continue button. This is to ensure that any customization in the data set structure and mappings made during the first pass through this page does not get overwritten. You can manually add or edit fields and mappings on the Step 3: Modify Connector Configuration page.

## 8.2.5 Verifying Connector Information

In the last step of the connector creation process, you review the information furnished while creating the connectors. For verification, a page-wise explanation of the changes is provided.

Use this page to review information that you have provided up to this point for creating generic technology connectors. The following is a page-wise explanation of the changes that are permitted on the earlier pages:

- **Step 1: Provide Basic Information page**  
You can use either the View link or Back button to reopen and view the information provided on the Step 1: Provide Basic Information page. You cannot change the information displayed on this page, because any change in this information would amount to creating a new generic technology connector.
- **Step 2: Specify Parameter Values page**  
You can use either the Change link or Back button to reopen this page. You can change parameter values on this page. However, metadata detection does not take place when you submit the changed values. This is to ensure that any customization in the data set structure and mappings made during the first pass through this page does not get overwritten. You can manually add or edit fields and mappings on the Step 3: Modify Connector Configuration page.
- **Step 3: Modify Connector Configuration page**  
You can use the Change link to reopen this page and add or edit fields and mappings.
- **Step 4: Verify Connector Form Names page**  
You cannot revisit this page.

After you verify all the information displayed on the Step 5: Verify Connector Information page, click **Create**.

At this stage, the generic technology connector framework creates all the standard connector objects on the basis of the information that you provide. The list of these objects includes the connector XML file, which is created and imported automatically into Oracle Identity Manager. Except for the form names, the names of the connector objects are in the *GTCname\_GTC* format.

For example, if you specify `DB_conn` as the name of a generic technology connector that you create, all (except the forms) the connector objects are named `DB_CONN_GTC`.

At the end of the process, a message stating that the connector has been successfully created is displayed on the page.



**Note:**

If the creation process fails, objects that are created are not automatically deleted.

## 8.3 Managing Generic Technology Connectors

The generic technology connector framework offers features that enable you to modify a generic connector. The connector management includes tasks, such as editing parameter values and exporting or import a generic connector by using the Deployment Manager.

This section contains these topics:

- [Modifying Generic Technology Connectors](#)
- [Exporting Generic Technology Connectors](#)
- [Importing Generic Technology Connectors](#)
- [Importing Connector XML File](#)

## 8.3.1 Modifying Generic Technology Connectors

You can edit or change parameter values that were used during the connector creation process. Use the Design Console to change existing parameter values.

### **Caution:**

The Design Console can be used to modify connector objects that are automatically created at the end of the generic technology connector creation process. If you use the Manage Generic Technology Connector feature to modify a generic technology connector whose connector objects have been customized by using the Design Console, all the customization work done using the Design Console would get overwritten. Therefore, Oracle recommends that you follow one of the following guidelines:

- Do not use the Design Console to modify generic technology connector objects.  
The exception to this guideline is the IT resource. You can modify the parameters of the IT resource by using the Design Console. However, for the changes to take effect, you must purge the cache either before or after you modify IT resource parameters.
- If you use the Design Console to modify generic technology connector objects, do not use the Manage Generic Technology Connector feature to modify the generic technology connector.

In addition, you can modify only one connector at a time. If you try to use the Modify pages for two different connectors at the same time on the same computer, the Modify features would not work correctly.

To modify a generic technology connector:

1. Login to Identity System Administration.
2. Under Provisioning Configuration, click **Generic Connector**.
3. Search for the connector that you want to modify. To simplify your search, you can use a combination of the search criteria provided on this page. Alternatively, to view all the generic technology connectors that have been created on this Oracle Identity Manager installation, click **Search connectors** without specifying any search criteria.
4. In the results that are displayed, click the generic technology connector that you want to modify.
5. Click **Edit Parameters**. The Step 2: Specify Parameter Values page of the connector creation process is displayed. From this point onward, follow the procedure described in the Step 2 section.

### **Note:**

The only difference between this procedure and the procedure that you follow to create the generic technology connector procedure is that automatic metadata detection does not take place when you modify an existing generic technology connector.

 **Caution:**

If you modify attributes of fields of the OIM - Account data set or its child data sets, corresponding changes are not made in the Oracle Identity Manager database entries for these data sets. At the same time, no error message is displayed.

Therefore, Oracle recommends that you do not modify the fields or child data sets of the OIM - Account data set.

## 8.3.2 Exporting Generic Technology Connectors

You can export the XML file of a generic technology connector. This XML file contains definitions for all the objects that are part of the connector.

If you want to use the same generic technology connector on a new Oracle Identity Manager installation, you must first export the XML file and import it into the new Oracle Identity Manager installation.

To export the connector XML file:

1. In the Oracle Identity Manager Advanced Administration, under System Management, click **Export Deployment Manager File**.
2. On the first page of the Deployment Manager Wizard, select **Generic Connector** from the list and click **Search**.
3. In the search results, select the generic technology connector whose XML file you want to export.
4. Click **Select Children**.
5. For the selected generic technology connector, select the child entities that you want to export and click **Select Dependencies**.
6. Select the dependencies that you want to export, and click **Confirmation**.
7. After you verify that the elements displayed on the page cover your export requirements, click **Add for Export**.
8. Click **Exit wizard and show full selection**, and click **OK**.

## 8.3.3 Importing Generic Technology Connectors

You can import a stored XML file that contains object definitions. The process of exporting and importing XML files help in reusing an existing objects that are part of the connector.

To copy a generic technology connector to a different Oracle Identity Manager installation:

1. If the connector uses custom providers, you must copy the files created during provider creation to the appropriate directories on the destination Oracle Identity Manager installation.
2. Export the connector XML file on the source Oracle Identity Manager installation.
3. Import the connector XML file on the destination Oracle Identity Manager installation.

 **Caution:**

You must ensure that the names you select for a generic technology connector and its constituent objects on a staging server do not cause naming conflicts with existing connectors and objects on the production server.

The following scenario explains why you must follow this guideline:

Suppose you create a generic technology connector on a staging server, and want to import the connector to a production server. While creating the generic technology connector on the staging server, you would have ensured that the names of the generic technology connector and the connector objects are unique on that server. At the same time, you must also ensure that the names are not the same as the names of connectors and connector objects on the production server.

If any of the names happen to be the same, the old objects would be overwritten by the new objects when you import the connector XML file from the staging server to the production server. No message is displayed during the overwrite process, and the process would lead to eventual failure of the affected connectors.

To ensure that you are able to revert to a working state in the event that an object is overwritten, you must create a backup of the destination Oracle Identity Manager database before you import a connector XML file.

## 8.3.4 Importing Connector XML File

Import the connector XML file by checking its contents and removing redundant entities.

To import the connector XML file:

1. In the Oracle Identity Manager Advanced Administration, under System Management, click **Import Deployment Management File**. A dialog box for locating files is displayed.
2. Locate and open the connector XML file from the directory into which you copy it.
3. Click **Add File**.
4. Click **Next**, **Next**, and **Skip**.
5. Click **View Selections**.

The contents of the connector XML file are displayed on the Import page. You *may* see a cross-shaped icon along with some nodes. These nodes represent Oracle Identity Manager entities that are redundant. Before you import the connector XML file, you must remove these entities by right-clicking each node and selecting **Remove**.

6. Click **Import**. The connector file is imported into Oracle Identity Manager.

After you import the connector XML file, you must update the run-time parameters of the generic technology connector.

 **Note:**

These values are not copied in the connector XML file when you export it.

To update the values of the run-time parameters, follow the procedure described in [Modifying Generic Technology Connectors](#).

# 9

## Managing Application Instances

Managing application instances involves understanding the concepts related to application instances, managing and configuring application instances, developing entitlements, and managing disconnected resources.

This chapter contains the following sections:

- [About Application Instances](#)
- [Application Instance Concepts](#)
- [Managing Application Instances](#)
- [Configuring Application Instances](#)
- [Developing Entitlements](#)
- [Managing Disconnected Resources](#)

### 9.1 About Application Instances

Application instance is an abstraction that combines an IT resource instance (target connectivity and connector configuration) and resource object (provisioning mechanism).

In earlier releases, requests creation is based on name of resources, and it was administrator-centric, which requires good knowledge of technology. However, in this release of Oracle Identity Manager, accounts and entitlements of users are associated with application instances, and not with the IT resource instance or resource object. This makes it easier for an end user to operate.

Application instance will be published to organizations and can be requested by users of those organizations. Supposing Microsoft Active Directory (AD) is to be provisioned to users across different organizations or departments across the world, you can define application instances consisting of the following:

- AD as the resource object
- Each AD server instance with the connectivity information, such as URL and password, as IT resources

This is because the resource object is same for all users, but the connectivity information, such as port number, can be different for users who are part of different organizations. Therefore, the AD resource object can be provisioned as an application instance without the user being aware of the connectivity information.

Application Instance is the provisionable entity. In order to get an account in a specific target, end users will need to request for the application instance. Instead of requesting for a resource and configuring IT resource instance separately, end user can request for an application instance. The request is subject to approval by an approver. When the request is approved, the resource is provisioned to the user, and an account is created in the target system.



**Note:**

If the request is coming from an authorizer, then it may not require approval, where as a request coming from an end user needs approval by approver.

## 9.2 Application Instance Concepts

Understand the concepts related to application instances, such as multiple accounts per application instance, entitlements, disconnected application instances, and application instance security.

The application instance concepts are described in the following sections:

- [Multiple Accounts Per Application Instance](#)
- [Entitlements](#)
- [Disconnected Application Instances](#)
- [Application Instance Security](#)

### 9.2.1 Multiple Accounts Per Application Instance

Users in an enterprise can have multiple accounts in a single application instance.

This is required in a scenario in which an HR administrator performs various tasks for other employees in the organization by using an administrative account. The same HR administrator logs in by using a separate user account when performing certain tasks for self. In this example, the same user requires two different accounts for logging in to the system and performs different types of operations.

In addition, supporting multiple accounts for users is required to prevent potential security threats. Suppose a user uses the same account for logging in to the environment, and performs administrative tasks, regular business tasks for self and others, and tasks related to IT infrastructure. If there is an intrusion in the system and the account is hacked, the hacker can access infrastructure data and other confidential information. If the user has multiple accounts for each type of task and the regular account is hacked, the confidential information related to IT infrastructure and other sensitive resources are secured from the hacker.

Oracle Identity Manager supports multiple accounts in a single application instance. The first account that is created is tagged as primary account, and there can be only one primary account for a user. The subsequent accounts created on the same application instance would be tagged as Other.

When the user gets provisioned to an application instance, the Oracle Identity Manager checks if it is the first account getting provisioned for the user in that application instance. If it is the first account, then the account is marked as primary. When existing user accounts are reconciled from application instances, the first account that gets reconciled is marked as primary. If the account marked as primary is not the actual primary account, then you can manually change the primary tag for the account and mark another account as primary.

### 9.2.2 Entitlements

An entitlement granted to an account on a target system enables the account owner (user) to perform a specific task or function.

An entitlement can be a role, responsibility, or group membership. For example, if user Richard is granted the Inventory Analyst role on a target system, then Richard can use that entitlement to access and generate inventory-related reports from the target system.

In Oracle Identity Manager, there is one process form for each account (resource) provisioned to an Oracle Identity Manager User. Entitlement data is stored in child process form. In the example described earlier, the process form for Richard's account on the target system has a child process form that holds Inventory Manager role data.

 **Note:**

To reconcile entitlements created in the target system into Oracle Identity Manager, you must first run the scheduled job for lookup field synchronization, and then run the Entitlement List scheduled job.

Attributes that constitute entitlement data stored on a child process form may vary from one target system to another. In addition, different types of entitlements, such as roles and responsibilities, may have different attributes.

Entitlements can be requested directly instead of first requesting a modify resource on user accounts. Entitlements are not part of the account data as the child forms are handled independently. A user can provision, modify, or revoke an entitlement. For the requested entitlements, the user can provide additional information that might help an approver during the approval process.

All types of entitlements are available for request in the request catalog. If the request for an administrative entitlement is approved, then it is associated to the primary account. In addition, the requester can select target accounts, and approvers can also modify the target account.

You can edit the entitlements by using the Application Instances section of the Oracle Identity System Administration.

See [Developing Entitlements](#) for detailed information about entitlements.

## 9.2.3 Disconnected Application Instances

You can manually perform provisioning in the target application instance when the application instance is of the disconnected type.

You might deploy self service, delegated administration, request management, and role-based provisioning features in Oracle Identity Manager, and might not deploy provisioning and reconciliation connectors to automate provisioning. After completion of delegated administration operation, request-approval, or role-based provisioning, a manual provisioning task is assigned to an administrator. The administrator then manually performs the provisioning in the target application instance. An example of this is provisioning of an access card, which is physical. Because Oracle Identity Manager cannot provision a physical access card, the application instance of the disconnected resource is to be provisioned.

To achieve provisioning of disconnected resource, you can create application instances of the disconnected type. The manual provisioning administrator can use the Inbox section of the Oracle Identity Self Service to update all fields in the request. After the manual provisioning administrator submits the manual provisioning worklist item, the provisioning infrastructure marks the underlying provisioning task to be completed based on the response of the manual provisioning administrator. If the administrator specifies that task is manually completed, then the status is changed to provisioned.

## 9.2.4 Application Instance Security

The application instance is an entity with which security primitives are associated via the organization publishing mechanism.

Only those organizations that have the application instance published to them are able to provision to the targets.

## 9.3 Managing Application Instances

You manage application instances by using Oracle Identity System Administration. It involves searching, creating, modifying, and deleting application instances, and creating and modifying forms associated with application instances.

This section contains the following topics:

- [Creating Application Instances](#)
- [Searching Application Instances](#)
- [Modifying Application Instances](#)
- [Understanding the Deletion of Application Instances](#)
- [Creating and Modifying Forms Associated With the Application Instances](#)

### See Also:

Converting a Disconnected Application Instance to Connected in *Developing and Customizing Applications for Oracle Identity Governance* for information about converting a disconnected application instance to a connected application instance

### 9.3.1 Creating Application Instances

Use the Application Instances page of the Identity System Administration to create application instances by specifying attributes, such as application instance name and display name, whether or not disconnected, resource object, IT resource instance, form, and parent application instance.

To create an application instance:

1. Login to Oracle Identity System Administration.
2. In the left pane, under Provisioning Configuration, click **Application Instances**. The Application Instances page is displayed.
3. From the Actions menu, select **Create**. Alternatively, click **Create** on the toolbar. The Create Application Instance page is displayed.
4. Enter the values of the attributes, as listed in [Table 9-1](#):

**Table 9-1 Fields in the Create Application Instance Page**

Attribute	Description
Name	The name of the application instance. This is a required field. <b>Note:</b> If you enter non-ASCII characters in the Name field, then an error message is displayed when you try to save the application instance. It is recommended that you enter only ASCII or alphanumeric characters in the Name field.
Display Name	The display name of the application instance. This is a required field.
Description	A description of the application instance.
Disconnected	Select if you want to specify the application instance as disconnected. Selecting this option creates a new approval process that is assigned to the manual provisioning administrator. See " <a href="#">Disconnected Application Instances</a> " for more information. <b>Note:</b> Disconnected application instance can only be created when a sandbox is active. See "Managing Sandboxes" in <i>Developing and Customizing Applications for Oracle Identity Governance</i> for more information about sandbox.
Resource Object	The resource object name. You can click the search icon next to this field to search and select a resource object.
IT Resource Instance	The IT resource instance name. You can click the search icon next to this field to search and select an IT resource instance.
Form	Select the form or dataset name. The forms associated with the selected resource object are populated in the Forms list. Here, only pre-existing forms can be selected.
Parent ApplInstance	The application instance name that you want to specify as a parent to the new application instance. The new application instance inherits all the properties of the parent application instance. Resource must be assigned as 'Depends on' in the Design Console to populate this lookup.

5. Click **Save**. The application instance is created, and the details of the application instance is displayed in a page.

## 9.3.2 Searching Application Instances

You can search application instances based on application instance attributes that you can include in various search conditions.

To search for application instances:

1. In the Oracle Identity System Administration, under Provisioning Configuration, click **Application Instances**. The Application Instances page is displayed.
2. Select any one of the following:
  - **All:** On selecting this option, the search is performed with the AND condition. This means that the search operation is successful only when all the search criteria specified are matched.
  - **Any:** On selecting this option, the search is performed with the OR condition. This means that the search operation is successful when any search criterion specified is matched.
3. In the searchable application instance attribute fields, such as Display Name, specify a value.

For some attributes, select the attribute value from the lookup. For example, to search all application instances with a particular resource object, specify the resource object name in the Resource Object field.

4. For each attribute value that you specify, select a search operator from the list. The following search operators are available:
  - Starts with
  - Ends with
  - Equals
  - Does not equal
  - Contains
5. To add a searchable application instance attribute to the Application Instances page, click **Add Fields**, and select the attribute from the list of attributes.

For example, if you want to search all application instances under a parent application instance, then you can add the Parent AppInstance attribute as a searchable field and specify a search condition.

6. Optionally click **Reset** to reset the search conditions that you specified. Typically, you perform this step to remove the specified search conditions and specify a new search condition.
7. Click **Search**. The search result is displayed in a tabular format.

 **Tip:**

You can use the Query By Example feature to refine your search based on specific values. For more information, see *Using Query By Example in Performing Self Service Tasks with Oracle Identity Governance*.

## 9.3.3 Modifying Application Instances

You can open an application instance and modify the attributes, assign and revoke organizations to which the application instance is available, and edit the entitlements associated with the application instance.

These tasks are described in the following sections:

- [Modifying Application Instance Attributes](#)
- [Managing Organizations Associated With Application Instances](#)
- [Managing Entitlements Associated With Application Instances](#)

### 9.3.3.1 Modifying Application Instance Attributes

You can modify application instance attributes by opening the application instance details, and then by running the Catalog Synchronization Job scheduled job.

To modify the attributes of an application instance:

1. In the Application Instances page, search and select the application instance that you want to open.

2. From the Actions menu, select **Open**. Alternatively, click **Open** on the toolbar. You can also click the Display Name of the application instance.  
The Application Instance details page is displayed.
3. Ensure that the Attributes tab is displayed. The fields that you are not allowed to modify are grayed out.
4. Edit the values in the fields, such as Display Name, Description, Form, and Parent ApplInstance.
5. Click **Apply**. The attribute modifications are saved.
6. Run the Catalog Synchronization Job scheduled job.

 **Note:**

The Catalog Synchronization Job should be run preferably in Incremental mode so that changes, such as add, update, and delete, in base entity application instance and entitlements are synced to catalog DB.

### 9.3.3.2 Managing Organizations Associated With Application Instances

You must make an application instance available for requesting and subsequent provisioning to users by publishing the application instance to an organization. Managing the organizations associated with application instances are done by publishing the application instances to organizations or revoking them.

This section describes about managing organizations associated with application instances in the following tasks:

- [About Organizations Associated With Application Instances](#)
- [Publishing an Application Instance to Organizations](#)
- [Revoking Organizations From an Application Instance](#)

#### 9.3.3.2.1 About Organizations Associated With Application Instances

You must make an application instance available for requesting and subsequent provisioning to users by publishing the application instance to an organization. The users in that organization or the users who has User Viewer role in that organization or the users who has Application Instance Viewer role + User Viewer Role in that organization can request for application instance.

In the Organizations tab of the Application Instance details page, you can publish the application instance to organizations, and revoke organizations from the application instance.

In addition, you can publish the application instance to an organization and its suborganizations so that users of the suborganizations can also request for the application instance. You can also publish an application instance to organizations with entitlements so that users of the organization can request for the application instance with the entitlements associated with it.

 **Note:**

An administrator user can publish an entity to any organization that the administrator can view. For example, an Entitlement Administrator can publish entitlements with administrative permissions to any organization on which the Entitlement Administrator has view permission.

### 9.3.3.2.2 Publishing an Application Instance to Organizations

To publish an application instance to organizations:

1. In the Application Instance details page, click the **Organizations** tab. A list of organizations to which the open application instance is published is displayed.

For each organization, the **include sub-orgs** option is displayed in the Hierarchy Aware column. Select this option to make the open application instance available to the organization and its suborganizations. Deselect this option to make the open application instance available to the organization only.

2. From the Actions menu, click **Assign**. Alternatively, click **Assign** on the toolbar. The Select Organizations dialog box is displayed.
3. Search for the organizations to which you want to publish to the open application instance.

 **Note:**

If you are using Oracle Identity System Administration in French on Google Chrome web browser, the right arrow may be missing or truncated in the search panel of the Select Organizations dialog box. To fix this issue, verify the display language setting in Chrome and change it to French if necessary.

4. Click **Add Selected**. The selected organizations are added to the Selected Organizations table.

If you want to select all organizations, then click **Add All**.

5. For each organization added to the Selected Organizations table, a checkbox is displayed in the Hierarchy column. Select the **Hierarchy** option to publish the open application instance to the suborganizations of the selected organization.

To publish the open application instance to the selected organizations only, leave the **Hierarchy** option deselected.

6. Select the **Apply to Entitlement** option to publish the open application instance to the selected organizations with the entitlements associated with the application instance. Otherwise, leave this option deselected.
7. Click **Select**. The application instance is published to the selected organizations.  
The **include sub-orgs** option is displayed for the organizations for which you selected the **Hierarchy** option in the Select Organizations dialog box.

### 9.3.3.2.3 Revoking Organizations From an Application Instance

To revoke an organization from an application instance:

1. In the Organizations tab, select an organization that you want to revoke from the open application instance.
2. From the Action menu, select **Revoke**. Alternatively, click **Revoke** on the toolbar. A confirmation box is displayed with the selected organization.
3. Click **Yes** to confirm. The organization is revoked from the application instance.

 **Tip:**

To revoke from suborganization of the organization to which the application instance is published, deselect the corresponding **include sub-orgs** option, and click **Apply**.

### 9.3.3.3 Managing Entitlements Associated With Application Instances

You modify the entitlements associated with application instances to change the entitlement attribute values, and publish or revoke the entitlements to organizations.

This section contains the following topics:

- [Modifying Entitlement Attributes](#)
- [Publishing an Entitlement to an Organization](#)
- [Revoking an Entitlement from an Organization](#)

#### 9.3.3.3.1 Modifying Entitlement Attributes

To modify the attributes of an entitlement associated with an application instance:

1. In the Application Instance details page, click the **Entitlements** tab. A list of entitlements associated with the open application instance is displayed.
2. Select the entitlement that you want to modify.
3. From the Actions menu, select **Edit**. Alternatively, click **Edit** on the toolbar. The details of the selected entitlement is displayed in a page.
4. Change the values of the attributes, such as Display Name and Description, and click **Save**. The entitlement modifications are saved.
5. Run the Catalog Synchronization Job scheduled job.

#### 9.3.3.3.2 Publishing an Entitlement to an Organization

To publish an entitlement associated with an application instance to an organization:

1. In the Application Instance details page, click the **Entitlements** tab. A list of entitlements associated with the open application instance is displayed.
2. Select the entitlement that you want to publish. The entitlement details is displayed at the bottom of the page.
3. From the Actions menu, select **Assign**. Alternatively, click **Assign** on the toolbar. The Select Organizations dialog box is displayed.
4. Search and select the organization to which you want to publish the entitlement.
5. Click **Add Selected**. The organization is added to the Selected Organizations list.



If you want to publish the entitlement to all organizations, then click **Add All**.

6. Optionally, select the **Hierarchy** option if you want to publish the entitlement to the suborganizations of the selected organization.
7. Click **Select**.
8. Run the Catalog Synchronization Job scheduled job.

### 9.3.3.3 Revoking an Entitlement from an Organization

To revoke an entitlement associated to an application instance from an organization:

1. In the Application Instance details page, click the **Entitlements** tab. A list of entitlements associated with the open application instance is displayed.
2. Select the entitlement that you want to revoke. The entitlement details is displayed at the bottom of the page.
3. If you want to revoke the entitlement from the suborganizations of the organization, then keep the **include sub-orgs** option selected.
4. From the Actions menu, select **Revoke**. Alternatively, click **Revoke** on the toolbar. A warning is displayed asking for confirmation.
5. Click **Yes**.
6. Run the Catalog Synchronization Job scheduled job.

## 9.3.4 Understanding the Deletion of Application Instances

You can delete application instances from the Application Instances page and then by running the Application Instance Post Delete Processing Job scheduled job.

This section describes how application instance can be deleted. This is described in the following sections:

- [About Deleting Application Instances](#)
- [Deleting an Application Instance](#)

### 9.3.4.1 About Deleting Application Instances

An application instance can be deleted in any one of the following ways:

- Deleting the application instance from the Application Instances section of the Oracle Identity System Administration.
- Deleting the IT resource, which is a constituent of the application instance.

When you delete an application instance by using any one these methods, the application instance is not hard-deleted from Oracle Identity Manager. The application instance is soft-deleted. This is because accounts provisioned as a result of the application instance might exist in the target system. Therefore, after deleting an application instance, you must run a scheduled job to achieve the following:

- Unpublish the application instance from the entity publication
- Unpublish the associated entitlements from the entity publication
- Revoke, or hard-delete, or mark as deleted all the accounts for the application instance

## 9.3.4.2 Deleting an Application Instance

To delete an application instance:

1. In Oracle Identity System Administration, under Provisioning Configuration, click **Application Instances**. The Application Instances page is displayed with a list of application instances that are published to your organization.
2. Search and select the application instance that you want to delete.
3. From the Actions menu, select **Delete**. Alternatively, click **Delete** on the toolbar. A message box is displayed asking for confirmation.
4. Click **Delete** to confirm. The application instance is soft-deleted in Oracle Identity Manager.

You can also delete an application instance by deleting the IT resource of the application instance. For information about deleting IT resources, see *Managing IT Resources in Developing and Customizing Applications for Oracle Identity Governance*.

5. Run the Application Instance Post Delete Processing Job scheduled job. This scheduled job can be run in any one of the following modes:
  - **Revoke:** This mode is used when the application instance is deleted, but the provisioned accounts in the target system still exist. Using the Revoke mode deletes the accounts from the target system.
  - **Delete:** This mode is used when the target system no longer exists, and there are no traces of the accounts in Oracle Identity Manager. Using the Delete mode hard-deletes the accounts from all provisioning tasks and targets, and subsequently from Oracle Identity Manager.
  - **Decommission:** This mode is used when the target system no longer exists and the provisioned accounts cannot be revoked from the target system. Using the Decommission mode changes the account status to Revoke without keeping the accounts in Oracle Identity Manager in provisioned state.

For information about scheduled jobs, see [Managing the Scheduler](#) .

 **Note:**

The Application Instance Post Delete Processing Job scheduled job can be run after deleting each application instance.

6. Run the Catalog Synchronization Job scheduled job. This scheduled job identifies the soft-deleted application instances, and removes them from the catalog.

 **Note:**

- The Catalog Synchronization Job scheduled job run is independent of the Application Instance Post Delete Processing Job run. This means that the Catalog Synchronization Job scheduled job removes the soft-deleted application instances from the catalog even if Application Instance Post Delete Processing Job is not run after soft-deleting the application instances.
- Catalog Synchronization Job should be run preferably in Incremental mode so that changes, such as add, update, and delete, in base entity application instance and entitlements are synced to catalog DB.

## 9.3.5 Creating and Modifying Forms Associated With the Application Instances

In the Application Instances page of the Identity System Administration, you can create and modify forms associated with the resource objects, and subsequently with the application instances.

 **See Also:**

- See Managing Sandboxes in *Developing and Customizing Applications for Oracle Identity Governance* for information about sandbox.
- See [Managing Forms](#) for information about creating forms.
- See [Configuring Custom Attributes](#) for information about configuring custom attributes.

This section describes the following topics:

- [Creating Forms Associated With Application Instances](#)
- [Modifying Forms Associated With Application Instances](#)
- [Localizing Application Instance Form](#)

### 9.3.5.1 Creating Forms Associated With Application Instances

To create a form associated with an application instance:

 **Note:**

You cannot create forms directly. Before creating forms, you must create a sandbox and activate it. See *Managing Sandboxes in Developing and Customizing Applications for Oracle Identity Governance* for information about creating and activating a sandbox.

1. Login to Oracle Identity System Administration.
2. Create and activate a sandbox. A warning message is displayed if no sandbox is activated. For detailed instructions on creating and activating a sandbox, see *Managing Sandboxes in Developing and Customizing Applications for Oracle Identity Governance*.
3. In the left pane, under Provisioning Configuration, click **Form Designer**. The Form Designer page is displayed.
4. From the Actions menu, select **Create**. Alternatively, click **Create** on the toolbar. The Create Form page is displayed.
5. In the Resource Type field, specify a resource object with which you want to associate the form. To do so:
  - a. Click the lookup icon next to the Name field. The Search and Select: Name dialog box is displayed.
  - b. In the Name field, enter the name of the resource object you want to search. You can leave this field blank if you want to display all resource objects.
  - c. Click **Search**. The resource objects that match the search condition are displayed.
  - d. Select the resource object that you want to associate with the form, and click **OK**. The resource object name is displayed in the Name field of the Create Form page.
6. In the Form Name field, enter a form name.
7. (Optional) Select any one of the available options for Form Type:
  - **Parent Form + Child Tables (Master/Detail)**
  - **Parent Form (Master)**
  - **Parent Form + Child Tables for Non Entitlement (Master/Detail)**
8. (Optional) Select the **Generate Entitlement Forms** option if you want to associate the new form with the entitlements. Using this form, users can provide additional information that might help an approver during the approval process.
9. In the Available form fields section, a list of form field names along with description and Display Name are displayed. These fields are available for the form you are creating. For each available form field, you can select the Bulk Update option. Selecting this option makes the form field available for updating the entities in bulk.
10. In the Create Application Instance page or the Attributes tab of the Application Instance details page, click **Refresh** adjacent to the Form field.
11. Select the newly created form in the Form list and click **Apply**.

### 9.3.5.2 Modifying Forms Associated With Application Instances

 **Note:**

You cannot modify forms directly. Before creating forms, you must create a sandbox and activate it. See *Managing Sandboxes in Developing and Customizing Applications for Oracle Identity Governance* for information about modifying and activating a sandbox.

To modify a form associated with an application instance:

1. Open the Create Application Instance page or the Attributes tab of the Application Instance details page.
2. From the Form list, select the form you want to modify.
3. Click **Edit** to right of the Form field. The Manage Form page is displayed.

For information about creating and editing custom fields, see [Configuring Custom Attributes](#).

4. (Optional) If you want to associate a form with an entitlement, then you can regenerate the form to allow users to provide additional information that might help the approver during the approval process. To do so, click **Regenerate View**. In the Regenerate View popup window, select the **Generate Entitlement Forms** checkbox. See [Modifying Forms By Using the Form Designer](#) for information about the options available in the Regenerate View popup window.

#### Note:

If you have upgraded Oracle Identity Manager, then you must regenerate all the forms to use this feature.

### 9.3.5.3 Localizing Application Instance Form

To localize the application instance form:

1. Create an application instance of connector with a form attached to it.
2. Login to Oracle Enterprise Manager.
3. Go to **Application Deployments, oracle.iam.console.identity.sysadmin.ear, MDS Configuration**.
4. Click **Export** and save the archive to the host.
5. Unzip the archive, and open the `SAVE_LOCATION\xliffBundles\oracle\iam\ui\runtime\BizEditorBundle.xlf` file in a text editor.

#### Note:

This file may not exist in MDS. If it does not exist, then create a new one, but the path must be the same.

6. Edit the BizEditorBundle.xlf file in the following way:
  - a. Search and replace the following:

```
<file source-language="en"
original="/xliffBundles/oracle/iam/ui/runtime/BizEditorBundle.xlf"
datatype="x-oracle-adf">
```

With the following for Japanese language:

```
<file source-language="en" target-language="ja"
original="/xliffBundles/oracle/iam/ui/runtime/BizEditorBundle.xlf"
datatype="x-oracle-adf">
```

- b. Search for the application instance code. This procedure shows a sample edit for JDE application instance. The original code is:

```
<trans-unit id="$
{adfBundle['oracle.adf.businesseditor.model.util.BaseRuntimeResourceBundle']
['persdef.sessiondef.oracle.iam.ui.runtime.form.model.user.entity.userEO.UD_JDE_L
ANGUAGE__c_description']}">
<source>Language</source>
</target>
</trans-unit>
<trans-unit
id="sessiondef.oracle.iam.ui.runtime.form.model.JDEArj.entity.JDEArjEO.UD_JDE_LAN
GUAGE__c_LABEL">
<source>Language</source>
</target>
</trans-unit>
```

- c. Open the resource file from the connector package, for example JDEdwards\_ja.properties, and get the value of the attribute from the file, for example, global.udf.UD\_JDE\_LANGUAGE=\u8A00\u8A9E.
- d. Replace the original code shown in step 6b with the following:

```
<trans-unit id="$
{adfBundle['oracle.adf.businesseditor.model.util.BaseRuntimeResourceBundle']
['persdef.sessiondef.oracle.iam.ui.runtime.form.model.user.entity.userEO.UD_JDE_L
ANGUAGE__c_description']}">
<source>Language</source>
<target>\u8A00\u8A9E</target>
</trans-unit>
<trans-unit
id="sessiondef.oracle.iam.ui.runtime.form.model.JDEArj.entity.JDEArjEO.UD_JDE_LAN
GUAGE__c_LABEL">
<source>Language</source>
<target>\u8A00\u8A9E</target>
</trans-unit>
```

- e. Repeat steps 6a through 6d for all attributes of the process form.
- f. Save the file as BizEditorBundle\_ja.xml.
7. Repackage the ZIP file and import it to MDS.

#### See Also:

Deploying and Undeploying Customizations chapter in *Developing and Customizing Applications for Oracle Identity Governance*, for more information about exporting and importing metadata files.

8. Logout or Oracle Identity Manager and login again.

## 9.4 Configuring Application Instances

After creating application instances, you need to configure application instances, which involves configuring resource objects, IT resources, and password policies for the application instances.

This section contains the following topics:

- [Configuring a Resource Object](#)

- [Configuring IT Resource](#)
- [Configuring Password Policies for Application Instances](#)

## 9.4.1 Configuring a Resource Object

Use the Design Console to configure resource objects.

The Resource Objects form is in the Resource Management folder. You use this form to create and manage the resource objects for the Oracle Identity Manager resources that you want to provision for organizations or users. Resource object definitions are templates for provisioning the resource. However, the provisioning of the resource depends on the design of the provisioning processes that you link to the resource object.

## 9.4.2 Configuring IT Resource

An application instance can be configured for only one IT resource. If the process form requires value of two or more IT resources for provisioning an account, then it cannot be configured directly from the UI.

To configure two or more IT resources for provisioning an account:



### Note:

For information about configuring an IT resource, see [Managing IT Resources](#).

1. Identify the main IT resource for the account and configure the application instance with that.
2. Use entity adapter to populate the value for other required IT resources. For example, the Microsoft Exchange connector 9.1.1.7 requires an IT resource value of AD IT resource and Exchange IT resource to provision Exchange account. Perform Step 3 and 4 to make it work in R2.
3. Create an application instance with Exchange IT resource, and choose AD application instance as parent application because it is a dependent resource for Exchange.
4. Configure an entity adapter to pass the value of the AD IT resource to the process form. To do so:
  - a. Keep a track of the dependent IT resource name, such as Exchange, and independent IT resource name, such as AD. This can be in the code, or externalized in a lookup and then initialized in the code.
  - b. Create an entity adapter that takes long as a parameter. This is the parent IT resource key that will be populated.
  - c. In the adapter code, find the parent IT resource name and do a reverse lookup on the child IT resource name by using the map mentioned in step i.
  - d. From the child IT resource name, get the child IT resource key as a long and return it. The entity adapter return value gets set on the child IT resource field on the process form.

## 9.4.3 Configuring Password Policies for Application Instances

You can create a password policy for an application instance. This is done by setting a new rule for the password in the Design Console.

Perform the following steps to configure the password policy for application instances:

1. Login to Oracle Identity Self Service.
2. Create a password policy for the application instance by setting a new rule for the password. See *Managing Password Policies in Performing Self Service Tasks with Oracle Identity Governance* for information about creating and managing password policies.
3. After you set the password policy for an Application Instance, you need to attach the new policy to the connected (AD User) application instance. To do so:
  - a. Go to Design Console.
  - b. Under Resource Management, click **Resource Objects**.
  - c. Click on Password Policies Rule tab.
  - d. Select the new password policy (AD pwdpolicy) that you created to attach it to the connected application instance.
  - e. Click **Add**.

Figure 9-1 shows the Password Policies Rule tab of the Resource Object form.

**Figure 9-1 Attach Password Policy to Application Instance**

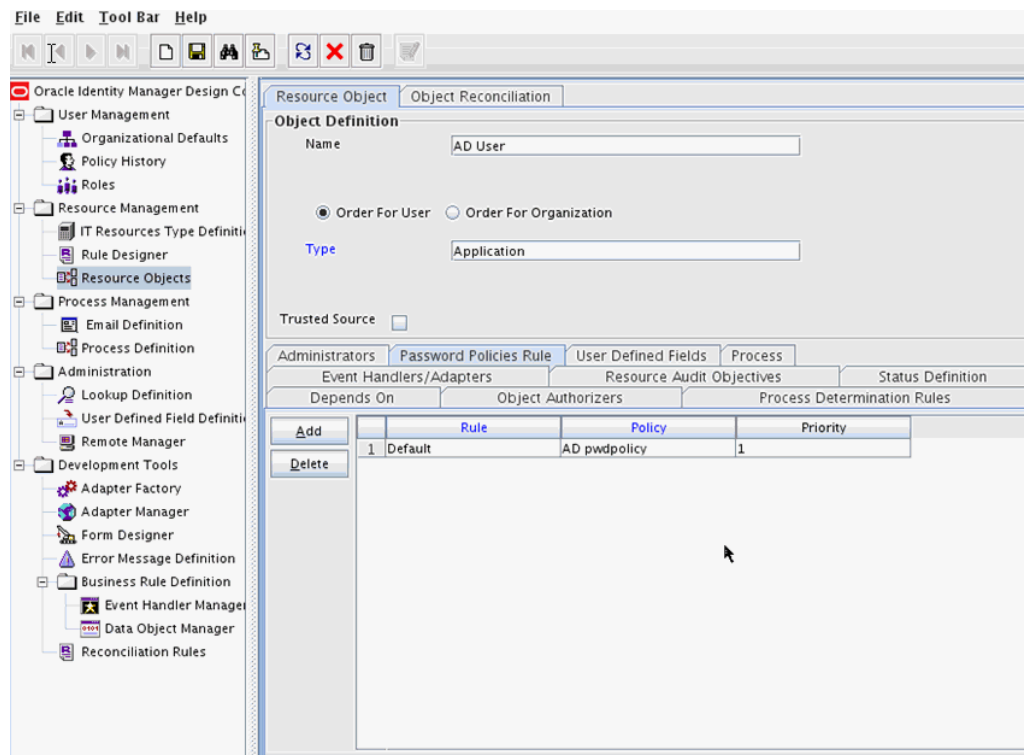



## 9.5 Developing Entitlements

Concepts related to developing entitlements are entitlement data capture process, marking entitlement attributes on child process forms, duplicate validation for entitlements, configuring scheduled tasks for working with entitlement data, deleting entitlements, refreshing the entitlement list post delete for new entries, disabling the capture of modifications to assigned entitlements, and generating entitlement-related reports.

This section discusses about developing entitlements in the following topics:

- [About Entitlements](#)
- [Available Entitlements and Assigned Entitlements](#)
- [Entitlement Data Capture Process](#)
- [Marking Entitlement Attributes on Child Process Forms](#)
- [Duplicate Validation for Entitlements or Child Data](#)
- [Configuring Scheduled Tasks for Working with Entitlement Data](#)
- [Disabling the Capture of Modifications to Assigned Entitlements](#)
- [Deleting Entitlements](#)
- [Refreshing the Entitlement List Post Delete for New Entries](#)
- [Disabling the Capture of Modifications to Assigned Entitlements](#)
- [Entitlement-Related Reports](#)

### 9.5.1 About Entitlements

An entitlement granted to an account on a target system enables the account owner (user) to perform a specific task or function.

An entitlement can be a role, responsibility, or group membership. For example, if user Richard is granted the Inventory Analyst role on a target system, then Richard can use that entitlement to access and generate inventory-related reports from the target system.

In Oracle Identity Manager, there is one process form for each account (resource) provisioned to an Oracle Identity Manager User. Entitlement data is stored in child process forms of the process form. In the example described earlier, the process form for Richard's account on the target system has a child process form that holds Inventory Manager role data.

Entitlements can be requested directly instead of first requesting a modify resource on user accounts. Entitlements are not part of the account data as the child forms are handled independently. A user can provision, modify, or revoke an entitlement. For the requested entitlements, the user can provide additional information that might help an approver during the approval process.

Attributes that constitute entitlement data stored on a child process form may vary from one target system to another. In addition, different types of entitlements, such as roles and responsibilities, may have different attributes. For example, Target System A contains the following role data attributes:

- Role Name
- Role Description
- Start Date

- End Date

The same target system can have a different set of attributes for responsibility data:

- Responsibility ID
- Date Assigned
- Proxy User
- Escalation User

You can mark or highlight the attribute that uniquely identifies an entitlement on a target system. For the sample role and responsibility data attributes listed earlier, the Role Name and Responsibility ID attributes uniquely identify the role and responsibility entitlements on Target System A. By marking attributes that uniquely identify entitlements, you enable the capture of entitlement data that can be used by other identity management solutions and also displayed in reports.

 **Note:**

If you are using the SAP User Management connector release 9.x with this release of Oracle Identity Manager, then perform the following steps for the Roles and Profiles entitlements to work correctly:

1. In the Role Child Form, from the Role System Name field, remove the Entitlement and Required properties.
2. In the Profiles Child Form, from the Profile System Name field, remove the Entitlement and Required properties.

## 9.5.2 Available Entitlements and Assigned Entitlements

The target system provides a list of preconfigured entitlements that are available along with an assigned entitlement list. You can use these entitlements and assign them to users on the target system.

A target system can have a set of entitlements defined and ready for assignment to accounts (users) on the target system. When you integrate this target system with Oracle Identity Manager, you can import (synchronize) entitlement data from the target system into the LKV table on Oracle Identity Manager.

 **Note:**

If you use a predefined connector to integrate the target system, then you can use scheduled tasks to fetch entitlement data into this table.

The Entitlement List scheduled job is run synchronize the entitlements to the request catalog. An entitlement is available when it can be found in the request catalog. See [Ongoing Synchronization](#) for more information about configuring Catalog Synchronization.

During a provisioning operation, you request the entitlement through the Catalog. You can also populate the entitlement data along with the parent data as request data set when submitting a request for an application instance. In this guide, entitlements assigned to accounts are called assigned entitlements. Data about assigned entitlements is stored in child process form tables.

## 9.5.3 Entitlement Data Capture Process

After you mark the entitlement attribute in each child process form, capture of data about available entitlements take place.

The following steps describe how data about available entitlements is captured:

### Note:

- You must mark the entitlement attribute in each child process form to enable the process described in these steps. The procedure is described later in this chapter.
- Make sure that the parent form has the latest child form version. It does not automatically happen when you create, edit, and activate the child parent without doing the same with the parent form. The Entitlement field can be marked from the Form Designer, which takes care of activating the parent/child forms.

1. Data about available entitlements is stored in the LKV table through synchronization with the target system.
2. You schedule and run the Entitlement List scheduled task.
3. The schedule task identifies the entitlement through the entitlement property in process form.
4. The scheduled task copies data about available entitlements from the LKV table to the ENT\_LIST table.

## 9.5.4 Marking Entitlement Attributes on Child Process Forms

You must mark the entitlement attribute in the child process form UD\_ table for resources for which you want to capture entitlement data.

Suppose there are 15 target systems in your operating environment. If you want to capture entitlement data from 12 of 15 resources, then you must mark the entitlement attribute in those 12 resources.

Apply the following guidelines while performing the procedure described in this section:

- On a child process form, only one attribute holding entitlement data can be marked.
- The attribute that you mark must be of the LookupField type and its property must be one of the following:

- Lookup code
- Lookup query

The Lookup query must satisfy the following conditions:

- \* The query uses the LKU and LKV tables
- \* The Lookup code in the query is from the LKU table
- \* The LKV\_ENCODED column value is used for saving
- \* The LKV\_DECODED column value is used for display purposes

To mark a field as an entitlement in a child process form:

1. Login to Identity System Administration.
2. Using the Form Designer, create a child form attribute, as described in [Creating a Custom Child Form Attribute](#). Make sure that the **Entitlement** and **Searchable** options are selected when creating an attribute for entitlement.

## 9.5.5 Duplicate Validation for Entitlements or Child Data

Duplicate entitlement or child data are validated based on the Key attribute or the Entitlement attribute, whichever is set.

The configuration of the above mentioned attributes are checked prior to validating duplicates in the child data. [Table 9-2](#) summarizes the possible valid and invalid configurations.

**Table 9-2 Possible Scenarios and Duplicate Validation Basis**

Entitlement Attribute	Key Attribute for Reconciliation Field Mapping	Configuration Validation	
		Connected Application Instance	Disconnected Application Instance
Not defined <b>Note:</b> In this scenario, the user is at a risk of adding duplicate entitlements or child data as the configurations are not defined properly. A warning message is logged on the server asking the user to define entitlement attribute and matching reconciliation field mapping.	Not defined	Valid	Valid
Defined. One attribute, say UD_CHILD1_ENT1 has Entitlement=true <b>Note:</b> Entitlement attribute does not have a matching key attribute defined in reconciliation field mapping.	Not defined	Invalid	Valid
Not defined	Defined. One attribute, say UD_CHILD1_ENT1 is set as the key attribute in recon field mapping.	Valid	Valid
Defined. One attribute, say UD_CHILD1_ENT1 has Entitlement=true	Defined. One attribute, say UD_CHILD1_ENT1 is set as the key attribute in recon field mapping.	Valid	Valid

**Table 9-2 (Cont.) Possible Scenarios and Duplicate Validation Basis**

Entitlement Attribute	Key Attribute for Reconciliation Field Mapping	Configuration Validation	
		Connected Application Instance	Disconnected Application Instance
Defined. One attribute, say UD_CHILD1_ENT1 has Entitlement=true <b>Note:</b> Entitlement attribute is a subset of the reconciliation field mapping key attributes.	Defined. Two or more attributes, say UD_CHILD1_ENT1 and UD_CHILD1_ENT2 are defined as key attributes in recon field mapping for child table UD_CHILD1.	Valid	Valid
Defined. One attribute, say UD_CHILD1_ENT1 has Entitlement=true <b>Note:</b> Entitlement attribute does not have a matching key attribute defined in reconciliation field mapping.	Defined. One or more attributes, say UD_CHILD1_ENT2 and UD_CHILD1_ENT3 are defined as key attributes in recon field mapping	Invalid	Invalid

Oracle recommends configuring both the entitlement attribute and the matching key attribute for the child data in reconciliation field mappings to enable effective validation.

Once a valid configuration is detected, duplicates are validated based on the operation as listed in [Table 9-3](#).

**Table 9-3 Duplicate Validation Based on Operation**

Operation	Duplicate Validation Description
Adding entitlement(s)	The attribute for which "Entitlement=true" property is defined.
Adding child data	The attribute that is the key attribute in the reconciliation field mappings.



**Note:**

Oracle recommends configuring both the entitlement attribute and the key attribute for the child data in reconciliation field mappings to enable effective duplicate entitlement or child data validation.

## 9.5.6 Configuring Scheduled Tasks for Working with Entitlement Data

The Entitlement List and Entitlement Assignments scheduled tasks must be configured to work with entitlement data.

You configure the following scheduled tasks for working with entitlement data:

- [Entitlement List](#)

- [Entitlement Assignments](#)

### 9.5.6.1 Entitlement List

The Entitlement List scheduled task identifies the entitlement attribute from the child process form table and then copies entitlement data from the LKV table into the ENT\_LIST table. A record created in the ENT\_LIST table corresponds to an entitlement defined on a particular target system.

You must set a schedule for this task depending on how frequently new entitlements are defined on the target systems in your operating environment. In addition, you must run this scheduled task when new target systems are integrated with Oracle Identity Manager. In other words, you must run this task each time you mark a new entitlement. After the connector scheduled tasks fetch lookup field data from the target system into the LKV table, you can run the Entitlement List scheduled task to copy that entitlement data into the ENT\_LIST table.

This scheduled task also handles updates to or deletion of entitlements from the target system. For example, if the Senior Accounts Analyst role is removed from the target system, then the connector scheduled task removes the entry for that role from the LKV table. When the Entitlement List scheduled task is run, it marks the row containing the role in the ENT\_LIST table as a deleted row.

### 9.5.6.2 Entitlement Assignments

The Entitlement Assignments scheduled task is used for copying data about assigned entitlements into the ENT\_ASSIGN table, in case when triggers fail to synchronization entitlement from UD table to ENT\_ASSIGN. This task identifies the entitlement attribute from the child process form table, and then copies data about assigned entitlements from the child process form table into the ENT\_ASSIGN table. A record created in the ENT\_ASSIGN table corresponds to an entitlement assigned to a particular user on a particular target system.

You can use the RECORDS\_TO\_PROCESS\_IN\_BATCH attribute of this scheduled task to specify the number of records in each batch. The default batch size is 5000.

In addition, it creates INSERT, UPDATE, and DELETE triggers on the child process form tables from which it copies entitlement data.

### 9.5.7 Deleting Entitlements

When you delete entitlements, they are marked as soft-deleted. You must perform post-process the deletion tasks to delete the entitlement permanently.

This section describes how to delete entitlements. This is described in the following section:

- [About Entitlement Deletion](#)
- [Deleting Entitlement Post-Processing](#)

#### 9.5.7.1 About Entitlement Deletion

Entitlements can get deleted in any one of the following ways:

- Deleting the Entitlement in the target, followed by synchronizing it via lookup reconciliation and further by the Entitlement List schedule job.
- Direct deletion of the Entitlement from Entitlement List via APIs.
- Deleting via corresponding application instance.

In all the ways of deleting, the Entitlement will be marked as soft-deleted, that is, the "valid" flag on the Entitlement will be updated to mark it as soft-deleted.

In all the cases of deleting, you need to perform the following post-processing.

- Unpublish the entitlement from the organization to which it is published
- Update the `Modify_date` on the Entitlement in Entitlement List to the current date
- Purge the instances of the Entitlement in the child table and Entitlement Assign
- Remove the Entitlements that are picked up by Catalog harvesting, that are marked as soft-deleted, and all request profiles.

 **Note:**

- In-flight requests that have references to soft-deleted Entitlements will fail.
- Access Policies having deleted Entitlements should be manually updated to remove the same.

## 9.5.7.2 Deleting Entitlement Post-Processing

To perform post-processing of Entitlement soft-deletion in the provisioning component:

1. Run the Entitlement Post Delete Processing Job scheduled job.

This task will take the following inputs:

- Application Instance Name/ALL
- Mode: Revoke/Delete

2. The task will perform the following functionality:
  - a. Revoke mode: The scheduled task will revoke the entitlement-grant for all the accounts in Oracle Identity Manager, which have that specific entitlement granted.
  - b. Delete mode: The schedules task will simply hard-delete the entitlements from Oracle Identity Manager database in the `UD_CHILD` table.
  - c. In both the above cases, the Entitlement grant entry will be removed from `ENT_ASSIGN`.

 **Note:**

The `Mode` flag must be set to `Delete`, and not `Revoke`, when you want to compensate for the post deletion of the entitlements. If you want that the entitlements being deleted from the backend through the Design Console should also be removed from the request details, and the `Grand` task and the `Revoke` task should not appear in the user's inbox, then you must run the `Entitlement Post Delete Processing Job` scheduled job with the `Mode` flag set to `Delete`.

3. Run the Entitlement List scheduled task. This is an existing schedule task that will go to all the resources that have an entitlement field, get the corresponding lookup definition and populate `ENT_LIST` with the values from the lookup definition, setting the correct `SVR_KEY` in the process.

## 9.5.8 Refreshing the Entitlement List Post Delete for New Entries

Synchronizing data to the entitlement list is done by running the Entitlement List and Entitlement Post Delete Processing Job scheduled jobs.

When an entry with the same encoded value is deleted and added consecutively in a lookup code, you need to perform the following steps to synchronize the data to the entitlement list:

1. Login to Oracle Identity System Administration.
2. Run the Entitlement List job to soft delete the existing entry.
3. Run the Entitlement Post Delete Processing Job scheduled job with Delete mode to clean up soft deleted items.
4. Run Entitlement List job again to add the new entry.

## 9.5.9 Disabling the Capture of Modifications to Assigned Entitlements

You can manually disable incremental synchronization of assigned entitlement data in the ENT\_ASSIGN table. In other words, you can disable the capture of modifications to assigned entitlements.

To achieve this, you create and run an SQL script to drop the following triggers created on the child process form tables:



### Note:

These triggers are created by the Entitlement Assignments scheduled task.

- The OIU\_UDPATE trigger created on the OIU table
- The *TABLE\_NAME\_ENT\_TRG* triggers created on the UD\_ tables:

After you run the script, modifications to assigned entitlements are not copied into the staging table.

The following is a sample SQL script to drop the triggers on the child process form tables:

```
create or replace
TRIGGER UD_LDAP_GRP_ENT_TRG
AFTER INSERT
OR DELETE
OR UPDATE OF UD_LDAP_GRP_GROUP_NAME
ON UD_LDAP_GRP
FOR EACH ROW
BEGIN
CASE
WHEN INSERTING THEN
OIM_SP_MANAGEENTITLEMENT('UD_LDAP_GRP', :NEW.UD_LDAP_GRP_GROUP_NAME, NULL,
:NEW.UD_LDAP_GRP_KEY, :NEW.ORG_KEY, NULL, NULL, NULL,
NULL, NULL, 'INSERT');
WHEN UPDATING THEN
IF :NEW.UD_LDAP_GRP_GROUP_NAME != :OLD.UD_LDAP_GRP_GROUP_NAME
THEN
OIM_SP_MANAGEENTITLEMENT('UD_LDAP_GRP', :NEW.UD_LDAP_GRP_GROUP_NAME,
:OLD.UD_LDAP_GRP_GROUP_NAME, :NEW.UD_LDAP_GRP_KEY, :NEW.ORG_KEY, NULL,
NULL, NULL,
```



```
NULL, NULL, 'UPDATE');  
END IF;  
WHEN DELETING THEN  
OIM_SP_MANAGEENTITLEMENT('UD_LDAP_GRP', :OLD.UD_LDAP_GRP_GROUP_NAME,  
NULL, NULL, :OLD. ORC_KEY, NULL, NULL, NULL,  
NULL, NULL, 'DELETE');  
END CASE;  
END;
```

## 9.5.10 Entitlement-Related Reports

Predefined reports that provide data about assigned entitlements are Entitlement Access List, Entitlement Access List History, User Resource Entitlement, and User Resource Entitlement History.

The following predefined reports provide data about assigned entitlements:

### Note:

You must be a member of the ADMINISTRATORS group to be able to view these reports.

Duplicate assignments of the same entitlement to a particular user are suppressed in the reports because they are not copied to the ENT\_ tables. For example, if user John Doe has been assigned the Sales Superintendent role twice on a target system, then the reports show only one instance of this entitlement.

- [Entitlement Access List](#)
- [Entitlement Access List History](#)
- [User Resource Entitlement](#)
- [User Resource Entitlement History](#)

### 9.5.10.1 Entitlement Access List

The Entitlement Access List report lists users who are currently assigned the entitlements that you specify while generating the report. The report provides basic information about the entitlements and the list of users to whom the entitlements are assigned.

### 9.5.10.2 Entitlement Access List History

The Entitlement Access List History report lists users who had been assigned the entitlements that you specify while generating the report. The report provides basic information about the entitlements and the list of users to whom the entitlements were assigned.

### 9.5.10.3 User Resource Entitlement

The User Resource Entitlement report lists the current entitlements of users whom you specify while generating the report. The report displays basic user information and entitlement details.

#### 9.5.10.4 User Resource Entitlement History

The User Resource Entitlement History report lists details of past entitlements assigned to users whom you specify while generating the report. The report displays basic user information and entitlement details.

## 9.6 Managing Disconnected Resources

Managing disconnected resources include understanding disconnected resources, managing disconnected application instance, provisioning operations on a disconnected application instance, configuring entitlement grant, understanding the status changes in manual process task action, customizing provisioning SOA composite, and troubleshooting disconnected resources.

This section describes about disconnected resources. This is described in the following section:

- [About Disconnected Resources](#)
- [Disconnected Resources Architecture](#)
- [Managing Disconnected Application Instance](#)
- [Provisioning Operations on a Disconnected Application Instance](#)
- [Configuring Entitlement Grant](#)
- [Status Changes in Manual Process Task Action](#)
- [Customizing Provisioning SOA Composite](#)
- [Troubleshooting Disconnected Resources](#)

### 9.6.1 About Disconnected Resources

Disconnected resources are targets for which there is no connector. Therefore, the provisioning fulfillment for disconnected resources is not automated, but manual.

In earlier releases of Oracle Identity Manager, disconnected provisioning is not supported as a first class use case, it is supported by using manual tasks in the provisioning process. This approach has a number of limitations, which are taken care in Disconnected Resources model. Disconnected resources are an enhanced configuration for manual provisioning that leverage SOA integration to provide higher flexibility and configurability of the manual provisioning workflow.

Some examples of disconnected resources include a Badge, Laptop, Pager, or any such item wherein the fulfillment is manual.

### 9.6.2 Disconnected Resources Architecture

The Disconnected Resource feature makes use of the existing Oracle Identity Manager provisioning engine artifacts such as the Provisioning Process, Process Task, Adapters and so on while providing BPEL Integration in a seamless and configurable manner.

When a Disconnected Application Instance is created from the UI, it automatically seeds a number of backend configuration artifacts, including a resource object (of type Disconnected), a provisioning process with tasks for the basic provisioning operations, an IT resource, and a process form with the minimal fields (which can be further customized).

Figure 9-2 illustrates the provisioning process architecture for disconnected resources.

**Figure 9-2 Disconnected Resource Architecture**

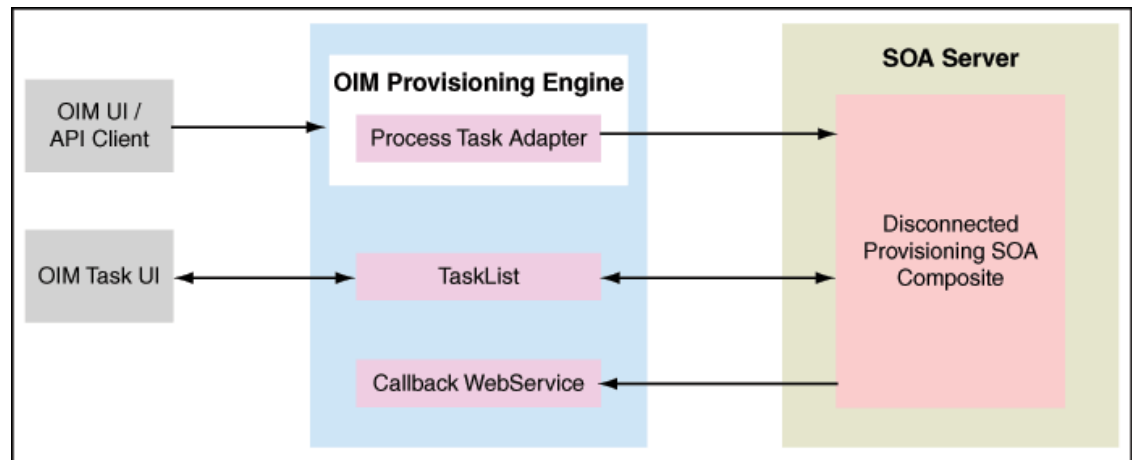

When a disconnected application instance is provisioned to a user (via request or otherwise), the specific workflow in the provisioning process is triggered. This fires the corresponding process task and executes the manual provisioning adapter that invokes the out of the box disconnected provisioning SOA composite. A SOA manual task is assigned to System Administrator by default. When the assignee acts on the manual task, the provisioningcallback webservice is invoked with the assignee specified response and it then completes or aborts the provisioning operation and updates the account appropriately.

Table 9-4 displays the attributes for manual provisioning SOA composite payload that is available in the composite.

**Table 9-4 Manual Provisioning SOA Composite Payload Attributes**

Attribute	Description
Account ID	Account ID (oiu_key) for the account under consideration
AppInstance Name	Disconnected Application Instance Display Name
Resource Object Name	Disconnected Resource Object Name
ITResource Name	Disconnected ITResource Name
Beneficiary Login	Login of the account beneficiary
Entity Key	Application Instance Key in case of Provision, Revoke, Disable, and Enable account operations.
Entity Type	Type is set to ApplicationInstance, in case of Provision, Revoke, Disable, and Enable account operations.
Beneficiary First Name	First name of the account beneficiary
Beneficiary Last Name	Last name of the account beneficiary
Descriptive Field	Account descriptive field for the account under consideration
URL	Oracle Identity Manager callback URL for the webservice.
Request Key	Request Key if operation is through request.
Requester Login	Login of the requester if operation is through request.

## 9.6.3 Managing Disconnected Application Instance

Managing disconnected application instance includes creating a disconnected application instance and creating a disconnected application instance for an existing disconnected resource.

Managing disconnected application instance includes the following tasks:

- [Creating a Disconnected Application Instance](#)
- [Creating a Disconnected Application Instance for an Existing Disconnected Resource](#)

### 9.6.3.1 Creating a Disconnected Application Instance

#### Note:

You must create a new sandbox before creating the application instance. You must publish the sandbox after creating the application instance. See *Managing Sandboxes in Developing and Customizing Applications for Oracle Identity Governance* for information about creating and publishing a sandbox.

To create disconnected application instance:

1. Log in to Oracle Identity System Administration.
2. Create and activate a sandbox.
3. In the left pane, under Configuration, click **Application Instances**. The Application Instances page is displayed.
4. From the Actions menu, select **Create**. Alternatively, click **Create** on the toolbar. The Create Application Instance page is displayed.
5. In the respective attribute fields, enter the values as shown in the following table:

Attribute	Value
Name	Enter the name of the application instance. This is a required field.
Display Name	Enter the display name of the application instance. This is a required field.
Description	Specify a description of the application instance.
Disconnected	Select the checkbox. This is the flag to indicate whether the application instance is not connected.  Note: This is a UI only flag and is not persisted in the backend. Checking this flag will disable Resource Object and ITResource Instance fields, as these will be automatically created in the back end.

Figure 9-3 shows the attributes in the Create Application Instance page.

**Figure 9-3 Create Application Instance Attributes**

6. Click **Save**, and then click **OK** on the information dialog box. The application instance is created, and the details of the application instance is displayed.
7. Publish the sandbox.
8. The UI form for the disconnected resource is automatically created and set, click **Apply**.
9. In addition to the application instance, in the back end, the following provisioning artifacts are automatically created:
  - Resource object of type Disconnected
  - ITresource type definition with the following parameters:
    - Configuration Lookup
    - Connector Server Name
    - Identity Gateway Name

 **Note:**

IT resource type definition parameters are for future use and the values for the same need not be set.

- IT resource of type definition
- Parent process form with the following fields:
  - Account ID
  - Password
  - Account login
  - IT resource
- Process definition with workflows for the following operations:
  - Provision Account

- Enable Account
  - Disable Account
  - Revoke Account
  - Modify Account Attributes
  - Adapters
    - Manual Provisioning
    - Manual Entitlement Provisioning
10. From the System Administration UI, search for scheduled job called Catalog Synchronization Job and execute it.

### 9.6.3.2 Creating a Disconnected Application Instance for an Existing Disconnected Resource

To create a disconnected application instance for an existing disconnected resource, see [Creating Application Instances](#).



#### Note:

You must not select the **Disconnected** option, as this will create artifacts including the resource object and IT resource in the backend.

### 9.6.4 Provisioning Operations on a Disconnected Application Instance

When provisioning process is triggered for Enable, Disable, Revoke, or Provision operations, the corresponding process task is inserted which runs the Manual Provisioning adapter. This adapter invokes the out of the box provisioning SOA composite. A SOA Human Task is assigned to the System Administrator by default.

From the Inbox in Oracle Identity Self Service, the System Administrator can:

- Check the task details
- Check the account details
- Change process form data in Oracle Identity Manager by changing data and clicking the Fulfill button
- Perform the operation manually in the target
- Act on the pending task by clicking Complete or Reject.

When the assignee acts on the pending manual tasks, the provisioning callback web service is invoked which continues with the Oracle Identity Manager operation and updates the account appropriately. See [Status Changes in Manual Process Task Action](#) for details on changes to account status based on assignee action.

Oracle Identity Manager does not support the following provisioning operations on a disconnected application instance:

- Password operations
- Provisioning process customization operations

When a process form field of a disconnected resource is updated, the "<FORM\_NAME> Updated" process task will be inserted into the provisioning process. This would generate a manual SOA human task, so that the assignee can manually update the changes in the corresponding target.

 **Note:**

The "<FORM\_NAME> Updated" task will be inserted irrespective of whether updates are to a single process form field or multiple process form field. This behavior is different from that of a connected resource. In addition, note that the individual process form field update tasks need not be configured for a disconnected resource.

## 9.6.5 Configuring Entitlement Grant

Configuring entitlement grant for disconnected resource involves creating a child form and configuring the lookup definition for entitlements.

To configure an entitlement grant:

 **Note:**

Before creating child forms, create and activate a sandbox.

1. Go to Oracle Identity System Administration. Under Configuration, click **Form Designer** and perform the following steps:
  - a. Click on the Resource Type and search for the Disconnected Resource.
  - b. From the search result, click on the disconnected application instance form name.
2. Go to Child Objects tab and click **Add** to add a child form.
3. In the Name field, provide a name to the child table and click **OK**.
4. Click the name link to open it for editing.
5. Click **Create**. In the Select Field Type dialog box, select **Lookup**, and click **OK**.
6. Provide the following values for the entitlement field:
  - a. In the Display Label field, enter a display name.
  - b. In the Name field, enter a name for the lookup.
7. Select the following check boxes:
  - Searchable
  - Entitlement
  - Searchable Picklist

 **Note:**

It is mandatory that you must select Searchable, Entitlement, and Searchable Picklist check boxes to create an entitlement field on the child form.

8. Create a new custom field of Lookup Type and click **OK**.
9. In the List of Values section, click the create a new lookup type icon and provide values for Meaning (for example, Lookup.Laptop.apps), Code (for example, Lookup.Laptop.apps) and description as follows:
  - a. Click new to add entitlement values to add Lookup Codes. The value in the Code and Meaning columns should have the following format:

Code	Meaning
<ENTITLEMENT_NAME>	<ENTITLEMENT_DESCRIPTION>

- b. Click **Save**. The Create Lookup Type dialog box closes.
  - c. Click **Save and Close**.
10. Click **Back to Parent Object** to return to the parent form.
11. Click **Regenerate View** to regenerate UI artifacts and dataset, and confirm by clicking **OK**.  
See [Modifying Forms By Using the Form Designer](#) for information about the options available in the Regenerate View popup window.
12. Publish the sandbox.
13. Go back to Oracle Identity System Administration, System Management, Scheduler.
14. Search for a scheduled job called Entitlement List and execute it.
15. After the scheduled job execution completes, search for another schedule job called Catalog Synchronization Job and execute it.

 **Note:**

Customization of the provisioning process is not supported, but you can customize the Disconnected Provisioning Composite.

## 9.6.6 Status Changes in Manual Process Task Action

Provisioning action statuses change based on each manual task action on provisioning operations.

[Table 9-5](#) provides details about status changes based on manual task action:

**Table 9-5 Manual Process Task Action Statuses**

Provisioning Operation	Manual Task Action	Provisioning Action
Provision	Complete	Account status will be set to Provisioned.
Provision	Reject	Account status will not be updated.



**Table 9-5 (Cont.) Manual Process Task Action Statuses**

Provisioning Operation	Manual Task Action	Provisioning Action
Disable	Complete	Account status will be set to Disabled.
Disable	Reject	Account status will not be updated.
Enable	Complete	Account status will be set to Enabled.
Enable	Reject	Account status will not be updated.
Revoke	Complete	Account status will be set to Revoked.
Revoke	Reject	Account status will not be updated.
Update	Complete	No Operation
Update	Reject	No Operation
Grant Entitlement	Complete	Completes the child table insert trigger process task and sets entitlement status to Provisioned.
Grant Entitlement	Reject	Cancels the child table insert trigger process task, which deletes the child table entry.
Revoke Entitlement	Complete	Deletes the child table entry from Oracle Identity Manager.
Revoke Entitlement	Reject	No Operation

## 9.6.7 Customizing Provisioning SOA Composite

Customizing the provisioning SOA composite involves customizing the Human Task Assignment via SOA Composer and modifying the predefined composite.

Provisioning SOA composite includes the following customizations:

- [Customizing Human Task Assignment via SOA Composer](#)
- [Customizing by Modifying the Predefined Composite](#)

### 9.6.7.1 Customizing Human Task Assignment via SOA Composer

The manual disconnected provisioning SOA composite, has a default rule, `ManualProvisioningRule`, which assigns the human task to the System Administrator.

A custom rule with higher priority, based on the payload, for example Application Instance Name, can be created from the SOA Composer UI, based on which the manual task assignment can be customized.

To add a custom rule:

1. Access Oracle SOA Composer by navigating to the following URL:  
`http://SOA_HOST:SOA_PORT/soa/composer`
2. Log in to the SOA Composer UI and click **Open Task** and select `DisconnectedProvisioning_rev1.0` composite.
3. From the `ManualProvisioningTaskRules.rules` tab, click **Edit** to add a custom rule.
4. Add Rule by providing the rule name and the conditional assignment rule.
5. Using the Up arrow, move the custom rule above the `ManualProvisioningRule`.
6. Save and commit changes. The manual provisioning rule is added.

 **See Also:**

SOA Composer documentation for more information about creating rules

### 9.6.7.2 Customizing by Modifying the Predefined Composite

To modify the default and predefined Disconnected Provisioning composite:

1. Copy the composite from *OIM\_HOME/workflows/composites/DisconnectedProvisioning.zip* to a local JDeveloper working location. Unzip it in the same directory to create the *DisconnectedProvisioning* directory.
2. Open the composite in JDeveloper in Default Role.

 **Note:**

You must install the version of JDeveloper that is compatible with the Oracle Identity Manager deployment. In addition, install any patches for JDeveloper so that JDeveloper works correctly with the SOA composites.

3. As part of customization do not alter the following:
  - Payload attributes defined in *DisconnectedProvisioning\xsd\ManualProvisioningTaskPayload.xsd*
  - *ProvisioningCallbackService* partnerlink and mappings
4. Double-click **composite.xml** to open the composite and modify as per your requirements.
5. Deploy the SOA composite from JDeveloper to Oracle SOA server. Make sure that you do not update the Revision ID and select the Overwrite any existing composites with the same revision ID option.

### 9.6.8 Troubleshooting Disconnected Resources

Common problems that you may encounter while performing provisioning and other tasks for disconnected resources are manual tasks not assigned to assignee or account status not modified.

[Table 9-6](#) displays the common problems that you may encounter while performing provisioning and other tasks for disconnected resources.

**Table 9-6 Troubleshooting Disconnected Resources**

Problem	Solution
Upon provisioning disconnected application instance, manual task is not assigned to assignee.	Perform the following steps: <ol style="list-style-type: none"> <li>1. Make sure that the SOA server is running.</li> <li>2. Check Open tasks page for rejected process tasks, and check the error information in the task, if it exists.</li> <li>3. Check Oracle Identity Manager logs to check if adapter is running.</li> </ol>

**Table 9-6 (Cont.) Troubleshooting Disconnected Resources**

Problem	Solution
Upon manual task completion, account status is not modified.	Perform the following steps: <ol style="list-style-type: none"><li data-bbox="786 359 1393 417">1. Make sure that the provisioning callback webservice, Provcallback is deployed.</li><li data-bbox="786 432 1435 464">2. Test the Webservice from the application server console.</li></ol>

# 10

## Managing Connector Lifecycle

Managing a connector lifecycle includes installation, configuration, and cloning of connectors. After a connector is installed and configured successfully, the connector lifecycle provides option to upgrade and export connector object definitions.

This chapter provides information about Connector Lifecycle Management (LCM) features. This chapter contains the following sections:

- [Lifecycle of a Connector](#)
- [Change Management Terminology](#)
- [Viewing Connector Details](#)
- [Installing Connectors](#)
- [Defining Connectors With Oracle Identity Governance](#)
- [Cloning Connectors in Oracle Identity Governance](#)
- [Exporting Connector Object Definitions in Connector XML Format](#)
- [Upgrading Connectors](#)
- [Uninstalling Connectors](#)
- [Troubleshooting Connector Management Issues](#)

### 10.1 Lifecycle of a Connector

Lifecycle of a connector includes stages, such as deployment, customization, cloning, upgrade, and uninstallation.

Oracle Identity Governance offers various solutions for integration with different kinds of IT-based resources in an organization. Oracle Identity Governance connectors are the recommended solution for integration between Oracle Identity Governance and resources that store and use user data. A connector enables exchange of user data between Oracle Identity Governance and a specific resource or target system.

Oracle Identity Governance server uses connectors to perform operations on target systems. Oracle provides connectors for common enterprise resources. You can develop custom connectors for your own resources.

A connector consists of the following artifacts:

- Binaries (JAR and DLL files) that contain the connector code
- XML file(s) consisting of data of Objects defined in Oracle Identity Governance, such as an IT resource, resource object, provisioning process and process tasks, process form and child forms, adapters and adapter tasks, lookup definitions, reconciliation rules, and scheduled tasks
- Integration libraries that enable adapters to perform actions on the target system

For some target systems, third-party integration libraries might be required to enable communication or specific functionality with the target systems.

 **See Also:**

*Oracle Identity Governance Connector Concepts* for detailed conceptual information about connectors and connector objects

The following are stages in the lifecycle of a connector:

- **Deployment**

A connector can be installed by clicking the **Manage Connector** menu on the Advanced Administration section of the Oracle Identity System Administration.

To complete the deployment procedure, you might also need to copy connector files and external code files to destination directories on Oracle Identity Governance and target system host computers. Some other connectors, specifically the identity connectors, require the local and remote connector server.

Oracle Identity Governance provides Connector LCM to manage connectors and uses Connector Installer (CI) for installing connector.

Installing a connector using Connector Installer is not the same as doing it using Deployment Manager. Although the Deployment Manager offers an alternative approach to import definitions of the objects that constitute a connector, the connector imported using Connector LCM can be managed better as Connector LCM offers a more broader and richer feature than Deployment Manager. Therefore, the Install Connectors feature is the recommended approach for Oracle Identity Manager 11g based connector installation and/or management.

 **See Also:**

- Oracle Identity Governance Connector documentation for information about copying connector files and external code files to destination directories on Oracle Identity Governance and target system host computers. Connector documentation is available on the Oracle Web site at the following URL:  
<https://docs.oracle.com/middleware/oig-connectors-12213/index.html>
- Understanding Identity Connector Framework in *Developing and Customizing Applications for Oracle Identity Governance* for information about the Identity Connector Framework and how to use it to create an identity connector.
- Managing Application Onboarding in *Performing Self Service Tasks with Oracle Identity Governance* for information about installing ICF connectors using the new Application Onboarding feature in Identity Self Service.

- **Customization**

After deployment, you might customize a connector to meet business requirements that are not addressed by the default configuration of the connector. For example, you might add new attributes for reconciliation and provisioning with the target system. An enhancement of this type requires changes to be made in multiple connector objects, such as Resource Object, Process Definition, and Process Form. See Connector Documentation for detailed information about changes required in connector objects.

- **Cloning**

You might have more than one installation of a target system. If you have a target system with multiple instances, and data is either same or shared or replicated, such as in Microsoft Exchange or Active Directory connectors, then you do not need to clone the connector. You need to create multiple IT resources for the instances. The target works as a single resource object.

If you have a target system with different installations or schema or data, such as a LDAP server for internal users and another LDAP server for external, contractors, and consumers, then you need to clone the connector. The connectors will work as two separate targets.

There might be a scenario where the connector attributes are different. Then instead of creating a new connector, the existing connector can be cloned by using the XML of the original connector. The **Clone Connectors feature** of the Advanced Administration enables you to automatically generate copies of a set of connector objects.

- **Upgrade**

To make use of new features introduced in later releases of a connector, you might upgrade a connector by applying patch sets released by Oracle. Typically, upgrading to a new release of a connector involves processes that range from simple changes (such as a JAR file upgrade) to changes that affect most of the adapter tasks that were shipped as part of the connector. You can use the **Upgrade Connectors feature** to upgrade a connector.

 **Note:**

Upgrading connectors preserve the existing customizations in a connector.

- **Uninstalling**

 **Note:**

Uninstalling a connector is performed in the development environment and not in production environment.

If you stop using a connector, then this action is also provided to additional environments, such as System Integration Testing, User Acceptance Testing, and Staging, where that connector is also stopped.

The need to keep a clean development environment that does not have any unnecessary Oracle Identity Governance objects, you would like to uninstall a particular connector version that you no longer need to use. The **Uninstall Connectors utility** enables you to uninstall connectors as well as individual connector objects.

 **Note:**

You must have the System Administrator role to perform connector lifecycle management tasks, such as installing connectors including importing connector XML files by using the Deployment Manager, and cloning, defining, upgrading, and uninstalling connectors.

Figure 10-1 depicts the connector lifecycle:

Figure 10-1 Connector Lifecycle

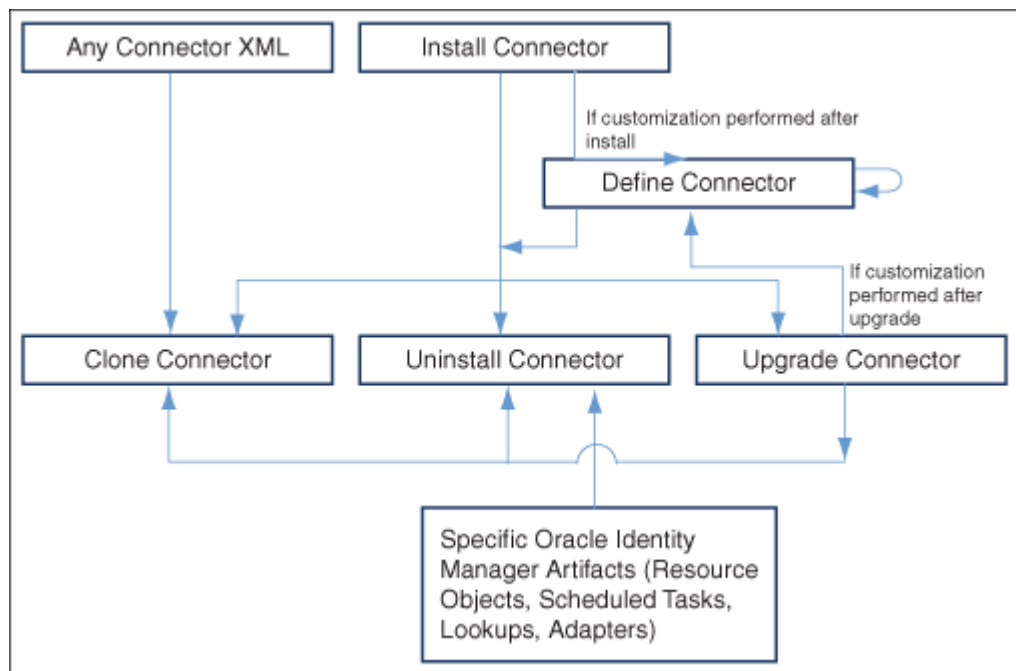

## 10.2 Change Management Terminology

Important terminologies used in connector change management are Oracle-released connector, custom connector, target connector, configuration XML file, and connector XML file.

The following terms have been introduced in this chapter:

- **Oracle-released connector** refers to a connector released by Oracle.
- **Custom release** or **custom connector** refers to connectors that you develop as well as Oracle-released connectors that you customize or reconfigure in any way.
- **Source release** or **source connector** refers to the existing release of the connector that you want to upgrade to a different (that is, new) release. For example, if you want to upgrade the SAP User Management connector from release 9.1.2 to release 9.1.2.1, then release 9.1.2 is the source release.
- **Target release** or **target connector** is the release to which you want to upgrade the source release. In the preceding example, SAP User Management release 9.1.2.1 is the target release.

### Note:

Some of the preceding terms can be combined to provide a shortened description of the type of connector that is under discussion. For example, a **custom source release** is a connector that you had created, customized, or reconfigured and now want to upgrade to a target release.

- A **configuration XML file** contains information that is used during connector installation by the Install Connectors feature. For a connector released by Oracle, the configuration XML file is included in the deployment package. For a custom-developed connector, you might want to develop the individual connector objects on the staging (test) server and then deploy the connector on the production server. In this case, you can create a configuration XML file for the connector if you want to install the connector on the production server by using the Install Connectors feature.

 **See Also:**

[Installing Connectors](#) for information about the Install Connectors feature.

- A **connector XML file** contains definitions of the individual objects that constitute a connector. When the XML file is imported into Oracle Identity Governance through the Deployment Manager, these objects definitions are used to create the connector objects in the Oracle Identity Governance database. The manner in which the XML file is imported into Oracle Identity Governance depends on the type of connector:
  - For an Oracle-released connector that is compatible with the Install Connectors feature, the connector XML file is automatically imported when you use the Install Connectors feature. This feature implicitly calls the Deployment Manager to import the connector XML file.
  - For an Oracle-released connector that is not compatible with the Install Connectors feature, you use the Deployment Manager to import the XML file.
  - For a custom connector, you can use the Deployment Manager to first export definitions of objects that you had created on the staging server. The output of this process is the connector XML file. You can then import the file into the production server. Alternatively, if you create a complete deployment package (including the configuration XML file) for the connector, then you can use the Install Connectors feature to install the connector. This feature implicitly calls the Deployment Manager to import the file.

 **See Also:**

[Exporting Connector Object Definitions in Connector XML Format](#) for information about exporting connector object definitions by using the Deployment Manager

## 10.3 Viewing Connector Details

When you search for a connector, the search results table displays various connector-related information that you can use during the lifecycle management operations.

To view the details of a connector:



 **Note:**

In this release of Oracle Identity Governance, the connector lifecycle management functionality have been introduced such as defining, cloning, upgrading, and uninstalling connectors. For all these features, complete connector DM-XML is required in the database, and this is the source for all the connector lifecycle management activities.

When Oracle Identity Governance is upgraded from earlier releases, you must define the connector so that all the lifecycle management operations on the connector are possible to perform. Without defining the connector, it is not possible to search for the installed connector, upgrade the installed connector, clone the connector, and uninstall the connector. See [Defining Connectors With Oracle Identity Governance](#) for information about defining connectors.

1. Login to Oracle Identity System Administration.
2. In the left pane, under Provisioning Configuration, click **Manage Connector**.
3. In the **Connector Name** field, enter the name of the connector.
4. Click **Search**. The search result shows the details of the connector.

If you want to display details of all installed connectors, then you can leave the Connector Name field blank and click **Search**.

The search results table displays the connector name, release number, status, and the date and time at which the connector was installed. The remaining columns of the table provide icons that you can use to begin any of the lifecycle management operations on a connector.

## 10.4 Installing Connectors

Installing a connector includes various stages such as understanding the connector deployment, creating user accounts, and the connector installation operation.

This sections describe the Connector Deployment process, the installation procedure and post installation steps:

- [Understanding the Connector Deployment Process](#)
- [Installing a Connector](#)
- [Postinstallation Steps](#)

 **Note:**

To determine whether you can install an Oracle-released connector by using the Install Connectors feature, see the connector guide.

## 10.4.1 Understanding the Connector Deployment Process

Connector deployment includes both manual and automated steps. After a successful connector install operation, Oracle Identity Governance stores the connector data in the server database.

To install a connector, you perform some or all of the following tasks:

 **Note:**

Users belonging to the SYSTEM ADMINISTRATORS role of Oracle Identity Governance can install connectors.

1. Verify the installation requirements.
2. Configure the target system.
3. Copy the connector files and external code files to directories on the Oracle Identity Governance server.
4. Configure Oracle Identity Governance.
5. Import the connector XML files.
6. Configure reconciliation.
7. Configure provisioning.
8. Configure Secure Sockets Layer (SSL).

Of these tasks, the Install Connectors feature automatically performs the following:

 **Note:**

You manually perform the remaining tasks. Connector documentation provides instructions.

- Copying the connector files and external code files to directories on the Oracle Identity Governance server
- Importing the connector XML files
- Compiling adapters (which is part of the procedure to configure provisioning)

At the end of a successful installation, an entry is created in a table in the Oracle Identity Governance database that stores data about installed connectors. [Defining Connectors With Oracle Identity Governance](#) describes the data that is stored in the database.

## 10.4.2 Installing a Connector

Installing a connector involves fetching and storing various connector install files, ensuring all connector installation dependencies are handled, and troubleshooting errors encountered during the connector install operation.

 **Note:**

Re-installing a connector is not supported. You cannot install a connector that has already been installed in Oracle Identity Governance. However, if the installation process is not successful, Oracle Identity Governance allows you to reinstall the connector.

Before you install a connector, copy the installation files of the connectors that you want to install into a directory of your choice (Alternative directory) or a default connector installation directory, which is:

```
OIM_HOME/server/ConnectorDefaultDirectory
```

To install a connector:

1. Log in to Oracle Identity System Administration by using the SYSTEM ADMINISTRATORS account.
2. In the left pane, under Provisioning Configuration, click **Manage Connector**. The Manage Connector page is displayed.
3. Click **Install**. The Install Connector page is displayed.
4. In the Select Connector to Install tab:
  - a. To install a connector from default directory (*OIM\_HOME*/server/ConnectorDefaultDirectory):
    - i. From the **Connector List** list, select the connector you want to install. This list displays the name and release number of connectors whose installation files are present in the default connector installation directory (*OIM\_HOME*/server/ConnectorDefaultDirectory).
    - ii. Click **Next**. The Review History and Dependency Details tab is displayed.
  - b. To install a connector from the installation file saved in a directory of your choice(Alternative Directory):
    - i. In the **Alternative Directory** field, enter the full path of the directory.
    - ii. Click **Load** to update the list of connectors in the Connector List.
    - iii. From the **Connector List** list, select the connector you want to install.
    - iv. Click **Next**. The Review History and Dependency Details tab is displayed.
5. In the Review History and Dependency Details tab, you can review the connectors prior installation details and dependency details. Click **Install**. The Summary tab is displayed.
6. In the Summary tab, you can monitor the connector installation task progress. The following tasks are performed in sequence during installation:
  - a. Configuration of connector libraries

- b. Import of the connector XML files (by using the Deployment Manager)
- c. Compilation of adapters

On successful completion of a task, a check mark is displayed for the task. If a task fails, then an X mark and a message stating the reason for the failure is displayed.

Depending on the reason for the failure, make the required correction and then try to install the connector again.

If all three tasks of the connector installation process are successful, then a message indicating successful installation is displayed. In addition, a list of the steps that you must perform after the installation is displayed. These steps are as follows:

- If there are any prerequisites for using the connector, then ensure they are addressed.
- Creating an IT resource for the connector.

Most of the connectors are shipped with a default IT resource. You can use either the default IT resource or create a new one. For more information on Creating IT Resource, see [Creating IT Resources](#).

- Configuring the scheduled tasks that are created when you installed the connector. For more information on searching and configuring scheduled tasks, see [Managing the Scheduler](#).

### 10.4.3 Postinstallation Steps

After a successful connector install operation, you need to perform the post installation steps. These steps include adding or editing the IT resource, creation of new entities, such as sandbox, UI form, and application instance, along with sandbox publishing operations.

To perform postinstallation configuration:

1. Create or update IT resource with appropriate values using steps defined in step 6 of [Installing a Connector](#).
2. Creating a Sandbox. To do so:

#### See Also:

Managing Sandboxes in *Developing and Customizing Applications for Oracle Identity Governance* for complete information on Sandboxes

- a. Navigate to System Administration and on the top right hand corner, click **Sandboxes**.
  - b. In the Manage Sandboxes tab, click **Create Sandbox**.
  - c. In the Create Sandbox dialog box, enter a sandbox name and description, click **Save and Close**. Click **Ok** in the confirmation dialog box.
3. Creating a new UI form. To do so:

#### See Also:

see [Managing Forms](#). for complete information about forms.

- a. In the System Administration page, under Provisioning Configuration, click **Form Designer**.
  - b. Under Search Results, click **Create**.
  - c. Select the resource type for which form needs to be created.
  - d. Enter a form name and click **Create**.
4. Creating an Application Instance. To do so:

 **See Also:**

see [Managing Application Instances](#) . for complete information about Application Instances.

- a. In the System Administration page, under Provisioning Configuration, click **Application Instances**.
  - b. Under Search Results, click **Create**.
  - c. Enter appropriate values for fields displayed on the Attributes form and click **Save**.
  - d. In the Form dropdown, select the newly created form and click **Apply**.
  - e. Publish the application instance. See [Managing Organizations Associated With Application Instances](#) for more information about publishing an application instance for a particular organization.
5. Export the sandbox and publish it.
- It is recommended that you export the sandbox to store all the changes made in your sandbox.
- For information about exporting and publishing sandboxes, see *Managing Sandboxes in Developing and Customizing Applications for Oracle Identity Governance*.
6. Entitlement Harvesting and Catalog Sync:
- a. In the Identity System Administration, under System Configuration, click **Scheduler**.
  - b. Run connector lookup reconciliation scheduled jobs.
  - c. Run Entitlement List scheduled job.
  - d. Run Catalog Synchronization Job scheduled job.

## 10.5 Defining Connectors With Oracle Identity Governance

Oracle Identity Governance provides an option to customize or re-configure the installed connector to suit your requirements.

This section describes the process of defining connectors with Oracle Identity Governance:

- [About Defining a Connector](#)
- [Defining a Connector](#)

### 10.5.1 About Defining a Connector

Defining connectors involve steps to add/edit object definitions or to reconfigure existing attribute names and key fields.

Connector LCM operations such as Upgrade, Clone, and Uninstall needs a source for each connector where all the connector objects reside. The Connector Install stores the Deployment Manager (DM) XML in Oracle Identity Governance database.

Typically, you will install the shipped connector and then perform one or both of the following operations:

- Customize the connector by, for example, add/ modify existing object definitions, add additional adapters
- (Re) Configure the connector by, for example, changing attribute names and key fields

The DM XML in Oracle Identity Governance database, which will be the reference for all Connector LCM operations need to be updated for customization changes. Oracle Identity Governance provides **Define** feature to update the DM XML stored in Oracle Identity Governance database with customization changes. Define feature is similar to Export where user need to add all the connector objects related to a specific connector. The end result of defining a connector is an XML file, which will be updated in Oracle Identity Governance database.

At this point, the customized or re-configured connector is not the same as the Oracle-released connector. The connector XML file for the Oracle-released connector might not be valid for the customized or re-configured connector.

In the Advanced Administration page of the Oracle Identity System Administration, you can **define** a customized or re-configured connector. Defining a connector is equivalent to registering the connector with Oracle Identity Governance.

 **Note:**

You must add only those Oracle Identity Governance artifacts that are specific to the connector and do not add default objects or any other connector objects that are shared across connectors. The defined XML is the source for life cycle operations such as upgrade, clone, and uninstall. If an object is used in define and is shared across connectors or a default Oracle Identity Governance object, then there will be un-intended behavior. For example, a Lookup Definition which is there by default in Oracle Identity Governance is added as a part of define, then clone operation will create another copy of the object, which is not required. The uninstall will delete this default object from Oracle Identity Governance as it is defined specific to a connector. Such incorrect definition will have impact on Oracle Identity Governance functionality. Therefore, you must be careful while adding an object while defining a connector.

When you define a connector, a record representing the connector is created in the Oracle Identity Governance database. If this record already exists, then it updates:

- The name of the connector. For example, `Microsoft Active Directory`.
- The release number of the connector. For example, `9.1.1`.
- The connector XML definitions.

 **Note:**

- You can define the connector XML definitions in the form of an XML file. See the "Exporting Connector Object Definitions in Connector XML Format" section of the connector guide for more information. You can then use this connector XML file to build the installation package for installing the connector on a different Oracle Identity Governance installation.
- Oracle recommends defining a connector immediately after customizing the connector or updating the DM XML file with the customization changes.

A connector is automatically defined when you install it using the Install Connectors feature or when you upgrade it using the Upgrade Connectors feature. Therefore, if you install a connector and want to clone it without customizing the connector, then there is no need to define the connector.

You must manually define a connector, otherwise newer version (which basically pertains to entry in CIH table) of connector may not be reflected even though import of new XML was successfully completed. Perform this procedure only if:

- You import the connector by using the Deployment Manager.
- You customize or reconfigure the connector.

 **Note:**

You can continue to use a connector without defining it after you customize or reconfigure a connector or after you upgrade Oracle Identity Governance. However, if you want to upgrade, clone, or uninstall the connector, then you must first define it.

- You upgrade Oracle Identity Governance.
- It is a custom connector that you develop.

## 10.5.2 Defining a Connector

The Connector Management Defining wizard, which you can open from the Manage Connector page of Identity System Administration, lets you define a connector.

To define a connector:

 **Note:**

To determine whether you can define a particular release of a connector by using the Oracle Identity System Administration, see the documentation for that release of the connector.

1. Log in to Oracle Identity System Administration.

2. In the left pane, under Provisioning Configuration, click **Manage Connector**. The Manage Connector page is displayed.
3. Click **Define**. The Connector Management Defining page is displayed.
4. In the Search page, you can search and select the entities that you want to include in the connector definition. To do so:
  - a. Search for the required entity. For example, to search for process forms, select **Process Form** from the Type list, and click the search icon. In the Name field, you can enter a search string and the asterisk (\*) as a wildcard character to refine your search for process forms belonging to the connector. Then, click the search icon. The process forms that match the search criteria are displayed in the Available Entities list.

Alternatively, to select all entities of all types, select **All** in the Type list, and click the search icon.

Similarly, you can search for any other entity objects, such as IT resources or process definitions, until you select and build the complete entity list for the connector definition.

- b. In the Available Entities list, select the checkbox for the entity to include it in the Selected Entities list. To select all entities from the Available Entities list, select the checkbox to the left of the Name column.

If you want to remove any selected entity, then click Remove adjacent to that entity in the Selected Entities list.

Figure 10-2 shows the Search page with the complete list of selected connector objects that are to be included in the connector definition.

**Figure 10-2 Selected Connector Objects**

Connector Management Defining

Search without type parameter will display a maximum of 25 records. Please narrow down your search or include type parameter in the search.

Available Entities		Selected Entities	
Name	Type	Name	Type
<input type="checkbox"/> OrdOIMApplicationInstanceAuthorizerRole	Admin Role	<input type="checkbox"/> OrdOIMSystemAdministrator	Admin Role
<input type="checkbox"/> OrdOIMApplicationInstanceViewerRole	Admin Role	<input type="checkbox"/> OrdOIMSystemConfigurator	Admin Role
<input type="checkbox"/> OrdOIMOrgAdministrator	Admin Role	<input type="checkbox"/> OrdOIMCatalogAdmin	Admin Role
<input type="checkbox"/> OrdOIMOrgViewer	Admin Role	<input type="checkbox"/> OrdOIMRoleAdministrator	Admin Role
<input type="checkbox"/> OrdOIMUserAdmin	Admin Role	<input type="checkbox"/> OrdOIMRoleAuthorizer	Admin Role
<input type="checkbox"/> OrdOIMUserHelpDesk	Admin Role	<input type="checkbox"/> OrdOIMRoleViewer	Admin Role
<input type="checkbox"/> OrdOIMUserViewer	Admin Role	<input type="checkbox"/> OrdOIMEntitlementAdministrator	Admin Role
<input type="checkbox"/> OrdOIMSPMLAdmin	Admin Role	<input type="checkbox"/> OrdOIMEntitlementAuthorizer	Admin Role
<input type="checkbox"/> OrdOIMAdminRoleAdministrator	Admin Role	<input type="checkbox"/> OrdOIMEntitlementViewer	Admin Role
<input type="checkbox"/> OrdOIMIdentityAuditAdministrator	Admin Role	<input type="checkbox"/> OrdOIMApplicationInstanceAdministratorRole	Admin Role



 **Note:**

Make sure that you have added all the Oracle Identity Governance connector objects specific to defining connector. If you do not have a specific connector object while defining the connector, then upgrade, clone, or uninstall may not handle the undefined object.

The following are Oracle Identity Governance artifacts that are generally associated with almost all the connectors:

- Resource objects
- Event handlers
- Process forms
- IT resources
- Data object definitions
- Prepopulate adapters
- Processes
- IT resource type definitions
- Task adapters
- Lookups
- Scheduled tasks

- c. When you have selected the complete entity list for the connector definition, click **Next**. The Define Options page is displayed.
5. From the Dependency list, select **Yes** if you want to define the connector with all dependencies. Otherwise, select **No**. Then, click **Next**. The Summary page is displayed.
6. The Summary page displays the name and type of all the selected entities, and the selected define option. If you want to change the entity selection, then click **Back** to navigate to the Search page, and re-select the entities. Otherwise, click **Define**.
7. In the Define dialog box, select any one of the following options:
  - Select the name of the connector, and then enter a release number for it: Select this option if an earlier release of this connector already exists on this Oracle Identity Governance deployment. In addition, select a connector name and enter a release number.
  - Enter the Name and release number for the connector: Select this option if an earlier release of this connector does not exist on this Oracle Identity Governance deployment. In addition, enter a connector name and release number.
8. Click **Define** to define the connector in the system. At the end of the process, a message stating that the operation was successful is displayed.

## 10.6 Cloning Connectors in Oracle Identity Governance

Oracle Identity Governance provides the option to replicate an existing connector definition. Using the replicated or the cloned version, you can customize the connector definition to suit your requirement. Cloning a connector involves creating the connector XML file and installing the clone connector operation.

 **Note:**

In this guide, the term **Clone Connectors feature** refers to the set of Oracle Identity Self Service pages that you can use to clone connectors.

This section describes the procedure to create a copy of a connector by setting new names for some of the objects that comprise the connector. The outcome of the process is a new connector XML file. Most of the connector objects, such as Resource Object, Process Definition, Process Form, IT Resource Type Definition, IT Resource Instances, Lookup Definitions, Adapters, Reconciliation Rules and so on in the new connector XML file have new names. This section contains the following topics:

- [Guidelines for Cloning a Connector](#)
- [#unique\\_252](#)
- [Installing the Clone Connector](#)
- [Post-Cloning Steps](#)

## 10.6.1 Guidelines for Cloning a Connector

Important guidelines for cloning a connector are making sure that the connector is compatible with clone feature and avoiding duplicate object names.

 **Note:**

Oracle Identity Governance offers a different feature for using a single connector to integrate:

- Multiple installations of a particular target system with Oracle Identity Governance
- A target system that stores data about multiple user types (for example, employee and contractor) and requires Oracle Identity Governance to provide a different resource object for each user type

See the connector guide for information about how to use access policies to create resource objects for different user types on a particular target system.

Apply the following guidelines while using the Clone Connectors feature:

- A connector must be compatible with the Clone Connectors feature before you can use the utility to create a clone of the connector. For an Oracle-released connector, see the connector guide for information about whether or not the connector is supported by the Clone Connectors feature.
- Validation performed on the names of connector objects does not cover the names of objects that belong to other connectors. However, when you import the connector XML file that is created by the Clone Connectors feature, the Deployment Manager throws an error when it encounters duplicate object names. This is illustrated by the following example:

AD\_USER is the name of a resource object belonging to the Microsoft Active Directory connector. Suppose My\_RO is the name of an existing resource object defined in the Oracle Identity Governance database. If the new name that you specify for the AD\_USER

resource object is My\_RO, then the Clone Connectors feature does not display an error message stating that a resource object with the specified name already exists.

Cloning a connector involves performing a two-step procedure:

- Step 1: Create the connector XML file for the cloned connector

 **Note:**

Oracle Identity Governance supports two different ways of cloning a connector, Cloning Connector from XML and Cloning Connector from Installed Connectors.

- Step 2: Install the clone connector

## 10.6.2 Cloning Connector from XML File

Oracle Identity Governance, lets you clone a connector from a XML file.

To create the connector XML file for the cloned connector:

1. Log in to Oracle Identity System Administration.
2. In the left pane, under Provisioning Configuration, click **Manage Connector**. The Manage Connector page is displayed.
3. Click **Clone**, and then select **Clone From Connector XML**. The Clone Connector page is displayed.
4. In the Select Source Connector XML tab, enter the complete path of the connector XML file that you want to use to create the clone. For example, `/scratch/activedirectory-12.2.1.3.0/xml/ActiveDirectory-ConnectorConfig.xml`.

Click **Next**. The Review tab is displayed.

5. In the Review tab, you can provide a new name to the connector artifacts. To do so:
  - a. Enter the common prefix and then click **Add**.
  - b. Review the list of Resource Objects and the New Object Names. If any object name is missing the prefix, you can update the **New Object Names** field.

 **Note:**

You must ensure that the prefix that you specify does not cause the full name of any adapter to exceed 80 characters. The Clone Connectors feature cannot check if this limit is exceeded. However, when you import the connector XML file created for the clone, the Deployment Manager throws an error. Remember that the Deployment Manager is called even when you build a deployment package for the clone and use the Install Connectors feature to install the clone.

You can use the Design Console to determine the character length of the longest adapter name.

- c. Click **Next**. The Object Name Summary tab is displayed.

6. In the Object Name Summary tab, click **Generate XML**. The Clone XML file is saved in the default download folder.

### 10.6.3 Installing the Clone Connector

After creating a connector XML file, install the newly created clone connector either by importing the connector XML file or by creating and installing a deployment package for the cloned connector.

You can install the clone connector by using one of the following approaches:

**Note:**

You can install the clone connector on either the same or a different Oracle Identity Governance installation.

- Use the Deployment Manager to import the connector XML file. If you use Deployment Manager import to install the connector, then you need to define the cloned connector. This will enlist the cloned connector in the list of connectors in Connector Management Search. If the connector is imported in different Oracle Identity Governance environment where the original connector does not exist, then you need to upload the related Jar files of the connector using JarUpload utility and adapters need to be compiled after all connector jars have been uploaded.
- Create a deployment package for the cloned connector, and then install it using the Install Connectors feature. For a sample, see the contents of the deployment package for any Oracle-released connector.

### 10.6.4 Post-Cloning Steps

After a successful install operation, as a post-cloning step you need to modify the lookup definition and scheduled tasks to comply with your new connector definition.

After a copy of the connector is created by setting new names for connector objects, some objects might contain the details of the old connector objects. Therefore, you must modify the following Oracle Identity Governance objects to replace the base connector artifacts or attribute references with the corresponding cloned artifacts or attributes:

- **Lookup Definition:** If the lookup definition contains the old lookup definition details, then it must be modified to provide the new cloned lookup definition names. If the encode and decode values are referring the base connector attribute references, then these must be replaced with new cloned attributes.
- **Scheduled Task:** The base connector resource object name in the scheduled task must be replaced with the cloned resource object name. If the scheduled task parameter has any data referring to the base connector artifacts or attributes, then these must be replaced with the new cloned connector artifacts or attributes.

## 10.7 Exporting Connector Object Definitions in Connector XML Format

After successfully cloning a connector, you can export the object definition to an XML file.

This is described in the following section:

- [About Exporting Connector Object Definitions in Connector XML Format](#)
- [Exporting Connector Object Definitions in Connector XML Format](#)

## 10.7.1 About Exporting Connector Object Definitions in Connector XML Format

Oracle Identity Governance database stores the definitions of all connector objects. You can export these definitions to create a connector XML file for a particular connector. By using the Deployment Manager, you can import the connector XML file to create the connector object definitions in another Oracle Identity Governance installation.

Alternatively, you can use the connector XML file as one of the components of a deployment package that you create for the connector. This deployment package can then be installed using the Install Connectors feature. For a sample, see the contents of the deployment package for any Oracle-released connector. Another important component of a deployment package is the configuration XML file, which is used by the Install Connectors feature. You must manually create the configuration XML file.



### See Also :

Connector guide for information about the contents of the configuration XML file

## 10.7.2 Exporting Connector Object Definitions in Connector XML Format

Using the Manage Connector page, you can export a connector object definition to an XML file.

To export connector object definitions in connector XML format:

1. Log in to Oracle Identity System Administration.
2. In the left pane, under Provisioning Configuration, click **Manage Connector**. The Manage Connector page is displayed.
3. You can use one of the following options to export the connector XML file:
  - a. If you want the XML file to include definitions of only specific connector objects, then use the Export button to open the Deployment Manager. See the "Using the Deployment Manager" chapter in the connector guide for detailed information about using this feature to select connector objects whose definitions you want to include in the connector XML file.
  - b. If you want to create the connector XML file out of the connector XML stored in the database when the connector was defined, then:

In the Manage Connector page, use the Search feature to display the connector for which you want to create the connector XML file.

Select the Connector. Click **Export**, select **Export Connector XML**. In the File Download dialog box, use the Save File option to save the connector XML file of the clone to a location of your choice.

## 10.8 Upgrading Connectors

Upgrading connectors involve understanding the uses cases and connector object changes supported by the connector upgrade feature and the impact of upgrading a connector. Connector upgrade procedures include upgrading a connector, post upgrade tasks, and upgrading the 9.x connector version to an ICF connector.

This section describes how to upgrade a connector. It contains the following topics:

- [About Upgrading Connectors](#)
- [Upgrade Use Cases Supported by the Connector Upgrade Feature](#)
- [Connector Object Changes Supported by the Upgrade Connectors Feature](#)
- [What Happens When You Upgrade a Connector](#)
- [Summary of the Upgrade Procedure](#)
- [Procedure to Upgrade a Connector](#)
- [Postupgrade Procedure](#)
- [Procedure to Upgrade a 9.x Connector Version to an ICF Based Connector](#)

### 10.8.1 About Upgrading Connectors

The Connector Upgrade utility is responsible for upgrading the Oracle Identity Governance artifacts from the source version to the target version. The upgrade operation is performed by retaining the customization performed on the source connector.

 **Note:**

Connector upgrade does not handle connector library upgrade/update. Users need to manually upgrade the libraries involved in connector.

The following are sample scenarios that describe a need for upgrading a connector:

- Reconfiguring or customizing an existing connector  
After you install a connector, you might customize or reconfigure it according to your requirements. For example, you might add new attributes for reconciliation and provisioning and modify the scheduled tasks for reconciliation or lookup field synchronization. Ideally, you would make these changes to the connector on a staging server. You would then want to upgrade the connector deployed on your production server to the version that you create by making changes on the staging server.
- Upgrading a customer-developed connector  
You might have developed your own connector. When an Oracle-released upgrade is available for your connector, you might want to upgrade from your connector to the Oracle-released connector. For example, suppose you have developed and are using a connector for IBM Lotus Notes and Domino. When Oracle ships a new release of Oracle Identity Governance Connector for IBM Lotus Notes and Domino, you might want to use some of the features included in the new release. You can use the Upgrade Connectors feature to upgrade from your connector to the Oracle-released connector.
- Upgrading an Oracle-released connector

Oracle ships connector upgrades. An upgrade includes enhancements and fixes that you might need. For example, if you are currently using SAP User Management release 9.1.2, then you might want to upgrade to release 9.1.2.3 of the same connector when that release is available.

In scenarios such as these, you can use the Upgrade Connectors feature to upgrade the connector.

Upgrading connectors can be done by two ways:

- Silent mode upgrade: Used in staging and production environments
- Wizard mode upgrade: Used in development environment

In this guide, Wizard upgrade, which is performed using Oracle Identity System Administration pages is described.

## 10.8.2 Upgrade Use Cases Supported by the Connector Upgrade Feature

Typical use cases for connector upgrade include custom-developed source connector, Oracle-released connector that is installed and customized, and cloned connector.

The following types of source connectors are supported by the Upgrade Connectors feature:

- Customer-developed connectors
- Oracle-released connectors that are not supported by the Install Connectors feature
- Oracle-released connectors that are supported by the Install Connectors feature
- Oracle-released connectors that are supported by the Install Connectors feature and have been customized
- Cloned connectors

The upgrade process does not cover the following objects:

- E-mail definitions
- Password policies
- Error message definitions
- Business rule definitions
- Object forms
- Access policies

### Note:

- Connector lifecycle management does not support the upgrade of a trusted connector if the source connector uses the Xellerate User resource object for trusted source configuration. Therefore, you must manually upgrade the connector. Contact Oracle Support for more information.
- Connector lifecycle management does not support the upgrade of a connector from the target mode (source version) to the trusted mode (target version). Similarly, upgrading from trusted mode to the target mode is also not supported.

### Use Case 1: Custom-Developed Source Connector

A custom-developed source connector must meet the following requirements so that it is compatible with the Upgrade Connectors feature:

- The connector must be defined in Oracle Identity Governance. See [Defining Connectors With Oracle Identity Governance](#) if you want to manually define the connector.
- The connector must have a configuration XML file. See the connector guide for information about configuration XML files.

The following are sample events that can take place before you upgrade a custom-developed source connector:

- You develop the connector and its configuration XML file.
- Create a deployment package that is compatible with the Connector Installation feature. When you use this feature to deploy the connector on the production server, the connector is automatically defined at the end of the installation process.
- You use the connector for reconciliation and provisioning. Target system resources are allocated (through reconciliation and provisioning) for Oracle Identity Governance Users.
- You modify the connector on the staging server, redefine it, and then regenerate the connector XML file.

#### **Use Case 2: Oracle-released connector that is not supported by the Install Connectors feature**

A connector that is not supported by the Install Connectors feature connector must meet the following requirements so that it is compatible with the Upgrade Connectors feature:

- The connector must be defined in Oracle Identity Governance. See [Defining Connectors With Oracle Identity Governance](#) if you want to manually define the connector.
- The connector must have a configuration XML file. See the connector guide for information about configuration XML files.

Sample events and the upgrade procedure for this use case are the same as those for Use Case 1.

#### **Use Case 3: Oracle-released connector that is installed using the Install Connectors feature**

A connector that is installed using the Install Connectors feature meets the requirements specified for Use Cases 1 and 2.

#### **Use Case 4: Oracle-released connector that has been installed and then customized**

A connector that is supported by the Install Connectors feature meets the requirements specified for Use Cases 1 and 2. However, customizations are overwritten during the upgrade process. For example, if you have added an attribute in a scheduled task and also modified the JAR file for reconciliation, then this customization would be lost after the upgrade. To work around this issue:

1. Keep a record of customizations that you implement on a connector.
2. After you upgrade the connector, reapply the customizations.

#### **Use Case 5: Cloned connector**

A connector that is installed using the Clone Connectors feature meets the requirements specified for Use Cases 1 and 2.

After the upgrade operation, you can use each clone to manage resource data that was collected through the clone before the upgrade.



## 10.8.3 Connector Object Changes Supported by the Upgrade Connectors Feature

Before you upgrade a connector, you might have reconfigured or customized the connector by making changes in individual connector objects. The upgrade process itself changes individual connector objects.

The following sections list connector object changes supported by the Upgrade Connectors feature. These changes may have been performed manually (that is, at any time before the Upgrade Connectors feature is used) or may be performed by the Upgrade Connectors feature itself.

- [Resource Object Changes](#)
- [Process Definition Changes](#)
- [Resource Bundle Changes](#)
- [Process Form Changes](#)
- [Lookup Definition Changes](#)
- [Adapter Changes](#)
- [Rule Changes](#)
- [IT Resource Type Changes](#)
- [IT Resource Changes](#)
- [Scheduled Task Changes](#)

### 10.8.3.1 Resource Object Changes

The Upgrade Connectors feature can run on a resource object on which any combination of the following changes have been made. In addition, an upgrade operation might involve any combination of the following changes to a resource object.

- Status definitions can be added or deleted.
- Administrators can be assigned or deleted.
- Password policies can be added or deleted.
- User-defined fields (UDFs) can be added or deleted.
- Dependencies with other resource objects can be assigned or deleted.
- Object authorizers can be assigned or deleted. In addition, the priority number assigned to the authorizers can be modified.
- Process determination rules can be assigned or deleted.
- Event-handler adapters can be assigned or deleted.
- Resource object fields that are not present in the connector XML of the target connector are marked as obsolete.
- Customizations performed on the resource object are not retained.

After the upgrade, the new name of the resource object is the one specified in the connector XML of the target connector.

### 10.8.3.2 Process Definition Changes

The Upgrade Connectors feature can run on a process definition on which any combination of the following changes have been made. In addition, an upgrade operation might involve any combination of the following changes to a process definition.

- The existing process definition can be replaced by a new process definition.
- The existing provisioning definition can be renamed.
- Existing reconciliation field mappings can be retained without change or modified.
- New process tasks can be added.
- Custom process tasks can be retained without a change.
- Default process tasks can be retained, but you need to confirm that there are no changes in the default process task in the new version. Refer to the connector guide for more information.
- Any combination of the following changes can be made to an existing process task:
  - The name and properties of the task can be modified.
  - An attached event handler-adapter can be modified.
  - Preceding and dependent tasks can be added, modified, or deleted.
  - New response codes can be added.
  - Existing response codes can be modified or deleted.
  - New tasks can be generated.
  - Undo tasks and recovery tasks can be modified.
  - Task-to-object status mapping can be modified.
  - Assignment rules can be modified.
- Existing process tasks can be deleted.

After the upgrade, the new name of the process definition is the one specified in the connector XML of the target connector.

### 10.8.3.3 Resource Bundle Changes

To update the resource bundles:

1. If there are any customization on the resource bundles such as adding new entries to the connector resource bundles, the changes need to be applied on the resource bundles present in the "resources" folder of the connector distribution bundle. The existing resource bundles present in Oracle Identity Governance database can be downloaded using the DownloadResourceBundles utility available under *OIM\_HOME*/server/bin.
2. Use DownloadResourceBundles utility (available under *OIM\_HOME*/server/bin) to delete all the resource bundles specific to the connector from Oracle Identity Governance database.
3. Use UploadResourceBundles utility (available under *OIM\_HOME*/server/bin) to upload all the resource bundles specific to the connector to Oracle Identity Governance database.

### 10.8.3.4 Process Form Changes

The Upgrade Connectors feature can run on a process form on which any combination of the following changes have been performed. In addition, an upgrade operation might involve any combination of the following changes to a process form.

 **Note:**

- An upgrade operation works on only the active version of the process form. No changes are made to earlier versions.
  - The existing process form cannot be renamed.
- 
- Columns can be added, modified, or deleted.
  - Child forms can be added, modified, or deleted.
  - Pre-populate adapters can be added.
  - The name, mappings, order, and rule of existing pre-populate adapters can be modified.
  - The user can manually add the customizations to the active version if they wish to add certain fields to the new version that were present in the existing form.
  - If the form attribute is retained and the corresponding connector objects, for example Lookup Definition and IT Resource Type Definition are removed to which this attribute has references, then you need to modify the form attribute properties by pointing it to the correct connector object.

After the upgrade, the name of the process form is the version number of the upgraded connector.

### 10.8.3.5 Lookup Definition Changes

The Upgrade Connectors feature can run on a lookup definition on which any combination of the following changes have been made. In addition, an upgrade operation might involve any combination of the following changes to a lookup definition.

- Lookup definitions can be added.

 **Note:**

Existing lookup definitions are not deleted during an upgrade operation.

- Existing lookup definitions can be retained or modified. During an upgrade operation, new entries in an existing lookup definition are appended after the existing entries.

### 10.8.3.6 Adapter Changes

The Upgrade Connectors feature can run on an adapter on which any combination of the following changes have been made. In addition, an upgrade operation might involve any combination of the following changes to an adapter.

**Note:**

Existing adapters are not deleted during an upgrade operation.

- New adapters can be added.
- The custom adapters are retained as part of upgrade. If there are any customization on the default adapters, these changes need to be applied after upgrade as all the default adapters will be overwritten.
- After applying the customization on the default adapters (if there are any), the corresponding mapping for these adapters in Process Task, form field, and data object manager need to be verified for mapping.

### 10.8.3.7 Rule Changes

The Upgrade Connectors feature can run on a rule on which any combination of the following changes have been made. In addition, an upgrade operation might involve any combination of the following changes to a rule.

- New rules can be added.
- If there are any customizations in default Rules, these customizations need to be applied after the upgrade as all default Rules will be overwritten.

### 10.8.3.8 IT Resource Type Changes

The Upgrade Connectors feature can run on an IT resource type on which any combination of the following changes have been made. In addition, an upgrade operation might involve any combination of the following changes to an IT resource type.

- The existing IT resource type can be replaced by a new IT resource type.
- In an existing IT resource type, new parameters can be added and existing parameters can have their default values and types modified or deleted.
- All custom parameters are displayed while mapping IT Resource Type definitions. You can retain the custom parameters.

### 10.8.3.9 IT Resource Changes

The Upgrade Connectors feature can run on an IT resource on which any combination of the following changes have been made. In addition, an upgrade operation might involve any combination of the following changes to an IT resource.

- The parameter retained for IT Resource Type definition will be available for all the IT Resource instances of this type. If an existing parameter in IT Resource Type definition is not retained, then this parameter will not be available in all the IT Resource instances of this type.
- In an existing IT resource, new parameters can be added and existing parameters can have their default values and types modified or deleted.

After the upgrade, the new name of the IT Resource Type definition is the one specified in the connector XML of the target connector.

### 10.8.3.10 Scheduled Task Changes

The Upgrade Connectors feature can run on a scheduled task that has been retained or existing scheduled tasks have been replaced by new scheduled tasks.

## 10.8.4 What Happens When You Upgrade a Connector

The source and target connector objects must be mapped when upgrading a connector.

See [Upgrade Use Cases Supported by the Connector Upgrade Feature](#) for information about the changes that can be put into effect when you upgrade a connector.

In addition, the following event is part of the outcome of an upgrade operation:

- While performing the upgrade procedure, you are prompted to map new connector objects with existing objects. For example, you are prompted to map each resource object in the target connector with a resource object in the source connector. If the object names are same in both source and target, then for the new object, the corresponding old object need to be mapped. If there are changes in the object names in source and target, then you need to map the object properly by referring the source and target connector release documents. It is your responsibility map the source and target objects properly. If the objects are not mapped properly, then the source object will be corrupted by the upgrade process. Therefore, it is mandatory that you must know about all the source and the target connector objects.

## 10.8.5 Summary of the Upgrade Procedure

The connector upgrade procedure involves upgrading the source connector to target on staging server, using silent delta XML for connector upgrade, verifying that the source connector on the production server is the same as the source connector on the staging server, and importing the delta XML file on the production server.

The following is a summary of the procedure to upgrade a connector:

 **Note:**

The procedure explained in this document is based on the best practice in which you first perform the upgrade in a test development environment. All functional use cases need to be tested before applying the upgrade in production server. Wizard mode upgrade should not be used in production, only silent mode need to be used in production server.

1. Read through the upgrade procedure.

This will let you make an estimate of the time for which the connector and, therefore, the target system might be unavailable to Oracle Identity Governance users. You can also determine if you have the Oracle Identity Governance expertise required to complete all the upgrade and post-upgrade steps.

2. Make a note of associations between objects of the source connector and other Oracle Identity Governance objects. For example, make a note of associations between resource objects and access policies.
3. If required, create the connector XML file for a clone of the source connector.

If the object names in the target connector are different from object names in the source connector, then it is recommended that you first create the connector XML file for the clone connector. [Cloning Connector from XML File](#) describes the procedure. While performing the procedure, specify object names that are the same as object names in the target connector. This will help avoid the need for renaming connector objects after you upgrade the connector.

4. Upgrading the source connector to target connector on staging server.

The XML file contains details of changes to be made to the connector objects of the source connector so that they are converted into the connector objects of the target connector. These changes are applied automatically during the upgrade process.

To upgrade the source connector:

- a. Back up the Oracle Identity Governance database on the production server.
- b. Perform the steps described in [Preupgrade Procedure](#)
- c. Perform the steps described in [Silent Mode Upgrade in Staging and Production Environment](#). The resulting transformed XML can be generated and used in production server.

5. Use the silent delta XML for connector upgrade.

To use the delta XML file:

- a. Restore the production database on the staging server.
- b. Perform the steps described in [Preupgrade Procedure](#).
- c. Perform the steps described in [Silent Mode Upgrade in Staging and Production Environment](#).
- d. Perform the steps described in [Postupgrade Procedure](#).

6. Verify that the source connector on the production server is the same as the source connector on the staging server. If there are differences in the source connector on the staging server and the production server, then the delta XML file is not correctly imported on the production server.

7. Import the delta XML file on the production server.

After you verify that the upgraded target connector is working as expected on the staging server, perform the following steps:

- a. Perform the steps described in [Preupgrade Procedure](#).
- b. Perform the steps described in [Silent Mode Upgrade in Staging and Production Environment](#).
- c. Perform the steps described in [Postupgrade Procedure](#).

### 10.8.5.1 Guidelines for Upgrading Cloned Connectors

The general guidelines for upgrading a cloned connector are the following:

1. If the cloned connector, which is the source connector for the upgrade, is not defined, then define the cloned connector by following the procedure in [Defining a Connector](#). After defining the cloned source connector, the cloned connector name and version entry will be available in the Manage Connector page.
2. Create the clone of the target connector by using the target connector configuration XML file with exact object names used while cloning the source connector. To generate the cloned target connector configuration XML:

- a. Go to the Manage Connector page, and click **Clone** in the Connector Management box.
  - b. In the Select Connector XML for the Cloning Operation prompt, provide the XML file of the target connector configuration XML.
  - c. Follow the procedure to create the cloned connector XML with the exact object names used while cloning the source connector.
3. Upgrade the cloned source connector that you defined in step 1 by using the cloned target connector config XML file. Follow the connector upgrade procedure described in [Summary of the Upgrade Procedure](#) and [Procedure to Upgrade a Connector](#).

## 10.8.6 Procedure to Upgrade a Connector

Upgrading a connector includes steps to perform preupgrade procedure and performing wizard mode or silent mode upgrade.

The following sections discuss the procedure to upgrade a connector:

- [Preupgrade Procedure](#)
- [Wizard Mode Upgrade in Staging Environment](#)
- [Silent Mode Upgrade in Staging and Production Environment](#)



### Note:

Keep the SOA server running during the upgrade process.

### 10.8.6.1 Preupgrade Procedure

Before you begin the upgrade procedure, ensure that the following prerequisites are addressed:

- Read through the upgrade procedure documented in this chapter.
- Note down customizations made in the connector objects on source connector.
- Call a Java API to handle workflows that are in progress. See Step 3 of [Wizard Mode Upgrade in Staging Environment](#) for information about pending workflows. You need to make sure that there are no requests in pending state for the resource objects that are part of this connector. You also need to complete all the requests before going for connector upgrade. Requests can be closed if they are in a closable state. All the requests associated with the connector resource objects should in one of the following states before starting the upgrade process.
  - Request Completed
  - Request Closed
  - Request Withdrawn
  - Request Failed
  - Request Approval Rejected
  - Operation Approval Rejected
- If required, create the connector XML file for a clone of the source connector.

- Disable all the scheduled tasks.
- Make sure that the connector is defined if there are any customizations done after installing the connector. See [Defining Connectors With Oracle Identity Governance](#) for information about defining connectors.

Upgrading connectors is a two-stage procedure:

- Wizard Mode Upgrade in Staging Environment
- Silent Mode Upgrade in Staging and Production Environment

### 10.8.6.2 Wizard Mode Upgrade in Staging Environment



#### Note:

You need to perform preupgrade and post upgrade steps while performing wizard mode upgrade.

To perform the wizard mode upgrade on the staging server:

1. Create a backup of the Oracle Identity Governance database.
2. Create Oracle Identity Governance metadata (MDS) backup. See Migrating User Modifiable Metadata Files in *Developing and Customizing Applications for Oracle Identity Governance* for information about exporting and importing Oracle Identity Governance metadata to and from MDS.
3. Run the connector preupgrade utility.

A validation script is provided with Oracle Identity Governance. This script performs the following functions:

- Determines whether the connector that you want to upgrade has been defined in Oracle Identity Governance

In other words, the script checks whether the connector XML stored in the database when the connector was installed/defined is consistent with the connector object definitions in the database. Apart from checking the consistency of the connector XML, it also checks whether the Connector XML is present in Oracle Identity Governance Database or not. If it is not present, then it displays the corresponding message to define the connector before proceeding with upgrade. Refer the [Defining Connectors With Oracle Identity Governance](#) to perform the procedure to define a connector.

- Identifies the Oracle Identity Governance scheduled tasks that are currently running.

You must disable all scheduled tasks that belong to the source connector before you proceed with the upgrade procedure. In addition, it is recommended to disable all other scheduled tasks before proceeding with the upgrade procedure.

- Identifies the Attestation tasks associated with the resource object of the connector.

You must complete all the attestation tasks that belong to the source connector before you proceed with the upgrade procedure.

- Identifies all the pending requests associated with the resource objects of the connectors.

You must either close or complete all the pending requests that belong to the source connector before you proceed with the upgrade procedure.



To run the validation script:

- a. Ensure that Oracle Identity Governance is running.
- b. In a command window, change to the *OIM\_HOME/server/bin* directory.
- c. Run the script as follows:

 **Note:**

Set *APP\_SERVER*, *OIM\_ORACLE\_HOME*, *JAVA\_HOME*, *MW\_HOME*, *WL\_HOME*, and *DOMAIN\_HOME* before running the scripts.

For Unix:

```
sh ConnectorPreUpgradeUtil.sh
```

For Windows:

```
ConnectorPreUpgradeUtil.bat
```

 **Note:**

If Oracle Identity Governance is installed on IPv6 Linux host computer, then pass *ipv6* as the input argument to the *ConnectorPreUpgradeUtil.sh* script, as shown:

```
sh ConnectorPreUpgradeUtil.sh ipv6
```

On Windows environment, do not pass any parameter for IPv6 while running *ConnectorPreUpgradeUtil.bat*.

You will be prompted to provide the following details:

- Enter Oracle Identity Governance administrator's username: Enter the Oracle Identity Governance administrator's username.
- Enter Oracle Identity Governance administrator's password: Enter the Oracle Identity Governance administrator's password.
- Enter t3 Oracle Identity Governance Server URL: Enter the Oracle Identity Governance server URL. For example, *t3://HOST\_NAME:HOST\_PORT*.
- Enter context factory: Enter the name of the context factory.
- Enter the connector name: Enter the connector name to be validated before upgrade.
- Enter the connector version: Enter the connector version to be validated before upgrade.

On successfully connecting to the Oracle Identity Governance server, a message is displayed.

The output generated by the script is displayed in the command window and is also recorded in the *OIM\_HOME/server/bin/validateUtil.log* file.

The action that you must take depends on the message generated by the script:

- If the message states that the connector XML in the database is not consistent with the connector objects defined in the database, then perform the procedure described in the [Defining Connectors With Oracle Identity Governance](#) of the connector guide.
  - If the message states that the "connector XML does not exists in Oracle Identity Governance database. Define a connector before upgrade.", then perform the procedure described in the [Defining Connectors With Oracle Identity Governance](#) section of the connector guide before proceeding with upgrade
  - If the message contains the names of the scheduled tasks that are currently running, then you must disable all scheduled tasks. To disable a scheduled task, in the Advanced Administration, click **System Management**, search for scheduled jobs, and click the specific scheduled job, and then click **Stop**.
  - If the message contains the names of the Attestation Processes of which some attestation tasks associated with the resource object of the connector is pending, then you must complete all the attestation tasks belonging to the connector that you are upgrading before proceeding with the upgrade process.
  - If the message contains the names of the pending requests associated with the resource object of the connector, then you must either close or complete all the pending requests belonging to the connector that you are upgrading before proceeding with the upgrade process.
4. Copy the JARs and the resource bundles to the specified directories.
- If the target release also contains new or updated JARs and resource bundles, then download the version of the jar to Oracle Identity Governance, check the version of the jar which is shipped with Oracle Identity Governance, compare these files and copy the JARs manually to their destination directories. For an Oracle-shipped connector, details of the destination directories are given in the connector guide. See the [Connector Code File Changes](#) section for more information.
5. Use the Upgrade Connectors feature.
- a. Log in to the Oracle Identity System Administration.
  - b. In the left pane, under Provisioning Configuration, click **Manage Connector**. The Manage Connector page is displayed.
  - c. Click **Search**. From the search results table, select the connector you want to upgrade.
  - d. Click **Upgrade**, and then select **Upgrade**. The Upgrade Connector page is displayed.
  - e. In the Select tab:
    - i. In the **Alternative Directory** field, enter the full path of the directory in which the connector installation file is saved.
    - ii. Click the **Load** button to update the list of connectors in the Connector List.
    - iii. From the **Connector List** list, select the connector version to which you want to upgrade the connector.
    - iv. Click **Next**. The Resource Object Mappings tab is displayed.
  - f. In the Resource Object Mappings tab:

Review the default mapping of all the existing resource object with the new resource objects and then, click **Next**. The Process Definition Mappings tab is displayed.



To change the default resource mapping:

    - i. Click **Edit**.
    - ii. From the **Existing Resource Object** list, select the resource object.

- iii. Click **Preview** to check for the unmapped resource object. A summary of the resource object mappings that are in the source release that do not have corresponding resource objects in the target release is listed.
- iv. If you want to remove the unmapped resource object, then select the check box corresponding to that resource object in the **Remove** column.

 **Note:**

The removed resource object is not deleted from the Oracle Identity Governance database. The OBJ\_IS\_SOFT\_DELETE flag for this resource object is set to 1. This resource is available for all provisioning and reconciliation purposes.

- v. Click **Next**. The Process Definition Mappings tab is displayed.
- g.** In the Process Definition Mappings tab:  
Review the default mapping of all the new process definitions with the existing process definition. To view the list of process tasks for each process definition type, click  .
- You can retain the process tasks from the existing process definition. If there are any custom process tasks added to the existing process definition, they can be retained. If there are any customizations on the default process task, then before retaining such tasks you need to refer to the connector guide to make sure there are no changes for this process task in the new connector release version. It is recommended only to retain tasks that are added by the user as part of the customization of the source connector.
- To retain the process task from the existing process definition:
- i. Select the check box corresponding to the process task you want to retain.
  - ii. Click **Next**. The Define Form Mappings tab is displayed.
- h.** In the Define Form Mappings tab:  
Review the form mapping of all the new forms with the existing forms. To view, the list of process form fields from the existing process form attributes that are not available in the new process form, click  .
- These attributes might be added to the existing process as part of customization or they are default attributes that were part of the existing process form. You can retain the attributes added for customization. However, verify that the default attribute is required before you retain it.
- To select the process form attribute:
- i. Select the check box corresponding to the process form attribute you want to retain.
  - ii. Click **Next**. The IT Resource tab is displayed.
- i.** In the IT Resource tab:  
Review the IT Resource mapping of all the new IT resource definition with the existing IT resource definition. To view the list of IT Resource definition parameters that are part of existing definition but not available in the new definition, click  .

These parameters might be added to the existing definition as part of customization or they are default parameters that were part of the existing definition. You can retain the parameters added for customization. However, verify that the default parameters is required before you retain it.

To retain the IT Resource type definition attribute:

- i. Select the check box corresponding to the parameter you want to retain.
  - ii. Click **Next**. The Connector Summary Table tab is displayed.
  - j. In the Connector Summary Table tab:

Review the connector summary that lists the entity names and entity types that have been selected for the upgrade.

Click **Upgrade** to start the upgrade process. The Summary tab is displayed.
  - k. In the Summary tab, you can view the status of the upgrade process.
  - l. Note down the process definition names and the corresponding process task names. These process tasks are not going to be used by Oracle Identity Governance anymore. Therefore, all their pending and rejected instances need to be canceled. Use `cancelProcessTask` utility available in `OIM_HOME/server/bin`. The utility takes the process definition name and the process task name as input. You need to run the utility for each process task. The Upgrade Connectors feature processes connector object mappings in the following manner:
    - If a new connector object is mapped to None, then the new connector object is inserted in the database.
    - A new resource object, process definition, or form replaces the old resource object, process definition, or form to which it is mapped.
    - The new names of the process form are converted into the old process form names.
    - If an old and a new lookup definition have the same name, then their contents are merged.
    - When the Upgrade Connectors feature tries to delete an object, which is not going to be used by upgraded version of connector, an exception is thrown if the instances of the object exist in Oracle Identity Governance database. Such an object is renamed and soft deleted so that it will not be used anymore by Oracle Identity Governance.
6. Perform the following steps:
- a. Change form names and form field column name references in the following objects:

 **Note:**

For an Oracle-released connector, see the connector guide for information about the changes to be made.

- Lookup definitions
  - Process task literals
  - Adapter literals
- b. All the default adapters are overwritten. Therefore, if customer has done any customization, the changes need to be applied after connector upgrade.

- c. After the upgrade, contents of existing and new lookup definitions are merged. In these lookup definitions, you must manually delete entries that are not required.
7. Verify that all use cases specific to the target are working fine including provisioning and reconciliation.
8. Generate the XML file. This XML file contains details of the object definition changes from the source release to the target release.

To generate this file:

- a. Log in to the Oracle Identity System Administration.
- b. In the left pane, under Provisioning Configuration, click **Manage Connector**. The Manage Connector page is displayed.
- c. Click Search. From the search results table, select the connector you have upgraded.
- d. Click **Export**, select **Export Silent Upgrade XML**.
- e. Specify the location where you want the file to be saved.

 **Note:**

If the upgrade fails, then perform the following steps:

- a. Look at the exception and take suitable action.
- b. Restore the Oracle Identity Governance database and MDS.
- c. Proceed for the upgrade.

### 10.8.6.3 Silent Mode Upgrade in Staging and Production Environment

Ensure that you perform the preupgrade and post upgrade steps for silent mode upgrade.

Verify that the source connector on the production server is the same as the source connector on the staging server. Ensure that the exported silent XML file is placed in connector bundle under XML directory.

To perform the silent mode upgrade on the production server:

1. Log in to the Oracle Identity System Administration.
2. In the left pane, under Provisioning Configuration, click **Manage Connector**. The Manage Connector page is displayed.
3. Click **Search**. From the search results table, select the connector you want to upgrade.
4. Click **Upgrade**, and then select Silent Upgrade. The Upgrade Connector page is displayed.
5. In the Select tab:
  - a. To upgrade a connector from default directory (`OIM_HOME/server/ConnectorDefaultDirectory`):
    - i. From the Connector List list, select the connector you want to upgrade. This list displays the name and release number of connectors whose installation files are present in the default connector installation directory (`OIM_HOME/server/ConnectorDefaultDirectory`).
    - ii. Click **Next**. The Details tab is displayed.

- b. To upgrade a connector from the installation file saved in a directory of your choice(Alternative Directory):
  - i. In the **Alternative Directory** field, enter the full path of the directory.
  - ii. Click **Load** to update the list of connectors in the Connector List.
  - iii. From the **Connector List** list, select the connector you want to upgrade.
  - iv. Click **Next**. The Details tab is displayed.
6. In the Details tab, you can review the summary of the connector objects that you selected for upgrade. Click **Upgrade** to start the upgrade process. The Summary tab is displayed.
7. In the Summary tab, you can view the status of the upgrade process.

## 10.8.7 Postupgrade Procedure

Some of the postupgrade procedures include code file changes, running utilities, updating access policies, IT resource configuration, and schedule task configuration.

The following sections describe procedures that you must perform after the upgrade operation:

- [Connector Code File Changes](#)
- [Running the PurgeCache Utility](#)
- [Running cancelProcessTask Utility](#)
- [Updating Access Policies](#)
- [Configuring the IT Resource](#)
- [Configuring the Scheduled Tasks](#)
- [Updating Adapters for Changes in IT Resource Type Definition Parameter](#)
- [Other Postupgrade Steps](#)

### 10.8.7.1 Connector Code File Changes

During an upgrade operation, you need copy connector code files, which include JAR files and scripts to the specified directories. To do so:

1. Manually upload all the connector specific jars (excluding common library files Common.jar, FAMILYCommon.jar, and icf-Common.jar) present in the "lib" folder of the connector distribution bundle using UpdateJars utility (available under *OIM\_HOME/server/bin*) to Oracle Identity Governance database. Before running the UpdateJars utility, set *APP\_SERVER*, *OIM\_ORACLE\_HOME*, *JAVA\_HOME*, *MW\_HOME*, *WL\_HOME*, and *DOMAIN\_HOME*.
2. Download common library (Common.jar, FAMILYCommon.jar and icf-Common.jar) from Oracle Identity Governance database using DownloadJar utility (available under *OIM\_HOME/server/bin*).
3. Extract MANIFEST.MF from the downloaded libraries. Compare this version of MANIFEST.MF with the version in MANIFEST.MF of the common libraries that is available as part of ICF based distribution bundle. If the distributed library version is higher than the one downloaded from Oracle Identity Governance database, then use the UploadJar utility (available under *OIM\_HOME/server/bin*) to upload the common libraries to Oracle Identity Governance database.

## 10.8.7.2 Running the PurgeCache Utility

When the upgrade is performed, there might be stale data in the cache, which is required to be purged. The PurgeCache utility purges the cache. For information about purging the cache, see *Purging the Cache in Performance and Tuning Guide*.

 **Note:**

Before running this utility, set `APP_SERVER`, `OIM_ORACLE_HOME`, `JAVA_HOME`, `MW_HOME`, `WL_HOME`, and `DOMAIN_HOME`.

## 10.8.7.3 Running cancelProcessTask Utility

The utility is available in `OIM_HOME/server/bin`. This utility will take the process task name and the corresponding process definition name as input.

 **Note:**

Before running this utility, set `APP_SERVER`, `OIM_ORACLE_HOME`, `JAVA_HOME`, `MW_HOME`, `WL_HOME`, and `DOMAIN_HOME`.

## 10.8.7.4 Updating Access Policies

In Oracle Identity Governance, an access policy is associated with a resource object. While creating an access policy, user would have provided the data for the process form attributes. As part of the connector upgrade, if there are changes in the form attributes, then you need to edit the access policy to check the data for the existing and the new fields. For example, if the connector upgrade adds a new process form attribute, then you can provide the data for the new attribute by editing the access policy.

If you are upgrading from the 9.x version of the connector, then perform the following steps to correct the data if old data from the previous version of the corrector is still present:

1. Disable the Evaluate User Policies scheduled job.
2. Make sure that policy evaluation is pending or in progress for no users. Run the following query to see the users:

```
select * from user_provisioning_attrs where policy_eval_needed=1 or  
policy_eval_in_progress=1;
```

If any users are returned by the query, then clear the users by running the Evaluate User Policies scheduled job.

3. Open the access policy, and update the parent and child forms with the new organizations/groups that were reconciled through group/OU reconciliation scheduled jobs. Starting from Oracle Identity Governance 11g, the groups/entitlements are prefixed with `ITRESOUCES_KEY~`. Save the changes.

4. After the access policy is updated, check the POC and POF tables and make sure that the columns POC\_FIELD\_VALUE and POF\_FIELD\_VALUE have a value similar to the following (prefixed with IT resource key):

```
1~cn=group10,cn=Groups,dc=example,dc=com
```

5. As the access policy is updated, users are marked for re-evaluation. Run the following query to check the users and total count. Create a backup of these user keys.

```
select * from user_provisioning_attrs where policy_eval_needed=1;
```

6. As you do not want to re-evaluate the users because they are provisioned, unmark the users from policy evaluation by running the following query.

```
update user_provisioning_attrs set policy_eval_needed=0 where  
policy_eval_needed=1;  
commit;
```

Here, the value of the `policy_eval_needed` flag is changed to 0 so that the users are not re-evaluated.

7. Enable the Evaluate User Policies scheduled job.
8. Run the access policy job for any new user, and verify whether the provisioning of account and entitlements are happening as expected.

### 10.8.7.5 Configuring the IT Resource

Verify that the IT resource instances have proper values after upgrade.

### 10.8.7.6 Configuring the Scheduled Tasks

Set values for attributes of the scheduled tasks of the target release. For an Oracle-released target connector, see the connector guide for information about the scheduled task attributes.

### 10.8.7.7 Updating Adapters for Changes in IT Resource Type Definition Parameter

If there are changes in the IT Resource Type Definition Parameter names, you need to update the custom adapters for the parameter changes. To do so:

1. Log in to Design Console.
2. Open the custom adapter using the adapter factory.
3. Go to the variable list and check if there are any variables of type IT Resource, as shown in [Figure 10-3](#):



**Figure 10-3 The Variable List Tab of the Adapter Factory Form**

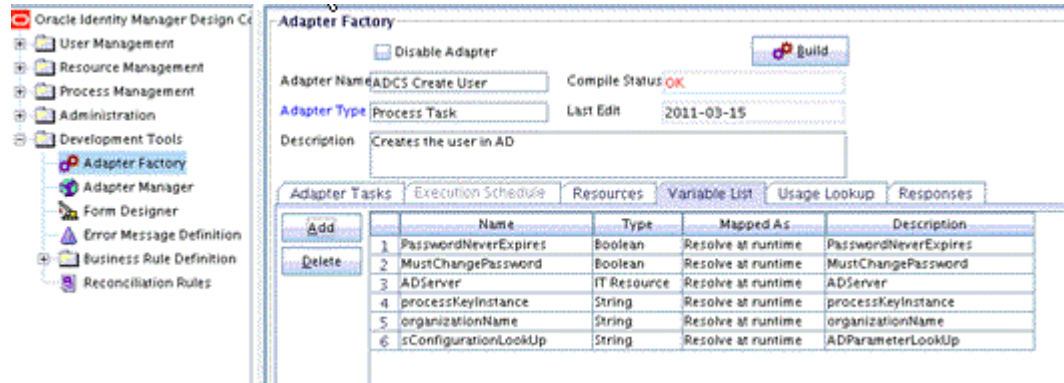

4. If there is a variable of IT Resource, then go to the task details and change the mapping of the IT Resource parameter mapping to the new target field (if the parameter is changed/ deleted).

Figure 10-4 shows the Edit Adapter Factory Task Parameters dialog box that enables you to change the mapping of the IT Resource parameter mapping to the new target field:

**Figure 10-4 The Edit Adapter Factory Task Parameters Dialog Box**

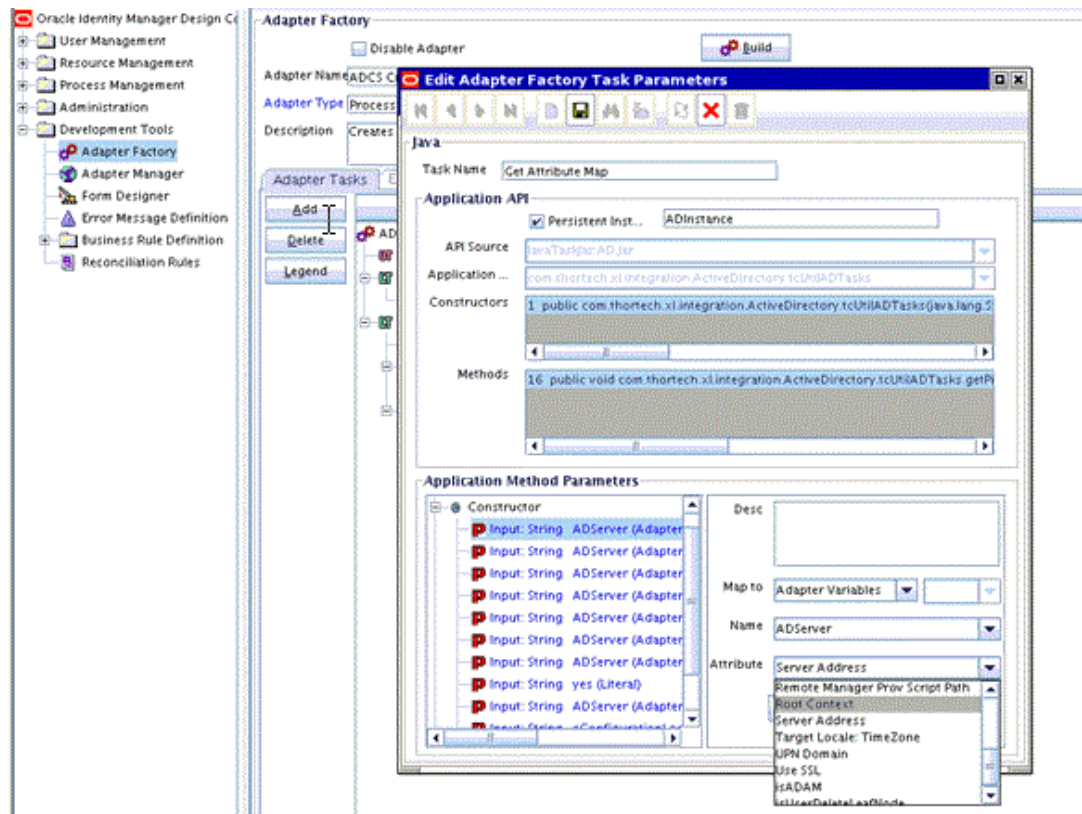

5. If the adapter is mapped to the IT Resource Type Definition parameter, then you need to verify if the mapped parameter is not deleted. If the parameter is deleted, then you need to remap it to the correct parameter.

To verify the adapter mappings:

- a. Verify the mapping for process task adapter. To do so, log in to Design Console. Go to Process Definition. Click the task, and then click the **Integration** tab, as shown in Figure 10-5:

**Figure 10-5 The Integration Tab of the Editing Task Dialog Box**

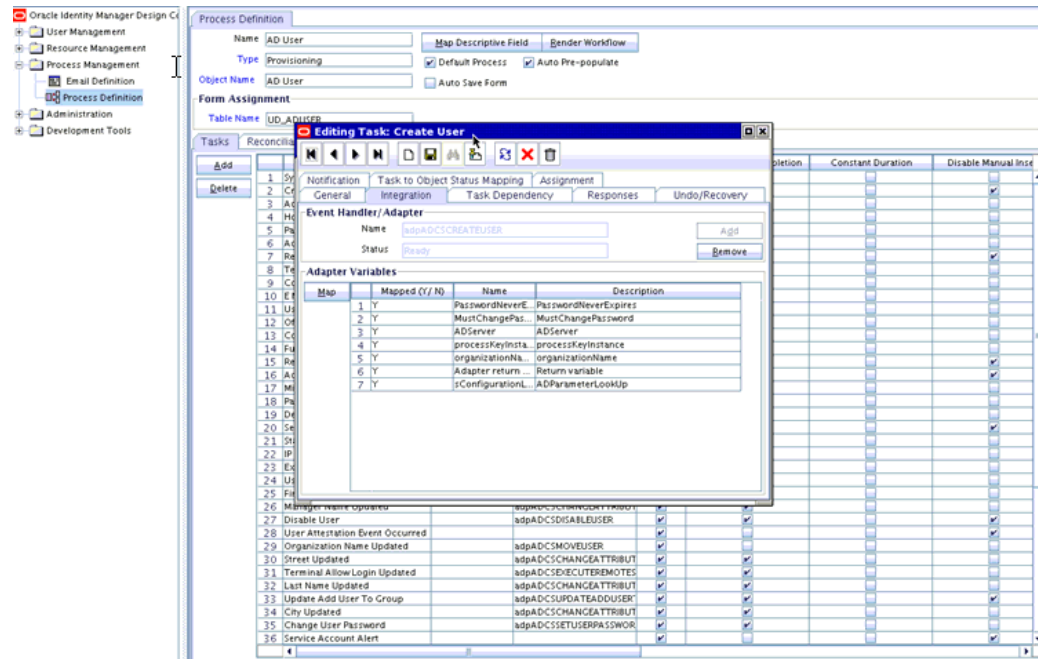

Check if the adapter variable is mapped to the deleted/modified form attribute. If yes, remap such attributes to adapter variables. Repeat this step for all process tasks of all process definitions of the connector.

Figure 10-6 shows the Editing Data Mapping for Variable dialog box that enables you to view and edit the adapter variable mapping to the form attribute:

**Figure 10-6 The Editing Data Mapping for Variable Dialog Box**

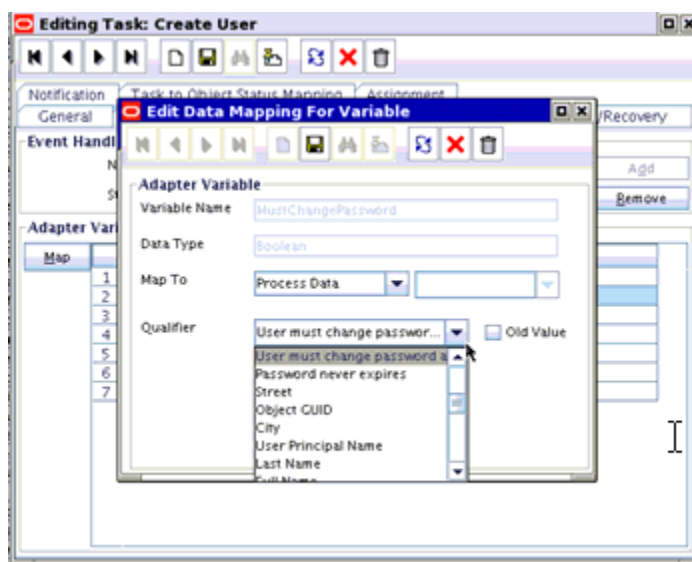

- b. Prepopulate adapter mappings, log in to Design Console. Go to Form Designer, Pre-Populate Adapters, as shown in [Figure 10-7](#):

**Figure 10-7 The Pre-Populate Adapters Dialog Box**

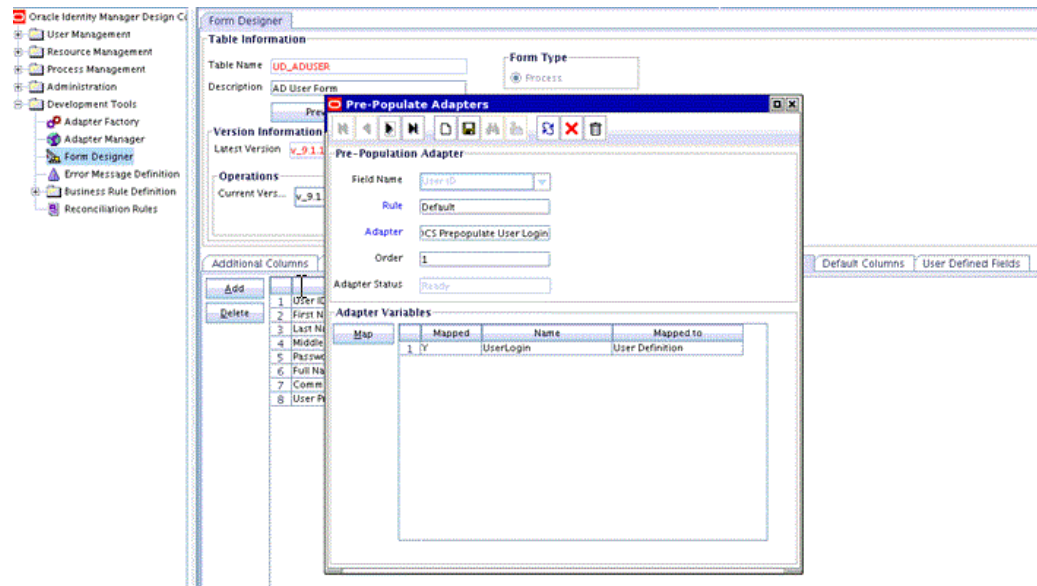

Click **Map** to map adapter variable and check if any of the fields are mapped to the process data attributes. If it is mapped, then verify the process form attribute is not deleted as part of upgrade. If the process form attributes are deleted, then remap them to the correct form attribute data.

[Figure 10-8](#) shows the Map Adapter Variable dialog box:

**Figure 10-8 The Map Adapter Variable Dialog Box**

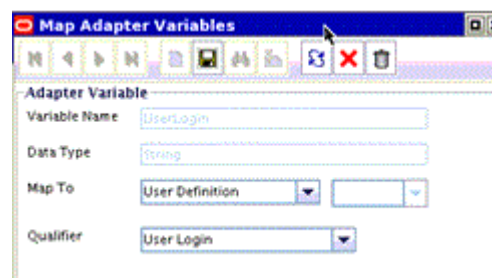

 **Note:**

Repeat the procedure for all the prepopulated fields of all the process forms of the connector. If there are any entity adapter, then check the adapter variables mapping for these adapters in Data Object Manager.

## 10.8.7.8 Other Postupgrade Steps

Perform the following postupgrade steps:

1. Change form names and form field column name references in the following objects:

 **Note:**

For an Oracle-released connector, see the connector guide for information about the changes to be made.

- Lookup definitions
  - Process task literals
  - Adapter literals
2. Verify all the reconciliation fields on the resource object and corresponding reconciliation form field mapping on the process definition. Delete old default reconciliation fields, if there are any, which have mapping to the process form fields that are not retained as part of upgrade.
  3. Verify that upgrade process has retained all customizations, for example, customizations on Resource Object, Process definition, and Process Form.
  4. After the upgrade, contents of existing and new lookup definitions are merged. In these lookup definitions, you must manually delete entries that are not required.
  5. Run the Lookup reconciliation again. The old lookup reconciliation data will be available in the Lookups after upgrade. Re-running the Lookups is required if there is a change in the format for the lookup values. Refer the specific connector guide for more details about lookup reconciliation.
  6. Recalculate statistics and re-create indexes and other database objects that are removed or made invalid by the upgrade process. For more information, see Oracle Identity Governance Database guide.
  7. Check adapters status related to the connectors. If the adapters are not compiled, then you must compile them.
  8. Verify that the custom parameters are available after upgrade. Custom Scheduled Task parameters are retained as part of upgrade process. Modify the scheduled task to add the parameter if it is not available after upgrade.
  9. Verify if there are any changes in the application forms. If yes, then delete the existing forms for the resource. Modify the new application forms for any customization.

## 10.8.8 Procedure to Upgrade a 9.x Connector Version to an ICF Based Connector

ICF based Connector provides LCM as a feature that uses Connector Installer to import the connector, whereas 9.x connector uses Deployment Manager to import definitions of the objects that constitute a connector.

Because LCM offers a broader and richer feature in installing and/or managing a connector than Deployment Manager, it is recommended to use only Connector installer for Oracle Identity Manager 11g connectors installation and/or management.

To upgrade a 9x connector version to a ICF based connector:

1. Delete all the existing jar files such as Javataasks, ScheduleTask, and ThirdParty jars related to the 9x connector except for the Common.jar file.
2. Download Common.jar and extract its MANIFEST.MF. Compare this version of MANIFEST.MF with the version in MANIFEST.MF of the Common.jar that is available as part of ICF based connectors distribution bundle. Retain/Upload (using UploadJars utility) Common.jar in Oracle Identity Governance database that has higher version.
3. Manually upload all the jars present in the "lib" folder of the ICF based connector distribution bundle using the UploadJars utility in Oracle Identity Governance database (available under *OIM\_HOME/server/bin*).
4. Explode the connector bundle (with naming convention "org.identityconnectors.\*") in some temporary folder. Make a folder named "lib" in the same temporary folder and copy all the third party libraries to that folder.
5. Retain MANIFEST.MF from the above exploded bundle.
6. Repackage the connector with the same name and with the same MANIFEST.MF that was being retained. Now, the repackaged connector bundle will also be having third party libraries.
7. Upload the repackaged connector in Oracle Identity Governance database with jar type as "ICFBundle".
8. Delete the temporary folder created in Step 4.
9. Upgrade the connector by following the upgrade process
10. Purge cache or restart the server.

## 10.9 Uninstalling Connectors

Uninstalling connectors involve understanding the uninstall proces and supported usecases, configuring the connector uninstall utility, and uninstalling connectors and removing connector objects.

This section describes how to uninstall a connector. This is described in the following section:

- [About Uninstalling Connectors Utility](#)
- [Use Cases Supported by the Uninstall Connectors Utility](#)
- [Overview of the Connector Uninstall Process](#)
- [Setting Up the Uninstall Connector Utility](#)
- [Uninstalling Connectors and Removing Connector Objects](#)

- [Running the Script to Uninstall Connectors and Connector Objects](#)

## 10.9.1 About Uninstalling Connectors Utility

Connector uninstall utility deletes the data related to the connector chosen for uninstall from Oracle Identity Governance Database. It deletes all the account related data associated with resource objects of the connector.

This utility does not delete:

- The actual user account from the target system
- Identities from Oracle Identity Governance although the users are brought from trusted source to Oracle Identity Governance through trusted reconciliation
- Audit data
- Archival data

Connector uninstall utility does not validate and notify the user if there is any object dependency present. For example, while uninstalling a Microsoft Active Directory (AD) connector, it does not validate if a dependent connector, such as Microsoft Exchange connector, already exists or not. Before uninstalling a connector, you must check if there are any other connectors dependent on the connector. If there are any, then the connector must not be uninstalled because this will affect the functionality of the dependent connectors. You must uninstall all the dependent connectors before uninstalling the base connector.

## 10.9.2 Use Cases Supported by the Uninstall Connectors Utility

Typical use cases supported by the Uninstall Connectors utility are for decommissioned target systems, uninstall for the purpose of freshly installing a connector, and removing individual connector objects from the database.

The following use cases are supported by the Uninstall Connectors utility:

- A target system that has been decommissioned, and you want to uninstall the connector that was used to link that target system with Oracle Identity Governance.
- Instead of directly upgrading to the latest release of a connector, you want to uninstall the earlier release and then perform a fresh installation of the latest release.
- You want to remove an individual connector object from the Oracle Identity Governance database. For example, you had created a resource object in Oracle Identity Governance to represent the Intern user type defined in your target system. This user type has been removed from the target system, and you now want to remove the resource object from Oracle Identity Governance.

The Uninstall Connectors utility supports independent deletion of following connector artifacts:

- Adapters
- Lookup definitions
- Resource objects
- Scheduled tasks

## 10.9.3 Overview of the Connector Uninstall Process

The Uninstall Connectors utility verifies that there are no access policies and requests associated with resource objects of the connector, and displays the list of attestation processes associated with the resource objects, before removing the connector objects.

When you run the Uninstall Connectors utility, the utility performs the following steps before deleting the resource objects of the connector:

1. Checks if there are any access policies associated with the resource objects of the connector. If there are any access policies present, then the utility displays the list of access policies associated with the resource object and prompts you to modify the access policy and terminates with no data deletion. The access policy should be modified to remove the resource object from it. If the access policy is associated with only one resource object, then you need to create a dummy resource object, assign it to the access policy and then proceed with the removal of resource object from the access policy.
2. Closes all requests associated with the resource objects.
3. Displays the list of attestation processes which are associated with the resource objects. Attestation processes are generic in nature, therefore the utility does not delete attestation processes from Oracle Identity Governance. It prompts you to modify these processes as the resource objects would be deleted from Oracle Identity Governance.

The following objects that constitute the connector are dropped from the Oracle Identity Governance database.

1. Resource object and objects related to the resource object.
  - a. Entitlement assignment, entitlement assignment history, and entitlement data
  - b. Tasks and task history associated with any provisioning process linked to the resource object
  - c. Process forms associated with the resource object
  - d. Process instance and object instances associated with the resource object
  - e. Reconciliation events and data associated with the resource object
  - f. Attestation event data for the resource object
  - g. Requests and request data associated with the resource object
  - h. E-mail definitions for the resource object
  - i. Entitlements associated with the resource object
  - j. Regular rules associated with the resource object
  - k. Reconciliation owner matching rules for the resource object
  - l. Reconciliation action rules for the resource object
  - m. Status codes corresponding to this resource object
  - n. Reconciliation process mappings for the resource object
  - o. Reconciliation object fields for the resource object
  - p. Application form to process form mappings for the resource object.
  - q. Object dependency tables for parent and child forms for the resource object
  - r. Resource object for organization
  - s. Process determination rules associated with the resource object

- t. Password policy rules associated with the resource object
  - u. IT resource instances that are associated with IT resource types defined on forms that are linked to provisioning processes. If there is any default IT resource instance, they will not be deleted.
  - v. Process instances and resource object instances
  - w. Tasks associated with the provisioning processes
  - x. The actual object and process, parent and child tables associated with the resource object.
2. Scheduled tasks and scheduled jobs
  3. Adapters/Event Handlers
  4. Lookup definitions

## 10.9.4 Setting Up the Uninstall Connector Utility

Files that constitute the Uninstall Connector utility are available in *OIM\_HOME/server/bin* directory.

Ensure that the following files that constitute the Uninstall Connector utility are available in *OIM\_HOME/server/bin* directory:

- ConnectorUninstall.properties
- uninstallConnector.bat
- uninstallConnector.sh

## 10.9.5 Uninstalling Connectors and Removing Connector Objects

You can run the Uninstall Connectors utility to uninstall a connector and remove adapters, lookup definitions, resource objects, and scheduled tasks.

Depending on your requirements, you can use the Uninstall Connectors utility to perform any of the following tasks:

- [Uninstalling a Connector](#)
- [Removing Adapters, Lookup Definitions, Resource Objects, and Scheduled Tasks](#)

### 10.9.5.1 Uninstalling a Connector

#### **Caution:**

It is strongly recommended that Oracle Identity Governance is idle and it is not available for any operations. You must ensure that:

- There are no operations on Oracle Identity Governance while using uninstalling connector or connector objects
- All scheduled tasks are disabled and there are no asynchronous messages pending for processing such as audit messages, offline provisioning messages, offline task messages, requests scheduled for future and so on.



You can use the ConnectorUninstall script to uninstall a connector. When you run the script, all objects that form part of the connector and all the resource data that was collected through the connector are deleted from the database.

 **Note:**

Before running the uninstall utility:

- To delete applications that are created through Application Onboarding capability in Identity Self Service, you need to update `ConnectorUninstall.properties` file with `ObjectType` and `ObjectValues` before running the `./uninstallConnector` utility.

For example, if you want to delete resource objects, scheduled tasks, and scheduled jobs associated with a connector, then provide `ResourceObject`, `ScheduleTask`, and `ScheduleJob` as the value of the `ObjectType` property and provide a semicolon separated list of values corresponding to the connector to `ObjectValues` before running the `./uninstallConnector` utility.

- You cannot delete data that are already archived.
- You must ensure that you have the latest Oracle Identity Governance schema and MDS backup, which will help to restore if uninstall utility does not complete successfully.
- You must ensure that your UNDO tablespace is sized properly. This is required if your development/test environment has significant amount of data to be deleted.

As mentioned earlier in this guide, when a connector is defined, an entry is created for the connector in the Oracle Identity Governance database. This entry also includes the contents of the connector XML. When you choose to uninstall a connector, the utility identifies the connectors objects to be dropped by parsing the connector XML contents.

 **Note:**

- Connector uninstall collects all the objects information from the connector XML, which is created while installing or defining a connector. If an additional object, which is not related to this connector is added while defining the connector, uninstall would delete that too. For example, while defining AD connector, if user adds a system lookup or lookup related to other connector, uninstall would delete that lookup.
- Ensure that only the connector specific objects are added while defining a connector.

See [Running the Script to Uninstall Connectors and Connector Objects](#) for the procedure.

## 10.9.5.2 Removing Adapters, Lookup Definitions, Resource Objects, and Scheduled Tasks

 **Caution:**

It is strongly recommended that Oracle Identity Manager is idle and it is not available for any operations. You must ensure that:

- there are no operations on Oracle Identity Manager while using uninstalling connector or connector objects
- all scheduled tasks are disabled and there are no asynchronous messages pending for processing such as audit messages, offline provisioning messages, offline task messages, requests scheduled for future and so on.

You can use the ConnectorUninstall script to remove an adapter, lookup definition, resource object, or scheduled task. Only the object that you specify is removed from Oracle Identity Manager.

## 10.9.6 Running the Script to Uninstall Connectors and Connector Objects

Instead of removing each component individually, you can run scripts to remove connector objects. Running the scripts include steps to be performed before running the script, running the uninstall script, and the steps to be performed after running the uninstall script.

Running the script to uninstall connectors and connector objects includes the following procedures:

- [Preuninstall the Connectors and Connector Objects](#)
- [Uninstall the Connectors and Connector Objects](#)
- [Postuninstall the Connectors and Connector Objects](#)

### 10.9.6.1 Preuninstall the Connectors and Connector Objects

 **Note:**

Before executing the uninstall, you must ensure that all scheduled tasks are disabled.

Before Uninstalling the connector, you must:

1. Create a backup of Oracle Identity Governance database so that if something goes wrong during uninstalling, then the data can be restored. See Oracle Identity Governance Database documentation for details about creating database backup.
2. Create Oracle Identity Governance metadata (MDS) backup.
3. Ensure that there are no operations on Oracle Identity Governance until the Uninstall utility is completed. Oracle Identity Governance and SOA servers should be up and running.
4. Ensure that all the JMS messages are processed.

## 10.9.6.2 Uninstall the Connectors and Connector Objects

To run the ConnectorUninstall script for uninstalling the connector:

1. Set values in the properties file used by the script.

 **Note:**

If you provide ConnectorName and Release along with ObjectType and ObjectValues, then deletion of ObjectValues will be performed by the utility and the Connector information will be skipped.

The ConnectorUninstall.properties file is a viable in *OIM\_HOME*/server/bin. This file contains information that is used by the script for deleting connector objects.

Open the properties file in a text editor, and then set values for the following properties:

- DatabaseURL: Enter the JDBC URL for the Oracle Identity Governance database in the following format:

```
jdbc:oracle:thin:@HOST_NAME:DATABASE_PORT:DATABASE_NAME/ORACLE_SID
```

For example: jdbc:oracle:thin:@localhost:1521:orcl

- DBUserName: Enter the user name of an Oracle Identity Governance database.
- DBType: Specifies the type of database.
- LogLevel: Enter one of the following as the log level: DEBUG, WARN, INFO, or ERROR.
- Location: Enter the directory location where you want to have all the log files generated by the Uninstall utility.

If the Uninstall utility completes successfully, then the ConnectorUninstall.log file, along with <ResourceObject>.log files are generated.

If the Uninstall utility fails, then the ConnectorUninstall.log file along with the ConnectorUninstall\_Error.log file are generated.

 **Note:**

If the uninstall utility fails with errors, then check the ConnectorUninstall.log and ConnectorUninstall\_Error.log and take suitable action. Then, run the uninstall utility again.

For example, if the Uninstall utility of ActiveDirectory Connector succeeds, then the following logs will be generated:

- ConnectorUninstall.log
- AD User.log
- AD Group.log
- AD Organization Unit.log

- AD User Trusted.log

If the Uninstall utility of ActiveDirectory Connector Fails, then the following logs will be generated:

- ConnectorUninstall.log
- ConnectorUninstall\_Error.log

- ConnectorName: The value that you set for this property depends on your requirement. If you want to delete a specific connector, then enter the name of the connector. The name that you enter must be the same as the name shown in the search results displayed through the Manage Connector feature. For example, enter `Active Directory` if you want to delete the Microsoft Active Directory connector.
- Release: The value that you set for this property depends on your requirement. If you want to delete a specific connector, then enter the release number of the connector. The release number that you enter must be the same as the release number shown in the search results displayed through the Manage Connector feature. For example, enter `9.1.0.1` if you want to delete the Microsoft Active Directory 9.1.0.1 connector.
- ObjectType: The value that you set for this property depends on your requirement:
  - If you want to uninstall a connector, then ensure that the ObjectType property is not assigned a value.
  - If you want to delete adapters, lookup definitions, resource objects, or scheduled task, then enter `Adapter`, `Lookup`, `ResourceObject`, or `ScheduledTask` respectively.

Example: `ResourceObject`

- ObjectValues: Enter a semicolon-separated list of object values.

Example: `AD User; AD Group`

2. In a command window, change to the `OIM_HOME/server/bin` directory and then run the script, `sh uninstallConnector.sh` (or `bat` file).

#### Note:

- Before running this utility, set `APP_SERVER`, `OIM_ORACLE_HOME`, `JAVA_HOME`, `MW_HOME`, `WL_HOME`, and `DOMAIN_HOME`.
- If Oracle Identity Governance is installed on IPv6 Linux host computer, then pass `ipv6` as the input argument to the `uninstallConnector.sh` script, as shown:

```
sh uninstallConnector.sh ipv6
```

If you do not pass `ipv6` as input argument, then the connector uninstall fails with the following error:

```
Error : Error encountered while getting a connection :IO Error: The
      Network Adapter could not establish the connectionDB cant connect
with host name in property .
```

- On Windows environment, do not pass any parameter for IPv6 while running `uninstallConnector.bat`.

While the script runs, logs will be generated at the location provided.

After you run the utility, you will be prompted to enter following information:

- a. Oracle Identity Governance Database Password
- b. Oracle Identity Governance Administrator Name
- c. Oracle Identity Governance Administrator Password
- d. Oracle Identity Governance Server t3 URL

For example: t3://<HOST\_NAME>:<HOST\_PORT>

 **Note:**

For cluster setup, the t3 URL should be t3://<NODE1>:<PORT1>,<NODE2>:<PORT2>.

- e. Context Factory
- f. Confirmation for the deletion of the connector/object(s)

### 10.9.6.3 Postuninstall the Connectors and Connector Objects

After uninstalling the connector, you must perform the following steps:

1. Use DeleteJars utility for deleting the jars associated with the connector from Oracle Identity Governance database.
2. Use DeleteResourceBundles utility for deleting all resources that are associated with the connector from Oracle Identity Governance database.
3. Revisit the log, look for the following information and perform the steps mentioned for each of it:
  - a. The list of attestation processes: Delete/modify these attestation process as the resource objects, which used these attestation processes are now deleted.
  - b. Modify requests manually to delete the resource object names that are cleaned by the uninstall utility.
  - c. As the part of connector uninstall, the approval processes (Approval workflow/SOA composites) are not deleted. If the approval processes are generic, then you need to modify them if they have association with the deleted resource objects.
4. Recalculate statistics and re-create indexes and other database objects that are removed by the connector uninstall utility.
5. Restart Oracle Identity Governance, or use PurgeCache utility to purge the Cache.

See Purging the Cache in *Performance and Tuning Guide* for information about purging the cache.

## 10.10 Troubleshooting Connector Management Issues

Common connector management problems for troubleshooting can be missing forms with application instances or error thrown during upgrade procedure.

### Problem

Using Oracle Identity Governance, you can configure a cloned Active Directory (AD) Release 9.x connector for target AD and run an AD trusted source reconciliation to create users in Oracle Identity Governance. After the user is created in Oracle Identity Governance, when you run the target resource reconciliation for AD, the user details are linked in the Accounts tab. However the Detail Information tab displays a blank page. When you check the Application Instances section in Oracle Identity System Administration and search and open the relevant application instance, no form is found associated with the application instance.

### Solution

Create a new set of forms for each application instance.

### Problem

When you are upgrading a connector, the following error may be encountered by Oracle Identity Governance:

```
<Error> <XELLERATE.WEBAPP> <BEA-000000> <Class/Method:tcActionBase/execute  
encounter some problems: Bean has been deleted. javax.ejb.NoSuchEJBException:  
Bean has been deleted.
```

### Solution

Restart Oracle Identity Governance server and retry upgrading the connector. This error may be encountered when Oracle Identity Governance is in idle state for a long time.

# 11

## Managing Reconciliation

Key concepts related to reconciliation are reconciliation based on the objects being reconciled, modes of reconciliation, and approach used for reconciliation. Reconciliation events are managed by using the Identity System Administration.

This chapter contains the following sections:

- [About Reconciliation](#)
- [Reconciliation Based on the Object Being Reconciled](#)
- [Mode of Reconciliation](#)
- [Approach Used for Reconciliation](#)
- [Managing Reconciliation Events](#)

### See Also:

Customizing Reconciliation in *Developing and Customizing Applications for Oracle Identity Governance* for information about reconciliation features and architecture.

### 11.1 About Reconciliation

Reconciliation is the process by which operations, such as user creation, modification, or deletion, started on the target system are communicated to Oracle Identity Manager.

The reconciliation process compares the entries in Oracle Identity Manager repository and the target system repository, determines the difference between the two repositories, and applies the latest changes to Oracle Identity Manager.

Reconciliation of roles, role memberships, and role hierarchy changes are handled as separate reconciliation events. Ideally role events must be submitted first and then only the membership events in order to avoid race conditions. For race conditions, the automatic retry logic allows the reconciliation engine to handle it.

### See Also:

Handling of Race Conditions in *Developing and Customizing Applications for Oracle Identity Governance* for information about race conditions

**Figure 11-1** shows that provisioning and reconciliation involve synchronization from Oracle Identity Manager to the target system or from the target system to Oracle Identity Manager. Provisioning and reconciliation enable the provisioning system to build the managed identities in the target system as well as replicate the managed identities as they already exist in the target system.

**Figure 11-1 Provisioning and Reconciliation**

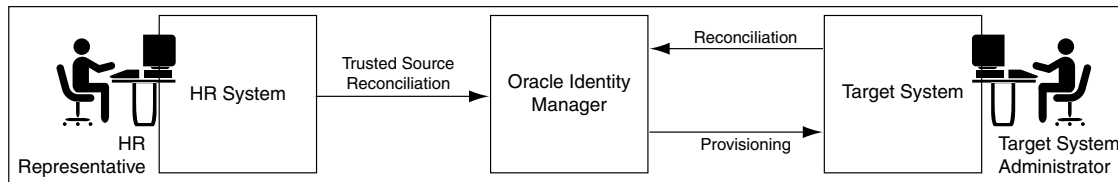

In [Figure 11-1](#), a user is created by the HR representative when a new employee joins. The user is reconciled to Oracle Identity Manager by trusted source reconciliation. When the user is created in Oracle Identity Manager, the account for the user is provisioned in the target system. In the target system, the target system administrator can make changes in the account, which must be reconciled to Oracle Identity Manager.

In terms of data flow, provisioning provides the outward flow from the provisioning system by using a push model, in which the provisioning system indicates the changes to be made to the target system. Reconciliation provides the inward flow into the provisioning system by using either a push or a pull model, by which the provisioning system finds out about any activity on the target system.

The reconciliation process involves generation of events to be applied to Oracle Identity Manager. These events reflect atomic changes in the target system, and contain the data that has changed, the type of change, along with other information. The reconciliation events that are generated consequently because of changes occurring in the target system are managed by using the Event Management section in Oracle Identity System Administration, which addresses these event management needs. See "[Managing Reconciliation Events](#)" for information about managing reconciliation events by using Oracle Identity System Administration.

### Types of Reconciliation and Classification Criteria

Reconciliation can be of different types, as shown in [Table 11-1](#):

**Table 11-1 Types of Reconciliation**

Classification Criteria	Reconciliation Type
Object being reconciled	Based on identity being reconciled, such as user, account, role, organization, or relationship that includes role hierarchy and role membership
Mode of reconciliation	Changelog
Mode of reconciliation	Regular
Approach used for reconciliation	Incremental reconciliation
Approach used for reconciliation	Full reconciliation

## 11.2 Reconciliation Based on the Object Being Reconciled

Depending on the entity object that is being reconciled, reconciliation can be trusted source or target resource.

This section discusses about object based reconciliation in the following topics:

- [Entities that are Reconciled in Oracle Identity Governance](#)



- [Trusted Source Reconciliation](#)
- [Account Reconciliation](#)
- [Reconciliation Process Flow](#)

## 11.2.1 Entities that are Reconciled in Oracle Identity Governance

The entities that are reconciled are user, account, organization, role, role hierarchy, and role membership.

Reconciliation depends on the entity object that is being reconciled. The following entities in Oracle Identity Manager are reconciled:

- **User:** A user is an identity that exists within and is managed through Oracle Identity Manager.
- **Account:** An account entity is granted to a user in Oracle Identity Manager. It represents a collection of the attributes and privileges for the user that uniquely identifies the user in a provisioning target. The existence of an account in Oracle Identity Manager makes it possible for the user to access the provisioning target.
- **Organization:** An organization entity represents a logical container of entities, such as users and other organizations, that exists in Oracle Identity Manager.
- **Role:** A role is a logical grouping of users to whom you can assign access rights within Oracle Identity Manager, provision resources automatically, or use in common tasks such as approval and certification.
- **Role hierarchy:** Role hierarchy is the inheritance of the parent role to child roles. The parent role has the same permissions and privileges on the members as the inherited roles.
- **Role membership:** Role membership means that the members of the inheritor role inherit from the inherited role. See *Managing Roles in Performing Self Service Tasks with Oracle Identity Governance* for detailed information about membership and permission inheritance.

## 11.2.2 Trusted Source Reconciliation

If data is reconciled from a system that drives the creation of users, roles, role memberships, or role hierarchies in Oracle Identity Manager repository, then that reconciliation mode is called identity reconciliation, or authoritative source reconciliation, or trusted source reconciliation.

The system that is being reconciled from is referred to as the authoritative source for the enterprise identities, and may be an HR system or a corporate directory.



### Note:

If the user login is not passed for trusted reconciliation, then the login handler generates the user login. The password is generated in postprocessing event handler, and notification is sent for the same.

As shown in [Figure 11-2](#), the authoritative sources of identity may be more than one. The different authoritative sources may be the source of reconciliation for different categories of user identities or may be the source of reconciliation for different sets of attributes. The various events generated by the reconciliation engine are add, modify, and delete.

**Figure 11-2 Trusted Source Reconciliation from Single and Multiple Authoritative Sources**

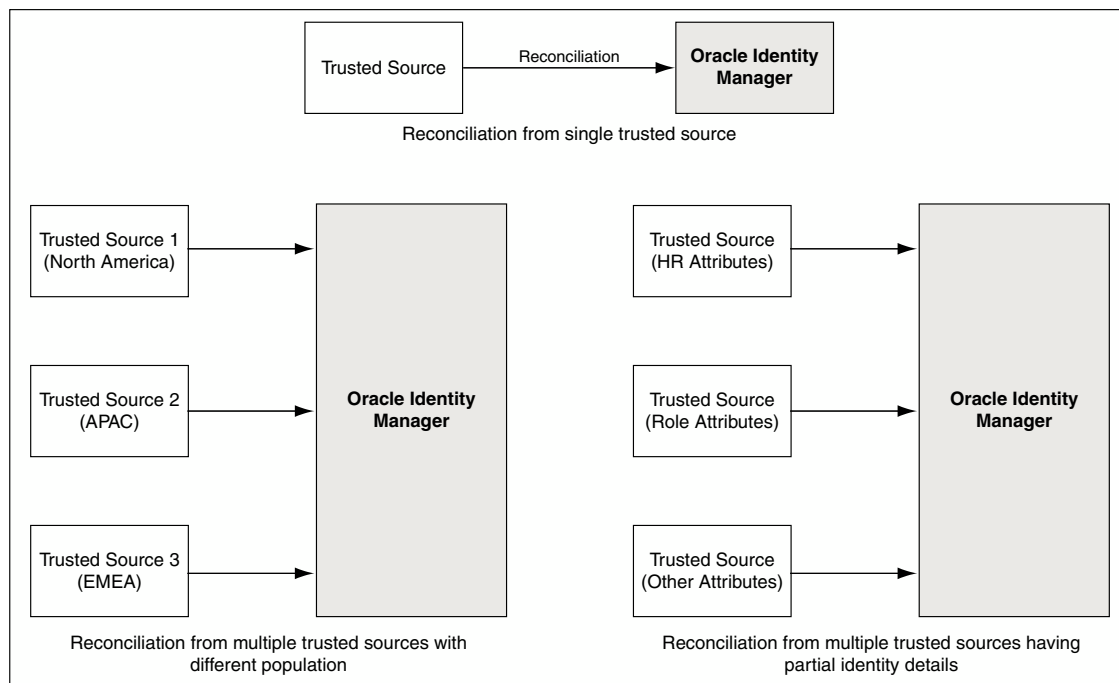

In [Figure 11-2](#), trusted source reconciliation from a single authoritative source and multiple authoritative sources are shown. Creation of user entities can be reconciled from multiple authoritative sources. In addition, different attributes can be reconciled from different multiple authoritative sources. For example, the user ID and e-mail ID can be provided by an authoritative source and role attributes can be provided by another authoritative source.

Trusted source reconciliation must be followed by account reconciliation when the target system is the source for identities as well as accounts. For instance, if Active Directory is the corporate LDAP repository in which user information is stored, then the user information is reconciled from the Active Directory target system. Subsequently, the Active Directory accounts are reconciled into Oracle Identity Manager by using a different connector. Identity reconciliation occurs only from trusted sources, by using connectors specific to those trusted sources.



**Note:**

A reconciliation connector is a component developed to reconcile identities or accounts from a specific target system. Typically, a reconciliation connector is configured to be run as a scheduled task. However, there are push-based connectors, such as the PeopleSoft HR connector, for which there is no scheduled task to trigger the reconciliation.

### 11.2.3 Account Reconciliation

If the target system identities are accounts that get reconciled to Oracle Identity Manager, then that is target resource reconciliation or account reconciliation.

This type of reconciliation is to reconcile a specific resource object that represents the target system being managed. There is always a corresponding provisioning flow for it. The identity retrieved from the target system maps to a resource object instance that has been provisioned to a user or organization.

Account reconciliation takes place in the following two scenarios:

- Scenario I: Account Reconciliation From a Target System
- Scenario II: Identity and Account Reconciliation

### 11.2.3.1 Scenario I: Account Reconciliation From a Target System

Identity gets created in Oracle Identity Manager from an authoritative source. The identities are provisioned with resources on the target system. Any change on the target system is reconciled with Oracle Identity Manager. Figure 11-3 shows account reconciliation from a target system:

**Figure 11-3 Account Reconciliation From a Target System**

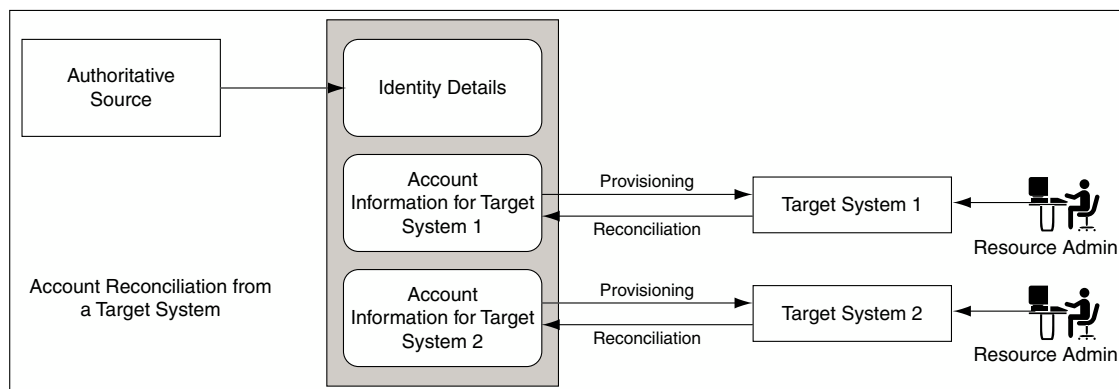

### 11.2.3.2 Scenario II: Identity and Account Reconciliation

In this scenario, the target system initially plays the role of an authoritative source. Later it plays the role of a regular provisioning target. Following are the sequence of steps:

1. Identities are created in Oracle Identity Manager based on the target system entity details. Corresponding accounts are also created for these entities.
2. The entities are updated as provisioned entities in the target system.
3. The resource administrator at the target system makes changes to the accounts.
4. The changes made on the target system are reconciled with Oracle Identity Manager.

Figure 11-4 shows identity reconciliation followed by account reconciliation:

**Figure 11-4 Identity and Account Reconciliation**

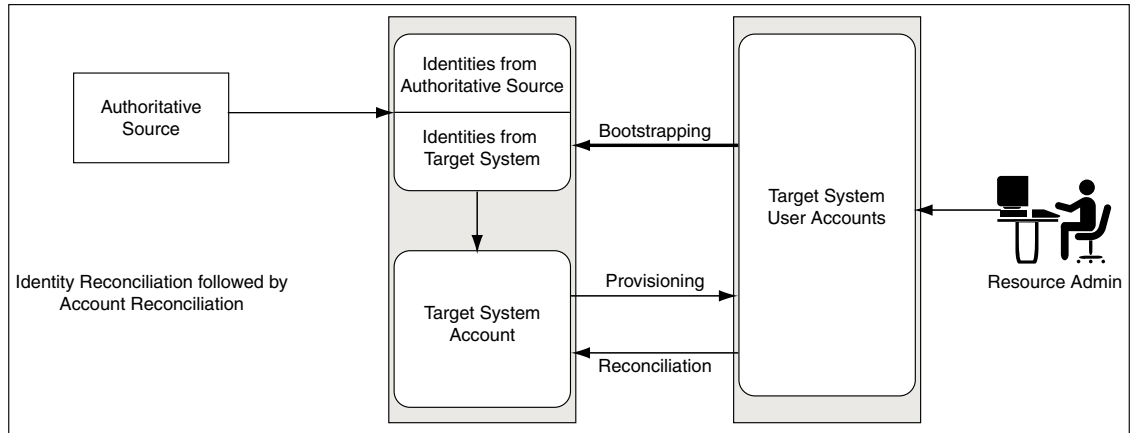

**Note:**

When the value of the `XL.UserProfileAuditDataCollection` property is set to an audit data collection level, then the account reconciliation performs the matching in the database layer at a batch-level and performs the event action by using the provisioning APIs. This in turn triggers the audit event handlers for account reconciliation. By default, the value of this property is set to Resource Form. See [Administering System Properties](#) for information about system properties in Oracle Identity Manager.

## 11.2.4 Reconciliation Process Flow

Primary steps in the reconciliation process flow involves changes made in the target system, providing reconciliation data to the connector, creating reconciliation event record, processing reconciliation event data, taking manual action on the event, and post-processing action.

The reconciliation process flow is shown in [Figure 11-5](#):

Figure 11-5 Reconciliation Process Flow

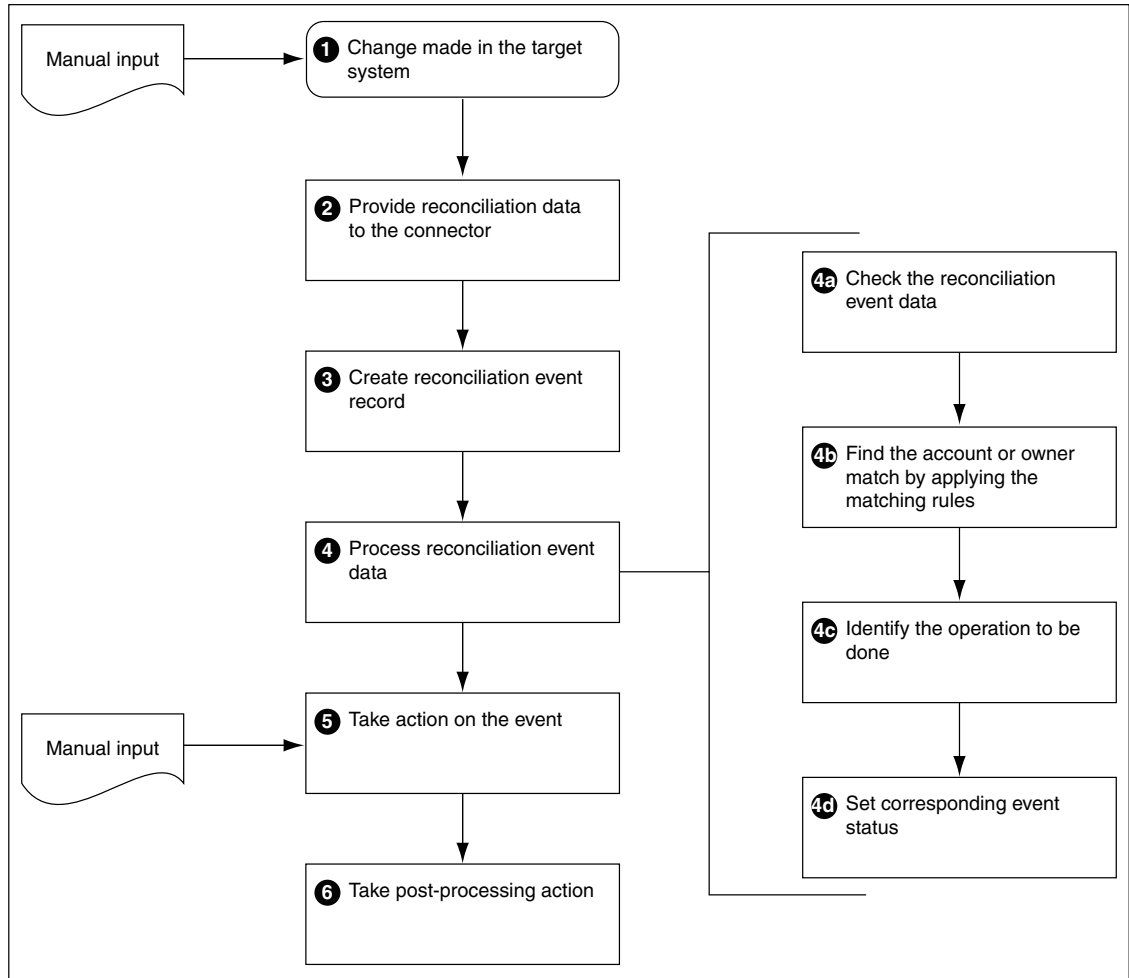

Reconciliation process involves the following steps:

1. **Changes in the target system:** The various activities that can happen in the target system are creation, modification, or deletion of user, account, role, role membership, or role hierarchy.

 **Note:**

If you create an entity on an external system and then modify it a short time later, reconciliation processes the create entity step, but the modify entity step fails with the Creation Failed event status. This is because reconciliation cannot process a create and a modify action for the same entity in the same batch process.

However, the entity modification action can be resubmitted for reconciliation at a later time by one of the following built-in mechanisms:

- The "Automated Retry of Failed Async Task" scheduled task will run to re-process the failed events without any manual intervention.
- The failed event will be re-processed if the "Manual Retry Error Handling Mechanism" is triggered.

Reconciliation failure messages that are caused by processing conflicts within the same batch process should be regarded as transitory failures only.

2. **Providing reconciliation data:** When the creation, modification, or deletion event occurs, data about that event is sent to the reconciliation service by using reconciliation APIs.

 **Note:**

Reconciliation service refers to the collection of reconciliation engine, reconciliation APIs, and the associated metadata and schema.

3. **Creation of reconciliation event record:** When the data for a reconciliation event is provided to reconciliation service, a record of that event is stored in Oracle Identity Manager repository.
4. **Processing of the reconciliation event data:** The data received is then evaluated to determine the actual operation to be performed in Oracle Identity Manager based on the changes in the target system. The evaluation involves application of a specific set of rules that help in:
  - a. Identifying whether the data is for an account or for an identity that Oracle Identity Manager already has a record of
  - b. Identifying the owner of the account or identity that the data represents
  - c. Defining the context-sensitive action to be taken
  - d. Setting the status of the event at the end of evaluation and the action that the reconciliation engine must take
5. **Taking action on the event:** Based on the evaluation result of processing the reconciliation event data, the intended action is taken. The various actions can be:

 **Note:**

The actions on the event can be manually performed through the UI, or they can be automatic actions.

- Creating a new account and associating with proper owner identity
- Updating the matched account
- Deleting the matched account
- Creating a new user in Oracle Identity Manager
- Modifying an existing user in Oracle Identity Manager
- Deleting an existing user
- Enabling and disabling account status by updating the status attribute
- Enabling or disabling user
- Creating, updating, or deleting role
- Creating or deleting role membership
- Creating or deleting role hierarchy

 **See Also:**

Reconciliation Engine in *Developing and Customizing Applications for Oracle Identity Governance* for information about role membership and role hierarchy

6. **Follow up actions triggered by the reconciliation event:** After the action is taken, follow up tasks can be started based on the reconciliation event. An example of follow up tasks or post-processing task is creating a request to provision a resource, such as a laptop computer, after a user creation event.

## 11.3 Mode of Reconciliation

Mode of reconciliation can be changelog or regular.

Most connectors, such as Active Directory, use the pull model. For the pull model, a pull reconciliation task is scheduled in the IAM Scheduler. The task runs at recurring intervals.

 **See Also:**

[Managing the Scheduler](#) for information about the IAM Scheduler.

Typically, the pull-based reconciliation connectors submit the reconciliation events within a scheduled task. Every time the scheduled task runs, a new reconciliation run is triggered and the reconciliation events are created in batches. When the batch size is met, the batch is submitted for processing. At the end of the scheduled task, an end of job listener is triggered, which submits all the batches whose size is not met.

Other reconciliation connectors, such as the PeopleSoft connector, use a push model. The connector comprises of an HTTP listener that detects any asynchronous messages issued by PeopleSoft. On receiving a message, the listener submits reconciliation events by calling the reconciliation API. The events are processed by the reconciliation engine in batches when the batch size is met. For batches where batch size is not met, a scheduled task runs periodically and submits the batches for reconciliation processing.

Pull or push model is used based on the nature of the target system and how the changes can be detected in the target system. But irrespective of the push or pull model being used, reconciliation is performed by using a scheduled task that runs in the IAM Scheduler.



**Note:**

You can also create the reconciliation events directly by using the reconciliation APIs.

Changelog reconciliation is the default reconciliation mode. In this mode, only changed attributes are reconciled. Unspecified fields are ignored. You typically use the Changelog reconciliation mode when a connector is aware of the list of changed attributes. Along with the changed attributes, Oracle Identity Manager needs a list of required fields for matching. The Changelog reconciliation mode was supported in previous Oracle Identity Manager releases, so all connectors work in this mode.

Regular reconciliation is a reconciliation mode where the reconciliation engine completely replaces the existing snapshot of the entity. You typically use this reconciliation mode when the connector cannot determine which attributes have changed, and therefore, sends an entire snapshot of the entity. For new connectors, you can specify this mode when performing a full reconciliation. Using regular reconciliation mode results in better performance because the events are processed faster.



**Note:**

The mode of reconciliation depends on the connector implementation. For information about connector implementation, see *Connector for Reconciliation in Developing and Customizing Applications for Oracle Identity Governance*.

Table 11-2 lists the differences between regular and change log reconciliation modes:

**Table 11-2 Regular and Changelog Reconciliation Modes**

Regular	Changelog
Must pass a full set of mapped attributes	Must pass a subset of mapped attributes that are required by the specific profile and used by matching a rule
Performs better in batch processing mode (no difference in performance while in single event processing mode)	
Creates and updates all fields	Creates and updates only specified fields, and all other fields remain unchanged



**See Also:**

Changing the Profile Mode in *Developing and Customizing Applications for Oracle Identity Governance* for information about changing the reconciliation mode



## 11.4 Approach Used for Reconciliation

Full reconciliation and incremental reconciliation are two approaches used for reconciliation.

When you run reconciliation for the first time on a target system, all users and accounts on the target system are reconciled into Oracle Identity Manager by default. This is called full reconciliation. To perform full reconciliation, the connector sends the reconciliation events for each entity in the target system. The reconciliation engine processes the events as create or update events depending on whether or not the entity already exists in Oracle Identity Manager. The connector also identifies all the deleted entries and sends the deletion events to Oracle Identity Manager.

At the end of full reconciliation, the connector typically sets the last execution time parameter to the time when the reconciliation run ends. For the next reconciliation run, only the entity records that have been added, modified, or deleted after the first reconciliation run ended are fetched for reconciliation. This is called incremental reconciliation.

You can manually switch from incremental reconciliation to full reconciliation by setting the value of the timestamp IT resource parameter to 0.

## 11.5 Managing Reconciliation Events

Managing reconciliation events include searching events, determining event actions, re-evaluating events, closing events, and linking reconciliation events. You can manage reconciliation events by using the Event Management section of Identity System Administration.

This section contains the following topics:

- [About Reconciliation Events](#)
- [Searching Events](#)
- [Displaying Event Details](#)
- [Determining Event Actions](#)
- [Re-evaluating Events](#)
- [Closing Events](#)
- [Linking Reconciliation Events](#)

### 11.5.1 About Reconciliation Events

The reconciliation process involves generation of events to be applied to Oracle Identity Manager. These events reflect atomic changes in the target system, and contain the data that has changed, the type of change, along with other information.

The reconciliation events that are generated as a result of changes occurring in the target system must be managed in such a way that they meet various business requirements. The Event Management section in the Oracle Identity Manager Advanced Administration addresses these event management requirements.

You can manage reconciliation events by using the Event Management section, which lets you query the events stored in various ways and display all event data. The events are always displayed in the same form, which is on the Event Details page. You can run custom queries

for the events through the Advanced Search feature. It also allows you to perform any necessary action to resolve event issues.

Events are generated by reconciliation runs. These reconciliation runs are scheduled to run by using the Oracle Identity Manager Scheduler.



**See Also:**

[Managing the Scheduler](#) for detailed information about the scheduler.

## 11.5.2 Searching Events

Identity System Administration lets you perform quick and simple event search based on simple criterion, such as event ID or profile name. In addition, you can specify complex criteria for searching events in the UI.

You can display a summary of reconciliation events by performing the following types of search:

- [Performing a Simple Search for Events](#)
- [Performing an Advanced Search for Events](#)

### 11.5.2.1 Performing a Simple Search for Events

To perform a simple search for events:

1. Login to Oracle Identity System Administration.
2. In the left pane, under Provisioning Configuration, click **Reconciliation**. The Advanced Administration is displayed with the Reconciliation section in the Event Management tab active.
3. In the left pane, enter a search criterion in the Search field. You can include wildcard characters (\*) in your search criterion.

The simple search takes one argument. The text arguments are searched in the following event fields:

- Event ID
- Profile Name
- Key Fields



**Note:**

In simple search, you cannot perform the search by event dates.

4. Click the icon next to the Search field. The events that match your search criterion is displayed in the search results table.

The search fetches all rows for which the aforementioned attributes contains the string specified in the Search field. The search result displays the Event ID, Profile Name, and Key Fields columns. The Event ID column displays the event ID. The IDs are sorted as integers, not strings. The Profile Name column displays the name of the reconciliation

profile. Key field is an attribute that uniquely identifies a row of data. In reconciliation, some attributes are flagged as Key in the profile. These fields are displayed in the Key Fields column.

 **Note:**

Simple Search is paginated, meaning it only displays search results 64 rows at a time. This is to improve performance. Scrolling down past the 64th row in the UI triggers another page fetched from the database and so on for every 64 rows beyond that.

## 11.5.2.2 Performing an Advanced Search for Events

The advanced search takes multiple arguments and lets you fine-tune the list of events. To perform an advanced search for events:

1. In the left pane of the Reconciliation section, click **Advanced Search**. The Search: Events page is displayed.
2. Select any one of the following options:
  - **All:** On selecting this option, the search is performed with the AND condition. This means that the search operation is successful only when all the search criteria specified are matched.
  - **Any:** On selecting this option, the search is performed with the OR condition. This means that the search operation is successful when any search criterion specified is matched.
3. In the Event ID field, enter the event ID that you want to search. You can use wildcard characters (\*) in your search criteria. Select a search condition in the list adjacent to the Event ID field.
4. Specify search arguments in the other fields displayed in the Search: Events page. [Table 11-3](#) lists the fields in the Search: events page.

**Table 11-3 Advanced Search Fields**

Field	Description
Event Id	The event ID. The IDs are sorted as integers, not strings.
Resource Name	The name of the resource object representing the target system the event originates from.
Current Status	A string representing the current state of the event.
Type	The type of operation performed by the event: regular (add or modify), delete, or changelog.
Profile Name	The name of the reconciliation profile this event pertains to. <b>See Also:</b> Reconciliation Profile in <i>Developing and Customizing Applications for Oracle Identity Governance</i> for information about reconciliation profile
Entity	The type of Oracle Identity Manager entity this event pertains to. Can be either user, account, role, role grant, or role hierarchy.
Start Date	Oldest event creation date to search for.
End Date	Most recent event creation date to search for.

**Table 11-3 (Cont.) Advanced Search Fields**

Field	Description
Linked User Login	A string representing the login ID of the user linked to the event.
Key Fields	The fields flagged as key fields in the reconciliation profile that uniquely identifies rows of data.

- Click **Search**. The search results are displayed, which consists of the Event ID, Resource Name, Entity, Current Status, Type, Profile Name, Job ID, Key Fields, and Date columns.

From the search results, you can perform event bulk actions, such as close and re-evaluate, and also display the details of any specific event.

If you want to search for events with LDAP profile, use the following LDAP profiles in your search:

Object	Profile
User	LDAPUser
Role	LDAPRole
Role Membership	LDAPRoleMembership
Role Hierarchy	LDAPRoleHierarchy

### 11.5.3 Displaying Event Details

The Event Details page displays the details of a reconciliation event, such as event ID, reconciliation data, matched accounts, and event history.

To display the details pertaining to an event:

- In the left pane of the Oracle Identity Manager Advanced Administration, from the list of events, select an event whose details you want to display.
- From the advanced search result table, click an event in the Event ID column.
- From the Actions list, select **Lookup**. The Event Details page is displayed. The fields in the Event Details page change dynamically based on the event type and event status. Alternatively, you can select an event from the Event Summary on the right pane, and click the magnifying glass icon for lookup to open the Event Details page.

The data in the Event Details page is displayed in the following sections:

- Event:** This section displays the information about the event, such as event ID, whether the event type is User or Account, the time when the event was created, the reconciliation run ID, resource name, the profile name, and the key field values. Reconciliation can use several key fields, and the key field values are shown separated by commas.
- Linked To:** This section shows that the event is linked to a user or account. It displays the user or account ID to which the event is linked, the account description (if any), and the type of linking, such as rule-based linking or manual linking. Rule-based linking means that the reconciliation engine has performed the linking. Manual linking means that the administrator performs the linking manually.
- Notes:** The reconciliation engine adds notes where appropriate. For example, when there is a 'Data Validation Fail', the engine adds a note explaining the reason. This is a read-only field and is blank if no notes are attached to the event.
- Reconciliation Data:** This table displays the reconciliation event data. This shows the attribute name, attribute value, and Oracle Identity Manager mapped field. It also shows

the child data of the event, if any. The reconciliation data displays the last name, first name, hiring date, user ID, and the IT resource name.

If there are attributes with multi-language support, then these attribute values are also displayed in a separate table similar to child data.

- **Matched Accounts:** This table displays the accounts that are matched. The columns in the Matched Accounts table are listed in [Table 11-4](#):

**Table 11-4 Columns in the Matched Accounts Table**

Column	Description
Account ID	The account ID of the matched account
Orc Key	An internal key that is stored in the ORC table. This key indicated if the event is matched to a user or an account.
Descriptor Field	A description that is associated to the account
Login ID	The user login ID corresponding to the user ID displayed for user events.
Account Owner Name	A string comprising of the first name and last name and the login ID of the user who owns the account. The event pertains to this account.
Account Owner Type	The type of account owner, such as user.

- **Matched Users:** This table shows the user matches found by the reconciliation engine. For a multiple match, the linked user is not shown in this table.
- **History:** This table shows the operations that took place for this event from event creation and data validation to account matching and whether the update was successful. The columns in the History table are listed in [Table 11-5](#):

**Table 11-5 Columns in the History Table**

Column	Description
Status	Event status at the given date and time.
Action	Action performed on the event at the given date and time.
Action Performed by User	The ID and login ID of the user who performed the cited action. The engine uses the Default IAM Admin id: xelsysadm, ID = 1.
Date and Time	Date and time of the cited action.
Notes	Any notes attached to the event at the specified date and time.



**Note:**

Oracle Identity Manager does not support translation of the reconciliation field names.

## 11.5.4 Determining Event Actions

The list of actions allowed for an event depends on the status, type, and operation of the event.

[Table 11-6](#) lists the possible actions for each type and status of events.

**Table 11-6 Actions for Event Status and Types**

Event Status	Event Type	Possible Actions
No matches found	User	Close event Re-apply reconciliation rules Create entity Ad-hoc linking
No matches found	Account	Close event Re-evaluate event Ad-hoc linking
Users matched	User	Close event Re-apply reconciliation rules Linking
Users matched	Account	Close event Re-apply reconciliation rules Linking
Accounts matched	Account	Close event Re-apply reconciliation rules Linking
Event Received	Any	Close event

The possible actions are described in the subsequent sections.

## 11.5.5 Re-evaluating Events

Re-evaluating an event means reapplying the reconciliation rules on the event. Reconciliation rule refers to the matching rule used to identify the owner of an event.

For instance, if you change the reconciliation rules by using the Design Console, then you can re-evaluate the rules in the Event Management section of the Oracle Identity Manager Advanced Administration.

To re-evaluate an event:

1. From the list of events, select an event. You can select multiple event rows by pressing the Ctrl key if you want to re-evaluate multiple events at a time.
2. From the Actions list, select **Reevaluate Event**. The Reevaluate Event dialog box is displayed with the event IDs that you have selected.
3. Click **Reevaluate**. A confirmation message is displayed stating that the reconciliation rules are successfully reapplied for the event. If the selected action fails for any event, a generic message is displayed that shows the event IDs for which bulk processing has failed. The events can then be processed one at a time.

 **Note:**

- The preprocess validation lists the events that are valid and those that are invalid for re-evaluation. If you click Reevaluate, then only the valid events are re-evaluated.
- All event actions are tracked in the Event History table.

## 11.5.6 Closing Events

Closing a reconciliation events closes or discards the selected events, and the events are removed from any further processing queues.

To close an event:

1. From the list of events, select an event.
2. From the Actions list, select **Close Event**. You can select multiple event rows by pressing the Ctrl key if you want to close multiple events at a time. The Close Event dialog box is displayed.

 **Note:**

If closing an event is not a valid option, then an error message is displayed in the Close Event dialog box.

3. In the Justification box, enter a reason to close the event.
4. Click **Close**. A confirmation message is displayed stating that the event is closed. If the selected action fails for any event, a generic message is displayed that shows the event IDs for which bulk processing has failed. The events can then be processed one at a time.

 **Note:**

- All event actions are tracked in the Event History table.
- The close event operation needs a justification to be entered. Therefore, when multiple events are closed at a time by performing bulk action, all the closed events will have the same justification.

## 11.5.7 Linking Reconciliation Events

Linking reconciliation events includes ad hoc linking, manual linking, and linking orphan accounts.

Oracle Identity Manager allows you to perform the following operations for linking reconciliation events:

- [Ad Hoc Linking](#)
- [Manual Linking](#)

- [Linking Orphan Accounts](#)

### 11.5.7.1 Ad Hoc Linking

Ad hoc linking allows you to link an event to any user or role in Oracle Identity Manager. Even if the reconciliation engine finds user matches for the events, you can use ad hoc linking to ignore those matches and select a different user. This allows you to handle exceptions resulting from error matches because the reconciliation matching rules may not work correctly all the time. This action lets you link an event to any entity other than the already matched entities. In other words, instead of selecting a row from the Matched Users table, you can select another user to link with the event.

To create an ad hoc link for an event:

1. In the Event Details page, from the Actions list, select **Ad Hoc Link**. The Ad Hoc Link dialog box is displayed.
2. Click the lookup icon, and perform a user search.
3. Select a user from the search result, and click **Link**. A confirmation message is displayed that states that the ad hoc linking with the event is successful.

### 11.5.7.2 Manual Linking

When a reconciliation event has multiple matches, each match is displayed on the Matched Accounts (for account entity) or Matched Users (for user entity) tab of the Event Details page. You can manually select any match out of all the matches found by the reconciliation engine. To perform manual linking:



#### Note:

In manual linking, you select a match from a list of matches found by the reconciliation engine instead of selecting from a list of all Oracle Identity Manager users.

1. In the Event Details page, select a row from the table that lists all the matches found by the reconciliation engine.
2. Click **Link**. A message is displayed asking for confirmation.
3. Click OK to confirm.

### 11.5.7.3 Linking Orphan Accounts

The Event Management section allows you to resolve orphan accounts by selecting the correct user for the match in the following scenarios:

- [About Linking Orphan Accounts](#)
- [For an Event With Multiple Matches](#)
- [For an Event With No Matches](#)

#### 11.5.7.3.1 About Linking Orphan Accounts

Orphan accounts refer to accounts in the target system for which there is no corresponding user that exists in Oracle Identity Manager.



You can resolve events for orphan accounts for which the events either have no user match in Oracle Identity Manager, or several users are found for the match. You can therefore perform any one of the following:

- Re-create the user in Oracle Identity Manager
- Trigger a provisioning process to delete the user or account from the target system
- Perform ad hoc or manual linking

#### 11.5.7.3.2 For an Event With Multiple Matches

When several users are matched to the event data by the reconciliation engine, you must select the right user by using ad hoc or manual linking.

For information about ad hoc linking, see [Ad Hoc Linking](#).

For information about manual linking, see [Manual Linking](#).

#### 11.5.7.3.3 For an Event With No Matches

When no matches are found for an event, you can either trigger an entity creation, or select an Oracle Identity Manager entity to link to the event. For information about how to select and Oracle Identity Manager entity to link to an event, see [Ad Hoc Linking](#).

# Part VI

## Requests

Access to entities through request generation and approval is centralized in the Access Request Catalog.

This part describes the administration of request catalog and request service. It contains the following chapter:

- [Managing the Access Request Catalog](#)

# 12

## Managing the Access Request Catalog

The Access Request Catalog provides a simple, intuitive, web-based user interface that allows business users to request access to roles, application instance, and additional access (also known as entitlements) within applications.

This chapter contains the following topics:

- [Access Request Catalog](#)
- [Configuring the Access Request Catalog](#)
- [Administering the Access Request Catalog](#)
- [Managing the Lifecycle of the Catalog](#)
- [Troubleshooting Access Request Catalog](#)

### 12.1 Access Request Catalog

The Access Request Catalog allows a business to categorize and publish roles, application instance, and entitlements to the Catalog and provide additional business context using extensible metadata. Users use familiar request access for themselves using an intuitive 'catalog search' and 'shopping cart' user experience.

This section provides an introduction to the Access Request Catalog. It contains the following sections:

- [Access Request Challenges](#)
- [Access Request Catalog Concepts](#)
- [Access Request Catalog Use Cases](#)
- [Features and Benefits of Access Request Catalog](#)
- [Access Request Catalog Architecture](#)

#### 12.1.1 Access Request Challenges

Enterprises have tried to simplify and streamline the process of managing the identity lifecycle and access privileges of end users as part of improving operational efficiency and reducing IT costs.

To meet these goals, businesses have tried to implement various solutions to allow end users to manage their own identity and access. However, they have faced several challenges in doing so:

- End-users had to be trained to understand IT concepts and terminology and use IT processes to request access.
- The training cycle had to be repeated as new employees joined, lowering productivity, and increasing IT costs.
- End-users had to get IT assistance when their requests were not fulfilled in a timely manner and did not have visibility into the status of their request.

- Typically, additional access within an application had to be granted by IT or by Application administrators.
- This limited business users' view of available access and limited their productivity, while forcing them to rely on IT.

The Access Request Catalog addresses these challenges by providing an easy to use web interface where users can search and browse various types of access and select the ones they need to perform their job duties. It provides the following benefits:

- The end user does not need to know technical jargon or follow IT processes to request access. The Catalog uses well-known and familiar search and shopping cart patterns to guide the user through the access request process.
- The end-user does not need to know specific application instance, role or entitlement names. The Catalog provides an extensible metadata model and provides tagging capabilities. This allow business users to specify alternate terms to be used to search for the specific access. End users can search the Catalog using combinations of keywords and wildcards to search for the access they need.

## 12.1.2 Access Request Catalog Concepts

Some of the key concepts related to the access request catalog are catalog item, category, application instance, enterprise role, entitlement, catalog item metadata, and catalog synchronization.

The following introduces the key access request catalog concepts:

- **Catalog:** Catalog (aka Request Catalog) offers a consistent and intuitive request experience for customers to request Roles, Entitlements and Application Instances following the commonly used Shopping Cart paradigm. The catalog is a structured commodity with its own set of metadata.
- **Catalog Item:** A Catalog Item is an item (Roles, Entitlements or Application Instances) that can be requested by a user, either for themselves or on behalf of other users.
- **Category:** A Catalog Item Category is a way to organize the request catalog. Each catalog item is associated with one and only one category. A catalog item navigation category is an attribute of the catalog item. Catalog Administrators can edit a Catalog Item and provide a value for the category.

### Note:

You cannot leave Category field blank for a catalog item. Therefore, you must ensure that a value is present for the category.

- **Application Instance:** An Application Instance represents an account on particular target. When users request an application instance, they are requesting an account in a particular target. Application Instances can be connected, if fulfillment is automated via a Connector, or disconnected, if fulfillment is manual. Application Instances can have entitlements associated with them.
- **Enterprise Roles:** Enterprise Roles are defined by customers. Enterprise Roles have policies associated with them. Users can request enterprise roles via the Catalog. When a role is granted, application instances or entitlements are provisioned to the user.
- **Entitlement:** Entitlements are privileges in an application that govern what a user of the application can do.

- **Catalog User-defined field:** Catalog User-defined fields are additional attributes that are added by customers to the Catalog entity
- **Catalog Item Metadata:** Catalog Item Metadata refers to the values for the Catalog Item attributes. Metadata can be managed on a per-item basis by the Catalog Administrator or can be populated in bulk.
- **Tags:** Tags are search keywords. When users search the Access Request Catalog, the search is performed against the tags. Tags are of two types:
  - Auto-generated: The Catalog synchronization process auto-tags the Catalog Item using the Item Type, Item Name and Item Display Name
  - User-defined: User-defined Tags are additional keywords entered by the Catalog Administrator
- **Catalog Administrator:** The Catalog Administrator is a global security role. The Catalog can be managed by members of this role only.
- **Shopping Cart:** The Shopping Cart refers to the collection of Catalog Items that are being requested. A user can have only one cart active at any given time and the cart can contain roles, application instances, entitlements, or any combination of the three.
- **Catalog synchronization:** Catalog synchronization refers to the process of loading roles, application instances, and entitlements into the Catalog.

### 12.1.3 Access Request Catalog Use Cases

Typical use cases of using the access request catalog are to make applications and entitlements in the applications and roles visible in the catalog and allowing users to request access to them via simple web-based interface.

Use cases in this section explain how the access request catalog make it easy for end users to request roles, application instance, and entitlements required to perform their duties.

#### Requesting Access

Mary, a Manager in MyCorp, would like to request access to MyCorp Trading application for herself and her directs. To do this, she searches the Catalog using the keyword trading. The catalog returns all items that match Mary's keywords and that she is allowed to request. Mary filters the search results by selecting Application from the list of categories. The Catalog returns a reduced set of search results. Mary adds the MyCorp Trading application to the cart and checks out. She adds herself and her directs to the request and submits the request.

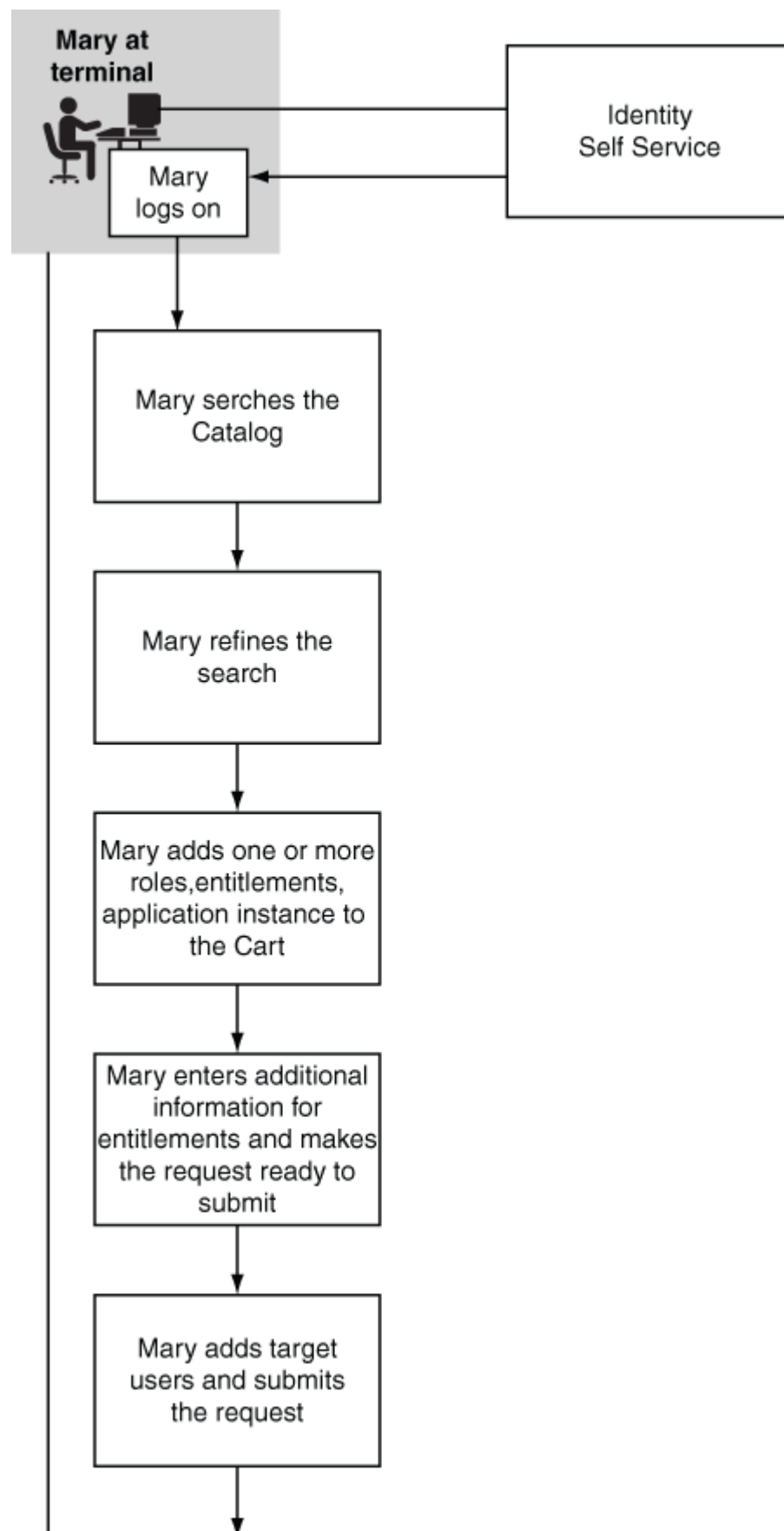

## Administering the Catalog

Jim, a Catalog Administrator, would like to onboard new application instance and their entitlements, add additional attributes and improve the searchability of the catalog items. He runs the Catalog Synchronization Job scheduled job to harvest the new application instance and their entitlements. Next, he extends the Catalog metadata by adding additional attributes and identifies certain attributes as searchable. Next, he loads the catalog with metadata and tags for the new attributes. For certain Catalog items, he searches the Catalog and edits the Catalog item in place.

 **Note:**

The Catalog Administrator must have the System Configuration Administrator admin role for running the Catalog Synchronization Job.

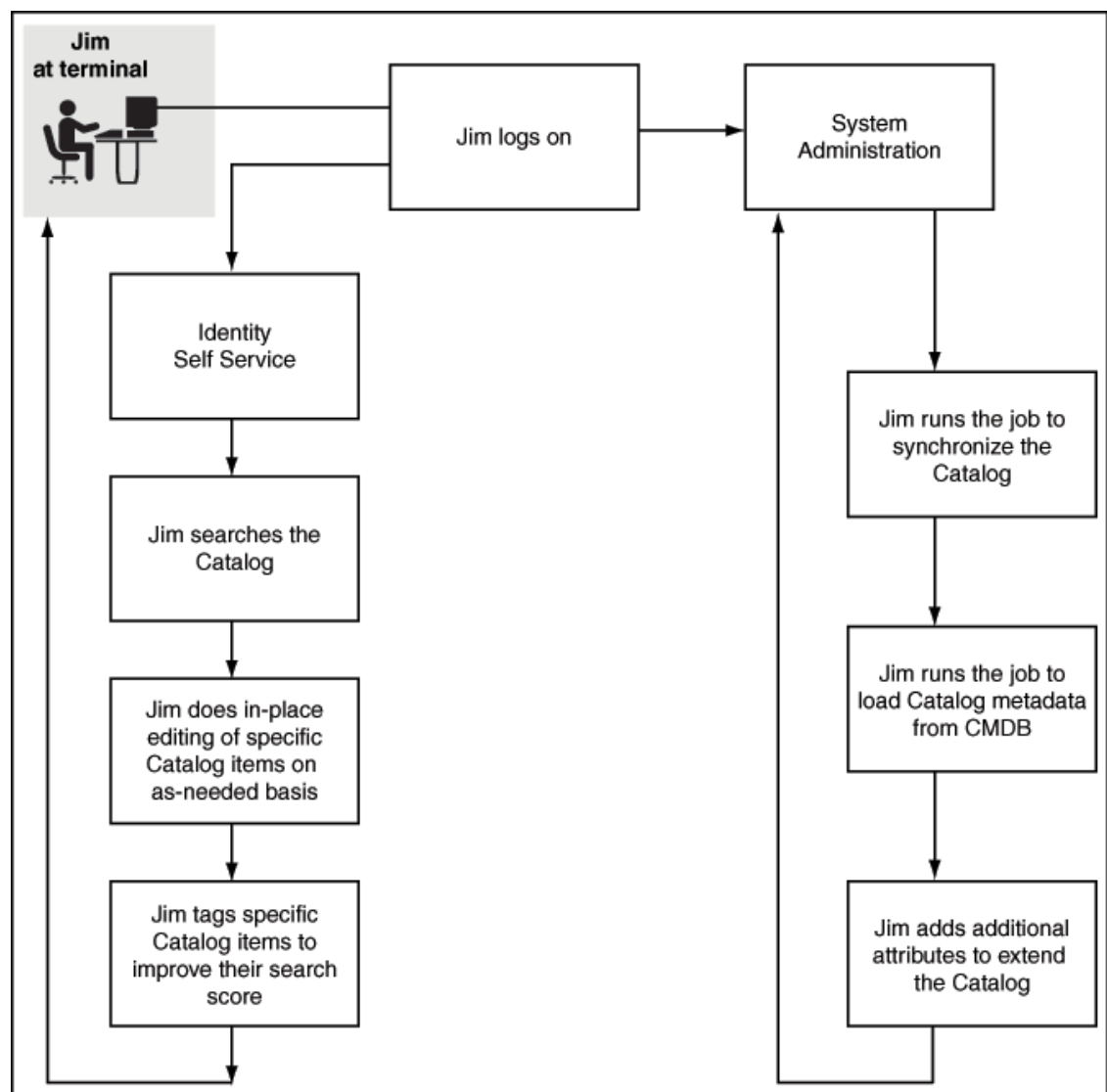

These use cases are typical examples of using the Access Request Catalog to make applications and entitlements in the applications and roles visible in the Catalog and allowing users to request access to them via simple web-based interface.

## 12.1.4 Features and Benefits of Access Request Catalog

The Access Request Catalog is a searchable, categorized collection of entities that are requestable in Oracle Identity Manager. Any authenticated user can access and search the Catalog using one or more keywords and search operators, add one or more Catalog items into a shopping cart, and submit a request for themselves and others.

Key features of the access request catalog include:

- Extensible Catalog schema that allows administrators to add additional attributes and specify how the attribute is rendered using a simple browser-based UI
- Automated harvesting of roles, applications, and entitlements
- Automated loading of Catalog metadata using a CSV file
- Powerful search using keywords with support for complex search operators
- Flexible categorization model that allows the Catalog to be organized based on customer choice
- Catalog search results secured based on viewer privileges of the requester
- Catalog item data available via a web service for use in workflows

## 12.1.5 Access Request Catalog Architecture

The access request catalog architectural components include catalog tables, catalog loaders, catalog metadata, and catalog user interface in Identity Self Service.

[Figure 12-1](#) shows the components of the Access Request Catalog and its relationship with other components of Oracle Identity Manager.



Figure 12-1 High-Level Catalog Architecture

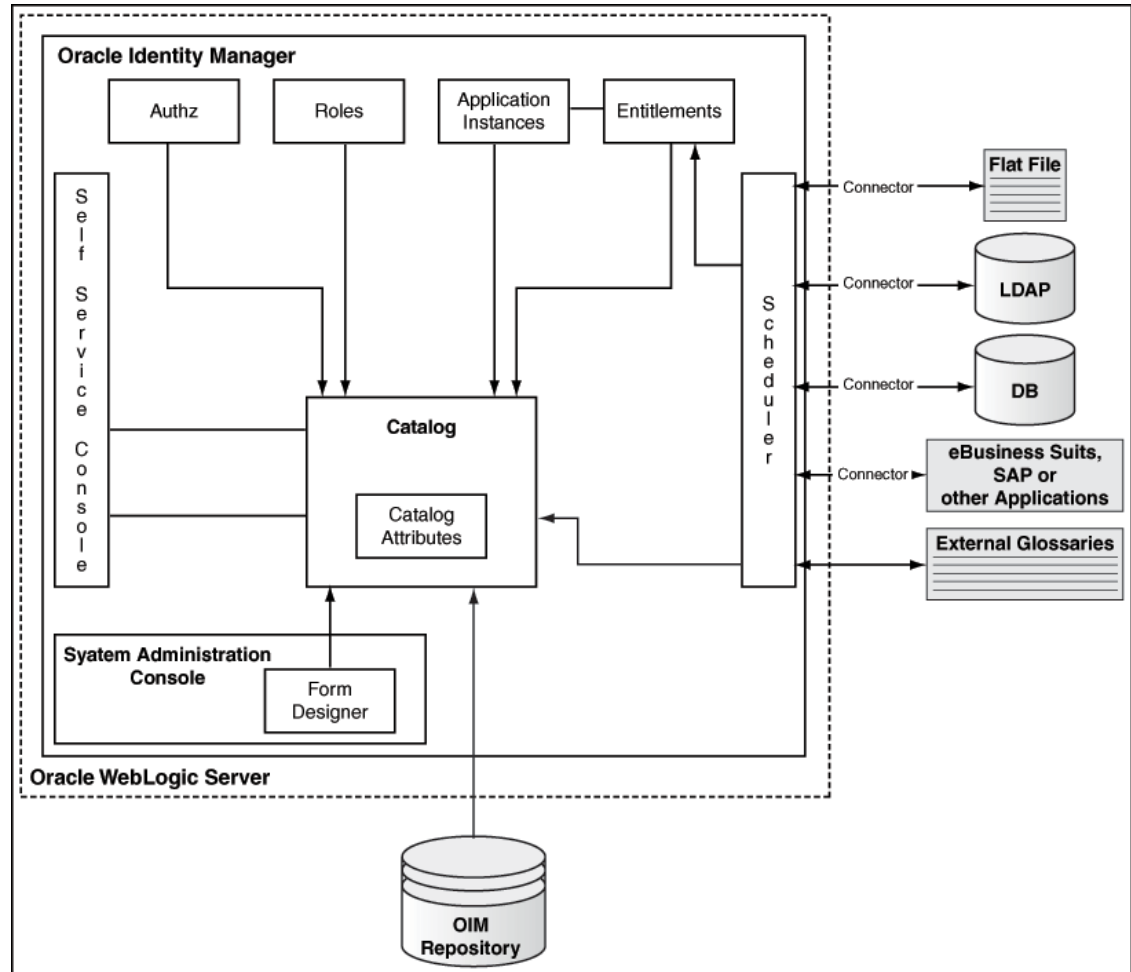

## 12.2 Configuring the Access Request Catalog

Configuring the access request catalog involves adding attributes to the catalog search form, configuring application selection limit in entitlement search, and configuring the catalog to use a custom search form.

This section describes the following configurations for the access catalog:

- [Adding More Attributes to the Default Search Form](#)
- [Configuring Application Selection Limit in Entitlement Search](#)
- [Configuring Catalog to Use a Custom Search Form](#)

### 12.2.1 Adding More Attributes to the Default Search Form

Additional attributes can be added to the catalog search form.

The attributes marked as searchable are displayed automatically as text fields in the default search form. These attributes must be added to the cart details form via customization. For information about defining a custom attribute, see [Configuring Custom Attributes](#).

## 12.2.2 Configuring Application Selection Limit in Entitlement Search

You can configure the number of applications that can be selected in the default search form during entitlement search.

The search limit is configurable by using the `Catalog Advanced Search Maximum Applications` system property. For information about this system property, see [Default System Properties in Oracle Identity Governance](#).

## 12.2.3 Configuring Catalog to Use a Custom Search Form

For advanced customizations to the catalog search, the default catalog search form can be replaced with a custom-built search form.

The catalog search form can be configured by using the `Catalog Advanced Search Taskflow` system property. For information about developing a custom taskflow for catalog search, see *Customizing Catalog Search in [Developing and Customizing Applications for Oracle Identity Governance](#)*.

# 12.3 Administering the Access Request Catalog

Administering the access request catalog involves setting the prerequisites for catalog administration, performing common administration tasks, configuring catalog auditing and hierarchical attributes of entitlements, and implementing best practices related to the database and text index optimization.

This section describes the basic administration of the Access Request Catalog. It consists of the following topics

- [Prerequisites of Catalog Administration](#)
- [Common Tasks to be Performed by the Catalog Administrator](#)
- [Catalog Auditing](#)
- [Configuring Hierarchical Attributes of Entitlements](#)
- [Database Best Practices for Access Request Catalog](#)

## 12.3.1 Prerequisites of Catalog Administration

Prerequisites of catalog administration include setting up the catalog administrator, defining catalog metadata, and adding attributes to the catalog.

The Access Request Catalog is used by end-users to request access to roles and entitlements to help them perform their duties. As a result, it is very important that the Catalog be current, have a rich metadata and be organized so that users can find the right access. To ensure this, you need to have a plan to manage the Access Request Catalog. The ensuring sections give the steps that you should follow to administer the Catalog. Before implementing those steps, there are certain pre-requisites. These include:

- [Setting Up the Catalog Administrator](#)
- [Defining the Catalog Metadata](#)
- [Adding Attributes to the Catalog](#)

### 12.3.1.1 Setting Up the Catalog Administrator

The Catalog Administrator is an admin role, similar to the System Administrator and System Configurator role. A member of this role (and those of the System Administrators role) can perform the following actions:

- Load the Catalog
- Manage Catalog Items
- Manage Request Profiles

This role is a global role and not scoped by organization.

To grant the Catalog Administrator:

1. Log in to Oracle Identity Self Service.
2. Click the **Manage** tab, and click **Organizations**.
3. Search and open the Top organization.
4. Click the **Admin Roles** tab.
5. Select the **Catalog System Administrator** admin role and click **Assign** in the toolbar.
6. Search and select the users that you want to assign, and click **Add Selected**.
7. Click **Add** to add the users.

The new members of the Catalog System Administrator role can login to the Self Service Console and start managing the Catalog.

### 12.3.1.2 Defining the Catalog Metadata

A rich catalog metadata is important to for the following reasons:

- End-users are only interested in getting access to what they need to perform their job duties. When they search and browse the Catalog, the information presented to them must relate to the business. If the Catalog is sparse (minimal attributes), users will not know which access to pick. If the Catalog is rich but technical, users will get confused and will choose not to use the Catalog.
- Requesters and Approvers need as much contextual information as possible to help them submit a request or approver one. When approvers review a request, the Catalog item detail helps them understand what is being requested, why and the impact of approving the request.
- Approval workflows use routing rules to correctly determine approvers. These rules need access to additional context about the requested item to do approver resolution. If the Catalog information is sparse, the routing rules will not have enough data available to determine the correct approvers.

To meet these challenges, the Catalog must contain additional metadata that can help place the access, that is the Catalog item, in the correct business context.

### 12.3.1.3 Adding Attributes to the Catalog

To add one or more attributes to the Catalog:

1. Log in to the Oracle Identity System Administration Console.

2. Create and activate a sandbox. See *Managing Sandboxes in Developing and Customizing Applications for Oracle Identity Governance*.
3. Under System Entities, click **Catalog**.
4. Click **Custom New Attribute** to add an attribute.
5. Select from one of the pre-defined attribute types and click **OK**.
6. Provide the necessary information and click **Save and Close**.

 **Note:**

If new custom attribute (UDF) is made Searchable, it is recommended to create a normal index on the database column of the custom attribute for optimal search performance. You can find the database columns of custom attributes in CATALOG table of Oracle Identity Manager schema.

7. Add additional attributes as required.  
You have completed the first step in extending the Catalog.
8. If you do not want to modify the Catalog search results or Catalog Item details UI, then you can have your changes reviewed and after approval of the changes, export and publish the sandbox. It is recommended that you export the sandbox to store all the changes made in your sandbox.  
  
If you want to modify the Catalog search results and Catalog Item details UI, then proceed further.
9. Logout and login to the Identity Console as a member of the System Administrator role.
10. Create a new sandbox and activate it.
11. Add the attribute to the catalog details page by referring to [Adding a Custom Attribute](#).
12. Export and publish the sandbox.

## 12.3.2 Common Tasks to be Performed by the Catalog Administrator

Some common tasks to be performed by the Catalog Administrator are on-boarding and automating the on-boarding of applications and roles, bootstrapping and enriching the catalog, and managing catalog items.

This section describes the common tasks to be performed by the Catalog Administrator. It consists of the following tasks:

- [Onboard Applications and Roles](#)
- [Bootstrapping the Catalog](#)
- [Ongoing Synchronization](#)
- [Enrich the Catalog](#)
- [Managing Catalog Items](#)

### 12.3.2.1 Onboard Applications and Roles

The Access Request Catalog must be populated with enterprise roles, application instances and entitlements so that users can search and request for access. You must develop a process by which enterprise roles, application instances and entitlements can be on-boarded to the

Catalog with minimal administrator intervention. This section covers the various steps involved in on-boarding roles, application instances and entitlements into the Catalog.

- [Prepare an Onboarding checklist](#)
- [Onboarding Roles](#)
- [About Onboard Application Instances](#)
- [Onboarding Application Instances](#)
- [About Onboard Entitlements](#)
- [Onboarding Entitlements](#)

### 12.3.2.1.1 Prepare an Onboarding checklist

Use the following onboarding checklist items to develop a high-level process for onboarding roles, application instances and entitlements into the Access Request Catalog. Later, you can follow individual checklists for roles, application instances, and entitlements.

- Identify Catalog Administrators
- Identify and extended Catalog attributes
- Customize Catalog search results UI
- Customize Catalog Item Details UI
- Identify navigational categories
- Identify Owners, Certifiers, Approvers for roles and applications
- Identify sources of truth for Catalog Item metadata/glossary
- Develop procedures to generate and load Catalog item metadata/glossary
- Develop glossary of tags and a process to maintain tags

### 12.3.2.1.2 Onboarding Roles

There are no onboarding steps for enterprise roles. Roles, belonging to a role category other than Oracle Identity Manager Roles are published directly to the Catalog when they are created.

When user edits the role and changes its category from Oracle Identity Manager Role to any other category, then the Catalog Synchronization Job scheduled job must be run to have the role searchable in the catalog.

### 12.3.2.1.3 About Onboard Application Instances

Application Instances require additional configuration before they can be requested by end users. Use the following checklist items to make sure that you have performed the configuration required to onboard application instances:

- Ensure that the Connector is installed (for new targets).
- If you are upgrading Oracle Identity Manager from Release 11g, then see [Upgrading Oracle Identity Manager Single Node Environments](#) in *Upgrading Oracle Identity and Access Management* for information about mandatory post-upgrade steps.
- Verify that the process forms have an IT resource field.
- Verify that you have defined the form field properties correctly.

- Verify that you have created the application instances with suitable display names and descriptions.
- Verify that you have created the forms required for account requests.
- Verify that you have published the application instances to the relevant organizations.
- For disconnected applications, verify that you have created the application instances. See [Managing Disconnected Resources](#) for detailed description of the steps.

After verifying the steps in the check list, follow the instructions below to onboard application instances.



#### See Also:

[Managing Application Instances](#) for more information on managing Application Instances

### 12.3.2.1.4 Onboarding Application Instances

To onboard Application Instances:

1. Login to the Identity System Administration as a member of the System Administrator role.
2. In the left pane, under System Configuration, click **Scheduler**.
3. Search for the Catalog Synchronization Job scheduled job.
4. Check the `Process Application Instances` parameter.
5. Set the parameter `Mode` to Incremental.

### 12.3.2.1.5 About Onboard Entitlements

Use the following checklist items to make sure that you have performed the configuration required to onboard entitlements.



#### Note:

Job entitlement list loader should be executed before executing the Catalog Synchronization Job scheduled job.

- Ensure that the Connector is installed (for new targets).
- If you are upgrading Oracle Identity Manager from Release 11g, then see *Upgrading Oracle Identity Manager from 11g* of the *Upgrading Oracle Identity and Access Management* for information about mandatory post-upgrade steps.
- Verify that the process forms have an IT resource field.
- Verify that you have defined the form field properties correctly.
- Verify that you have correctly associated the parent and child forms.
- Verify that you have run the common lookup reconciliation job for ICF-based targets.
- Verify that you have run the connector-specific lookup reconciliation jobs for non-ICF connectors.

- Verify that you have created application instances correctly, corresponding to the resource object and IT resource instance specified in the Lookup Reconciliation job.
- Verify that you have published entitlements to relevant organizations.
- Verify that you have run the entitlement list loader job, so that data can be populated in ent\_list table.

After verifying the steps in the check list, follow the instructions in [Onboarding Entitlements](#) to onboard entitlements.

### 12.3.2.1.6 Onboarding Entitlements

To onboard Entitlements:

1. Login to Identity System Administration as a member of the System Administrator role.
2. In the left pane, under System Configuration, click **Scheduler**.
3. Search for the Catalog Synchronization Job scheduled job.
4. Check the `Process Entitlements` parameter.
5. Set the parameter `Mode` to `Incremental`.

#### Note:

- If its a first time harvesting, then you should set the parameter to `Full`.
- If the parameter mode is `Incremental`, then only those entities will be picked by scheduled task for processing, whose create date is greater than update date for creation, and update date is greater than update date value.

## 12.3.2.2 Bootstrapping the Catalog

This section describes about bootstrapping the catalog in the following topics:

- [About Bootstrapping the Catalog](#)
- [Bootstrapping the Catalog with Roles](#)
- [Bootstrapping the Catalog with Application Instances](#)
- [Bootstrapping the Catalog with Entitlements](#)

### 12.3.2.2.1 About Bootstrapping the Catalog

Bootstrapping refers to the process of populating the Catalog for the first time. After Bootstrapping large number of any entity, you can gather statistics on base tables. This section refers to bootstrapping the Catalog after you have installed Oracle Identity Manager 12c (12.2.1.3.0).

If you are upgrading from Oracle Identity Manager 11g, then see Upgrading Oracle Identity Manager Single Node Environments in *Upgrade Guide for Oracle Identity and Access Management*.

The pre-requisites for bootstrapping Catalog are as follows:

- You have extended the Catalog using the Catalog system entities by following the steps given in [Defining the Catalog Metadata](#) .

- You have carried out the necessary UI customization steps required when a user-defined field is added to the Catalog.

There are two ways to bootstrap the Catalog with Roles.

- Bootstrapping the Catalog with Roles when you are not using Oracle Identity Analytics customer.

Roles are published immediately to the Catalog when they are created and assigned a role category other than the Oracle Identity Manager Roles category. If you have made changes to the role categories or need to synchronize the enterprise roles with the Catalog, perform the steps given in [Bootstrapping the Catalog with Roles](#).

- Bootstrapping the Catalog with Roles when you are using Oracle Identity Analytics for managing the lifecycle of enterprise roles.

Bootstrapping the Catalog with Application Instances requires additional steps to be carried out. Use the checklist given in [About Onboard Application Instances](#) to ensure that you have completed the pre-requisites.

Bootstrapping the Catalog with Entitlements requires additional steps to be carried out. Use the checklist given in [About Onboard Entitlements](#) to ensure that you have completed the pre-requisites.

### 12.3.2.2.2 Bootstrapping the Catalog with Roles

To bootstrap the catalog with roles:

1. Login to Identity System Administration as a member of the System Administrator role.
2. In the left pane, under System Configuration, click Scheduler.
3. Search for the Catalog Synchronization Job scheduled job.
4. Check the `Process Roles` parameter.
5. Set the parameter `Mode` to `Full`.

 **Note:**

If you are running the job for the first time and the **Mode** is set to **Full**, then you must not provide any value in the Update Date parameter.

6. Click **Run Now** to run the job immediately or provide a date and time to run the job later.

### 12.3.2.2.3 Bootstrapping the Catalog with Application Instances

Once you have completed the pre-requisites, follow the steps given below to onboard application instances:

1. Login to Identity System Administration as a member of the System Administrator role.
2. In the left pane, under System Configuration, click **Scheduler**.
3. Search for the Catalog Synchronization Job scheduled job.
4. Check the `Process Application Instances` parameter.
5. Set the parameter `Mode` to `Full`.



 **Note:**

If you are running the job for the first time and the **Mode** is set to **Full**, then you must not provide any value in the Update Date parameter.

6. Click **Run Now** to run the job immediately or provide a date and time to run the job later.

#### 12.3.2.2.4 Bootstrapping the Catalog with Entitlements

Once you have completed the pre-requisites, follow the steps given below to onboard entitlements.

1. Login to Identity System Administration as a member of the System Administrator role.
2. In the left pane, under System Configuration, click **Scheduler**.
3. Search for the Catalog Synchronization Job scheduled job.
4. Check the `Process Entitlements` parameter.
5. Set the parameter `Mode` to `Full`.

 **Note:**

If you are running the job for the first time and the **Mode** is set to **Full**, then you must not provide any value in the Update Date parameter.

6. Click **Run Now** to run the job immediately or provide a date and time to run the job later.

#### 12.3.2.3 Ongoing Synchronization

To automate the process of onboarding roles, application instances, and entitlements, you can configure the Catalog Synchronization Job scheduled job in the following manner.

1. Login to Identity System Administration as a member of the System Administrator role.
2. In the left pane, under System Configuration, click **Scheduler**.
3. Search for the Catalog Synchronization Job scheduled job.
4. Check the `Process Roles`, `Process Application Instances`, and `Process Entitlements` parameters.
5. Set the parameter `Mode` to `Incremental`.
6. Provide a date and time to run the job later.
7. Set the Job frequency to run every five minutes.

#### 12.3.2.4 Enrich the Catalog

This section describes how to enrich the Catalog in the following sections:

- [About Enriching the Catalog](#)
- [Editing a Catalog Item Online](#)
- [Enriching the Catalog in Bulk from External Sources](#)

- [Loading data from an external source](#)

#### 12.3.2.4.1 About Enriching the Catalog

Enriching the Catalog refers to the process of populating the Access Request Catalog with data so that the information is available for end-users to see. The additional data helps end-users understand the business context associated with the Catalog Item. The additional data is also available as part of the approval workflow, allowing the workflow to make intelligent routing decisions based on the data about the Catalog Item.

The pre-requisites are:

- You have extended the Catalog using the Catalog system entities by following the steps given in [Defining the Catalog Metadata](#) .
- You have added UI customizations required when a user-defined field is added to the Catalog. See [Configuring Custom Attributes](#) for information about adding user-defined fields and customizing the UI to display the user-defined field in the UI.
- You have created a Catalog Administrator role and assigned users as given in [Setting Up the Catalog Administrator](#) .

#### 12.3.2.4.2 Editing a Catalog Item Online

To edit a Catalog Item online by using the Oracle Identity Self Service:



##### Note:

Name, Display Name, and Description cannot be edited on the catalog screen. These are base level attributes and you cannot edit from Catalog UI.

When editing a Catalog Item, for list of values (LOV) type of fields, it is recommended to select and specify values by picking from the associated lists, instead of typing the values into the fields directly.

1. Log in to Identity Manager Self Service as a member of the Catalog Administrator role.
2. Click **Catalog** to access the request catalog.
3. Enter one or more keywords and click **Search**.
4. Use the Refine Search to find the Catalog Item(s) to be edited.
5. Select the Catalog Item to be edited.
6. In the Detailed Information section, edit the Catalog Item and click **Apply**. Verify the confirmation message.

#### 12.3.2.4.3 Enriching the Catalog in Bulk from External Sources

While Catalog Administrators can make use of the robust Catalog Item editing capabilities in the Oracle Identity Self Service, there are scenarios where the data needs to be loaded in bulk from external sources. Examples of bulk updates:

- MyCorp wants to provide users with asset information from their IT CMDB system or from their Corporate Asset Management system. The information cannot be entered manually

since the CMDB or AMS system gets updated on a regular basis. In such a scenario, MyCorp needs a way to update the Catalog in bulk.

- MyCorp was using a home grown access request application prior to implementing Oracle Identity Manager 11g R2. This application contains the glossary and other relevant information about the roles, application instances and entitlements. As part of migrating to Oracle Identity Manager, MyCorp Catalog Administrators would like to move the Catalog Item information from the legacy system.

#### 12.3.2.4.4 Loading data from an external source

Follow the steps given below to load data from an external source into the Catalog:

1. Export the data to be loaded into a comma-separated values format file.
2. Ensure that the first line of the file contains the Catalog attribute names.
3. Move the file to a file system that is accessible from the server on which is Oracle Identity Manager is deployed.
4. Login to Identity System Administration as a member of the System Administrator or System Configurator role.
5. In the left pane, under System Configuration, click **Scheduler**.
6. Search for the Catalog Synchronization Job scheduled job.
7. Provide the full path to the file in the parameter `File Path`.
8. Set the value of the parameter `Mode` to `Metadata`. [Table 12-1](#) provides sample parameter details.

**Table 12-1 Catalog Metadata Loader Sample**

Parameter	Value
ENTITY_TYPE	Role
ENTITY_KEY	12
ENTITY_NAME	test
IS_REQUESTABLE	1
USER_DEFINED_TAGS	UDTags
CATEGORY	mycategory
AUDIT_OBJECTIVE	AO111
APPROVER_USER	1
APPROVER_ROLE	1
FULFILLMENT_USER	1
FULFILLMENT_ROLE	1
CERTIFIER_USER	1
CERTIFIER_ROLE	1
ITEM_RISK	5
CERTIFIABLE	1
STUDF	1

9. Click **Run Now** to run the job immediately, or select a date and click **Apply** to run the job later.

## 12.3.2.5 Managing Catalog Items

This section describes about managing catalog items in the following topics:

- [Deleting a Catalog Items of Type Roles](#)
- [Deleting Catalog Items of Type Application Instances](#)
- [Deleting Catalog Items of type Entitlements](#)

### 12.3.2.5.1 Deleting a Catalog Items of Type Roles

To delete role Catalog Items:

1. Login to Identity Self Service.
2. Search for the role to be deleted and delete the role.
3. The associated Catalog Item will be marked as soft-deleted and will not appear in the Catalog.
4. For deleting large number of roles, use the APIs to delete the role. It is not recommended to use database techniques to delete roles.

### 12.3.2.5.2 Deleting Catalog Items of Type Application Instances

Application Instances, in almost all use cases, represent a target system (sometimes known as an endpoint) and an account in a target system. When you delete an Application Instance, you are essentially decommissioning the target system from Oracle Identity Manager. Depending upon the scale of your deployment and the number of accounts provisioned to the target system, deleting an Application Instance can have a significant impact to the end users and their access.

To delete application instance Catalog Items:

1. Login to Oracle Identity System Administration.
2. Click **Application Instances**.
3. Search for application instances.
4. Select one or more application instances. Delete and confirm.
5. Click **Scheduler**.
6. Search for the Catalog Synchronization Job scheduled job.
7. Set the Mode to Incremental.
8. Click **Run Now** to run the job immediately or set it up to run at a particular time.

See [Understanding the Deletion of Application Instances](#) for more information about deleting application instances.

### 12.3.2.5.3 Deleting Catalog Items of type Entitlements

To delete entitlement Catalog Items:

1. To delete Entitlements, login to Oracle Identity System Administration.
2. Click **Lookups**.
3. In the Code column, enter the name of the Lookup Definition that contains the entitlement. Refer to the Connector documentation to find out the name of the Lookup Definition.

4. Delete one or more entitlement values.
5. Click **Scheduler**.
6. Search for the **Entitlement List Load** job.
7. Click **Run now**.
8. Search for the Catalog Synchronization Job scheduled job.
9. Set the Mode to **Incremental**.
10. Click **Run Now** to run the job immediately or set it up to run at a particular time.

## 12.3.3 Catalog Auditing

You configure catalog auditing to track who changes what and when in the access request catalog through the UI.

This section describes about catalog auditing in the following topics:

- [About Catalog Auditing](#)
- [Configuring Catalog Auditing](#)

### 12.3.3.1 About Catalog Auditing

Catalog auditing maintains a footprint of changes in the access request catalog. By enabling catalog auditing, you can track who changes what and when in the access request catalog through the UI.

Catalog auditing stores the footprints of the following changes in the access request catalog:

- A change in the value of a catalog UDF.
- Any value of a catalog item attribute is changed from the catalog UI or any other custom UI.
- Following is the list of consolidated catalog attributes that are part of auditing during updation of catalog item:

Category, Audit Objective, Approver User, Approver Role, Fulfillment User, Fulfillment role, Certifier User, Certifier Role, Item Risk, Certifiable

#### **Note:**

Auditing takes place only for those entities that can be modified through the Catalog UI. Audit does not happen for entities that are modified in the catalog through synchronization. In addition, auditing is not supported for User Defined Tags.

### 12.3.3.2 Configuring Catalog Auditing

To configure catalog auditing:

1. Login to Oracle Identity System Administration.
2. Under System Configuration, click **Configuration Properties**.

3. Search for the Catalog Audit Data Collection system property with keyword `XL.CatalogAuditDataCollection`. The default value of this property is `none`, which specifies that catalog auditing is disabled.
4. Set the value of the `XL.CatalogAuditDataCollection` system property to `catalog`. This enables catalog auditing.
5. Click **Save**.

After enabling catalog auditing, the changes in the access request catalog are audited. For changes in the access request catalog, such as changing the risk level of a role, the footprints of the changes are stored in the `CPA_CATALOG` and `CPA_CATALOG_FIELDS` tables in the database on running the Issue Audit Messages Task scheduled job. For information about this scheduled job, see [Predefined Scheduled Tasks](#).

## 12.3.4 Configuring Hierarchical Attributes of Entitlements

You configure the hierarchical attributes of entitlements to display additional details of entitlements.

This section describes about the configuration of hierarchical attributes of entitlements in the following topics:

- [About Hierarchical Attributes of Entitlements](#)
- [Enabling the Display of Additional Details of the Entitlements](#)

### 12.3.4.1 About Hierarchical Attributes of Entitlements

You can enable the display of hierarchical attributes of entitlements to requesters, approvers, and certifiers to view additional details of entitlements (hierarchical attributes) in the catalog detail screen. The additional details of entitlements is called technical glossary. The technical glossary is displayed in a list view with bread crumbs at the top showing the navigational path. For information about viewing the additional details in the catalog detail screen, see [Viewing Hierarchical Attributes of Entitlements in \*Performing Self Service Tasks with Oracle Identity Governance\*](#).

#### Note:

The child entitlements are not requestable in the access catalog. The hierarchical entitlements feature is meant for display purpose only.

The additional details or hierarchical attributes is read-only information. This information must be provided in the form of an XML, which is seeded in Oracle Identity Manager. The technical glossary is inserted and replaced in the database. The following is a sample XML code of the hierarchical attributes:

```
<oim>
  <applicationInstances>
    <applicationInstance>SampleEBS</applicationInstance><!-- Application Name
for which entitlements are seeded-->
  </applicationInstances>
  <attributes>
    <attribute name="Responsibility Name"><!-- Label name of the field which is
marked Entitlement field in Child form-->
      <entitlementValues>
        <entitlementValue><!-- Below is the Hierarchical data XML for
```

```

Entitlement and Entitlement Display Name is used to denote entitlement -->
<value>Payables Menu</value>
<attributes>
  <attribute name="Menu">
    <entitlementValues>
      <entitlementValue>
<value>ALR_OAM_NAV_GUI_USER_NAME</value>
<description>Alerts Manager View</description>
<attributes>
  <attribute name="Function Code">
    <entitlementValues>
      <entitlementValue>
        <value>ALR_OBJ_ACTIVATE_ACCT</value>
        <description>Create, Activate, Deactive User Account</description>
</entitlementValue>
<entitlementValue>
<value>ALR_OBJ_EDIT_FORM</value>
</entitlementValue>
<entitlementValue>
<value>ALR_OBJ_VIEW_PERSON</value>
      </entitlementValue>
    </entitlementValues>
  </attribute>
</attributes>
      </entitlementValue>
    <entitlementValue>
<value>EMPLOYEE_W2_MENU</value>
<description>Alerts Manager View</description>
<attributes>
  <attribute name="Function Code">
    <entitlementValues>
<entitlementValue>
  <value>Employee_OBJ_ACTIVATE_ACCT</value>
  <description>Create, Activate, Deactive User Account</description>
</entitlementValue>
<entitlementValue>
  <value>Employee_OBJ_EDIT_FORM</value>
</entitlementValue>
<entitlementValue>
  <value>Employee_OBJ_VIEW_PERSON</value>
</entitlementValue>
    </entitlementValues>
  </attribute>
</attributes>
      </entitlementValue>
    <entitlementValue>
<value>VISION_OAM_NAV_GUI</value>
<description>Alerts Manager View</description>
<attributes>
  </attributes>
</entitlementValue>
</entitlementValues>
</attribute>
      </attributes>
    </entitlementValue>
  </entitlementValues>
</attribute>
</attributes>
</oim>

```

RDBMS features, such as Securefile LOB and Oracle XML DB, are used for storing hierarchical data in Oracle Database. Securefile is a new re-architecture featuring entirely new disk formats, network protocol, space management, redo and undo formats, buffer caching, and intelligent I/O subsystems. It delivers substantially improved performance along with optimized storage for unstructured data, which resides in Oracle Database as compared to LOB's storage structure. Oracle XML DB provides a high-performance, native XML storage and retrieval technology. It absorbs the W3C XML data model into the Oracle Database, provides new standard access methods for navigating and querying XML, and provides the advantages of relational database technology together with the advantages of XML.

### 12.3.4.2 Enabling the Display of Additional Details of the Entitlements

To enable the display of additional details of the entitlements in the access request catalog:

1. Seed the additional hierarchical data in Oracle Identity Manager. To do so, create a XML file per the XSD with all the additional details about the entitlement. The XSD is used to register XML schema in the database.
2. Place the XML file in a directory in the Oracle Identity Manager server. You must have read and write permissions on the directory.
3. Specify the details of the technical glossary in the Catalog Synchronization Job scheduled job. To do so:
  - a. Login to Oracle Identity System Administration.
  - b. Under System Configuration, click **Scheduler**.
  - c. Search and open the Catalog Synchronization Job scheduled job.
  - d. In the Parameters section, in the Mode field, enter `Technical Glossary`.
  - e. In the File Path field, enter the directory path of the XML file.
  - f. Click **Apply**.

When you run the Catalog Synchronization Job scheduled job, a new link, which is called technical glossary details, is displayed just before the catalog details link for entitlements. Clicking this link opens the technical glossary additional information in a different tab. The XML file is deleted from the directory after processing and is moved to the archive directory with time stamp appended to its name.

Any failed record is logged in a file, which is placed in the `xmlprocessedlogs` directory. The log file has the name of the XML file with time stamp appended to it.

### 12.3.5 Database Best Practices for Access Request Catalog

Some database best practices for the access request catalog involves optimization for text index, and addressing some frequently asked questions about database usage related to the catalog.

Following sections are aimed at providing more information in this regard for Oracle Identity Manager administrators and database administrators.

- [About Database Best Practices for Access Request Catalog](#)
- [One-Time Optimizations for Oracle Text Index](#)
- [Text Index Optimization](#)
- [Frequently Asked Questions about the Access Request Catalog](#)



## 12.3.5.1 About Database Best Practices for Access Request Catalog

Access Request Catalog uses "Oracle Text" option in Oracle database for text search capabilities. Oracle Text is a fast and accurate full-text retrieval technology integrated with Oracle Database.

The CATALOG table which contains catalog items is indexed using CONTEXT index type of Oracle Text. Although Oracle Text index operates like a regular database index, the architecture and processing behind Text index highlights the importance of best practices when creating the Text index and also the on-going maintenance.

## 12.3.5.2 One-Time Optimizations for Oracle Text Index

When you install Oracle Identity Manager, the Text index for Access Request Catalog is created with possible optimizations. However, Oracle Text has some more optimizations that are better applied based on the characteristics of the deployment. Following are the optimizations that you should consider applying for improving Access Request Catalog search performance. It is important to note that Access Request Catalog is not usable when applying these and these are recommended to be done during a scheduled maintenance window.



### Note:

Catalog Synchronization Job and Access Request Catalog should be down when these one-time optimizations are applied.

- [Storage of Text Index](#)
- [KEEP Pool Settings for Text Index](#)

### 12.3.5.2.1 Storage of Text Index

Oracle Text index is stored in relational tables (DR\$) which are presently resides in the default tablespace of Oracle Identity Manager schema. It is recommended to separate them out to their own tablespace. You can use the following commands to do that. You are recommended to be familiar with these steps and also make changes where needed.

1. Login to SYS schema and create a new tablespace to hold the text index internal tables. You can use the following sample command for it. Replace DATA\_DIR with the directory in which you want to store the data file and adjust the size and other parameters as necessary for your environment.

```
CREATE TABLESPACE catalog_text_ind_tables
  DATAFILE 'DATA_DIR/catalog_text_ind_tables_01.dbf' SIZE 2048M REUSE
  EXTENT MANAGEMENT LOCAL SEGMENT SPACE MANAGEMENT AUTO;
```

2. Connect to the database using Oracle Identity Manager schema.
3. Create a storage preference using the commands below. Oracle recommends you to be familiar with BASIC\_STORAGE clause of Oracle Text and add more storage clauses if required. You can find more info on BASIC\_STORAGE in Oracle Text Reference document.

```
Begin
Ctx_Ddl.Create_Preference('cat_storage', 'BASIC_STORAGE');
End;
/
```

```

Begin
ctx_ddl.set_attribute('cat_storage','I_TABLE_CLAUSE','tablespace
catalog_text_ind_tables storage (initial 5M next 5M)');
End;
/

Begin
ctx_ddl.set_attribute('cat_storage', 'K_TABLE_CLAUSE','tablespace
catalog_text_ind_tables storage (initial 5M next 5M)');
End;
/

Begin
ctx_ddl.set_attribute('cat_storage', 'R_TABLE_CLAUSE','tablespace
catalog_text_ind_tables storage (initial 1M) lob (data) store as (cache)');
End;
/

Begin
ctx_ddl.set_attribute('cat_storage', 'N_TABLE_CLAUSE','tablespace
catalog_text_ind_tables storage (initial 1M)');
End;
/

Begin
ctx_ddl.set_attribute('cat_storage', 'I_INDEX_CLAUSE','tablespace
catalog_text_ind_tables storage (initial 1M) compress 2');
End;
/

```

4. Apply the new storage preference using the following command. Make sure the Text index status is valid after this step.

```
ALTER INDEX CAT_TAGS rebuild parameters ('replace storage cat_storage');
```

5. Verify that the above tables are moved to the new tablespace by querying USER\_SEGMENTS table.

### 12.3.5.2.2 KEEP Pool Settings for Text Index

Oracle recommends put all the tables that make up the Text index in database KEEP pool to improve the performance of Access Request Catalog search. You must resize the KEEP pool (DB\_KEEP\_CACHE\_SIZE) correctly so that these Text index tables and other Oracle Identity Manager objects are retained in KEEP pool. To do so:

1. Connect to the database using Oracle Identity Manager schema.
2. Compute the size of the text index using the following query and use that to set/adjust DB\_KEEP\_CACHE\_SIZE accordingly.
3. Run the following commands as Oracle Identity Manager schema user to put the tables in KEEP pool.

```
SELECT ctx_report.index_size('CAT_TAGS') FROM dual;
```

```

ALTER INDEX DR$CAT_TAGS$X STORAGE (buffer_pool keep);
ALTER TABLE DR$CAT_TAGS$R STORAGE (buffer_pool keep);
ALTER TABLE DR$CAT_TAGS$R STORAGE (buffer_pool keep) MODIFY lob (data) (STORAGE
(buffer_pool keep));
ALTER TABLE DR$CAT_TAGS$K STORAGE (buffer_pool keep);
ALTER TABLE DR$CAT_TAGS$I STORAGE (buffer_pool keep);

```

### 12.3.5.3 Text Index Optimization

The Text index could become fragmented due to on-going catalog synchronization. Optimizing the text index on regular basis removes the old data and minimizes the fragmentations, which can improve the search performance of Access Request Catalog. To perform this, Oracle Identity Manager has introduced the following Oracle Database scheduler jobs:

- FAST\_OPTIMIZE\_CAT\_TAGS
- REBUILD\_OPTIMIZE\_CAT\_TAGS

 **Note:**

You can check for the jobs logged into Oracle Identity Manager schema by running the following query:

```
SELECT * FROM user_scheduler_jobs;
```

These jobs reside in Oracle Identity Manager database schema and they are disabled by default. Oracle strongly recommends you to view these jobs, make schedule changes if needed and enable them. When changing the schedule, make sure the new schedule is set on the same line as the default schedule.

FAST\_OPTIMIZE\_CAT\_TAGS is meant to be running on frequent basis. By default, it is scheduled to run once a day at 1 AM. REBUILD\_OPTIMIZE\_CAT\_TAGS does a full optimization and rebuilds the Text index. REBUILD\_OPTIMIZE\_CAT\_TAGS is not meant to be running frequently. By default, REBUILD\_OPTIMIZE\_CAT\_TAGS is scheduled to run every Sunday at 2 AM. Note that optimization may take a long time if your Text index is big.

Make sure that the default schedule (daily 1 AM for FAST and every Sunday 2 AM for REBUILD) is acceptable to your environment. If not, change the schedule. If you are not sure, then you can keep the default schedule and change later when needed.

 **Note:**

The Text index optimization can be done when the server is up and search of Access Request Catalog takes place.

### 12.3.5.4 Frequently Asked Questions about the Access Request Catalog

Some of the frequently asked questions about the access request catalog are related to catalog search, supported search operators, and text index.

This section answers some frequently asked questions about the access request catalog.

#### **What is the access request catalog?**

The Access Request Catalog is a searchable, categorized collection of entities that are requestable in Oracle Identity Manager. Any authenticated user can access and search the catalog using one or more keywords and search operators, add catalog items to a shopping cart, and submit a request for themselves and others.

### What is Oracle Text Index?

Built on the RDBMS Oracle Text component, Oracle Text (previously known as intermedia Text and ConText) is an extensive full-text indexing technology that lets you efficiently query free text and produce document classification applications. It provides indexing, word and theme searching, and viewing capabilities for text. Oracle Text has various options for domain-based indexes:

- ConText
- CatSearch
- CtxRule

Out of these, only ConText is in the scope of Oracle Identity Manager's Oracle Text.

### What are the supported search operators for Oracle Identity Manager?

Use the Catalog field to specify a (case-insensitive) keyword for searching or browsing the request catalog. The supported search operators are:

- One or more keywords (sample value: `administrator`)
  - This search condition finds all catalog items that start with the term `administrator`.
  - Sample value for more than one keyword: `web administrator`
  - This search condition finds all catalog items that start with the terms `web` and `administrator`. Because a space character between keywords behaves as an AND operator, this search automatically applies the AND operator to the search keywords. Alternatively, you can use an `&` operator to denote an AND relationship explicitly. For example, `web administrator` and `web & administrator` return catalog items that starts with both `web` and `administrator`.
- Phrase
  - To search for catalog items that start with the exact phrase you enter, you must specify the search condition within double quotes ("").
  - For example, searching for `web administrator` returns catalog items starting with the phrase `web administrator`.
- OR [|] search
  - Use the OR [|] operator to search for catalog items starting with any of the search keywords.
  - Sample value 1: `web | administrator`. This search condition returns catalog items starting with the term `web` or `administrator`.
  - Sample value 2: `vision purchasing | administrator`. This search condition returns catalog items starting with the phrase `vision purchasing` or the term `administrator`.

### Why do we perform One-Time Optimizations for Oracle Text index?

When you install Oracle Identity Manager, the Text Index for Access Request Catalog is created with possible optimizations. However, Oracle Text has other RDBMS recommended optimizations that are better applied, based on the characteristics of the deployment. All one-time optimizations for Oracle Text index are seeded by default in Oracle Identity Manager. If you have an upgraded deployment of Oracle Identity Manager, then you must apply the one-time optimizations manually (if not already present).

**What is required for ongoing maintenance of Oracle Text index?**

The Text Index can become fragmented because of ongoing catalog synchronization. Regularly optimizing the Text Index removes the old data and minimizes the fragmentations, and can improve the search performance of the Access Request Catalog.

`FAST_OPTIMIZE_CAT_TAGS` and `REBUILD_OPTIMIZE_CAT_TAGS` are the Oracle Database scheduler jobs which are executed for the text index maintenance.

**What are the prerequisites for applying One-Time Optimizations for Oracle Text index?**

The Catalog Synchronization Job scheduled job and the Access Request Catalog must be down when the One-Time Optimizations are being applied.

**What are the prerequisites for applying Text Index Optimizations?**

Text Index optimization can be performed when the server is up and Access Request Catalog is being searched.

**How to troubleshoot Oracle Text errors?**

The `CTX_USER_INDEX_ERRORS` view shows the row ID of the failed row in the source table. Use this row ID to update the row in the source table that failed.

Specifically, perform a dummy update against the column that holds the text index (`update table x set columnx = columnx where rowid = ?`). This will generate a row in the `CTX_USER_PENDING` view.

Then perform `CTX_DDL.SYNC_INDEX`, which will index the rows in the `CTX_USER_PENDING` view.

```
SELECT err_timestamp, err_text
FROM ctx_user_index_errors
ORDER BY err_timestamp DESC;
```

Pending DML requests can be queried with the `CTX_PENDING` and `CTX_USER_PENDING` views.

DML errors can be queried with the `CTX_INDEX_ERRORS` or `CTX_USER_INDEX_ERRORS` view.

```
SELECT pnd_index_name, pnd_rowid, TO_CHAR( pnd_timestamp, 'dd-mon-yyyy hh24:mi:ss' )
TIMESTAMP
FROM ctx_user_pending;
```

**How to re-create the catalog's Text index?**

If `CAT_TAGS` index is found to be present in the database in `INVALID` status because of some reason, and you want to re-create the Text index, then perform the following steps:

1. Connect to Oracle Identity Manager schema, and run the following SQL command to check the current status of the `CAT_TAGS` index:

```
SELECT index_name, table_name, status, parameters, domidx_status, domidx_opstatus
FROM user_indexes
WHERE index_type='DOMAIN';
```

Expected output is for `CAT_TAGS` domain index to be present in `INVALID` status.

2. Connect to Oracle Identity Manager schema, and run the following PL/SQL blocks in the order in which they are given:

a. Drop and recreate the Text Index CAT\_TAGS.

```

SET SERVEROUTPUT ON
DECLARE
  P_DROPINDEX NUMBER;
  P_CREATEINDEX NUMBER;
  STRERRMESSAGE_OUT VARCHAR2(200);
BEGIN
  P_DROPINDEX := 1;
  P_CREATEINDEX := 0;

  OIM_PKG_CATALOG_INDEX.OIM_SP_CREATEDROPCATALOGINDEX(
    P_DROPINDEX => P_DROPINDEX,
    P_CREATEINDEX => P_CREATEINDEX,
    STRERRMESSAGE_OUT => STRERRMESSAGE_OUT
  );
  DBMS_OUTPUT.PUT_LINE('STRERRMESSAGE_OUT = ' || STRERRMESSAGE_OUT);
END;
/

```

b. Recreate the Text Index.

```

SET SERVEROUTPUT ON
DECLARE
  P_DROPINDEX NUMBER;
  P_CREATEINDEX NUMBER;
  STRERRMESSAGE_OUT VARCHAR2(200);
BEGIN
  P_DROPINDEX := 0;
  P_CREATEINDEX := 1;

  OIM_PKG_CATALOG_INDEX.OIM_SP_CREATEDROPCATALOGINDEX(
    P_DROPINDEX => P_DROPINDEX,
    P_CREATEINDEX => P_CREATEINDEX,
    STRERRMESSAGE_OUT => STRERRMESSAGE_OUT
  );
  DBMS_OUTPUT.PUT_LINE('STRERRMESSAGE_OUT = ' || STRERRMESSAGE_OUT);
END;
/

```

3. Re-run the SQL command given in step 1. The following output is displayed;

```

CAT_TAGS    CATALOG    VALID      sync (on commit) stoplist CTXSYS.EMPTY_STOPLIST
lexer CATALOG_PREFERENCE    VALID      VALID

```

**Is catalog search using stopwords (such as a, d, l, s, t) very slow and sometimes freezes the UI?**

Remove stopwords from the CAT\_TAGS Oracle Text index, by following the steps in My Oracle Support document [Remove stopwords from CAT\\_TAGS text index in OIM \(Doc ID 2217118.1\)](#).

**Does catalog search of entitlements with "\_" (underscore) character not displayed correctly and/or returns incorrect results?**

Remove stopwords from the CAT\_TAGS Oracle Text index by following the steps in My Oracle Support document [Remove stop words from CAT\\_TAGS text index in OIM \(Doc ID 2217118.1\)](#).

**Does wild card search with large data-matching result in errors?**

This is default functionality in interMedia (Oracle Text). We cannot use a wild card (such as % or \*) in the search string. Oracle Text interrelates this as a wild card by itself and tries to return all products as if you are searching using just %. This causes the error from Oracle Text.

In Oracle Database 11g, the maximum number of distinct tokens (not rows) that a wild card can match without producing an error is 50,000. You can use the `wildcatters` property of the word list if you decide to return more than 20,000 distinct tokens in Oracle Database 11g and 5,000 distinct tokens in Oracle Database 10g R2.

In the `wildcatters` property, specify the maximum number of terms in a wild card (%) expansion. Use this parameter to keep wild card query performance within an acceptable limit. Oracle Database returns an error when the wild card query expansion exceeds this number. To implement the solution, perform the following steps:

1. Log in to Oracle Identity Manager schema, and run the following statements:

```
BEGIN
  ctx_ddl.create_preference('<Pref_name>', 'BASIC_WORDLIST');
  ctx_ddl.set_attribute('<Pref_name>', 'WILDCARD_MAXTERMS', 50000);
END;
/

ALTER INDEX cat_tags rebuild parameters ('replace metadata word list <Pref_name>');
```

2. Repeat the search.

Here, 15,000 is the maximum number if the database version is lower than 10.2.0.3, or 50,000 if the database version is 10.2.0.3 or higher. The number can be set to a number between 5,000 (default value) and 15,000/50,000, based on the database version, to any number that enables a successful search. However, the higher you set this value, the more memory it will take.

### How to handle break/escape characters in Oracle Text index?

We can use the backslash `\` character to escape characters with special meaning and treat them as regular text. Run the following command from Oracle Identity Manager schema:

```
BEGIN
  CTX_DDL.CREATE_PREFERENCE ('my_lexer', 'BASIC_LEXER');
  CTX_DDL.SET_ATTRIBUTE ('my_lexer', 'PRINTJOINS', '~!@#%^&*()-_+=|;:,. /');

  --OR

  CTX_DDL.SET_ATTRIBUTE ('my_lexer', 'SKIPJOINS', '`-=[];'\,./~!@#%^&*()-_{}:|?'
  $' " % & * ( ) _ + { } : " | ?
  END;
/
```

### How to collect diagnostic data for Oracle Text index?

To collect diagnostic data, run the following SQL commands from Oracle Identity Manager schema:

To set Oracle Text index size:

```
SELECT ctx_report.index_size('CAT_TAGS') FROM dual;
```

To describe Oracle Text index:

```
SELECT ctx_report.describe_size('CAT_TAGS') FROM dual;
```

To collect Oracle Text index statistics:

```
CREATE TABLE output(result CLOB);
```

```
DECLARE
  x CLOB := NULL;
```

```

BEGIN
  ctx_report.index_stats('CAT_TAGS',x);
  INSERT INTO output VALUES(x);
  COMMIT;
  dbms_lob.freetemporary(x);
END;
/

```

```
SELECT * FROM output;
```

To create Oracle Text index script:

```
SELECT ctx_report.create_index_script('CAT_TAGS') FROM dual;
```

### Is single character search slow even after removing stop words?

Create Prefix index with min and max length (recommended). To do so, from Oracle Identity Manager schema, run the following SQL commands:

To create new preference:

```

BEGIN
ctx_ddl.create_preference('mywordlist', 'BASIC_WORDLIST');
ctx_ddl.set_attribute('mywordlist','PREFIX_INDEX','TRUE');
ctx_ddl.set_attribute('mywordlist','PREFIX_MIN_LENGTH',1);
ctx_ddl.set_attribute('mywordlist','PREFIX_MAX_LENGTH',3);
END;
/

```

To rebuild parameters:

```
ALTER INDEX cat_tags REBUILD PARAMETERS('replace word list mywordlist');
```

To rebuild Text index:

```

BEGIN
dbms_scheduler.run_job ('REBUILD_OPTIMIZE_CAT_TAGS');
END;
/

```

## 12.4 Managing the Lifecycle of the Catalog

You can extend the Catalog, customize the Catalog UI, and develop and test the customizations in a test environment, and then eventually roll out the customizations to your production environment.

This section describes how to move Catalog customizations from a test environment to a production environment. It includes the following topics:

- [Overview of Catalog Customization](#)
- [Test to Production Procedures for Catalog Customizations](#)
- [Limitations of the Test to Production Procedures](#)

### 12.4.1 Overview of Catalog Customization

While the Access Request Catalog provides robust and rich functionality by default, there may be scenarios where you need to extend the Catalog and customize it to meet your business needs.



The following scenarios illustrate common scenarios where the Catalog may require customization.

- MyCorp would like to add additional attributes, such as Cost to Line of Business and License Required, to give the requester an idea about the cost that would be incurred by the Line Of Business, when the requested item was granted. To support this scenario, the Catalog System Administrator extends the Catalog and adds two additional attributes, Cost to Line of Business and License required. Next, the administrator customizes the Catalog search results and Catalog item details page.

 **Note:**

In the request catalog, only String type of UDF can be created. If you mark that attribute as searchable attribute, it will be of size 256 Char. If it is not a searchable attribute, then it will be of size 2000 char. You cannot mark a non-searchable attributes to searchable.

- MyCorp would like to show the Risk associated with an entitlement as part of Catalog search results. To support this scenario, the Catalog System Administrator customizes the Catalog search results and adds the item risk as an image widget.

These customizations will be implemented by System Integrators or the customer's own IT staff and need to be moved to Test and to Production. [Figure 12-2](#) shows the high-level process of moving customizations from Test to Production for the Catalog.

**Figure 12-2 Test to Production Process for Catalog**

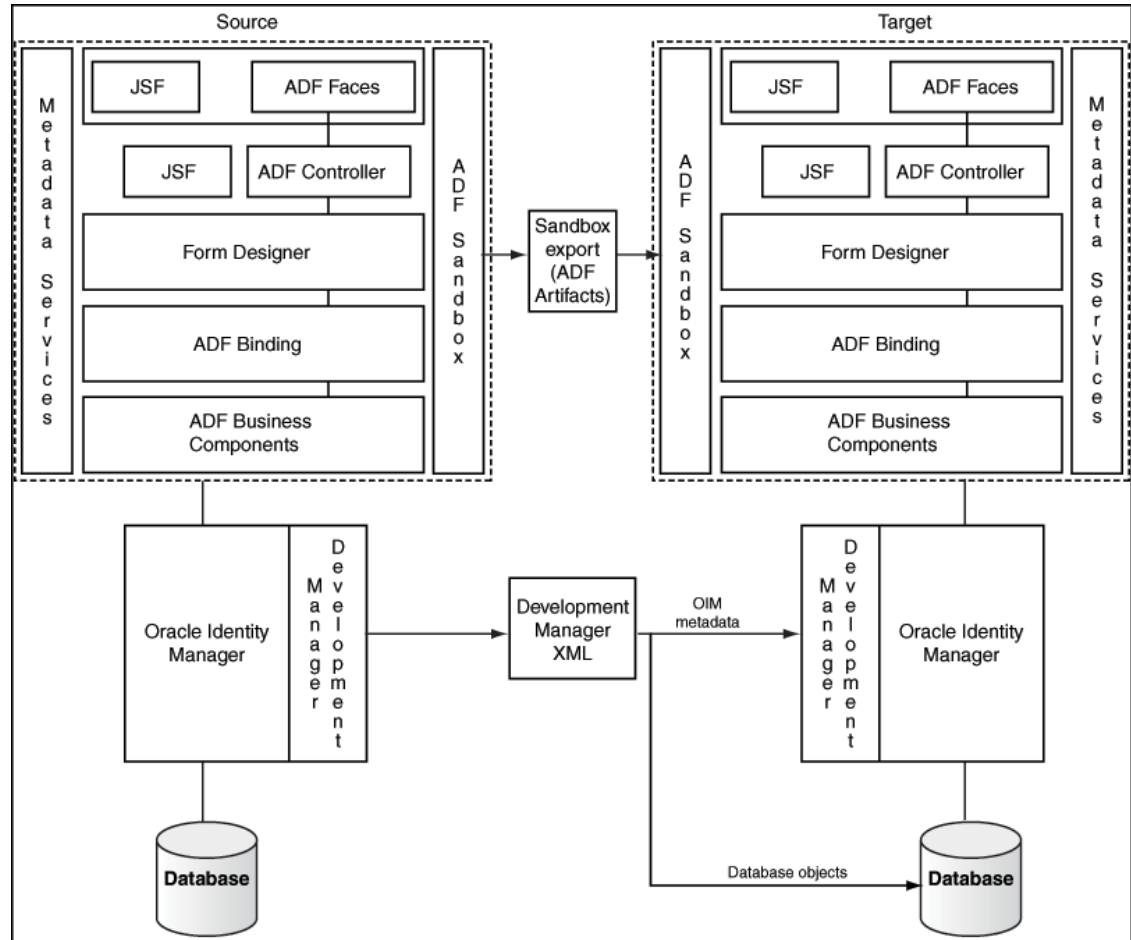

Catalog customizations have three components:

1. ADF customizations

ADF customizations include Catalog UI customizations including search results, item details, cart details and Catalog attributes added or modified using the Form Designer. These customizations should be done within a Sandbox session. For more information on Sandboxes, please refer to [Test to Production Procedures for Catalog Customizations](#)

2. Oracle Identity Manager metadata customizations

When you add new attributes to the Catalog entity or modify an existing attribute and change its properties, additional metadata is generated in Oracle Identity Manager. For example, if a new attribute, Secondary Approver, is added to the Catalog entity using the Catalog system entities, Oracle Identity Manager adds a database column corresponding to the attribute. If the attribute is searchable, Oracle Identity Manager stores additional metadata. These customizations should be moved from Test to Production using the Deployment Manager.

3. Data Migration

The Catalog needs to be populated with relevant information, after adding/ modifying attributes in the Catalog to make the Catalog business-friendly and provide enough information so that users can use the Catalog effectively. Once this additional information,

also referred to as the Glossary, has been reviewed and approved, it needs to be moved to Production.

## 12.4.2 Test to Production Procedures for Catalog Customizations

Catalog customizations can be imported and exported by using the sandbox and the Deployment Manager.

This section describes the steps to perform for moving the Catalog definition from Test to Production. It consists of the following steps:

- [About Test to Production Procedures for Catalog Customizations](#)
- [Exporting Using the Sandbox and Deployment Manager](#)
- [Importing Using the Sandbox and Deployment Manager](#)

### 12.4.2.1 About Test to Production Procedures for Catalog Customizations

Depending upon the type of customization done, you may need either one or both the steps. Use [Figure 12-2](#) to make a determination of which steps to carry out.

**Table 12-2 Catalog Customization Steps**

Customization	Sandbox required	Deployment Manager required
Adding/ Modifying a seeded Catalog attribute	Yes	Yes
Adding/ Modifying a Catalog UDF	Yes	Yes
Customizing Catalog UI	Yes	No
Populating Catalog	No	No

#### See Also:

- [Migrating Incrementally Using the Deployment Manager](#) for detailed information about the Deployment Manager
- [Managing Sandboxes in \*Developing and Customizing Applications for Oracle Identity Governance\*](#) for detailed information about sandboxes
- [Handling Concurrency Conflicts in \*Developing and Customizing Applications for Oracle Identity Governance\*](#) for information about handling concurrency conflicts when multiple users customize an application by using sandboxes and troubleshooting concurrency issues

### 12.4.2.2 Exporting Using the Sandbox and Deployment Manager

This section describes about exporting Catalog definition using the sandbox and deployment manager in the following topics:

- [Exporting Using the Sandbox](#)
- [Exporting Using the Deployment Manager](#)

### 12.4.2.2.1 Exporting Using the Sandbox

To move the ADF customizations from Test to Production, follow the steps given below:

1. Login to Oracle Identity System Administration as a member of the System Administrator role.

 **Note:**

In scenarios where you need to switch between the Self Service (or Identity) and System Administration interfaces and the Oracle Identity Manager deployment is not protected by Single Sign On, you must log out of one console before logging in into another.

2. Click **Sandbox** and select the Sandbox to be exported.
3. Click **Export Sandbox**. A sandbox can be exported as a file for transporting, sharing, and other usages where packaging it as a file is required.
4. Specify a file location for the zip file created.

### 12.4.2.2.2 Exporting Using the Deployment Manager

To export the Oracle Identity Manager metadata from Test to Production, follow the steps given below:

1. Login to Oracle Identity System Administration as a member of the System Administrator or System Configurator role.
2. In the left pane, under System Configuration, click **Export**.
3. Select **Catalog Metadata** as the object to be exported.
4. Enter \* in the search field and click **Search**.
5. Follow the steps to generate the Deployment Manager XML.

 **Note:**

Perform the following optional steps as a best practice:

- Backup/Check-in the sandbox zip file and the Deployment Manager XML as a single file into a source code control system like Subversion, SourceSafe, and so on.
- Repeat the steps above in the target (Production) environment and backup the Catalog entity and the Catalog UI.

### 12.4.2.3 Importing Using the Sandbox and Deployment Manager

Importing the customizations should be done in the reverse order. This is required since the ADF customizations expect the Oracle Identity Manager metadata to be present, when the ADF customizations are imported. This section contains the following:

- [Importing Using the Sandbox](#)

- [Importing Using the Deployment Manager](#)

### 12.4.2.3.1 Importing Using the Sandbox

To move the ADF customizations from Test to Production:

1. Login to Oracle Identity System Administration as a member of the System Administrator role.

 **Note:**

In scenarios where you need to switch between the Self Service (or Identity) and System Administration interfaces and the Oracle Identity Manager deployment is not protected by Single Sign on, you must log out of one console before logging in into another.

2. Click **Sandbox** and then click **Import Sandbox**.
3. In the dialog, select the file to be imported.
4. In the left pane, under System Configuration, Click **Import**.
5. In the Sandbox Manager, select the sandbox and click **Publish Sandbox**.
6. Logout and log back in to view and verify the changes.

### 12.4.2.3.2 Importing Using the Deployment Manager

To import the Oracle Identity Manager metadata from Test to Production:

1. Login to Oracle Identity System Administration as a member of the System Administrator or System Configurator role.
2. In the left pane, under System Configuration, click **Import**.
3. In the File browser popup, select the **Deployment Manager** XML file to be imported.
4. Follow the wizard steps to import the XML.

For detailed steps see, [Importing Deployments](#)

## 12.4.3 Limitations of the Test to Production Procedures

Some limitations of the Test to Production process of the catalog are related to sandbox usage and the Deployment Manager.

There are some limitations in the Test to Production process for the Catalog, which including the following:

- All ADF customizations must be done within a single sandbox session. While you can have multiple sandboxes, only one sandbox can be active at a time and as a result, changes in the System Administration Console i.e. Catalog entity extension and those done in the Identity Console, that is, Catalog UI customization, must be done in the same sandbox.
- Changes done outside a sandbox or done either before creating and activating a sandbox or after, are not visible in the sandbox.
- Once you publish a sandbox, you cannot export it or revert it. As a result, you must export the sandbox while it is still activated and not published and also ensure that you back your customizations before you import and publish a sandbox.

- Deployment Manager imports are committed immediately. There is no rollback capability in the Deployment Manager.

## 12.5 Troubleshooting Access Request Catalog

Some of the troubleshooting requirements for the Access Request Catalog are related to catalog synchronization, catalog security, catalog search, and request failure.

This section describes the troubleshooting procedures to be followed while resolving issues with the Access Request Catalog. It contains the following topics:

- [Catalog Synchronization Issues](#)
- [Catalog Security Issues](#)
- [Catalog Search Issues](#)
- [Common Reasons for Request Failure](#)

### 12.5.1 Catalog Synchronization Issues

Catalog synchronization issues occur when roles, application instances and entitlements are not visible in the Access Request Catalog.

Use the flow charts given below to troubleshoot synchronization issues for each of three Catalog item types that can be requested.

#### Note:

Harvesting job picks up the data for harvesting on the basis of the Update date parameter. If the update is blank, then all the records are fetched for processing. However, if the user has specified some date in the Update date parameter, only that data is processed which is created or updated after the given date.

- Troubleshooting synchronizing Roles with the Catalog

The synchronization of Roles with the Catalog is real-time in nature. When a role is created, it is published to the Catalog immediately as long as it does not belong to the Oracle Identity Manager Roles category.

#### Note:

The Oracle Identity Manager Roles role category is meant for Oracle Identity Manager usage only. Customers should not use this category for their enterprise Roles.

In a new Oracle Identity Manager installation, enterprise roles created by customers will be available in the Catalog and the visibility will be based on the organization scoping. In an upgraded environment, customers will have to run the Catalog Synchronization job in a bootstrap mode to publish the existing roles to the Catalog. New roles, created after upgrade, will be available in the Catalog immediately.

Figure 12-3 shows a diagnostic flowchart that customers can use to troubleshoot scenarios where the roles created in Oracle Identity Manager are not visible in the Catalog.

**Figure 12-3 Catalog Synchronization Diagnostic Flowchart**

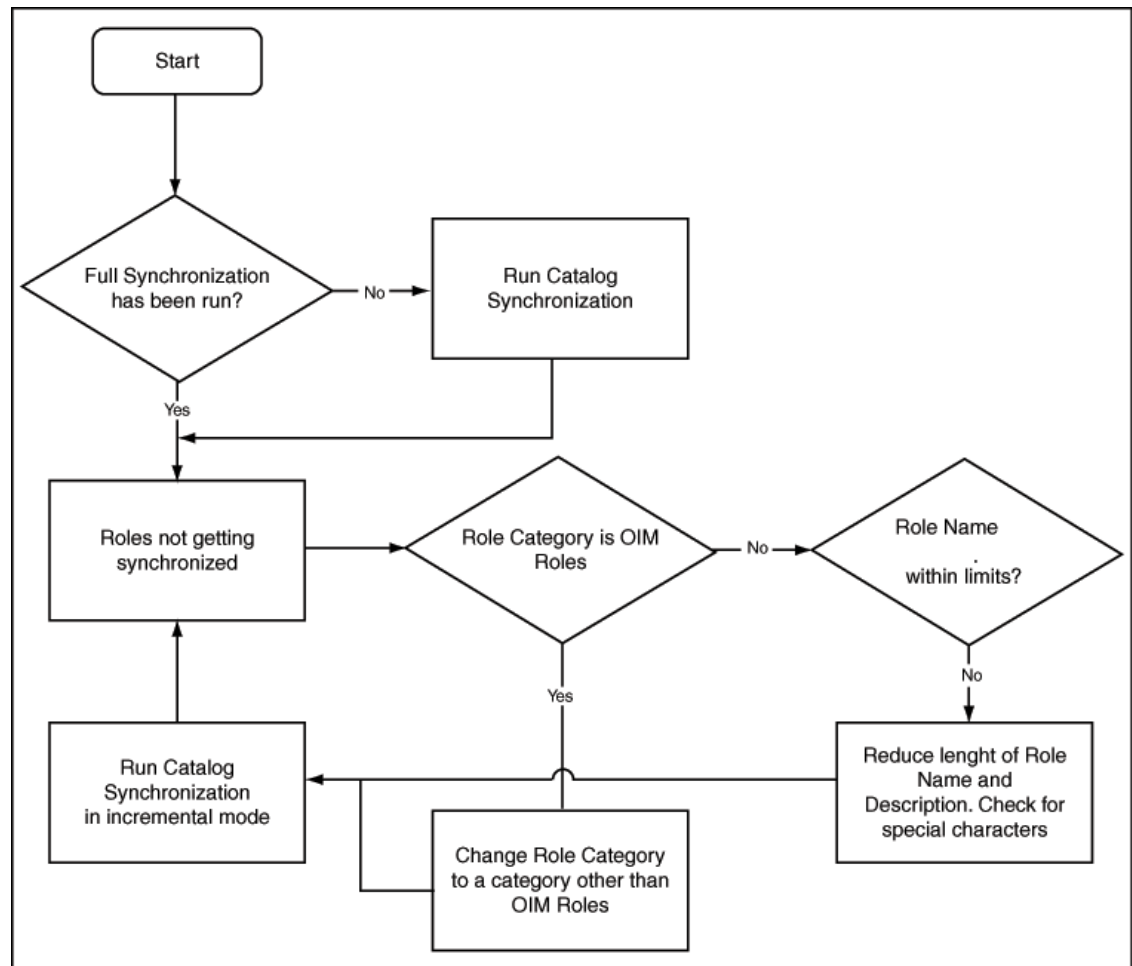

- Troubleshooting synchronizing Application Instances with the Catalog

The synchronization of Application Instances with the Catalog is controlled by the Catalog Synchronization job. Application Instances require more configuration (than enterprise roles) and hence are not synchronized immediately with the Catalog.

Figure 12-4 shows a diagnostic flowchart to be followed when troubleshooting issues related to synchronizing application instances with the Catalog.

Figure 12-4 Trouble Shooting Synchronization Application Instances Flowchart

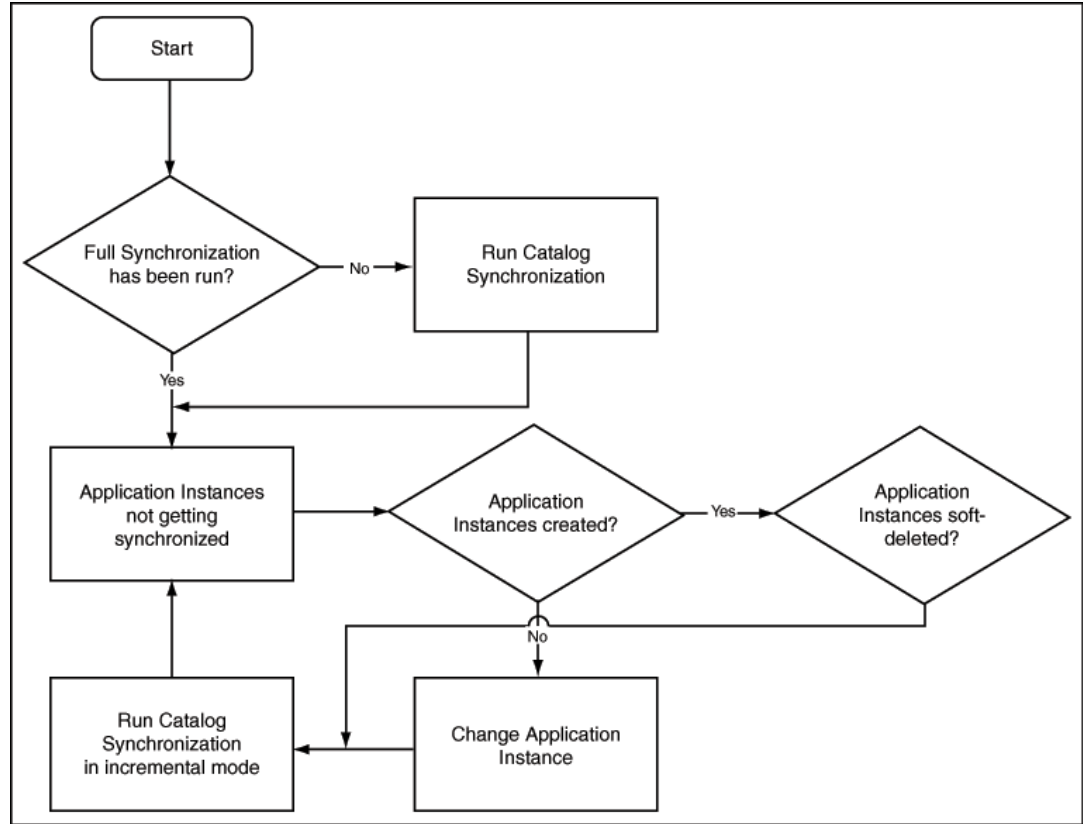

- Troubleshooting synchronizing Entitlements with the Catalog



**Figure 12-5 Troubleshooting Synchronizing Entitlements Flowchart**

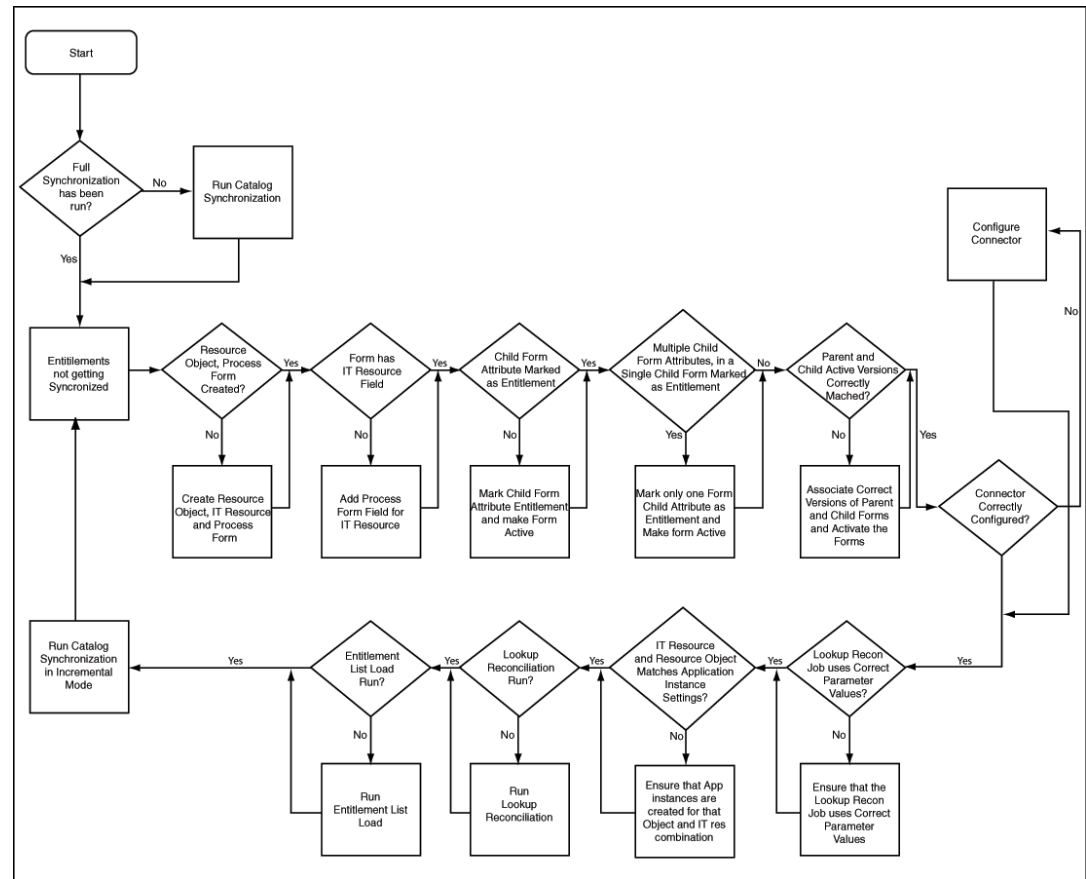

## 12.5.2 Catalog Security Issues

Catalog security issues might occur because of the type of security model used for the deployment.

Catalog security is driven by two factors:

- The security model that uses Organization-based scoping for users, roles, application instances and entitlements. This security model controls what items a requester can see in the Catalog search results and the users who can be added as target users.
- The security model that is not scoped by organization and is used for global Admin Roles such as Catalog Administrator.

Typical issues with Catalog security are:

- Requesters cannot see the Catalog item even though they have entered the correct search keyword.
- Requesters are not able to add target users to the request
- Requesters are not able to provide additional information for application instance requests
- Requesters cannot see Catalog Item details such as Approver User, Approver Role, Fulfillment User, and Fulfillment Role.
- Catalog Administrators do not see the Catalog Item in an edit mode and are not able to edit the Catalog Item

- Catalog Administrators are not able to create Request Profiles

Figure 12-6 shows a diagnostic flow chart to be followed to troubleshoot issues with Catalog security.

**Figure 12-6 Diagnostic Flowchart With Security Issues**

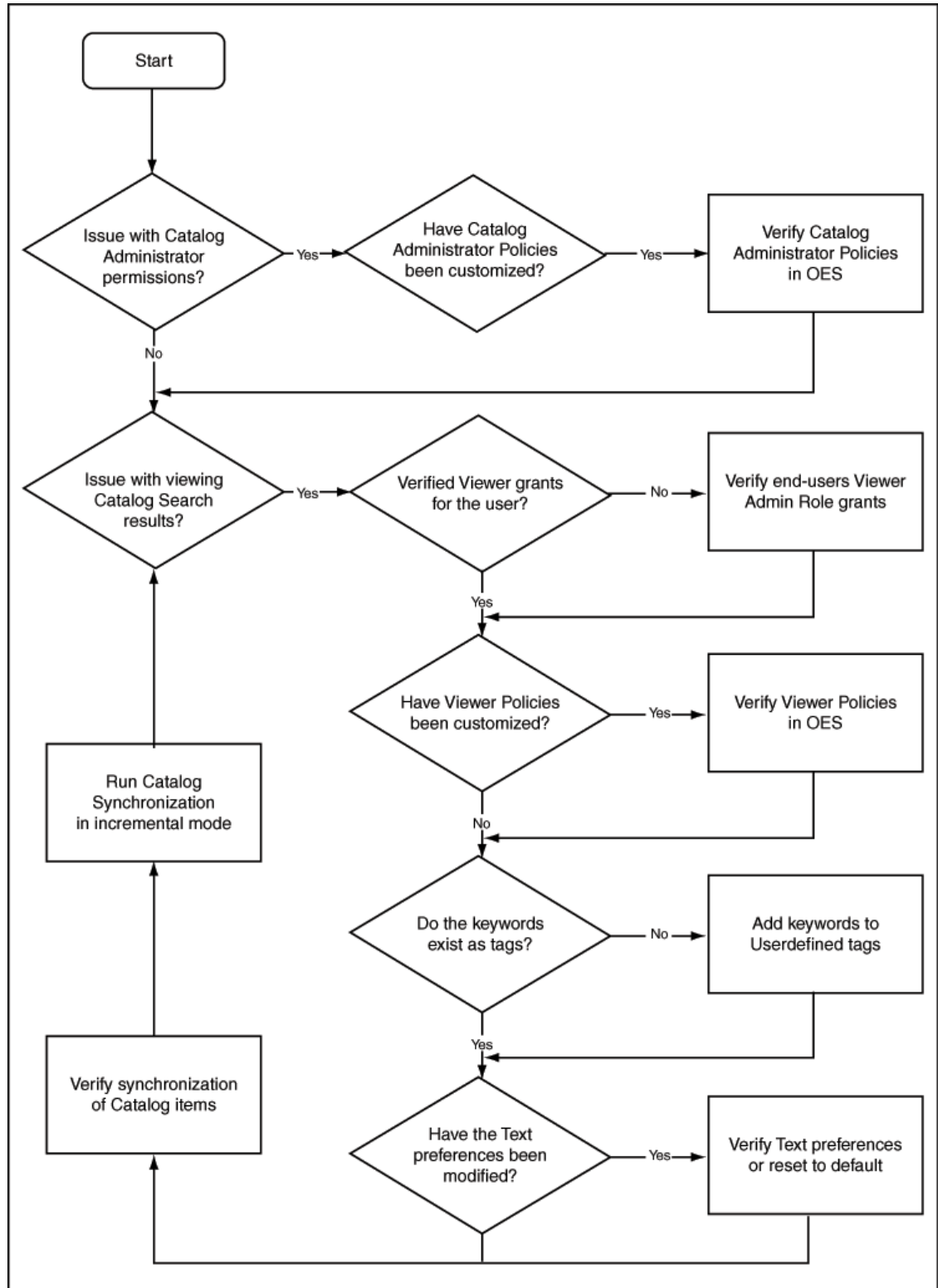

## 12.5.3 Catalog Search Issues

Some of the catalog search issues can be related to text syntax and text indexing.

Figure 12-7 shows a diagnostic flow chart to be followed to troubleshoot issues with Catalog search.

**Figure 12-7 Catalog Search**

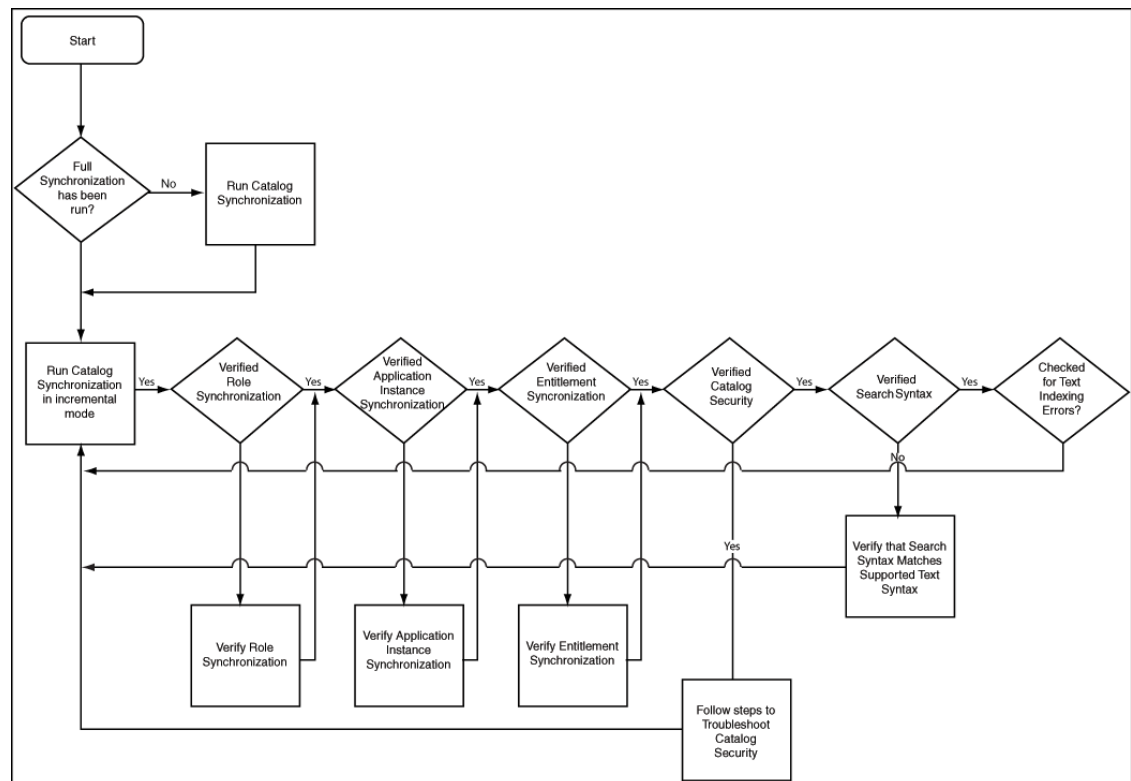

## 12.5.4 Common Reasons for Request Failure

When the associated operations specified in a request fail to execute, the request cancels any pending operations and moves the request to the Request Failed stage. Clicking the Request Failed hyperlink displays the reason for request failure.

A request can fail for any one of the following reasons:

- If you are requesting a role, then your request can fail due to an SoD violation.
- If you are requesting an application instance and that application instance depends on another application instance, then the request moves to 'Request Approved Fulfillment Pending' status because the parent application instance is not provisioned. For example, to successfully provision a user to a Microsoft Exchange account, the user must have a Microsoft Active Directory account in the domain controller that is managing the users of the Exchange server.

In addition to the preceding reasons, failures can occur because of incorrect password, password policy violation, target system being unavailable, and so on.

# Part VII

## System Configuration

The System Configuration section in Identity System Administration lets you manage home organization and self service capability policies, lookups, role categories, scheduled tasks and scheduled jobs, various configurations via system properties, and transition from a test to a production environment.

This part describes system configuration in Oracle Identity Manager. It contains the following chapters:

- [Managing the Home Organization Policy](#)
- [Managing Self Service Capability Policy](#)
- [Managing Lookups](#)
- [Managing Role Categories](#)
- [Managing the Scheduler](#)
- [Managing Notification Service](#)
- [Configuring Oracle Identity Governance](#)
- [Moving From Test to Production](#)
- [Migrating Application and Database Binaries](#)

# 13

## Managing the Home Organization Policy

Managing the home organization policy involves understanding the use cases for home organization policy and creating, editing, and deleting rules in the home organization policy. This chapter contains the following sections:

- [About Home Organization Policy](#)
- [Use Cases for the Home Organization Policy](#)
- [Creating a Rule in Home Organization Policy](#)
- [Modifying a Rule in Home Organization Policy](#)
- [Deleting a Rule in Home Organization Policy](#)

### 13.1 About Home Organization Policy

Home organization policy lets you to determine the home organizations of the self-registering users. The Home Organization Policy page in the Identity System Administration allows you to view, create, delete, and modify rules in the home organization policy.

When an user submits a request for self-registration, the home organization of the user gets determined by the home organization policy. The organization name (as determined by the home organization policy) is filled in the request submitted. The approver can override the home organization of the user while approving the request. If a pre-process custom handler is defined to determine the home organization during self-registration, then home organization policy will not be evaluated. If workflow policy is defined, then it takes precedence over the home organization policy.

The home organization policy allows you to define rules based on user attributes. The return value of the rule is the organization name. Rules are evaluated, in the order in which they appear on the Home Organization Policy page, starting from first rule to the last rule. Rules can be re-ordered from the Home Organization Policy page. Evaluation of rules is stopped on first rule match and the organization name is returned, remaining rules are not evaluated.

During Oracle Identity Manager initialization (deployment) a default home organization policy called **Home Organization Determination Policy** and a default rule called **Default All Users To Single Organization** is seeded if not present. New home organization policies cannot be defined by the customer, however new rules can be created under the default home organization policy.

The **Default All Users To Single Organization** rule is satisfied by every user. If for any reason the default rule is deleted, and if a user does not satisfy any other rule, then home organization of that user is left blank in the request submitted. The approver can fill in the home organization name before approving. In SOA OFF mode, this is not supported and hence blank home organization field will result in request failure. It is recommended to ensure that rules are defined in such a way that every user will satisfy at least one rule and a home organization is assigned.

Rules in home organization policy can be defined using Text, Number, Checkbox and Date Type UDFs. However, LookUp Type UDFs can not be added to self-registration page. List of operators available to build the IF condition is different for each type of UDF.

## 13.2 Use Cases for the Home Organization Policy

Supported use cases for the home organization policy includes self-registration using default, simple, or complex rules, use cases for rule evaluation order, and self-registration when SOA is turned off.

Following use cases shows how the home organization policy works:

- [Self-Registration Use Case Using Default Rule](#)
- [Self-Registration Use Case Using Simple Rule](#)
- [Self-Registration Use Case Using Complex Rule](#)
- [Use Case for Rule Evaluation Order](#)
- [Self-Registration Use Case When SOA is Off](#)

### 13.2.1 Self-Registration Use Case Using Default Rule

Default rule is named as **Default All Users To Single Organization Rule**. This rule can be modified but cannot be deleted.

The condition defined is:

```
IF user.User Login Equals $(user.User Login) THEN organization equals "Xellerate Users"
```

The default condition always evaluates to True. Thus, if any other rule defined in the home organization policy does not get satisfied, the default rule will definitely be satisfied and will provide the home organization name.

For example, when an user with userLogin **User1** submits a self-registration request, and if no other rule is defined or satisfied, default rule is evaluated. And the home organization is set to **Xellerate Users**.

### 13.2.2 Self-Registration Use Case Using Simple Rule

A simple rule is a rule created with a single IF condition and without using any operator, such as AND or OR.

For example, if a rule called **ExampleSimpleRule** is defined with the following condition:

```
IF user.Nickname Starts with "Test" THEN organization equals "testOrg2"
```

Here, *user.Nickname* is a text UDF attribute.

Now, if a user with nickname as **TestUser2** submits a self-registration request, then the rule condition is satisfied and the home organization is set to **testOrg2**.

### 13.2.3 Self-Registration Use Case Using Complex Rule

A complex rule is a rule created with more than one IF condition and uses AND or OR operators to form the rule.

For example, if a rule called **ExampleComplexRule** is defined with the following condition:

```
IF user.Nickname Starts with "Test" AND user.Display Name Ends with "User" THEN organization equals "testOrg3"
```

Here, *user.Nickname* is a UDF attribute and *user.Display Name* is default attribute.

Now, if a user with nickname as **TestUser3** and display name as **testUser** submits a self-registration request, then the rule condition is satisfied and the home organization is set to **testOrg3**.

## 13.2.4 Use Case for Rule Evaluation Order

When a user self-registers, the first rule that is evaluated is the top rule on the list that appears on the home organization page, followed by the next rule up to the last rule.

Evaluation stops as soon as a match is found. For example, if the **ExampleSimpleRule** is created followed by **ExampleComplexRule** as shown in [Figure 13-1](#).

**Figure 13-1** List of Rules defined in Home Organization Policy Page

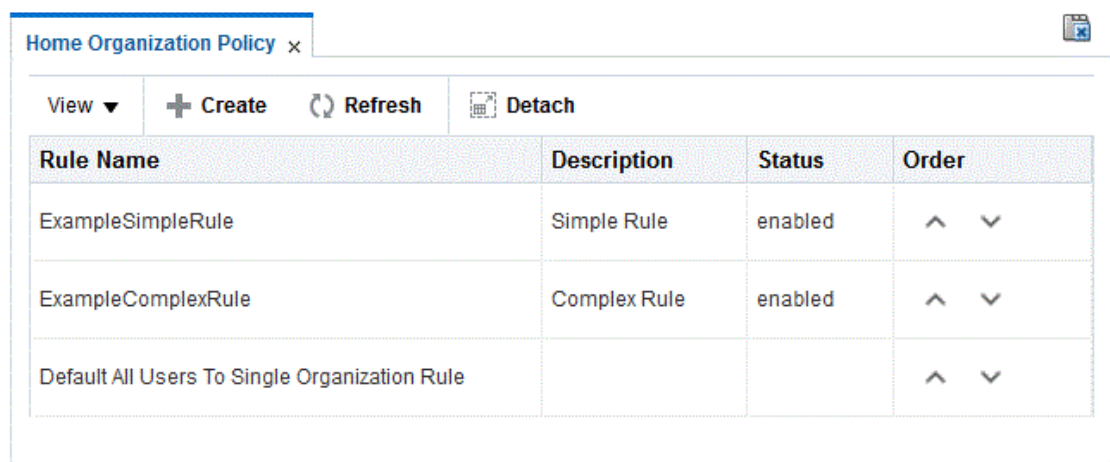

Rule Name	Description	Status	Order
ExampleSimpleRule	Simple Rule	enabled	^ v
ExampleComplexRule	Complex Rule	enabled	^ v
Default All Users To Single Organization Rule			^ v

Then, when a user self-registers, user attribute values are evaluated against **ExampleComplexRule** first, if it does not match, it proceeds to evaluate against **ExampleSimpleRule**. If this also does not match it is evaluated against **Default All Users To Single Organization Rule** which is the default rule.

If evaluation against **ExampleSimpleRule** is satisfied, then the home organization of the user is set according to the condition in the rule.

## 13.2.5 Self-Registration Use Case When SOA is Off

When SOA is turned off, and a self-registration request is submitted, the request gets auto-approved and the status of the request is shown as completed.

For steps to disable SOA server, refer to [Disabling SOA Server](#).

Now, when a user submits a self-registration, the request is auto-approved and the status is shown as complete. Evaluation of the home organization rule is same as explained in the examples above.

## 13.3 Creating a Rule in Home Organization Policy

Using the Home Organization Policy page, you can create and configure a rule by using the condition builder, or instead you can use scripts to perform the rule setting operation.

To create a rule:

1. Login to Oracle Identity System Administration.
2. In the left pane, under **System Configuration**, click **Home Organization Policy** to open the Home Organization Policy page.
3. Click **Create** on the toolbar to open the **Add Home Org Policy Rule** page.
4. Under the Create Rule section, enter **Name**, **Description**, **Owner**, and **Status** for the new rule. Set the **Status** of the rule to **Enable** or **Disable**. If the **Status** is set to **Disable**, then when a user self-registers, this rule is skipped during evaluation.
5. Set the rule condition in Condition Builder section. For example, If Display name contains Test and Last name contains User, then Organization is Vision North America. In this example Attribute is Display name, Condition is Contains and Value is Test.

You can set the rule using Condition Builder (Step 6) or Script(Step 7).

6. To set rule using Condition Builder:
  - a. Under IF part of the rule, click the Condition Builder icon to open the Condition Builder window.

As an example, [Figure 13-2](#) shows the Create Rule page with Condition Builder option to set rule.

**Figure 13-2 Creating rule with Condition Builder Option**

The screenshot displays the 'Create Rule' interface. At the top right, there are 'Create' and 'Cancel' buttons. The form includes the following fields:

- Name:** ExampleComplexRule
- Description:** Complex Rule
- Owner:** (Searchable field)
- Status:** Enabled (dropdown menu)
- Type:** User Home Organization

The **Condition Builder** section is active, showing two options: 'Condition Builder' (selected) and 'Script'. Below this, there is a note: 'Click on the icon to the right of the Condition field to launch a dialog window to begin building your condition.'

The **IF** section contains two conditions:

- user.Display Name Contains Test
- user.Last Name Contains User

The conditions are connected by an **AND** operator. The **THEN** section contains one condition:

- organization Equal Vision North America

- b. Select the user attribute for the attribute list, list of UDF and default attribute associated with the user is listed.

Search for the particular attribute from the list or type the name of the attribute in the field and click the **Search** icon. Select the attribute from the list and click **OK**.



- c. Select the condition from the conditions list. The available conditions are, Equal, Not Equal, Contains, Does Not Contain, Begins With, Does Not Begins With, Ends With, and Does Not Ends With.

 **Note:**

This list varies based on the type of attribute. The list above is for text type. Number type attributes can have values Greater than, Lesser than and so on.

- d. To enter value, type the value in the field and click **OK** or click the **Value** icon to open the Condition Builder window.

In the Condition Builder, you can enter **Value** or **Expression**.

If you select **Value**, list of value is displayed. Select the required value or type the value in the field and click **OK**.

If you select **Expression**, list of condition is displayed. Select the required value and click **OK**.

- e. To enter the THEN part of the rule, click the organization icon. The Condition Builder window is displayed. Select organization and click **OK**.
  - f. Condition is by default set to Equals and cannot be changed.
  - g. To select the organization, click the organization name icon. The Condition Builder window is displayed. Select the organization name from the list and click **OK**.
  - h. To set complex rules click **Add Condition**. Select **AND** or **OR** condition and set additional rule.
7. To set rule using a Script, perform the following:
- a. When **Script** is selected, this section shows the existing script. For example, if user has department number configured, then set organization value as department number. If department number is Oracle, Oracle-HQ, or Oracle-IDC, then organization value is set to department number. Make sure that organization with name Oracle, Oracle-IDC, Oracle-HQ exists in the system.

```
String deptNum= vo.getString("user.Department Number");
if(deptNum)
{
    ValueObject rvo = new ValueObject();
    rvo.put("organization",deptNum);
    return rvo;
}
```

As an example, [Figure 13-3](#) shows the Create Rule page with **Script** option to set rule.

**Figure 13-3** Creating rule with Script Option

Home Organization Policy x Add Home Org Policy Rule x

**Create Rule** Create Cancel

\* Name

Description

Owner

Status

Type User Home Organization

**Condition Builder**

Condition Builder  Script

Find

```

1 String deptNum= vo.getString("user.Department Number");
2 if (deptNum) {
3     ValueObject rvo = new ValueObject();
4     rvo.put ("organization", deptNum);
5     return rvo;
6 }

```

- b. Enter any word you would want to find and click the **Search** icon. Find and Replace panel is displayed.
  - c. To jump to a particular line, enter line number and click the **Search** icon.
8. Click **Create**.
  9. The Home Organization Policies page lists all the rules defined. The defined rule can be moved up or down in the list to change its order, to do so click the Up or Down arrow in the Order column of the rule.

## 13.4 Modifying a Rule in Home Organization Policy

You can edit the existing rules in the home organization policy by opening the policy, modifying the rule details, and saving the modified policy.

To modify a rule in home organization policies:

1. Login to Oracle Identity System Administration.
2. In the left pane, under **System Configuration**, click **Home Organization Policy** to open the Home Organization Policy window.
3. Select the required home organization policy from the list and click **Open**.
4. Modify the required details and click **Update**.

If you do not wish to update the changes made to the rule, click **Revert**. The rule is restored to the original rule.

## 13.5 Deleting a Rule in Home Organization Policy

Delete the rules in the home organization policy that are not required or are not in use.

To delete a rule in home organization policy:

1. Login to Oracle Identity System Administration.
2. In the left pane, under **System Configuration**, click **Home Organization Policy** to open the Home Organization Policy window.
3. Select the home organization policy rule that needs to be deleted, and click **Delete**.

# 14

## Managing Self Service Capability Policy

Managing the self service capability policy involves understanding the default self service capability rule, rule evaluation order, and creating, modifying, and deleting rules in the self service capability policy.

This chapter contains the following sections:

- [About Self Service Capability Rule](#)
- [Default Self Service Capability Rule](#)
- [Example of Self Service Capability Rules and Rule Evaluation Order](#)
- [Creating a Rule in Self Service Capability Policy](#)
- [Modifying a Rule in Self Service Capability Policy](#)
- [Deleting a Rule in Self Service Capability Policy](#)

### 14.1 About Self Service Capability Rule

The self service capabilities feature lets you control what operations a user can perform for the self by setting rules in the self service capability policy. The Self Service Capabilities page in the Identity System Administration allows you to view, create, delete, and modify rules.

Oracle Identity Manager allows you to control what operations a user can perform for the self. For example, if a user belongs to a particular organization then, user is allowed only to change self profile and other operations in Oracle Identity Manager is restricted. This can be achieved by setting rules in Self Service Capability Policy. In Self Service Capability Policy, you can define rules based on user attributes. You can set user attributes as denied attributes for the user who satisfies the rule. The user attributes marked as denied attributes can not be viewed or edited. The return value of this rule is the capability assigned to the user and the denied attributes that are configured. Self Service Capability is seeded with a default rule.

Multiple self service capability rules can be configured. The evaluation of these rules will be based on their order. The order can be configured from the Self Service Capability page. All the rules will be evaluated one by one and capabilities of the first matching rule will be assigned to user.

### 14.2 Default Self Service Capability Rule

Self Service Capability is seeded with a **Default Self Service Capability** rule.

The default condition always evaluates to True. Thus if any other rule defined in Self Service Capability does not get satisfied, the default rule will be satisfied and will provide the user with all the self service capabilities.

## 14.3 Example of Self Service Capability Rules and Rule Evaluation Order

Self service capability rules and the order of rule evaluation can be set based on the type and role of the user.

Example of rules that can be set are:

- If user type is Contractor then, user is allowed only to manage self profile.  

```
If user.Role Equal Contractor THEN capability Equal selfModifyUser
```
- If user type is Full Time and belongs to Sales department then, user is allowed to request roles and modify their profiles.  

```
If user.Role Equal Full-time AND user.Department Number Equal Sales
THEN
capability Equal addSelfRoles
AND
capability Equal selfModifyUser
```
- If user type is Full Time and country is not USA then, user is allowed to modify their profiles and Middle Name is a denied attribute to this user.  

```
If user.Role Equal Full-time AND user.Country Not Equal USA
THEN
capability Equal selfModifyUser
AND
deniedAttribute Equal Middle Name
```
- If user type is Full Time and country is USA then, user is allowed to modify their profiles.  

```
If user.Role Equal Full-time AND user.Country Equal USA
THEN
capability Equal selfModifyUser
```

When a user is created, the first rule that is evaluated is the latest defined rule, followed by the next latest up to the default rule. Evaluation stops as soon as a match is found.

For example, if **Contractor** rule is created first, followed by **Full-Time User**, **Full Time User USA**, and **Full Time User non USA**. [Figure 14-1](#) shows the order of rules.

**Figure 14-1** List of Rules defined in Self Service Capabilities page

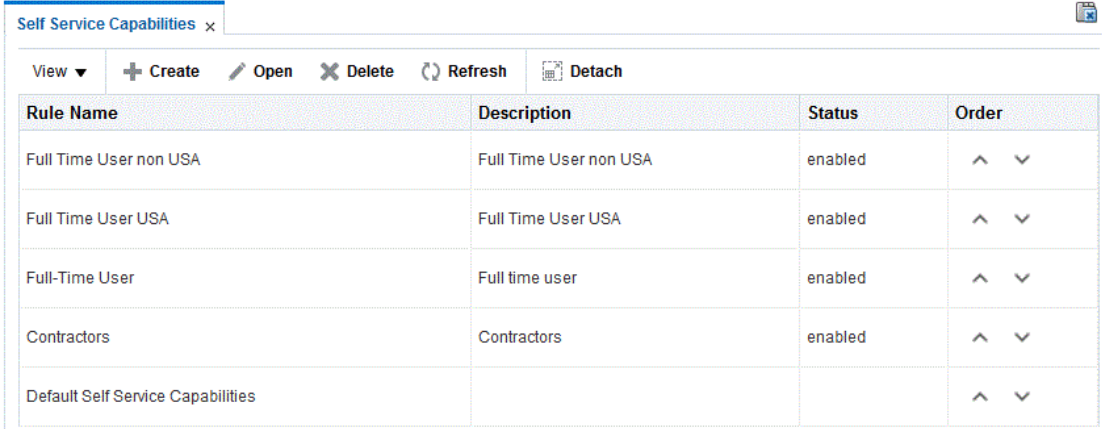

Rule Name	Description	Status	Order
Full Time User non USA	Full Time User non USA	enabled	^ v
Full Time User USA	Full Time User USA	enabled	^ v
Full-Time User	Full time user	enabled	^ v
Contractors	Contractors	enabled	^ v
Default Self Service Capabilities			^ v

Then, when a user is created, user attribute values are evaluated against **Full Time User non USA** first, if it does not match, it proceeds to evaluate against **Full Time User USA**. If this also does not match it is evaluated against **Full-Time User** and then **Contractor**. If non of these rules match then, it is evaluated against the default rule, that is **Default Self Service Capability**. If evaluation against **Full Time User non USA** is satisfied then, capability of the user is set according to the condition in the rule.

The order of the rule can be modified using the arrow buttons in the **Order** column of the rule.

## 14.4 Creating a Rule in Self Service Capability Policy

You can create a new rule in the Add Self Service Capability Policy Rule page. Using the Condition Builder, you can configure a rule condition. Using the AND or OR condition option, you can configure an advanced rule.

To create a rule in self service capabilities:

1. Login to Oracle Identity System Administration.
2. In the left pane, under **System Configuration**, click **Self Service Capabilities**. The Self Service Capabilities page is displayed.
3. Click **Create** on the toolbar. The **Add Self Service Capability Policy Rule** page is displayed.
4. Under the **Create Rule** section, enter **Name**, **Description**, **Owner**, and **Status** for the new rule. **Status** of a rule can be set to **Enable** or **Disable**. If the **Status** is set to **Disable** then when a user is created, this rule is skipped during evaluation.
5. Set the rule condition in the Condition Builder section. For example,

To set rule using Condition Builder:

- a. Under IF part of the rule, to enter attribute, click the condition builder icon. Condition builder pop-up screen is displayed.

As an example, [Figure 14-2](#) shows the Add Rule page.

**Figure 14-2** Creating rule with Condition Builder Option for Self Service Capability

The screenshot shows the 'Create Rule' dialog box. At the top, there are tabs for 'Self Service Capabilities' and 'Add Self Service Capabil...'. The 'Create Rule' section contains the following fields:
 

- Name:** Full-Time User
- Description:** Full time user
- Owner:** System Administrator
- Status:** Enabled (dropdown)
- Type:** Self Service Capability

 Below this is the 'Condition Builder' section. It includes instructions: 'Click on the icon to the right of the Condition field to launch a dialog window to begin building your condition.'
 

- IF:** A row with 'user.Role' in a text box, an 'Equal' dropdown, and 'Full-time' in another text box.
- THEN:** Two rows. The first has 'capability' in a text box, an 'Equal' dropdown, and 'addSelfRoles' in another text box. The second has 'capability' in a text box, an 'Equal' dropdown, and 'selfModifyUser' in another text box.

 Buttons for 'Group', 'Ungroup', 'Add Condition', and 'Remove' are visible above the condition rows. 'Create' and 'Cancel' buttons are at the top right.

- b. Select the User attribute from the attribute list. List of searchable attributes and UDFs associated with User are listed.

Search for the particular attribute from the list or type the name of the attribute in the text box and click the **Search** icon. Select the attribute from the list and click **OK**.

- c. Select the condition from the conditions drop-down. The available conditions are, Equal, Not Equal, Contains, Does Not Contain, Begins With, Does Not Begins With, Ends With, and Does Not Ends With.

**Note:**

This list varies based on the type of attribute. The list above is for text type. Number type attributes can have values Greater than, Lesser than and so on.

- d. To enter value, type the value in the text box and click **OK** or click the **Value** icon to open the Condition builder pop-up screen.

In the condition builder, you can opt to enter **Value** or **Expression**.

If you select **Value**, list of value is displayed. Select the required value or type the value in the text box and click **OK**.

If you select **Expression**, list of condition is displayed. Select the required value and click **OK**.

**Note:**

This field is case sensitive.

- e. To enter the THEN part of the rule, click the condition builder icon. Condition builder pop-up screen is displayed. Select **Capability** or **Denied Attributes** and click **OK**.
- f. Condition is set to **Equals** and cannot be changed.
- g. To select the **Capability** or **Denied Attribute** based on the selection in previous step, click condition builder icon under THEN section. Condition builder pop-up screen is displayed. Select the desired default capability or denied attribute from the list and click **OK**.

 **Note:**

- Mandatory attributes and System generated attributes like Status, Display name, User Login and so on cannot be included in denied attributes list.
- When denied attributes are specified, the user will not be able to view or modify those attributes.

6. To set complex rules click **Add Condition**. Select **AND** or **OR** condition and set additional rule by following instruction in Step 5.
7. Click **Create**.

## 14.5 Modifying a Rule in Self Service Capability Policy

You can edit the existing rules in the self service capability policy by opening the policy, modifying the rule details, and saving the modified policy.

To modify a rule in self service capabilities:

1. Login to Oracle Identity System Administration.
2. In the left pane, under **System Configuration**, click **Self Service Capabilities**. The Self Service Capabilities window is displayed.
3. Select the self service capability you want to modify from the list and click **Open**.
4. Modify the required details and click **Update**.

If you do not wish to update the changes made to the rule, click **Revert**. The rule is restored to the original rule.

## 14.6 Deleting a Rule in Self Service Capability Policy

Delete the rules in the self service capability policy that are not required or are not in use.

To delete a rule in self service capabilities:

1. Login to Oracle Identity System Administration.
2. In the left pane, under **System Configuration**, click **Self Service Capabilities**. The Self Service Capabilities window is displayed.
3. Select the self service capability that needs to be deleted from the list and click **Delete**.



# Managing Lookups

You can manage lookups from the Identity System Administration. However, lookup queries are not supported. Managing lookups include searching lookup type, creating lookup type, and modifying lookup type.

This chapter describes how to manage lookups in Oracle Identity Manager by using the Form Designer in the Oracle Identity System Administration.

The Form Designer in the Oracle Identity System Administration enables you to perform the following:

- [Searching a Lookup Type](#)
- [Creating a Lookup Type](#)
- [Modifying a Lookup Type](#)

## 15.1 Searching a Lookup Type

Use the Search and Select: Lookup Type Window to search for lookup types.

To search for a lookup type:

1. Login to Oracle Identity System Administration.
2. In the left pane, under System Configuration, click **Lookups**. The Search and Select: Lookup Type window is displayed.
3. Select any one of the following options:
  - **All:** On selecting this option, the search is performed with the AND condition. This means that the search operation is successful only when all the search criteria specified are matched.
  - **Any:** On selecting this option, the search is performed with the OR condition. This means that the search operation is successful when any search criterion specified is matched.
4. In the Meaning field, enter the humanly readable description of the lookup value you want to search.

 **Note:**

Meaning is the decoded value, and Code is the encoded value. The value in the Meaning field is a humanly readable description of the field. The value in the Code field is the actual code value that is used for provisioning. For example, decoded value can be a LDAP group name, and encoded value is the LDAP group GUID.

5. In the Code value, enter the Code value of the lookup type that you want to search.

 **Note:**

To specify the search criteria, you can use the percent (%) wildcard character.

6. In the Description field, you can enter a description of the lookup type.
7. Click **Search**. The lookup types that match your search criteria are displayed in a tabular format.
8. Select a row in the search results table. The details of the selected lookup type is displayed in the Lookup Values section, as shown in [Figure 15-1](#):

**Figure 15-1 The Search and Select: Lookup Type Window**

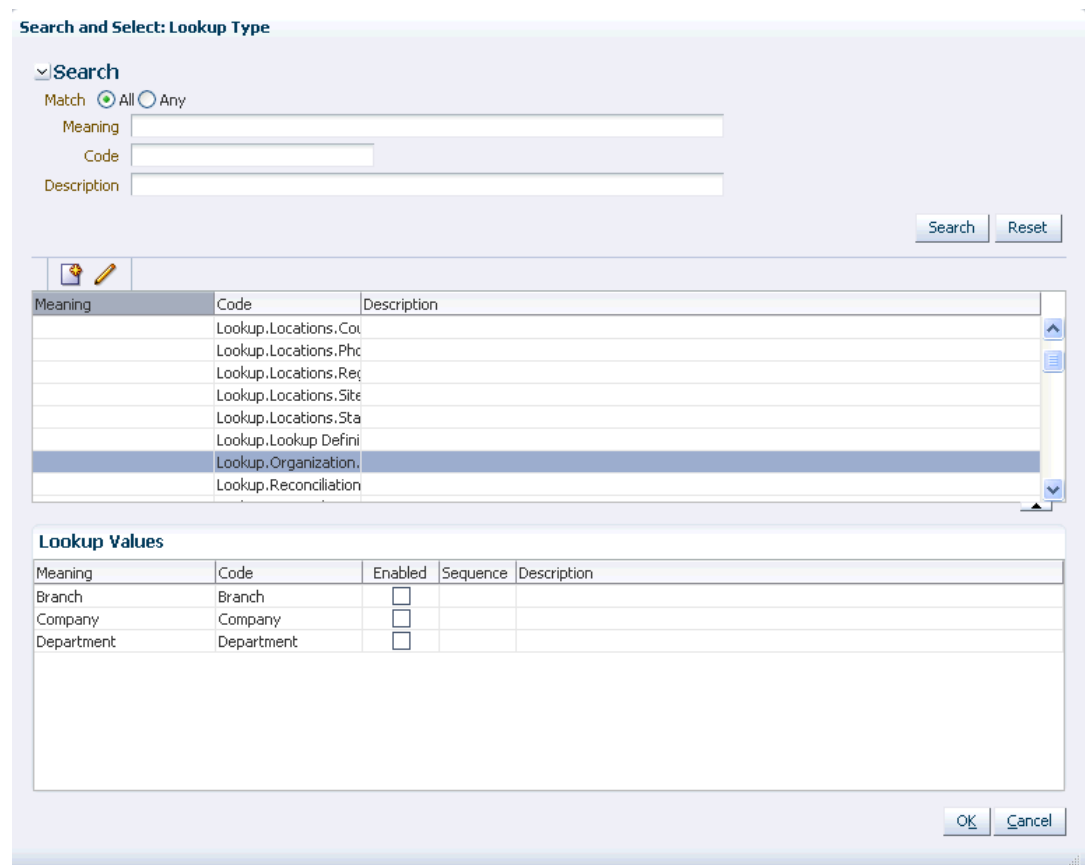

**Search and Select: Lookup Type**

Search Match  All  Any

Meaning

Code

Description

Meaning	Code	Description
	Lookup.Locations.Cou	
	Lookup.Locations.Phc	
	Lookup.Locations.Req	
	Lookup.Locations.Site	
	Lookup.Locations.Sta	
	Lookup.Lookup Defini	
	Lookup.Organization;	
	Lookup.Reconciliation	

**Lookup Values**

Meaning	Code	Enabled	Sequence	Description
Branch	Branch	<input checked="" type="checkbox"/>		
Company	Company	<input checked="" type="checkbox"/>		
Department	Department	<input checked="" type="checkbox"/>		

9. The lookup values are enabled by default. You can deselect the checkboxes in the Enabled column for each lookup value to disable the lookup value.

 **Note:**

There are multiple ways in which lookups are used. One way is to populate some form with data via the lookup icon on some process form to provision to a target system. Many lookups, such as lookups for most connectors, contain some configuration information. These lookups do not honor the checkbox in the Disabled column and assume that all configuration settings are valid.

Task triggering based on lookup.usr\_process\_triggers, does not take into account or depend upon enabling and disabling of lookup value. If an entry is made into the lookup and the corresponding task is defined, then the task is triggered.

To work around this, either change the task name at process definition or change the value in the lookup definition level for task name. Oracle recommends changing the value in the lookup definition level for task name as a better approach.

10. When finished, click **OK**.

## 15.2 Creating a Lookup Type

Use the Create Lookup Type dialog box to create a new lookup type.

To create a lookup type:

1. Open the Search and Select: Lookup Type window.
2. Click the Create Lookup Type icon on the toolbar. The Create Lookup Type dialog box is displayed, as shown in [Figure 15-2](#):

**Figure 15-2 The Create Lookup Type Dialog Box**

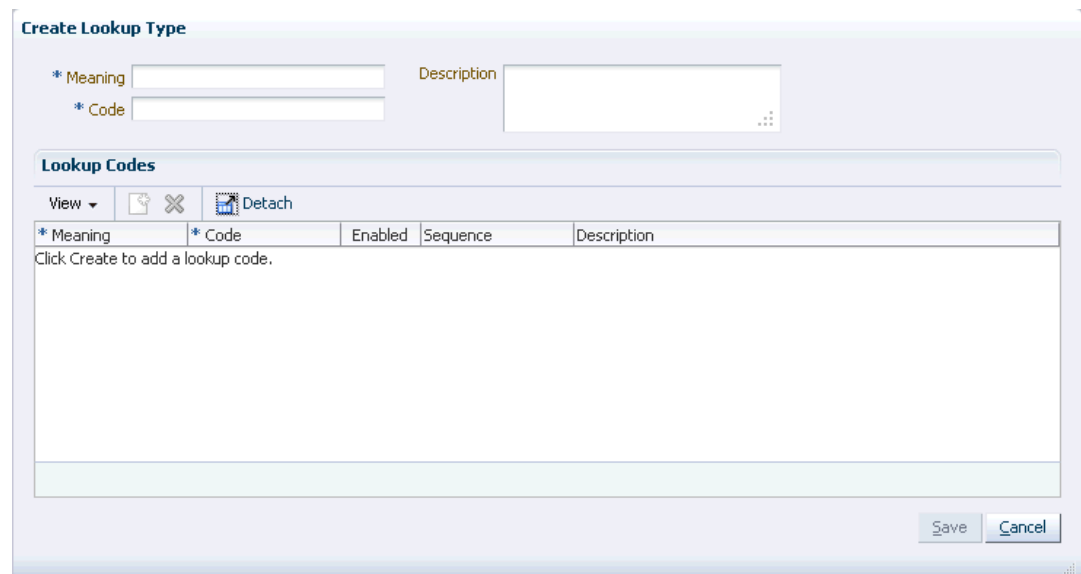

* Meaning	* Code	Enabled	Sequence	Description
Click Create to add a lookup code.				

3. Enter values in the Meaning and Code fields. These are mandatory fields. For a description of the Meaning and Code fields, see step 4 in [Searching a Lookup Type](#).

 **Note:**

In a clustered Oracle Identity Governance setup, when you try to create a new lookup type by entering a value in the Meaning field, the following error is displayed:

```
"IAM-0120030:A system error #1528299731519 has occurred. Please contact System Administrator."
```

The log file also shows the following:

```
oracle.jbo.AttrSetValException: JBO-27020: The set method for attribute
"Meaning" in LookupTypes cannot be resolved.
at oracle.jbo.server.EntityImpl.setAttribute(EntityImpl.java:2230)
at
oracle.jbo.server.ViewRowStorage.setAttributeValue(ViewRowStorage.java:2554)
at
oracle.jbo.server.ViewRowStorage.setAttributeInternal(ViewRowStorage.java:23
54)
at oracle.jbo.server.ViewRowImpl.setAttributeInternal(ViewRowImpl.java:1691)
.....
Caused By: java.lang.NullPointerException
at
oracle.jbo.server.DBTransactionImpl.addPendingEvent(DBTransactionImpl.java:6
030)
at oracle.jbo.server.EntityCache.deliverEntityEvent(EntityCache.java:1737)
```

To resolve this issue, perform the following steps:

- a. Stop all SOA Managed servers and OIM Managed servers.
- b. On each OIM Managed server, add the java option -  
Doracle.adfm.useSharedTransactionForFrame=false in  
the `$DOMAIN_HOME/bin/setDomainEnv.sh` file, as shown:

```
if [ "${SERVER_NAME}" = "<OIM_SERVER_NAME>" ] ; then
JAVA_OPTIONS="${JAVA_OPTIONS}
-Doracle.adfm.useSharedTransactionForFrame=false"
export JAVA_OPTIONS
fi
```

- c. Restart the SOA Managed servers, and then restart the OIM Managed servers.

4. In the Description field, optionally enter a description of the lookup type.
5. Create one or more lookup codes for the lookup type. To do so:
  - a. In the Lookup Codes section, click the Create Lookup Code icon. A row is added to the Lookup Codes section in which you can specify values for the attributes of the lookup code.
  - b. Enter values for the Meaning, Code, and Description attributes.
  - c. Select the checkbox in the Enabled column if you want to enable the lookup code.
  - d. Repeat steps a to c to create as many lookup codes you want. To remove a lookup code, you can select the row for the code, and click the Remove Lookup Code icon.
6. Click **Save**. The lookup type is created.

## 15.3 Modifying a Lookup Type

Use the Edit Lookup Type dialog box to edit an existing lookup type.

To modify a lookup type:

1. Open the Search and Select: Lookup Type window.
2. Click the Edit Lookup Type icon on the toolbar. The Edit Lookup Type dialog box is displayed, as shown in [Figure 15-3](#):

**Figure 15-3 The Edit Lookup Type Dialog Box**

* Meaning	* Code	Enabled	Sequence	Description
The name of the or	Organization	<input type="checkbox"/>		
The primary locatic	Location	<input type="checkbox"/>		
The role of the use	Role	<input type="checkbox"/>		
The type of the us	Xellerate Type	<input type="checkbox"/>		

3. To modify the values of the Meaning and Description attributes, specify values in the respective fields. The Code field is a read-only field.
4. To modify lookup codes, select a row for the lookup code, and change the attribute values.
5. Add or remove lookup values by clicking the Create Lookup Code and Remove Lookup Code icons respectively. For more information, see step 5 of [Creating a Lookup Type](#).
6. Click **Save**. The Lookup Type is modified.

### Note:

PurgeCache utility must be run after updating lookup definition, without which you must re-save lookup UDF in a sandbox before the new lookup values can be used. This is also applicable to predefined fields and their lookup definitions. Therefore, PurgeCache utility must be run to purge cache for all categories.

See *Purging the Cache* in *Performance and Tuning Guide* for information about purging the cache.

# 16

## Managing Role Categories

Managing role categories include creating, searching, modifying, and deleting role categories. This chapter describes the Role Categories in Oracle Identity Manager.



### Note:

Role categories exist in this release of Oracle Identity Manager only for the purpose of backward compatibility. Using role categories is not recommended.

This section describes the following topics:

- [About Role Category](#)
- [Creating a Role Category](#)
- [Searching Role Categories](#)
- [Modifying a Role Category](#)
- [Deleting a Role Category](#)

### 16.1 About Role Category

There are two default role categories, OIM Roles and Default. If you are using a fresh deployment of Oracle Identity Manager, then use the Category attribute in the access catalog. If you are using an upgraded deployment of Oracle Identity Manager, then update the Catalog category attribute with the role category information.

The default role categories in Oracle Identity Manager are:

- **OIM Roles:** All the predefined roles in Oracle Identity Manager are assigned to this category. These are roles that exist in Oracle Identity Manager by default and are primarily used for managing permissions. There will not be any corresponding entity in catalog for these predefined roles.
- **Default:** A newly created role must have a role category. Therefore, if a role category is not specified at the time of creating the role, then the role is assigned to this category by default.



### Note:

The default role categories cannot be localized.

## 16.2 Creating a Role Category

Use the Create Role Category page to create a new role category.

To create a role category:

1. Login to Oracle Identity System Administration.
2. On the left pane, under System Configuration, click **Role Categories**. The Search Role Categories page is displayed.
3. From the Actions menu, select **Create**. Alternatively, click **Create** on the toolbar. The Create Role Category page is displayed.
4. In the Role Category box, enter the name of the role category. This is a mandatory field.
5. In the Role Category Description box, enter a description for the role category. This step is optional.
6. Click **Save**. The role category is created, and the role category details page is displayed. This page consists of the Attributes tab.

The Attributes tab displays the attributes of the role category. You can edit the fields in this tab to edit the role category.

## 16.3 Searching Role Categories

Use the Search Role Categories page to search for existing role categories. You can search by specifying a value or wildcard character, and also use various search operators.

To search for role categories:

1. In Oracle Identity System Administration, Under System Configuration, click **Role Categories**. The Search Role Categories page is displayed.
2. In the Role Category field, specify a value. You can include wildcard characters (\*) in the attribute value.
3. For the attribute value that you specify, select a search operator from the list. The following search operators are available:
  - Starts with
  - Ends with
  - Equals
  - Does not equal
  - Contains
  - Does not contain

The search operator can be combined with wildcard characters to specify a search condition. The asterisk (\*) character is used as a wildcard character. For example, you can specify the value to be D\* as the search criteria, and select Equals as the search operator. The role categories that begins with D are displayed.

4. To add a searchable attribute to the Role Categories, click **Add Fields**, and select the attribute from the list of attributes.

5. If you want to change the order of the search fields, then click **Reorder**. The **Reorder Search Fields** dialog box is displayed. Move the search fields up or down by using the up and down arrows. When finished, click **OK**.
6. If you want to save the search criteria for future user, then click **Save**. See *Performing Self Service Tasks with Oracle Identity Governance* for information about saved search.
7. Optionally click **Reset** to reset the values that you specified as search conditions. Typically, you perform this step to remove the specified search conditions and specify a new search condition.
8. Click **Search**. The search result is displayed in a tabular format.

## 16.4 Modifying a Role Category

Use the role category details page to edit the basic attributes of an existing role category.

To modify a role category:

1. In the **Search Role Categories** page, search and select the role category you want to modify.
2. From the **Actions** menu, select **Open**. Alternatively, click **Open** on the toolbar. A page with details about the role category is displayed.

You can also open the role category details by clicking the role category name.

3. The **Attributes** tab is open by default. Edit the fields in this tab to modify basic category information such as name and description. When finished, click **Apply**.

## 16.5 Deleting a Role Category

Delete a role category, which is not required, either by searching for it or from the role category details page.

To delete a role category:

1. In the **Search Role Categories** page, search and select the role category you want to delete.
2. From the **Actions** menu, select **Delete**. Alternatively, click **Delete** on the toolbar.

If the role category detail page is open, then click **Delete** on the toolbar.

A message box is displayed asking for confirmation.

3. Click **Delete**. The role category is deleted. Alternatively, you can also delete the role category from its details page.



# Managing the Scheduler



This content applies only to OIG Bundle Patch 12.2.1.4.220703 and releases earlier to July 22 Bundle Patch.

Managing the scheduler involves understanding scheduled tasks and scheduled jobs, configuring the `oim-config.xml` file, starting and stopping the scheduler, understanding the predefined scheduled tasks, managing scheduled jobs, and diagnosing scheduled jobs.

This chapter describes about the Scheduler in Oracle Identity Manager. This chapter contains the following sections:

- [About Scheduler](#)
- [Configuring the oim-config.xml File](#)
- [Start and Stop the Scheduler](#)
- [Scheduled Tasks](#)
- [Managing Jobs](#)
- [Diagnosing Scheduled Jobs](#)

## 17.1 About Scheduler

The scheduler enables you to schedule jobs that automatically run predefined scheduled tasks at the specified time.

This is illustrated by the following example:

To meet the security policies of an organization, employees may be required to change their product application password every 60 days. For this purpose, the system administrator has to ensure that an email is sent to all employees whose passwords for the respective product applications have expired. One approach would be to identify the set of users whose passwords have expired and send email to each employee manually. Alternatively, the system administrator can use a service, such as scheduler. In Oracle Identity Manager, there is a predefined scheduled task called Password Warning Task. The system administrator can use this scheduled task to create a scheduled job with the intended schedule.



### See Also:

[Table 17-2](#) for information about the Password Warning Task scheduled task

Scheduler also enables you to create your own scheduled tasks that can be run by a job at a set time.

A **scheduled task** configures the metadata for a job, which is to be run, and the parameters required for execution of that task. This metadata is predefined for the predefined tasks. A new task can be added by the user, which will have the new metadata or the existing tasks can be updated to add/update the parameters for other configuration details. A **job** can be scheduled to run at the specified interval. You can create multiple jobs scheduled to run at different time intervals. A **job run** is a specific execution of a job. Each job run includes information such as the start time, stop time, exceptions and status of the execution.

## 17.2 Configuring the oim-config.xml File

The oim-config.xml file consists of the Scheduler element, whose child elements define the scheduler settings.

After you install Oracle Identity Manager, you can configure the scheduler settings by editing the child elements of the Scheduler element in the oim-config.xml file located in the MDS. To access the oim-config.xml file by using Oracle Enterprise Manager:

1. Log in to Oracle Enterprise Manager.
2. Click **Application Deployments**.
3. Right-click **OIMAppMetadata(11.1.2.0.0)(oim\_server\_name)**, and select **System MBean Browser**.
4. In the System MBean Browser, navigate to **Application Defined MBeans, oracle.iam, Server: oim server, Application: oim, XMLConfig, Config, XMLConfig.SchedulerConfig, Scheduler**.

**Table 17-1** lists the default elements that you can configure within the Scheduler element in the oim-config.xml file.

### Note:

You can add new configurable child elements. For the information about new child elements, refer to the following URL:

<http://www.quartz-scheduler.org/>

**Table 17-1 Child Elements of the Scheduler Element**

Element Within Scheduler Element	Description
DSJndiURL	This element is used for configuring transactional data source in the application server, which is used by Quartz to establish the connection. Default value: jdbc/operationsDB
nonTxnDSJndiURL	This element is used for configuring non-transactional data source in the application server, which is used by Quartz to establish the connection. Default value: jdbc/oimJMSStoreDS
Clustered	Enter <code>true</code> if Oracle Identity Manager has been installed in a clustered environment. Otherwise, enter <code>false</code> . Default value: <code>true</code> <b>NOTE:</b> In a clustered environment, the clocks on all nodes of the cluster must be synchronized.

**Table 17-1 (Cont.) Child Elements of the Scheduler Element**

Element Within Scheduler Element	Description
implementationClass	Enter the name of the Java class that implements scheduler. Default value: oracle.iam.scheduler.impl.quartz.QuartzSchedulerImpl
instanceID	Enter a unique string value in this element. This value represents a string that uniquely identifies an Oracle Identity Manager scheduler instance. <b>NOTE:</b> In a clustered environment, each node of the cluster must have a unique InstanceID. This can be achieved by entering a value of <code>AUTO</code> in the instanceID element.
startOnDeploy	Enter <code>false</code> if you do not want scheduler service to start automatically when Oracle Identity Manager is started. Otherwise, enter <code>true</code> . Default value: <code>true</code>
threadPoolSize	Enter an integer value in this element. This value represents the number of threads that must be used for running jobs. Default Value: 10

## 17.3 Start and Stop the Scheduler

Starting or stopping the scheduler involves understanding the Started and Stopped scheduler statuses, and controlling the scheduler status in a single-node or clustered deployment.

This section describes how to start and stop the scheduler. This section contains the following:

- [About Enabling and Disabling the Scheduler](#)
- [Starting and Stopping the Scheduler](#)
- [Controlling Scheduler Start or Stop in a Clustered Environment](#)

### 17.3.1 About Enabling and Disabling the Scheduler

At a given instance, the scheduler status can either be Started or Stopped.

The search results of the **Manage Scheduler Jobs** page displays the current status of the scheduler. At any given instance, the scheduler can be in one of the following statuses:

- **Enable**  
If the scheduler is in the started status, then jobs can be scheduled and jobs that have already been scheduled will continue to run at the scheduled time.
- **Disable**  
If the scheduler is in the stopped status, then all jobs are stopped. When the scheduler gets the stopped status while jobs are running, the currently running jobs are stopped. In addition, the jobs that are scheduled to run does not run, but are submitted for run according to the schedule. When the Scheduler Service is up in the future, all submitted jobs are run.

The Manage Scheduler Jobs page also displays a detailed error message in the Last Error field, if any.

You can use the Scheduler Status page to either start, stop, or reinitialize the scheduler.

By default, the scheduler is in the started status after you install Oracle Identity Manager. However, if you want to stop scheduler for any reason and then restart it, then you must follow the procedure discussed in this section.

## 17.3.2 Starting and Stopping the Scheduler

Use the **Scheduler Jobs** page to start, stop, or re-initialize the scheduler.

To start or stop the scheduler:

### Note:

- You need to have Scheduler Admin role to start or stop the scheduler.
- In a clustered environment, you must perform this procedure on each node of the cluster.

1. Browse to the following URL by using a Web browser:

`http://OIM_HOST:OIM_PORT/SchedulerService-web/status`

In this URL, *OIM\_HOST* represents the name of the computer hosting the Oracle Identity Manager server, and *OIM\_PORT* refers to the port on which Oracle Identity Manager server is listening.

2. Enter the User ID and password, and then click **Submit**.

The Scheduler Status page is displayed.

### Note:

You may be automatically logged in to the scheduler service if you are working in a single sign-on environment.

3. Depending on the type of action that you want to perform, click one of the following:

- **START:** Click this button to start the scheduler.
- **STOP:** Click this button to stop the scheduler. This stops the scheduler and further execution of triggers, but it does not stop or abort any jobs that are already executing. When the Scheduler Service is started again, jobs will then be executed at their appropriate times based on when they are scheduled.
- **REINIT:** Click this button to reinitialize the scheduler.

## 17.3.3 Controlling Scheduler Start or Stop in a Clustered Environment

The scheduler.disabled system property is required if you want to control scheduler start or stop on a clustered setup. The scheduler.disabled system property must be set to true if you do not want to start the scheduler service on that node of the cluster.

This section contains the following topics:

- [Adding the Server Side Property for Oracle Identity Governance](#)
- [Restarting Oracle Identity Governance Managed Servers from the Node Manager](#)

- [Modifying the Server Side Property for Oracle Identity Governance](#)

### 17.3.3.1 Adding the Server Side Property for Oracle Identity Governance

To add the scheduler.disabled server-level property:

1. Log in to the WebLogic Administrative Console.
2. On the left panel, select **Environment, Servers**.
3. Click the name of the managed server where you want to add the scheduler.disabled=false property.
4. Select **Lock and Edit**.
5. Select **Configuration, Server Start**.
6. In the Arguments box, add the scheduler.disabled=false property, and click **Save**.
7. Click **Activate Change**.

Restart the managed server using node manager so that the newly added property is picked up. Restarting from the Command-Line Interface does not work.

### 17.3.3.2 Restarting Oracle Identity Governance Managed Servers from the Node Manager

To restart Oracle Identity Governance Managed Servers from the Node Manager:

1. Start the Administration server. To do so:
  - a. From your current working directory, go to the *MW\_HOME/user\_projects/domains/base\_domain/* directory.
  - b. Run the following command:  
For UNIX:  

```
startWebLogic.sh
```

  
For Windows:  

```
startWebLogic.cmd
```
2. Start the Node Manager. To do so:
  - a. From your current working directory, go to the *MW\_HOME/wlserver\_10.3/server/bin/* directory.
  - b. Run the following command:  
For UNIX:  

```
startNodeManager.sh
```

  
For Windows:  

```
startNodeManager.cmd
```
3. Log in to the WebLogic Administrative Console.
4. On the left panel, select **Environment, Servers**.
5. Select Control from the right panel.
6. Select the option where the property is added, and click **Start**.

### 17.3.3.3 Modifying the Server Side Property for Oracle Identity Governance

To modify the scheduler.disabled system property:

1. Log in to the WebLogic Administrative Console by using the WebLogic administrator credentials.
2. Under Domain Structure, select **Environment, Servers**. The Summary of Servers page is displayed.
3. Click the Oracle Identity Manager server name, for example, oim\_server1. The settings for oim\_server1 is displayed.
4. Click **Configuration, Server Start**.
5. In the Arguments box, change the existing property scheduler.disabled = false/true.
6. Click **Save**.
7. Click **Activate Changes**.
8. Restart the Oracle Identity Manager Managed Server.

 **Note:**

After modifying the scheduler.disabled system property, you must start the Managed Server by using the Node Manager.

## 17.4 Scheduled Tasks

Oracle Identity Manager provides a list of predefined scheduled tasks. In addition, you can create your own custom scheduled tasks based on the requirement.

This section describes the scheduled tasks. This is discussed in the following topics:

- [About Scheduled Tasks](#)
- [Predefined Scheduled Tasks](#)
- [Creating Custom Scheduled Tasks](#)

### 17.4.1 About Scheduled Tasks

In Oracle Identity Manager, metadata is predefined for the default scheduled tasks. New tasks can be added by the user with new metadata, or the existing tasks can be updated to add or update the parameters or other configuration details.

For example, you can configure a reconciliation run using a scheduled task that checks for new information on target systems periodically and replicates the same in Oracle Identity Manager. Each scheduled task contains the following metadata information:

- Name of the scheduled task
- Name of the Java class that runs the scheduled task
- Description
- Retry

- (Optional) Parameters that the scheduled task accepts. Each parameter contains the following additional information:
  - Name
  - Data Type
  - Required/ Optional
  - Help Text
  - Encryption

## 17.4.2 Predefined Scheduled Tasks

Oracle Identity Manager provides a set of predefined scheduled tasks that you can use while creating or working with jobs.

Table 17-2 lists the predefined scheduled tasks.

**Table 17-2 Predefined Scheduled Tasks**

Job Name	Description	User-Configurable Attributes	Enabled By Default
Application Instance Post Delete Processing Job	<p>This scheduled task is used to revoke, delete, or decommision applicaion instances that have been soft-deleted. It can be run in the following modes:</p> <ul style="list-style-type: none"> <li>• <b>Revoke:</b> Deletes the provisioned accounts from the target system after the application instances has been deleted</li> <li>• <b>Delete:</b> Hard-deletes the accounts from all provisioning tasks and targets, and subsequently from Oracle Identity Manager</li> <li>• <b>Decommission:</b> Changes the account status to Revoke without keeping the accounts in Oracle Identity Manager in provisioned state</li> </ul>	None	Yes
Application Bulk Create	<p>This scheduled task is used to seed Application and Instance Application in bulk. There is no default job for this scheduled task however, you can create job using this task. You need to provide directory path of list of Application and Instance Application Template.</p> <p>Template will be processed as per below convention:</p> <ul style="list-style-type: none"> <li>• All template that does not contain Base Application Name are processed on priority and such templates are eligible for new Application. Such Applications will be created in sequence from job.</li> <li>• All template that contains Base Application Name are eligible for Instance Application. All such template are processed asynchronously.</li> </ul>	Template Directory and Archive Directory	Yes

Table 17-2 (Cont.) Predefined Scheduled Tasks

Job Name	Description	User-Configurable Attributes	Enabled By Default
Application Template Generation Job	This scheduled task is used to generate the template for applications that are created through connector installer or if there is a upgrade. The generated templates are stored in internal database table, which is used to manage the application from Application Tab in Identity Self Service.	<p><b>Application Names:</b> A list of comma separated application instance names for which templates have to be generated.</p> <p><b>Generate in Bulk:</b> If set to Yes, template is generated for all application instances which are not Deleted. If Generate in Bulk is set to Yes, then <b>Application Names</b> should not be set. Default value is No.</p>	Yes
<div style="border-left: 2px solid #0070C0; padding-left: 10px;"> <p> <b>Note:</b></p> <p>For authoritative applications, create an application instance using API and then use this job to generate the template.</p> </div>			
Attestation Grace Period Expiry Checker	This scheduled task delegates the attestation process after the grace period expires.	None	Yes
Automated Retry of Failed Async Task	This scheduled task retries Async Tasks (JMS Messages) that have failed. If the execution of the task succeeds, it is removed from the list of failed tasks. If it fails, the retry count is incremented. The maximum number of times a Failed Task is retried is determined by the 'maxRetries' defined for that task in async-messaging.xml.	None	Yes
Automatically Unlock User	This scheduled task automatically unlocks a user after the specified number of days. This job supports job frequency in days, minutes, and hours. As password policy in supports lockout duration in minutes, It is recommended to keep the frequency of this scheduled job in minutes.	None	Yes
Bulk Load Archival Job	This scheduled task cleans up the processed entries in the Oracle Identity Manager Database staging tables used during bulk load post processing.	<ul style="list-style-type: none"> <li>• <b>Archival Date:</b> This attribute specifies the date up to which the records will be purged. It must have a value. The format is <b>ddMMyyyy</b> or <b>MMM dd, yyyy</b>.</li> <li>• <b>Batch Size:</b> Database records are cleaned up in batches. This attribute specifies the size of the batch and must have a value. The default is 1000.</li> </ul>	No



Table 17-2 (Cont.) Predefined Scheduled Tasks

Job Name	Description	User-Configurable Attributes	Enabled By Default
Bulk Load Post Process	This scheduled task starts post processing jobs for the Bulk Load Utility.	<ul style="list-style-type: none"><li>• Batch Size for Processing Records: User records are processed in batches. This attribute specifies the size of the batch and must have a value. The default is 500.</li><li>• Generate Password: This attribute specifies whether a password will be automatically generated when users are created with the Bulk Load Utility. It must have a value of Yes or No; the default is Yes.</li><li>• Ldap Sync: This attribute specifies whether users created in Oracle Identity Manager using the Bulk Load Utility will also be created in the LDAP repository in an LDAP enabled environment. This attribute must have a value of Yes or No; the default is No.</li><li>• Notification: This attribute specifies whether users created using the Bulk Load Utility will be notified with an email. It must have a value of Yes or No; the default is Yes.</li><li>• Process User Ids: This attribute specifies the range of user keys (in the Oracle Identity Manager Database) that need to be processed. The keys are associated with the users created using the Bulk Load Utility. It defines a range from start (From:) to finish (To:).</li></ul>	No

Table 17-2 (Cont.) Predefined Scheduled Tasks

Job Name	Description	User-Configurable Attributes	Enabled By Default
Catalog Synchronization Job	The scheduled task is used to harvest roles, application instances, and entitlements into the catalog. It is also used to load catalog metadata.	<p><b>Mode:</b> The Catalog Synchronization Job scheduled job can be run in the following modes:</p> <ul style="list-style-type: none"> <li>• <b>Incremental:</b> Updates catalog entries based on the Update Date parameter. Only data changed on or after this date is refreshed in the catalog.</li> <li>• <b>Full:</b> Refreshes the entire catalog from the source entities. All the data in the catalog is replaced.</li> <li>• <b>Metadata:</b> Updates or adds metadata columns of catalog items based on the supplied CSV file. The CSV file should contain details of the existing catalog items. It should contain Catalog_ID or ENTITY_TYPE, ENTITY_KEY of the existing catalog item.</li> <li>• <b>Technical Glossary:</b> Loads data in the catalog that represent hierarchical attributes of entitlements based on external source (XML).</li> <li>• <b>Recalculate Tags:</b> Refreshes CATALOG TAGS column using CATALOG.USER_DEFINED_TAGS and other searchable CATALOG attributes. The same values can be used in keyword search.</li> </ul>	Yes
Certification Event Trigger Job	<p>This scheduled task is responsible for running event listeners against the set of user modification events that have occurred in the system. All event listeners will be executed by default if none are listed in the Event Listener Name List parameter.</p> <p>See Configuring Event Listeners and Certification Event Trigger Jobs in <i>Performing Self Service Tasks with Oracle Identity Governance</i> for more information.</p>	Event Listener Name List: This is a comma-separated list of event listeners to be evaluated. If no value is specified for this attribute, then all event listeners will be evaluated.	No

Table 17-2 (Cont.) Predefined Scheduled Tasks

Job Name	Description	User-Configurable Attributes	Enabled By Default
Certification Maintenance Job	This job populates the required data for pre-upgrade certifications. If you are using an upgraded deployment of Oracle Identity Manager, then run this job to access certifications from Certification Dashboard UI. See <i>Accessing Pre-Upgrade Certifications in the Dashboard in Performing Self Service Tasks with Oracle Identity Governance</i> for information about populating pre-upgrade certifications in the Dashboard by running this scheduled job.	<ul style="list-style-type: none"> <li>Batch Size: Number of certifications to process in a thread.</li> <li>Number of Concurrent Threads: Number of processing threads used by Certification Maintenance Job for parallel processing. This attribute should be updated depending on the OIM host capabilities and performance requirements.</li> </ul>	Yes
Certification Comments Mining Job	This schedule job computes and store the latest comments for each entity line item from last completed certification if available or from the request justification.	Mine Comments OOTB Value: No	No
<div style="border-left: 2px solid #0070C0; border-right: 2px solid #0070C0; border-bottom: 2px solid #0070C0; padding: 10px; background-color: #E6F2FF;"> <p> <b>Note:</b></p> <p>To ensure the comments are populated, the value of this attribute must be changed to <b>Yes</b>.</p> </div>			
DataCollection Scheduled Task	This scheduled task is used to populate data from Oracle Identity Manager operational tables to the staging tables in an offline manner. The scheduled task is set to run manually, and is triggered when Oracle Identity Analytics (OIA) invokes the DataCollectionOperationsIntf->startDataCollection API.	None	Yes

Table 17-2 (Cont.) Predefined Scheduled Tasks

Job Name	Description	User-Configurable Attributes	Enabled By Default
Delayed Delete User	<p>This scheduled task automatically deletes the user whose delete date is before the start of today.</p> <p>The XL.UserDeleteDelayPeriod system property indicates the number of days after which the user is to be deleted. When the administrator deletes a user, the user is marked in the Disabled state, and the user's 'Automatically Delete On' date is set for the future date after the number of days indicated in the XL.UserDeleteDelayPeriod system property.</p> <p>This scheduled task finds all such users for whom the 'Automatically Delete On' date is less than the start of today. All those users are marked as Deleted.</p> <p>For example, Jane Doe is a user with '2014-03-24 01:55:00' as the 'Automatically Delete On' date, and John Doe is a user with '2014-03-25 18:55:00' as the 'Automatically Delete On' date. When the scheduler is run on '2014-03-25', only Jane Doe is deleted. John Doe will be deleted when the scheduler runs on '2014-03-26'.</p> <p><b>Note:</b> See <a href="#">Default System Properties in Oracle Identity Governance</a> for information about the XL.UserDeleteDelayPeriod system property.</p> <p><b>Note:</b> Oracle recommendation is to run this scheduled task once per day.</p>	None	No

Table 17-2 (Cont.) Predefined Scheduled Tasks

Job Name	Description	User-Configurable Attributes	Enabled By Default
Deleted User Account Clean Up Job	This scheduled task removes sensitive data of deleted users, such as user attributes and account data.	<p><b>User Login(s):</b> This is a comma-separated list of deleted user login(s). If this list includes any active user, then an error message is displayed. Check the <i>diag_log</i> and <i>diag_log_dtls</i> tables for details.</p> <p>For diagnostic logging and debugging information during or after the scheduled task execution, see <a href="#">Using PL/SQL Unified Diagnostic Logging and Debugging Framework</a>.</p>	No
	<div style="border-left: 2px solid #0070C0; border-right: 2px solid #0070C0; padding: 10px;"> <p> <b>Note:</b></p> <p>Transitional data, such as reconciliation events, might have parts of relevant user data, which is taken care of by regular data purge utilities. If archival tables are used, such data persists in archival tables.</p> <p>Running the Deleted User Account Clean Up Job does not clean up certification campaigns for the users under consideration. As base records for users are completely cleaned up meanwhile, a detailed review of such users from certification campaign may not work.</p> </div>		
Disable Hierarchical Entitlement Task	This scheduled task cleans up the hierarchy from the TARGET_HIERARCHICAL_DATA table and deletes the assigned indirect entitlements.	<ul style="list-style-type: none"> <li>• <b>Application Name:</b> Use this field to specify the name of the application.</li> <li>• <b>Nested Object Name:</b> Use this field to identify the name of the nested group object. Example: Use <b>groups</b> for AD target.</li> <li>• <b>Number of Threads:</b> Use this attribute to specify the total number of threads.</li> </ul>	Yes

Table 17-2 (Cont.) Predefined Scheduled Tasks

Job Name	Description	User-Configurable Attributes	Enabled By Default
Disable/Delete User After End Date	An end date is defined when a user account is created. This scheduled task disables user accounts for which the end date had passed the current date at the time when the task is run.  <b>Note:</b> Oracle recommendation is to run this scheduled task every 30 minutes or 1 hour.	None	Yes
Enable User After Start Date	A start date is set when a user account is created. This scheduled task enables user accounts for which the start date has passed, and the user status is Disabled Until Start Date. These users are enabled through this scheduled task, thereby making the users ACTIVE.	None	Yes
Entitlement Assignments	This scheduled task populates Entitlement Assignment schema from child process form table whose field, Entitlement is marked as true.	RECORDS_TO_PROCESS_IN_BATCH: Number of records to process in a batch.	No
Entitlement List	This scheduled task populates Entitlement schema from the lookup table whose child process form field Entitlement is marked as true.	Auto Publish: When the value of this field is true, the entitlement is automatically published to the organization that is already part of the application instance. The default value of this field is true.  If the value is false, then the entitlement is not published to the organization that is already part of the application instance.	No
Entitlement Post Delete Processing Job	This scheduled task is used for post-processing of entitlement soft deletion in the provisioning component. It is used to revoke or delete entitlements that have been soft-deleted. It can be run in the following modes: <ul style="list-style-type: none"> <li>• <b>Revoke:</b> Revokes the entitlement-grant for all the accounts in Oracle Identity Manager, which have that specific entitlement granted.</li> <li>• <b>Delete:</b> Hard-deletes the entitlements from the UD_CHILD table.</li> </ul> Irrespective of the mode, the entitlement grant entry is removed from the ENT_ASSIGN table.	None	Yes

Table 17-2 (Cont.) Predefined Scheduled Tasks

Job Name	Description	User-Configurable Attributes	Enabled By Default
Evaluate User Policies	This scheduled task evaluates the access policies.	<p>Number of Threads: Use this attribute to specify the total number of threads that will process re-evaluation. The default value is 20.</p> <p>Batch Size: Use this attribute to fetch number of records from the database to be processed in one iteration. The default value is 500.</p> <p>Time Limit in mins: Use this attribute to specify time in minutes, after which the schedule task will stop. By default, this attribute is not specified and disabled. You must enable and configure the time.</p>	Yes
Form Upgrade Job	<p>This scheduled task updates the form version to the latest active version and the form data to the value specified during the field's creation for all accounts.</p> <p><b>Note:</b> If this scheduled task is not run, then the form version and data will be incorrect in the audit snapshot and the reporting tables.</p>	<ul style="list-style-type: none"> <li>Application Instance Name: Name of the application instance. The default value is "ALL."</li> <li>Batch Size: Use this attribute to fetch number of records from the database to be processed in one iteration. The default value is 500.</li> </ul>	Yes
Get SOD Check Results Approval	This scheduled task gets back the result of SoD Evaluation from the SoD Server, for example, OAACG, SAP, and GRC for all requests waiting for SoD Check results. It reflects the SoDCheckResult and violation in appropriate dataset attributes. It will pick up all requests that are in 'SoD check result pending' state and mark them as 'SoD check completed'.	None	No
Get SOD Check Results Provisioning	This scheduled task gets back the result of SoD Evaluation from the SoD Server, for example, OAACG, SAP, and GRC for all pending SoDCheck provisioning tasks. It reflects the SoDCheckResult and violation in appropriate process form attributes.	None	No

Table 17-2 (Cont.) Predefined Scheduled Tasks

Job Name	Description	User-Configurable Attributes	Enabled By Default
Hierarchy Search Recon Task	This scheduled task populates the hierarchy details from the target system to the new OIG database table <b>TARGET_HIERARCHICAL_DATA.</b>	<ul style="list-style-type: none"> <li>Application Name: Use this field to specify the name of the application.</li> <li>Object Type: Use this field to identify the type of the object. <b>Example:</b> Object Type = Group</li> <li>Parent Attribute Name: Use this field to specify the name of the parent groups. <b>Example:</b> Parent Attribute Name = memberOf for AD target</li> <li>Attribute Name: Use this field to specify the attribute name. <b>Example:</b> Attribute Name = __NAME__</li> <li>Form Name: Use this field to specify the name of the form. <b>Example:</b> Form Name = groups</li> </ul>	Yes
Hierarchical Entitlement Processing Task	This scheduled task calculates and assigns/revokes the indirect entitlements between the users for a given application and the nested object name.	<ul style="list-style-type: none"> <li>Application Name: Use this field to specify the name of the application.</li> <li>Nested Object Name: Use this field to specify the name of the nested group object name. The value for Nested Object Name is <b>groups</b> for AD target.</li> <li>Number of Threads: Use this field to specify the number of threads to be used while calculating and assigning or revoking the indirect entitlements.</li> </ul>	Yes

 **Note:**

The Hierarchical Entitlement Processing task is performance intensive operation. You must enable the task only if required. To return to the earlier behavior, you must run the Disable Hierarchical Entitlement job.



**Table 17-2 (Cont.) Predefined Scheduled Tasks**

Job Name	Description	User-Configurable Attributes	Enabled By Default
Identity Audit Scan Cleanup	<p>This scheduled task processes existing detective scan runs and purges old data from the tables used to store history of users and policies connected with the scan runs. Records are purged from the IDA_SCAN_RUN_POLICIES and IDA_SCAN_RUN_USERS tables.</p> <p>To retain the history, enable the job and schedule it to run periodically based on the activity in the system.</p>	<p>Number of Threads: Use this field to specify the number of threads to be used while running a scan cleanup job. Default value is 4.</p> <p>Scan Run Batch Size: Use this field to specify the number of scan run entities per batch for a single processing thread. Default value is 20.</p>	No
Issue Audit Messages Task	<p>This scheduled task fetches audit message details from the aud_jms table and sends a single JMS message for a particular identifier and auditor entry in the aud_jms table. An MDB processes the corresponding audit message.</p>	<p>Max Records: Use this attribute to specify the maximum number of audit messages to be processed for a specified scheduled task run. The default value of this attribute is 400.</p>	Yes

**Table 17-2 (Cont.) Predefined Scheduled Tasks**

Job Name	Description	User-Configurable Attributes	Enabled By Default
Job History Archival	This scheduled task is designed to archive/purge entries for Job History.	Archival Date: Use this attribute to specify date till which the records need to be archived/purged. Supported archival date format is ddMMyyyy.	No

 **Note:**

Archival Date parameter is auto incremented by one day on each job execution. So job should be scheduled with daily frequency to work as expected.

Batch Size: Use this attribute to specify the size of a batch in which the records must be processed.

Operation Type: Use this attribute to specify the operation type. This attribute can have two possible values, Archive and Purge.

The default value is Archive.

Table 17-2 (Cont.) Predefined Scheduled Tasks

Job Name	Description	User-Configurable Attributes	Enabled By Default
Non Scheduled Batch Recon	This scheduled task tries to process all the events created by non scheduled task based connectors such as PeopleSoft. Such connector created events are in either Event Received State or Data Received State, they only get processed if the batch size specified by the set of events is reached or via this scheduled task. This task executes as per settings to pick up all the unprocessed non scheduled task based events and submits them to the reconciliation engine for processing.	None	No
OIM Certification Purge Job	This scheduled task is used to purge data from the certification tables. It provides for some critical parameters to be specified or configured (although default values are available for these), such as retention period, run duration, and purge criteria, for online and continuous purge of data in the background.	For information about the user-configurable attributes, see <a href="#">Configuring Real-Time Certification Purge Job</a> .	No
<div style="border-left: 2px solid #0070C0; border-right: 2px solid #0070C0; border-bottom: 2px solid #0070C0; padding: 10px; background-color: #E6F2FF;"> <p> <b>Note:</b></p> <p>By default, the OIM Certification Purge Job is seeded with default values for input parameters, such as purge interval and purge retention period. You must revisit the input parameters to change their default values as required.</p> </div>			
OIM Data Purge Job	This scheduled task is used as a single unified interface for archive/purge of data for the Requests, Reconciliation, Provisioning Tasks, and Orchestration entities. It provides for some critical parameters to be specified/configured (although default values are available for these), such as retention period, run duration, and purge criteria, for online and continuous purge of data in the background.  <b>Note:</b> By default, the OIM Data Purge Job scheduled job is seeded in the enabled state with a retention period of 90 days. You must revisit the job parameters to disable or to change the purge interval as required.	For information about the user-configurable attributes, see <a href="#">Configuring Real-Time Purge and Archival</a> .	Yes

Table 17-2 (Cont.) Predefined Scheduled Tasks

Job Name	Description	User-Configurable Attributes	Enabled By Default
OIM Entitlement Assignment History Purge Job	The scheduled task is used for archive/purge of data for the Entitlement Assignment History table.	For information about using Entitlement Assignment History Purge, see .	No
Password Expiration Task	This scheduled task sends e-mail to users whose password expiration date had passed at the time when the task was run and then updates the USR_PWD_EXPIRED flag on the user profile.	Email Definition Name: Name of the email definition created in the Design Console for sending password expired notification to the user. The default value is "Password Expired".	Yes
Password Warning Task	This scheduled task sends e-mail to users whose password warning date had passed at the time when the task was run and then updates the USR_PWD_WARNED flag on the user profile.	Email Definition Name: Name of the email definition created in the Design Console for sending password expiration warning notification to the user. The default value is "Password Expiration Warning".	No
Process Pending Role Grants	This scheduled task is responsible for processing of future role grants. It grants the role for which start date has reached and revokes the role if role grant end date has reached. This task is scheduled to run daily.	None	Yes
Reconciliation Retry Scheduled Task	This scheduled task processes the failed reconciliation event for the users whose status is set as Failed.	None	Yes
Refresh Materialized View	The materialized view is used to generate reports related to reconciliation. This view needs to be updated periodically (at a specified interval, for instance, once a day).	None	No
Refresh Organization Memberships	This evaluates the organization memberships and assigns users to organizations based on rules. This job evaluates all the organizations whose membership rules have changed since the last job run and their immediate evaluation have not been opted by the administrator.	None	Yes
Refresh Role Memberships	This evaluates the role memberships and assigns users to roles based on rules. This job evaluates all the roles whose membership rules have changed since the last job run and their immediate evaluation have not been opted by the administrator.	None	Yes

Table 17-2 (Cont.) Predefined Scheduled Tasks

Job Name	Description	User-Configurable Attributes	Enabled By Default
Remove Audit Log Entries	<p>This scheduled task is used to permanently remove audit log events which are older than a specified number of days. On job completion, the scheduled task will add a single audit log event in AUDIT_EVENT table recording the number of records removed from the database, the job return code, and an error message if the job fails.</p> <p>For more information on how to control audit data growth in Lightweight audit framework, see <a href="#">About Audit Data Growth Control Measures in Lightweight Audit Framework</a>.</p>	<ul style="list-style-type: none"> <li>Batch Size: The number of records to be removed as a batch. Default value is 500.</li> <li>Maximum Job Duration (in Mins): Default value is 30 minutes.</li> <li>Remove Audit Log Events older Than (in days): Audit events whose date is older than this value will be permanently deleted from the audit event table. Default value is 180 days.</li> </ul>	Yes
Remove Open Tasks	<p>This scheduled task removes information about open tasks from the table that serves as the source for the list displayed in Oracle Identity System Administration.</p>	<p>Day Limit</p> <p>Number of days for which information about an open task should be retained in the table before the information is deleted</p> <p>By default, this attribute is not specified and disabled. You must enable and configure the time.</p>	No
Request Execution Scheduled Task	<p>This is a periodic scheduled task searches for requests with status "Request Awaiting Completion" and moves requests forward to the next stage "Operation Initiated" if the effective date set during the request submission is prior or equal to the current date.</p>	<p>Job Periodic Settings: Use this attribute to specify the time interval for the scheduled task to be run.</p> <p>The default value is 6 hours.</p>	Yes
Resubmit Uninitiated Approval SODChecks	<p>This scheduled task tries to initiate SoD Check for pending requests, which have SoDCheckStatus as "SoD check not initiated" or "SoD check completed with error". The pending requests are the ones for which SoD initiation failed in first try and are pending for some level of approval.</p>	None	No
Resubmit Uninitiated Provisioning SODChecks	<p>This scheduled task tries to initiate SoD Check by submitting a JMS message for all pending SoDCheck provisioning tasks. The SoD Check initiation may have failed because of SoD server being down at the time of entitlement add/update via direct provisioning.</p>	None	No

Table 17-2 (Cont.) Predefined Scheduled Tasks

Job Name	Description	User-Configurable Attributes	Enabled By Default
Retry Failed Orchestrations	This scheduled task retries all failed orchestrations based on the attribute values provided. If there is no parameter value defined, no orchestration will be retried.	<ul style="list-style-type: none"> <li>Orchestration ID: This attribute takes a comma separated list of Orchestration Ids to be retried.</li> <li>Entity Type: Orchestrations submitted for the given Entity will be retried.</li> <li>Operation: Orchestrations submitted for given Operation will be retried.</li> <li>Stage: Orchestrations on the given stage will be retried.</li> <li>From Date: Orchestrations submitted after the given date will be retried. The format is <b>ddMMyyyy</b> or <b>MMM dd, yyyy</b>.</li> <li>To Date: Orchestrations submitted before given date will be retried. The format is <b>ddMMyyyy</b> or <b>MMM dd, yyyy</b>.</li> </ul>	No
Retry Reconciliation Batch Job	This scheduled task is used to re-process batches with the 'Ready for Processing' status.	Batch ID: This is the comma-separated ID of the batches to be retried.	No
Risk Aggregation Job	This scheduled task is used for calculating the risk summary value for users, roles, and accounts based on their item-risk and risk-factor levels as defined in the system <b>Note:</b> See About Risk Aggregation and Risk Summaries in the <i>Performing Self Service Tasks with Oracle Identity Governance</i> for more information.	<ul style="list-style-type: none"> <li>Number of Concurrent Threads: No Use this attribute to specify the number of threads that process risk aggregation.</li> <li>User Batch Size: Use this attribute to specify the number of users that must be processed in each thread.</li> </ul>	No
Run Future Dated Reconciliation Events	This scheduled task processes the current dated reconciliation event for the users whose status is set as Deferred.	None	No
Set User Deprovisioned Date	A deprovisioning date is defined when a user account is created. For users whose deprovisioning date had passed at the time when this scheduled task was run, the task sets the deprovisioned date as the current date.	None	Yes
Set User Provisioned Date	This scheduled task sets the provisioned date to the current date for users for whom all of the following conditions are true: <ul style="list-style-type: none"> <li>The provisioning date is in the past.</li> <li>The deprovisioned date has not been set.</li> <li>The deprovisioning date has not been reached or is NULL.</li> </ul>	None	Yes

Table 17-2 (Cont.) Predefined Scheduled Tasks

Job Name	Description	User-Configurable Attributes	Enabled By Default
Seed Home Organization	<p>This scheduled task evaluates and updates organization data for existing users based on configured Home Organization Policy. For more information, see <a href="#">Managing the Home Organization Policy</a>.</p> <p>Ensure that Home Organization Policy rule for organization evaluation is configured correctly, and the organization should already exist in Oracle Identity Manager.</p> <p>This job can be run for environments that are based on LDAP synchronization. For information about LDAP synchronization, see Enabling LDAP Synchronization in Oracle Identity Manager in <i>Oracle Fusion Middleware Integration Guide for Oracle Identity Management Suite</i>.</p> <p>Example scenario for LDAP synchronization: During first time identity data sync from the directory server to Oracle Identity Manager, you want to sync organizations based on a rule, which is based on, say department number. To do so:</p> <ol style="list-style-type: none"> <li>1. Run the User Create/Update Full Reconciliation scheduled job. This creates users with default organizations provided within the job parameter.</li> <li>2. Create a home organization rule, and run the Seed Home Organization scheduled job with <code>Reset Home Organization</code> option as <b>Yes</b>. This overwrites organizations based on the configured rule.</li> </ol> <p><b>Note:</b> Run the Seed Home Organization scheduled job with <code>Reset Home Organization</code> option as <b>Yes</b> with caution because organizations will be overwritten.</p>	<p>Batch Size: Use this attribute to fetch number of entries from the persistent store in each query.</p> <p>Reset Home Organization: Use this attribute to determine if the organization value of default users will be re-evaluated and overwritten. Select one of the following options:</p> <ul style="list-style-type: none"> <li>• <b>No:</b> If the requirement is to set the organization value for users that do not have any value.</li> <li>• <b>Yes:</b> If the requirement is to reset the organization value for all users. This re-evaluates and overrides the organization value for all nondefault users. This option re-evaluates the rule for all existing user data and resets the organization value. If you run the scheduled job with this option selected, then data will be overwritten. The <b>No</b> option is the default for this scheduled job.</li> </ul>	No
Sunrise of Accounts and entitlements	<p>This scheduled task sets the status of an account to ENABLE when the start date of the account is reached.</p> <p>In the case of entitlements, this scheduled task grants an entitlement to an account when the start date of the entitlement is reached.</p> <p><b>Note:</b> This task impacts only the accounts and entitlements provisioned directly or through a request.</p>	<ul style="list-style-type: none"> <li>• Application Instance Name: Name of the application instance. The default value is "ALL."</li> <li>• Max Execution Time: Use this attribute to specify time in minutes, after which the schedule task will stop. The default value is empty.</li> <li>• Process Entity Types: Use this attribute to specify whether the task should process accounts or entitlements. The default value is "ALL."</li> </ul>	Yes

Table 17-2 (Cont.) Predefined Scheduled Tasks

Job Name	Description	User-Configurable Attributes	Enabled By Default
Sunset of Accounts and entitlements	<p>This scheduled task sets the status of an account to REVOKE or DISABLE when the end date of the account is reached.</p> <p>In the case of entitlements, this scheduled task revokes an entitlement from an account when the end date of the entitlement is reached.</p> <p><b>Note:</b> This task impacts only the accounts and entitlements provisioned directly or through a request.</p>	<ul style="list-style-type: none"><li>• Account Sunset Action: Use this attribute to specify whether the status of the accounts should be set to REVOKE or DISABLE. The default value is REVOKE.</li><li>• Application Instance Name: Name of the application instance. The default value is "ALL."</li><li>• Max Execution Time: Use this attribute to specify time in minutes, after which the schedule task will stop. The default value is empty.</li><li>• Process Entity Types: Use this attribute to specify whether the task should process accounts or entitlements. The default value is "ALL."</li></ul>	Yes
Task Escalation	This scheduled task escalates pending tasks whose escalation time had elapsed at the time when the scheduled task was run.	None	Yes
Task Timed Retry	This scheduled task creates a retry task for rejected tasks whose retry time has elapsed and whose retry count was greater than zero.	None	Yes



Table 17-2 (Cont.) Predefined Scheduled Tasks

Job Name	Description	User-Configurable Attributes	Enabled By Default
Update Accounts with App Instance Job	<p>This scheduled task is used to ensure that application instance keys are populated for all entries in the OIU table.</p> <p>In some instances, the application instance might not be available when the account is provisioned. This is possible when:</p> <ul style="list-style-type: none"> <li>• Oracle Identity Manager is upgraded, when app_instance_key is to be populated for all the existing entries in the OIU table.</li> <li>• Accounts are brought in via reconciliation, but the application instances are not available when the accounts are reconciled. The application instances are created after the reconciliation.</li> <li>• Accounts are provisioned via access policies, but the application instances are not available when the accounts are provisioned. The application instances are created after the provisioning.</li> </ul> <p>The Update Accounts with App Instance Job scheduled task checks all the entries in the OIU table corresponding to the resource objects that have a null app_instance_key. It attempts to determine the application instance key based on the obj_key and the IT Resource instance value in the process form. If the scheduled task finds an application instance corresponding to the obj_key and IT resource instance value, then it updates the app_instance_key in the OIU table.</p>	None	Yes
User Operations	<p>This scheduled task performs the operation specified by the UserOperation attribute on the user account specified by the UserLogin attribute.</p>	<ul style="list-style-type: none"> <li>• UserLogin: User ID of the user on the account.</li> <li>• UserOperation: Operation that you want to perform on the user account. The value of this attribute can be ENABLE, DISABLE, or DELETE.</li> </ul>	No

Table 17-2 (Cont.) Predefined Scheduled Tasks

Job Name	Description	User-Configurable Attributes	Enabled By Default
User Password Upgrade Task	This scheduled task is used to enable the No Password Propagation Support feature in OIG by setting the value of the <i>No Password Propagation Support</i> system property to True.	<ul style="list-style-type: none"> <li>Batch Size for Processing Records: User records are processed in batches. This attribute specifies the size of the batch and must have a value. The default is 500.</li> <li>Status for initiating the task: This task is executed if the value of the status is INITIATE. After the job is run successfully, this is changed to STOPPED. It is recommended not to change this status or run this job again. This job changes the login behavior of OIG, hence it should be executed with prior consultation.</li> </ul>	No
User Profile Audit Compression	This job compresses the uncompressed user profile audit data and reduces the size of UPA table.	<ul style="list-style-type: none"> <li><b>Number of Threads:</b> The number of threads to be executed during the job run. This is a required parameter and the default value is 2.</li> <li><b>Batch Size:</b> The size of the batch for the job run. This is a required parameter and the default value 1000.</li> <li><b>Time Limit in mins:</b> Time for which you want to run the job. This is an optional parameter and the default value is 90.</li> </ul> <p>See <a href="#">#unique_438</a> for information about user profile audit data compression.</p>	No

### 17.4.3 Creating Custom Scheduled Tasks

You can create your own scheduled task metadata, develop the scheduled task class, package it in a JAR file, and upload the JAR file to MDS.

#### See Also:

Developing Scheduled Tasks in *Developing and Customizing Applications for Oracle Identity Governance* for detailed information about creating a scheduled task.

To create a custom scheduled task:

1. Create the scheduled task XML file and seed it in MetaData Store (MDS).
2. Develop the schedule task class and package it in a Jar.

### 3. Upload the Jar by:

#### Using Plug-ins:

You can upload the jar using the Plug-in Framework provided by Oracle Identity Manager.

To upload the jar using plug-ins:

- a. Create the plugin.xml file.
- b. Create the directory structure (plugin.zip) for the scheduled task.
- c. Place the ZIP file in the file store (the *OIM\_HOME*/plugins/ directory) or database store.

#### Using DB:

You can upload the jar in the database (DB) of Oracle Identity Manager.

To upload the jar using DB:

Upload the jar in DB using UploadJar utility. You can run this utility from the following location:

```
$OIM_HOME/bin/
```

#### See Also:

Upload Jar Utility in *Developing and Customizing Applications for Oracle Identity Governance* for information about running the Upload Jar utility

## 17.5 Managing Jobs

A job is a task that can be scheduled to run at the specified interval. A job run is a specific execution of a job. Each job run includes information such as the start time, stop time, job status, exceptions and status of the execution.

This section contains the following topics:

- [Creating Jobs](#)
- [Editing or Viewing the Job](#)
- [Modifying Jobs](#)
- [About Disabling and Enabling Jobs](#)
- [Disabling and Enabling Jobs](#)
- [Starting and Stopping Jobs](#)
- [Deleting Jobs](#)

## 17.5.1 Creating Jobs

Use the **Create Job** page in the Scheduler section of Identity System Administration to create a new job.

 **Note:**

- The procedure described in this section assumes that the XML file for the scheduled task, which contains the job description is available in the `OIM_HOME/metadata/file` directory.

To create a job:

1. Log in to Oracle Identity System Administration with the appropriate credentials.

 **Note:**

For OIG Bundle Patch 12.2.1.4.2210XX and later, please refer to the updated navigation path provided in the topic [Creating Jobs \(1\)](#)

2. In the left pane, under **System Configuration**, click **Scheduler**.

The **Advanced Administration** is displayed with the Scheduler section in the System Management tab active.

3. On the left pane, from the **Actions** menu, select **Create**. Alternatively, you can click the icon with the plus (+) sign beside the View list.
4. On the **Create Job page**, enter values in the following fields under the Job Information section:
  - **Name:** Enter a name for the job.
  - **Template:** Specify the template of the scheduled task that runs the job.
  - **Start Date:** Specify the date and time on which you want the job to run. To do this, select the date and time along with timezone from the date editor and click **Ok**. By default, the timezone is "(UTC-08:00) US Pacific Time".
  - **Retries:** Retry count is used to manage the job in case of failure in the scheduler framework during job execution. If a job fails to execute due to the scheduler framework failure 'n' times consecutively ( 'n' is the retry count) , then the job is disabled. The job must be enabled from the UI for further execution in this case.

 **Note:**

When a job fails due to any reason other than the scheduler framework, then this retry count is not affected and the job will not be disabled.

- **Schedule Type:** Depending on the frequency at which you want the job to run, select one of the following schedule types:

- **Periodic:** Select this option if you want the job to be run at a time that you specify, on a repeating basis. If you select this option, then you must enter an integer value in the Run every field under the Job Periodic Settings section and select one of the following values:
    - mins
    - hrs
    - days
  - **Single:** Select this option if the job is to be run only once at the specified start date and time.
  - **None:** This option specifies that no schedule is attached to the job you are creating, and therefore, it is not triggered automatically. As a result, the only option to trigger the job is by clicking **Save and Run Now**.
  - **Sub Types:** Select the sub category type for the job.
5. Enter the following values in the **Parameters** section:

 **Note:**

The following values are dynamic and change depending on the job template that you select.

- **Flat File Path:** Enter the path of CSV file for seeding metadata or directory path containing XML for seeding technical glossary.
  - **Batch Size:** Enter the size of the batch.
  - **Thread Size:** Enter the Thread size.
  - **Mode:** Enter the mode.
6. Enter values in the following fields under the **Scheduling Failed Notification** section:
- **Beneficiary:** Select the Beneficiary type to whom the scheduled job failure notification email is sent.
    - User Login
    - Role Name
    - Specified Address
  - **Send To:** Enter the User Login, Role name or specific email id to which scheduled job failure notification email is sent.
7. Click **Next**.
8. Enter the following values in **Schedule** section:

 **Note:**

This is a mandatory field.

Select one of the following schedule types:

- **Periodic:** Select this option if you want the job to be run at a time that you specify, on a repeating basis.

- **Single:** Select this option if the job is to be run only once at the specified start date and time.
  - **None:** This option specifies that no schedule is attached to the job you are creating, and therefore, it is not triggered automatically.
9. In the **Summary** section, verify if the details are correct.
  10. Select one of the following options:
    - **Create and Run Job:** Select to save and create and run the job immediately.
    - **Create:** Select to create the job.
    - **Back:** Select to go to the previous screen.
    - **Cancel:** Select to cancel the operation/.

## 17.5.2 Searching Jobs

Use the Scheduler section of Identity System Administration to perform simple and advanced search for scheduled jobs.



### Note:

The search operation is applicable only to OIG Bundle Patch 12.2.1.4.220703 and releases earlier to July 22 Bundle Patch. Use the Job Details page in Identity System Administration to view job-related information, such as job status, scheduled job failed notifications, job history information, along with a display of errors and milestones during the job search operation.

You can perform the following search operations to search for jobs in the Oracle Identity Administration:

- [Performing a Simple Search for Jobs](#)
- [Performing an Advanced Search for Jobs](#)

### 17.5.2.1 Performing a Simple Search for Jobs

To perform a simple search for jobs:

1. In the Welcome page of the Advanced Administration, under System Management, click **Search Scheduled Jobs**. Alternatively, you can click the **System Management** tab, and then click **Scheduler**.
2. On the left pane, in the **Search** field, specify the search criterion for the job that you want to locate. You can also include wildcard characters in the search criteria.
3. Click the icon next to the Search field. A list of all jobs that meet the search criterion is displayed.

The search results are displayed in a tabular format with the following columns:

- **Job Name:** This column displays the name of the job. If you want to view the details of the job, then click its name in the column.
- **Status:** This column displays the status of the Job. A job can be in any one of the following statuses:

- **Running:** The job is currently running.
- **Stopped:** The job is currently not running. However, the job will run again at the date and time specified in the Next Scheduled Run field.
- **Interrupt:** The job is interrupted while running. This status may appear if admin server go down in between while job is running.
- **Failed:** The Job was failed to execute due to some reasons.

## 17.5.2.2 Performing an Advanced Search for Jobs

To perform an advanced search for scheduler:

1. On the left pane of the Scheduler section, click **Advanced Search**. The Advanced Search: Scheduled Jobs page is displayed.
2. Select any one of the following options:
  - **All:** On selecting this option, the search is performed with the AND condition. This means that the search operation is successful only when all the search criteria specified are matched.
  - **Any:** On selecting this option, the search is performed with the OR condition. This means that the search operation is successful when any search criterion specified is matched.
3. In the Job Name field, enter the job name that you want to search. You can use wildcard characters in your search criteria. Select a search condition in the list adjacent to the Job Name field. The search conditions include Not Contains, Not Begins With, Not Equals, Equals, Ends With, Not Ends With, Contains, and Begins With.
4. For the Status field, select a search condition. Then select a status: **All**, **Running**, or **Stopped**.
5. In the Task Name field, enter the task name. You can use wildcard characters in your search criteria. Select a search condition in the list adjacent to the Task Name field.
6. Click **Search**. The list of jobs that match your search criteria are displayed in the search results table.

[Table 17-3](#) lists the columns of the search results table:

**Table 17-3 Fields in the Search Results Table**

Field	Description
Job Name	The name of the scheduled job
Task	The task associated with the job
Status	The status of the job, RUNNING, STOPPED, FAILED, or INTERRUPT
Schedule	The schedule or the time for the job to run
Last Run	The time when the job ran for the last time
Enable	The job is enabled or disabled

## 17.5.3 Editing and Viewing Jobs

Use the Job Details page in Identity System Administration to view job-related information, such as job status, scheduled job failed notifications, job history information, along with a display of errors and milestones during the job search operation.

 **Note:**

The steps are applicable for OIG Bundle Patch 12.2.1.4.220703 and releases earlier to July 22 Bundle Patch. For later releases, refer to the Editing and Viewing Jobs (1)

To edit or view the details of a job:

1. Search for the job whose details you want to view.  
The **Job Details** page is divided into the following sections:
  - **Template:** Enter the template name to modify the details of the job name.
  - **Retries:** Enter the retry count for the job.
  - **Schedule Type:** Select one of the following schedule types:
    - Periodic: Select this option if you want the job to be run at a time that you specify, on a repeating basis.
    - Single: Select this option if the job is to be run only once at the specified start date and time.
    - None: This option specifies that no schedule is attached to the job you are creating, and therefore, it is not triggered automatically.
  - **Start Time:** Select the start date and time on which you want the job to run.
  - **Interval Type:** Select the interval frequency from the following drop-down options:
    - Minutes
    - Hours
    - Days
    - Weeks
    - Months
    - Yearly
  - **Minutes:** Enter the minutes by which the scheduled job needs to be run.
  - **Beneficiary:** Select the type of beneficiary from the list:
    - User Login
    - Role Name
    - Specified Address
  - **Send To:** Enter the User Login, Role name or specific email id to which scheduled job failure notification email is sent.

After viewing the details of the job, you can either modify, run, or stop the job. In addition, you can also enable or disable the job. Job Detail screen can be refreshed.



After you view the details of the job on the Job Details page, you can perform one of the following:

- If you want to modify the details of the job, then make the relevant change and click **Execute** to run the job.
- You can enable or disable by selecting either **Enable** or **Disable**.
- You can reset the values by selecting **Reset**.
- If the Disable button is enable, then it means that the job is currently enabled and you can disable the job by clicking **Disable**.
- If the Enable button is enable, then it means that the job is currently disabled and you and enable the job by clicking **Enable**.

## 17.5.4 Modifying Jobs

Use the Job Details page to modify the attributes of a scheduled job, except for the Job Name and Task fields under the Job information section and the fields under the Job Status section.

To modify a job:

1. Search and view the details of the job that you want to modify. See [Editing and Viewing Jobs](#) for information about viewing job details.

### Note:

If you want to run the job, then click the job name in the first column of the search results table and then click **Run Now**. After you click **Run Now**, you need not perform the rest of the steps in this procedure. However, if you want to modify the job and then run it, then perform the next step and click **Run Now**.

### Note:

This content applies only to OIG Bundle Patch 12.2.1.4.220703 and releases earlier to July 22 Bundle Patch. For later release, refer to the Modifying Jobs (1) Modifying Jobs (1) in Performing Self Service Tasks with Oracle Identity Governance.

2. On the Job Details page, you can modify all the details of the job, except for the Job Name and Task fields under the Job information section and the fields under the Job Status section. See Step 4 of [Creating Jobs](#) for details about the fields that you want to modify.
3. Click **Apply** to commit the changes made on the Job Details page to the database.  
A message confirming that the job has been successfully modified is displayed.

## 17.5.5 About Disabling and Enabling Jobs

You can disable a job that is currently enabled, and enable a job that has been disabled earlier.

On the Job Details page:

- If the Enabled button is enable, then it means that the job is currently disabled and you can enable it by clicking **Enable**. A job that has been enabled will run only when one of the following is true on the Job Details page:

- The date and time displayed in the **Start Date** field matches the current date and time.
- The date and time displayed in the **Next Scheduled Run** field matches the current date and time.
- If the Disabled button is enable, then it means that the job is currently enabled and you can disable the job by clicking **Disable**. A job that has been disabled will not run even when the date and time on which the job has been scheduled to run matches the current date and time.

## 17.5.6 Disabling and Enabling Jobs

Use the Job Details page to enable or disable a scheduled job.

To enable or disable a job:

1. In the **Job Results** table, select the job name you want to enable or disable.
2. Select **Enable** or **Disable**. Depending on whether you click **Enable** or **Disable**, a message indicating that the job has either been successfully enabled or disabled is displayed.
3. Click **OK** to close the dialog box.

## 17.5.7 Starting and Stopping Jobs

In addition to scheduling jobs to run automatically at the specified time, you can manually start or stop a job at any given time.

For example, you create and schedule a job that runs every Friday. However, if you want to run the job on any day other than Friday, then you must run the job manually.

**To start or stop a job:**

1. Search for the job that you want to start or stop by performing the procedure described in [Searching Jobs](#).
2. On the left pane, in the search results table, click the job name of the job that you want to start or stop.

### **Note:**

By default, the status of all jobs is STOPPED unless a job is running.

3. If you want to start a job, then from the Actions list, click **Run Now**.  
A dialog box prompting you to confirm if you want to run the job is displayed.
4. If you want to stop a job, then from the Action list, click **Stop**.  
A dialog box prompting you to confirm if you want to stop the job is displayed.
5. Click **OK**.

## 17.5.8 Deleting Jobs

Use the Manage Scheduler section under the Manage tab to delete scheduled jobs that are not required or are not in use.

To delete a job:

1. Navigate to the **Jobs** tab, in the search option, search for the job you want to delete by entering the name of the job.
- 2.
3. Click **Yes**. A message indicating that the job has been deleted successfully is displayed.

## 17.6 Diagnosing Scheduled Jobs

Diagnose issues related to scheduled job run when the scheduled job is not running according to the scheduled time.

This section describes how to diagnose issues related to scheduled job run.

- [Schedule Job Errors](#)
- [Resolving the Schedule Job Errors](#)
- [#unique\\_451](#)

### 17.6.1 Schedule Job Errors

Typical scheduled job errors include no job run at the specified time, no entry in the JOB\_HISTORY table for the run, and no exceptions recorded in the server logs.

Scheduled job is not running according to the scheduled time, and the following is observed:

- Scheduled job is not run on the scheduled time.
- No entry exists in JOB\_HISTORY table for this run. This can be verified by opening the job details in the Scheduler section of Identity System Administration.
- No exceptions are recorded in the server logs.

### 17.6.2 Resolving the Schedule Job Errors

Diagnosing scheduled job errors include activities such as, enabling scheduler logging, and verifying that scheduler is running, the job is enabled, and clocks are in sync on all nodes.

To diagnose this issue:

1. Verify whether scheduler service is running or not. Scheduler service is deployed on each node of the cluster until this service is not explicitly disabled. This can be disabled by setting the `scheduler.disabled` server level property to `false` for that node. The following URL can be used to verify the status of the scheduler service:

`http://OIM_HOST:OIM_PORT/SchedulerService-web/status`

In this URL, `OIM_HOST` is the name of the computer hosting the Oracle Identity Manager server and `OIM_PORT` is the port on which Oracle Identity Manager server is listening.

2. Verify whether the specific job is enabled or not. This can be verified from the Scheduler section of Identity System Administration. The job must be enabled to run per the schedule.
3. Verify whether clocks are in sync for all nodes. Clocks must be within a second of each other
4. Delete the existing trigger from Scheduler UI, and schedule a new trigger from the UI. Verify whether the issue persists or not.

5. Enable scheduler logs by changing log level to `DEBUG`. This can be done by changing log level for the `oracle.iam.scheduler.impl` package from Oracle Enterprise Manager. Verify whether the following messages are traced in logs or not:

```
Job Listener, Job was executed '$JOB_NAME'  
Job Listener, Job to be executed '$JOB_NAME'
```

Here, `$JOB_NAME` is the name of the job that is supposed to be executed at that time.

If the messages are not logged, then contact Oracle Support.

6. In Oracle Enterprise Manager, check the `threadPoolSize` parameter for the `schedulerConfig` segment in the `oim-config.xml` file. This is the number of threads that are available for concurrent execution of jobs. Therefore, the number of jobs that can be executed on a particular time cannot be more than the configured `threadPoolSize` count. Running of such jobs is skipped and executed as per the next scheduled time, which gives an impression that the job is not executed per the scheduled time. The default value of this parameter is 10, but it can be tuned as required.
7. Restart the server and verify whether the job has been run or not.
8. Verify whether the following exception is logged:

```
Caused By: java.lang.NullPointerException at  
org.quartz.SimpleTrigger.computeNumTimesFiredBetween(SimpleTrigger.java:800)
```

Run following query to fix this issue:

```
UPDATE QRTZ92_TRIGGERS SET NEXT_FIRE_TIME=1 WHERE NEXT_FIRE_TIME<1;
```

9. Sometimes the trigger status is not updated in the `QRTZ92_TRIGGER` table from `BLOCKED` to `PAUSED` state. This situation happens if the environment is not tuned properly, and database connections from the pool are exhausted by other parallel operations running on the server. As a result, QUARTZ framework is not able to get connection from the pool to update the running job. This situation can be identified if exceptions related to database connection pool is observed in the server logs. Usually, such triggers get fixed after server restart, but if trigger status still remains the same, then running the following query can help:

```
UPDATE QRTZ92_TRIGGERS SET TRIGGER_STATUS='WAITING' WHERE JOB_NAME = '$JOB_NAME'
```

Replace `$JOB_NAME` with the job name.

10. Sometimes manual trigger for a job is not updated in the `QRTZ92_TRIGGER` table. Manual trigger is created in the system when you execute the job by clicking **Run Now** from the Scheduler UI or use the Scheduler `runNow()` API. Such trigger is supposed to be deleted after the job is executed successfully. To fix this issue:

- a. Shutdown the server.

- b. Run the following queries on Oracle Identity Manager database:

```
DELETE FROM QRTZ92_FIRED_TRIGGERS where TRIGGER_NAME like ('MT_%');  
DELETE FROM QRTZ92_SIMPLE_TRIGGERS where TRIGGER_NAME like ('MT_%');  
DELETE FROM QRTZ92_TRIGGERS where TRIGGER_NAME like ('MT_%');
```

Automatic deletion of such manual triggers is maintained by the Quartz framework.

# 18

## Managing Notification Service

Managing notification involves understanding the notification service, managing notification providers and notification templates, configuring email notification in various workflows, disabling notification, and troubleshooting notification issues.

The notification templates and notification providers are described in the following sections:

- [About Notification Providers](#)
- [Managing Notification Providers](#)
- [Managing Notification Templates](#)
- [Configuring Email in Provisioning Workflow](#)
- [Configuring SOA Email Notification](#)
- [Disabling Oracle Identity Governance Email Notifications](#)
- [Troubleshooting Notification](#)

### 18.1 About Notification Providers

Information about events occurring in Oracle Identity Manager is required to be sent to various users, such as requesters, beneficiaries, or administrators. This information about events is sent by using the notification service in the form of notification e-mail messages. The notification service allows you to perform all notification-related operations.

An event is an operation that occurs in Oracle Identity Manager, such as user creation, request initiation, or any custom event created by the user. The events are generated as part of business operations or via generation of errors. Event definition is the metadata that describes the event. To define metadata for events, it is important to identify all event types supported by a functional component. For example, as a part of the scheduler component, metadata can be defined for scheduled job execution failed and shutting down of the scheduler. Every time a job fails or the scheduler is shut down, the events are raised and notifications associated with that event are sent.

The data available in the event is used to create the content of the notification. The different parameters defined for an event help the system to select the appropriate notification template. The different parameters that are defined for an event help the system decide which event variables can be made available at template design time.

A notification template is used to send notifications. These templates contain variables that refer to available data to provide more context to the notifications. The channel through which a notification is sent is known as the notification provider. Examples of such channels are e-mail, Instant Messaging (IM), Short Message Service (SMS), and voice. To use these notification providers, Oracle Identity Manager uses Oracle User Messaging Service (UMS).

At the backend, the notification engine is responsible for generating the notification, and utilizing the notification provider to send the notification.

## 18.2 Managing Notification Providers

Managing notification providers includes using UMS, SMTP, and SOA composite for notification, configuring custom notification provider, and enabling and disabling notification providers.

Managing notification providers is described in the following sections:

- [Using UMS for Notification](#)
- [Using SMTP for Notification](#)
- [Using SOA Composite for Notification](#)
- [Configuring Custom Notification Provider](#)
- [Disabling and Enabling Notification Providers](#)

### 18.2.1 Using UMS for Notification

Using UMS for notification ensures support for a variety of messaging channels and robust delivery of messages. Configuring UMS for notification involves enabling UMS for notification and applying OWSM policy to the UMS web service.

This section describes how to use UMS for notification in the following topics:

- [About UMS for Notification](#)
- [Enabling Oracle Identity Governance to Use UMS for Notification](#)
- [Applying OWSM Policy to the UMS Web Service](#)

#### 18.2.1.1 About UMS for Notification

UMS offers various capabilities for sending notifications. These capabilities are used by Oracle Identity Manager notification engine to achieve the following:

- **Support for a variety of messaging channels:** Messages can be sent and received through e-mail, IM, SMS, and voice. Oracle Identity Manager supports sending notification messages only via e-mail.
- **Robust message delivery:** UMS keeps track of delivery status information provided by messaging gateways, and makes this information available to applications so that they can respond to a failed delivery.

#### 18.2.1.2 Enabling Oracle Identity Governance to Use UMS for Notification

To enable Oracle Identity Governance to use UMS for notification:

1. Configure UMS properties by using the `UMSEmailNotificationProviderMBean` MBean. To do so:
  - a. Log in to Oracle Enterprise Manager.
  - b. Click **Application Deployments**.
  - c. Right-click **OIMAppMetadata(11.1.2.0.0)(oim\_server\_name)**, and select **System MBean Browser**.

- d. In the System MBean Browser, navigate to **Application Defined MBeans, oracle.iam, Server: oim\_server\_name, Application: oim, IAMAppRuntimeMBean**, and select **UMSEmailNotificationProviderMBean**.
- e. In the Attributes tab, enter the information listed in [Table 18-1](#):

**Table 18-1 Parameters in Attributes Tab**

Attribute	Description
Policies	The Messaging UMS web service is used for integration between Oracle Identity Manager and UMS. This Web Service can be secured via Oracle Web Services Manager (OWSM) policy. If OWSM policy is attached to the Messaging web service at server level, then provide the name of the corresponding client side policy. Otherwise, leave the field blank. For example, if oracle/wss11_username_token_with_message_protection_service_policy is applied at the server level, then provide the corresponding client policy name here, such as oracle/wss11_username_token_with_message_protection_client_policy.
WSUrl	This is the URL of the UMS Web service to be started. By default, it contains the URL of the Messaging UMS web service used for integration between Oracle Identity Manager and UMS. You can use any other SOA server, for example: http://SOA_HOST:SOA_PORT/ucs/messaging/webService Here, replace SOA_HOST with the host name of the SOA server and SOA_PORT with the port number to connect to the SOA server.
CSFKey	This is the UMS e-mail notification provider credential store (CSF) key name. The key name is populated by default. This key is in the oracle.wsm.security map. You can find the oracle.wsm.security map as follows: <ol style="list-style-type: none"> <li>i. In Oracle Enterprise Manager, expand <b>WebLogic Domain</b>.</li> <li>ii. Right-click the base domain, and select <b>Security, Credentials</b>. The Credentials page is displayed.</li> <li>iii. In the Credential column, expand the oracle.wsm.security map.</li> </ol>

[Figure 18-1](#) shows the properties of the UMSEmailNotificationProviderMBean in the Attributes tab of the System MBean Browser.

**Figure 18-1 UMSEmailNotificationProviderMBean Properties**

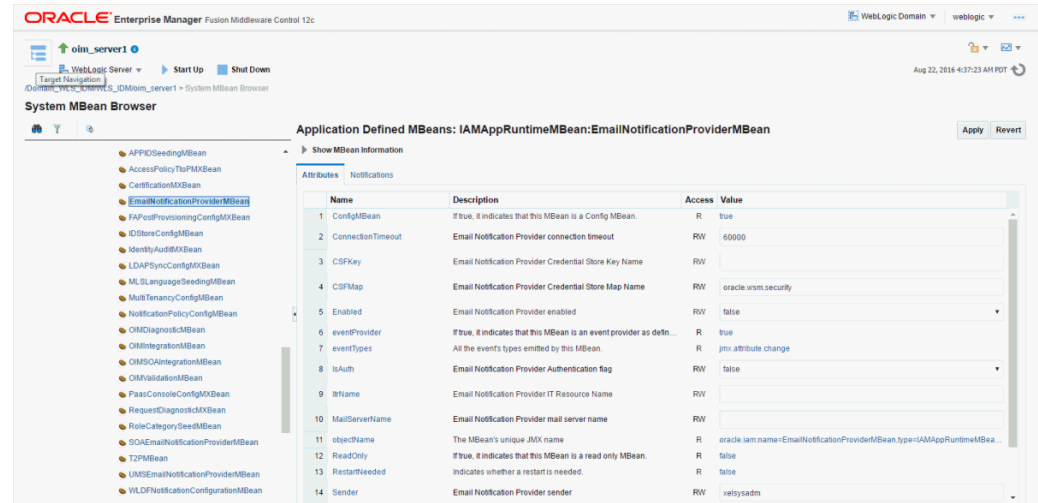

- f. Click **Apply**.
2. If Oracle Identity Manager and UMS server are in different domains, then you must import the UMS public key into Oracle Identity Manager domain's keystore, and must import Oracle Identity Manager domain's public key into the UMS keystore.

 **See Also:**

Configuring Oracle User Messaging Service in *Administrator's Guide for Oracle SOA Suite and Oracle Business Process Management Suite* for details about UMS Web service security.

3. Configure the e-mail driver. There is no default configured e-mail driver. The e-mail driver must be configured explicitly.

To create the e-mail driver:

- a. Go to the Target Navigation by clicking the table icon beside the domain name.
- b. Expand **User Messaging Service**.
- c. Click **usermessagingdriver-email (soa\_server1)**.
- d. Select the User Messaging Email Driver drop down.
- e. Click **Email Driver Properties**.
- f. Click **Create** to create the driver.
- g. Provide values for the following and save:
  - Name: EmailDriver1 (example value)
  - Select Capability : SEND
  - Outgoing Mail Server : localhost (example value)
  - Outgoing Mail Server Port : 25 (example value)
4. If mail server security is SSL, then you must remove DemoTrust store references from the SOA environment. To do so:



- a. In a text editor, open the `DOMAIN_HOME/bin/setDomainEnv.sh` file. Open `setDomainEnv.bat` file for Microsoft Windows.
- b. Remove the following line:
 

```
-Djavax.net.ssl.trustStore=$WL_HOME/server/lib/DemoTrust.jks from
EXTRA_JAVA_PROPERTIES
```
- c. Save and close the file.
- d. In a text editor, open the `DOMAIN_HOME/bin/startManagedWeblogic.sh` file. For Microsoft Windows, open the `startManagedWeblogic.bat` file.
- e. Remove the following `weblogic.security.SSL.trustedCAKeyStore` property set in `JAVA_OPTIONS` from this file:
 

```
JAVA_OPTIONS="-Dweblogic.security.SSL.trustedCAKeyStore="{MW_HOME}/server/
server/lib/cacerts" ${JAVA_OPTIONS}"
```
- f. Save and close the file.
- g. Restart the Admin and Managed servers.

 **Note:**

For more details on configuring UMS to connect to a mail server with SSL, see "Configuring Oracle User Messaging Service" in *Administrator's Guide for Oracle SOA Suite and Oracle Business Process Management Suite*.

5. Edit the username and password in the CSF key. To do so:
  - a. In Oracle Enterprise Manager, expand **WebLogic Domain**.
  - b. Right-click the base domain, and select **Security, Credentials**. The Credentials page is displayed.
  - c. In the Credential column, expand the **oracle.wsm.security** map.
  - d. Select the record for the **Notification.Provider.Key** credential key.
  - e. On the toolbar, click **Edit**. The Edit Key dialog box is displayed.
  - f. Edit the values in the User Name and Password fields, and click **OK**.

### 18.2.1.3 Applying OWSM Policy to the UMS Web Service

Server-side OWSM policy can be applied to the UMS Web service to protect any other Web service that uses EM. The corresponding client side policy, username, and password must be provided in the provider XML or via MBean.

- [Attaching Server-Side Policy to the UMS Web Service](#)
- [Attaching Server-Side Username and Password](#)

#### 18.2.1.3.1 Attaching Server-Side Policy to the UMS Web Service

To attach server-side policy to the UMS Web Service:

1. In Oracle Enterprise Manager, expand **User Messaging Service**, and click **usermessagingserver (soa\_server)**.
2. From the User Messaging Service list, select **Web Services**.

3. In the Web Service Details section, click the **Web Service Endpoints** tab.
4. In the Endpoint Name column, click **Messaging**.
5. Click the **OWSM Policies** tab.
6. Under Directly Attached Policies, click **Attach/Detach**. A list of available policies and the options to attach and detach policies are displayed.
7. Select a policy from the available policies list, and click **Attach**. The selected policy is added to the Directly Attached Policies list.  
The policy you select is for securing the Messaging UMS web service.
8. To remove a policy, under Directly Attached Policies, select a policy and click **Detach**. The selected policy is removed from the Directly Attached Policies list.
9. To validate the applied policy combination, click **Validate**. A message is displayed stating that the validation is successful.
10. Click **OK**.

### 18.2.1.3.2 Attaching Server-Side Username and Password

To provide the corresponding client-side policy to the UMSEmailProviderMBean, provide the name of the client-side policy in the UMSEmailNotificationProviderMBean MBean. To do so:

1. Login to Oracle Enterprise Manager.
2. Go to **Application Deployments**. Right-click **OIMAppMetadata(11.1.2.0.0)(oim\_server1)**, and select **System MBean Browser**.
3. Go to **Application Defined MBeans, oracle.iam, Server: oim\_server1, Application: oim, IAMAppRuntimeMBean, UMSEmailNotificationProviderMBean**.

[Table 18-2](#) lists the properties of the UMSEmailProviderMBean.

**Table 18-2 UMSEmailNotificationProviderMBean Properties**

Property	Description
Enabled	A notification provider is used to send the notification e-mail if value for this property is true.
Type	In this release of Oracle Identity Manager, this value is EMAIL only, and the property is not used.
ItrName	Various configuration values required to send the e-mail via UMS, can be either provided in XML properties or IT resource. If configuration values are to be read from IT resource, then provide the name of the IT resource here. If the IT resource name is present, than the IT resource configuration settings are used. If IT resource name is incorrect or invalid, or the values given in the IT resource instance are invalid, then an error is generated and email is not sent.  <b>Note:</b> Using the IT resource is not a recommended channel to configure UMS in Oracle Identity Manager. This is because there is no mechanism to validate the values provided in the XML or IT resource before sending the e-mail to the server.
WSUrl	The URL of UMS Web service to be invoked. Any SOA server can be used, in the following format: <code>http://SOA_HOST/SOA_PORT/ucs/messaging/webservice</code>

**Table 18-2 (Cont.) UMSEmailNotificationProviderMBean Properties**

Property	Description
CSFKey	This is the default notification key under oracle.wsm.security.map. This key contains username and password required for OWSM policy. The default and recommended username/password in this key is the WebLogic administrator username and password. This can be changed to any valid username/password on the server side, which is SOA. See step 5 in <a href="#">Enabling Oracle Identity Governance to Use UMS for Notification</a> for information about editing the default values in CSF key by using Oracle Enterprise Manager.
Policies	If OWSM policy is attached to the given Web service at server level, then provide the name of the corresponding client side policy here. Otherwise, leave this field blank. For example, if oracle/wss11_username_token_with_message_protection_service_policy is applied at server level, then provide the corresponding client policy name here, such as oracle/wss11_username_token_with_message_protection_client_policy.
KeystoreAlias	The keystore alias for the target service. For details about the keystore alias, see "Client Aliases" in the <i>Oracle Fusion Middleware Administrator's Guide for Oracle SOA Suite and Oracle Business Process Management Suite</i> .
Sender	A valid username of any Oracle Identity Manager User. The e-mail ID of this user is used to send the e-mail.

4. Provide the client-side policy name in the policies properties shown in this MBean.

### 18.2.1.4 Changing UMS Client Connection Pooling

For performance enhancement, Oracle Identity Manager creates a pool for UMS client object. The default pool configurations are as follows:

Configuration parameter	Value
abandonedConnectionTimeout	600ms
connectionWaitTimeout	60ms
inactiveConnectionTimeout	300000ms
initialPoolSize	5
maxPoolSize	40
minPoolSize	10
timeoutCheckInterval	30ms
connectionPoolingSupported	true

You can change these default values by passing the following system properties along with new values while starting the Oracle Identity Manager server.

System Properties	Description
ums.ucp.abandonedConnectionTimeout	For abandoned connection timeout
ums.ucp.connectionWaitTimeout	For connection wait timeout
ums.ucp.inactiveConnectionTimeout	For inactive connection timeout
ums.ucp.initialPoolSize	For initial pool size

System Properties	Description
ums.ucp.maxPoolSize	For maximum pool size
ums.ucp.minPoolSize	For minimum pool size
ums.ucp.timeoutCheckInterval	For timeout check interval
ums.ucp.connectionPoolingSupported	For connection pooling supported

For example, to change initial pool size property (initialPoolSize), you can configure the system property in the following manner:

```
sh startManagedWebLogic.sh oim_server1  
-Dums.ucp.initialPoolSize=10
```

## 18.2.2 Using SMTP for Notification

Using SMTP for notification involves configuring the SMTP email notification provider properties and adding the CSF key.

By default, the SMTP Email Notification Provider is disabled. This is enabled by setting the value of the enabled attribute to true.

- [Configuring the SMTP Email Notification Provider Properties](#)
- [Adding the CSF Key](#)
- [Enabling SSL for the SMTP Notification Provider](#)

### 18.2.2.1 Configuring the SMTP Email Notification Provider Properties

To configure SMTP Email Notification Provider properties by using the EmailNotificationProviderMBean MBean:

1. Login to Oracle Enterprise Manager.
2. Click **Application Deployments**.
3. Right-click **OIMAppMetadata(11.1.2.0.0)(oim\_server1)**, and select **System MBean Browser**. The System MBean Browser is displayed.
4. Navigate to **Application Defined MBeans, oracle.iam, Server: oim\_server1, Application: oim, IAMAppRuntimeMBean, EmailNotificationProviderMBean**. All the attributes of the EmailNotificationProviderMBean MBean is displayed in the Attributes tab.

[Figure 18-2](#) shows the properties of EmailNotificationProviderMBean in the Attributes tab of the System Mbean Browser.

Figure 18-2 EmailNotificationProviderMBean Properties

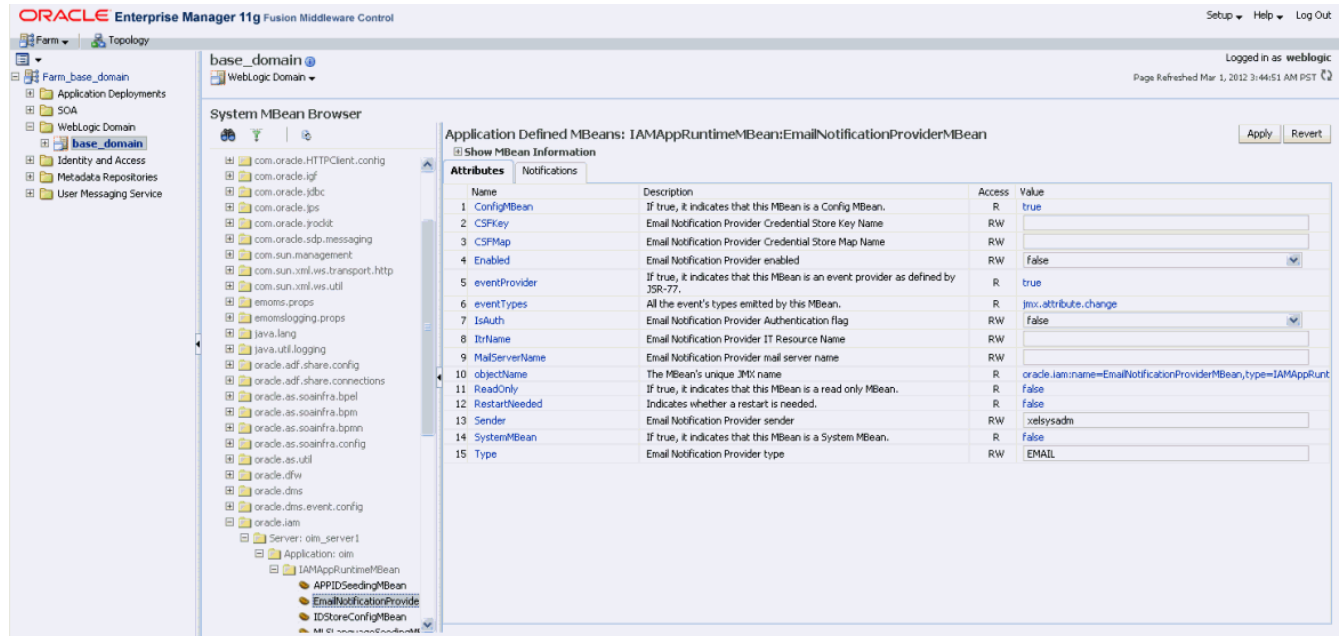

Table 18-3 describes the properties of Default SMTP Email notification provider.

Table 18-3 Default SMTP Email Notification Provider Properties

Property	Description
Enabled	This property derives the status of the notification provider. If the value of this property is false, then the provider is inactive. To activate the provider, change the value to true.
Type	This property determines the type of the notification provider. Oracle Identity Manager supports only Email type.
IsAuth	If the value of this flag is false, then authentication is not required at mail server. As a result, you do not need to provide the CSFKey and CSFMap values. But this depends on the mail server in use. Most of the mail servers support this flag. If any mail server does not support this flag, then authentication credentials must be provided in CSFKey and corresponding CSFMap.
ItrName	If you want to provide connectivity information via IT resource instance of type Mail Server, then provide the name of IT resource instance here. This is not a recommended option.
CSFMap	This property determines the name of the existing CSF Map, for example oim and oracle.wsm.security.

**Table 18-3 (Cont.) Default SMTP Email Notification Provider Properties**

Property	Description
CSFKey	This property takes the name of the key that contains the authentication credentials, which are username and password. This key must exist under the map name. By default, one key with name Notification.Provider.Key is available under oracle.wsm.security map. This key is used for UMS Email notification provider.  If UMS email provider is disabled, then use the same map and key to provide the username and password required at mail server for authentication. Otherwise, create a new key under any of the default maps, and provide the name of map and key in these properties.  Adding a CSF key is described later in this section.
ConnectionTimeout	This is in milliseconds. This is required for setting a maximum time for connection establishment.
MailServername	This is the name of mail server.
Sender	This is the sender used in Oracle Identity Manager for sending the emails.

### 18.2.2.2 Adding the CSF Key

To add a CSF key:

1. Login to Oracle Enterprise Manager.
2. Expand **WebLogic Domain**.
3. Right-click **base\_domain**, and select **Security, Credentials**.
4. Expand **oracle.wsm.security**, and then click **Create Key**.
5. Create a key of type password. Provide the key name, description, username, and password. Click **OK**.

### 18.2.2.3 Enabling SSL for the SMTP Notification Provider

To enable SSL-related properties for the SMTP notification provider:

1. Login to Oracle Enterprise Manager.
2. Click **Application Deployment**.
3. Right-click **OIMAppMetadata(oim\_server1)**, and select **System MBean Browser**.  
The System MBean Browser is displayed.
4. Navigate to **Application Defined MBeans, oracle.iam, Server: oim\_server1, Application: oim, IAMAppRuntimeMBean, EmailNotificationProviderMBean**.
5. For the `SSLEnabled` property, provide the value as **true**.
6. Click **Apply**.

### 18.2.3 Using SOA Composite for Notification

Using SOA composite for notification involves creating a SOA composite with notification activity, deploying the SOA composite on the SOA server, setting workflow notification

properties, configuring the SOA email notification provider properties, and configuring the user messaging drivers.

By default, the SOA Email Notification Provider is disabled. You can enable this notification provider by changing the value of the enabled property to true.

To use SOA composite in Oracle Identity Manager for notification perform the below listed procedure in the given order :

- [Creating a SOA Composite with Notification Activity](#)
- [Deploying the SOA Composite on the SOA Server Manually](#)
- [Setting Workflow Notification Properties](#)
- [Configuring the SOA Email Notification Provider Properties](#)
- [Configuring the User Messaging Drivers](#)

### 18.2.3.1 Creating a SOA Composite with Notification Activity

Create a SOA composite with notification activity. For details, see Using the Notification Service in *Developer's Guide for Oracle SOA Suite*.

Figure 18-3 shows the sample mapping of the composite payload via Expression Builder.

**Figure 18-3 Sample Mapping of Composite Payload**

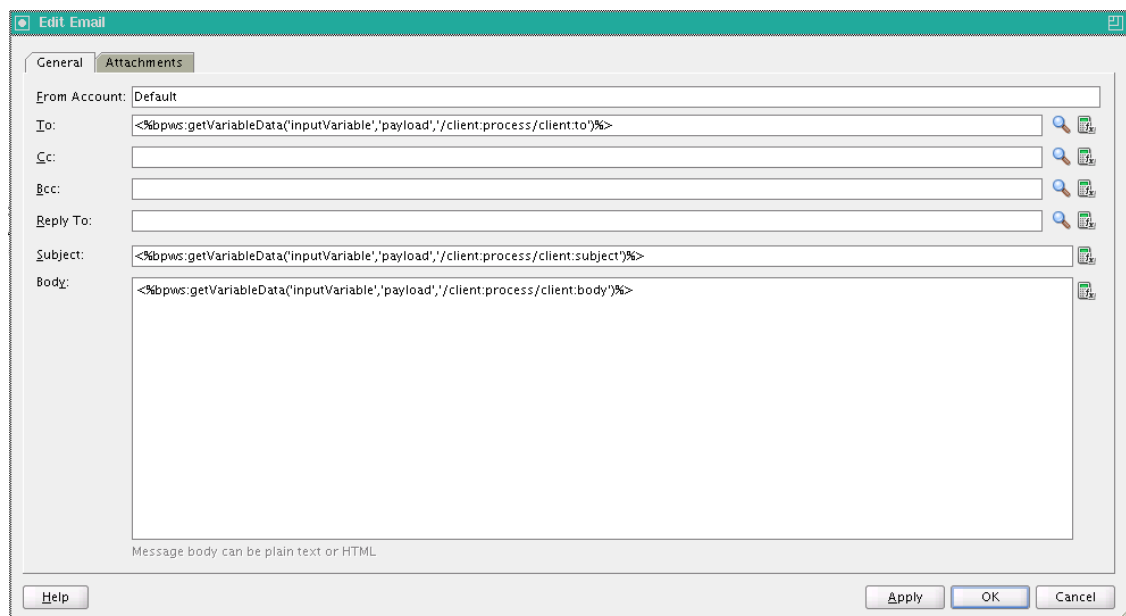

### 18.2.3.2 Deploying the SOA Composite on the SOA Server Manually

Manually deploy the SOA composite on the SOA server. To do so:

1. Create an application connection. To do so:
  - a. Open the SOA composite in JDeveloper.
  - b. Create a new Application Server Connection by right-clicking the project and selecting **New, Connections, Application Server Connection**.

- c. Name the connection as `SOA_server`, and click **Next**.
  - d. Select WebLogic 10.3 as the Connection Type.
  - e. Enter the authentication information. The typical values are:  
**Username:** weblogic  
**Password:** `PASSWORD`
  - f. On the Connection screen, enter the hostname, port, and SSL port for the SOA Admin server or Admin server, and enter the name of the WebLogic domain.
  - g. Click **Next**.
  - h. On the Test screen, click **Test Connection**. Verify that the success message is displayed.
2. Deploy the project. To do so:
    - a. Right-click the project, select **deploy**, select the project name. Select the **to** option to create the application connection, which is `SOA_server`. Verify that the build successful message is stored in the log.
    - b. Enter the default revision, and click **OK**. Verify that the Deployment Finished message is stored in the deployment log.

### 18.2.3.3 Setting Workflow Notification Properties

Using Enterprise Manager, navigate to **soa-infra**. Right-click **soa-infra**, and select **SOA Administration, Workflow Properties**. Under Workflow Notification Properties, select **ALL** from the drop down to set the Notification Mode to ALL.

### 18.2.3.4 Configuring the SOA Email Notification Provider Properties

Configure the SOA Email Notification Provider properties by using the `SOAEmailNotificationProviderMBean` MBean. To do so:

1. Log in to Oracle Enterprise Manager.
2. Expand **Application Deployments**. Right-click **OIMAppMetadata(11.1.2.0.0) (oim\_server1)**, and select **System MBean Browser**.
3. Navigate to **Application Defined MBeans, oracle.iam, Server: oim\_server1, Application: oim, IAMAppRuntimeMBean, SOAEmailNotificationProviderMBean**.

Change the value of the enabled property from false to true in the `SOAEmailNotificationProviderMBean`. [Figure 18-4](#) shows the properties of the Bean of SOA Email notification provider.



Figure 18-4 SOAEmailNotificationProviderMBean Properties

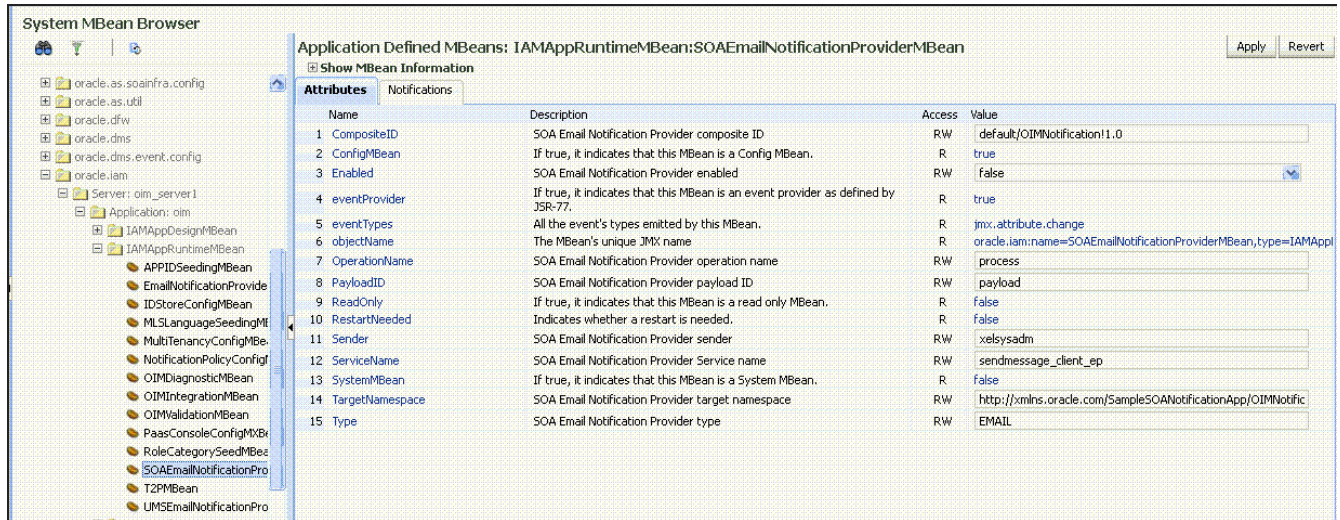

Table 18-4 lists some of the properties of the SOA Email Notification Provider.

Table 18-4 SOA Email Notification Provider Properties

Property	Description
Enabled	This property derives the status of the notification provider. If the value of this property is false, then the provider is inactive. To activate the provider, change the value to true.
Type	This property determines the type of the notification provider. Oracle Identity Manager supports only Email type.
CompositeID	This represents the name of the SOA composite. Name includes pkg/Name!version.
ServiceName	This is the name given to the service in the SOA composite.
OperationName	This is the name given to the process in the SOA composite.
PayloadID	This is the name given to the payload in the SOA composite.
TargetNamespace	This is the name of the targetNamespace given in various XMLs generated while creating the SOA composite.
Sender	This is the sender used in Oracle Identity Manager for sending the emails.

### 18.2.3.5 Configuring the User Messaging Drivers

Configure the user messaging drivers, if required. If you do not specify values for the user messaging drivers, then the local Linux mail server is used by default. To use any other mail server:

1. Log in to Oracle Enterprise Manager.
2. Navigate to **User Messaging Service, usermessagingdriver-email (soa\_server1), Email Driver Properties** in Driver-Specific Configuration.
3. Configure the following mandatory values:
  - **OutgoingMailServer:** Name of the SMTP server, for example, stbeehive.oracle.com.

- **OutgoingMailServerPort:** Port of the SMTP server, for example, 465.
- **OutgoingMailServerSecurity:** The security setting used by the SMTP server. Possible values can be None, TLS, or SSL.
- **OutgoingUsername:** Any valid username, similar to firstname.lastname@abc.com.
- **OutgoingPassword:** Select **Indirect Password, Create New User**. Provide a unique string for Indirect Username/Key, for example, OIMEmailConfig. This will mask the password and not expose it in clear text in the config file. Provide a valid password for this account.

#### See Also:

Configuring the Email Driver in *Administrator's Guide for Oracle SOA Suite and Oracle Business Process Management* for more information about configuring user messaging drivers.

## 18.2.4 Configuring Custom Notification Provider

You can configure and use a custom notification provider, other than the default notification providers, for sending notifications.

To configure a custom notification provider:

1. Implement a custom Notification Provider class extending the `oracle.iam.notification.provider.NotificationProviderBase` base class.
2. Create a JAR file, for example `Notification_provider.jar`, containing this class.
3. Create an XML file similar to the following:

```
<beans xmlns="http://www.springframework.org/schema/beans"\\\\" xmlns:xsi="http://
www.w3.org/2001/XMLSchema-instance"\\\\" xmlns:util="http://www.springframework.org/
schema/util"\\\\" xsi:schemaLocation="http://www.springframework.org/schema/beans
http://www.spri ngframework.org/schema/beans/spring-beans-2.0.xsd http://
www.springframework.org /schema/util http://www.springframework.org/schema/util/
spring-util-2.0.xsd" def ault-lazy-init="true">
<bean id="<Name of custom Provider>" class="<Class having custom provider logic
e.g.oracle.iam.notification.provider.CustomProvider>" lazy-init="true">
<!--Mandatory Attributes-->
<property name="enabled" value="<true>" />
<property name="type" value="EMAIL" />
<!--Optional Attributes-->
<property name="sender" value="SYSTEM_ADMINISTRATOR_USERNAME" />
</bean>
</beans>
```

When the value of the `enabled` property name is `true`, then this custom provider is used for sending notifications. You can add more properties to this spring bean XML of the custom notification provider, as required.

4. Import the XML file to MDS by using Oracle Enterprise Manager. For information about exporting and importing metadata files to and from MDS, see *Migrating User Modifiable Metadata Files in Developing and Customizing Applications for Oracle Identity Governance*.
5. Package all the files as a plug-in.zip file. The structure of the custom notification provider plug-in is:

- The lib/ directory:  
Notification\_provider.jar
- The plugin.xml file

 **See Also:**

Developing Plug-ins in *Developing and Customizing Applications for Oracle Identity Governance* for information about the concepts related to plug-in and how to develop and use a plug-in.

## 18.2.5 Disabling and Enabling Notification Providers

The notification providers, such as UMS notification provider or EmailNotificationProvider, can be disabled or enabled by using Oracle Enterprise Manager.

For example, to disable UMS notification provider:

1. Login to Enterprise Manager.
2. Go to **Application Deployments**.
3. Right-click **OIMAppMetadata(11.1.2.0.0)(oim\_server1)**, and select **System MBean Browser**. The System MBean Browser pane is displayed.
4. Go to **Application Defined MBeans, oracle.iam, Server: oim\_server1, Application: oim, IAMAppRuntimeMBean**.
5. Select **UMSEmailNotificationProviderMBean**.
6. In the Attributes tab, from the Value list corresponding to the Enabled attribute, select **false** to disable UMS notification provider. To enable UMS notification provider, select **true**.
7. Click **Apply**.

## 18.3 Managing Notification Templates

A notification template, which contains variables that refer to available data to provide more contexts to the notifications, is used to send notifications. Managing notification templates include searching, creating, modifying, enabling and disabling, and deleting notification templates, adding and removing locales to and from notification templates, and configuring notification for a proxy.

This section describes about notification templates in the following topics:

- [Default Notification Template](#)
- [Searching for a Notification Template](#)
- [Creating a Notification Template](#)
- [Modifying a Notification Template](#)
- [Disabling a Notification Template](#)
- [Enabling a Notification Template](#)
- [Adding Locales to a Notification Template](#)
- [Removing Locales from a Notification Template](#)

- [Deleting a Notification Template](#)
- [Configuring Notification for a Proxy](#)

## 18.3.1 Default Notification Template

Default notification templates are available for various notification scenarios, such as for bulk requests, proxies, password generation, warning, expiry, and reset, and request creation and status change.

Oracle Identity Manager provides a set of default notification templates, as shown in [Table 18-5](#).

**Table 18-5 Default Notification Templates**

Notification Template	Description
Add Proxy Notification	Template to send notification after a proxy has been added for a user
Bulk Request Creation	Template to send notification during a bulk request creation
Create User Self Service Notification	Template to send notification after a new user is created
End Date	Template to send notification to the manager when end date of the reportee expires
Forgotten Username Notification	Template to send notification after user submits the Forgotten Username form
Generated Password Notification	Template to send notification after a password is generated by Oracle Identity Manager
Password Expired Notification	Template to send notification after password has expired
Password Warning Notification	Template to send notification before password expires
Request Creation	Template to send notification during a request creation
Request Identity Creation	Template to send notification during a Create User request
Request Status Change	Template to send notification during a request status change
Reset Password	Template to send notification after password has been reset
User Deleted	Template to send notification to the manager when the user account of the reportee is deleted as a result of expired end date

## 18.3.2 Searching for a Notification Template

You can perform a simple search or an advanced search for a notification template by using the Identity System Administration.

This section contains the following topics:

- [Performing Simple Search for a Notification Template](#)
- [Performing Advanced Search for a Notification Template](#)

### 18.3.2.1 Performing Simple Search for a Notification Template

To perform a simple search for a notification template:

1. Login to Oracle Identity System Administration.

2. In the left pane, under System Configuration, click **Notification**. Advanced Administration is displayed with the Notification tab enabled.
3. Click the icon next to the **Search** field. All the existing notification templates are displayed on the left pane, as shown in [Figure 18-5](#):

**Figure 18-5 Notification Search Result**

The screenshot shows a 'Search' window with a search bar containing an asterisk and a play button. Below the search bar is the text 'Advanced Search'. A toolbar contains 'Actions' and 'View' dropdown menus, and icons for edit, add, delete, and print. Below the toolbar is a table with two columns: 'Template Name' and 'Event Name'.

Template Name	Event Name
RequestCreation	RequestCreation
RequestIdentityCr...	CreateUser
RequestStatusCha...	RequestStatusChange
something	Sample Notification
ssss	CreateUser
Work Template	Sample Notification

4. Select the template that you want to view. The details of the selected notification template are displayed on the right pane.

### 18.3.2.2 Performing Advanced Search for a Notification Template

To perform an advanced search for a notification template:

1. In the left pane of the Advanced Administration, click **Advanced Search**. The Advanced Search page is displayed.
2. Select one of the following matching options:
  - **All:** On selecting this option, the search is performed with the AND condition. This means that the search operation is successful based on Search field with any input from the user. Search field with no input from the user is not considered.
  - **Any:** On selecting this option, the search is performed with the OR condition. This means that the search operation is successful when any search criterion specified is matched.
3. Specify the search criteria in the Template Name, Event Name, and Subject Details fields. You can remove any of these fields that you do not want to include in the search by clicking the icon next to it. You can add a field that you want to include in the search by clicking **Add Fields**, and then selecting the field name from the list.
4. Click **Search**. The search results table is displayed with details about template names, event names, and subject details.

## 18.3.3 Creating a Notification Template

Use the Notification page to create a new notification template by specifying various attributes, such as template name and description, event details, and locale information.

 **Note:**

Corresponding to each event that happens, you have to configure an XML file. The XML file defines the behavior of each event. You must first configure the XML for an event. After this is done, you can create a notification template for that event.

For information about creating the event XML file, see *Defining Event Metadata in Developing and Customizing Applications for Oracle Identity Governance*.

To create a notification template:

1. Log in to Oracle Identity System Administration.
2. In the left pane, under System Configuration, click **Notification**. The Notification page is displayed.
3. From the Actions menu, select **Create**. Alternatively, click the Create icon. The Create Template page is displayed.
4. In the Template Information section, enter values for the following fields:
  - **Template Name:** Enter the template name in this field.
  - **Description Text:** Enter a brief description of the template in this field.

 **Note:**

The Description Text field cannot be translated and is available only in English.

5. In the Event Details section, from the Available Event list, select the event for which the notification template is to be created from a list of available events. Depending on your selection, other fields are displayed in the Event Details section.
6. Under the Locale Information section, enter values in the following fields:

 **Note:**

The Default Locale information is stored in the PTY table and is fetched from there.

- To specify a form of encoding, select either UTF-8 or ASCII.
- In the **Message Subject** field, enter a subject for the notification.
- From the **Type** options, select the data type in which you want to send the message. You can choose between HTML and Text/Plain.

- In the **Short Message** field, enter a short version of the message.
  - In the **Long Message** field, enter the message that will be sent as the notification. See step 7.
7. To use the token for available data in the messages that will be sent as notification:
    - a. In the Event Details section, select the attribute from the Available Data list. This attribute will be displayed in the Selected Data field.
    - b. Copy the attribute and add it in the message text by placing it inside `{}`. For example, if selected data is `FA_Territory`, then include it in the text as `{FA_Territory}`.

Figure 18-6 shows the Create Notification Template page with sample values:

**Figure 18-6 The Create Notification Template Page**

8. After you have entered the required values in all the fields, click **Save**.
9. A message is displayed confirming the creation of the notification template. Click **OK**.

### 18.3.4 Modifying a Notification Template

Use the notification template details page to modify the attributes of a notification template.

To modify a notification template:

1. In Identity System Administration, under System Configuration, click **Notification**.
2. Search for the notification template that you want to modify.
3. Select the template that you want to modify. The details of a notification template is displayed, as shown in Figure 18-7.

Figure 18-7 Notification Template Modification

The screenshot shows the 'Notification Template Details: Generated Password Notification' page. At the top right, there are buttons for 'Cancel', 'Revert', 'Save', 'Enable', and 'Disable'. The page is divided into three main sections:

- Template Information:**
  - Template Name: Generated Password Notification
  - Description Text: To be sent after password has been
- Event Details:**
  - \* Available Event: Generated Password
- Locale Information:**
  - Language tabs: Norwegian, Dutch, Hungarian, Hebrew, English (selected), German, Simplified Chinese, Polish, Arabic
  - \* Encoding: UTF-8
  - \* Message Subject: New Account Information
  - \* Type:  HTML,  Text/Plain
  - Short Message: Generated Password
  - \* Long Message:
 

```
<html> <head> </head> <body>
<p>
An account has been created for you with the following details. You will be required
to change your password on next login.
</p><p>
UserID: $userLogin<br>
Password: $password<br>
</p><p>
For any issues, please contact [admin email or phone]
```

4. Change the values that you want to and click **Save**.
5. A message is displayed confirming the modification of the notification template. Click **OK**.

### 18.3.5 Disabling a Notification Template

Use the Notification section of the Identity System Administration to disable a notification template.

You can disable an enabled notification template in the following ways:

1. Disable by selecting the notification template in the notification search results. To do so:
  - a. In the Identity System Administration, under System Configuration, click **Notification**.
  - b. Search for the notification template that you want to disable.
  - c. Select the template that you want to disable. Note that the Disable button is active if the notification template is in enabled state.
  - d. Click **Disable**. A message is displayed prompting you to confirm the disable operation. Click **Yes**. A message is displayed confirming the disable operation.
2. Disable by opening the notification template details. To do so:
  - a. In the Identity System Administration, under System Management, click **Notification**.
  - b. Search for the notification template that you want to disable.
  - c. Click the template name to open the template details. In the notification template details page, the Disable button is active if the notification template is in enabled state, as shown in [Figure 18-7](#).



- d. Click **Disable**. A message is displayed confirming the disable operation.

## 18.3.6 Enabling a Notification Template

Use the Notification section of the Identity System Administration to enable a notification template.

You can enable a disabled notification template in the following ways:

1. Enable by selecting the notification template in the notification search results. To do so:
  - a. In the Identity System Administration, under System Configuration, click **Notification**.
  - b. Search for the notification template that you want to enable.
  - c. Select the template that you want to disable. Note that the Enable button is active if the notification template is in disabled state.
  - d. Click **Enable**. A message is displayed prompting you to confirm the enable operation. Click **Yes**. A message is displayed confirming the enable operation.
2. Enable by opening the notification template details. To do so:
  - a. In the Identity System Administration, under System Management, click **Notification**.
  - b. Search for the notification template that you want to enable.
  - c. Click the template name to open the template details. In the notification template details page, the Enable button is active if the notification template is in disabled state.
  - d. Click **Enable**. A message is displayed confirming the enable operation.

## 18.3.7 Adding Locales to a Notification Template

You can add a locale to a notification template from a list of locales that are present in Oracle Identity Manager instance.

To add locales to a notification template:

1. In the Identity System Administration, under System Configuration, click **Notification**.
2. Search and select the template to which you want to add a locale.
3. From the Actions menu, select **Add Locale**. The Add Locale page is displayed.
4. In the Locale Name field, click the icon next to the Locale Name field to select a locale from a list. After selecting the locale, and click **Confirm**.
5. Click **Next**. The Locale Information page is displayed and the locale that you added is displayed as a tab in the page.
6. In the Locale Information section, specify values for all the fields as mentioned in step 6 of [Creating a Notification Template](#), and then click **Save**. The locale is added to the template.

### Note:

Notification can be sent in all the locales that are added to the notification template. A user receives notification in the same locale specified in the user preferences. If a locale is not specified in the user preferences, then the notification is sent in the default locale. The default locale is to be specified in the PTY table in Oracle Identity Manager database at the time of installation.

## 18.3.8 Removing Locales from a Notification Template

Use the Remove Locale page to remove locales from a notification template.

To remove locales from a notification template:

1. Search for the notification template from which you want to remove a locale. Select the template from the search results table.
2. From the Actions menu, click **Remove Locale**. The Remove Locale page is displayed.
3. Click the icon next to the Locale Name field to select a locale from a list. You can remove a locale from a template only if that template contains multiple locales. You cannot remove a locale if it is the only one associated with the template. Click **Save**.
4. A message is displayed confirming the removal of the locale. Click **OK**.

### Note:

You must not remove default locale to ensure that a notification is sent every time when there is no user preferred locale is set or when notification template does not contain a locale template matching to user preferred locale.

## 18.3.9 Deleting a Notification Template

Use the Delete option in the Notification section of Identity System Administration to delete a notification template that is not required or is not in use.

To delete a notification template:

1. In the Identity System Administration, under System Configuration, click **Notification**.
2. Search for the notification template that you want to delete.
3. Select the template that you want to delete.
4. From the Actions menu, click **Delete**. Alternatively, click the cross icon on the toolbar. A message is displayed prompting you to confirm the delete the operation. Click **Yes**. A message is displayed confirming the delete operation.

## 18.3.10 Configuring Notification for a Proxy

You can configure notification for a proxy by configuring a new email IT resource, and specifying a user as a proxy for another user.

Use the following steps to configure notification for a proxy:

1. Configure a new Email IT resource.
2. Create a new user. (For example, create a user Jane Doe.)
3. Create a second user. (For example, create a user John Doe.)
4. Assign the Jane Doe user as a manager for John Doe.
5. Specify your email ID for John Doe, which enables you to receive notifications in your inbox.
6. Login to Oracle Identity Self Service as Jane Doe.

7. In the Self Service tab, click **My Information**. The My Information page is displayed.
8. Expand **Proxies**. In the Proxies section, add John Doe as a proxy for Jane Doe.

 **Note:**

If you successfully added the proxy, you (John Doe in this case) will receive an email notification message similar to the following:

"You have been made the proxy for Jane Doe [JANED] from April 9, 2012 12:00:00 AM to April 30, 2010 12:00:00 AM".

## 18.4 Configuring Email in Provisioning Workflow

You can configure email notifications for using them in provisioning processes by configuring the default email provider.

To configure default email provider:

1. Login to Oracle Identity System Administration, and set the value of the Email Server system property (with keyword XL.MailServer) to point to the IT resource with name Email Server. For information about this system property, see [Configuring Oracle Identity Governance](#).
2. Verify that the Email Server IT resource exists. This IT resource must have Mail Server as the IT resource type, and it must have a server name, for example localhost. If this IT resource is not present for mail server, then create the IT resource. For information about creating IT resources, see [Creating IT Resources](#).

## 18.5 Configuring SOA Email Notification

You can configure and actionable email notification on SOA and troubleshoot issues related to SOA email notification.

This section describes how to configure SOA email notifications in the following topics:

- [Configuring Actionable Email Notification on SOA](#)
- [Troubleshooting SOA Email Notification](#)

### 18.5.1 Configuring Actionable Email Notification on SOA

To configure actionable email notification on SOA, specify email as the notification mode and specify driver-specific attributes for email notification.

To configure email notifications on SOA:

1. Before performing the steps to configure email notifications in SOA, ensure the following:
  - Make sure that the user to whom task is assigned has a valid email account set in Oracle Identity Manager.
  - If you want email notifications to be actionable, such as allowing approving or rejecting requests from the email, then ensure that you have configured human task to send actions in the notification. You can verify this by using SOA Composer. To do so:
    - a. Login to SOA Composer by using weblogic user by using the following URL:

- `http://SOA_HOST:SOA_PORT/soa/composer`
- b. From the Open menu, select **Open Tasks**.
    - c. In the Select a Task to open dialog box, select the human task for which you want to verify the settings, and then click **Open**.
    - d. In Notification Settings section, verify that the **Make notification actionable** option is selected.
  2. Login to Oracle Enterprise Manager as weblogic user.
  3. Go to SOA. Right-click **soa-infra (soa\_server\_name)**, and select **SOA Administration, Workflow Properties**.
  4. In the Workflow Notification Properties dialog box, select Email from the Notification Mode list.
  5. Enter values for the following:
    - **Email : From Address:** Email account from which notification will be sent to approvers
    - **Email : Actionable Address:** Email account that will receive approve/reject response sent by approvers via email
    - **Email : Reply To Address:** Optional email address to which the reply will be sent, for example, no.reply@yourdomain.com
  6. Click **Apply**.
  7. Go to User Messaging Service. Right-click **usermessagingdriver-email (soa\_server\_name)**, and select **Email Driver properties**.
  8. In the Driver-Specific Configuration section, configure the following minimum attributes for email notifications to work correctly:
    - **MailAccessProtocol:** Select IMAP or POP3
    - **OutgoingMailServer:** Name of the SMTP server, for example, myhost.mycompany.com
    - **OutgoingMailServerPort:** Port of the SMTP server, for example, 465
    - **OutgoingDefaultFromAddress:** Same as OutgoingMailServer
    - **OutgoingPassword:** You can provide the password in clear text stored in driverconfig.xml, or store password in CSF by using indirect option.
    - **IncomingMailServer:** The hostname of the incoming mail server. Required only if receiving emails is supported on the driver instance.
    - **IncomingMailIDs:** The email addresses corresponding to the user names. Each email address is separated by a comma and must reside in the same position in the list as their corresponding user name appears on the usernames list. Required only if receiving emails is supported on the driver instance.
    - **IncomingUserPasswords:** You can provide password in clear text stored in driverconfig.xml, or store password in CSF using indirect option.
    - **Debug (Optional):** Setting this to true logs all email activity on SOA server console but not SOA log files. Set this to true until you are sure that notifications are working correctly.

 **See Also:**

[Configuring Human Workflow Service Components and Engines](#) and [Configuring Oracle User Messaging Service](#) in *Administrator's Guide for Oracle SOA Suite and Oracle Business Process Management Suite* for detailed information about driver-specific configuration and Human workflow service components.

9. Click **Apply**, and restart SOA Managed Server.

## 18.5.2 Troubleshooting SOA Email Notification

Troubleshooting considerations for SOA email notification can be enabling Debug mode for driver-specific configuration, verifying email server and accounts, and scrutinizing the SOA server log.

Consider the following to troubleshoot issues encountered with SOA email notification:

- Enable the Debug option in the driver-specific configuration if you are facing issues with sending or receiving notifications. If you modify the email driver properties, then restart SOA server.
- Send test notifications. To do so:  
Login to Oracle Enterprise Manager. Go to SOA. Right-click **soa-infra** (**soa\_server\_name**), and select **Service Engines, Human Workflow, Notification Management, Send Test Notification**.
- Verify that email server and accounts are working. Try sending/receiving emails using your email client.
- Check the SOA server log. Usually, the issue is with user messaging service configuration. If you have enabled the debug option, then SOA server log provides debugging information.
- Sometimes if email is not being sent to a particular email account (because of incorrect configuration), then SOA server marks it as bad address. You must manually remove such bad address. To do so:  
Login to Oracle Enterprise Manager. Go to SOA. Right-click **soa-infra** (**soa\_server\_name**), **Service Engines, Human Workflow, Notification Management, View Bad Address, Remove the Bad Address**.

## 18.6 Disabling Oracle Identity Governance Email Notifications

Disabling email notifications involves disabling email notification by removing the SelfServiceNotificationHandler or PasswordNotificationHandler.

This section describes how to disable Oracle Identity Governance email notification in the following topics:

- [About Disabling Oracle Identity Governance Email Notifications](#)
- [Disabling Sending Email Notification by Removing the SelfServiceNotificationHandler](#)
- [Disabling Sending Email Notification by Removing the PasswordNotificationHandler](#)

## 18.6.1 About Disabling Oracle Identity Governance Email Notifications

Notifications are sent in some scenarios by event handlers when users are created through UI or through SPML. The scenarios are user creation with manual password, manual or auto generated password change, email notification disablement.

Notifications are sent in the following scenarios by event handlers when users are created through UI or through SPML:



### See Also:

Developing Event Handlers in *Developing and Customizing Applications for Oracle Identity Governance* for information about event handlers.

- A user is created with manual password as a result of SelfServiceNotificationHandler. To disable sending email notification, remove the SelfServiceNotificationHandler section in the /metadata/iam-features-selfservice/event-definition/EventHandlers.xml in MDS. To do so, see [Disabling Sending Email Notification by Removing the SelfServiceNotificationHandler](#).
- System Administrator creates user with autogenerated password as a result of PasswordNotificationHandler. To disable sending email notification, remove the PasswordNotificationHandler section in the /metadata/iam-features-passwordmgmt/event-definition/EventHandlers.xml file in MDS.  
To do so, see [Disabling Sending Email Notification by Removing the PasswordNotificationHandler](#).
- System Administrator changes password manually. The notification can be disabled through UI based on the email checkbox selected on the UI.
- System Administrator changes password with autogenerated password (reset password) as a result of ResetPasswordActionHandler. This is not a postprocess event handler that can be disabled.
- To disable notifications related to reconciliation, login to Oracle Identity System Administration, and set the 'Should send notifications in recon or not' system property to FALSE. For information about this system property, see [Default System Properties in Oracle Identity Governance](#).
- To disable all email notifications in Oracle Identity Manager, set the value of the XL.DisableAllNotifications system property to true. By default, the value of this system property is false. If an incorrect value is specified for this system property, then notifications are enabled. See [Default System Properties in Oracle Identity Governance](#) for information about this system property.

## 18.6.2 Disabling Sending Email Notification by Removing the SelfServiceNotificationHandler

A user is created with manual password as a result of SelfServiceNotificationHandler. To disable sending email notification, remove the SelfServiceNotificationHandler section in the /metadata/iam-features-selfservice/event-definition/EventHandlers.xml in MDS.

A user is created with manual password as a result of SelfServiceNotificationHandler. To disable sending email notification, remove the SelfServiceNotificationHandler section in the /metadata/iam-features-selfservice/event-definition/EventHandlers.xml in MDS. To do so:

1. Export the /metadata/iam-features-selfservice/event-definition/EventHandlers.xml file from MDS by using Oracle Enterprise Manager. See Migrating User Modifiable Metadata Files in *Developing and Customizing Applications for Oracle Identity Governance*.

 **Note:**

Save a local copy of the EventHandlers.xml for future reference.

2. Remove the following from the EventHandlers.xml file:

```
<postprocess-handler
class="oracle.iam.selfservice.uself.uselfmgmt.impl.handlers.create.SelfServiceNotific
ationHandler"
entity-type="User"
operation="CREATE"
name="SelfServiceNotificationHandler"
order="1160"
stage="postprocess"
sync="TRUE">
</postprocess-handler>
```

3. Import the files to MDS by following the instructions in Migrating User Modifiable Metadata Files in *Developing and Customizing Applications for Oracle Identity Governance*.
4. Export the files again to verify that the edits have been correctly uploaded to MDS.

 **Note:**

If the steps described in this topic are performed to achieve some desired functionality, then these changes will be lost after upgrade. Therefore, redo the same changes after upgrade.

## 18.6.3 Disabling Sending Email Notification by Removing the PasswordNotificationHandler

System Administrator creates user with autogenerated password as a result of PasswordNotificationHandler. To disable sending email notification, remove the

PasswordNotificationHandler section in the /metadata/iam-features-passwordmgmt/event-definition/EventHandlers.xml file in MDS.

To remove the PasswordNotificationHandler section in the /metadata/iam-features-passwordmgmt/event-definition/EventHandlers.xml file in MDS:

1. Export the /metadata/iam-features-passwordmgmt/event-definition/EventHandlers.xml file from MDS by using Oracle Enterprise Manager.
2. Remove the following from the EventHandlers.xml file:
 

```
<postprocess-handler
class="oracle.iam.passwordmgmt.eventhandlers.PasswordNotificationHandler"
entity-type="User" operation="CREATE" name="PasswordNotificationHandler"
order="1180" stage="postprocess" sync="TRUE">
</postprocess-handler>
```
3. Import the files to MDS by following the instructions in Migrating User Modifiable Metadata Files in *Developing and Customizing Applications for Oracle Identity Governance*.
4. Export the files again to verify that the edits have been correctly uploaded to MDS.

#### Note:

If the steps described in this topic are performed to achieve some desired functionality, then these changes will be lost after upgrade. Therefore, redo the same changes after upgrade.

## 18.7 Troubleshooting Notification

Troubleshooting notification includes issues related to incorrect URL, incorrect outgoing server email driver properties, SOA server errors, authentication failure, and failed email deliver not reported through Enterprise Manager.

This section describes the following issues that you might encounter with UMS configuration and the corresponding solutions:

- [Issues Related to Incorrect URL](#)
- [Incorrect Outgoing Server Email Driver Properties](#)
- [Error Generated at the SOA Server](#)
- [Authentication Failure](#)
- [Issues Related to Failed Email Delivery Not Reported Through EM](#)

### 18.7.1 Issues Related to Incorrect URL

Notification issues related to incorrect URL can be because of malformed or incorrect URLs.

#### Problem

Oracle Identity Manager log shows the following error:

```
<Jun 13, 2012 12:53:25 AM PDT> <Warning>
<oracle.adfinternal.view.faces.renderkit.rich.SelectItemUtils> <ADF_FACES-30118> <No
help provider found for helpTopicId=create_user.>
java.net.MalformedURLException: For input string: "SOA_PORT"
at java.net.URL.<init>(URL.java:601)
```



```

at java.net.URL.<init>(URL.java:464)
at java.net.URL.<init>(URL.java:413)
at java.net.URI.toURL(URI.java:1081)
at oracle.j2ee.ws.common.transport.HttpTransport.transmit(HttpTransport.java:61)
at oracle.j2ee.ws.common.async.MessageSender.call(MessageSender.java:64)
at oracle.j2ee.ws.common.async.Transmitter.transmitSync(Transmitter.java:134)
at oracle.j2ee.ws.common.async.Transmitter.transmit(Transmitter.java:90)
at oracle.j2ee.ws.common.async.RequestorImpl.transmit(RequestorImpl.java:273)
at oracle.j2ee.ws.common.async.RequestorImpl.invoke(RequestorImpl.java:94)
at oracle.j2ee.ws.client.jaxws.DispatchImpl.invoke(DispatchImpl.java:811)
at
oracle.j2ee.ws.client.jaxws.OracleDispatchImpl.synchronousInvocationWithRetry(OracleDispatchImpl.java:235)
at oracle.j2ee.ws.client.jaxws.OracleDispatchImpl.invoke(OracleDispatchImpl.java:106)
at
oracle.j2ee.ws.client.jaxws.WsClientProxyInvocationHandler.invoke(WsClientProxyInvocationHandler.java:254)
at $Proxy422.send(Unknown Source)
at oracle.ucs.messaging.ws.MessagingClient.send(MessagingClient.java:299)
at
oracle.iam.notification.provider.UMSEmailServiceProvider.sendMessage(UMSEmailServiceProvider.java:188)
at
oracle.iam.notification.provider.UMSEmailServiceProvider.sendNotification(UMSEmailServiceProvider.java:173)
at
oracle.iam.notification.impl.NotificationServiceImpl.sendEmailNotification(NotificationServiceImpl.java:601)
at
oracle.iam.notification.impl.NotificationServiceImpl.notify(NotificationServiceImpl.java:540)
at
oracle.iam.notification.impl.NotificationServiceImpl.notify(NotificationServiceImpl.java:271)
<Jun 13, 2012 12:53:31 AM PDT> <Error> <oracle.iam.notification.impl> <BEA-000000>
<Provider UMSEmailServiceProvider has encountered exception : null>
<Jun 13, 2012 12:53:31 AM PDT> <Error> <oracle.iam.notification.impl> <BEA-000000>
<Sending notification with Provider UMSEmailServiceProvider has encountered exception :
Error occured while Sending Notification through Provider UMSEmailServiceProvider : null>
<Jun 13, 2012 12:53:31 AM PDT> <Error> <oracle.iam.notification.impl> <BEA-000000>
<Sending notification with Provider UMSEmailServiceProvider detailed exception : null>

```

## Solution

The cause of this error is malformed URL. To resolve the issue, provide the correct values for *SOA\_PORT* and *SOA\_HOST* in Enterprise Manager (EM).

## Problem

Oracle Identity Manager log shows the following error:

```

<Jun 13, 2012 3:14:14 AM PDT> <Error> <oracle.iam.notification.impl> <BEA-000000>
<Provider UMSEmailServiceProvider has encountered exception :
javax.xml.soap.SOAPException: javax.xml.soap.SOAPException: Bad response: 404 Not Found
from url http://myhost.mycompany.com:8003/ucs/messaging/webservice>
<Jun 13, 2012 3:14:14 AM PDT> <Error> <oracle.iam.notification.impl> <BEA-000000>
<Sending notification with Provider UMSEmailServiceProvider has encountered exception :
Error occured while Sending Notification through Provider UMSEmailServiceProvider :
javax.xml.soap.SOAPException: javax.xml.soap.SOAPException: Bad response: 404 Not Found
from url http://myhost.mycompany.com:8003/ucs/messaging/webservice>
<Jun 13, 2012 3:14:14 AM PDT> <Error> <oracle.iam.notification.impl> <BEA-000000>
<Sending notification with Provider UMSEmailServiceProvider detailed exception :

```

javax.xml.soap.SOAPException: javax.xml.soap.SOAPException: Bad response: 404 Not Found from url http://myhost.mycompany.com:8003/ucs/messaging/webService>

### Solution

The cause of this problem is incorrect URL. To resolve the issue, provide the correct URL in EM.

## 18.7.2 Incorrect Outgoing Server Email Driver Properties

To troubleshoot notification issues related to outgoing server email driver properties, provide the correct email server address, and ensure that the server is running.

### Problem

The following error is generated:

```
<Jun 13, 2012 3:39:14 AM PDT> <Error> <oracle.sdp.messaging.driver.email> <SDP-25700>
<An unexpected exception was caught.
javax.mail.MessagingException: Unknown SMTP host: abc.example.com;
nested exception is:
java.net.UnknownHostException: abc.example.com
at com.sun.mail.smtp.SMTPTransport.openServer (SMTPTransport.java:1389)
at com.sun.mail.smtp.SMTPTransport.protocolConnect (SMTPTransport.java:412)
at javax.mail.Service.connect (Service.java:310)
at javax.mail.Service.connect (Service.java:169)
at javax.mail.Service.connect (Service.java:118)
at oracle.sdpinternal.messaging.driver.email.EmailDriver.send (EmailDriver.java:780)
at
oracle.sdpinternal.messaging.driver.email.EmailManagedConnection.send (EmailManagedConnection.java:50)
at
oracle.sdpinternal.messaging.driver.DriverConnectionImpl.send (DriverConnectionImpl.java:41)
at
oracle.sdpinternal.messaging.dispatcher.DriverDispatcherBean.onMessage (DriverDispatcherBean.java:296)
at sun.reflect.NativeMethodAccessorImpl.invoke0 (Native Method)
at sun.reflect.NativeMethodAccessorImpl.invoke (NativeMethodAccessorImpl.java:39)
at sun.reflect.DelegatingMethodAccessorImpl.invoke (DelegatingMethodAccessorImpl.java:25)
at java.lang.reflect.Method.invoke (Method.java:597)
at
com.bea.core.repackaged.springframework.aop.support.AopUtils.invokeJoinpointUsingReflection (AopUtils.java:310)
at
com.bea.core.repackaged.springframework.aop.framework.ReflectiveMethodInvocation.invokeJoinpoint (ReflectiveMethodInvocation.java:182)
at
com.bea.core.repackaged.springframework.aop.framework.ReflectiveMethodInvocation.proceed (ReflectiveMethodInvocation.java:149)
at
com.bea.core.repackaged.springframework.aop.interceptor.ExposeInvocationInterceptor.invoke (ExposeInvocationInterceptor.java:89)
at
com.bea.core.repackaged.springframework.aop.framework.ReflectiveMethodInvocation.proceed (ReflectiveMethodInvocation.java:171)
at
com.bea.core.repackaged.springframework.aop.support.DelegatingIntroductionInterceptor.doProceed (DelegatingIntroductionInterceptor.java:131)
at
com.bea.core.repackaged.springframework.aop.support.DelegatingIntroductionInterceptor.invoke
```

```
oke(DelegatingIntroductionInterceptor.java:119)
at
com.bea.core.repackaged.springframework.aop.framework.ReflectiveMethodInvocation.proceed(
ReflectiveMethodInvocation.java:171)
at
com.bea.core.repackaged.springframework.aop.framework.JdkDynamicAopProxy.invoke(JdkDynam
icAopProxy.java:204)
at $Proxy349.onMessage(Unknown Source)
at weblogic.ejb.container.internal.MDListener.execute(MDListener.java:583)
at weblogic.ejb.container.internal.MDListener.transactionalOnMessage(MDListener.java:486)
at weblogic.ejb.container.internal.MDListener.onMessage(MDListener.java:388)
at weblogic.jms.client.JMSSession.onMessage(JMSSession.java:4659)
at weblogic.jms.client.JMSSession.execute(JMSSession.java:4345)
at weblogic.jms.client.JMSSession.executeMessage(JMSSession.java:3821)
at weblogic.jms.client.JMSSession.access$000(JMSSession.java:115)
at weblogic.jms.client.JMSSession$UseForRunnable.run(JMSSession.java:5170)
at
weblogic.work.SelfTuningWorkManagerImpl$WorkAdapterImpl.run(SelfTuningWorkManagerImpl.jav
a:545)
at weblogic.work.ExecuteThread.execute(ExecuteThread.java:256)
at weblogic.work.ExecuteThread.run(ExecuteThread.java:221)
Caused By: java.net.UnknownHostException: abc.example.com
at java.net.PlainSocketImpl.connect(PlainSocketImpl.java:195)
at java.net.SocksSocketImpl.connect(SocksSocketImpl.java:366)
at java.net.Socket.connect(Socket.java:529)
at com.sun.net.ssl.internal.ssl.SSLSocketImpl.connect(SSLSocketImpl.java:564)
at com.sun.net.ssl.internal.ssl.BaseSSLSocketImpl.connect(BaseSSLSocketImpl.java:141)
at com.sun.mail.util.SocketFetcher.createSocket(SocketFetcher.java:233)
at com.sun.mail.util.SocketFetcher.getSocket(SocketFetcher.java:163)
at com.sun.mail.smtp.SMTPTransport.openServer(SMTPTransport.java:1359)
at com.sun.mail.smtp.SMTPTransport.protocolConnect(SMTPTransport.java:412)
at javax.mail.Service.connect(Service.java:310)
at javax.mail.Service.connect(Service.java:169)
at javax.mail.Service.connect(Service.java:118)
at oracle.sdpinternal.messaging.driver.email.EmailDriver.send(EmailDriver.java:780)
at
oracle.sdpinternal.messaging.driver.email.EmailManagedConnection.send(EmailManagedConnect
ion.java:50)
at
oracle.sdpinternal.messaging.driver.DriverConnectionImpl.send(DriverConnectionImpl.java:4
1)
at
oracle.sdpinternal.messaging.dispatcher.DriverDispatcherBean.onMessage(DriverDispatcherBe
an.java:296)
at sun.reflect.NativeMethodAccessorImpl.invoke0(Native Method)
at sun.reflect.NativeMethodAccessorImpl.invoke(NativeMethodAccessorImpl.java:39)
at sun.reflect.DelegatingMethodAccessorImpl.invoke(DelegatingMethodAccessorImpl.java:25)
at java.lang.reflect.Method.invoke(Method.java:597)
at
com.bea.core.repackaged.springframework.aop.support.AopUtils.invokeJoinpointUsingReflecti
on(AopUtils.java:310)
at
com.bea.core.repackaged.springframework.aop.framework.ReflectiveMethodInvocation.invokeJo
inpoint(ReflectiveMethodInvocation.java:182)
at
com.bea.core.repackaged.springframework.aop.framework.ReflectiveMethodInvocation.proceed(
ReflectiveMethodInvocation.java:149)
at
com.bea.core.repackaged.springframework.aop.interceptor.ExposeInvocationInterceptor.invok
e(ExposeInvocationInterceptor.java:89)
at
com.bea.core.repackaged.springframework.aop.framework.ReflectiveMethodInvocation.proceed(
```

```
ReflectiveMethodInvocation.java:171)
at
com.bea.core.repackaged.springframework.aop.support.DelegatingIntroductionInterceptor.doProceed(DelegatingIntroductionInterceptor.java:131)
at
com.bea.core.repackaged.springframework.aop.support.DelegatingIntroductionInterceptor.invoke(DelegatingIntroductionInterceptor.java:119)
at
com.bea.core.repackaged.springframework.aop.framework.ReflectiveMethodInvocation.proceed(ReflectiveMethodInvocation.java:171)
at
com.bea.core.repackaged.springframework.aop.framework.JdkDynamicAopProxy.invoke(JdkDynamicAopProxy.java:204)
at $Proxy349.onMessage(Unknown Source)
at weblogic.ejb.container.internal.MDListener.execute(MDListener.java:583)
at weblogic.ejb.container.internal.MDListener.transactionalOnMessage(MDListener.java:486)
at weblogic.ejb.container.internal.MDListener.onMessage(MDListener.java:388)
at weblogic.jms.client.JMSSession.onMessage(JMSSession.java:4659)
at weblogic.jms.client.JMSSession.execute(JMSSession.java:4345)
at weblogic.jms.client.JMSSession.executeMessage(JMSSession.java:3821)
at weblogic.jms.client.JMSSession.access$000(JMSSession.java:115)
at weblogic.jms.client.JMSSession$UseForRunnable.run(JMSSession.java:5170)
at
weblogic.work.SelfTuningWorkManagerImpl$WorkAdapterImpl.run(SelfTuningWorkManagerImpl.java:545)
at weblogic.work.ExecuteThread.execute(ExecuteThread.java:256)
at weblogic.work.ExecuteThread.run(ExecuteThread.java:221)
>
```

### Solution

The cause of this problem is incorrect Outgoing Server EMail Driver properties. To rectify the issue, provide the correct email server address, and ensure that the server is running.

## 18.7.3 Error Generated at the SOA Server

To troubleshoot error generated at the SOA server, ensure that the outgoing server host, outgoing server port, and outgoing server security information are provided correctly.

### Problem

The following error is displayed in the SOA server logs:

```
<Jun 13, 2012 3:53:20 AM PDT> <Error> <oracle.sdp.messaging.driver.email> <SDP-25700>
<An unexpected exception was caught.
javax.mail.MessagingException: Could not connect to SMTP host: stbeehive.example.com,
port: 25;
nested exception is:
java.net.ConnectException: Connection refused
at com.sun.mail.smtp.SMTPTransport.openServer(SMTPTransport.java:1391)
at com.sun.mail.smtp.SMTPTransport.protocolConnect(SMTPTransport.java:412)
at javax.mail.Service.connect(Service.java:310)
at javax.mail.Service.connect(Service.java:169)
at javax.mail.Service.connect(Service.java:118)
at oracle.sdpinternal.messaging.driver.email.EmailDriver.send(EmailDriver.java:780)
at
oracle.sdpinternal.messaging.driver.email.EmailManagedConnection.send(EmailManagedConnection.java:50)
at
oracle.sdpinternal.messaging.driver.DriverConnectionImpl.send(DriverConnectionImpl.java:41)
1)
```

```
at
oracle.sdpinternal.messaging.dispatcher.DriverDispatcherBean.onMessage(DriverDispatcherBe
an.java:296)
at sun.reflect.NativeMethodAccessorImpl.invoke0(Native Method)
at sun.reflect.NativeMethodAccessorImpl.invoke(NativeMethodAccessorImpl.java:39)
at sun.reflect.DelegatingMethodAccessorImpl.invoke(DelegatingMethodAccessorImpl.java:25)
at java.lang.reflect.Method.invoke(Method.java:597)
at
com.bea.core.repackaged.springframework.aop.support.AopUtils.invokeJoinpointUsingReflecti
on(AopUtils.java:310)
at
com.bea.core.repackaged.springframework.aop.framework.ReflectiveMethodInvocation.invokeJo
inpoint(ReflectiveMethodInvocation.java:182)
at
com.bea.core.repackaged.springframework.aop.framework.ReflectiveMethodInvocation.proceed(
ReflectiveMethodInvocation.java:149)
at
com.bea.core.repackaged.springframework.aop.interceptor.ExposeInvocationInterceptor.invok
e(ExposeInvocationInterceptor.java:89)
at
com.bea.core.repackaged.springframework.aop.framework.ReflectiveMethodInvocation.proceed(
ReflectiveMethodInvocation.java:171)
at
com.bea.core.repackaged.springframework.aop.support.DelegatingIntroductionInterceptor.doP
roceed(DelegatingIntroductionInterceptor.java:131)
at
com.bea.core.repackaged.springframework.aop.support.DelegatingIntroductionInterceptor.inv
oke(DelegatingIntroductionInterceptor.java:119)
at
com.bea.core.repackaged.springframework.aop.framework.ReflectiveMethodInvocation.proceed(
ReflectiveMethodInvocation.java:171)
at
com.bea.core.repackaged.springframework.aop.framework.JdkDynamicAopProxy.invoke(JdkDynami
cAopProxy.java:204)
at $Proxy345.onMessage(Unknown Source)
at weblogic.ejb.container.internal.MDListener.execute(MDListener.java:583)
at weblogic.ejb.container.internal.MDListener.transactionalOnMessage(MDListener.java:486)
at weblogic.ejb.container.internal.MDListener.onMessage(MDListener.java:388)
at weblogic.jms.client.JMSSession.onMessage(JMSSession.java:4659)
at weblogic.jms.client.JMSSession.execute(JMSSession.java:4345)
at weblogic.jms.client.JMSSession.executeMessage(JMSSession.java:3821)
at weblogic.jms.client.JMSSession.access$000(JMSSession.java:115)
at weblogic.jms.client.JMSSession$UseForRunnable.run(JMSSession.java:5170)
at
weblogic.work.SelfTuningWorkManagerImpl$WorkAdapterImpl.run(SelfTuningWorkManagerImpl.jav
a:545)
at weblogic.work.ExecuteThread.execute(ExecuteThread.java:256)
at weblogic.work.ExecuteThread.run(ExecuteThread.java:221)
Caused By: java.net.ConnectException: Connection refused
at java.net.PlainSocketImpl.socketConnect(Native Method)
at java.net.PlainSocketImpl.doConnect(PlainSocketImpl.java:351)
at java.net.PlainSocketImpl.connectToAddress(PlainSocketImpl.java:213)
at java.net.PlainSocketImpl.connect(PlainSocketImpl.java:200)
at java.net.SocksSocketImpl.connect(SocksSocketImpl.java:366)
at java.net.Socket.connect(Socket.java:529)
at com.sun.net.ssl.internal.ssl.SSLSocketImpl.connect(SSLSocketImpl.java:564)
at com.sun.net.ssl.internal.ssl.BaseSSLSocketImpl.connect(BaseSSLSocketImpl.java:141)
at com.sun.mail.util.SocketFetcher.createSocket(SocketFetcher.java:233)
at com.sun.mail.util.SocketFetcher.getSocket(SocketFetcher.java:163)
at com.sun.mail.smtp.SMTPTransport.openServer(SMTPTransport.java:1359)
at com.sun.mail.smtp.SMTPTransport.protocolConnect(SMTPTransport.java:412)
at javax.mail.Service.connect(Service.java:310)
```

```
at javax.mail.Service.connect (Service.java:169)
at javax.mail.Service.connect (Service.java:118)
at oracle.sdpinternal.messaging.driver.email.EmailDriver.send (EmailDriver.java:780)
at
oracle.sdpinternal.messaging.driver.email.EmailManagedConnection.send (EmailManagedConnect
ion.java:50)
at
oracle.sdpinternal.messaging.driver.DriverConnectionImpl.send (DriverConnectionImpl.java:4
1)
at
oracle.sdpinternal.messaging.dispatcher.DriverDispatcherBean.onMessage (DriverDispatcherBe
an.java:296)
at sun.reflect.NativeMethodAccessorImpl.invoke0 (Native Method)
at sun.reflect.NativeMethodAccessorImpl.invoke (NativeMethodAccessorImpl.java:39)
at sun.reflect.DelegatingMethodAccessorImpl.invoke (DelegatingMethodAccessorImpl.java:25)
at java.lang.reflect.Method.invoke (Method.java:597)
at
com.bea.core.repackaged.springframework.aop.support.AopUtils.invokeJoinpointUsingReflecti
on (AopUtils.java:310)
at
com.bea.core.repackaged.springframework.aop.framework.ReflectiveMethodInvocation.invokeJo
inpoint (ReflectiveMethodInvocation.java:182)
at
com.bea.core.repackaged.springframework.aop.framework.ReflectiveMethodInvocation.proceed (
ReflectiveMethodInvocation.java:149)
at
com.bea.core.repackaged.springframework.aop.interceptor.ExposeInvocationInterceptor.invok
e (ExposeInvocationInterceptor.java:89)
at
com.bea.core.repackaged.springframework.aop.framework.ReflectiveMethodInvocation.proceed (
ReflectiveMethodInvocation.java:171)
at
com.bea.core.repackaged.springframework.aop.support.DelegatingIntroductionInterceptor.doP
roceed (DelegatingIntroductionInterceptor.java:131)
at
com.bea.core.repackaged.springframework.aop.support.DelegatingIntroductionInterceptor.inv
oke (DelegatingIntroductionInterceptor.java:119)
at
com.bea.core.repackaged.springframework.aop.framework.ReflectiveMethodInvocation.proceed (
ReflectiveMethodInvocation.java:171)
at
com.bea.core.repackaged.springframework.aop.framework.JdkDynamicAopProxy.invoke (JdkDyname
icAopProxy.java:204)
at $Proxy345.onMessage (Unknown Source)
at weblogic.ejb.container.internal.MDListener.execute (MDListener.java:583)
at weblogic.ejb.container.internal.MDListener.transactionalOnMessage (MDListener.java:486)
at weblogic.ejb.container.internal.MDListener.onMessage (MDListener.java:388)
at weblogic.jms.client.JMSSession.onMessage (JMSSession.java:4659)
at weblogic.jms.client.JMSSession.execute (JMSSession.java:4345)
at weblogic.jms.client.JMSSession.executeMessage (JMSSession.java:3821)
at weblogic.jms.client.JMSSession.access$000 (JMSSession.java:115)
at weblogic.jms.client.JMSSession$UseForRunnable.run (JMSSession.java:5170)
at
weblogic.work.SelfTuningWorkManagerImpl$WorkAdapterImpl.run (SelfTuningWorkManagerImpl.jav
a:545)
at weblogic.work.ExecuteThread.execute (ExecuteThread.java:256)
at weblogic.work.ExecuteThread.run (ExecuteThread.java:221)
>
```

## Solution

This is an error in SOA server. To rectify the issue, ensure that the outgoing server host, outgoing server port, and outgoing server security information are provided correctly.

## 18.7.4 Authentication Failure

To troubleshoot authentication failure, provide the correct username and password, deploy and configure the application server, and ensure certification exchange.

### Problem

The following errors are generated:

```
javax.mail.AuthenticationFailedException
```

### OR

```
<Jun 13, 2012 4:30:41 AM PDT> <Error> <oracle.sdp.messaging.driver.email> <SDP-25700>
<An unexpected exception was caught.
javax.mail.MessagingException: Exception reading response;
nested exception is:
javax.net.ssl.SSLHandshakeException: sun.security.validator.ValidatorException: PKIX
path building failed: sun.security.provider.certpath.SunCertPathBuilderException: unable
to find valid certification path to requested target
at com.sun.mail.smtp.SMTPTransport.readServerResponse(SMTPTransport.java:1611)
at com.sun.mail.smtp.SMTPTransport.openServer(SMTPTransport.java:1369)
at com.sun.mail.smtp.SMTPTransport.protocolConnect(SMTPTransport.java:412)
at javax.mail.Service.connect(Service.java:310)
at javax.mail.Service.connect(Service.java:169)
at javax.mail.Service.connect(Service.java:118)
at oracle.sdpinternal.messaging.driver.email.EmailDriver.send(EmailDriver.java:780)
at
oracle.sdpinternal.messaging.driver.email.EmailManagedConnection.send(EmailManagedConnect
ion.java:50)
at
oracle.sdpinternal.messaging.driver.DriverConnectionImpl.send(DriverConnectionImpl.java:4
1)
at
oracle.sdpinternal.messaging.dispatcher.DriverDispatcherBean.onMessage(DriverDispatcherBe
an.java:296)
at sun.reflect.NativeMethodAccessorImpl.invoke0(Native Method)
at sun.reflect.NativeMethodAccessorImpl.invoke(NativeMethodAccessorImpl.java:39)
at sun.reflect.DelegatingMethodAccessorImpl.invoke(DelegatingMethodAccessorImpl.java:25)
at java.lang.reflect.Method.invoke(Method.java:597)
at
com.bea.core.repackaged.springframework.aop.support.AopUtils.invokeJoinpointUsingReflecti
on(AopUtils.java:310)
at
com.bea.core.repackaged.springframework.aop.framework.ReflectiveMethodInvocation.invokeJo
inpoint(ReflectiveMethodInvocation.java:182)
at
com.bea.core.repackaged.springframework.aop.framework.ReflectiveMethodInvocation.proceed(
ReflectiveMethodInvocation.java:149)
at
com.bea.core.repackaged.springframework.aop.interceptor.ExposeInvocationInterceptor.invok
e(ExposeInvocationInterceptor.java:89)
at
com.bea.core.repackaged.springframework.aop.framework.ReflectiveMethodInvocation.proceed(
ReflectiveMethodInvocation.java:171)
```

```
at
com.bea.core.repackaged.springframework.aop.support.DelegatingIntroductionInterceptor.doProceed(DelegatingIntroductionInterceptor.java:131)
at
com.bea.core.repackaged.springframework.aop.support.DelegatingIntroductionInterceptor.invoke(DelegatingIntroductionInterceptor.java:119)
at
com.bea.core.repackaged.springframework.aop.framework.ReflectiveMethodInvocation.proceed(ReflectiveMethodInvocation.java:171)
at
com.bea.core.repackaged.springframework.aop.framework.JdkDynamicAopProxy.invoke(JdkDynamicAopProxy.java:204)
at $Proxy349.onMessage(Unknown Source)
at weblogic.ejb.container.internal.MDListener.execute(MDListener.java:583)
at weblogic.ejb.container.internal.MDListener.transactionalOnMessage(MDListener.java:486)
at weblogic.ejb.container.internal.MDListener.onMessage(MDListener.java:388)
at weblogic.jms.client.JMSSession.onMessage(JMSSession.java:4659)
at weblogic.jms.client.JMSSession.execute(JMSSession.java:4345)
at weblogic.jms.client.JMSSession.executeMessage(JMSSession.java:3821)
at weblogic.jms.client.JMSSession.access$000(JMSSession.java:115)
at weblogic.jms.client.JMSSession$UseForRunnable.run(JMSSession.java:5170)
at
weblogic.work.SelfTuningWorkManagerImpl$WorkAdapterImpl.run(SelfTuningWorkManagerImpl.java:545)
at weblogic.work.ExecuteThread.execute(ExecuteThread.java:256)
at weblogic.work.ExecuteThread.run(ExecuteThread.java:221)
Caused By: javax.net.ssl.SSLHandshakeException:
sun.security.validator.ValidatorException: PKIX path building failed:
sun.security.provider.certpath.SunCertPathBuilderException: unable to find valid
certification path to requested target
at com.sun.net.ssl.internal.ssl.Alerts.getSSLException(Alerts.java:174)
at com.sun.net.ssl.internal.ssl.SSLSocketImpl.fatal(SSLSocketImpl.java:1731)
at com.sun.net.ssl.internal.ssl.Handshaker.fatalSE(Handshaker.java:241)
at com.sun.net.ssl.internal.ssl.Handshaker.fatalSE(Handshaker.java:235)
at
com.sun.net.ssl.internal.ssl.ClientHandshaker.serverCertificate(ClientHandshaker.java:1206)
at
com.sun.net.ssl.internal.ssl.ClientHandshaker.processMessage(ClientHandshaker.java:136)
at com.sun.net.ssl.internal.ssl.Handshaker.processLoop(Handshaker.java:593)
at com.sun.net.ssl.internal.ssl.Handshaker.process_record(Handshaker.java:529)
at com.sun.net.ssl.internal.ssl.SSLSocketImpl.readRecord(SSLSocketImpl.java:925)
at
com.sun.net.ssl.internal.ssl.SSLSocketImpl.performInitialHandshake(SSLSocketImpl.java:1170)
at com.sun.net.ssl.internal.ssl.SSLSocketImpl.readDataRecord(SSLSocketImpl.java:785)
at com.sun.net.ssl.internal.ssl.AppInputStream.read(AppInputStream.java:75)
at com.sun.mail.util.TraceInputStream.read(TraceInputStream.java:110)
at java.io.BufferedInputStream.fill(BufferedInputStream.java:218)
at java.io.BufferedInputStream.read(BufferedInputStream.java:237)
at com.sun.mail.util.LineInputStream.readLine(LineInputStream.java:88)
at com.sun.mail.smtp.SMTPTransport.readServerResponse(SMTPTransport.java:1589)
at com.sun.mail.smtp.SMTPTransport.openServer(SMTPTransport.java:1369)
at com.sun.mail.smtp.SMTPTransport.protocolConnect(SMTPTransport.java:412)
at javax.mail.Service.connect(Service.java:310)
at javax.mail.Service.connect(Service.java:169)
at javax.mail.Service.connect(Service.java:118)
at oracle.sdpinternal.messaging.driver.email.EmailDriver.send(EmailDriver.java:780)
at
oracle.sdpinternal.messaging.driver.email.EmailManagedConnection.send(EmailManagedConnection.java:50)
at
```



```
oracle.sdpinternal.messaging.driver.DriverConnectionImpl.send(DriverConnectionImpl.java:4
1)
at
oracle.sdpinternal.messaging.dispatcher.DriverDispatcherBean.onMessage(DriverDispatcherBe
an.java:296)
at sun.reflect.NativeMethodAccessorImpl.invoke0(Native Method)
at sun.reflect.NativeMethodAccessorImpl.invoke(NativeMethodAccessorImpl.java:39)
at sun.reflect.DelegatingMethodAccessorImpl.invoke(DelegatingMethodAccessorImpl.java:25)
at java.lang.reflect.Method.invoke(Method.java:597)
at
com.bea.core.repackaged.springframework.aop.support.AopUtils.invokeJoinpointUsingReflecti
on(AopUtils.java:310)
at
com.bea.core.repackaged.springframework.aop.framework.ReflectiveMethodInvocation.invokeJo
inpoint(ReflectiveMethodInvocation.java:182)
at
com.bea.core.repackaged.springframework.aop.framework.ReflectiveMethodInvocation.proceed(
ReflectiveMethodInvocation.java:149)
at
com.bea.core.repackaged.springframework.aop.interceptor.ExposeInvocationInterceptor.invok
e(ExposeInvocationInterceptor.java:89)
at
com.bea.core.repackaged.springframework.aop.framework.ReflectiveMethodInvocation.proceed(
ReflectiveMethodInvocation.java:171)
at
com.bea.core.repackaged.springframework.aop.support.DelegatingIntroductionInterceptor.doP
roceed(DelegatingIntroductionInterceptor.java:131)
at
com.bea.core.repackaged.springframework.aop.support.DelegatingIntroductionInterceptor.inv
oke(DelegatingIntroductionInterceptor.java:119)
at
com.bea.core.repackaged.springframework.aop.framework.ReflectiveMethodInvocation.proceed(
ReflectiveMethodInvocation.java:171)
at
com.bea.core.repackaged.springframework.aop.framework.JdkDynamicAopProxy.invoke(JdkDynam
icAopProxy.java:204)
at $Proxy349.onMessage(Unknown Source)
at weblogic.ejb.container.internal.MDListener.execute(MDListener.java:583)
at weblogic.ejb.container.internal.MDListener.transactionalOnMessage(MDListener.java:486)
at weblogic.ejb.container.internal.MDListener.onMessage(MDListener.java:388)
at weblogic.jms.client.JMSSession.onMessage(JMSSession.java:4659)
at weblogic.jms.client.JMSSession.execute(JMSSession.java:4345)
at weblogic.jms.client.JMSSession.executeMessage(JMSSession.java:3821)
at weblogic.jms.client.JMSSession.access$000(JMSSession.java:115)
at weblogic.jms.client.JMSSession$UseForRunnable.run(JMSSession.java:5170)
at
weblogic.work.SelfTuningWorkManagerImpl$WorkAdapterImpl.run(SelfTuningWorkManagerImpl.jav
a:545)
at weblogic.work.ExecuteThread.execute(ExecuteThread.java:256)
at weblogic.work.ExecuteThread.run(ExecuteThread.java:221)
Caused By: sun.security.validator.ValidatorException: PKIX path building failed:
sun.security.provider.certpath.SunCertPathBuilderException: unable to find valid
certification path to requested target
at sun.security.validator.PKIXValidator.doBuild(PKIXValidator.java:323)
at sun.security.validator.PKIXValidator.engineValidate(PKIXValidator.java:217)
at sun.security.validator.Validator.validate(Validator.java:218)
at
com.sun.net.ssl.internal.ssl.X509TrustManagerImpl.validate(X509TrustManagerImpl.java:126)
at
com.sun.net.ssl.internal.ssl.X509TrustManagerImpl.checkServerTrusted(X509TrustManagerImpl
.java:209)
at
```

```
com.sun.net.ssl.internal.ssl.X509TrustManagerImpl.checkServerTrusted(X509TrustManagerImpl
.java:249)
at
com.sun.net.ssl.internal.ssl.ClientHandshaker.serverCertificate(ClientHandshaker.java:118
5)
at
com.sun.net.ssl.internal.ssl.ClientHandshaker.processMessage(ClientHandshaker.java:136)
at com.sun.net.ssl.internal.ssl.Handshaker.processLoop(Handshaker.java:593)
at com.sun.net.ssl.internal.ssl.Handshaker.process_record(Handshaker.java:529)
at com.sun.net.ssl.internal.ssl.SSLSocketImpl.readRecord(SSLSocketImpl.java:925)
at
com.sun.net.ssl.internal.ssl.SSLSocketImpl.performInitialHandshake(SSLSocketImpl.java:117
0)
at com.sun.net.ssl.internal.ssl.SSLSocketImpl.readDataRecord(SSLSocketImpl.java:785)
at com.sun.net.ssl.internal.ssl.AppInputStream.read(AppInputStream.java:75)
at com.sun.mail.util.TraceInputStream.read(TraceInputStream.java:110)
at java.io.BufferedInputStream.fill(BufferedInputStream.java:218)
at java.io.BufferedInputStream.read(BufferedInputStream.java:237)
at com.sun.mail.util.LineInputStream.readLine(LineInputStream.java:88)
at com.sun.mail.smtp.SMTPTransport.readServerResponse(SMTPTransport.java:1589)
at com.sun.mail.smtp.SMTPTransport.openServer(SMTPTransport.java:1369)
at com.sun.mail.smtp.SMTPTransport.protocolConnect(SMTPTransport.java:412)
at javax.mail.Service.connect(Service.java:310)
at javax.mail.Service.connect(Service.java:169)
at javax.mail.Service.connect(Service.java:118)
at oracle.sdpinternal.messaging.driver.email.EmailDriver.send(EmailDriver.java:780)
at
oracle.sdpinternal.messaging.driver.email.EmailManagedConnection.send(EmailManagedConnect
ion.java:50)
at
oracle.sdpinternal.messaging.driver.DriverConnectionImpl.send(DriverConnectionImpl.java:4
1)
at
oracle.sdpinternal.messaging.dispatcher.DriverDispatcherBean.onMessage(DriverDispatcherBe
an.java:296)
at sun.reflect.NativeMethodAccessorImpl.invoke0(Native Method)
at sun.reflect.NativeMethodAccessorImpl.invoke(NativeMethodAccessorImpl.java:39)
at sun.reflect.DelegatingMethodAccessorImpl.invoke(DelegatingMethodAccessorImpl.java:25)
at java.lang.reflect.Method.invoke(Method.java:597)
at
com.bea.core.repackaged.springframework.aop.support.AopUtils.invokeJoinpointUsingReflecti
on(AopUtils.java:310)
at
com.bea.core.repackaged.springframework.aop.framework.ReflectiveMethodInvocation.invokeJo
inpoint(ReflectiveMethodInvocation.java:182)
at
com.bea.core.repackaged.springframework.aop.framework.ReflectiveMethodInvocation.proceed(
ReflectiveMethodInvocation.java:149)
at
com.bea.core.repackaged.springframework.aop.interceptor.ExposeInvocationInterceptor.invoke
(ExposeInvocationInterceptor.java:89)
at
com.bea.core.repackaged.springframework.aop.framework.ReflectiveMethodInvocation.proceed(
ReflectiveMethodInvocation.java:171)
at
com.bea.core.repackaged.springframework.aop.support.DelegatingIntroductionInterceptor.doP
roceed(DelegatingIntroductionInterceptor.java:131)
at
com.bea.core.repackaged.springframework.aop.support.DelegatingIntroductionInterceptor.invo
ke(DelegatingIntroductionInterceptor.java:119)
at
com.bea.core.repackaged.springframework.aop.framework.ReflectiveMethodInvocation.proceed(
```

```
ReflectiveMethodInvocation.java:171)
at
com.bea.core.repackaged.springframework.aop.framework.JdkDynamicAopProxy.invoke (JdkDynamicAopProxy.java:204)
at $Proxy349.onMessage(Unknown Source)
at weblogic.ejb.container.internal.MDListener.execute (MDListener.java:583)
at weblogic.ejb.container.internal.MDListener.transactionalOnMessage (MDListener.java:486)
at weblogic.ejb.container.internal.MDListener.onMessage (MDListener.java:388)
at weblogic.jms.client.JMSSession.onMessage (JMSSession.java:4659)
at weblogic.jms.client.JMSSession.execute (JMSSession.java:4345)
at weblogic.jms.client.JMSSession.executeMessage (JMSSession.java:3821)
at weblogic.jms.client.JMSSession.access$000 (JMSSession.java:115)
at weblogic.jms.client.JMSSession$UseForRunnable.run (JMSSession.java:5170)
at
weblogic.work.SelfTuningWorkManagerImpl$WorkAdapterImpl.run (SelfTuningWorkManagerImpl.java:545)
at weblogic.work.ExecuteThread.execute (ExecuteThread.java:256)
at weblogic.work.ExecuteThread.run (ExecuteThread.java:221)
Caused By: sun.security.provider.certpath.SunCertPathBuilderException: unable to find
valid certification path to requested target
at
sun.security.provider.certpath.SunCertPathBuilder.engineBuild (SunCertPathBuilder.java:174)
)
at java.security.cert.CertPathBuilder.build (CertPathBuilder.java:238)
at sun.security.validator.PKIXValidator.doBuild (PKIXValidator.java:318)
at sun.security.validator.PKIXValidator.engineValidate (PKIXValidator.java:217)
at sun.security.validator.Validator.validate (Validator.java:218)
at
com.sun.net.ssl.internal.ssl.X509TrustManagerImpl.validate (X509TrustManagerImpl.java:126)
at
com.sun.net.ssl.internal.ssl.X509TrustManagerImpl.checkServerTrusted (X509TrustManagerImpl.java:209)
at
com.sun.net.ssl.internal.ssl.X509TrustManagerImpl.checkServerTrusted (X509TrustManagerImpl.java:249)
at
com.sun.net.ssl.internal.ssl.ClientHandshaker.serverCertificate (ClientHandshaker.java:1185)
)
at
com.sun.net.ssl.internal.ssl.ClientHandshaker.processMessage (ClientHandshaker.java:136)
at com.sun.net.ssl.internal.ssl.Handshaker.processLoop (Handshaker.java:593)
at com.sun.net.ssl.internal.ssl.Handshaker.process_record (Handshaker.java:529)
at com.sun.net.ssl.internal.ssl.SSLSocketImpl.readRecord (SSLSocketImpl.java:925)
at
com.sun.net.ssl.internal.ssl.SSLSocketImpl.performInitialHandshake (SSLSocketImpl.java:1170)
at com.sun.net.ssl.internal.ssl.SSLSocketImpl.readDataRecord (SSLSocketImpl.java:785)
at com.sun.net.ssl.internal.ssl.AppInputStream.read (AppInputStream.java:75)
at com.sun.mail.util.TraceInputStream.read (TraceInputStream.java:110)
at java.io.BufferedInputStream.fill (BufferedInputStream.java:218)
at java.io.BufferedInputStream.read (BufferedInputStream.java:237)
at com.sun.mail.util.LineInputStream.readLine (LineInputStream.java:88)
at com.sun.mail.smtp.SMTPTransport.readServerResponse (SMTPTransport.java:1589)
at com.sun.mail.smtp.SMTPTransport.openServer (SMTPTransport.java:1369)
at com.sun.mail.smtp.SMTPTransport.protocolConnect (SMTPTransport.java:412)
at javax.mail.Service.connect (Service.java:310)
at javax.mail.Service.connect (Service.java:169)
at javax.mail.Service.connect (Service.java:118)
at oracle.sdpinternal.messaging.driver.email.EmailDriver.send (EmailDriver.java:780)
at
oracle.sdpinternal.messaging.driver.email.EmailManagedConnection.send (EmailManagedConnection.java:50)
```

```
at
oracle.sdpinternal.messaging.driver.DriverConnectionImpl.send(DriverConnectionImpl.java:4
1)
at
oracle.sdpinternal.messaging.dispatcher.DriverDispatcherBean.onMessage(DriverDispatcherBe
an.java:296)
at sun.reflect.NativeMethodAccessorImpl.invoke0(Native Method)
at sun.reflect.NativeMethodAccessorImpl.invoke(NativeMethodAccessorImpl.java:39)
at sun.reflect.DelegatingMethodAccessorImpl.invoke(DelegatingMethodAccessorImpl.java:25)
at java.lang.reflect.Method.invoke(Method.java:597)
at
com.bea.core.repackaged.springframework.aop.support.AopUtils.invokeJoinpointUsingReflecti
on(AopUtils.java:310)
at
com.bea.core.repackaged.springframework.aop.framework.ReflectiveMethodInvocation.invokeJo
inpoint(ReflectiveMethodInvocation.java:182)
at
com.bea.core.repackaged.springframework.aop.framework.ReflectiveMethodInvocation.proceed(
ReflectiveMethodInvocation.java:149)
at
com.bea.core.repackaged.springframework.aop.interceptor.ExposeInvocationInterceptor.invoke
(ExposeInvocationInterceptor.java:89)
at
com.bea.core.repackaged.springframework.aop.framework.ReflectiveMethodInvocation.proceed(
ReflectiveMethodInvocation.java:171)
at
com.bea.core.repackaged.springframework.aop.support.DelegatingIntroductionInterceptor.doP
roceed(DelegatingIntroductionInterceptor.java:131)
at
com.bea.core.repackaged.springframework.aop.support.DelegatingIntroductionInterceptor.inv
oke(DelegatingIntroductionInterceptor.java:119)
at
com.bea.core.repackaged.springframework.aop.framework.ReflectiveMethodInvocation.proceed(
ReflectiveMethodInvocation.java:171)
at
com.bea.core.repackaged.springframework.aop.framework.JdkDynamicAopProxy.invoke(JdkDynam
icAopProxy.java:204)
at $Proxy349.onMessage(Unknown Source)
at weblogic.ejb.container.internal.MDListener.execute(MDListener.java:583)
at weblogic.ejb.container.internal.MDListener.transactionalOnMessage(MDListener.java:486)
at weblogic.ejb.container.internal.MDListener.onMessage(MDListener.java:388)
at weblogic.jms.client.JMSSession.onMessage(JMSSession.java:4659)
at weblogic.jms.client.JMSSession.execute(JMSSession.java:4345)
at weblogic.jms.client.JMSSession.executeMessage(JMSSession.java:3821)
at weblogic.jms.client.JMSSession.access$000(JMSSession.java:115)
at weblogic.jms.client.JMSSession$UseForRunnable.run(JMSSession.java:5170)
at
weblogic.work.SelfTuningWorkManagerImpl$WorkAdapterImpl.run(SelfTuningWorkManagerImpl.jav
a:545)
at weblogic.work.ExecuteThread.execute(ExecuteThread.java:256)
at weblogic.work.ExecuteThread.run(ExecuteThread.java:221)
>
```

## Solution

Ensure the following:

- Username and password provided are correct.
- Entry for DemoTrust.jks is removed from setDomainEnv script.
- Application server, such as Oracle WebLogic Server, has been deployed and configured correctly.

- Certificate exchange is done.

## 18.7.5 Issues Related to Failed Email Delivery Not Reported Through EM

The Status Code can be DELIVERY\_TO\_GATEWAY\_SUCCESS in Usermessagingserver Message Status in the Enterprise Manager, although the email is invalid.

### **Problem**

Status Code is always DELIVERY\_TO\_GATEWAY\_SUCCESS in Enterprise Manager (EM) Usermessagingserver Message Status, although the email is invalid. The status code does not update to failure even if the user does not receive any email.

### **Solution**

Ensure that the following Incoming settings in the Driver configuration are properly configured:

- MailAccessProtocol
- ReceiveFolder
- IncomingMailServer
- IncomingMailServerPort
- IncomingMailServerSSL
- IncomingMailIDs
- IncomingUserIDs
- IncomingUserPasswords
- ImapAuthPlainDisable

For additional information on , see [Configuring Oracle User Messaging Service](#) in the *Administrator's Guide for Oracle SOA Suite and Oracle Business Process Management Suite*.

# 19

## Configuring Oracle Identity Governance

You can control the behavior of various Oracle Identity Governance components by using system properties. Managing system properties involve understanding the predefined and configurable system properties, searching and modifying the system properties, and configuring various components and the identity provider by using the system properties.



This content applies only to OIG Bundle Patch 12.2.1.4.220703 and releases earlier to July 22 Bundle Patch.

This chapter describes how to configure Oracle Identity Governance deployment by using system configuration properties. It contains the following sections:

- [About System Properties](#)
- [Types of System Properties](#)
- [Managing System Properties](#)
- [Configuring Oracle Identity Governance Components](#)
- [Configuring the Access Request Catalog](#)
- [Configuring the Identity Provider](#)

### 19.1 About System Properties

System Properties are entities that lets you control the configuration of Oracle Identity Manager.

System properties define the characteristics that control the behavior of Oracle Identity Manager. You can define the functionality of user interfaces, such as the Oracle Identity Manager Self Service and Oracle Identity Administration, by using system properties. For example, you can define the number of consecutive attempts the user can make to login to Oracle Identity Manager unsuccessfully before Oracle Identity Manager locks the user account. In other words, a system property is an entity by which you can control the configuration of Oracle Identity Manager.

### 19.2 Types of System Properties

Various system properties are predefined in the PTY table of the database. In addition, you can add some system properties to the PTY table.

This section describes the different types of system properties in the following topics:

- [Default System Properties in Oracle Identity Governance](#)
- [Non-Default System Properties in Oracle Identity Governance](#)

## 19.2.1 Default System Properties in Oracle Identity Governance



Default system properties are predefined in the PTY table. Each system property has a keyword and default value.

Table 19-1 describes default system properties in Oracle Identity Governance.

**Table 19-1 Default System Properties in Oracle Identity Governance**

Property Name	Keyword	Default Value	Description
Access Policy Revoke If No Longer Applies Enhancement	XL.AccessPolicyRevokelfNoLongerApplieEnhancement	FALSE	<p>Determines if the Revoke if no longer applies flag in access policy is applicable.</p> <p>If the value is true, then this flag is applicable to child table data (entitlements) along with parent data. The user can determine if child data must be removed or retained when access policy no longer applies to user based on this flag.</p> <p>If the value if false, then child table data (entitlements) are always removed after access policy is no longer applied.</p> <p><b>Note:</b> This property is not used in Oracle Identity Manager Release 2 (11.1.2) or later.</p>
Allows access policy based provisioning of multiple instances of a resource	XL.AllowAPBasedMultipleAccountProvisioning	FALSE	<p>Determines if multiple instances of a resource can be provisioned to multiple target resources.</p> <p>When the value is false, provisioning multiple instances of resource object via access policy is not allowed.</p> <p>When the value is true, provisioning multiple instances of resource object via access policy is allowed.</p>
Allows control over role hierarchical access policy evaluation	XL.AllowRoleHierarchicalPolicyEval	FALSE	<p>This property is used to control allowing role hierarchical access policy evaluation. When this system property is set to TRUE, access from inherited access policies is given to the user. If set to FALSE, access from access policies attached to inherited roles is not given to the user.</p>
Allows linking of access policies to reconciled and bulk loaded accounts	XL.AllowAPHarvesting	FALSE	<p>Determines if access policy engine can link access policies to reconciled accounts and to accounts created by the Bulk Load Utility.</p> <p>This property is used in the context of evaluating access policies for reconciled accounts and to accounts created by the Bulk Load Utility.</p> <p><b>Note:</b> This property is used in Oracle Identity Manager 11g Release 2 (11.1.2.2.0) or later.</p>

**Table 19-1 (Cont.) Default System Properties in Oracle Identity Governance**

Property Name	Keyword	Default Value	Description
Allows linking of access policies to Direct Provisioned accounts	XL.APHarvestDirectProvisionAccount	FALSE	<p>This property is used to link access policies to accounts that are provisioned through Direct Provisioning.</p> <p>When this system property is set to True, the account which is provisioned through Direct Provisioning is linked to the Access Policy based provisioned account. If set to FALSE, then the account which is provisioned through Direct Provisioning is not linked to the Access Policy based provisioned account.</p>
Allows linking of access policies to request based accounts	XL.APHarvestRequestAccount	FALSE	<p>This property is used to link access policies to accounts that are provisioned through Request Provisioning.</p> <p>When this system property is set to True, the account which is provisioned through Request Provisioning is linked to the Access Policy based provisioned account. If set to FALSE, then the account which is provisioned through Request Provisioning is not linked to the Access Policy based provisioned account.</p>
XL.APHarvesting.AllowAccountDataUpdate	XL.APHarvesting.AllowAccountDataUpdate	FALSE	<p>This property is used to update the account data with the policy defaults for the accounts linked to the access policies.</p> <p>When this system property is set to True, the account data is updated with the policy defaults for the accounts linked to access policy. If set to False or if the system property does not exist, the account data is not updated.</p>
<div style="border-left: 2px solid #0070C0; padding-left: 10px; margin-bottom: 10px;"> <p> <b>Note:</b></p> <p>This system property is available only after you apply Oracle Identity Governance Bundle Patch 12.2.1.4.201011.</p> </div>			
Do not evaluate Access policy for disabled user	XL.DoNotEvaluateAPForDisableUsers	FALSE	<p>If the value is set to TRUE, then disabled users are not evaluated for <b>Evaluate User Policies</b> by Access Policy.</p> <p>If the value is set to FALSE, then disabled users are evaluated by <b>Evaluate User Policies</b> Scheduler Job.</p>
<div style="border-left: 2px solid #0070C0; padding-left: 10px;"> <p> <b>Note:</b></p> <p>This system property is available only after you apply Oracle Identity Governance Bundle Patch 12.2.1.4.211010.</p> </div>			



**Table 19-1 (Cont.) Default System Properties in Oracle Identity Governance**

Property Name	Keyword	Default Value	Description
Are challenge questions disabled in OIM	OIM.DisableChallengeQuestions	FALSE	<p>Determines if challenge questions are enabled or disabled when a user logs in to Oracle Identity Manager for the first time.</p> <p>When value is False, challenge questions are enabled.</p> <p>When value is True, challenge questions are disabled.</p> <p>This property is primarily used in the context of Oracle Adaptive Access Manager (OAAM) configuration. When the value is TRUE, the challenge questions are handled by OAAM.</p> <p>When the value is FALSE, then PWR.PWR_CHA_POLICY_ENABLED is honored to determine if challenge policy is enabled or not.</p>
Catalog Additional Application Details Task Flow	CatalogAdditionalApplicationDetailsTaskFlow	/WEB-INF/oracle/iam/ui/common/tfs/empty-tf.xml#empty-tf	A custom task flow is to be displayed when an application is selected from the catalog checkout page. The task flow page will display as a tab in the cart details section.
Catalog Additional Entitlement Details Task Flow	CatalogAdditionalEntitlementDetailsTaskFlow	/WEB-INF/oracle/iam/ui/common/tfs/empty-tf.xml#empty-tf	A custom task flow is to be displayed when an entitlement is selected from the catalog checkout page. The task flow page will display as a tab in the cart details section.
Catalog Additional Role Details Task Flow	CatalogAdditionalRoleDetailsTaskFlow	/WEB-INF/oracle/iam/ui/common/tfs/empty-tfs.xml#empty-tfs	A custom task flow is to be displayed when a role item is selected from the catalog checkout page. The task flow page will display as a tab in the cart details section.
Catalog Advanced Search Maximum Applications	CatalogAdvancedSearchMaxApps	15	In the default form for catalog advanced search, you can search for entitlements by specifying the list of applications to search from. This system property controls the maximum number of applications that can be selected for entitlement search.
Catalog Advanced Search Taskflow	CatalogAdvancedSearchTaskflow	/WEB-INF/oracle/iam/ui/catalog/tfs/catalog-advanced-search-tf.xml#catalog-advanced-search-tf	Determines the taskflow used for catalog search. If you create custom taskflow for catalog search, then change the value of this property to the complete path of the custom taskflow.

**Table 19-1 (Cont.) Default System Properties in Oracle Identity Governance**

Property Name	Keyword	Default Value	Description
Catalog Attributes for Sorting Search Results	CatalogSortAttributes	ENTITY_DISPLAY_NAME; ENTITY_TYPE	This property determines the attributes that will be displayed in the Sort By drop down in the catalog results tab.
Catalog Audit Data Collection	XL.CatalogAuditDataCollection	none	Determines if catalog auditing is enabled or disabled. The default value is <code>none</code> , which specifies that catalog auditing is disabled. To enable catalog auditing, set the value of this property to <code>catalog</code> .
Category count option can be 0, 1 or 2	CATALOG.CATEGORY_COUNT_OPTION	2	Determines what is displayed in the Category count block. If the value is 0, then Category Count block is deactivated. If the value is 1, then distinct categories across the system are displayed without respective category count. If the value is 2, then Categories with count are displayed. <b>Note:</b> It is recommended that the values be modified in cases they are observing poor Catalog Search performance.
Catalog Regex for special characters	Catalog.SpecialCharacterRegex	[^w]	Enables text parsing and escaping of special characters when performing a catalog search by using some special characters. If you do not want any text parsing and escaping of special characters, then change the value of this property to <code>[^\w^\W]</code> .
Catalog search MAX result size. Default value is -1 which means return all	XL.CatalogSearchResultCap	-1	When the data is huge in the request catalog and you encounter any issue with the performance of the catalog, you can change the value of this system property and provide some reasonable values, such as 500. As a result, catalog search will not return more than the specified value. If the value is -1, then no result size limit is applied on the catalog search result.
Catalog Searchable UDF In Tags	CATALOG.SearchableUdfInTags	FALSE	If want to use searchable UDF in TAGS, then you can set the value of this property to TRUE. Then, you can run the scheduled task in recalculate tags mode and searchable UDF values will be part of the TAGS column. The same value can be used in keyword search.
Catalog Table Rows To Display Size	CatalogTableRowsToDisplaySize	10	This property is used to control the number of rows displayed in all tables found in all catalog-related pages. <b>Note:</b> The value of this system property must be less than or equal to 50.
Common Name generation plugin	XL.DefaultCommonNamePolicyImpl	oracle.iam.ldapasync.impl.plugins.FirstNameLastNamePolicy	Determines the common name generation plugin to generate common name.

**Table 19-1 (Cont.) Default System Properties in Oracle Identity Governance**

Property Name	Keyword	Default Value	Description
Compiler Path for Connectors	XL.CompilerPath	JAVA_HOME	Specifies the Java home depending on the application server. <b>Note:</b> If the path of the JDK directory is not included in the System Path variable, then you must set the path of the JDK directory in the XL.CompilerPath system property. If this is not done, then an error is encountered during the adapter compilation stage of the process performed when you import an XML file by using the Deployment Manager.
Compute and Persist Min Age On Password Change	ComputePersistMinAgeOnPasswordChange	proactive	Password minimum age calculation has two modes, proactive and reactive mode.  In proactive, where minimum age date is calculated at password change time, any subsequent change to the user's applicable password policy's minimum age property will not be honored until the next password change, where as with the reactive approach, policy changes will be applied immediately.  To enable proactive or reactive approach, system property Compute Persist Min Age On Password Change is introduced.
Control allowing Request Data to Prepopulate Adapters	XL.AllowRequestDataToPrepopAdapter	FALSE	This property is used to control the order of preference for populating the process form data during provisioning. If this property is set to TRUE, pre-populate adapters data will take precedence over access policy or request data. That is access policy or request data will be overridden with pre-populate adapters data. If the property is set to FALSE, access policy or request data will have precedence over pre-populate adapters data.
Copy manager of user also for create user email notification	XL.NotifyUserCreateToOther	TRUE	Copies the user's manager in the email notification that is sent when a user is created.
Data Collection Session ID	XL.DataCollectionSessionID	dummy	Specifies the session ID of the current Oracle Identity Analytics (OIA) Data collection session.
Data Collection Status	XL.DataCollectionStatus	FINALIZED	Specifies the status of the current OIA data collection session.
DB Diagnostic Level for Data Truncate	OIM.DBDiagnosticLevelDataTruncate	NONE	This property controls the amount of diagnostic logging for Complete Nuke Cleanup operation. The values can be: <ul style="list-style-type: none"> <li><b>NONE:</b> No information is collected to debug the complete nuke cleanup operation. This is the default value.</li> <li><b>FINEST:</b> Fine-grained information is collected to debug the complete nuke cleanup operation.</li> </ul>

**Table 19-1 (Cont.) Default System Properties in Oracle Identity Governance**

Property Name	Keyword	Default Value	Description
DB Diagnostic Level for Offline Data Purges	OIM.DBDiagnosticLevelOffPurge	NONE	This property controls the amount of diagnostic logging for Offline Data Purge operation. The values can be: <ul style="list-style-type: none"> <li><b>NONE:</b> No information is collected to debug the offline data purge operation. This is the default value.</li> <li><b>FINEST:</b> Fine-grained information is collected to debug the offline data purge operation.</li> </ul>
DB Diagnostic Level for OIM GDPR support	OIM.DBDiagnosticLevelGdprSupp	NONE	This property is used to enable or disable detailed logging in database. The values can be: <ul style="list-style-type: none"> <li><b>NONE:</b> Logging is disabled. This is the default value.</li> <li><b>FINEST:</b> Logging is enabled.</li> </ul>
DB Diagnostic Level for OIM Mview Legacy Data Migration	OIM.DBDiagnosticLevelMviewMig	NONE	This property defines the DB diagnostic level for OIG materialized view legacy data migration. The values can be: <ul style="list-style-type: none"> <li><b>NONE:</b> Logging is disabled. This is the default value.</li> <li><b>FINEST:</b> Logging is enabled.</li> </ul>
DB Diagnostic Level for MView creation for BIP report	OIM.DBDiagnosticLevelMviewBIP	NONE	This property defines the DB diagnostic level for Mview creation for BIP reports. The values can be: <ul style="list-style-type: none"> <li><b>NONE:</b> Logging is disabled. This is the default value.</li> <li><b>FINEST:</b> Logging is enabled.</li> </ul>
DB Diagnostic Level for Online Data Purge	OIM.DBDiagnosticLevelDataPurge	NONE	This property controls the amount of diagnostic logging and debugging required in PL/SQL layer during OIM Data Purge scheduled task operation. The values can be: <ul style="list-style-type: none"> <li><b>NONE:</b> No information is collected to debug the online data purge operation in PL/SQL layer. This is the default value.</li> <li><b>FINEST:</b> Fine-grained information is collected to debug the online data purge operation in PL/SQL layer.</li> </ul>
DB Diagnostic Level for Recon	OIM.DBDiagnosticLevelRecon	INFO	This property controls the amount of diagnostic logging and debugging required in PL/SQL layer during reconciliation operations. The values can be: <ul style="list-style-type: none"> <li><b>INFO:</b> Coarse-grained level information is collected to debug the reconciliation operation in PL/SQL layer. This is the default value.</li> <li><b>FINE:</b> Fine-grained information is collected to debug the reconciliation operation in PL/SQL layer.</li> <li><b>FINEST:</b> Fine-grained information along with data for collection variables used as input to Stored Program Units is collected to debug the reconciliation operation in PL/SQL layer.</li> <li><b>NONE:</b> No information is collected to debug the reconciliation operation in PL/SQL layer.</li> </ul>

**Table 19-1 (Cont.) Default System Properties in Oracle Identity Governance**

Property Name	Keyword	Default Value	Description
DB Diagnostic Level for Online Recon Exceptions Purge	OIM.DBDiagnosticLevelRecx	NONE	<p>This property controls the amount of diagnostic logging and debugging required in PL/SQL layer during Recon Exceptions Purge operation. The values can be:</p> <ul style="list-style-type: none"> <li><b>INFO:</b> Coarse-grained level information is collected to debug the Recon Exceptions Purge operation in PL/SQL layer.</li> <li><b>FINE:</b> Fine-grained information is collected to debug the Recon Exceptions Purge operation in PL/SQL layer.</li> <li><b>FINEST:</b> Fine-grained information along with data for collection variables used as input to Stored Program Units is collected to debug the Recon Exceptions Purge operation in PL/SQL layer.</li> <li><b>NONE:</b> No information is collected to debug the Recon Exceptions Purge operation in PL/SQL layer. This is the default value.</li> </ul>
Default Date Format	XL.DefaultDateFormat	yyyy/mm/dd hh:mm:ss z	When creating reconciliation events by calling the APIs and date format is not passed as one of the arguments to the API, Oracle Identity Manager assumes that all the date field values are specified in Default Date Format.
Default policy for username generation	XL.DefaultUsernamePolicyImpl	oracle.iam.identity.usermgmt.impl.plugins.DefaultComboPolicy	Determines the username policy to use when generating a username.
Default user name domain	XL.UserNameDomain	oracle.com	This property is used by the DefaultComboPolicy to generate a user name in e-mail format.
Disable Catalog Blank Search	CATALOG.DISABLE_BLANK_SEARCH	True	<p>This property is used to enable or disable blank text search in Catalog. If the value is True, then blank text search is disabled. If the value is False, then blank text search is enabled.</p> <p><b>Note:</b> Catalog search functionality can run slow depending upon the volume of data in the system. It is recommended to disable blank search functionality to improve search performance.</p>
Disabling Default Search of UI pages	OIG.DisableDefaultTableSearches	FALSE	This property is used to enable or disable blank text search in the Users, Roles, Organizations, and Administration Roles page. If the value is TRUE, then blank text search is enabled. If the value is FALSE, then blank text search is disabled.
Display Certification or Attestation	OIM.ShowCertificationOrAttestation	attestation	<p>This property has been superseded by the <code>Identity Auditor Features Enabled</code> system property, and attestation is no longer supported.</p> <p><b>Note:</b> In this release, this property is not used as Attestation is not supported. This property is superceded by the <code>Identity Auditor Features Enabled</code> system property.</p>
DM Global Search Result Size	DMGlobalSearchResultSize	100	<p>This system property controls the number of records displayed for deployment manager global search result. If incorrect or non-numeric value is set, then default value is considered.</p> <p><b>Note:</b> It is recommended that the value of this system property is less than 1000.</p>

**Table 19-1 (Cont.) Default System Properties in Oracle Identity Governance**

Property Name	Keyword	Default Value	Description
Does user have to provide challenge information during registration	PCQ.PROVIDE_DURING_SELFREG	TRUE	If the value is TRUE, then users will have to provide challenge information during registration.
Email Server	XL.MailServer	Email Server	Name of the e-mail server. <b>Note:</b> After modifying the Email Server system property value, you must restart the server for the change to take effect.
Email URL token expiration time (in days)	OIM_EMAIL_URL_EXPIRE_TIME	1	This system property determines the time until when the forgot password Email link is valid.
Email Validation Pattern	XL.EmailValidationPattern	[A-Za-z0-9\.\_\#\!\\$\&!\*\ \=!\? \` \{ \} \~ \ %\+ \-]+\@[A-Za-z0-9\.\-]+\.[A-Za-z]{2,4}	This property contains the regular expression used to validate the email ID of a user.
Enable disabled resource instances when a user is enabled	XL.EnableDisabledResources	TRUE	If the value is TRUE, then the disabled resource instances are enabled when a user is enabled.
Enable email notification based password reset	OIM_ENABLE_EMAIL_SEC_FEAT	True	This property is used to enable Email notification for forgot password. If this property is set to False, then the feature is disabled.
Enable Exception Reports	XL.EnableExceptionReports	TRUE	This property is used to enable the exception reporting feature. Exception reporting is enabled only if the value is set to TRUE.
Enable User Login Validation	XL.ValidateWhiteSpace	FALSE	This property enforces the validation of the user login for special characters.

**Table 19-1 (Cont.) Default System Properties in Oracle Identity Governance**

Property Name	Keyword	Default Value	Description
Evaluate LDAP Container Rules for Entity Modification	LDAPEvaluateContainerRulesForModification	FALSE	<p>If the property value is TRUE, then the LDAP container rules defined in LDAPContainerRules.xml are evaluated for entity modification. However, if none of the rules match, then the default container is not returned. The original parent container of the entity is returned, which means that there is no change in the entity DN.</p> <p>If the property value is FALSE, then the LDAP container rules defined in LDAPContainerRules.xml are not evaluated. The entity DN does not change.</p> <p><b>Note:</b> This property only applies to a modification scenario and not to the entity creation scenario.</p>
Execute Dynamic Role Membership Orchestration Using Async	XL.ExecuteDynamicRoleMembershipOrchestrationUsingAsync	false	<p>If the value of this property is set to true, then the role grant/revoke takes place asynchronously.</p>
Force to set questions at startup	PCQ.FORCE_SET_QUESTIONS	False	<p>When the user logs into the Oracle Identity Self Service or Oracle Identity System Administration for the first time, the user must set the default questions for resetting the password.</p> <p><b>Note:</b> After modifying the value of this property, you must restart Oracle Identity Manager server for the changes to take effect.</p>
GTC Auto Import	XL.GTCAutoImport	true	<p>Based on the value of this property, the DM xml that is generated while Generic Technology Connector (GTC) creation can be saved to a directory. The default value of this property is true.</p> <p>When the value of this property is set to "False", then while creating GTC, the DM xml (the xml that GTC creates and imports using Deployment Manager internally while GTC creation) created by the GTC framework is stored in the following directory:</p> <p><i>OIM_HOME/GTC/XMLOutput</i></p> <p>The naming convention followed for the DM xml is:</p> <p><i>GTCNAME_CURRENTDATE_TIMESTAMP</i> created using date format "yyyy-MM-dd-HH-mm-ss".xml</p> <p>For example:</p> <p>TRUSTEDCSV_2009-02-05-22-41-11.xml</p>
IDMDF: Attachment File Path	IDM.Diagnostics.IDMDFClient.Notifier.Attachment.File	/scratch/IDMDFAttachment	<p>This property determines the path to store the attachment files.</p>
IDMDF: Buffer size to hold context sensitive logs	IDM.Diagnostics.EventProcessing.ContextSensitiveLogsBufferSize	10000	<p>This property determines the size of the buffer that holds detailed logs of the product.</p>
IDMDF: Buffer size to hold failed records	IDM.Diagnostics.EventProcessing.FailedRecordBufferSize	1000	<p>This property determines the size of the buffer that holds failed (functional/SLA) events.</p>

**Table 19-1 (Cont.) Default System Properties in Oracle Identity Governance**

Property Name	Keyword	Default Value	Description
IDMDF: Debug mode (true/false)	IDM.Diagnostics.Debug	False	This property determines if logs of IDMDF framework in a log file is saved. When set to TRUE, debug mode is enabled. When set to False, debug mode is disabled.
IDMDF: Default SLA	IDM.Diagnostics.DefaultSLA	300000	This property determines the size of the default SLA for events.
IDMDF: E-mail notification to	IDM.Diagnostics.Notification.Email.To	dummy.dummy@dummy.com	This property determines the email address to which notification is sent.
IDMDF: E-mail notification from	IDM.Diagnostics.Notification.Email.From	dummy.dummy@dummy.com	This property determines the email address from which notification is sent.
IDMDF: Email Message Template Path	IDM.Diagnostics.IDMDFClient.Notifier.Email.MessageTemplatePath		This property determines the path of the email message template.
IDMDF: Enabled/Disabled By Sysadmin	IDM.Diagnostics.Enabled	false	This property is used by the system administrator to enable or disable IDMDF.
IDMDF: Flood Control Duration(In Days)	IDM.Diagnostics.EmailFloodControl.DurationInDays	1	This property indicates the retention period in days for Flood Control Max email. After the defined number of days, the Flood Control Max email counter is reset.
IDMDF: Flood Control Max Email	IDM.Diagnostics.EmailFloodControl.MaxEmail	2	This property determines the maximum number of notifications allowed per use case.
IDMDF: In-Memory Logging	IDM.Diagnostics.IDMDFClient.InMemoryLogging	false	This property determines if logs are stored in the memory.
IDMDF: Max failed event to execute concurrently	IDM.Diagnostics.EventProcessing.MaxConcurrentFailedEvent	2	This property determines the number of threads to execute events concurrently and put it in the database.



**Table 19-1 (Cont.) Default System Properties in Oracle Identity Governance**

Property Name	Keyword	Default Value	Description
IDMDF: Notification provider	IDM.Diagnostics.NotificationProvider	oracle.idm.diagnostics.notification.service.impl.IdmdfNotifier	This property determines the service used for sending notifications.
IDMDF : Notification template file name	IDM.Diagnostics.IDMDFClient.Notifier.Email.MessageTemplateName		This property determines the notification template file name.
IDMDF: IDMDF Rest service end-point	IDM.Diagnostics.IDMDFServiceEndpoint	http://localhost:14000/idmeventrecording	This property determines the URL where IDMDF services are deployed. <div style="border: 1px solid #0070C0; padding: 10px; margin-top: 10px;"> <p> <b>Note:</b></p> <p>If the REST service is not working as expected, then check and if required update the local host name and port number configured in IDMDF: IDMDF Rest service end point. On a clustered environment, the IDMDF: IDMDF Rest service end point should be updated with host name and port number where OHS is running. In a single node configuration, this end point should be updated with host name and port number where OIG is running.</p> </div>
IDMDF: SMTP Server Name	IDM.Diagnostics.Email.Server.Host	localhost	This property represents the server responsible for sending email notification.
IDMDF: SLA template file	IDM.Diagnostics.IDMDFClient.Notifier.Sla.File	None	This property determines the file that contains the list of SLAs for defined use cases.
Identity Auditor Feature Set Availability	OIG.IsIdentityAuditorEnabled	FALSE	When the value of this property is TRUE, role lifecycle management, Segregation of Duties (SoD), and identity certification are enabled. <b>Note:</b> After modifying the value of this system property, you must restart Oracle Identity Governance server for the changes to take effect.
Inbox Task Tabs (none/all)	UI.INBOX.VIEW.TaskTabs	none	This property determines whether or not to show additional links, such as Initiated tasks, Reportees and Administrative tasks, in the Inbox. When set to all, the following links are displayed in the Inbox: My tasks, Initiated tasks, Reportees, Administrative tasks. When set to none, only the My tasks link is displayed in the Inbox.

**Table 19-1 (Cont.) Default System Properties in Oracle Identity Governance**

Property Name	Keyword	Default Value	Description
Indicates if referential integrity is enabled in target LDAP directory	XL.IsReferentialIntegrityEnabledInLDAP	FALSE	The value of this property is TRUE if referential integrity in target LDAP directory is turned on. The value of this property is FALSE if referential integrity in target LDAP directory is turned off. To be able to modify an entity stored in LDAP, this prop must be set to TRUE.
Is DataProvider LDAP/DB	OIM.DataProvider	DB	Specifies the data provider, which is Oracle Identity Manager database. The default value is DB, which indicates that the database is the data provider.
Is disabled manager allowed	AllowDisabledManagers	FALSE	Specifies whether a user in the disabled state can be set as a manager for another user.
Is OIM Notifications disabled (true/false)	XL.DisableAllNotifications	false	This property is used to enable or disable all notifications in Oracle Identity Manager. When the value of this property is set to false, notifications are enabled. When the value of this property is true, notifications are disabled.
Is Self-Registration Allowed	XL.SelfRegistration Allowed	TRUE	If the value is TRUE, then the users are allowed to self-register.
LDAP Reservation Plugin	XL.LDAPReservationPluginImpl	oracle.iam.identity.usermgmt.impl.plugins.reservation.ReservationInOID	This property determines the LDAP reservation plugin implementation to be picked up for reservation of user attributes.
Level of Role Auditing	XL.RoleAuditLevel	None	This property controls the amount of audit data collected when an operation is performed on a role, such as creation or modification. The supported levels are: <ul style="list-style-type: none"> <li><b>None:</b> No audit data is collected.</li> <li><b>Role:</b> Creation, modification, and deletion of role is audited.</li> <li><b>Role Hierarchy:</b> Changes made to the role inheritance is audited.</li> </ul>
Login Validation Pattern	XL.LoginPattern	(^[A-z0-9@._-]{2,256}\$)	This property contains the regular expression used to validate the login of a user when XL.ValidateWhiteSpace is set to true. If XL.LoginPattern is empty, then user login is validated against the default pattern. <b>Note:</b> It is recommended that the regular expression is developed and tested fully for specific validation requirements before using this system property.

**Table 19-1 (Cont.) Default System Properties in Oracle Identity Governance**

Property Name	Keyword	Default Value	Description
Locale for dependent request justification created by server of a bulk request	OIM.RequestJustificationLocale	en_US	The value of the property is a locale, the same locale will be used to translate request justification text for bulk requests. The format of locale is languageCode_CountryCode such as en_US, fr_FR. For details, refer <a href="#">Preparing to Install and Configure Oracle Identity and Access Management</a> .
Notify other recipients with the password reset email if email of user is null	XL.NotifyPasswordGenerationToOther	TRUE	When the value of this property is TRUE, the email notification for reset password is sent to other recipients if the email ID of the user is not specified.
Number of records to be executed in a batch during Catalog Enrichment	XL.CatalogEnrichmentBatchSize	500	This property determines how many records must be processed in a batch by the catalog job during catalog enrichment.
Maximum number of records to be fetched from Catalog	Catalog.SearchResultCap	-1	This property determines how many records must be fetched from catalog when a search is performed. If the value is -1, then all records are fetched from catalog table. If the value is 10000, then only 10000 records are fetched from catalog. <b>Note:</b> It is recommended that you set the value to 10000 only if poor catalog search performance is experienced.
Max Result size for lookups	LOOKUP_MAX_RESULTSIZE	1000	This property determines how many records must be fetched from the lookup table when a search is performed. For example, if the value is set to 500, then only 500 records are fetched from the lookup table. If the value is set to 0, then there is no restriction on the number of records fetched from the lookup table.

**Table 19-1 (Cont.) Default System Properties in Oracle Identity Governance**



Property Name	Keyword	Default Value	Description
Midtier compression for Audit(UPA) data	OIM.AuditCompression	0	<p>This property is used to configure user profile audit data compression. It can have the following values:</p> <ul style="list-style-type: none"> <li><b>0:</b> This is the default value. It determines that none of the columns in the UPA table are compressed.</li> <li><b>1:</b> This value determines that the SNAPSHOT column in the UPA table is compressed.</li> <li><b>3:</b> This value determines that the SNAPSHOT and DELTAS columns in the UPA table are compressed.</li> </ul>
Midtier compression for Audit(UPA) data algo	OIM.AuditCompressionAlgo	GZIP	<p>This property determines that GZIP is used as the compression algorithm. Only GZIP is supported in this release.</p>
OIA integration status	OIM.IsOIAIntegrationEnabled	FALSE	<p>Specifies whether OIA is integrated with Oracle Identity Manager. Set the value of this property to <b>TRUE</b> before you add role memberships in Oracle Identity Manager.</p> <p>If you set the value of this property to <b>FALSE</b>, incremental role memberships into OIA will not work.</p> <p><b>Note:</b> You must do a full import of role memberships at least once after this property is enabled.</p>
OIM Complex Password Policy compatible with Active Directory	OIM.ADPasswordPolicyCompatibilityEnabled	FALSE	<p>On setting the value of this property to <b>TRUE</b>, the last rule (inclusion of user ID, first name, or last name in password) of the OIG complex password policy is replaced with the Active Directory (AD) password policy (inclusion of Display Name and User Login in password). This property is applicable to all complex password policies.</p>
<div style="border-left: 2px solid #0070C0; padding-left: 10px; margin-bottom: 10px;">  <b>Note:</b>                      This system property is available only after you apply Oracle Identity Governance Bundle Patch 12.2.1.4.200624.                 </div>			
OIM No Password Propagation Support	NO_PASSWORD_PROPAGATION_SUPPORT	FALSE	<p>This property determines if the No Password Propagation Support is enabled in Oracle Identity Governance. If this property is set to true, then the access policy based password provisioning is disabled. It is recommended not to change this property value directly as it changes the Oracle Identity Governance login behavior.</p>
Old Password Validator	OIM.OldPasswordValidator	oracle.iam.identity.usermgmt.impl.ContainerLoginPasswordVerifier	<p>The property specifies the name of the plugin class to be used for verifying old passwords.</p>

Table 19-1 (Cont.) Default System Properties in Oracle Identity Governance

Property Name	Keyword	Default Value	Description
OMSS Enabled	OMSS Enabled	false	When the value of this property is true, OMSS integration is enabled, and the OMSS links and tabs are displayed in Oracle Identity Self Service. <b>Note:</b> After modifying the value of this system property, you must restart Oracle Identity Manager server for the changes to take effect.
Period to Delay User Delete	XL.UserDeleteDelay Period	0	This property is used to specify the time period before deleting a user. When this property is set and a user is deleted, the user's state is changed to disabled and "automatically delete on date" is set to current date plus the delay period.  If this property is not set, then the user is automatically deleted at the expiration of the end date by the Disable/Delete User After End Date scheduled job.
Proxy User Email Notification	XL.ProxyNotification Template	Notify Proxy User	The corresponding PTY_VALUE is the e-mail definition name that is sent when a proxy user is created. User gets a notification e-mail when the user is made the proxy for some other user.
Recon Batch Size	OIM.ReconBatchSize	500	This property is used to specify the batch size for reconciliation. You can specify 0 as the value for this to indicate that the reconciliation will not be performed in batches. <b>Note:</b> You must restart Oracle Identity Manager server after setting this property.
Request Notification Level	RequestNotification Level	0	This property indicates whether or not notification is sent to the requester and beneficiary when a request is created or the request status is changed. This property can have the following values: <ul style="list-style-type: none"> <li>• <b>0:</b> The notification feature is disabled.</li> <li>• <b>1:</b> Notifications are sent for every change in request status.</li> <li>• <b>2:</b> Notifications are sent for request creation and change of status to any of the Request End statuses. Request End statuses include Request Failed and other failure related statuses, Request Completed, Request Withdrawn, and Request Closed.</li> <li>• <b>3:</b> Email notifications are sent only on request completion.</li> </ul> For request notification level 2, notifications are sent for request creation and change of status to any of the Request End statuses. Request End statuses include Request Failed and other failure related statuses, Request Completed, Request Withdrawn, and Request Closed.
Retry Count for recon event	Recon.RetryCount	5	This property determines the reconciliation retry count. The retry count value is picked up from the value of this property.  If you specify a value that is greater than 0, then auto retry is configured. If you specify 0 as the value of this property, then auto retry is not configured.

**Table 19-1 (Cont.) Default System Properties in Oracle Identity Governance**

Property Name	Keyword	Default Value	Description
Reset Password	SSO.RESETPASS WORDONTARGET BYPASSINGCONN ECTOR	False	Set this value to true and import the Active Directory (AD) certificate into Oracle Identity Governance (OIG) to improve the performance of Reset Password in AD integration.  This system property is available only after you apply Oracle Identity Governance Bundle Patch 12.2.1.4.210708.
 <b>Note:</b> For details, see Improving Reset Password Performance on AD Integration in <i>Integration Guide for Oracle Identity Management Suite</i> .			
Search Stop Count	XL.IDADMIN_STOP _COUNT	300	This property determines the maximum number of records that are displayed in the advanced search result. If the search criteria specified returns more number of records than that value of this property, then the number of records displayed is limited to this value. In addition, a warning is displayed stating that the results exceed maximum counts and you must refine your search with additional attributes.
Segregation of Duties (SOD) Check Required	XL.SoDCheckRequired	FALSE	This property indicates whether or not Segregation of Duties (SoD) check is required.
Send email notification based on user locale	XL.SendEmailNotificationBasedOnUserLocale	false	This property determines whether an email notification is sent based on the receiver's (user/manager/assignee/requestor) locale when the value is set to true. If the value is set to false, then notification is sent in the server locale.  <b>Note:</b> This system property has been deprecated in this release of Oracle Identity Manager.
Should send notifications in recon or not	Recon.SEND_NOTIFICATION	true	Determines if notification is sent to the user when the user login and password are generated in postprocess event handler for user creation via trusted source reconciliation.  If the value is set to true, then notification is sent when user login and password are generated in postprocess event handler for user creation via trusted source reconciliation.  If the value is set to false, then notification is not sent when user login and password are generated in postprocess event handler for user creation via trusted source reconciliation.
Shows tasks assigned to group users with highest priority or least load only	XL.ShowTaskAssignedToGroupUserOnly	FALSE	If the value is TRUE, then the tasks are assigned to group users with highest priority or least load only when the assignment type is Group User With Least Load.

**Table 19-1 (Cont.) Default System Properties in Oracle Identity Governance**

Property Name	Keyword	Default Value	Description
Shows Revoked Accounts In the Accounts Tab	ShowRevokedAccountsInAccountsTab	TRUE	By default, the revoked accounts always appear in the Accounts tab. To hide the revoked accounts, this feature should be updated to "FALSE".
Specifies the LDAP container mapper plug-in to be used	LDAPContainerMapperPlugin	oracle.iam.idapsync.impl.DefaultLDAPContainerMapper	When Oracle Identity Manager is installed with LDAP synchronization enabled, this plug-in determines in which container users and roles are to be created. Value of this system property indicates the default Oracle Identity Manager plug-in name used for computing the container values. If the default plug-in does not meet the requirement, then you can define your own plug-in to determine the container and specify the name of the plug-in in this system property.
URL for challenge questions modification	OIM.ChallengeQuestionsModificationURL	NONE	When a user is locked, an automatic unlock occurs after a prescribed time period. This property defines that time period in seconds. Therefore, for example, if a user account is locked and the value of this property is 86400 seconds (one day), then the account is automatically unlocked after one day.  The value of this property is the URL within OAAM that handles the challenge questions. For example:  <code>http://OAAM_HOST:OAAM_PORT/OAAM_SERVER/userPreferences.do?showView=registerQuestions</code>
URL for change password	OIM.ChangePasswordURL	NONE	This property is used in combination with the property OIM.DisableChallengeQuestions. The value of this property is the URL within OAAM that handles the change password functionality. For example:  <code>http://OAAM_HOST:OAAM_PORT/OAAM_SERVER/userPreferences.do?showView=changePassword</code>
User Attribute Reservation Enabled	XL.IsUsrAttribReservationEnabled	TRUE	This property is used to enable user attribute reservation.
User Id reuse property. Requires dropping the index present on USR_LOGIN column	XL.UserIDReuse	FALSE	Determines whether a deleted user account can be reused. To reuse a deleted user account, assign this property a value of TRUE and drop the unique index for the USR_LOGIN column in the USR table and create a nonunique index. To prevent a user account from being reused, assign this property a value of FALSE.  <b>Note:</b> It is imperative to de-provision all accounts associated with a deleted user, because if you create a new user with the same user name as that of the deleted user by setting the <code>XL.UserIDReuse</code> property to <code>true</code> , then the new user might get access to offline accounts of the deleted user that was not deleted as part of the de-provisioning process.
User Language	user.language	en	The user.language value is configured during installation for Locale handling at server side.

**Table 19-1 (Cont.) Default System Properties in Oracle Identity Governance**

Property Name	Keyword	Default Value	Description
User profile audit data collection level	XL.UserProfileAuditDataCollection	Resource Form	<p>This property controls the user profile data that is collected for audit purpose when an operation is performed on the user, such as creation, modification, or deletion of a user, role grants or revokes, and resource provisioning or deprovisioning. Depending upon the property value, such as Resource Form or None, the data is populated in the UPA table.</p> <p>The audit levels are specified as values of this property. The supported levels are:</p> <ul style="list-style-type: none"> <li>• <b>Process Task:</b> Audits the entire user profile snapshot together with the resource lifecycle process.</li> <li>• <b>Resource Form:</b> Audits user record, role membership, resource provisioned, and any form data associated to the resource.</li> <li>• <b>Resource:</b> Audits the user record, role membership, and resource provisioning.</li> <li>• <b>Membership:</b> Only audits the user record and role membership.</li> <li>• <b>Core:</b> Only audits the user record.</li> <li>• <b>None:</b> No audit is stored.</li> </ul>
User Region	user.region	US	The user.region value is configured during installation for Locale handling at server side.
Whether or not email should be validated for uniqueness	OIM.EmailUniqueCheck	TRUE	<p>This property is available in a deployment that has been upgraded from an earlier release of Oracle Identity Manager.</p> <p>If the value of this property is FALSE, then Email Uniqueness check is not performed by Oracle Identity Manager.</p> <p>If the value if TRUE, then Email Uniqueness check is performed by Oracle Identity Manager.</p> <p><b>Note:</b> If this property is not present, then Email Uniqueness check is performed by Oracle Identity Manager.</p>
Width of JGRAPH CELL	XL.GTCNexawebUIColumnWidth	155	This property controls the field length of GTC mapping attributes. Default value is 155, Maximum value is upto 255.
Workflows Enabled	Workflows Enabled	TRUE	<p>This property determines whether SOA server is turned on or turned off.</p> <p>If the value of this property is TRUE, then SOA sever is turned on.</p> <p>If the value of this property is FALSE, then SOA server is turned off.</p> <p><b>Note:</b> After setting the value of this system property, you must restart Oracle Identity Manager.</p> <p><b>Note:</b> Toggling between enabling and disabling workflows is not supported.</p>
Workflow Policies Enabled	Workflow Policies Enabled	TRUE	<p>This property determines whether approval workflows is enabled or disabled in Oracle Identity Manager. Approval workflows is used to determine if operation requires approval or not, and if approval is required, then which workflow is to be invoked.</p> <p>If the value of this property is TRUE, then approval workflow is enabled.</p> <p>If the value of this property is FALSE, then approval workflow is disabled.</p> <p>For detailed information about approval workflow, see <a href="#">Managing Workflows</a>.</p>
XL.AlternativeReviewerIDForManager	XL.AlternativeReviewerIDForManager	xelsysadm	<p>This property provides an alternative certification reviewer for users who do not have a manager or whose manager is disabled.</p> <p>If this property is set to NULL, or if the specified alternative reviewer is disabled or does not exist, then a warning message is logged and these users are omitted from user certifications-by-manager.</p>



**Table 19-1 (Cont.) Default System Properties in Oracle Identity Governance**

Property Name	Keyword	Default Value	Description
OIG.DefaultTaskReassignee	OIG.DefaultTaskReassignee	SYSTEM ADMINISTRATORS	<p>This property defines the default task reassignee to reassign tasks to other assignees when the current assignee is disabled or deleted.</p> <p>By default, the value of the <code>OIG.DefaultTaskReassignee</code> system property is the <code>SYSTEM ADMINISTRATORS</code> role so that pending tasks can be reassigned to the <code>SYSTEM ADMINISTRATORS</code> role when a user is disabled or deleted.</p> <p>When the value of the <code>OIG.DefaultTaskReassignee</code> system property is a manager, Oracle Identity Governance finds the closest active manager from the hierarchy if the current target assignee is disabled.</p> <p>When the value of the <code>OIG.DefaultTaskReassignee</code> system property is a user, Oracle Identity Governance reassigns the task to the user.</p> <p>When the value of the <code>OIG.DefaultTaskReassignee</code> system property is a role, Oracle Identity Governance reassigns the task to the role. Here, the role name as the value of the <code>OIG.DefaultTaskReassignee</code> system property is case-sensitive.</p> <p>If Oracle Identity Governance cannot find any valid assignee, then the tasks are reassigned to the System Administrator.</p> <p>It is important to set the value of this property with an active user or role. For example:</p> <pre>OIG.DefaultTaskReassignee=Manager OIG.DefaultTaskReassignee=User:user1 OIG.DefaultTaskReassignee=Role:role1</pre>
OIG.BeneficiaryManagerApprovalWorkflows	OIG.BeneficiaryManagerApprovalWorkflows	default/BeneficiaryManagerApproval!4.0	When the initial target assignee is disabled, Oracle Identity Governance looks for the closest manager of the beneficiary of the request with the approval workflow specified in this system property. You can specify multiple composites with the comma separator.
OIG.RequesterManagerApprovalWorkflows	OIG.RequesterManagerApprovalWorkflows	default/RequesterManagerApproval!4.0	When the initial target assignee is disabled, Oracle Identity Governance looks for the closest manager of the requester of the request with the approval workflow specified in this system property. You can specify multiple composites with the comma separator.

## 19.2.2 Non-Default System Properties in Oracle Identity Governance

Oracle Identity Manager provides a set of system properties that are not present in the PTY table by default.

You can add these non-default system properties to the PTY table by using the Identity System Administration, and then use the properties to change some of the default settings in Oracle Identity Manager. For example, if you want to configure the number of times Oracle Identity Manager retries to get a connection when the JDBC connection fails, then you can configure the `JDBC Connection Retry Attempts` system property.

**See Also:**

Overview of Generic Technology Connectors in *Developing and Customizing Applications for Oracle Identity Governance* for more information about GTC

**Table 19-2** lists and describes Non-Default system properties which you can add to the PTY table

**Table 19-2 Non-Default System Properties**

Property Name	Description	Keyword	Sample Value
OIM Database Query Retry Attempts	Number of times SQL queries to be retried for handling Oracle RAC failures.  In the absence of this property in the PTY table, SQL queries for handling Oracle RAC failures are retried three times by default.	OIM.DBQueryRetryAttempts	5
OIM Database Query Retry Interval	Time in seconds after which each SQL retry takes place for Oracle RAC failures.  In the absence of the property in the PTY table, SQL query occurs after every 7 seconds by default.	OIM.DBQueryRetryInterval	10 seconds
OIM Paging Limit	Default paging limit for search operations on user entity.	OIM.PagingLimit	300
JDBC Connection Retry Attempts	Number of times Oracle Identity Manager retries to get a connection when the JDBC connection fails.  In the absence of this property in the PTY table, the JDBC connection is retried three times by default.	OIM.JDBCCConnectionRetryAttempts	5 When the value is 0, it means no retry.
JDBC Connection Retry Interval	Time in seconds between each JDBC connection retry.  In the absence of this property in the PTY table, each JDBC connection retry occurs at an interval of 7 seconds.	OIM.JDBCCConnectionRetryInterval	10 seconds
Allowed Back URLs	This property is required if you want to setup any non-OIM/OAM URLs to be a valid backURL on the Track Self Registration Request page. Oracle Identity Manager validates the back URLs and redirect URLs against a list of URLs provided by this system property. The value of this property is a comma-separated list of URLs that Oracle Identity Manager allows for redirection.	XL.AllowedBackURLs	http://OIM_HOST:OIM_PORT/

Table 19-2 (Cont.) Non-Default System Properties

Property Name	Description	Keyword	Sample Value
Allowed Back URLs Mode	<p>This system property determines the mode in which the XL.AllowedBackURLs system property works. It has the following possible values:</p> <ul style="list-style-type: none"> <li>• <b>Enforce:</b> Ensure that the current URL is present in the white list specified as the value of XL.AllowedBackURLs. If not present, then change the back URL to the default URL, which is the sign-in page.</li> <li>• <b>Disable:</b> Log all the white list validations.</li> </ul> <p>The default value is <code>Enforce</code>.</p>	XL.AllowedBackURLs Mode	Enforce
XL.AllowedOrigins	Allows users to set the whitelist for the CORS filter.	XL.AllowedOrigins	<p>Apply the following guidelines for specifying the value:</p> <ul style="list-style-type: none"> <li>• The URLs can be comma separated, for example <code>http://www.example.com:14001</code> and <code>https://www.test.com:14003</code>.</li> <li>• The URL can contain simple wildcard matching (for example <code>http://*.example.com:14000</code>, <code>http://*.com:14001</code>) with only a single '*' character. <code>*.example*.com</code> will not work correctly.</li> <li>• The pattern matching is very simple and only pertains to the domain part of the URL. No matching on scheme or port is supported (<code>*://example.com:14001</code> or <code>http://example.com.*</code>).</li> <li>• Only <code>http</code> and <code>https</code> schemes are supported.</li> <li>• The matching goes from right to left.</li> <li>• The '*' will only match the text of domain after the period and before the next period. Patterns such as <code>*.ampl.com</code> and <code>*.partial*.c*</code> are not supported.</li> <li>• A single '*' will match anything and should be used for test/development only.</li> </ul>

## 19.3 Managing System Properties

Managing system properties involve searching and modifying system properties by using Identity System Administration, and purging the cache.

This section contains the following topics:

- [Searching for System Properties](#)

- [#unique\\_507](#)
- [Editing System Properties](#)
- [Purging Cache](#)

## 19.3.1 Searching for System Properties

Use the **Configuration Properties** section of the Identity System Administration to perform simple and advanced search for system properties..



### Note:

The search is applicable to OIG Bundle Patch 12.2.1.4.220703 and releases earlier to July 22 Bundle Patch.

- [Performing a Simple Search for System Properties](#)
- [Performing an Advanced Search for System Properties](#)

### 19.3.1.1 Performing a Simple Search for System Properties

To perform a simple search for system properties:

1. Login to Oracle Identity System Administration.
2. In the left pane, under System Configuration, click **Configuration Properties**.
3. In the left pane, enter a search criterion in the Search field for the system property that you want to search. You can include wildcard characters (\*) in your search criterion.

If you search without any value or with wild card character \* in the Search field, then all the system properties are displayed. You can filter your search by combining characters with the wildcard characters. For example, to search all system properties starting with p, you can enter p\* in the Search field.

4. Click the icon next to the Search field. A list of all system properties that meet the search criterion is displayed.

The search results table displays the system property names and keywords. You can click a property name to open the details for the system property.

### 19.3.1.2 Performing an Advanced Search for System Properties

To perform an advanced search for system properties:

1. In the left pane of Oracle Identity System Administration, under System Configuration, click **Configuration Properties**.
2. In the left pane of the System Configuration section, click **Advanced Search**. The Properties: Advanced Search page is displayed.
3. In the list adjacent to the Property Name field, select a search condition.
4. In the Property Name field, enter a search criterion for the system property that you want to search. You can include wildcard characters (\*) in your search criterion. Select the search conditions in the list adjacent to the fields. The search conditions include Begins with, Contains, Does not begin with, Does not contain, Does not end with, Does not equal, Ends with, Equals, Is not present, and Is present.

5. Click **Search**. The system properties that match the search criterion are displayed in the search results table.

The search result displays key, property name, keyword, value, allowed value, and date level for each system property.

## 19.3.2 Editing System Properties

The Edit option allows you to modify an existing system property by using the System Property Details page. If any system property is tagged with a set of allowed values, then you must specify a value from that set only.

You cannot modify the Property Name and Keyword fields of a system property created in a non-English locale. As a workaround, delete the existing system property and create a new one with the desired values.

In an English locale, non-ASCII characters are allowed in a system property name. When you modify the name of a system property to include non-ASCII characters, you must ensure the following if you want the changes to be translated into other languages:

To edit a System Property:



### Note:

This content applies only to OIG Bundle Patch 12.2.1.4.220703 and releases earlier to July 22 Bundle Patch.

1. Search for the system property that you want to modify.
2. In the **Property Name** column of the search results table, click the system property that you want to modify. The System Property Details page is displayed.
3. Modify the values in the fields. Generally, you need to modify the Value field to change the functionality that the system property provides.
4. Click **Save** to save the changes made.

A message confirming that the system property has been modified is displayed.

## 19.3.3 Purging Cache

Whenever you make any change to a system property by using any method other than from the Identity System Administration, you must run purge cache utility to fetch the changes that are reflected in Oracle Identity Manager.

To clear the server cache:

1. Depending on the operating system being used, navigate to the following directory:
  - For Microsoft Windows:  
`OIM_HOME\server\bin\`
  - For UNIX:  
`OIM_HOME/server/bin/`
2. Run one of the following commands:

- For Microsoft Windows:

```
PurgeCache.bat CATEGORY_NAME
```

- For UNIX:

```
sh PurgeCache.sh CATEGORY_NAME
```

The *CATEGORY\_NAME* name argument represents the Oracle Identity Manager category name that is to be purged, for example, FormDefinition.

To purge all the categories, pass a value of "All" to the PurgeCache utility. It is recommended to clear all the categories.

```
sh PurgeCache.sh All
```

#### Note:

- If Oracle Identity Governance is installed on IPv6 Linux host computer, then pass `ipv6` as the last input argument to the `PurgeCache.sh` script, as shown:

```
sh PurgeCache.sh All ipv6
```

On Windows environment, do not pass any parameter for IPv6 while running `PurgeCache.bat`.

- When you run the `PurgeCache.sh` utility in an IPv6 enabled setup, the following error is encountered:

```
Exception in thread "main" javax.security.auth.login.LoginException:  
java.net.UnknownHostException: exampledomain.com: Name or service not  
known
```

To workaround this issue:

- a. Open the `PurgeCache.sh` script in a text editor.
- b. Modify the following line:

```
bash oimClientWrapper.sh $CLIENT_CLASS $1
```

To:

```
bash oimClientWrapper.sh $CLIENT_CLASS $*
```

- c. Save the file.

## 19.4 Configuring Oracle Identity Governance Components

You can configure various Oracle Identity Manager components, such as product options, URLs for challenge questions and change password, username generation, user ID reuse, and delayed delete interval, by setting the values of system properties.

This section describes how to configure the following functionalities in Oracle Identity Manager:

- [Configuring Product Options](#)
- [Configuring the URL for Challenge Questions](#)
- [Configuring the URL for Change Password](#)
- [Enabling Challenge Questions](#)

- [Configuring User name Generation](#)
- [Configuring User ID Reuse](#)
- [Configuring Delayed Delete Interval](#)

## 19.4.1 Configuring Product Options

Use the `OIG.IsIdentityAuditorEnabled` system property to enable or disable role lifecycle management, SoD, and identity certification.

You can configure the availability of some of the features in Oracle Identity Manager with the help of system properties. To do so:

1. Login to Oracle Identity System Administration.
2. In the **Manage** section, under System Configuration, click **Configuration Properties**.
3. Enable role lifecycle management, Segregation of Duties (SoD), and identity certification. To do so:

- a. Search for the `Identity Auditor Feature Set Availability` system property with keyword `OIG.IsIdentityAuditorEnabled`.

The default value of this property is `FALSE`, which means that role lifecycle management, Segregation of Duties (SoD), and identity certification are disabled by default.

- b. Modify the value of the property to `TRUE`.
  - c. Click **Save**.
4. Enable the integration with Oracle Identity Analytics (OIA). To do so:
    - a. Search for the `OIA Integration Status` system property with keyword `OIM.IsOIAIntegrationEnabled`.

The default value of this property is `FALSE`, which means that integration with OIA is disabled by default.
    - b. Modify the value of the property to `TRUE`.
    - c. Click **Save**.
  5. Restart Oracle Identity Manager.

You must restart Oracle Identity Manager after modifying the values of each of the `Identity Auditor Feature Set Availability`, `OIA Integration Status`, and `OIA Integration Status` system properties.

## 19.4.2 Configuring the URL for Challenge Questions

Use the `OIM.ChallengeQuestionsModificationURL` system property to configure the URL for challenge questions.

To configure the URL within Oracle Adaptive Access Manager (OAAM) that handles challenge questions:

1. Login to Oracle Identity System Administration.
2. Select **Manage**, under System Configuration, click **Configuration Properties**.
3. Search for the `URL for challenge questions modification` system property with keyword `OIM.ChallengeQuestionsModificationURL`.

The default value of this property is `NONE`.

4. Modify the value of the property to specify the URL within OAAM that handles the challenge questions. For example:

```
http://OAAM_HOST:OAAM_PORT/OAAM_SERVER/userPreferences.do?showView=registerQuestions
```

5. Click **Save**.

### 19.4.3 Configuring the URL for Change Password

Use the `OIM.ChangePasswordURL` system property to configure the URL for change password.

To configure the URL within OAAM that handles change password:

1. Login to Oracle Identity System Administration.
2. Select **Manage**, under System Configuration, click **Configuration Properties**.
3. Search for the URL for change password system property with keyword `OIM.ChangePasswordURL`.

The default value of this property is `NONE`.

4. Modify the value of the property to specify the URL within OAAM that handles the change password functionality. For example:

```
http://OAAM_HOST:OAAM_PORT/OAAM_SERVER/userPreferences.do?showView=changePassword
```

5. Click **Save**.

### 19.4.4 Enabling Challenge Questions

Use the `OIM.DisableChallengeQuestions`, `PCQ.FORCE_SET_QUES`, and `PCQ.PROVIDE_DURING_SELFREG` system properties to enable challenge questions.

To enable challenge questions in Oracle Identity Manager:

1. Navigate to **Manage** tab, under System Configuration, click **Configuration Properties**.
2. Challenge questions in Oracle Identity Manager are controlled by a combination of three system properties. Search and specify values for the following system properties:

- **Are challenge questions disabled in OIM:** Determines whether challenge questions are enabled or disabled when a user logs in to Oracle Identity Manager for the first time. When value is `False`, challenge questions are enabled. When value is `True`, challenge questions are disabled.

This property is primarily used in the context of OAAM configuration. When the value is `TRUE`, the challenge questions are handled by OAAM.

- **Force to set questions at startup:** Determines whether or not the user must set the default questions for resetting the password when the user logs into the Oracle Identity Self Service or Oracle Identity System Administration for the first time. When the value is `FALSE`, the user is not forced to set the default questions for resetting the password on first login. When the value is `TRUE`, the user must set the default questions for resetting the password on first login.

After modifying the value of this property, you must restart Oracle Identity Manager server for the changes to take effect.



- **Does user have to provide challenge information during registration:** Determines whether or not users must provide challenge information during registration. When the value is `TRUE`, user must provide challenge information during registration.
3. Save the system property values.

## 19.4.5 Configuring User name Generation

Use the `XL.DefaultUserNamePolicyImpl`, `XL.UserNameDomain`, and `XL.DefaultCommonNamePolicyImpl` system properties to configure username generation.

To configure username generation:

1. Navigate to **Manage** tab, under System Configuration, click **Configuration Properties**.
2. Username generation in Oracle Identity Manager is controlled by a combination of three system properties. Search and specify values for the following system properties:
  - **Default policy for username generation:** Determines the username policy to use when generating a username. The default value is `oracle.iam.identity.usermgmt.impl.plugins.DefaultComboPolicy`.
  - **Default user name domain:** This property is used by the `DefaultComboPolicy` to generate a user name in e-mail format. The default value is `oracle.com`.
  - **CommonName generation plugin:** Determines the common name generation plugin to generate common name. The default value is `oracle.iam.ldapsync.impl.plugins.FirstNameLastNamePolicy`.
3. Save the system property values.

## 19.4.6 Configuring User ID Reuse

Use the `XL.UserIDReuse` system property to configure the recycle of existing User IDs that are no longer being used.

To configure user ID reuse:

1. Navigate to **Manage** tab, under System Configuration, click **Configuration Properties**.
2. Search for the `User Id reuse` property. Requires dropping the index present on `USR_LOGIN` column system property with keyword `XL.UserIDReuse`.

This property determines whether or not a deleted user account can be reused.

3. To reuse a deleted user account, modify the value of this property to `TRUE`, and drop the unique index for the `USR_LOGIN` column in the `USR` table and create a non unique index. To prevent a user account from being reused, assign this property a value of `FALSE`.

### Note:

It is imperative to de-provision all accounts associated with a deleted user, because if you create a new user with the same user name as that of the deleted user by setting the `XL.UserIDReuse` property to `TRUE`, then the new user might get access to offline accounts of the deleted user that was not deleted as part of the de-provisioning process.

4. In addition to creating a non-unique index, create a unique functional index similar to the following:

```
DROP INDEX UDX_USR_LOGIN;  
CREATE INDEX UDX_USR_LOGIN ON USR (USR_LOGIN);
```

This index prevents the existence of multiple active users with the same login name, while permitting the existence of multiple deleted users with that login name. Without this unique index, it is possible in race conditions to create two active users with the same login name, if they are both created at the same time.

5. Click **Save**.

## 19.4.7 Configuring Delayed Delete Interval

Use the `XL.UserDeleteDelayPeriod` system property to configure delayed delete interval.

To configure the delayed delete interval:

1. Navigate to **Manage** tab, under System Configuration, click **Configuration Properties**.
2. Search for the `Period to Delay User Delete` system property with keyword `XL.UserDeleteDelayPeriod`.

This property is used to specify the time period before deleting a user.

3. If you set a value of this property and a user is deleted, then the user's state is changed to disabled and "automatically delete on date" is set to current date plus the delay period.
4. If you do not set a value of this property, then the user is automatically deleted at the expiration of the end date by the `Disable/Delete User After End Date` scheduled job.
5. Save the system property value.

## 19.5 Configuring the Access Request Catalog

Configuring the access request catalog includes configuring additional information of entities, search results, sort by attributes, and custom search.

This section describes about configuring access catalog in the following topics:

- [Configuring Additional Information](#)
- [Configuring Search Results](#)
- [Configuring the Sort By Attributes](#)
- [Configuring Custom Search](#)

### 19.5.1 Configuring Additional Information

Use the `CatalogAdditionalApplicationDetailsTaskFlow`, `CatalogAdditionalEntitlementDetailsTaskFlow`, and `CatalogAdditionalRoleDetailsTaskFlow` system properties to configure the display of additional information of entities in the access request catalog.

To configure additional information displayed in the access catalog:

1. Navigate to **Manage** tab, under System Configuration, click **Configuration Properties**.
2. Search one or more of the following system properties depending on the entity for which you want to display additional information, and specify values.

- **Catalog Additional Application Details Task Flow:** A custom task flow is to be displayed when an application is selected from the catalog checkout page. The task flow page will display as a tab in the cart details section.

Replace the default value with the path to your custom task flow.

- **Catalog Additional Entitlement Details Task Flow:** A custom task flow is to be displayed when an entitlement is selected from the catalog checkout page. The task flow page will display as a tab in the cart details section.

Replace the default value with the path to your custom task flow.

- **Catalog Additional Role Details Task Flow:** A custom task flow is to be displayed when a role item is selected from the catalog checkout page. The task flow page will display as a tab in the cart details section.

Replace the default value with the path to your custom task flow.

3. Save the system properties.

## 19.5.2 Configuring Search Results

Use the `CatalogTableRowsToDisplaySize`, `CATALOG.SearchableUdfInTags`, and `CatalogAdvancedSearchMaxApps` system properties to configure search results in the access request catalog.

To configure the display of search results in the access request catalog:

1. Navigate to **Manage** tab, under System Configuration, click **Configuration Properties**.
2. To change the number of rows displayed in the tables in the access catalog, search for the `Catalog Table Rows To Display Size` system property, and specify the number of rows as the value.
3. If want to use searchable UDF in TAGS, then search for the `Catalog Searchable UDF In Tags` system property, and set the value to `TRUE`. Then, you can run the scheduled task in recalculate tags mode and searchable UDF values will be part of the TAGS column. The same value can be used in keyword search.
4. To control the maximum number of applications that can be selected for entitlement search, search for the `Catalog Advanced Search Maximum Applications` system property, and specify the number of applications.
5. Save the system properties.

## 19.5.3 Configuring the Sort By Attributes

Use the `CatalogSortAttributes` system property to configure the attributes that you can use to sort the catalog search results.

To configure the attributes that you can use to sort the catalog search results:

1. Navigate to **Manage** tab, under System Configuration, click **Configuration Properties**.
2. Search for the `Catalog Attributes for Sorting Search Results` system property.
3. Specify the attributes that you want to be displayed in the Sort By drop down in the catalog results as the value of this property in the following format:

```
ENTITY_DISPLAY_NAME; ENTITY_TYPE
```

4. Save the system property.

## 19.5.4 Configuring Custom Search

Use the `CatalogAdvancedSearchTaskflow` system property to customize catalog search.

To customize catalog search, for example add search fields and search operators:

1. Navigate to **Manage** tab, under System Configuration, click **Configuration Properties**.
2. Search for the `Catalog Advanced Search Taskflow` system property.
3. Replace the value of this system property with the complete path to the custom taskflow that you created. See *Customizing Catalog Search in Developing and Customizing Applications for Oracle Identity Governance* for information about creating the custom taskflow.
4. Save the system property.

## 19.6 Configuring the Identity Provider

Configuring the Identity Provider includes configuring attribute reservation, common name generation, LDAP reservation, and referential integrity.

This section describes how to configure identity provider in the following topics:

- [Configuring Attribute Reservation](#)
- [Configuring Common Name Generation](#)
- [Configuring LDAP Reservation](#)
- [Configuring Referential Integrity](#)

### 19.6.1 Configuring Attribute Reservation

Use the `XL.IsUsrAttribReservEnabled` system property to configure attribute reservation.

To configure attribute reservation in Oracle Identity Manager:

1. Login to Oracle Identity System Administration.
2. Navigate to **Manage** tab, under System Configuration, click **System Properties**.
3. Search for the `User Attribute Reservation Enabled` system property with keyword `XL.IsUsrAttribReservEnabled`.

The default value of this `TRUE`, which means that user attribute reservation is enabled by default.

4. To disable user attribute reservation, modify the value of this property to `FALSE`.
5. Click **Save**.

### 19.6.2 Configuring Common Name Generation

Use the `XL.DefaultCommonNamePolicyImpl` system property to configure attribute reservation.

To configure attribute reservation in Oracle Identity Manager:

1. Login to Oracle Identity System Administration
2. Navigate to **Manage** tab, under System Configuration, click **Configuration Properties**.

3. Search for the `CommonName` generation plugin system property with keyword `XL.DefaultCommonNamePolicyImpl`.

This property determines the common name generation plugin to generate common name. The default value is `oracle.iam.ldapsync.impl.plugins.FirstNameLastNamePolicy`.

4. Modify the value of this property to specify a different common name generation plugin.
5. Click **Save**.

 **See Also:**

Common Name Generation in *Developing and Customizing Applications for Oracle Identity Governance* for more information

## 19.6.3 Configuring LDAP Reservation

Use the `XL.LDAPReservationPluginImpl` system property to configure LDAP reservation.

To configure LDAP reservation in Oracle Identity Manager:

1. Login to Oracle Identity System Administration
2. Navigate to **Manage** tab, under System Configuration, click **Configuration Properties**.
3. Search for the LDAP Reservation Plugin system property with keyword `XL.LDAPReservationPluginImpl`.

This property determines the LDAP reservation plugin implementation to be picked up for reservation of user attributes.

4. Modify the value of this property to specify a different LDAP reservation plugin implementation for reservation of user attributes.
5. Click **Save**.

## 19.6.4 Configuring Referential Integrity

Use the `XL.IsReferentialIntegrityEnabledInLDAP` system property to configure referential integrity.

To configure referential integrity in Oracle Identity Manager:

1. Login to Oracle Identity System Administration.
2. Navigate to **Manage** tab, under System Configuration, click **Configuration Properties**.
3. Search for the `Indicates if referential integrity is enabled in target LDAP directory` system property with keyword `XL.IsReferentialIntegrityEnabledInLDAP`.

The default value of this property is `FALSE`, which means that referential integrity in the target LDAP directory is disabled.

4. To enable referential integrity in target the LDAP directory, modify the value of this property to `TRUE`.
5. Click **Save**.

# 20

## Configuration of JCS

Starting from 14c version, OIG uses JCS Cache to manage cached data instead of EH cache. The EH cache is replaced by JCS due to security vulnerability reasons. JCS uses Lateral UDP Discovery (LTCP) to distribute cache among the nodes. To learn about JCS, refer to <https://commons.apache.org/proper/commons-jcs/LateralUDPDiscovery.html>

JCS uses cache region (or category) for storing the related data together and every region has its own configuration. The cache configuration for all regions is stored in a file called `cache.ccf` that is found at the location `<OIM_HOME>/server/config/`.

An example of one region configuration is shown below.

To change the settings as desired, you must edit this file and restart the server to make the changes effective. The description of each parameter is explained at <https://commons.apache.org/proper/commons-jcs/LateralTCPProperties.html>.

```
jcs.region.SSOIntegration=LTCP
jcs.region.SSOIntegration.cacheattributes=org.apache.commons.jcs3.engine.Compo
siteCacheAttributes
jcs.region.SSOIntegration.cacheattributes.MaxObjects=200001
jcs.region.SSOIntegration.cacheattributes.MemoryCacheName=org.apache.commons.j
cs3.engine.memory.lru.LRUMemoryCache
jcs.region.SSOIntegration.cacheattributes.UseMemoryShrinker=truejcs.region.SSO
Integration.cacheattributes.MaxMemoryIdleTimeSeconds=3600jcs.region.SSOIntegra
tion.cacheattributes.ShrinkerIntervalSeconds=60
jcs.region.SSOIntegration.elementattributes=org.apache.commons.jcs3.engine.Ele
mentAttributes
jcs.region.SSOIntegration.elementattributes.IsEternal=false
jcs.region.SSOIntegration.elementattributes.MaxLifeSeconds=700
jcs.region.SSOIntegration.elementattributes.IdleTime=1800
jcs.region.SSOIntegration.elementattributes.IsSpool=true
jcs.region.SSOIntegration.elementattributes.IsRemote=true
jcs.region.SSOIntegration.elementattributes.IsLateral=true
```

The `oim-config.xml` also contains the cache settings in an XML tag `<cacheCategoryConfig>` as shown below.

The attribute **expirationTime** found in this file is same as the attribute `"jcs.region.<region name>.elementattributes.MaxLifeSeconds"` found in the `cache.ccf` file. The changes performed in `oim-config.xml` overrides the default configuration. Hence, use `cache.ccf` for any configuration.

```
<cacheCategoryConfig name="SSOIntegration" enabled="true"
expirationTime="14400" />
```

In addition to JCS specific configuration, the following two extra parameters are used to override the parameter `"TcpListenerPort"`. You can use this configuration if multiple OIM nodes are running in a same host.

```
jcs.auxiliary.LTCP.attributes.TcpListenerPort=10890
```

#When there are multiple OIM servers in the same host machine, jcs.auxiliary.LTCP.attributes.TcpListenerPort must be defined with a different value per server. In this case, to override the default configuration.

#### **#machine1**

```
oracle.iam.host.WLS_OIM1.tcpport=10890
```

```
oracle.iam.host.WLS_OIM2.tcpport=10891
```

#### **#machine2**

```
oracle.iam.host.WLS_OIM3.tcpport=10890
```

```
oracle.iam.host.WLS_OIM4.tcpport=10891
```

## 20.1 Configuration in a Single Node

Open the <OIM\_HOME>/server/config/cache.ccf" file and make sure the default auxiliary is set to LTCP for every region as given below.

```
jcs.default=LTCP
```

```
jcs.region.DataObjectEventHandlers=LTCP
```

```
jcs.region.ProcessDefinition=LTCP
```

At the end of the cache.ccf file, keep all default LTCP settings as explained in the "Configuration" section of JCS doc <https://commons.apache.org/proper/commons-jcs/LateralUDPDiscovery.html> unless you need to change based on your requirements.

## 20.2 Configuration in a Cluster Setup

1. JCS provides multiple auxiliaries which can be plugged into a cache region and OIG uses TCP Lateral(LTCP). Please read thru the below doc to know more about it. <https://commons.apache.org/proper/commons-jcs/LateralTCPAuxCache.html>

Every JCS region is shipped with a empty value for Auxiliary. Please open the file <OIM\_HOME>/server/config/cache.ccf file and provide the value "LTCP" for each region.

Example:

```
jcs.default=LTCP
```

```
jcs.region.DataObjectEventHandlers=LTCP
```

```
jcs.region.ProcessDefinition=LTCP
```

etc..

- The last section of "cache.ccf" file shows the below content. The value for "jcs.auxiliary.LTCP.attributes.UdpDiscoveryAddr" (i.e multicast address) attribute can be determined by running the below command

```
# TCP and UDP
jcs.auxiliary.LTCP=org.apache.commons.jcs3.auxiliary.lateral.socket.tcp.LateralTCPCacheFactory
jcs.auxiliary.LTCP.attributes=org.apache.commons.jcs3.auxiliary.lateral.socket.tcp.TCPLateralCacheAttributes
jcs.auxiliary.LTCP.attributes.TcpListenerPort=7800
jcs.auxiliary.LTCP.attributes.UdpDiscoveryAddr=230.182.50.205
jcs.auxiliary.LTCP.attributes.UdpDiscoveryPort=45566
jcs.auxiliary.LTCP.attributes.UdpDiscoveryEnabled=true
jcs.auxiliary.LTCP.attributes.UdpTTL=4
jcs.auxiliary.LTCP.attributes.Receive=true
jcs.auxiliary.LTCP.attributes.AllowGet=false
jcs.auxiliary.LTCP.attributes.IssueRemoveOnPut=false
jcs.auxiliary.LTCP.attributes.PutOnlyMode=true
```

### Determining the value for multicast address

```
jcs.auxiliary.LTCP.attributes.UdpDiscoveryAddr
```

Multicast addresses can be found from the OS level command like In Linux.

#### > ip maddr show

Sample output:

```
6: eth0
link 33:33:00:00:00:01
link 01:00:5e:00:00:01
inet 224.0.0.1
```

Pickup the IP address "224.0.0.1" and provide the same for the attribute "jcs.auxiliary.LTCP.attributes.UdpDiscoveryAddr".

All OIM servers in the OIM cluster must share the same multicast address and multicast port like

```
jcs.auxiliary.LTCP.attributes.UdpDiscoveryAddr=224.0.0.1
jcs.auxiliary.LTCP.attributes.UdpDiscoveryPort=45566
```

#### Note:

That the jcs.auxiliary.LTCP.attributes.UdpDiscoveryPort must be chosen to form a unique JCS multicast channels within OIM servers.

- Save the changes and restart the server.



## 20.3 Manage JCS Logging

The JCS cache logging can be managed thru the logger "org.apache.commons.jcs3". The log level can be changed using the below steps.

1. Open the file "logging.xml" found at "<Middleware>/user\_projects/domains/<OIMDOMAIN>/config/fmwconfig/servers/<OIM\_SERVER>".
2. Add a new logger and save the changes.

### Note:

By default logger level is "ON".

```
<logger name='org.apache.commons.jcs3' level='off' useParentHandlers='false'/>
```

3. Restart the OIM server.

## 20.4 Troubleshooting

### Error 1

The host where OIG is running is expected to have public IP enabled. If the host does not have public IP enabled, then you will see the below error while starting the OIM server.

You will see the below error for each cache category/region which are mentioned in **cache.ccf** file. The nodes in a cluster environment exchange the cache data over UDP protocol. To make this happen, the hosts should have public IP enabled so that the nodes can exchange the data.

```
2024-11-28T07:31:49.014+00:00] [oim_server1] [ERROR] []
[org.apache.commons.jcs3.engine.control.CompositeCacheConfigurator] [tid:
[ACTIVE].ExecuteThread: '11' for queue: 'weblogic.kernel.Default (self-tuning)']
[userId: <anonymous>] [ecid: 0438c8f0-2a7c-408b-88da-0b2f5f2c142a-000000c4,0]
[APP: oim] Could not instantiate auxiliary cache named "RuleDefinition"[[
java.lang.NullPointerException: Cannot invoke
"java.net.NetworkInterface.getInetAddresses()" because "serviceInterface" is null
at
org.apache.commons.jcs3.utils.discovery.UDPDiscoveryService.<init>(UDPDiscoverySe
rvice.java:144)
at
org.apache.commons.jcs3.utils.discovery.UDPDiscoveryManager.lambda$getService$0(U
DPDiscoveryManager.java:118)
at java.base/
java.util.concurrent.ConcurrentHashMap.computeIfAbsent(ConcurrentHashMap.java:170
8)
at
org.apache.commons.jcs3.utils.discovery.UDPDiscoveryManager.getService(UDPDiscove
ryManager.java:108)
```

```
at
org.apache.commons.jcs3.auxiliary.lateral.socket.tcp.LateralTCPConnectionFactory.createDiscoveryService(LateralTCPConnectionFactory.java:435)

at
org.apache.commons.jcs3.auxiliary.lateral.socket.tcp.LateralTCPConnectionFactory.createCache(LateralTCPConnectionFactory.java:125)

at
org.apache.commons.jcs3.auxiliary.lateral.socket.tcp.LateralTCPConnectionFactory.createCache(LateralTCPConnectionFactory.java:56)
```

**Solution:** If your environment is a single node system, you can ignore the above error. Also, you can also suppress the above error by setting the log level to "OFF" as shown below. Please refer [Manage JCS Logging](#) for more details.

```
<logger name='org.apache.commons.jcs3' level='off' useParentHandlers='false'/>.
```

In case of cluster setup, this issue needs to be addressed by the network administrators. Contact your network administrators to have a public IP for the host system.

# 21

## Moving From Test to Production

Migrating from Test to Production (T2P) can be done by using the Deployment Manager or by using the chghost utility.

This chapter describes T2P migration for Oracle Identity Governance. It contains the following topics:

- [About Test to Production Migration](#)
- [Migrating Incrementally Using the Deployment Manager](#)
- [Migrating Incrementally Using the Deployment Manager](#)

### 21.1 About Test to Production Migration

Configurations and customizations in Oracle Identity Governance can be migrated from one deployment to another deployment. For example, you might want to migrate configurations and customizations from a test environment to a production environment. This is referred to as Test to Production (T2P).

T2P can be performed in the following ways:

- **Using Incremental T2P:** In this type of T2P, you use the Deployment Manager tool for exporting and importing Oracle Identity Governance configurations and customizations. This is used when target/production setup is already configured and you want to move certain specific artifacts/configuration incrementally into the target setup.
- **Using the chghost utility:** You can use the chghost utility to change the host name or IP address, along with procedures described in [About Changing the Network Configuration of Administering Oracle Fusion Middleware](#) to move your Oracle Fusion Middleware deployment to a new host.

### 21.2 Migrating Incrementally Using the Deployment Manager

Incremental migration of deployments by using the Deployment Manager involves importing and exporting deployments, and understanding the best practices and troubleshooting of the Deployment Manager.

This section discusses how to migrate Oracle Identity Manager incrementally using the Deployment Manager. It contains the following topics:

- [About the Deployment Manager](#)
- [Features of the Deployment Manager](#)
- [Enabling Deployment Manager in SSL Mode](#)
- [About Exporting Deployments](#)
- [Exporting Deployments](#)
- [About Importing Deployments](#)
- [#unique\\_538](#)
- [#unique\\_539](#)

- [Importing Deployments](#)
- [Best Practices for Using the Deployment Manager](#)
- [Troubleshooting the Deployment Manager](#)



**Note:**

Only the system administrator can use the Deployment Manager to import and export deployments.

## 21.2.1 About the Deployment Manager

The Deployment Manager is a tool for exporting and importing Oracle Identity Manager configurations. Usually, you use the Deployment Manager to migrate a configuration from one deployment to another, (for example, from a test to a production deployment) or to create a backup of your system.

You can save some or all of the objects in your configuration. Exporting your configuration lets you develop and test it in a test environment. You can then import the tested objects into your production environment. You can export and import an object and all of its dependent and related objects at the same time. Alternatively, you can export and import each object individually.

The Deployment Manager allows you to retrieve configuration information and binary data from the source system, store the information in an XML file, and then import the information from the XML file to the target system. The binary data includes plug-ins, Java archives (JARs), and custom resource bundles.

You must import an exported object into the same type of repository.



**Note:**

You can also use the sandbox feature to migrate configurations and customizations from one deployment to another. For information about working with sandboxes, see *Managing Sandboxes in Developing and Customizing Applications for Oracle Identity Governance*.

## 21.2.2 Features of the Deployment Manager

The Deployment Manager enables you to import and export supported configuration artifacts along with additional comments and information about the exported files.

The Deployment Manager helps you migrate Oracle Identity Manager deployments from one server environment to another, such as from a testing environment to a staging environment or from a staging environment to a production environment.

The Deployment Manager enables you to:

- Update individual components of a deployment in different test environments
- Identify objects that are associated with exported components, so that those resources can be included

- Provide information about exported files
- Add comments

The Deployment Manager handles the following types of configuration artifacts:

- Access Policy
- Admin Role
- Application Instance
- Application Template
- Approval Policy
- Attestation Process
- Catalog metadata
- Certification Configuration
- Certification Definition
- Custom resource bundle
- Data Object Definition
- E-mail Definition
- Entity Adapter (Deprecated)
- Error Code
- Event Handler
- Generic Connector
- GTC Provider
- Identity Audit configuration
- Identity Audit Rule in readable format. See [#unique\\_538](#).
- Identity Audit scan definition
- IT resource definition
- IT resource
- JAR
- Lookup
- Notification templates
- Orchestration Event handler
- Org Metadata
- Organization
- Password Policy
- Policy
- Plugin
- Prepopulate Adapter
- Process
- Process Form

- Provisioning workflows and process task adapters
- Request dataset
- Resource
- Risk configuration
- Role metadata
- Role, including custom attributes. See [#unique\\_539](#).
- Rule-deprecated
- Scheduled job
- Scheduled task
- System property
- Task Adapter
- User metadata

 **Note:**

- On the source deployment, the following artifacts might contain references to specific users, roles, application instances, entitlements, or organizations:
  - Certification definitions
  - Policies
  - Identity Audit configurations
  - Identity Audit scan definitions

These references are scrubbed when you export the artifacts. You must open and update these artifacts on the target deployment. For example, the remediator name for the Identity Audit policy is deleted when it is exported, and must be reselected on the target environment. An artifact that lacks specific references may cause errors in the deployment.

- All rules other than Identity Audit Rules can only be exported and imported with their policy and cannot be exported or imported independently.
- If you use Connector Installer to create an application, and if you then import the application to another environment using the Deployment Manager's Application Instance artifact, then you must import the scheduled jobs by using the Deployment Manager. However, if you create an application by using the application onboarding feature in Identity Self Service, then the scheduled jobs are automatically created and do not have to be imported.

The Deployment Manager has the following limitations:

- **Merge Utility:** The Deployment Manager is not a merge utility.  
The Deployment Manager cannot mix modifications that are made in both production and test environments. It replaces the object in the target system with the object in the XML file.
- **Version Control Utility:** The Deployment Manager does not track versions of imported files, and does not provide rollback functionality.  
You can use the Deployment Manager only to move data between environments.

## 21.2.3 Enabling Deployment Manager in SSL Mode

When you enable Secure Sockets Layer (SSL) for the Oracle Identity Manager server, you must provide the URL host and port as the OIMFrontEndURL for the Discovery MBean, log in to Identity System Administration using the HTTPS protocol using the appropriate port, and clear the browser cache.

To enable Deployment Manager in SSL mode:

- Enable SSL for the OIM server. You can follow the steps given below to enable SSL:
  1. In the WebLogic Server Administration Console, click **Environment** and select **Servers**. The Summary of Server page opens.
  2. On the Configuration tab, select the server name (for example, OIM\_Server1). The Setting page for the server opens.
  3. On the General tab, select the **SSL Listen Port Enabled** check box. Enter the SSL Listen Port details.
  4. Click **Save**.
- Make sure to provide the URL host and port value as OIMFrontEndURL for Discovery MBean.
- Oracle recommends that you log in to Oracle Identity System Administration using the HTTPS protocol and the appropriate port. If the HTTPS certification is invalid, accept the default certificate.
- Oracle recommends that you clear the browser cache before you access Oracle Identity System Administration. Otherwise, JavaScript and HTML files may be cached.

## 21.2.4 About Exporting Deployments

You can export objects from your Oracle Identity Manager system and save them in an XML file. The Deployment Manager has an Export Wizard that lets you create your export file.

Add objects one type at a time: for example, roles, then forms, then processes.

### **Note:**

Application instances are exported and imported without the datasets. The datasets are migrated as a part of UI customization.

If you select an object that has child objects or dependencies, you have the option to add dependency. When you have all the objects you want, the Deployment Manager saves them in a single XML file.

When user-defined fields are associated with a specific resource object, the Deployment Manager considers them dependencies only if the values of the fields are not empty.

## 21.2.5 Exporting Deployments

Use the Export Configuration page in Identity System Administration to export a deployment.

To export a deployment:

1. Login to Oracle Identity System Administration.
2. In the left pane, under System Configuration, click **Export** to open the Export Configuration page.
3. To search for an object, enter the name of the object.

You can use an asterisk (\*) as a wildcard in the name search field. An asterisk represents zero or more occurrences of an alphanumeric character. For example, you can enter Role\*, \*Role, \*OIM\*, and similar types of searches. By default, an asterisk is appended at the end of an entered string.

4. Select **Type** from the list, and click the Search icon. The search result appears in the **Available Entities** table.

By default, Type is set to All. The objects supported by the Deployment Manager for migration are available for exporting. For the list of objects supported by the Deployment Manager for migration, see [Features of the Deployment Manager](#).

 **Note:**

When you search for an entity name across all entity types, then the number of records displayed is controlled by value set for *DMGlobalSearchResultSize* system property. For more information on this system property, see [Default System Properties in Oracle Identity Governance](#).

To narrow your search, choose the entity name or entity type from the list.

5. In the Available Entities table, select the checkbox next to the entity to be exported. The entity is moved to the Selected Entities table. You can select multiple entities.

To remove any entity from the Selected Entities table, click **Remove**.

To navigate to a page, click the page number at the bottom of search table or enter a page number in the page number text. Use the **Rows Displayed** option to specify the number of rows in the search table.

 **Note:**

You can perform multiple searches and add any combination of entities to the **Selected Entities** table to build a list of exportable objects.

6. Click **Next**, or click **Export Options** to open the Export Options page.
7. If dependent entities are to be downloaded, set **Dependency** to **Yes**. Otherwise, set to **No**. By default, Dependency is set to Yes.
8. Click **Next** or click **Summary** to open the Summary page.
9. Make sure that all the required entities are selected, and that they appear in the **Selected Entities** panel. Make sure that the dependency information appears in the **Export Options** panel, and then click **Export** to open the Export window.
10. In the Export window, enter a description for the file. This description appears when the file is imported.
11. Click **Export** to open the Save As dialog box.
12. Enter a file name or browse to find a location.



13. Click **Save**.

## 21.2.6 About Importing Deployments

When objects have been exported into an XML file by using the Deployment Manager, you can use the Deployment Manager to import these objects into Oracle Identity Manager.

The Deployment Manager ensures that the dependencies for the objects that you are importing are available either in the import or in your system. When you import, you can substitute an object that you are importing for one in your system. For example, you can substitute a group that is specified in the XML file for a group in your system.

### Note:

- If a user belongs to a group to which the Import menu item has been assigned, then that user must also have the necessary permissions for the objects that the user wants to import. Without these object-specific permissions, the Import operation fails. Only System Administrators can see Deployment Manager menu items in the UI.
- When you use Deployment Manager to import more than a thousand resources, process definitions, parent forms, child forms, access policies, roles, and rules, the size of the EIF table increases. The amount of data in this table can be reduced by running a simple SQL query such as Delete from EIF.

## 21.2.7 Importing Deployments

To import a deployment, use the Import Configuration page in Identity System Administration.

### Note:

Before importing data that contains references to menu items, you must first create the menu items in the target system.

To import an XML file:

1. Log in to Oracle Identity System Administration.
2. In the left pane, under System Configuration, click **Import** to open the Import Configuration page.
3. To select the XML file, click **Browse**. Navigate to the location of the XML file, select the file, and click **Open**.
4. Click **Next** or click **Import Options** to open the Import Options page.
5. Select one or more of the following import options:
  - **User Reference:** The XML files you want to import may have references to users who are not present in the target environment. You can replace the user references or retain them.

Select **Keep Original** to import without making changes to the user references. Otherwise, select **Change**. Click the search icon, search for the user, select the user from the search results, and click **Select**.

- **Role Reference:** The XML file you want to import may have references to roles that are not present in the target environment. You can replace the role references or retain them.

Select **Keep Original** to import without making changes to the role references. Otherwise, select **Change**. Click the search icon, search for the role, select the role from the search results, and click **Select**.

- **If Object Exists:** The XML file you want to import may have objects (such as entities and artifacts) that are present in the target environment. You can replace them with the objects in the imported XML definition or retain the objects that are already present.

Select **Override** to replace the system definitions from the imported XML file. Otherwise, select **Skip**.

6. Click **Next** or click **Summary** to open the Summary page.

Review the summary. If you want to go back to the Import Options page and make changes, click **Back**.

7. Click **Import**.

## 21.2.8 Best Practices for Using the Deployment Manager

Best practices for using the Deployment Manager include exporting related groups of objects at once, using logical naming conventions for form versions, providing clear export descriptions, backing up the database, and importing data when system activity is low.

This section includes the following topics:

- [Do Not Export System Objects](#)
- [Exporting Related Groups of Objects](#)
- [Using Logical Naming Conventions for Versions of a Form](#)
- [Exporting Root to Preserve a Complete Organizational Hierarchy](#)
- [Providing Clear Export Descriptions](#)
- [Checking Dependencies Before Exporting Data](#)
- [Matching Scheduled Task Parameters](#)
- [Deployment Manager Actions on Reimported Scheduled Tasks](#)
- [Compiling Adapters and Enable Scheduled Tasks](#)
- [Checking Permissions for Roles](#)
- [Creating a Backup of the Database](#)
- [Importing Data When the System Is Quiet](#)
- [Exporting and Importing Data in Bulk](#)
- [Exporting Entity Publications](#)

### 21.2.8.1 Do Not Export System Objects

Avoid exporting or importing system objects unless it is absolutely necessary. (Examples of system objects include Request, Xellerate User, and System Administrator.) Exporting system

objects from the testing and staging environments into production can cause problems. Whenever, possible, exclude system objects when you export or import data.

You may want to export or import system objects when, you define trusted source reconciliation on Xellerate User resource objects, or in similar situations.

 **Caution:**

The Deployment Manager keeps track of imported components and structures, but does not keep track of completed imports. After an import is completed, you cannot revert to a previous version of the imported component.

## 21.2.8.2 Exporting Related Groups of Objects

Oracle recommends that you use the Deployment Manager to export sets of related objects. A unit of export should be a collection of items that you want to group together.

Avoid exporting everything in the database in one operation, or exporting items one at a time. For example, suppose that you manage integration between Oracle Identity Manager and a target system that includes processes, resource objects, adapters, IT resource type definitions, IT resource definitions, and scheduled tasks. In this environment, you should create groups of related objects before you export items.

For example, if you use the same e-mail definitions in multiple integrations, export the e-mail definitions as one unit, and the integrations as a different unit. You can then import changes to e-mail definitions independently of changes to the target system integration. Or, if multiple resources use the same IT resource type definition, you can export and import the type definition separately from other data.

You can import multiple sets of exported data once. For example, you can import a resource object definition, an e-mail definition, and an IT resource type definition in a single operation.

## 21.2.8.3 Using Logical Naming Conventions for Versions of a Form

When you revise forms multiple times before you export them, avoid generic names, such as, "v23," to differentiate versions of a form. Instead, create meaningful names, such as, "Before Production" or "After Production Verification." Do not use special characters, such as double quotation marks, in version names.

## 21.2.8.4 Exporting Root to Preserve a Complete Organizational Hierarchy

When you export a leaf or an organization in an organizational hierarchy, only one dependency level is exported. To export a complete organizational hierarchy, export the root of the hierarchy.

## 21.2.8.5 Providing Clear Export Descriptions

The Deployment Manager records some information automatically, including the date of the export, who performed the export, and the source database. You should also provide a meaningful description of the content of the export, such as, "resource definition after xxx attributes added in reconciliation." This informs the importer of the file of the contents of the item being imported.

## 21.2.8.6 Checking Dependencies Before Exporting Data

The wizard in the top right pane displays the resources that must be available in the target system.

Consider the following:

- If the resources are already available in the target system, they do not need to be exported.
- If the resources are new (not in the target system), they must be exported.
- If the target system does not include the resources, such as lookups, IT resource definitions, or others that are reused, then record the data and export it in a separate file so it can be imported if necessary.



### Note:

When you export a resource, groups with Data Object permissions on that form are not exported with the resource.

## 21.2.8.7 Matching Scheduled Task Parameters

Scheduled tasks depend on certain parameters to run properly. You can import scheduled task parameters to the production server. [Table 21-1](#) shows the rules for determining how to import scheduled tasks. Note that parameters may be available for tasks that no longer reside on the target system.

**Table 21-1 Parameter Import Rules**

Parameter Exists in Target System	Parameter Exists in the XML File	Action Taken
Yes	No	Remove the parameter from the target system.
No	Yes	Add the parameter and current value from the XML file.
Yes	Yes	Use the more recent value of the parameter.

## 21.2.8.8 Deployment Manager Actions on Reimported Scheduled Tasks

One of the objects that you can import by using the Deployment Manager is a scheduled task. Typically, you import a scheduled task into your Oracle Identity Manager environment and later change the values of the scheduled attributes to meet your production requirements. However, if you import the same scheduled task a second time into the same Oracle Identity Manager server, the Deployment Manager does not overwrite the attribute values in the database. Instead, the Deployment Manager compares the attribute value of the reimported XML file to any corresponding attribute values in the database.

The following table summarizes the actions performed by the Deployment Manager when a scheduled task is reimported:

Does the Scheduled Task have attribute values in the XML file being imported?	Are there any corresponding attribute values in the database?	Deployment Manager Action
Yes	No	Store attribute values in the database
No	Yes	Delete existing attribute values in the database
Yes	Yes (newer attribute values indicated by time stamp)	No change in the database
Yes (new attribute values indicated by time stamp)	Yes	Update the database with the new attribute values

### 21.2.8.9 Compiling Adapters and Enable Scheduled Tasks

Adapters are automatically recompiled after being imported if their Java dependencies (classes) were previously imported. After the import, the adapter status is set to OK. If the Java dependencies were not imported before the adapter was imported, then after you import the classes and adjust the task attributes, manually recompile the adapters and enable the scheduled tasks.

### 21.2.8.10 Checking Permissions for Roles

When you export roles, the role permissions on different data objects are also exported. However, when you import data, permissions for missing data objects are ignored. If you are exporting the role as a way of exporting the role permission setup, then check the warnings carefully to ensure that the permission requirements are met. For example, if a role has permissions for objects A, B, and C, but the target system only has objects A and B, the permissions for object C are ignored. If object C is added later, the role permissions for C must be added manually, or the role must be imported again.

When you export a role that has permissions for viewing certain reports, ensure that the reports exist in the target environment. If the reports are missing, then consider removing the permissions before exporting the role.

### 21.2.8.11 Creating a Backup of the Database

Before you import data into a production environment, back up the database. This enables you to restore the data if anything goes wrong with the import. Backing up the database is always a good precaution before significant changes.



#### Note:

When you import forms and user-defined fields, you add entries to the database. These database entries cannot be rolled back or deleted. Before each import operation, ensure that the correct form version is active.

### 21.2.8.12 Importing Data When the System Is Quiet

You cannot complete an import operation in a single transaction because it includes schema changes. These changes affect currently running transactions on the system. To limit the effect

of an import operation, temporarily disable the Web application for general use and perform the operation when the system has the least activity, such as, overnight.

### 21.2.8.13 Exporting and Importing Data in Bulk

The Deployment Manager is not a tool for data movement or for the migration of large volumes of data. Use your judgment when you use the Deployment Manager to export or import objects. When the volume of data is large, use other bulk tools to export and import entities, such as users, organizations, and roles.

To avoid exporting or importing these kinds of entities, ensure that users, roles, and organizations are always loaded, synchronized, or both before you move configuration objects such as policies, rules, application instances, and connector configuration.



#### Note:

When you export or import large volumes of data, timeouts may occur in the UI.

### 21.2.8.14 Exporting Entity Publications

When you use the Deployment Manager to export or import an entity, any publication previously associated to the entity is removed. If you do not export the publication, no publication is assigned by. Therefore, when you import an admin role (for example) that is published to an organization in the source environment, the admin role's publication information is lost in the target environment. You must import the entity publication along with the admin role.

## 21.2.9 Troubleshooting the Deployment Manager

To help troubleshoot Deployment Manager issues, enable logging for the Deployment Manager, and set the log level to Notification.

To enable logging for the Deployment Manager:

1. Add a new logger for the Deployment Manager by editing the logging.xml file, which is located in the following directory:

*DOMAIN\_NAME/config/fmwconfig/servers/SERVER\_NAME/*

For instance, to enable notification-level logging for Deployment Manager, add the following logger inside the <loggers> section:

```
<logger name='XELLERATE.DDM' level='NOTIFICATION:1' />
```

2. Change the log level defined in the relevant <log\_handler>.



#### See Also:

For information about logging level and log handlers in Oracle Identity Manager, see [Configuring Log Services for Oracle Identity Governance](#).

# Migrating Application and Database Binaries

You can move Oracle Identity Governance application and database binaries from a source host to a target host.

This chapter contains the following topics:

- [Migrating Application Binaries to a New Host With Existing Database](#)
- [Migrating the Database and Application Binaries to a New Host](#)

## 22.1 Migrating Application Binaries to a New Host With Existing Database

Migrate the application binaries to the new host and point them to the existing database.

This section contains the following topics:

- [Moving the Application Binary Files](#)
- [Postconfiguration Changes on the Target Host](#)
- [Updating EndPoint Address in SOA Composites](#)

### 22.1.1 Moving the Application Binary Files

To migrate the application binaries to a new host and point the binaries to the existing database:

1. Perform the following steps on HOST1, which is the source host:
  - a. Create a cold backup of the database and the `ORACLE_HOME` directory.
  - b. Create a directory in any location, for example `/temporary_location/t2p/copyBinary_xbo`.  
  
This directory will contain the generated JAR file when the `copyBinary` script is run, and this location will be referred to as the `archiveLoc` attribute of the `copyBinary` script.
  - c. Navigate to `/temporary_location/t2p/MW/oracle_common/bin/`.
  - d. Run the `copyBinary` command in any of the following ways:

```
./copyBinary.sh -javaHome
                /temporary_location/t2p/jdk1.8.0_131 -archiveLoc
                /temporary_location/t2p/copyBinary_xbo/copyBinary_source.jar -
sourceOracleHomeLoc
                /temporary_location/t2p/MW
```

Or:

```
./copyBinary.sh -javaHome
                /temporary_location/t2p/jdk1.8.0_131 -archiveLoc
                /temporary_location/t2p/copyBinary_xbo/copyBinary_source.jar -
sourceOracleHomeLoc
```

```

/temporary_location/t2p/MW -invPtrLoc
/temporary_location/t2p/oraInventory/oraInst.loc -logDirLoc
/temporary_location/t2p/MW/clone_log/ -ignoreDiskWarning true

```

### The output is as shown:

```

Launcher log file is
  /temporary_location/OraInstall2018-05-03_04-12-08AM/
launcher2018-05-03_04-12-08AM.log.Checking swap space: must be greater than 500
MB. Actual 15455 MB
  PassedChecking if this platform requires a 64-bit
  JVM. Actual 64 Passed (64-bit not required)Parsing arguments for clone
archive creationInitializing variables for clone archiveRequired
  space for archive: 5325145157 bytesAvailable
  space: 25149345792 bytesThe archive will be
  located in /temporary_location/t2p/copyBinary_xbo/
copyBinary_source.jarGetting files installed by OUIProcessing directory
ouiProcessing directory soaProcessing directory
  coherenceProcessing directory
  .patch_storageProcessing directory
  emProcessing directory
  inventoryProcessing directory
  oracle_commonProcessing directory
  idmProcessing directory
  wlserverProcessing directory
  jdeveloperProcessing directory
  mftProcessing directory oepProcessing directory OPatchProcessing directory
osbGetting include directoriesGenerating
  manifestGenerating permissions
  fileAdding main class to jarArchive created successfully at
  /temporary_location/t2p/copyBinary_xbo/copyBinary_source.jarLogs
successfully copied to
  /temporary_location/t2p/app/oraInventory/logs.Logs details :"  

=====
  " Netrw Directory Listing(netrw v134)" /temporary_location/t2p/app/
oraInventory/logs" Sorted by name"
  Sort sequence:
  [\/]$,\.h$,\.c$,\.cpp$,*,\.o$,\.obj$,\.info$,\.swp$,\.bak$,~$" Quick
Help: <F1>:help -:go up dir D:delete R:rename s:sort-by
  x:exec"
=====
  ../

NextGenCreateCloneArchive2018-05-03_04-12-08AM.loginstall2017-11-10_01-22-14AM.lo
g
  install2017-11-10_01-22-14AM.log
  install2018-03-05_01-15-24AM.log
  install2018-03-19_02-48-21AM.log
  install2018-04-05_10-54-59PM.log
  install2018-04-12_02-45-22AM.log
  install2018-04-17_10-45-24PM.log
  install2018-05-02_11-22-05PM.log
  installActions2017-11-09_11-56-26PM.log
  installProfile2017-11-10_01-22-14AM.log
  installProfile2018-03-05_01-15-24AM.log
  installProfile2018-03-19_02-48-21AM.log
  installProfile2018-04-05_10-54-59PM.log
  installProfile2018-04-12_02-45-22AM.log
  installProfile2018-04-17_10-45-24PM.log
  installProfile2018-05-02_11-22-05PM.log
  launcher2017-11-10_01-22-14AM.log

```



```

launcher2018-03-05_01-15-24AM.log
launcher2018-03-19_02-48-21AM.log
launcher2018-04-05_10-54-59PM.log
launcher2018-04-12_02-45-22AM.log
launcher2018-04-17_10-45-24PM.log
launcher2018-05-02_11-22-05PM.log
launcher2018-05-03_04-12-08AM.log
oraInstall2017-11-09_11-56-26PM.err
oraInstall2017-11-09_11-56-26PM.out
oraInstall2017-11-10_01-22-14AM.err
oraInstall2017-11-10_01-22-14AM.out
oraInstall2018-03-05_01-15-24AM.err
oraInstall2018-03-05_01-15-24AM.out
oraInstall2018-03-19_02-48-21AM.err
oraInstall2018-03-19_02-48-21AM.out
oraInstall2018-04-05_10-54-59PM.err
oraInstall2018-04-05_10-54-59PM.out
oraInstall2018-04-12_02-45-22AM.err
oraInstall2018-04-12_02-45-22AM.out
oraInstall2018-04-17_10-45-24PM.err
oraInstall2018-04-17_10-45-24PM.out
oraInstall2018-05-02_11-22-05PM.err
oraInstall2018-05-02_11-22-05PM.out
time2017-11-09_11-56-26PM.log

```

The `copyBinary` utility has run successfully, and the `copyBinary_source.jar` file is created.

**e.** Validate the following:

- The `copyBinary_source.jar` file is created in the `/temporary_location/t2p/copyBinary_xbo/` directory.
- Ensure that all servers WebLogic, SOA, and OIG are in stopped state.

**f.** Create the `user_project.zip` file. To do so:

**i.** Navigate to `MW_HOME`.

**ii.** Run the following command:

```
zip -r user_project.zip user_project
```

**iii.** Copy the `user_project.zip` to the target host, which is `HOST2`.

**2.** Perform the following steps on `HOST2`:

**a.** Copy the `copyBinary_source.jar` file to any location on `HOST2`, for example: `/temporary_location/t2p/copyBinary_source.jar`.

**b.** Copy the `pasteBinary.jar` file anywhere in `HOST2`, for example: `/temporary_location/t2p/pasteBinary.jar`.

**c.** Copy the `oraInst.loc` file from `HOST1` to `HOST2`.

Example location on `HOST1`: `/temporary_location/t2p/oraInventory/oraInst.loc`

Example location on `HOST2`: `/temporary_location/t2p/oraInventory/oraInst.loc`

**d.** Copy JDK on `HOST2`.

 **Note:**

Make sure that both environments have the same Java version.

- e. Run the `./pasteBinary.sh` command, as shown:

```
/temporary_location/t2p/jdk1.8.0_131/bin/java -jar
  /temporary_location/t2p/copyBinary_source1.jar -targetOracleHomeLoc
  /temporary_location/t2p/MW -invPtrLoc
  /temporary_location/t2p/oraInventory/oraInst.loc -javaHome
  /temporary_location/t2p/jdk1.8.0_131
```

 **Note:**

In this command, the binaries are extracted from the JAR file created in the `copy binaries` command.

The output is as shown:

```
Setup successful
Save inventory pending
Saving inventory
100%
Saving inventory complete
100%
Configuration complete
Starting permissions check
Finished permissions check
Archive applied successfully at /temporary_location/t2p/MW
Logs successfully copied to /temporary_location2/app/oraInventory/logs.
```

- f. Validate the following:
- In the Middleware directory, folders are created for IDM, SOA, and WLSERVER except DOMAIN\_HOME.
  - With the execution of `pasteBinary.sh` or `copyBinary.sh`, everything is done except creation of DOMAIN\_HOME.
- g. Copy `user_project.zip` file to HOST2 in the `/temporary_location/t2p/MW/` directory, and unzip it. After extraction, the `user_projects` folder will be under the MW (Middleware) folder.
- h. Create the `text.txt` file, say at the location `/temporary_location/t2p/` with the following contents:

```
[ARGUMENTS]
[SERVER_HOST_MAPPING]
#pattern source_host_name=target_host_name
```

For example, `source_host.example.com=target_host.example.com`

- i. Configure wallet on HOST2. To do so, navigate to `/temporary_location/t2p/MW/oracle_common/common/bin/`, and run the following command:

```
./configWallet.sh -walletDir /temporary_location/t2p/myWalletDir weblogic
weblogic:
Must enter password.
weblogic:
Confirm weblogic:
```

The `wallet.sso` and `cwallet.sso.lck` files are generated in the `/temporary_location/t2p/myWalletDir/` directory.

- j. In the `installationpath/idm/plugins/t2p/` directory, remove the `am_t2p_registration.xml` file.
- k. Navigate to `MIDDLEWARE_HOME`, and set the following environment variable:

```
<MiddleWare_HOME > Setenv
    CHGHOST_JAVA_OPTIONS "-Dchghost.ignore.validation.port=true
    -Dchghost.temporary.port.range=14000-14100"
```

- l. Set the value of `-logPriority` to `FINE` to enable debugging at the command line. To do so, set the `T2P_JAVA_OPTIONS` variable to include the following:

```
-Dt2p.logging.level=FINE
```

- m. Navigate to `MW_HOME/oracle_common/bin/`, and run the following command:

```
./chghost.sh -chgHostInputFile /temporary_location/t2p/text.txt -javaHome /
temporary_location/t2p/jdk1.8.0_131 -domainLoc /temporary_location/t2p/MW/
user_projects/domains/domain_name -domainAdminUserName weblogic -walletDir /
temporary_location/t2p/myWalletDir -logPriority FINE -logDir /
temporary_location/t2p/logs
```

For example:

```
/temporary_location/t2p/jdk1.8.0_131/jre/bin/java -Xms4g -Xmx8g -
DignoreErrors=true -Dweblogic.security.SSL.ignoreHostnameVerification=true -
Dchghost.ignore.validation.port=true -Dchghost.temporary.port.range=14000-14100 -
cp /temporary_location/t2p/MW/wlserver/server/lib/weblogic.jar:/
temporary_location/t2p/MW/oracle_common/modules/oracle.pki/oraclepki.jar:/
temporary_location/t2p/MW/oracle_common/jlib/cloningclient.jar:/
temporary_location/t2p/MW/oracle_common/jlib/chghost.jar:/
temporary_location/t2p/MW/oracle_common/modules/oracle.ldap/ojmisc.jar:/
temporary_location/t2p/MW/oracle_common/modules/features/cieCfg_cam_lib.jar
oracle.g lcm.fmw.chghost.Chghost -chgHostInputFile /temporary_location/t2p/
text.txt -domainLoc /temporary_location/t2p/MW/user_projects/domains/domain_name
-domainAdminUserName weblogic -walletDir /temporary_location/t2p/myWalletDir -
logPriority FINE -logDir /temporary_location/t2p/logs
```

The `chghost` log file is saved at `/temporary_location/t2p/logs/`

`CHGHOST2018-05-07_07-41_1387880282/logs/chghost.log`. The following is a sample log:

```
May 07, 2018 7:41:58 AM oracle.g lcm.fmw.chghost.util.DomainUtil isDomainHomeValid
INFO: DomainHome found from domain home /temporary_location/t2p/MW/user_projects/
domains/domain_name is /temporary_location/t2p/MW/user_projects/domains/
domain_name
May 07, 2018 7:42:00 AM oracle.g lcm.fmw.chghost.util.DomainUtil isDomainHomeValid
INFO: [CHGHOST-21001-INFO] Domain home "/temporary_location/t2p/MW/user_projects/
domains/domain_name" is configured using Oracle Home "/temporary_location/t2p/
MW".
May 07, 2018 7:42:00 AM oracle.g lcm.fmw.chghost.util.DomainUtil isDomainHomeValid
INFO: [CHGHOST-23033-INFO] Domain home "/temporary_location/t2p/MW/user_projects/
domains/domain_name" is configured using java home "/temporary_location/t2p/
jdk1.8.0_131".
May 07, 2018 7:42:00 AM oracle.g lcm.fmw.chghost.Chghost initializeDomainProps
INFO: Domain home /temporary_location/t2p/MW/user_projects/domains/domain_name
is associated with Oracle home /temporary_location/t2p/MW
May 07, 2018 7:42:00 AM
oracle.g lcm.fmw.chghost.framework.execute.ChangeHostExecute execute
INFO: Gathering more information from domain ...
May 07, 2018 7:42:00 AM oracle.g lcm.fmw.chghost.util.DomainUtil
```

```

isStandAloneAttributeSet
INFO: In domain home /temporary_location/t2p/MW/user_projects/domains/
domain_name , value of cam-environment attribute is : appserver
May 07, 2018 7:42:00 AM oracle.glcm.fmw.chghost.util.DomainUtil
isWebLogicManagedDomain
INFO: Domain home /temporary_location/t2p/MW/user_projects/domains/domain_name
is a WebLogic managed domain.
May 07, 2018 7:42:00 AM oracle.glcm.fmw.chghost.util.DomainUtil
isStandAloneAttributeSet
INFO: In domain home /temporary_location/t2p/MW/user_projects/domains/
domain_name , value of cam-environment attribute is : appserver
May 07, 2018 7:42:00 AM oracle.glcm.fmw.chghost.util.DomainUtil
isWebLogicManagedDomain
INFO: Domain home /temporary_location/t2p/MW/user_projects/domains/domain_name
is a WebLogic managed domain.
May 07, 2018 7:42:44 AM
oracle.glcm.fmw.chghost.framework.process.helper.PluginExecutionHelper
updateChgHostConfigWithAdminHostAndPort
INFO: Found AdminServerName : AdminServer
May 07, 2018 7:42:44 AM
oracle.glcm.fmw.chghost.framework.process.helper.PluginExecutionHelper
updateChgHostConfigWithAdminHostAndPort
INFO: Trying to find out admin server host and port by reading its properties .
May 07, 2018 7:43:06 AM
oracle.glcm.fmw.chghost.framework.process.helper.PluginExecutionHelper
updateChgHostConfigWithAdminHostAndPort
INFO: Admin server host is :localhost . So setting its value to default value :
localhost
May 07, 2018 7:43:06 AM
oracle.glcm.fmw.chghost.framework.process.helper.PluginExecutionHelper
updateChgHostConfigWithAdminHostAndPort
INFO: Admin server host and port are : localhost , 7001
May 07, 2018 7:43:06 AM
oracle.glcm.fmw.chghost.framework.execute.ChangeHostExecute validateServerHost
INFO: Performing server host validation ...
May 07, 2018 7:43:06 AM
oracle.glcm.fmw.chghost.framework.execute.ChangeHostExecute validateServerHost
INFO: [CHGHOST-23043-INFO] Validating server hosts
{host.example.com=host.example.com}
May 07, 2018 7:43:06 AM oracle.glcm.fmw.chghost.util.HostNameUtil
validateHostName
INFO: [CHGHOST-23042-INFO] Server host validation successful for host.example.com
May 07, 2018 7:43:06 AM
oracle.glcm.fmw.chghost.framework.execute.ChangeHostExecute validateServerPort
INFO: Performing server port validation ...
May 07, 2018 7:43:06 AM
oracle.glcm.fmw.chghost.framework.input.ChghostInputValidation isValidServerPorts
INFO: Trying to find out servers host and port from domain /
temporary_location/t2p/MW/user_projects/domains/domain_name
May 07, 2018 7:43:27 AM
oracle.glcm.fmw.chghost.framework.input.ChghostInputValidation isValidServerPorts
INFO: Entry in server_details_properties : server_name = oim_servername
server_host = All Local Addresses server_port = 14000 ssl_port = None
May 07, 2018 7:43:27 AM
oracle.glcm.fmw.chghost.framework.input.ChghostInputValidation isValidServerPorts
INFO: Entry in server_details_properties : server_name = AdminServer server_host
= All Local Addresses server_port = 7001 ssl_port = None
May 07, 2018 7:43:27 AM
oracle.glcm.fmw.chghost.framework.input.ChghostInputValidation isValidServerPorts
INFO: Entry in server_details_properties : server_name = soa_servername
server_host = All Local Addresses server_port = 7003 ssl_port = None
May 07, 2018 7:43:27 AM

```

```
oracle.glcm.fmw.chghost.framework.input.ChghostInputValidation isValidServerPorts
INFO: Checking if ports are unique across all server or not ...
May 07, 2018 7:43:27 AM
oracle.glcm.fmw.chghost.framework.input.ChghostInputValidation isValidServerPorts
INFO: No duplicate port found across servers.
May 07, 2018 7:43:28 AM
oracle.glcm.fmw.chghost.framework.input.ChghostInputValidation isValidServerPorts
INFO: Port : 7001 is free to bind with localhost.
May 07, 2018 7:43:28 AM
oracle.glcm.fmw.chghost.framework.input.ChghostInputValidation isValidServerPorts
INFO: Port : 7003 is free to bind with localhost.
May 07, 2018 7:43:28 AM
oracle.glcm.fmw.chghost.framework.input.ChghostInputValidation isValidServerPorts
INFO: Port : 14000 is free to bind with localhost.
May 07, 2018 7:43:28 AM
oracle.glcm.fmw.chghost.framework.execute.ChangeHostExecute backupConfigDir
INFO: Taking backup of config directory /temporary_location/t2p/MW/user_projects/
domains/domain_name/config of size 4 MB , at /temporary_location/
CHGHOST275881279/config_dir_backup_bf_any_update_-706830822.jar
May 07, 2018 7:43:28 AM
oracle.glcm.fmw.chghost.framework.execute.ChangeHostExecute updateHost
INFO: Updating domain present in admin server host with new host(s) information
using standard wlst command in offline mode ...
May 07, 2018 7:44:23 AM
oracle.glcm.fmw.chghost.framework.execute.ChangeHostExecute execute
INFO: Update of domain with new host(s) information using standard wlst command
is successful.
May 07, 2018 7:44:23 AM
oracle.glcm.fmw.chghost.framework.execute.ChangeHostExecute backupConfigDir
INFO: Taking backup of config directory /temporary_location/t2p/MW/user_projects/
domains/domain_name/config of size 4 MB , at /temporary_location/
CHGHOST275881279/config_dir_backup_af_any_update_-522610278.jar
May 07, 2018 7:44:23 AM
oracle.glcm.fmw.chghost.framework.execute.ChangeHostExecute execute
INFO: Updating domain with new host(s) information using chghost and T2P
plugins ...
May 07, 2018 7:44:23 AM
oracle.glcm.fmw.chghost.framework.process.PluginExecution executeAllPlugins
INFO: Gathering more information from domain ...
May 07, 2018 7:44:23 AM oracle.glcm.fmw.chghost.util.DomainUtil
isStandAloneAttributeSet
INFO: In domain home /temporary_location/t2p/MW/user_projects/domains/
domain_name , value of cam-environment attribute is : appserver
May 07, 2018 7:44:23 AM oracle.glcm.fmw.chghost.util.DomainUtil
isWebLogicManagedDomain
INFO: Domain home /temporary_location/t2p/MW/user_projects/domains/domain_name
is a WebLogic managed domain.
May 07, 2018 7:44:23 AM oracle.glcm.fmw.chghost.util.DomainUtil
isStandAloneAttributeSet
INFO: In domain home /temporary_location/t2p/MW/user_projects/domains/
domain_name , value of cam-environment attribute is : appserver
May 07, 2018 7:44:23 AM oracle.glcm.fmw.chghost.util.DomainUtil
isWebLogicManagedDomain
INFO: Domain home /temporary_location/t2p/MW/user_projects/domains/domain_name
is a WebLogic managed domain.
May 07, 2018 7:44:45 AM
oracle.glcm.fmw.chghost.framework.process.helper.PluginExecutionHelper
updateChgHostConfigWithAdminHostAndPort
INFO: Found AdminServerName : AdminServer
May 07, 2018 7:44:45 AM
oracle.glcm.fmw.chghost.framework.process.helper.PluginExecutionHelper
updateChgHostConfigWithAdminHostAndPort
```

```

INFO: Trying to find out admin server host and port by reading its properties .
May 07, 2018 7:45:07 AM
oracle.glcm.fmw.chghost.framework.process.helper.PluginExecutionHelper
updateChgHostConfigWithAdminHostAndPort
INFO: Admin server host is :localhost . So setting its value to default value :
localhost
May 07, 2018 7:45:07 AM
oracle.glcm.fmw.chghost.framework.process.helper.PluginExecutionHelper
updateChgHostConfigWithAdminHostAndPort
INFO: Admin server host and port are : localhost , 7001
May 07, 2018 7:45:07 AM
oracle.glcm.fmw.chghost.framework.process.helper.PluginExecutionHelper
getT2PPlugins
INFO: Finding T2P plugins from Oracle home /temporary_location/t2p/MW
May 07, 2018 7:45:07 AM
oracle.glcm.fmw.chghost.framework.plugin.factory.PluginInfoFactory
getPluginInfoObject
INFO: list of pluginFiles : [/temporary_location/t2p/MW/soa/plugins/t2p/
soa_t2p_registration.xml, /temporary_location/t2p/MW/soa/plugins/t2p/
BAM_t2p_registration.xml]
May 07, 2018 7:45:07 AM
oracle.glcm.fmw.chghost.framework.plugin.factory.PluginInfoFactory
getPluginInfoObject
INFO: list of pluginFiles : [/temporary_location/t2p/MW/oracle_common/
plugins/t2p/ess_t2p_registration.xml, /temporary_location/t2p/MW/oracle_common/
plugins/t2p/ums_t2p_registration.xml, /temporary_location/t2p/MW/oracle_common/
plugins/t2p/opss_t2p_registration.xml, /temporary_location/t2p/MW/oracle_common/
plugins/t2p/libovd_t2p_registration.xml, /temporary_location/t2p/MW/
oracle_common/plugins/t2p/wsm_t2p_registration.xml, /temporary_location/t2p/MW/
oracle_common/plugins/t2p/adf_t2p_registration.xml]
May 07, 2018 7:45:07 AM
oracle.glcm.fmw.chghost.framework.process.helper.PluginExecutionHelper
getChgHostPlugins
INFO: Finding chghost plugins from Oracle home /temporary_location/t2p/MW
May 07, 2018 7:45:07 AM
oracle.glcm.fmw.chghost.framework.plugin.factory.PluginInfoFactory
getPluginInfoObject
INFO: list of pluginFiles : [/temporary_location/t2p/MW/oracle_common/plugins/
chghost/libovd_chghost_metadata.xml, /temporary_location/t2p/MW/oracle_common/
plugins/chghost/opss_chghost_metadata.xml]
May 07, 2018 7:45:07 AM
oracle.glcm.fmw.chghost.framework.plugin.filter.PluginFilter
filterT2PPluginBasedOnChgHostPlugin
INFO: Removing T2P plugin /temporary_location/t2p/MW/oracle_common/plugins/t2p/
libovd_t2p_registration.xml from execution list as corresponding chghost
metadata file exist.
May 07, 2018 7:45:07 AM
oracle.glcm.fmw.chghost.framework.plugin.filter.PluginFilter
filterT2PPluginBasedOnChgHostPlugin
INFO: Removing T2P plugin /temporary_location/t2p/MW/oracle_common/plugins/t2p/
opss_t2p_registration.xml from execution list as corresponding chghost metadata
file exist.
May 07, 2018 7:45:07 AM
oracle.glcm.fmw.chghost.framework.process.PluginExecution executeAllPlugins
INFO: Executing chghost plugins ...
May 07, 2018 7:45:07 AM
oracle.glcm.fmw.chghost.framework.plugin.impl.chghost.ChghostMetadataPluginExecut
orImpl executePlugin
INFO: Invoking file fixing for chghost metadata registration file /
temporary_location/t2p/MW/oracle_common/plugins/chghost/
libovd_chghost_metadata.xml
May 07, 2018 7:45:08 AM

```

```
oracle.glcm.fmw.chghost.framework.plugin.impl.chghost.ChghostMetadataPluginExecut
orImpl executePlugin
INFO: Status of Invoking file fixing forchghost metadata registration file /
temporary_location/t2p/MW/oracle_common/plugins/chghost/
libovd_chghost_metadata.xml is true
May 07, 2018 7:45:08 AM
oracle.glcm.fmw.chghost.framework.plugin.impl.chghost.ChghostMetadataPluginExecut
orImpl executePlugin
INFO: Invoking file fixing for chghost metadata registration file /
temporary_location/t2p/MW/oracle_common/plugins/chghost/opss_chghost_metadata.xml
May 07, 2018 7:45:08 AM
oracle.glcm.fmw.chghost.framework.plugin.impl.chghost.ChghostMetadataPluginExecut
orImpl executePlugin
INFO: Status of Invoking file fixing forchghost metadata registration file /
temporary_location/t2p/MW/oracle_common/plugins/chghost/
opss_chghost_metadata.xml is true
May 07, 2018 7:45:08 AM
oracle.glcm.fmw.chghost.framework.process.PluginExecution executeAllPlugins
INFO: Status of execution of chghost plugins true
May 07, 2018 7:45:08 AM
oracle.glcm.fmw.chghost.framework.process.PluginExecution executeAllPlugins
INFO: Executing T2P plugins ...
May 07, 2018 7:45:08 AM
oracle.glcm.fmw.chghost.framework.plugin.impl.t2p.builder.T2PPluginBuilder
buildPluginsByParsingRegistration
INFO: Preparing class loaders for all T2P plugins ...
May 07, 2018 7:45:08 AM
oracle.glcm.fmw.chghost.framework.plugin.impl.t2p.builder.T2PPluginBuilder
initializeClassLoaderForT2PPlugin
INFO: Initializing class loader for plugin registrationFileLoc: /
temporary_location/t2p/MW/soa/plugins/t2p/soa_t2p_registration.xml ,
productDir: /temporary_location/t2p/MW/soa , id : soa , type: T2P ...
May 07, 2018 7:45:08 AM
oracle.glcm.fmw.chghost.framework.plugin.impl.t2p.builder.T2PPluginBuilder
initializeClassLoaderPerRegistrationFile
INFO: Initializing class loader for registration file =/
temporary_location/t2p/MW/soa/plugins/t2p/soa_t2p_registration.xml with
ProductHome=/temporary_location/t2p/MW/soa
May 07, 2018 7:45:08 AM
oracle.glcm.fmw.chghost.framework.plugin.impl.t2p.builder.T2PPluginBuilder
initializeClassLoaderForT2PPlugin
INFO: Initializing class loader for plugin registrationFileLoc: /
temporary_location/t2p/MW/soa/plugins/t2p/BAM_t2p_registration.xml ,
productDir: /temporary_location/t2p/MW/soa , id : BAM , type: T2P ...
May 07, 2018 7:45:08 AM
oracle.glcm.fmw.chghost.framework.plugin.impl.t2p.builder.T2PPluginBuilder
initializeClassLoaderPerRegistrationFile
INFO: Initializing class loader for registration file =/
temporary_location/t2p/MW/soa/plugins/t2p/BAM_t2p_registration.xml with
ProductHome=/temporary_location/t2p/MW/soa
May 07, 2018 7:45:08 AM
oracle.glcm.fmw.chghost.framework.plugin.impl.t2p.builder.T2PPluginBuilder
initializeClassLoaderForT2PPlugin
INFO: Initializing class loader for plugin registrationFileLoc: /
temporary_location/t2p/MW/oracle_common/plugins/t2p/ess_t2p_registration.xml ,
productDir: /temporary_location/t2p/MW/oracle_common , id : ess , type: T2P ...
May 07, 2018 7:45:08 AM
oracle.glcm.fmw.chghost.framework.plugin.impl.t2p.builder.T2PPluginBuilder
initializeClassLoaderPerRegistrationFile
INFO: Initializing class loader for registration file =/
temporary_location/t2p/MW/oracle_common/plugins/t2p/ess_t2p_registration.xml
with ProductHome=/temporary_location/t2p/MW/oracle_common
```

```
May 07, 2018 7:45:08 AM
oracle.glcm.fmw.chghost.framework.plugin.impl.t2p.builder.T2PPluginBuilder
initializeClassLoaderForT2PPlugin
INFO: Initializing class loader for plugin registrationFileLoc: /
temporary_location/t2p/MW/oracle_common/plugins/t2p/ums_t2p_registration.xml ,
productDir: /temporary_location/t2p/MW/oracle_common , id : ums , type: T2P ...
May 07, 2018 7:45:08 AM
oracle.glcm.fmw.chghost.framework.plugin.impl.t2p.builder.T2PPluginBuilder
initializeClassLoaderPerRegistrationFile
INFO: Initializing class loader for registration file =/
temporary_location/t2p/MW/oracle_common/plugins/t2p/ums_t2p_registration.xml
with ProductHome=/temporary_location/t2p/MW/oracle_common
May 07, 2018 7:45:08 AM
oracle.glcm.fmw.chghost.framework.plugin.impl.t2p.builder.T2PPluginBuilder
initializeClassLoaderForT2PPlugin
INFO: Initializing class loader for plugin registrationFileLoc: /
temporary_location/t2p/MW/oracle_common/plugins/t2p/wsm_t2p_registration.xml ,
productDir: /temporary_location/t2p/MW/oracle_common , id : wsm , type: T2P ...
May 07, 2018 7:45:08 AM
oracle.glcm.fmw.chghost.framework.plugin.impl.t2p.builder.T2PPluginBuilder
initializeClassLoaderPerRegistrationFile
INFO: Initializing class loader for registration file =/
temporary_location/t2p/MW/oracle_common/plugins/t2p/wsm_t2p_registration.xml
with ProductHome=/temporary_location/t2p/MW/oracle_common
May 07, 2018 7:45:08 AM
oracle.glcm.fmw.chghost.framework.plugin.impl.t2p.builder.T2PPluginBuilder
initializeClassLoaderForT2PPlugin
INFO: Initializing class loader for plugin registrationFileLoc: /
temporary_location/t2p/MW/oracle_common/plugins/t2p/adf_t2p_registration.xml ,
productDir: /temporary_location/t2p/MW/oracle_common , id : adf , type: T2P ...
May 07, 2018 7:45:08 AM
oracle.glcm.fmw.chghost.framework.plugin.impl.t2p.builder.T2PPluginBuilder
initializeClassLoaderPerRegistrationFile
INFO: Initializing class loader for registration file =/
temporary_location/t2p/MW/oracle_common/plugins/t2p/adf_t2p_registration.xml
with ProductHome=/temporary_location/t2p/MW/oracle_common
May 07, 2018 7:45:08 AM
oracle.glcm.fmw.chghost.framework.plugin.impl.t2p.T2PPluginExecutorImpl
executeCopyConfigOps
INFO: * * * * * executeCopy * * * * *
May 07, 2018 7:45:08 AM
oracle.glcm.fmw.chghost.framework.plugin.impl.t2p.T2PPluginExecutorImpl
executeCopyForJ2EEDomain
INFO: Building FMWT2PCopyBean object ...
May 07, 2018 7:45:08 AM
oracle.glcm.fmw.chghost.framework.plugin.impl.t2p.T2PPluginExecutorImpl
executeCopyForJ2EEDomain
INFO: Starting AdminServer ...
May 07, 2018 7:45:08 AM
oracle.glcm.fmw.chghost.framework.plugin.impl.t2p.T2PPluginExecutorImpl
startAdminServer
INFO: /temporary_location/t2p/MW/user_projects/domains/domain_name weblogic
password : *** localhost 7001 /temporary_location/t2p/MW
INFO : May 7, 2018 7:45:18 AM - CLONE-23538 Starting Administration Server ...
..... 1 minute .....
INFO : May 7, 2018 7:47:20 AM - CLONE-23270 Connecting to domain runtime ...
INFO : May 7, 2018 7:47:20 AM - CLONE-23271 Trying to connect to
localhost:7001 ...
INFO : May 7, 2018 7:47:20 AM - CLONE-23272 Successfully connected to the domain
Runtime.
INFO : May 7, 2018 7:47:20 AM - CLONE-23266 Connecting to runtime ...
INFO : May 7, 2018 7:47:20 AM - CLONE-23271 Trying to connect to
```



```

localhost:7001 ...
INFO : May 7, 2018 7:47:21 AM - CLONE-23269 Successfully connected to runtime.
INFO : May 7, 2018 7:47:21 AM - CLONE-23357 AdminServer is already running on
port 7001
INFO : May 7, 2018 7:47:21 AM - CLONE-23552 Administration Server started
successfully.
May 07, 2018 7:47:21 AM
oracle.glcm.fmw.chghost.framework.plugin.impl.t2p.helper.ServerLifecycleHelper
enableOrDisableNetworkChannelForServersViaOnline
INFO: NetworkChannel is not configured. So nothing to disable
May 07, 2018 7:47:21 AM
oracle.glcm.fmw.chghost.framework.plugin.impl.t2p.T2PPluginExecutorImpl
executeCopyForJ2EEDomain
INFO: Starting all managed servers ...
May 07, 2018 7:47:21 AM
oracle.glcm.fmw.chghost.framework.plugin.impl.t2p.helper.ServerLifecycleHelper
startEachManagedServer
INFO: Starting managed server AdminServer
May 07, 2018 7:47:21 AM
oracle.glcm.fmw.chghost.framework.plugin.impl.t2p.helper.ServerLifecycleHelper
startEachManagedServer
INFO: Starting managed server oim_servername
INFO : May 7, 2018 7:47:48 AM - CLONE-23540 Starting Managed Server
oim_servername ...
INFO : May 7, 2018 7:51:20 AM - CLONE-23553 Managed Server oim_servername
started successfully.
May 07, 2018 7:51:20 AM
oracle.glcm.fmw.chghost.framework.plugin.impl.t2p.helper.ServerLifecycleHelper
startEachManagedServer
INFO: Starting managed server soa_servername
INFO : May 7, 2018 7:51:53 AM - CLONE-23540 Starting Managed Server
soa_servername ...
INFO : May 7, 2018 7:54:28 AM - CLONE-23553 Managed Server soa_servername
started successfully.
May 07, 2018 7:56:30 AM
oracle.glcm.fmw.chghost.framework.plugin.impl.t2p.T2PPluginExecutorImpl
executeCopyForJ2EEDomain
INFO: Executing copyConfig operation of T2P plugins ...
May 07, 2018 7:56:30 AM
oracle.glcm.fmw.chghost.framework.plugin.impl.t2p.helper.T2PCopyConfigHelper
executeT2PPluginsForCopy
INFO: Introspecting domain configuration ...
INFO : May 7, 2018 7:56:30 AM - CLONE-23273 Examining Servers.
INFO : May 7, 2018 7:56:30 AM - CLONE-23274 Examining Machines.
INFO : May 7, 2018 7:56:30 AM - CLONE-23275 Examining Clusters.
INFO : May 7, 2018 7:56:30 AM - CLONE-23276 Examining Datasources.
INFO : May 7, 2018 7:56:31 AM - CLONE-23264 Examining FileStore ...
INFO : May 7, 2018 7:56:31 AM - CLONE-23362 Examining RDBMS Security Store.
INFO : May 7, 2018 7:56:31 AM - CLONE-23312 Examining LDAP Authenticators.
INFO : May 7, 2018 7:56:31 AM - CLONE-23292 Examining Adapters.
INFO : May 7, 2018 7:56:31 AM - CLONE-23293 Examining Resource Adapters. The
Resource Adapters with deployment plan will be added to move plan.
INFO : May 7, 2018 7:56:31 AM - CLONE-23374 Examining applications with custom
deployment plans.
INFO : May 7, 2018 7:56:31 AM - CLONE-23375 Examining applications with custom
deployment plans. The applications with a deployment plan will be added to the
move plan.
INFO : May 7, 2018 7:56:32 AM - CLONE-21274 Examining Coherence Cluster
configuration.
INFO : May 7, 2018 7:56:32 AM - CLONE-21268 Examining Node Manager configuration.
INFO : May 7, 2018 7:57:02 AM - CLONE-23351 MDS data export flag is set to
false. Skipping MDS configurations.

```

```
INFO : May 7, 2018 7:57:02 AM - CLONE-23394 Exporting default providers ...
May 07, 2018 7:57:10 AM
oracle.glcm.fmw.chghost.framework.plugin.impl.t2p.helper.T2PCopyConfigHelper
executeT2PPluginsForCopy
INFO: Executing T2P plugins ...
May 07, 2018 7:57:10 AM
oracle.glcm.fmw.chghost.framework.plugin.impl.t2p.helper.T2PCopyConfigHelper
executeAllJ2EET2PPlugins
INFO: - - - - - Execution of copy operation for all J2EE T2P plugin started ...
May 07, 2018 7:57:10 AM
oracle.glcm.fmw.chghost.framework.plugin.impl.t2p.helper.T2PCopyConfigHelper
executeEachPlugin
INFO: Executing oracle.as.t2p.plugin.soa.impl.SOACopyConfigImpl ...
May 07, 2018 7:57:10 AM
oracle.glcm.fmw.chghost.framework.plugin.impl.t2p.helper.T2PCopyConfigHelper
executeEachPlugin
INFO: CopyConfig implementation Class name =
oracle.as.t2p.plugin.soa.impl.SOACopyConfigImpl and its product home =/
temporary_location/t2p/MW/soa
May 07, 2018 7:57:10 AM
oracle.glcm.fmw.chghost.framework.plugin.impl.t2p.helper.T2PCopyConfigHelper
executeEachPlugin
INFO: Setting product home in the T2P bin to =/temporary_location/t2p/MW/soa
May 07, 2018 7:57:10 AM
oracle.glcm.fmw.chghost.framework.plugin.impl.t2p.helper.T2PCopyConfigHelper
executeEachPlugin
INFO: Setting current thread context classloader to custom class loader...
INFO : May 7, 2018 7:57:10 AM - CLONE-23270 Connecting to domain runtime ...
INFO : May 7, 2018 7:57:10 AM - CLONE-23271 Trying to connect to
localhost:7001 ...
INFO : May 7, 2018 7:57:10 AM - CLONE-23272 Successfully connected to the domain
Runtime.
INFO : May 7, 2018 7:57:10 AM - CLONE-23266 Connecting to runtime ...
INFO : May 7, 2018 7:57:10 AM - CLONE-23271 Trying to connect to
localhost:7001 ...
INFO : May 7, 2018 7:57:10 AM - CLONE-23269 Successfully connected to runtime.
May 07, 2018 7:57:10 AM
oracle.glcm.fmw.chghost.framework.plugin.impl.t2p.helper.T2PCopyConfigHelper
executeEachPlugin
INFO: invoking doCopyConfigValidation of
oracle.as.t2p.plugin.soa.impl.SOACopyConfigImpl
INFO : [PLUGIN][SOA] May 7, 2018 7:57:10 AM - CLONE-51002 Executing "copyConfig
Validation" operation of the SOA plugin.
INFO : [PLUGIN][SOA] May 7, 2018 7:57:10 AM - CLONE-51000 Is SOA Domain = true.
INFO : [PLUGIN][SOA] May 7, 2018 7:57:10 AM - CLONE-51004 SOA Oracle Home
Location is /temporary_location/t2p/MW/soa
May 07, 2018 7:57:11 AM
oracle.glcm.fmw.chghost.framework.plugin.impl.t2p.helper.T2PCopyConfigHelper
executeEachPlugin
INFO: invoking doCopyConfig of oracle.as.t2p.plugin.soa.impl.SOACopyConfigImpl
INFO : [PLUGIN][SOA] DEBUG : System Flag 'ignoreErrors' is set to 'true'.
INFO : [PLUGIN][SOA] May 7, 2018 7:57:10 AM - CLONE-51002 Executing "copyConfig
Validation" operation of the SOA plugin.
INFO : [PLUGIN][SOA] May 7, 2018 7:57:10 AM - CLONE-51000 Is SOA Domain = true.
INFO : [PLUGIN][SOA] May 7, 2018 7:57:10 AM - CLONE-51004 SOA Oracle Home
Location is /temporary_location/t2p/MW/soa
May 07, 2018 7:57:11 AM
oracle.glcm.fmw.chghost.framework.plugin.impl.t2p.helper.T2PCopyConfigHelper
executeEachPlugin
INFO: invoking doCopyConfig of oracle.as.t2p.plugin.soa.impl.SOACopyConfigImpl
INFO : [PLUGIN][SOA] DEBUG : System Flag 'ignoreErrors' is set to 'true'.
INFO : [PLUGIN][SOA] May 7, 2018 7:57:11 AM - CLONE-51003 Executing "Copy
```

```

Configuration" operation of the SOA plugin.
INFO : [PLUGIN][SOA] May 7, 2018 7:57:11 AM - CLONE-51014 Exporting SOA
Composites.
INFO : [PLUGIN][SOA] May 7, 2018 7:59:17 AM - CLONE-51020 Adding Composite
AutoApproval to the move plan.
INFO : [PLUGIN][SOA] May 7, 2018 7:59:17 AM - CLONE-51020 Adding Composite
BeneficiaryManagerApproval to the move plan.
INFO : [PLUGIN][SOA] May 7, 2018 7:59:17 AM - CLONE-51020 Adding Composite
CertificationOverseerProcess to the move plan.
INFO : [PLUGIN][SOA] May 7, 2018 7:59:17 AM - CLONE-51020 Adding Composite
CertificationProcess to the move plan.
INFO : [PLUGIN][SOA] May 7, 2018 7:59:17 AM - CLONE-51020 Adding Composite
DefaultOperationalApproval to the move plan.
INFO : [PLUGIN][SOA] May 7, 2018 7:59:17 AM - CLONE-51020 Adding Composite
DefaultRequestApproval to the move plan.
INFO : [PLUGIN][SOA] May 7, 2018 7:59:17 AM - CLONE-51020 Adding Composite
DefaultRequestApproval to the move plan.
INFO : [PLUGIN][SOA] May 7, 2018 7:59:17 AM - CLONE-51020 Adding Composite
DefaultRoleApproval to the move plan.
INFO : [PLUGIN][SOA] May 7, 2018 7:59:17 AM - CLONE-51020 Adding Composite
DefaultSODApproval to the move plan.
INFO : [PLUGIN][SOA] May 7, 2018 7:59:17 AM - CLONE-51020 Adding Composite
DisconnectedProvisioning to the move plan.
INFO : [PLUGIN][SOA] May 7, 2018 7:59:17 AM - CLONE-51020 Adding Composite
IdentityAuditRemediation to the move plan.
INFO : [PLUGIN][SOA] May 7, 2018 7:59:17 AM - CLONE-51020 Adding Composite
OAACGRoleAssignSODCheck to the move plan.
INFO : [PLUGIN][SOA] May 7, 2018 7:59:17 AM - CLONE-51020 Adding Composite
ProvideInformation to the move plan.
INFO : [PLUGIN][SOA] May 7, 2018 7:59:17 AM - CLONE-51020 Adding Composite
RequesterManagerApproval to the move plan.
INFO : [PLUGIN][SOA] May 7, 2018 7:59:17 AM - CLONE-51020 Adding Composite
RoleLCMApproval to the move plan.
INFO : [PLUGIN][SOA] May 7, 2018 7:59:17 AM - CLONE-51047 "mdsDataExport" flag
is set to false. Skipping MDS migration for B2B, Human WorkFlow and OWSM
May 07, 2018 7:59:17 AM
oracle.glcm.fmw.chghost.framework.plugin.impl.t2p.helper.T2PCopyConfigHelper
executeEachPlugin
INFO: Invoking doPostCopyConfig of
oracle.as.t2p.plugin.soa.impl.SOACopyConfigImpl
INFO : [PLUGIN][SOA] May 7, 2018 7:59:17 AM - CLONE-51001 Executing "Post-Copy
Configuration" operation of the SOA plugin.
May 07, 2018 7:59:17 AM
oracle.glcm.fmw.chghost.framework.plugin.impl.t2p.helper.T2PCopyConfigHelper
executeEachPlugin
INFO: Resetting current thread context classloader
May 07, 2018 7:59:17 AM
oracle.glcm.fmw.chghost.framework.plugin.impl.t2p.helper.T2PCopyConfigHelper
executeEachPlugin
INFO: Execution of oracle.as.t2p.plugin.soa.impl.SOACopyConfigImpl done .
May 07, 2018 7:59:17 AM
oracle.glcm.fmw.chghost.framework.plugin.impl.t2p.helper.T2PCopyConfigHelper
executeEachPlugin
INFO: Executing oracle.beam.impexp.t2p.BAMCopyConfigImpl ...
May 07, 2018 7:59:17 AM
oracle.glcm.fmw.chghost.framework.plugin.impl.t2p.helper.T2PCopyConfigHelper
executeEachPlugin
INFO: CopyConfig implementation Class name =
oracle.beam.impexp.t2p.BAMCopyConfigImpl and its product home =/
temporary_location/t2p/MW/soa
May 07, 2018 7:59:17 AM
oracle.glcm.fmw.chghost.framework.plugin.impl.t2p.helper.T2PCopyConfigHelper

```

```
executeEachPlugin
INFO: Setting product home in the T2P bin to =/temporary_location/t2p/MW/soa
May 07, 2018 7:59:17 AM
oracle.glcm.fmw.chghost.framework.plugin.impl.t2p.helper.T2PCopyConfigHelper
executeEachPlugin
INFO: Setting current thread context classloader to custom class loader...
INFO : May 7, 2018 7:59:17 AM - CLONE-23270 Connecting to domain runtime ...
INFO : May 7, 2018 7:59:17 AM - CLONE-23271 Trying to connect to
localhost:7001 ...
INFO : May 7, 2018 7:59:17 AM - CLONE-23272 Successfully connected to the domain
Runtime.
INFO : May 7, 2018 7:59:17 AM - CLONE-23266 Connecting to runtime ...
INFO : May 7, 2018 7:59:17 AM - CLONE-23271 Trying to connect to
localhost:7001 ...
INFO : May 7, 2018 7:59:17 AM - CLONE-23269 Successfully connected to runtime.
May 07, 2018 7:59:17 AM
oracle.glcm.fmw.chghost.framework.plugin.impl.t2p.helper.T2PCopyConfigHelper
executeEachPlugin
INFO: invoking doCopyConfigValidation of oracle.beam.impexp.t2p.BAMCopyConfigImpl
May 07, 2018 7:59:18 AM
oracle.glcm.fmw.chghost.framework.plugin.impl.t2p.helper.T2PCopyConfigHelper
executeEachPlugin
INFO: invoking doCopyConfig of oracle.beam.impexp.t2p.BAMCopyConfigImpl
May 07, 2018 7:59:18 AM
oracle.glcm.fmw.chghost.framework.plugin.impl.t2p.helper.T2PCopyConfigHelper
executeEachPlugin
INFO: Invoking doPostCopyConfig of oracle.beam.impexp.t2p.BAMCopyConfigImpl
May 07, 2018 7:59:18 AM
oracle.glcm.fmw.chghost.framework.plugin.impl.t2p.helper.T2PCopyConfigHelper
executeEachPlugin
INFO: Resetting current thread context classloader
May 07, 2018 7:59:18 AM
oracle.glcm.fmw.chghost.framework.plugin.impl.t2p.helper.T2PCopyConfigHelper
executeEachPlugin
INFO: Execution of oracle.beam.impexp.t2p.BAMCopyConfigImpl done .
May 07, 2018 7:59:18 AM
oracle.glcm.fmw.chghost.framework.plugin.impl.t2p.helper.T2PCopyConfigHelper
executeEachPlugin
INFO: Executing oracle.as.ess.t2p.impl.ESST2PPluginCopyConfigImpl ...
May 07, 2018 7:59:18 AM
oracle.glcm.fmw.chghost.framework.plugin.impl.t2p.helper.T2PCopyConfigHelper
executeEachPlugin
INFO: CopyConfig implementation Class name =
oracle.as.ess.t2p.impl.ESST2PPluginCopyConfigImpl and its product home =/
temporary_location/t2p/MW/oracle_common
May 07, 2018 7:59:18 AM
oracle.glcm.fmw.chghost.framework.plugin.impl.t2p.helper.T2PCopyConfigHelper
executeEachPlugin
INFO: Setting product home in the T2P bin to =/temporary_location/t2p/MW/
oracle_common
May 07, 2018 7:59:18 AM
oracle.glcm.fmw.chghost.framework.plugin.impl.t2p.helper.T2PCopyConfigHelper
executeEachPlugin
INFO: Setting current thread context classloader to custom class loader...
INFO : May 7, 2018 7:59:18 AM - CLONE-23270 Connecting to domain runtime ...
INFO : May 7, 2018 7:59:18 AM - CLONE-23271 Trying to connect to
localhost:7001 ...
INFO : May 7, 2018 7:59:18 AM - CLONE-23272 Successfully connected to the domain
Runtime.
INFO : May 7, 2018 7:59:18 AM - CLONE-23266 Connecting to runtime ...
INFO : May 7, 2018 7:59:18 AM - CLONE-23271 Trying to connect to
localhost:7001 ...
```

```
INFO : May 7, 2018 7:59:18 AM - CLONE-23269 Successfully connected to runtime.
May 07, 2018 7:59:18 AM
oracle.glcm.fmw.chghost.framework.plugin.impl.t2p.helper.T2PCopyConfigHelper
executeEachPlugin
INFO: invoking doCopyConfigValidation of
oracle.as.ess.t2p.impl.ESST2PPluginCopyConfigImpl
INFO : [PLUGIN][ESS] May 7, 2018 7:59:18 AM - CLONE-29001 Executing "Copy Config
Validation" operation of the ESS T2P plugin.
INFO : [PLUGIN][ESS] May 7, 2018 7:59:18 AM - CLONE-29000 Is ESS Domain = false.
INFO : [PLUGIN][ESS] May 7, 2018 7:59:18 AM - CLONE-29004 Not a valid ESS
Domain. Skipping ESS specific copy configuration steps.
May 07, 2018 7:59:18 AM
oracle.glcm.fmw.chghost.framework.plugin.impl.t2p.helper.T2PCopyConfigHelper
executeEachPlugin
INFO: invoking doCopyConfig of oracle.as.ess.t2p.impl.ESST2PPluginCopyConfigImpl
May 07, 2018 7:59:18 AM
oracle.glcm.fmw.chghost.framework.plugin.impl.t2p.helper.T2PCopyConfigHelper
executeEachPlugin
INFO: Invoking doPostCopyConfig of
oracle.as.ess.t2p.impl.ESST2PPluginCopyConfigImpl
May 07, 2018 7:59:18 AM
oracle.glcm.fmw.chghost.framework.plugin.impl.t2p.helper.T2PCopyConfigHelper
executeEachPlugin
INFO: Resetting current thread context classloader
May 07, 2018 7:59:18 AM
oracle.glcm.fmw.chghost.framework.plugin.impl.t2p.helper.T2PCopyConfigHelper
executeEachPlugin
INFO: Execution of oracle.as.ess.t2p.impl.ESST2PPluginCopyConfigImpl done .
May 07, 2018 7:59:18 AM
oracle.glcm.fmw.chghost.framework.plugin.impl.t2p.helper.T2PCopyConfigHelper
executeEachPlugin
INFO: Executing oracle.ucsinternal.messaging.t2p.UmsCopyConfigImpl ...
May 07, 2018 7:59:18 AM
oracle.glcm.fmw.chghost.framework.plugin.impl.t2p.helper.T2PCopyConfigHelper
executeEachPlugin
INFO: CopyConfig implementation Class name =
oracle.ucsinternal.messaging.t2p.UmsCopyConfigImpl and its product home =/
temporary_location/t2p/MW/oracle_common
May 07, 2018 7:59:18 AM
oracle.glcm.fmw.chghost.framework.plugin.impl.t2p.helper.T2PCopyConfigHelper
executeEachPlugin
INFO: Setting product home in the T2P bin to =/temporary_location/t2p/MW/
oracle_common
May 07, 2018 7:59:18 AM
oracle.glcm.fmw.chghost.framework.plugin.impl.t2p.helper.T2PCopyConfigHelper
executeEachPlugin
INFO: Setting current thread context classloader to custom class loader...
INFO : May 7, 2018 7:59:18 AM - CLONE-23270 Connecting to domain runtime ...
INFO : May 7, 2018 7:59:18 AM - CLONE-23271 Trying to connect to
localhost:7001 ...
INFO : May 7, 2018 7:59:18 AM - CLONE-23272 Successfully connected to the domain
Runtime.
INFO : May 7, 2018 7:59:18 AM - CLONE-23266 Connecting to runtime ...
INFO : May 7, 2018 7:59:18 AM - CLONE-23271 Trying to connect to
localhost:7001 ...
INFO : May 7, 2018 7:59:18 AM - CLONE-23269 Successfully connected to runtime.
May 07, 2018 7:59:18 AM
oracle.glcm.fmw.chghost.framework.plugin.impl.t2p.helper.T2PCopyConfigHelper
executeEachPlugin
INFO: invoking doCopyConfigValidation of
oracle.ucsinternal.messaging.t2p.UmsCopyConfigImpl
INFO : [PLUGIN][ums] May 7, 2018 7:59:18 AM - CLONE-92100 In method
```

```
doCopyConfigValidation.
May 07, 2018 7:59:18 AM
oracle.glcm.fmw.chghost.framework.plugin.impl.t2p.helper.T2PCopyConfigHelper
executeEachPlugin
INFO: invoking doCopyConfig of oracle.ucsinternal.messaging.t2p.UmsCopyConfigImpl
INFO : [PLUGIN][ums] May 7, 2018 7:59:18 AM - CLONE-92101 In method doCopyConfig.
INFO : [PLUGIN][ums] May 7, 2018 7:59:18 AM - CLONE-92107 Download data for User
Preferences.
INFO : [PLUGIN][ums] May 7, 2018 7:59:21 AM - CLONE-92109 Extract driver
configuration.
May 07, 2018 7:59:22 AM
oracle.glcm.fmw.chghost.framework.plugin.impl.t2p.helper.T2PCopyConfigHelper
executeEachPlugin
INFO: Invoking doPostCopyConfig of
oracle.ucsinternal.messaging.t2p.UmsCopyConfigImpl
INFO : [PLUGIN][ums] May 7, 2018 7:59:22 AM - CLONE-92102 In method
doPostCopyConfig..
May 07, 2018 7:59:22 AM
oracle.glcm.fmw.chghost.framework.plugin.impl.t2p.helper.T2PCopyConfigHelper
executeEachPlugin
INFO: Resetting current thread context classloader
May 07, 2018 7:59:22 AM
oracle.glcm.fmw.chghost.framework.plugin.impl.t2p.helper.T2PCopyConfigHelper
executeEachPlugin
INFO: Execution of oracle.ucsinternal.messaging.t2p.UmsCopyConfigImpl done .
May 07, 2018 7:59:22 AM
oracle.glcm.fmw.chghost.framework.plugin.impl.t2p.helper.T2PCopyConfigHelper
executeEachPlugin
INFO: Executing oracle.wsm.lifecycle.t2p.impl.CopyConfigImpl ...
May 07, 2018 7:59:22 AM
oracle.glcm.fmw.chghost.framework.plugin.impl.t2p.helper.T2PCopyConfigHelper
executeEachPlugin
INFO: CopyConfig implementation Class name =
oracle.wsm.lifecycle.t2p.impl.CopyConfigImpl and its product home =/
temporary_location/t2p/MW/oracle_common
May 07, 2018 7:59:22 AM
oracle.glcm.fmw.chghost.framework.plugin.impl.t2p.helper.T2PCopyConfigHelper
executeEachPlugin
INFO: Setting product home in the T2P bin to =/temporary_location/t2p/MW/
oracle_common
May 07, 2018 7:59:22 AM
oracle.glcm.fmw.chghost.framework.plugin.impl.t2p.helper.T2PCopyConfigHelper
executeEachPlugin
INFO: Setting current thread context classloader to custom class loader...
INFO : May 7, 2018 7:59:22 AM - CLONE-23270 Connecting to domain runtime ...
INFO : May 7, 2018 7:59:22 AM - CLONE-23271 Trying to connect to
localhost:7001 ...
INFO : May 7, 2018 7:59:22 AM - CLONE-23272 Successfully connected to the domain
Runtime.
INFO : May 7, 2018 7:59:22 AM - CLONE-23266 Connecting to runtime ...
INFO : May 7, 2018 7:59:22 AM - CLONE-23271 Trying to connect to
localhost:7001 ...
INFO : May 7, 2018 7:59:22 AM - CLONE-23269 Successfully connected to runtime.
May 07, 2018 7:59:22 AM
oracle.glcm.fmw.chghost.framework.plugin.impl.t2p.helper.T2PCopyConfigHelper
executeEachPlugin
INFO: invoking doCopyConfigValidation of
oracle.wsm.lifecycle.t2p.impl.CopyConfigImpl
INFO : [PLUGIN][OWSM] May 7, 2018 7:59:22 AM - CLONE-40001 OWSM Plug-in Copy
Config Operation Started.Validating source environment.
May 07, 2018 7:59:22 AM
oracle.glcm.fmw.chghost.framework.plugin.impl.t2p.helper.T2PCopyConfigHelper
```

```
executeEachPlugin
INFO: invoking doCopyConfig of oracle.wsm.lifecycle.t2p.impl.CopyConfigImpl
INFO : [PLUGIN][OWSM] May 7, 2018 7:59:28 AM - CLONE-40003 Reading bootstrap
configuration file.
INFO : [PLUGIN][OWSM] May 7, 2018 7:59:29 AM - CLONE-40010 WSM specific
artifacts are not modified on source environment. Nothing will be added to
moveplan.
May 07, 2018 7:59:29 AM
oracle.glcm.fmw.chghost.framework.plugin.impl.t2p.helper.T2PCopyConfigHelper
executeEachPlugin
INFO: Invoking doPostCopyConfig of oracle.wsm.lifecycle.t2p.impl.CopyConfigImpl
INFO : [PLUGIN][OWSM] May 7, 2018 7:59:29 AM - CLONE-40011 OWSM Plug-in Copy
Config operation finished.
May 07, 2018 7:59:29 AM
oracle.glcm.fmw.chghost.framework.plugin.impl.t2p.helper.T2PCopyConfigHelper
executeEachPlugin
INFO: Resetting current thread context classloader
May 07, 2018 7:59:29 AM
oracle.glcm.fmw.chghost.framework.plugin.impl.t2p.helper.T2PCopyConfigHelper
executeEachPlugin
INFO: Execution of oracle.wsm.lifecycle.t2p.impl.CopyConfigImpl done .
May 07, 2018 7:59:29 AM
oracle.glcm.fmw.chghost.framework.plugin.impl.t2p.helper.T2PCopyConfigHelper
executeEachPlugin
INFO: Executing
oracle.adf.t2p.plugins.adfconn.impl.ADFConnectionCopyConfigImpl ...
May 07, 2018 7:59:29 AM
oracle.glcm.fmw.chghost.framework.plugin.impl.t2p.helper.T2PCopyConfigHelper
executeEachPlugin
INFO: CopyConfig implementation Class name =
oracle.adf.t2p.plugins.adfconn.impl.ADFConnectionCopyConfigImpl and its product
home =/temporary_location/t2p/MW/oracle_common
May 07, 2018 7:59:29 AM
oracle.glcm.fmw.chghost.framework.plugin.impl.t2p.helper.T2PCopyConfigHelper
executeEachPlugin
INFO: Setting product home in the T2P bin to =/temporary_location/t2p/MW/
oracle_common
May 07, 2018 7:59:29 AM
oracle.glcm.fmw.chghost.framework.plugin.impl.t2p.helper.T2PCopyConfigHelper
executeEachPlugin
INFO: Setting current thread context classloader to custom class loader...
INFO : May 7, 2018 7:59:29 AM - CLONE-23270 Connecting to domain runtime ...
INFO : May 7, 2018 7:59:29 AM - CLONE-23271 Trying to connect to
localhost:7001 ...
INFO : May 7, 2018 7:59:29 AM - CLONE-23272 Successfully connected to the domain
Runtime.
INFO : May 7, 2018 7:59:29 AM - CLONE-23266 Connecting to runtime ...
INFO : May 7, 2018 7:59:29 AM - CLONE-23271 Trying to connect to
localhost:7001 ...
INFO : May 7, 2018 7:59:29 AM - CLONE-23269 Successfully connected to runtime.
May 07, 2018 7:59:29 AM
oracle.glcm.fmw.chghost.framework.plugin.impl.t2p.helper.T2PCopyConfigHelper
executeEachPlugin
INFO: invoking doCopyConfigValidation of
oracle.adf.t2p.plugins.adfconn.impl.ADFConnectionCopyConfigImpl
INFO : [PLUGIN][OracleADF] May 7, 2018 7:59:29 AM - CLONE-33010 Start to run T2P
ADF Connection Plugins.
May 07, 2018 7:59:29 AM
oracle.glcm.fmw.chghost.framework.plugin.impl.t2p.helper.T2PCopyConfigHelper
executeEachPlugin
INFO: invoking doCopyConfig of
oracle.adf.t2p.plugins.adfconn.impl.ADFConnectionCopyConfigImpl
```

```

May 07, 2018 7:59:30 AM
oracle.glcm.fmw.chghost.framework.plugin.impl.t2p.helper.T2PCopyConfigHelper
executeEachPlugin
INFO: Invoking doPostCopyConfig of
oracle.adf.t2p.plugins.adfconn.impl.ADFConnectionCopyConfigImpl
INFO : [PLUGIN][OracleADF] May 7, 2018 7:59:30 AM - CLONE-33020 Finish running
T2P ADF Connection Plugins.
May 07, 2018 7:59:30 AM
oracle.glcm.fmw.chghost.framework.plugin.impl.t2p.helper.T2PCopyConfigHelper
executeEachPlugin
INFO: Resetting current thread context classloader
May 07, 2018 7:59:30 AM
oracle.glcm.fmw.chghost.framework.plugin.impl.t2p.helper.T2PCopyConfigHelper
executeEachPlugin
INFO: Execution of
oracle.adf.t2p.plugins.adfconn.impl.ADFConnectionCopyConfigImpl done .
May 07, 2018 7:59:30 AM
oracle.glcm.fmw.chghost.framework.plugin.impl.t2p.helper.T2PCopyConfigHelper
executeAllJ2EET2PPlugins
INFO: - - - - - Execution of copy operation for all J2EE T2P plugin completed.
May 07, 2018 7:59:30 AM
oracle.glcm.fmw.chghost.framework.plugin.impl.t2p.helper.T2PCAMCopyConfigHelper
executeCAMPlugins
INFO: Checking whether system components directory present or not ....
May 07, 2018 7:59:30 AM
oracle.glcm.fmw.chghost.framework.plugin.impl.t2p.helper.T2PCAMCopyConfigHelper
executeCAMPlugins
INFO: No system components are configured in the domain.
May 07, 2018 7:59:30 AM
oracle.glcm.fmw.chghost.framework.plugin.impl.t2p.helper.T2PCopyConfigHelper
executeT2PPluginsForCopy
INFO: Executing persistMovePlan with argument /temporary_location/
CLONINGCLIENT1233945222590395849/configplans/moveplan.xml
May 07, 2018 7:59:30 AM
oracle.glcm.fmw.chghost.framework.plugin.impl.t2p.helper.T2PCopyConfigHelper
executeT2PPluginsForCopy
INFO: Persisting moveplan to archive
May 07, 2018 7:59:30 AM
oracle.glcm.fmw.chghost.framework.plugin.impl.t2p.T2PPluginExecutorImpl
executeCopyForJ2EEDomain
INFO: Shutting down all managed servers
May 07, 2018 7:59:30 AM
oracle.glcm.fmw.chghost.framework.plugin.impl.t2p.helper.ServerLifecycleHelper
stopEachManagedServer
INFO: Stopping managed server AdminServer
May 07, 2018 7:59:30 AM
oracle.glcm.fmw.chghost.framework.plugin.impl.t2p.helper.ServerLifecycleHelper
stopEachManagedServer
INFO: Stopping managed server oim_servername
INFO : May 7, 2018 7:59:30 AM - CLONE-23541 Stopping Managed Server
oim_servername ...
INFO : May 7, 2018 7:59:30 AM - CLONE-23270 Connecting to domain runtime ...
INFO : May 7, 2018 7:59:30 AM - CLONE-23271 Trying to connect to
localhost:7001 ...
INFO : May 7, 2018 7:59:30 AM - CLONE-23272 Successfully connected to the domain
Runtime.
INFO : May 7, 2018 7:59:30 AM - CLONE-23266 Connecting to runtime ...
INFO : May 7, 2018 7:59:30 AM - CLONE-23271 Trying to connect to
localhost:7001 ...
INFO : May 7, 2018 7:59:30 AM - CLONE-23269 Successfully connected to runtime.
INFO : May 7, 2018 8:00:33 AM - CLONE-23551 Managed Server oim_servername
stopped successfully.

```



```
May 07, 2018 8:00:33 AM
oracle.glcm.fmw.chghost.framework.plugin.impl.t2p.helper.ServerLifecycleHelper
stopEachManagedServer
INFO: Stopping managed server soa_servername
INFO : May 7, 2018 8:00:33 AM - CLONE-23541 Stopping Managed Server
soa_servername ...
INFO : May 7, 2018 8:01:14 AM - CLONE-23551 Managed Server soa_servername
stopped successfully.
May 07, 2018 8:01:14 AM
oracle.glcm.fmw.chghost.framework.plugin.impl.t2p.T2PPluginExecutorImpl
executeCopyForJ2EEDomain
INFO: Shutting down AdminServer
May 07, 2018 8:01:14 AM
oracle.glcm.fmw.chghost.framework.plugin.impl.t2p.helper.T2PConfigHelper
backupFromCloningTempLocation
INFO: Taking backup everything under /temporary_location/
CLONINGCLIENT1233945222590395849 at /temporary_location/
CLONINGCLIENT1233945222590395849/backup_after_copy
May 07, 2018 8:01:14 AM
oracle.glcm.fmw.chghost.framework.plugin.impl.t2p.T2PPluginExecutorImpl
executePasteConfigOps
INFO: * * * * * updateMovePlan * * * * *
May 07, 2018 8:01:14 AM
oracle.glcm.fmw.chghost.framework.plugin.impl.t2p.T2PPluginExecutorImpl
updateMovePlan
INFO: Extracting moveplan and other plans under /temporary_location/
CHGHOST275881279/t2p_plans_1525705274473 from archive file /temporary_location/
CLONINGCLIENT1233945222590395849/t2p.jar
May 07, 2018 8:01:14 AM
oracle.glcm.fmw.chghost.framework.plugin.impl.t2p.helper.MovePlanUpdateHelper
updateMoveableComponent
INFO: Updating moveplan for MoveableComponent name: domain_name and type :
J2EEDomain
May 07, 2018 8:01:14 AM
oracle.glcm.fmw.chghost.framework.plugin.impl.t2p.helper.MovePlanUpdateHelper
updateMoveableComponent
INFO: Updating moveplan for MoveableComponent name: null and type : SOA-INFRA
May 07, 2018 8:01:14 AM
oracle.glcm.fmw.chghost.framework.plugin.impl.t2p.helper.MovePlanUpdateHelper
updateMoveableComponent
INFO: Updating moveplan for MoveableComponent name: null and type : Composite
May 07, 2018 8:01:14 AM
oracle.glcm.fmw.chghost.framework.plugin.impl.t2p.helper.MovePlanUpdateHelper
updateMoveableComponent
INFO: Updating moveplan for MoveableComponent name: null and type : MDM Url
Resolver
May 07, 2018 8:01:14 AM
oracle.glcm.fmw.chghost.framework.plugin.impl.t2p.helper.MovePlanUpdateHelper
updateMoveableComponent
INFO: Updating moveplan for MoveableComponent name: null and type : UMS
May 07, 2018 8:01:14 AM
oracle.glcm.fmw.chghost.framework.plugin.impl.t2p.helper.MovePlanUpdateHelper
updateMoveableComponent
INFO: Updating moveplan for MoveableComponent name: null and type : ADF
Connections
May 07, 2018 8:01:14 AM
oracle.glcm.fmw.chghost.framework.plugin.impl.t2p.T2PPluginExecutorImpl
updateMovePlan
INFO: Persisting updated moveplan at /temporary_location/CHGHOST275881279/
t2p_plans_1525705274473/moveplan_updated_1525705274616.xml
May 07, 2018 8:01:14 AM
oracle.glcm.fmw.chghost.framework.plugin.impl.t2p.T2PPluginExecutorImpl
```

```

executePasteConfigOps
INFO: * * * * * executePasteConfig * * * * *
May 07, 2018 8:01:14 AM
oracle.glcm.fmw.chghost.framework.plugin.impl.t2p.T2PPluginExecutorImpl
executePasteConfig
INFO: Executing pasteConfig operation of T2P plugins ...
May 07, 2018 8:01:14 AM
oracle.glcm.fmw.chghost.framework.plugin.impl.t2p.helper.T2PPasteConfigHelper
applyAllJ2EEPlugins
INFO: - - - - - Execution of offline paste operation for all J2EE T2P plugin
started ...
May 07, 2018 8:01:14 AM
oracle.glcm.fmw.chghost.framework.plugin.impl.t2p.helper.T2PPasteConfigHelper
applyEachJ2EEPlugin
INFO: Executing oracle.wsm.lifecycle.t2p.impl.PasteConfigImpl ...
May 07, 2018 8:01:14 AM
oracle.glcm.fmw.chghost.framework.plugin.impl.t2p.helper.T2PPasteConfigHelper
applyEachJ2EEPlugin
INFO: invoking doOfflineConfig of oracle.wsm.lifecycle.t2p.impl.PasteConfigImpl
INFO : [PLUGIN][OWSM] May 7, 2018 8:01:14 AM - CLONE-40021 OWSM Plug-in Paste
Config operation started. Validating target environment.
INFO : [PLUGIN][OWSM] May 7, 2018 8:01:16 AM - CLONE-40037 Oracle WSM datasource
(i.e. mds-owsm) is configured in the /temporary_location/t2p/MW/user_projects/
domains/domain_name domain.
INFO : [PLUGIN][OWSM] May 7, 2018 8:01:16 AM - CLONE-40026 Bootstrap movable
component is not present in moveplan. Bootstrap configurations will not be
updated.
INFO : [PLUGIN][OWSM] May 7, 2018 8:01:36 AM - CLONE-40035 OWSM Plug-in Paste
Config Operation Finished.
May 07, 2018 8:01:36 AM
oracle.glcm.fmw.chghost.framework.plugin.impl.t2p.helper.T2PPasteConfigHelper
applyEachJ2EEPlugin
INFO: Execution of oracle.wsm.lifecycle.t2p.impl.PasteConfigImpl done.
May 07, 2018 8:01:36 AM
oracle.glcm.fmw.chghost.framework.plugin.impl.t2p.helper.T2PPasteConfigHelper
applyEachJ2EEPlugin
INFO: Executing oracle.as.t2p.plugin.soa.impl.SOAPasteConfigImpl ...
May 07, 2018 8:01:36 AM
oracle.glcm.fmw.chghost.framework.plugin.impl.t2p.helper.T2PPasteConfigHelper
applyEachJ2EEPlugin
INFO: invoking doOfflineConfig of
oracle.as.t2p.plugin.soa.impl.SOAPasteConfigImpl
May 07, 2018 8:01:36 AM
oracle.glcm.fmw.chghost.framework.plugin.impl.t2p.helper.T2PPasteConfigHelper
applyEachJ2EEPlugin
INFO: Execution of oracle.as.t2p.plugin.soa.impl.SOAPasteConfigImpl done.
May 07, 2018 8:01:36 AM
oracle.glcm.fmw.chghost.framework.plugin.impl.t2p.helper.T2PPasteConfigHelper
applyEachJ2EEPlugin
INFO: Executing
oracle.adf.t2p.plugins.adfconn.impl.ADFConnectionPasteConfigImpl ...
May 07, 2018 8:01:36 AM
oracle.glcm.fmw.chghost.framework.plugin.impl.t2p.helper.T2PPasteConfigHelper
applyEachJ2EEPlugin
INFO: invoking doOfflineConfig of
oracle.adf.t2p.plugins.adfconn.impl.ADFConnectionPasteConfigImpl
May 07, 2018 8:01:36 AM
oracle.glcm.fmw.chghost.framework.plugin.impl.t2p.helper.T2PPasteConfigHelper
applyEachJ2EEPlugin
INFO: Execution of
oracle.adf.t2p.plugins.adfconn.impl.ADFConnectionPasteConfigImpl done.
May 07, 2018 8:01:36 AM

```

```
oracle.glcm.fmw.chghost.framework.plugin.impl.t2p.helper.T2PPasteConfigHelper
applyEachJ2EEPlugin
INFO: Executing oracle.as.ess.t2p.impl.ESST2PPluginPasteConfigImpl ...
May 07, 2018 8:01:36 AM
oracle.glcm.fmw.chghost.framework.plugin.impl.t2p.helper.T2PPasteConfigHelper
applyEachJ2EEPlugin
INFO: invoking doOfflineConfig of
oracle.as.ess.t2p.impl.ESST2PPluginPasteConfigImpl
May 07, 2018 8:01:36 AM
oracle.glcm.fmw.chghost.framework.plugin.impl.t2p.helper.T2PPasteConfigHelper
applyEachJ2EEPlugin
INFO: Execution of oracle.as.ess.t2p.impl.ESST2PPluginPasteConfigImpl done.
May 07, 2018 8:01:36 AM
oracle.glcm.fmw.chghost.framework.plugin.impl.t2p.helper.T2PPasteConfigHelper
applyEachJ2EEPlugin
INFO: Executing oracle.beam.impexp.t2p.BAMPasteConfigImpl ...
May 07, 2018 8:01:36 AM
oracle.glcm.fmw.chghost.framework.plugin.impl.t2p.helper.T2PPasteConfigHelper
applyEachJ2EEPlugin
INFO: invoking doOfflineConfig of oracle.beam.impexp.t2p.BAMPasteConfigImpl
May 07, 2018 8:01:36 AM
oracle.glcm.fmw.chghost.framework.plugin.impl.t2p.helper.T2PPasteConfigHelper
applyEachJ2EEPlugin
INFO: Execution of oracle.beam.impexp.t2p.BAMPasteConfigImpl done.
May 07, 2018 8:01:36 AM
oracle.glcm.fmw.chghost.framework.plugin.impl.t2p.helper.T2PPasteConfigHelper
applyEachJ2EEPlugin
INFO: Executing oracle.ucsiinternal.messaging.t2p.UmsPasteConfigImpl ...
May 07, 2018 8:01:36 AM
oracle.glcm.fmw.chghost.framework.plugin.impl.t2p.helper.T2PPasteConfigHelper
applyEachJ2EEPlugin
INFO: invoking doOfflineConfig of
oracle.ucsiinternal.messaging.t2p.UmsPasteConfigImpl
May 07, 2018 8:01:36 AM
oracle.glcm.fmw.chghost.framework.plugin.impl.t2p.helper.T2PPasteConfigHelper
applyEachJ2EEPlugin
INFO: Execution of oracle.ucsiinternal.messaging.t2p.UmsPasteConfigImpl done.
May 07, 2018 8:01:36 AM
oracle.glcm.fmw.chghost.framework.plugin.impl.t2p.helper.T2PPasteConfigHelper
applyAllJ2EEPlugins
INFO: - - - - - Execution of offline paste operation for all J2EE T2P plugin
completed.
May 07, 2018 8:01:36 AM
oracle.glcm.fmw.chghost.framework.plugin.impl.t2p.helper.T2PPasteConfigHelper
executeT2PPluginsForPaste
INFO: Starting AdminServer ...
INFO : May 7, 2018 8:01:46 AM - CLONE-23538 Starting Administration Server ...
INFO : May 7, 2018 8:01:46 AM - CLONE-23270 Connecting to domain runtime ...
INFO : May 7, 2018 8:01:46 AM - CLONE-23271 Trying to connect to
localhost:7001 ...
INFO : May 7, 2018 8:01:47 AM - CLONE-23272 Successfully connected to the domain
Runtime.
INFO : May 7, 2018 8:01:47 AM - CLONE-23266 Connecting to runtime ...
INFO : May 7, 2018 8:01:47 AM - CLONE-23271 Trying to connect to
localhost:7001 ...
INFO : May 7, 2018 8:01:47 AM - CLONE-23269 Successfully connected to runtime.
INFO : May 7, 2018 8:01:47 AM - CLONE-23357 AdminServer is already running on
port 7001
INFO : May 7, 2018 8:01:47 AM - CLONE-23552 Administration Server started
successfully.
May 07, 2018 8:01:47 AM
oracle.glcm.fmw.chghost.framework.plugin.impl.t2p.helper.T2PPasteConfigHelper
```

```

applyAllJ2EEPlugins
INFO: - - - - - Execution of paste operation for all J2EE T2P plugin
started ...
May 07, 2018 8:01:47 AM
oracle.glcm.fmw.chghost.framework.plugin.impl.t2p.helper.T2PPasteConfigHelper
applyEachJ2EEPlugin
INFO: Executing oracle.wsm.lifecycle.t2p.impl.PasteConfigImpl ...
INFO : May 7, 2018 8:01:47 AM - CLONE-23270 Connecting to domain runtime ...
INFO : May 7, 2018 8:01:47 AM - CLONE-23271 Trying to connect to
localhost:7001 ...
INFO : May 7, 2018 8:01:47 AM - CLONE-23272 Successfully connected to the domain
Runtime.
INFO : May 7, 2018 8:01:47 AM - CLONE-23266 Connecting to runtime ...
INFO : May 7, 2018 8:01:47 AM - CLONE-23271 Trying to connect to
localhost:7001 ...
INFO : May 7, 2018 8:01:47 AM - CLONE-23269 Successfully connected to runtime.
May 07, 2018 8:01:47 AM
oracle.glcm.fmw.chghost.framework.plugin.impl.t2p.helper.T2PPasteConfigHelper
applyEachJ2EEPlugin
INFO: Invoking doPasteConfigValidation of
oracle.wsm.lifecycle.t2p.impl.PasteConfigImpl
May 07, 2018 8:01:47 AM
oracle.glcm.fmw.chghost.framework.plugin.impl.t2p.helper.T2PPasteConfigHelper
applyEachJ2EEPlugin
INFO: Invoking doPrePasteConfigValidation of
oracle.wsm.lifecycle.t2p.impl.PasteConfigImpl
May 07, 2018 8:01:47 AM
oracle.glcm.fmw.chghost.framework.plugin.impl.t2p.helper.T2PPasteConfigHelper
applyEachJ2EEPlugin
INFO: Invoking doPasteConfig of oracle.wsm.lifecycle.t2p.impl.PasteConfigImpl
May 07, 2018 8:01:47 AM
oracle.glcm.fmw.chghost.framework.plugin.impl.t2p.helper.T2PPasteConfigHelper
applyEachJ2EEPlugin
INFO: Invoking doPostPasteConfig of oracle.wsm.lifecycle.t2p.impl.PasteConfigImpl
May 07, 2018 8:01:47 AM
oracle.glcm.fmw.chghost.framework.plugin.impl.t2p.helper.T2PPasteConfigHelper
applyEachJ2EEPlugin
INFO: Execution of oracle.wsm.lifecycle.t2p.impl.PasteConfigImpl done.
May 07, 2018 8:01:47 AM
oracle.glcm.fmw.chghost.framework.plugin.impl.t2p.helper.T2PPasteConfigHelper
applyEachJ2EEPlugin
INFO: Executing oracle.as.t2p.plugin.soa.impl.SOAPasteConfigImpl ...
INFO : May 7, 2018 8:01:47 AM - CLONE-23270 Connecting to domain runtime ...
INFO : May 7, 2018 8:01:47 AM - CLONE-23271 Trying to connect to
localhost:7001 ...
INFO : May 7, 2018 8:01:47 AM - CLONE-23272 Successfully connected to the domain
Runtime.
INFO : May 7, 2018 8:01:47 AM - CLONE-23266 Connecting to runtime ...
INFO : May 7, 2018 8:01:47 AM - CLONE-23271 Trying to connect to
localhost:7001 ...
INFO : May 7, 2018 8:01:47 AM - CLONE-23269 Successfully connected to runtime.
May 07, 2018 8:01:47 AM
oracle.glcm.fmw.chghost.framework.plugin.impl.t2p.helper.T2PPasteConfigHelper
applyEachJ2EEPlugin
INFO: Invoking doPasteConfigValidation of
oracle.as.t2p.plugin.soa.impl.SOAPasteConfigImpl
INFO : [PLUGIN][SOA] May 7, 2018 8:01:47 AM - CLONE-51025 Executing "pasteConfig
Validation" operation of the SOA plugin.
May 07, 2018 8:01:47 AM
oracle.glcm.fmw.chghost.framework.plugin.impl.t2p.helper.T2PPasteConfigHelper
applyEachJ2EEPlugin
INFO: Invoking doPrePasteConfigValidation of

```

```

oracle.as.t2p.plugin.soa.impl.SOAPasteConfigImpl
INFO : [PLUGIN][SOA] May 7, 2018 8:01:47 AM - CLONE-51026 Executing "Pre-Paste
Configuration" operation of the SOA plugin.
INFO : [PLUGIN][SOA] May 7, 2018 8:01:47 AM - CLONE-51000 Is SOA Domain = true.
INFO : [PLUGIN][SOA] May 7, 2018 8:01:47 AM - CLONE-51004 SOA Oracle Home
Location is /temporary_location/t2p/MW/soa
INFO : May 7, 2018 8:02:12 AM - CLONE-23540 Starting Managed Server
soa_servername ...
INFO : May 7, 2018 8:04:36 AM - CLONE-23553 Managed Server soa_servername
started successfully.
May 07, 2018 8:06:37 AM
oracle.glcm.fmw.chghost.framework.plugin.impl.t2p.helper.T2PPasteConfigHelper
applyEachJ2EEPlugin
INFO: Invoking doPasteConfig of oracle.as.t2p.plugin.soa.impl.SOAPasteConfigImpl
INFO : [PLUGIN][SOA] DEBUG : System Flag 'ignoreErrors' is set to 'true'.
INFO : [PLUGIN][SOA] May 7, 2018 8:06:37 AM - CLONE-51027 Executing "Paste
Configuration" operation of the SOA plugin.
INFO : [PLUGIN][SOA] May 7, 2018 8:06:37 AM - CLONE-51028 Extracting soat2p
folder from archive.
INFO : [PLUGIN][SOA] May 7, 2018 8:06:37 AM - CLONE-51063 Importing SOA
configuration to MDS.
INFO : [PLUGIN][SOA] Stopping SOA Managed Server before HW Import
INFO : May 7, 2018 8:06:37 AM - CLONE-23541 Stopping Managed Server
soa_servername ...
INFO : May 7, 2018 8:07:18 AM - CLONE-23551 Managed Server soa_servername
stopped successfully.
INFO : [PLUGIN][SOA] Starting SOA Managed Server before HW Import
INFO : May 7, 2018 8:07:44 AM - CLONE-23540 Starting Managed Server
soa_servername ...
INFO : May 7, 2018 8:10:17 AM - CLONE-23553 Managed Server soa_servername
started successfully.
INFO : [PLUGIN][SOA] Starting SOA Managed Server Started
INFO : [PLUGIN][SOA] wait until soa infra is ready
INFO : [PLUGIN][SOA] import composites (HWF composites)
INFO : [PLUGIN][SOA] May 7, 2018 8:12:52 AM - CLONE-51031 Importing Human
WorkFlow Migration XML to target domain.
INFO : [PLUGIN][SOA] May 7, 2018 8:12:52 AM - CLONE-51049 Human WorkFlow MDS
data is not exported during "copyConfig".Human WorkFlow data will not be
migrated.
INFO : [PLUGIN][SOA] May 7, 2018 8:12:52 AM - CLONE-51039 Importing B2B Delivery
Channels to target domain.
INFO : [PLUGIN][SOA] May 7, 2018 8:12:52 AM - CLONE-51050 B2B is not deployed Or
B2B metadata is not exported during "copyConfig". So B2B metadata migration will
not be done.
May 07, 2018 8:12:52 AM
oracle.glcm.fmw.chghost.framework.plugin.impl.t2p.helper.T2PPasteConfigHelper
applyEachJ2EEPlugin
INFO: Invoking doPostPasteConfig of
oracle.as.t2p.plugin.soa.impl.SOAPasteConfigImpl
INFO : [PLUGIN][SOA] May 7, 2018 8:12:52 AM - CLONE-51024 Executing "Post-Paste
Configuration" operation of the SOA plugin.
INFO : [PLUGIN][SOA] Stopping SOA Managed Server
INFO : May 7, 2018 8:12:52 AM - CLONE-23541 Stopping Managed Server
soa_servername ...
INFO : May 7, 2018 8:13:38 AM - CLONE-23551 Managed Server soa_servername
stopped successfully.
May 07, 2018 8:13:38 AM
oracle.glcm.fmw.chghost.framework.plugin.impl.t2p.helper.T2PPasteConfigHelper
applyEachJ2EEPlugin
INFO: Execution of oracle.as.t2p.plugin.soa.impl.SOAPasteConfigImpl done.
May 07, 2018 8:13:38 AM
oracle.glcm.fmw.chghost.framework.plugin.impl.t2p.helper.T2PPasteConfigHelper

```

```

applyEachJ2EEPlugin
INFO: Executing
oracle.adf.t2p.plugins.adfconn.impl.ADFConnectionPasteConfigImpl ...
INFO : May 7, 2018 8:13:38 AM - CLONE-23270 Connecting to domain runtime ...
INFO : May 7, 2018 8:13:38 AM - CLONE-23271 Trying to connect to
localhost:7001 ...
INFO : May 7, 2018 8:13:38 AM - CLONE-23272 Successfully connected to the domain
Runtime.
INFO : May 7, 2018 8:13:38 AM - CLONE-23266 Connecting to runtime ...
INFO : May 7, 2018 8:13:38 AM - CLONE-23271 Trying to connect to
localhost:7001 ...
INFO : May 7, 2018 8:13:38 AM - CLONE-23269 Successfully connected to runtime.
May 07, 2018 8:13:38 AM
oracle.glcm.fmw.chghost.framework.plugin.impl.t2p.helper.T2PPasteConfigHelper
applyEachJ2EEPlugin
INFO: Invoking doPasteConfigValidation of
oracle.adf.t2p.plugins.adfconn.impl.ADFConnectionPasteConfigImpl
INFO : [PLUGIN][OracleADF] May 7, 2018 8:13:38 AM - CLONE-33010 Start to run T2P
ADF Connection Plugins.
May 07, 2018 8:13:38 AM
oracle.glcm.fmw.chghost.framework.plugin.impl.t2p.helper.T2PPasteConfigHelper
applyEachJ2EEPlugin
INFO: Invoking doPrePasteConfigValidation of
oracle.adf.t2p.plugins.adfconn.impl.ADFConnectionPasteConfigImpl
May 07, 2018 8:13:38 AM
oracle.glcm.fmw.chghost.framework.plugin.impl.t2p.helper.T2PPasteConfigHelper
applyEachJ2EEPlugin
INFO: Invoking doPasteConfig of
oracle.adf.t2p.plugins.adfconn.impl.ADFConnectionPasteConfigImpl
May 07, 2018 8:13:38 AM
oracle.glcm.fmw.chghost.framework.plugin.impl.t2p.helper.T2PPasteConfigHelper
applyEachJ2EEPlugin
INFO: Invoking doPostPasteConfig of
oracle.adf.t2p.plugins.adfconn.impl.ADFConnectionPasteConfigImpl
INFO : [PLUGIN][OracleADF] May 7, 2018 8:13:38 AM - CLONE-33020 Finish running
T2P ADF Connection Plugins.
May 07, 2018 8:13:38 AM
oracle.glcm.fmw.chghost.framework.plugin.impl.t2p.helper.T2PPasteConfigHelper
applyEachJ2EEPlugin
INFO: Execution of
oracle.adf.t2p.plugins.adfconn.impl.ADFConnectionPasteConfigImpl done.
May 07, 2018 8:13:38 AM
oracle.glcm.fmw.chghost.framework.plugin.impl.t2p.helper.T2PPasteConfigHelper
applyEachJ2EEPlugin
INFO: Executing oracle.as.ess.t2p.impl.ESST2PPluginPasteConfigImpl ...
INFO : May 7, 2018 8:13:38 AM - CLONE-23270 Connecting to domain runtime ...
INFO : May 7, 2018 8:13:38 AM - CLONE-23271 Trying to connect to
localhost:7001 ...
INFO : May 7, 2018 8:13:38 AM - CLONE-23272 Successfully connected to the domain
Runtime.
INFO : May 7, 2018 8:13:38 AM - CLONE-23266 Connecting to runtime ...
INFO : May 7, 2018 8:13:38 AM - CLONE-23271 Trying to connect to
localhost:7001 ...
INFO : May 7, 2018 8:13:38 AM - CLONE-23269 Successfully connected to runtime.
May 07, 2018 8:13:38 AM
oracle.glcm.fmw.chghost.framework.plugin.impl.t2p.helper.T2PPasteConfigHelper
applyEachJ2EEPlugin
INFO: Invoking doPasteConfigValidation of
oracle.as.ess.t2p.impl.ESST2PPluginPasteConfigImpl
INFO : [PLUGIN][ESS] May 7, 2018 8:13:38 AM - CLONE-29009 Executing "Paste
Config Validation" operation of the ESS plugin.
INFO : [PLUGIN][ESS] May 7, 2018 8:13:38 AM - CLONE-29000 Is ESS Domain = false.

```

```
INFO : [PLUGIN][ESS] May 7, 2018 8:13:38 AM - CLONE-29012 Not a valid ESS
Domain. Skipping ESS specific paste configuration steps.
May 07, 2018 8:13:38 AM
oracle.glcm.fmw.chghost.framework.plugin.impl.t2p.helper.T2PPasteConfigHelper
applyEachJ2EEPlugin
INFO: Invoking doPrePasteConfigValidation of
oracle.as.ess.t2p.impl.ESST2PPluginPasteConfigImpl
May 07, 2018 8:13:38 AM
oracle.glcm.fmw.chghost.framework.plugin.impl.t2p.helper.T2PPasteConfigHelper
applyEachJ2EEPlugin
INFO: Invoking doPasteConfig of
oracle.as.ess.t2p.impl.ESST2PPluginPasteConfigImpl
May 07, 2018 8:13:38 AM
oracle.glcm.fmw.chghost.framework.plugin.impl.t2p.helper.T2PPasteConfigHelper
applyEachJ2EEPlugin
INFO: Invoking doPostPasteConfig of
oracle.as.ess.t2p.impl.ESST2PPluginPasteConfigImpl
May 07, 2018 8:13:38 AM
oracle.glcm.fmw.chghost.framework.plugin.impl.t2p.helper.T2PPasteConfigHelper
applyEachJ2EEPlugin
INFO: Execution of oracle.as.ess.t2p.impl.ESST2PPluginPasteConfigImpl done.
May 07, 2018 8:13:38 AM
oracle.glcm.fmw.chghost.framework.plugin.impl.t2p.helper.T2PPasteConfigHelper
applyEachJ2EEPlugin
INFO: Executing oracle.beam.impexp.t2p.BAMPasteConfigImpl ...
INFO : May 7, 2018 8:13:38 AM - CLONE-23270 Connecting to domain runtime ...
INFO : May 7, 2018 8:13:38 AM - CLONE-23271 Trying to connect to
localhost:7001 ...
INFO : May 7, 2018 8:13:38 AM - CLONE-23272 Successfully connected to the domain
Runtime.
INFO : May 7, 2018 8:13:38 AM - CLONE-23266 Connecting to runtime ...
INFO : May 7, 2018 8:13:38 AM - CLONE-23271 Trying to connect to
localhost:7001 ...
INFO : May 7, 2018 8:13:38 AM - CLONE-23269 Successfully connected to runtime.
May 07, 2018 8:13:38 AM
oracle.glcm.fmw.chghost.framework.plugin.impl.t2p.helper.T2PPasteConfigHelper
applyEachJ2EEPlugin
INFO: Invoking doPasteConfigValidation of
oracle.beam.impexp.t2p.BAMPasteConfigImpl
May 07, 2018 8:13:38 AM
oracle.glcm.fmw.chghost.framework.plugin.impl.t2p.helper.T2PPasteConfigHelper
applyEachJ2EEPlugin
INFO: Invoking doPrePasteConfigValidation of
oracle.beam.impexp.t2p.BAMPasteConfigImpl
May 07, 2018 8:13:38 AM
oracle.glcm.fmw.chghost.framework.plugin.impl.t2p.helper.T2PPasteConfigHelper
applyEachJ2EEPlugin
INFO: Invoking doPasteConfig of oracle.beam.impexp.t2p.BAMPasteConfigImpl
May 07, 2018 8:13:38 AM
oracle.glcm.fmw.chghost.framework.plugin.impl.t2p.helper.T2PPasteConfigHelper
applyEachJ2EEPlugin
INFO: Invoking doPostPasteConfig of oracle.beam.impexp.t2p.BAMPasteConfigImpl
May 07, 2018 8:13:38 AM
oracle.glcm.fmw.chghost.framework.plugin.impl.t2p.helper.T2PPasteConfigHelper
applyEachJ2EEPlugin
INFO: Execution of oracle.beam.impexp.t2p.BAMPasteConfigImpl done.
May 07, 2018 8:13:38 AM
oracle.glcm.fmw.chghost.framework.plugin.impl.t2p.helper.T2PPasteConfigHelper
applyEachJ2EEPlugin
INFO: Executing oracle.ucsinternal.messaging.t2p.UmsPasteConfigImpl ...
INFO : May 7, 2018 8:13:38 AM - CLONE-23270 Connecting to domain runtime ...
INFO : May 7, 2018 8:13:38 AM - CLONE-23271 Trying to connect to
```

```

localhost:7001 ...
INFO : May 7, 2018 8:13:38 AM - CLONE-23272 Successfully connected to the domain
Runtime.
INFO : May 7, 2018 8:13:38 AM - CLONE-23266 Connecting to runtime ...
INFO : May 7, 2018 8:13:38 AM - CLONE-23271 Trying to connect to
localhost:7001 ...
INFO : May 7, 2018 8:13:38 AM - CLONE-23269 Successfully connected to runtime.
May 07, 2018 8:13:38 AM
oracle.glcm.fmw.chghost.framework.plugin.impl.t2p.helper.T2PPasteConfigHelper
applyEachJ2EEPlugin
INFO: Invoking doPasteConfigValidation of
oracle.ucsinternal.messaging.t2p.UmsPasteConfigImpl
INFO : [PLUGIN][ums] May 7, 2018 8:13:38 AM - CLONE-92103 In method
doPasteConfigValidation.
May 07, 2018 8:13:38 AM
oracle.glcm.fmw.chghost.framework.plugin.impl.t2p.helper.T2PPasteConfigHelper
applyEachJ2EEPlugin
INFO: Invoking doPrePasteConfigValidation of
oracle.ucsinternal.messaging.t2p.UmsPasteConfigImpl
INFO : [PLUGIN][ums] May 7, 2018 8:13:38 AM - CLONE-92104 In method
doPrePasteConfig.
May 07, 2018 8:13:38 AM
oracle.glcm.fmw.chghost.framework.plugin.impl.t2p.helper.T2PPasteConfigHelper
applyEachJ2EEPlugin
INFO: Invoking doPasteConfig of
oracle.ucsinternal.messaging.t2p.UmsPasteConfigImpl
INFO : [PLUGIN][ums] May 7, 2018 8:13:38 AM - CLONE-92105 In method
doPasteConfig.
INFO : [PLUGIN][ums] May 7, 2018 8:13:38 AM - CLONE-92119 Handle User
Preferences.
INFO : [PLUGIN][ums] May 7, 2018 8:13:38 AM - CLONE-92117 Starting server
soa_servername.
INFO : May 7, 2018 8:14:04 AM - CLONE-23540 Starting Managed Server
soa_servername ...
INFO : May 7, 2018 8:16:26 AM - CLONE-23553 Managed Server soa_servername
started successfully.
INFO : [PLUGIN][ums] May 7, 2018 8:18:30 AM - CLONE-92114 Upload data for User
Preferences.
INFO : [PLUGIN][ums] May 7, 2018 8:18:30 AM - CLONE-92118 Stopping server
soa_servername.
INFO : May 7, 2018 8:18:30 AM - CLONE-23541 Stopping Managed Server
soa_servername ...
INFO : May 7, 2018 8:19:11 AM - CLONE-23551 Managed Server soa_servername
stopped successfully.
May 07, 2018 8:19:11 AM
oracle.glcm.fmw.chghost.framework.plugin.impl.t2p.helper.T2PPasteConfigHelper
applyEachJ2EEPlugin
INFO: Invoking doPostPasteConfig of
oracle.ucsinternal.messaging.t2p.UmsPasteConfigImpl
INFO : [PLUGIN][ums] May 7, 2018 8:19:11 AM - CLONE-92106 In method
doPostPasteConfig.
May 07, 2018 8:19:11 AM
oracle.glcm.fmw.chghost.framework.plugin.impl.t2p.helper.T2PPasteConfigHelper
applyEachJ2EEPlugin
INFO: Execution of oracle.ucsinternal.messaging.t2p.UmsPasteConfigImpl done.
May 07, 2018 8:19:11 AM
oracle.glcm.fmw.chghost.framework.plugin.impl.t2p.helper.T2PPasteConfigHelper
applyAllJ2EEPlugins
INFO: - - - - - Execution of paste operation for all J2EE T2P plugin completed.
May 07, 2018 8:19:11 AM
oracle.glcm.fmw.chghost.framework.plugin.impl.t2p.helper.T2PPasteConfigHelper
executeT2PPluginsForPaste

```



```

INFO: Stopping all managed servers ...
INFO : May 7, 2018 8:19:11 AM - CLONE-23358 Stopping all Managed Servers.
INFO : May 7, 2018 8:19:11 AM - CLONE-23541 Stopping Managed Server
oim_servername ...
INFO : May 7, 2018 8:19:11 AM - CLONE-23270 Connecting to domain runtime ...
INFO : May 7, 2018 8:19:11 AM - CLONE-23271 Trying to connect to
localhost:7001 ...
INFO : May 7, 2018 8:19:11 AM - CLONE-23272 Successfully connected to the domain
Runtime.
INFO : May 7, 2018 8:19:11 AM - CLONE-23266 Connecting to runtime ...
INFO : May 7, 2018 8:19:11 AM - CLONE-23271 Trying to connect to
localhost:7001 ...
INFO : May 7, 2018 8:19:11 AM - CLONE-23269 Successfully connected to runtime.
INFO : May 7, 2018 8:19:11 AM - CLONE-23554 Managed Server oim_servername is
already in shut down state.
INFO : May 7, 2018 8:19:27 AM - CLONE-23541 Stopping Managed Server
soa_servername ...
INFO : May 7, 2018 8:19:27 AM - CLONE-23554 Managed Server soa_servername is
already in shut down state.
May 07, 2018 8:19:43 AM
oracle.glcm.fmw.chghost.framework.plugin.impl.t2p.helper.T2PCAMPasteConfigHelper
applyAllCAMPluginImpl
INFO: CopyConfig was not executed for any CAM T2P plugin. No CAM T2P plugin will
be executed during pasteConfig.
May 07, 2018 8:19:43 AM
oracle.glcm.fmw.chghost.framework.plugin.impl.t2p.helper.ServerLifeCycleHelper
enableOrDisableNetworkChannelForServersViaOnline
INFO: NetworkChannel is not configured. So nothing to enable
May 07, 2018 8:19:43 AM
oracle.glcm.fmw.chghost.framework.plugin.impl.t2p.T2PPluginExecutorImpl
executePasteConfig
INFO: Shutting down AdminServer ...
INFO : May 7, 2018 8:19:43 AM - CLONE-23539 Stopping Administration Server ...
INFO : May 7, 2018 8:21:45 AM - CLONE-23550 Administration Server stopped
successfully.
May 07, 2018 8:21:45 AM
oracle.glcm.fmw.chghost.framework.process.PluginExecution executeAllPlugins
INFO: Status of execution of T2P plugins true
May 07, 2018 8:21:45 AM
oracle.glcm.fmw.chghost.framework.execute.ChangeHostExecute execute
INFO: Chghost and T2P plugins are executed successfully.

```

3. On HOST1, stop all servers, which are WebLogic, SOA, and OIG servers.
4. On HOST2, restart the following servers:
  - a. Stop and start the WebLogic server by running the following command:

```
./startWeblogic.sh
```
  - b. Stop and start the SOA server by running the following command:

```
./StartManagedWeblogic.sh soa_servername
```
  - c. Stop and start the OIG server by running the following command:

```
./StartManagedWeblogic.sh oim_servername
```

## 22.1.2 Postconfiguration Changes on the Target Host

Postconfiguration changes on the target host includes SOA composite changes, WebLogic-level changes, and changes related to BI Publisher reports.

After migrating the database and application binaries from HOST1 to HOST2, perform the following postconfiguration changes:

1. On HOST2, after you restart WebLogic, SOA, and OIG servers, open the WebLogic Administration Server Console and Oracle Enterprise Manager Fusion Middleware Control. Examples URLs are:

```
http://<OIG_HOSTNAME>:7001/console
http://<OIG_HOSTNAME>:7001/em
```

2. Login to the Oracle Enterprise Manager Fusion Middleware Control, and perform the following SOA composite changes:

 **Note:**

This step is required to open the details of the in-flight/pending requests.

- a. Go to **soa, Soa-infrastructure, deployed composite**. Click **DefaultOperationalApproval [5.0]**, click the **Approval Task** link of component type `Human Workflow` under the Component Metrics section. Then click the **Administration** tab. If there is an existing URI, then modify the host name and port number.
- b. Go to **soa, Soa-infrastructure, deployed composite**. Click **DefaultOperationalApproval [5.0]**, click the **Challenge Task** link of component type `Human Workflow` under the Component Metrics section. Then click the **Administration** tab, and modify the host name and port number.
- c. Repeat steps a and b for all other SOA composites.

These steps are applicable for component type as `Human Workflow` under the Component Metrics heading in the SOA Composites details.

 **Note:**

Host and port details under the Administration tab are available for update only for composites that have been used for any types of requests at source setup. If these values are blank for any composite, then do not update anything.

3. Perform the following WebLogic-level changes so that your request details are rendered:
  - a. In the Oracle Enterprise Manager Fusion Middleware Control, click **Weblogic Domain, System Mbean Browser**.
  - b. Search for the **OIMSOAIntegrationMBean**
  - c. Click the **Operations** tab of the mbean, and select **integrateWithSOAServer**.
  - d. Enter the attributes required to invoke the mbean, and then click **Invoke**.

 **Note:**

Any in-flight tasks will try to use the original `oimFrontEndURL` value that was passed to the composite when the instance was created. If the move from HOST1 to HOST2 results in a changed `oimFrontEndURL` value, then update the endpoint addresses so that SOA can call back to OIG by using the new address as required, as described in [Updating EndPoint Address in SOA Composites](#).

4. Perform the following sanity checks on the HOST2 environment:
  - Request (administrator and end-user): For applications, entitlements, roles, self registration
  - Identity administration: For user, organization, role CRUD operations
  - Provisioning (connected and disconnected): Direct provisioning, access policies
  - Reconciliation
  - Certification
  - Identity audit
  - Reports
  - Design Console forms: Parent forms, child forms, prepopulate adapters added literal value, rebuild, process definitions (added table), resource objects
  - Deployment Manager
  - Utilities (db/server): UploadJar, PurcheCache, DeleteJar, resource bundler (upload, delete), GenerateSnapshot, request archival, reconciliation archival, task archival
  - Authorization
  - Bulk load: Users, user managers, roles, role members, accounts, and entitlements
  - Enterprise Manager: Export/import metadata, Mbean changes

### 22.1.3 Updating EndPoint Address in SOA Composites

SOA composites have Endpoint Address URL for Reference Web services. This can be a load balancer URL or Web server URL depending on whether the application server is front-end with load balancer, or Web server, or single application server URL. After running the `chghost` utility, perform the following steps to update this URL with the target system host values:

 **Note:**

Perform the steps in this topic only if there are in-flight requests in the source host before running the `chghost` utility, and you want to act upon these in-flight requests after running the utility.

1. Login to Oracle Enterprise Manager Fusion Middleware Control.
2. For a clustered deployment, ensure that at least one SOA server in the SOA cluster is running. On the left pane, navigate to **SOA, soa-infra(SOA\_SERVER\_NAME), default**.  
This displays a list of SOA composites.

3. Click the **DefaultRequestApproval** SOA composite.
4. In the Services and References section, click the **CallbackService\_2** link of Usage type **Reference**.
5. Click the **Properties** tab. Add the following URL in the `Endpoint Address` property, and then click **Apply**.

```
http://OHS_HOST:OHS_OIM_PORT/workflowservice/CallbackService
```

By default, this property value is empty.

6. Go back to the **DefaultRequestApproval** composite details page.
7. In the Services and References section, click the **RequestWSPartnerLink** link of the Usage type **Reference**.
8. Click the **Properties** tab. Add the following URL in the `Endpoint Address` property, and then click **Apply**.

```
http://OHS_HOST:OHS_OIM_PORT/workflowservice/RequestDataService
```

By default, this property value is empty.

9. Repeat steps 4 through 8 for the **DefaultOperationalApproval**, **ProvideInformation**, and **RoleLCMApproval** composites.
10. Repeat steps 4 and 5 for the **DefaultRoleApproval**, **AutoApproval**, **BeneficiaryManagerApproval**, **RequesterManagerApproval**, and **DefaultSODApproval** composites.
11. Go back to the **DefaultSODApproval** composite details page.
12. In the Services and References section, click the **SodCheckServicePortImplService** link of Usage type **Reference**.
13. Click the **Properties** tab. Add the following URL in the `Endpoint Address` property, and then click **Apply**.

```
http://OHS_HOST:OHS_OIM_PORT/workflowservice/SodCheckServicePortImplService
```

By default, this property value is empty.

14. Click the **OAACGRoleAssignSODCheck** SOA composite.
15. In the Services and References section, click the **RoleSODService** link of Usage type **Reference**.
16. Click the **Properties** tab. Add the following URL in the `Endpoint Address` property, and then click **Apply**.

```
http://OHS_HOST:OHS_OIM_PORT/workflowservice/OAACGRoleSODService
```

By default, this property value is empty.

17. Click the **IdentityAuditRemediation** SOA composite.
18. In the Services and References section, click the **IdentityAuditWSPartnerLink** link of Usage type **Reference**.
19. Click the **Properties** tab. Add the following URL in the `Endpoint Address` property, and then click **Apply**.

```
http://OHS_HOST:OHS_OIM_PORT/workflowservice/IdentityAuditCallbackService
```

By default, this property value is empty.

20. Click the **DisconnectedProvisioning** SOA composite.
21. In the Services and References section, click the **ProvisioningCallbackService** link of the Usage type **Reference**.
22. Click the **Properties** tab. Add the following URL in the `Endpoint Address` property, and then click **Apply**.

```
http://OHS_HOST:OHS_OIM_PORT/provisioning-callback/ProvisioningCallbackService
```

By default, this property value is empty.

23. Click the **CertificationProcess** SOA composite.
24. In the Services and References section, click the **CertificationWSPartnerLink** link of Usage type **Reference**.
25. Click the **Properties** tab. Add the following URL in the `Endpoint Address` property, and then click **Apply**.

```
http://OHS_HOST:OHS_OIM_PORT/workflowservice/CertificationCallbackService
```

By default, this property value is empty.

26. Repeat steps 24 and 25 for the **CertificationOverseerProcess** composite.

## 22.2 Migrating the Database and Application Binaries to a New Host

Migrate the database to the different host, and wire the application with the database that is moved to the new host. Alternatively, migrate both the database and application to the new host.

This chapter contains the following topics:

- [Moving the Database to Another Environment](#)
- [Postconfiguration Changes on the Target Environment](#)

### 22.2.1 Moving the Database to Another Environment

To move the database to another environment:

1. Perform the following steps on the source host, which is HOST1:
  - a. Set environment variables for `ORACLE_HOME`, `ORACLE_SID`, and `PATH` to include oracle executables. For example:

```
setenv PATH /temporary_location2/product/11.2.0/dbhome_1/bin:$PATH
setenv ORACLE_SID orcl
setenv ORACLE_HOME /temporary_location2/product/11.2.0/dbhome_1/
```

- b. Create a directory to store the dump files. For example:

```
mkdir /temporary_location2/t2ps
```

- c. Login to SQLPlus with `SYS` credentials, and run the following command:

```
Sql> conn sys/<Password>@<SID>as sysdba;
Connected
Sql> create directory t2ps_dir as '/temporary_location2/t2ps';
```

- d. Verify that the directory has been created by running the following SQL query:

```
select * from dba_directories;
Grant :
grant read,write on directory t2ps1 to sys;
Grant succeeded.
```

- e. To display all the PREFIX\_\* schemas, run the following command:

```
select * from System.SCHEMA_VERSION_REGISTRY$;
```

- f. Run the following command:

```
$ORACLE_DB_HOME > expdp
SCHEMAS=PREFIX_IAU_APPEND,PREFIX_STB,PREFIX_IAU_VIEWER,PREFIX_MDS,PREFIX_WLS,PREF
IX_UMS,PREFIX_IAU,PREFIX_OPSS,PREFIX_SOAINFRA,PREFIX_OIM DIRECTORY=t2ps1
DUMPFILE=t2ps.dmp PARALLEL=4 LOGFILE=export.log JOB_NAME=OIMBDDUMP
EXCLUDE=STATISTICS
```

The last three lines of the output are:

```
Dump file set for SYS.OIMBDDUMP is:
/temporary_location/t2p/t2ps1/t2ps.dmp
Job "SYS"."OIMBDDUMP" successfully completed at Wed May 16 03:01:33 2018 elapsed
0 00:02:12
```

2. Perform the following steps on the target host, which is HOST2:

- Install the database. Provide the same port and service name as the source host.
- Run the RCU utility. Create the tablespace with the same name as was done for the source host.
- Copy all the dump files to the target environment.
- Set the ORACLE\_HOME, PATH, and ORACLE\_SID environment variables.
- Create a dump directory on the target env. For example:

```
mkdir /temporary_location/t2p/t2ps1
```

- Create a directory t2ps1 in the location /temporary\_location/t2p/, and grant read and write permissions to t2ps1.
- Run the following SQL block:

```
sqlplus /nolog
Sql > conn PREFIX_OIM/<Password>@<SID>
Connected
Sql >
BEGIN
for s in (select object_type,object_name from user_objects
where object_type not in('TABLE','LOB', 'INDEX','TYPE')
and not (( object_name = 'OIM_RECON_CHANGES_BY_RES_MV'
and object_type = 'MATERIALIZED VIEW' )
or ( object_name = 'OIM_AFTERLOGON_TRIGGER'
and object_type = 'TRIGGER' )) )
loop
BEGIN
dbms_output.put_line('Drop '|| s.object_type ||' '|| s.object_name);
execute immediate 'Drop '|| s.object_type ||' '|| s.object_name ;

EXCEPTION
WHEN OTHERS THEN
dbms_output.put_line(SQLERRM);
END;
```

```
end loop;
END;
```

- h.** For mapping database tablespace structures, run the following command:

```
select * from dba_tablespaces;
```

- i.** Run the `impdp` command, which has the following syntax:

```
impdp system/password DIRECTORY=dump_dir DUMPFILE=export.dmp
LOGFILE=import.log remap_schema=src_env_schema_name:tgt_env_schema_name
REMAP_TABLESPACE=src_env_oim_tablespace:tgt_env_oim_tablespace,
src_oim_lob_tablespace_name:tgt_oim_lob_tablespace_name, ...
TABLE_EXISTS_ACTION=REPLACE
```

For example:

```
impdp DIRECTORY=t2ps1 DUMPFILE=t2ps.dmp LOGFILE=import.log
remap_schema=t2ps_OIM:t2ps_OIM
REMAP_TABLESPACE=t2ps_OIM:t2ps_OIM,t2ps_OIM_LOB:t2ps_OIM_LOB
TABLE_EXISTS_ACTION=REPLACE
```

Here, both source and target environment schemas are the same.

During the import, you may see the following errors, which can be ignored:

```
Processing object type SCHEMA_EXPORT/EVENT/TRIGGER
ORA-39083: Object type TRIGGER failed to create with error:
ORA-00942: table or view does not exist
Failing sql is:
CREATE TRIGGER oim_afterlogon_trigger
AFTER LOGON ON RC2T2P_OIM.SCHEMA
BEGIN
EXECUTE IMMEDIATE 'ALTER SESSION SET NLS_LENGTH_SEMANTICS=CHAR';
9EXECUTE IMMEDIATE 'ALTER SESSION SET NLS_SORT=BINARY NLS_COMP=BINARY';
EXCEPTION
WHEN OTHERS THEN
RAISE ;
END set_nlslengthsemantics_trigger;
Processing object type SCHEMA_EXPORT/MATERIALIZED_VIEW
ORA-31684: Object type
MATERIALIZED_VIEW:"RC2TARG_OIM"."OIM_RECON_CHANGES_BY_RES_MV" already exists
```

Any other errors concerning objects that already exist.

- j.** Update the following XML files for the database service name as these are not updated by the script:

```
bip_datasource-jdbc.xml = Not available in my setup
//Update the bip_datasource-jdbc.xml only if BI Publisher is configured in the
OIG setup.
opss-audit-jdbc.xml = ./user_projects/domains/domain_name/config/jdbc/opss-audit-
jdbc.xml
EDNDataSource-jdbc.xml = ./user_projects/domains/domain_name/config/jdbc/
EDNDataSource-jdbc.xml
SOALocalTxDataSource-jdbc.xml = ./user_projects/domains/domain_name/config/jdbc/
SOALocalTxDataSource-jdbc.xml
OraSDPMDDataSource-jdbc.xml = ./user_projects/domains/domain_name/config/jdbc/
OraSDPMDDataSource-jdbc.xml
EDNLocalTxDataSource-jdbc.xml = ./user_projects/domains/domain_name/config/jdbc/
EDNLocalTxDataSource-jdbc.xml
opss-auditview-jdbc.xml = ./user_projects/domains/domain_name/config/jdbc/opss-
auditview-jdbc.xml
opss-jdbc.xml = Not available on my machine
mds-soa-jdbc.xml = ./user_projects/domains/domain_name/config/jdbc/mds-soa-
```

```

jdbc.xml
oimApplicationDBDS-jdbc.xml = ./user_projects/domains/domain_name/config/jdbc/
oimApplicationDBDS-jdbc.xml
mds-owsm-jdbc.xml = ./user_projects/domains/domain_name/config/jdbc/mds-owsm-
jdbc.xml
LocalSvcTblDataSource-jdbc.xml = ./user_projects/domains/domain_name/config/jdbc/
LocalSvcTblDataSource-jdbc.xml
opss-datasource-jdbc.xml = ./user_projects/domains/domain_name/config/jdbc/opss-
datasource-jdbc.xml
WLSSchemaDataSource-jdbc.xml = ./user_projects/domains/domain_name/config/jdbc/
WLSSchemaDataSource-jdbc.xml
oimMDS-jdbc.xml = ./user_projects/domains/domain_name/config/jdbc/oimMDS-jdbc.xml
soaOIMLookupDB-jdbc.xml = ./user_projects/domains/domain_name/config/jdbc/
soaOIMLookupDB-jdbc.xml
oimOperationsDB-0237-jdbc.xml = ./user_projects/domains/domain_name/config/jdbc/
oimOperationsDB-0237-jdbc.xml
SOADatasource-jdbc.xml = ./user_projects/domains/domain_name/config/jdbc/
SOADatasource-jdbc.xml
oimJMSStoreDS-0269-jdbc.xml = ./user_projects/domains/domain_name/config/jdbc/
oimJMSStoreDS-0269-jdbc.xml
jps-config-jse.xml =
./oracle_common/modules/oracle.jps/domain_config/restricted_jrf/wls/jps-config-
jse.xml
./user_projects/domains/domain_name/config/fmwconfig/jps-config-jse.xml
jps-config.xml =
./idm/oam/server/rreg/config/jps-config.xml
./idm/server/setup/templates/wls/jps-config.xml
./idm/server/setup/templates/was/jps-config.xml
./idm/server/setup/templates/jps-config.xml
./idm/server/apps/oim.ear/META-INF/jps-config.xml
./oracle_common/ess/extensibility_scripts/Fusion/Template_UI/src/META-INF/jps-
config.xml
./oracle_common/ess/extensibility_scripts/Fusion/Template_Hosting/src/META-INF/
jps-config.xml
./oracle_common/modules/oracle.jps/domain_config/wls/jps-config.xml
./oracle_common/modules/oracle.jps/domain_config/restricted_jrf/wls/jps-
config.xml
./oracle_common/modules/oracle.jps/domain_config/jse/jps-config.xml
./user_projects/domains/domain_name/config/fmwconfig/jps-config.xml
./user_projects/domains/domain_name/servers/soa_servername/temporary_location/
_WL_user/usermessagingserver/lbg1rl/META-INF/jps-config.xml
./user_projects/domains/domain_name/servers/soa_servername/dc/
soa_5c9049b6-916a-4192-b7cc-f0446713e1da/SCA-INF/classes/META-INF/jps-config.xml
./user_projects/domains/domain_name/servers/soa_servername/dc/
soa_3bf84b5c-2faa-420f-add2-fa9f9abbb7ed/SCA-INF/classes/META-INF/jps-config.xml
./user_projects/domains/domain_name/servers/soa_servername/dc/soa_fe9d8539-
d6cc-4513-99c2-de03783feb67/SCA-INF/classes/META-INF/jps-config.xml
./user_projects/domains/domain_name/servers/soa_servername/dc/soa_c02a0b49-
bf9a-4ab0-baaa-298706bd593d/SCA-INF/classes/META-INF/jps-config.xml
./user_projects/domains/domain_name/servers/AdminServer/temporary_location/
_WL_user/em/hsz5x1/adf/META-INF/jps-config.xml

```

3. Perform the steps for wiring OIG applications to the database schemas as described in *OIM 12c: Schema Backup and Restoration using Data Pump Client Utility (Doc ID 2584066.1)* at <https://support.oracle.com>.

## 22.2.2 Postconfiguration Changes on the Target Environment

Perform the following schema password and MBean configuration steps on the target environment, which is HOST2:



1. Login to Oracle Enterprise Manager Fusion Middleware Control by navigating to the following URL:  
`http://HOST_NAME:WEBLOGIC_ADMINCONSOLE_PORT/em`
2. Edit the data sources. See section 'OIM 12c Mid-Tier side JDBC Connection Configuration' of the KM note *OIM 12c: Schema Backup and Restoration using Data Pump Client Utility (Doc ID 2584066.1)* at My Oracle Support website:  
<https://support.oracle.com>
3. Go to **Security, Credentials**.
4. Edit the `OIMSchemaPassword` attribute if there is a change in the OIG schema password.
5. Perform the following MBean configuration changes:
  - a. Go to the **System MBean Browser, Configuration MBeans, Security, myrealm, OIMAuthenticationProvider, Attributes**.
  - b. Edit the `DBUrl` and `DBUser` attributes for connection-related information.
  - c. Go to the **System MBean Browser, Application Defined MBeans, oracle.iam, Server: *oim\_servername*, XML Config, DirectDB**.
  - d. Click the **Attributes** tab, and edit the `Url` and `UserName` attributes for connection-related information.
  - e. Restart the SOA and OIM Managed Servers.
  - f. Connect to the OIG application by logging in to the Identity Self Service and Identity System Administration interfaces.
  - g. Perform the sanity test cases.
6. If OHS is configured, update the OHS logout URL for a OAM-OIG integrated setup. To do so:
  - a. In a text editor, open the `DOMAIN_HOME/config/fmwconfig/jps-config.xml` file.
  - b. Search for the following line:  

```
<property name="logout.url" value="https://SOURCE_HOST:PORT/oam/server/logout?end_url=https://:/identity"/>
```
  - c. Update the source host value to target host value, as shown:  

```
<property name="logout.url" value="https://TARGET_HOST:PORT/oam/server/logout?end_url=https://:/identity"/>
```
  - d. Save the `jps-config.xml` file.

# Part VIII

## Auditing and Reporting

Auditing and reporting comprises of configuring audit and using various categories of reports, and using the archival and purge utilities for controlling data growth.

This part describes auditing and reporting features of Oracle Identity Manager. It contains the following chapters:

- [Configuring Auditing](#)
- [Using Reporting Features](#)
- [Using the Archival and Purge Utilities for Controlling Data Growth](#)
- [Using the Offline Data Purge Framework](#)
- [Using the Complete Nuke Cleanup Utility](#)

## Using the Offline Data Purge Framework

Oracle Identity Governance provides a new Offline Data Purge Framework to purge huge data sets in a few iterations and reclaim huge storage space with the same operation.

Oracle Identity Governance has been providing real-time and continuous data purge solution to meet the standards of performance and scalability by maintaining the data generated for the life cycle management of various entities. However, there is a need for an Offline Data Purge Framework to purge huge data sets in few iterations, and also reclaim huge storage space with the same operation.

This chapter contains the following sections:

- [About the Offline Data Purge Framework](#)
- [Prerequisites for Running the Offline Data Purge Framework](#)
- [Configuring and Running the Offline Data Purge Operation](#)

## About the Offline Data Purge Framework

The Offline Data Purge Framework helps to purge huge volume of data sets in fewer iterations.

Using the Offline Data Purge Framework, you can purge non-purgeable data, for example, data that is in In-Progress status for Oracle Identity Governance entities such as Reconciliation, Provisioning Task, and Orchestration.

Oracle recommends using this framework in the following situations:

- When you have not executed the default Online Data Purge scheduled task, and accumulated huge volume of purgeable data
- When you want to purge non-purgeable data for Oracle Identity Governance entities: reconciliation, provisioning task, and orchestration
- When you want to run the default scheduled task for online data purge, but the volume of purgeable data is exceptionally high

- When you want to purge all data for Oracle Identity Governance entities, reconciliation, provisioning task, and orchestration, based on retention period

Some of the key features of the Offline Data Purge Framework are:

- The Offline Data Purge Framework is disabled in Oracle Identity Governance by default.
- The Create Table As Select (CTAS) approach is used to purge data and also auto-reclaims storage space for the purged data set.
- The Offline Data Purge Framework supports data purge based on Oracle Identity Governance entity type, purge criteria, and purge retention period.
- The [Table 16](#) lists the purge criteria (based on purge retention period) that are supported for the Oracle Identity Governance entities.

**Table 16 Supported Purge Criteria for Oracle Identity Governance Entities**

Entity	Purgeable Events	Non-Purgeable Events	All Data
<b>Reconciliation</b>	Event Closed, Creation Succeeded, Update Succeeded, and Delete Succeeded	ALL events except the Purgeable Events	Yes (based on retention period)
<b>Provisioning Task</b>	Completed and Cancelled	NA	NA
<b>Orchestration</b>	Completed, Failed, Cancelled, Compensated, and Cancelled_With_Compensation	ALL events except the Purgeable Events	Yes (based on retention period)

- You can perform the offline data purge operation by running the Oracle DBMS scheduler job.
- The Offline Data Purge Framework uses the existing PL/SQL diagnostic logging and debugging framework to track the progress of the offline data purge operation.
- The summary and detailed information for the offline data purge operation is captured in two separate diagnostic logging tables, DIAG\_LOG and DIAG\_LOG\_DTLS.

## Prerequisites for Running the Offline Data Purge Framework

The following prerequisites must be met before running the offline data purge operation:

- Before running the offline data purge operation, create a backup of the data to be purged.
- Ensure that you do not have a business use for the data identified for purging in the mainstream Oracle Identity Governance operations.
- It is recommended to have sufficient space in OIM, UNDO, and TEMP tablespaces. To calculate extra space required in these tablespaces:
  - Calculate the cumulative size of the tables from which data is required to be purged. The tables are:
    - \* For orchestration: ORCHPROCESS
    - \* For provisioning task: OSI, OSH, SCH, OTI

- \* For reconciliation: RA\_XELLERATE\_ORG, RA\_LDAPROLEHIERARCHY, RA\_LDAPROLEMEMBERSHIP, RA\_MLS\_LDAPROLE, RA\_LDAPROLE, RA\_MLS\_LDAPUSER, RA\_LDAPUSER, RECON\_ROLE\_MEMBER\_MATCH, RECON\_ROLE\_HIERARCHY\_MATCH, RECON\_ROLE\_MATCH, RECON\_ORG\_MATCH, RECON\_CHILD\_MATCH, RECON\_ACCOUNT\_MATCH, RECON\_USER\_MATCH, RECON\_HISTORY, RECON\_EVENT\_ASSIGNMENT, RECON\_BATCHES, RECON\_JOBS, RECON\_EVENTS, and other RA\_\* tables
- Based on the result of the previous step, double the size can be allocated to OIM tablespace. The UNDO and TEMP tablespaces require lesser space than the OIM tablespace.
- Make sure to collect latest statistics for OIM database schema.
- Ensure that Oracle Identity Governance server is down during the purge operation.
- It is recommended to perform the offline data purge operation in a lower environment with representative data and similar configurable Oracle DBMS scheduled job parameters, to get an idea about how much downtime would be required in production environment beforehand.
- Enable diagnostic logging during the offline data purge operation, by setting the diagnostic level as the value of the `OIM.DBDiagnosticLevelOffPurge` system property. See [Default System Properties in Oracle Identity Governance](#) for information about this system property.

After the diagnostic data is collected, reset the value of the system properties from `FINISH` to the default value of `NONE`. See [Editing System Properties](#) for information about modifying the values of system properties.

## Configuring and Running the Offline Data Purge Operation

To run the offline data purge operation:



### Note:

Before beginning the configuration, ensure that all the prerequisites are met.

1. Login to Oracle Identity Governance Database schema by using SQLPLUS shell, SQL Developer, or any other interface tool.
2. Configure the `OIM_OFFLINE_DATAPURGE` Oracle DBMS scheduled job.

[Table 17](#) lists the configurable parameters of the `OIM_OFFLINE_DATAPURGE` Oracle DBMS scheduled job.

**Table 17 Configuration Parameters for OIM\_OFFLINE\_DATAPURGE DBMS Scheduled Job**

Parameter	Description	Default Value
OIG Entity	This takes the following values: <ul style="list-style-type: none"> <li>• 1 for orchestration</li> <li>• 2 for provisioning task</li> <li>• 3 for reconciliation</li> </ul>	NULL

**Table 17 (Cont.) Configuration Parameters for OIM\_OFFLINE\_DATAPURGE DBMS Scheduled Job**

Parameter	Description	Default Value
<b>Recon Entity</b>		
Purge Criteria	This takes the following values: <ul style="list-style-type: none"> <li>• 1 for purging purgeable events</li> <li>• 2 for purging non-purgeable events</li> <li>• 3 for all data</li> </ul>	NULL
Purge Retention period (in days)	This indicates the retention period in days for the purge. Based on the value <code>recon_events.re_create</code> .	NULL
<b>Orchestration Entity</b>		
Purge Criteria	This takes the following values: <ul style="list-style-type: none"> <li>• 1 for purging purgeable events</li> <li>• 2 for purging non-purgeable events</li> <li>• 3 for all data</li> </ul>	NULL
Purge Retention period (in days)	This indicates the retention period in days for the purge. Based on the value <code>orchprocess.modifiedon</code> .	NULL
<b>Prov Task Entity</b>		
Purge Criteria	This takes the following values: <ul style="list-style-type: none"> <li>• 1 OR 2 OR 3 for purging purgeable/non-purgeable/All data events</li> </ul>	NULL
Purge Retention period (in days)	This indicates the retention period in days for the purge. Based on the value <code>'sch.sch_create</code> .	NULL

a. Replace the following attributes of the Oracle DBMS scheduled job with desired values by using the following syntax:

- `<OIM_ENTITY>`: OIG entity type (1,2, or 3)
- `<PURGE_CRITERIA>`: Purge criteria (1,2, or 3)
- `<RETENTION_PERIOD>`: Retention period (in days)

```
SQL> BEGIN dbms_scheduler.set_attribute( name =>
'OIM_OFFLINE_DATAPURGE', attribute => 'job_action', value => '
BEGIN
oim_pkg_offline_datapurge.oim_sp_offline_dataprg_wrapper(p_oim_entity
=> <OIM_ENTITY>, p_purge_criteria => <PURGE_CRITERIA>,
p_retention_period => <RETENTION_PERIOD>);
END;'
);
END;
/
```

For example, in the following scenario, all the non-purgeable data for orchestration entity type that is older than 365 days is purged from the database.

```
SQL> BEGIN
      dbms_scheduler.set_attribute
      (
        name => 'OIM_OFFLINE_DATAPURGE',
        attribute => 'job_action',
        value => 'BEGIN
oim_pkg_offline_datapurge.oim_sp_offline_dataprg_wrapper(p_oim_entity
=> 1, p_purge_criteria => 1, p_retention_period => 365); END;'
      );
      END;
      /
```

- b. Run the following SQL command to run the Oracle DBMS scheduled job:

```
SQL> EXEC dbms_scheduler.run_job('OIM_OFFLINE_DATAPURGE');
```

- c. Run the following SQL command to track the purge operation progress by using the existing PL/SQL diagnostic logging and debugging tables:

```
SQL> SELECT * FROM diag_log ORDER BY 1 DESC;
SQL> SELECT * FROM diag_log_dtls ORDER BY 2 DESC, 1;
```

After successful completion of the offline data purge operation:

- The active database tables show only the data that needs to be retained after the purge operation.
- The parameter value of the OIM\_OFFLINE\_DATAPURGE DBMS scheduled job is reset to NULL.

#### See Also:

- [Understanding the Data Captured by PL/SQL Diagnostic Logging Tables](#) for information about how data is captured by PL/SQL diagnostic logging tables.
- [Collecting Data Captured by PL/SQL Diagnostic Logging Tables](#) for information about how the diagnostic data is collected during the offline data purging operation.

## Using the Complete Nuke Cleanup Utility

Oracle Identity Governance provides a new data cleanup utility to purge huge data and reclaim large storage space with the same operation in the non-production environment.

Oracle Identity Governance has been providing real-time and continuous data purge solution to meet the standards of performance and scalability by maintaining the data generated for the life cycle management of various entities. However, there is a need for a complete data cleanup utility to purge huge data for reconciliation, certification, legacy audit, orchestration, and provisioning task entities, and also reclaim huge storage space with the same operation in the non-production environment.

This chapter contains the following topics:

- [About Complete Nuke Cleanup Utility](#)
- [Prerequisites for Running the Complete Nuke Cleanup Utility](#)
- [Running the Complete Nuke Cleanup Utility](#)

## About Complete Nuke Cleanup Utility

The Complete Data Cleanup Utility helps to purge huge volume data sets in non-production environments.

Using the Complete Data Cleanup Utility, you can purge data of Oracle Identity Governance entities, such as reconciliation, provisioning task, certification, audit legacy, and orchestration in the non-production environment.

Oracle recommends using the Complete Data Cleanup Utility when you have to completely remove the data of all or any of the entities, such as reconciliation, provisioning task, certification, audit legacy, and orchestration.

Some of the key features of the Complete Data Cleanup Utility are:

- The Complete Data Cleanup Utility supports data purge based on Oracle Identity Governance entity type.
- The Truncate Table approach is used to purge data. Also, storage space for the purged data set is automatically reclaimed.
- You can perform the complete nuke cleanup operation by using the PL/SQL block.
- The logging of the Complete Data Cleanup Utility is disabled in Oracle Identity Governance by default.
- The Complete Data Cleanup Utility uses the existing PL/SQL diagnostic logging and debugging framework to track the progress of the cleanup operation.
- The summary and detailed information for the complete nuke cleanup operation is captured in two separate diagnostic logging tables, DIAG\_LOG and DIAG\_LOG\_DTLS.
- If an error is encountered during the execution of complete nuke cleanup, then rectify the error and retry. If the environment is required immediately, then restore the schema from the backup.

## Prerequisites for Running the Complete Nuke Cleanup Utility

The following prerequisites must be met before running the Complete Nuke Cleanup Utility operation:

- Before running the complete nuke cleanup operation, create a backup of the tables to be purged.
- Ensure that you do not have a business use for the data identified for purging in the mainstream Oracle Identity Governance operations.
- Make sure to collect latest statistics for Oracle Identity Governance database schema.
- Ensure that Oracle Identity Governance server is down during the purge operation.
- Make sure to perform the complete nuke cleanup operation only in the non-production environment.

- Enable diagnostic logging during the complete nuke cleanup operation by setting the diagnostic level to `FINEST` as the value of the `OIM.DBDiagnosticLevelDataTrunc` system property. See [Default System Properties in Oracle Identity Governance](#) for information about this system property.

After the diagnostic data is collected, reset the values of the system properties from `FINEST` to the default value of `NONE`. See [Editing System Properties](#) for information about modifying the values of system properties.

## Running the Complete Nuke Cleanup Utility

To run the Complete Nuke Cleanup Utility:



### Note:

Before running the complete nuke cleanup, start the diagnostic logging.

1. Login to Oracle Identity Governance Database schema by using SQLPLUS shell, SQL Developer, or any other interface tool.
2. To run the complete nuke cleanup for reconciliation entities, execute the below code block:

```
declare
    v_err_code number;
    v_err_msg  varchar2(4000);
begin
    OIM_PKG_DATA_TRUNCATE.ReconDataTruncate(v_err_code,v_err_msg);
    dbms_output.put_line(v_err_code);
    dbms_output.put_line(v_err_msg);
end;
```

To run the cleanup for other entities, replace `OIM_PKG_DATA_TRUNCATE.ReconDataTruncate` with:

- `OIM_PKG_DATA_TRUNCATE.OrchestrationDataTruncate` for orchestration
- `OIM_PKG_DATA_TRUNCATE.ProvDataTruncate` for provisioning
- `OIM_PKG_DATA_TRUNCATE.ReconDataTruncate` for reconciliation
- `OIM_PKG_DATA_TRUNCATE.CertDataTruncate` for certification
- `OIM_PKG_DATA_TRUNCATE.AudDataTruncate` for legacy audit

Check whether the objects related to the purged entity are valid after successful completion of the complete nuke cleanup operation. If the objects are invalid, then check the log and contact Oracle Support with the logs.



 **See Also:**

- [Understanding the Data Captured by PL/SQL Diagnostic Logging Tables](#) for information about how data is captured by PL/SQL diagnostic logging tables.
- [Collecting Data Captured by PL/SQL Diagnostic Logging Tables](#) for information about how the diagnostic data is collected during the complete nuke cleanup operation.

# 23

## Configuring Auditing

You can configure profile auditing, which includes audit for user profile, role profile, and catalog. Otherwise, you can use lightweight audit. This chapter describes about auditing in Oracle Identity Governance and compressing user profile audit data. It contains the following sections:

- [About Auditing](#)
- [User Profile Auditing](#)
- [Role Profile Auditing](#)
- [Catalog Auditing](#)
- [Enabling and Disabling Auditing in Oracle Identity Governance](#)
- [Lightweight Audit](#)

### 23.1 About Auditing

Oracle Identity Manager provides an audit engine to collect extensive data for audit and compliance purposes. You can use the audit functionality to capture, archive, and view entity and transactional data for compliance monitoring and IT-centric processes and forensic auditing.

Oracle Identity Manager provides auditing and historical archiving of profile information. It takes a snapshot of a profile, stores the snapshot in an audit table in the database, and updates the snapshot each time the profile data changes. In the context of profile auditing, the term snapshot means a copy taken of the entire profile data at any instant when the data is modified.

### 23.2 User Profile Auditing

Understand the data collected, post processor and tables used for user profile auditing, and archiving and compressing user profile audit data.

This section discusses the following topics:

- [Data Collected for User Profile Audits](#)
- [Post-Processor Used for User Profile Auditing](#)
- [Tables Used for User Profile Auditing](#)
- [Archiving User Profile Audit Data](#)
- [#unique\\_438](#)

#### 23.2.1 Data Collected for User Profile Audits

Data collected for user profile audits involves setting the supported audit levels, capture of user profile audit data, storage of snapshots for user profile audit, and trigger for taking snapshots for user profile audit.

This section discusses about how data is collected for user profile audits in the following topics:

- [About Data Collected for User Profile Audits](#)
- [Capture of User Profile Audit Data](#)
- [Storage of Snapshots for User Profile Audit](#)
- [Trigger for Taking Snapshots for User Profile Audit](#)

### 23.2.1.1 About Data Collected for User Profile Audits

By default, user profile auditing is enabled and the auditing level is set to Resource Form when you install Oracle Identity Manager. This auditing level specifies the minimum level required for attestation of form data.

You configure the audit level in the System Configuration part of the Advanced Administration by using the `XL.UserProfileAuditDataCollection` system property.



#### See Also:

[Default System Properties in Oracle Identity Governance](#) for information about the `XL.UserProfileAuditDataCollection` system property

The supported audit levels are:

- **Process Task:** Audits the entire user profile snapshot together with the resource lifecycle process.
- **Resource Form:** Audits user record, role membership, resource provisioned, and any form data associated to the resource.
- **Resource:** Audits the user record, role membership, and resource provisioning.
- **Membership:** Only audits the user record and role membership.
- **Core:** Only audits the user record.
- **None:** No audit is stored.

### 23.2.1.2 Capture of User Profile Audit Data

Each time a user profile changes, Oracle Identity Manager takes a snapshot of the user profile and stores the snapshot in an audit table in the database.

A snapshot is also generated when there is a change in a user profile that must be audited, even if an initial snapshot is missing. The current snapshot is treated as the initial snapshot.

The following are the components of a user profile and the tables that store these components:

- **User Record:** Contains the `USR` table, including all User Defined Fields (UDFs).  
The `USR` table stores user attributes. When you create a user, Oracle Identity Manager adds an entry to this table.
- **User Role Membership:** Contains the `UGP` table.  
The `UGP_USER_MEMBERSHIP_RULE` column of the `UGP` table stores the user role membership rule.

Role Manager API method *SearchRule getUserMembershipRule(String roleKey)* can be used to retrieve the user membership rule from UGP table.

For more information about Role Manager APIs, see [Java API Reference for Oracle Identity Manager](#).

- **Admin Role Membership:** Contains the ARM\_AUD table.  
The ARM\_AUD table defines the membership ID, admin role ID, user ID, organization, hierarchy, action, and logged-in user.
- **User Policy Profile:** Contains the following tables:
  - **UPD:** Stores User Policy Profile data. This is a policy-centric view of the resources that are provisioned to a user.
  - **UPP:** Stores User Policy Profile-related details. This is a user-centric view of all the applicable policies for a user, and the resources they allow/deny.

 **Note:**

When you change a role name by using Oracle Identity Self Service, the User Profile Audit (UPA) tables in the database are not updated with the change until the next snapshot of the user.

- **User Resource Profile:** This component can be divided into the following subcomponents:
  - **User Resource Instance:** Contains the OBI, OBJ, and OIU tables, as listed in [Table 23-1](#).

**Table 23-1 User Resource Instance Tables**

Table Name	Description
OBI	Stores resource (object) instance information. Oracle Identity Manager creates a resource instance every time a resource is provisioned. This instance stores all generic information related to that provisioned instance, including a request key (if the resource has been provisioned through a request), the corresponding process instance, and the instance status.
OBJ	Represents the resource object data, including details about the resource, such as resource name, whether or not auto-save and auto-prepopulate are set, and whether or not the resource object allows multiple instances.
OIU	Associates applicable user information to the resource object instance when provisioning takes place. In addition, it stores policy-related information for the specific resource instance.

- **Resource Lifecycle (Provisioning) Process:** Contains the MIL, ORC, OSI, PKG, SCH, and TOS tables, as listed in [Table 23-2](#).

**Table 23-2 Resource Lifecycle Process Tables**

Table Name	Description
MIL	Defines the process task definitions. Each entry corresponds to a process task. A process definition (PKG table) comprises of multiple tasks, which are a part of the various workflows in the definition.
ORC	Stores process instance information when provisioning takes place. When provisioning starts, Oracle Identity Manager generates an associated process (or workflow) instance that stores process-related information specific to the provisioning instance.
OSI	Stores information about tasks created for process instance.
PKG	Defines processes or workflows in Oracle Identity Manager, including process details such as process name, process type, descriptive field mapping, and associated resources and process forms.
SCH	Stores information related to running of a specific task instance such as the task status, status bucket, and timing of when the adapter run started or ended.
TOS	Stores atomic process information.

- **Resource State (Process) Form:** This information is stored in the UD parent and child tables. The UD\_\* tables are user-defined field tables that store the account state.

### 23.2.1.3 Storage of Snapshots for User Profile Audit

When Oracle Identity Manager takes a snapshot of a user profile, it stores the snapshot in the UPA table. The structure of the UPA table is described in [Table 23-3](#).

**Table 23-3 Definition of the UPA Table**

Column	Data Type	Description
UPA_KEY	NUMBER (19,0)	Key for the audit record
USR_KEY	NUMBER (19,0)	Key for the user whose snapshot is recorded in this entry
EFF_FROM_DATE	TIMESTAMP (6)	Date and time at which the snapshot entry became effective
EFF_TO_DATE	TIMESTAMP (6)	Date and time at which the snapshot entry was no longer effective  In other words, this is the date and time at which the next snapshot entry was created. For the entry representing the latest user profile, the To Date column value is set to NULL.
SRC	VARCHAR2 (4000)	User ID of the user responsible for the change, and the API used to carry out the change
SNAPSHOT	CLOB	XML representation of the snapshot
DELTAS	CLOB	XML representation of old and new values corresponding to a change made to the snapshot
SIGNATURE	CLOB	Can be used to store a digital signature for the snapshot (for nonrepudiation purposes)

**Note:**

The initial audit snapshots for default users in Oracle Identity Manager is not UTF-8 encoded. However, auditing of subsequent modifications to these users have UTF-8 encoded snapshots.

### 23.2.1.4 Trigger for Taking Snapshots for User Profile Audit

When any data element in a user profile changes, Oracle Identity Manager creates a snapshot.

The following events trigger the creation of a user profile snapshot:

- Modification of any kind to the user record (for example, through reconciliation and direct provisioning)
- Role membership change for the user
- Changes in the policies that apply to the user
- Provisioning a resource to the user
- Deprovisioning of a resource for the user
- Any provisioning-related event for a provisioned resource:
  - Resource status change
  - Addition of provisioning tasks to the provisioning process
  - Updates to provisioning tasks in the provisioning process, for example, status changes, escalations, and so on
  - Creation of or updates to Process Form data

### 23.2.2 Post-Processor Used for User Profile Auditing

The user profile auditor has an internal post-processor that normalizes the snapshot XML into the reporting tables.

The user profile auditor has an internal post-processor that normalizes the snapshot XML into the reporting tables: UPA\_USR, UPA\_FIELDS, UPA\_GRP\_MEMBERSHIP, UPA\_RESOURCE, UPA\_UD\_FORMS, and UPA\_UD\_FORMFIELDS. These tables are used by the reporting module to generate the appropriate reports.

### 23.2.3 Tables Used for User Profile Auditing

The database tables used for user profile auditing are UPA\_USR, UPA\_FIELDS, UPA\_GRP\_MEMBERSHIP, UPA\_RESOURCE, UPA\_UD\_FORMS, and UPA\_UD\_FORMFIELDS.

[Table 23-4](#) lists the tables in the database that User profile audits use:

 **Note:**

For more information about the User Profile Audits tables, such as column names and how to use them, refer to the schema documentation provided with Oracle Identity Manager.

**Table 23-4 User Profile Audit Tables**

Table Name	Description
AUD	Stores detailed information about all of the Auditors (for example, the User Profile Auditor) supported by Oracle Identity Manager.
AUD_JMS	Staging table that stores information about changes made as a part of any business transaction. This is an intermediate table to temporarily store data changelog data before the audit engine consumes it. When Audit messages are successfully processed, corresponding records are deleted from the table. <b>Note:</b> This table is not intended for end users and must not be used directly.
UPA	Main auditing table for storing all snapshots and changes made to the user profiles.
UPA_FIELDS	Stores user profile audit history changes in denormalized (vertical) format.
UPA_GRP_MEMBERSHIP	Stores groups membership history in denormalized format.
UPA_RESOURCE	Stores user profile resource history in denormalized format.
UPA_USR	Stores user profile history in denormalized format.
UPA_UD_FORMS	Together with the UPA_UD_FORMFIELDS table, contains information about changes to the user's account profile (process form). This table keeps track of the changes to the various forms, such as parent or child forms, which are being changed in any transaction. The changes to the account or entitlement attributes are stored in the UPA_UD_FORMFIELDS table.
UPA_UD_FORMFIELDS	Stores the names of account or entitlement profile fields that are modified. This table also keeps track of the old and new values of the modified fields.

 **Note:**

- The UPA\_UD\_FORMS and UPA\_UD\_FORMFIELDS tables together store the audit trail of changes to the user's account profile in a de-normalized format. These tables can be used in various audit-related reports.
- The UPA\_UD\_FORMS and UPA\_UD\_FORMFIELDS tables will be populated only if the XL.EnableExceptionReports system property is set to TRUE. For more information about this property, see [Default System Properties in Oracle Identity Governance](#).
- The Form Upgrade Job schedule task updates the form version to the latest active version and the form data to the value specified during the field's creation for all accounts. If this scheduled task is not run, then the form version and data will be incorrect in the audit snapshot and the reporting tables.

## 23.2.4 Archiving User Profile Audit Data

The audit archival and purge utility is used to archive user profile audit data.

User Profile audit data growth is based on the setting of the audit levels, and the growth can be significant in most of the deployments.

There is also a requirement to clean or archive the old user profile audit data to accommodate future growth.

You can use Audit Archival and Purge Utility to meet these requirements. See [Using the Audit Archival and Purge Utility](#) for detailed information about this utility.

## 23.3 Role Profile Auditing

Understand the audit levels, capture and archive of data, storage of snapshots, and trigger for taking snapshots for role profile audit data.

This section discusses about role profile auditing in the following topics:

- [About Role Profile Auditing](#)
- [Capture and Archiving of Role Profile Audit Data](#)
- [Storage of Snapshots for Role Profile Auditing](#)
- [Trigger for Taking Snapshots for Role Profile Auditing](#)

### 23.3.1 About Role Profile Auditing

The supported audit levels for role profile auditing are None, Role, and Role Hierarchy.

The supported levels are:

- **None:** No audit data is collected. This is the default value.
- **Role:** Creation, modification, and deletion of role is audited.
- **Role Hierarchy:** Changes made to the role inheritance is audited.



## 23.3.2 Capture and Archiving of Role Profile Audit Data

Each time a role profile changes, a snapshot of the role profile is stored in an audit table.

Role profile audits cover changes to role profile attributes, role administrators, and direct subroles.

Each time a role profile changes, Oracle Identity Manager takes a snapshot of the role profile and stores the snapshot in an audit table in the database.

Oracle Identity Manager generates a snapshot when an audit is created for a role, even if an initial snapshot is missing. The current snapshot is treated as the initial snapshot.

The following are the components of a role profile and the tables that constitute these components:

- UGP: Role record, including all UDFs for roles
- GPG: Subrole/parent role information

## 23.3.3 Storage of Snapshots for Role Profile Auditing

The GPA table stores the snapshot of role profile audits. The ARM\_AUD table stores the snapshot of an admin role membership profile.

When Oracle Identity Manager takes a snapshot of a role profile, it stores the snapshot in a GPA table. The structure of this table is as described in [Table 23-5](#).

**Table 23-5 Definition of the GPA Table**

Column	Data Type	Description
GPA_KEY	NUMBER (19,0)	Key for the audit record
UGP_KEY	NUMBER (19,0)	Key for the role whose role snapshot is recorded
EFF_FROM_DATE	TIMESTAMP (6)	Date and time at which the snapshot entry became effective
EFF_TO_DATE	TIMESTAMP (6)	Date and time at which the snapshot entry was no longer effective In other words, this is the date and time at which the next snapshot entry was created. For the entry representing the latest user profile, the To Date column value is set to NULL
SRC	VARCHAR2 (4000)	Source of the entry, User ID of the user responsible for the change, and the API used to carry out the change
SNAPSHOT	CLOB	XML representation of the snapshot
DELTAS	CLOB	XML representation of old and new values corresponding to a change made to the snapshot
SIGNATURE	CLOB	Can be used to store a digital signature for the snapshot (for nonrepudiation purposes)

When Oracle Identity Manager takes a snapshot of an admin role membership profile, it stores the snapshot in the ARM\_AUD table. The structure of this table is as described in [Table 23-6](#).

**Table 23-6 Definition of the ARM\_AUD Table**

Column	Data Type	Description
ARM_AUD_ID	NUMBER(20)	Admin role audit ID
MEMBERSHIP_ID	NUMBER(20)	Admin role membership ID
ROLE_ID	NUMBER(20)	Admin role ID
USER_ID	VARCHAR2(256 CHAR)	User member ID
SCOPE_ID	NUMBER(20)	Scope ID of the admin role membership
INCLUDE_HIERARCHY	NUMBER(1)	Whether or not organization hierarchy is included
ARM_AUD_EFF_FROM_DATE	TIMESTAMP(6)	Date from which admin role audit is effective
ARM_AUD_EFF_TO_DATE	TIMESTAMP(6)	Date up to which admin role audit is effective
USR_ACTION	VARCHAR2(10 CHAR)	Action of the user members
USR_LOGIN	VARCHAR2(256 CHAR)	Login names of the user members

### 23.3.4 Trigger for Taking Snapshots for Role Profile Auditing

When any data element in the role profile snapshot changes, a snapshot is created.

The creation of role profile snapshots is triggered by events that result in changes in any of the following:

- Role profile data
- Parent role information
- Adding or revoking users or user memberships

## 23.4 Catalog Auditing

You can enable catalog auditing by setting the value of the `XL.CatalogAuditDataCollection` system property to `catalog`.

See [Configuring Catalog Auditing](#) for information about catalog auditing.

## 23.5 Enabling and Disabling Auditing in Oracle Identity Governance

You can disable or enable auditing by setting appropriate values for the `XL.UserProfileAuditDataCollection` and `XL.CatalogAuditDataCollection` system properties.

This section describes how to enable and disable auditing in Oracle Identity Governance in the following sections:

- [Disabling Auditing in Oracle Identity Governance](#)
- [Enabling Auditing in Oracle Identity Governance](#)

## 23.5.1 Disabling Auditing in Oracle Identity Governance

You can disable auditing by setting values in the `XL.UserProfileAuditDataCollection`, `XL.RoleAuditLevel`, and `XL.CatalogAuditDataCollection` system properties.

To disable auditing in Oracle Identity Manager:

1. Set the values of User profile audit data collection level (`XL.UserProfileAuditDataCollection`) and Level of Role Auditing (`XL.RoleAuditLevel`) system properties to `None`, as described in [Editing System Properties](#).
2. Disable the Issue Audit Messages Task scheduled job as described in [Disabling and Enabling Jobs](#).

If pending audit changes are required to be recorded in the audit tables, then disable the scheduled task after all the pending audit changes are processed.

To disable catalog auditing, set the value of the `XL.CatalogAuditDataCollection` system property to `none`.

## 23.5.2 Enabling Auditing in Oracle Identity Governance

You can enable auditing by setting values in the `XL.UserProfileAuditDataCollection`, `XL.RoleAuditLevel`, and `XL.CatalogAuditDataCollection` system properties. In addition, enable the Issue Audit Messages Task scheduled job and run the `GnerateSnapshot` script.

To enable auditing in Oracle Identity Governance:

1. Set the values of User profile audit data collection level (`XL.UserProfileAuditDataCollection`) and Level of Role Auditing (`XL.RoleAuditLevel`) system properties to one of the levels defined in [User Profile Auditing](#) and [Capture and Archiving of Role Profile Audit Data](#) for user profile and role profile auditing respectively. See [Configuring Oracle Identity Governance](#) for information about modifying the values of system properties.
2. Enable the Issue Audit Messages Task scheduled job as described in [Disabling and Enabling Jobs](#).
3. For user profile auditing, generate snapshots by running the `GenerateSnapshot` script as described in [Generating an Audit Snapshot in Developing and Customizing Applications for Oracle Identity Governance](#).

The following is the command-line usage of the `GenerateSnapshot` script:

```
./GenerateSnapshot.sh -username OIM_ADMIN_USERNAME -numOfThreads 8 -serverURLt3://  
WLS_SERVER:PORT -ctxFactory weblogic.jndi.WLInitialContextFactory[-inputFile  
fileWithUserKeys]
```

Here:

- `OIM_ADMIN_USERNAME` is the Oracle Identity Manager administrator username.
- `WLS_SERVER` is the Oracle WebLogic Server name.
- `PORT` is the port number of the WebLogic Server.

 **Note:**

If Oracle Identity Governance is installed on IPv6 host computer, then pass `ipv6` as the last input argument to the `GenerateSnapshot.sh` script.

To enable catalog auditing, set the value of the `XL.CatalogAuditDataCollection` system property to `catalog`.

## 23.6 Lightweight Audit

Using lightweight audit involves the understanding the entities that are audited, the definition of the table that stores audit data, and audit logging configuration.

This section describes the lightweight audit engine in Oracle Identity Manager. It contains the following topics:

- [About Lightweight Audit](#)
- [Audit Logging Configuration](#)

### 23.6.1 About Lightweight Audit

Some of the entities that are audited by lightweight audit engine are user, role, role membership, organization, organization-user membership, scan definition, and policy violation. The `AUDIT_EVENT` table stores the audit data.

The lightweight audit feature is a forward looking audit engine for Oracle Identity Manager. Lightweight Audit engine is direct and, unlike the legacy auditing, does not have a denormalized reporting schema. For backward compatibility Oracle Identity Manager uses both the audit engines. This topic provides entities that are audited by the Lightweight Audit Engine in a tabular format.

[Table 23-7](#) lists the entities that are audited by the Lightweight Audit Engine:

**Table 23-7 Entities that are audited in Oracle Identity Manager by Lightweight Audit Engine**

Entity	Operation
User	Create, Modify, Delete, Enabled, Disabled, Lock, Unlock, Reset Password, Change Password
Role	Create, Modify, Delete
Role-User Membership	Add, Remove, Modify
Organization	Create, Modify, Delete
Organization-User Membership	Added, Removed
Policy	Create, Modify, Delete, Enabled, Disabled
Rule	Create, Modify, Delete, Enabled, Disabled
Return Value (Child)	Create, Modify, Delete
Rule-Return Value (Child)	Add, Remove
Policy-Rule Relationship	Add, Remove
Policy Violation	Create, Modify, Delete, Enabled, Disabled

**Table 23-7 (Cont.) Entities that are audited in Oracle Identity Manager by Lightweight Audit Engine**

Entity	Operation
Policy Violation Cause	Create, Modify, Delete, Enabled, Disabled
Scan Definition	Create, Modify, Delete, Enabled, Disabled
Scan Definition-Policy Relationship	Create, Modify, Delete, Enabled, Disabled
Scan Run	Create, Modify, Delete, Enabled, Disabled
Scan Run-Policy Relationship	Add, Remove
Scan Run-User Relationship	Add, Remove
Scan Run-Policy Violation Relationship	Add, Remove
Remediator	Create, Modify, Delete
Task Policy Violation	Create, Modify, Delete

When Oracle Identity Manager records the changes to an entity or relationship, it stores the data in the following AUDIT\_EVENT table. [Table 23-8](#) lists the content of the AUDIT\_EVENT table.

**Table 23-8 Definition of the AUDIT\_EVENT Table**

Attribute	Data Type	Description
event_id	VARCHAR2(40)	Unique ID of the audit log event
event_action	VARCHAR2(255)	Set of entity type actions such as CREATE, MODIFY, DELETE, ADD, REMOVE, MODIFY_RULE, and DELETE_RULE.
event_date	TIMESTAMP	Date of event
event_actor_id	VARCHAR2(40)	ID of the user who performed the action
event_actor_name	VARCHAR2(255)	Name of the user who performed the action
event_mechanism	VARCHAR2(40)	Self, Admin, Recon, Policy-Based, Request
event_request_id	VARCHAR2(40)	If mechanism is Request, then requestId of request
event_status	VARCHAR2(1)	Status of request S (success) or F (failure)
event_fail_reason	VARCHAR2(255)	Descriptive reason for failed action. For example, POLICY_VIOLATION, ACCOUNT_LOCKED, and REQUEST NOT APPROVED.
event_values_added	CLOB	Values added. Data is in name1=value1 name2=value2 format, where name can be a simple name (for example firstname, userMembers) or a path expression to represent complex, nested attributes (for example user.address[type=work].street) - enables SQL "contains" search
event_values_removed	CLOB	Values removed. Data is in name1=value1 name2=value2 format, where name can be a simple name (for example firstname, userMembers) or a path expression to represent complex, nested attributes (for example user.address[type=work].street) - enables SQL "contains" search
entity_type	VARCHAR2(40)	Type of entity
entity_id	VARCHAR2(40)	ID of entity

**Table 23-8 (Cont.) Definition of the AUDIT\_EVENT Table**

Attribute	Data Type	Description
entity_name	VARCHAR2(255)	Name of the entity, for example User Login, Role Name, or Policy Name.
to_entity_type	VARCHAR2(40)	Type of entity in relationship (for example User in Role-User, Rule in Policy-Rule, and so on)
to_entity_id	VARCHAR2(40)	ID of to entity in relationship
to_entity_name	VARCHAR2(255)	Name of to entity in relationship

## 23.6.2 Audit Logging Configuration

The lightweight audit engine allows configuration of audit events through predefined groups. You can also add new entity types or actions.

There is no configuration for audit event logging in the legacy auditing, which results in data growth and performance issues. In other words, you can configure what gets audited for your deployment, and enable or disable audit logging at the following levels:

- Enable or disable audit for all entities
- Configure auditing per entity type or per action, such as create role

For each of these, you can configure whether to enable or disable success, failure, or both.

The audit logging configuration can be done by using the `AuditEventManager` and `AuditEventEntityTypeActionManager` public interfaces. For information about these APIs, see [Java API Reference for Oracle Identity Manager](#).

By default, auditing for all data is enabled. You can disable or configure the audit data based on your requirement. [Table 23-9](#) lists the entity types or actions per group that are supported by default. You can add new entity types or actions, which will then be supported.

**Table 23-9 Group Entity Type Actions**

Group Name	Entity Type / Action
User management	User / CREATE
	User / MODIFY
	User / DELETE
	User / LOCK
	User / UNLOCK
	User / ENABLE
	User / DISABLE
Role management	Role / CREATE
	Role / MODIFY
	Role / DELETE
	RoleRole / ADD
	RoleRole / REMOVE
Role membership	RoleUser / GRANT
	RoleUser / REVOKE

**Table 23-9 (Cont.) Group Entity Type Actions**

<b>Group Name</b>	<b>Entity Type / Action</b>
Password management	User / CHANGE PASSWORD
	User / RESET_PASSWORD
Login / logoff	User / LOGIN
	User / LOGOFF
Organization management	Organization / CREATE
	Organization / MODIFY
	Organization / DELETE
	Organization / ENABLE
	Organization / DISABLE
Organization membership	Organization User / ADD
	Organization User / REMOVE
Access policy management	Policy / CREATE
	Policy / MODIFY
	Policy / DELETE
	Policy Type / CREATE
	Policy Type / MODIFY
	Policy Type / DELETE
	Rule / CREATE
	Rule / MODIFY
Rule / DELETE	

# Using Reporting Features

Reporting uses the standard features of Oracle Analytics Server. Using reports involve understanding the output formats, types of reports, and required scheduled tasks, and following best practices for using reports.

This chapter describes reporting in Oracle Identity Manager. It contains the following sections:

- [About Reporting in Oracle Identity Governance](#)
- [Supported Output Formats for Reports](#)
- [Classification of Oracle Identity Governance Reports](#)
- [Required Scheduled Tasks for Oracle Analytics Server Reports](#)
- [Best Practices for Running Oracle Identity Governance Reports](#)

## 24.1 About Reporting in Oracle Identity Governance

Oracle Analytics Server is Oracle's primary reporting tool for authoring, managing, and delivering all your highly formatted documents.

You can use standalone Oracle Analytics Server to view and run Oracle Identity Manager reports.

After Oracle Analytics Server configuration, you can take advantage of the standard features of Oracle Analytics Server, such as:

- Highly formatted and professional quality reports with pagination and headers/footers.
- PDF, Word, and HTML output of reports.
- Capability to develop your own custom reports against the Oracle Identity Manager repository (read-only repository access).
- Scheduling capabilities and delivery mechanisms, such as e-mail and FTP of Oracle Analytics Server.
- Format (report) can be edited separately from the data definition (data model).
- Standardized Oracle Identity subtemplate for headers.
- National Language Support (NLS) for BI Publisher report output.

 **Note:**

Before using Oracle Identity Manager reports, configure standalone Oracle Analytics Server reports. See *Configuring Reports in Developing and Customizing Applications for Oracle Identity Governance*.



## 24.2 Supported Output Formats for Reports

Oracle Analytics Server supports multiple report output formats, such as HTML, PDF, RTF, and MHTML.

All reports are generated in a native XML format which can be transformed into different other output formats. The following formats are supported:

- HTML
- PDF
- RTF
- MHTML

## 24.3 Classification of Oracle Identity Governance Reports

Oracle Identity Governance reports are classified into various categories based on functional areas.

All the reports containing Date type input parameters must be provided with the date range in the Date Input Parameters before running the report. Otherwise, the reports will not display any data.

Oracle Identity Manager Reports are classified into the following categories based on their functional areas:

- [Access Policy Reports](#)
- [Request and Approval Reports](#)
- [Role and Organization Reports](#)
- [Password Reports](#)
- [Resource and Entitlement Reports](#)
- [User Reports](#)
- [Certification Reports](#)
- [Identity Audit Reports](#)
- [Exception Reports](#)

### 24.3.1 Access Policy Reports

The access policy reports are Access Policy Details and Access Policy List by Role.

Oracle Analytics Server Reports provides the following access policy reports for Oracle Identity Manager:

- [Access Policy Details](#)
- [Access Policy List by Role](#)

#### 24.3.1.1 Access Policy Details

It provides administrators or auditors the ability to view a current snapshot of all the policies associated only with roles defined in Oracle Identity Manager system, along with key

information about each policy, and the number of instances in which each policy has been activated.

### Input Parameters

The following table lists the input parameters for the report.

Report Parameter	Description
Access Policy Name	Name of the Access Policy

### Fields

The following table lists the fields of the report:

Report Field	Description
Description	Description of the policy
Approval Required	Approval required for the policy
Creation Date	Date when the policy is created
Retrofit Access Policy	Retrofit of the access policy
Created By	Name of the person who created the policy
Priority	Priority of the policy

### Columns

The following table lists the columns of the report:

Report Column	Description
Application Instance Name	Name of the application instance

## 24.3.1.2 Access Policy List by Role

It lists all policies defined in Oracle Identity Manager system by role. This report can be used for operational and compliance purposes.

### Input Parameters

The following table lists the input parameters for the report:

Report Parameter	Description
Role Name	Name of the role

### Fields

The following table lists the fields of the report:

Report Field	Description
Description	Description of the policy
Approval Required	Approval required for the policy
Creation Date	Date when the policy is created
Retrofit Access Policy	Retrofit of the access policy

Report Field	Description
Created By	Name of the person who created the policy
Priority	Priority of the policy

### Columns

The following table lists the columns of the report:

Report Column	Description
Role Name	Name of the role

## 24.3.2 Request and Approval Reports

The request and approval reports are Approval Activity Report, Request Details Report, Request Summary Report, and Task Assignment History.

Oracle Analytics Server Reports provides the following request and approval reports for Oracle Identity Manager:

- [Approval Activity Report](#)
- [Request Details Report](#)
- [Request Summary Report](#)
- [Task Assignment History](#)

### 24.3.2.1 Approval Activity Report

This report provides the administrators the ability to view the approval activity including requests that are approved, rejected, or pending.

#### Input Parameters

The following table lists the input parameters for the report.

Report Parameter	Description
Approver's First Name	First name of the approver
Approver's Last Name	Last name of the approver
Approver's User ID	User ID of the approver
Organization	Name of the organization

#### Fields

N/A

#### Columns

The following table lists the columns of the report:

Report Column	Description
Approver's First Name	First name of the approver

Report Column	Description
Approver's Last Name	Last name of the approver
Approver's User ID	User ID of the approver
Organization	Organization of the approver
Approval Accepted	Count of the accepted approval
Approval Rejected	Count of the rejected approval
Approvals Pending	Count of the pending approval
Approval Requests Total	Total number of approval requests

### 24.3.2.2 Request Details Report

This report provides administrators the ability to view the details (requestor, current approver and so on) of all requests with the input current status. Additionally, this report displays the details of all users (user name, organization, manager details, user status and so on) that will be provisioned as a result of the request approval. This helps administrators in planning and prioritizing operational activities so that they may expedite the closure of pending requests.

#### Input Parameters

The following table lists the input parameters for the report.

Report Parameter	Description
Requestor User First Name	First name of the requestor
Requestor User Last Name	Last name of the requestor
Request User ID	ID of the requestor
Request ID	Request ID
Request Parent ID	Parent ID of the request
Request Status	Status of the request
Request Type	Type of the request
Request Date From	Start date of the request
Request Date To	End date of the request
Beneficiary User First Name	First name of the beneficiary
Beneficiary User Last Name	Last name of the beneficiary
Beneficiary User ID	ID of the beneficiary

#### Fields

The following table lists the fields of the report:

Report Field	Description
Request ID	Request ID
Request Type	Type of the request
Requester User ID	ID of the requester
Request Date	Date on which request is initiated
Approver User ID	ID of the approver

Report Field	Description
Current Status	Status of the request
Parent Request ID	ID of the parent Requester

### Columns

The following table lists the columns of the report, if a beneficiary is present:

Report Column	Description
First Name	First name of the beneficiary
Last Name	Last name of the beneficiary
User ID	ID of the beneficiary
User Type	Type of user
User Status	Status of the beneficiary
Organization	Organization of the beneficiary
Request Value	Request value of the resource

The following table lists the columns of the report, if a beneficiary is not present:

Report Column	Description
Request Name	Name of the request
Request Value	Value of the request

The following table provides the approver details:

Report Column	Description
Approver User ID	User ID of the approver of the request
Approver User Name	User name of the approver of the request

## 24.3.2.3 Request Summary Report

This report provides administrators the ability to view the current status of all requests raised in the specified time interval. This helps administrators in planning and prioritizing operational activities so that they may expedite the closure of pending requests.

### Input Parameters

The following table lists the input parameters for the report.

Report Parameter	Description
Request Type	Type of request
Request Date From	Start date of the request
Request Date To	End date of the request
Organization	Details of the organization

### Fields

N/A

### Columns

The following table lists the columns of the report:

Report Column	Description
Request ID	Request ID
Parent Request ID	ID of the parent Requester
Request Type	Type of request
Request Status	Status of request
Requester User ID	ID of the requester
Requester User Name	Name of the requester of the request
Beneficiary User ID	ID of the beneficiary
Request Details	Details of the request
Approver User ID	ID of the approver
Approver User Name	Name of the approver of the request
Request Date	Date of request

## 24.3.2.4 Task Assignment History

It lists the history of all task assignments.

### Input Parameters

The following table lists the input parameters for the report.

Report Parameter	Description
Resource Name	Name of the resource
Assignee User ID	ID of the assignee user
Assignee First Name	First name of the assignee user
Assignee Last Name	Last name of the assignee user

### Fields

The following table lists the fields of the report:

Report Field	Description
Resource Type	Type of resource

### Columns

The following table lists the columns of the report:

Report Column	Description
User ID	ID of the beneficiary
Assignee First Name	First name of the assignee
Assignee Last Name	Last name of the assignee

Report Column	Description
Assignee User ID	ID of the assignee
Assignee Role Name	Role name of the assignee
Assignee User Name	User name of the assignee
Employee Type	Type of employee

## 24.3.3 Role and Organization Reports

The role and organization reports are Role Membership History, Role Membership Profile, Role Membership, Organization Details, and User Membership History.

Oracle Identity Manager provides the following role and organization reports:

- [Role Membership History](#)
- [Role Membership Profile](#)
- [Role Membership](#)
- [Organization Details](#)
- [User Membership History](#)

### 24.3.3.1 Role Membership History

This report displays membership history of all the roles. The report will not show indirect memberships.

#### Input Parameters

The following table lists the input parameters for the report.

Report Parameter	Description
Role Name	Name of the role
Role Category	Category of the role
Employee Type	Type of the employee: Full-Time, Part-Time, Temp, Intern, Consultant, Contractor
Employee Status	Status of the employee: Active, Disabled, Deleted, Disabled Until Start Date
Membership Status	Status of membership: Revoked, Active
Effective From	Role membership effective from date
Effective To	Role membership effective to date

#### Fields

The following table lists the fields of the report:

Report Field	Description
Created By	Name of the person who created the role
Creation Date	Date on which the role was created

#### Columns

The following table lists the columns of the report:

Report Column	Description
First Name	First name of the user
Last Name	Last name of the user
User ID	ID of the user
Employee Type	Type of employee
Employee Status	Status of the employee
Membership Status	Membership date of the user
Effective From	Membership start date of the user
Effective To	Membership end date of the user
Manager's First Name	First name of the manager
Manager's Last Name	Last name of the manager
Manager's User ID	ID of the manager
Updated By	Name of the user who updated the record

### 24.3.3.2 Role Membership Profile

This report shows number of users present for number of roles and the details of users belonging to count number of roles.

#### Input Parameters

The following table lists the input parameters for the report.

Report Parameter	Description
Organization	Organization of the user

#### Fields

The following table lists the fields of the report:

Report Field	Description
Membership in Number of Roles	Number of members in number of roles
Number of Users	Number of users in the role

#### Columns

The following table lists the columns of the report:

Report Column	Description
First Name	First name of the user
Last Name	Last name of the user
User ID	ID of the user
Employee Type	Type of the employee: Full-Time, Part-Time, Temp, Intern, Consultant, Contractor



### 24.3.3.3 Role Membership

This report displays membership details of all roles.

#### Input Parameters

The following table lists input parameters for the report.

Report Parameter	Description
Role Name	Name of the role
Role Category	Category of the role
Organization	Name of the organization
Employee Type	Type of the employee: Full-Time, Part-Time, Temp, Intern, Consultant, Contractor
Employee Status	Status of the employee: Active, Disabled, Deleted, Disabled Until Start Date

#### Fields

The following table lists the fields of the report:

Report Field	Description
Created By	Name of the person who created the user
Creation Date	Date on which the user is created

#### Columns

The following table lists the columns of the report:

Report Column	Description
First Name	First name of the user
Last Name	Last name of the user
User ID	ID of the user
Organization	Organization of user
Employee Status	Status of the user
Employee Type	Type of the employee: Full-Time, Part-Time, Temp, Intern, Consultant, Contractor
Member Since	Joining date of the user
Manager's First Name	First name of the manager
Manager's Last Name	Last name of the manager
Manager's User ID	ID of the manager

### 24.3.3.4 Organization Details

It lists the hierarchical organization structure and details about users in the organization.

#### Input Parameters

The following table lists the input parameters for the report.

Report Parameter	Description
Organization Name	Name of the organization

### Fields

The following table lists the fields of the report:

Report Field	Description
Parent Organization Name	Name of the parent organization

### Columns

The following table lists the columns of the report:

Report Column	Description
Role	Name of Administrator User roles
First Name	First name of the user in the organization
Last Name	Last name of the user in the organization
User ID	ID of the user
User Status	Status of the user
User Type	Type of user
Start Date	Joining date of the user
End Date	Leaving date of the user

## 24.3.3.5 User Membership History

This report lists the logged in users with their membership history.

### Input Parameters

The following table lists the input parameters for the report.

Report Parameter	Description
Last Name	First name of the user
First Name	Last name of the user
User ID	ID of the user
Organization	Organization of the user
Employee Status	Status of the employee: Active, Disabled, Deleted, Disabled Until Start Date
Employee Type	Type of the employee: Full-Time, Part-Time, Temp, Intern, Consultant, Contractor

### Fields

The following table lists the fields of the report:

Report Field	Description
User ID	ID of the user
User First Name	First name of the user
User Last Name	Last name of the user
Organization	Organization of the user
Employee Status	Status of the employee: Active, Disabled, Deleted, Disabled Until Start Date
Employee Type	Type of the employee: Full-Time, Part-Time, Temp, Intern, Consultant, Contractor

### Columns

The following table lists the columns of the report:

Report Column	Description
User Role	Name of the user role
Membership Status	Status of membership
Effective From	Date from which the membership is effective
Updated By	User who updated the record

## 24.3.4 Password Reports

The password reports are Password Expiration Summary Report, Password Reset Summary Report, and Resource Password Expiration Report.

Oracle Identity Manager provides the following password reports:

- [Password Expiration Summary Report](#)
- [Password Reset Summary Report](#)
- [Resource Password Expiration Report](#)

### 24.3.4.1 Password Expiration Summary Report

This report shows the list of all active users whose Oracle Identity Manager passwords are about to expire within a specified period.

#### Input Parameters

The following table lists the input parameters for the report.

Report Parameter	Description
Last Name	Last name of the user
First Name	First name of the user
User ID	ID of the user
Organization	Organization of the user
Expiration Date Range From	Start date of the expiration date
Expiration Date Range To	End date of the expiration date

### Fields

N/A

### Columns

The following table lists the columns of the report:

Report Field	Description
First Name	First name of the user
Last Name	Last name of the user
User ID	ID of the user
Employee Type	Type of the employee: Full-Time, Part-Time, Temp, Intern, Consultant, Contractor
Employee Status	Status of the employee: Active, Disabled, Deleted, Disabled Until Start Date
Organization	Organization of the user
Password Expiration Date	Date on which the password expires

## 24.3.4.2 Password Reset Summary Report

This report provides the ability to view the aggregated metrics around password change attempts done by users themselves or on behalf of them. The metrics include all password change attempts, successful or failure outcome of password change attempt, users locked due to multiple concurrent unsuccessful password change attempts.

### Input Parameters

The following table lists the input parameters for the report.

Report Parameter	Description
Aggregation Frequency	The frequency of the report generated
Date Range From	Start date of the report generated
Date Range To	End date of the report generated
Organization	Name of the organization

### Fields

The following table lists the fields of the report:

Report Field	Description
Aggregation Frequency	The frequency of the report generated

### Columns

The following table lists the columns of the report:

Report Column	Description
Time Period	Date and time of reset attempts performed
Reset Attempts	Number of reset attempts

Report Column	Description
Failed Reset Attempts	Number of failed reset attempts
Locked Users due to Failed Reset Attempts	Number of users locked due to a failed reset attempt
Resets by non-beneficiary	Number of resets by non-beneficiary

### 24.3.4.3 Resource Password Expiration Report

It lists users whose resource passwords will expire in a specified time period.

#### Input Parameters

The following table lists the input parameters for the report.

Report Parameter	Description
Resource Name	Name of the resource
First Name	First name of the user
Last Name	Last name of the user
User ID	ID of the user
User Status	Status of the user
Password Expiration Date From	The password expiry starting date
Password Expiration Date To	The password expiry ending date

#### Fields

The following table lists the fields of the report:

Report Field	Description
Resource Type	Type of resource

#### Columns

The following table lists the columns of the report:

Report Field	Description
First Name	First name of the user
Last Name	Last name of the user
User ID	ID of the user
Organization	Organization of the user
User Status	Status of the user: Active, Disabled, Deleted, Disabled Until Start Date
User Type	Type of the user: Full-Time, Part-Time, Temp, Intern, Consultant, Contractor
Password Expiration Date	Date on which the password expires

## 24.3.5 Resource and Entitlement Reports

The resource and entitlement reports are Account Activity In Resource, Delegated Admins and Permissions by Resource, Delegated Admins by Resource, Entitlement Access List, Entitlement Access List History, Financially Significant Resource Details, Resource Access List History, Resource Access List, Resource Account Summary, Resource Activity Summary, User Resource Access History, User Resource Access, User Resource Entitlement, and User Resource Entitlement History.

Oracle Analytics Server Reports provides the following resource and entitlement reports for Oracle Identity Manager:

- [Account Activity In Resource](#)
- [Delegated Admins and Permissions by Resource](#)
- [Delegated Admins by Resource](#)
- [Entitlement Access List](#)
- [Entitlement Access List History](#)
- [Financially Significant Resource Details](#)
- [Resource Access List History](#)
- [Resource Access List](#)
- [Resource Account Summary](#)
- [Resource Activity Summary](#)
- [User Resource Access History](#)
- [User Resource Access](#)
- [User Resource Entitlement](#)
- [User Resource Entitlement History](#)

### 24.3.5.1 Account Activity In Resource

The Account Activity in Resource report lists all account activities in each resource, and provides information on how each user is associated with a specific activity of that resource.

#### Input Parameters

The following table lists the input parameters for the report.

Report Parameter	Description
Resource Name	Name of the resource
Date Range From	Date from which reports are displayed
Date Range To	Date to which reports are displayed

#### Fields

The following table lists the fields of the report:

Report Field	Description
Resource Name	Name of the resource

Report Field	Description
Activity Type	The type of activity
Resource Authorizer User Role(s)	Name of the role which authorize the role
Resource Administrator User Role(s)	Name of the role which authorize the resource

### Columns

The following table lists the columns of the report:

Report Column	Description
First Name	First name of the user
Last Name	Last name of the user
User ID	ID of the user
User Status	Status of the user: Active, Disabled, Deleted, Disabled Until Start Date
Organization	Organization of the user
Manager's User ID	ID of the manager
Timestamp	Date when the report is created

## 24.3.5.2 Delegated Admins and Permissions by Resource

This report displays the list of user roles with write and delete access that are administrators of the resource.

### Input Parameters

The following table lists the input parameters for the report.

Report Parameter	Description
Resource Name	Name of the resource

### Fields

N/A

### Columns

The following table lists the columns of the report:

Report Column	Description
Administrator Role Name	Name of the Administrator role
Administrator Role Information	Information about the Administrator role
Read Access	Indicates whether the resource has read access
Write Access	Indicates whether the resource has write access
Delete Access	Indicates whether the resource has delete access
Authorizer Role	Authorizer role name
Name Priority	Priority of the resource
Created By	Name of the person who created the resource

Report Column	Description
Creation Date	Resource creation date

### 24.3.5.3 Delegated Admins by Resource

The report displays the list of user roles that are the administrators or authorizers of the resource and members of those roles.

#### Input Parameters

The following table lists the input parameters for the report.

Report Parameter	Description
Resource Name	Name of the resource
Resource Type	Type of resource
Resource Audit Objective	Objective to carry out the audit for the resource

#### Fields

The following table lists the fields of the report:

Report Field	Description
Resource Type	Type of resource
Target	Indicates whether the resource is a target for organization or user
Write Access	Indicates whether the resource has write access
Delete Access	Indicates whether the resource has delete access
Creation By	Resource creation source
Creation Date	Date on which resource is created

#### Columns

The following table lists the columns of the report:

Report Column	Description
First Name	First name of the user
Last Name	Last name of the user
User ID	ID of the user
Organization	Organization of the user
User Status	Status of the user
Member Since	Joining date of the user
Manager's First Name	First name of the manager
Manager's Last Name	Last name of the manager
Manager's User ID	ID of the manager



## 24.3.5.4 Entitlement Access List

This report provides administrators or auditors the ability to query all existing users, who have a specified entitlement. This report can be used for operational and compliance purposes.

### Input Parameters

The following table lists the input parameters for the report.

Report Parameter	Description
Entitlement Code	Code of the entitlement
Resource Name	Name of the resource
Organization	Organization of the user
Role Name	Name of the role
User Status	Status of the user: Active, Disabled, Deleted, Disabled Until Start Date
User Type	Type of user
Provisioning Date From	Date from which the resource is provisioned to the user
Provisioning Date To	Date to which the resource is provisioned to the user

### Fields

The following table lists the fields of the report:

Report Field	Description
Entitlement Code	Code of the entitlement
Entitlement Name	Name of the entitlement
Entitlement status	Status of the entitlement.
Resource Name	Name of the resource
Resource Type	Type of resource

### Columns

The following table lists the columns of the report:

Report Column	Description
User Id	ID of the user
First Name	First name of the user
Last Name	Last name of the user
User Status	User Status
User Type	Type of the user
Organization	Organization of the user
Valid To Date	Entitlement valid from date
Valid From Date	Entitlement valid to date

### 24.3.5.5 Entitlement Access List History

This report provides administrators or auditors the ability to query all existing users provisioned to a entitlement over its lifecycle. This is a lifetime report showing entire history of resource's access list or entitlements.

#### Input Parameters

The following table lists the input parameters for the report.

Report Parameter	Description
Entitlement Code	Code of the entitlement
Resource Name	Name of the resource
Organization	Organization of the user
Role Name	Name of the role
User Status	Status of the user: Active, Disabled, Deleted, Disabled Until Start Date
User Type	Type of user
Effective From Date	Entitlement effective from date
Effective To Date	Entitlement effective to date

#### Fields

The following table lists the fields of the report:

Report Field	Description
Entitlement Code	Code of the entitlement
Entitlement Name	Name of the entitlement
Resource Name	Name of the resource
Resource Type	Type of resource

#### Columns

The following table lists the columns of the report:

Report Column	Description
User Id	ID of the user
First Name	First name of the user
Last Name	Last name of the user
User Status	Status of the user
User Type	Type of user
Effective From	Entitlement effective from date
Effective To	Entitlement effective to date

### 24.3.5.6 Financially Significant Resource Details

This report provides Administrators to get a list of financially significant resources to prioritize various administrative and cleanup activities. It also helps Compliance or Privacy and Security

officers assessing effectiveness of preventive and detective controls in financial significant resources and Auditors to understand the IT resources that host financial data.

### Input Parameters

The following table lists the input parameters for the report.

Report Parameter	Description
Resource Name	Name of the resource

### Fields

The following table lists the fields of the report:

Report Field	Description
Resource Type	Type of resource

### Columns

The following table lists the columns of the report:

Report Column	Description
User Roles	Lists the resource administrator user roles

## 24.3.5.7 Resource Access List History

This report provides administrators or auditors the ability to query all existing users provisioned to a resource over its lifecycle. This is a lifetime report showing entire history of resource's access list or entitlements.

### Input Parameters

The following table lists the input parameters for the report.

Report Parameter	Description
Resource Name	Name of the resource
First Name	First name of the user
Last Name	Last name of the user
User ID	ID of the user
Organization	Organization of the user
User Status	Status of the user
User Type	Type of the user
Snapshot Date From	Effective start date of resource access to the user
Snapshot Date To	Effective end date of resource access to the user
Changes Date From	Resource changed from date to user
Changes Date To	Resource changed to date to user

### Fields

The following table lists the fields of the report:

Report Field	Description
Resource Type	Type of resource

### Columns

The following table lists the columns of the report:

Report Column	Description
First Name	First name of the user
Last Name	Last name of the user
User ID	ID of the user
Organization	Organization of the user
Resource Descriptive data	Descriptive data to identify the resource
User Status	Status of the user
Resource Status	Status of the resource
Effective From	Effective start date
Effective To	Effective end date

## 24.3.5.8 Resource Access List

This report provides administrators or auditors the ability to query all existing users provisioned to a specified resource. This report can be used for operational and compliance purposes.

### Input Parameters

The following table lists the input parameters for the report.

Report Parameter	Description
Resource Name	Name of the resource
First Name	First name of the user
Last Name	Last name of the user
User ID	ID of the user
Organization	Organization of the user
User Status	Status of the user
User Type	Type of the user
Provisioning Date From	Resource provision start date
Provisioning Date To	Resource provision end date

### Fields

The following table lists the fields of the report:

Report Field	Description
Resource Type	Type of resource

### Columns

The following table lists the columns of the report:

Report Parameter	Description
First Name	First name of the user
Last Name	Last name of the user
User ID	ID of the user
User Type	Type of the user
User Status	Status of the user
Organization	Organization of the user
Provisioning Date	Date on which the resource is provisioned

### 24.3.5.9 Resource Account Summary

This report lists the number of users for each status within each resource.

#### Input Parameters

The following table lists the input parameters for the report.

Report Parameter	Description
Resource Name	Name of the resource
Resource Type	Type of resource
Account Status	Status of the account

#### Fields

The following table lists the fields of the report:

Report Field	Description
Resource Type	Type of resource
Total Number of Users	Total number of users associated with the account

#### Columns

The following table lists the columns of the report:

Report Column	Description
Account Status	Status of the account
Number of Users	Number of users with that account status

### 24.3.5.10 Resource Activity Summary

It lists the history of all provisioning and approval activities for a resource.

#### Input Parameters

The following table lists the input parameters for the report.

Report Parameter	Description
Resource Name	Name of the resource
Date Range From	Start date
Date Range To	End date

### Fields

The following table lists the fields of the report:

Report Field	Description
Resource Type	Type of resource

### Columns

The following table lists the columns of the report:

Report Column	Description
Accounts Provisioned	Number of accounts provisioned
Accounts De-Provisioned	Number of accounts de-provisioned
Approval Requests	Number of approval requests
Approval Accepted	Number of approved requests
Approval Rejected	Number of rejected requests

## 24.3.5.11 User Resource Access History

This report provides administrators or auditors the ability to view user's resource access history over user's lifecycle. This report can be used for compliance and forensic auditing purposes. This is not a user access profile snapshot report. This is a lifetime report showing entire history of user's entitlements.

### Input Parameters

The following table lists the input parameters for the report.

Report Parameter	Description
First Name	First name of the user
Last Name	Last name of the user
User ID	ID of the user
Organization	Organization of the user
Status	Status of the user
Employee Type	Type of employee

### Fields

The following table lists the fields of the report:

Report Field	Description
User ID	ID of the user
User First Name	First name of the user
User Last Name	Last name of the user
Manager User ID	ID of the reporting Manager
Manager First Name	First name of the reporting Manager
Manager Last Name	Last name of the reporting Manager
Organization	Organization of the user
Employee Status	Status of employee
Employee Type	Type of employee
Identity Creation Date	User creation date

### Columns

The following table lists the columns of the report:

Report Column	Description
Resource Name	Name of the resource
Resource Descriptive Data	Description of the resource
Provisioned Date	Date on which the resource is provisioned
Provisioned By	Name of the person who provisioned the resource
Effective From	Effective start date of resource access to the user
Effective To	Effective end date of resource access to the user

## 24.3.5.12 User Resource Access

This report provides administrators or auditors the ability to query all existing users provisioned to a specified resource. This report can be used for operational and compliance purposes.

### Input Parameters

The following table lists the input parameters for the report.

Report Parameter	Description
First Name	First name of the user
Last Name	Last name of the user
User ID	ID of the user
Organization	Organization of the user
Employee Status	Status of employee
Employee Type	Type of employee

### Fields

The following table lists the fields of the report:

Report Field	Description
User ID	ID of the user
User First Name	First name of the user
User Last Name	Last name of the user
Manager User ID	ID of the reporting Manager
Manager First Name	First name of the reporting Manager
Manager Last Name	Last name of the reporting Manager
Organization	Organization of the user
Employee Status	Status of employee
Employee Type	Type of employee
Identity Creation Date	User creation date

### Columns

The following table lists the columns of the report:

Report Column	Description
Resource Name	Name of the resource
Resource Descriptive Data	Description of the resource
Resource Status	Status of the resource
Provisioned Date	Date on which the resource is provisioned

## 24.3.5.13 User Resource Entitlement

This report provides administrators or auditors the ability to query all existing entitlements provisioned to specific users. This report can be used for operational and compliance purposes.

### Input Parameters

The following table lists the input parameters for the report.

Report Parameter	Description
User ID	ID of the user
First Name	First name of the user
Last Name	Last name of the user
Email	Email of the user
Resource Name	Name of the resource
Organization	Organization of the user
Role Name	Name of the role
User Status	Status of the user
User Type	Type of the user

### Fields

The following table lists the fields of the report:



Report Field	Description
User ID	ID of the user
First Name	First name of the user
Middle Name	Middle name of the user
Last Name	Last name of the user
Email	Email of the user
Organization	Organization of the user
User Status	Status of the user
User Type	Type of the user
Manager First Name	First name of the manager
Manager Last Name	Last name of the manager
Start Date	Entitlement of resource start date
End Date	Entitlement of resource end date

### Columns

The following table lists the columns of the report:

Report Column	Description
Entitlement Code	Code of the entitlement
Entitlement Name	Name of the entitlement
Entitlement Status	Status of the entitlement
Resource	Type of the resource
Provisioning Start	Date from which the resource is provisioned to the user
Valid From Date	Entitlement of resource valid start date

## 24.3.5.14 User Resource Entitlement History

This report provides administrators or auditors the ability to view user's resource entitlement history over user's lifecycle. This report can be used for compliance and forensic auditing purposes. This is not a user access profile snapshot report. This is a lifetime report showing entire history of user's entitlements.

### Input Parameters

The following table lists the input parameters for the report.

Report Parameter	Description
User ID	ID of the user
First Name	First name of the user
Last Name	Last name of the user
Email	Email of the user
Resource Name	Name of the resource
Organization	Organization of the user

Report Parameter	Description
Role Name	Name of the role
User Status	Status of the user
User Type	Type of the user
Effective From Date	Resource entitlement effective start date
Effective To Date	Resource entitlement effective end date

### Fields

The following table lists the fields of the report:

Report Field	Description
User ID	ID of the user
First Name	First name of the user
Last Name	Last name of the user
User Status	Status of the user
User Type	Type of the user
Organization	Organization of the user
Email	Email of the user
Start Date	Start date of resource entitlement
End Date	End date of resource entitlement
Identity Creation Date	Date of identity creation
Manager First Name	First name of the manager
Manager Last Name	Last name of the manager

### Columns

The following table lists the columns of the report:

Report Column	Description
Entitlement Code	Code of the entitlement
Entitlement Name	Name of the entitlement
Resource	Type of the resource
Effective From Date	Resource entitlement effective start date
Effective To Date	Resource entitlement effective end date

## 24.3.6 User Reports

The user reports are User Creation, User Profile History, User Summary, Users Deleted, Users Disabled, and Users Unlocked.

Oracle Identity Manager provides the following user reports:

- [User Creation](#)
- [User Profile History](#)
- [User Summary](#)

- [Users Deleted](#)
- [Users Disabled](#)
- [Users Unlocked](#)

### 24.3.6.1 User Creation

This report lists all Oracle Identity Manager users created between a specified date range. In addition, it provides the source of information on the users created.

#### Input Parameters

The following table lists the input parameters for the report.

Report Parameter	Description
First Name	First name of the user
Last Name	Last name of the user
User ID	ID of the user
Employee Status	Status of the user
Employee Type	Type of employee
Creation Date From	Start date of user summary
Creation Date To	End date of user summary
Organization	Organization of the user

#### Fields

N/A

#### Columns

The following table lists the columns of the report:

Report Column	Description
First Name	First name of the user
Last Name	Last name of the user
User ID	ID of the user
Organization	Organization of the user
Employee Current Status	Status of the user
Employee Type	Type of employee
Manager ID	ID of the Manager to whom the user reports
Source of Creation	User creation source
Creation On	Date on which the user is created
Created By	User who created the user

### 24.3.6.2 User Profile History

This report shows all the users and their details based on the input parameters.

#### Input Parameters

The following table lists the input parameters for the report.

Report Parameter	Description
First Name	First name of the user
Last Name	Last name of the user
User ID	ID of the user
Organization	Organization of the user
Role Name	Role of the user
Manager User ID	ID of the Manager to whom the user reports
Employee Status	Status of the user
Employee Type	Type of employee
Changes Date Range From	Effective start date of the changes
Changes Date Range To	Effective end date of the changes
Snapshot Date Range From	Effective start date of resource access to the user
Snapshot Date Range To	Effective end date of resource access to the user

### Fields

The following table lists the fields of the report:

Report Field	Description
User ID	ID of the user
User First Name	First name of the user
User Last Name	Last name of the user
Manager User ID	ID of the reporting Manager
Manager First Name	First name of the reporting Manager
Manager Last Name	Last name of the reporting Manager
Organization	Organization of the user
Employee Status	Status of employee
Employee Type	Type of employee
Identity Creation Date	User creation date

### Columns

The following table lists the columns of the report:

Report Column	Description
Profile Parameter	Name of user profile
Value	Value of user profile
Date Effective From	Effective from date
Time Effective From	Effective from time
Updated By	User who updated the record

## 24.3.6.3 User Summary

It lists all Oracle Identity Manager User's summary in a specified time period. It includes user details along with source of creation, and who created it and when.

### Input Parameters

The following table lists the input parameters for the report.

Report Parameter	Description
First Name	First name of the user
Last Name	Last name of the user
User ID	ID of the user
Employee Status	Status of the user
Employee Type	Type of employee
Creation Date From	Start date of user summary
Creation Date To	End date of user summary
Organization	Organization of the user

### Fields

N/A

### Columns

The following table lists the columns of the report:

Report Column	Description
First Name	First name of the user
Last Name	Last name of the user
User ID	ID of the user
Organization	Organization of the user
Employee Status	Status of the user
Employee Type	Type of employee
Manager ID	ID of the Manager to whom the user reports
Source	User creation source
Creation Date	Date at which the user is created

## 24.3.6.4 Users Deleted

This report shows all the deleted users and their details based on input parameters.

### Input Parameters

The following table lists the input parameters for the report.

Report Parameter	Description
First Name	First name of the user
Last Name	Last name of the user
User ID	ID of the user
Organization	Organization of the user
Employee Type	Type of employee
Deletion Date From	Start date of summary of deleted users

Report Parameter	Description
Deletion Date To	End date of summary of deleted users
Organization	Organization of the user

#### Fields

N/A

#### Columns

The following table lists the columns of the report:

Report Column	Description
First Name	First name of the user
Last Name	Last name of the user
User ID	ID of the user
Organization	Organization of the user
Employee Type	Type of employee
Manager ID	ID of the Manager to whom the user reports
Source	User creation source
Deletion Date	Date at which the user is deleted

### 24.3.6.5 Users Disabled

This report provides the ability to view the details of users whose accounts are disabled. The account may be disabled for various reasons, for example, unsuccessful login or password reset attempts failure.

#### Input Parameters

The following table lists the input parameters for the report.

Report Parameter	Description
First Name	First name of the user
Last Name	Last name of the user
User ID	ID of the user
Organization	Organization of the user
Employee Type	Type of employee
Disabled Date From	Start date of user disabled
Disabled Date To	End date of user disabled
Organization	Organization of the user

#### Fields

N/A

#### Columns

The following table lists the columns of the report:

Report Column	Description
First Name	First name of the user
Last Name	Last name of the user
User ID	ID of the user
Organization	Organization of the user
Employee Status	Current status of the employee
Employee Type	Type of employee
Manager ID	ID of the Manager to whom the user reports
Source	User creation source
Disabled Date	Date at which the user is disabled
Updated By	Users who updated the record

### 24.3.6.6 Users Unlocked

This report provides the ability to view the details of users whose disabled accounts are unlocked by administrators. Delegated administrators of the organizations to whom the user belongs may enable the accounts.

#### Input Parameters

The following table lists the input parameters for the report.

Report Parameter	Description
First Name	First name of the user
Last Name	Last name of the user
User ID	ID of the user
Organization	Organization of the user
Employee Type	Type of employee
Unlocked Date From	Start date of user unlocked
Unlocked Date To	End date of user unlocked
Organization	Organization of the user

#### Fields

N/A

#### Columns

The following table lists the columns of the report:

Report Column	Description
First Name	First name of the user
Last Name	Last name of the user
User ID	ID of the user
Organization	Organization of the user
Employee Status	Status of the user

Report Column	Description
Employee Type	Type of employee
Manager ID	ID of the Manager to whom the user reports
Source	User creation source
Unlocked Date	Date at which the user is unlocked
Updated By	User who updated the record

## 24.3.7 Certification Reports

Certification reports select data from the certification tables of the Oracle Identity Manager database.

There are a list of predefined or default certification reports in Oracle Identity Manager. [Table 24-1](#) lists the default certification reports for each type of certification.

**Table 24-1 Default Certification Reports**

Certification Type	Certification Report	Description
User certification	Complete Certification Report	Presents comprehensive data of a user certification. This report includes a list of all employees and their access.
User certification	Certified Access Report	Lists access marked as certified.
User certification	Revoked Access Report	Lists access marked as revoked.
User certification	Abstained Access Report	Lists certification items that the certifier declined to complete because the certifier is not responsible for verifying the user's assigned roles and entitlements.
User certification	Certified Conditionally Access Report	Lists access that the certifier approved temporarily, even though the access may not be appropriate or justified in the long term. Reviewers are required to enter an end date, which is included in this report. However, the access is not revoked and notices are not sent out about expired end dates.
User certification	Complete Certification Task Report	Presents user-certification data based on certification tasks. This is a subset of the Complete Certification Report.
Role certification	Complete Certification Report	Presents comprehensive data of a role certification.
Role certification	Certified Access Report	Lists entitlements marked as certified.
Role certification	Revoked Access Report	Lists entitlements as revoked.
Role certification	Abstained Access Report	Lists certification items that the certifier declined to complete because the certifier is not responsible for verifying the role's assigned memberships.
Role certification	Certified Conditionally Access Report	Lists access that the certifier approved temporarily, even though the access may not be appropriate or justified in the long term. Reviewers are required to enter an end date, which is included in this report. However, the access is not revoked and notices are not sent out about expired end dates.
Role certification	Complete Certification Task Report	Presents role-certification data based on certification tasks. This is a subset of the Complete Certification Report.
Application instance certification	Complete Certification Report	Presents comprehensive data of an application instance certification.



**Table 24-1 (Cont.) Default Certification Reports**

Certification Type	Certification Report	Description
Application instance certification	Certified Access Report	Lists entitlements marked as certified.
Application instance certification	Revoked Access Report	Lists entitlements marked as revoked.
Application instance certification	Abstained Access Report	Lists certification items that the certifier declined to complete because the certifier is not responsible for verifying the application instances's assigned users and accounts.
Application instance certification	Certified Conditionally Access Report	Lists access that the certifier approved temporarily, even though the access may not be appropriate or justified in the long term. Reviewers are required to enter an end date, which is included in this report. However, the access is not revoked and notices are not sent out about expired end dates.
Application instance certification	Complete Certification Task Report	Presents certification data for application instances based on certification tasks. This is a subset of the Complete Certification Report.
Entitlement certification	Complete Certification Report	Presents comprehensive data of an entitlement certification.
Entitlement certification	Certified Access Report	Lists access marked as certified.
Entitlement certification	Revoked Access Report	Lists access marked as revoked.
Entitlement certification	Abstained Access Report	Lists certification items that the certifier declined to complete because the certifier is not responsible for verifying the entitlement's assigned accounts and attributes.
Entitlement certification	Certified Conditionally Access Report	Lists access that the certifier approved temporarily, even though the access may not be appropriate or justified in the long term. Reviewers are required to enter an end date, which is included in this report. However, the access is not revoked and notices are not sent out about expired end dates.
Entitlement certification	Complete Certification Task Report	Presents entitlement-certification data based on certification tasks. This is a subset of the Complete Certification Report.

## 24.3.8 Identity Audit Reports

An IDA Policy Violation report can be generated for a Policy, Scan Stop Date, Manager, Remediator or selected users.

IDA Policy Violation Reports are available for download from Reports link in the **Compliance** tab of Oracle Identity Self Service.

The following types of reports are available:

- **Closed Policy Violation Report:** Contains all the policy violations that are in Closed state.
- **Remediation Completed Policy Violation Report:** Contains all the policy violations that are in Remediation Completed state.
- **Expired Policy Violation Report:** Contains all the policy violations that are in Expired state.

- **Remediation In Progress Policy Violation Report:** Contains all the policy violations that are in Remediation In Progress state.
- **Remediation Under Review Policy Violation Report:** Contains all the policy violations that are in Remediation Under Review state.
- **Open Policy Violation Report:** Contains all the policy violations that are in Open state.
- **Preview Policy Violation Report:** Contains all the policy violations that are in Preview state.
- **Assigned Policy Violation Report:** Contains all the policy violations that are in Assigned state.

## 24.3.9 Exception Reports

The exception reports are Fine Grained Entitlement Exceptions By Resource, Orphaned Account Summary Report, and Rogue Accounts By Resource.

This section describes about the exception reports in the following topics:

- [About Exception Reports](#)
- [Fine Grained Entitlement Exceptions By Resource](#)
- [#unique\\_641](#)
- [#unique\\_642](#)
- [Orphaned Account Summary Report](#)
- [Rogue Accounts By Resource](#)

### 24.3.9.1 About Exception Reports

In Oracle Identity Manager, **exception** refers to the difference between accounts that a user is entitled to and the accounts that are actually assigned to a user. The user is assigned these accounts as a result of access policies, provisioning of resources, approval requests, and reconciliation events. Any difference of these accounts assigned to a user in the target system and the ones assigned to the user in Oracle Identity Manager comprises an exception. Exception reports are enabled by default.

Oracle Identity Manager provides the following exception reports:

- **Rogue Accounts By Resource**

This report returns a list of all the rogue accounts existing in a resource. The following exceptions are reported:

- Account exists in the target system, but has been deprovisioned for the corresponding user in Oracle Identity Manager
- Account exists and is active in the target system, but account does not exist in Oracle Identity Manager (user exists)
- Account exists and is active in the target system, but user does not exist in Oracle Identity Manager
- Account exists and is active in the target system, but Oracle Identity Manager user has been disabled
- Account exists and is active in the system target, but Oracle Identity Manager user has been deleted

- **Orphaned Account Summary Report:** An account that exists in the target system, but the corresponding user to whom the account is provisioned has been deleted in Oracle Identity Manager. For the given input resource, it lists the rogue accounts that exist in the target system, but the corresponding users to whom the accounts are provisioned has never existed in Oracle Identity Manager.
- **Fine Grained Entitlement Exceptions By Resource**  
This report returns a list of all the accounts in a resource for which the process form data being reconciled is different from the expected values. It means that this report returns any account existing in the target system that is also provisioned to the corresponding user in Oracle Identity Manager, but for which the process data does not match.

 **Note:**

- After completion of initial target reconciliation, all account-related activities performed directly on a target resource are tracked as exception activity. Account-related activities include account creation, account modification, and entitlement assignment/revocation. The exception reports should be used only if the organization policies enforce that all account-related activities in target resources would always be initiated in Oracle Identity Manager. In addition, remember that exception detection and recording are an extension of account data reconciliation and, therefore, may result in a drop in performance during reconciliation.
- All the exception reports depend on reconciliation data. Therefore, these reports will not display any data if the corresponding reconciliation events are archived.

### 24.3.9.2 Fine Grained Entitlement Exceptions By Resource

This report enables administrators, signing officers, internal and external auditors to analyze discrepancies in various process forms and related child tables of various resources and mitigate material weaknesses in the resources through remediation activities.

#### Input Parameters

The following table lists the input parameters for the report.

Report Parameter	Description
Resource Name	Name of the resource
First Name	First name of the user
Last Name	Last name of the user
User ID	ID of the user
Employee Type	Type of the employee such as fulltime, part time
Organization Name	Name of the organization
Role Name	Name of the role

#### Fields

The following table lists the fields of the report:

Report Field	Description
Resource Name	Name of the resource
User ID	ID of the user
First Name	First name of the user
Last Name	Last name of the use
Organization Name	Name of the organization
Employee Status	Status of the user
Employee Type	Type of the user
Reviewer First Name	First name of the reviewer
Reviewer Last Name	Last name of the reviewer
Unique ID Attribute	Unique ID attribute in account profile
Unique ID Value in Account Profile	Unique ID value in account profile

### Columns

The following table lists the columns of the report:

Report Column	Description
Form Name	Name of the form
Form Type	Type of the form
Form Field Name	Field name of the form
Expected Form Field Value	Old value of the field
Actual Form Field Value	New value of the field



#### Note:

Before running this report, you must populate data for account audit and reconciliation exceptions.

To populate the data for account audit and reconciliation exceptions:

1. Provision an user to any target.
2. Modify any of the user's attribute in the target and reconcile the user.
3. Find data in UPA\_UD\_FORMFIELDS and UPA\_UD\_FORMS tables.
4. Go to Oracle Identity Manger server and run RefreshMaterializedViewScheduler Task.
5. Log in to BIP and view the report.

### 24.3.9.3 Orphaned Account Summary Report

It lists the rogue accounts for the input resource for which a user existed in the target system, but the associated user to whom the account is provisioned never existed in Oracle Identity Manager.

#### Input Parameters

The following table lists the input parameters for the report.

Report Parameter	Description
Resource Name	Name of the resource
Reconciliation Date Range From	Start date of reconciliation
Reconciliation Date Range To	End date of reconciliation

#### Fields

N/A

#### Columns

The following table lists the columns of the report:

Report Column	Description
Resource	Name of the resource
Account Information	Information of the orphaned account
Account Detail	Details of the account associated with this orphaned account
Reconciliation Date	Date of reconciliation

### 24.3.9.4 Rogue Accounts By Resource

This report includes all rogue accounts for the input resource. This enables administrators, signing officers, internal and external auditors to identify material weaknesses in the resources and plan their mitigation through remediation activities.

#### Input Parameters

The following table lists the input parameters for the report.

Report Parameter	Description
Resource Name	Name of the resource
First Name	First name of the user
Last Name	Last name of the user
User ID	ID of the user
Organization Name	Organization of the user
User Status	Status of the user
User Type	Type of the user
Exception Type	Type of exception

#### Fields

The following table lists the fields of the report:

Report Field	Description
Resource Type	Type of resource

#### Columns

The following table lists the columns of the report:

Report Column	Description
Exception Type	Type of exception
First Name	First name of the user
Last Name	Last name of the user
User ID	ID of the user
Organization	Organization of the user
User Status	Status of the user
User Type	Type of the user
Account Details	Details of the rogue account
Reviewer First Name	First name of the reviewer
Reviewer Last Name	Last name of the reviewer
Reviewer User ID	User ID of the reviewer

## 24.4 Required Scheduled Tasks for Oracle Analytics Server Reports

The RefreshMaterializedView, IssueAuditTask, Entitlement List, Entitlement Assignment, and Entitlement Updates scheduled tasks are required for Oracle Analytics Server reports.

Table 24-2 lists the scheduled tasks required for Oracle Analytics Server reports:

**Table 24-2 Scheduled Tasks for Oracle Analytics Server Reports**

Report Name	Scheduled Task Name	Description
Fine Grained Entitlement Exceptions By Resource	RefreshMaterializedView	To refresh the Materialized View used in this report with the latest data
User Profile History	IssueAuditTask	To populate the audit tables with the latest data
User Unlocked	IssueAuditTask	To populate the audit tables with the latest data
User Membership History	IssueAuditTask	To populate the audit tables with the latest data
Role Membership History	IssueAuditTask	To populate the audit tables with the latest data
Resource Access List History	IssueAuditTask	To populate the audit tables with the latest data
User Resource Access History	IssueAuditTask	To populate the audit tables with the latest data
Resource Activity Summary	IssueAuditTask	To populate the audit tables with the latest data
Password Reset Summary	IssueAuditTask	To populate the audit tables with the latest data
Entitlement Reports	Entitlement List	To populate the Entitlement List table with the marked entitlements
Entitlement Reports	Entitlement Assignment	To populate the Entitlement Assignment tables with the assigned entitlements
Entitlement Reports	Entitlement Updates	To populate the latest data into the Entitlement Assignment tables, if any entitlement has assigned to any user periodically or later

## 24.5 Best Practices for Running Oracle Identity Governance Reports

Some of the best practices to be followed for Oracle Analytics Server reports include not running the reports with null value in date range parameters and running the reports with the set of values as input parameters to provide the selectivity.

As a best practice, you must consider the following points before running Oracle Analytics Server reports:

- Do not run Oracle Identity Manager reports with null value in date range parameters. You must run Oracle Identity Manager reports always with date range values in data range parameters, otherwise report will not display anything.
- Invoke the reports with the set of values as input parameters to provide the selectivity, thus improving the performance.
- By default, the System Administrator user of Oracle Identity Manager has all the permissions to login to Oracle Analytics Server and access all the Oracle Identity Manager Reports.

# Using the Archival and Purge Utilities for Controlling Data Growth

Data archival and purge solution involves real-time archival and purge and command-line option of the archival purge utilities.

This chapter contains the following sections:

- [About Archival and Purge Utilities](#)
- [Archival and Purge Concepts](#)
- [Using Real-Time Purge and Archival Option in Oracle Identity Governance](#)
- [Using Command-Line Option of the Archival Purge Utilities in Oracle Identity Governance](#)
- [Using the Audit Archival and Purge Utility](#)
- [Using the Real-Time Certification Purge in Oracle Identity Governance](#)
- [#unique\\_650](#)
- [#unique\\_651](#)



## Note:

- Oracle recommends that you use the real-time purge and archival option rather than the command-line utilities.
- The archival and purge utilities (scheduled task-based and command-line) only purge data from the underlying Oracle Identity Manager tables, and do not reclaim space. For information about reclaiming space, see the document titled *How To Reclaim Space For Overgrown/Huge Footprint Of LOB Columns In OIM Database* (Doc ID 2017034.1) in the My Oracle Support web site at the following URL:  
<https://support.oracle.com>

## 25.1 About Archival and Purge Utilities

Oracle Identity Manager provides archival and purge solutions for its entities and their dependant data.

The application capabilities in Oracle Identity Manager generate a large volume of data. To meet the standards of performance and scalability, maintaining the data generated for the life cycle management of Oracle Identity Manager entities is a challenge. Oracle Identity Manager meets this challenge by providing online and continuous as well as offline data purge and archival solutions.

[Table 25-1](#) lists the archival and purge solutions provided by Oracle Identity Manager for its entities and their dependent data.



**Table 25-1 Archival and Purge Solutions**

Archival and Purge for Entities	Real-time Online Mode	Operated via Command Line	Available via Other Modes
Reconciliation	Yes	Yes	
Provisioning Tasks	Yes	Yes	
Request	Yes	Yes	
Orchestration	Yes	No	
Certification	Yes	No	
Legacy Audit	Yes	No	For more information on partition-based approach, see <a href="#">About Audit Data Growth Control Measures in Legacy Audit Framework</a> .
Lightweight Audit	Yes	No	For more information on partition-based approach, see <a href="#">About Audit Data Growth Control Measures in Lightweight Audit Framework</a> .

## 25.2 Archival and Purge Concepts

Archival and purge concepts include purge-only or archive solution, archival and purging of data, retention period, and modes of archival purge operations.

This section contains the following topics:

- [Purge Only Solution Versus Purge and Archive Solution for Entities](#)
- [Archival of Data in Oracle Identity Governance](#)
- [Purging of Data in Oracle Identity Governance](#)
- [Real-Time Purging in Oracle Identity Governance](#)
- [Retention Period in Oracle Identity Governance](#)
- [Modes of Archival Purge Operations](#)

### 25.2.1 Purge Only Solution Versus Purge and Archive Solution for Entities

The purge only solution and the purge plus archive solution is applicable to the real-time purge and archival feature.

Oracle Identity Manager entities are divided into the following on the basis of how the data related to them are purged and archived from the perspective of real-time purge archival feature:

- **Purge only:** Entities for which data is directly purged but not archived. These entities are Reconciliation, Provisioning Tasks, Orchestration, and Legacy Audit (UPA).
- **Purge and archive:** Entities for which data is purged as well as archived. This is applicable to the Request, Reconciliation Exceptions and Certification entities.

 **Note:**

The real-time purge and archival solution provides data purge capabilities on a continuous basis. In addition, you can use the command-line archival utilities periodically to archive data, if required. There is no such categorization of entities in their command-line archive purge utilities version. They essentially archive prior to purge. For details about the command-line archival utilities, see [Using Command-Line Option of the Archival Purge Utilities in Oracle Identity Governance](#).

## 25.2.2 Archival of Data in Oracle Identity Governance

Archival (prior to purge) is the standard mechanism followed in Oracle Identity Manager command-line utilities that offer for deleting data from the Active Feature or Entity tables.

Archival of data is done by copying the data to a shadow copy or replica of the original table, typically with a suffix `ARCH_TABLE_NAME`. Archive operation precedes purge in data purge solutions for entities in the Purge and Archive category.

## 25.2.3 Purging of Data in Oracle Identity Governance

Purging of data is the mechanism to delete or purge data from the Active Feature or Entity tables without any preceding archive operation.

Data purged is non-recoverable in Oracle Identity Manager.

## 25.2.4 Real-Time Purging in Oracle Identity Governance

Real-time purge denotes that data is deleted or purged when Oracle Identity Manager is up and running and is available irrespective of the feature invocation, concurrency, or workload.

However, in contrast to the literal meaning of real-time, entity data created in the system is not deleted immediately.

## 25.2.5 Retention Period in Oracle Identity Governance

Retention period defines the age of the data that needs to be retained in Oracle Identity Manager for functional usage and compliance purpose.

Data is deleted based on the age defined by the retention period value for the entity data in question. The Retention Period attribute must be defined for the real-time purge feature via the OIM Data Purge scheduled job user interface.

## 25.2.6 Modes of Archival Purge Operations

Archival purge operations can be run in online or offline modes.

Archival purge operations can be performed in the following modes:

- **Offline mode:** In this mode, archival and purge of data renders Oracle Identity Manager unusable for the time period it is being run. Because the entire operation being database-intensive, it disables the constraints/indexes at the beginning, copies, deletes the data from the entity tables, and re-enables the post deletion. This is for attaining the maximum performance in the delete operation and eliminating possibilities of functional

inconsistencies in the data entered in the window of deletion with table-level constraints disabled. Therefore, any transactional-level changes from Oracle Identity Manager usage is not advised, and as a result, the system is offline from the usage perspective.

- **Online mode:** In this mode, archival and purge of data happens with the entire database-level indexes/constraints enabled as usual. Therefore, Oracle Identity Manager usage can be continued in online mode from the operational perspective.

 **Note:**

Real-time purge supports online mode only. Command-line Archival Purge Utilities support both online and offline modes based on the user input.

## 25.3 Using Real-Time Purge and Archival Option in Oracle Identity Governance

Oracle Identity Manager provides a real-time and continuous data purge solution to meet the standards of performance and scalability by maintaining the data generated for the life cycle management of various entities.

Information about using real-time and continuous data purge solution is described in the following sections:

- [About Real-Time Data Purge and Archival](#)
- [Configuring Real-Time Purge and Archival](#)
- [About the Orchestration Purge Utility](#)
- [#unique\\_661](#)
- [Collecting Diagnostic Data of the Online Archival and Purge Operations](#)

### 25.3.1 About Real-Time Data Purge and Archival

The real-time purge and archival capability is provided by default in Oracle Identity Manager. Entity data can be continuously purged through this based on the options.

The configuration is one time and the purge solution works automatically without any intervention from the administrator.

The real-time purge and archival has the following features:

- The administrators provides values for some critical parameters, such as retention period, run duration, and purge criteria, for entities by using the Scheduled Tasks section of Oracle Identity System Administration.
- Diagnostic information about each purge run is captured as a log.
- Purge tasks run periodically.
- The entity modules, such as Request, Reconciliation, Reconciliation Exceptions, Task, Orchestration, and Legacy Audit is purged according to the allotted time duration.
- The purge solution is fail safe. This means that in the event of a situation, the system does not endlessly consume CPU cycles. A fail-safe design has a minimum impact on other modules. The fail-safe capability is provided by:

- Maximum Run Time for Auto-Cutoff in Purge Run for each Entity: Each run of the purge utility is governed by the value of the Maximum Purge Run Time parameter, the value of which is in minutes. Purge automatically stops when this maximum purge run duration is exceeded. This is provided at the each entity level so that you can control the Purge Time Period allocation at the feature level.

Each batch picked up for deletion is aware of the time factor. When the time factor exceeds, the next batch is skipped and the utility's flow of control comes to completion.

The Maximum Purge Run Time in minutes for each entity can be specified in the scheduled task UI.

- Single-threaded batching: The purge operation accepts a batch size, which is the maximum number of rows to delete before a commit is issued. This keeps the redo log segments from growing too large when purge is applied to a large number of rows. The batch size is accepted from the scheduled task interface for the purge run operation.
- Data growth and subsequent footprint is controlled on an on-going basis.
- It operates online with no disruption of service.
- The purge operation via an automated scheduled task runs silently at a predefined periodicity and is non-interactive. Various metrics related to the purge operation, such as names of the entity modules, success or failure status, and number of rows targeted for deletion, are logged. These logs are diagnostic pointers for the purge operation for every run.
- The volume of data purged through the Real-time Purge Utilities Framework is a function of a few inputs, such as time duration window, entities selected, and existing workload. There might be instances when outflow of data in Oracle Identity Manager via this purge functionality is less than the inflow, which means that there would be some data volume accumulating in the system. This can be then purged via the Command-Line Archival/ Purge Utilities at a reasonable point in time.

## 25.3.2 Configuring Real-Time Purge and Archival

Entity data via the Purge solution is continuously purged based on the options or choices that you make when you configure running of the utility. You can modify these options based on data retention policies and maintenance requirements.

To configure real-time purge and archival:

1. Log in to Oracle Identity System Administration.
2. Under System Management, click **Scheduler**.
3. Search and open the `OIM Data Purge Job` or `OIM Recon Exceptions Purge Job` scheduled job.
4. In the Parameters section, specify values for the parameters, as described in [Table 25-2](#):

**Table 25-2 Purge Configuration Parameters**

Category	Parameter	Description	Default Value
Global parameters	Batch Size	The purge operation runs in batches. It represents the maximum number of rows to delete before a commit is issued.	5000

**Table 25-2 (Cont.) Purge Configuration Parameters**

Category	Parameter	Description	Default Value
Global parameters	Maximum Purge Run Duration Per Entity(in Mins)	This is the maximum run duration in minutes for purge processing for each entity.	30 mins
Orchestration purge parameters	Orchestration Entity Selection	This specifies whether or not data is to be purged from orchestration tables.	Yes
Orchestration purge parameters	Orchestration Purge Criteria	This takes the following values: <ul style="list-style-type: none"> <li>• 1 for completed orchestrations</li> <li>• 2 for failed, compensated, canceled, or canceled with compensation orchestrations</li> <li>• 3 for both 1 and 2</li> </ul>	1
Orchestration purge parameters	Orchestration[COMPLETED] Retention Period(in days)	This indicates the retention period in days for completed orchestrations.	1 day
Orchestration purge parameters	Orchestration[OTHERS] Retention Period(in days)	This indicates the retention period in days for failed, compensated, or other orchestrations	30 days
Provisioning task purge parameters	Provisioning Task Entity Selection	This specifies whether or not data is to be purged from provisioning task tables.	Yes
Provisioning task purge parameters	Provisioning Tasks Purge Criteria	This takes the following values: <ul style="list-style-type: none"> <li>• 1 for completed provisioning tasks</li> <li>• 2 for completed and canceled provisioning tasks</li> </ul>	1
Provisioning task purge parameters	Provisioning Tasks Retention Period(in days)	This indicates the retention period in days for provisioning tasks.	90 days
Reconciliation purge parameters	Recon Entity Selection	This specified whether or not data is to be purged from reconciliation tables.	Yes
Reconciliation purge parameters	Recon Purge Criteria	This takes the following values: <ul style="list-style-type: none"> <li>• 1 for completed reconciliation events</li> <li>• 2 for linked reconciliation events</li> <li>• 3 for both 1 and 2</li> </ul>	1
Reconciliation purge parameters	Recon Exceptions Purge Criteria	This takes the following values: <ul style="list-style-type: none"> <li>• 1 for completed reconciliation events</li> <li>• 2 for linked reconciliation events</li> <li>• 3 for both 1 and 2</li> <li>• 4 for ALL reconciliation events</li> </ul>	
Reconciliation purge parameters	Recon Retention Period(in days)	This indicates the retention period in days for reconciliation events.	180 days
Request purge parameters	Request Entity Selection	This specifies whether or not data is to be purged from request tables.	No
Request purge parameters	Request Purge Criteria	This takes the following values: <ul style="list-style-type: none"> <li>• 1 for completed requests</li> <li>• 2 for failed requests</li> <li>• 3 for completed and failed requests</li> </ul>	1
Request purge parameters	Request Retention Period(in days)	This indicates the retention period in days for requests.	90 days

**Table 25-2 (Cont.) Purge Configuration Parameters**

Category	Parameter	Description	Default Value
Legacy Audit (UPA)	User Audit Entity Selection	This specifies whether or not data is to be purged from audit table.	Yes
<div style="border: 1px solid #0070C0; padding: 10px; background-color: #E6F2FF;"> <p> <b>Note:</b></p> <p>After you upgrade to Oracle Identity Governance 12c (12.2.1.3.0) from an earlier release, for all the scheduled jobs defined against the OIM Data Purge Task scheduled task, the User Audit Entity Selection parameter value is No. As a result, the existing OIM data is not automatically purged without notifying the user. If you want to start the data purge per this job definition, then change the value of the User Audit Entity Selection parameter to Yes.</p> </div>			
Legacy Audit (UPA)	User Audit Retention Period (in days)	This indicates the retention period in days for user audit.	365

 **Note:**

By default, the 'OIM Data Purge Job' scheduled job is available in the enabled state with a retention period of 90 days. You must revisit the job parameters to disable or to change the purge interval as required.

**5. Click **Apply**.**

In addition to the steps on the Scheduled Task UI for configuration inputs documented in this section, there are no further steps required manually, such as archival tablespace creation. All the steps in the subsequent sections are for running the command-line version of the utilities.

 **Note:**

- For Real-time Archival Purge operation via Scheduled Task interface, Retention Period must not be specified as ZERO as this can cause inconsistencies in purge operation.
- Simultaneous runs of multiple OIM Data Purge Job scheduled jobs is not supported via instantiation of the Scheduled Task functionality.
- There should be no overlap of archival/purge utility run for an entity from both modes in Oracle Identity Manager, which are scheduled task and command-line modes.
- For details of the purge internals, such as tables that undergo purge for Request, Reconciliation, and Provisioning Tasks, refer to the subsequent sections of the command-line utilities. Both real-time scheduled job-based purge and command-line archival utilities purge data from the same set of table for an entity.
- If database is restarted when any scheduled job is running, then the job is stuck in RUNNING status. You need to restarting the scheduler service to stop all the jobs which are stuck in RUNNING status.

For more information on how to stop the scheduled services, see [Starting and Stopping the Scheduler](#).

### 25.3.3 About the Orchestration Purge Utility

Orchestration data purge takes place from the active orchestration tables via the unified OIM Data Purge Job scheduled job interface.

Orchestration data purge is based on the following criteria:

 **Note:**

Orchestration purge is available only in online mode and via the scheduled job interface.

- Orchestration process status, such as Completed, Failed, Compensated, Canceled, or Canceled with Compensation.
- Time-based criteria, which is specified via the retention period value specified in days on the scheduled job interface.

The following active orchestration tables undergo purge via the Orchestration Purge feature:

- ORCHPROCESS
- CALLBACK\_INVOCATION\_RESULT

## 25.3.4 Collecting Diagnostic Data of the Online Archival and Purge Operations

You can capture and communicate the various metrics and diagnostic data related to the archival and purge operation.

The Real-Time Purge and Archival operation via the automated scheduled task runs silently at a predefined periodicity and is non-interactive. However, you can capture and communicate the various metrics related to the purge operation, such as:

- Names of the Entity modules that were picked
- Success/failure status
- Exceptions encountered during the run
- Number of rows targeted for deletion
- Actual number of rows purged

At a minimum, these metrics are logged for every run. At any point in time, data of the most recent 500 runs is available.

The following diagnostic logging tables are part of the Real-Time Purge and Archival operation to store the diagnostic information of the entity purge runs:

- **OIM\_DATAPURGE\_TASK\_LOG:** Stores the critical information related to the purge runs controlled by the scheduled task for the deletion of Entity data.

[Table 25-3](#) lists the columns of the OIM\_DATAPURGE\_TASK\_LOG table.

**Table 25-3 Columns of the OIM\_DATAPURGE\_TASK\_LOG Table**

Column	Description
OIM_DATAPRGTASK_KEY	Stores keys to uniquely identify tasks
OIM_DATAPRG_ID	Stores unique purge name
SCH_JOB_ID	Stores the Job ID of the scheduled task as assigned by the Scheduler
EXECUTION_MODE	The execution mode of the purge run, which is SCH for scheduled task mode.
PURGERUN_START_TIME	Stores the start time of the entire purge run
PURGERUN_END_TIME	Stores the end time of the entire purge run



**Table 25-3 (Cont.) Columns of the OIM\_DATAPURGE\_TASK\_LOG Table**

Column	Description
PURGERUN_STATUS	<p>Stores the overall status of the purge run, which can be any one of the following during the run:</p> <ul style="list-style-type: none"> <li>– STARTED</li> <li>– COMPLETED</li> <li>– ERRORED_OUT</li> </ul> <p>Task-level purge run could not proceed due to run-time errors. The root cause can be further probed into via the PURGE_RUN_NOTE column that stores the exception stack trace.</p> <ul style="list-style-type: none"> <li>– COMPLETED WITH ERROR</li> </ul> <p>Task-level purge run has completed but one of its modules could not get completed within the allotted time or encountered some run-time errors. The root cause can be further probed into via the PURGE_RUN_NOTE column that stores the exception stack trace.</p>
PURGE_RUN_NOTE	Stores the task-level exception details at the purge run

- **OIM\_DATAPRG\_TASKS\_LOGDTLS:** Stores the critical information related to the Module or Entity-level purge runs controlled by the scheduled task.

[Table 25-4](#) lists the columns of the OIM\_DATAPRG\_TASKS\_LOGDTLS table.

**Table 25-4 Columns of the OIM\_DATAPRG\_TASKS\_LOGDTLS Table**

Column	Description
OIM_DATPRGLOGDET_KEY	Stores keys to uniquely identify a module in a task
OIM_DATAPRGTASK_KEY	Stores the logical foreign key for the OIM_ENTITYPURGE_TASK_LOG table
MOD_NAME	<p>Stores the module name, such as:</p> <ul style="list-style-type: none"> <li>– RECON</li> <li>– REQUEST</li> <li>– ORCH</li> <li>– PROVTASKS</li> <li>– AUDIT</li> <li>– RECON EXCEPTIONS</li> </ul>
EST_ALLOCT_TIME	Stores the time allocated for the module purge run

**Table 25-4 (Cont.) Columns of the OIM\_DATAPRG\_TASKS\_LOGDTLS Table**

Column	Description
MOD_STATUS	<p>Stores the module status, which can be any one of the following during the run:</p> <ul style="list-style-type: none"> <li>– STARTED</li> <li>– COMPLETED</li> <li>– COMPLETED WITH ERROR</li> </ul> <p>Module or Entity purge run has completed within the allotted time duration but encountered errors during its execution. The root cause can be further probed into via the MOD_PURGE_RUN_NOTE column that stores the exception stack trace.</p> <ul style="list-style-type: none"> <li>– ERRORED_OUT</li> </ul> <p>Module or Entity purge run could not proceed because of run-time errors. The root cause can be further probed into via the MOD_PURGE_RUN_NOTE column that stores the exception stack trace.</p> <ul style="list-style-type: none"> <li>– PARTIALLY COMPLETED</li> </ul> <p>Module or Entity purge run is unable to complete within the allotted time duration. This is an acceptable functional state of completion. The root cause can be further probed into via the MOD_PURGE_RUN_NOTE column that stores the exception stack trace.</p> <ul style="list-style-type: none"> <li>– PARTIALLY_COMPLETED WITH ERROR</li> </ul> <p>Module or Entity purge run could not complete within the allotted time duration but also encountered errors during its execution. The root cause can be further probed into via the MOD_PURGE_RUN_NOTE column that stores the exception stack trace.</p>
MODPURGERUN_START_TIME	Stores the start time of the module purge run
MODPURGERUN_END_TIME	Stores the end time of the module purge run
EST_PURGE_ROW_CNT	Stores the driving table target row count for purge run for the module
ACTUAL_PURGE_ROW_COUNT	Stores the actual driving table rows deleted during purge run
MOD_PURGE_RUN_NOTE	Stores the exception or other information encountered at module level

- **OIM\_DATAPRG\_FAILED\_KEYS:** Stores the entity keys for each Module or Entity that have failed during the scheduled purge run.

[Table 25-5](#) lists the columns of the OIM\_DATAPRG\_FAILED\_KEYS table.

**Table 25-5 Columns of the OIM\_DATAPRG\_FAILED\_KEYS Table**

Column	Description
OIM_DATAPRGFAILED_KEY	Stores keys to uniquely identify a failed task
OIM_DATAPRGTASK_KEY	Stores the logical foreign key for the OIM_ENTITYPURGE_TASK_LOG table
MOD_NAME	Stores the module name for which the purge run fails
MOD_ENTITY_KEY	Stores the driving table key for each module

**Table 25-5 (Cont.) Columns of the OIM\_DATAPRG\_FAILED\_KEYS Table**

Column	Description
ERROR_NOTE	Stores the exception stack trace

The OIM\_DATAPURGE\_TASK\_LOG and OIM\_DATAPRG\_TASKS\_LOGDTLS tables contain the data of the last 500 runs. The OIM\_DATAPRG\_FAILED\_KEYS table stores the failed keys data for the last run only.

**Note:**

For troubleshooting issues in the PL/SQL layer during OIM Data Purge scheduled task run, see [Using the PL/SQL Unified Diagnostic Logging and Debugging Framework](#).

## 25.4 Using Command-Line Option of the Archival Purge Utilities in Oracle Identity Governance

The command-line option of the archival purge utilities includes the Reconciliation Archival Utility, Task Archival Utility, and Requests Archival Utility.

This section describes how to use the command-line archival purge utilities. It contains the following topics:

- [About Command-Line Utilities](#)
- [Using the Reconciliation Archival Utility](#)
- [Using the Task Archival Utility](#)
- [Using the Requests Archival Utility](#)

**Note:**

You can use the Reconciliation Archival utility, the Task Archival utility, and the Requests Archival utility in both offline and online modes.

### 25.4.1 About Command-Line Utilities

Oracle Identity Manager provides archival and purge of entity data via command-line utilities option for three entities, namely reconciliation, provisioning tasks, and requests..

All the command-line utilities are part of Oracle Identity Manager installation and are interactive to capture user-specified parameters to archive and purge entity data. These utilities are available for both Linux and Microsoft Windows operating system environments.

### 25.4.2 Using the Reconciliation Archival Utility

You can use the Reconciliation Archival utility to archive data that has been reconciled with Oracle Identity Manager. This involves meeting the prerequisites, understanding the archival

criteria for reconciliation data, running the utility, understanding the logs generated, and troubleshooting any issues.

This section describes how to use the Reconciliation Archival utility. It contains the following topics:

- [About the Reconciliation Archival Utility](#)
- [Prerequisite for Running the Reconciliation Archival Utility](#)
- [Archival Criteria for Reconciliation Data](#)
- [Running the Reconciliation Archival Utility](#)
- [Log File Generated by the Reconciliation Archival Utility](#)
- [Troubleshooting Scenario for Reconciliation Archival Utility](#)

### 25.4.2.1 About the Reconciliation Archival Utility

Oracle Identity Manager stores reconciliation data from target systems in Oracle Identity Manager tables called **active reconciliation tables**:

During the reconciliation process, Reconciliation Manager reconciles data in the active reconciliation tables with the Oracle Identity Manager core tables. Because Reconciliation Manager does not remove reconciled data from the active reconciliation tables, they might eventually grow very large, resulting in decreased performance during the reconciliation process. You can use the Reconciliation Archival utility to archive data that has been reconciled with Oracle Identity Manager. The Reconciliation Archival utility stores archived data in the **archive reconciliation tables**, which have the same structure as the active reconciliation tables.

[Table 25-6](#) lists the active reconciliation tables with the corresponding archive reconciliation tables in which data from the active reconciliation tables are archived.

**Table 25-6 Active and Archive Reconciliation Tables**

Active Reconciliation Tables (Oracle Identity Manager Tables)	Archive Reconciliation Tables
RECON_EVENTS	ARCH_RECON_EVENTS
RECON_JOBS	ARCH_RECON_JOBS
RECON_BATCHES	ARCH_RECON_BATCHES
RECON_EVENT_ASSIGNMENT	ARCH_RECON_EVENT_ASSIGNMENT
RECON_HISTORY	ARCH_RECON_HISTORY
RECON_USER_MATCH	ARCH_RECON_USER_MATCH
RECON_ACCOUNT_MATCH	ARCH_RECON_ACCOUNT_MATCH
RECON_CHILD_MATCH	ARCH_RECON_CHILD_MATCH
RECON_ORG_MATCH	ARCH_RECON_ORG_MATCH
RECON_ROLE_MATCH	ARCH_RECON_ROLE_MATCH
RECON_ROLE_HIERARCHY_MATCH	ARCH_RECON_ROLE_HIER_MATCH
RECON_ROLE_MEMBER_MATCH	ARCH_RECON_ROLE_MEMBER_MATCH
RA_LDAPUSER	ARCH_RA_LDAPUSER
RA_MLS_LDAPUSER	ARCH_RA_MLS_LDAPUSER
RA_LDAPROLE	ARCH_RA_LDAPROLE

**Table 25-6 (Cont.) Active and Archive Reconciliation Tables**

Active Reconciliation Tables (Oracle Identity Manager Tables)	Archive Reconciliation Tables
RA_MLS_LDAPROLE	ARCH_RA_MLS_LDAPROLE
RA_LDAPROLEMEMBERSHIP	ARCH_RA_LDAPROLEMEMBERSHIP
RA_LDAPROLEHIERARCHY	ARCH_RA_LDAPROLEHIERARCHY
All horizontal tables mentioned under RECON_TABLES	"ARCH_" + first 25 characters of the horizontal tables (RA_* tables)

 **Note:**

Data from RECON\_EXCEPTION table will not be archived and purged. This is due to Oracle Identity Manager predefined BIP Report dependency. The data from RECON\_EXCEPTION table can be purged by running the scheduled task.

The Reconciliation Archival utility performs the following tasks:

- Archives all or specific data from the active reconciliation tables to the archive reconciliation tables
- Deletes all data from the active reconciliation tables

The Reconciliation Archival Utility archives data by moving it from the active reconciliation tables to the archive reconciliation tables based on the following two-fold criteria per the user inputs:

- The date- based criteria, which is the reconciliation event creation date. This must be specified in the YYYYMMDD format. All records on or before this date will be archived.
- The functional reconciliation event state-based criteria, which is the reconciliation event status. This must be selected from the prompted status options when the utility is run.

For information about the archiving criteria, refer to [Archival Criteria for Reconciliation Data](#).

If you choose to archive selective data, then the utility archives reconciliation data based on selected event status that have been created on or before the specified date and event status.

When you archive all data from the active reconciliation tables to the archive reconciliation tables, the Reconciliation Archival utility archives all reconciliation data that have been created on or before the specified date.

The files that constitute the Oracle Database version of the Reconciliation Archival utility are located in the following directory:

```
OIM_HOME/server/db/oim/oracle/Utilities/Recon1lgArchival
```

You can run the Reconciliation Archival utility in offline mode with Oracle Identity Manager stopped, or in online mode with Oracle Identity Manager running.

Before running the utility in offline mode, you must stop Oracle Identity Manager.

## 25.4.2.2 Prerequisite for Running the Reconciliation Archival Utility

Before running the Reconciliation Archival utility, the OIM\_RECON\_ARCH tablespace must be created in the database. To do so, you can run the following sample command as a DBA privilege user, for instance SYS or SYSTEM.

```
CREATE TABLESPACE OIM_RECON_ARCH
  LOGGING DATAFILE 'ORADATA/OIM_RECON_ARCH.dbf'
  SIZE 500M REUSE AUTOEXTEND ON NEXT 10M;
```

### Note:

- You must replace *ORADATA* in the preceding sample command with the full path to your *ORADATA* directory.
- You must set *LD\_LIBRARY\_PATH* to start Oracle utilities such as SQL\*Plus in the environment where you want to run Oracle Identity Manager utilities.
- Data that has been archived from the active reconciliation tables to the archive reconciliation tables will no longer be available through Oracle Identity Manager. To access this data, you must query the archive reconciliation tables in your Oracle Identity Manager database.

If you are using ASM, Exadata (ASM) or Oracle Managed Files (OMF), then follow the instructions described here.

If you are using ASM, then you can use the name of a diskgroup say *DATA 1* to create the tablespace in the database as follows:

```
CREATE TABLESPACE OIM_RECON_ARCH
  LOGGING DATAFILE '+DATA1'
  SIZE 500M AUTOEXTEND ON NEXT 10M;
```

If you are using Oracle Managed Files, then you can omit the datafile and run the command as follows:

```
CREATE TABLESPACE OIM_RECON_ARCH
  LOGGING DATAFILE
  SIZE 500M AUTOEXTEND ON NEXT 10M;
```

If you want to run the utility in offline mode, then you must stop Oracle Identity Manager before running the utility.

## 25.4.2.3 Archival Criteria for Reconciliation Data

To select reconciliation data to archive, provide the following criteria. Data with matching values and having no reference in *RECON\_EXCEPTION* table will be archived and purged.

1. Date must be in the format *YYYYMMDD*. All records on or before this date that match the specified reconciliation event parameter value will be archived.
2. Select *Closed*, *Linked*, or *Closed and Linked* for the reconciliation event parameter.
  - *Closed* describes events that have been manually closed in Reconciliation Manager, that is, any recon events with status as Event Closed.

- Linked describes events that were reconciled in Oracle Identity Manager, including the Creation Succeeded, Update Succeeded, and Delete Succeeded states.
- Closed or Linked.
- Select status for reconciliation events to be archived. Enter 1 for Closed status, enter 2 for Linked status, enter 3 for Closed and Linked status, and enter 4 for Exit status.

### 25.4.2.4 Running the Reconciliation Archival Utility

To run the Reconciliation Archival utility:

1. Ensure that the Oracle Identity Manager database is available and that no reconciliation processes are running.

 **Note:**

Oracle recommends that you run the Reconciliation Archival utility during off-peak hours.

2. If you want to run the utility in offline mode, then stop Oracle Identity Manager.

To run the utility in online mode, ignore this step and proceed to step 3.

3. On Microsoft Windows platforms, you must specify the short date format as M/d/yyyy. In addition, you must specify the time format as H:mm:ss. To customize the date and time formats, use the Regional and Language Options command in Control Panel.

 **Note:**

- When you change the date and time format, the change is applied to all the applications running on the Microsoft Windows platform.
- Minimal validation is done on date before calling the utility, and you can scan logs files for any ORA-18xx errors for invalid date-related errors.

4. On Linux or UNIX platforms, run the following commands to set execution permission for the oim\_recon\_archival.sh file and to ensure that the file is a valid Linux or UNIX text file:

```
chmod 755 path/oim_recon_archival.sh
dos2unix path/oim_recon_archival.sh
```

5. On Linux or UNIX platforms, run the *path/oim\_recon\_archival.sh* file to run the utility.

On Microsoft Windows platforms, run the *path\oim\_recon\_archival.bat* file to run the utility.

6. For Oracle Database installations, enter values for the following parameters when prompted:

- Oracle home directory
- Oracle Identity Manager database user name and password

7. Enter the reconciliation creation date in the YYYYMMDD format. All records on or before this date with required status value will be archived.

8. When prompted, select a reconciliation event status for the data that you want to archive:
  - Enter 1 for Closed

- Enter 2 for Linked
  - Enter 3 for Closed or Linked
  - Enter 4 for Exit
9. When prompted to specify the mode of running the utility, enter 1 if you want to run the utility in online mode. Otherwise, enter 2 to run the utility in offline mode.
  10. Enter the batch size for processing.  
The default batch size is 5000.

 **Note:**

Batch size is a value for the number of records to be processed in a single iteration of archival/purge, also as an internal commit at the database level. You must provide the batch size as an input parameter value while starting the operation of Archival Utilities at run time.

This batch size by default is 5000. When purging greater than few hundred thousand recon\_events, a higher batch size can be opted for. This may need more resources from RDBMS, such as more space from the TEMP and UNDO tablespaces.

The utility archives the reconciliation data and provides an execution summary in a log file.

11. On Microsoft Windows platforms, reset the short date format to the date format for your region or locale after you run the utility. Use the Regional and Language Options command in Control Panel to reset the date format.
12. Because the data from active reconciliation tables are removed, your DBA must analyze the active reconciliation tables and their indexes in order to update the statistics.

### 25.4.2.5 Log File Generated by the Reconciliation Archival Utility

After running the Reconciliation Archival utility, if the following error is encountered:

```
ORA-01034: ORACLE not available or ORA-27101: shared memory realm does not exist
```

Then check whether the target instance is up and running. If not, then contact the DBA, and bring up the instance. Ensure that target instance is accessible with OIM DB user credentials using SQLPLUS command.

### 25.4.2.6 Troubleshooting Scenario for Reconciliation Archival Utility

While running the Reconciliation Archival utility, if the following error is encountered:

```
ORA-01034: ORACLE not available, ORA-27101: shared memory realm does not exist
```

Then, verify whether the target instance is up and running. If not, then contact the database administrator, and bring up the instance. Ensure that the target instance is accessible with Oracle Identity Manager database user credentials by using the SQLPLUS command.



## 25.4.3 Using the Task Archival Utility

You can use the Task Archival utility to archive the task data and remove it from the active task tables. This involves preparing the database, running the utility, and reviewing the generated output files.

This section describes how to use the Task Archival utility. It contains the following topics:

- [About the Task Archival Utility](#)
- [Preparing Oracle Database for the Task Archival Utility](#)
- [Running the Task Archival Utility](#)
- [Reviewing the Output Files Generated by the Task Archival Utility](#)

### 25.4.3.1 About the Task Archival Utility

In Oracle Identity Manager, a **task** refers to one or more activities that comprise a process, which handles the provisioning of a resource. For example, a process for requesting access to a resource may include multiple provisioning tasks. Oracle Identity Manager stores task data in the **active task tables**.

By default, Oracle Identity Manager does not remove completed tasks from the active task tables. As the size of the active task tables increases, you might experience a reduction in performance, especially when managing provisioning tasks. After a task executes successfully, you can use the Task Archival utility to archive the task data and remove it from the active task tables. Archiving task data with the Task Archival utility improves performance and ensures that the data is safely stored.

The Task Archival utility stores archived task data in the **archive task tables**, which have the same structure as the active task tables.

[Table 25-7](#) lists the active task tables with the corresponding archive task tables in which data from the active task tables are archived.

**Table 25-7 Active and Archive Task Tables**

Active Task Tables	Archive Task Tables
OSI	ARCH_OSI
OSH	ARCH_OSH
SCH	ARCH_SCH

You can use the Task Archival utility to archive the following types of tasks:

- Provisioning tasks that have been completed
- Provisioning tasks that have been completed and canceled

The Task Archival Utility archives provisioning tasks by moving it from the active task tables to the archive task tables. This is based on the following two-fold criteria per the user inputs provided:

- The date-based criteria, which is the provisioning task creation date. This must be specified in the YYYYMMDD format. All records on or before this date will be archived

- The functional criteria task status, which is the provisioning task status, for example, provisioning tasks with Completed or Completed and Canceled status. This must be selected from the prompted status options when the utility is run.

The archive operation represents the type of task data to archive and the user status determines whether to archive data for users who have been deleted, disabled, or both. The task execution date represents the date on which a task is executed and must be in the format YYYYMMDD.

All executed tasks, up to the task execution date you specify, will be archived. To reduce the time that the archiving process takes, the utility drops the indexes on all active task tables when the number of records to be archived is greater than 200000. The indexes are re-created after the archived data is deleted from the active task tables. You can change the value 200000 to your preferred value. You can change the value in the following lines of code in the `OIM_TasksArch.bat` file or in the `OIM_TasksArch.sh` file:

In the `.bat` file, set `INDXRESP=200000`

In the `.sh` file, `indxopt=200000`

The files that constitute the Oracle Database version of the Task Archival utility are located in the following directory:

```
OIM_HOME/server/db/oim/oracle/Utilities/TaskArchival
```



#### Note:

Data that has been archived from the active task tables to the archive task tables will no longer be available through Oracle Identity Manager. To access this data, you must query the archive task tables in your Oracle Identity Manager database.

You can run the Task Archival utility in offline mode with Oracle Identity Manager stopped, or in online mode with Oracle Identity Manager running.

Before running the utility in offline mode, you must stop Oracle Identity Manager.

### 25.4.3.2 Preparing Oracle Database for the Task Archival Utility

Before you can use the Task Archival utility with Oracle Database, you must perform the following steps:

1. Start SQL\*Plus and connect to Oracle Database as a SYS user.
2. Create a separate tablespace for the archival task tables by entering the following command. Replace `DATA_DIR` with the directory in which you want to store the data file and adjust the size and other parameters as necessary for your environment.

```
CREATE TABLESPACE TasksArch
  DATAFILE 'DATA_DIR\tasksarch_01.dbf' SIZE 1000M REUSE
  EXTENT MANAGEMENT LOCAL SEGMENT SPACE MANAGEMENT AUTO;
```

 **Note:**

Oracle recommends that you allocate a large UNDO tablespace when archiving large amounts of data. In addition, turn on parallel execution by configuring the `parallel_max_servers` and `parallel_min_servers` initialization parameters. Parallel execution helps improve the performance of the archival process.

3. Connect to Oracle Database as the Oracle Identity Manager database user.

 **Note:**

You must set `LD_LIBRARY_PATH` to start Oracle utilities such as SQL\*Plus in the environment where you want to run Oracle Identity Manager utilities.

### 25.4.3.3 Running the Task Archival Utility

Perform the following steps to run the Task Archival utility:

1. Ensure that the Oracle Identity Manager database is available but it is not open to other Oracle Identity Manager transactions.

 **Note:**

Oracle recommends that you run the Task Archival utility during off-peak hours.

2. Ensure that you have created a backup of the OSI, SCH, and OSH tables.
3. If you want to run the utility in offline mode, then stop Oracle Identity Manager.  
To run the utility in online mode, ignore this step and proceed to step 4.
4. On Microsoft Windows platforms, you must specify the short date format as `dddd M/d/yyyy`. In addition, you must specify the time format as `H:mm:ss`. To customize the date and time formats, select the Regional and Language Options command in the Control Panel.

 **Note:**

- When you change the date and time format, the change is applied to all the applications running on the Microsoft Windows platform
- Minimal validation is done on date before calling the utility, and you can scan logs files for any ORA-18xx errors for invalid date-related errors

5. On Linux and UNIX platforms, run the `path/OIM_TasksArch.sh` file. On Microsoft Windows platforms, run the `path\OIM_TasksArch.bat` file.

On UNIX platform, run the following commands to set execution permission for the OIM\_TasksArch.sh file and to ensure that the file is a valid UNIX text file:

```
chmod 755 path/OIM_TasksArch.sh
dos2unix path/OIM_TasksArch.sh
```

6. For Oracle Database installations, enter values for the following parameters when prompted:
  - Oracle home directory
  - Oracle Identity Manager database name or TNS string if the Oracle Identity Manager database is running on a remote computer
  - Oracle Identity Manager database user name and password
7. When prompted, select one of the following options:
  - Archive Provisioning Tasks which have been Completed.
  - Archive Provisioning Tasks which have been Completed and Cancelled.
  - Exit.
8. When prompted to specify the mode of running the utility, enter 1 if you want to run the utility in online mode. Otherwise, enter 2 to run the utility in offline mode.
9. Enter a task execution date in the format YYYYMMDD when prompted. All executed tasks, up to the task execution date you specify, will be archived. To archive all tasks that were executed on or before the current date, press **Enter** without entering a date.
10. Summary information is displayed before the utility starts the archival process. The summary information gives you the total number of tasks to be archived. Read the summary information carefully and make sure your database can support the delete volume listed in the summary.

Enter a value of **y** or **Y** when prompted to archive the tasks. Otherwise, enter a value of **n** or **N** to exit the utility.

 **Note:**

You must enter the value of Y or N when prompted. If you press Enter without selecting a value, then the utility again counts the number of tasks to be archived and prompts you without beginning the archive.

11. On Microsoft Windows platforms, reset the short date format to the date format for your region or locale after the Task Archival utility finishes running. Use the Regional and Language Options command in the Control Panel to reset the date format.

 **Note:**

You must analyze the active task tables and their indexes for updated statistics, because the data from active task tables is removed. Perform this step only if you are using Oracle Database as the database for Oracle Identity Manager.

## 25.4.3.4 Reviewing the Output Files Generated by the Task Archival Utility

Table 25-8 describes the output files that are generated by the Task Archival utility.

**Table 25-8 Output Files Generated by the Task Archival Utility**

File	Description
Err_DB_Conn_timestamp.log	Generated when the utility is unable to connect to the database with the specified credentials
Err_Arch_Tasks_timestamp.log	Generated when the archival or deletion processes fail
Arch_TaskData_timestamp.log	Generated when the archival or deletion processes succeed



### Note:

These error log files are deleted when you run the utility again.

## 25.4.4 Using the Requests Archival Utility

You can use the Requests Archival utility to archive the closed or withdrawn requests. This involves meeting the prerequisites, understanding the input parameters, running the utility, and understanding the generated logs.

This section describes how to use the Requests Archival utility. It contains the following topics:

- [About the Requests Archival Utility](#)
- [Prerequisites for Running the Requests Archival Utility](#)
- [Input Parameters used by the Requests Archival Utility](#)
- [Running the Requests Archival Utility](#)
- [Log Files Generated by the Utility](#)

### 25.4.4.1 About the Requests Archival Utility

By default, Oracle Identity Manager does not remove closed or withdrawn requests from the active request tables. To archive these requests and free up the disk space and thereby enhance database performance, the Requests Archival utility is used. You can archive request data based on request creation date and request status. Archiving requests based on the request status is optional. By using request status, you can archive:

- Completed requests such as requests with status Withdrawn, Closed, and Completed. This is specified by selecting the **1 for Completed** option.
- Failed requests such as requests with status Failed, and Partially Failed. This is specified by selecting the **2 for Failed** option.
- Completed and failed requests, such as requests with status Withdrawn, Closed, Completed, Failed, and Partially Failed. This is specified by selecting the **3 for Completed and Failed** option.

Table 25-9 lists the names of the tables which are to be archived and the corresponding archival table names.

**Table 25-9 Archival Tables**

Main Table	Archival Table
REQUEST	ARCH_REQUEST
REQUEST_HISTORY	ARCH_REQUEST_HISTORY
REQUEST_APPROVALS	ARCH_REQUEST_APPROVALS
REQUEST_ENTITIES	ARCH_REQUEST_ENTITIES
REQUEST_ENTITY_DATA	ARCH_REQUEST_ENTITY_DATA
REQUEST_BENEFICIARY	ARCH_REQUEST_BENEFICIARY
REQUEST_BENEFICIARY_ENTITIES	ARCH_REQUEST_BE
REQUEST_BENEFICIARY_ENTITYDATA	ARCH_REQUEST_BED
REQUEST_TEMPLATE_ATTRIBUTES	ARCH_REQUEST_TA
WF_INSTANCE	ARCH_WF_INSTANCE
REQUEST_COMMENTS	ARCH_REQUEST_COMMENTS

The files that constitute the Oracle Database version of the Requests Archival utility are located in the following directory:

```
OIM_HOME/server/db/oim/oracle/Utilities/RequestArchival
```

You can run the Requests Archival utility in offline mode with Oracle Identity Manager stopped, or in online mode with Oracle Identity Manager running.

Before running the utility in offline mode, you must stop Oracle Identity Manager.

## 25.4.4.2 Prerequisites for Running the Requests Archival Utility

If you want to run the utility in offline mode, then you must stop Oracle Identity Manager before running the utility.



### Note:

You must set *LD\_LIBRARY\_PATH* to start Oracle utilities such as SQL\*Plus in the environment where you want to run Oracle Identity Manager utilities.

## 25.4.4.3 Input Parameters used by the Requests Archival Utility

Table 25-10 lists the input parameters used by the Requests Archival Utility:

**Table 25-10 Input Parameters**

Parameter	Description
Oracle Home	The value of <i>ORACLE_HOME</i> environment variable on the system.
Oracle SID	The SID of the Oracle Identity Manager database, which is a TNS name or TNS alias.

**Table 25-10 (Cont.) Input Parameters**

Parameter	Description
OIM DB User	The database login ID of the Oracle Identity Manager database user.
OIM DB Pwd	The password of the Oracle Identity Manager database user.
Request Status	The request status based on the user inputs 1, 2, or 3.
Request Creation Date	The utility archives all requests created on or before this request creation date with the required request status.
Batch Size	The utility processes a group of records or batch as a single transaction. The batch size can influence the performance of the utility. Default value of Batch Size is 2000.
Utility Running Mode	The mode in which you want to run the utility, online or offline. You must enter 1 for online mode, or 2 for offline mode.  The utility runs faster when you run it in offline mode than online mode. However, running the utility in offline mode requires downtime. The archival operation can be speeded up by running in offline mode, but Oracle Identity Manager is not usable until the utility completes the archival operation. Therefore, make sure that Oracle Identity Manager is not running before choosing this option.

#### 25.4.4.4 Running the Requests Archival Utility

To run the Requests Archival utility:

1. Ensure that the Oracle Identity Manager database is available.

 **Note:**

It is recommended that you run the Requests Archival utility during off-peak hours.

2. If you want to run the utility in offline mode, then stop Oracle Identity Manager.  
To run the utility in online mode, ignore this step and proceed to step 3.
3. On Microsoft Windows platform, you must specify the short date format as `dddd M/d/yyyy`. In addition, you must specify the time format as `H:mm:ss`. To customize the date and time formats, use the Regional and Language Options command in Control Panel.

 **Note:**

- When you change the date and time format, the change is applied to all the applications running on the Microsoft Windows platform.
- Minimal validation is done on date before calling the utility, and you can scan logs files for any ORA-18xx errors for invalid date-related errors.

4. On UNIX platform, run the following commands to set execution permission for the `OIM_request_archival.sh` file and to ensure that the file is a valid UNIX text file:

```
chmod 755 path/OIM_request_archival.sh
dos2unix path/OIM_request_archival.sh
```

5. On UNIX platform, run the `path/OIM_request_archival.sh` file. On Microsoft Windows platform, run the `path\OIM_request_archival.bat` file.

The `oim_request_archival` script validates the database input and establishes a connection with the database. It then calls the `oim_request_archival.sql` script, the script is used to compile PL/SQL procedures related to the utility.

6. For Oracle Database installations, enter values for the following parameters when prompted:
  - Oracle home directory.
  - Oracle Identity Manager database name or TNS string if the Oracle Identity Manager database is running on a remote computer. Otherwise, enter ORACLE SID.
  - Oracle Identity Manager database user name and password.
7. When prompted, enter one of the following options:
  - Enter 1 to archive the requests with status Request Withdrawn, Request Closed, or Request Completed, and requests with creation date on or before the request creation date specified by the user in the format YYYYMMDD.
  - Enter 2 to archive the requests with status Request Failed, Request Partially Failed, and requests with creation date on or before the request creation date specified by the user in the format YYYYMMDD.
  - Enter 3 to archive the requests with status Request Withdrawn, Request Closed, Request Completed, Request Failed, or Request Partially Failed, and requests with creation date on or before the request creation date specified by the user in the format YYYYMMDD.
8. When prompted to specify the mode of running the utility, enter 1 if you want to run the utility in online mode. Otherwise, enter 2 to run the utility in offline mode.
9. Specify the batch size, when prompted.

 **Note:**

Batch size is a value for the number of records to be processed in a single iteration of archival/purge also an internal commit at the database level. You must provide the batch size as an input parameter value while starting the operation of Archival Utilities at run time.

This batch size by default is 2000. A higher batch size can be opted for, but this might require more resources from the database, such as more space from the TEMP and UNDO tablespaces.

The utility archives the request data and provides an execution summary in a log file.

10. On Microsoft Windows platforms, reset the short date format to the date format for your region or locale after you run the utility. Use the Regional and Language Options command in Control Panel to reset the date format.
11. Because the data from active request tables are removed, your DBA must analyze the active request tables and their indexes in order to update the statistics. Perform this step only if you are using Oracle Database as the database for Oracle Identity Manager.



### 25.4.4.5 Log Files Generated by the Utility

All the logs are written to the logs/ directory created in the current folder. [Table 25-11](#) lists the log files generated by the utility.

**Table 25-11** Logs Generated by the DB Archival Utility

Log File	Description
validate_date.log	Created when the input REQUEST_CREATION_DATE is invalid
oim_request_archival_summary_TIMESTAMP.log	Contains the summary of the run
Err_DB_Conn_TIMESTAMP_ATTemptNumber.log	Created when the utility is unable to connect to the database with the credentials provided

## 25.5 Using the Audit Archival and Purge Utility

Growth control measures for audit data are available for the lightweight audit framework as well as for the legacy audit framework.

This section discusses tools and methodologies available to control the data growth in Lightweight Audit framework and Legacy Audit framework:

- [About Audit Archival and Purge Utility](#)
- [Audit Data Growth Control Measures in Lightweight Audit Framework](#)
- [Partition-Based Approach for Audit Growth Control Measures in Legacy Audit \(UPA\) Framework](#)

### 25.5.1 About Audit Archival and Purge Utility

The Audit Archival and Purge utility controls the growth of the audit data by purging the data in a logical and consistent manner.

Continuous business operations in the Oracle Identity Manager Database results in audit data growth which also has gradual increase in the storage consumption of the database server. Oracle Identity Manager's audit data related to provisioning feature are stored in legacy audit table called UPA and rest of data which are audited using lightweight auditing framework goes into AUDIT\_EVENT table.

To keep this disk space consumption in control, you can use the Audit Archival and Purge utility. This utility controls the growth of the audit data by purging the data in a logical and consistent manner.

### 25.5.2 Audit Data Growth Control Measures in Lightweight Audit Framework

Controlling the growth of audit data involves partitioning the AUDIT\_EVENTS table, archiving or purging the AUDIT\_EVENTS table, and maintaining the partition on an ongoing basis.

This section describes how to use the Partition Based Approach to control growth of audit data in Lightweight Audit framework. It contains the following topics:

- [About Audit Data Growth Control Measures in Lightweight Audit Framework](#)
- [Overview of Partition Based Approach](#)

- [Prerequisites for Partitioning the AUDIT\\_EVENT Table](#)
- [Preparing the AUDIT\\_EVENT Table for Archival and Purge](#)
- [Archiving or Purging the AUDIT\\_EVENT Data Using Partitions](#)
- [Ongoing Partition Maintenance](#)

### 25.5.2.1 About Audit Data Growth Control Measures in Lightweight Audit Framework

To control the growth of audit data in lightweight audit framework, that is AUDIT\_EVENT table, there are two available solutions:

1. Run the `Remove Audit Log Events` scheduled job.

When this scheduled job is run, the system will automatically start purging all audit records that are older than the retention period configured in *Remove Audit Log Events older Than (in days)* field. By default it is 180 days. This scheduled job is enabled by default and has purge only option.

For more information about Scheduled jobs, see [Scheduled Tasks](#).

2. Partitioning AUDIT\_EVENT table.

 **Tip:**

This is a documented approach and you will need to use this solution based on your audit data compliance or lifecycle management requirement. This solution complements purge scheduled job.

This solution allows you to achieve the following:

- Archiving the data, where as Schedule job allows only purging audit data.
- Flexibility to manage disk size based on your requirement. For example, data needs to be saved for a longer duration of time or if high audit growth is expected.

[Figure 25-1](#) helps you to pick the option(s) that might be suitable to control audit data growth in your deployment.

**Figure 25-1 Solutions Available to Control Audit Data Growth in Lightweight Audit Framework**

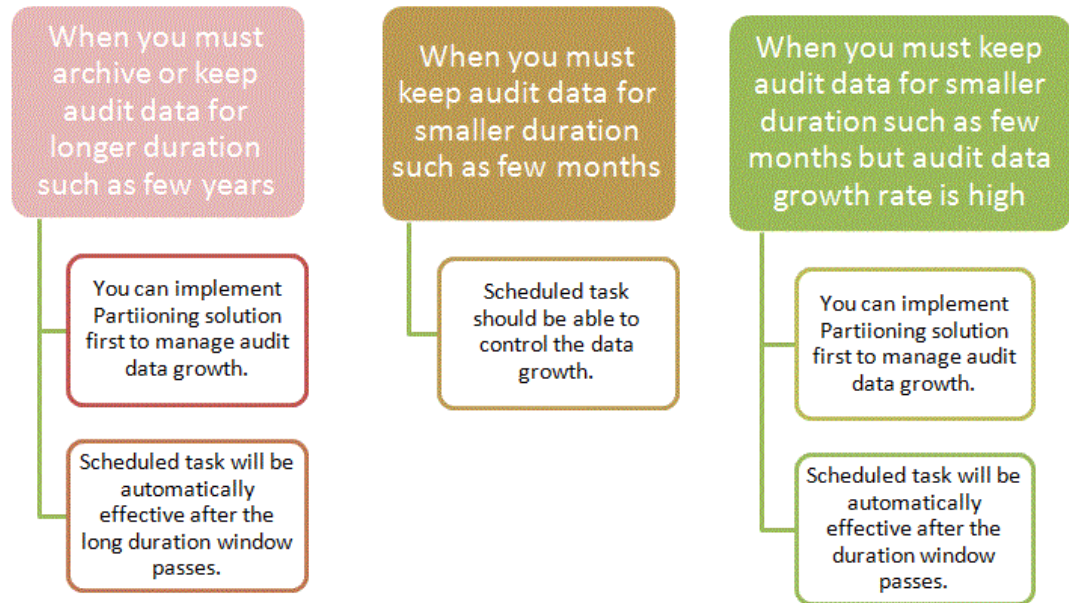

### 25.5.2.2 Overview of Partition Based Approach

When Partition based approach is used in combination with Scheduled job, it helps you to achieve the following solutions suitable for your deployment :

- If you need to archive or keep audit data for longer duration like, few years, then:
  1. Implement Partition based approach to manage audit data growth. This allows you to archiving and/or managing data growth.
  2. Schedule job will come into purview later when you start approaching the retention period.
- If you need to keep audit data for smaller duration, like few months, then Schedule job should be able to control the data growth.If you need to keep audit data for smaller duration, like few months, but audit data growth rate is high due to high number of business operations, then:
  1. Implement Partition based approach to manage audit data growth.
  2. Purge the data by running Schedule job.

### 25.5.2.3 Prerequisites for Partitioning the AUDIT\_EVENT Table

The following prerequisites must be met before or when using Partition based approach:

- Licensing for Database partitioning is required to use partitioning feature of Oracle Database.
- It is recommended to try out this solution in the development or staging environment before implementing it on the production database.

- Make sure that the latest backup of the AUDIT\_EVENT table is available. Creating a backup of the AUDIT\_EVENT table is a compulsory prerequisite before applying this solution.
- It is recommended to use INTERVAL partitioning if your Oracle database release is 11g. Use RANGE partitioning if your oracle database is pre-11g. Partitioning should be done on the basis of month by using EVENT\_DATE column.
- Decide how many months of audit data you require to keep online before implementing this solution. For example, if your audit data retention is six months, you have to partition AUDIT\_EVENT table for six months based on month partition.
- Make sure that Oracle Identity Manager is not running and is not available for off-line utilities. You can start Oracle Identity Manager after partition for current month is created successfully and rest of audit data can be partitioned while Oracle Identity Manager is running.

### 25.5.2.4 Preparing the AUDIT\_EVENT Table for Archival and Purge

To prepare the AUDIT\_EVENT table for the audit and purge solution:

1. Query the AUDIT\_EVENTS table to get the minimum and maximum calendar month for the audit data.

Following queries can help you get the minimum and maximum month. The maximum month should be the current calendar month.

```
SELECT MIN (event_date) min_month, MAX (event_date) running_month FROM AUDIT_EVENT
```

2. Based on the result of the previous step, three possible scenarios and time phases listed in [Table 25-12](#) can be considered for partitioning.

**Table 25-12 Possible Scenarios That are Considered For Partitioning**

Scenario	Time Phase
Scenario 1	If the minimum and calendar month is the same, then you can create partition for the current month. Partitions for rest of the months will be created in the future if you use INTERVAL partitioning. If RANGE partitioning is used, then you need to create future partitioning manually.
Scenario 2	If the minimum and calendar month falls within your retention duration for example six months. For example, minimum month is OCT-2015 and calendar month is DEC-2015. Then you will want to partition from OCT-2015 to DEC-2015. Future partitions will be created automatically.
Scenario 3	If the minimum and calendar month falls out of your duration, like more than six months. For example, minimum month is MAY-2015 and calendar month is DEC-2015. Then, you will want to partition from JUL-2015 to DEC-2015. You will need to decide what to do with data for months (May, June) that falls out of your selected duration.

3. Refer Oracle RDBMS partitioning documentation for steps or commands to partition AUDIT\_EVENT table.

### 25.5.2.5 Archiving or Purging the AUDIT\_EVENT Data Using Partitions

Archiving or purging of audit data can be done by moving or dropping the partitions. Oracle Identify Manager does not use any partitions other than the current month. You cannot move or drop the current month partition. Which partitions to archive or purge depends on your audit data compliance or life cycle requirement.

For example if your requirement is to retain one year of audit data for compliance purpose, then follow these steps:

1. Change the retention period of audit in `Remove Audit Log Events` scheduled job from default six months (180 days) to one year.
2. Implement the partition based solution for `AUDIT_EVENT` table using `INTERVAL` or `RANGE` partitioning.
3. Archive or drop any partitions except the current month partition to offline storage if disk space is a concern. Oracle Identity Manager uses the current month partition to update or insert audit records. You have to keep the current month partition intact for Oracle Identity Manager to work.
4. When you are about to reach the retention duration, you may want to archive or move the partition that contains the first month data to offline storage. Otherwise, `Remove Audit Log Events` scheduled job will purge that data when it falls out of your retention period set in `Remove Audit Log Events` scheduled job.

### 25.5.2.6 Ongoing Partition Maintenance

The partition of the `AUDIT_EVENTS` table requires the following maintenance activities on an ongoing basis:

- `Remove Audit Log Events` scheduled job will purging data from partitions that contains audit data older than the retention period. This creates empty partitions in `AUDIT_EVENT` table. It is recommended to periodically check for these empty partitions and drop them.
- Drop these empty partitions in your maintenance window using SQL like:

```
Alter table AUDIT_EVENT drop partition PARTITION_NAME UPDATE GLOBAL INDEXES;
```

### 25.5.3 Partition-Based Approach for Audit Growth Control Measures in Legacy Audit (UPA) Framework

Using the Audit Archival and Purge utility to control the growth of the legacy audit data involves meeting the prerequisites of running the utility, preparing the UPA table for archival and purge, and archiving and purging the UPA table.

This topic contains the following sections:

- [About Audit Data Growth Control Measures in Legacy Audit Framework](#)
- [Prerequisites for Using the Utility](#)
- [Preparing the UPA Table for Archival and Purge](#)
- [Archiving or Purging the UPA Table](#)

 **Note:**

The partitioning feature of Oracle Database Enterprise Edition is required for implementing audit archival and purge.

### 25.5.3.1 About Audit Data Growth Control Measures in Legacy Audit Framework

To control the growth in legacy audit engine, that is in UPA tables, you can use the Audit Archival and Purge utility. This utility controls the growth of the audit data by purging the data in a logical and consistent manner.

 **Note:**

- The audit archival and purge solution is only applicable to the UPA table. It is not applicable to audit reporting tables, which are tables with the UPA\_ prefix.
- The utility is compatible with Oracle Identity Manager release 9.1.0 and later.

You must shut down Oracle Identity Manager to fetch the latest data, which is to retrieve EFF\_TO\_DATE as null records. You can retrieve the remaining data later when Oracle Identity Manager is running with the new partitioned UPA.

Oracle recommends partitioning of the UPA table on the basis of calendar year, which allows you to archive or drop partitions. The advantage of partitioning is that the old partitions can be archived or purged because Oracle Identity Manager does not use old audit data lying in those partitions. Oracle Identity Manager uses the latest audit data and the current calendar year data. Therefore, the UPA table is partitioned based on date range-partitioning approach by calendar year using EFF\_TO\_DATE column. After partitioning, the latest audit data where EFF\_TO\_DATE is NULL, can be grouped in one partition, and there will be one partition for each calendar year. Oracle Identity Manager do not read or write into any other partitions except the latest and current year partitions.

For instance, if you are using Oracle Identity Manager audit feature since 2005 and implementing the audit archive and purge solution in calendar year 2011, then you will have seven partitions after this exercise, assuming that you create a partition for each calendar year. In those seven partitions, Oracle Identity Manager will only read or write the following partitions:

- The latest partition
- The partition for the current year, for example 2011

All the previous year partitions can be archived and then purged. If you do not want to archive, then you can purge those old partitions. You can reclaim the space by archiving and purging those old partitions. You must keep the latest and current year partitions untouched for Oracle Identity Manager to continue working.

### 25.5.3.2 Prerequisites for Using the Utility

The following prerequisites must be met before or when using the Audit Archival and Purge utility:

- Database partitioning is supported only on Enterprise Edition of Oracle Database. Therefore, to implement the audit archival and purge solution, you must run Enterprise Edition of Oracle Database.
- The UPA table must be range-partitioned. Time interval can be any value as per data distribution. Other modes of partition methods are not supported.

- Make sure that the latest backup of the UPA table is available. Creating a backup of the UPA table is a compulsory prerequisite before applying this solution. It is recommended to try out this solution in the development or staging environment before implementing it on the production database.
- Decide how many previous year's of audit data you require to keep online before implementing this solution. This helps in creating partitions beforehand.
- Each partition should be placed on its own tablespace. Do not share the tablespace between partitions of different year or with some other data.
- During partitioning, the audit data for each calendar year is copied into a table before it is moved into a final destination. You must have provision for disk space to hold the copied data.

### 25.5.3.3 Preparing the UPA Table for Archival and Purge

To prepare the UPA table for the audit and purge solution:

1. Make sure that Oracle Identity Manager database has no transaction against it until the UPA table is partitioned.
2. Query the UPA table to get the minimum and maximum calendar year for the audit data. Following queries can help you get the minimum and maximum year. The maximum year should be the current calendar year.

```
SELECT EXTRACT (YEAR FROM MIN (eff_to_date)) min_year,EXTRACT (YEAR FROM MAX
(eff_to_date)) running_year FROM upa;
```

This helps in deciding the partitions for each calendar year starting from minimum year.

3. Make sure that Oracle Identity Manager is not running and is not available for off-line utilities.
4. Create a new partition table.

Assuming 2005 as minimum year and 2011 as running or current calendar year, the following decisions are to be made before creating a newly partition table:

- How many years of old audit data you want to keep? If it is important to keep only three years of audit data, then you have to create newly partitioned table starting from year 2008. The data older than 2008 will get cleaned up when the original UPA table gets dropped.
- After deciding the years of old data to keep, the next question is how and where the old data should be kept? Do you want to keep all the old data partitions in the active UPA table, or create backup of the old partitions and then drop the old partitions? Oracle recommends moving the old partitions into tapes and then purging them from the UPA table. As stated earlier, you must keep the latest and running calendar year partition untouched.

The following sample assumes that you want to keep three years of audit data in UPA table and current calendar year is 2011:

```
SQL> SELECT 'Create Table UPA_PART
(
UPA_KEY NUMBER (19) Not Null,
USR_KEY NUMBER (19) Not Null,
EFF_FROM_DATE TIMESTAMP (6) Not Null,
EFF_TO_DATE TIMESTAMP (6),
SRC VARCHAR2 (4000),
SNAPSHOT CLOB,
DELTAS CLOB,
```

```

SIGNATURE CLOB
)
PARTITION BY RANGE (EFF_TO_DATE)
(PARTITION UPA_2008 VALUES LESS THAN (TO_DATE('01/01/2009', 'DD/MM/YYYY'))
Tablespace upa_2008,
PARTITION UPA_2009 VALUES LESS THAN (TO_DATE('01/01/2010', 'DD/MM/YYYY'))
Tablespace upa_2009,
PARTITION UPA_2010 VALUES LESS THAN (TO_DATE('01/01/2011', 'DD/MM/YYYY'))
Tablespace upa_2010,
PARTITION UPA_2011_PART1 VALUES LESS THAN (TO_DATE(''|TO_CHAR(SYSDATE, 'DD/MM/YYYY
HH24:MI:SS')||'', 'DD/MM/YYYY HH24:MI:SS')) TABLESPACE UPA_2011_PART1,
PARTITION UPA_2011_PART2 VALUES LESS THAN (TO_DATE('01/01/2012', 'DD/MM/YYYY'))
TABLESPACE UPA_2011_PART2,
PARTITION UPA_LATEST VALUES LESS THAN (MAXVALUE) TABLESPACE UPA_MAX
)
ENABLE ROW MOVEMENT;' FROM DUAL;

```

5. Create another non-partitioned table with similar structure as the UPA table, by running the following statement:

```
SQL> Create table upa_non_part Tablespace TBS_NAME as select * from upa where 1=2;
```

Here, *TBS\_NAME* is the name of the same tablespace as of partition, which is to be exchanged.

This table is temporary in nature. The purpose of this table is to facilitate the loading of audit data to a newly partitioned UPA table.

 **Note:**

UPA\_NON\_PART or temporary non-partitioned table must be created on same tablespace as the partition to be exchanged.

6. Load the latest audit data into the non-partitioned UPA table, as shown:

```
SQL> Insert /*+ parallel */ into upa_non_part select /*+ parallel */ * from upa
where eff_to_date is null;
SQL> COMMIT;
```

 **Note:**

Using hint */\*+parallel\*/* in the INSERT statement is optional and you can use other hints also to improve performance according to the available resources.

7. Swap the data into the partitioned table by using the ALTER TABLE command, as shown:

```
SQL> ALTER TABLE upa_part EXCHANGE PARTITION UPA_LATEST WITH TABLE UPA_NON_PART WITH
VALIDATION UPDATE GLOBAL INDEXES;
```

8. Drop the upa\_non\_part table, as shown:

```
SQL> DROP TABLE upa_non_part;
```

While exchanging partitions, the data dictionary is updated instead of writing data physically. Therefore, it is necessary to drop and re-create the temporary non-partitioned UPA\_NON\_PART table in the same tablespace associated to the partition to be exchanged.

9. Rename the original non-partitioned UPA table to UPA\_OLD, as shown:



```
SQL> ALTER TABLE upa rename TO upa_old;
```

10. Rename the newly partitioned UPA\_PART table to UPA:

```
SQL> RENAME UPA_PART to UPA;
```

11. Manage the constraints for the new UPA table. To do so:

- a. Rename the constraint from old UPA table to some other name, as shown:

```
ALTER TABLE UPA_old RENAME CONSTRAINT PK_UPA TO PK_UPA_old;
ALTER INDEX IDX_UPA_EFF_FROM_DT RENAME TO IDX_UPA_EFF_FROM_DT_old;
ALTER INDEX IDX_UPA_EFF_TO_DT RENAME TO IDX_UPA_EFF_TO_DT_old;
ALTER INDEX IDX_UPA_USR_KEY RENAME TO IDX_UPA_USR_KEY_old;
ALTER INDEX PK_UPA RENAME TO PK_UPA_OLD;
```

- b. Create the necessary indexes and primary key constraint on the newly partitioned UPA table. Make sure to add storage characteristics, such as tablespace and size. To do so, run the following SQL query:

```
SQL>create index IDX_UPA_EFF_FROM_DT on UPA (EFF_FROM_DATE) Local;
SQL>create index IDX_UPA_EFF_TO_DT on UPA (EFF_TO_DATE) Local;
SQL>create index IDX_UPA_USR_KEY on UPA (USR_KEY) Local;
SQL>ALTER TABLE UPA add constraint PK_UPA primary key (UPA_KEY) using index;
```

 **Note:**

The global non-partitioned index is created to support the primary key. Global index becomes unusable every time a partition is touched. You must rebuild the index when required.

12. Run the statistics collection for the UPA table, as shown:

```
SQL>Exec dbms_stats.gather_table_stats(ownname => 'SCHEMA_NAME',tabname =>
'UPA',cascade => TRUE,granularity => 'GLOBAL and PARTITION');
```

 **Note:**

Global statistics must be gathered by default. Oracle 11g includes improvements to statistics collection for partitioned objects so untouched partitions are not rescanned. This significantly increases the speed of statistics collection on large tables where some of the partitions contain static data. When a new partition is added to the table, you need to collect statistics only for the new partition. The global statistics is automatically updated by aggregating the new partition synopsis with the existing partitions synopsis.

13. Start Oracle Identity Manager. The database is ready to be opened for transactions. Test and make sure that applications are running as expected.
14. Bring current year data in UPA\_2011\_PART1 to have all data and maintain consistency for current year. To do so, run the following SQL queries in sequence:

```
SQL> CREATE TABLE upa_non_part Tablespace TBS_NAME AS SELECT * FROM upa WHERE 1=2;
```

Here, *TBS\_NAME* is the same tablespace name as of the partition, which is to be exchanged.

```
SQL> Alter Table UPA_NON_PART add constraint PK_UPA_NON_PART primary key (UPA_KEY)
using index;
```

```

.....
.....
SQL> Insert into upa_non_part select * from upa_old where eff_to_date >=
to_date('01/01/2011', 'mm/dd/yyyy');

.....
.....
SQL> COMMIT;

.....
.....

SQL> ALTER TABLE upa exchange partition UPA_2011_PART1 WITH table upa_non_part WITH
VALIDATION UPDATE GLOBAL INDEXES;

.....
.....
SQL> Drop table upa_non_part;

```

**15.** If required, bring previous year's data into the newly partitioned UPA table. To do so:

**a.** Run the following SQL queries in sequence:

```
SQL> CREATE TABLE upa_non_part Tablespace TBS_NAME AS SELECT * FROM upa WHERE
1=2;
```

Here, *TBS\_NAME* is the same tablespace as of the partition, which is to be exchanged.

```

.....
.....
SQL> Alter Table UPA_NON_PART add constraint PK_UPA_NON_PART primary key
(UPA_KEY) using index;
.....
.....
SQL> Insert into upa_non_part select * from upa_old where eff_to_date >=
to_date('01/01/YEAR', 'mm/dd/yyyy') and eff_to_date < to_date('01/01/<YEAR+1>',
'mm/dd/yyyy');
```

Here, *YEAR* is the year for which you want to bring the data into newly partitioned UPA table.

```

.....
.....
SQL>COMMIT;

.....
.....
SQL> Alter table upa exchange partition UPA_<year> with table upa_non_part
with validation Update global indexes;
```

**b.** Rebuild indexes if they are unusable. The Following SQL query shows the indexes that are unusable:

```
SQL> Select index_name, partition_name, tablespace_name, status from
user_ind_partitions;
```

**c.** Drop the table *upa\_non\_part*, as shown:

```
SQL> Drop table upa_non_part;
```

 **Note:**

Repeat step 15 for each old year.

16. All partition operations against UPA table are done and all the data is brought into. Run the statistics collection for the UPA table, as shown:

```
SQL>Exec dbms_stats.gather_table_stats(ownname => '<Schem_name>',tabname =>
'UPA',cascade => TRUE,granularity => 'GLOBAL and PARTITION');
```

17. Drop the UPA\_OLD table if it is not required. You can create a backup of this table before dropping.

## 25.5.3.4 Archiving or Purging the UPA Table

Archiving and purging the UPA table is described in the following sections:

- [Partitions That Must Not Be Archived or Purged](#)
- [Ongoing Partition Maintenance](#)
- [Archiving or Purging Partitions in the UPA Table](#)

### 25.5.3.4.1 Partitions That Must Not Be Archived or Purged

Oracle Identity Manager always requires the latest and the current calendar year audit data. The following are the names of latest and calendar year partitions:

- **UPA\_LATEST:** The latest partition
- **UPA\_2011\_PART1** and **UPA\_2011\_PART2:** Partitions for the current year if current year is 2011

You must keep these two partitions untouched for Oracle Identity Manager to continue working. These two partitions should never be archived or purged.

### 25.5.3.4.2 Ongoing Partition Maintenance

A new partition must be added to the UPA table before the new calendar year arrives. To do so, use the following SQL template:

```
SQL> Alter table UPA split partition UPA_LATEST at (TO_DATE('01/01/YEAR+1','DD/MM/
YYYY')) into (partition UPA_YEAR tablespace UPA_YEAR,partition UPA_LATEST tablespace
UPA_MAX) update global indexes;
```

Here, *YEAR* in the `TO_DATE` function represents the new calendar year plus one. *YEAR* for partition name and tablespace name represents new upcoming calendar year.

An example of SQL statement for adding new partition for new calendar year 2012 is as follows:

```
SQL> Alter table UPA split partition UPA_LATEST at (TO_DATE('01/01/2013','DD/MM/YYYY'))
into (partition UPA_2012 tablespace UPA_2012,partition UPA_LATEST tablespace UPA_MAX)
update global indexes;
```

Oracle recommends adding new partition with the given SQL template before the new calendar year arrives. However, if you do not add the same before the arrival of the next calendar year, then the same can be done after the next year has started by using the same SQL command.

### 25.5.3.4.3 Archiving or Purging Partitions in the UPA Table

To archive or purge partitions in the UPA table:

1. If you use the attestation feature of Oracle Identity Manager, then make sure that the partition to be archived or purged does not have any active attestation records. You can use the following SQL to verify that.

```
SQL> SELECT COUNT(1) FROM UPA PARTITION(<PARTITION_TO_BE_DROPPED>) WHERE UPA_KEY IN
(select distinct (upa_key) from apt apt, atr atr, atd atd where
apt.atr_key=atr.atr_key and atr.atr_completion_time is NULL and apt.apr_key =
atd.apr_key);
```

This query should return zero records, which means there are no active attestation records. If this returns non-zero value, then it means that there are still active attestations pointing to the partition to be dropped. This is not common, but you must make sure that there are no active attestation records before dropping an old year partition.

2. Make sure that there are no custom reports or queries that needs the data from partition to be dropped.
3. Archive the partition to be dropped to tape or any other media. There are many ways to archive a partition. One of the ways is to use data pump or export utility to archive the partition to be dropped. Choose a way that works best in your environment.
4. Purge the partition. To do so:

```
SQL> Alter table UPA drop partition PARTITION_NAME UPDATE GLOBAL INDEXES;
SQL> Drop tablespace TBS_NAME including contents and datafiles;
```

Here, TBS\_NAME is the tablespace associated with the partition to be dropped, and it must not contain any other data.

#### Note:

- The current year contains two partitions named UPA\_2011\_PART1 and UPA\_2011\_PART2. When current year becomes an old year and the data for that is ready to be archived or purged, make sure to archive or purge these two partitions.
- It is your responsibility to restore the archived data later, if required.

## 25.6 Using the Real-Time Certification Purge in Oracle Identity Governance

Using real-time certification purge in Oracle Identity Manager involves understanding and configuring the real-time certification purge job utility.

The concepts related to real-time certification purge solutions in Oracle Identity Manager are described in the following sections:

- [Understanding Real-Time Certification Purge Job](#)
- [Configuring Real-Time Certification Purge Job](#)

## 25.6.1 Understanding Real-Time Certification Purge Job

The Real-Time Certification Purge Job capability is provided by default in Oracle Identity Manager. Certification data can be continuously purged using this feature based on the options or choices made during configuration. This configuration is a onetime process and the purge solution works automatically without any intervention from the administrator.

The Real-Time Certification Purge Job has the following features:

- The administrator provides values for some critical parameters by using the Scheduled Tasks section of Oracle Identity System Administration.
- Diagnostic information about each purge run is captured as a log.
- Purge tasks run periodically according to the allotted time duration.
- Data growth and subsequent footprint is controlled on an on-going basis.
- It operates online with no disruption of service.
- The purge operation via an automated scheduled task runs silently at a predefined periodicity and is non-interactive.
- Various metrics related to the purge operation, such as names of the entity modules, success or failure status, and number of rows targeted for deletion, are logged.
- These logs are diagnostic pointers for the purge operation for every run.
- Certification Purge task utilizes the existing Purge diagnostic logging framework. Refer to section [Collecting Diagnostic Data of the Online Archival and Purge Operations](#) for more information on the framework.

Oracle Identity Manager stores certification data in Oracle Identity Manager tables called **active certification tables**.

Naming convention used in Oracle Identity Manager in storing active certification data in the database has acronym as listed in [Table 25-13](#).

**Table 25-13 Acronyms Used in Archive Certification Tables**

Table Acronym	Description
CERT_*	Table stores the certifications. CERT_ID is the key to each of these tables
CERTD_*	Table stores the decision-data for certifications
CERTDS_*	Table stores the decision-data and the snapshot-data for certifications
CERTS_*	Table stores the snapshot-data for certifications

You can use the Certification Purge Job to archive data in the archive certification tables, which have the same structure as the active certification tables.

[Table 25-14](#) lists the active certification tables with the corresponding archive certification tables in which data from the active certification tables are archived.

**Table 25-14 Active and Archive Certification Tables**

Active Certification Tables (Oracle Identity Manager Tables)	Archive Certification Tables
CERT_CERTS	ARCH_CERT_CERTS
CERT_CONFIG	ARCH_CERT_CONFIG
CERT_LAST_DECISION	ARCH_CERT_LAST_DECISION
CERT_TASK_INFO	ARCH_CERT_TASK_INFO
CERT_TASK_ACTION	ARCH_CERT_TASK_ACTION
CERT_ACTION_HISTORY_SCOPE	ARCH_CERT_ACTION_HISTORY_SCOPE
CERT_ACTION_HISTORY	ARCH_CERT_ACTION_HISTORY
CERTD_USER	ARCH_CERTD_USER
CERTD_USER_ACCT	ARCH_CERTD_USER_ACCT
CERTD_ROLE	ARCH_CERTD_ROLE
CERTD_APP_INST	ARCH_CERTD_APP_INST
CERTD_ENT_DEFN	ARCH_CERTD_ENT_DEFN
CERTD_ACCT_ENT_ASGN	ARCH_CERTD_ACCT_ENT_ASGN
CERTD_ROLE_POLICY	ARCH_CERTD_ROLE_POLICY
CERTD_POL_ENT_DEFN	ARCH_CERTD_POL_ENT_DEFN
CERTDS_USER_ROLE_ASGN	ARCH_CERTDS_USER_ROLE_ASGN
CERTDS_ENT_ASGN	ARCH_CERTDS_ENT_ASGN
CERTS_USER	ARCH_CERTS_USER
CERTS_USR_UDF	ARCH_CERTS_USR_UDF
CERTS_ROLE	ARCH_CERTS_ROLE
CERTS_APP_INST	ARCH_CERTS_APP_INST
CERTS_ENT_DEFN	ARCH_CERTS_ENT_DEFN
CERTS_ACCOUNT	ARCH_CERTS_ACCOUNT
CERTS_ACCT_ENT_ASGN	ARCH_CERTS_ACCT_ENT_ASGN
CERTS_POLICY	ARCH_CERTS_POLICY
CERTS_POL_ENT_DEFN	ARCH_CERTS_POL_ENT_DEFN
CERTS_CATALOG_UDF	ARCH_CERTS_CATALOG_UDF

 **Note:**

Certification purge is available only in online mode and via the scheduled job interface. Data from CERTD\_STATS, CERT\_DEFN, CERT\_EVT\_LSNR and CERT\_EVT\_TRIG tables will not be archived and purged.

For information on collecting diagnostic data of real-time certification purge job, see [Collecting Diagnostic Data of the Online Archival and Purge Operations](#).

## 25.6.2 Configuring Real-Time Certification Purge Job

Certification entity data via the purge solution is continuously purged based on the selections made during configuration of the utility. You can modify these options based on data retention policies and maintenance requirements.

To configure real-time certification purge:

1. Login to Oracle Identity System Administration.
2. In the left pane, under System Configuration, click **Scheduler**.
3. Search for the **OIM Certification Purge Job**.
4. Enable the OIM Certification Purge Job scheduled job.

 **Note:**

The OIM Certification Purge Job scheduled job is disabled by default. Enable it after installing or upgrading Oracle Identity Manager.

5. In the Parameters section, specify values for the parameters, as described in [Table 25-15](#):

**Table 25-15 OIM Certification Purge Job Parameters**

Option	Description
<b>Cert Campaigns for Purge</b>	The purge operation runs in batches based on the input passed to this parameter. It represents the maximum no of certification campaign to delete before a commit is issued. Default value is 10. In this field, a minimum value of 10 and a maximum value of 25 is recommended to be used.
<b>Maximum Purge Run Duration(in Mins)</b>	This is the maximum run duration in minutes for purge processing. Default value is 30.
<b>Purge Criteria</b>	This is the purge criteria and it takes the following values: <ul style="list-style-type: none"> <li>• 1– Completed certification campaigns</li> <li>• 2– Expired certification campaigns</li> <li>• 3– Both completed certification campaigns and expired certification campaigns</li> </ul> Default value is 1.
<b>Purge Retention Period(in days)</b>	This indicates the retention period in days for Certification Campaigns. Default value is 180.

 **Note:**

By default, the **OIM Certification Purge Job** is seeded with default values for input parameters like purge criteria, purge retention period etc. You must revisit the input parameters to change their default values as required.

6. Click **Apply**.

In addition to the steps on the Scheduled Task UI for configuration inputs documented in this section, there are no further manual steps required to be performed.

 **Note:**

- For Certification Real-Time Purge operation via Scheduled Task interface, Retention Period must not be specified as ZERO as this can cause inconsistencies in purge operation.
- Simultaneously running multiple instances of the **OIM Data Purge Job** and the **OIM Certification Purge Job** is not supported via instantiation of the Scheduled Task functionality.



# Part IX

## Lifecycle Management

Lifecycle management includes handling the changes related to lifecycle management, such as URL changes, password changes, and SSL configuration, and securing a deployment.

This part describes a number of additional features for Oracle Identity Manager administrators. It contains the following chapters:

- [Handling Lifecycle Management Changes](#)
- [Securing a Deployment](#)

# Handling Lifecycle Management Changes

Because of integrated deployment of Oracle Identity Governance with other applications, such as Oracle Access Manager (OAM), and configuration changes in those applications, various configuration changes might be required in Oracle Identity Governance and Oracle WebLogic Server.

These configuration changes are described in the following sections:

- [URL Changes Related to Oracle Identity Governance](#)
- [Password Changes Related to Oracle Identity Governance](#)
- [Configuring SSL for Oracle Identity Governance](#)
- [Using Ready App](#)

**Note:**

In this section there are several command examples which includes, `password` in the command, this needs to be replaced with the actual password before executing the commands.

## 26.1 URL Changes Related to Oracle Identity Governance

Oracle Identity Governance uses various host names and ports in its configuration. Corresponding changes to host names and ports are required in Oracle Identity Governance and Oracle WebLogic configuration.

This section describes ways to make the corresponding changes in Oracle Identity Governance and Oracle WebLogic configuration. It contains the following topics:

- [Oracle Identity Governance Host and Port Changes](#)
- [Oracle Identity Governance Database Host and Port Changes](#)
- [Changing Oracle Virtual Directory Host and Port](#)
- [Changing BI Publisher Host and Port](#)
- [Changing SOA Host and Port](#)
- [Changing OAM Host and Port](#)

### 26.1.1 Oracle Identity Governance Host and Port Changes

Oracle Identity Governance host and port changes include changing `OimFrontEndURL` and `backOfficeURL` in Oracle Identity Governance configuration, changing task details URL in human task configuration, and changing OIG server port on WebLogic Administrative Console.

This section describes about Oracle Identity Governance host and port changes in the following topics:

- [Changing OimFrontEndURL in Oracle Identity Governance Configuration](#)
- [Changing backOfficeURL in Oracle Identity Governance Configuration](#)
- [Changing Task Details URL in Human Task Configuration](#)
- [Changing OIG Server Port on WebLogic Administrative Console](#)

 **Note:**

When additional Oracle Identity Governance nodes are added or removed, perform the procedures described in these sections to configure Oracle Identity Governance host and port changes.

### 26.1.1.1 Changing OimFrontEndURL in Oracle Identity Governance Configuration

The OimFrontEndURL is the URL used to access the Oracle Identity Governance UI. This can be a load balancer URL or Web server URL depending on the application server is fronted with a load balancer or web server or a single application server URL. This is used by Oracle Identity Governance in the notification e-mails as well as the callback URL for SOA calls.

The change may be necessary because of change in Web server hostname or port for Oracle Identity Governance deployment in a clustered environment, or WebLogic managed server hostname or port changes for Oracle Identity Governance deployment in a nonclustered environment.

 **Note:**

In order to change OimFrontEndURL, perform the steps provided in this section as well as the steps in [Changing OIM Server Port on WebLogic Administrative Console](#).

To change the OimFronEndURL in Oracle Identity Governance configuration:

1. Login to Enterprise Manager by using the following URL when the WebLogic Administrative Server and Oracle Identity Governance managed servers, at least one of the servers in case of a clustered deployment, are running:  
`http://ADMIN_SERVER/em`
2. Navigate to **Identity and Access, oim**.
3. Right-click **oim**, and navigate to **System MBean Browser**.
4. Under Application Defined MBeans, navigate to **oracle.iam, Application:oim, XMLConfig, Config, XMLConfig.DiscoveryConfig**, and then **Discovery**.

In a clustered deployment, when you select **oracle.iam** under Application Defined MBeans, Oracle Identity Governance server name is displayed. Select the server and continue with the navigation.

 **Note:**

In a clustered deployment, the change to the OimFrontEndURL must be made on each server in the cluster.

5. Enter new value for the OimFrontEndURL attribute, and click **Apply** to save the changes. Example values can be:  
`http://OIM_SERVER:OIM_PORT`  
`https://myoim.example.com`  
`https://myoimserver.example.com:14001`

 **Note:**

SPML clients store Oracle Identity Governance URL for invoking SPML and sending callback response. Therefore, changes are required corresponding to this. In addition, if Oracle Identity Governance is integrated with OAM, OAAM, or Oracle Identity Navigator (OIN), there may be corresponding changes necessary. For more information, refer to OAM, OAAM, and OIN documentation in the Oracle Technology Network (OTN) Web site.

### 26.1.1.2 Changing backOfficeURL in Oracle Identity Governance Configuration

Changing backOfficeURL is required only for Oracle Identity Governance deployed in front-office and back-office configuration. This change does not apply for simple clustered or nonclustered deployments. This URL is used internally by Oracle Identity Governance for accessing back-office components from the front-office components. You might change the value of this attribute during the implementation of back-office and front-office configuration, for adding additional servers to back office, and for removing servers from back-office.

To change the value of the backOfficeURL attribute:

1. Login to Enterprise Manager by using the following URL when the WebLogic Administrative Server and Oracle Identity Governance managed servers, at least one of the servers in case of a clustered deployment, are running:  
`http://ADMIN_SERVER/em`
2. Navigate to **Identity and Access**, and then **oim**.
3. Right-click **oim**, and navigate to **System MBean Browser**.
4. Under Application Defined MBeans, navigate to **oracle.iam, Application:oim, XMLConfig, Config, XMLConfig.DiscoveryConfig, Discovery**.
5. Enter a new value for the BackOfficeURL attribute, and click **Apply** to save the changes. Example values can be:  
`t3://mywls1.example.com:8001`  
`t3://mywls1.example.com:8001,mywls2.example.com:9001`

 **Note:**

The value of the BackOfficeURL attribute must be empty for Oracle Identity Governance nonclustered and clustered deployments.

### 26.1.1.3 Changing Task Details URL in Human Task Configuration

The task details URL is the URL of the task details page for a particular human task in the Inbox. This can be a load balancer URL or Web server URL depending on whether the application server is fronted with load balancer, or Web server, or single application server URL.

The change might be required because of change in Web server hostname or port for Oracle Identity Governance deployment in a clustered environment, or WebLogic managed server hostname or port changes for Oracle Identity Governance deployment in a nonclustered environment.

To change the task details URL in human task configuration:

1. Login to Oracle Enterprise Manager by using the following URL:  
`http://ADMIN_SERVER/em`  
For a clustered deployment, ensure that at least one SOA server in the SOA cluster is running.
2. Click the Target Navigation image shown on the left of the domain name in upper left corner of the Enterprise Manager console.
3. Click **SOA**, and then select **soa-infra(SOA\_SERVER\_NAME)**.
4. Click the **Deployed Composite** tab.
5. Click the **DefaultOperationalApproval [6.0]** composite.
6. In the Components section, click the **ApprovalTask** link of type Human Workflow.
7. Click the **Administration** tab.
8. Make the required changes to Host Name, HTTP Port, and HTTPS Port.
9. Repeat steps 6 through 8 for all other composites.

### 26.1.1.4 Changing OIG Server Port on WebLogic Administrative Console

You can update the OIG server port by using the WebLogic Administrative Console.

To change the OIG server port by using the WebLogic Administrative Console::

1. Login to Weblogic Administrative Console by using the following URL when the WebLogic Administrative Server is running:  
`http://ADMIN_SERVER/console`
2. Click **Lock and Edit** on the top left corner..
3. Navigate to **Environment, Servers**. Select **oim\_server** for which you need to modify the port. Modify the Listen Port field with the new value.
4. Click **Save**. Then click **Activate all changes** on the top left corner.

## 26.1.2 Oracle Identity Governance Database Host and Port Changes

Database host name and port number changes can be in various configuration areas, such as datasource oimJMSStoreDS, oimAuthenticatorProvider, DirectDB, and incorrect database configurations.

This section describes the configuration areas where database hostname and port number are used.

After installing Oracle Identity Governance, if there are any changes in the database hostname or port number, then the following changes are required:



**Note:**

Before making changes to the database host and port, shutdown the managed servers hosting Oracle Identity Governance. But you can keep the Oracle WebLogic Administrative Server running.

- [Modifying Datasource oimJMSStoreDS Configuration](#)
- [Modifying Datasource soaOIMLookupDB Configuration](#)
- [Modifying Datasource oimOperationsDB Configuration](#)
- [Modifying Datasource ApplicationDB Configuration](#)
- [Modifying Datasource Related to Oracle Identity Governance Meta Data Store](#)
- [Modifying OIMAuthenticationProvider Configuration](#)
- [Modifying DirectDB Configuration](#)
- [Modifying the Oracle Identity Governance Database Host and Port in BI Publisher](#)
- [Changing Incorrect Database Configuration](#)
- [#unique\\_731](#)

### 26.1.2.1 Modifying Datasource oimJMSStoreDS Configuration

To change datasource oimJMSStoreDS configuration:

1. Navigate to **Services, JDBC, Data Sources**, and then **oimJMSStoreDS**.
2. Click the **Connection Pool** tab.
3. Modify the values of the URL and Properties fields to reflect the changes to database host and port.

### 26.1.2.2 Modifying Datasource soaOIMLookupDB Configuration

To change datasource soaOIMLookupDB configuration:

1. Navigate to **Services, JDBC, Data Sources**, and then **soaOIMLookupDB**.
2. Click the **Connection Pool** tab.
3. Modify the values of the URL and Properties fields to reflect the changes to database host and port.

### 26.1.2.3 Modifying Datasource oimOperationsDB Configuration

To change datasource oimOperationsDB configuration:

1. Navigate to **Services, JDBC, Data Sources**, and then **oimOperationsDB**.
2. Click the **Connection Pool** tab.

3. Modify the values of the URL and Properties fields to reflect the changes to database host and port.

### 26.1.2.4 Modifying Datasource ApplicationDB Configuration

To change datasource ApplicationDB configuration:

1. Navigate to **Services, JDBC, Data Sources**, and then **ApplicationDB**.
2. Click the **Connection Pool** tab.
3. Modify the values of the URL and Properties fields to reflect the changes to database host and port.

### 26.1.2.5 Modifying Datasource Related to Oracle Identity Governance Meta Data Store

To change the datasource related to Oracle Identity Governance Meta Data Store (MDS) configuration:



**Note:**

This step is required only if database host and port of MDS schema is changed.

1. Navigate to **Services, JDBC, Data Sources**, and then **mds-oim**.
2. Click the **Connection Pool** tab.
3. Modify the values of the URL and Properties fields to reflect the changes in the database host and port.

### 26.1.2.6 Modifying OIMAuthenticationProvider Configuration

To change OIMAuthenticationProvider configuration, on Host A, which is the computer that hosts the freshly configured domain:

1. Stop OIM Managed server and SOA Managed server of the newly installed setup of Oracle Identity Governance. To do so, from the `<HOSTA_DOMAIN_HOME>/bin/` directory, run the following commands:

```
sh stopManagedWebLogic.sh <OIM_MANAGED_SERVER_NAME>  
sh stopManagedWebLogic.sh <OIM_MANAGED_SERVER_NAME>
```

2. From Host A, login to Oracle WebLogic Administrative Console by navigating to the following URL:

For non-SSL setup:

```
http://<ADMIN_SERVER_HOSTNAME_HOST_A>:<ADMIN_SERVER_PORT_HOST_A>/console
```

For SSL-enabled setup:

```
https://<ADMIN_SERVER_HOSTNAME_HOST_A>:<ADMIN_SERVER_SSL_PORT_HOST_A>/console
```

Use the WebLogic admin user login credentials, which is `weblogic` and `<WEBLOGIC_ADMIN_PASSWORD>`.

3. Navigate to **Security Realms, myrealm**, and then **Providers**.

4. Click **OIMAuthenticationProvider**.
5. Click **Provider Specific**.
6. Modify the value of the DBUrl, DBUser and DBPassword fields to reflect the credentials of OIG schema of the database on Host B, as shown in [Figure 26-1](#).

**Figure 26-1 Setting for OIMAuthenticationProvider**

The screenshot displays the configuration page for the OIMAuthenticationProvider. The breadcrumb trail is: Home > Summary of Security Realms > myrealm > Providers > OIMAuthenticationProvider. The page title is 'Settings for OIMAuthenticationProvider'. There are two tabs: 'Common' and 'Provider Specific', with 'Provider Specific' selected. A 'Save' button is located at the top left of the configuration area. Below the button, a message states: 'This page allows you to configure additional attributes for this security provider.' The configuration fields are as follows:

Inactive Connection Timeout:	300
PKIKeystore Provider:	sun.security.rsa.SunRsa:
DBDriver:	oracle.jdbc.OracleDriver
DBUrl:	jdbc:oracle:thin:@:.....
DBPassword:	.....
Confirm Credential:	.....
SSOMode	<input type="checkbox"/>
DBUser:	OIMR2PS2_OIM
Symmetric Key Keystore Provider:	com.sun.crypto.provider.

7. Click **Save**.

### 26.1.2.7 Modifying DirectDB Configuration

To change DirectDB configuration:

1. Login to Enterprise Manager by using the following URL:  
`http://ADMIN_SERVER/em`
2. Navigate to **Identity and Access**, and then **oim**.
3. Right-click **oim**, and navigate to **System MBean Browser** under Application Defined MBeans.
4. Navigate to **oracle.iam, Application:oim, XMLConfig, Config, XMLConfig.DirectDBConfig**, and then **DirectDB**.
5. Enter the new value for the URL attribute to reflect the changes to host and port, and then apply the changes.



 **Note:**

When Oracle Identity Governance single instance deployment is changed to Oracle Real Application Clusters (Oracle RAC) or Oracle RAC is changed to single instance deployment, change the `oimJMSStoreDS`, `oimOperationsDB`, and `mds-oim` datasources. In addition to the generic changes to make these datasources to multidatasource configuration, change the `OIMAuthenticationProvider` and domain credential store configurations to reflect the Oracle RAC URL. For information about these generic changes, see *High Availability Guide for Oracle Identity and Access Management*.

See [Oracle Identity Governance Database Host and Port Changes](#) for information about changing the port at the database.

### 26.1.2.8 Modifying the Oracle Identity Governance Database Host and Port in BI Publisher

To change the Oracle Identity Governance database host and port in BI Publisher:

1. Login to BI Publisher.
2. Click the **Administration** tab.
3. Click **JDBC Connection** under Data Sources.
4. Click **OIM JDBC**, and change the database host and port.
5. Click **Test Connection**. The connection is established successfully after confirmation.
6. Click **Apply**.

### 26.1.2.9 Changing Incorrect Database Configuration

Perform the following additional steps if Oracle Identity Governance is made to point to another database of another Oracle Identity Governance instance instead of current database port being changed:

1. Copy `.xldatabasekey` from Oracle Identity Governance that is installed on the destination DB to the source Oracle Identity Governance deployment. Copy `DOMAIN_HOME/config/fmwconfig/.xldatabasekey` from destination to source Oracle Identity Governance.
2. Copy the following keys from Oracle Identity Governance deployment on the destination DB to the source deployment:  
OIMSchemaPassword  
.xldatabasekey  
DataBaseKey
3. To get the Oracle Identity Governance credential store from Oracle Identity Governance installed on the destination DB:
  - a. Login to Oracle Enterprise Manager by using the following URL:  
`http://HOST:ADMIN_SERVER_PORT>/em`
  - b. Navigate to Weblogic Domain, right-click **DOMAIN\_NAME**, and select **System MBean Browser**.

- c. Under Application Defined MBeans, navigate to **com.oracle.jps, Server:OIM\_SERVER\_NAME, JpsCredentialStore**.
  - d. Go to **Operations, getPortableCredentialMap**. Enter the parameter value as `oim` and Invoke.  
  
This displays the oim credential map. Note the passwords for OIMSchemaPassword, .xldatabasekey, and DataBaseKey.
4. To change the keys in the OIM credential store on the source deployment:
    - a. **OIMSchemaPassword**: Navigate to Weblogic Domain, right-click **DOMAIN\_NAME**, and navigate to **Security, Credentials**. Expand **oim**, and click **OIMSchemaPassword**. Click **Edit**, and enter the new password in Password and Confirm Password fields.
    - b. **.xldatabasekey**: Repeat the same steps for .xldatabasekey.
    - c. **DataBaseKey**: Repeat the same steps for DataBaseKey.

### 26.1.3 Changing Oracle Virtual Directory Host and Port

When LDAP synchronization is enabled, Oracle Identity Governance connects with directory servers through Oracle Virtual Directory (OVD). This connection takes place by using LDAP/LDAPS protocol.

To change OVD host and port:

1. Login to Oracle Identity System Administration.
2. Under Provisioning Configuration, click **IT Resource**.
3. From the IT Resource Type list, select **Directory Server**, and click **Search**.
4. Edit the Directory Server IT resource. To do so:
  - a. If the value of the Use SSL field is set to `False`, then edit the Server URL field. If the value of the Use SSL field is set to `True`, then edit the Server SSL URL field.
  - b. Click **Update**.

### 26.1.4 Changing BI Publisher Host and Port

You can change the BI Publisher host and port in the `jms_cluster_config.properties` file, after which you must restart BI Publisher server.

To change BI Publisher host and port:

1. Login to Enterprise Manager by using the following URL when the WebLogic Administrative Server and Oracle Identity Governance managed servers, at least one of the servers in case of a clustered deployment, are running:  
  
`http://ADMIN_SERVER/em`
2. Navigate to **Identity and Access, oim**.
3. Right-click **oim**, and navigate to **System MBean Browser**.
4. Under Application Defined MBeans, navigate to **oracle.iam, Application:oim, XMLConfig, Config, XMLConfig.DiscoveryConfig, Discovery**.
5. Enter a new value for the BIPublisherURL attribute, for example `http://bi.example.com`, and click **Apply** to save the changes.
6. To change the BI Publisher host and port in `jms_cluster_config.properties` file:

- a. Go to the `DOMAIN_NAME/config/bipublisher/repository/Admin/Scheduler/` directory.
- b. In a text editor, open the `jms_cluster_config.properties` file, and replace the BI Publisher host and port.
- c. Save the `jms_cluster_config.properties` file.
- d. Restart BI Publisher server.

## 26.1.5 Changing SOA Host and Port

You change SOA JNDIProvider host and port when additional SOA nodes are added or removed.

To change the SOA host and port:



### Note:

When additional SOA nodes are added or removed, perform this procedure to change the SOA host and port.

1. Login to Enterprise Manager by using the following URL when the WebLogic Administrative Server and Oracle Identity Governance managed servers, at least one of the servers in case of a clustered deployment, are running:

`http://ADMIN_SERVER/em`

2. Navigate to **Identity and Access, oim**.
3. Right-click **oim**, and navigate to **System MBean Browser**.
4. Under Application Defined MBeans, navigate to **oracle.iam, Application:oim, XMLConfig, Config, XMLConfig.SOAConfig, SOAConfig**.
5. Change the value of the `Rmiurl` attribute, and click **Apply** to save the changes.

The `Rmiurl` attribute is used for accessing SOA EJBs deployed on SOA managed servers. This is the application server URL. For a clustered deployment of Oracle Identity Governance, it is a comma-separated list of all the SOA managed server URLs. Example values for this attribute can be:

`t3://mysoa1.example.com:8001`

`t3s://mysoaserver1.example.com:8002,mysoa2.example.com:8002`

`t3://mysoa1.example.com:8001,mysoa2.example.com:8002,mysoa3.example.com:8003`

6. Change the SOA JNDIProvider host and port. To do so:
  - a. Login to WebLogic Administration Console.
  - b. In the Domain Structure section, navigate to **OIM\_DOMAIN, Services, Foreign JNDI Providers**.
  - c. Click **ForeignJNDIProvider-SOA**.
  - d. In the Configuration tab, verify that the **General** subtab is active.
  - e. Change the value of Provider URL to the `Rmiurl` provided in Step 5.

## 26.1.6 Changing OAM Host and Port

To change OAM host and port, change the values of the `AccessServerHost` and `AccessServerPort` attributes and other attributes, as required.

To change the OAM host and port:

1. Login to Enterprise Manager by using the following URL when the WebLogic Administrative Server and Oracle Identity Governance managed servers, at least one of the servers for a clustered deployment, are running:  
`http://ADMIN_SERVER/em`
2. Navigate to **Identity and Access**, and then to **oim**.
3. Right-click **oim**, and navigate to **System MBean Browser**.
4. Under Application Defined MBeans, navigate to **oracle.iam, Application:oim, XMLConfig, Config, XMLConfig.SSOConfig**, and then **SSOConfig**.
5. Change the values of the `AccessServerHost` and `AccessServerPort` attributes and other attributes as required, and click **Apply** to save the changes.

## 26.2 Password Changes Related to Oracle Identity Governance

Various passwords are used for Oracle Identity Governance configuration because of the architectural and middleware requirements.

This section describes the default passwords and ways to make the changes to the password in Oracle Identity Governance and Oracle WebLogic configuration for any change in the dependent or integrated products.

This section consists of the following topics:

- [Updating Oracle WebLogic Administrator Credentials](#)
- [Changing Oracle WebLogic Administrator Password](#)
- [Changing Oracle Identity Governance Administrator Password](#)
- [Changing Oracle Identity Governance Administrator Database Password](#)
- [Changing Oracle Identity Governance Database Password](#)
- [About Credential Store Framework Keys](#)
- [Changing Oracle Identity Governance Passwords in the Credential Store Framework](#)
- [Changing OVD Password](#)
- [Changing Oracle Identity Governance Administrator Password in LDAP](#)
- [Unlocking Oracle Identity Governance Administrator Password in LDAP](#)
- [Changing Schema Passwords](#)

### 26.2.1 Updating Oracle WebLogic Administrator Credentials

Oracle WebLogic credentials must be updated in Foreign JNDI Provider and `SOAdminPassword` in CSF.

Weblogic credentials must be updated in the following places:

1. Foreign JNDI Provider. To do so:
  - a. Login to WebLogic Administrative Console.
  - b. In the Domain Structure section, navigate to **OIM\_DOMAIN, Services, Foreign JNDI Providers**.
  - c. Click **ForeignJNDIProvider-SOA**.
  - d. In the Configuration tab, verify that the General subtab is active.
  - e. Provide weblogic user's new password in the password and confirm password fields.
2. SOAAdminPassword in CSF. See [Changing Oracle Identity Governance Passwords in the Credential Store Framework](#) for details.

## 26.2.2 Changing Oracle WebLogic Administrator Password

Use the WebLogic Administrative console to change the WebLogic administrator password,

To change Oracle WebLogic administrator password:

1. Login to WebLogic Administrative console.
2. Navigate to **Security Realms, myrealm, Users and Groups, weblogic, Password**.
3. In the New Password field, enter the new password.
4. In the Confirm New Password field, re-enter the new password.
5. Click **Apply**.

## 26.2.3 Changing Oracle Identity Governance Administrator Password

During Oracle Identity Governance installation, the installer prompts for the Oracle Identity Governance administrator password. If required, you can change the administrator password after the installation is complete.

To do so, you must login to Oracle Identity Governance Self Service as Oracle Identity Governance administrator. For information about how to change the administrator password, see Changing Enterprise Password in *Performing Self Service Tasks with Oracle Identity Governance*.

When you change the Oracle Identity Governance system administrator password, you must also update the password in:

- The `OIMAdmin` CSF key under the `oracle.wsm.security` map
- The `sysadmin` CSF key under the `oim` map

### Note:

If OAM or OAAM is integrated with Oracle Identity Governance, then you must make corresponding changes in those applications. For more information, refer to OAM and OAAM documentation in the Oracle Technology Network (OTN) Web site by using the following URL:

<http://www.oracle.com/technetwork/indexes/documentation/index.html>

## 26.2.4 Changing Oracle Identity Governance Administrator Database Password

System administrator database password can be reset in stand-alone deployment of Oracle Identity Governance and in a deployment that is integrated with OAM.

This section describes resetting Oracle Identity Governance password in the following topics:

- [Resetting Oracle Identity Governance Password](#)
- [Resetting System Administrator Database Password in Oracle Identity Governance Deployment](#)
- [Resetting System Administrator Database Password When Oracle Identity Governance Deployment is Integrated With Access Manager](#)

### 26.2.4.1 Resetting Oracle Identity Governance Password

This section describes resetting Oracle Identity Governance password in the following types of deployments:

- Oracle Identity Governance deployment without LDAP synchronization
- Oracle Identity Governance deployment with LDAP synchronization enabled
- Oracle Identity Governance deployment that is integrated with Access Manager (OAM)

Resetting System Administrator password can be performed by using the `oimadminpasswd_wls.sh` utility, which is available in the `OIM_HOME/server/bin/` directory. The steps to run the `oimadminpasswd_wls.sh` utility are the same for both types of deployment: Oracle Identity Governance with LDAP synchronization enabled and without LDAP synchronization enabled.

### 26.2.4.2 Resetting System Administrator Database Password in Oracle Identity Governance Deployment

To reset System Administrator database password:

1. As a prerequisite for running the `oimadminpasswd_wls.sh` utility, open the `OIM_HOME/server/bin/oimadminpasswd_wls.properties` file in a text editor, and set values for the following properties:
  - **JAVA\_HOME:** Set this to JDK8, for example:  
`JAVA_HOME=/opt/softwarewares/shiphome/jdk180_131`
  - **COMMON\_COMPONENTS\_HOME:** This is Oracle Middleware common home directory, for example:  
`COMMON_COMPONENTS_HOME=/opt/softwarewares/shiphome/oracle_common`
  - **OIM\_ORACLE\_HOME:** This is Oracle Identity Governance Oracle home directory, for example:  
`OIM_ORACLE_HOME=/opt/softwarewares/shiphome/Oracle_IDM1`
  - **ORACLE\_SECURITY\_JPS\_CONFIG:** Specify the `jps-config-jse.xml` file location present in Oracle Identity Governance Domain, for example:  
`ORACLE_SECURITY_JPS_CONFIG=/opt/softwarewares/shiphome/user_projects/domains/base_domain/config/fmwconfig/jps-config-jse.xml`

- **DOMAIN\_HOME:** Specify Oracle Identity Governance Domain Home location of the Weblogic Application Server, for example:

```
DOMAIN_HOME=/opt/softwarewares/shiphome/user_projects/domains/base_domain
```

- **DBURL:** Oracle Identity Governance database URL, for example:

```
DBURL=jdbc:oracle:thin:@dbhostname:5521:orclsid
```

- **DBSCHEMAUSER:** Oracle Identity Governance schema username, for example:

```
DBSCHEMAUSER=DEV_OIM
```

- **OIM\_OAM\_INTG\_ENABLED:** Set this to false if Oracle Identity Governance deployment is not integrated with Access Manager, for example:

```
OIM_OAM_INTG_ENABLED=false
```

 **Note:**

Other properties, such as LDAPURL, LDAPADMINUSER, and OIM\_ADMIN\_LDAP\_DN can be ignored as they are used only in an integrated setup between Oracle Identity Governance and Access Manager.

2. Go to the `OIM_HOME/server/bin/` directory, and run the following command:

```
sh oimadminpasswd_wls.sh oimadminpasswd_wls.properties
```

The following is a sample output:

```
Enter OIM DB Schema Password :
Enter OIM Administrator xelsysadm new Password:
Re-enter OIM Administrator xelsysadm new Password:
WARNING: Not able to fetch OIMPlatform instance for the given Platform. Hence
defaulting to the OIMWebLogicPlatform
```

```
OIM Admin user xelsysadm password reset successfully in OIMDB
```

 **Note:**

The warning messages that are displayed while running the `oimadminpasswd_wls.sh` script can be ignored.

### 26.2.4.3 Resetting System Administrator Database Password When Oracle Identity Governance Deployment is Integrated With Access Manager

If Oracle Identity Governance is integrated with OAM, then LDAP directory, such as Oracle Internet Directory, is used for all authentication purposes. Therefore, Oracle Identity Governance Administrator `xelsysadm` password is reset in LDAP. Although the `xelsysadm` password present in Oracle Identity Governance database is not used in this topology, it is also reset along with LDAP directory to ensure that the passwords in both repositories are in sync.

To reset System Administrator database password when Oracle Identity Governance Deployment is Integrated With Access Manager:

1. As a prerequisite for running the `oimadminpasswd_wls.sh` utility, open the `OIM_HOME/server/bin/oimadminpasswd_wls.properties` file in a text editor, and set values for the following properties:
  - **JAVA\_HOME:** Set this to JDK8, for example:
 

```
JAVA_HOME=/opt/softwarewares/shiphome/jdk180_131
```
  - **COMMON\_COMPONENTS\_HOME:** This is Oracle Middleware common home directory, for example:
 

```
COMMON_COMPONENTS_HOME=/opt/softwarewares/shiphome/oracle_common
```
  - **OIM\_ORACLE\_HOME:** This is Oracle Identity Governance Oracle home directory, for example:
 

```
OIM_ORACLE_HOME=/opt/softwarewares/shiphome/Oracle_IDM1
```
  - **ORACLE\_SECURITY\_JPS\_CONFIG:** Specify the `jps-config-jse.xml` file location present in Oracle Identity Governance Domain, for example:
 

```
ORACLE_SECURITY_JPS_CONFIG=/opt/softwarewares/shiphome/user_projects/domains/base_domain/config/fmwconfig/jps-config-jse.xml
```
  - **DOMAIN\_HOME:** Specify Oracle Identity Governance Domain Home location of the Weblogic Application Server, for example:
 

```
DOMAIN_HOME=/opt/softwarewares/shiphome/user_projects/domains/base_domain
```
  - **DBURL:** Oracle Identity Governance database URL, for example:
 

```
DBURL=jdbc:oracle:thin:@dbhostname:5521:orclsid
```
  - **DBSCHEMAUSER:** Oracle Identity Governance schema username, for example:
 

```
DBSCHEMAUSER=DEV_OIM
```
  - **OIM\_OAM\_INTG\_ENABLED:** Set this to true if Oracle Identity Governance deployment is integrated with Access Manager, for example:
 

```
OIM_OAM_INTG_ENABLED=true
```
  - **LDAPURL:** LDAP directory URL. Non-SSL port must be specified, for example:
 

```
LDAPURL=ldap://LDAP_HOSTNAME:3060
```
  - **LDAPADMINUSER :** LDAP directory admin username, for example:
 

```
LDAPADMINUSER=cn=orcladmin
```
  - **OIM\_ADMIN\_LDAP\_DN:** Oracle Identity Governance Administrator `xelsysadm` complete DN in the LDAP directory, for example:
 

```
OIM_ADMIN_LDAP_DN=cn=xelsysadm,cn=Users,dc=us,dc=example,dc=com
```
2. Go to the `OIM_HOME/server/bin/` directory, and run the following command:
 

```
sh oimadminpasswd_wls.sh oimadminpasswd_wls.properties
```

The following is a sample output:

```
Enter OIM DB Schema Password :
Enter OIM Administrator xelsysadm new Password:
Re-enter OIM Administrator xelsysadm new Password:
WARNING: Not able to fetch OIMPlatform instance for the given Platform. Hence
defaulting to the OIMWebLogicPlatform

OIM Admin user xelsysadm password reset successfully in OIMDB
OIM Admin user cn=xelsysadm,cn=Users,dc=...,dc=...,dc=... password reset
successfully in LDAP
```



 **Note:**

- The warning messages that are displayed while running the `oimadminpasswd_wls.sh` script can be ignored.
- The `xelsysadm` password expiry setting is not set to expire until 2035. During integration between Oracle Identity Governance and Access Manager, the `obpasswordexpirydate` setting for the `xelsysadm` user is set to `"2035-01-01T00:00:00Z"`. If this value has been changed, then revert it to `"2035-01-01T00:00:00Z"` for `xelsysadm`. This value is initially loaded from a following template LDIF file:  
`$OIM_ORACLE_HOME/idmtools/templates/oid/idm_xelsysadmin_user.ldif`

## 26.2.5 Changing Oracle Identity Governance Database Password

Oracle Identity Governance uses two database schemas for storing Oracle Identity Governance operational and configuration data. It uses Oracle Identity Governance MDS schema for storing configuration-related information and Oracle Identity Governance schema for storing other information. Any change in the schema password requires changes on Oracle Identity Governance configuration.

Changing Oracle Identity Governance database password involves the following:

After changing the Oracle Identity Governance database password, restart the WebLogic Administrative Server. Start the Oracle Identity Governance managed WebLogic Servers as well.

 **Note:**

Before changing the database password, shutdown the managed servers that host Oracle Identity Governance. However, you can keep the Oracle WebLogic Administrative Server running.

- [Changing Datasource oimJMSStoreDS Configuration](#)
- [Changing Datasource ApplicationDB Configuration](#)
- [Changing Datasource soaOIMLookupDB Configuration](#)
- [Changing Datasource oimOperationsDB Configuration](#)
- [Changing Datasource Related to Oracle Identity Governance Meta Data Store](#)
- [Changing OIMAuthenticationProvider Configuration](#)
- [Changing Domain Credential Store Configuration](#)
- [Changing the Oracle Identity Governance Database Password in BI Publisher](#)

### 26.2.5.1 Changing Datasource oimJMSStoreDS Configuration

To change datasource `oimJMSStoreDS` configuration:

1. Navigate to **Services, JDBC, Data Sources, oimJMSStoreDS**.

2. Click the **Connection Pool** tab.
3. In the Password and Confirm password fields, enter the new Oracle Identity Governance database schema password.
4. Click **Save** to save the changes.

### 26.2.5.2 Changing Datasource ApplicationDB Configuration

To change datasource ApplicationDB configuration:

1. Navigate to **Services, JDBC, Data Sources, ApplicationDB**.
2. Click the **Connection Pool** tab.
3. In the Password and Confirm password fields, enter the new Oracle Identity Governance database schema password.
4. Click **Save** to save the changes.

### 26.2.5.3 Changing Datasource soaOIMLookupDB Configuration

To change datasource soaOIMLookupDB configuration:

1. Navigate to **Services, JDBC, Data Sources**, and then **soaOIMLookupDB**.
2. Click the **Connection Pool** tab.
3. Modify the values of the URL and Properties fields to reflect the changes to database host and port.
4. Click **Save** to save the changes.

### 26.2.5.4 Changing Datasource oimOperationsDB Configuration

To change datasource oimOperationsDB configuration:

1. Navigate to **Services, JDBC, Data Sources, oimJMSStoreDS**.
2. Click the **Connection Pool** tab.
3. In the Password and Confirm password fields, enter the new Oracle Identity Governance database schema password.
4. Click **Save** to save the changes.

### 26.2.5.5 Changing Datasource Related to Oracle Identity Governance Meta Data Store

To change datasource related to Oracle Identity Governance MDS configuration:

1. Navigate to **Services, JDBC, Data Sources, mds-oim**.
2. Click the **Connection Pool** tab.
3. In the Password and Confirm password fields, enter the new Oracle Identity Governance MDS database schema password.
4. Click **Save** to save the changes.

 **Note:**

- For Oracle Identity Governance deployments with Oracle Real Application Clusters (Oracle RAC) configuration, you might have to make changes in all the datasources under the respective multi-datasource configurations.
- You might have to make similar changes for datasources related to SOA or OWSM, if required.

## 26.2.5.6 Changing OIMAuthenticationProvider Configuration

To change OIMAuthenticationProvider configuration:

1. In the WebLogic Administrative console, navigate to **Security Realms, myrealm**, and then **Providers**.
2. Click **OIMAuthenticationProvider**.
3. Click **Provider Specific**.
4. In the DBPassword field, enter the new Oracle Identity Governance database schema password.
5. Click **Save** to save the changes.

## 26.2.5.7 Changing Domain Credential Store Configuration

To change domain credential store configuration:

1. Login to Enterprise Manager by using the following URL:  
`http://ADMIN_SERVER/em`
2. Navigate to **Weblogic Domain**, and then **DOMAIN\_NAME**.
3. Right click **oim**, and navigate to **Security, Credentials**, and then **oim**.
4. Select **OIMSchemaPassword**, and click **Edit**.
5. In the Password field, enter the new password, and click **OK**.

## 26.2.5.8 Changing the Oracle Identity Governance Database Password in BI Publisher

To change the Oracle Identity Governance database password in BI Publisher:

1. Login to BI Publisher.
2. Click the **Administration** tab.
3. Click **JDBC Connection** under Data Sources.
4. Click **OIM JDBC**, and change the password in the Password field.
5. Click **Test Connection**. The connection is established successfully after confirmation.
6. Click **Apply**.

## 26.2.6 About Credential Store Framework Keys

Oracle Identity Governance installer stores several passwords during the install process. Various values are stored in Credential Store Framework (CSF) as key and value.

Table 26-1 lists the keys and the corresponding values:

**Table 26-1 CSF Keys**

Key	Description
DataBaseKey	The password for the key used to encrypt database. The password is the user input value in the installer for the Oracle Identity Governance keystore.
.xldatabasekey	The password for keystore that stores the database encryption key. The password is the user input value in the installer for the Oracle Identity Governance keystore.
xell	The password for key 'xell', which is used for securing communication between Oracle Identity Governance components. Default password generated by Oracle Identity Governance installer is xellerate.
default_keystore.jks	The password for the default_keystore.jks JKS keystore in the <i>DOMAIN_HOME/config/fmwconfig/</i> directory. The password is the user input value in the installer for the Oracle Identity Governance keystore.
SOAdminPassword	The password is user input value in the installer for SOA Administrator Password field.
OIMSchemaPassword	The password for connecting to Oracle Identity Governance database schema. Password is user input value in the installer for OIM Database Schema Password field.
JMSKey	The password is the user input value in the installer for the Oracle Identity Governance keystore.

## 26.2.7 Changing Oracle Identity Governance Passwords in the Credential Store Framework

To change Oracle Identity Governance password in the CSF, edit the Directory Server IT resource.

To change the values of the CSF keys:

1. Login to Oracle Enterprise Manager by navigating to the following URL:  
`http://ADMIN_SERVER/em`
2. Navigate to **Weblogic Domain**, *DOMAIN\_NAME*.
3. Right-click **oim**, and select **Security, Credentials**.
4. Edit the Directory Server IT resource. To do so, in the Admin Password field, enter the new OVD password, and click **Update**.

## 26.2.8 Changing OVD Password

Edit the Directory Server IT resource and specify the new OVD password in the Admin Password field.

To change the OVD password:

1. Login to Oracle Identity Governance Administration.
2. Click **Advanced**.
3. Under Configuration, click **Manage IT Resource**.
4. From the IT Resource Type list, select **Directory Server**.
5. Click **Search**.
6. Edit the Directory Server IT resource. To do so, in the Admin Password field, enter the new OVD password, and click **Update**.

## 26.2.9 Changing Oracle Identity Governance Administrator Password in LDAP

To change Oracle Identity Governance System Administrator password in LDAP in a Oracle Identity Governance deployment that is SSO-enabled and integrated with OAM, search for the dn for the user from LDAP, create a temporary file with the new password, and then use the file to change the password.

To change Oracle Identity Governance System Administrator password in LDAP in a Oracle Identity Governance deployment that is SSO-enabled and integrated with Access Manager (OAM):

1. Look up the dn for the user from LDAP, as shown:

```
$ORACLE_HOME/bin/ldapsearch -D cn=orcladmin -w fusionapps1 -h localhost -p 6501 -b dc=com "cn=SYS_ADMIN" orclaccountlocked dn
```

Here, *SYS\_ADMIN* is the System Administrator user login.

2. Create a file similar to the following:

```
$ more /tmp/resetpassword_SYS_ADMIN

dn: cn=SYS_ADMIN,cn=Users,dc=us,dc=example,dc=com
changetype: modify
replace: userPassword
userPassword: NEW_PASSWORD
```

Here, *NEW\_PASSWORD* is the password that you want in clear text.

3. Change the password, as shown:

```
$ORACLE_HOME/bin/ldapmodify -D cn=orcladmin -w fusionapps1 -h localhost -p 6501 -f /tmp/resetpassword_SYS_ADMIN
```

4. Verify that the user password is changed, as shown:

```
$ORACLE_HOME/bin/ldapbind -D 'cn=SYS_ADMIN,cn=Users,dc=us,dc=example,dc=com' -w NEW_PASSWORD -h localhost -p 6501
```

## 26.2.10 Unlocking Oracle Identity Governance Administrator Password in LDAP

To unlock Oracle Identity Governance System Administrator password in LDAP in a Oracle Identity Governance deployment that is SSO-enabled and integrated with OAM, search for the dn for the user from LDAP, create a temporary file for unlocking the password, and then use the file unlock the System Administrator password.

To unlock Oracle Identity Governance System Administrator password in LDAP in a Oracle Identity Governance deployment that is SSO-enabled and integrated with OAM:

1. Look up the dn for the user from LDAP, as shown:

```
$ORACLE_HOME/bin/ldapsearch -D cn=orcladmin -w fusionapps1 -h localhost -p 6501 -b dc=com "cn=SYS_ADMIN" orclaccountlocked dn
```

If orclaccountlocked has a value of 1, then it means that the user is locked.

2. Create a file similar to the following:

```
$ more /tmp/unlock_SYS_ADMIN

dn: cn=SYS_ADMIN,cn=Users,dc=us,dc=example,dc=com
changetype: modify
replace: orclaccountlocked
orclaccountlocked: 0
```

3. Unlock the user, as shown:

```
$ORACLE_HOME/bin/ldapmodify -D cn=orcladmin -w fusionapps1 -h localhost -p 6501 -f /tmp/unlock_SYS_ADMIN
```

4. Verify that the user is unlocked, as shown:

```
$ORACLE_HOME/bin/ldapsearch -D cn=orcladmin -w fusionapps1 -h localhost -p 6501 -b dc=com "cn=SYS_ADMIN" orclaccountlocked dn
```

The value of orclaccountlocked must be 0.

## 26.2.11 Changing Schema Passwords

Changing schema passwords include changing the passwords for the OIG, MDS, SOAINFRA, OPSS, ORASDPM, and BI Publisher schemas.

To change OIG, MDS, SOAINFRA, OPSS, ORASDPM, and BI Publisher schema passwords:

1. Stop all the Managed Servers and application server.
2. Create a backup of the entire domain and the database.
3. Start the application server.
4. Change the xxxx\_OPSS user password. To do so:

- a. Run the following command:

```
SQL> alter user xxxx_OPSS identified by NEW_PASSWORD;
```

- b. Go to the `ORACLE_COMMON/common/bin/` directory, and run the `wlst` command.
- c. Run the `modifyBootStrapCredential` script, as shown:

```
modifyBootStrapCredential(jpsConfigFile='DOMAIN_NAME/config/fmwconfig/jps-
config.xml', username='xxxx_OPSS', password='NEW_PASSWORD')
```

5. Login to Weblogic Administrative Console. Navigate to **Services, Data Sources**.
6. Select **opss-DBDS, Connection Pool**, and enter the new password set to xxxx\_opss in step 4a. Save the changes.
7. Restart the application server, but do not start the Managed Servers.
8. Connect to the database with sqlplus as system user, and then run the following commands:
  - a. To change the password for xxx\_OIM, run:
 

```
SQL> alter user xxx_OIM identified by NEW_PASSWORD;
```
  - b. To change the password for xxx\_MDS, run:
 

```
SQL> alter user xxx_MDS identified by NEW_PASSWORD;
```
  - c. To change the password for xxx\_SOAINFRA, run:
 

```
SQL> alter user xxx_SOAINFRA identified by NEW_PASSWORD;
```
  - d. To change the password for xxx\_ORASDPM, run:
 

```
SQL> alter user xxx_ORASDPM identified by NEW_PASSWORD;
```
  - e. To change the password for xxx\_BIPLATFORM, run:
 

```
SQL> alter user xxx_BIPLATFORM identified by NEW_PASSWORD;
```
9. Verify that the passwords have been changed. To do so, login to the database with sqlplus and the four users and the new passwords.
10. Login to the WebLogic Administrative Console.
11. Go to **Services, Data Sources**, and then perform the following:
  - a. Select **soaOIMLookupDB, Connection Pool**, and enter the new password set to xxx\_OIM in step 12a.
  - b. Select **oimJMSStoreDS, Connection Pool**, and enter the new password set to xxx\_OIM in step 12a.
  - c. Select **oimOperationsDB, Connection Pool**, and enter the new password set to xxx\_OIM in step 12a.
  - d. Select **ApplicationDB, Connection Pool**, and enter the new password set to xxx\_OIM in step 12a.
  - e. Select **mds-oim, Connection Pool**, and enter the new password set to xxx\_MDS in step 12b.
  - f. Select **mds-owsm, Connection Pool**, and enter the new password set to xxx\_MDS in step 12b.
  - g. Select **mds-soa, Connection Pool**, and enter the new password set to xxx\_MDS in step 12b.
  - h. Select **EDNDataSource, Connection Pool**, and enter the new password set to xxx\_SOAINFRA in step 12c.
  - i. Select **EDNLocalTxDataSource, Connection Pool**, and enter the new password set to xxx\_SOAINFRA in step 12c.
  - j. Select **SOADDataSource, Connection Pool**, and enter the new password set to xxx\_SOAINFRA in step 12c.

- k. Select **SOALocalTxDataSource**, **Connection Pool**, and enter the new password set to xxx\_SOAINFRA in step 12c.
  - l. Select **OraSDPMDDataSource**, **Connection Pool**, and enter the new password set to xxx\_ORASDPM in step 12d.
12. Change OIMAuthenticationProvider configuration. To do so:
  - a. In the WebLogic Administrative Console, navigate to **Security Realms**, **myrealm**, and then **Providers**.
  - b. Click **OIMAuthenticationProvider**.
  - c. Click **Provider Specific**.
  - d. In the DBPassword field, enter the new Oracle Identity Governance database schema password.
  - e. Click **Save** to save the changes.
13. Change the domain credential store configuration. To do so:
  - a. Login to Oracle Enterprise Manager.
  - b. Navigate to **Weblogic Domain**, and then **DOMAIN\_NAME**.
  - c. Right-click the domain name, and select **Security**, **Credentials**, and then **oim**.
  - d. Select **OIMSchemaPassword**, and click **Edit**.
  - e. In the Password field, enter the new password, and then click **OK**.
14. Change the oim and soa schema password in BI Publisher. To do so:
  - a. Login to BI Publisher.
  - b. Click the **Administration** tab.
  - c. Click **JDBC Connection** under Data Sources.
  - d. Click **OIM JDBC**, and change the password in the Password field.
  - e. Click **Test Connection**. The connection is established successfully after confirmation.
  - f. Click **Apply**.
  - g. Repeat the steps 14d through 14f for JDBC data source **BPEL JDBC**.
15. If BI Publisher schema password is changed, then perform the following steps:
  - a. Login to Oracle Enterprise Manager.
  - b. Expand **WebLogic Domain**, **DOMAIN\_NAME**.
  - c. Under the **DOMAIN\_NAME** on the right pane, from the WebLogic Domain list, select **JDBC Data Sources**.
  - d. Select **bip\_datasource** in the table, and then click **Edit** on the toolbar.
  - e. Click the **Connection Pool** tab. In the Database Connection Information section, change the password, and then click **Apply** on the upper right corner.
  - f. Start BI Publisher services.
16. Restart WebLogic Admin Server.
17. Start the SOA and Oracle Identity Governance Managed Servers.



## 26.3 Configuring SSL for Oracle Identity Governance

Configuring SSL for Oracle Identity Governance includes generating keys, signing and exporting certificates, setting up SSL Configuration for Oracle Identity Governance and for the components with which Oracle Identity Governance interacts, and establish secure communication between them.

A SHA-2 compliant certificate is a prerequisite for using TLS v1.2 protocol for SSL communication.

### Note:

- For information related to IBM Java 7, SR4 version support of SHA-2 cipher suites and Transport Layer Security (TLS) version 1.2 refer to IBM documentation.
- In the following sections several examples are provided. They have parameters which are used to enable more debugging information and are optional. For example:

```
-Dweblogic.StdoutDebugEnabled=true -Dssl.debug=true -  
Djavax.net.debug=ssl:handshake:verbose.
```

For Oracle JDK 8, download and apply latest Java Cryptography Extension (JCE) Unlimited Strength Jurisdiction Policy Files. Relocate the local\_policy.jar and US\_export\_policy.jar jars files into <JAVA\_HOME>/jre/lib/security directory.

### Note:

If Opatch version is lesser than 12.1.0.1.10, then upgrade the OPatch utility by applying p21142429\_121010\_Linux-x86-64.zip patch.

Apply p23176395\_121020\_Generic.zip patch to DB\_HOME to get the support of TLS v1.2 on Oracle 12c DB (12.1.0.2).

Apply p13964737\_1036\_Generic.zip Weblogic patch via BSU if Demo Identity and Demo trust is used at Weblogic Level.

This section contains the following topics:

- [Generating Custom Key Stores \(Optional\)](#)
- [Configuring Custom Key Stores \(Optional\)](#)
- [Enabling SSL for Oracle Identity Governance and SOA Servers](#)
- [Enabling SSL for Oracle Identity Governance DB](#)
- [Enabling SSL for SOA Approval Composites](#)
- [Configuring SSL for the Design Console](#)
- [Configuring SSL for Oracle Identity Governance Utilities](#)

- [#unique\\_761](#)
- [#unique\\_762](#)
- [#unique\\_763](#)
- [#unique\\_764](#)
- [#unique\\_765](#)

 **Note:**

- Section [Generating Custom Key Stores \(Optional\)](#) provides example commands that are used later in the document. These are for reference and not part of the mandatory steps of configuration.
- For configuring Oracle User Messaging Service (UMS) notification that is SSL-based, see [Using UMS for Notification](#).
- For more details on configuring UMS to connect to a mail server with SSL, see [Configuring Oracle User Messaging Service](#) in *Administrator's Guide for Oracle SOA Suite and Oracle Business Process Management Suite*.

## 26.3.1 Generating Custom Key Stores (Optional)

This section includes the following topics:

- [Creating the Custom Identity Store](#)
- [Self Signing the Certificates of Custom identity keystore](#)
- [Exporting the Certificate From Custom Identity Keystore](#)
- [Importing the Certificate of Custom Identity to Trust Store](#)

 **Note:**

The procedures described in this section are optional. These steps are required if you have custom identity and trust store for WebLogic servers. SSL can be enabled with default identity and trust store as well.

### 26.3.1.1 Creating the Custom Identity Store

You can generate private and public certificate pairs by using the keytool command.

The following command creates an identity keystore (oimsupportidentity.jks).

```
$JAVA_HOME/jre/bin/keytool -genkey -alias ALIAS -keyalg ALGORITHM -keysize KEY_SIZE -  
sigalg SIGN_ALGORITHM -dname DISTINGUISHED_NAME -keypass KEY_PASSWORD -keystore  
KEYSTORE_NAME -storepass KEYSTORE_PASSWORD
```

For example:

```
$JAVA_HOME/jre/bin/keytool -genkey -alias supportpvtkey -keyalg RSA -keysize 2048 -  
sigalg SHA256withRSA -dname "CN=oimhost.example.com, OU=Identity,
```

```
O=ORGANIZATION_NAME,C=US" -keypass privatepassword -keystore oimsupportidentity.jks -  
storepass password
```

 **Note:**

- Change the parameter values passed to the keytool command according to your requirements. Ensure that there is no line break in the keytool argument.
- The custom identity keystore, oimsupportidentity.jks must be created or copied under WL\_HOME/server/lib/.
- In this release, JDK 8u131 is used. Therefore, the value of the keysize option must be greater than or equal to 1024. For more information about this limitation, see [JDK8u131 Update Release Notes](#).

### 26.3.1.2 Self Signing the Certificates of Custom identity keystore

Use the keytool command by passing the required parameter values to self sign the certificates you created.

Run the following keytool command to sign the certificates that you created:

```
$JAVA_HOME/jre/bin/keytool -selfcert ALIAS -keyalg ALGORITHM -keysize KEY_SIZE -sigalg  
SIGN_ALGORITHM -dname DISTINGUISHED_NAME -keypass KEY_PASSWORD -keystore KEYSTORE_NAME -  
storepass KEYSTORE_PASSWORD
```

For example:

```
$JAVA_HOME/jre/bin/keytool -selfcert -alias supportpvtkey  
-sigalg SHA256withRSA -validity 2000 -keypass privatepassword  
-keystore oimsupportidentity.jks  
-storepass password
```

 **Note:**

Change the parameter values passed to the keytool command according to your requirements. Ensure that there is no line break in the keytool argument.

### 26.3.1.3 Exporting the Certificate From Custom Identity Keystore

Use the keytool command to export the certificate from the identity keystore to a file, for example, supportcert.pem.

Run the following keytool command:

```
$JAVA_HOME/jre/bin/keytool -export -alias ALIAS -file FILE_TO_EXPORT -keypass  
KEY_PASSWORD -keystore KEYSTORE_NAME -storepass KEYSTORE_PASSWORD
```

For example, the following command exports the certificate to a file named supportpvtkeycert.pem:

```
$JAVA_HOME/jre/bin/keytool -export -alias supportpvtkey  
-file supportpvtkeycert.pem  
-keypass password
```

```
-keystore oimsupportidentity.jks  
-storepass password
```

### 26.3.1.4 Importing the Certificate of Custom Identity to Trust Store

If custom trust store is used, then import the certificate in that custom trust store. If Java Standard Trust is used as trust store then import the certificate in that Java Standard Trust, such as `JAVA_HOME/jre/lib/security/cacerts`.

Use the `keytool` command to import the certificate from a file. The syntax is:

```
keytool -import -alias ALIAS -trustcacerts -file FILE_TO_IMPORT -keystore KEYSTORE_NAME -  
storepass KEYSTORE_PASSWORD
```

In the following example, the certificate file `supportpvtkeycert.pem` is imported to the identity keystore `oimsupporttrust.jks`:

```
$JAVA_HOME/jre/bin/keytool -import -alias supportpvtkey -trustcacerts -file  
supportpvtkeycert.pem -keystore oimsupporttrust.jks -storepass <password>
```

#### Note:

This command loads a trusted CA certificate into a custom keystore `oimsupporttrust.jks`. If the keystore does not exist, it is created.

This custom trust keystore `oimsupporttrust.jks` must be created or copied under `DOMAIN_HOME/config/fmwconfig/`.

Change the parameter values passed to the `keytool` command according to your requirements. Ensure that there is no line break in the `keytool` argument.

## 26.3.2 Configuring Custom Key Stores (Optional)

#### Note:

See [Generating Custom Key Stores \(Optional\)](#) for information about generating custom keys.

Perform the following steps to configure custom key stores:

1. In the WebLogic Server Administration Console, click **Environment, Servers, Server\_Name (OIM\_Server1), Configuration**, and then **General**.
2. Click **Lock & Edit**.
3. Select **SSL listen port enabled**. The default SSL port is 14002 and 14001 for non-SSL.
4. Select the **Keystores** tab.
5. From the Keystore list, select **Custom Identity and Custom Trust**.

 **Note:**

If you have created only custom identity and using java standard trust, then select the **Custom Identity, Java Standard Trust** option.

6. Copy the custom identity keystore file, say `oimsupportidentity.jks`, under the `WL_HOME/server/lib/` directory. Enter the absolute path of this key store (`WL_HOME/server/lib/oimsupportidentity.jks`) in the Custom Identity Keystore field.
7. Specify JKS as the custom identity keystore type.
8. Type the password (`password`) into the Custom Identity Keystore Passphrase and the Confirm Custom Identity Keystore Passphrase fields.

 **Note:**

If you are creating a custom trust keystore, then perform the steps 6 to 8 of this section for custom trust keystore field with path `DOMAIN_HOME/config/fmwconfig/oimsupporttrust.jks`.

9. Click **Save**.
10. Click the **SSL** tab.
11. Type `supportpvtkey` as the private key alias.
12. Type the password (`password`) into the Private Key Passphrase and the Confirm Private Key Passphrase fields.
13. Click **Save**.
14. Perform similar steps (steps 1 through 13) for Admin and SOA Servers.
15. Click **Activate changes**.
16. Import the certificate that you exported in [Exporting the Certificate From Custom Identity Keystore](#) into the SPML client truststore and Java Standard Trust Store, and WebLogic trust store:

```
MW_HOME/wlserver_10.3/server/lib/cacerts
```

For example:

```
./keytool -importcert -alias startssl -keystore MW_HOME/wlserver_10.3/
server/lib/cacerts -storepass password
-file supportpvtkeycert.pem JAVA_HOME/jre/lib/security/cacerts
```

For example:

```
./keytool -importcert -alias startssl -keystore JAVA_HOME/jre/lib/security/
cacerts -storepass password -file supportpvtkeycert.pem
```

 **Note:**

Where *password* is the default password for Java's Standard truststore (`JAVA_HOME/jre/lib/security/cacerts`).

See [Importing the Certificate of Custom Identity to Trust Store](#) for information about importing the certificate.

17. The database trust keystore created at `DOMAIN_HOME/config/fmwconfig/` by Oracle Identity Governance during installation is `default-keystore.jks` by default. If you are using a different name for truststore than the default name, which is `dbcustomtrust-keystore.jks`, then perform the following steps:
  - a. Add Oracle Identity Governance Credential store map key. If you are using any other name, such as `dbcustomtrust-keystore.jks`, then create a key in the credential store by using Oracle Enterprise Manager as `default-keystore.jks` is created with Oracle Identity Governance configuration by default. To create a key in the credential store:
    - i. Login to Oracle Enterprise Manager.
    - ii. Expand **Weblogic Domain**, *DOMAIN\_NAME*. Right-click *DOMAIN\_NAME*, and select **Security, Credentials**.
    - iii. In the Credential Store Provider table, click **oim**.
    - iv. Create a key with type as **Password** and with the credentials, User Name: `dbcustomtrust-keystore.jks`, Password: `password`.
  - b. Change `DirectDB`, `SSLConfig` config in the `oim-Config.xml` file either by exporting/importing this file from MDS or by using Enterprise Manager. For the latter, navigate to **oracle.iam, XMLConfig, DirectDB, SSLConfig** in Application Defined MBeans section of System Mbean Browser, and then change the SSL parameters, for example:

```
SSLConfig DBTrustStore="dbcustomtrust-keystore.jks"
SSLConfig DBTrustStorePasswordKey = NAME_OF_CSF_KEY
```

 **Note:**

If the CN of the certificate is not the same as the hostname of the machine where WLS is installed, then you need to select the hostname verification as **None**. To do so, go to SSL tab, Advanced section, select **None** from the Hostname Verification list.

### 26.3.3 Enabling SSL for Oracle Identity Governance and SOA Servers

Enabling SSL for Oracle Identity Governance servers and other managed servers involves enabling SSL for Oracle Identity Governance, changing `OimFrontEndURL` and `backOfficeURL` to use SSL Port, and changing SOA server URL to use SSL port.

You need to perform the following configurations in Oracle Identity Governance and SOA servers to enable SSL:

- [Enabling SSL for Oracle Identity Governance](#)
- [Changing OimFrontEndURL to Use Oracle Identity Governance SSL Port](#)

- [Changing backOfficeURL to Use SOA SSL Port](#)
- [Changing SOA Server URL to Use SOA SSL Port](#)

### 26.3.3.1 Enabling SSL for Oracle Identity Governance

Enabling SSL for Oracle Identity Governance is described in the following sections:

- [Enabling SSL for Oracle Identity Governance By Using Default Setting](#)
- [Enabling SSL for Oracle Identity Governance By Using Custom Identity and Custom Trust](#)

#### 26.3.3.1.1 Enabling SSL for Oracle Identity Governance By Using Default Setting

To enable SSL for Oracle Identity Governance and SOA servers by using default setting:

1. Log in to WebLogic Server Administrative console and go to Servers, OIM\_SERVER1, General. Under the general section, you can enable ssl port to any value and activate it.
2. The server will start listening and you can access the URL with HTTPS protocol.
3. Perform the same steps for Admin/SOA Servers as Oracle Identity Governance might need to interact with SSL-enabled SOA Server.

#### Note:

- If JDK 7u40 or later is used, then the value of the keysize option must be greater than or equal to 1024. For more information about this limitation, see "Default x.509 Certificates Have Longer Key Length" at the following URL:  
<http://www.oracle.com/technetwork/java/javase/7u40-relnotes-2004172.html>
- If SSL is configured by using the default certificates as described in this section, then apply p13964737\_1036\_Generic.zip. You can download this patch from the My Oracle Support web site at:  
<https://support.oracle.com>

4. Restart all servers for the changes to take effect.

Ensure that when only SSL listen port is enabled on Oracle Identity Governance server and non-SSL listen port is disabled, you must set the value of the providerURL JVM system property to point to the Oracle Identity Governance RMI t3s URL, as follows: For instance, on Linux, if you are using csh shell, then set the environment variable in the following way:

```
setenv SSL_CONFIG_PARAMS="-Dweblogic.security.TrustKeyStore=DemoTrust -  
Dweblogic.security.SSL.ignoreHostnameVerification=true -DproviderURL=t3s://  
<hostname>:<port>"
```

For bash, set the following:

```
export SSL_CONFIG_PARAMS="-Dweblogic.security.TrustKeyStore=DemoTrust -  
Dweblogic.security.SSL.ignoreHostnameVerification=true -DproviderURL=t3s://  
<hostname>:<port>"
```

On Microsoft Windows, set the environment variable in the following way:

```
SET SSL_CONFIG_PARAMS=-Dweblogic.security.TrustKeyStore=DemoTrust -
Dweblogic.security.SSL.ignoreHostnameVerification=true -DproviderURL=t3s://
<hostname>:<port>
```

### 26.3.3.1.2 Enabling SSL for Oracle Identity Governance By Using Custom Identity and Custom Trust

To enable SSL for Oracle Identity Governance by using custom identity and custom trust:



#### Note:

See [Generating Custom Key Stores \(Optional\)](#) and [Configuring Custom Key Stores \(Optional\)](#) for information about generating custom keys.

1. In the *DOMAIN\_HOME/bin/setDomainEnv.sh* file for UNIX or *DOMAIN\_HOME\bin\setDomainEnv.cmd* for Microsoft Windows. Locate the line # SET THE CLASSPATH and add the following:

```
TLS_JAVA_OPTIONS=" -Dweblogic.management.username=username -
Dweblogic.management.password=password -
Djavax.net.ssl.trustStore=$TRUSTSTORE_LOCATION -
Dweblogic.security.SSL.ignoreHostnameVerification=true -
Dweblogic.security.SSL.enforceConstraints=off -
Dweblogic.ssl.JSSEEnabled=true -Dweblogic.security.SSL.enableJSSE=true -
Dweblogic.security.SSL.protocolVersion=TLSv1.3 -Dhttps.protocols=TLSv1.3 -
Djdk.tls.client.protocols=TLSv1.3 -
Djdk.tls.disabledAlgorithms=SSLv2Hello,SSLv3,TLSv1,TLSv1.1,TLSv1.2 -
Dssl.debug=true -Djavax.net.debug=ssl:handshake:verbose "
```

```
JAVA_OPTIONS="${JAVA_OPTIONS} ${TLS_JAVA_OPTIONS}"
export JAVA_OPTIONS
```

Here, the value of TRUSTSTORE\_LOCATION in case of custom trust store is:

```
DOMAIN_HOME/config/fmwconfig/oimsupporttrust.jks
```

The value of TRUSTSTORE\_LOCATION in case of Demo trust store is:

```
${WL_HOME}/server/lib/DemoTrust.jks
```

The value of TRUSTSTORE\_LOCATION in case of Java Standard Trust store is:

```
$JAVA_HOME/jre/lib/security/cacerts
```



 **Note:**

- These settings work with JDK7u131, Use `-Dssl.debug=true -Djavax.net.debug=ssl:handshake:verbose` only for enabling SSL debugging information.
- Stop `Weblogic.sh` is not supporting to pass or set the trust store in use. These scripts use Java standard trust. Import certificate in Java standard trust along with custom trust store while doing the basic SSL configurations.

2. In a text editor, open the `startManagedWebLogic.sh` file and do the following:
  - a. Change the value of `ADMIN_URL` to point to a SSL URL. For example:

```
ADMIN_URL="https://myhost.example.com:7002"
```

- b. Comment out below line:

```
#JAVA_OPTIONS="-Dweblogic.security.SSL.trustedCAKeyStore="WL_HOME/
server/lib/cacerts" ${JAVA_OPTIONS}"
#export JAVA_OPTIONS
```

Save the `startManagedWebLogic.sh` file.

3. Restart all servers for the changes to take effect.

Ensure that when only SSL listen port is enabled on Oracle Identity Governance server and non-SSL listen port is disabled, you must set the value of the `providerURL` JVM system property to point to the Oracle Identity Governance RMI t3s URL, as follows:

```
-DproviderURL=t3s://OIM_HOST:OIM_SSL_PORT
```

This can be done by setting the value of the `JAVA_OPTIONS` environment variable before starting Oracle Identity Governance Managed Server from the command prompt.

For instance, on Linux, if you are using `csh` shell, then set the environment variable in the following way:

```
setenv JAVA_OPTIONS -DproviderURL=t3s://OIM_HOST:OIM_SSL_PORT
```

For `bash`, set the following:

```
export JAVA_OPTIONS=-DproviderURL=t3s://OIM_HOST:OIM_SSL_PORT
```

On Microsoft Windows, set the environment variable in the following way:

```
SET JAVA_OPTIONS=-DproviderURL=t3s://OIM_HOST:OIM_SSL_PORT
```

If Oracle Identity Governance server is managed through Node Manager, then add the following as an argument under `oim_server`, Configuration, Server start, Arguments.

```
-DproviderURL=t3s://OIM_HOST:OIM_SSL_PORT
```

Backup the `WL_HOME/common/nodemanager/nodemanager.properties` file. Open the file and add the following:

```
KeyStores=CustomIdentityAndCustomTrust
CustomIdentityKeyStoreType=JKS
CustomIdentityKeyStoreFileName=DOMAIN_HOME/config/fmwconfig/
oimsupporttrust.jks
CustomIdentityAlias=supportpvtkey
CustomIdentityKeyStorePassPhrase=password
CustomIdentityPrivateKeyPassPhrase=privatepassword
```

Ensure that the path, alias, and password is updated as per the AdminServer configuration.

 **Note:**

Oracle Identity Governance can connect to SOA via web services. If web service invocation fails, then SOA cannot connect to Oracle Identity Governance, and as a result, requests can be stuck. For example, after a create user request is approved, the request might be stuck because the corresponding SOA composite is not able to invoke the request web service deployed on Oracle Identity Governance server, which is SSL-enabled. To avoid such issues, set `JAVA_OPTIONS` in the `in setDomainEnv.sh` file, for example, with:

```
-Djavax.net.ssl.trustStore==DOMAIN_HOME/config/fmwconfig/
oimsupporttrust.jks
```

### 26.3.3.2 Changing OimFrontEndURL to Use Oracle Identity Governance SSL Port

To change the `OimFrontEndURL` to use Oracle Identity Governance SSL port:

1. When the WebLogic admin and Oracle Identity Governance managed servers (at least one of the servers in case of cluster) are running, log in to Enterprise Manager (EM).

For example:

```
http://<AdminServer>/em
```

2. Click **WebLogic Doman**, and select **System MBean Browser**.
3. Under Application Defined MBeans, navigate to **oracle.iam**, **Server:<oim\_servername>**, **Application:oim**, **XMLConfig**, **Config**, **XMLConfig.DiscoveryConfig**, **Discovery**.

In a clustered deployment, when you select **oracle.iam** under Application Defined MBeans, Oracle Identity Governance server name is displayed. Select the server and continue with the navigation.

 **Note:**

In a clustered deployment, the change to the `OimFrontEndURL` must be made on each server in the cluster.

4. Enter a new value for the `OimFrontEndURL` attribute and click **Apply** to save the changes.

For example:

```
https://myoimserver.example.com:14002
```

 **Note:**

Fusion Apps or SPML clients store Oracle Identity Governance URL for invoking SPML and also send callback response. Therefore, there will be changes needed corresponding to this. Also, if Oracle Identity Governance is integrated with OAM/OIAM/OIN, there may be corresponding changes necessary.

### 26.3.3.3 Changing backOfficeURL to Use SOA SSL Port

To change the backOfficeURL to use SOA SSL port:

1. When the WebLogic admin and Oracle Identity Governance managed servers (at least one of the servers in case of cluster) are running, log in to Enterprise Manager (EM).

For example:

```
http://<AdminServer>/em
```

2. Click **WebLogic Domain**, and then select **System MBean Browser**.
3. Under Application Defined MBeans, navigate to oracle.iam, Application:oim, XMLConfig, Config, XMLConfig.DiscoveryConfig, Discovery.
4. Enter a new value for the backOfficeURL attribute and click **Apply** to save the changes.

For example:

```
t3s://mywls1.example.com:14001
```

```
t3s://mywls1.example.com:14001,mywls2.example.com:14001
```

 **Note:**

For simple cluster and non-cluster installations the value must be empty.

### 26.3.3.4 Changing SOA Server URL to Use SOA SSL Port

To change SOA server URL to use SOA SSL port:

1. When the admin server and Oracle Identity Governance managed servers are running, log in to Enterprise Manager (EM).

For example:

```
http://ADMINISTRATIVE_SERVER/em
```

2. Click **WebLogic Domain**, and then select **System MBean Browser**.
3. Under Application Defined MBeans, navigate to oracle.iam, Application:oim, XMLConfig, Config, XMLConfig.SOACfg, SOACfg.
4. Change the values of the Rmiurl attribute.

 **Note:**

Rmiurl is used for accessing SOA EJBs deployed on SOA managed servers.

This is the application server URL. For clustered installation, it is a comma separated list of all the SOA managed server URLs.

For example:

```
t3s://mysoa1.example.com:8002
t3s://
mysoa1.example.com:8002,mysoa2.example.com:8003,mysoa3.example.com:8004
```

5. Change the value of the Soapurl attribute. For example:

```
https://mysoa.example.com:8002
```

 **Note:**

Soapurl is used to access SOA web services deployed on SOA managed servers. This is the web server/load balancer URL, in case of a SOA cluster front ended with web server/load balancer. In case of single SOA server, it can be application server URL.

6. Click **Apply** to save the changes.

The SOA server URL must be enabled in ForeignJNDIProvider-SOA as well:

1. Login to WebLogic Administrative Console.
2. Navigate to **domain, services, ForeignJNDIProvider**.
3. Click **ForeignJNDIProvider-SOA**, and modify it to:

```
t3s://HOST_NAME:SSL_SOA_PORT
```

For example:

```
t3s://mysoa.example.com:8002
```

## 26.3.4 Enabling SSL for Oracle Identity Governance DB

Enabling SSL for Oracle Identity Governance database involves setting up the database in server-authentication SSL mode, creating KeyStores and certificates, updating Oracle Identity Governance, and updating WebLogic Server.

You need to perform the following configurations to enable SSL for Oracle Identity Governance database:

- [Creating KeyStores and Certificates](#)

- [Setting Up Database in Server-Authentication SSL Mode](#)
- [Updating Oracle Identity Governance](#)
- [Updating WebLogic Server](#)
- [#unique\\_780](#)

### 26.3.4.1 Creating KeyStores and Certificates

You can create server side and client side KeyStores using the orapki utility. This utility will be shipped as a part of Oracle DB installation.

KeyStores could be of any format such as JKS and PKCS12. The format of keystore changes based on the provider implementation. For example, JKS is the implementation provided by Sun Oracle where as PKCS12 is implemented by OraclePKIProvider.

Only JKS client KeyStore is used in Oracle Identity Governance for DB server. This is because using non-JKS KeyStores format such as PKCS12 requires significant changes on the installer side at the critical release time. However, Oracle Identity Governance already has a KeyStore named default-KeyStore.jks, which is in JKS format.

The following are the KeyStores that you can create using orapki utility:

- [Creating a Root CA Wallet](#)
- [Creating DB Server Side Wallet](#)
- [Creating Client Side Wallet](#)

#### 26.3.4.1.1 Creating a Root CA Wallet

To create a root certification authority (CA) wallet:

1. Navigate to the following path:

```
$DB_ORACLE_HOME/bin directory
```

2. Create a wallet by using the command:

```
./orapki wallet create -wallet CA_keystore.p12 -pwd KEYSTORE_PASSWORD
```

*KEYSTORE\_PASSWORD* can be any password, it is not related to *KEYSTORE\_PASSWORD* provided while installing Oracle Identity Governance.

3. Add a self signed certificate to the CA wallet by using the command:

```
./orapki wallet add -wallet CA_keystore.p12 -dn 'CN=root_test,C=US' -  
keysize 2048 -self_signed -validity 3650 -pwd KEYSTORE_PASSWORD -sign_alg  
sha256
```

4. View the wallet using the command:

```
./orapki wallet display -wallet CA_keystore.p12 -pwd KEYSTORE_PASSWORD
```

5. Export the self signed certificate from the CA wallet using the command:

```
./orapki wallet export -wallet CA_keystore.p12 -dn 'CN=root_test,C=US' -  
cert self_signed_CA.cert -pwd KEYSTORE_PASSWORD
```

### 26.3.4.1.2 Creating DB Server Side Wallet

To create a DB server side wallet:

1. Create a server wallet using the command:

```
./orapki wallet create -wallet server_keystore_ssl.p12 -auto_login -pwd  
KEYSTORE_PASSWORD
```

2. Add a certificate request to the server wallet using the command:

```
./orapki wallet add -wallet server_keystore_ssl.p12 -dn  
'CN=Customer,OU=Customer,O=Customer,L=City,ST=NY,C=US' -keysize 2048 -  
sign_alg sha256 -pwd KEYSTORE_PASSWORD -sign_alg sha256
```

3. Export the certificate request to a file, which is used later for getting it signed using the root CA signature:

```
./orapki wallet export -wallet server_keystore_ssl.p12 -dn  
'CN=Customer,OU=Customer,O=Customer,L=City,ST=NY,C=US' -request  
server_creq.csr -pwd KEYSTORE_PASSWORD  
-sign_alg sha256
```

4. Get the server wallet's certificate request signed using the CA signature:

```
./orapki cert create -wallet CA_keystore.p12 -request server_creq.csr -  
cert server_creq_signed.cert -validity 3650 -pwd KEYSTORE_PASSWORD  
-sign_alg sha256
```

5. View the signed certificate using the command:

```
/orapki cert display -cert server_creq_signed.cert -complete
```

6. Import the trusted certificate in to the server wallet using the command:

```
./orapki wallet add -wallet server_keystore_ssl.p12 -trusted_cert -cert  
self_signed_CA.cert -pwd KEYSTORE_PASSWORD  
-sign_alg sha256
```

7. Import this newly created signed certificate (user certificate) to the server wallet using the command:

```
./orapki wallet add -wallet server_keystore_ssl.p12 -user_cert -cert  
server_creq_signed.cert -pwd KEYSTORE_PASSWORD
```

### 26.3.4.1.3 Creating Client Side Wallet

To create a client side (Oracle Identity Governance server) wallet:

1. Create a client keystore or use existing keystore default-keystore.jks at following path:

```
DOMAIN_HOME/config/fmwconfig
```

 **Note:**

You can also use Oracle PKCS12 wallet as the client keystore.

2. Import the self-signed CA trusted certificate that you have already exported using the server side commands, to the client keystore (default-keystore.jks) by running the following command:

```
JAVA_HOME/jre/bin/keytool -import -trustcacerts -alias dbtrusted -noprompt
-keystore default-keystore.jks -file self_signed_CA.cert -storepass
KEYSTORE_PASSWORD
```

Here, *KEYSTORE\_PASSWORD* is the password given for the keystore during Oracle Identity Governance installation.

 **Note:**

For custom trust keystore, import the self-signed CA trusted certificate to that, for example:

```
JAVA_HOME/jre/bin/keytool -import -trustcacerts -alias dbtrusted -
noprompt -keystore oimsupporttrust.jks -file self_signed_CA.cert -
storepass KEYSTORE_PASSWORD
```

## 26.3.4.2 Setting Up Database in Server-Authentication SSL Mode

To set up Database in Server-Authentication SSL mode:

1. Stop the Database server and the listener.
2. Configuring the listener.ora file as follows:
  - a. Navigate to the path:

```
$DB_ORACLE_HOME/network/admin directory
```

For example:

```
/u01/app/user1/product/12.1.0/dbhome_1/network/admin
```

- b. Edit the listener.ora file to include SSL listening port and Server Wallet Location.

The following is the sample listener.ora file:

```
# listener.ora Network Configuration File: DB_ORACLE_HOME/listener.ora
# Generated by Oracle configuration tools.
```

```
SSL_VERSION = 1.2
SSL_CLIENT_AUTHENTICATION = FALSE
```

```

WALLET_LOCATION =
  (SOURCE =
    (METHOD = FILE)
    (METHOD_DATA =
      (DIRECTORY = DB_ORACLE_HOME/bin/server_keystore_ssl.p12)
    )
  )

LISTENER =
  (DESCRIPTION_LIST =
    (DESCRIPTION =
      (ADDRESS = (PROTOCOL = TCPS) (HOST = server1.mycompany.com) (PORT = 2484))
    )
    (DESCRIPTION =
      (ADDRESS = (PROTOCOL = TCP) (HOST = server1.mycompany.com) (PORT = 1521))
    )
  )

TRACE_LEVEL_LISTENER = SUPPORT

```

**3. Configure the sqlnet.ora file as follows:**

**a. Navigate to the path:**

\$DB\_ORACLE\_HOME/network/admin directory

For example:

/u01/app/user1/product/12.1.0/dbhome\_1/network/admin

**b. Edit sqlnet.ora file to include:**

- TCPS Authentication Services
- SSL\_VERSION
- Server Wallet Location
- SSL\_CLIENT\_AUTHENTICATION type (either true or false)
- SSL\_CIPHER\_SUITES that can be allowed in the communication (optional)

The following is the sample sqlnet.ora file:

```

# sqlnet.ora Network Configuration File: DB_ORACLE_HOME/sqlnet.ora
# Generated by Oracle configuration tools.

SQLNET.AUTHENTICATION_SERVICES= (BEQ,NTS, TCPS)

SSL_VERSION = 1.2
SSL_CLIENT_AUTHENTICATION = FALSE

WALLET_LOCATION =
  (SOURCE =
    (METHOD = FILE)
    (METHOD_DATA =
      (DIRECTORY = DB_ORACLE_HOME/bin/server_keystore_ssl.p12)
    )
  )

```

**4. Configure the tnsnames.ora file as follows:**

**a. Navigate to the path:**

\$DB\_ORACLE\_HOME/network/admin directory



For example:

```
/u01/app/user1/product/12.1.0/dbhome_1/network/admin
```

- b. Edit the tnsnames.ora file to include SSL listening port in the description list of the service.

The following is the sample tnsnames.ora file:

```
# tnsnames.ora Network Configuration File: DB_ORACLE_HOME/tnsnames.ora
# Generated by Oracle configuration tools.

PRODDB =
  (DESCRIPTION_LIST =
    (DESCRIPTION =
      (ADDRESS = (PROTOCOL = TCPS) (HOST = server1.mycompany.com) (PORT = 2484))
      (CONNECT_DATA =
        (SERVER = DEDICATED)
        (SERVICE_NAME = proddb)
      )
    )
  )
  (DESCRIPTION =
    (ADDRESS = (PROTOCOL = TCP) (HOST = server1.mycompany.com) (PORT = 1521))
    (CONNECT_DATA =
      (SERVER = DEDICATED)
      (SERVICE_NAME = proddb)
    )
  )
)
```

5. Start/Stop utilities for Database server.
6. Start the Database server.

### 26.3.4.3 Updating Oracle Identity Governance

You need to perform the following steps in Oracle Identity Governance to enable Oracle Identity Governance and Oracle Identity Governance DB in SSL mode for a secure communication:

1. Import the trusted certificate into the default-keystore.jks keystore of Oracle Identity Governance.
2. Log in to Enterprise Manager.
3. Navigate to Identity and Access, OIM.
4. Right click and navigate to System MBean Browser.
5. Under Application Defined MBeans, navigate to oracle.iam, Application:oim, XMLConfig, Config, XMLConfig.DirectDBConfig, and DirectDB.
6. Change the values for attributes "Sslenabled", "Url" and click **Apply**. If SSL mode is enabled for DB, then "Url" should contain TCPS enables and SSL port in it.

For example:

```
url="jdbc:oracle:thin:@(DESCRIPTION=(ADDRESS_LIST=(ADDRESS=(PROTOCOL=TCP)
(HOST=my.example.com)(PORT=2484)))
(CONNECT_DATA=(SERVICE_NAME=proddb)
(SEcurity=(SSL_SERVER_CERT_DN="CN=root_test,C=US")))"
```

7. Restart the Oracle Identity Governance server.

## 26.3.4.4 Updating WebLogic Server

After enabling SSL for Oracle Identity Governance Database, you need to change the following Oracle Identity Governance datasources and authenticators to use Database SSL port:

- [Updating Datasource oimOperationsDB Configuration](#)
- [Updating Oracle Identity Governance Authenticators](#)

### Note:

Before performing changes to database host/port, you must shutdown the managed servers hosting Oracle Identity Governance application. However, you can keep the WebLogic Admin Server up and running.

### 26.3.4.4.1 Updating Datasource oimOperationsDB Configuration

To update the Change Datasource oimOperationsDB Configuration:

1. Log in to WebLogic Server.
2. Navigate to Services, JDBC, Data Sources, oimOperationsDB.
3. Click the **Connection Pool** tab.
4. Change the value of the URL to reflect the changes to SSI DB host/port, similar to the following example:

```
jdbc:oracle:thin:@(DESCRIPTION= (ADDRESS_LIST= (ADDRESS= (PROTOCOL=TCPS)
(HOST=myhost.example.com) (PORT=2484)))
(CONNECT_DATA= (SERVICE_NAME=myhost1.example.com)
(SEcurity=(SSL_SERVER_CERT_DN="CN=root_test,C=US")))
```

Where `SSL_SERVER_CERT_DN="CN=root_test,C=US"` is DB root certificate DN.

5. Update Properties to add the following SSL-related properties:

```
javax.net.ssl.trustStore=DOMAIN_HOME/config/fmwconfig/default-keystore.jks
javax.net.ssl.trustStoreType=JKS
EncryptionMethod=SSL
oracle.net.ssl_version=1.0 for all data sources
javax.net.ssl.trustStorePassword=PASSWORD
```

Here, `PASSWORD` is the password given for the keystore during Oracle Identity Governance configuration.

 **Note:**

- Use default-keystore.jks or dbcusomtrust-keystore.jks based on values provided for Wallet.
- For custom trust keystore, provide the path of keystore in the javax.net.ssl.trustStore property file. For example:

```
javax.net.ssl.trustStore=DOMAIN_HOME/config/fmwconfig/  
dbcusomtrust-keystore.jks
```

- If required, perform similar updates to all datasources related to SOA, OWSM, or OPSS like ApplicationDB, bip\_datasource, EDNDataSource, EDNLocalTxDataSource, mds-oim, mds-owsm, mds-soa, oimJMSStoreDS, opss-DBDS, OraSDPMDDataSource, SOADDataSource, SOALocalTxDataSource, and soaOIMLookupDB.

#### 26.3.4.4.2 Updating Oracle Identity Governance Authenticators

The existing Oracle Identity Governance authenticators in the WebLogic server are configured against Non-SSL DB details and they do not use datasources for communicating with Oracle Identity Governance DB. In order to use SSL DB details in the authenticators, you must perform the following:

1. Ensure that Datasources are configured to SSL.
2. In WebLogic Administrative console, navigate to Security Realms, myrealm, Providers.
3. Remove OIMAuthenticationProvider.
4. Create an authentication provider of type "OIMAuthenticator" and mark the control flag as SUFFICIENT.
5. Create an authentication provider of type "OIMSignatureAuthenticator" and mark the control flag as SUFFICIENT.
6. Reorder the authenticators as:
  - a. DefaultAuthenticator
  - b. OIMAuthenticator
  - c. OIMSignatureAuthenticator
  - d. Other providers if any
7. Restart all servers.

#### 26.3.5 Enabling SSL for SOA Approval Composites

Enabling SSL for SOA approval composites involves updating the HTTPS port for each composite with a Human Workflow component type that has a valid worklist URL entry that must use the HTTPS port.

To enable SSL for SOA approval composites:

1. Ensure that the SOA Managed Server is running.
2. Log in to Oracle Enterprise Manager by using your WebLogic Server administrator credentials.

3. Click the Target Navigation image shown on the left of the domain name in upper left corner of the Enterprise Manager console.
4. Click **SOA**, and then select **soa-infra(SOA\_SERVER\_NAME)**.
5. Click the **Deployed Composite** tab.
6. Click the **DefaultOperationalApproval [6.0]** composite.
7. In the Components section, click the **ApprovalTask** link of type Human Workflow.
8. Click the **Administration** tab.
9. Make the required changes to Host Name, HTTP Port, and HTTPS Port.
10. Repeat steps 7 through 9 for each composite with a Human Workflow component type that has a valid worklist URL entry that needs to now use the HTTPS port,, such as DefaultOperationalApproval [6.0].

## 26.3.6 Configuring SSL for the Design Console

To change the Design console to establish secure connection between Oracle Identity Governance and Design console:

Prerequisite:

1. **Edit xlclient.sh and add the below line.** `-Djavax.net.ssl.trustStore=/scratch/Oracle/Middleware/wlserver/server/lib/DemoTrust.jks \`  
 Old Line  

```

: $JAVA_HOME/bin/java -DXL.ExtendedErrorOptions=TRUE \ -DXL.HomeDir=. -
Djava.security.policy=config/xl.policy \ -Djava.security.manager -
Djava.security.auth.login.config=config/authwl.conf \ -DAPPSERVER_TYPE=wls \ -
Djavax.net.ssl.trustStore=/scratch/Oracle/Middleware/wlserver/server/lib/
DemoTrust.jks \ -cp $CLASSPATH com.thortech.xl.client.base.tcAppWindow -server
server JAVA_HOME/bin/java -DXL.ExtendedErrorOptions=TRUE \ -DXL.HomeDir=. -
Djava.security.policy=config/xl.policy \ -Djava.security.manager -
Djava.security.auth.login.config=config/authwl.conf \ -DAPPSERVER_TYPE=wls \ -
cp $CLASSPATH com.thortech.xl.client.base.tcAppWindow -server server

```

New Line:

```

$JAVA_HOME/bin/java -DXL.ExtendedErrorOptions=TRUE \ -DXL.HomeDir=. -
Djava.security.policy=config/xl.policy \ -Djava.security.manager -
Djava.security.auth.login.config=config/authwl.conf \ -DAPPSERVER_TYPE=wls \ -
Djavax.net.ssl.trustStore=/scratch/Oracle/Middleware/wlserver/server/lib/
DemoTrust.jks \ -cp $CLASSPATH com.thortech.xl.client.base.tcAppWindow -server
server

```

2. Provide the following URL in the log in screen:  
`t3s://<host>:<SSL_Port>`

The following steps provide the details for configuring SSL for the Design Console:

1. Copy `wlthint3client.jar` file from `WEBLOGIC_HOME/server/lib` folder to `DESIGN_CONSOLE_HOME/ext` folder.
2. Ensure that `./ext/wlthint3client.jar` is set in the relevant file:  
 For Linux: `DESIGN_CONSOLE_HOME/classpath.sh`  
 For Windows: `DESIGN_CONSOLE_HOME/classpath.bat`

3. Copy `/oracle_common/modules/oracle.rsa/cryptoj.jar` to the `OIM_HOME/designconsole/ext/` directory.
4. Edit the `$DESIGN_CONSOLE_HOME/config/xlconfig.xml` file. Make the following changes:

Change:

```
<Discovery>
  <CoreServer>
    <java.naming.provider.url>t3://HOST_NAME:OIM_PORT/oim</
    java.naming.provider.url>
    <java.naming.factory.initial>weblogic.jndi.WLInitialContextFactory</
    java.naming.factory.initial>
  </CoreServer>
</Discovery>
```

To:

```
<Discovery>
  <CoreServer>
    <java.naming.provider.url>t3s://HOST_NAME:OIM_SSL_PORT/oim</
    java.naming.provider.url>
    <java.naming.factory.initial>weblogic.jndi.WLInitialContextFactory</
    java.naming.factory.initial>
  </CoreServer>
</Discovery>
```

5. If `$DESIGN_CONSOLE_HOME/config/xl.policy` does not contain the default grant policy for all, then add the following permission for `cryptoj.jar` at the end of the file, as shown:

```
grant codeBase "file:DESIGN_CONSOLE_HOME/ext/cryptoj.jar" { permission
java.security.AllPermission;};
```

Copy `$MW_HOME/modules/cryptoj.jar` to the `$OIM_HOME/designconsole/ext/` directory.

#### Note:

Here, copying `$MW_HOME/modules/cryptoj.jar` to the `$OIM_HOME/designconsole/ext/` directory is a mandatory step. Setting the permission is necessary if `xl.policy` does not contain the default grant policy for all.

6. In the relevant file, add the following properties:

For Linux: `DESIGN_CONSOLE_HOME/xlclient.sh`

For Windows: `DESIGN_CONSOLE_HOME/xlclient.cmd`

```
/u01/jdks/jdk1.8.0_131/bin/java -DXL.ExtendedErrorOptions=TRUE \
  -DXL.HomeDir=. -Djava.security.policy=config/xl.policy \
  -Djava.security.manager -Djava.security.auth.login.config=config/
authwl.conf \
  -Dlog4j.configuration=config/log.properties \
  -DAPPSERVER_TYPE=wls \
  -Djavax.net.ssl.trustStore=$TRUSTSTORE_LOCATION \
  -Dweblogic.security.SSL.protocolVersion=TLSv1.2 \
```

```
-Dhttps.protocols=TLSv1.2 \
-Dweblogic.security.SSL.minimumProtocolVersion=TLSv1.2 \
-DproviderURL=t3s://oimhost.us.example.com:14002 \
-Dweblogic.ssl.JSSEEnabled=true \
-Dweblogic.security.SSL.enableJSSE=true \
-Dweblogic.security.allowCryptoJDefaultJCEVerification=true \
-Dweblogic.security.SSL.enforceConstraints=off \
-Dweblogic.security.SSL.ignoreHostnameVerification=true \
-Dweblogic.StdoutDebugEnabled=true \
-Dssl.debug=true \
-Djavax.net.debug=ssl:handshake:verbose \
-cp $CLASSPATH com.thortech.xl.client.base.tcAppWindow -server server
```

7. Set environment variable `TRUSTSTORE_LOCATION` to the location of custom/demo/Java Standard trust keystore used at server side.

For example:

```
setenv TRUSTSTORE_LOCATION DOMAIN_HOME/config/fmwconfig/oimsupporttrust.jks
```

#### Note:

- To get trust store location, in the WebLogic Server Administration Console, click **Environment, Servers**. Click `OIM_SERVER_NAME` to view details of the Oracle Identity Governance server.

Click **KeyStores** tab and note down the Trust keystore location in the Trust section.

- If the Design Console and Oracle Identity Governance are deployed on a different host, then copy the Trust keystore to the host on which Design Console is deployed, and set the `TRUSTSTORE_LOCATION` environment variable to the location where Trust keystore is copied on the local host.

For example:

```
setenv TRUSTSTORE_LOCATION OIM_HOME/designconsole/
copied_oimsupporttrust.jks
```

## 26.3.7 Configuring SSL for Oracle Identity Governance Utilities

Oracle Identity Governance client utilities include `PurgeCache`, `GenerateSnapshot`, `UploadJars`, and `UploadResources`.

When Oracle Identity Governance is configured with TLS, perform the following steps to configure Oracle Identity Governance utilities:

1. Export the Oracle Identity Governance server certificate and import it into custom keystore `oimsupporttrust.jks`.

2. Edit the `OIM_HOME/server/bin/oimClientWrapper.sh` file to add the following parameters after `$JAVA_HOME/bin/java -cp $CLASSPATH`:

```
-Dweblogic.security.SSL.trustedCAKeyStore=$TRUSTSTORE_LOCATION
-Dweblogic.security.SSL.protocolVersion=TLSv1.3
-Dhttps.protocols=TLSv1.3
-Dweblogic.security.SSL.minimumProtocolVersion=TLSv1.3
-DproviderURL=t3s://oimhost.us.example.com:14002
-Dweblogic.ssl.JSSEEnabled=true
-Dweblogic.security.SSL.enableJSSE=true
-Dweblogic.security.allowCryptoJDefaultJCEVerification=true
-Dweblogic.security.SSL.enforceConstraints=off
-Dweblogic.security.SSL.ignoreHostnameVerification=true
-Dweblogic.StdoutDebugEnabled=true
-Dssl.debug=true
-Djavax.net.debug=ssl:handshake:verbose
```

3. Before running the utilities, in the command prompt, set the `TRUSTSTORE_LOCATION` environment variable to pointing towards the location of custom/demo/Java Standard trust keystore used at server side. For example:

```
setenv TRUSTSTORE_LOCATION DOMAIN_HOME/config/fmwconfig/oimsupporttrust.jks
```

 **Note:**

Ensure that Oracle Identity Governance server certificate is already imported into above trust store.

4. For clients and other utilities to connect to Oracle Identity Governance in SSL/TLS way, the public key (certificate) must be made available in the keystore for clients to use it. To do so, export and import public key (certificate) as below:
  - a. Export the public certificate from `Demoidentity.jks` or `oimsupportidentity.jks`, which has private keys, by using the following command. Alternatively, you can export from the browser.

```
$JAVA_HOME/jre/bin/keytool -export -file key.cer -alias demoidentity -
keystore DemoIdentity.jks -storepass DemoIdentityKeyStorePassPhrase
```

In case of custom identity store:

```
$JAVA_HOME/jre/bin/keytool -export -alias supportpvtkey -file
supportpvtkeycert.pem -keypass password -keystore
oimsupportidentity.jks -storepass password
```

- b. Import that certificate to the client keystore, as shown:

```
$JAVA_HOME/jre/bin/keytool -import -trustcacerts -file key.cer -alias
qa_certgenca -keystore DemoTrust.jks -storepass
DemoTrustKeyStorePassPhrase
```

Here, it is `DemoTrust.jks` for demo keystore or `oimsupporttrust.jks` for custom key store.

- c. In clients, such as Design Console and utilities, point TRUSTSTORE\_LOCATION or -Dweblogic.security.SSL.trustedCAKeyStore to this key store, as shown:

```
setenv TRUSTSTORE_LOCATION WL_HOME/server/lib/DemoTrust.jks
-Dweblogic.security.SSL.trustedCAKeyStore= WL_HOME/server/lib/
DemoTrust.jks \
```

## 26.4 Using Ready App

Understand, register, and use Ready App to allow applications that are not fully initialized at the time when WebLogic Server completes the application's deployment to register their desire to participate in the readiness state of the server and tell the server when it is fully initialized.

This section contains the following topics:

- [About Ready App](#)
- [Registering Your Applications with Ready App](#)
- [Using Ready App with an EAR](#)
- [Using Ready App with a WAR](#)
- [Testing Ready App](#)

### 26.4.1 About Ready App

Ready App is a mechanism within WebLogic that allows an application to influence the ready state of the server and/or partition in which it runs. This is done by registering and using the ready() and notReady() methods of the ReadyLifecycle java interface.

For a lot of applications, everything in the server is ready to receive requests if WebLogic Server (WLS) is in a RUNNING state. But for some applications, asynchronous processing may be occurring that may take longer than WebLogic Server's startup cycle. If there is a possibility that your application is not going to be ready to handle requests when WebLogic reaches the RUNNING state, then that application should register with ReadyApp. LoadBalancers and lifecycle tooling should always utilize the ReadyApp URL to determine if a WebLogic Server instance is ready to receive requests just in case one of the deployed applications may not be ready prior to reaching the RUNNING state.

During the startup process of the Fusion Middleware applications, WebLogic Server does not have the visibility of the startup processes for upper stack applications, such as SOA Suite or BPM. This creates the situation where a load balancer or other WLS instance prematurely starts routing traffic to the server that is not fully functional. In addition, it is difficult for patch tools and other lifecycle operations to determine when a server is ready during automated steps involving server restarts. This document defines a mechanism for the upper stack applications to register with WLS and to notify the WLS startup process when the application startup is complete.

The purpose of this framework is to allow applications that are not fully initialized at the time WebLogic Server completes the application's deployment to register their intent to participate in the readiness state of the server and tell the server when it is fully initialized. This is important for the following purposes:

- For any automation mechanisms, tools need a reliable way to determine when the server, with all of its applications, is ready to process requests. This check enables the automation tooling to know when it is safe to proceed to the next step of the process. For example, when a tool needs to perform a rolling restart of a set of servers, it is vital that the stopped



server be completely available before initiating the shutdown of the next server in the domain or cluster so that the domain or cluster does not end up in the state where more than one server is unavailable (or still starting/initializing).

- For load balancing purposes, this framework provides a reliable health-check URL for the server (and the partition in the case of multi-tenancy) so that the load balancer can reliably determine when the server is ready to accept requests.

If your application is fully initialized and ready to accept requests as soon as WebLogic Server completes the deployment of the application during startup (that is, by the time that the server listen port is opened), then there is no need for an application to participate or use this framework.

## 26.4.2 Registering Your Applications with Ready App

To use the Ready App feature, you have to register your application with Ready App.

The recommended method of registering your applications with Ready App is to put the following line in the `META-INF\weblogic-application.xml` file:

```
<wls:ready-registration>true</wls:ready-registration>
```

### Note:

Depending on the contents of your `weblogic-application.xml` file, the 'wls:' may or may not be required. If other tags do not have the prefix, then remove it from the Ready App registration tag.

This automatically registers your application and sets the ready state to `Not Ready` on application startup. It also automatically unregisters your application if the application is undeployed from WebLogic.

## 26.4.3 Using Ready App with an EAR

To use Ready App with an EAR, register your application with Ready App and make calls to the `ready()` and `notready()` methods.

To use the Ready App feature with your application EAR:

1. Register your application with Ready App. See [Registering Your Applications with Ready App](#) for information about registering your application with Ready App.
2. Find a location in your code immediately after it has completed its initialization. At that point, you can put the following line of code to indicate that your application is ready:

```
weblogic.application.ready.ReadyLifecycleManager.getInstance().ready();
```

This indicates to Ready App that your application is ready to process requests. This does not mean that the server or partition will be ready as all other registered applications must signal they are ready prior to the server or partition being ready.

3. If your application needs to stop processing requests, for example, to reinitialize, then you can call the following method to indicate that your application is no longer ready:

```
weblogic.application.ready.ReadyLifecycleManager.getInstance().notReady();
```

This should be followed by your initialization code and then another call to the `ready()` method. Otherwise, the server or partition will remain in a not ready state and will not be able to receive requests.

The calls to `ready()` and `notReady()` have the possibility of causing two different run time exceptions. They are:

Exception	Description
<code>IllegalArgumentException</code>	This exception occurs with the applicationId reported by the Component Invocation Context is null.
<code>IllegalStateException</code>	This exception occurs when the application has not be properly registered. Check the deployment descriptor for proper setup.

## 26.4.4 Using Ready App with a WAR

To use Ready App with an EAR, register your application with Ready App and make calls to the `ready()` and `notready()` methods.

To use the Ready App feature with your application WAR:

### Note:

These instructions only apply to independently deployed WAR files. If you deploy your application as a WAR inside of an EAR, then see the instructions in [Using Ready App with an EAR](#) for using Ready App with an EAR.

1. Register your application with Ready App. See [Registering Your Applications with Ready App](#) for information about registering your application with Ready App.
2. Find a location in your code immediately after it has completed its initialization. At that point, you can put the following line of code to indicate that your application is ready:

```
weblogic.application.ready.ReadyLifecycleManager.getInstance().ready();
```

This indicates to Ready App that your application is ready to process requests. This does not mean that the server or partition will be ready as all other registered applications must signal they are ready prior to the server or partition being ready.

3. If your application needs to stop processing requests, for example to re-initialize, then you can call the following method to indicate that your application is no longer ready:

```
weblogic.application.ready.ReadyLifecycleManager.getInstance().notReady();
```

This should be followed by your initialization code and then another call to the `ready()` method. Otherwise, the server or partition will remain in a not ready state and will not be able to receive requests.

The calls to `ready()` and `notReady()` have the possibility of causing two different run time exceptions. They are:

Exception	Description
IllegalArgumentException	This exception occurs with the applicationId reported by the Component Invocation Context is null.
IllegalStateException	This exception occurs when the application has not be properly registered. Check the deployment descriptor for proper setup.

## 26.4.5 Testing Ready App

To test whether or not Ready App is working, login to the WebLogic Administrative Console, and enable the debug settings for DebugReadyApp.

Perform the following steps to test whether or not Ready App is working:

1. Login to WebLogic Administrative Console by navigating to the following URL:

`http://localhost:PORT/weblogic/ready`

Change hostname and port to the appropriate *SERVER:PORT* that you are using. This returns a page with any one of the following status:

- 200: This means that the server is ready.
- 503: This means that the server is not ready.

This is a blank page with only the HTTP status set, and therefore, you need to use a tool inside the browser to see the status. Google Chrome web browser has a Developer Tools setting that shows the status of the page and the latency. Other browsers might have similar functionality.

2. If you are unable to see the HTTP status from the browser, then you can also turn on debug logging in WebLogic. To do so:
  - a. In the WebLogic Administrative Console, navigate to the server debug page.
  - b. Expand weblogic, application. Select the checkbox adjacent to DebugReadyApp, and then click **Enable**. This will write information out to your log file (or console if you have STDOUT logging on).
3. Set the log levels to Debug. To do so, select the following options, and then click **Save**.
  - a. From the Minimum severity to log list, select **Debug**.
  - b. Under Log file, from the Severity level list, select **Debug**.
  - c. Under Standard out, from the Severity level list, select **Debug**.
  - d. Under Domain log broadcaster, from the Severity level list, select **Debug**.

When you hit the `/weblogic/ready` URL, something similar to the following will be displayed:

```
<Aug 19, 2016 6:43:53 AM PDT> <Debug> <ReadyApp> <BEA-000000>
<getReadyStatus for partition GLOBAL>

<Aug 19, 2016 6:43:53 AM PDT> <Debug> <ReadyApp> <BEA-000000> <
*****

Ready App Map - Operation: Get Ready Status
```

```
Partition Id GLOBAL
Item 0 key: TestEar value: 1
Partition Id ratestp2
Item 0 key: ReadyApp2Test$ratestp2 value: 1
Partition Id ratestp1
Item 0 key: ReadyApp2Test$ratestp1 value: 1
*****
>
```

In this example, there are three applications that are being deployed to the server; one in the global partition, and one each in the latest partitions. You can see from this the value of 1, which means not ready. If the `ready()` method is called on these applications, then the value will be 0, indicating that the application is ready.

If all applications are ready, then the server is considered ready. It is possible for one partition to have all applications ready but other applications could not be ready.

# 27

## Securing a Deployment

Securing an Oracle Identity Manager deployment involves authorizing and hardening, and configuring secure cookies.

This chapter describes securing an Oracle Identity Manager deployment and how to configure secure cookies. It contains the following sections:

- [Authorizing and Hardening](#)
- [Configuring Secure Cookies](#)

### 27.1 Authorizing and Hardening

Securing an Oracle Identity Manager deployment is achieved through authorization and hardening. Authorization controls the access to various components. Hardening secures the components from potential security threats.

[Table 27-1](#) lists the various topics that you can refer for information about securing an Oracle Identity Manager deployment:

**Table 27-1 Securing a Deployment**

Topic	Topic Type	Information Covered
<a href="#">Managing the Scheduler</a>	Hardening	Scheduled tasks and scheduled jobs. Ensure that only required scheduled tasks are enabled.
<a href="#">Default System Properties in Oracle Identity Governance</a>	Hardening	System properties related to system behavior. Ensure that password policies and challenge questions and answers are defined.
<a href="#">Configuring Secure Cookies</a>	Hardening	Enabling Oracle Identity Manager to work over SSL.
<a href="#">Configuring LDAP Synchronization</a> in the <i>Integration Guide for Oracle Identity Management Suite</i>	Hardening	Enabling LDAP authentication.
<a href="#">URL Changes Related to Oracle Identity Governance</a>	Hardening	Steps to make the corresponding changes in Oracle Identity Manager and Oracle WebLogic configuration for any change in the integrated and dependent applications
<a href="#">Password Changes Related to Oracle Identity Governance</a>	Hardening	Steps to make the changes to the password in Oracle Identity Manager and Oracle WebLogic configuration for any change in the dependent or integrated products.
<a href="#">Configuring SSL for Oracle Identity Governance</a>	Hardening	Securing Oracle Identity Manager by configuring SSL.
Managing Password Policies in <i>Performing Self Service Tasks with Oracle Identity Governance</i> .	Hardening	Password policy configuration.

 **See Also:**

*Installation Guide for Oracle Identity and Access Management* and *Enterprise Deployment Guide for Oracle Identity Management* for information about Oracle Identity Management software integrations and related security aspects

## 27.2 Configuring Secure Cookies

Configuring secure cookies can be done in the default scenario when there is no deployment plan for the applications or when updating a current deployment plan if you have explicitly configured it.

This section describes how to configure secure cookies in the default scenario when there is no deployment plan for these applications. It also describes the configuration when updating a current deployment plan if you have explicitly configured it. This section contains the following topics:

- [About Secure Cookies](#)
- [Configuring a New Deployment Plan](#)
- [Updating an Existing Deployment Plan](#)

### 27.2.1 About Secure Cookies

You can secure cookies by setting the `cookie-secure` tag to `true`. This tag enables the browser to send the cookie back over an HTTPS connection only. This ensures that the cookie ID is secure and is only used upon HTTPS access of Oracle Identity Manager.

Oracle Identity Manager application is not configured for SSL access by default. So, the `oimjsessionid` cookie used by Oracle Identity Manager web applications is not secure for HTTPS access. In other words, the `cookie-secure` tag is not set to `true`. However, when SSL access to Oracle Identity Manager is enabled, it is recommended to configure `oimjsessionid` as a secure cookie by setting the `cookie-secure` tag to `true`. This tag enables the browser to send the cookie back over an HTTPS connection only. This ensures that the cookie ID is secure and is only used upon HTTPS access of Oracle Identity Manager. This also implies that HTTP access to Oracle Identity Manager no longer works when this feature is enabled. In addition, the `url-rewriting-enabled` element must be disabled.

Secure cookies need to be configured for the following Oracle Identity Manager UI pages:

- `/identity`, available in `OIM_HOME/apps/oracle.iam.console.identity.self-service.ear/oracle.iam.console.identity.self-service.war`
- `/sysadmin`, available in `OIM_HOME/apps/oracle.iam.console.identity.sysadmin.ear/oracle.iam.console.identity.sysadmin.war`
- `/oim`, available in `OIM_HOME/apps/oim.ear/iam-consoles-faces.war`
- `/xlWebApp`, available in `OIM_HOME/apps/oim.ear/xlWebApp.war`

Secure cookies can be configured by updating the deployment plan for each of the applications, which are `iam.console.identity.self-service.ear`, `oracle.iam.console.identity.sysadmin.ear`, and `oim.ear`.

## 27.2.2 Configuring a New Deployment Plan

Configuring a new deployment plan to secure cookies involves creating a deployment plan and using the plan to configure the deployment.

This section describes how to configure a deployment plan in the following topics:

- [Sample Deployment Plans](#)
- [Configuring the Deployment](#)

### 27.2.2.1 Sample Deployment Plans

Deployment plan specific to the applications can be configured by logging into the WebLogic Administrative Console. The following are sample deployment plans with secure cookie enabled for each of the applications:

- Following is the sample deployment plan XML for the `oracle.iam.console.identity.self-service.ear` application. In this deployment plan, `cookie-secure` is configured to `true`, and `url-rewriting-enabled` is configured to `false` for the `oracle.iam.console.identity.self-service.war` web application:

```
<?xml version='1.0' encoding='UTF-8'?>
<deployment-plan xmlns="http://xmlns.oracle.com/weblogic/deployment-plan"
xmlns:xsi="http://www.w3.org/2001/XMLSchema-instance" xsi:schemaLocation="http://
xmlns.oracle.com/weblogic/deployment-plan http://xmlns.oracle.com/weblogic/
deployment-plan/1.0/deployment-plan.xsd">

  <application-name>oracle.iam.console.identity.self-service.ear#V2.0</application-
name>
  <variable-definition>
    <variable>
      <name>SessionDescriptor_CookieSecure_identity_13909448828172</name>
      <value>true</value>
    </variable>
    <variable>
      <name>SessionDescriptor_UrlRewritingEnabled_identity_139095392691833</name>
      <value>false</value>
    </variable>
  </variable-definition>
  <module-override>
    <module-name>oracle.iam.console.identity.self-service.war</module-name>
    <module-type>war</module-type>
    <module-descriptor external="false">
      <root-element>weblogic-web-app</root-element>
      <uri>WEB-INF/weblogic.xml</uri>
      <variable-assignment>
        <name>SessionDescriptor_CookieSecure_identity_13909448828172</name>
        <xpath>/weblogic-web-app/session-descriptor/cookie-secure</xpath>
      </variable-assignment>
      <variable-assignment>
        <name>SessionDescriptor_UrlRewritingEnabled_identity_139095392691833</name>
        <xpath>/weblogic-web-app/session-descriptor/url-rewriting-enabled</xpath>
      </variable-assignment>
    </module-descriptor>
  </module-override>
</deployment-plan>
```

- The following is the sample deployment plan XML for the `oracle.iam.console.identity.sysadmin.ear` application. In this deployment plan,

cookie-secure is configured to true, and url-rewriting-enabled is configured to false for the oracle.iam.console.identity.sysadmin.war web application.

```
<?xml version='1.0' encoding='UTF-8'?>
<deployment-plan xmlns="http://xmlns.oracle.com/weblogic/deployment-plan"
xmlns:xsi="http://www.w3.org/2001/XMLSchema-instance" xsi:schemaLocation="http://
xmlns.oracle.com/weblogic/deployment-plan http://xmlns.oracle.com/weblogic/
deployment-plan/1.0/deployment-plan.xsd">

  <application-name>oracle.iam.console.identity.sysadmin.ear#V2.0</application-name>
  <variable-definition>
    <variable>
      <name>SessionDescriptor_CookieSecure_sysadmin_13909448828173</name>
      <value>true</value>
    </variable>
    <variable>
      <name>SessionDescriptor_UrlRewritingEnabled_sysadmin_139095392691834</name>
      <value>false</value>
    </variable>
  </variable-definition>
  <module-override>
    <module-name>oracle.iam.console.identity.sysadmin.war</module-name>
    <module-type>war</module-type>
    <module-descriptor external="false">
      <root-element>weblogic-web-app</root-element>
      <uri>WEB-INF/weblogic.xml</uri>
      <variable-assignment>
        <name>SessionDescriptor_CookieSecure_sysadmin_13909448828173</name>
        <xpath>/weblogic-web-app/session-descriptor/cookie-secure</xpath>
      </variable-assignment>
      <variable-assignment>
        <name>SessionDescriptor_UrlRewritingEnabled_sysadmin_139095392691834</name>
        <xpath>/weblogic-web-app/session-descriptor/url-rewriting-enabled</xpath>
      </variable-assignment>
    </module-descriptor>
  </module-override>
</deployment-plan>
```

- The following is the sample deployment plan XML for the oim.ear application. In this deployment plan, cookie-secure is configured to true, and url-rewriting-enabled is configured to false for the iam-consoles-faces.war and xlWebApp.war web applications.

```
<?xml version='1.0' encoding='UTF-8'?>
<deployment-plan xmlns="http://xmlns.oracle.com/weblogic/deployment-plan"
xmlns:xsi="http://www.w3.org/2001/XMLSchema-instance" xsi:schemaLocation="http://
xmlns.oracle.com/weblogic/deployment-plan http://xmlns.oracle.com/weblogic/
deployment-plan/1.0/deployment-plan.xsd">

  <application-name>oim#11.1.2.0.0</application-name>
  <variable-definition>
    <variable>
      <name>SessionDescriptor_CookieSecure_oim_13909448828170</name>
      <value>true</value>
    </variable>
    <variable>
      <name>SessionDescriptor_UrlRewritingEnabled_oim_139095392691831</name>
      <value>false</value>
    </variable>
    <variable>
      <name>SessionDescriptor_CookieSecure_xlWebApp_13909448828171</name>
      <value>true</value>
    </variable>
    <variable>

```



```

        <name>SessionDescriptor_UrlRewritingEnabled_xlWebApp_139095392691832</name>
        <value>false</value>
    </variable>
</variable-definition>
<module-override>
    <module-name>iam-consoles-faces.war</module-name>
    <module-type>war</module-type>
    <module-descriptor external="false">
        <root-element>weblogic-web-app</root-element>
        <uri>WEB-INF/weblogic.xml</uri>
        <variable-assignment>
            <name>SessionDescriptor_CookieSecure_oim_13909448828170</name>
            <xpath>/weblogic-web-app/session-descriptor/cookie-secure</xpath>
        </variable-assignment>
        <variable-assignment>
            <name>SessionDescriptor_UrlRewritingEnabled_oim_139095392691831</name>
            <xpath>/weblogic-web-app/session-descriptor/url-rewriting-enabled</xpath>
        </variable-assignment>
    </module-descriptor>
</module-override>
<module-override>
    <module-name>xlWebApp.war</module-name>
    <module-type>war</module-type>
    <module-descriptor external="false">
        <root-element>weblogic-web-app</root-element>
        <uri>WEB-INF/weblogic.xml</uri>
        <variable-assignment>
            <name>SessionDescriptor_CookieSecure_xlWebApp_13909448828171</name>
            <xpath>/weblogic-web-app/session-descriptor/cookie-secure</xpath>
        </variable-assignment>
        <variable-assignment>
            <name>SessionDescriptor_UrlRewritingEnabled_xlWebApp_139095392691832</name>
            <xpath>/weblogic-web-app/session-descriptor/url-rewriting-enabled</xpath>
        </variable-assignment>
    </module-descriptor>
</module-override>
</deployment-plan>

```

### 27.2.2.2 Configuring the Deployment

To configure the deployment plan(s), copy them to the host on which the Oracle Identity Manager application is deployed. Perform the following steps for all the applications, which as `iam.console.identity.self-service.ear`, `oracle.iam.console.identity.sysadmin.ear`, and `oim.ear`:

1. Login to WebLogic Administrative Console.
2. Navigate to **Deployments**, and then select the application.
3. Click **Update**. The Update Application Assistant page is displayed.
4. Click **Change Path** against the deployment plan path configuration.
5. Specify the path to the deployment plan XML file specific to the application, and click **Next**.
6. Select the **Update this application in place with new deployment plan changes** option. Click **Finish** to complete the deployment plan configuration. Activate changes if required.

 **Note:**

You can ignore the following error while updating the deployment plan for `iam.console.identity.self-service.ear` and `oracle.iam.console.identity.sysadmin.ear`:

```
'weblogic.management.DeploymentException: The application
oracle.iam.console.identity.self-service.ear#V2.0 cannot have the resource
WEB-INF/weblogic.xml updated dynamically. Either:
1.) The resource does not exist.
   or
2.) The resource cannot be changed dynamically.'
```

7. Perform steps 1 through 6 for all the three applications.
8. Restart the Oracle Identity Manager Managed Server.

## 27.2.3 Updating an Existing Deployment Plan

If any of the applications, `iam.console.identity.self-service.ear`, `oracle.iam.console.identity.sysadmin.ear`, and `oim.ear` have an existing deployment plan, then you must update it to configure `cookie-secure` and `url-rewriting-enabled`.

To do so, locate the corresponding deployment plan XML file, and edit it to add the highlighted content (in bold), as shown in the sample deployment plans in [Configuring a New Deployment Plan](#).

For example, to configure `cookie-secure` for `oracle.iam.console.identity.self-service.war` web application, add the highlighted content as follows:

```
<?xml version='1.0' encoding='UTF-8'?>
<deployment-plan xmlns="http://xmlns.oracle.com/weblogic/deployment-plan"
xmlns:xsi="http://www.w3.org/2001/XMLSchema-instance" xsi:schemaLocation="http://
xmlns.oracle.com/weblogic/deployment-plan http://xmlns.oracle.com/weblogic/deployment-
plan/1.0/deployment-plan.xsd">

  <application-name>oracle.iam.console.identity.self-service.ear#V2.0</application-name>
  .....
  .....
  <variable-definition>
    .....
    <variable>
      <name>SessionDescriptor_CookieSecure_identity_13909448828172</name>
      <value>true</value>
    </variable>
    <variable>
      <name>SessionDescriptor_UrlRewritingEnabled_identity_139095392691833</name>
      <value>>false</value>
    </variable>
    .....
  </variable-definition>
  .....
  .....
  <module-override>
    <module-name>oracle.iam.console.identity.self-service.war</module-name>
    <module-type>war</module-type>
    <module-descriptor external="false">
      <root-element>weblogic-web-app</root-element>
      <uri>WEB-INF/weblogic.xml</uri>
```

```
.....  
<variable-assignment>  
  <name>SessionDescriptor_CookieSecure_identity_13909448828172</name>  
  <xpath>/weblogic-web-app/session-descriptor/cookie-secure</xpath>  
</variable-assignment>  
<variable-assignment>  
  <name>SessionDescriptor_UrlRewritingEnabled_identity_139095392691833</name>  
  <xpath>/weblogic-web-app/session-descriptor/url-rewriting-enabled</xpath>  
</variable-assignment>  
.....  
</module-descriptor>  
</module-override>  
</deployment-plan>
```

Save the updated the deployment plan XML file, and then restart the Oracle Identity Manager Managed Server for the changes to take effect.

# Part X

## Diagnostics and Troubleshooting

Diagnostics and troubleshooting in Oracle Identity Governance is achieved by using Oracle Enterprise Manager or Identity Management Diagnostic Framework (ID MDF) to configure logging and diagnosing operation failures. In addition, the PL/SQL Unified Diagnostic Logging and Debugging framework captures diagnostic information from the PL/SQL layer for reconciliation and online data purge operations.

This part describes diagnostics in Oracle Identity Manager and troubleshooting tasks.

It contains the following chapters:

- [Using Enterprise Manager for Managing Oracle Identity Governance](#)
- [Using the PL/SQL Unified Diagnostic Logging and Debugging Framework](#)
- [Using the Identity Management Diagnostic Framework](#)
- [Browser Specific Known Issues](#)

## Using the Identity Management Diagnostic Framework

Using the Identity Management Diagnostic Framework (ID MDF) involves enabling and configuring the framework, understanding how ID MDF works, and using the output for logging and debugging.

### Topics

- [About the Identity Management Diagnostic Framework](#)
- [Enabling ID MDF](#)
- [Configuring the IDM Diagnostic Framework](#)
- [Understanding the Workflow of SLA Monitoring](#)
- [SLA for Predefined Operations](#)
- [Understanding the Output](#)

## About the Identity Management Diagnostic Framework

Identity Management Diagnostic Framework (ID MDF) is a framework to provide first occurrence diagnostics and (Service-Level Agreement) SLA-based notification.

ID MDF provides a diagnostic framework that helps you with faster resolution of issues.

It provides the following capabilities:

- Enable/disable SLA-based event monitoring for predefined events
- Update/set SLA for predefined events

- Detailed events logging for SLA breaches
- Notification for SLA breaches along with events log
- Trace level logs for failed operations and SLA breaches only if in-memory logging is enabled (should be used in rare cases only)

## Enabling ID MDF

ID MDF is enabled or disabled by setting the value of the `ID MDF: Enabled/Disabled By Sysadmin` system property.

SLA-based monitoring in Oracle Identity Governance using ID MDF is disabled by default. To enable it:

1. Log in to Identity System Administration.
2. On the left navigation pane, under System Configuration, click **Configuration Properties**.
3. In the System Configuration tab, search for the `ID MDF: Enabled/Disabled By Sysadmin` system property with keyword `IDM.Diagnostics.Enabled`.
4. Click the system property name to open it.
5. In the value field, replace the current value with `true`.
6. Click **Save**.

## Configuring the IDM Diagnostic Framework

Oracle Identity Governance provides a number of predefined system properties to control SLA-based monitoring and notification.

You can modify the values of the system properties to change the way you want to debug various operations. [Table 4](#) lists these properties.

**Table 4 Configurable Properties to Control Logging**

System Property	Description	Default/Sample Value
ID MDF: Debug mode (true/false)	Property to determine if the logs of ID MDF framework is saved in a log file.	Default value is False, therefore, debug mode is disabled. When set to True, debug mode is enabled.
ID MDF: Default SLA	Property to determine the size of the default SLA for events.	600000 milliseconds
ID MDF: SMTP Server Name	Property to specify the server responsible for sending email notification.	localhost
ID MDF: Flood Control Duration(In Days)	Property to indicate the retention period in days for Flood Control Max email. After the defined number of days, the Flood Control Max email counter is reset.	1
ID MDF: Enabled/Disabled By Sysadmin	Property used by the system administrator to enable or disable ID MDF.	false

**Table 4 (Cont.) Configurable Properties to Control Logging**

System Property	Description	Default/Sample Value
IDMDF: Buffer size to hold context sensitive logs	Property to determine the number of records in the queue that holds detailed logs of the product.	10000
IDMDF: Buffer size to hold failed records	Property to determine the number of records in the queue that holds failed (functional/SLA) events.	1000
IDMDF: Max failed event to execute concurrently	Property to determine the number of threads to execute events concurrently and put it in the database.	2
IDMDF: In-Memory Logging	Property to determine if the logs are stored in the memory.	false
IDMDF: Attachment FilePath	Property to specify the path to store the attachment files.	Default value: /scratch/ IDMDFAttachment Sample value: <i>OIM_HOME</i> / IDMDFAttachment/
IDMDF: Notification template file name	Property to determine the notification template file name.	None
IDMDF: Email Message Template Path	Property to determine the path of the email message template.	None
IDMDF: SLA template file name	Property to determine the file containing the list of SLAs for defined use cases.	None
IDMDF: IDMDF Rest service endpoint	Property to determine the URL on which IDMDF services are deployed.	http://localhost: <i>PORT</i> / idmeventrecording
IDMDF: E-mail notification from	Property to determine the email address from which notification is sent.	dummy.dummy@dummy.com
IDMDF: E-mail notification to	Property to determine the email address to which notification is sent.	dummy.dummy@dummy.com
IDMDF: Notification provider	Property to determine the service used for sending notifications.	oracle.idm.diagnostics.notification.service.impl.IdmdfNotifier <b>Note:</b> If you want to change the default notification provider and use a custom notification provider, then extend the oracle.idm.diagnostics.notification.service.impl.IdmdfNotifier base class. To do so, perform the procedure described in <a href="#">Configuring Custom Notification Provider</a> .
IDMDF: Flood Control Max Email	Property to determine the maximum number of notifications allowed per use case.	2

See [Default System Properties in Oracle Identity Governance](#) for more information about the predefined IDMDF system properties.

See [Editing System Properties](#) for information about modifying system properties.

# Understanding the Workflow of SLA Monitoring

The order of precedence for logging and notification by ID MDF is determined by custom system properties, predefined SLA values, and a default SLA value for all events.

After you enable ID MDF, the SLA monitoring and notification works in the following way:

1. Oracle Identity Governance lets you set the SLA value for an operation or event. You can do that by defining a system property with keyword in the format `ID MDF:EVENT_NAME`, and specifying an appropriate value. You can determine the event name by referring to a list of predefined event APIs and corresponding SLA values, as listed in [SLA for Predefined Operations](#).

For example, for the search catalog event, specify a keyword `ID MDF.Search.Catalog` for the system property you create with value as 50000 (in milliseconds). Here, the predefined event API name is `Search Catalog-API`. The value you specify for the system property will override the predefined SLA value, which is 60000 milliseconds. Therefore, if the search catalog operation takes more than 50000 milliseconds to complete, then a notification is sent to the administrator with diagnostic information.

## Note:

See [#unique\\_507](#) for information about creating system properties.

See [Understanding the Output](#) for information about the output of ID MDF and the mail format in which notification is sent.

If a property is defined for the event and an appropriate value is set for that, then ID MDF uses that to log and send notification.

2. If you do not define a system property for the event, then the default SLA value for that event API is considered by ID MDF for SLA monitoring and sending notification.
3. If the SLA value is not predefined for an event, then the SLA value for that event is determined by the `ID MDF: Default SLA` system property. See [Default System Properties in Oracle Identity Governance](#) for information about the `ID MDF: Default SLA` system property.

## SLA for Predefined Operations

Oracle Identity Governance provides default SLA values for a number of operations.

[Table 5](#) lists the predefined operations or events and their corresponding SLA values.

**Table 5 Predefined Events and SLA Values**

Category	Event	SLA (in milliseconds)
CATALOG API	Find Catalog-API	60000
CATALOG API	Search Catalog-API	60000
CATALOG API	Catalog Item Details-API	60000
CATALOG API	Catalog Details In Bulk-API	60000
CATALOG API	Catalog Details As Metadata-API	60000

**Table 5 (Cont.) Predefined Events and SLA Values**

Category	Event	SLA (in milliseconds)
CATALOG UI	Find Catalog-UI	60000
CATALOG UI	Catalog Item Details-UI	60000
SELF REGISTRATION API	Self Registration-API	60000
SELF REGISTRATION UI	Self Registration-UI	60000
TRACK REQUEST API	Get Request Data-API	60000
TRACK REQUEST API	Withdraw Request-API	60000
TRACK REQUEST API	Close Request-API	60000
TRACK REQUEST API	Get Requests-API	60000
TRACK REQUEST_UI	Track Request-UI	60000
TRACK REQUEST_UI	Withdraw Request-UI	60000
TRACK REQUEST_UI	Close Request-UI	60000
TRACK REQUEST_UI	Get Requests-UI	60000
Application Onboarding	Create Application-REST	60000
Application Onboarding	Create Application-API	60000
Application Onboarding	Create Application Instance-API	60000
Reconciliation	Create Reconciliation Event-API	60000
Provisioning	Account Provision-API	60000
Provisioning	Revoke Account-API	60000
Provisioning	Revoke Entitlement-API	60000
Role API	Create Role-API	60000
Role API	Update Role-API	60000
Role API	Modify Role Based On SearchCriteria-API	60000
Role API	Delete Role-API	60000
Role API	Delete Bulk Role-API	60000
Role UI	Delete Bulk Role-API	60000
Access Policy API	Evaluate Policies For User-API	60000
Access Policy API	Initiate Policy Evaluation-API	60000
Access Policy API	Create Access Policy-API	60000
Access Policy API	Update Access Policy-API	60000
Access Policy API	Delete Access Policy-API	60000
Access Policy UI	Update Access Policy-UI	60000
Access Policy UI	Delete Access Policy-UI	60000
Access Policy UI	Create Access Policy-UI	60000
MY Information UI	Update MyInfo Changes-UI	60000
MY Information UI	Apply Changes For ChallengeQuestion-UI	60000
MY Information UI	MyInformation Change User Password-UI	60000
MY Information UI	Apply Proxy Add/Update-UI	60000
MY Information UI	Remove Proxy-UI	60000
MY Information UI	Remove All Proxy-UI	60000
My Information API	Change password-API	60000
My Information API	Set challenge values-API	60000



**Table 5 (Cont.) Predefined Events and SLA Values**

Category	Event	SLA (in milliseconds)
My Information API	Modify Profile Details-API	60000
My Information API	Add Proxy For User-API	60000
My Information API	Update Proxy For User-API	60000
My Information API	Remove Proxy-API	60000
My Information API	Remove All Proxies For User-API	60000
Password Policy UI	Delete Password Policy-UI	60000
Password Policy UI	Apply Create/Update Password Policy-UI	60000
Password Policy API	Delete Password Policy-API	60000
Password Policy API	Update Password Policy-API	60000
Password Policy API	Create Password Policy-API	60000
Certification API	Complete Certification-API	60000
Certification API	Certify Users-API	60000
Certification API	Reassign Items Phase60000-API	60000
Certification API	Save Certification Definition-API	60000
Certification API	Create Certification Job-API	60000
Certification API	Update Certification-API	60000
SoD API	Initiate SoD Check--API	60000
SoD API	Get Result For Synchronous SoD Check-API	60000
SoD API	Execute Sod Async Provisioning Task-API	60000
SoD API	Execute Sod Async Task-API	60000
NA	Create User-API	60000
NA	Delete User-API	60000
NA	Delete User by search criteria-API	60000
NA	Delete Users in Bulk-API	60000
NA	Update Audit Profile	60000
NA	Update Audit Records	60000
NA	Initialize IAuditor	60000
NA	Create Auditor	60000
NA	Create Audit Event	60000
NA	Create Audit Event in Bulk	60000
NA	Delete AuditEvent Group	60000
NA	Create Fresh Profile	60000
NA	Create AuditEvent Group	60000
NA	Create and Modify Organization-UI	60000
NA	Delete Organization-UI	60000
NA	Modify User-API	60000
NA	Modify User by search criteria-API	60000
NA	Modify Users in bulk-API	60000

**Table 5 (Cont.) Predefined Events and SLA Values**

Category	Event	SLA (in milliseconds)
NA	Create and Modify AdminRole-UI	60000
NA	Save AdminRole-UI	60000
NA	Delete the AdminRole-UI	60000
NA	Approval Callback-UI	60000
NA	Submit Request-UI	60000
NA	Create User-REST	60000
NA	Submit OIM Operation-API	60000
NA	Submit Request-API	60000
NA	Approval Callback-API	60000
NA	Post Approval Callback-API	60000
NA	Start Orchestration-API	60000
NA	Create Organization-API	60000
NA	Authorize Access-API	60000
NA	Refresh Entity Cache-API	60000
NA	Delete Organization-API	60000
NA	Execute OIM Event	60000
NA	Search Organization To Modify-API	60000
NA	Modify Organization-API	60000
NA	Send Notification-API	60000
NA	Send Bulk Notification-API	60000
NA	Create Admin Role-API	60000
NA	Modify Admin Role-API	60000
NA	Delete Admin Role-API	60000
NA	Submit OIM Operation-API	60000
NA	Async Processing-API	60000
NA	Create Entity-API	60000
NA	Modify Entity-API	60000
NA	Delete Entity-API	60000
NA	Find Entities-API	60000
NA	Find Entity-API	60000

## Understanding the Output

IDMDF sends an email notification for each SLA failure.

The email contains information about the event and broken SLA along with two attachments, a detailed log and an event tree XML file.

### Notification Email

[Table 6](#) lists the contents of the notification email.

**Table 6 ID MDF Email Notification**

Field	Sample Value	Description
User	4	The user ID of the logged-in user.
Product Name	OIG	The Identity Management product in which the event occurred. ID MDF supports event logging in Oracle Identity Governance (OIG) and Oracle Access Management (OAM).
SLA	2 ms	The default or defined SLA value in milliseconds.
Start Time	2019-03-01 01:18:24.99	The date and time when the event started.
End Time	2019-03-01 01:18:24.994	The date and time when the event ended.
Actual Time Taken	4 ms	The actual time taken in milliseconds for the event to complete.
ECID (Event Identifier)	dced1e07-1e20-43 42- b8fb-3bc819b904df -0000000a	The unique identifier for the event.

**Detailed Log**

[Table 7](#) lists the information in the detailed log attachment in the email notification.

**Table 7 Detailed Log**

Field	Sample Value	Description
Log Level	FINEST	The diagnostic log level, which can be INFO, FINE, FINEST, or NONE. See <a href="#">Configurable Diagnostic Levels Provided in the Framework</a> for information about the diagnostic levels.
Log Time	Jan 14,2019 02:11:33.831	The date and time of the log.
Log Message	Number of invocations of loginSessionCreate d is 6	The error or warning message indicating the problem.
Parameters	[getRunAsUser, configurationInstan ce, []]	The parameters of the log.
Source Class Name	AuthenticationCont extUtilForEJB	The class from which the exception has been raised or source class in which the SLA breach has happened.
Source Method Name	setAuthenticationC ontextInEJB	The method name that is taking time to execute.
Stack Trace	NA	The trace that contains the detail of the events that are executed in between.

## Event Tree XML

The event tree XML file contains information about the event execution. The following is the contents of a sample event tree XML file:

```
<structure>
  <thread>
    <threadId>25</threadId>
    <event name="Find Entities-API" startTime="Jan 14,2019 02:11:33.991"
endTime="Jan 14,2019 02:11:34.002" status="SUCCESS">
      <eventDetails>find/lookup for a list of entites</eventDetails>
    </event>
    <event name="Authorize Access-API" startTime="Jan 14,2019 02:11:34.115"
endTime="Jan 14,2019 02:11:34.115" status="SUCCESS">
      <eventDetails>Check if action is authorized for the user.</
eventDetails>
    </event>
    <event name="Find Entity-API" startTime="Jan 14,2019 02:11:34.117"
endTime="Jan 14,2019 02:11:34.131" status="SUCCESS">
      <eventDetails>find/lookup an entity</eventDetails>
    </event>
  </thread>
</structure>
```

# Browser Specific Known Issues

Sometimes, Chrome browser shows unresponsive error when clicking on some buttons. Even the pop-up screen do not show. This error happens in a windows platform on few occasions.

Solution: This issue is specific to Chrome browser. The page becomes unresponsive when the zoom is set to 100%. You must increase the screen zoom to more than or less than 100 by clicking on the 3 dots (...) and select 'Zoom'.

To ensure that the zoom is set to 100% for high DPI (4k) monitors: [https://ahipacs.americanhealthimaging.com/webhelp5/languages/en-us/content/html/Ensuring\\_the\\_Browser\\_Zoom\\_Factor\\_is\\_100\\_Percent.htm](https://ahipacs.americanhealthimaging.com/webhelp5/languages/en-us/content/html/Ensuring_the_Browser_Zoom_Factor_is_100_Percent.htm).

1. Right-click the Chrome shortcut.
2. Select **Properties**.
3. In the **Target** field, add `/force-device-scale-factor=1` after the existing path.
4. Click **Apply**.

# Using Enterprise Manager for Managing Oracle Identity Governance

You can use Oracle Enterprise Manager for managing Oracle Identity Governance configuration, using the `OrchestrationEngine` MBean, log services configuration, and `EHCACHE` configuration.

This chapter describes how to configure Oracle Identity Governance by using Oracle Enterprise Manager Fusion Middleware Control. It contains the following topics:

- [Managing Oracle Identity Governance Configuration](#)
- [Using the `OrchestrationEngine` MBean](#)
- [Configuring Log Services for Oracle Identity Governance](#)
- [Handling Cache](#)

## 28.1 Managing Oracle Identity Governance Configuration

Oracle Identity Manager stores the configuration files in MDS. Most of the configurations are exposed as MBeans. Therefore, you can control the configuration values by using Oracle Enterprise Manager. In some instances, you might have to export the complete files to the file system, make the necessary changes, and then import the files back into the repository.

This topic contains the following sections:

- [Using MBeans for Configuration Changes](#)
- [Exporting and Importing Configuration Files](#)

### 28.1.1 Using MBeans for Configuration Changes

The configurations files are stored as MBeans, which you can modify to change configuration settings.

To change configuration settings by using Mbeans:

1. When the administrative server and at least one Oracle Identity Manager managed server is running, login to Oracle Enterprise Manager Fusion Middleware Control by using the URL in the following format:  
`http://ADMINISTRATION_SERVER:PORT/em`
2. Click the weblogic domain drop down on the left hand side at the top of the screen. Select **System Mbean Browser**.
3. Navigate to Application Defined MBeans, **oracle.iam**, **Server:<server\_instance\_name>**, **Application:oim**, **XMLConfig:Config**.

All the configuration files are in this location.

## 28.1.2 Exporting and Importing Configuration Files

For making changes to the configuration files, you can export the existing configuration files to an external file system, edit the files to make necessary changes, and import the newly edited files back to the repository.

To export or import configuration files:

1. When the administrative server and at least one Oracle Identity Manager managed server is running, login to Oracle Enterprise Manager Fusion Middleware Control by using the URL in the following format:

`http://ADMINISTRATION_SERVER:PORT/em`

2. Click the weblogic domain drop down on the left hand side at the top of the screen, and **System Mbean browser**.

3. Navigate to Application Defined MBeans, **oracle.mds.lcm**, **Server:<server\_instance\_name>**, **Application:oim**, **MDSAppRuntime**.

4. To export the configuration files:

- a. Click the **Operations** tab, and then click **exportMetaData**.
- b. In the toLocation field, enter `/tmp` or the name of another directory.
- c. Select createSubDir as **false**.
- d. In the docs field, enter the complete file location as the Element.
- e. Also select **false** for excludeAllCust, excludeBaseDocs, and excludeExtendedMetadata. Then, click **Invoke**.

This exports the file specified in the docs field to the directory specified in the toLocation field.

5. To import the configuration files:

- a. Click **importMetaData**.
- b. In the fromLocation field, enter `/tmp` or the name of the directory in which you have the configuration files.
- c. Select createSubDir as **false**.
- d. In the docs field, enter the complete file location as the Element. For example, `/db/oim-config.xml`.
- e. Also select **false** for excludeAllCust, excludeBaseDocs, and excludeExtendedMetadata. Then, click **Invoke**.

This imports the file specified in the docs field to MDS in the toLocation field.

## 28.2 Using the OrchestrationEngine MBean

Using the OrchestrationEngine MBean includes accessing the OrchestrationEngine Mbean, operations supported by the MBean, and diagnosis of operation failures.

You can manage the orchestration engine by using the OrchestrationEngine MBean provided by Oracle Enterprise Manager. This section describes the MBean and its various operations and parameters. It contains the following topics:

- [Accessing the OrchestrationEngine MBean](#)

- [About the Operations Supported by the MBean](#)
- [About Diagnosis of Operation Failures Using the Orchestration Engine](#)
- [Diagnosing Operation Failures Using the Orchestration Engine](#)

## 28.2.1 Accessing the OrchestrationEngine MBean

Login to Oracle Enterprise Manager, open System MBean Browser, and display the MBean information for the OrchestrationEngine MBean under Application Defined MBeans.

To access the OrchestrationEngine MBean:

1. Login to Oracle Enterprise Manager.
2. Click **WebLogic Domain** at the top, and select **System MBean Browser**.
3. Expand **Application Defined Mbeans**, **oracle.iam**, **Server:SERVER\_INSTANCE\_NAME**, **Application:oim**, **Kernel**, and then click **OrchestrationEngine**.

The Operations tab of the Application Defined MBeans: Kernel:OrchestrationEngine page is displayed.

4. You can expand **Show MBean Information** to display the details of the OrchestrationEngine MBean, specifically the full MBean name and description.

The Operations tab displays in a tabular format the operation names, descriptions, parameters, and return types of the operations that you can invoke by using the OrchestrationEngine MBean.

5. Click an operation name to open the details of the operation. The operation details page displays the full MBean name, operation name, description of the operation, and return type. It also lists the parameters and allows you to enter values for the parameters.

## 28.2.2 About the Operations Supported by the MBean

The OrchestrationEngine MBean supports various operations, such as dump, findEventHandlers, findEventsForProcess, and findOperations.

[Table 28-1](#) lists the operations supported by the OrchestrationEngine MBean.

**Table 28-1 Operations Supported by OrchestrationEngine**

Operation	Description
dump	<p>This operation dumps complete orchestrations to the console or to a file. The console cannot print more than three to five orchestrations because of size limitations, and therefore, file system must be used.</p> <p>Paging must be used to dump data in chunks if the number of processes to be dumped is high, as it can put load on the server. If paging is used to dump data to a single file, then set the appendFile parameter to true, so that page dumps are appended in the file. Otherwise, use separate file per page dump.</p>
familyTree	<p>This operation returns the entire family tree of a process whose ID is provided as a parameter. The family includes children, siblings, and parent up to n-level.</p> <p>Setting the value of the detailed parameter to true returns full detailed process, which is a heavyweight call for the server, and must be used with care.</p>

**Table 28-1 (Cont.) Operations Supported by `OrchestrationEngine`**

Operation	Description
<code>findEventHandlers</code>	<p>This operation returns a list of supported event handlers for a particular combination of entity type and operation.</p> <p>The parameters of this operation are case-sensitive. Therefore, when some custom handlers are defined, it helps in debugging if they have the right case as these values are used in case-sensitive manner.</p> <p>All the handlers are returned in the order of execution.</p>
<code>findEventsForProcess</code>	<p>This operation returns the actual list of events applicable in the context/flow for a process, whose ID and/or name is provided.</p> <p>Handlers are returned in the order of execution.</p> <p>The list of handlers is not the complete handler list of an entity type and operation.</p>
<code>findOperations</code>	<p>This operation returns a list of all the configured operations for an entity type.</p> <p>If nothing is provided as parameter, then it returns a complete list of operations across entity operations.</p>
<code>findProcess</code>	<p>This operation returns a list of processes that satisfies the criteria based on the parameters passed.</p> <p>If search is not ID-based, then <code>pageSize</code> and <code>pageNumber</code> must be used to process chunks of data as the call is heavy.</p> <p>Setting the <code>detailed</code> parameter to <code>true</code> returns a full detailed orchestration object. Therefore, this parameter must used with care to prevent extra load on the server.</p> <p>If no value is provided as parameter value, then it returns all the processes saved in the database, which can be a large number.</p>
<code>listEntityTypes</code>	This operation returns a list of Oracle Identity Manager entity types.

### 28.2.3 About Diagnosis of Operation Failures Using the `OrchestrationEngine`

Most of the operations done on various entities in Oracle Identity Manager go via the orchestration engine. The list of entity types using orchestration engine as their back bone can be obtained via the `listEntityTypes` operation on the `OrchestrationEngine` Mbean.

End to end detailed flow of every operation is logged in the log files. For debugging purposes, finer details can be obtained by setting the logging level of the `oracle.iam.platform.kernel` logger to `INFO` or `FINE`.

Orchestrations only get serialized in the database if they have not achieved completed status, which might occur because of failures or waiting for another thread to resume processing.

To understand the cause of incomplete processing of any orchestration process, which can be because of various reasons, you can either look into the logs or use the orchestration process ID obtained from logs to get the details from the `OrchestrationEngine` Mbean.

#### Note:

Orchestration Process ID is a unique combination of two fields, a long type ID and a string type Name. Either of the two can be provided to the Mbean operations to get results. You can provide both for exact record match.



Orchestration process ID can be obtained in the following ways:

- From the log files
- From `getOrchestrationIds` operation of `EventDiagnostic MBean` (`oracle.iam:Location=oim_server1,name=EventDiagnostic,type=Reconciliation,Application=oim`) for reconciliation flows.
- From the `processInfo` operation of the `RequestDiagnostic MBean` (`oracle.iam:Location=oim_server1,name=RequestDiagnosticMXBean,type=IAMAppRuntimeMBean,Application=oim`), by providing the request ID or from the `orchestration_process_id` column of the request table for request flows.
- By using the `findProcess` operation of the `OrchestrationEngine MBean`, which searches through the database of incomplete orchestrations based on the provided criteria

 **Note:**

If the `findProcess` operation of the MBean for a particular process ID returns nothing, then it means that either the provided ID is incorrect or the particular process completed successfully and does not exist in the database. Information for such a process ID is available only in the log files.

## 28.2.4 Diagnosing Operation Failures Using the Orchestration Engine

Diagnosing operation failures using the Orchestration Engine involves enabling internal details of the process, invoking the `findEventsForProcess` operation followed by the `dump` operation, and invoking the `familyTree` operation for parent and child orchestrations.

After the process ID is found, perform the following steps to diagnose operation failures:

1. Invoke the `findProcess` operation of the MBean, pass the process ID and set the `detailed` parameter as `true`. This provides all the internal details of the process.
2. Get the details of the handlers involved in the order of execution by invoking the `findEventsForProcess` operation on the MBean.
3. Dump the complete process to the console or a file by invoking the `dump` operation of the MBean. Pass the process ID and the file name if it is required to be dumped to a file.
4. Complex cases involving parent and child orchestrations up to n-level can be completely traced by invoking the `familyTree` operation on the `OrchestrationEngine MBean`.

If the process ID is not found, then multiple orchestrations can be dumped to a file by using the `dump` operation of the MBean, based on the parameters provided to the mbean. This dump file along with the log files help understand the cause of various issues. These files can also be provided to Oracle support as part of service request.

## 28.3 Configuring Log Services for Oracle Identity Governance

Oracle Identity Manager uses two logging services: Oracle Diagnostic Logging (ODL), which is the logging service used by most Oracle Fusion Middleware applications, and Apache log4j.

Oracle Identity Manager logging is primarily done with ODL. Apache log4j is only used with third-party applications, such as Nexaweb for Deployment Manager and Workflow Designer.

This topic contains the following sections:

- [Logging in Oracle Identity Governance By Using ODL](#)
- [Logging in Oracle Identity Governance By Using log4j](#)
- [Setting Warning State](#)
- [Switching Down the Log Level](#)

## 28.3.1 Logging in Oracle Identity Governance By Using ODL

Logging by using ODL involves understanding message types and levels, log handler, and logging configuration, configuring loggers and log handlers, and starting and stopping jobs.

This section describes about the logs generated in Oracle Identity Manager using the ODL in the following topics:

- [About Oracle Diagnostic Logging](#)
- [Message Types and Levels in Oracle Identity Governance](#)
- [Log Handler and Logger Configuration](#)
- [Configuring Log Handlers](#)
- [About Configuring Loggers](#)
- [Configuring Loggers in Oracle Identity Governance](#)
- [Starting and Stopping Jobs](#)
- [Sample ODL Log Output](#)

### 28.3.1.1 About Oracle Diagnostic Logging

Oracle Diagnostic Logging (ODL) is the principal logging service used by Oracle Identity Manager. For ODL logging to work, both loggers and log handlers need to be configured. Loggers send messages to handlers, and handlers accept messages and output them to log files.

Logging configuration is controlled by the logging.xml file described in [Log Handler and Logger Configuration](#). This file can either be edited directly or edited through the Enterprise Manager. On the Enterprise Manager, the logging configuration can be accessed by clicking the OIM server link and by selecting the WebLogic Server drop down from the top, and then clicking on Logs - Log Configuration.

To access the logging configuration on the Enterprise Manager:

1. Click the target application on the left hand side at top of the screen. Navigate to **Weblogic Domain, base\_domain, oim\_server1**. Click the weblogic server drop down.
2. From the WebLogic Server list, select Logs - Log Configuration. All the packages available for logging are displayed on the log configuration screen.

For any additional packages to be logged that are not available in the Enterprise Manager (such as, for connector packages), follow the instructions to manually edit the logging.xml file. The packages specific to Oracle Identity Manager can be accessed under oracle.iam. The different log levels are available for selection under the Oracle Diagnostic Logging Level column. Select a particular log level, and then click **Apply** for the changes to take effect. In addition, new log handlers can be created and configured by clicking the **Log Files** tab.

Each Oracle Identity Manager module has its own logger that can be configured independently to send different amounts of information to one or more log handlers. [Table 28-3](#) lists the more

than twenty different Oracle Identity Manager loggers that can be configured to send messages to log handlers.

You can output more or less information to a log by adjusting the level attribute for each logger. To select a logging level, choose from one of five message types (INCIDENT\_ERROR, ERROR, WARNING, NOTIFICATION, and TRACE). Each message type can also take a numeric value between 1 (highest severity) and 32 (lowest severity) that you can use to further restrict the volume of messages that a logger will output. Table 1 on page 2 lists the message type and level combinations that are used most often.

Log handlers specify the target where log messages should appear. For example, log handlers can write messages to the console, to various log files, and to additional outputs.

### 28.3.1.2 Message Types and Levels in Oracle Identity Governance

ODL recognizes five message types: INCIDENT\_ERROR, ERROR, WARNING, NOTIFICATION, and TRACE. Each message type can also take a numeric value between 1 (highest severity) and 32 (lowest severity) that you can use to further restrict message output.

When you specify a message type, ODL returns all messages of that type, as well as the messages that have a higher severity. For example, if you set the message type to WARNING, ODL also returns messages of type INCIDENT\_ERROR and ERROR.

Message types and levels are described in greater detail in Setting the Level of Information Written to Log Files of the *Administrator's Guide*. [Table 28-2](#) lists the diagnostic message types that you can use most often with Oracle Identity Manager.

**Table 28-2 Oracle Identity Manager Diagnostic Message Types**

Message Type and Numeric Value	Description
INCIDENT_ERROR:1	A serious problem that may be caused by a bug in the product and that should be reported to Oracle Support. Examples are errors from which you cannot recover.
ERROR:1	A serious problem that requires immediate attention from the administrator and is not caused by a bug in the product. An example is if Oracle Fusion Middleware cannot process a log file, then you can correct the problem by fixing the permissions on the document.
WARNING:1	A potential problem that should be reviewed by the administrator. Examples are invalid parameter values or a specified file does not exist.
NOTIFICATION:1	A major lifecycle event such as the activation or deactivation of a primary sub-component or feature. This is the default level for NOTIFICATION.
NOTIFICATION:16	A finer level of granularity for reporting normal events.
TRACE:1	Trace or debug information for events that are meaningful to administrators, such as public API entry or exit points.
TRACE:16	Detailed trace or debug information that can help Oracle Support diagnose problems with a particular subsystem.
TRACE:32	Very detailed trace or debug information that can help Oracle Support diagnose problems with a particular subsystem.

### 28.3.1.3 Log Handler and Logger Configuration

Both log handlers and loggers can be configured by editing `logging.xml`, which is located in:

`DOMAIN_NAME/config/fmwconfig/servers/SERVER_NAME/logging.xml`

Here, `DOMAIN_NAME` and `SERVER_NAME` are the domain name and server name respectively specified during the installation of Oracle Identity Manager.

The `logging.xml` file has a `<log_handlers>` configuration section, followed by a `<loggers>` configuration section. Each log handler is defined within the `<log_handlers>` section, and each logger is defined within the `<loggers>` section.

The file has the following basic structure:

```
<logging configuration>
  <log_handlers>
    <log_handler name='console-handler' level="NOTIFICATION:16"></log_handler>
    <log_handler name='odl-handler'></log_handler>
    <!--Additional log_handler elements defined here....-->
  </log_handlers>
  <loggers>
    <logger name="example.logger.one" level="NOTIFICATION:16">
      <handler name="console-handler"/>
    </logger>
    <logger name="example.logger.two" />
    <logger name="example.logger.three" />
    <!--Additional logger elements defined here....-->
  </loggers>
</logging_configuration>
```

When configuring a logger to write messages to either the console or a file, make configuration changes to both the logger and the handler. Setting the level attribute for the logger configures the amount of detail (and therefore, the volume of messages) that the logger sends to the handler. Similarly, setting the level attribute for the handler configures the amount of detail that the handler accepts from the logger.

#### Note:

If you are not getting the volume of output that you expect in a log, then verify that the level attribute for both the logger and the log handler are set appropriately. For example, if the logger is set to TRACE and the log handler is set to WARN, then the handler does not generate messages more detailed than WARN.

### 28.3.1.4 Configuring Log Handlers

Individual log handlers are configured in the `<log_handlers>` section of the `logging.xml` file. Configure the level attribute for the handler to set the amount of detail that the handler will accept from loggers.

To configure the log handler-level attribute:

 **Note:**

You must have a basic understanding of XML syntax before you attempt to modify the logging.xml file.

1. Open the `DOMAIN_NAME/config/fmwconfig/servers/SERVER_NAME/logging.xml` file.
2. Change the level attribute as shown in the following examples.

In this example XML code, the level attribute for the console-handler is set to `WARNING:32`.

```
<log_handler name='console-handler' class='oracle.core.ojdl.logging.ConsoleHandler'
formatter='oracle.core.ojdl.weblogic.ConsoleFormatter' level='WARNING:32'/>
```

For the console-handler to be able to write TRACE level messages to the console, change the level attribute as shown:

```
<log_handler name='console-handler' class='oracle.core.ojdl.logging.ConsoleHandler'
formatter='oracle.core.ojdl.weblogic.ConsoleFormatter' level='TRACE:1'/>
```

3. Save your changes and restart the application server.

### 28.3.1.5 Log Handler Configuration Tools

Log handlers that write to a file have additional properties that can be configured. For example, this excerpt from logging.xml configures the odl-handler:

```
<log_handler name='odl-handler' class='oracle.core.ojdl.logging.ODLHandlerFactory'
filter='oracle.dfw.incident.IncidentDetectionLogFilter'>
  <property name='path' value='${domain.home}/servers/${weblogic.Name}/logs/${
weblogic.Name}-diagnostic.log'/>
  <property name='maxFileSize' value='10485760'/>
  <property name='maxLogSize' value='104857600'/>
  <property name='encoding' value='UTF-8'/>
  <property name='useThreadName' value='true'/>
  <property name='supplementalAttributes' value='J2EE_APP.name,J2EE_MODULE.name,
WEBSERVICE.name,WEBSERVICE_PORT.name,composite_instance_id,component_instance_id,
composite_name,component_name'/>
</log_handler>
```

To make changes to log handler properties, you can use either the Fusion Middleware Control tool or the WLST command-line tool.

 **See Also:**

- Configuring Settings for Log Files in *Administrator's Guide* for information about both the Fusion Middleware Control tool and the WLST command-line tool
- Logging Custom WLST Commands in *WebLogic Scripting Tool Command Reference* for information about the WLST command-line tool

### 28.3.1.6 About Configuring Loggers

Individual loggers are configured in the <loggers> section of the logging.xml file. More than twenty different Oracle Identity Manager loggers that can be configured to send messages to log handlers. Oracle Identity Manager loggers are described in Table 2 on page 7. Setting the level attribute for the logger configures the amount of detail (and, hence, the volume of messages) that the logger sends to its handlers. Nesting one or more <handler> elements inside of <logger> elements assigns handlers to loggers. The following excerpt shows a logger called OIMCP.PSFTCOMMON. The level attribute is set to WARNING:32 and the logger sends messages to three handlers:

```
<logger name="OIMCP.PSFTCOMMON" level="WARNING:32" useParentHandlers="false">
  <handler name="odl-handler"/>
  <handler name="wls-domain"/>
  <handler name="console-handler"/>
</logger>
```

A logger can inherit a parent logger's settings, including the parent's level setting and other attributes, as well as the parent logger's handlers. To disable inheritance, set the useParentHandlers attribute to false, as shown in the previous excerpt.

At the top of the logger inheritance tree is the root logger. The root logger is the logger with an empty name attribute, as shown in the following example.

```
<loggers>
  <logger name="" level="WARNING:1">
    <handler name="odl-handler"/>
    <handler name="wls-domain"/>
    <handler name="console-handler"/>
  </logger>

  <!-- Additional loggers listed here -->
</loggers>
```

If a logger is configured with only its name attribute, the logger will inherit the rest of its attributes from the root logger, as shown in the following example:

```
<loggers>
  <logger name="oracle.iam.identity.rolemgmt"/>
  <!-- Additional loggers listed here -->
</loggers>
```

### 28.3.1.7 Configuring Loggers in Oracle Identity Governance

To configure loggers:

1. Open the *DOMAIN\_NAME/config/fmwconfig/servers/SERVER\_NAME/logging.xml* file.
2. Locate the logger you want to configure. [Table 28-3](#) lists the Oracle Identity Manager loggers.

**Table 28-3 Oracle Identity Manager Loggers**

Logger	Description
oracle.iam.request oracle.iam.requestdatasetgeneration oracle.iam.requestactions oracle.iam.platform.workflowservice	Logs events related to request and request dataset management.
oracle.iam.selfservice	Logs events related to authenticated and unauthenticated self-service operations.
oracle.iam.ChangePasswordtaskflow	Logs events for the password change functionality UI.
oracle.iam.forgotpasswordtaskflow	Logs events for the "forgot password" functionality UI.
oracle.iam.identitytaskflow	Logs events for the administrative UI identity operations.
oracle.iam.identity.orgmgmt	Logs events related to the organization manager service operations.
oracle.iam.identity.rolemgmt	Logs events related to the role manager service operations.
oracle.iam.identity.usermgmt	Logs events related to the user manager service operations.
oracle.iam.identity.scheduledtasks	Logs events related to scheduled tasks in the identity feature.
oracle.iam.platform.utils	Logs events related to utilities provided by the platform (mainly used by other features). Includes utilities for message resources handling, logging handling, internationalization, caching, and so on.
oracle.iam.platformservice	Logs events related to utilities that are mainly executed from the client side. For example, the plug-in registration utility, the purge cache utility, and so on. Some server-side utilities, such as the date-time utility and the exception handling utility, also use this logger.
oracle.iam.platform.canonic	Logs events related to the platform UI framework.
oracle.iam.consoles.faces oracle.iam.consoles.common	Logs messages generated from the UI framework.
oracle.iam.platform.kernel	Logs events related to the kernel. This includes the logging generated during the handling of orchestrations by the platform. The event handlers executed in the orchestrations within each feature use that feature's respective logger.
oracle.iam.platform.context	Logs events related to the context management feature.

**Table 28-3 (Cont.) Oracle Identity Manager Loggers**

Logger	Description
oracle.iam.platform.entitymgr	Logs events related to the entity manager feature. This feature provides generic handling of different types of entities, such as users, roles, and so on, and appropriate routing to the respective operations on them.
oracle.iam.scheduler oracle.iam.platform.scheduler Xellerate.Scheduler Xellerate.Scheduler.Task	Logs events related to the scheduler. Note that certain scheduled tasks may also use other loggers.
oracle.iam.reconciliation	Logs events related to the reconciliation feature.
oracle.iam.accesspolicy	Logs events related to the access policy feature.
oracle.iam.utoroles	Logs events related to the auto role membership assignment feature.
oracle.iam.callbacks	Logs events related to the callbacks feature.
oracle.iam.configservice	Logs events related to the Configuration service APIs that are used for configuration of entity attributes.
oracle.iam.ldap-sync	Logs events related to the Oracle Identity Manager and LDAP synchronization feature.
oracle.iam.notification	Logs events related to e-mail templates and the notifications handling feature.
oracle.iam.passwdmngt	Logs events related to the password management feature.
oracle.iam.platform.pluginframework	Logs events from the plug-in framework feature that handles the management of plug-ins.
oracle.iam.platform.async	Logs events from platform that handles asynchronous operations.
oracle.iam.spmlws oracle.iam.wsschema	Logs events related to web services used for Fusion applications that generate requests for different operations.
oracle.iam.diagnostic	Logs messages from the diagnostic service APIs used to run diagnostic checks.
oracle.iam.oimdataprovers	Logs events related to the Oracle Identity Manager data providers. The Oracle Identity Manager data providers provide code to update and fetch data from the Oracle Identity Manager database.
Xellerate.Database	Logs database operations.
Xellerate.PreparedStatement	Same as Xellerate.Database, but logs only PreparedStatement details.



**Table 28-3 (Cont.) Oracle Identity Manager Loggers**

Logger	Description
Xellerate.Performance	Logs database performance, such as time to execute a statement (query), or time to iterate through a result set to get data/metadata.
oracle.iam.platform.auth	Logs events for the authentication handling feature.
oracle.iam.platform.authz oracle.iam.authzpolicydefn	Logs events for the feature that handles authorization policies.
oracle.iam.sod Xellerate.SoD	Logs events related to SoD (Segregation of Duties).
oracle.jps	Logger for the embedded Oracle Entitlements Server MicroSM engine. Note that the log file is created in the <i>OIM_ORACLE_HOME</i> folder named as Managed Server name-microsm.log (for example, OIMServer1-microsm.log).
Xellerate.Entitlementment	Provides logging for entitlement operations used for provisioning entitlements.
oracle.iam.conf	Logs events related to the system configuration services feature that includes handling system properties.
oracle.iam.transUI	Logs events related to the transitional UI feature that handles initiation of legacy APIs from the 11g code. This includes operations such as initiation of provisioning during user creation, and so on.
Xellerate.AccountManagement	Provides logging in legacy user operations APIs.
Xellerate.Server	Provides logging in data objects.
Xellerate.ResourceManagement Xellerate.ObjectManagement	Provides logging for resource object operations.
Xellerate.Workflow	Provides logging for provisioning process operations.
Xellerate.WebApp	Provides logging for the transitional UI operations.
Xellerate.Adapters	Provides logging for the adapter factory.
Xellerate.JavaClient	Provides logging for client-side data objects.
Xellerate.Policies	Provides logging for data objects related to access policies.
Xellerate.Rules	Provides logging for data objects related to rules.

**Table 28-3 (Cont.) Oracle Identity Manager Loggers**

Logger	Description
Xellerate.APIs	Provides logging for legacy public APIs.
Xellerate.JMS	Provides logging for JMS operations where messages are produced.
Xellerate.RemoteManager	Provides logging in remote manager.
Xellerate.Auditor	Provides logging in audit framework.
Xellerate.Attestation	Provides logging in the attestation UI and operations.
oracle.iam.connectors.icfcommon	Provides logging for connector framework.

3. Define the level attribute for the <logger> element. See the example at the beginning of this section.
4. Add one or more <handler> elements to the <logger> element.
5. When you are finished editing both the <loggers> and <log\_handlers> sections of logging.xml, save the file.
6. Restart the application server for the changes to take effect.

### 28.3.1.8 Sample ODL Log Output

The following ODL log excerpt illustrates the kind of output you can expect.

```
<Jun 15, 2010 2:01:20 AM IST> <Error> <oracle.iam.platform.authz.impl>
<IAM-1010032>
<No OES Policy found for the given Action.>
<Jun 15, 2010 2:02:02 AM IST> <Warning> <oracle.iam.platform.canonic.agentry>
<IAM-0091108> <readme.txt is not a valid connector resource file.>
<Jun 15, 2010 2:02:52 AM IST> <Error> <oracle.iam.configservice.impl>
<IAM-3020003> <The attribute User Type does not exist!>
```

For information about managing and interpreting log output, see Managing Log Files and Diagnostic Data in *Administrator's Guide*.

## 28.3.2 Logging in Oracle Identity Governance By Using log4j

Apache log4j is used with third-party applications, such as Nexaweb.

The location of the log4j configuration file is:

`OIM_HOME/config/log.properties`

Logging in Oracle Identity Manager by using log4j is described in the following sections:

- [Log Levels for log4j](#)
- [Loggers in Third-Party Applications](#)
- [Configuring and Enabling Logging](#)

### 28.3.2.1 Log Levels for log4j

Table 28-4 lists the log levels for log4j:

**Table 28-4 Log Levels for log4j**

Log Level	Description
DEBUG	The DEBUG level designates fine-grained informational events that are useful to debug an application.
INFO	The INFO level designates informational messages that highlight the progress of the application at coarse-grained level.
WARN	The WARN level designates potentially harmful situations.
ERROR	The ERROR level designates error events that might allow the application to continue running.
ALL	The ALL level has the lowest possible rank and is intended to turn on all logging.
OFF	The OFF level has the highest possible rank and is intended to turn off logging.

### 28.3.2.2 Loggers in Third-Party Applications

The loggers for the third-party applications used is `com.nexaweb.server` for Nexaweb.

### 28.3.2.3 Configuring and Enabling Logging

Any of the log levels can be used in the `OIM_HOME/config/log.properties` file for the third-party applications, as follows:

```
log4j.logger.com.nexaweb.server=WARN
```

### 28.3.3 Setting Warning State

To set the Oracle Identity Manager server warning state, set the re-delivery limit on all OIM JMS queues to 1, purge all bad messages, and restart the server.

To set the Oracle Identity Manager server warning state:

1. Set the re-delivery limit on all OIM JMS queues to 1. To do so:
  - a. Login to the WebLogic Administration Console as the administrative user.
  - b. Click **JMS Modules** on the Home page.
  - c. Click **OIMJMSModule**.
  - d. Click **Lock & Edit**.
  - e. For each of the queues, click the queue, and then click the **Delivery Failure** tab. Change the Redelivery Limit value from -1 to 1, and then click **Save**.
  - f. Make sure you have performed steps 1.d and 1.e for all the queues under OIMJMSModule.
  - g. Release the configuration and restart Oracle Identity Manager.

This re-delivery is not applicable for existing messages. When the server is restarted, wait for all the good messages to be processed. After that, all the bad messages must be purged.

2. To purge all bad messages:
  - a. Login to the WebLogic Administration Console as the administrative user.
  - b. Click **JMS Servers** on the home page.
  - c. Navigate to **OIMJMSServer, Monitoring, Active Destinations**.
  - d. Select the queues that contain messages. Click **Consumption, Pause**.
  - e. Delete the messages, as described in the following URL:  
[http://docs.oracle.com/cd/E12840\\_01/wls/docs103/ConsoleHelp/taskhelp/jms\\_modules/queues/ManageQueues.html](http://docs.oracle.com/cd/E12840_01/wls/docs103/ConsoleHelp/taskhelp/jms_modules/queues/ManageQueues.html)
  - f. After messages are deleted, resume the consumption that has been paused in step 2.d.
3. Restart Oracle Identity Manager.

## 28.3.4 Switching Down the Log Level

You can switch down the logging level to avoid high volume of log file entries.

By default, the logging level for `oracle.*` packages is defined as `NOTIFICATION/INFO`. This results in high volume of log file entries. To avoid this, it is recommended that you switch down the logging level. To do so:

1. In a text editor, open the `/domains/DOMAIN_NAME/config/fmwconfig/servers/OIM_SERVER_NAME/logging.xml` file.
2. Search for the following line:

```
<logger name='oracle' level='NOTIFICATION:1' />
```
3. Change the log level from `NOTIFICATION` to `WARNING`, as shown:

```
<logger name='oracle' level='WARNING:1' />
```
4. Save the `logging.xml` file.

## 28.4 Handling Cache

In this release, caching is handled by configuring `EHCACHE`, which internally uses `JGroups` for replication and supports two configurations, unicast and multicast.

These configurations can be set by using the `XLCacheProvider` Mbean through Oracle Enterprise Manager Fusion Middleware Control.

### Topics

- [#unique\\_826](#)
- [#unique\\_827](#)

# Using the PL/SQL Unified Diagnostic Logging and Debugging Framework

The PL/SQL Unified Diagnostic Logging and Debugging framework captures diagnostic information from the PL/SQL layer for various operations, such as reconciliation and real-time data purge, and reconciliation exceptions purge, while ensuring that performance, scalability, and availability are not affected.

This chapter describes how to use the framework. It contains the following topics:

- [Understanding the PL/SQL Unified Diagnostic Logging and Debugging Framework](#)
- [Configuring the Diagnostic Level](#)
- [Understanding the Data Captured by PL/SQL Diagnostic Logging Tables](#)
- [Collecting Data Captured by PL/SQL Diagnostic Logging Tables](#)
- [Controlling Data Growth of PL/SQL Diagnostic Logging Tables](#)

## 29.1 Understanding the PL/SQL Unified Diagnostic Logging and Debugging Framework

Understanding the PL/SQL Unified Diagnostic Logging and Debugging framework involves understanding diagnostic logging and debugging, how to configure the system properties to control logging of diagnostic data, and the other important features of the framework.

This section contains the following topics:

- [About the PL/SQL Unified Diagnostic Logging and Debugging Framework](#)
- [Features of the Framework](#)
- [Configurable Diagnostic Levels Provided in the Framework](#)
- [Configurable System Properties to Control Logging](#)

### 29.1.1 About the PL/SQL Unified Diagnostic Logging and Debugging Framework

The PL/SQL Unified Diagnostic Logging and Debugging framework helps track progress and debug problems with operations in the PL/SQL layer based on the diagnostic level that you select for the operations.

Without some kind of debugging functionality in the PL/SQL operations code, it can be difficult to track down the source of a PL/SQL error for operations, such as reconciliation, data purge and reconciliation exceptions purge.

The framework provides logging and debugging information as operations run. You can control the amount of information to be logged by using the system properties.

Summary and detailed information is captured in two separate diagnostic logging tables, DIAG\_LOG and DIAG\_LOG\_DTLS. By default, the DIAG\_LOG\_DTLS table does not store diagnostic data for OIM operations that completes successfully. It stores only relevant data for unsuccessful runs.

## 29.1.2 Features of the Framework

You can control the level of data collection in PL/SQL Unified Diagnostic Logging and Debugging framework for reconciliation and data purge operations by setting the values of system properties.

The framework is enabled in Oracle Identity Governance by default. Note the following information about the framework:

- By default, coarse-grained level information is captured in PL/SQL diagnostic logging tables as a log for reconciliation runs. No information is stored for OIM Data Purge scheduled task and Fine Grained Exception BIP report runs.
- For troubleshooting in PL/SQL layer for reconciliation operations, Fine Grained Exception BIP report, or data purge executions, you can set the following values for the system properties:
  - DB Diagnostic Level for Recon: FINE for collecting fine-grained informational events, or FINEST for collecting fine-grained informational events along with data for collection variables that are used as input to Stored Program Units. FINE is the recommended value.
  - DB Diagnostic Level for Online Data Purge: FINEST for collecting fine-grained information to debug the online data purge operation.
  - DB Diagnostic Level for OIM GDPR support: FINEST for collecting fine-grained information to debug the Deleted User Account Clean Up scheduled task.
  - DB Diagnostic Level for Offline Data Purges: FINEST for collecting fine-grained information to debug the Offline Data Purge operation.
  - DB Diagnostic Level for Online Recon Exceptions Purge: FINE for collecting fine-grained informational events, or FINEST for collecting fine-grained informational events along with data for collection variables that are used as input to Stored Program Units. FINE is the recommended value.
  - DB Diagnostic Level for OIM Mview Legacy Data Migration: FINEST for collecting fine-grained information to debug the legacy data migration operation for Fine Grained Exception BIP report.
  - DB Diagnostic Level for MView creation for BIP report: FINEST for collecting fine-grained information to debug the data generation operation for Fine Grained Exception BIP report.
- When the diagnostic data is captured, you can reset the values of the system properties to the default values for the operations.
- Data growth and the subsequent footprint in the PL/SQL diagnostic logging tables are controlled on an on-going basis.

### 29.1.3 Configurable Diagnostic Levels Provided in the Framework

You can configure the amount and the type of information written to the PL/SQL diagnostic logging tables by specifying the diagnostic level.

You can configure the following diagnostic levels by using system properties for OIM operations:

- **INFO:** This is the default level for reconciliation operation. This level designates informational messages that highlight the progress of the operation at coarse-grained level. This does not have any performance impact on the operations.
- **FINE:** This level designates fine-grained informational events that are most useful for debugging an unsuccessful operation. If an operation fails and you need diagnostic information, you can set this diagnostic level by configuring a system property.
- **FINEST:** This level designates fine-grained informational events that are most useful for debugging an operation. Collection type variables passed as input parameters to the particular operation subprograms are also logged in this level. If an operation fails and you need diagnostic information, you can set this diagnostic level by configuring a system property.
- **NONE:** This is the default level for real-time data purge operation. This level disables the PL/SQL diagnostic logging. If you are facing performance issues during any of the operations because of the PL/SQL diagnostic logging, then you can configure a system property to set this level to switch off logging for any operation.

For the diagnostic levels, the data captured in the diagnostic logging tables are segregated into the message types listed in [Table 29-1](#).

**Table 29-1 Message Types for Diagnostic Levels**

Message Type	Message Description	Available in Diagnostic Level
NOTIFICATION	A major lifecycle event, such as the activation or deactivation of primary programs or subprograms of an operation.	INFO, FINE, FINEST
DEBUG	Detailed trace or debug information that can help Oracle Support diagnose problems for the particular operation.	FINE, FINEST
WARNING	A potential problem that the administrator should review. Examples are invalid parameter values or nonexistence of a specified file.	INFO, FINE, FINEST
FATAL	A serious problem that requires immediate attention from the administrator.	INFO, FINE, FINEST

### 29.1.4 Configurable System Properties to Control Logging

To control the amount of logging for reconciliation and data purge, you can set the diagnostic levels as values for the `OIM.DBDiagnosticLevelRecon`, `OIM.DBDiagnosticLevelDataPurge`, `OIM.DBDiagnosticLevelOffPurge`, `OIM.DBDiagnosticLevelGdprSupp`, `OIM.DBDiagnosticLevelMviewMig`, and `OIM.DBDiagnosticLevelMviewBIP` system properties.

The following system properties control the amount of logging for reconciliation and OIM Data Purge scheduled task run:

- DB Diagnostic Level for Recon with keyword `OIM.DBDiagnosticLevelRecon`

- DB Diagnostic Level for Online Data Purge with keyword  
OIM.DBDiagnosticLevelDataPurge
- DB Diagnostic Level for OIM GDPR support with keyword  
OIM.DBDiagnosticLevelGdprSupp
- DB Diagnostic Level for Offline Data Purges with keyword  
OIM.DBDiagnosticLevelOffPurge
- DB Diagnostic Level for OIM Mview Legacy Data Migration with keyword  
OIM.DBDiagnosticLevelMviewMig
- DB Diagnostic Level for MView creation for BIP report with keyword  
OIM.DBDiagnosticLevelMviewBIP

See [Default System Properties in Oracle Identity Governance](#) for information about the system properties.

## 29.2 Configuring the Diagnostic Level

You can set the diagnostic level for reconciliation and online data purge operations by setting the values of the DB Diagnostic Level for Online Data Purge, DB Diagnostic Level for Recon, DB Diagnostic Level for Offline Data Purges, DB Diagnostic Level for OIM GDPR support, DB Diagnostic Level for OIM Mview Legacy Data Migration, and DB Diagnostic Level for MView creation for BIP report system properties.

To configure the diagnostic level for troubleshooting reconciliation or data purge operations in the PL/SQL layer:

1. Log in to Oracle Identity System Administration.
2. Under System Management, click **System Configuration**.
3. Search for and open the DB Diagnostic Level for Online Data Purge, DB Diagnostic Level for Recon, DB Diagnostic Level for OIM GDPR support, DB Diagnostic Level for Offline Data Purges, DB Diagnostic Level for OIM Mview Legacy Data Migration, or DB Diagnostic Level for MView creation for BIP report system properties.
4. Modify the value of the system properties to **FINE** or **FINEST**.
5. Click **Save**.

After the diagnostic data is collected, reset the values of the system properties to the default values.

## 29.3 Understanding the Data Captured by PL/SQL Diagnostic Logging Tables

The PL/SQL Unified Diagnostic Logging and Debugging framework collects information in the background based on the diagnostic level set.

The framework can capture the following metrics:

- Summary level info available for the operations run:
  - Batch-level summary for reconciliation operations
  - Run-level summary for real-time data purge operations
- ECID for transactions



- Success or failure status
- Starting, ending, and execution time for the operation-level and subprogram-level run
- Subprogram run-level diagnostic information

The following tables store the diagnostic information for the operations:

### The DIAG\_LOG Table

This table stores operation-level run data. [Table 29-2](#) lists the columns of the DIAG\_LOG table.

**Table 29-2 The DIAG\_LOG Table**

Column	Description
DIAG_LOG_KEY	Stores the keys to uniquely identify the operation-level runs
ECID	Stores the unique identifier to correlate events or requests associated with the same transaction across several components
MODULE_NAME	Stores the following OIM operation names: <ul style="list-style-type: none"> <li>• RECONCILIATION</li> <li>• DATAPURGE</li> <li>• OIM_GDPR_SUPPORT</li> <li>• OFFLINE_DATAPURGE</li> <li>• RECONEXCEPTIONS</li> <li>• DATATRUNCATE</li> <li>• OIM_MVIEW_LEGACY_DATA_MIG</li> <li>• OIM_MVIEW_BIP_REP_GEN</li> </ul>
DIAGNOSTIC_LEVEL	Stores the following values: <ul style="list-style-type: none"> <li>• INFO</li> <li>• FINE</li> <li>• FINEST</li> <li>• NONE</li> </ul>
START_TIME	Stores the start time of the entire operation run
END_TIME	Stores the end time of the entire operation run
STATUS	Stores the overall status of the operation run, which can be any one of the following during the run: <ul style="list-style-type: none"> <li>• STARTED</li> <li>• COMPLETED</li> <li>• ERRORED_OUT, which means that the operation run could not proceed because of run-time errors. You can explore the root cause further by using the DESCRIPTION column.</li> </ul>
DESCRIPTION	Stores the operation run-level description, such as RB_KEY (reconciliation batch key) and RJ_KEY (reconciliation job key), and the type of reconciliation, such as trusted source, target resource, role, or role hierarchy

### The DIAG\_LOG\_DTLS Table

This table stores the subprogram run-level diagnostic details. [Table 29-3](#) lists the columns of the DIAG\_LOG\_DTLS table.

**Table 29-3 The DIAG\_LOG\_DTLS Table**

Column	Description
DIAG_LOGDTLS_KEY	Stores the keys to uniquely identify a subprogram in an operation
DIAG_LOG_KEY	Stores the logical foreign key for the DIAG_LOG table

**Table 29-3 (Cont.) The DIAG\_LOG\_DTLS Table**

Column	Description
MESSAGE_TYPE	Stores the following message types based on the diagnostic level set for the operation: <ul style="list-style-type: none"> <li>• NOTIFICATION</li> <li>• DEBUG</li> <li>• FATAL</li> <li>• WARNING</li> </ul>
SUBPROGRAM_NAME	Stores the name of the subprogram invoked during operation run
SUBPROGRAM_EXEC_TIME	Stores the execution time of the subprogram invoked during the operation run
SUBPROGRAM_RUN_NOTE	Stores the run-level log of the subprogram invoked during the operation run

## 29.4 Collecting Data Captured by PL/SQL Diagnostic Logging Tables

You can share the diagnostic data collected in the DIAG\_LOG and DIAG\_LOG\_DTLS tables in Excel format or by using Oracle Data Pump Export/Import utility.

To help troubleshoot issues with reconciliation and data purge operations, you may want to share diagnostic data with Oracle. You can use one of the following methods to share the diagnostic data collected in the DIAG\_LOG and DIAG\_LOG\_DTLS tables:

- If the data volume in the tables is no more than a few thousands, then you can share the data from the two tables in a Microsoft Excel spreadsheet.
- If the data volume is more than a few thousand, then you can share the diagnostic data in a dump file. To create the dump file, use the Oracle Data Pump Export/Import utility. Use the following command to create a `DiagTblsExp.dmp` file that includes the two tables:

```
expdp system/<SYSTEM_PASSWD> tables=<OIM_SCHEMA_NAME>.DIAG_LOG,
<OIM_SCHEMA_NAME>.DIAG_LOG_DTLS directory=DATA_PUMP_DIR dumpfile=DiagTblsExp.dmp
logfile=DiagTblsExp.log
```

Here, replace `<SYSTEM_PASSWD>` with the SYSTEM user password and `<OIM_SCHEMA_NAME>` with the name of the Oracle Identity Manager schema. For example:

```
expdp system/PASSWORD tables=DEV_OIM.DIAG_LOG, TEST_OIM.DIAG_LOG_DTLS
directory=DATA_PUMP_DIR dumpfile=DiagTblsExp.dmp logfile=DiagTblsExp.log
```

## 29.5 Controlling Data Growth of PL/SQL Diagnostic Logging Tables

By default, the DIAGNOSTIC\_MAINT Oracle Database scheduler job is automatically scheduled to purge data from the diagnostic logging tables. You can change the retention period as required.

To control the data growth in the two PL/SQL diagnostic logging tables (DIAG\_LOG and DIAG\_LOG\_DTLS), DIAGNOSTIC\_MAINT is automatically scheduled to run once a week on Sunday 05:00 AM.

By default, the job performs the following operations:

- All records with status COMPLETED are purged from the DIAG\_LOG table.
- All records in either table from the last 7 days that have the status STARTED or ERRORED\_OUT are retained.

If you want to increase the retention period from the default value of 7 days, then log in as OIM User and run the following block:

```
BEGIN
  DBMS_SCHEDULER.SET_ATTRIBUTE (
    name      => 'DIAGNOSTIC_MAINT',
    attribute => 'job_action',
    value     => 'BEGIN oim_pkg_db_diagnostics.oim_sp_diag_purge(<RETENTION_PERIOD>);
END;');
END;
/
```

Here, replace <RETENTION\_PERIOD> with the appropriate value as required. For example, to change the retention period to 15 days, run:

```
BEGIN
  DBMS_SCHEDULER.SET_ATTRIBUTE (
    name      => 'DIAGNOSTIC_MAINT',
    attribute => 'job_action',
    value     => 'BEGIN oim_pkg_db_diagnostics.oim_sp_diag_purge(15); END;');
END;
/
```

# Part XI

## Appendixes

Supplementary information for administrators include default user accounts, configuring SSO providers, using database roles/grants for the database, enabling Transparent Data Encryption (TDE), and troubleshooting clustered OIM and Eclipselink cache coordination.

This part contains the following appendixes:

- [Default User Accounts](#)
- [Configuring SSO Providers for Oracle Identity Governance](#)
- [Using Database Roles/Grants for Oracle Identity Governance Database](#)
- [Enabling Transparent Data Encryption](#)
- [Troubleshooting Clustered OIM and Eclipselink Cache Coordination](#)
- [Scheduler and System Properties do not come up in the Integrated Environment](#)

# A

## Default User Accounts

The default user accounts are XELSYSADM, WEBLOGIC, and OIMINTERNAL. [Table A-1](#) lists the default user accounts that are created in Oracle Identity Manager.

**Table A-1 Default User Accounts**

Account	Description
XELSYSADM	This account is the Oracle Identity Manager administrator (super-user) and is created during installation. You create a password for this account during installation. To change the password at any later point in time after installation, see <a href="#">Changing Oracle Identity Governance Administrator Password</a> .
WEBLOGIC	This account is used for integrating SOA and Oracle Identity Manager by using the 'User Role Provider' implementation. When SOA is reconfigured to use LDAP-based user-role provider, Oracle Identity Manager does not require this account. This account is created during installation. You create a password for this account during installation. To change the user name of this account at any later point in time after installation.
OIMINTERNAL	This account is created during installation and is for internal Oracle Identity Manager use only.

# B

## Configuring SSO Providers for Oracle Identity Governance

To implement the SSO functionality, Oracle Identity Governance uses third-party SSO providers, such as OpenSSO, IBM Tivoli Access Manager, and CA SiteMinder. This appendix contains the configuration steps for enabling Oracle Identity Governance for Single Sign On (SSO). To do so, Oracle Identity Governance is enabled to use third-party SSO providers, such as OpenSSO, IBM Tivoli Access Manager, and CA SiteMinder.

This appendix contains the following sections:

- [Common Prerequisites for Integration With Third-Party SSO Solutions](#)
- [Enabling Oracle Identity Governance to Work With OpenSSO](#)
- [Enabling Oracle Identity Governance to Work With IBM Tivoli Access Manager](#)
- [Enabling Oracle Identity Governance to Work With CA SiteMinder](#)
- [Configuring Basic SSO Using OAM](#)
- [Simplifying Third-Party SSO Integration](#)
- [Using Configurable Login ID Support for SSO Integration](#)
- [Configuring Login ID Support for SSO Integration](#)
- [Integrating Oracle Identity Governance with Identity Providers using SAML2 Asserter](#)

### B.1 Common Prerequisites for Integration With Third-Party SSO Solutions

In addition to SSO provider-specific prerequisites, there are some common prerequisites for integration with third-party SSO providers, such as SiteMinder, OpenSSO, and Tivoli Access Manager.

This section lists the common prerequisites for integrating Oracle Identity Manager with third-party SSO providers, such as SiteMinder, OpenSSO, and Tivoli Access Manager. SSO provider-specific prerequisites are listed separately in corresponding sections. The common prerequisites are as follows:

- Identity population in Oracle Identity Manager is synchronized with identity information in the LDAP registry used by the SSO provider. Oracle Identity Manager's LDAP synchronization feature can be used for this purpose.
- Oracle Identity Manager system administrator (xelsysadm) account should be created in the LDAP repository so that you can perform SSO login to OIM using this administrator account. This account should be created in the same user container that has other OIM users in the LDAP repository. Also ensure that the LDAP user attribute, which is mapped to Oracle Identity Manager user login (uid or samAccountName), has the value set as XELSYSADM.
- It is required that the SSO header returned by the SSO provider contains the username value which maps to OIM User Login field.

## B.2 Enabling Oracle Identity Governance to Work With OpenSSO

To integrate a third party SSO provider, you need to enable Oracle Identity Manager to communicate with the Open SSO application. The enabling operation includes steps, such as prerequisites, the actual integration process, and validation of the integration operation.

This section describes how to enable Oracle Identity Manager with OpenSSO. It contains the following topics:

- [Prerequisites for Integrating Oracle Identity Governance with OpenSSO](#)
- [Integrating Oracle Identity Governance with OpenSSO](#)
- [Running Validation Tests to Verify the Configuration](#)

### B.2.1 Prerequisites for Integrating Oracle Identity Governance with OpenSSO

The prerequisites for OpenSSO integration are installing and configuring Oracle Identity Governance, OpenSSO, and OpenSSO Enterprise Policy Agent, and meeting the common prerequisites for third-party SSO solutions.

The prerequisites for integrating Oracle Identity Governance with OpenSSO are:

- Oracle Identity Governance 12c (12.2.1.4.0) is installed and configured.
- OpenSSO 8.0 is installed and configured
- OpenSSO Enterprise Policy Agent 3.0 for Oracle WebLogic Server/Portal 10 (weblogic\_v10\_agent\_3) is installed and configured.
- The common prerequisite for integrating Oracle Identity Governance with third-party SSO solutions has been met, as described in [Common Prerequisites for Integration With Third-Party SSO Solutions](#).

### B.2.2 Integrating Oracle Identity Governance with OpenSSO

Integrating Oracle Identity Manager with OpenSSO involves performing the integration procedure, adding OpenSSO agent filter to Oracle Identity Manager web-apps, and configuring SSO in Oracle Identity Manager.

This section describes about integrating Oracle Identity Manager with OpenSSO in the following topics:

- [Integrating Oracle Identity Governance with OpenSSO Procedure](#)
- [Adding OpenSSO Agent Filter to Oracle Identity Governance Web-apps](#)
- [Configuring SSO in Oracle Identity Governance](#)

#### B.2.2.1 Integrating Oracle Identity Governance with OpenSSO Procedure

To integrate Oracle Identity Governance 12c (12.2.1.4.0) with OpenSSO 8.0 on Oracle WebLogic Server:

1. Start OpenSSO.
2. Start Oracle Identity Governance.

3. Install OpenSSO policy agent on Admin Server of Oracle Identity Manager domain. To do so:
  - a. Create a J2EE agent profile on OpenSSO. Refer to the policy agent section in OpenSSO documentation for creating the profile.
  - b. Install agent on WebLogic Admin Server. Install the agent by using the agentadmin utility. Refer to the policy agent section in OpenSSO documentation.
4. Install OpenSSO policy agent on Oracle Identity Governance Managed Server of Oracle Identity Manager domain. To do so, install agent on Oracle Identity Manager Managed Server. Refer to the policy agent section of OpenSSO documentation for installing the agent on a managed server. Use the same agent profile that you created in step 3.a.

 **Note:**

For a clustered deployment of Oracle Identity Governance, install the policy agent on each Oracle Identity Manager Managed Server.

5. To configure OpenSSO policy agent after installation:

 **Note:**

For a clustered deployment of Oracle Identity Governance, OpenSSO policy agent must be configured on each Oracle Identity Governance Managed Server.

- a. Configure WebLogic Server instances with set Agent classpath and JAVA options.
  - b. Deploy agent application on Admin and Managed Servers.
  - c. Deploy and configure agent authentication provider.
  - d. Add WebLogic admin to bypasslist.
  - e. Install agent filter to oim web-apps. In this step, add OpenSSO Agent filter to all the Oracle Identity Manager web-apps that support OIM user login. To do so see, [Adding OpenSSO Agent Filter to Oracle Identity Governance Web-apps](#).
6. Update the agent profile for Oracle Identity Governance Managed Server with Oracle Identity Governance URL information. To do so:
    - a. Login to OpenSSO application, and select the Oracle Identity Governance Managed Server agent profile.
    - b. Click the **general** tab. Change the Agent filter mode. Remove all existing values. Add new value with empty key and corresponding map value as J2EE\_POLICY.
    - c. Click the **applications** tab. Update the various sections as follows:
      - Login Form URI. Add the following:

```
/oim/faces/pages/Login.jspx  
/identity/faces/signin  
/sysadmin/faces/signin
```
      - Login Error URI. Add the following:

```
/identity/faces/signin  
/sysadmin/faces/signin  
/oim/faces/pages/LoginError.jspx
```



- **Not Enforced URI Processing.** Add the following:

```

/identity/faces/register
/identity/faces/forgotpassword
/identity/faces/trackregistration
/identity/faces/forgotuserlogin
/identity/faces/accountlocked
/identity/adfAuthentication
/identity/afr/blank.html
/sysadmin/adfAuthentication
/sysadmin/afr/blank.html
/sysadmin/faces/noaccess
/oim/afr/blank.html
/workflowservice/*
/callbackResponseService/*
/spml-xsd/*

```

7. Configure SSO in Oracle Identity Governance. To do so see, [Configuring SSO in Oracle Identity Governance](#).

8. Restart Oracle Identity Governance domain.

9. Test the configuration by navigating to the following URL:

`http://OIM_HOST:OIM_PORT/identity/`

The page is redirected to the OpenSSO login page. Login as valid Oracle Identity Manager user.

## B.2.2.2 Adding OpenSSO Agent Filter to Oracle Identity Governance Web-apps

To add OpenSSO Agent filter to all the Oracle Identity Manager web-apps that support OIM user login:

### Note:

The corresponding deployment-descriptors are located at:

- `IDM_ORACLE_HOME/server/apps/oim.ear/iam-consoles-faces.war/WEB-INF/web.xml`
- `IDM_ORACLE_HOME/server/apps/oracle.iam.console.identity.self-service.ear/oracle.iam.console.identity.self-service.war/WEB-INF/web.xml`
- `IDM_ORACLE_HOME/server/apps/oracle.iam.console.identity.sysadmin.ear/oracle.iam.console.identity.sysadmin.war/WEB-INF/web.xml`

1. Go to the `IDM_ORACLE_HOME/server/apps/` directory.
2. Create a backup of the `oim.ear/iam-consoles-faces.war/WEB-INF/web.xml` file, and then edit it to add the filter element as mentioned in OpenSSO documentation. Save the changes.
3. Create a backup of the `oracle.iam.console.identity.self-service.ear` file, and then extract it in a temporary location. Then extract the `oracle.iam.console.identity.self-service.war` file. Edit `WEB-INF/web.xml` to add the filter element as mentioned in OpenSSO documentation. Repackage `oracle.iam.console.identity.self-service.war` with the modified `web.xml`, and then repackage `oracle.iam.console.identity.self-service.ear` with modified `oracle.iam.console.identity.self-service.war`.

4. Create a backup of `oracle.iam.console.identity.sysadmin.ear`, and then extract it in a temporary location. Then extract the `oracle.iam.console.identity.sysadmin.war` file. Edit `WEB-INF/web.xml` to add the filter element as mentioned in OpenSSO documentation. Repackage `oracle.iam.console.identity.sysadmin.war` with the modified `web.xml`, and then repackage `oracle.iam.console.identity.sysadmin.ear` with modified `oracle.iam.console.identity.sysadmin.war`.

 **Note:**

Ensure that after performing steps iii and iv, the only difference between the modified EAR files and the original EAR files is in the `web.xml` files.

5. Shutdown Oracle Identity Manager instance.
6. Go to `OIM_DOMAIN_HOME\servers\OIM_SERVER_INSTANCE\tmp\_WL_user\` directory. Go to `OIM_DOMAIN_HOME\servers\OIM_SERVER_INSTANCE\tmp\_WL_user\` directory if the setup is on Microsoft Windows.
7. Delete the directories specific to `oracle.iam.console.identity.self-service.ear` and `oracle.iam.console.identity.sysadmin.ear` UI applications. In a typical Oracle Identity Manager setup, the directories to be deleted are `oracle.iam.console.identity.self-service.ear_V2.0` and `oracle.iam.console.identity.sysadmin.ear_V2.0`.
8. Restart Oracle Identity Manager Managed Server instance, and then check that the directories are re-created in the directory path mentioned in Step 4.

### B.2.2.3 Configuring SSO in Oracle Identity Governance

Configure SSO in Oracle Identity Manager. To do so:

1. Set up WebLogic authenticators. To do so:
  - a. Add and configure WebLogic authentication provider for LDAP server corresponding to the user data store used by OpenSSO. For example, if OpenSSO uses Sun DSEE, then configure iPlanet authentication provider. Set the control flag as SUFFICIENT.

 **Note:**

Ensure that all the Oracle Identity Manager users are synchronized with the LDAP server to which the authenticator points to.

- b. Add and configure Oracle Identity Manager signature authentication provider (`OIMSignatureAuthenticator`). Set the control flag as SUFFICIENT.
- c. Arrange the authenticator chain in the following order:
  - `DefaultAuthenticator` - SUFFICIENT
  - `OIMSignatureAuthenticator` - SUFFICIENT
  - `AgentAuthenticator` - OPTIONAL
  - `LDAPAuthenticator` - SUFFICIENT
  - `DefaultIdentityAsserter`
2. Change the Oracle Identity Manager logout to execute OpenSSO logout URL by running the following command:

```
cd <IDM_ORACLE_HOME>/common/bin
./wlst.sh
connect()
addOAMSSOProvider(loginuri="{app.context}/adfAuthentication", logouturi="http(s)://
openssohost:openssoport/opensso/UI/Logout", autologinuri="/obrar.cgi")
exit()
```

3. Set Oracle Identity Manager ssoenabled flag to true. To do so:
  - a. Login to Enterprise Manager. Open System Mbean Browser.
  - b. Open the oracle.iam:Location=OIM\_SERVER\_NAME,name=SSOConfig,type=XMLConfig.SSOC onfig,XMLConfig=Config,Application=oim,ApplicationVersion=11.1.2.0.0 mbean.
  - c. Set the value of ssoEnabled to True.

## B.2.3 Running Validation Tests to Verify the Configuration

Validation tests to verify OpenSSO integration are: logging in to Oracle Identity Manager through SSO, client-based logging with SSO password, and signature-based authentication.

Run the following validation steps to verify if the integration between Oracle Identity Manager and OpenSSO is successful:

### 1. User Login to Oracle Identity Governance Through SSO:

**Prerequisite:** Create a user, for example ENDUSER001 in Oracle Identity Manager and LDAP.

**Step:** Try logging in to Oracle Identity Manager through SSO as the user you created, for example ENDUSER001, and check if the login is successful.

**Expected output:** Login is successful.

### 2. Client-Based Login to Oracle Identity Governance:

**Prerequisite:** Make sure that the Design Console is installed and configured.

**Step:** Try logging in to the Design Console as system administrator with SSO password.

**Expected output:** Login to the Design Console is successful, assuming that LDAPAuthenticator is configured properly for SSO login.

### 3. Signature-Based Authentication:

To test signature-based authentication:

- a. Try accessing the scheduler service URL. It should be running on Oracle Identity Manager Managed Server port, as shown:

http://OIM\_HOST:OIM\_PORT/SchedulerService-web

- b. Login as system administrator with SSO password.
- c. If the login is successful and you can see the following details on the screen, then signature login is successful:

Scheduler Current Status: STARTED

Last Error: NONE

- d. Click **Start** on the page if the following is displayed:

Scheduler Current Status: STOPPED

If no errors are displayed on the page, then signature login is successful.

## B.3 Enabling Oracle Identity Governance to Work With IBM Tivoli Access Manager

Enabling Oracle Identity Manager to integrate with IBM Tivoli Access Manager involves meeting the prerequisites, performing the integration procedure, and running validation tests.

This section describes about how to enable Oracle Identity Manager to work with IBM Tivoli Access Manager in the following topics:

- [Prerequisites for Integrating Oracle Identity Governance with IBM Tivoli Access Manager](#)
- [Integrating Oracle Identity Governance with IBM Tivoli Access Manager](#)
- [Running Validation Tests to Validate the Configuration](#)

### B.3.1 Prerequisites for Integrating Oracle Identity Governance with IBM Tivoli Access Manager

Prerequisites for Tivoli Access Manager integration include installing and configuring Oracle Identity Governance, Tivoli Access Manager for e-business and WebLogic Server, and meeting the common prerequisites for third-party SSO solutions.

The prerequisites for integrating Oracle Identity Governance with IBM Tivoli Access Manager are:

- Oracle Identity Governance 12c (12.2.1.4.0) is installed and configured.
- IBM Tivoli Access Manager (TAM) for e-business 6.1 is installed and configured.
- IBM Tivoli Access Manager Adapter for Oracle WebLogic Server for TAM 6.1 and Oracle WebLogic Server 10g or 11g are installed and configured.
- The common prerequisite for integrating Oracle Identity Governance with third-party SSO solutions has been met, as described in [Common Prerequisites for Integration With Third-Party SSO Solutions](#).
- Form based login is enabled in TAM.

### B.3.2 Integrating Oracle Identity Governance with IBM Tivoli Access Manager

Tivoli Access Manager integration steps include setting up connection between webseal and WebLogic, changing Oracle Identity Governance logout to execute TAM logout URL, setting OIM ssoenabled flag to true, and restarting Oracle Identity Manager.

To integrate Oracle Identity Governance 12c (12.2.1.4.0) with IBM Tivoli Access Manager for e-business 6.1:

1. Start IBM Tivoli Access Manager.
2. Start Oracle Identity Governance.
3. Setup connection between webseal and WebLogic. To do so:
  - a. Create junctions to connect webseal to Oracle Identity Governance WebLogic Server.
  - b. Configure webseal logout and login page.

c. Deploy weblogic security providers.

Refer to TAM-weblogic integration documentation provided as part of IBM Tivoli Access Manager Adapter for Oracle WebLogic Server. The additional details are as follows:

- Keep both non-SSL and SSL ports on Oracle Identity Governance into consideration while creating junctions.
- While creating webseal junction(s) for protected resources, make sure to use the "-c iv-user" (insert iv-user HTTP header) option.
- List of resources that needs to be protected/unprotected:

Protect the following resources:

/oim

/xlWebApp

/Nexaweb

/identity

/sysadmin

Unprotect following uris:

/identity/faces/register

/identity/faces/forgotpassword

/identity/faces/trackregistration

/identity/faces/forgotuserlogin

/identity/faces/accountlocked

/identity/adfAuthentication

/identity/afr/blank.html

/sysadmin/adfAuthentication

/sysadmin/afr/blank.html

/sysadmin/faces/noaccess

/oim/afr/blank.html

Unprotect following resources:

/workflowservice

/callbackResponseService

/spml-xsd

- Only configure Tivoli Access Manager Identity assertion provider (AMIdentityAsserterLite). Select the **iv-user** option while configuring it.
- Do not configure Tivoli Access Manager Identity authentication provider.
- Configure WebLogic authentication provider for LDAP server corresponding to the LDAP registry used by TAM. For example, if TAM uses Sun DSEE, then configure iPlanet authentication provider. Set its control flag as SUFFICIENT. Ensure that all users in Oracle Identity Manager are synchronized to this LDAP server. If any Oracle Identity Manager user is not present in the LDAP server, then that user will not be able to login to Oracle Identity Manager.

- Configure Oracle Identity Governance signature authentication provider (OIMSignatureAuthenticationProvider). Provide the Oracle Identity Manager database details while configuring it. You can use the same details as specified in OIMAuthenticationProvider. Set its control flag as SUFFICIENT.
- Arrange the authenticator chain in the following order:
  - TAMIdentityAsserter
  - OIMSignatureAuthenticator - SUFFICIENT
  - LDAPAuthenticator - SUFFICIENT
  - DefaultAuthenticator - SUFFICIENT
  - DefaultIdentityAsserter

 **Note:**

If you cannot use TAMIdentityAsserter, then you can use the OAMIdentityAsserter, as described in [Simplifying Third-Party SSO Integration](#)

4. Change the Oracle Identity Manager logout to execute TAM logout URL by using the following commands:

```
cd <IDM_ORACLE_HOME>/common/bin
./wlst.sh
connect()
addOAMSSOProvider(loginuri="/${app.context}/adfAuthentication", logouturi="http(s)://
<webseal-host:port>/pkmslogout", autologinuri="/obrar.cgi")
exit()
```

5. Set OIM ssoenabled flag to true. To do so:
  - a. Login to Enterprise Manager. Open System Mbean Browser.
  - b. Open the oracle.iam:Location=OIM\_SERVER\_NAME,name=SSOConfig,type=XMLConfig.SSOC onfig,XMLConfig=Config,Application=oim,ApplicationVersion=11.1.2.0.0 mbean.
  - c. At the value of ssoEnabled to true.
6. Restart Oracle Identity Manager.
7. Test the configuration by navigating to the following URL:

`http(s)://WEBSEAL_HOST:WEBSEAL_PORT/identity/faces/home`

TAM login page is displayed. Login as valid Oracle Identity Governance user, and the login should be successful.

### B.3.3 Running Validation Tests to Validate the Configuration

Validation tests to verify Tivoli Access Manager integration are: logging in to Oracle Identity Manager through SSO, client-based logging with SSO password, and signature-based authentication.

Run the following validation steps to verify if the integration Oracle Identity Manager and TAM is successful:

1. **User Login to Oracle Identity Governance Through SSO:**

**Prerequisite:** Create a user, for example ENDUSER001, in Oracle Identity Manager and LDAP.

**Step:** Try logging in to Oracle Identity Manager through SSO as the user that you created, for example ENDUSER001, and check if the login is successful.

**Expected output:** Login should be successful.

## 2. Client-Based Single Login to Oracle Identity Governance:

**Prerequisite:** Make sure that the Design Console is installed and configured.

**Step:** Try logging in to the Design Console as system administrator with SSO password.

**Expected output:** Login to the Design console must be successful, assuming that LDAPAuthenticator is configured properly for SSO login.

## 3. Signature-Based Authentication:

To test signature-based authentication:

- a. Try accessing the scheduler service URL. It should be running on Oracle Identity Manager Managed Server port, as shown:

`http://OIM_HOST:OIM_PORT/SchedulerService-web`

- b. Login as system administrator by providing SSO password.
- c. If the login is successful and you can see the following details on the screen, then signature login is successful:

Scheduler Current Status: STARTED

Last Error: NONE

- d. Click **Start** on the page if the following is displayed:

Scheduler Current Status: STOPPED

If there are no errors on the page, then the signature login is successful.

# B.4 Enabling Oracle Identity Governance to Work With CA SiteMinder

Enabling Oracle Identity Manager to integrate with CA SiteMinder involves meeting the prerequisites, performing the actual integration procedure, and running validation tests.

This section describes how to enable Oracle Identity Manager to work with CA SiteMinder in the following topics:

- [Prerequisites for Integrating Oracle Identity Governance with CA SiteMinder](#)
- [Integrating Oracle Identity Governance with CA SiteMinder](#)
- [Running Validation Tests to Validate the Configuration](#)

## B.4.1 Prerequisites for Integrating Oracle Identity Governance with CA SiteMinder

Prerequisites for SiteMinder integration include installing and configuring Oracle Identity Manager and CA SiteMinder, and meeting the common prerequisites for third-party SSO solutions.

The prerequisites for integrating Oracle Identity Manager with CA SiteMinder are:

- Oracle Identity Manager is installed and configured.
- CA SiteMinder is installed and configured.
- The common prerequisite for integrating Oracle Identity Manager with third-party SSO solutions has been met, as described in [Common Prerequisites for Integration With Third-Party SSO Solutions](#).

## B.4.2 Integrating Oracle Identity Governance with CA SiteMinder

SiteMinder integration steps include installing SiteMinder WebLogic Agent, updating the `setDomainEnv.sh`, `startWebLogic.sh`, and `WebAgent.conf` files to specify required variables and parameters, add or configure `SiteminderIdentityAsserter` and `SiteminderAuthenticationProvider` in the Weblogic authentication chain, and enabling SSO.

To integrate Oracle Identity Manager with CA SiteMinder:

1. Install SiteMinder WebLogic Agent by referring to SiteMinder installation documentation. Follow install GUI instructions.

2. Edit the `setDomainEnv.sh` file to set the variables, as shown:

```
ASA_HOME='PATH_TO_SITEMINDER_AGENT_HOME'
export ASA_HOME

SMASA_CLASSPATH="$ASA_HOME/conf:$ASA_HOME/lib/smagentapi.jar:$ASA_HOME/lib/
smjavasdk2.jar:$ASA_HOME/lib/sm_jsafe.jar:$ASA_HOME/lib/
smclientclasses.jar:$ASA_HOME/lib/sm_jsafeJCE.jar"
export SMASA_CLASSPATH

SM_JAVA_OPTIONS=" -Dsmasa.home=$ASA_HOME"
export SM_JAVA_OPTIONS

CLASSPATH=${SMASA_CLASSPATH}:${CLASSPATH}
export CLASSPATH
```

3. Edit the `startWebLogic.sh` file to add `SM_JAVA_OPTIONS` to the `JAVA` command, as shown:

```
$JAVA_HOME/bin/java ${JAVA_VM} ${MEM_ARGS} -Dweblogic.Name=${SERVER_NAME} -
Djava.security.policy=${WL_HOME}/server/lib/weblogic.policy ${JAVA_OPTIONS}
${SM_JAVA_OPTIONS} ${PROXY_SETTINGS} ${SERVER_CLASS}
```

4. Edit the `ASA_HOME/conf/WebAgent.conf` file to change the value of the `EnableWebAgent` parameter to `YES`.
5. Restart all Managed and Admin servers.
6. Add/Configure `SiteminderIdentityAsserter` and `SiteminderAuthenticationProvider` in the Weblogic authentication chain. In Identity Asserter common configuration, select `SMSESSION`.
7. In the Provider Specific subtab, set the "SMIdentity Asserter Config File:" field to `ASA_HOME/conf/WebAgent.conf`.
8. In `SiteminderAuthenticationProvider` 'ProviderSpecific', update "SMAuth Provider Config File:" to `ASA_HOME/conf/WebAgent.conf`.
9. Remove existing `OIMAuthenticationProvider` from the authentication chain.
10. Add `OIMSignatureAuthenticator` to the authentication chain. Set the control flag to `SUFFICIENT`. This authenticator is added only to handle signature based login to Oracle Identity Manager.



11. Add LDAP Authenticator (OID, Iplanet, and so on) to the authentication chain, and set its control flag as SUFFICIENT. Ensure that this authenticator is configured to point to the same LDAP provider, that is :
  - a. Synchronized with Oracle Identity Manager, that is, have all the OIM Identity population
  - b. Used by the Siteminder server for authentication purposes

LDAPAuthenticator needs to be added in order to handle non-http based login requests (For example, login to OIM design console, or any other OIM client login) and OPSS based Assertion requests.
12. Rearrange the authentication chain, as listed in [Table B-1](#):

**Table B-1 Authentication Chain**

Authentication Provider	Control Flag
SiteminderIdentityAsserter	
OIMSignatureAuthenticator	SUFFICIENT
SiteminderAuthenticationProvider	SUFFICIENT
LDAPAuthenticator	SUFFICIENT
DefaultAuthenticator	SUFFICIENT
DefaultIdentityAsserter	

13. Restart Admin server and all the Managed Servers in the domain.
14. Configure SSO logout for oim by using the following command:

```
cd <IDM_ORACLE_HOME>/common/bin

./wlst.sh

connect()

addOAMSSOProvider(loginuri="/${app.context}/adfAuthentication",
logouturi="SITEMINDER_LOGOUT_URL", autologinuri="/obrar.cgi")

exit()
```

 **Note:**

The connect() call will ask for Admin server URL and WebLogic Admin username and password.

15. Set the ssoenabled flag for Oracle Identity Manager to true. To do so:
  - a. Login to Enterprise Manager, and open System MBean Browser.
  - b. Open the oracle.iam:Location=OIM\_SERVER\_NAME,name=SSOConfig,type=XMLConfig.SSOC onfig,XMLConfig=Config,Application=oim,ApplicationVersion=11.1.2.0.0 mbean.
  - c. Set the value of ssoEnabled to true.
16. Restart Admin Server and all Managed Servers in the domain.
17. Protect/unprotect the following Oracle Identity Manager resources:

- Protect following resources:
    - /identity
    - /sysadmin
    - /oim
    - /xlWebApp
    - /Nexaweb
  - Unprotect the following URIs:
    - /identity/faces/register
    - /identity/faces/forgotpassword
    - /identity/faces/trackregistration
    - /identity/faces/forgotuserlogin
    - /identity/faces/accountlocked
    - /identity/adfAuthentication
    - /identity/afr/blank.html
    - /sysadmin/adfAuthentication
    - /sysadmin/afr/blank.html
    - /sysadmin/faces/noaccess
    - /oim/afr/blank.html
  - Unprotect the following resources:
    - /workflowservice
    - /callbackResponseService
    - /spml-xsd
    - /reqsvc
    - /sysadmin/logout
    - /identity/logout
    - /identity/notification/secure
    - /SchedulerService-web
    - /wsm-pm
    - /workflow
    - /soa-infra
    - /integration
    - /b2b
    - /sdpmessaging/userprefs-ui
- 18.** To support client-based login to Oracle Identity Manager, the smclientclasses.jar must be added to the client classpath. To set the client classpath:
- a. Go to the `OIM_ORACLE_HOME/server/bin/` directory using the `cd` command.
  - b. Open the `setEnv.sh` file in VI Editor.

- c. Add `smclientclasses.jar` to the `CLASSPATH` variable at the end. This setting ensures successful client login to Oracle Identity Manager while executing most of the client utilities present in `OIM_ORACLE_HOME/server/bin`.

However, client classpath must be separately set for the Design Console login to work. To do so:

- a. Go to the `OIM_ORACLE_HOME/designconsole` directory.
- b. Open the `classpath.sh` file in VI Editor.
- c. Add `smclientclasses.jar` to the `CLASSPATH` variable at the end.

## B.4.3 Running Validation Tests to Validate the Configuration

Validation tests to verify SiteMinder integration are: logging in to Oracle Identity Manager through SSO, client-based logging with SSO password, and signature-based authentication.

Run the following validation steps to verify if the integration Oracle Identity Manager and CA SiteMinder is successful:

### 1. User Login to Oracle Identity Governance Through SSO:

**Prerequisite:** Create a user, for example `ENDUSER001`, in Oracle Identity Manager and LDAP.

**Step:** Try logging in to Oracle Identity Manager through SSO as the user that you created, for example `ENDUSER001`, and check if the login is successful.

**Expected output:** Login should be successful.

**Step:** Try logging in to Oracle Identity Manager System Administration console (`/sysadmin`) as OIM Administrator (typically `XELSYSADM`), and check if login is successful.

Expected output: Login should be successful.

### 2. Client-Based Login to Oracle Identity Governance:

**Prerequisite:** Make sure that the Design Console is installed and configured.

**Step:** Try logging in to the Design Console as the system administrator with SSO password.

**Expected output:** Login to the Design console should be successful, assuming that `SiteMinderAuthenticationProvider` is configured properly for SSO login.

### 3. Signature-Based Authentication:

To test signature-based authentication:

- a. Try accessing the scheduler service URL. It should be running on Oracle Identity Manager Managed Server port, as shown:

`http://OIM_HOST:OIM_PORT/SchedulerService-web`

- b. Login as system administrator by providing SSO password.

- c. If the login is successful and you can see the following details on the screen, then signature login is successful:

Scheduler Current Status: STARTED

Last Error: NONE

- d. Click **Start** on the page if the following is displayed:

Scheduler Current Status: STOPPED

If there are no errors on the page, then the signature login is successful.

## B.5 Configuring Basic SSO Using OAM

Configuring Basic SSO using OAM involves meeting the prerequisites, configuring SSO logout and authenticator, and running validation tests.

This section describes how to configure basic integration between Oracle Identity Manager and OAM, and protect the integration with SSO authentication. It includes the following sections:

### Note:

Performing the procedure provided in this section only enables basic SSO. Use a LDAP connector to provision passwords and also do additional configuration so that the lock status can be propagated to the directory.

- [Prerequisites for Configuring SSO Logout and the Authenticator](#)
- [Configuring SSO Logout and the Authenticator](#)
- [Running Validation Tests to Validate the Configuration](#)

### B.5.1 Prerequisites for Configuring SSO Logout and the Authenticator

Prerequisites for Configuring Basic SSO using OAM include installing and configuring Oracle Identity Governance and OAM, frontending Oracle Identity Governance with OHS/reverse-proxy that hosts OAM 11g webgate, and enabling LDAP synchronization.

Perform the following prerequisites:

- Ensure that Oracle Identity Governance 12c (12.2.1.4.0) is installed and configured.
- Oracle Identity Governance must be frontended with OHS/reverse-proxy, which hosts OAM 11g webgate.
- Ensure that Oracle Identity Governance user population is maintained in sync with LDAP repositories by using a connector. Also ensure that the Oracle Identity Governance system administrator account is created in the LDAP repository.
- Ensure that OAM 12.2.1.4.0 is installed and configured to authenticate Oracle Identity Governance users against the same LDAP repository that is synchronized with Oracle Identity Governance.

### Note:

OIDAuthenticator is used as a reference in this procedure. If you have any other LDAP Server, such as AD, ODSEE, or OUD, then create appropriate WebLogic LDAP Authentication providers.

## B.5.2 Configuring SSO Logout and the Authenticator

Steps to configure basic SSO using OAM include setting the OIM ssoenabled flag to true, configuring SSO logout and authentication providers.

To configure SSO logout and the authenticator:

1. Set OIM ssoenabled flag to true. To do so:
  - a. Login to Oracle Enterprise Manager, and navigate to *OIM\_DOMAIN*.
  - b. Right click **OIMDomain**, and select **System MBean Browser**.
  - c. Click the search icon, enter `ssoconfig`, and search.
  - d. In the details page, look for `SSOEnabled` flag, and select **true** from the drop down. Click **Apply** to save the configuration change.
2. Configure SSO logout for oim, as shown:

```
<IDM_ORACLE_HOME>/common/bin/wlst.sh
connect()
addOAMSSOProvider(loginuri="{app.context}/adfAuthentication", logouturi="/
oamssso/logout.html", autologinuri="/obrar.cgi")
exit()
```

 **Note:**

The `connect()` call prompts for Admin server URL and WebLogic administrator username and password.

3. Configure authentication providers. To do so:

 **Note:**

This step configures the security providers in OIM domain in such a way that the SSO login, and OIM-client based login works fine. For this, OAMIDAsserter and OIDAAuthenticator must be setup. OIDAAuthenticator is configured to authenticate/assert users against OID. To authenticate/assert users against any other Directory server, which is also used by OAM for authentication, corresponding authenticator must to be configured instead of OIDAAuthenticator.

- a. Login to Oracle WebLogic Administrative Console, and navigate to **Security realms, myrealm, Providers, Authentication**.
- b. Click **New** to add OAMIDAsserter of type OAMIdentityAsserter. Click **OK**.  
Edit OAMIDAsserter that you added, and set the `control` flag to `REQUIRED`.  
Ensure that `Chosen Active Type` is set to `OAM_REMOTE_USER`, and then save the configuration.
- c. Click **New** to add OIMSignatureAuthenticator of type OIMSignatureAuthenticator. Click **OK**. Edit OIMSignatureAuthenticator and set the `Control` flag to `SUFFICIENT`. Save the configuration.

- d. Click **New** to add `OIDAuthenticator` of type `OracleInternetDirectoryAuthenticator`. Click **OK**. Edit `OIDAuthenticator` and set the `Control` flag to `SUFFICIENT`. Save the configuration. Open the `Provider` specific tab, and set the following attributes (only), and then save the configuration.
  - **Host:** `OID_HOST_NAME`
  - **Port:** `OID_PORT`
  - **Principal:** `cn=orcladmin`
  - **Credential/Confirm Credential:** `orcladmin_password`
  - **User Base DN:** `cn=Users,dc=us,dc=oracle,dc=com`
  - **All Users Filter:** `(&(uid=*)(objectclass=inetOrgPerson))`
  - **User From Name Filter:** `(&(uid=%u)(objectclass=inetOrgPerson))`
  - **UserNameAttribute:** `uid`
  - **User Object class:** `inetOrgPerson`
  - **Use retrieved use name as principal:** `true`
  - **Group Base DN:** `cn=Groups,dc=us,dc=oracle,dc=com`
  - **All groups filter:** `(&(cn=*)(objectclass=groupOfUniqueNames))`
  - **Group from name filter:** `(&(cn=%g)(objectclass=groupOfUniqueNames))`
- e. Remove `OIMAuthenticationProvider` that is already configured.
- f. Re-order the remaining authentication providers in the following order:
  - OAMIDAsserter
  - OIMSignatureAuthenticator
  - OIDAuthenticator
  - DefaultAuthenticator
  - DefaultIdentityAsserter
- g. Activate all the changes done, and then restart all the servers configured in OIM domain.

## B.5.3 Running Validation Tests to Validate the Configuration

Validation tests to verify basic SSO configuration are: logging in to Oracle Identity Manager through SSO, client-based logging with SSO password, and signature-based authentication.

Validate the SSO logout and authenticator configuration by running the following validation tests:

### 1. User Login to Oracle Identity Governance Through SSO

**Prerequisites:** Create a user, for example, `ENDUSER001`, in Oracle Identity Manager and LDAP.

**Step:** Try logging in to Oracle Identity Self Service through SSO URL as the user you created, for example `ENDUSER001`, and check if the login is successful. Also try to login to Oracle Identity System Administration as the system administrator, and try accessing various links, such as Access Policies. Try logging out from either of the consoles, and re-login with same or different users.

**Expected output:** Login is successful, and all the links work as expected.

## 2. Client-Based Login to Oracle Identity Governance:

**Prerequisites:** The Design Console is installed and configured.

**Step:** Try logging in to the Design Console as the system administrator with SSO password.

**Expected output:** Login to the Design console as the system administrator is successful, assuming that LDAPAuthenticator is configured properly for SSO login.

## 3. Signature-Based Authentication:

To test signature-based authentication:

- a. Try accessing the Scheduler service URL running on Oracle Identity Manager Managed server port, as shown:

`http://OIM_HOST:PORT/SchedulerService-web`

- b. Login as system administrator with SSO password.
- c. If the login is successful and you can see the following details on the screen, then signature login is successful:

Scheduler Current Status: `STARTED`

Last Error: `NONE`

- d. Click **Start** on the page if the following is displayed:

Scheduler Current Status: `STOPPED`

If there are no errors on the page, then signature login is successful.

# B.6 Simplifying Third-Party SSO Integration

Configure Oracle's Identity Asserter provided by third-party SSO solutions, which is the recommended approach for providing SSO for Oracle Identity Manager.

To integrate Oracle Identity Manager with third-party SSO providers, such as Tivoli Access Manager and CA Siteminder, it is recommended to follow instructions provided in [Enabling Oracle Identity Governance to Work With IBM Tivoli Access Manager](#) and [Enabling Oracle Identity Governance to Work With CA SiteMinder](#) .

WebLogic plug-ins (identity asserters or authenticators) provided by third-party SSO solutions are the recommended approach for providing SSO for Oracle Identity Manager. However, if it is not feasible to configure integration using SSO provider-specific Weblogic plug-ins, as mentioned in sections [Enabling Oracle Identity Governance to Work With IBM Tivoli Access Manager](#) and [Enabling Oracle Identity Governance to Work With CA SiteMinder](#) , then instructions in this section can be followed to achieve the integration.



### Note:

This asserter currently supports third-party SSO providers, such as IBM Tivoli Access Manager and CA Siteminder.

To configure Oracle's Identity Asserter:

1. Login to Oracle WebLogic Administrative Console.
2. Navigate to **Security Realms, myrealm, Providers, Authentication**.

3. Click **New** to add `OAMIdentityAsserter`.
4. Open the asserter that you just added, and set the control flag to `REQUIRED`. In the `Active Types` shuttle, select the SSO specific HTTP header as the Chosen Active type. For example, if Siteminder SSO provider is being used, then select `SM_USER` header. Similarly, if Tivoli Access Manager SSO provider is being used, then select `iv-user` header.
5. Similarly, change the value of the `SSOHeader Name` field in provider-specific properties to `iv-user` or `SM_USER` appropriately.

 **Note:**

- `SM_USER` and `iv-user` are mentioned as these seem to be the default SSO headers set by CA Siteminder and IBM Tivoli Access Manager respectively.
- For some reason, if the SSO header does not contain the username value that maps to OIM User Login field, then it is recommended to configure SSO provider to return the username as part of a header named `OAM_REMOTE_USER`. In this case, select `OAM_REMOTE_USER` as Chosen Active type in step 4, and skip step 5.

6. Save the configuration.
7. Configure the authentication chain as follows:

`OAMIDAsserter - REQUIRED`  
`OIMSignatureAuthenticator - SUFFICIENT`  
`LDAPAuthenticator - SUFFICIENT`  
`DefaultAuthenticator - SUFFICIENT`  
`DefaultIdentityAsserter`

 **Note:**

`LDAPAuthenticator` must be replaced by the appropriate authenticator that can authenticate against the LDAP provider being used by the SSO provider, for example `OIDAuthenticator`.

8. Configure SSO logout for Oracle Identity Manager as mentioned in sections [Enabling Oracle Identity Governance to Work With IBM Tivoli Access Manager](#) or [Enabling Oracle Identity Governance to Work With CA SiteMinder](#) , based on the SSO provider.
9. Set the `ssoenabled` flag for Oracle Identity Manager to true. To do so:
  - a. Login to Oracle Enterprise Manager, and open System MBean Browser.
  - b. Open the `oracle.iam:Location=OIM_SERVER_NAME,name=SSOConfig,type=XMLConfig.SSOC onfig,XMLConfig=Config,Application=oim,ApplicationVersion=11.1.2.0.0` mbean.
  - c. Set the value of `ssoEnabled` to `true`.
10. Ensure to protect/unprotect the Oracle Identity Manager resources on the SSO provider side, as mentioned in sections [Enabling Oracle Identity Governance to Work With IBM Tivoli Access Manager](#) or [Enabling Oracle Identity Governance to Work With CA SiteMinder](#) , based on the SSO provider.



11. Restart all servers in the Oracle Identity Manager domain.

While using this approach of configuring Oracle's Identity Asserter, take note of the following security considerations:

- Follow standard security practices for securing OHS and WebLogic.
- Ensure that the HTTP web server front ending Oracle Identity Manager is appropriately secured by using the SSO solution's standard security practices.

## B.7 Using Configurable Login ID Support for SSO Integration

Generally, the SSO providers use the Login ID attribute for performing a SSO login. However, Oracle Identity Manager uses User ID attribute for a SSO login.

Oracle Identity Manager can be integrated with third-party SSO providers, such as Siteminder and Tivoli Access Manager, in order to achieve single sign-on. These third-party SSO providers allow configuration of the login ID attribute, which the users need to use to perform SSO login. For example, if you want to allow users to login by using the email attribute (instead of User ID), then that configuration is allowed by SSO providers. However, this configuration will not work well when Oracle Identity Manager is integrated with the SSO provider. This is because the Login ID attribute in Oracle Identity Manager is `User Login`, and it is not possible to configure some other user attribute (say email) as the Login ID attribute. So, this feature is about making the Login ID attribute configurable in Oracle Identity Manager. After the login ID attribute is configured to some other user entity attribute of Oracle Identity Manager, say Email, then the users can perform SSO login to Oracle Identity Manager using the email values.

### Note:

- It is not recommended to use this configuration in an Oracle Identity Manager deployment that is not integrated with SSO providers.
- This solution is recommended if your Oracle Identity Manager deployment is integrated with third-party SSO providers, and you want to allow users to login with an attribute other than User Login.
- It is not recommended to use this solution when Oracle Identity Manager is integrated with OAM. It is possible to configure OAM to allow users to login with multiple attributes, yet assert the User Login equivalent attribute. With that configuration, although the user performs SSO login using email, the JAAS subject is populated with User Login attribute.

## B.8 Configuring Login ID Support for SSO Integration

Configuring the login ID attribute in Oracle Identity Manager involves configuring the loginMapper property in oim configuration to use the SSOLoginIdMapper, configuring SSO, specifying the same value for loginIdAttribute and USR\_LOGIN for each user, and modifying LDAP-specific authenticator configuration.

To configure Login ID attribute in Oracle Identity Manager:

1. Login to Oracle Enterprise Manager.
2. Expand **WebLogic Domain**. Right-click **DOMAIN\_NAME**, and select **System MBean Browser**.

3. Configure the `loginMapper` property in `oim` configuration to use the `SSOLoginIdMapper`. To do so:
  - a. Go to **Application Defined MBeans, oracle.iam, Server:OIM\_SERVER\_NAME, Application:oim, XML Config, Config**.
  - b. Change the value of the `loginMapper` attribute to `oracle.iam.platform.auth.impl.SSOLoginIDMapper`.
4. Configure Oracle Identity Manager for SSO by setting the `ssoEnabled` attribute of `ssoConfig` to `true`. To do so:
  - a. Go to **Application Defined MBeans, oracle.iam, Server:oim\_server1, Application:oim, XML Config, XMLConfig:SSOConfig, SSOConfig**.
  - b. Select `true` as the value of the `SSOEnabled` attribute.
5. In the same page, set the value of `loginIdAttribute` to a valid Oracle Identity Manager user entity attribute.

 **Note:**

If `loginIdAttribute` is configured to Email, then all users must have a valid email ID, and the values must be unique across all the Oracle Identity Manager users.

6. For all Oracle Identity Manager users seeded by default, ensure that the value of `loginIdAttribute` is the same as that of `USR_LOGIN`. For example, if `loginIdAttribute` is configured to Email, then make sure that the email IDs of default users are the same as the `USR_LOGIN` values. The following SQL statements can be run against Oracle Identity Manager database schema:

```
update usr SET usr_email='OIMINTERNAL' where usr_login='OIMINTERNAL';
update usr SET usr_email='XELSYSADM' where usr_login='XELSYSADM';
update usr SET usr_email='WEBLOGIC' where usr_login='WEBLOGIC';
update usr SET usr_email='XELOPERATOR' where usr_login='XELOPERATOR';
```

7. Modify LDAP-specific authenticator configuration to use the appropriate attribute for User Name Attribute, User From Name Filter, and All Users Filter. For example, if `loginIdAttribute` is configured to Email, then make sure that the authenticator is configured as follows:

```
User Name Attribute: mail
User From Name Filter: (&(|(mail=%u)(uid=%u))(objectclass=inetOrgPerson)
All Users Filter: (&(mail=*)) (objectclass=inetOrgPerson)
```

 **Note:**

User From Name Filter contains an OR condition to be able to lookup users either by using `uid` attribute (which is the default) or by using `mail` (if `loginIdAttribute` is configured as Email).

However, it is recommended that you perform API client-based login only by using `loginIdAttribute` (`mail` for example), if configured.

8. Create the System Administrator user entry in the LDAP provider. Ensure that the `uid` and `mail` (assuming `loginIdAttribute` is configured as Email) attributes are set as `SYSTEM_ADMINISTRATOR`.

 **Note:**

If the `loginIdAttribute` is set to some other unique attribute in Oracle Identity Manager, then the corresponding mapping attribute in LDAP must be set as `SYSTEM_ADMINISTRATOR`.

## 9. Perform the following changes at the OPSS layer:

Considering the fact that Oracle Identity Manager connects to SOA via HTTP (UI) as well as t3 (server) channels, you need to configure `OIMDBProvider` to handle user lookups based on the SSO Login ID, instead of the default User Login. This can be done by modifying the `idstore.oim` service instance in the `jps-config.xml` file as follows:

```
<serviceInstance name="idstore.oim" provider="idstore.oim.provider" location=" ">
  <description>OIM Identity Store Service Instance</description>
  <property name="idstore.type" value="CUSTOM"/>
  <property name="ADF_IM_FACTORY_CLASS"
value="oracle.iam.userrole.providers.oimdb.OIMDBIdentityStoreFactory"/>
  <property name="DATASOURCE_NAME" value="jdbc/soaOIMLookupDB"/>
  <property value="USER_NAME=USR_EMAIL:USER_ID=USR_EMAIL"
name="PROPERTY_ATTRIBUTE_MAPPING"/>
</serviceInstance>
```

 **Note:**

The values for `USER_NAME` and `USER_ID` properties must be the field-mapping corresponding to `loginIdAttribute`. So if `loginIdAttribute` is configured as `Email`, then `USER_NAME` and `USER_ID` properties should be set to `USR_EMAIL`, since `Email` attribute maps to `USR_EMAIL` column.

10. Ensure that the authentication provider configuration in the Oracle Identity Manager domain security realm is as documented for that specific SSO provider, for example [Enabling Oracle Identity Governance to Work With IBM Tivoli Access Manager](#) or [Enabling Oracle Identity Governance to Work With CA SiteMinder](#) . **Note:**

Ensure the following while developing custom SOA composites, when a custom `loginIdAttribute` (say `Email`) is configured:

- When Oracle Identity Manager initiates SOA composites for approval, it passes `RequesterDetails`, `BeneficiaryDetails` as part of the payload.  
The `Login` and `ManagerLogin` fields within these would be set to `Email` instead of `User Login`.
- Ensure that you use the `loginIdAttribute` value as the task assignee.

In order to fetch the `loginIdAttribute` value for a user (given user key), you can use the `getUserDetails` operation of `RequestDataService` in the BPEL process.

The same applies to already existing custom SOA composites.

## B.9 Integrating Oracle Identity Governance with Identity Providers using SAML2 Asserter

This section describes the configuration steps for enabling Oracle Identity Governance for Single Sign On (SSO) by using SAML2 single sign on flow. The identity provider (IDP) or SAML2 assertion provider used in this document is Oracle Access Manager (OAM). You can also use any other IDP that supports SAML2.

This section contains the following topics:

- [Prerequisites for Integrating Oracle Identity Governance with Identity Providers](#)
- [Configuring the SAML2 Asserter in the Oracle Identity Governance Domain](#)
- [Configuring Identity Federation Settings on Oracle Identity Governance](#)
- [Exporting the Identity Federation Document](#)
- [Configuring the Identity Provider Metadata on Oracle Identity Governance](#)
- [Updating Identity Self Service, System Administration, and FacadeWebApp to Change the Session Cookie](#)
- [Testing the SAML2.0 Flow with Identity Self Service and System Administration Pages](#)

### B.9.1 Prerequisites for Integrating Oracle Identity Governance with Identity Providers

Before integrating Oracle Identity Governance with Identity Providers (IDPs), perform the following prerequisites:

1. Install Oracle Access Manager 12c (12.2.1.4.0) on a host computer, say host1.
2. Install Oracle Identity Governance 12c (12.2.1.4.0) on another host computer, say host2.
3. On host2, configure Oracle HTTP Server (OHS) 12c (12.2.1.4.0) on top of OIG. To do so:
  - a. Update the `$DOMAIN_HOME/config/fmwconfig/components/OHS/ohs1/mod_wl_ohs.conf` file as shown in this step. The following entries are standard for OHS and OIG integration. Change the value of all instances of `WLCookieName` from `oimjessionid` to `JSESSIONID`, as shown:

```
<Location /reqsvc>
  SetHandler weblogic-handler
  WLCookieName JSESSIONID
  WebLogicHost exampledomain.com
  WebLogicPort PORT
  WLLogFile "${ORACLE_INSTANCE}/diagnostics/logs/mod_wl/oim_component.log"
</Location>
```

```
<Location /identity>
  SetHandler weblogic-handler
  WLCookieName JSESSIONID
  WebLogicHost mydomian.com
  WebLogicPort PORT
  WLLogFile "${ORACLE_INSTANCE}/diagnostics/logs/mod_wl/oim_component.log"
</Location>
```

```

<Location /sysadmin>
  SetHandler weblogic-handler
  WLCookieName JSESSIONID
  WebLogicHost exampledomain.com
  WebLogicPort PORT
  WLLogFile "${ORACLE_INSTANCE}/diagnostics/logs/mod_wl/oim_component.log"
</Location>

<Location /admin>
  SetHandler weblogic-handler
  WebLogicHost exampledomain.com
  WebLogicPort PORT
  WLCookieName JSESSIONID
  WLLogFile "${ORACLE_INSTANCE}/diagnostics/logs/mod_wl/oim_component.log"
</Location>

# oim self and advanced admin webapp consoles(canonic webapp)
<Location /oim>
  SetHandler weblogic-handler
  WebLogicHost exampledomain.com
  WebLogicPort PORT
  WLCookieName JSESSIONID
  WLLogFile "${ORACLE_INSTANCE}/diagnostics/logs/mod_wl/oim_component.log"
</Location>

# SOA Callback webservice for SOD
<Location /sodcheck>
  SetHandler weblogic-handler
  WebLogicHost exampledomain.com
  WebLogicPort PORT
  WLCookieName JSESSIONID
  WLLogFile "${ORACLE_INSTANCE}/diagnostics/logs/mod_wl/oim_component.log"
</Location>

# Callback webservice for SOA. SOA calls this when a request is approved/rejected
# Provide the SOA Managed Server Port
<Location /workflowservice>
  SetHandler weblogic-handler
  WebLogicHost exampledomain.com
  WebLogicPort PORT
  WLCookieName JSESSIONID
  WLLogFile "${ORACLE_INSTANCE}/diagnostics/logs/mod_wl/oim_component.log"
</Location>

# Nexaweb WebApp - used for workflow designer and DM
<Location /Nexaweb>
  SetHandler weblogic-handler
  WLCookieName JSESSIONID
  WebLogicHost exampledomain.com
  WebLogicPort PORT
  WLLogFile "${ORACLE_INSTANCE}/diagnostics/logs/mod_wl/oim_component.log"
</Location>

# used for FA Callback service.
<Location /callbackResponseService>
  SetHandler weblogic-handler
  WLCookieName JSESSIONID
  WebLogicHost exampledomain.com
  WebLogicPort PORT
  WLLogFile "${ORACLE_INSTANCE}/diagnostics/logs/mod_wl/oim_component.log"
</Location>

```

```

# spml xsd profile
<Location /spml-xsd>
  SetHandler weblogic-handler
  WLCookieName JSESSIONID
  WebLogicHost exampledomain.com
  WebLogicPort PORT
  WLogFile "${ORACLE_INSTANCE}/diagnostics/logs/mod_wl/oim_component.log"
</Location>

<Location /HTTPClnt>
  SetHandler weblogic-handler
  WLCookieName JSESSIONID
  WebLogicHost exampledomain.com
  WebLogicPort PORT
  WLogFile "${ORACLE_INSTANCE}/diagnostics/logs/mod_wl/oim_component.log"
</Location>

<Location /provisioning-callback>
  SetHandler weblogic-handler
  WLCookieName JSESSIONID
  WebLogicHost exampledomain.com
  WebLogicPort PORT
  WLogFile "${ORACLE_INSTANCE}/diagnostics/logs/mod_wl/oim_component.log"
</Location>

<Location /CertificationCallbackService>
  SetHandler weblogic-handler
  WLCookieName JSESSIONID
  WebLogicHost exampledomain.com
  WebLogicPort PORT
  WLogFile "${ORACLE_INSTANCE}/diagnostics/logs/mod_wl/oim_component.log"
</Location>

<Location /FacadeWebApp>
  SetHandler weblogic-handler
  WLCookieName JSESSIONID
  WebLogicHost exampledomain.com
  WebLogicPort PORT
  WLogFile "${ORACLE_INSTANCE}/diagnostics/logs/mod_wl/oim_component.log"
</Location>

<Location /iam/governance/configmgmt>
  SetHandler weblogic-handler
  WLCookieName JSESSIONID
  WebLogicHost exampledomain.com
  WebLogicPort PORT
  WLogFile "${ORACLE_INSTANCE}/diagnostics/logs/mod_wl/oim_component.log"
</Location>

<Location /iam/governance/scim/v1>
  SetHandler weblogic-handler
  WLCookieName JSESSIONID
  WebLogicHost exampledomain.com
  WebLogicPort PORT
  WLogFile "${ORACLE_INSTANCE}/diagnostics/logs/mod_wl/oim_component.log"
</Location>

<Location /iam/governance/token/api/v1>
  SetHandler weblogic-handler
  WLCookieName JSESSIONID
  WebLogicHost exampledomain.com

```

```

WebLogicPort PORT
WLLogFile "${ORACLE_INSTANCE}/diagnostics/logs/mod_wl/oim_component.log"
</Location>

<Location /OIGUI>
  SetHandler weblogic-handler
  WLCookieName JSESSIONID
  WebLogicHost exampledomain.com
  WebLogicPort PORT
  WLLogFile "${ORACLE_INSTANCE}/diagnostics/logs/mod_wl/oim_component.log"
</Location>

<Location /iam/governance/applicationmanagement>
  SetHandler weblogic-handler
  WLCookieName JSESSIONID
  WebLogicHost exampledomain.com
  WebLogicPort PORT
  WLLogFile "${ORACLE_INSTANCE}/diagnostics/logs/mod_wl/oim_component.log"
</Location>

```

- b. Add the following snippet for adding redirection of SAML2 response recieved from the IDP:

```

<Location /saml2>
  SetHandler weblogic-handler
  WLCookieName JSESSIONID
  WebLogicHost exampledomain.com
  WebLogicPort PORT
</Location>

```

4. Save the mod\_wl\_ohs.conf file.

## B.9.2 Configuring the SAML2 Asserter in the Oracle Identity Governance Domain

To configure the SAML2 identity asserter in the Oracle Identity Governance domain:

1. Login to Oracle WebLogic Server Administration Console 12c.
2. Navigate to the Security Realm, and click the **Providers** tab. All the configured providers are displayed.
3. In the Authentication tab, under Authentication Providers, click **New**. The Create a New Identity Provider page is displayed.
4. In the Name field, enter a name for the identity asserter.
5. Make sure that **SAML2IdentityAsserter** is selected in the Type list, and click **OK**.
6. Reorder the identity providers so that SAML2IdentityAsserter is the first in the list. To do so:
  - a. In the Authentication tab, under Authentication Providers, click **Reorder**. The Reorder Authentication Providers page is displayed.
  - b. Under Authentication Providers, in the Available list, reorder the SAML2 identity asserter that you created to be the first in the list by using the navigation arrows adjacent to the list.
  - c. Click **OK**.
7. Restart the servers for the changes to take effect.

(Optional) Enter the result of the procedure here.

## B.9.3 Configuring Identity Federation Settings on Oracle Identity Governance

To configure Identity Federation settings on Oracle Identity Governance:

1. Login to Oracle WebLogic Administration Console 12c.
2. Navigate to **Environments, Servers, OIM\_SERVER\_NAME**.
3. Click the **Federation Services** tab.
4. Click the **SAML2.0 Service Provider** tab.
5. Enter the following details, and click **Save**.
  - **Authentication Request Cache Size:** 10000
  - **Authentication Request Cache Timeout:** 300
  - **Preferred Binding:** None
  - **Default URL:** `https://host1.example.com:PORT/identity/faces/home`
6. Click the **SAML2.0 General** tab, and enter the following details:
  - **Entity ID:** `OIM_SAML2`  
This can be any name. It is the name through which the identity provider identifies the service provider.
  - **Published Site URL:** `http://host1.example.com:PORT/saml2` or `http://host1.example.com:OHS_PORT/saml2`  
This is the URL to which the SAML2 response is sent after the authentication on the identity provider. If OHS is installed on top of Oracle Identity Governance, then use OHS host and port.
  - **Single Sign Signing Key Alias:** `DemoIdentity/DemoIdentityPassPhrase`  
This is the keystore alias for the key to be used for signing documents.
7. Click **Save**.

## B.9.4 Exporting the Identity Federation Document

To export the Identity Federation document :

1. In the SAML2.0 General tab, click **Publish Metadata**. The Publish SAML2.0 Meta Data page is displayed.
2. In the Path field, enter the directory path and name of the file that you want to export, for example, `/scratch/USER_NAME/12cPS4OIM/PS4mw/user_projects/domains/base_domain/OIM_SAML2.xml`.
3. Optionally select the **Overwrite** option if you want the metadata to be written to the file if the file already exists. Otherwise, leave this option unchecked.
4. Click **OK**.



## B.9.5 Configuring the Identity Provider Metadata on Oracle Identity Governance

To configure the Oracle Access Manager (identity provider) metadata on Oracle Identity Governance (service provider):

1. Login to Oracle WebLogic Server Administration Console 12c.
2. Go to **Security Realm**, and then click the **Providers** tab.
3. Click the SAML2 asserter created in .
4. Click the **Management** tab.
5. Click **New**, and select **New Web Single Sign-On Identity Provider Partner**. The Create a SAML2.0 Web Single Sign-On Identity Provider Partner page is displayed.

If you the following error on the page:

```
Cannot resolve 'query:AttributeQueryDescriptorType' to a type definition for element 'md:RoleDescriptor'.
Create Operation failed - no partner created.
```

Then modify the metadata file, and remove the `AttributeQueryDescriptorType` element from the OAMMetadata file.

On successful import, the message `Partner created successfully.` is displayed, and OAMIDP is displayed in the Identity Provider Partners list. By default, the configured partner is disabled.

6. Under Identity Provider Partners, click the created partner, and set the values of the following parameters:
  - a. In the Overview section, select **Enabled** to enable the partner.
  - b. In the Redirect URIs box, enter the following to add redirect URIs:

```
/identity/adfAuthentication
/sysadmin/adfAuthentication
```

7. Restart the Oracle Identity Governance domain servers for the changes to take effect and the federation between Oracle Access Management and Oracle Identity Governance to be successful.

## B.9.6 Updating Identity Self Service, System Administration, and FacadeWebApp to Change the Session Cookie

To update the EAR files for Identity Self Service, Identity System Administration, and FacadeWebApp, to change the session cookie:

### Note:

This step is required to support SAML2 flow if the application uses custom cookie. See Use of Non-default Cookie Name in the *Fusion Middleware Securing Oracle WebLogic Server*.

1. Create Plan.xml files for `oracle.iam.console.identity.self-service.ear`, `oracle.iam.console.identity.sysadmin.ear`, and `oim.ear`. Make sure to provide a unique name for Plan.xml for these applications to avoid collision. For example, store the files as `MW_HOME/idm/server/apps/identityPlan.xml`, `MW_HOME/idm/server/apps/sysadminPlan.xml`, and `MW_HOME/idm/server/apps/oimPlan.xml`.

The sample Plan.xml files are as follows:

#### Sample deployment plan XML for `oracle.iam.console.identity.self-service.ear`

```
<?xml version='1.0' encoding='UTF-8'?>
<deployment-plan xmlns="http://xmlns.oracle.com/weblogic/deployment-plan"
xmlns:xsi="http://www.w3.org/2001/XMLSchema-instance" xsi:schemaLocation="http://
xmlns.oracle.com/weblogic/deployment-plan http://xmlns.oracle.com/weblogic/
deployment-plan/1.0/deployment-plan.xsd">
  <application-name>oracle.iam.console.identity.self-service.ear#V2.0</application-
name>
  <variable-definition>
    <variable>
      <name>NewCookieName</name>
      <value>JSESSIONID</value>
    </variable>
  </variable-definition>
  <module-override>
    <module-name>oracle.iam.console.identity.self-service.war</module-name>
    <module-type>war</module-type>
    <module-descriptor external="false">
      <root-element>weblogic-web-app</root-element>
      <uri>WEB-INF/weblogic.xml</uri>
      <variable-assignment>
        <name>NewCookieName</name>
        <xpath>/weblogic-web-app/session-descriptor/cookie-name</xpath>
      </variable-assignment>
    </module-descriptor>
  </module-override>
</deployment-plan>
```

#### Sample deployment plan XML for `oracle.iam.console.identity.sysadmin.ear`

```
<?xml version='1.0' encoding='UTF-8'?>
<deployment-plan xmlns="http://xmlns.oracle.com/weblogic/deployment-plan"
xmlns:xsi="http://www.w3.org/2001/XMLSchema-instance" xsi:schemaLocation="http://
xmlns.oracle.com/weblogic/deployment-plan http://xmlns.oracle.com/weblogic/
deployment-plan/1.0/deployment-plan.xsd">
  <application-name>oracle.iam.console.identity.sysadmin.ear#V2.0</application-name>
  <variable-definition>
    <variable>
      <name>NewCookieName</name>
      <value>JSESSIONID</value>
    </variable>
  </variable-definition>
  <module-override>
    <module-name>oracle.iam.console.identity.sysadmin.war</module-name>
    <module-type>war</module-type>
    <module-descriptor external="false">
      <root-element>weblogic-web-app</root-element>
      <uri>WEB-INF/weblogic.xml</uri>
      <variable-assignment>
        <name>NewCookieName</name>
        <xpath>/weblogic-web-app/session-descriptor/cookie-name</xpath>
      </variable-assignment>
    </module-descriptor>
  </module-override>
</deployment-plan>
```

```

</module-override>
</deployment-plan>

```

### Sample deployment plan XML for oim.ear

```

<?xml version='1.0' encoding='UTF-8'?>
<deployment-plan xmlns="http://xmlns.oracle.com/weblogic/deployment-plan"
xmlns:xsi="http://www.w3.org/2001/XMLSchema-instance" xsi:schemaLocation="http://
xmlns.oracle.com/weblogic/deployment-plan http://xmlns.oracle.com/weblogic/
deployment-plan/1.0/deployment-plan.xsd">
  <application-name>oim</application-name>
  <variable-definition>
    <variable>
      <name>NewCookieName</name>
      <value>JSESSIONID</value>
    </variable>
  </variable-definition>
  <module-override>
    <module-name>iam-consoles-faces.war</module-name>
    <module-type>war</module-type>
    <module-descriptor external="false">
      <root-element>weblogic-web-app</root-element>
      <uri>WEB-INF/weblogic.xml</uri>
      <variable-assignment>
        <name>NewCookieName</name>
        <xpath>/weblogic-web-app/session-descriptor/cookie-name</xpath>
      </variable-assignment>
    </module-descriptor>
  </module-override>
  <module-override>
    <module-name>FacadeWebApp.war</module-name>
    <module-type>war</module-type>
    <module-descriptor external="false">
      <root-element>weblogic-web-app</root-element>
      <uri>WEB-INF/weblogic.xml</uri>
      <variable-assignment>
        <name>NewCookieName</name>
        <xpath>/weblogic-web-app/session-descriptor/cookie-name</xpath>
      </variable-assignment>
    </module-descriptor>
  </module-override>
</deployment-plan>

```

2. Login to Oracle WebLogic Administrative Console.
3. Navigate to **Deployments**, and then select the application.
4. Click **Update**. The Update Application Assistant page is displayed.
5. Click **Change Path** against the deployment plan path configuration.
6. Specify the path to the deployment plan XML file specific to the application, and click **Next**.
7. Select the **Update this application in place with new deployment plan changes** option. Click **Finish** to complete the deployment plan configuration. Activate changes if required.

 **Note:**

You can ignore the following errors while updating the plan:

**oracle.iam.console.identity.self-service.ear and  
oracle.iam.console.identity.sysadmin.ear error:**

```
'weblogic.management.DeploymentException: The application
oracle.iam.console.identity.self-service.ear#V2.0 cannot have the resource
WEB-INF/weblogic.xml updated dynamically. Either:
1.) The resource does not exist.
   or
2) The resource cannot be changed dynamically.
```

**oim error:**

```
weblogic.descriptor.DescriptorUpdateRejectedException: Non-dynamic
properties were found to be updated Bean:
weblogic.j2ee.descriptor.WebAppBeanImpl FilterMappings (REMOVE
weblogic.j2ee.descriptor.FilterMappingBeanImpl@be33a8a0 (/
FilterMappings[[CompoundKey: SSOsessionSynchronizationFilter[CompoundKey: ]
[CompoundKey: /*]]]) (Dynamic=false) [Original Value:
[Lweblogic.j2ee.descriptor.FilterMappingBeanImpl;@148fdb1f, Proposed Value:
[Lweblogic.j2ee.descriptor.FilterMappingBeanImpl;@7075de61] FilterMappings
(REMOVE weblogic.j2ee.descriptor.FilterMappingBeanImpl@5a3116b4 (/
FilterMappings[[CompoundKey: JpsFilter[CompoundKey: ] [CompoundKey: /*]]])
(Dynamic=false) [Original Value:
[Lweblogic.j2ee.descriptor.FilterMappingBeanImpl;@148fdb1f, Proposed Value:
[Lweblogic.j2ee.descriptor.FilterMappingBeanImpl;@7075de61] FilterMappings
(REMOVE weblogic.j2ee.descriptor.FilterMappingBeanImpl@3f7e90c7 (/
FilterMappings[[CompoundKey: ExtensibleGlobalFilter[CompoundKey: ]
[CompoundKey: /*]]]) (Dynamic=false) [Original Value:
[Lweblogic.j2ee.descriptor.FilterMappingBeanImpl;@148fdb1f, Proposed Value:
[Lweblogic.j2ee.descriptor.FilterMappingBeanImpl;@7075de61] FilterMappings
(REMOVE weblogic.j2ee.descriptor.FilterMappingBeanImpl@a18ad6a0 (/
FilterMappings[[CompoundKey: DMSSystemFilter[CompoundKey: ] [CompoundKey: /
*]]]) (Dynamic=false) [Original Value:
[Lweblogic.j2ee.descriptor.FilterMappingBeanImpl;@148fdb1f, Proposed Value:
[Lweblogic.j2ee.descriptor.FilterMappingBeanImpl;@7075de61] FilterMappings
(REMOVE weblogic.j2ee.descriptor.FilterMappingBeanImpl@c63fc573 (/
FilterMappings[[CompoundKey: OAMAgentFilter[CompoundKey: ] [CompoundKey: /
*]]]) (Dynamic=false) [Original Value:
[Lweblogic.j2ee.descriptor.FilterMappingBeanImpl;@148fdb1f, Proposed Value:
[Lweblogic.j2ee.descriptor.FilterMappingBeanImpl;@7075de61] Filters (REMOVE
weblogic.j2ee.descriptor.FilterBeanImpl@88cea9cf (/Filters[JpsFilter]))
(Dynamic=false) [Original Value:
[Lweblogic.j2ee.descriptor.FilterBeanImpl;@32be66e8, Proposed Value:
[Lweblogic.j2ee.descriptor.FilterBeanImpl;@39c7fa98] Filters (REMOVE
weblogic.j2ee.descriptor.FilterBeanImpl@eb9d7cfb (/Filters[DMSSystemFilter]))
(Dynamic=false) [Original Value:
[Lweblogic.j2ee.descriptor.FilterBeanImpl;@32be66e8, Proposed Value:
[Lweblogic.j2ee.descriptor.FilterBeanImpl;@39c7fa98] Filters (REMOVE
weblogic.j2ee.descriptor.FilterBeanImpl@45ac8348 (/Filters[OAMAgentFilter]))
(Dynamic=false) [Original Value:
[Lweblogic.j2ee.descriptor.FilterBeanImpl;@32be66e8, Proposed Value:
[Lweblogic.j2ee.descriptor.FilterBeanImpl;@39c7fa98] Filters (REMOVE
weblogic.j2ee.descriptor.FilterBeanImpl@17e26bdc (/
Filters[ExtensibleGlobalFilter])) (Dynamic=false) [Original Value:
[Lweblogic.j2ee.descriptor.FilterBeanImpl;@32be66e8, Proposed Value:
[Lweblogic.j2ee.descriptor.FilterBeanImpl;@39c7fa98] Filters (REMOVE
weblogic.j2ee.descriptor.FilterBeanImpl@dea456fb (/
Filters[SSOsessionSynchronizationFilter])) (Dynamic=false) [Original Value:
```

```

[Lweblogic.j2ee.descriptor.FilterBeanImpl;@32be66e8, Proposed Value:
[Lweblogic.j2ee.descriptor.FilterBeanImpl;@39c7fa98] Id (CHANGE)
(Dynamic=false)(Original Value: WebApp_ID, Proposed Value: null]
;Non-dynamic properties were found to be updated Bean:
weblogic.j2ee.descriptor.WebAppBeanImpl FilterMappings (REMOVE
weblogic.j2ee.descriptor.FilterMappingBeanImpl@be33a8a0(/
FilterMappings[[CompoundKey: SSOSessionSynchronizationFilter[CompoundKey: ]
[CompoundKey: /*]]])) (Dynamic=false)(Original Value:
[Lweblogic.j2ee.descriptor.FilterMappingBeanImpl;@148fdb1f, Proposed Value:
[Lweblogic.j2ee.descriptor.FilterMappingBeanImpl;@7075de61] FilterMappings
(REMOVE weblogic.j2ee.descriptor.FilterMappingBeanImpl@5a3116b4(/
FilterMappings[[CompoundKey: JpsFilter[CompoundKey: ][CompoundKey: /*]]]))
(Dynamic=false)(Original Value:
[Lweblogic.j2ee.descriptor.FilterMappingBeanImpl;@148fdb1f, Proposed Value:
[Lweblogic.j2ee.descriptor.FilterMappingBeanImpl;@7075de61] FilterMappings
(REMOVE weblogic.j2ee.descriptor.FilterMappingBeanImpl@3f7e90c7(/
FilterMappings[[CompoundKey: ExtensibleGlobalFilter[CompoundKey: ]
[CompoundKey: /*]]])) (Dynamic=false)(Original Value:
[Lweblogic.j2ee.descriptor.FilterMappingBeanImpl;@148fdb1f, Proposed Value:
[Lweblogic.j2ee.descriptor.FilterMappingBeanImpl;@7075de61] FilterMappings
(REMOVE weblogic.j2ee.descriptor.FilterMappingBeanImpl@a18ad6a0(/
FilterMappings[[CompoundKey: DMSSystemFilter[CompoundKey: ][CompoundKey: /
*]]])) (Dynamic=false)(Original Value:
[Lweblogic.j2ee.descriptor.FilterMappingBeanImpl;@148fdb1f, Proposed Value:
[Lweblogic.j2ee.descriptor.FilterMappingBeanImpl;@7075de61] FilterMappings
(REMOVE weblogic.j2ee.descriptor.FilterMappingBeanImpl@c63fc573(/
FilterMappings[[CompoundKey: OAMAgentFilter[CompoundKey: ][CompoundKey: /
*]]])) (Dynamic=false)(Original Value:
[Lweblogic.j2ee.descriptor.FilterMappingBeanImpl;@148fdb1f, Proposed Value:
[Lweblogic.j2ee.descriptor.FilterMappingBeanImpl;@7075de61] Filters (REMOVE
weblogic.j2ee.descriptor.FilterBeanImpl@88cea9cf(/Filters[JpsFilter]))
(Dynamic=false)(Original Value:
[Lweblogic.j2ee.descriptor.FilterBeanImpl;@32be66e8, Proposed Value:
[Lweblogic.j2ee.descriptor.FilterBeanImpl;@39c7fa98] Filters (REMOVE
weblogic.j2ee.descriptor.FilterBeanImpl@eb9d7cfb(/Filters[DMSSystemFilter]))
(Dynamic=false)(Original Value:
[Lweblogic.j2ee.descriptor.FilterBeanImpl;@32be66e8, Proposed Value:
[Lweblogic.j2ee.descriptor.FilterBeanImpl;@39c7fa98] Filters (REMOVE
weblogic.j2ee.descriptor.FilterBeanImpl@45ac8348(/Filters[OAMAgentFilter]))
(Dynamic=false)(Original Value:
[Lweblogic.j2ee.descriptor.FilterBeanImpl;@32be66e8, Proposed Value:
[Lweblogic.j2ee.descriptor.FilterBeanImpl;@39c7fa98] Filters (REMOVE
weblogic.j2ee.descriptor.FilterBeanImpl@17e26bdc(/
Filters[ExtensibleGlobalFilter])) (Dynamic=false)(Original Value:
[Lweblogic.j2ee.descriptor.FilterBeanImpl;@32be66e8, Proposed Value:
[Lweblogic.j2ee.descriptor.FilterBeanImpl;@39c7fa98] Filters (REMOVE
weblogic.j2ee.descriptor.FilterBeanImpl@dea456fb(/
Filters[SSOSessionSynchronizationFilter])) (Dynamic=false)(Original Value:
[Lweblogic.j2ee.descriptor.FilterBeanImpl;@32be66e8, Proposed Value:
[Lweblogic.j2ee.descriptor.FilterBeanImpl;@39c7fa98] Id (CHANGE)
(Dynamic=false)(Original Value: WebApp_ID, Proposed Value: null]

```

8. Restart the servers.

## B.9.7 Testing the SAML2.0 Flow with Identity Self Service and System Administration Pages

To test the SAML2.0 flow with Oracle Identity Governance Self Service and System Administration pages:

1. Login to Oracle Identity Self Service by navigating to `http://host1.example.com:PORT/identity/faces/home` or `http://host1.example.com:OHS_PORT/identity/faces/home` (if OHS is installed on top of Oracle Identity Governance).

This redirects to the Oracle Access Management home page.

2. Enter the credentials of a user that is present in both OAM and OIG user stores. For example, enter the credentials of the weblogic user that is present on OAM.

The user is logged-in to the Identity Governance Self Service.

3. Login to Oracle Identity System Administration by navigating to `http://host1.example.com:PORT/sysadmin/faces/home` or `http://host1.example.com:OHS_PORT/sysadmin/faces/home` (if OHS is installed on top of Oracle Identity Governance).

This redirects to the Oracle Access Manager home page.

4. Enter the credentials of the system administrator user, which exists on the OAM user store.

The user is logged-in to the Identity Governance System Administration.

# C

## Using Database Roles/Grants for Oracle Identity Governance Database

As a database administrator, you can create roles to grant all privileges to a secure application role required to run a database application. You can then grant the secure application role to other roles or users.

An application can have various roles, each granted a different set of privileges that allow the user access more or less data while using the application. For example, you can create a role with a password to prevent unauthorized use of the privileges granted to the role. An application can be designed in such a way so that when it starts, it enables the proper role. As a result, an application user does not need to know the password for an application's role.

Depending on what is granted or revoked, a grant or revoke takes effect at different times, such as:

- All grants and revokes for system and object privileges to users, roles, and PUBLIC grants take immediate effect.
- All grants and revokes of roles to users, other roles, and PUBLIC take effect only when a current user session issues a SET ROLE statement to re-enable the role after the grant and revoke, or when a new user session is created after the grant or revoke.

You can see which roles are currently enabled by examining the SESSION\_ROLES data dictionary view.

In Oracle Identity Manager, there are prerequisite grants that are provided to Oracle Identity Manager schema to create necessary objects before installing Oracle Identity Manager. Some of these grants can be revoked later on after installing the Oracle Identity Manager and can be granted to particular users in future as required by the application.

[Table C-1](#) describes the grants required for database applications.

**Table C-1 Role Grants for Database Applications**

<b>Role Name</b>	<b>Description</b>	<b>Oracle Identity Governance Usage</b>	<b>Can this Role/ Grants be Removed Safely After Installation?</b>	<b>If Revoked</b>
CREATE TABLE	Enables a user to create, modify, and delete tables in the user's schema.	Although this is part of grant resource, this is explicitly required because the grant resource does not allow to create a table through a procedure.	Conditional	User will not be able to create any new tables programmatically.  You can revoke this grant when the Oracle Identity Manager deployment is stable, which means all the components and connectors are imported and working as expected. This is because each connector creates its own schema object. This grant is needed for initial run of any archival utility because the archival utilities create tables programmatically.
CONNECT	Provides the create session privileges	To create sessions for users	Conditional	This can be replaced with create session after installation. You can do this when the Oracle Identity Manager deployment is stable, which means all the components and connectors are imported and working as expected. This is because each connector creates its own schema object.



Table C-1 (Cont.) Role Grants for Database Applications

Role Name	Description	Oracle Identity Governance Usage	Can this Role/ Grants be Removed Safely After Installation?	If Revoked
RESOURCE	<p>Enables a user to create, modify, and delete certain types of schema objects in the schema associated with that user. Grant this role only to developers and to other users that must create schema objects. This role grants a subset of the create object system privileges. For example, it grants the CREATE TABLE system privilege, but does not grant the CREATE VIEW system privilege. It grants the following privileges:</p> <ul style="list-style-type: none"> <li>• CREATE CLUSTER</li> <li>• CREATE INDEXTYPE</li> <li>• CREATE OPERATOR</li> <li>• CREATE PROCEDURE</li> <li>• CREATE SEQUENCE</li> <li>• CREATE TABLE</li> <li>• CREATE TRIGGER</li> <li>• CREATE TYPE</li> </ul> <p>In addition, this role grants the UNLIMITED TABLESPACE system privilege, which effectively assigns a space usage quota of UNLIMITED on all tablespaces in which the user creates schema objects.</p>	To create sequences, indexes, procedures, triggers, and packages	Conditional	User will not be able to create any database objects. Only SYS user will be able to do so. You can revoke this grant when the Oracle Identity Manager deployment is stable, which means all the components and connectors are imported and working as expected. This is because each connector creates its own schema object. Specify the quota for tablespaces correctly.
CREATE VIEW	Enables a user to create, modify, and delete views in the user's schema	To create SDP_VISIBLE_V, SDP_REQUIRED_V, SDP_LOOKUPCODE_V, and SDP_RECURSIVE_V views in Oracle Identity Manager	Yes	The user will not be able to create any views. Only SYS user will be able to do so.

Table C-1 (Cont.) Role Grants for Database Applications

Role Name	Description	Oracle Identity Governance Usage	Can this Role/ Grants be Removed Safely After Installation?	If Revoked
DBMS_SHA RED_POOL	Fits a database object in a shared pool memory	Used for pinning all the procedures and functions used in Oracle Identity Manager in shared memory.  Oracle Identity Manager pinned sequences, function/procedures into memory.  Oracle Identity Manager also pinned USR table into memory if Oracle Identity Manager has less than 50000 users in the USR table.	Conditional	It can be revoked after installation but may impact performance because some of the procedures and functions may not be pinned explicitly. The pin_obj procedure is created only for Oracle Identity Manager. It is used to explicitly pin database objects into shared memory. Before revoking this role, make sure that the database-level trigger cache_seq is dropped, if already created.
SYS.DBMS_ SYSTEM	Enables an XA Resource Manager and sets privileges so that the XA Resource Manager can manage the interaction between the Oracle database and the applications.  <b>Note:</b> Each database connection is enlisted with the transaction manager as a transactional resource. The transaction manager obtains an XA Resource for each connection participating in a global transaction. The transaction manager uses the start method to associate the global transaction with the resource, and it uses the end method to disassociate the transaction from the resource. The resource manager associates the global transaction to all work performed on its data between the start and end method invocations.	For XA resource and database transactions	Yes	On Oracle Database version 10.2.0.4 onwards, it can be removed safely. Oracle has redeemed themselves by moving the DIST_TXN_SYNC procedure to a new package called DBMS_XA that is available to the public. Therefore, XA clients do not require execute privilege on DBMS_SYSTEM for later oracle versions.
SYS.DBMS_ FLASHBACK	Enables self-service repair. If you accidentally delete rows from a table, then you can recover the deleted rows.	For any failure during reconciliation, you can roll back the changes by using this.	No	This is required for the reconciliation engine in Oracle Identity Manager for error handling.

Table C-1 (Cont.) Role Grants for Database Applications

Role Name	Description	Oracle Identity Governance Usage	Can this Role/ Grants be Removed Safely After Installation?	If Revoked
CREATE_MATERIALIZED_VIEW	Creates a materialized view in the grantee's schema	To create the OIM_RECON_CHANGES_BY_RES_MV materialized view	Yes	User will not be able to create any materialized view. Only SYS user will be able to do so. This materialized view is required for reporting purpose only.
SELECT_ON_V\$XATrans SELECT_ON_PENDING_Trans\$ SELECT_ON_DBA_2PC_Pending SELECT_ON_DBA_Pending_Trans_Actions	Enables an XA Resource Manager and sets privileges so that the XA Resource Manager can manage the interaction between the Oracle database and the applications.	NA	No	Not recommended to remove. Required for XA support.
ADMINISTER_DATABASE_TRIGGER	Allows the creation of database-level triggers.	To create DDL trigger named ddl_trigger in Oracle Identity Manager	Yes	Users will not be able to create new DDL triggers. It can be removed after schema creation.
CREATE_SEQUENCE	Allows to Create sequences in the grantee's schema.	To create sequences	Conditional	Not recommended. User will not be able to create any sequence in the Oracle Identity Manager schema. Only SYS user will be able to do so. <b>Note:</b> You can revoke this grant when the Oracle Identity Manager deployment is stable, which means all the components and connectors are imported and working as expected. This is because each connector creates its own schema object which includes sequences also.
CREATE_SYNONYM	Allows to Create synonyms in the grantee's schema.	To create the following synonyms in Oracle Identity Manager schema: <ul style="list-style-type: none"> <li>ALTERNATE_ADF_LOOKUP_TYPES</li> <li>ALTERNATE_ADF_LOOKUPS</li> <li>FND_LOOKUPS</li> <li>FND_STANDARD_LOOKUP_TYPES</li> </ul>	Yes	The user will not be able to create any synonym. Only SYS user will be able to do so.

**Table C-1 (Cont.) Role Grants for Database Applications**

<b>Role Name</b>	<b>Description</b>	<b>Oracle Identity Governance Usage</b>	<b>Can this Role/ Grants be Removed Safely After Installation?</b>	<b>If Revoked</b>
CTXAPP	Before you can create Oracle Text indexes and use Oracle Text PL/SQL packages, you must grant with the CTXAPP role to the grantee's schema.	To create Oracle Text indexes and Oracle Text PL/SQL in Oracle Identity Manager schema.	No	Not recommended. Oracle Text feature will not work.
EXECUTE ON CTXSYS.CT X_ADM EXECUTE ON CTXSYS.CT X_CLS EXECUTE ON CTXSYS.CT X_DDL EXECUTE ON CTXSYS.CT X_DOC EXECUTE ON CTXSYS.CT X_OUTPUT EXECUTE ON CTXSYS.CT X_QUERY EXECUTE ON CTXSYS.CT X_REPORT EXECUTE ON CTXSYS.CT X_THES EXECUTE ON CTXSYS.CT X_ULEXER	Oracle Text includes several packages that let you perform actions ranging from synchronizing an Oracle Text index to highlighting documents.	Oracle Identity Manager is directly consuming CTXSYS.CTX_DDL. Other may consumed indirectly.	No	Not recommended. Optimization jobs for catalog will start failing.
CREATE JOB	It grants the Create Job privileges to the grantee schema.	To create jobs in Oracle Identity Manager.	Yes	Users will not be able to create new jobs. It can be removed after schema creation.

**Table C-1 (Cont.) Role Grants for Database Applications**

Role Name	Description	Oracle Identity Governance Usage	Can this Role/ Grants be Removed Safely After Installation?	If Revoked
EXECUTE ON DBMS_SCHEDULER	The DBMS_SCHEDULER package provides a collection of scheduling functions and procedures that can be called from any PL/SQL program.	To schedule the following Jobs in Oracle Identity Manager: PURGE FAST_OPTIMIZE_CATALOGS REBUILD_OPTIMIZE_CATALOG_TAGS PURGE_ADF_BC_TRANSACTIONABLE	No	Once revoked, jobs will start failing.
UTL_FILE	UTL_FILE is not used by Oracle Identity Manager.	NA	NA	NA
Database scheduling using CONTROL-M	In Oracle Identity Manager, Quartz scheduler is used for application side queuing and DBMS_SCHEDULER_JOB for database jobs scheduling.	CONTROL-M is not recommended/supported by Oracle Identity Manager.	No	NA
Advance Queuing Option	Advanced QUEUE feature is used by SOA.	Used by SOA.	No	NA
CREATE ANY INDEX	Used by OPSS.	Used by OPSS.	No	NA

# D

## Enable Administration Port in Oracle Identity Governance

### Important pre-requisite:

It is important that the domain is configured initially with non-secure mode.

Before enabling administration port(s), ensure that OIG with SSL configuration is completed and all the use cases are working as expected. Admin port enablement should be done post enablement of SSL configuration. Also, ensure that, OIM-SOA integration is also completed as documented at [Integrating Oracle Identity Governance with Oracle SOA Suite](#).

When you enable the administration ports in OIG weblogic domain, the following configuration must be performed for the OIG to work seamlessly.

The administration port accepts only secure and SSL traffic. WebLogic Server provides an option to enable administration ports for all the servers in the domain.



### Note:

To convert the node from non-secure to secure, use the remote console.

Admin port enabled at domain level.

- Enable Admin Port at Domain Level:

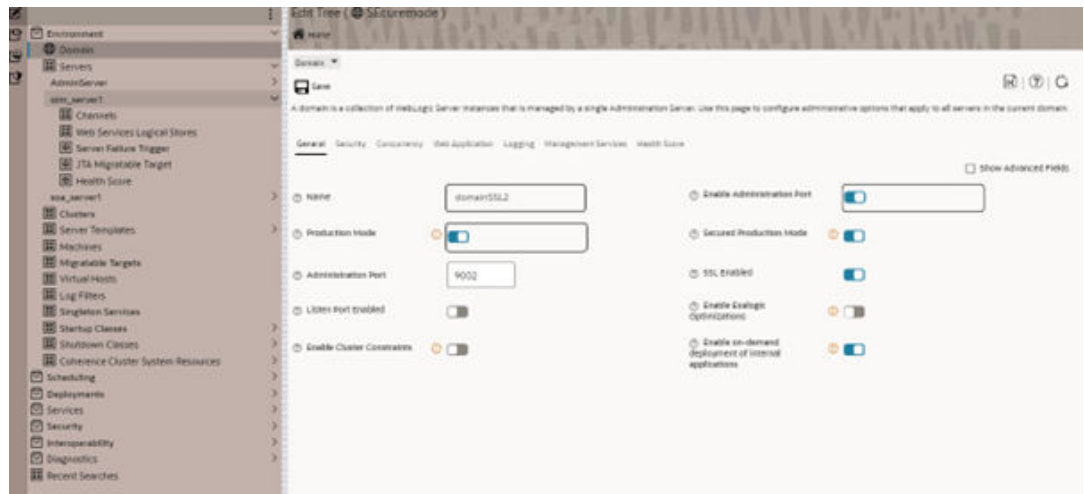

 **Note:**

Restart the servers using administration port as shown below:

```
sh startManagedWebLogic_new.sh soa_server1 https://<hostname>:9002
production
```

```
sh startManagedWebLogic_new.sh oim_server1 https://<hostname>:9002
production
```

Administration port enabled at managed server level.

After the admin ports are enabled, the following must be followed.

1. Access the WLS console using the admin port.

 **Note:**

The WLS console cannot be accessed by using any other option.

Example: `https://<host name>:9002`, where 9002 is admin port (not SSL port).

2. Access the **EM** console using admin port.  
Example: `https://<host name>:9002/em`
3. OIM uses the SSL port (14001 is default port).  
Example: `https://<host name>:14001/identity/`
4. SOA uses the SSL port (7004 is default port).  
Example: `https://<host name>:7004/soa-infra`
5. The SOA admin user allows OIM to communicate with SOA.  
By default, OIM uses "weblogic" user as SOA Admin user. Once you enable the admin ports, the OIM-SOA integration stops working while handling the requests due to the following error. A "weblogic" user is an administrator and hence it forces us to use admin ports.

```
oracle.bpel.services.workflow.client.WorkflowServiceClientException:
javax.naming.AuthenticationException: User 'principals=[weblogic,
Administrators]' has administration role. All tasks by administrators must go
through an Administration Port.
```

To resolve the above error, follow the below steps:

You must create a new user (non-admin user) synonymous with "weblogic" user with the required privileges.

1. Log in to Enterprise Manager.
2. Navigate to **"domain XX"->Security->Security Realms->myrealms->'Users and roles** tab.
3. Click on **Create** to create a user.





- d. Select the role and click **Edit**.
- e. Select **User** from the **Type** drop-down.
- f. Search “SOADMINUSER”.
- g. Add the user (SOADMINUSER) to this OIGSOAROLE role.

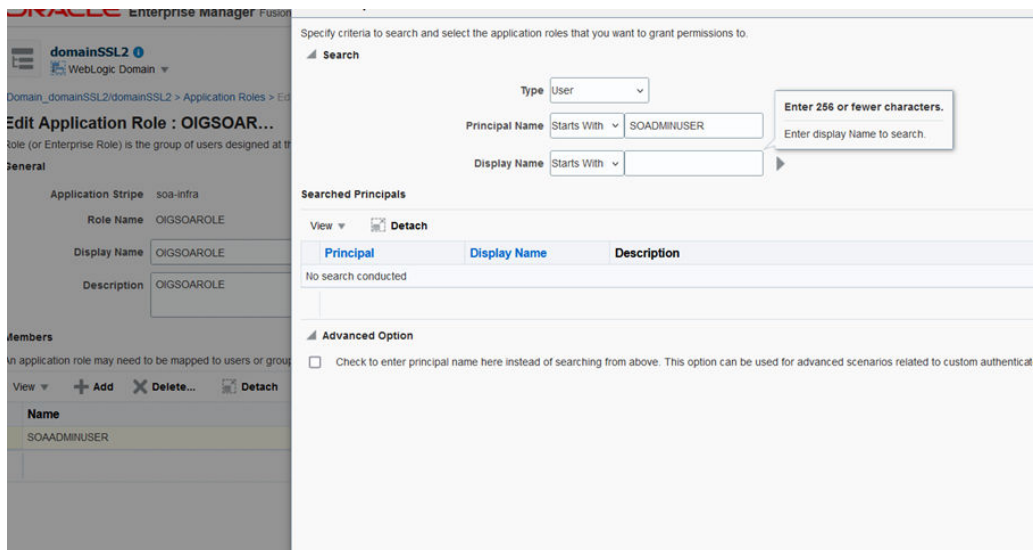

6. Let us create an application policies. To create application policies, perform the following:
  - a. Navigate to **Weblogic Domain ->Security->Application Policies**.

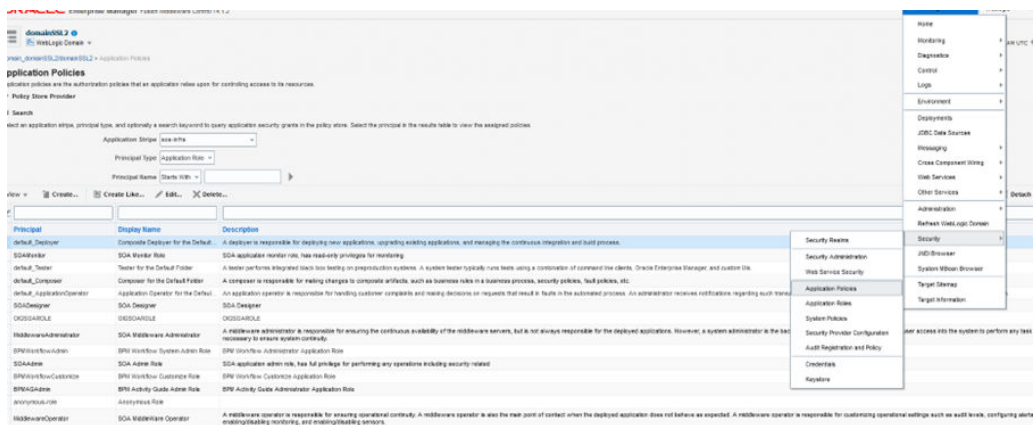

- b. Select **soa-infra** from the **Application Stripe** drop-down.
  - c. Click on **Create**.
  - d. Under the **Grantee** section, add the application role that is created in the above Step 4. Example: OIGSOAROLE

ORACLE Enterprise Manager Fusion Middleware Control 14.1.2

WebLogic Domain weblogic

domain@SSL2

WebLogic Domain

Domain\_domain@SSL2domain@SSL2 > Application Policies > Edit Application Grant

Application Set: soa-ent

**Edit Application Grant**

For managing an application policy, select a particular grantee and attach a permission to it.

Application Set: soa-ent

**Grantee**

Select the grantee (user, group or application role) you want to add to the policy.

View: Add Delete Detach

Name	Display Name	Type	Description
OKSSOROLE	OKSSOROLE	Application Role	OKSSOROLE

**Permissions**

Select from permissions and resources used in this application. Enter search criteria to search for right permissions.

View: Add Edit Delete Detach

Permission Class	Resource Name	Resource Type	Permission Actions	Permission Set
oracle.tpel.services.workflow.permission.WorkflowPermission	workflow.admin.evidenceDL			
oracle.tpel.services.workflow.permission.WorkflowPermission	workflow.mapping*			
oracle.tpel.services.workflow.permission.WorkflowPermission	workflow.admin		read, write, process, etc.	
oracle.fabric.permission.CompositePermission	+			

- e. Under **Permissions** tab, click **Add** to add the below permissions and save the changes.

ORACLE Enterprise Manager Fusion Middleware Control 14.1.2

WebLogic Domain weblogic

domain@SSL2

WebLogic Domain

Domain\_domain@SSL2domain@SSL2 > Application Policies > Edit Application Grant

Application Set: soa-ent

**Edit Application Grant**

For managing an application policy, select a particular grantee and attach a permission to it.

Application Set: soa-ent

**Grantee**

Select the grantee (user, group or application role) you want to add to the policy.

View: Add Delete Detach

Name	Display Name	Type	Description
OKSSOROLE	OKSSOROLE	Application Role	OKSSOROLE

**Permissions**

Select from permissions and resources used in this application. Enter search criteria to search for right permissions.

View: Add Edit Delete Detach

Permission Class	Resource Name	Resource Type	Permission Actions	Permission Set
oracle.tpel.services.workflow.permission.WorkflowPermission	workflow.admin.evidenceDL			
oracle.tpel.services.workflow.permission.WorkflowPermission	workflow.mapping*			
oracle.tpel.services.workflow.permission.WorkflowPermission	workflow.admin		read, write, process, etc.	
oracle.fabric.permission.CompositePermission	+			

 **Note:**

Please ensure to add the above 4 entries as shown in the screen shot.

7. Navigate to **Security ->Credentials**.
8. Select **OIM stripe** and then select **SOAAdminPassword**.
9. Click **Edit** and change the user name from weblogic to SOADMINUSER by using the same password used in the previous steps.

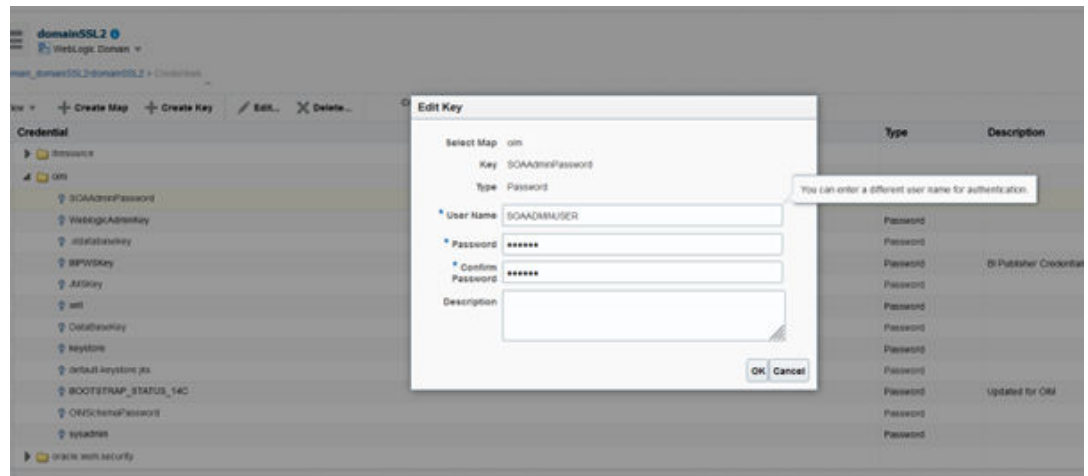

10. Navigate to **MBean** browser and open the Mbean “XMLConfig”.
11. Update the user name from “weblogic” to ‘SOAADMINUSER’ and save the changes

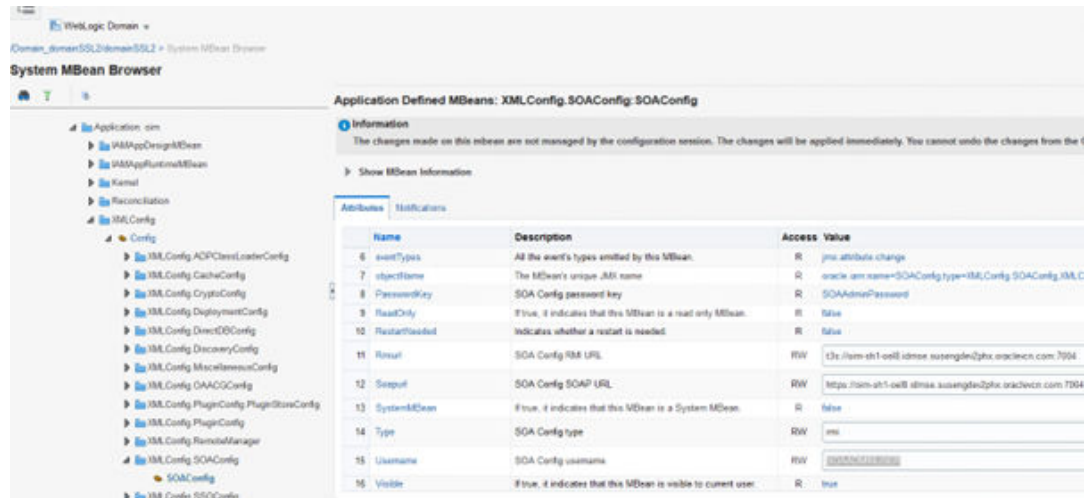

12. Log in into WLS console and change the user name to SOAADMINUSER in the **Services > Foreign JNDI Providers > ForeignJNDIProvider-SOA** section as shown below and remember to commit the changes.

 **Note:**

The SOA server's SSL port 7004 is used. Ex: t3s://<hostname>:7004

The screenshot displays the configuration page for a Foreign JNDI Provider in the Oracle WebLogic Administration Console. The breadcrumb navigation shows 'Foreign JNDI Providers / ForeignJNDIProvider-SOA'. A 'Save' button is visible at the top left. Below the breadcrumb, there is a 'Save' icon and a paragraph of text explaining that a foreign JNDI provider represents a JNDI tree that can reside outside of a WebLogic Server. Below this text, there are three tabs: 'General', 'Targets', and 'Properties', with 'General' being the active tab. The configuration fields are as follows:

Field	Value
Name*	ForeignJNDIProvider-SOA
Initial Context Factory	weblogic.jndi.WLInitialContextFactory
Provider URL	t3s://oim-sh1-oe18.idmsec.susengdev2phx.orac
User	SOAADMINUSER
Password	*****

13. Verification step: Log in into OIM and navigate to pending approvals page. Ensure that, you are able to see requests in the pending approvals page (provided there are some inflight requests) and request-details page opens up upon clicking the pending requests.

# E

## Enabling Transparent Data Encryption

Oracle Identity Manager supports Oracle Transparent Data Encryption (TDE). You can configure TDE before or after installing Oracle Identity Manager. This appendix describes how to configure Oracle Transparent Data Encryption (TDE) for Oracle Identity Manager. It contains the following topics:

- [Types of Data Encryption](#)
- [Configuring TDE for New Installation of Oracle Identity Governance](#)
- [Configuring TDE for an Existing Installation of Oracle Identity Governance](#)
- [Deconfiguring TDE for Oracle Identity Governance](#)

### E.1 Types of Data Encryption

Oracle Database supports TDE tablespace encryption and TDE column encryption.

Oracle Database supports the following types of data encryption:

- **TDE tablespace encryption:** Encrypts all content stored in that tablespace. It is useful in situations where the sensitive data are stored in multiple columns.
- **TDE column encryption:** Protects data stored in a table column. It encrypts and decrypts data transparently when data passes through the SQL layer.



#### Note:

For detailed information about TDE, see *Oracle Database Advanced Security Guide*.

Oracle Identity Manager supports and works with TDE tablespace encryption.

### E.2 Configuring TDE for New Installation of Oracle Identity Governance

Configuring TDE requires downtime for the data movement from un-encrypted tablespaces to encrypted tablespaces. Therefore, you configure TDE for Oracle Identity Manager deployment immediately after installing the database schemas using Repository Creation Utility (RCU) and before installing Oracle Identity Manager application.

To configure TDE for a new installation of Oracle Identity Manager:

1. Install Oracle Database. For details, refer to Oracle Database documentation.
2. Create Oracle Identity Manager schema and the dependent schemas by running RCU, as described in [Installing and Configuring Oracle Identity and Access Management](#) in *Installation Guide for Oracle Identity and Access Management*.
3. Shut down Oracle Identity Manager, if applicable.

If you are configuring TDE after installing Oracle Identity Manager, then you must shut down Oracle Identity Manager because TDE implementation does data movement and Oracle Identity Manager application will not be available for the time period when data movement occurs from normal tablespace to TDE-enabled tablespace.

4. Create a backup of Oracle Identity Manager database schema by using the Data Pump utility.

Using RDBMS data migration utilities, such as Data Pump, create a backup of Oracle Identity Manager database schema and the dependent schemas. This backup might be required to be restored post TDE enablement on tablespace level. The following is a sample command to create the backup:

```
expdp system/PASSWORD@TNS_ALIAS schemas=OIM_SCHEMA_NAME directory=DATA_PUMP_DIR
dumpfile=DUMP_FILE_NAME logfile=LOG_FILE_NAME
```

 **Note:**

Before exporting the Oracle Identity Manager schema, capture and retain the system and object grants on it by using the following SQL commands (to be run as SYS user):

- `SELECT DBMS_METADATA.GET_GRANTED_DDL ('SYSTEM_GRANT', 'OIM_SCHEMA_NAME') FROM DUAL;`
- `SELECT DBMS_METADATA.GET_GRANTED_DDL ('OBJECT_GRANT', 'OIM_SCHEMA_NAME') FROM DUAL;`

Copy the output of the SQL commands and edit it for appending semicolon (;) after each statement. The retained grants are required to be run post Step 10.

5. Specify the wallet location.

When you first enable TDE, you must create the wallet where the master key will be stored. By default, the wallet is created in the `$ORACLE_BASE/admin/$ORACLE_SID/wallet/` directory.

You can select a different directory path by specifying it in the `sqlnet.ora` file located in `$ORACLE_HOME/network/admin/` directory. For instance, if you want the wallet to be in the `orawallet/` directory, then include the following lines in the `sqlnet.ora` file:

```
ENCRYPTION_WALLET_LOCATION =
(SOURCE=
(METHOD=file)
(METHOD_DATA=
(DIRECTORY=ORACLE_HOME\orawallet)))
```

For Oracle RAC clusters with local file system for binaries, change the `SQLNET.ora` of all the nodes.

 **Note:**

A backup of the wallet location must be maintained along with the regular backups.

To use the same Oracle database wallet share by different Oracle components, set wallet parameter as follows:

```
WALLET_LOCATION =
(SOURCE=
(METHOD=file)
(METHOD_DATA=
(DIRECTORY=D:\oracle\product\11.2.0\dbhome_1\orawallet)))
```

**6. Create the wallet.**

**For Oracle Database 11g:**

To use TDE, you must have the ALTER SYSTEM privilege and a valid password to the Oracle wallet. If an Oracle wallet does not exist, then a new one is created by using the password specified in the SQL command.

To create a new master key and use TDE, run the following SQL command:

```
ALTER SYSTEM SET ENCRYPTION KEY AUTHENTICATED BY "PASSWORD";
```

This command performs the following:

- Creates the wallet in the location specified in step 4.
- Sets the password of the wallet as the one you provided. The password is case-sensitive and must be enclosed in double quotes.
- Opens the wallet for TDE to store and retrieve the master key.

The SQL command generates the database server master encryption key, which the server uses to encrypt the column encryption key for each table. No table column in the database can be encrypted until the master key of the server has been set.

**For Oracle Database 12c (12.1.0.2.0) Non-CDB and CDB:**

To use TDE, you must have the ALTER SYSTEM, ADMINISTER KEY MANAGEMENT or SYSKM privilege and a valid password to the Oracle wallet. If an Oracle wallet does not exist, then a new one is created by using the password specified in the SQL command.

To do so:

- a.** To create a keystore and use TDE, Run the following SQL command from SYS user:

```
SQL> ADMINISTER KEY MANAGEMENT CREATE KEYSTORE '<keystore_location>' IDENTIFIED
BY <keystore_password>;
```

Here, <keystore\_location> is the value provided in DIRECTORY path in the SQLNET.ORA file, as shown in step 5. <keystore\_password> is the keystore password.

This command performs the following:

- Creates the wallet in the location specified in step 4.
- Sets the password of the keystore as the one you provided. The password is case-sensitive.

The SQL command generates the database server (keystore) master key, which the server uses to encrypt the column encryption key for each table. No table column in the database can be encrypted until the keystore key of the server has been set.

- b.** Verify that keystore has been created. Run the below SQL command from PDB (for CDB) and SYS (for Non-CDB) user.

```
SQL> SELECT wrl_parameter,status FROM v$encryption_wallet;
```

The expected result of running this SQL command:

- **Status:** Closed
  - **wrl\_parameter:** <keystore\_location> mentioned in step 5
- c. Shut down the database, as shown:
- ```
SQL> shutdown immediate;
```
- d. Restart the database by running the following command. For CDB, make sure to start the respective pluggable database(s) also.
- ```
SQL> startup;
```
7. Open the wallet.

**For Oracle Database 11g:**

As the wallet is created only once, you must specify the wallet location and create the wallet only once. The wallet must be opened explicitly with the master key whenever the database instance starts.

To load the master key after the database is restarted, run the following SQL command:

```
ALTER system SET encryption wallet OPEN authenticated BY "PASSWORD";
```

OR:

```
ALTER system SET wallet OPEN IDENTIFIED BY "PASSWORD";
```

The wallet must be open for TDE to work. If the wallet is closed, then you can access all non-encrypted columns, but not the encrypted columns.



**Note:**

You can close the wallet by running the following command:

```
ALTER system SET encryption wallet CLOSE IDENTIFIED BY "PASSWORD";
```

**For Oracle Database 12c (12.1.0.2.0) Non-CDB**

As the keystore is created only once, you must specify the keystore location and create the keystore only once. The keystore must be opened explicitly with the (keystore) master key whenever the database instance starts.

To do so:

- a. Load the (keystore) master key after the database is restarted. Run the following SQL command as the SYS user:

```
SQL> ADMINISTER KEY MANAGEMENT SET KEYSTORE OPEN IDENTIFIED BY  
<keystore_password>;
```

Here, <keystore\_password> is the same password used in step 5 to create the wallet.

The keystore must be open for TDE to work. If the keystore is closed, then you can access all non-encrypted columns, but not the encrypted columns.

- b. Verify the status of the keystore. To do so, run the following SQL command as the SYS user:

```
SQL> SELECT status FROM v$encryption_wallet;
```

Running this command sets the status to OPEN\_NO\_MASTER\_KEY.



### For Oracle Database 12c (12.1.0.2.0) CDB

As the keystore is created only once, you must specify the keystore location and create the keystore only once. The keystore must be opened explicitly with the (keystore) master key whenever the database instance starts.

To load the (keystore) master key and verify the status of the keystore:

- a. To load the (keystore) master key after the database is restarted, run the following SQL command as the CDB SYS user:

```
SQL> ADMINISTER KEY MANAGEMENT SET KEYSTORE OPEN IDENTIFIED BY
<keystore_password>;
```

Here, <keystore\_password> is the same password used in step 5 to create the wallet.

The keystore must be open for TDE to work. If the keystore is closed, then you can access all non-encrypted columns, but not the encrypted columns.

- b. Verify the status of the keystore. To do so, run the following SQL command as the CDB SYS user:

```
SQL> SELECT status FROM v$encryption_wallet;
```

Running this command sets the status to OPEN\_NO\_MASTER\_KEY.

- c. To load the (keystore) master key after the database is restarted, run the following SQL command as the PDB SYS user:

```
SQL> ADMINISTER KEY MANAGEMENT SET KEYSTORE OPEN IDENTIFIED BY
<keystore_password>;
```

Here, <keystore\_password> is the same password used in step 5 to create the wallet.

The keystore must be open for TDE to work. If the keystore is closed, then you can access all non-encrypted columns, but not the encrypted columns.

- d. Verify the status of the keystore. To do so, run the following SQL command as the PDB SYS user.

```
SQL> SELECT status FROM v$encryption_wallet;
```

Running this command sets the status to OPEN\_NO\_MASTER\_KEY.

8. Set the master encryption key (applicable to Oracle Database 12c only).

### For Oracle Database 12c (12.1.0.2.0) Non-CDB

After the keystore is open, set the TDE master encryption key for the same. To do so:

- a. To set the TDE master encryption key in a keystore, use the ADMINISTER KEY MANAGEMENT statement with the SET KEY clause. Run the following SQL command as the SYS user:

```
SQL> ADMINISTER KEY MANAGEMENT SET KEY [USING TAG '<tag>'] IDENTIFIED BY
<password> [WITH BACKUP [USING 'backup_identifier']];
```

Here:

- <password> is the same password used in step 5 to create the wallet.
  - <tag> is the associated attributes and information that you define. Enclose this setting in single quotation marks ( ' ), for example 'oim12ccdb'.
- b. Verify the status of the keystore. Run the below SQL command from SYS and PDB SYS user.

```
SQL> SELECT status FROM v$encryption_wallet;
```

Running this command sets the status to OPEN.

**9. Drop Oracle Identity Manager and its tablespaces.**

Drop OIM user before dropping the tablespaces. The following are some sample commands to do so:

```
DROP USER OIM_SCHEMA_NAME CASCADE;
DROP TABLESPACE SCHEMA_NAME INCLUDING contents AND datafiles;
DROP TABLESPACE SCHEMA_NAME_LOB INCLUDING contents AND datafiles;
DROP TABLESPACE SCHEMA_NAME_ARCH_DATA INCLUDING contents AND datafiles;
```

**10. Create TDE-enabled tablespaces and user for Oracle Identity Manager.**

Create tablespaces for Oracle Identity Manager with encryption to enable TDE at tablespace layer. You must create all the three tablespaces that you dropped in step 8. You can use DBMS\_METADATA API to get the DDL for tablespace creation. The following are sample commands:

```
CREATE TABLESPACE SCHEMA_NAME DATAFILE 'FILE_PATH' SIZE 128K AUTOEXTEND ON NEXT 64K
EXTENT MANAGEMENT LOCAL SEGMENT SPACE MANAGEMENT AUTO ENCRYPTION USING 'AES256'
DEFAULT STORAGE(ENCRYPT);

CREATE TABLESPACE SCHEMA_NAME_LOB DATAFILE 'FILE_PATH' SIZE 128K AUTOEXTEND ON NEXT
64K EXTENT MANAGEMENT LOCAL SEGMENT SPACE MANAGEMENT AUTO ENCRYPTION USING 'AES256'
DEFAULT STORAGE(ENCRYPT);

CREATE TABLESPACE SCHEMA_NAME_ARCH_DATA DATAFILE 'FILE_PATH' SIZE 128K AUTOEXTEND ON
NEXT 64K EXTENT MANAGEMENT LOCAL SEGMENT SPACE MANAGEMENT AUTO ENCRYPTION USING
'AES256' DEFAULT STORAGE(ENCRYPT);

CREATE USER SCHEMA_NAME IDENTIFIED BY PASSWORD DEFAULT TABLESPACE OIM_DATA_TBS
TEMPORARY TABLESPACE OIM_TEMP;
```

 **Note:**

Datafile path can be referred from the following command:

```
Select name from v$datafile;
```

To validate the encryption at tablespace level, you run the following query:

```
SELECT ts.name, es.encryptedts, es.encryptionalg FROM v$tablespace ts INNER JOIN
v$encrypted_tablespaces es ON es.ts# = ts.ts#;
```

**11. Import the data back to Oracle Identity Manager database for Oracle Identity Manager and its dependent schemas.**

As TDE enabled-tablespaces are created, you must import/restore the Oracle Identity Manager schema backup. The following is a sample command to import the Oracle Identity Manager schema backup:

```
Impdp system/<PASSWORD>@TNS_ALIAS schemas=OIM_SCHEMA_NAME directory=DATA_PUMP_DIR
dumpfile=DUMP_FILE_NAME logfile=LOG_FILE_NAME
```

 **Note:**

- After importing the Oracle Identity Manager schema, execute the preserved grants, as suggested in step 4.
- After importing the Oracle Identity Manager schema, compile all the objects in the schema by using the following command (to be run as SYS user):

```
BEGIN
  UTL_RECOMP.recomp_serial('OIM_SCHEMA_NAME');
END;
```

Here, replace *OIM\_SCHEMA\_NAME* with the Oracle Identity Manager database schema name.

**12. Configure Oracle Identity Manager.**

On successful import of the Oracle Identity Manager schema backup, continue with Oracle Identity Manager installation and configuration.

## E.3 Configuring TDE for an Existing Installation of Oracle Identity Governance

Postinstallation configuration of TDE requires downtime for the data movement from un-encrypted tablespaces to encrypted tablespaces.

If you are configuring TDE after installing Oracle Identity Manager, then perform the following steps:

1. Shut down Oracle Identity Manager because TDE implementation performs data movement and Oracle Identity Manager application will not be available for that time period.
2. Perform steps 3 through 11, as described in [Configuring TDE for New Installation of Oracle Identity Governance](#).
3. Start Oracle Identity Manager.

## E.4 Deconfiguring TDE for Oracle Identity Governance

Deconfiguring TDE involves dropping OIM User and tablespaces after creating backups for the same, closing the encryption wallet, re-creating the tablespaces, and restoring the backups.

To deconfigure TDE for Oracle Identity Manager:

1. Create a backup of OIM User, tablespaces, and Object Grants by using DBMS\_METADATA.GET\_DDL() package.
2. Create a backup of Oracle Identity Manager database schema.
3. Drop OIM User.
4. Drop the following Oracle Identity Manager tablespaces:
  - DEV\_OIM
  - DEV\_OIM\_LOB

- DEV\_OIM\_ARCH\_DATA

5. Close the encryption wallet by running the following query as SYSDBA user:

```
ALTER system SET encryption wallet CLOSE IDENTIFIED BY "PASSWORD";
```

For Oracle Database 12c CDB and Non-CDB environment, connect to CDB as the SYS user, and run the following SQL command:

```
ADMINISTER KEY MANAGEMENT SET KEYSTORE CLOSE IDENTIFIED BY  
<SOFTWARE_KEYSTORE_PASSWORD> [CONTAINER = ALL | CURRENT];
```

6. Run the following Update query followed by Commit from SYSDBA user:

```
UPDATE TS$ SET flags=flags - 16384 WHERE online$=3 AND bitand(flags,16384) =  
16384;COMMIT;
```

7. Restart Oracle Identity Manager database.
8. Re-create OIM user, tablespaces, and Object Level grants.
9. Restore the Oracle Identity Manager backup.
10. Remove Encryption entry from the SQLNET.ORA file.
11. Remove the wallet key/directory, which is *ORACLE\_HOME/orawallet/*.
12. Start Oracle Identity Manager.

# F

## Troubleshooting Clustered OIM and Eclipselink Cache Coordination

Troubleshooting a clustered deployment of Oracle Identity Manager and Eclipselink cache coordination involves starting Oracle Identity Manager, SOA, and WebLogic services in a clustered deployment, setting the clustered deployment mode, configuring unique multicast address for each cluster, testing the multicast network, enabling additional logging for Eclipselink, and testing multicast connectivity between the nodes.

This appendix can be used by Oracle Identity Manager administrators and developers and WebLogic administrators dealing with clustered deployments of Oracle Identity Manager and SOA. It provides some pointers to verify, test, and correct startup procedure for a clustered installation of Oracle Identity Manager and its required components if eclipselink/toplink cache coordination issues are suspected, for example, if the following exception is seen in the logs:

```
oracle.iam.platform.kernel.ProcessNotInPrePostStageException
```

This appendix contains the following topics:

- [Startup Procedure for Clustered Installation of Oracle Identity Governance](#)
- [Setting Deployment Mode to Cluster](#)
- [Configuring Multicast Addressing for Oracle Identity Governance](#)
- [Multicast Addressing for Eclipselink](#)
- [Testing Multicast Network Testing](#)
- [Enabling Additional Logging for Eclipselink](#)
- [Testing Multicast Connectivity Between Oracle Identity Governance Nodes](#)

### F.1 Startup Procedure for Clustered Installation of Oracle Identity Governance

For eclipselink cache co-ordination to happen successfully in a cluster environment, the clustered nodes must be started one after another.

If you start all the nodes at the same time, then cache co-ordination initialization might not happen properly. In addition, the initial startup of the various managed servers is also critical, and starting servers in an incorrect order can cause some data seeding to fail.

Perform the following when starting Oracle Identity Manager, SOA, and WebLogic services:

1. Start the WebLogic Admin Server first and wait until it is in a RUNNING state.
2. Start one node of the SOA cluster and wait until it is in RUNNING state.
3. Start the next SOA Managed Server and wait until it is in RUNNING state.
4. Repeat step 3 for all SOA Managed Servers.
5. Start the first Oracle Identity Manager Managed Server and wait until it is in RUNNING state.

6. Start the next Oracle Identity Manager Managed Server and wait until it is in RUNNING state.
7. Repeat step 6 for each remaining Oracle Identity Manager Managed Server, one at a time.
8. After all services are in RUNNING state, wait for another two minutes before permitting end user operation and other business use of the system.

## F.2 Setting Deployment Mode to Cluster

In a clustered deployment, you need to set the deployment mode to cluster.

Make sure `deploymentMode` is set to `cluster` in the `oim-config.xml` file, and MDS is updated with the changes to the `oim-config.xml` file. Perform an export of `/db/oim-config.xml` and verify to make sure it is similar to the following:

```
<deploymentConfig>
<appServerName>weblogic</appServerName>
<initialContextFactory>weblogic.jndi.WLInitialContextFactory</initialContextFactory>
<dataBaseType>oracle</dataBaseType>
<deploymentMode>cluster</deploymentMode>
</deploymentConfig>
```

## F.3 Configuring Multicast Addressing for Oracle Identity Governance

In a clustered deployment, each cluster must have a unique multicast address.

Ensure that each cluster has its own unique multicast address configured in the `oim-config.xml` file within MDS. Production and test environments must not share the same multicast IP configurations. For example, the following must not share the same `multicastAddress` value:

```
<xLCacheProviderProps multicastAddress="IP_ADDRESS" size="5000">
<properties></properties>
</xLCacheProviderProps>
```

Do not share the same `multicastAddress` value as other Oracle Identity Manager deployments. If the value is used on a test domain, then do not specify the same address in the production `oim-config.xml` file.

## F.4 Multicast Addressing for Eclipselink

Eclipselink also makes use of multicast networking for its cache coordination.

Eclipselink cache coordination uses multicast port 3121 and a Time To Live (TTL) setting of 15 hops. This is not configurable. Firewalls must take into account all multicast networking requirements of the environment.

## F.5 Testing Multicast Network Testing

Some simple tests on your multicast network can be testing multicast connectivity between the nodes and running a multicast monitor test in a WebLogic cluster.

Refer to the following Tech notes in the My Oracle Support web site for information about how to run some simple tests on your multicast network:

- [Testing Multicast Connectivity Between OIM Nodes \(Doc ID 1360763.1\)](#)
- [How to Run a Multicast Monitor Test in a WebLogic Cluster \(Doc ID 1064062.1\)](#)

## F.6 Enabling Additional Logging for Eclipselink

Add the logging.xml file with the appropriate level and restart the domain to enable additional logging for Eclipselink.

Add the following to the logging.xml file to enable additional logging for elcipselink/toplink:

```
<logger name='org.eclipse.persistence.session.oim.propagation' level='TRACE:32'
useParentHandlers='false'>
<handler name='odl-handler' />
</logger>
```

Restart the domain for the changes to take effect.

## F.7 Testing Multicast Connectivity Between Oracle Identity Governance Nodes

Oracle Identity Manager makes use of multicast IP network communications for normal operations. It is used by the Design Console as well as for application-level caching within Oracle Identity Manager. Sometimes, a host or router might have multicast networking disabled.

This section describes how to test and verify if multicast communications between two or more nodes of an Oracle Identity Manager cluster is working.

To verify if multicast packets can be sent and received between different nodes of a WebLogic clustered Oracle Identity Manager environment:

1. Obtain the multicast IP address used by Oracle Identity Manager. To do so:
  - a. Expand **Identity and Access, OIM, oim(OIM\_SERVER)**, and from the drop-down menu on the right pane, view the System MBean Browser.
  - b. View the IP Address defined in the `MulticastAddress` attribute within **Application Defined MBeans, oracle-iam, MANAGED\_SERVER\_NAME, Application: oim, XMLConfig, config, XMLConfig.CacheConfig.XLCacheProvider, XLCacheProvider**.
2. Open a command window on each host involved.
3. Go to the `MIDDLEWARE_HOME` directory.
4. Go to the coherence directory, for example `coherence_3.6` or `coherence_3.7`, depending on which version you have.
5. If the scripts in the `bin` directory do not have execute permissions, then use the `chmod` command to enable execute permissions, as shown:

```
chmod u+x bin/*.sh
```

6. Run the following command to start sending and receiving multicast packets:

```
bin/multicast-test.sh -group MULTICAST_IP_ADDRESS:PORT
```

Here, `MULTICAST_IP_ADDRESS` is the IP address obtained in Step 1.

The following is a sample output:

```

Starting test on ip=iam.example.com/10.10.10.10, group=/IP_ADDRESS:12345, ttl=4
Configuring multicast socket...
Starting listener...
Wed Feb 21 21:49:59 UTC 2015: Sent packet 1 containing 1468 bytes.
Wed Feb 21 21:49:59 UTC 2015: Received test packet 5 from ip=idmsun.example.com/
10.20.20.20, group=/IP_ADDRESS, ttl=4 containing 1468 bytes.
Wed Feb 21 21:50:00 UTC 2015: Received test packet 1 from self (sent 1628ms ago).
Wed Feb 21 21:50:01 UTC 2015: Received test packet 6 from ip=idmsun.example.com/
10.20.20.20, group=/IP_ADDRESS:12345, ttl=4 containing 1468 bytes.
Wed Feb 21 21:50:02 UTC 2015: Sent packet 2 containing 1468 bytes.
Wed Feb 21 21:50:02 UTC 2015: Received test packet 2 from self
Wed Feb 21 21:50:03 UTC 2015: Received test packet 7 from ip=idmsun.example.com/
10.20.20.20, group=/IP_ADDRESS:12345, ttl=4 containing 1468 bytes.

```

Here, the multicast-test script is run on both the iam.example.com server and idmsun.example.com server using the same IP address and port number. The iam.example.com host is able to send the multicast packets and also receive the packets from idmsun.example.com host. Observing the output of the test script for a short while on each host is necessary to ensure that each host is receiving packets from all of the other hosts within the cluster. If only packets from `self` are observed, then this host is not receiving the test packets from any other systems running the multicast-test script.

 **Note:**

If the hosts are not within the number of network hops specified in Time To Live (TTL), then you can change the ttl by adding `-ttl 10` to the command.

Eclipselink also makes use of multicast networking for its cache coordination. eclipselink cache coordination uses multicast port 3121 and a TTL setting of 15 hops. Test both the default Oracle Identity Manager multicast port as well as the eclipselink port.

 **Note:**

If a second NIC is used for multicast, then specify the interface with the `-local` attribute, such as:

```
multicast-test.sh -local UNICAST_ADDRESS -group IP_ADDRESS:12345
```

Where `UNICAST_ADDRESS` is the unicast address on the interface used for the multicast network. For more information see Tech note [How To Verify that Multicast Communication Works Correctly Between Machines the Coherence Cluster Members Are Running On \(Doc ID 1936452.1\)](#) in the My Oracle Support web site.

If WebLogic is not used, and there is no equivalent multicast test script, then using a couple of small Java command-line applications can also be used for testing. For more information, see Tech note [How to Test Whether Multicast is Enabled on the Network \(Doc ID 413783.1\)](#) in the My Oracle Support web site.



# G

## Scheduler and System Properties do not come up in the Integrated Environment

1. Add the following entries in the `oim.conf` file at the following locations:

**Locations:**

```
OAM_DOMAIN_HOME/config/fmwconfig/components/OHS/ohs1/moduleconf/oim.conf
```

```
OAM_DOMAIN_HOME/config/fmwconfig/components/OHS/instances/ohs1/moduleconf/oim.conf
```

**Entries**

```
<Location /iam/governance/adminservice/api/v1>  
  SetHandler weblogic-handler  
  WLCookieName oimjsessionid  
  WebLogicHost %OIM_HOST%  
  WebLogicPort %OIM_PORT%  
  WLogFile "${ORACLE_INSTANCE}/diagnostics/logs/mod_wl/oim_component.log"  
</Location>
```

```
<Location /iam/governance/selfservice/api/v1>  
  SetHandler weblogic-handler  
  WLCookieName oimjsessionid  
  WebLogicHost %OIM_HOST%  
  WebLogicPort %OIM_PORT%  
  WLogFile "${ORACLE_INSTANCE}/diagnostics/logs/mod_wl/oim_component.log"  
</Location>
```

2. Restart the servers