

Oracle® Fusion Middleware

Developing Business Processes with Oracle Business Process Composer



14c (14.1.2.0.0)

F81880-01

December 2024

The Oracle logo, consisting of a solid red square with the word "ORACLE" in white, uppercase, sans-serif font centered within it.

ORACLE®

Oracle Fusion Middleware Developing Business Processes with Oracle Business Process Composer, 14c (14.1.2.0.0)

F81880-01

Copyright © 2001, 2024, Oracle and/or its affiliates.

Primary Author: Oracle Corporation

This software and related documentation are provided under a license agreement containing restrictions on use and disclosure and are protected by intellectual property laws. Except as expressly permitted in your license agreement or allowed by law, you may not use, copy, reproduce, translate, broadcast, modify, license, transmit, distribute, exhibit, perform, publish, or display any part, in any form, or by any means. Reverse engineering, disassembly, or decompilation of this software, unless required by law for interoperability, is prohibited.

The information contained herein is subject to change without notice and is not warranted to be error-free. If you find any errors, please report them to us in writing.

If this is software, software documentation, data (as defined in the Federal Acquisition Regulation), or related documentation that is delivered to the U.S. Government or anyone licensing it on behalf of the U.S. Government, then the following notice is applicable:

U.S. GOVERNMENT END USERS: Oracle programs (including any operating system, integrated software, any programs embedded, installed, or activated on delivered hardware, and modifications of such programs) and Oracle computer documentation or other Oracle data delivered to or accessed by U.S. Government end users are "commercial computer software," "commercial computer software documentation," or "limited rights data" pursuant to the applicable Federal Acquisition Regulation and agency-specific supplemental regulations. As such, the use, reproduction, duplication, release, display, disclosure, modification, preparation of derivative works, and/or adaptation of i) Oracle programs (including any operating system, integrated software, any programs embedded, installed, or activated on delivered hardware, and modifications of such programs), ii) Oracle computer documentation and/or iii) other Oracle data, is subject to the rights and limitations specified in the license contained in the applicable contract. The terms governing the U.S. Government's use of Oracle cloud services are defined by the applicable contract for such services. No other rights are granted to the U.S. Government.

This software or hardware is developed for general use in a variety of information management applications. It is not developed or intended for use in any inherently dangerous applications, including applications that may create a risk of personal injury. If you use this software or hardware in dangerous applications, then you shall be responsible to take all appropriate fail-safe, backup, redundancy, and other measures to ensure its safe use. Oracle Corporation and its affiliates disclaim any liability for any damages caused by use of this software or hardware in dangerous applications.

Oracle®, Java, MySQL, and NetSuite are registered trademarks of Oracle and/or its affiliates. Other names may be trademarks of their respective owners.

Intel and Intel Inside are trademarks or registered trademarks of Intel Corporation. All SPARC trademarks are used under license and are trademarks or registered trademarks of SPARC International, Inc. AMD, Epyc, and the AMD logo are trademarks or registered trademarks of Advanced Micro Devices. UNIX is a registered trademark of The Open Group.

This software or hardware and documentation may provide access to or information about content, products, and services from third parties. Oracle Corporation and its affiliates are not responsible for and expressly disclaim all warranties of any kind with respect to third-party content, products, and services unless otherwise set forth in an applicable agreement between you and Oracle. Oracle Corporation and its affiliates will not be responsible for any loss, costs, or damages incurred due to your access to or use of third-party content, products, or services, except as set forth in an applicable agreement between you and Oracle.

Contents

Preface

Audience	xx
Documentation Accessibility	xx
Related Documents	xx
Conventions	xx

Part I Introduction to Oracle Business Process Composer

1 Introduction to Oracle Business Process Composer

Signing On to Oracle Business Process Composer	1-1
Introduction to the Oracle Business Process Composer Application Welcome Page	1-2
Introduction to the Oracle Business Process Composer Toolbar	1-3
Introduction to the Oracle Business Process Composer Main Menu	1-3
Introduction to the Spaces Browser	1-4
How to Create a new Oracle Business Process Composer Space	1-5
How to Share a Space with Other Users or Groups	1-6
How to Delete an Oracle Business Process Composer Space	1-6
Introduction to the Project List	1-6
Introduction to Project Panels	1-7
Creating a New Empty Project with the BA Project Panel	1-7
Creating a New Populated Project with the BA Project Panel	1-8
Creating a New Empty Project with the BPM Project Panel	1-9
Creating a New Populated Project with the BPM Project Panel	1-9
Recent Projects Panel	1-10

Part II Performing Administrative Tasks Using Oracle Business Process Composer

2 Performing Administrative Tasks

Accessing the Oracle Business Process Composer Administrator View	2-1
-------------------------------------------------------------------	-----

How to Grant Administrator Privileges to a Business Process Composer User	2-2
How to Access the Administration View	2-3
Managing Business Process Composer Spaces	2-3
Configuring Access to a BPM Space	2-3
Removing Users from a BPM Space	2-4
How to Delete a BPM Space and Its Content	2-4
Managing Projects	2-5
How to Release the Lock on a Shared Project	2-5
How to Delete a Project	2-6
How to Configure Sharing for a Project	2-6
Defining SOA Administrator Credentials to Enable Process Player	2-6
How to Enable Process Player	2-7
What Happens When You Enable Process Player	2-7
How to Disable Process Player	2-8
Administering Business Architecture Reports	2-8
How to View Reports	2-8
How to Delete a Report	2-8

Part III Creating and Working With BA and BPM Projects

3 Creating and Managing BA and BPM Projects

Introduction to Project Sharing and Collaboration	3-1
Private and Public Projects	3-1
Edit Mode	3-1
Project Roles	3-1
Creating and Working with Projects	3-2
How to Open a Project Using the Application Welcome Page	3-2
How to Share a Project with Other Users	3-2
How to Edit a Shared Project	3-2
Managing Project Changes	3-3
How to Discard Changes to a Project	3-3
How to Close a Project	3-4
Working with Project Snapshots	3-4
How to Create a New Project Snapshot	3-4
How to View Contents of a Project Snapshot	3-4
How to Return to the Active Version of a Project	3-5
How to Delete a Project Snapshot	3-5
How to Export a Project Snapshot	3-5
How to Deploy a Project Snapshot	3-6
Importing and Exporting Projects	3-6

How to Import a Project from your Local File System	3-6
How to Export a Project from the Application Welcome Page	3-7
How to Export a Project or Project Snapshot from the Project Welcome Page	3-7

4 Performing Process Analysis and Discovery with Business Architecture

Introduction to Business Architecture	4-1
Introduction to Enterprise Maps	4-1
Introduction to Value Chain Models	4-2
Introduction to Strategy Models	4-3
Using KPIs to Analyze Performance	4-4
Introduction to the BA Project Welcome Page	4-4
Introduction to the Project Toolbar	4-5
Introduction to the Project Information Panel	4-6
Introduction to the Recent Activity Panel	4-7
Introduction to the Project Component Pane	4-7
Introduction to the Quickstart Menu	4-7
Working with Enterprise Maps	4-8
Creating an Enterprise Map for an Existing BA Project	4-8
Creating an Enterprise Map for New BA Project	4-8
How to Add Lanes and Process Areas to an Enterprise Map	4-9
How to Assign an Organization Unit to a Lane or Process Area	4-9
How to Assign a Value Chain Model to a Process Area	4-9
Working with Value Chain Models	4-9
How to Create a Value Chain Model	4-10
How to Assign BPM Projects or Value Chain Models to a Step within a Chain	4-10
How to Edit the Properties of a Value Chain Model Step	4-10
Working with Strategy Models	4-10
Creating a Strategy Model from the Business Architecture Welcome Page	4-11
Creating a Strategy Model from the Application Welcome Page	4-11
How to Edit a Strategy Model	4-11
Creating Value Chain References	4-11
Working with Key Performance Indicators (KPIs)	4-12
How to Create a KPI	4-12
How to Edit the Properties of a KPI	4-12
Working with Business Architecture Reports	4-13
How to Publish Report Data	4-13
How to Generate BA Reports	4-14
Interpreting the Impact Analysis and Process Criticality Reports	4-15

5 Creating and Working with BPM Projects

Introduction to Oracle BPM Projects	5-1
Introduction to Project Components and Resources	5-1
Editable Project Resources	5-2
The Business Catalog	5-3
Introduction to the Oracle BPM Repository	5-3
Introduction to the Project Welcome Page	5-3
Introduction to the Project Toolbar	5-4
Introduction to the Project Information Panel	5-5
Introduction to the Recent Activity Panel	5-6
Introduction to the Project Component Panel	5-6
Introduction to the Quickstart Menu	5-7
Introduction to the Oracle Business Process Composer Editors	5-7
Process Editor	5-7
Activity Guide Editor	5-7
Human Task Editor	5-7
Business Rules Editor	5-8
Data Associations Editor	5-8
Expression Editor	5-8
Introduction to the Supporting Browsers and Editors	5-8
Project and Process Validation Browser	5-8
Documentation Editor	5-8
Creating and Working with Projects	5-8
How to Create a New Project	5-9
How to Validate a Project	5-9
How to View the History of Changes Made to a Project	5-9
How to View and Edit Project Properties	5-10
Using Guided Business Processes to Create Project Milestones	5-10
Introduction to Guided Business Processes	5-10
Introduction to Activity Guides and Milestones	5-10
How to Configure the Activity Guide	5-11
Creating Project Milestones	5-12
Adding Milestones to User Tasks	5-12
Defining Project Roles, Business Parameters, and Organization Units	5-12
Defining Project Roles	5-12
Defining Business Parameters	5-13
Defining Organization Units	5-14
Generating Process Reports for Your Project	5-15

6 Documenting BPM Projects

Understanding Project-Level Documentation	6-1
Project Description	6-1
Role Description	6-2
Understanding Process-Level Documentation	6-2
Process Description	6-3
Process Documentation	6-4
Process Links	6-5
Requirements	6-5
Process Note	6-6
Understanding Activity-Level Documentation	6-6
Activity Description	6-7
Activity Links	6-8
Activity Documentation	6-8
Activity Comments	6-9
Activity Note	6-10
General	6-11
Activity Issues	6-11
RACI	6-12

Part IV Modeling and Testing Business Processes

7 Creating and Working with Business Processes

Introduction to Business Processes	7-1
Introduction to the Project Toolbar	7-2
Introduction to the Narrative View	7-2
Working with the Narrative View	7-3
Moving an Activity	7-4
Narrative View Options	7-4
Introduction to the Process Editor Graphical View	7-4
Introduction to the Process Editor Toolbar	7-5
Introduction to the Process Editor Canvas	7-6
Introduction to the BPMN Component Palette	7-6
Introduction to the Business Catalog	7-8
Working with Business Processes	7-8
How to Create a New Business Process	7-8
How to Open a Business Process	7-9
How to Delete a Business Process	7-9
What You Need to Know About Deleting a Business Process	7-9
Using Swimlanes to Organize Your Process	7-9

Introduction to Roles	7-9
Roles in Context	7-10
Introduction to Swimlanes	7-11
Swimlanes in Context	7-11
Adding Swimlanes to Your Process	7-11
Adding a Swimlane and a Flow Object to Your Process	7-12
How to Edit Swimlane Properties	7-12
Sharing Roles Between Business Process Composer and BPM Studio	7-12
Working with Flow Elements	7-13
How to Add a Flow Object from the Component Palette	7-13
How to Cut, Copy, or Delete a Flow Object	7-13
How to Paste a Flow Object in a Process	7-14
How to Add a Sequence Flow to a Process	7-14
How to Delete a Sequence Flow	7-14
What You Need to Know About Deleting a Sequence Flow	7-14
How to Edit the Properties of a Flow Object	7-14
How to Assign a Custom Icon to a Flow Object	7-15
Working with Business Catalog Components	7-15
Working with Draft Processes	7-15
How to Mark a Flow Object as Draft	7-15
Documenting Your Process	7-16
Importing and Exporting Process Models	7-16
Importing Process Models into Oracle BPM	7-17

8 Simulating Process Behavior

Introduction to Simulations	8-1
Simulation Models and Simulation Definitions	8-1
Simulation Parameters	8-2
General Simulation Definition Parameters	8-2
Simulation Model Parameters	8-2
Resource Parameters	8-3
Start Event Parameters	8-3
Activity Parameters	8-4
Creating and Running a Simulation	8-6
Working with Simulation Definitions	8-6
How to Create a Simulation Definition	8-6
What Happens When You Create a Simulation Definition	8-8
How to Edit a Simulation Definition	8-9
How to Associate a Simulation Model to a Simulation Definition	8-9
Working with Simulation Models	8-10
How to Create a New Simulation Model	8-10

How to Edit a Simulation Model	8-11
Running Simulations	8-12
How to Run a Simulation	8-12
Analyzing the Results of a Simulation	8-12
How to Analyze the Results of a Simulation Using a Chart	8-13

9 Using Process Player

Introduction to Process Player	9-1
How Process Player Handles the Flow Objects of Your Process	9-2
Enabling Process Player in Oracle Business Process Composer	9-3
Using Process Player to Test the Behavior of Business Processes	9-3
How to Map the Roles Defined in Your Process to Users in Your Organization	9-3
How to Use Process Player to Run a Business Process	9-4

Part V Defining How Users Interact with Your Business Processes

10 Working with Web Forms

Introduction to Forms in Oracle BPM	10-1
Introduction to Web Forms	10-2
Form First and Data First Design	10-2
Introduction to the Web Forms Designer	10-3
Introduction to the Web Forms Component Palette	10-5
Introduction to the Web Form Editor Toolbar	10-5
Introduction to the Property Editor	10-5
Introduction to the Data Source Panel	10-6
Introduction to the Form Canvas	10-7
Introduction to Web Form Controls	10-7
Input Controls	10-8
Text	10-8
TextArea	10-8
Date, Time, Date/Time	10-8
Email	10-11
Money	10-11
Phone	10-11
Quantity	10-11
Number	10-11
Selection Controls	10-11
Dropdown	10-12
Radio	10-12
Check Box	10-12

Booleancheckbox	10-12
Group Controls	10-12
Sections	10-12
Optional Sections	10-13
Tabs	10-14
Panels	10-14
Tables	10-15
Repeats	10-15
Changing a Repeat Control to a Table	10-16
Other Controls	10-16
Message Control	10-17
Link Control	10-17
Button Control	10-17
Image Control	10-18
Trigger Control	10-18
Introduction to Data Sources	10-18
Web Form Controls Generated by Payload Data Types	10-18
Modifying Web Form Controls Generated From Data Elements	10-19
What You Can Edit Using the Web Form Editor	10-19
What You Cannot Edit Using the Web Form Designer	10-20
Introduction to the Display As Property	10-20
Walkthrough: Creating a Web Form Using the Form First Method	10-20
Walkthrough: Creating a Web Form Using the Data First Method	10-21
Working with Web Forms	10-23
How to Add Controls to a Web Form	10-23
Creating Multi-Column Forms	10-24
How to Add Controls Based on Data Sources	10-24
Generating Form Controls for all Data Elements in a Payload	10-25
Generating Form Controls for Individual Data Elements	10-25
Adding Business Objects to a Web Form	10-25
How to Show Which Web Controls Were Created from a Data Source	10-26
How to Edit the Properties of a Web Form	10-27
How to Edit the Properties of Web Form Controls	10-27
How to Delete a Web Form	10-27
How to Remove a Control from a Web Form	10-28
Removing Controls	10-28
Removing Organizational Controls from a Web Form	10-28
How to Test a Web Form	10-29
About Localization in Web Forms	10-29

11 Working with Web Form Rules

Introduction to Form Rules	11-1
Form Rule Javascript Syntax	11-1
Control Name	11-2
Form Rule Identifiers	11-3
Strings and Numbers	11-5
Dates and Times	11-5
Writing Conditions	11-6
Select Controls	11-6
Initial Control State	11-6
Form Rules and Repeating Controls	11-6
Using Dynamic Content in Form Rules	11-7
Dynamic Content	11-7
Reusing Dynamic Content	11-8
Using Data and Built-in Methods in a Form Rule	11-8
Built-in Data	11-8
Built-in Methods	11-9
Understanding How Form Rules Work at Runtime	11-9
When are Form Rules Executed?	11-10
Infinite Loops	11-10
Debugging Form Rules	11-10
Debugging Duplicate Control Names	11-11
Form Rule Profiling	11-11
Working with Form Rules	11-11
How to Create a Form Rule	11-11
How to Test a Form Rule	11-12

12 Working with Human Tasks

Introduction to Human Tasks	12-1
Introduction to Participant and Routing Types	12-2
Participant Types	12-2
Routing Types	12-2
Outcome	12-3
Introduction to Participant Assignment	12-4
Introduction to Duration	12-4
Introduction to the Human Task Editor	12-5
Working with Human Tasks	12-5
Walkthrough: Creating and Configuring a Human Task	12-5
How to Create New Human Task	12-6
How to Open a Human Task	12-6

How to Configure Basic Task Properties	12-7
How to Configure the Deadline (Duration) for a Human Task	12-7
How to Specify the Presentation of a Human Task	12-8
Specifying the Presentation of a Human Task with an ADF Task Form	12-8
Specifying the Presentation of a Human Task with a Web Form	12-9
How to Change the Default Participant	12-9
How to Add Participants and Routing to a Human Task	12-10
How to Assign Users, Groups, and Roles to a Participant	12-10
Selecting Participants using Names and Expressions	12-10
Selecting Participants using Lane Participants	12-11
Selecting Participants using Parametric Roles	12-11
How to Configure the Outcome for Parallel Routing	12-12
How to Create and Configure the Data Payload for a Human Task	12-13
Assigning a Human Task to a User Task	12-13

Part VI Handling Data in Your Business Application

13 Working with Data Objects and Data Associations

About Handling Data Used by Your Business Processes	13-1
How to Define the Data Used by an Oracle BPM Application	13-1
Introduction to Data Objects	13-2
Introduction to Basic and Complex Data Objects	13-2
Introduction to Process and Project Data Objects	13-3
Process Data Objects	13-3
Project Data Objects	13-3
Working with Data Objects	13-4
How to Create a Data Object	13-4
How to Edit or Delete a Data Object	13-5
What Happens When You Delete or Edit a Data Object	13-5
Introduction to Data Associations	13-6
Introduction to the Data Associations Editor	13-7
How to Configure Data Associations for a Flow Object	13-8

14 Using Complex Data Types to Define Data Structures

Introduction to Complex Data Types	14-1
Working with Complex Data Types	14-2
How to Create a Complex Data Type Manually	14-2
Creating a New Business Object	14-3
Creating a New Exception	14-4
Creating a New Enum Object	14-5

What Happens When You Create a Complex Data Type	14-6
How to Edit a Complex Data Type	14-6
How to Delete a Complex Data Type, Module, or Attribute	14-7

15 Using Expressions to Control Data

Introduction to Expressions	15-1
Introduction to the Expression Editor	15-1
Types of Expressions	15-2
Simple Expressions	15-3
Operator Types	15-3
Operator Precedence	15-4
Working with Expressions	15-4
How to Define a Simple Expression for a Conditional Sequence Flow	15-5
How to Define a Simple Expression in Data Associations	15-5

16 Tracking Business Data in Your Application

Working with Key Performance Indicators (KPIs)	16-1
Introduction to Key Performance Indicators	16-1
KPI Lifecycle	16-1
Types of Key Performance Indicators	16-2
Working with Business Indicators and Counter Marks	16-2
Introduction to Business Indicators and Counters	16-2
Introduction to Counter Marks	16-3
How to Add a New Counter Mark to a Process	16-3
How to Delete a Counter Mark	16-4
Measuring Process Performance Using Measurement Marks	16-5
How to Add a Measurement Mark to a Process	16-6

Part VII Implementing and Deploying a BPM Project

17 Using Oracle Business Rules

Introduction to Oracle Business Rules	17-1
Working with Oracle Business Process Composer Rules Editor	17-3
Introduction to Decision Points	17-4
Working with Business Rule Dictionaries	17-4
How to Create a New Business Rule Dictionary	17-4
Viewing and Editing Dictionary Settings	17-5
Synchronizing Business Objects	17-7
Working with Dictionary Links	17-7

Working with Rulesets	17-8
How to Add General Rules and Verbal Rules to a Ruleset	17-8
Adding a Rule to a Ruleset	17-8
Adding a General Rule	17-9
Adding a Verbal Rule	17-9
Working with Decision Tables	17-10
How to Add a Decision Table to a Ruleset	17-12
Working with Facts	17-13
Working with Value Sets	17-14
How to Add a Value Set	17-14
How to Edit an Existing Value Set	17-15
Working with Global Variables	17-16
How to Add a Global Variable	17-16
About Final and Constant Options	17-17
How to Edit Globals	17-17
Working with Verbal Rules and Business Phrases	17-17
How to Create Business Phrases	17-18
Draft Business Phrases and Verbal Rules	17-18
Choosing or Adding Business Phrases in Verbal Rules	17-19
Instantiating New Business Phrases While Authoring a Verbal Rule	17-19
Choosing Business Phrases While Creating a Verbal Rule	17-19
Working with Decision Functions	17-19
Working with Explorer	17-21
Working with Translations	17-22
Assigning a Rule to a Business Rules Task	17-23
Editing Oracle Business Rules at Run Time	17-23

18 Communicating with Other Processes and Services

Defining Process Input and Output	18-1
How to Define the Input Arguments for a Process	18-1
How to Define Data Associations for a Message Start Event	18-2
How to Define the Output Arguments for a Process	18-2
How to Define Data Association for a Message End Event	18-2
Using the Send and Receive Tasks to Communicate Between Processes	18-2
Using Message Throw and Catch Events to Communicate Between Processes	18-3
Defining Conversations	18-5
Introduction to Conversations	18-5
Working with Conversations	18-5
How to Define a Conversation	18-5
How to Set the Default Conversation	18-6
How to Define a Conversation for a BPMN Flow Object	18-6

How to View a Collaboration Diagram	18-6
Working with Services	18-6
How to Create New Services in the Business Catalog	18-6
Creating New Services	18-7
Creating New Services in the Process Editor	18-7

19 Deploying a BPM Project

Who Can Deploy Projects?	19-1
How to Deploy a Project to Runtime	19-1
How to Edit a Deployed Project	19-3
How to Generate a Project SAR File	19-3
How to Generate a Deployment Plan	19-4

Part VIII Appendices

A BPMN Flow Object Reference

Defining the Start and End Point of a Process	A-1
Introduction to Start and End Events	A-1
Specifying the Start Events for Different Types of Processes	A-2
Using Multiple Start Events in a Process	A-2
Using Multiple End Events in a Process	A-2
Defining How a Process Instance is Triggered	A-3
Introduction to the None Start Event	A-3
The None Start Event in Context	A-4
Data Associations	A-4
Introduction to the Message Start Event	A-4
The Message Start Event in Context	A-5
Using Process Input and Output Arguments	A-5
Introduction to the Signal Start Event	A-5
The Signal Start Event in Context	A-6
Introduction to the Timer Start Event	A-6
Introduction to the Error Start Event	A-6
Introduction to the None End Event	A-7
The None End Event in Context	A-7
Introduction to the Error End Event	A-7
Introduction to the Message End Event	A-8
Introduction to the Terminate End Event	A-8
Adding User Interaction to Your Process	A-8
Introduction to Human Workflow	A-9
Introduction to Human Tasks	A-9

Introduction to the User Task	A-10
The User Task in Context	A-10
Using Interactive Activities	A-11
Introduction to the Manual Task	A-11
The Manual Task in Context	A-12
Introduction to the Update Task	A-12
Communicating With Other Processes and Services	A-12
Introduction to the Service Task	A-12
The Service Task in Context	A-13
Introduction to the Notification Task	A-13
Introduction to the Call Activity	A-14
Introduction to the Send Task	A-15
Introduction to the Receive Task	A-15
Starting a Process with the Receive Task	A-16
Introduction to the Message Throw Event	A-16
Introduction to the Message Catch Event	A-17
Adding Business Logic Using Oracle Business Rules	A-17
Introduction to Oracle Business Rules	A-17
Introduction to the Business Rule Task	A-17
The Business Rule Task in Context	A-18
Controlling Process Flow Using Sequence Flows	A-18
Introduction to Sequence Flows	A-18
Introduction to Unconditional Sequence Flows	A-19
Introduction to Conditional Sequence Flows	A-19
Introduction to Default Sequence Flows	A-19
Controlling Process Flow Using Gateways	A-20
Introduction to Gateways	A-20
Split-Merge Pairs	A-20
Introduction to the Exclusive Gateway	A-20
The Exclusive Gateway in Context	A-21
Splitting and Merging Exclusive Gateways	A-21
Introduction to the Inclusive Gateway	A-22
Splitting and Merging Inclusive Gateways	A-22
Introduction to the Parallel Gateway	A-23
The Parallel Gateway in Context	A-23
Splitting and Merging Parallel Gateways	A-23
Introduction to the Complex Gateway	A-24
Introduction to the Event-Based Gateway	A-24
Starting a Process with an Event-Based Gateway	A-26
Controlling Process Flow Using Intermediate Events	A-26
Introduction to Intermediate Events	A-26
Introduction to the Timer Catch Event	A-26

Introduction to the Error Catch Event	A-27
Using Subprocesses in Oracle BPM	A-28
Introduction to Reusable Processes (Reusable Subprocesses)	A-28
Introduction to Embedded Subprocesses (Inline Subprocesses)	A-28
Embedded Subprocesses and Sequence Flows	A-29
Embedded Subprocesses in Context	A-29
Looping Embedded Subprocesses	A-30
Introduction to Event Subprocesses (Event Handlers)	A-30
Changing the Value of Data Objects in Your Process	A-30
Introduction to the Script Task	A-31
The Script Task in Context	A-31

B Web Form and Web Form Control Property Reference

Web Form Properties	B-1
Settings Tab	B-1
Style Tab	B-2
Web Form Control Properties	B-3
Web Form Control Properties - Settings Tab	B-3
Web Form Control Properties - Style Tab	B-10

C Web Form Rules Examples

Calculate a Total	C-2
Show/Hide a Billing Address	C-2
Show/Hide Message	C-3
Enable/Disable a Question	C-3
Compute Subtotals for Repeating Items	C-3
Compute an Invoice Total	C-4
Textarea Max Length	C-4
Textarea Newline and Break	C-5
Dropdown Options	C-5
Finding a Selected Options Index	C-6
Synchronized Selects	C-6
Clearing Dropdown Options	C-7
Default Option	C-7
Check Box Options - Assigning Color to Check Box Choices	C-7
Check Box Options - Making a Control Visible/Invisible Based on Check Box Choices	C-8
Check Box Initialization	C-8
Displaying Selected Check Box Labels	C-9
Repeating Check Boxes	C-9
Display a Message Control Inside a Repeat Control	C-9

String Concatenation	C-10
Visible/Invisible	C-11
Visible/Invisible Section	C-11
Select Tab	C-12
Next Tab	C-12
Expand/Collapse Section	C-12
Multiple Choice	C-13
Dynamic Options	C-13
Triggers and Dynamic Options	C-13
Value Change and Dynamic Options	C-14
Dynamic Control Initialization	C-14
Verify User	C-15
Calculate Net Worth	C-15
Dates and Times	C-16
Duration	C-16
Today's Date and Time	C-16
Date/Time Stamp	C-17
Invalid if Before Today	C-17
Date Less than 14 Days from Today	C-17
Date Less than 30 Days Ago	C-18
Central Timezone adjusted for Daylight Savings	C-18
Hours > = 4 and < = 6 Apart	C-19
Times	C-19
Tenants, Roles and Users	C-20
Repeat Item Added	C-20
Repeat Item Added - Collapse Other Items	C-21
Tables	C-21
form.load	C-22
form.unload	C-22
Unique ID	C-23
Repeat Item Initialization	C-23
ItemAdded by Init Doc	C-24

D Preparing Processes for Import into Oracle BPM

Preparing a Visio File to Import as a BPMN Process	D-1
Working of Visio Shape Mapping	D-2
Conditional Mapping	D-3
Visio Modelling Tips	D-4
Updating VisioUserMap.XML	D-5
Valid BPMN Element Values	D-6
BPMN Element Attributes	D-7

Handling Extraneous Text	D-9
Customizing XPDL Import Using XSLT	D-10
Common Transformation Requirements	D-10
Overview of Transformation Logic	D-10
Special Attributes	D-11
Object Coordinates	D-12
Activity Local Coordinate System	D-14
Removing Invisible Elements	D-14
Handling Proprietary Namespaces	D-15
Supporting Multiple XPDL Versions	D-16
Testing and Debugging XSLT	D-16

Preface

Developing Business Processes with Oracle Business Process Composer describes the Oracle Business Process Composer application.

Audience

This guide is intended for process analysts who use the Business Process Composer application to create and edit the business processes and Oracle Business Process Management (Oracle BPM) projects used to create process-based applications using the Oracle Business Process Management Suite.

The information in the guide assumes that you have basic knowledge of business process design and are familiar with Business Process Management Notation (BPMN) 2.0.

Documentation Accessibility

For information about Oracle's commitment to accessibility, visit the Oracle Accessibility Program website at <http://www.oracle.com/pls/topic/lookup?ctx=acc&id=docacc>.

Accessible Access to Oracle Support

Oracle customers who have purchased support have access to electronic support through My Oracle Support. For information, visit <http://www.oracle.com/pls/topic/lookup?ctx=acc&id=info> or visit <http://www.oracle.com/pls/topic/lookup?ctx=acc&id=trs> if you are hearing impaired.

Related Documents

Refer to the [Oracle Fusion Middleware library on the Oracle Help Center](#) for additional information.

- For Oracle Business Process Management information, see Oracle Business Process Management.
- For Oracle SOA Suite information, see Oracle SOA Suite.
- For versions of platforms and related software for which Oracle products are certified and supported, review the [Certification Matrix on OTN](#).

Conventions

The following text conventions are used in this document:

Convention	Meaning
boldface	Boldface type indicates graphical user interface elements associated with an action, or terms defined in text or the glossary.
<i>italic</i>	Italic type indicates book titles, emphasis, or placeholder variables for which you supply particular values.
monospace	Monospace type indicates commands within a paragraph, URLs, code in examples, text that appears on the screen, or text that you enter.

Part I

Introduction to Oracle Business Process Composer

Understand the Oracle Business Process Composer concepts.

This part contains the following chapter:

- [Introduction to Oracle Business Process Composer](#)

1

Introduction to Oracle Business Process Composer

Get an overview of Oracle Business Process Composer and the overview of application user interface. Understand the most common scenarios for using Oracle Business Process Composer to design, implement, and deploy Oracle Business Process Management (Oracle BPM) projects to create process-based business applications.

- [Signing On to Oracle Business Process Composer](#)
- [Introduction to the Oracle Business Process Composer Application Welcome Page](#)
- [Introduction to Project Panels](#)

Signing On to Oracle Business Process Composer

Provide the Oracle Business Process Composer URL, and the username and password to sign in.

- **URL:** The location of your Oracle Business Process Composer installation.
- **Username:** The username you use to access Oracle Business Process Composer.
- **Password:** The security credential you use to access Oracle Business Process Composer.

Note:

Oracle Application Server Single Sign-On is enabled by default in Oracle BPM Suite. OracleAS Single Sign-On allows you to use one sign-on session to access multiple web-based applications. If OracleAS Single Sign-On is enabled and you have previously signed on to another application, the Oracle Business Process Composer sign on screen may not appear.

To sign on to Oracle Business Process Composer

1. Go to the Oracle Business Process Composer URL.
2. Enter your username and password, then click **Login** to display the Application Welcome page.

Note:

You can only sign on to Oracle Business Process Composer from one browser session. Concurrent sessions for the same user are not supported.

Introduction to the Oracle Business Process Composer Application Welcome Page

The Oracle Business Process Composer application is designed to allow you to easily create, edit, and manage BPM projects. A BPM project is the core component of an Oracle BPM application, which contains all the required resources of the application, including business processes.

See [Creating and Working with BPM Projects](#) for more information.

The Oracle Business Process Composer Application Welcome page is shown in [Figure 1-1](#).

Figure 1-1 The Oracle Business Process Composer Application Welcome Page

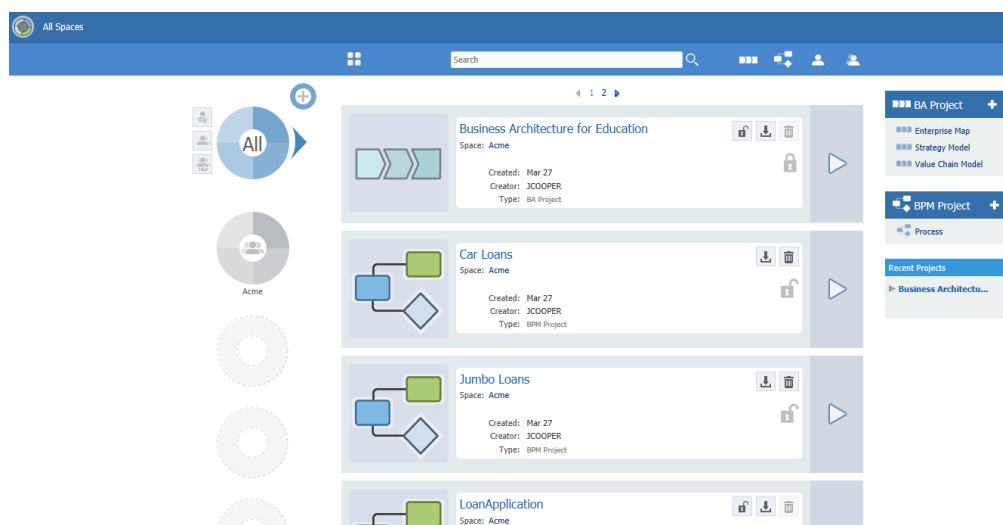

Use the Oracle Business Process Composer Application Welcome page to perform the following types of tasks:

- Create and view Oracle Business Process Composer spaces
- Create and manage Business Architecture (BA) projects
- Create and manage BPM projects

The Oracle Business Process Composer Application Welcome page is divided into the following sections:





- Oracle Business Process Composer toolbar
- Spaces browser
- Project list
- BA Project panel
- BPM project panel
- Recent projects panel

Introduction to the Oracle Business Process Composer Toolbar

The Oracle Business Process Composer toolbar is located across the top of page and provides access to the Oracle Business Process Composer main menu as well as allowing you to configure how BPM and BA projects are displayed in the Project List.

The toolbar provides access to the following:

Table 1-1 The Oracle Business Process Composer Application Toolbar

Toolbar element	Description
Main Menu	Click to access the Oracle Business Process Composer's main menu. From here you can use the Main Menu to: <ul style="list-style-type: none"> • Import a BPM project • Publish report data for a BA project • Generate reports for a BA project
	Click to choose how projects are displayed in the project browser. Choose either <i>List</i> , <i>Grid</i> , or <i>Table</i> .
Search	Use to search for a project by name. Enter the name of the project, then click the Search button. You can only search for projects that you have access to view or edit.
	Click to display BA projects in the project list.
	Click to display BPM projects in the project list.
	Click to display projects owned by the current user.
	Click to display projects shared by the current user.

Introduction to the Oracle Business Process Composer Main Menu

The application main menu provides access to frequently used commands and functionality. This menu is accessible from the Application Welcome page as shown in [Figure 1-2](#).

Figure 1-2 The Application Welcome Page Main Menu

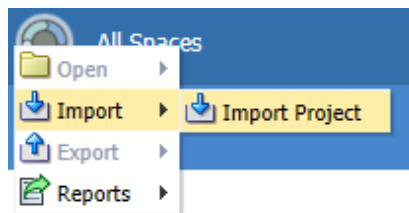

The main menu provides access to the menu items described in [Table 1-2](#).

Table 1-2 Main Menu Items

Menu item	Description
Open	Allows you to open a project stored in the Oracle BPM repository.
Import	Provides functionality for importing projects and process models into Oracle Business Process Composer. Imported projects are stored in the Oracle BPM repository. See Working with Project Snapshots for more information.
Export	Allows you to export projects to the local file system. See Importing and Exporting Projects for more information.
Reports	Provides functionality to publish report data for a BA project and generate reports for a BA project. See Working with Business Architecture Reports for more information.

Introduction to the Spaces Browser

Oracle Business Process Composer spaces group related BA and BPM projects together. An Oracle Business Process Composer space contains all of the project and resources for your organization, from high-level value chain models down to the lower level technical details required by your process-based application. Oracle Business Process Composer spaces are also used to control permissions on the projects they contain. You can specify which users or groups have permission to view or edit BA or BPM projects stored in that space.



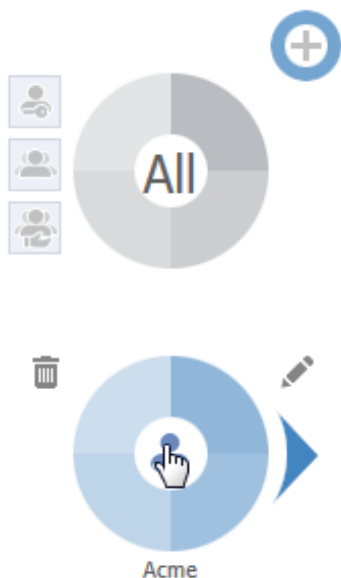

The spaces browser is located on the left-hand side of the Application Welcome page and can be used to create, view, and edit Oracle Business Process Composer spaces, as shown in [Figure 1-3](#). You can only view or edit the Oracle Business Process Composer spaces you created or have permission to view.

Figure 1-3 Spaces Browser



The different types of actions you can perform using the spaces browser are described in [Table 1-3](#)

Table 1-3 Spaces Browser Elements

Spaces Browser Element	Description
	Click to display the New Space dialog and create a new space. See How to Create a new Oracle Business Process Composer Space for more information.
All	Click to display all the projects in the project list that are contained in the spaces that you have permissions to view or edit.
	Click to display your private spaces. Private spaces are spaces that can only be viewed or edited by the owner.
	Click to display shared spaces that are owned by you.
	Click to display shared spaces that are owned by others.
Space icon	Click a specific space, as shown in Figure 1-3 to only display the projects contained in that space in the projects list. Hover over the space to display the Delete and Edit icons, as shown in Figure 1-3 . See How to Share a Space with Other Users or Groups and How to Delete an Oracle Business Process Composer Space for more information.

How to Create a new Oracle Business Process Composer Space

You can create a new Oracle Business Process Composer space from the Application Welcome page.

To create a new Oracle Business Process Composer space:

1. Access the Application Welcome page.
2. Click the **New Space** button as shown in [Figure 1-4](#).

Figure 1-4 The New Space Dialog



3. Enter a name, then click **Save**.

 **Note:**

Space name cannot start with a number.

How to Share a Space with Other Users or Groups

After creating an Oracle Business Process Composer space, you share the space with other users or groups. Sharing an Oracle Business Process Composer space also shares all of the Business Architecture and BPM projects within the space.

To share an Oracle Business Process Composer space:

1. Access the Application Welcome page.
2. Move the mouse over the space you want to share, then click the **Edit Space** button.
3. Click **Participants**.
4. Click **Choose**.
5. In the drop down list, select whether you want to search in users, groups, or both.
6. Enter the name of the user or group in the text field, then click **Search**.
Click **Search** without entering a name in the text field to return a list of all users or groups.
7. Click the check box next to the name of the users or groups you want to add. You can click **Select All** to select all the users in the search results.
8. Click **OK**.
9. Select a role from the drop down list. This role determines the changes a user or group can make to a product.
10. Click **Share**.
The user or group appears in the table along with the role assigned to them.
11. Click **Close**.

How to Delete an Oracle Business Process Composer Space

Administrators or users who are assigned the owner role can delete a space. Deleting a space removes it from the Oracle BPM repository and also removes all of the projects it contains.

To delete an Oracle Business Process Composer space:

1. Access the Application Welcome page.
2. Move the mouse over the space you want to delete, then click the **Delete** button.
3. Click **Yes** to confirm.

For more information about how administrators manage spaces, see [Managing Business Process Composer Spaces](#).

Introduction to the Project List

Use the project list to view and work with projects contained in all spaces you have permission to view or edit, privately owned spaces, shared spaces owned by you, or shared spaces owned by others. The projects displayed in the project list are based on the option you choose in the

spaces browser. By default, projects contained in all spaces you have permission to view or edit are displayed, as shown in [Figure 1-1](#).

You can change how Oracle Business Process Composer displays the projects (*List*, *Grid*, or *Table*) by clicking the **Views** icon located on the Application Welcome page toolbar. [Table 1-4](#) describes the elements displayed in the default *List* view, as shown in [Figure 1-5](#).

Figure 1-5 Project List - Project in List View

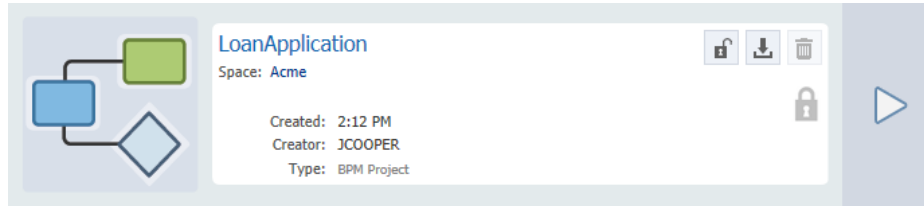



Table 1-4 Project Views

Project view	Description
Name	Displays the name of the project. Click to open the project and go to the Project Welcome page. Click the space name in the breadcrumb located at the top of the Project Welcome page to return back to the Application Welcome page.
	Click to download the project to your local file system.
	Click to delete the project. When you click this icon, a confirmation message appears. Click <i>Yes</i> to delete the project or click <i>No</i> to abort the action.
Locked /Unlocked	The lock icon displays either locked or unlocked for shared projects to inform users if the project is currently locked by another user.
Space	Displays the name of the space where the project is stored. Click to display more details about the space to the right of the project list.
Created	Displays the time and date the project was created.
Creator	Displays the user who created the project.
Type	Displays the type of project. (BPM project or BA project).

Introduction to Project Panels

The Application Welcome page displays three project panels: the BA Project Panel, the BPM Project Panel, and the Recent Projects panel.

- BA Project Panel: Allows you to create a new project.
- BPM Project Panel: Allows you to create a new project for BPM.
- Recent Projects Panel: Lists the projects you have accessed.

Creating a New Empty Project with the BA Project Panel

You can use the BA Project panel to create a new empty project.

To create a new empty project:

1. Access the Application Welcome page.
2. Click the + icon located in the top right-hand corner of the panel to display a popup where you enter the following information:
 - **Name:** (Required) After the project is created, you cannot change the name.

 **Note:**

Do not use # (hashtag),] (close bracket), . (period), [(open bracket), and % (percent sign) in the project name. Composer throws an error, if you try to use these special characters in the name.

- **Description:** (Optional) Descriptions are one or two expansions of the title to help a user distinguish between projects of similar or same titles.
 - **Space:** (Required) Select the space where the new project is to be stored. To create a new space, select *New Space* from the drop down list.
3. Click **Save**.

Creating a New Populated Project with the BA Project Panel

You can use the BA Project panel to create new projects containing an enterprise map, strategy model, or value chain model.

To create a project containing either an enterprise map, strategy model, or value chain model:

1. Access the Application Welcome page.
2. Click either the *Enterprise Map*, *Strategy Model*, or *Value Chain Model* link listed in the panel to display a popup where you enter the following information:
 - **Model Name:** (Required) Enter the name of the enterprise map, strategy model, or value chain model.
 - **Space:** (Required) Select the space where the new project is to be stored. To create a new space, select *New Space* from the drop down list.
 - **New Project:** (Required) After the project is created, you cannot change the name.

 **Note:**

Do not use # (hashtag),] (close bracket), . (period), [(open bracket), and % (percent sign) in the project name. Composer throws an error, if you try to use these special characters in the name.

- **Description:** (Optional) Descriptions are one or two expansions of the title to help a user distinguish between projects of similar or same titles.

Figure 1-6 Application Welcome Page - BPM project Panel

The screenshot shows a web form for creating a BPM project. At the top is a blue header bar with the text 'BPM Project' and a plus sign icon. Below this is a section titled 'Process'. The form contains the following fields: a required text input for 'Process Name', a required dropdown menu for 'Space' (currently showing 'BPMProjectsStore'), a required text input for 'New Project', and a text area for 'Description'. A 'Create' button is located at the bottom right of the form.

3. Click **Save**.

Creating a New Empty Project with the BPM Project Panel

You can use the BPM Project panel to create a new empty project.

To create a new empty project:

1. Access the Application Welcome page.
2. Click the + icon located in the top right-hand corner of the panel to display a popup where you enter the following information:
 - **Name:** (Required) After the project is created, you cannot change the name.
 - **Description:** (Optional) Descriptions are one or two expansions of the title to help a user distinguish between projects of similar or same titles.
 - **Space:** (Required) Select the space where the new project is to be stored. To create a new space, select *New Space* from the drop down list.
3. Click **Save**.

Creating a New Populated Project with the BPM Project Panel

You can use the BPM Project panel to create new projects containing a process.

To create a project containing a process:

1. Access the Application Welcome page.
2. Click the *Process* link listed in the panel to display a popup where you enter the following information:
 - **Process Name:** (Required) Enter the name of the process.
 - **Space:** (Required) Select the space where the new project is to be stored. To create a new space, select *New Space* from the drop down list.
 - **New Project:** (Required) After the project is created, you cannot change the name.
 - **Description:** (Optional) Descriptions are one or two expansions of the title to help a user distinguish between projects of similar or same titles.
3. Click **Save**.

Recent Projects Panel

The Recent Projects panel lists the projects you have accessed during the session. When you start your session, the message *No recent projects* is displayed in the panel.

Part II

Performing Administrative Tasks Using Oracle Business Process Composer

Perform administrative tasks using Oracle Business Process Composer.

This part contains the following chapter:

- [Performing Administrative Tasks](#)

2

Performing Administrative Tasks

Perform administrative tasks using Oracle Business Process Composer. Users who are assigned administration privileges can perform administrative tasks including managing Oracle Business Process Composer spaces, managing projects, and enabling the process player feature.



Note:

Only the users who are granted the Project Administrator security role can perform these tasks. For more information, see [How to Grant Administrator Privileges to a Business Process Composer User](#).

- [Accessing the Oracle Business Process Composer Administrator View](#)
- [Managing Business Process Composer Spaces](#)
- [Managing Projects](#)
- [Defining SOA Administrator Credentials to Enable Process Player](#)
- [Administering Business Architecture Reports](#)

Accessing the Oracle Business Process Composer Administrator View

Oracle Business Process Composer allows you to assign administrator privileges to a user.

When a user has administrator privileges, they have access to the Administration view accessible from the Oracle Business Process Composer application welcome page, as shown in [Figure 2-1](#).

Figure 2-1 Oracle Business Process Composer - Administrative View

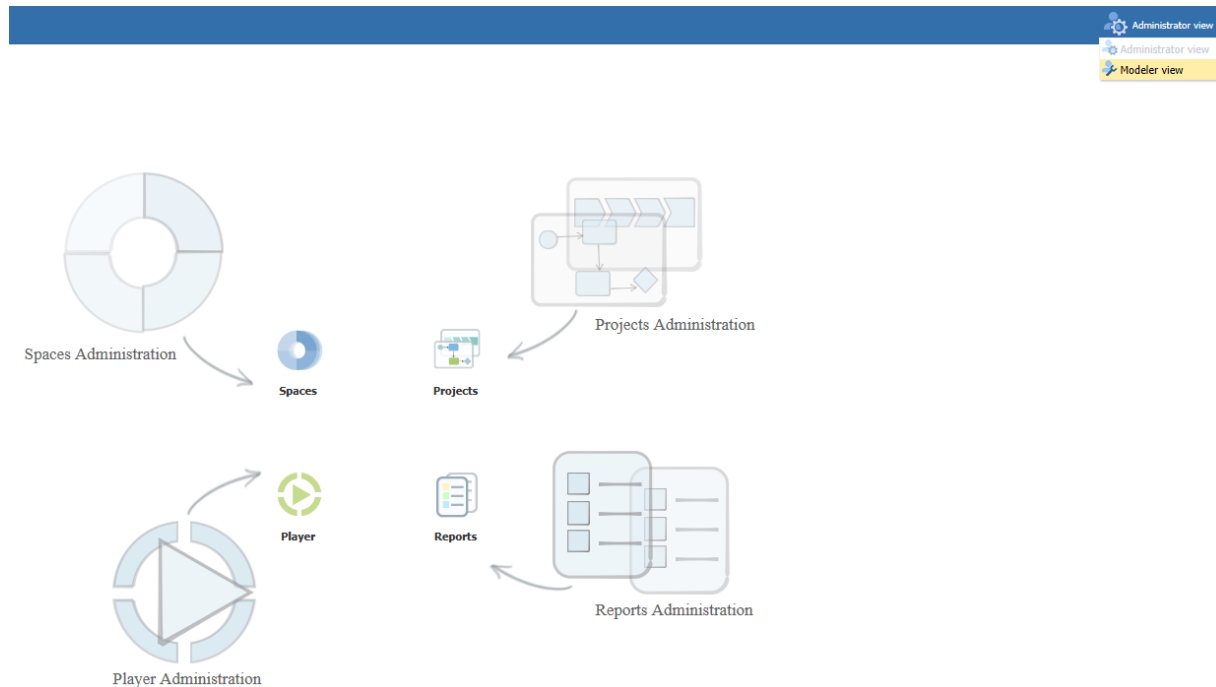

Administrators can perform the following tasks:

- Configure and remove Business Process Composer spaces.
- Delete projects.
- Release locks on projects.
- Configure administrator credentials for process player.
- View and delete reports.

How to Grant Administrator Privileges to a Business Process Composer User

Administrator privileges are granted by assigning the Administrators group to an Oracle Business Process Composer user.

To grant administrator privileges:

1. Log in to the WebLogic Administrator Console.
2. Go to **Security Realms** and then select **myRealms**.
3. Go to the Users/Groups tab and select the user you want to grant administrative privileges.
4. Move the *Administrators* group from the list of **Available** groups to the list of **Assigned** groups.
5. Click **Save** to save your changes.

The Oracle Business Process Composer user now has administrator privileges.

How to Access the Administration View

Users who have been granted administrator privileges can access the Administration view from the application welcome page.

How to access the administrator view:

1. Sign in to Oracle Business Process Composer as a user with administrator privileges.
2. In the upper right-hand corner of the application window, click **Modeler View**.
3. Select **Administrator View** from the drop-down list.
4. Click the icon for the administration functionality you want to access.

Managing Business Process Composer Spaces

Spaces enable you to define which Oracle Business Process Composer users have permission to view and edit Business Architecture (BA) and Business Process Management (BPM) projects.

Figure 2-2.

Figure 2-2 Administrative View - Spaces Administration

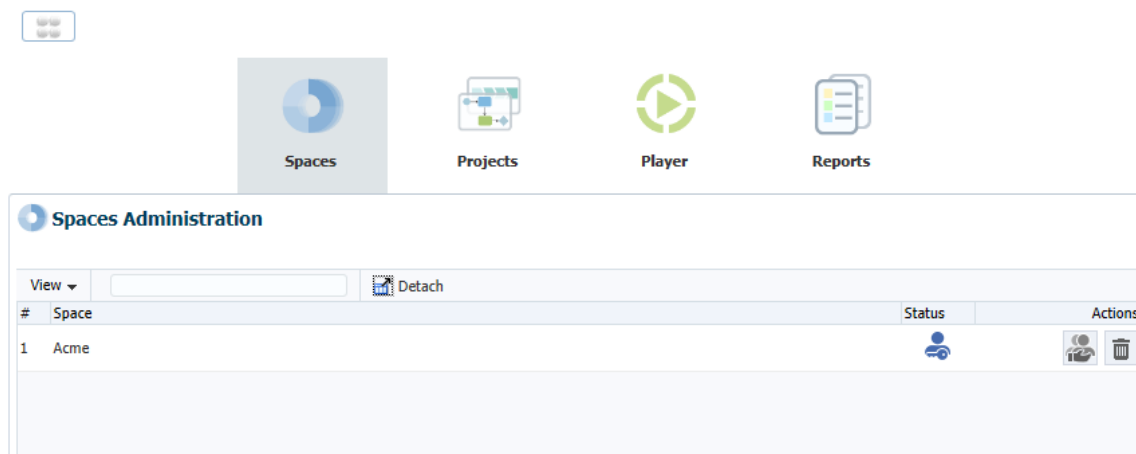

Use the spaces administration feature to perform the following:

- View the status of a BPM space.
- Share a BPM space.
- Delete a BPM space.

Configuring Access to a BPM Space

Using the Spaces Administration dialog you can define which users or groups of users can view or edit a BPM space.

To add users to a BPM space:

1. Ensure that you have created at least one BPM space from the application welcome page.
2. Sign in to Oracle Business Process Composer as a user with administrator privileges.
3. Access the Administrative view.
4. Click **Spaces**.
5. Click the **Share** icon in the **Actions** column for the space where you want to add users.
6. Click **Choose**, then select **Users** or **Groups** from the drop-down menu.
7. Enter the name of the user or group you want to search for, then click **Search**.
To see a list of all users or groups, leave the text area empty and click **Search**.
8. Click the check box next to the users or groups you want to add to the BPM space.
Each user or group you select appears in a list.
9. Click **OK**.
Each of the users or groups you selected appear in the text area.
10. Select a role from the drop-down list.
The role determines what changes the user or groups can make to the contents of a BPM space.
11. Click **Share**.
12. Click **Close**.

Removing Users from a BPM Space

Use the Spaces Administration dialog to remove users from a BPM space.

To remove users from a BPM space:

1. Sign in to Oracle Business Process Composer as a user with administrator privileges.
2. Access the Administrative View.
3. Click **Spaces**.
4. Click the **Share** icon in the **Actions** column for the space where you want to remove users.
5. Select the user or group from the list.
6. Click **Delete**, then click **Yes**.

How to Delete a BPM Space and Its Content

Use the Administrative View to delete a BPM space from the Oracle BPM repository.

To delete a BPM space:

1. Sign in to Oracle Business Process Composer as a user with administrator privileges.
2. Access the Administrative View.
3. Click **Spaces**.
4. Click the **Delete** icon in the row of the space you want to delete.

- Click **Yes** to confirm.

 **Note:**

Deleting a BPM space deletes the space and all of the business architecture and BPM projects it contained. After deleting a BPM space, its contents cannot be recovered.

Managing Projects

Use the Oracle Business Process Composer administrative view to manage projects.

Figure 2-3 Administrative View - Projects Administration

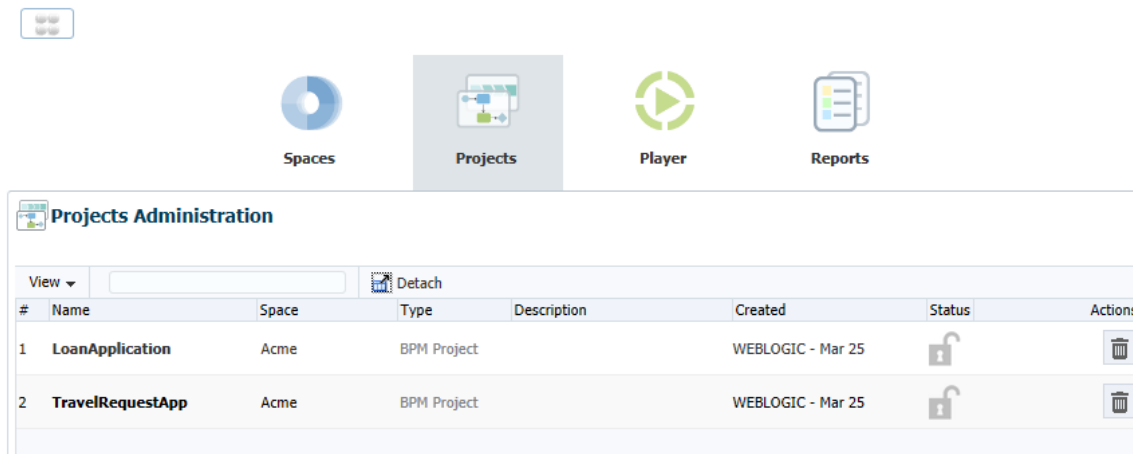

How to Release the Lock on a Shared Project

Administrators can release the locks on shared projects that have been locked by another user.

To release the lock on a shared project:

- Sign in to Oracle Business Process Composer as a user with administrator privileges.
- Access the Administrative View.
- Select the **Project**.
- In the **Actions** column, click **Unlock project** for the project whose lock you want to release.

 **Note:**

If you release the lock of a project that has unpublished changes, those changes are lost and cannot be recovered.

5. Click **Yes**.

How to Delete a Project

Administrators can delete projects.



Note:

Administrators cannot perform tasks on private projects. Only the project owner has access to private projects.

To delete a shared project:

1. Sign in to Oracle Business Process Composer as a user with administrator privileges.
2. Access the Administrative View.
3. Select **Project**.
4. Under the **Actions** column, click **Delete project** in the row of the project you want to delete.



Note:

Administrators cannot delete locked projects. To delete a project you must unlock it, then delete it.

5. Click **Yes** to confirm that you want to delete the project.

After deleting a project, it is removed from the Oracle BPM repository.

How to Configure Sharing for a Project

To configure which users and groups have access to a project, you must configure sharing on the Oracle Business Process Composer space containing the project. You cannot configure sharing on a specific project. See [Configuring Access to a BPM Space](#) for more information.

Defining SOA Administrator Credentials to Enable Process Player

Process player enables you to test the behavior of a business process at design time using Oracle Business Process Composer. You can test a process as different user IDs without having to deploy the BPM project and test the processes using Oracle Business Process Workspace.

See [Using Process Player](#) for more information.

When testing a business process, process player deploys a version of the BPM project to runtime using a special runtime partition. This allows process player to run a process using the same environment as a normally deployed BPM project.

To enable the process player feature in Oracle Business Process Composer, you must first provide the service-oriented architecture (SOA) administrator credentials. Oracle Business Process Composer uses the SOA administrator credentials to:

- Deploy a version of the project at runtime.
- Perform tasks on the process instance as different users.

After you provide the SOA administrator credentials, any user who has edit privileges on a project can run process player.

When starting process player, Oracle Business Process Composer deploys the project to runtime using these credentials. When the current user wants to perform an activity or task as another user, Oracle Business Process Composer also uses these credentials.

How to Enable Process Player

Before Oracle Business Process Composer users can access process player, you must enable it by providing the SOA administrator credentials, as shown in [Figure 2-4](#).

Figure 2-4 Administrative View - Player

To enable process player:

1. Sign in to Oracle Business Process Composer as a user with administrator privileges.
2. From the Application Welcome page, select the Administrative View.
3. Select **Player**.
4. Enter the username and password, and then the password for the SOA administrator, then click **Save**.

What Happens When You Enable Process Player

After enabling process player, Oracle Business Process Composer users can use it to test the behavior of their business processes. See [Using Process Player to Test the Behavior of Business Processes](#) for information.

Enabling process player makes it available to all Oracle Business Process Composer users. Any user who has edit privileges on a BPM project can run process player.

How to Disable Process Player

After you have enabled process player, you can disable it when necessary.

To disable process player:

1. Sign on to Oracle Business Process Composer as a user with administrator privileges.
2. From the Application Welcome page, select the Administrative View.
3. Select **Player**.
4. Click **Clear**.

Administering Business Architecture Reports

Use the Administrative view information about each of the reports created within a Oracle Business Process Composer installation.

You can also use the Administrative View to delete reports.

How to View Reports

You can use the Administrative View to view a list of reports.

To view reports:

1. Sign on to Oracle Business Process Composer as a user with administrator privileges.
2. Access the administrative View.
3. Select **Reports**.

Oracle Business Process Composer displays a list of reports in a table containing information about each report. See the Oracle Business Process Composer context-sensitive online help for information about each column in the table.

How to Delete a Report

Use the Administrative View to delete a report.

To delete a report:

1. Sign on to Oracle Business Process Composer as a user with administrator privileges.
2. Access the administrative View.
3. Select **Reports**.
4. Click the **Delete Report** button in the row of the report you want to delete.

Part III

Creating and Working With BA and BPM Projects

Learn how to create and work with Business Architecture (BA) and Business Process Management (BPM) projects in Oracle Business Process Composer.

This part contains the following chapters:

- [Creating and Managing BA and BPM Projects](#)
- [Performing Process Analysis and Discovery with Business Architecture](#)
- [Creating and Working with BPM Projects](#)
- [Documenting BPM Projects](#)

3

Creating and Managing BA and BPM Projects

Learn how to share projects and collaborate and also learn some basic functions available to create and manage Business Architecture (BA) and Business Process Management (BPM) projects.

- [Introduction to Project Sharing and Collaboration](#)
- [Creating and Working with Projects](#)
- [Working with Project Snapshots](#)
- [Importing and Exporting Projects](#)

Introduction to Project Sharing and Collaboration

Oracle Business Process Composer provides features for sharing BA and BPM projects among its users.

You can control who has access to view or edit projects.

Private and Public Projects

BA and BPM projects are defined as either private or public. Only the project owner can view or edit private projects. The project owner and other users who have the correct permissions can edit and view public projects.

For information about how to share projects, see [How to Share a Project with Other Users](#).

Edit Mode

Shared projects have an edit mode, which determines whether you can make changes or not. You can determine the current edit mode for a project in the project information pane.

In **Read-only** mode, the project is open for viewing only, and some project functionality is unavailable. In **Edit** mode, you can make changes to the project. Only you can make changes; other users can view it, but cannot make changes.

Project Roles

Project roles define who has access to view and make changes to a project. There are three types of project roles: owner, editor, and viewer.

- **Owner:** When a user creates a project, they are defined as the owner of the project. You can also define another user as the owner of a project. The owner of a project can perform the following:
 - Edit a project
 - Deploy a project
 - Create a project snapshot

- Share a project with other users
- Delete a project
- **Editor:** An editor can make changes to a project.
When a user with the editor role opens a project, by default it is in read mode. If no other users are editing the project, the user can begin editing it.
- **Viewer:** A viewer can view a project, but cannot make any changes to it.

Creating and Working with Projects

New BA and BPM projects are created from the Application Welcome page. These projects contain only basic information created by process analysts.

For more information about how to create new BA and BPM projects, see [Introduction to Project Panels](#).

How to Open a Project Using the Application Welcome Page

To open a project directly from the Application Welcome page, find the required project in the project list and then click on the name of the project.

The BA Project Welcome Page is displayed by default when you open a BA project from the Application Welcome page. For more information about the BA Project Welcome Page, see [Introduction to the BA Project Welcome Page](#).

The BPM Project Welcome Page is displayed by default when you open a BPM project from the Application Welcome page. For more information about the BPM Project Welcome Page, see [Introduction to the Project Welcome Page](#).

When you are editing a component within a project, you can return to the Project Welcome Page by clicking the **Project Home** tab.

How to Share a Project with Other Users

You share projects with other Oracle Business Process Composer users at the space level. Projects stored in a specific space share the same permissions. Only owners can change permissions at the project-level.

For more information about sharing projects, see [How to Share a Space with Other Users or Groups](#)

How to Edit a Shared Project

Shared projects open in view mode by default. If you have permissions to edit a project and the project is not locked by another user, you can edit it.

To begin editing a project:

To begin editing, click **Edit** at the top of the Project Welcome Page.

After you have enabled edit mode for a project, you can begin making changes to it.

Managing Project Changes

You can save changes to your project as you are editing project components. You must switch to edit mode to make changes.

To save changes to a private project:

To save changes to a private project, click **Save** in the project toolbar. The project is saved and you can continue making changes to the project as necessary.

To save changes to a shared project:

- If you want to save your changes and continue editing the project, click **Save** in the process editor toolbar.

All unsaved changes for each project component are saved. The project continues to be locked and you can continue editing.

- To release the lock on the project, click **Save and Release** in the process editor toolbar.

All unsaved changes for each project component are saved. If project sharing is enabled, other Oracle Business Process Composer and Oracle BPM Studio users who have permissions can begin editing the project. However, these changes are not available to other participants until they are published.

Caution:

If the project has not been published before you save and release, then it asks for whether you want to publish. If you do not publish before you release, your changes are lost.

To publish changes:

If you want to make your changes available to other participants, you must publish them. To do this you click the publish icon located on the Project toolbar.

Published changes are recorded in the Recent Activity pane in the Project Welcome page.

How to Discard Changes to a Project

While editing project elements, you can revert your changes and return to the most recent published version of a project.

To discard changes made to the current project:

1. From the Project toolbar, click the discard changes icon.
2. Click **OK** to confirm discarding changes to the current project.

Note:

After discarding your changes, they cannot be recovered.

How to Close a Project

To close a project, click **Close Project** in the upper right hand corner of the project home page. If you are sharing a project, a confirmation popup appears containing a **Release Lock** check box. Select this check box to release the lock and make the project available to edit by other project participants. Alternately, you can select the space name located at the top-right corner of the project welcome page to return to the application welcome page.

Working with Project Snapshots

A project snapshot is a read-only copy of a project at a particular moment. Since snapshots are read-only, they cannot be modified or opened for editing.

You can view the contents of a project snapshot as well as export and deploy a project based on a snapshot.

How to Create a New Project Snapshot

You can create a new project snapshot from the Project Welcome Page. However, you can only create a snapshot from the last published project.

To create a new project snapshot:

Users with owner and editor permissions on a project can create new snapshots.

1. Go to the Project Welcome Page, Recent Activity panel, then click **Snapshots** to open the Snapshots dialog, as shown in [Figure 3-1](#).

Figure 3-1 Snapshots Dialog - Add New Snapshot

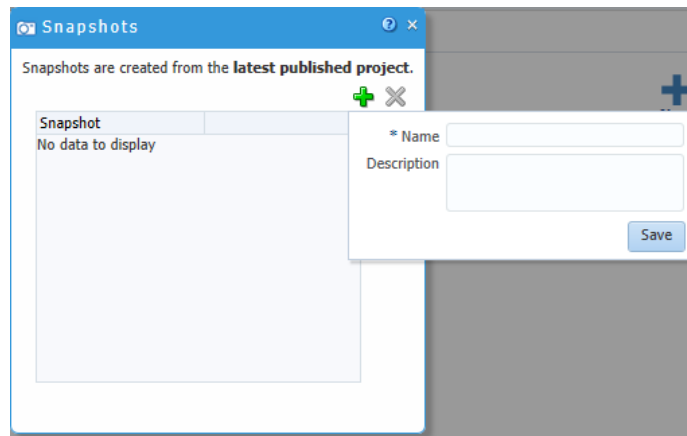

2. Click **New**.
3. Enter a name for your snapshot, then click **Create Snapshot**.

The snapshot appears in the list of snapshots defined for this project, including the date the snapshot was created and the user ID of the snapshot creator.

How to View Contents of a Project Snapshot

Viewing the contents of a project snapshot allows you to view and compare previous versions of a project with the current one.

To view the contents of a project snapshot:

1. Go to the Project Welcome Page, Recent Activity panel.
2. Click **Snapshots** to open the Snapshots dialog.
3. Click the name of the snapshot you want to view.

Within the snapshot view, you can view the state of the processes, rules, and human tasks associated with the project.

How to Return to the Active Version of a Project

To return to the active version of a project from a project snapshot, click the active versions' project name located in the bread-crumbs at the top of the Project Welcome Page.



How to Delete a Project Snapshot

Using Oracle Business Process Composer, a user who is granted the editor role of a project can delete the snapshots they created. A user who is granted the owner or administrator role of a project can delete any snapshot created by any user.

1. Open your project.
2. From the Project Welcome Page, Recent Activity panel, click **Snapshots**.
3. Select the snapshot you want to delete from the list, then click **Delete**.
4. Click **Yes** to confirm that you want to delete the project snapshot.

After you delete a project snapshot, it cannot be recovered.

How to Export a Project Snapshot

You can use Oracle Business Process Composer to export a project snapshot. Project snapshots are exported as normal BPM projects, which you can deploy, share with other users, and so on.

To export a project snapshot:

1. Open your project.
2. View the project snapshot you want to export.
For more information, see [How to View Contents of a Project Snapshot](#).
3. From the main menu, select **Export**, then **Export Project**.
4. Choose a location on your local file system and click **Save**.

The exported project snapshot is saved as an .EXP file on your file system.

How to Deploy a Project Snapshot

You can use Oracle Business Process Composer to deploy a project snapshot directly to runtime. This allows you to test or revert back to an older version of a project.

To deploy a project snapshot:

1. Open your project.
2. View the project snapshot you want to deploy.
For more information, see [How to View Contents of a Project Snapshot](#).
3. From the main menu, select **Deploy Project**.
4. Provide the information as described in [How to Deploy a Project to Run Time](#).
5. Click **Deploy**.

Alternatively, a user with an open project may select a snapshot from the Deploy popup. The default option is *Current Project*; however, if one is available, the user can select a snapshot.

Importing and Exporting Projects

Oracle Business Process Composer allows you to import and export BPM projects as .EXP files.

This allows you to share projects directly with other Oracle Business Process Composer and Oracle BPM Studio users directly through the file system without having to use the Oracle BPM repository.

Note:

To migrate projects from releases prior to 12c, import them into BPM Studio. You can then deploy the composite, or export the project and import it using Business Process Composer.

How to Import a Project from your Local File System

You can import a BPM 12c project that was previously exported and saved as an .EXP file. The imported project is stored in the Oracle BPM repository.

Note:

To migrate projects from releases prior to 12c, import them into BPM Studio. You can then deploy the composite, or export the project and import it using Business Process Composer.

To import a project:

1. Access the application welcome page.
2. From the main menu, select **Import**, then select **Import Project**.

The main menu is accessible from the upper left-hand corner of the Oracle Business Process Composer user interface as shown in [Figure 3-2](#).

Figure 3-2 Application Welcome Page Main Menu

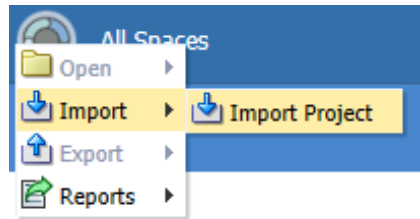

3. Select the space where you want to store your imported project.
You must create or choose a space before you can import a project.
4. Click **Browse**, then select the project file you want to import.
5. Click **OK** to import the project into the Oracle BPM repository.

How to Export a Project from the Application Welcome Page

Projects exported from Oracle Business Process Composer can be imported into Oracle BPM Studio. Exporting a project to your local file system allows you to share projects without using Oracle Process Asset Manager (PAM).

You can export a project from the application welcome pages' project list.

To export a project as an EXP file:

1. Find the project you want to export from the list of projects located in the project list, as shown in [Figure 3-3](#).

Figure 3-3 Project List - Project in List

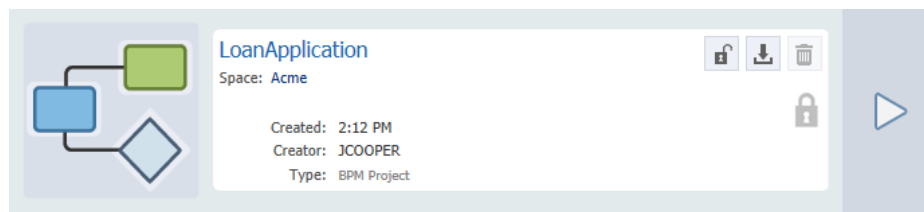

2. Click the Download icon (), which is located in the top right-hand corner.
3. Choose a location on your local file system and click **Save**.

Your exported project is saved as a.EXP file on your local file system.

How to Export a Project or Project Snapshot from the Project Welcome Page

Projects or project snapshots can be exported from Oracle Business Process Composer to your local file system from the Project Welcome page. Exporting a project or project snapshot

to your local file system allows you to share projects without using Oracle Process Asset Manager (PAM).

To export a project as an EXP file:

1. Open the project or project snapshot you want to export.
2. From the main menu select Export, then choose either to export the current project or the last published project, as shown in [Figure 3-4](#).

Note that only the **Last Published Project** option is available for project snapshots.

Figure 3-4 Project Main Menu - Export

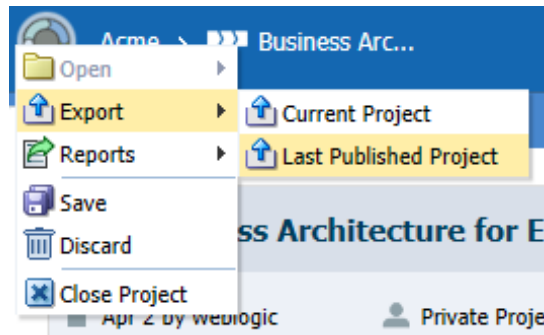

3. Choose a location on your local file system and click **Save**.
Your exported project is saved as a.EXP file on your local file system.

4

Performing Process Analysis and Discovery with Business Architecture

Using Oracle Business Process Composer, you can perform process analysis and discovery to determine how to improve the efficiency of processes within your organization. Learn how to work with Business Architecture (BA) projects and generate reports.

- [Introduction to Business Architecture](#)
- [Introduction to the BA Project Welcome Page](#)
- [Working with Business Architecture Reports](#)

Introduction to Business Architecture

Business Architecture is a methodology for performing high-level analysis of the business processes within your organization. These processes can be high-level processes that span an entire organization or specific, low-level processes performed within a specific group.

Business Architecture uses a top-down approach that allows for discovery of your organization's processes. You can define and evaluate high-level goals and map them to specific strategies for achieving them. You can also run reports on Business Architecture components to evaluate performance.

Oracle Business Process Composer provides a full-feature tool for performing analysis, refinement, and optimization of your business processes. This allows the business model to drive the IT development process by translating requirements into specific Business Process Model and Notation (BPMN) processes.

To create high-level models of your organization's processes, Oracle Business Process Composer provides capabilities for creating and editing the following:

- Enterprise Maps
- Value Chain Models
- Strategy Models

These components are described in the following sections.

Introduction to Enterprise Maps

Enterprise Maps provide a bird's eye view of your organization. They are models that show key process areas that reflect key business functions or services. The Enterprise Map is the entry point for process decomposition. Generally, there is only one Enterprise Map for the entire organization. This level defines the top-level business functions or process areas of the enterprise such as Marketing, Sales, Human Resources, and so on. Each top-level business further navigates down to a Value Chain Model into the next level, as shown in [Figure 4-1](#).

Figure 4-1 Business Architecture Project - Enterprise Map

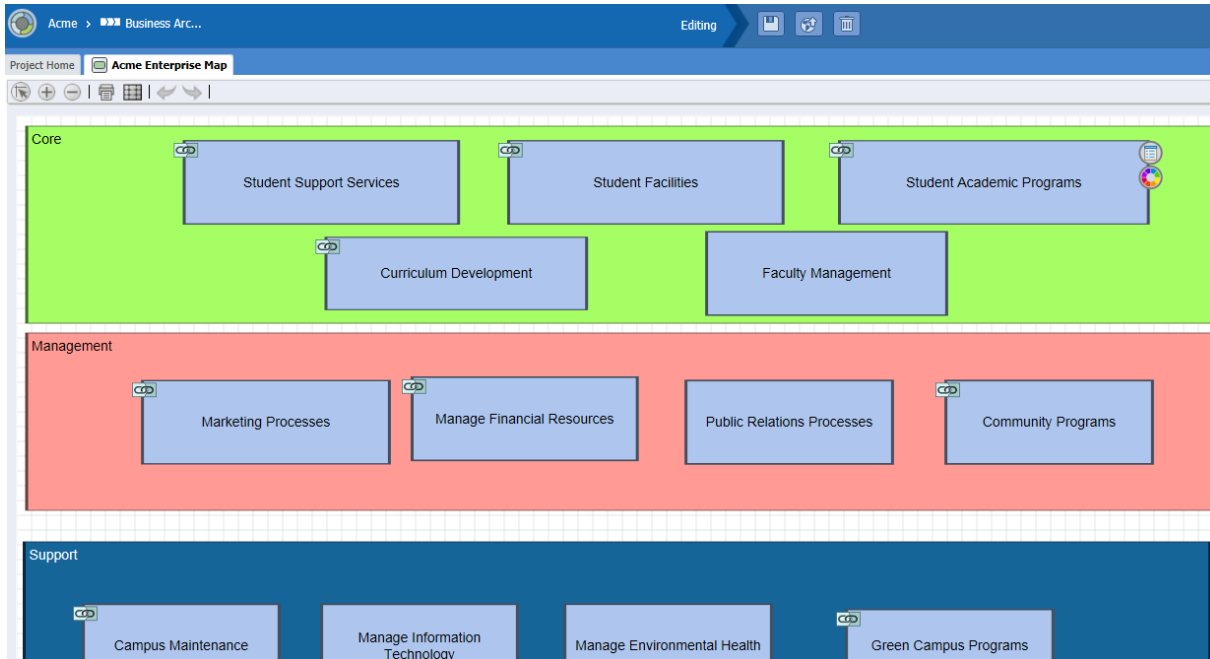

Enterprise Maps contain the following elements:

- **Lanes:** Provide a method for grouping process areas together within an Enterprise Map. Each Enterprise Map is created with three default lanes. These correspond to common divisions of process areas within an organization. The default lanes are:
 - **Core:** Core process areas are the areas that are essential to an organization. For example, a company that produces x may have purchasing, manufacturing, and sales.
 - **Management:** Management process areas are areas related to the management of an organization.
 - **Support:** Support process areas are areas that assist or enhance the core and management process areas in an organization.

When creating models of the process areas in your own organization, you can change the names of default lanes. You can also add additional lanes as necessary.

- **Process Areas:** Process areas correspond to the business functions of services. You can add one or more process areas to a lane. Each process area can be linked to a Value Chain Model, which provides more details about the specific procedures for each process area. You can assign organization units to lanes and process areas. You can also add attachments that provide additional information about your model and provide comments that make your processes easier to read.

Introduction to Value Chain Models

Value Chain Models allow you to specify more detail about your process. A Value Chain Model is a series of activities within an organization that perform a specific task. Value Chain Models

contain a series of value chain steps, which represent different stages of the process, as shown in [Figure 4-2](#).

Figure 4-2 BA Project - Value Chain

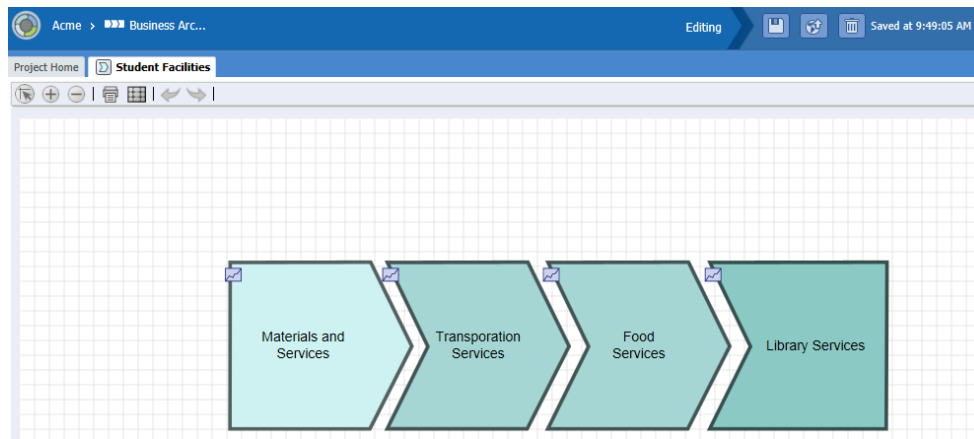

Each value chain step corresponds to a more detailed process performed by a smaller group. Each value chain step can be broken down into a separate Value Chain Model, creating a hierarchical group of value chain models. Alternatively, a sub-step can be linked to a BPMN process. BPMN processes define process flows that outline the IT requirements for implementing a process.

Within a Value Chain Model, you can also define key performance indicators (KPIs). KPIs are metrics that allow you to track important business information for an organization. For more information about using KPIs to track business data, see [Tracking Business Data in Your Application](#).

Value Chain Models are not required to have a start or an end step. In fact, they are not required to have any step at all (they can be blank).

Each link within a Value Chain Model can be linked to the following:

- Another Value Chain Model. This can be a Value Chain Model within the current BA project.
- A BPMN process. This process must be within a Business Process Management (BPM) project that you have permission to edit.



Note:

You can only link to a BA or BPM project within the space containing the current project.

Introduction to Strategy Models

Strategy Models help to define the corporate objectives and goals of an organization and create a strategy for achieving them. Strategy Models allow you to break a goal down into a series of actionable steps. They allow you to map high-level goals down to low-level business processes and tasks performed and implemented by an IT organization, as shown in [Figure 4-3](#).

Figure 4-3 BA Project - Strategy Model

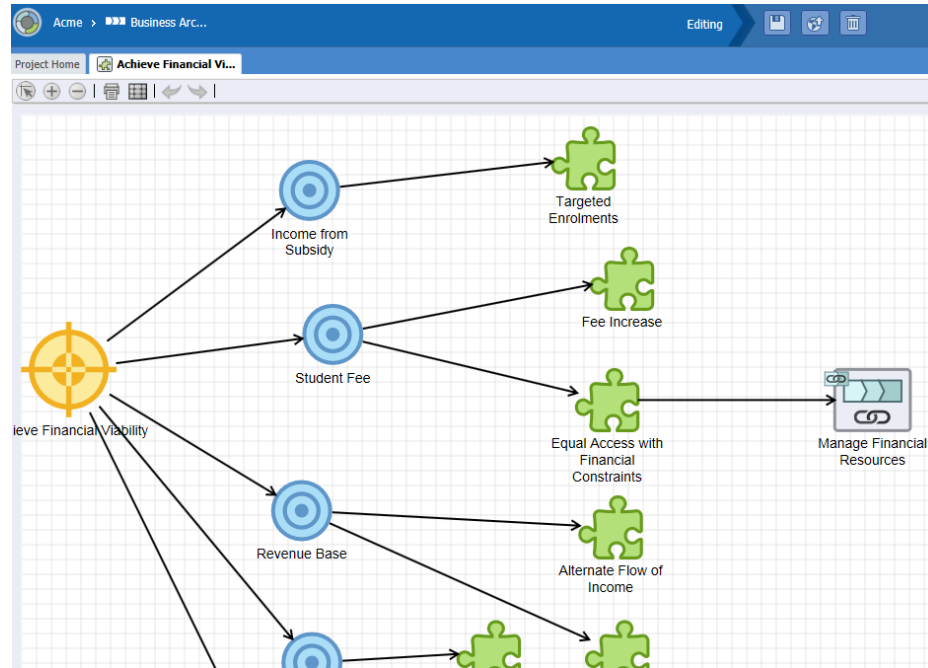

Strategy Models contain the following components:

- **Goal:** Defines the desired end result specified by the strategy model.
- **Objective:** A goal can be broken down into one or more objectives.
For example, the goal of achieving faculty excellence in an educational institute can be broken down into impacted objectives such as size and quality of the faculty, faculty compensation, and so on. The objectives are hierarchial, which means that an objective can be broken down into child objectives.
- **Strategy:** Defines the plan to achieve an objective.
For example, the objective of financial compensation can be achieved by using strategies for faculty salaries and perk benefits. Although strategies define how objectives are achieved, they are still high-level. The specific details for achieving an objective can be further refined by linking to a Value Chain Model.
- **Value Chain:** This is a reference to a Value Chain in this or another BA project.
It references (or links) to the value chain that defines the details of how this strategy is implemented. The Value Chain reference can also reference a BPMN process within a BPM project.

Using KPIs to Analyze Performance

KPIs define how an organization's performance is tracked against its objectives. [Working with Key Performance Indicators \(KPIs\)](#) describes how to use KPIs.

Introduction to the BA Project Welcome Page

The BA Project Welcome Page provides access to information about a BA project and access to common project-related features.

Figure 4-4 shows the Project Welcome Page for the Business Architecture for Education example project.

Figure 4-4 Business Architecture Project Welcome Page

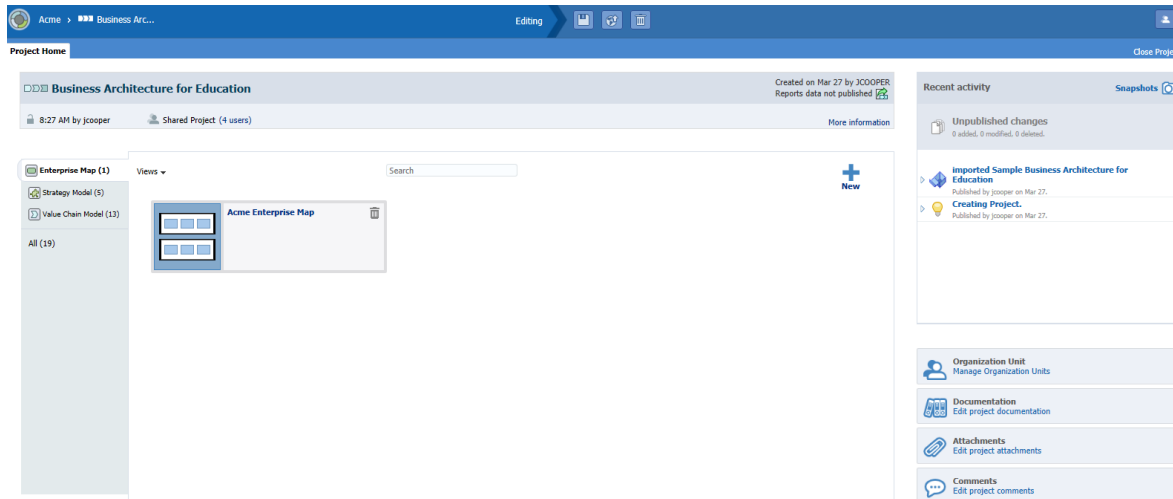

Use the Oracle Business Process Composer BA Project Welcome page to perform the following types of tasks:

- Edit and view a project's general information
- Create and manage project components
- Edit and publish BA projects
- Access the Quickstart menu

For more information about sharing projects, saving projects, discarding changes, and other general functions, see [Creating and Managing BA and BPM Projects](#).

The Oracle Business Process Composer BA Project Welcome page is divided into the following sections:







- Project toolbar
- Project Information panel
- Recent Activity panel
- Project Component pane
- Quickstart menu

Introduction to the Project Toolbar

The Oracle Business Process Composer BA project toolbar is located across the top of page and provides access to the Oracle Business Process Composer BA projects main menu as well as allowing you to save and publish your projects.

The toolbar provides access to the functions listed in [Table 4-1](#).

Table 4-1 Oracle Business Process Composer BA Project Welcome Page - Toolbar

Toolbar Element	Description
Main Menu 	Click to access the BA Project Welcome Page's main menu. From here you can use the Main Menu to: <ul style="list-style-type: none"> • Export a project • Publish report data • Generate BA project reports • Discard changes made to a project • Share a project • Close the current project
Viewing Mode	--
Edit 	Click this icon to toggle to the edit mode. When you first open a shared project, it opens in view mode. If the project isn't locked by another participant, you can click this icon to change to the edit mode if you have the correct permissions.
Editing Mode	--
Save 	Click to save the current project and continue editing.
Publish 	Click to publish the project data. Publishing a project makes the changes you have recently made available to other participants.
Discard 	Click to discard changes made to this project since the last publication.
Participants 	Displays the project type. In this case the project type is <i>Private</i> .
Close Project	Click to close the current project and return to the Oracle Business Process Composer Application Welcome page.

Introduction to the Project Information Panel

The project information panel displays general information about the project, as shown in [Figure 4-5](#).

Figure 4-5 BA Project Welcome Page- Information Panel

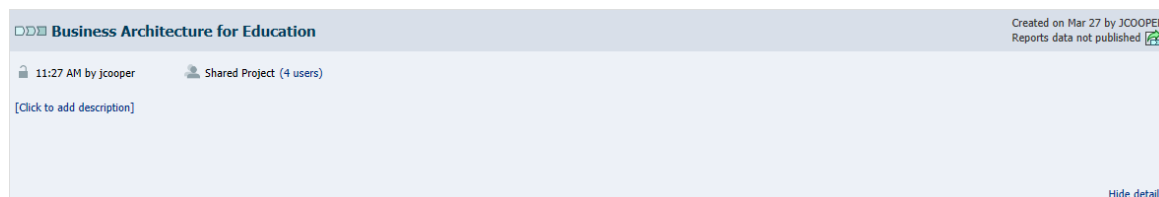

This pane displays the following information:

- **Title Bar:** Displays the name, creation date, and name of the user who created the project. Click the icon located below the user name to publish reports data.
- **Lock:** Displays the time and name of the user who is currently editing the project and has locked the project.

- **Type:** Displays the project type.
If the project is shared, it displays a link to the Team dialog where you can change the roles of team members.
- **More Information:** Click to display more general information.
Click **Hide Details** to hide the additional information.
- **Description:** Displays the project description.
Descriptions are one or two sentence expansions of the title to help a user distinguish between projects of similar or same titles.
Click the link to edit the description.

Introduction to the Recent Activity Panel

The recent activity browser provides a history of the major changes made to the current BA project.

Snapshots

Snapshots are created from the latest published project. Click the **Snapshots** link to open the Snapshot dialog where you can create and view the snapshots for this BPM project. Snapshots allow you to create backups of your projects and view the changes made to a project over time. Snapshots provide a record of the changes made to a project during the development life-cycle. For more information about snapshots, see [Working with Project Snapshots](#).

Introduction to the Project Component Pane

Use the project component pane to view and create the following project components:

- Enterprise Maps
- Strategy Models
- Value Chain Models

Listed to the right-hand side of each of the project components is the number of components created for this project. Located below the list of project components is the number for *All*.

Introduction to the Quickstart Menu

Use the Quickstart menu to quickly access the following common functionality within Oracle Business Process Composer:

- **Organization Unit:** Opens the Organization Units dialog, which allows you to create and browse the organization units defined for a project.
- **Documentation:** Opens the Documentation tab within the project properties panel, which allows you to view and edit project-level documentation.
Project documentation can be a one or two sentence an expansion of title or information that is required for comprehension.
- **Attachments:** Opens the Attachments tab within the project properties panel, which you can use to attach supplementary documents that are important to your BA project.
From the attachments tab, you can view, add or delete attachments.
- **Comments:** Opens the Comments tab within the project properties panel and can be used to add brief comments.

Comments are permanently attached to a project and should be used when it is important to keep a record.

Working with Enterprise Maps

Create and edit Enterprise Maps from the Project Welcome page.

You can create an Enterprise Map:

- for an existing BA project
- for a new project

Creating an Enterprise Map for an Existing BA Project

Use the Enterprise Map link on the BA Project Welcome page to create an Enterprise Map for an existing project.

To create an Enterprise Map for an existing BA project:

1. Open your BA project.
2. From the BA Project Welcome page, click the **Enterprise Map** link.
3. Click **New**, then enter a name and description for the Enterprise Map.
4. Click **Save**.

To open an Enterprise Map, click the name of the Enterprise Map in the Business Architecture Welcome page.

Creating an Enterprise Map for New BA Project

Use the Enterprise Map dialog to create an Enterprise Map for a new project.

To create an Enterprise Map for a new BA project:

1. Access the Application Welcome page.
2. Click **Enterprise Map** from the BA Project panel, as shown in [Figure 4-6](#).

Figure 4-6 BA Project - Enterprise Map Dialog

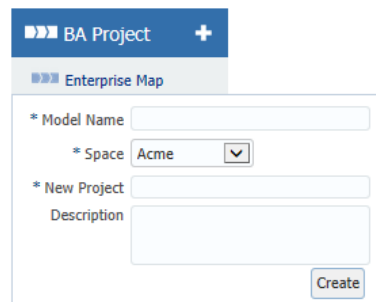

3. Enter a name for the Enterprise Map.
4. Select the Oracle Business Process Composer space where you want to create the enterprise map.
5. Enter a name for the new BA project.

6. Enter a description.

Descriptions are one or two sentence expansions of the title to help a user distinguish between projects of similar or same titles.

7. Click **Create**.

How to Add Lanes and Process Areas to an Enterprise Map

Using the Enterprise Map editor, you can add lanes and process areas to an Enterprise Map.

To add a lane to an Enterprise Map or process area:

1. From the component palette, click and drag a lane or process area to the position in the Enterprise Map editor canvas.
2. To resize the lane or process area, click it, then click and drag one of the corners.
3. To reposition the lane or process area, click and drag it to the new position.
4. To rename the lane or process area, double click the name, then enter a new one.

How to Assign and Organization Unit to a Lane or Process Area

Organization units enable you to define the groups within your organization that perform the work defined in your process models. You can assign an organization unit to a lane or process area.

To assign an organization unit to a lane or process area:

1. Move the mouse over the lane or process area.
2. Move the mouse over the edit (pencil) icon, then click the properties icon.
The Properties Editor appears in the lower area of the application.
3. In the Properties Editor, click **Search** next to the **Organization Unit** field.

How to Assign a Value Chain Model to a Process Area

You can assign a Value Chain Model to a process area.

To assign a Value Chain Model to a process area:

1. Move the mouse over the process area.
2. Move the mouse over the edit (pencil) icon, then click the properties icon.
The Properties Editor appears in the lower area of the application.
3. In the Properties Editor, click the **Search** icon next to the **Value Chain** field.
4. Select a BA project from the list.
5. Click **Next**.
6. Select a Value Chain Model from the list.
7. Click **Finish**.

Working with Value Chain Models

Using the Value Chain Editor, you can create and edit Value Chain Models.

If you intend to have a strategy implemented through a value chain, you must create an empty value chain model and link to it from the value chain in the strategy model. If you link the value chain model to the strategy, the value chain model does not display in the impact analysis report.

How to Create a Value Chain Model

To create a Value Chain Model:

1. Open your BA project.
2. Select the **Value Chain Model** tab.
3. Click **New**, then enter a name.

The new model appears in the **Value Chain Model** tab. By default, the list appears with icons for each Value Chain Model.

4. Optionally, to select a different view, click the **View** button, then select **Grid**.
5. To open a Value Chain Model, click its name.

How to Assign BPM Projects or Value Chain Models to a Step within a Chain

To assign a BPM Project or Value Chain Model to a step within a chain:

1. Open your Value Chain Model.
2. Move the mouse over the appropriate step.
3. Move the mouse over the edit icon, then click **Edit**.
4. In the Properties Editor tab, click the **Browse** button next to BPM or Value Chain.
5. Select a BPM or BA project from the list, then click **Next**.
6. If you selected a BPM project in the previous step, click a business process from the list.
If you selected a BA project in the previous step, select a Value Chain Model from the list.
7. Click **Finish**.

How to Edit the Properties of a Value Chain Model Step

To edit the properties of a Value Chain Model step:

1. Move the mouse over the step whose properties you want to edit.
2. Click the edit properties icon.

The Properties tab displays in the lower portion of the screen.

3. Click **Edit Properties**.
The Property Editor dialog appears.
4. Edit the properties as necessary, then click **OK**.

Working with Strategy Models

New Strategy Models can be created from the Oracle Business Process Composer Application Welcome Page or the BA Project Welcome page. You can then use the Strategy Model Editor to edit Strategy Models.

Creating a Strategy Model from the Business Architecture Welcome Page

To create a Strategy Model from the Business Architecture Welcome page:

1. Open your BA project.
2. Go to the Project Component pane and click Strategy Models.
3. Click **New**, then enter a name for the Strategy Model.
4. Click **Save**.

Creating a Strategy Model from the Application Welcome Page

To create a Strategy Model from the Application Welcome page:

1. Access the Application Welcome page.
2. Click **Strategy Model** from the **BA Project** panel.
3. Enter a name for the Strategy Model.
4. Select the Oracle Business Process Composer space where you want to create the Strategy Model.
5. Enter a name for the new BA project.
6. Click **Create**.

How to Edit a Strategy Model

To edit a Strategy Model:

1. Access the BA Project Welcome Page
2. Go to the Project Component pane and click Strategy Models.
3. Click the name of the Strategy Model you want to edit.
The selected Strategy Model opens in the Strategy Model Editor.
4. Drag and drop a Goal, Objectives, Strategies and Value Chain references to the canvas, as shown in [Figure 4-3](#).

A goal can be linked to one or more Objectives, an Objective can be linked to one or more Strategies, and a Strategy can be linked to one or more Value Chain references.

Creating Value Chain References

To create a Value Chain reference:

1. Drag and drop a Value Chain reference to the canvas.
2. Right click on the Value Chain reference and select properties.
3. In Properties dialog there is a field called **Link**, click on browse button and select an already created Value Chain Model.

Working with Key Performance Indicators (KPIs)

Use Oracle Business Process Composer to create, edit, and delete KPIs. For more information about working with KPIs see [Working with Key Performance Indicators \(KPIs\)](#).

How to Create a KPI

You can create KPIs within a BA project on:

- Strategy Model: Objective, Strategy, or Value Chain Model
- Value Chain Model: Value Chain Step

To create a KPI:

1. Open a BA project.
2. Open a Strategy Model or Value Chain Model.
3. Right-click on a Strategy Model object (*Objective, Strategy, or Value Chain*) or a Value Chain Model object (*Value Chain Step*), then select **KPIs**.
4. In the KPI tab, click **Add KPI** to display the New KPI dialog.
5. Enter the following information:

- **Name:** Enter a name for the KPI. This name cannot be changed.
- **Display Name:** Enter a display name.

This is the name that users see in BAM dashboards.

Description: Enter a description. This field is optional.

Type: Specify the type of KPI. Choose *External, Manual, or Rollup*.

For more information about creating KPIs, see [Tracking Business Data in Your Application](#) .

6. Click **OK** to create the KPI.

How to Edit the Properties of a KPI

After creating a KPI, you can edit its properties.

To edit the properties of a KPI:

1. Open a BA project.
2. Open a Strategy Model or Value Chain Model.
3. Right-click the object that contains the KPI.
4. Select the KPI link.
5. Click the edit icon for the KPI that you want to edit to display the Edit KPI dialog, as shown in [Figure 4-7](#).

Figure 4-7 Edit KPI Dialog

The screenshot shows the 'Editing KPI for Objective 1' dialog box. It is organized into three main sections: KPI, Measure, and Target. The KPI section contains fields for Name (OrderAmount), Display Name (Order Amount), Description (Order Amount), and Type (External). The Measure section includes Measure Name (OrderAmount), Operation (Total), and Time Range (Last 7 Days). The Target section features Target Type (Simple), Target Value (1,000), Allowed Deviation (None), and three range settings: Greater than Acceptable Range (Danger), Inside Acceptable Range (OK), and Less than Acceptable Range (Warning). The dialog concludes with OK and Cancel buttons.

6. Edit the KPI as necessary, then click **OK**.

Working with Business Architecture Reports

Oracle Business Process Composer also allows you to run reports on a BA project to view how the various components work together.

Business Architecture allows you to model the processes within your organization using Enterprise Maps, Value Chain Models, and Strategy Models.

How to Publish Report Data

Before you can generate a Business Architecture report, you must publish the report data for your BA project. Additionally, you must publish any changes you have made to your project before publishing the report data.

Note:

Ensure that BAM connection is up and running before you publish report data. For more information, see *Extending the SOA Domain to Include Oracle Business Activity Monitoring* in the *Enterprise Deployment Guide for Oracle SOA Suite* guide.

To publish report data:

You can publish report data from the Oracle Business Process Composer Application Welcome page.

1. From the Main Menu, select **Publish Report Data**.
2. Select a project.

You can select any project that you own or have permission to edit. The projects selected can be in different spaces.

Figure 4-8 Publish BA Reports Data Dialog

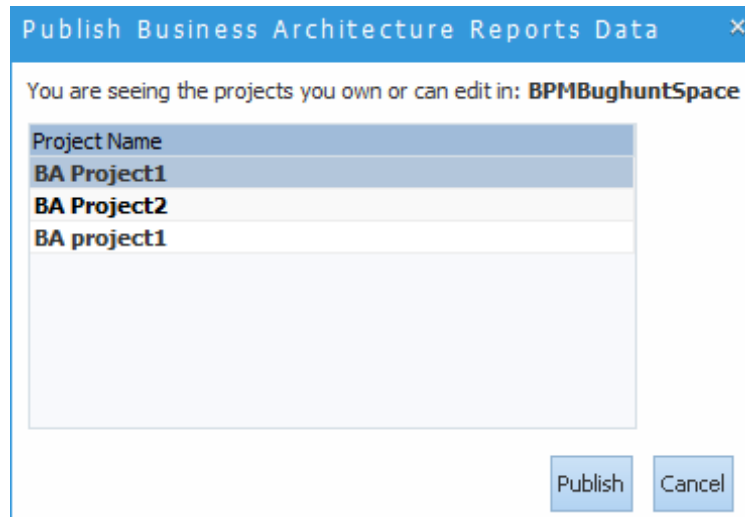

3. Click **Publish**.

How to Generate BA Reports

After you have published the report data, you can generate reports from the Oracle Business Process Composer Application Welcome page. The report types available are:

- Process Criticality report
- Impact Analysis report

To generate BA reports:

1. Go to the Oracle Business Process Composer Application Welcome page.
2. Click the main menu and select to generate either the Process Criticality report or the Impact Analysis report, as shown in [Figure 4-9](#).

Figure 4-9 Oracle Business Process Composer Application Welcome Page - Main Menu

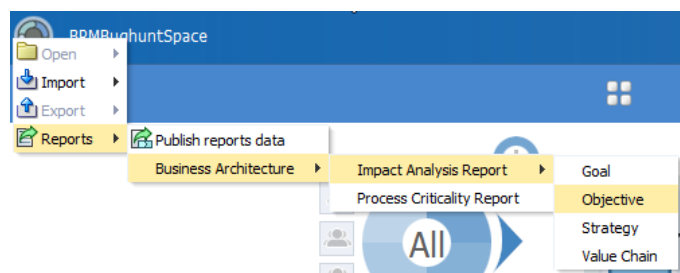

When you select to generate an impact analysis report, you must choose to base your report on one of the following:

- **Goal:** What are my goals?
- **Objective:** How are goals and objectives fulfilled by strategies?
- **Strategy:** How are goals, objectives, strategies, and value chains linked?
- **Value Chain:** How are goals, objectives, strategies, value chains, and processes linked?

3. Business Architecture reports are displayed in a report browser.

Interpreting the Impact Analysis and Process Criticality Reports

Impact Analysis Report

The Impact Analysis report is based on Strategy Model that shows different properties and hierarchy of BA components, as shown in [Figure 4-10](#).

Figure 4-10 Sample Impact Analysis Report

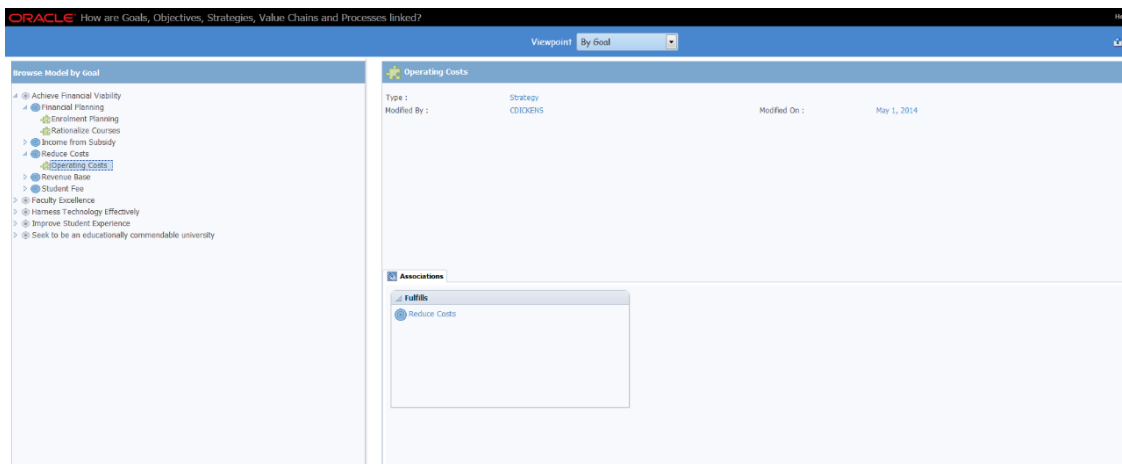

The Impact Analysis report uses published data stored in the Oracle BPM repository.

Process Criticality Report

The Process Criticality report is based on the Value Chain Models within a project. Oracle Business Process Composer displays a row for each Value Chain Model, as shown in [Figure 4-11](#).

Figure 4-11 Sample Process Criticality Report

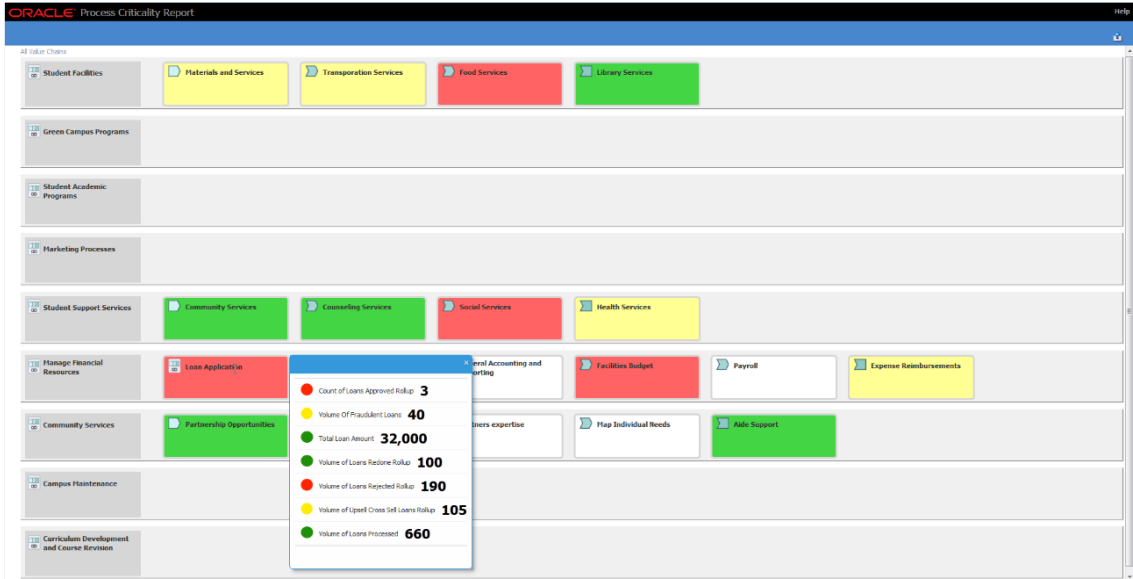

Business Architecture leverages Oracle Business Activity Monitoring (Oracle BAM) for KPI evaluation, which is an important feature of Process Criticality report. Therefore, the Process Criticality report uses published data stored in the Oracle Business Activity Monitoring (Oracle BAM) repository.

In order to publish data for this report, you must have the Oracle BAM server running. To enable Oracle BAM, the `processMetrics` system bean must be also enabled.

For more information about enabling the `processMetrics` system bean in Oracle BAM, see *Monitoring Business Activity with Oracle BAM*, "Integrating with Oracle Business Process Management", Enabling Process Metrics.

5

Creating and Working with BPM Projects

Create and use Business Process Management (BPM) projects using Oracle Business Process Composer.

- [Introduction to Oracle BPM Projects](#)
- [Introduction to the Project Welcome Page](#)
- [Creating and Working with Projects](#)
- [Using Guided Business Processes to Create Project Milestones](#)
- [Defining Project Roles, Business Parameters, and Organization Units](#)
- [Generating Process Reports for Your Project](#)

Introduction to Oracle BPM Projects

A BPM project is the core element of an Oracle BPM application. BPM projects contain the resources used to create and support a business application. These include business processes and components of the business catalog, including data objects, services, Business Rules, Human Tasks, and roles.

You can create new projects directly in Oracle Business Process Composer.

BPM projects promote collaboration between process analysts and process developers. Oracle Business Process Composer and Oracle BPM Studio users can share projects using the Oracle BPM repository. See [Introduction to the Oracle BPM Repository](#) for more information.

You can validate BPM projects and deploy them to runtime using Oracle Business Process Composer. See [Deploying a BPM Project](#) for more information.

Introduction to Project Components and Resources

Each project contains one or more business processes and may include other resources used by the business processes or application. These include reusable resources that allow you to connect your application to other applications and systems or define the user interface of your application.

Oracle Business Process Composer enables you to create, test, and deploy a fully-functioning BPM application. However, there are some advanced features that can only be performed using Oracle BPM Studio. These include:

- Configuring advanced human task parameters
- Creating and viewing ADF forms
- Creating external references
- Creating exceptions

Editable Project Resources

Using Oracle Business Process Composer, you can create and edit the following project resources:

- Processes

A business process is the core element of a business application. A process is defined as a related set of tasks or activities. An Oracle BPM application can contain one or more processes. Oracle Business Process Composer allows you to create and edit Business Process Model and Notation (BPMN) processes.

From the BPM Project Welcome page you can create new processes and edit existing ones. See [Creating and Working with Business Processes](#) for information on creating and working with processes.

- Oracle Business Rules

Oracle Business Rules are statements that describe business policies or describe key business decisions. Using Oracle Business Process Composer you can create and edit business rules. Business rules are editable components of a project, but they also appear as part of the business catalog.

See [Using Oracle Business Rules](#) for information.

- Human Tasks

Oracle Business Process Composer allows you to create and edit human tasks. Human tasks are used to define how users interact with your process-based applications.

From the BPM Project Welcome page, you can create new human tasks and edit existing ones. See [Working with Human Tasks](#) for more information. After creating a human task, it is accessible within the business catalog.

- Web Forms

Web forms define the interface that your application users see in Process Workspace. Oracle Business Process Composer allows you to create this interface from the ground up, or you can create a web form based on the existing data structure of a human task.

See [Working with Web Forms](#) for more information.

 **Note:**

Although web forms are a resource of a BPM project, they can only be created and edited in Oracle Business Process Composer. They cannot be viewed or edited in Oracle BPM Studio.

- Business Components

Business components represents real world concepts or objects such as a ticket, request, or employee. Business components are complex data types that you use to create the data structures required in your Oracle BPM application. You can use Oracle Business Process Composer to create complex data types manually or based on an XML schema.

See [Using Complex Data Types to Define Data Structures](#) for more information.

- Key Performance Indicators (KPIs)

KPIs represent the result of a business measure such as product sales or operational costs, evaluated against a target for that measure. KPIs can be created for a process or a specific activity within a process.

See [Tracking Business Data in Your Application](#) .

- Business Indicators

Business indicators are project data objects you use to store the value of the KPIs. Business indicators can be an attribute, counter, dimension, or measure.

See [Tracking Business Data in Your Application](#) .

- Simulation Definitions and Models

Use simulations to test the performance of your business processes. Simulations definitions and models define parameters used in a simulation and are stored as part of a BPM project.

See [Simulating Process Behavior](#) for more information.

- Activity Guides

An activity guide is a part of Guided Business Processes that allows you to define milestones for a project. Each project contains one activity guide where you can define multiple project milestones. Oracle Business Process Composer allows you to create and configure milestones.

See [Using Guided Business Processes to Create Project Milestones](#) for more information about creating and using project milestones.

The Business Catalog

Note:

With patch [23995890](#), the prior implementation of the Business Catalog in Oracle Business Process Composer is not available in this release due to the deprecation of Adobe Flash Player in the process editor. To use the Business Catalog, you can use Oracle BPM Studio (in JDeveloper) or contact Oracle Support for assistance.

Introduction to the Oracle BPM Repository

The Oracle BPM repository is based on Process Asset Manager (PAM), which serves as the design time repository to which projects are saved and shared between Oracle Business Process Composer and Oracle Business Process Management Studio.

Your system administrator installs and configures the Oracle BPM repository when installing Oracle Business Process Composer.

See [Creating and Working with Projects](#) for more information about opening projects in the Oracle BPM repository.

Introduction to the Project Welcome Page

The Project Welcome Page provides access to information about a BPM project and access to common project-related features.

Figure 5-1 shows the Project Welcome Page for the Travel Request Application example project.

Figure 5-1 The Project Welcome Page

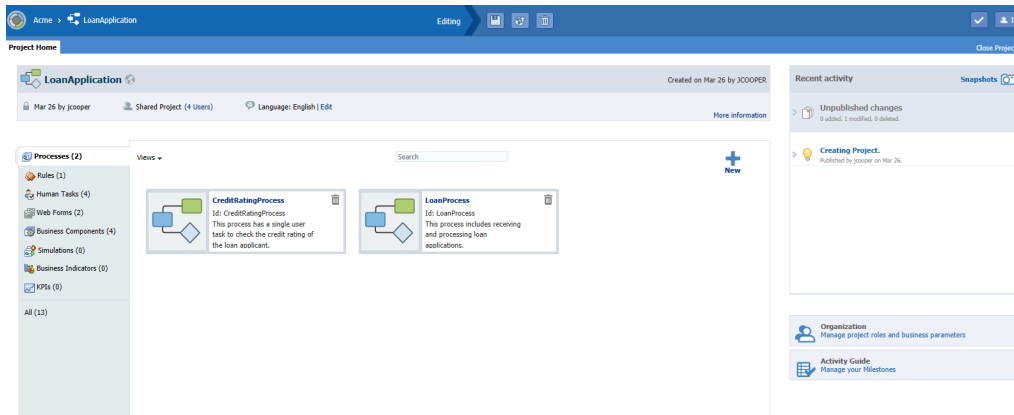

Use the Oracle Business Process Composer Project Welcome page to perform the following types of tasks:

- Edit and view a project's general information
- Create and manage project components
- Edit, validate, and publish BPM projects
- Access the Quickstart menu

For more information about sharing projects, saving projects, discarding changes, and other general functions, see [Creating and Managing BA and BPM Projects](#).

The Oracle Business Process Composer Project Welcome page is divided into the following sections:









- Project toolbar
- Project Information panel
- Recent Activity panel
- Project Component panel
- Quickstart menu

Introduction to the Project Toolbar

The Oracle Business Process Composer project toolbar is located across the top of page and provides access to the Oracle Business Process Composer projects main menu as well as allowing you to save, publish, and validate your projects.

The toolbar provides access to the following:

Table 5-1 Oracle Business Process Composer Project Welcome Page - Toolbar

Toolbar Element	Description
Main Menu 	Click to access the Project Welcome Page's main menu. From here you can use the Main Menu to: <ul style="list-style-type: none"> • Create a new simulation or service • Import a project model • Export a project • Generate a process report • Save a project • Discard changes made to a project • Validate a project • Close the current project
Viewing Mode	--
Edit 	Click this icon to toggle to the edit mode. When you first open a shared project, it opens in view mode. If the project isn't locked by another participant, you can click this icon to change to edit mode.
Editing Mode	--
Save 	Click to save the current project and continue editing.
Publish 	Click to publish the project data. Publishing a project makes the changes you have recently made available to other participants.
Discard 	Click to discard changes made to this project since the last publication.
Player 	Click to run the process player. This icon is only visible if the process player has been configured. For more information about the process player, see Using Process Player .
Validate 	Click to validate this project.
Participants 	Displays the project type. In this case the project type is <i>Private</i> .
Close Project	Click to close the current project and return to the Oracle Business Process Composer Application Welcome page.

Introduction to the Project Information Panel

The project information panel displays general information about the project.

This pane displays the following information:

- **Title Bar:** Displays the name, creation date, and name of the user who created the project. Click the icon to the right-hand side of the name to change the localized name.
- **Creation:** Displays the creation date and name of the user who created the project.
- **Type:** Displays the project type.
- **Language:** Use the drop-down list to choose the language for this project.

Click **Edit** to add language options to the drop-down list. Note that in order to work with additional languages in the Web Forms Internationalization dialog the languages must be added here first.

- **More Information:** Click to display more general information.

Click **Hide Details** to hide the additional information.

- **Sampling Point:** Click **Change** to select either: *Generate for All*, *Generate for Interactive(s)*, *Do not generate*, or *Generate for process(es) only*.
- **Description:** Displays the project description.

Descriptions are one or two sentence expansions of the title to help a user distinguish between projects of similar or same titles, as shown in [Figure 5-2](#).

Figure 5-2 Project Description

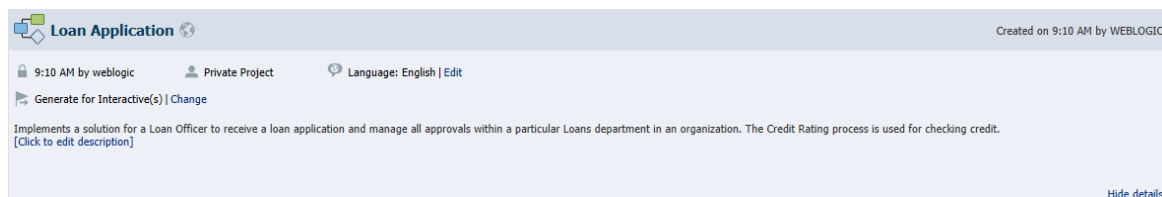

Click the link to edit the description.

Introduction to the Recent Activity Panel

The recent activity browser provides a history of the published changes made to the current BPM project.

See [How to View the History of Changes Made to a Project](#) for information about viewing recent project activity.

Snapshots

Snapshots are created from the latest published project. Click the **Snapshots** link to open the Snapshot dialog where you can create and view the snapshots for this BPM project. Snapshots allow you to create backups of your projects and view the changes made to a project over time. Snapshots provide a record of the changes made to a project during the development life-cycle. For more information about snapshots, see [Working with Project Snapshots](#).

Introduction to the Project Component Panel

Use the project component pane to view and create the following project components:

- Processes
- Rules
- Human tasks
- Web forms
- Business components
- Simulations

- Business Indicators
- KPIs

Listed to the right-hand side of each of the project components is the number of components created for this project. Located below the list of project components is the number for All.

Introduction to the Quickstart Menu

Use the Quickstart menu to quickly access the following common functionality within Oracle Business Process Composer:

- **Organization:** Opens the organization editor which allows you to create and browse the roles and business parameters defined for a project.
For more information, see [Defining Project Roles, Business Parameters, and Organization Units](#).
- **Activity guide:** Launches the activity guide editor that enables you to manage milestones within your project.

Introduction to the Oracle Business Process Composer Editors

You can use editors to work with various elements of a BPM project, including processes and components of the business catalog.

The following sections describe the different types of editors available in Oracle Business Process Composer.

Process Editor

You can use the process editor to view and edit business processes. You can access the process editor by opening a process from the Project Welcome page.

The editor window also contains a component palette. The exact components available depend on the following:

- In new projects created in Oracle Business Process Composer, the component palette displays BPMN flow objects and business catalog components that you have created.

You can create services and human tasks directly in Oracle Business Process Composer.

See [Creating and Working with Business Processes](#) for more information.

Activity Guide Editor

Use the Activity Guide editor view, create, and edit milestones within an activity guide. You can access the Activity Guide editor by clicking the **Activity Guide** link in the Quickstart menu. See [Using Guided Business Processes to Create Project Milestones](#).

Human Task Editor

Use the Human Task editor to create and edit human tasks included as part of the business catalog. See [Working with Human Tasks](#) for more information.

Business Rules Editor

Use the business rules editor to create, view and edit Business Rules. To access the business rules editor, open a business rule from the project Welcome page. See [Using Oracle Business Rules](#) for more information.

Data Associations Editor

Use the data associations editor to define the input and output for flow objects that contain implementations. To access the data associations editor, right-click a flow object within your business process and select **Data Associations**.

See [Working with Data Objects](#) for information about using data associations.

Expression Editor

Use the expression editor to define the expressions used within data associations and conditional sequence flows.

See [Using Expressions to Control Data](#) for information on using expressions and accessing the expression editor.

Introduction to the Supporting Browsers and Editors

Oracle Business Process Composer contains additional editors for viewing and editing other project components. These appear in the lower portion of the application window.



Note:

These editors are not displayed by default. They appear after performing actions related to each window. However, to display them manually click the **Restore Pane** icon in the lower right corner of Oracle Business Process Composer.

Project and Process Validation Browser

The project and process browsers display any validation errors for each individual process or the whole project. See [How to Validate a Project](#) for more information about validating projects.

Documentation Editor

Use the documentation editor to create and edit documentation for your processes.

See [Documenting Your Process](#) for more information.

Creating and Working with Projects

You can create and validate a new project, and view the change history and project properties.

The following sections provide information on how to create and use Oracle BPM projects.

For more information about sharing projects, saving projects, discarding changes, and other general functions, see [Creating and Managing BA and BPM Projects](#).

How to Create a New Project

New BPM projects are created from the Application Welcome page. These projects contain only basic business processes created by process analysts. You can use the BPM Project panel to create a new empty project or create new projects containing a process.

See [Creating a New Empty Project with the BA Project Panel](#) and [Creating a New Populated Project with the BA Project Panel](#) for more information.

How to Validate a Project

Validating a project allows you to check your project and processes for any errors. Oracle Business Process Composer displays these errors in the error browser. Oracle Business Process Composer has an error browser for the project and one for each process.

[Figure 5-3](#) shows an example of the types of errors displayed in the project error browser.

Figure 5-3 The Project Error Browser

Source Node	Message/Description
RequestQuote > CatchEvent	Node 'CatchEvent' has no implementation defined
RequestQuote > CatchEvent1	Node 'CatchEvent1' has no implementation defined
Process > UserTask	Node 'UserTask' has no implementation defined
Process > ServiceTask	Node 'ServiceTask' does not have an outgoing Default Sequence Flow
Process > ServiceTask	Node 'ServiceTask' has no implementation defined
Process > BoundaryEvent	Error not defined in Event 'BoundaryEvent'
Process > BoundaryEvent1	Node 'BoundaryEvent1' has no implementation defined

To validate a project:

1. Open your project.
2. Ensure that you are editing the project.
3. From the main menu, select **Validate Project**.

After validating your project, any errors found are displayed in the error browser for the project or process.



Note:

You cannot deploy projects that contain errors.

How to View the History of Changes Made to a Project

To view the history of major changes made to a project, use the recent activity browser. This browser displays these changes, including the following:

- Creating the project
- Modifying resources
- Creating processes or human tasks

To view the history of a project:

1. Navigate to the Project Welcome Page.
Project changes are displayed in the Recent Activity pane.
2. To view the details of a specific change, click the expand icon next to it.

How to View and Edit Project Properties

To view and edit project properties, use the project information pane of the Project Welcome Page.

You can edit the following properties of a project from this pane:

- **Description:** Adds an optional description of your project. This is useful when sharing your project with other users.
- **Event generation:** Configures how sampling points are generated for the project as a whole.

Use sampling points to generate information about the performance of a flow object within in a running process. The data generated according to this configuration is stored in the Process Analytics Database.

For more information on sampling, see *Using Dashboards in Process Workspace in Managing and Monitoring Processes with Oracle Business Process Management*.

You can view the following project properties from the project information pane:

- **Edit mode:** Displays the edit mode for the project.
See [How to Edit a Shared Project](#) for information on changing the edit mode of a project.
- **Sharing:** Displays the sharing configuration of the project.
- **Project Language:** Displays the project language.

Using Guided Business Processes to Create Project Milestones

Guided Business Processes provide a guided visual representation of a process flow, improving the user experience by providing process participants with an encapsulated hierarchical view of the business process.

The following sections describe how to use Guided Business Processes and project milestones.

Introduction to Guided Business Processes

Process designers can use Guided Business Processes to direct process participants to complete a business process through a set of guided steps associated with the process. By following the steps outlined in a Guided Business Process, process participants require less training to complete a business process, and the results of the process are more predictable.

Introduction to Activity Guides and Milestones

A Guided Business Process is modeled as an activity guide based on a business process. The Activity Guide includes a set of milestones. A milestone is a contained set of tasks that the

process participant must complete. A milestone is complete when the user successfully runs a specific set of tasks in the milestone.

Each milestone is a specific set of human workflow tasks. Each human workflow task is itself a task flow that may require the collaboration of multiple participants in various roles. Depending on the nature of the task flows, a participant can save an unfinished task flow and go back to it at a later time.

How to Configure the Activity Guide

Use Oracle Business Process Composer to configure Guided Business Processes and add milestones to them.

To configure the activity guide for a project:

1. Open your project.

2. From the Quickstart menu, select **Activity Guide**.

The activity guide editor is displayed.

3. Enter a title for the activity guide.

4. Configure the following optional properties:

- **Display Mode:** Determines how milestones and tasks within the Guided Business Process display links.

If the milestones and tasks use another configuration, then the guided business process configuration is ignored.

Possible values are:

- **Always:** Always displays the milestone and task links for all the milestones in this Guided Business Process.
- **When Instantiated:** Displays the milestone and task links only when one or more of the user tasks in the milestone are instantiated, for all the milestones in the Guided Business Process.

- **Task Access:** After the task is completed, the Guided Business Process uses this configuration to display the links.

If the task mode is active only, the tasks links are grayed out. If the task mode is any state, the tasks links remain enabled and a message appears when you run the task.

Possible values are:

- **Active Only:** The link to the task is enabled only when the task is active and the user can update it.

When you complete the task the link to the task, is grayed out.

- **Any State:** After you instantiate a task, the link to it is always enabled, even after you complete it.

- **Root Process:** Determines the process used for this Activity Guide.

You can only define one Guided Business Process per BPM project. This process is the root process.

- **Description:** Provides an optional description for the Activity Guide.

5. Click **Save** in the project toolbar.

Creating Project Milestones

Use Oracle Business Process Composer to add milestones to Guided Business Processes.

To create a new milestone:

1. Click **New Milestone**.
2. Select the milestone you just created from the list.
3. Configure the milestone as necessary.
4. Click **Save** in the project toolbar.

Adding Milestones to User Tasks

Use Oracle Business Process Composer to add milestones to user tasks in a Guided Business Processes.

To add a user task to a milestone:

1. Open the process to which you want to add a milestone.
2. Right-click the user task to which you want to add a milestone.
3. Select a milestone from the list and click **OK**.

Defining Project Roles, Business Parameters, and Organization Units

Use project roles to model the users or groups that perform the work your business process represents. Roles define functional categories that correspond to job functions or responsibilities within your organization. Use Oracle Business Process Composer to create and edit the required roles within your process and assign them to swimlanes.

This section describes how to create and manage project roles and business parameters.

Defining Project Roles

Use Oracle Business Process Composer to define the roles used by your BPM project. To perform more advanced mapping and configuration of project roles, including assigning users to the roles, use Oracle BPM Studio or Oracle Business Process Management Workspace. When a project is deployed to runtime, project roles can be mapped to the real-world users and groups of your organization.

Project roles are defined for the entire project. They can be shared by all the processes in your project. Within a process, roles are assigned to the horizontal swimlanes.

The following procedures describe how to create and delete project roles.

To create a project role:

1. Access the Project Welcome page.
2. Click **Organization**, then click the **Add** icon.
3. Provide a name for the new role, then click **Add Role**, as shown in [Figure 5-4](#).

Figure 5-4 Organization - Roles: Add Role

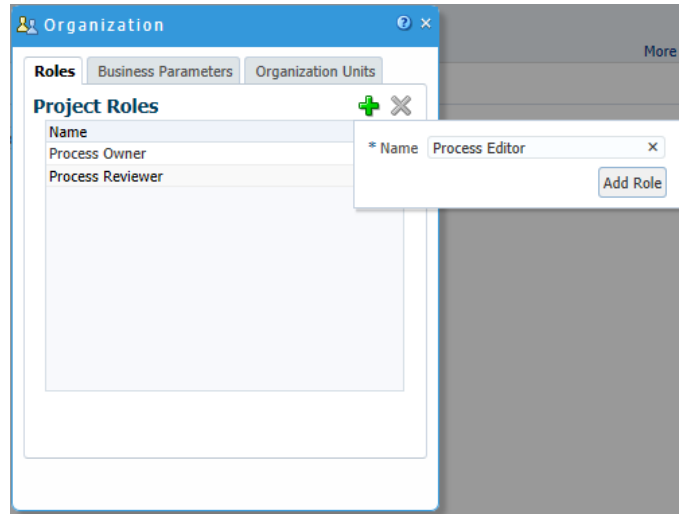

To delete a project role:

1. Access the Project Welcome Page.
2. Expand **Organization**.
3. Select the role you want to delete, then click the **Delete** icon.

Defining Business Parameters

Business Parameters are used for setting business specific constants and can be overridden for an Organization Unit. If there is no override value for Org Unit, the returned value is the default value.

To create a business parameter:

1. Access the Project Welcome page.
2. Click **Organization**, then select the Business Parameters tab.
3. Click the **Add** icon to create a new business parameter.
4. Provide a **Name** for the new business parameter.
This name must be in capital letters with no spaces.
5. Select a **Type** for the new business parameter.
Choose from the list shown in [Figure 5-5](#).

Figure 5-5 Organization - Business Parameters

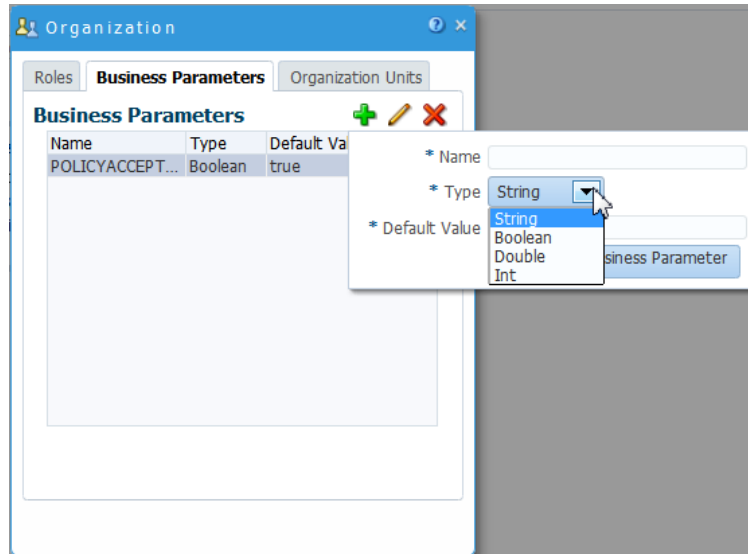

6. Specify the **Default Value**.
This is the value used for the business parameter if no other value is defined.
7. Click **Add Business Parameter**.

Defining Organization Units

An organization unit represents departments or divisions within an organization. Organization units can contain child organization units creating a hierarchy that corresponds to your organization.

To create an organization unit:

1. Access the Project Welcome page.
2. Click **Organization**, then select the Organization Units tab.
3. Click the **Add** icon to create a new organization unit, as shown in [Figure 5-6](#).

Figure 5-6 Organization - Organization Units

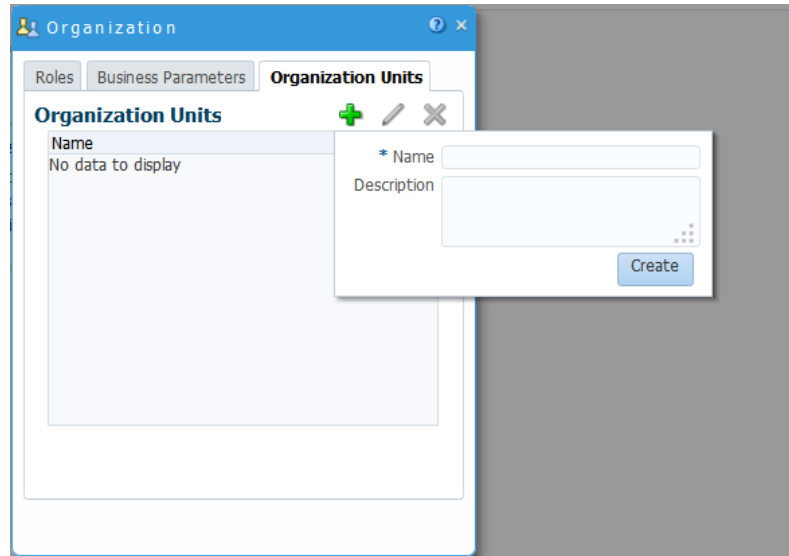

4. Enter a **Name** for the new organization unit.
5. Enter a **Description**. This field is optional.
6. Click **Create**.

Generating Process Reports for Your Project

You can generate reports that list each process in your project and show detailed information about each process.

- Detailed Business Process
- Business Requirements
- Issues and Comments
- Data Objects
- Process vs Data
- Data vs Process
- Human Tasks vs Process
- Service vs Process
- User Tasks
- Process image
- RACI (responsible, accountable, consulted, and informed)

To generate a process report:

1. Open your project.
2. From the Project Main menu, select **Process Report**.

The Process Report dialog is displayed, as shown in [Figure 5-7](#).

Figure 5-7 Process Report Dialog

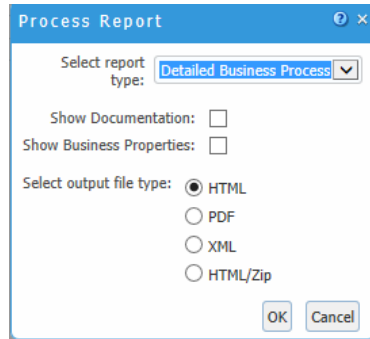

3. Select the following report details, then click **OK**:

- Select report type
- Show Documentation - Select to show descriptions
- Show Business Properties
- Select output file type

For more information about these reports, see [Documenting BPM Projects](#) .

6

Documenting BPM Projects

Oracle Business Process Composer processes documentation from the project-level, process-level, and activity-level. None of the documentation fields are mandatory; you can use any, some, or none of the fields.

- [Understanding Project-Level Documentation](#)
- [Understanding Process-Level Documentation](#)
- [Understanding Activity-Level Documentation](#)

Understanding Project-Level Documentation

Both project and role descriptions are available at the project level.

A project description is one or two sentences that help a user distinguish between projects of similar or same titles. A role may require more explanation as it can be an acronym that is not commonly used.

Project Description

A project description is one or two sentences that help a user distinguish between projects of similar or same titles.

Description Location

- When a project is created, as shown in [Figure 6-1](#).

Figure 6-1 New Project Description

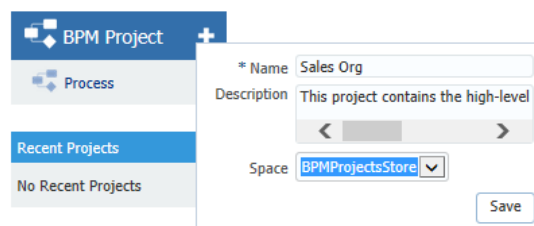

The screenshot shows a 'New Project Description' dialog box. On the left, there is a sidebar with 'BPM Project' (selected), 'Process', and 'Recent Projects' (No Recent Projects). The main dialog has the following fields: '* Name' with the value 'Sales Org', 'Description' with the value 'This project contains the high-level', and 'Space' with a dropdown menu showing 'BPMProjectsStore'. A 'Save' button is located at the bottom right of the dialog.

- Within a project, click on *More Information* to add, edit, or delete the description, as shown in [Figure 6-2](#).

Figure 6-2 Project Information

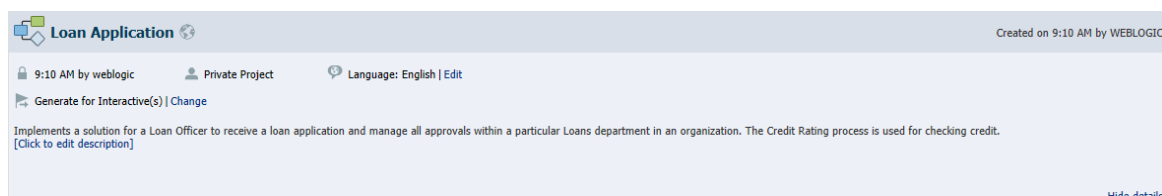

The screenshot shows the 'Project Information' page for a 'Loan Application' project. The page header includes the project name 'Loan Application' and the creation time 'Created on 9:10 AM by WEBLOGIC'. Below the header, there is a section for 'Project Information' with the following details: '9:10 AM by webllogic', 'Private Project', and 'Language: English | Edit'. There is a link to 'Generate for Interactive(s) | Change'. The main content area contains the description: 'Implements a solution for a Loan Officer to receive a loan application and manage all approvals within a particular Loans department in an organization. The Credit Rating process is used for checking credit.' A link to '[Click to edit description]' is provided. A 'Hide details' link is visible at the bottom right of the page.

When Used

When a user displays all projects available in all spaces, one or more projects of the same title may be displayed. In a multi-national corporation, there might be several Operations projects for different countries or divisions. The project description helps the user choose the appropriate project to open.

Where Used

Detailed Business Process Report

The project description also provides the appropriate context for a report on a project. Reports are often saved and distributed to viewers who do not have access to Oracle Business Process Composer, therefore it is important to provide detailed information on the project for which the report was created.

Role Description

A role may require more explanation as it can be an acronym that is not commonly used.

Description Location

Within the Narrative View below the role. You can add, edit, or delete the description.

When Used

The role description is used when a role requires more explanation.

Where Used

Detailed Business Process Report - Participants Table, as shown in [Figure 6-3](#).

Figure 6-3 Detailed Business Process Report - Participants

Participants		
Role	Description	Role Escalation
Process Owner		
Process Reviewer		
Sales Manager		
Sales Representative	The sales representative manages the customer account.	

Understanding Process-Level Documentation

Several kinds of documentation are available at the process level, including descriptions, links, requirements, and notes.

The following process-level documentation is available:

- Process description
- Process documentation
- Process links
- Requirements
- Process notes

Process Description

Like the project description, the process description is a one or two sentence expansion of the title. The description helps make a clear distinction between processes with similar titles.

Description Location

- When a process is created, as shown in [Figure 6-4](#).

Figure 6-4 New Process Description

The screenshot shows a 'New' dialog box with the following fields and controls:

- * Name:** Credit Rating Process
- Description:** This process is used to check credit
- Document-Only:** Document-Only process
- Buttons:** A 'Create' button is located at the bottom right.

- In the General tab of the Business Properties pane, as shown in [Figure 6-5](#).

Figure 6-5 Business Properties - General

The screenshot shows the 'Business Properties - General' pane for the 'Credit Rating Process'. The fields are:

- * Name:** Credit Rating Process
- Description:** This process is used for checking credit.

- Below the process name in the narrative view, as shown in [Figure 6-6](#).

Figure 6-6 Process Narrative View

The screenshot shows the 'Process Narrative View' for 'CreditRatingProcess'. The description field contains the text:

This process has a single user task to check the credit rating of the loan applicant.

When Used

The process description can be added or changed in several places, such as during process creation, in the business properties property panel, and in the narrative view.

Where Used

- Detailed Business Process report

- Business Requirements report
- Process Properties report

In a report that contains many processes, the process description can help the reader quickly navigate to the correct process. The description can not only explain what the process covers, but it can also detail what it does not cover along with a pointer to another process.

Process Documentation

Process documentation is rich text documentation that can be added to a process in the narrative view or in the documentation panel. If the documentation exists elsewhere, the user should add links so that information is not duplicated. If the documentation is more helpful in the activity documentation or description fields, it should be added to the field that is the most useful to the user.

Please note the **Documentation Type** option, which is displayed at the top right-hand side of the Documentation tab, as shown [Figure 6-8](#). Use the drop-down list to choose if you want your documentation to be created for external (*End User*) or *Internal* use. For your documentation to appear in the narrative view or process reports, you must set this option to *End User*. If the user doesn't realize that it is set to *Internal*, they may be confused when they don't see their documentation.

Documentation Location

- Below the process description in the narrative view, as shown in [Figure 6-7](#).

Figure 6-7 Narrative View Documentation

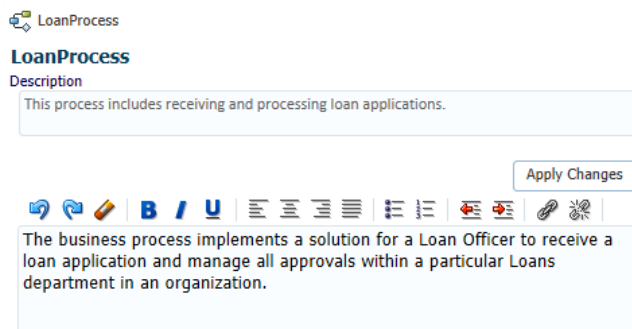

- In the documentation tab of the property pane, as shown in [Figure 6-8](#).

Figure 6-8 Process Property - Documentation

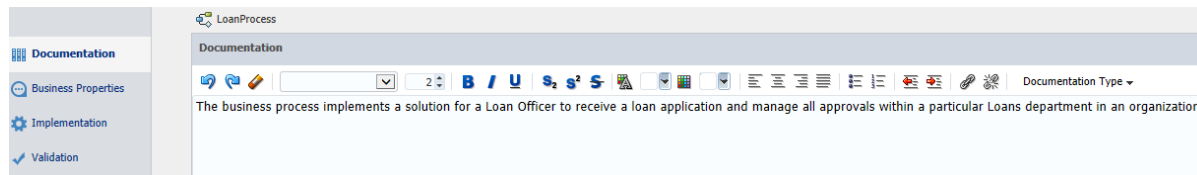

When Used

Documentation is added to a process when the information is important for comprehension or following the process, or when the information does not exist elsewhere.

Where Used

- Detailed Business Process report
- Business Requirements report

Process Links

If the name of the link is generic or could be confused for another document, use the description to provide more detail. For example, if there are several checklists that are used by the sales organization, the description can help the user determine if the link is to the appropriate checklist.

Links Location

In the Links tab within the business properties, as shown in [Figure 6-9](#).

Figure 6-9 Process: Business Properties - Links

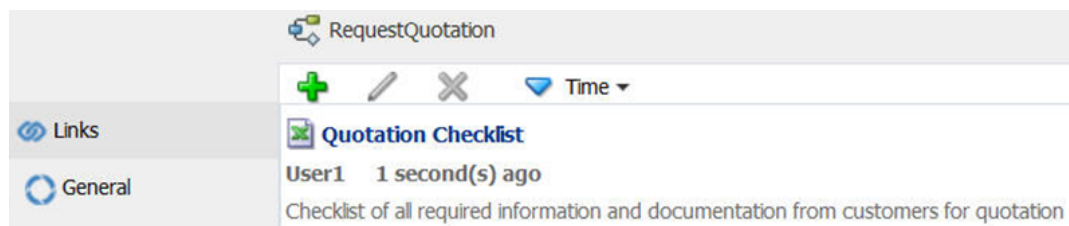

When Used

Links can be added to activities, processes, requirements, activity documentation, and process documentation. The description should be short and expand on the title to help a user determine whether the link contains the appropriate document.

Where Used

- Detailed Business Process report
- Business Requirements report

Requirements

Requirements can be added to a process in the business properties. There are two plain text fields - notes and solution - where more explanation can be added. Links to existing documentation can also be added.

Description Location

In the Requirements tab within the business properties, as shown in [Figure 6-10](#).

Figure 6-10 Process: Business Properties - Requirements

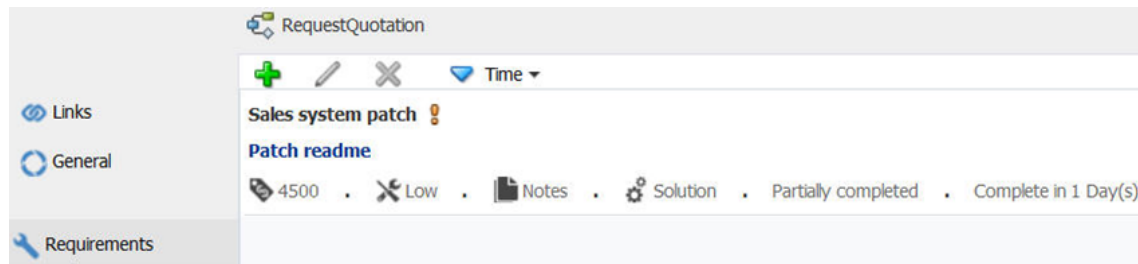

When Used

The requirements feature tracks the status, priority, and difficulty of the requirements of a process. Multiple requirements can be added to a process and they can be sorted by the various components, such as date, status, and so on.

Where Used

- Detailed Business Process report
- Business Requirements report

Process Note

A process note is the equivalent of a sticky note - impermanent and to be used more as a reminder. They are deleted as soon as the information is used.

Note Location

In the graphical view, a note can be dragged from the palette to the process, as shown in [Figure 6-11](#).

Figure 6-11 Process Note

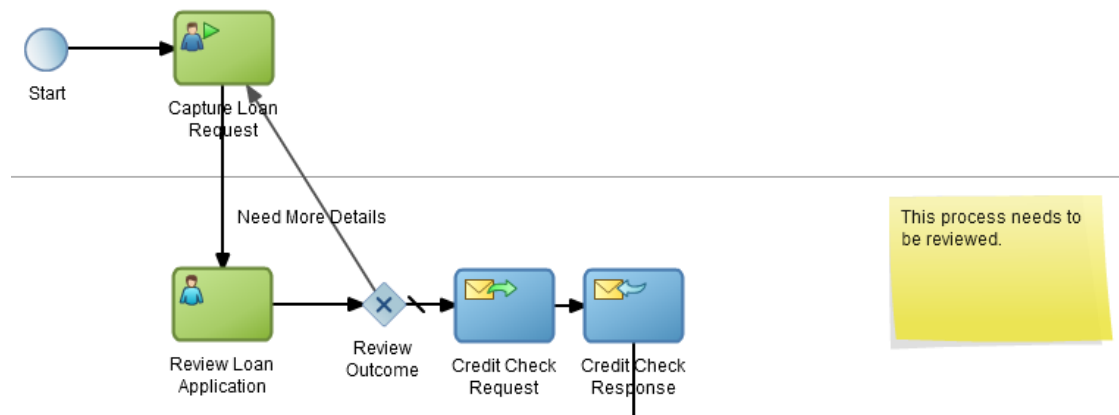

When Used

Notes are useful when collaborating with others while creating or editing a process. They are highly visible and can be easily added and deleted.

Where Used

Notes do not appear in the narrative view or in process reports.

Understanding Activity-Level Documentation

Documentation available at the activity level includes descriptions, links, comments, and notes.

The following activity-level documentation is available:

- Activity description
- Activity links

- Activity documentation
- Activity comments
- Activity notes
- General
- Issues
- RACI (responsible, accountable, consulted, informed)

Activity Description

The activity description should be a brief expansion of the activity name.

Description Location

The activity description is located in the following areas:

- Graphical view, in the properties of an activity, as shown in [Figure 6-12](#).

Figure 6-12 Activity Description (Graphical View)

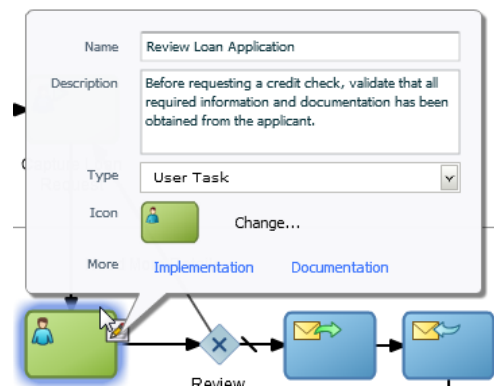

- Narrative view, below the activity name, as shown in [Figure 6-13](#).

Figure 6-13 Activity Description (Narrative View)

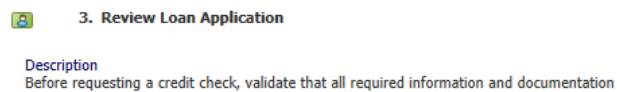

When Used

Names of activities tend to be very short. The description is an expansion of the name to help with understanding.

Where Used

- Detailed Business Process report
- Business Requirements report
- Human Tasks vs Process report
- Services vs Process report

Activity Links

Links can be added to activities, processes, requirements, activity documentation, and process documentation. The description should be short and expand on the title to help a user determine whether the link contains the appropriate document.

Links Location

In the Links tab within the business properties, as shown in [Figure 6-14](#).

Figure 6-14 Activity Links

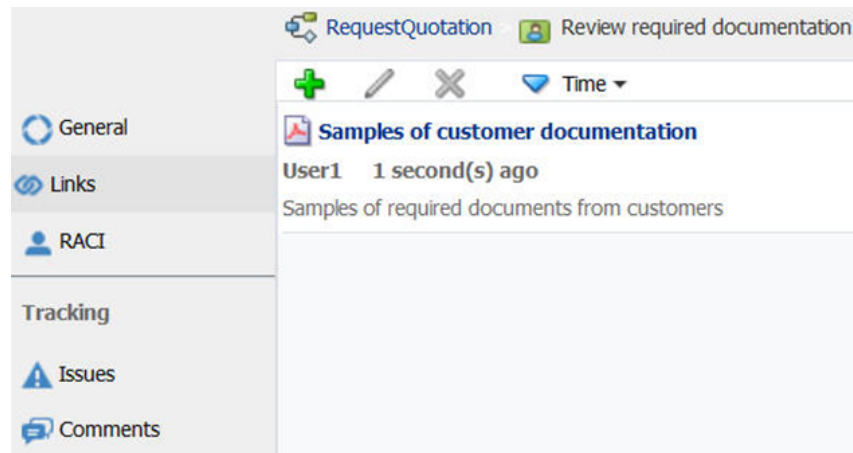

When Used

Customers often have a rich store of existing documentation that can be referenced from the process. Multiple links can be added to an activity, and these links are active in the process reports.

Where Used

- Detailed Business Process report
- Business Requirements report

Activity Documentation

Activity documentation is rich text documentation that can be added to an activity in the narrative view or in the documentation panel. If the documentation exists elsewhere, the user should add links so that information is not duplicated. If the documentation is more explanatory elsewhere, for example, in the description fields or as a comment, it should be added there. In other words, add it to the place that is most useful to the user.

Please note the **Documentation Type** option, which is displayed at the top right-hand side of the Documentation tab, as shown [Figure 6-8](#). Use the drop-down list to choose if you want your documentation to be created for external (*End User*) or *Internal* use. For your documentation to appear in the narrative view or process reports, you must set this option to *End User*. If the user doesn't realize that it is set to *Internal*, they may be confused when they don't see their documentation.

Documentation Location

The activity documentation is located in the following areas:

- Documentation tab of the property panel, as shown in [Figure 6-15](#).

Figure 6-15 Properties Panel: Documentation - Activity Documentation

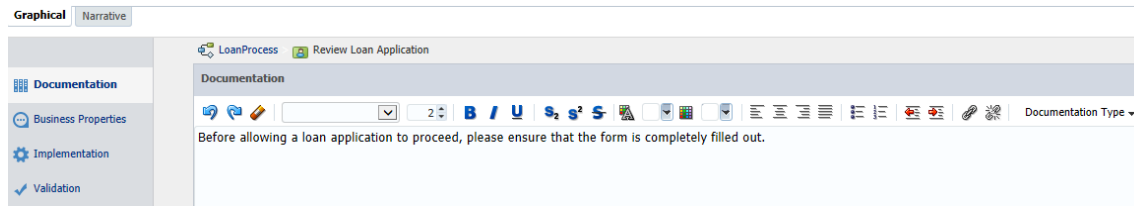

- Narrative view when the activity is in focus, as shown in [Figure 6-16](#).

Figure 6-16 Activity Documentation (Narrative View)

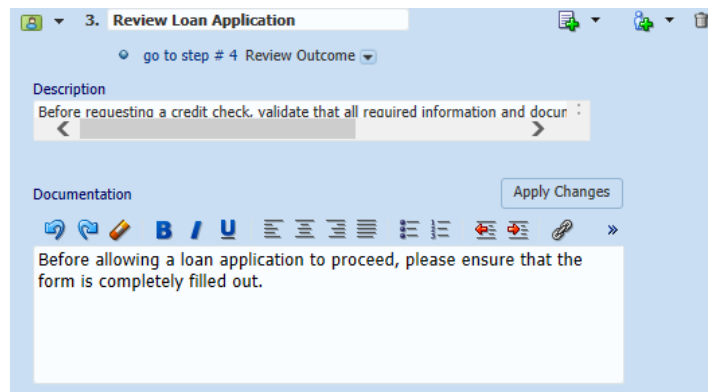

When Used

Documentation should be added to an activity when the information is important for comprehension or following the process, or the information does not exist elsewhere.

Where Used

- Detailed Business Process report
- Business Requirements report

Activity Comments

Activity comments can be added to an activity through the business properties. After it is added, a comment cannot be edited or deleted.

Comments Location

In the Comments tab within the Business Properties panel, as shown in [Figure 6-17](#).

Figure 6-17 Activity Comments

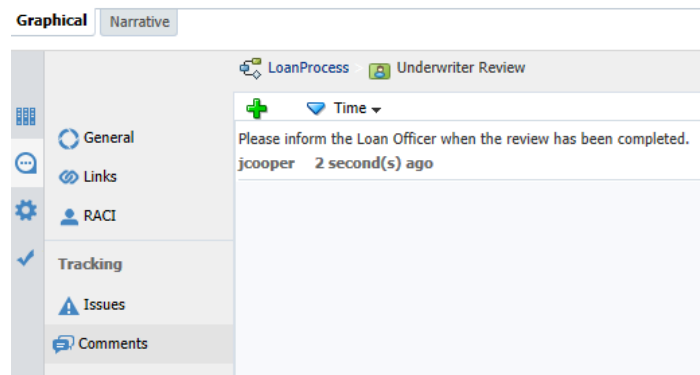

When Used

Activity comments are like notes in that they are brief, but, unlike notes, they are permanently attached to the process, and they are displayed in several process reports. Use comments when it is important to keep a record.

Where Used

- Detailed Business Process report
- Business Requirements report
- Issues and Comments report

Activity Note

An activity note is the equivalent of a sticky note - impermanent and to be used more as a reminder. They are deleted as soon as the information is used.

Note Location

A note can be dragged from the palette to the activity in the graphical view, as shown in [Figure 6-18](#).

Figure 6-18 Activity Note

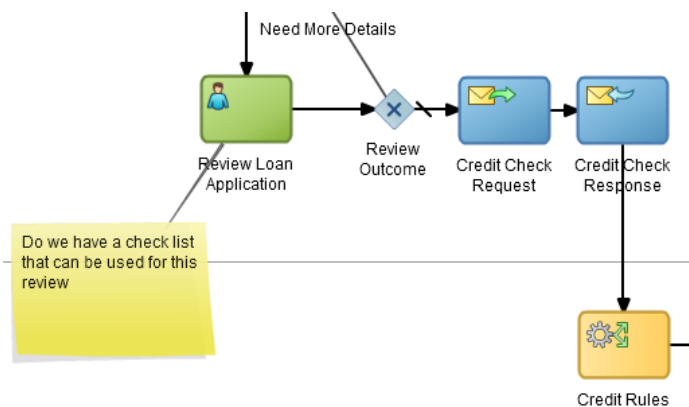

When Used

Activity notes are useful while collaborating with others when creating or editing a process. They are highly visible and can be easily added and deleted.

Where Used

Notes do not appear in the narrative view or in process reports.

General

The General tab tracks the cost, organization unit, application system, and time to complete an activity.

General Location

In the General tab within the Business Properties panel, as shown in [Figure 6-19](#).

Figure 6-19 Business Properties - General

The screenshot shows the 'Business Properties - General' tab. On the left is a sidebar with icons for 'General', 'Links', 'Tracking', 'Issues', and 'Comments'. The 'General' tab is active. The main content area contains the following fields:

- Cost:** A text input field containing the value '5000'.
- Organization Unit:** A dropdown menu with 'Student Loans' selected and a green plus icon to its right.
- Application System:** A dropdown menu with 'Kwik Loan Application System' selected and a green plus icon to its right.
- Time:** Two spinner controls. The first is labeled 'Month(s)' and has the value '0'. The second is labeled 'Day(s)' and has the value '1'.

When Used

General information is used for process improvement and discovery; it can be important to track the cost of performing the activity as well as how long it takes to complete.

Where Used

- Detailed Business Process report
- Business Requirements report

Activity Issues

The activity issues should be used to track specific issues including their severity, priority, and resolution status.

Issues Location

In the Issues tab within the Business Properties panel, as shown in [Figure 6-20](#).

Figure 6-20 Business Properties - Issues

Issue Title	Severity	Status	Owner	Date
Other assets not fully captured	Medium	Not Addressed	jstein	Aug 26, 2013
Past employment history not captured	High	Not Addressed	jstein	Aug 26, 2013
Co borrower details not captured	Critical	Not Addressed	jstein	Aug 26, 2013

When Used

Issues can be used during process improvement, testing, and discovery; it can be important to track the issues that are discovered. The issues can be sorted by severity, priority, resolution status, and date.

Where Used

- Detailed Business Process report
- Business Requirements report
- Issues and Comments report

RACI

The RACI feature tracks who is responsible, accountable, consulted, and informed on an activity.

RACI Location

In the RACI tab within the Business Properties panel, as shown in [Figure 6-21](#).

Figure 6-21 Business Properties - RACI

Graphical | Narrative

LoanProcess | Underwriter Review

Responsible: Underwriter

Accountable: LoanProcessor

Consulted: Process Owner

Informed: LoanAdministrator

When Used

The RACI data can be used during process improvement, testing, and discovery to ensure the proper roles are involved in the activity.

Where Used

RACI report

Part IV

Modeling and Testing Business Processes

Get a general overview of Oracle Business Process Composer and use Oracle Business Process Composer to model your business processes.

- [Creating and Working with Business Processes](#)
- [Simulating Process Behavior](#)
- [Using Process Player](#)

7

Creating and Working with Business Processes

Get an overview of business processes, the process editor window, and procedural information for creating and using processes, and also learn how to create and use business processes in Oracle Business Process Management (Oracle BPM).

For information about using Business Process Model and Notation (BPMN) 2.0 to design a business process, see [BPMN Flow Object Reference](#).

- [Introduction to Business Processes](#)
- [Introduction to the Project Toolbar](#)
- [Introduction to the Narrative View](#)
- [Working with the Narrative View](#)
- [Introduction to the Process Editor Graphical View](#)
- [Working with Business Processes](#)
- [Using Swimlanes to Organize Your Process](#)
- [Working with Flow Elements](#)
- [Working with Business Catalog Components](#)
- [Working with Draft Processes](#)
- [Documenting Your Process](#)
- [Importing and Exporting Process Models](#)

Introduction to Business Processes

A business process is a sequence of tasks that result in a well-defined outcome. Business processes are the core components of process-based business applications created with the Oracle BPM Suite.

Although projects are higher level wrappers that contain all the resources of a business application, the processes within the project determine how the application works. Within a business process, BPMN flow objects define the flow and behavior.

Business processes are generally created by process analysts who determine the business requirements that must be addressed and define the corresponding process flow.

[Table 7-1](#) describes how the type of a process determines how it behaves in relation to other business processes.

**Note:**

By default, new business processes are synchronous. After creating a new process, you can change the type by editing the process.

Table 7-1 Types of Business Processes

Process Type	Description
Synchronous Service	Synchronous services are a type of business process that is invoked from another process or service synchronously. In a synchronous service, the calling process waits until the process completes before continuing.
Asynchronous Service	Asynchronous services are a type of business process that is invoked from another process or service asynchronously. In an asynchronous service, the calling process does not wait until the process completes before continuing.
Manual Process	Manual processes are those that require user interaction. Manual processes must begin with a none start event. They must end with a none end event.
Reusable Process (Reusable Subprocess)	<p>Reusable processes are processes that can be called by a BPMN process. In BPMN terminology, reusable processes are often called <i>reusable subprocesses</i>. See Using Subprocesses in Oracle BPM for more information about the different types of subprocesses supported by Oracle BPM.</p> <p>Use the call activity to call reusable subprocesses within your business process. See Introduction to the Call Activity for information about calling reusable processes.</p>

Introduction to the Project Toolbar

The process editor opens as a tab on the BPM Project Welcome page. Therefore, the project toolbar remains visible when the process editor is open in either the narrative or graphical view.

The functions displayed on the project toolbar are available for use while editing processes.

For more information about the project toolbar options, see [Introduction to the Project Toolbar](#).

Introduction to the Narrative View

The narrative view provides a way of creating business processes by entering text rather than dragging graphical icons onto a palette. This is useful for process designers who are not familiar with BPMN.

When you add an item to your process textually, Oracle Business Process Composer automatically converts it to the correct underlying BPMN. The auto layout feature in the graphical view automatically formats the BPMN process.

Both views contain the same information, meaning that you can edit the same process in both views if necessary. When editing a process in one pane, it is automatically updated in the other.

The narrative view provides an alternate way of creating and editing business processes. However, it is not intended to be a replacement for the graphical editor. The following BPMN elements are visible in narrative view, but cannot be edited:

- script tasks
- business rules tasks

The following elements do not appear in the narrative view:

- Notes
- Measurement

Working with the Narrative View

Use the narrative view to manage activities, roles and documentation in a process.

Access the narrative view in a business process by clicking the **Narrative** tab at the bottom of the process editor, as shown in [Figure 7-1](#).

Figure 7-1 Process Editor - Narrative View

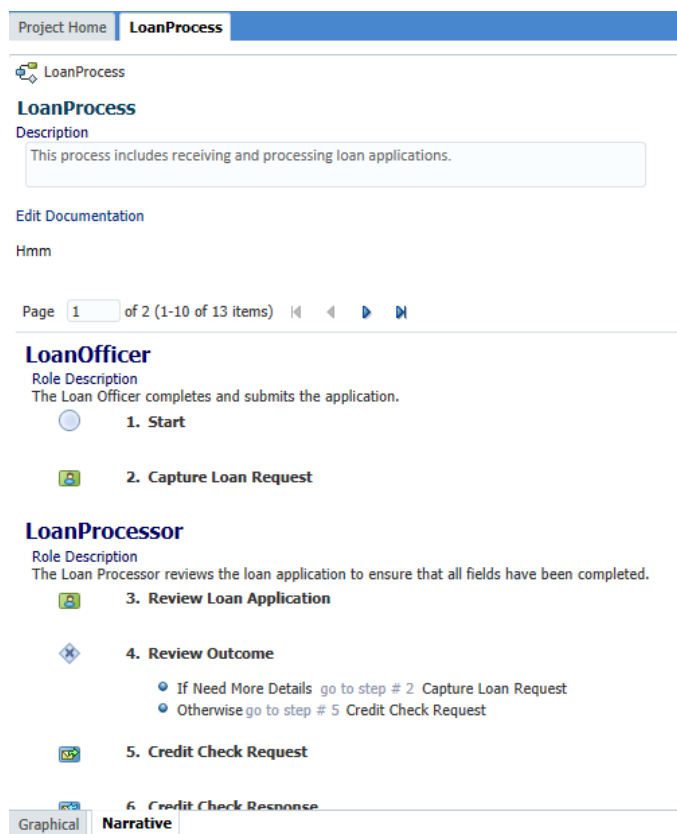

You can use the narrative view to perform the following tasks:

- Add activities to a process by clicking the **Add (+)** icon in the activity directly above where you want to add a new one. You can add documentation about the activity, if required.
- Delete a selected activity by clicking the delete icon and confirming the deletion.

- Move an activity to a different position in the process flow
- Assign roles to a selected activity by clicking the **Change Role** drop down to either add a new role or change the current role to a different role.
- View and edit documentation

Moving an Activity

To move an activity:

1. Select the activity you want to move.
2. Click the **Move** (📏) icon.
The **Drop Activity** (📌) now appears on the left-hand side of the activities.
3. Click the **Drop Activity** icon in the location where you want to move the original activity.

Narrative View Options

You can customize how the narrative view is displayed.

Click the Expand all documentation check box located at the top right-hand corner of the view, as shown in [Figure 7-2](#) to show all documentation.

Click the Show Icons check box located at the top right-hand corner of the view, as shown in [Figure 7-2](#) to view activities as icons.

Figure 7-2 Process Editor: Narrative View - Options

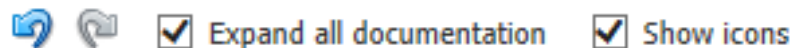

Introduction to the Process Editor Graphical View

The process editor allows you to quickly create and edit BPMN processes.

The process editor appears as a tabbed pane in the Business Process Composer application and is divided into four areas.

Note:

This view is available in 12c (12.2.1.4) only if you have installed patch 23995890. Sign in to [My Oracle Support](#) and search for the patch number to locate and download the patch.

Figure 7-3 BPM Process Editor - Graphical View

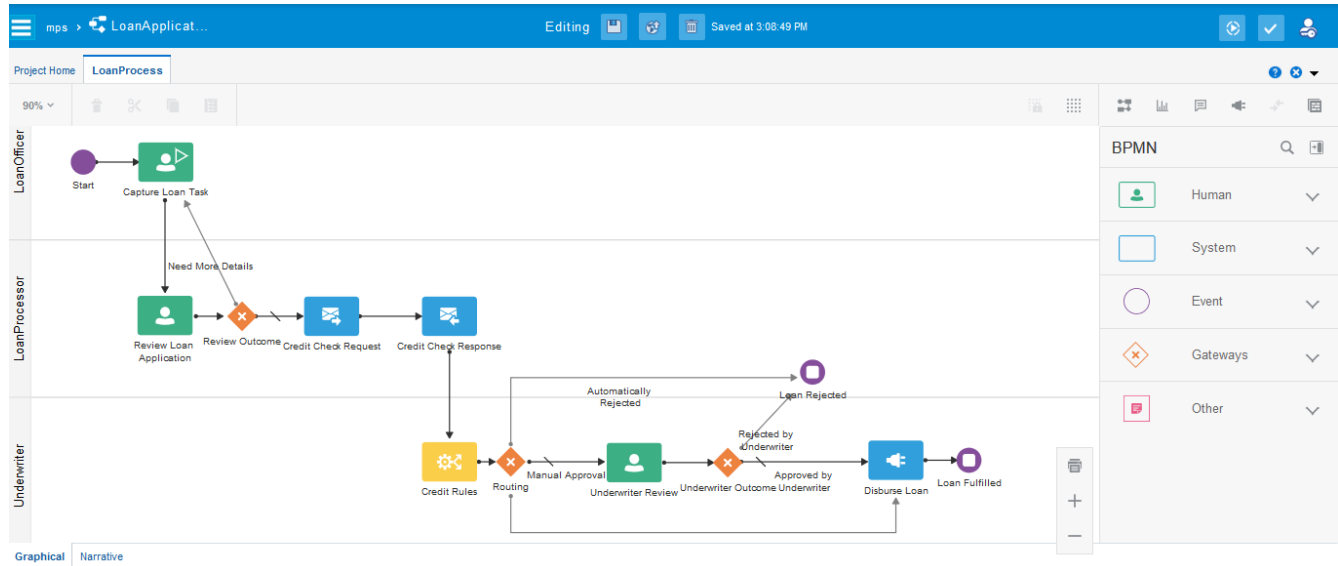

- **Process Editor Toolbar:** Provides quick access to menu items related to process design. See [Introduction to the Process Editor Toolbar](#) for more information.
- **Process Editor Canvas:** Provides a work area for creating your process flow. See [Introduction to the Process Editor Canvas](#) for more information.
- **BPMN Component Palette:** Enables you to quickly access the flow objects, sequence flows, and other elements that comprise a BPMN process.

You can drag and drop these elements from the BPMN component palette onto the process editor canvas. See [Introduction to the BPMN Component Palette](#) for more information.

 **Note:**

With patch [23995890](#), the prior implementation of the Business Catalog Palette in Oracle Business Process Composer is not available in this release due to the deprecation of Adobe Flash Player in the process editor. To use the Business Catalog, you can use Oracle BPM Studio (in JDeveloper) or contact Oracle Support for assistance.

You can open multiple processes within the same project simultaneously in Business Process Composer. Each process opens in its own tab within the editor window.

Introduction to the Process Editor Toolbar

The process editor window contains a toolbar enabling access to the Business Process Composer features described in [Table 7-2](#).

Table 7-2 Process Editor Menu

Menu Item	Description
Undo	Reverts the last change made to your process.
Redo	Reverses the last undo action you performed.
Cut	Cuts the selected items and copies them the clipboard.
Copy	Copies the selected items to the clipboard.
Paste	Pastes the items currently in the clipboard.
Delete	Deletes the selected elements from the process.
Autolayout	Automatically adjusts the layout of your process.
Toggle grid visibility	Shows or hides a grid in the process editor window.
Snap to grid	Centers the flow objects in your process on the nearest grid axis. Existing flow objects are automatically centered. New flow objects are automatically be centered when added. This menu item is active only when toggle grid visibility is enabled.
Print	Prints the process using your browser's printer setup.
Edit conversations	Opens the conversations editor. Use this editor to define the interface that determines the input and output data objects.
Find process usage	Determines which other processes within the current project call the current process.
View collaboration	Switches the process editor to collaboration view.
Data objects	Opens the data objects editor. See Working with Data Objects for more information.
Business indicators	Opens the business indicator editor.
Player	Launches the process player. See Using Process Player for more information.
Zoom slider	Zooms in and out of your process.

Introduction to the Process Editor Canvas

The process editor canvas is the central area of the process editor window. Use the process editor canvas to create the graphical representation of your process using the elements available in the BPMN component palette. In addition to a process flow, the process editor canvas also displays swimlanes.

For more information about swimlanes, see [Using Swimlanes to Organize Your Process](#).

Introduction to the BPMN Component Palette

Use the BPMN component palette to add flow objects, sequence flows and business catalog elements to your process.

 **Note:**

This component palette is available in 12c (12.2.1.4) only if you have installed patch 23995890. Sign in to [My Oracle Support](#) and search for the patch number to locate and download the patch.

Figure 7-4 BPM Process Editor - Component Palette

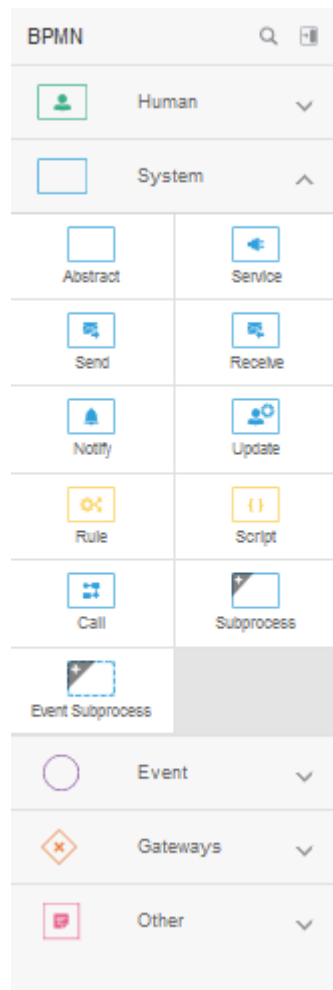

Use the component palette to drag and drop artifacts to the process editor window.

 **Note:**

The component palette is greyed-out until you enter edit mode for the project.

The component palette separates BPMN elements into the following groups:

- Human

- System
- Event
- Gateways
- Other

 **Note:**

With patch [23995890](#), the following features are not available in this release due to the deprecation of Adobe Flash Player in the process editor:

- Measurement group
- Two modes for adding flow objects: single object mode and multiple object mode

To use this functionality, you can use Oracle BPM Studio (in JDeveloper) or contact Oracle Support for assistance.

Introduction to the Business Catalog

 **Note:**

With patch [23995890](#), the prior implementation of the Business Catalog in Oracle Business Process Composer is not available in this release due to the deprecation of Adobe Flash Player in the process editor. To use the Business Catalog, you can use Oracle BPM Studio (in JDeveloper) or contact Oracle Support for assistance.

Working with Business Processes

You create business processes within an Oracle BPM project. You can add one or more processes to your project.

The following sections describe how to create, open, and delete business processes.

How to Create a New Business Process

To create a new business process:

1. Go to the Project Welcome Page.
2. If you are editing a shared project, ensure that you are currently editing the project.
3. Click **Processes**, then click **New Process**.
4. Enter a name for the process, then click **Create**.

The new process appears in the list of processes.

When you create a new business process it contains a start and end event connected by a default sequence flow. By default, both the start and end events are none events. You can change the type as required by your business process.

See [Defining the Start and End Point of a Process](#) for more information.

How to Open a Business Process

After opening an Oracle BPM project, you can open any of the processes it contains.

To open a business process:

1. Go to the Project Welcome Page.
2. Click **Processes**.
3. Click the name of the process you want to open.

The process opens in the process editor window. Before you can begin editing the process, you must ensure that you are in edit mode.

How to Delete a Business Process

You can delete processes from your project.

To delete a business process for a project:

1. Open your project.
2. Go to the Project Welcome Page.
3. Click **Processes**.
4. Move the cursor over the name of the process you want to delete.
5. Click the **Delete** icon, then click **OK**.

What You Need to Know About Deleting a Business Process

When deleting a process, ensure that there are no remaining references to the deleted process elsewhere in your project. For example, if the deleted process was invoked from another process through a message throw event, you must ensure that you have reconfigured the invoking process so it is no longer referring to the deleted process. An error is displayed during validation if any remaining references to the deleted process still exist.

Using Swimlanes to Organize Your Process

Swimlanes help you organize your process. They appear as horizontal lines across the process editor. All flow objects must be placed in a swimlane.

Roles are assigned to swimlanes and determine which members of your business organization are responsible for performing the work of your process-based application.

Introduction to Roles

The key to design a business process is to determine the people and roles required to complete each of the tasks that require user interaction. Within your process, roles are used to decide who is responsible for performing the work that is performed within your business processes. Roles allow you to define functional categories that represent job functions or responsibilities within your organization.

The roles defined in your process are also referred to as logical roles. When your Oracle BPM project is deployed to the runtime environment, these roles are mapped to LDAP roles that correspond to the users in your real-world organization.

Roles are assigned to the horizontal swimlanes that display the roles responsible for completing activities and tasks within your process. Oracle Business Process Composer allows you to create and edit the required roles within your process and assign them to swimlanes.

Oracle BPM Studio or Oracle BPM Workspace, you can also map roles to specific users using LDAP. Oracle BPM Studio also allows you to create more robust organizational models using organizational units, calendars, and holidays.

Roles in Context

Process analysts are responsible for determining what roles are required when designing a business process.

The LoanProcess example shown here defines the following roles:

- **Loan Officer:** Loan officers are responsible for creating the loan request and forwarding it to the loan processor.
- **Loan Processor:** Loan processors are responsible for reviewing the loan application and checking the credit history of the loan applicant before forwarding the application to the underwriter for approval.
- **Underwriter:** This role represents users who are responsible for reviewing and approving the loan application. Additionally, they disburse the loan if it is approved.

Note:

This view is available in 12c (12.2.1.4) only if you have installed patch 23995890. Sign in to [My Oracle Support](#) and search for the patch number to locate and download the patch.

Figure 7-5 BPM Process Editor - Swimlanes

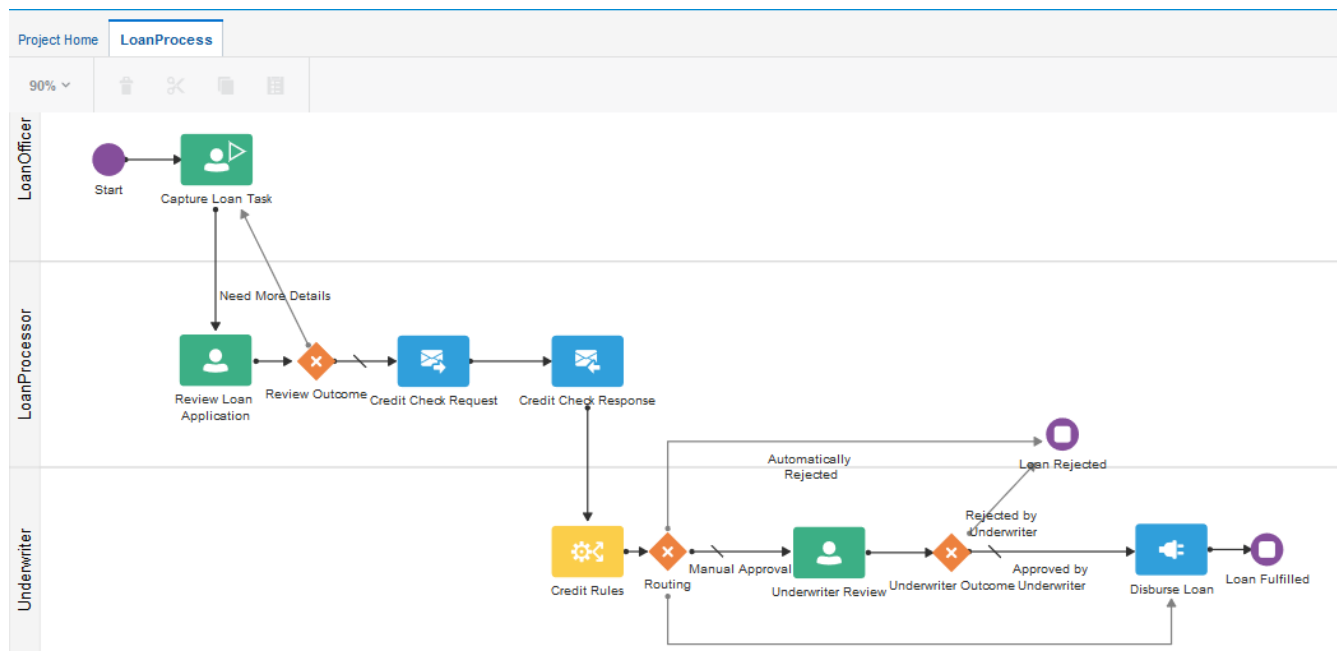

Introduction to Swimlanes

Swimlanes are the horizontal lines that run across the process editor. All flow objects must be placed within a swimlane.

Swimlanes can also be used to group flow objects based on the roles defined within your process. Swimlanes that contain user tasks must have roles assigned to them. Swimlanes visually display the role responsible for performing each flow object within your process. Additionally, you can have multiple swimlanes that are assigned to the same role.

Swimlanes can make your process more readable when you must use the same role in different parts of the same process.

When you create a new process, Oracle BPM Studio and Oracle Business Process Composer create a default swimlane. You can add additional swimlanes to your process as necessary. When adding interactive and manual activities to a process, you must assign a role to the swimlane.



Note:

You cannot delete a swimlane that contains the only start or end event of a process.

Swimlanes in Context

Figure 7-6 shows a simple process split across multiple swimlanes. In this example, the SalesRep role is assigned to the first swimlane. Because the Enter Quote user task appears inside this swimlane, process participants assigned to the SalesRep role are responsible for performing this task.

Figure 7-6 A Simple Business Process Split Across Two Swimlanes

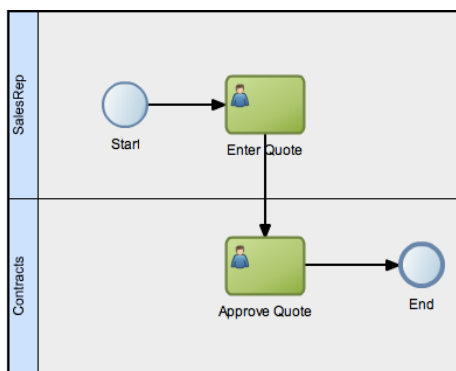

In a real-world business process, the combination of swimlanes and flow objects within them can be complex.

Adding Swimlanes to Your Process

You can add swimlanes to your BPMN process.

To add a new swimlane to your process:

1. Right-click on a white area of the process editor canvas.
2. Select **Add Lane**.

The new swimlane is created. By default, the swimlane is not assigned a role. You can add a role by editing the swimlane properties.

Adding a Swimlane and a Flow Object to Your Process

You can add a new swimlane and flow object to your BPMN process.

To add a new swimlane to your process by adding a new flow object:

1. Open the process where you want to add a swimlane.
2. From the component palette, select a flow object, then drag and drop it on the process canvas below an existing swimlane.

The new swimlane is created. By default, the swimlane is not assigned a role. You can add a role by editing the swimlane properties.

How to Edit Swimlane Properties

You can edit the properties of a swimlane in the process editor.

To edit swimlane properties:

1. Move the cursor over the role name for the swimlane.
2. Click the **Edit** icon.
3. Determine if you want to use an existing role, or create a new one:

To assign an existing role to a swimlane:

- a. Click the **Use** button.
- b. Select a role from the drop-down list.

To assigning a new role to a swimlane:

- a. Click the **Create** button.
 - b. Enter the name of the new role in the text field.
4. If you want to optionally add a custom icon to a swimlane, click **Change**, then select the icon you want to use.
 5. If you want to optionally change the background color of a swimlane:
 - a. Click **Implementation**.
 - b. In the implementation properties editor, enter the RGB value of the color or select a color from the color palette.
 - c. Click **Apply Changes**.

Sharing Roles Between Business Process Composer and BPM Studio

Oracle BPM Studio allows you to integrate roles within complex organization models based on organizational units, calendars and holidays.

When editing a project in Oracle Business Process Composer, you can access the roles defined within the project. However, you cannot view or edit the organizational information defined within the project.

Additionally, you can create new roles using Oracle Business Process Composer. These roles are incorporated as part of the overall organization information of the project.

Working with Flow Elements

Use the process editor to add flow elements to a process.

See [BPMN Flow Object Reference](#) for information about designing your business process using BPMN 2.0.

How to Add a Flow Object from the Component Palette

To add flow objects to your process drag them from the component palette onto the process editor canvas.

To add a flow element from the component palette:

1. Open the process where you want to add flow elements.
2. Ensure you are in edit mode.
3. In the component palette, double-click the type of flow object you want to add.
4. Select the object entry mode you wish to use.

You can choose to enter a single flow object or multiple flow objects of the same type. See [Introduction to the BPMN Component Palette](#) for more information.

5. Click and drag the flow object you want to add to the area in process editor canvas where you want to place it.

The cursor displays the icon associated with the type of flow object.

6. Position the cursor at the point in your process where you want to add the flow object, then click the mouse.

If you are in multiple object mode, you can continue clicking within the process editor canvas to add additional flow objects of the same type.

Note:

If you position the cursor over a sequence flow, Oracle Business Process Composer automatically creates incoming and outgoing sequence flows for the new flow object.

How to Cut, Copy, or Delete a Flow Object

Within the process editor window, you can cut, copy, or delete flow objects.

To cut, copy, or delete a flow object:

1. Select the flow object or sequence flow that you want to cut, copy, or delete.
2. Select **Cut**, **Copy**, or **Delete** from the process editor toolbar.

 **Note:**

When you cut or delete a flow object that contains incoming and outgoing sequence flow, Oracle Business Process Composer automatically connects it to the outgoing sequence flow. However, you may have to manually reconfigure the surrounding flow objects.

How to Paste a Flow Object in a Process

You can paste the flow object that you previously cut or copied.

To paste a flow object in a process:

1. Right-click in the area of the process editor canvas where you want to paste a flow object.
2. Select **Paste**.

How to Add a Sequence Flow to a Process

Sequence flows define the order or sequence which the work is performed within a process. For more information, see [Controlling Process Flow Using Sequence Flows](#)

To add sequence flows to your process:

1. Open your process.
2. Move the cursor over the flow object where you want to create the outgoing sequence flow.
3. Click the **Add Sequence flow** button.
This button only appears for flow objects that do not have outgoing sequence flows.
4. Move the cursor to the flow object you want to connect to, then left-click.

How to Delete a Sequence Flow

You can delete a sequence flow from a BPMN process.

To delete a sequence flow from a process:

1. In the process editor canvas, right-click the sequence flow you want to delete.
2. Select **Delete**.

What You Need to Know About Deleting a Sequence Flow

When you delete a sequence flow from a process, any implementation details you may have configured for the sequence flow are lost.

How to Edit the Properties of a Flow Object

You can edit the basic properties of a sequence flow.

To edit the properties of a flow object:

1. Right-click on the flow object.

2. Select **Properties**.
3. Edit the properties of the flow object.
4. When you are finished editing the properties, click the down arrow located at the top right-hand corner of the Properties pane.

How to Assign a Custom Icon to a Flow Object

Use Oracle Business Process Composer to select a custom icon to replace the default BPMN icon of a flow object. You can select from a list of custom icons provided by Oracle BPM.

To assign a custom icon to a flow object:

1. Right-click the flow object, then select **Properties**.
2. Click **Change**, then select the icon you want to use.
3. Click outside the properties window to apply your changes.

Working with Business Catalog Components

Note:

With patch [23995890](#), the prior implementation of the Business Catalog in Oracle Business Process Composer is not available in this release due to the deprecation of Adobe Flash Player in the process editor. To use the Business Catalog, you can use Oracle BPM Studio (in JDeveloper) or contact Oracle Support for assistance.

Working with Draft Processes

Oracle BPM allows you to create and deploy draft processes. A draft process has one or more flow objects, which do not have their implementation defined. By deploying a draft process, you can test the parts of your process that have been completed without having to wait until all flow objects have been implemented.

To create a draft process, mark one or more flow objects within the process as draft. However, a draft process must be valid before it can be deployed.

When a flow object is marked as draft, you cannot configure data associations for it. If you mark a flow object as draft that has previously had data associations configured, these are lost.

You can define the implementation details of a draft flow object. However, it is not required. A draft flow object with no implementation defined does not generate errors during project validation.

When a project containing a draft flow object is deployed, implementation details for those flow objects are ignored. For example, if your process contains a user task marked as draft, the runtime engine does not create instances of the associated human task.

How to Mark a Flow Object as Draft

To mark a flow objects as draft, edit the implementation properties, as shown in [Figure 7-7](#).

Figure 7-7 Activity Properties - Implementation

The screenshot shows the 'Implementation' tab of the 'Activity Properties' dialog. The left sidebar contains 'Documentation', 'Business Properties', 'Implementation' (selected), and 'Validation'. The main area shows the following settings:

- Is Draft:
- Type: **Process Call** (dropdown)
- Conversation: Default Advanced
- Process: CreditRatingProcess (text field with search and delete icons)
- * Target Node: Credit Rating Request (dropdown)
- Sampling Point: Inherit process default (dropdown)

To mark a flow object as draft:

1. Open your process.
2. Right-click on the flow object, then select **Implementation**.
3. Select the check box next to **Is Draft**.
4. Click **Apply Changes**.

Documenting Your Process

You create documentation for your process using the documentation editor. You can add documentation for an entire process or for individual flow objects within a process.

Using Oracle BPM you can create two different types of documentation:

- **End User:** Documentation visible to end users of your process-based application using Process Workspace.
- **Internal (Use Case):** Documentation for process analysts and developers who are collaborating on a business process or who may revise it later.

You can define use-case documentation for each of the activities, events, and gateways within your process.

Note:

You cannot create documentation for sequence flows or measurement marks.

For more information about documenting your process, see [Understanding Process-Level Documentation](#) and [Understanding Activity-Level Documentation](#).

Importing and Exporting Process Models

Use Oracle Business Process Composer to import and export external process models created in other programs.

Use the BPM Process Model Converter wizard to import external process models and convert them to BPMN.

Importing Process Models into Oracle BPM

Use the BPM Process Model Converter wizard to import external process models and convert them to BPMN. Oracle BPM supports importing and converting process models in the following formats, as shown in [Figure 7-8](#).

- Oracle Tutor (docx)
- Visio (vdx)
- Oracle Workflow (wft)
- BPMN 2.0 (bpmn)
- XPDL (xpd)

Figure 7-8 BPM Process Model Converter Wizard

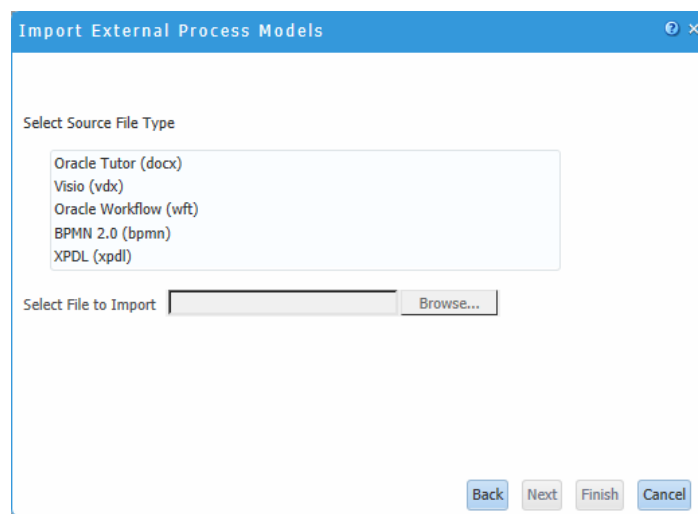

You may have to modify Visio and XPDL processes before conversion to ensure that they are converted accurately. See [Preparing Processes for Import into Oracle BPM](#) for more information.

Note:

If the original file contains properties and artifacts that are not supported by BPMN, the unsupported elements are not converted and are omitted from the final BPMN process.

For example, if the original file contains loop characteristics on a regular activity, which is not supported in Oracle BPM, the BPMN process does not contain the loop characteristics after conversion.

To import a process model:

1. From the main menu, select **Import**, then **Import Model** to open the BPM Process Model Converter wizard.

The wizards' welcome page is displayed. Click **Next**.

2. On your local file system, highlight the format type of your file and then browse to the file you want to import. Click **Next**.
3. If you are importing a Visio or XPDL file, select one of the following:
 - Create a separate model from each pool
 - Merge pools into a single model

This dialog appears even if the original file does not contain multiple pools.

4. Click **Finish**.

You can view the newly created BPMN processes from the Project Welcome Page.

8

Simulating Process Behavior

Use Oracle Business Process Composer to run simulations to improve the performance of your business processes. Learn how to create simulation models and simulation definitions, and how to run a simulation and analyze the results.

- [Introduction to Simulations](#)
- [Creating and Running a Simulation](#)
- [Working with Simulation Definitions](#)
- [Working with Simulation Models](#)
- [Running Simulations](#)
- [Analyzing the Results of a Simulation](#)

Introduction to Simulations

Oracle Business Process Management (Oracle BPM) provides functionality for simulating the behavior and performance of Business Process Model and Notation (BPMN) processes. Using Oracle Business Process Composer, process designers can run simulations during the design phase.

After creating and configuring a simulation, you run it in Oracle Business Process Composer to determine the efficiency of the process using the resources allocations you have defined. Using simulations, you can:

- Define multiple simulation models for a given process so that different conditions can be analyzed.
- Run multi-process simulations to learn how working in different business processes can affect shared resources such as human participants.



Note:

In Oracle Business Process Composer you can only run simulations based on test data you define using Oracle Business Process Composer. You can run simulations on real-world data using Oracle BPM Studio.

Simulation Models and Simulation Definitions

Before running a simulation, you must define the simulated behavior of the project and the processes you want to include in the simulation. To define a simulation you must create and configure the following in your BPM Project:

- **Simulation definition**

Simulation definitions define the processes and resources for a specific scenario. In a simulation definition you specify the processes included in the simulation by selecting the

simulation models associated to those processes. A process can have multiple simulation models defined for it. If a process has multiple simulation models defined, then you must select one of those models to use in the simulation definition.

Within a BPM project you can define multiple simulation definitions, each with its own parameter definitions and simulation models. This allows you to compare multiple scenarios.

- **Simulation model**

Simulation models define the simulated behavior of an individual process model. You can have multiple simulation models for each business process, allowing you to simulate different scenarios.

Simulations do not call each individual task within a process. For example, they do not run the service associated to a service task, variables are not assigned values, and external resources are not updated.

Simulation Parameters

In addition to the general parameters defined for a simulation definition and a simulation model, you can also define simulation parameters for the start events and activities within a BPMN process.

General Simulation Definition Parameters

The following parameters define the general behavior of a simulation definition.

- **Simulation definition:** Defines the name of the simulation definition.
- **Duration:** Defines the period the simulation runs.
This interval is specified in months, days, hours, minutes, and seconds.
- **Start time:** Defines the start time for the simulation.
This time is used only for logging. It is not used for scheduling purposes.
- **Let in-flight instances finish before simulation ends:** If selected, simulation ends only when the specified number of instances completes.
If deselected, simulation stops after the simulation duration is completed. At that point, all incomplete instances are shown in either *in-process* or *queue* status.

You must define these parameters when creating a simulation definition. However, you can redefine them later if necessary.

Simulation Model Parameters

The following parameters define the general behavior of a simulation model:

- **Model name:** Defines the name of the simulation model.
- **Specify number of process instances to be created:** Specifies the number of simulated instances that are created during simulation.
- **Interactive tasks:** Defines the distribution type used for interactive tasks.

The available distribution types are:

- Constant
- Uniform

- Exponential
- Normal

These are identical to the distribution methods defined for specific activities within a process. When you change distribution type or other parameters for a specific activity within a process, these values override the general values defined in the simulation model. See [Activity Parameters](#) for more information.

- **Automatic tasks:** Defines the number of simulated threads available when performing an automatic task.

This parameter is identical to the Threads parameter you can define for individual activities within your process. See [Activity Parameters](#) for more information.

Resource Parameters

Resources define the simulated resources within your organization. Resources are defined in a simulation definition and can be shared between each of the process models that are included. These resources can be associated with a specific role within your project. You can use these parameters together to create a resource profile that determines the expense, time, and efficiency of a person or group.

The following resource parameters are supported:

- **Name:** Defines the name of the resource.
- **Cost per hour:** Specifies the cost of the resource per hour when performing an activity.
- **Efficiency:** Specifies how efficient the resource is when performing an activity.

This parameter is used when selecting the Maximum efficiency policy when defining how organizational resources are allocated.

See [Activity Parameters](#) for more information.

- **Capacity:** Specifies how many activities can be performed at one time.
- **Availability:** Specifies the percentage of time this resource is available.
- **Roles:** Specifies the roles associated to this resource.

Start Event Parameters

To simulate the behavior and performance of start events, Oracle BPM uses a statistical model that simulates the probability of a certain behavior. You must select the statistical distribution that Oracle BPM uses.

The following distribution types are available:

- **Constant:** Triggers the start event at a specific interval.

For example, if you specify a period of 1 minute and 15 seconds, the event is triggered every 1 minute and 15 seconds. Each time the event is triggered, a new instance of the process is created.

- **Uniform:** Triggers the start event at intervals within a specific margin specified by the mean and delta parameters.

For example, if you define the mean as 30 seconds and the delta as 3 seconds, the start event creates a new instance in intervals between 27 and 33 seconds, with an equal probability.

- **Exponential:** Triggers the start event a specified number of times within a certain interval.

For example, if you define the frequency as 10 and the interval as 1 hour, the event is triggered 10 times per hour. The distribution of events is based on exponential distribution.

- **Normal:** Triggers the start event based on normal, or Gaussian, distribution.

This is a continuous probability distribution that is based on a bell curve. For example, if you define a mean of 10 minutes and a standard deviation of 2 minutes, the event triggers according to the probabilities shown in [Figure 8-1](#).

Figure 8-1 Simulation - Normal Distribution in a Start Event

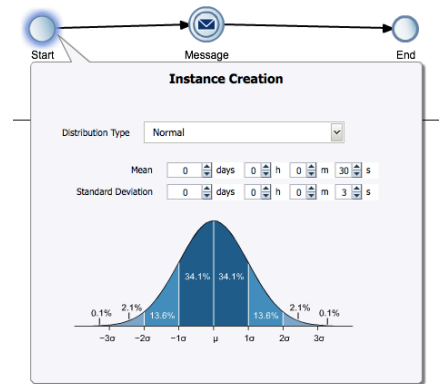

In this example, the event has a 62.8 percent probability of triggering in an interval between 8 and 12 minutes.

- **Real:** Triggers the start event based on user-specified intervals: hourly, daily, weekly, or monthly.

You can define the mean and standard deviation for each interval. Using these parameters, the start event creates new process instances using normal distribution.

For example, you can specify a daily distribution with a mean of 5 minutes and a standard deviation of 1 minute for weekdays and a mean of 1 hour and a standard deviation of 10 minutes for weekends.

Activity Parameters

In addition to start events, you can define parameters that determine the simulated behavior or interactive and automatic activities within a process. You define these parameters using the tabbed panes of the simulation editor. [Figure 8-2](#) shows an example of the tabbed panes of an interactive activity.

Figure 8-2 Simulation Parameters for an Interactive Activity

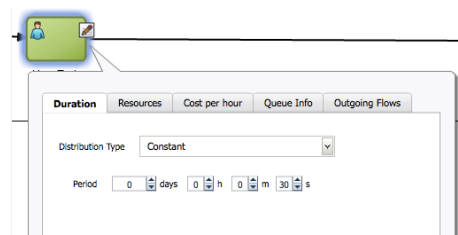

The simulation parameters for activities are:

- **Duration:** Defines the statistical model used to determine the amount of time required to perform an activity.

The statistical models used are similar to those defined for start events except, instead of defining how often an event is triggered, they define how long it takes to perform the work of a specific activity.

See [Start Event Parameters](#) for a description of each distribution type.

- **Resources** (interactive activities only): Defines how many interactive activities can be performed simultaneously.

You can define how simulated resources are allocated to this activity.

- **Organizational resources:** Resources shared between all the processes within a simulation definition.

You must specify the policy that determines how the simulated participants are selected to perform the activity.

- * **Minimum cost:** Selects less costly resources first.
- * **Maximum efficiency:** Selects the most efficient resources first.
- * **Random:** Randomly selects between Minimum cost and Maximum efficiency.

See [Resource Parameters](#) for information on defining organization resources within a simulation definition.

- **Fixed resources:** explicitly defines the number of resources available to perform the interactive activity.
- **Threads** (available only for automatic activities): Defines the number of simulated threads that are used to perform an automatic activity.
- **Cost per hour:** Defines the cost required to perform the activity.

Use this parameter to create cost-base reports.

- **Activity Cost Type:** Can be defined as a base cost or as a base cost plus the cost of resources assigned to perform the activity.
- **Activity Fixed Base Cost:** Defines the value (specified as a decimal number) of the fixed base cost.

See [Resource Parameters](#) for information on defining organization resources within a simulation definition.

- **Queue info:** Specifies the maximum size of the queue for this activity.

This is the number of instances that are currently waiting at this activity. When this number reaches the maximum size, the simulation issues a warning.

- **Outgoing flows:** Specifies the probability (defined as a decimal number) of a process instance continuing along each of the outgoing sequence flow.

If only one outgoing sequence flow is defined, the probability is specified as 1 and cannot be changed.

Creating and Running a Simulation

To run a simulation, you must first define a simulation model for your project and at least one simulation definition for each of the processes you want to include in your simulation. You can create multiple simulation definitions to test and compare the performance of your processes.

To create and run a simulation:

1. Create the BPMN processes you want to include in your simulation.
See [Working with Business Processes](#) for information about creating and working with business processes.
2. Create a simulation definition and simulation models.
The initial simulation model for a process can only be created in the simulation definition editor. After you have created at least one simulation model for a process, you can create additional simulation models for a process.
See [How to Create a Simulation Definition](#) for information about running the simulation wizard to create simulation definitions and simulation models.
3. Configure parameters to define the simulated behavior of your processes.
See [Simulation Parameters](#) for information about the different parameters you can define for a simulation definition and simulation model. See [How to Edit a Simulation Model](#) for information about how to configure parameters for the flow objects within your process.
4. Run the simulation.
After creating and configuring a simulation definition and simulation model, you can run your simulation.
See [Running Simulations](#) for more information.
5. Analyze the results of the simulation.
After running a simulation you can analyze the results of the simulation and make adjustments to the parameters to determine how to improve the performance of your process. See [Analyzing the Results of a Simulation](#) for more information.

Working with Simulation Definitions

Simulation definitions define the simulated behavior of your BPM project as a whole.

Within a simulation definition, you can define general parameters, including the organizational resources, and select which simulation models to include in a simulation. You can define multiple simulation definitions to test different combinations of parameters and processes.

After creating a simulation definition, you can edit its resources, add simulation models, and so on, as described in the following sections.

How to Create a Simulation Definition

In a simulation definition, you can change the values of different parameters to see how they influence the performance of a project. The parameters you can define include:

- The start time and duration of the simulation
- Which process simulation models you want to include in the project simulation

- Participant resources you want to include in the simulation

Oracle Business Process Composer provides a wizard that walks you through the process of creating and configuring a new simulation definition, creating and configuring new simulation models, and configuring organizational resources.

To create and configure a simulation definition:

1. Click **Simulations** from the Project Welcome Page.
2. Click the **New (+)** icon to start the simulation wizard.

The New Simulation dialog appears, as shown in [Figure 8-3](#).

Figure 8-3 New Simulation Dialog

3. Enter a name for the simulation definition and values for the duration and start time of the simulation definition.

Select the check box to let in-flight instances finish before simulation ends.

You must define these parameters when creating a simulation definition. However, you can redefine them later if necessary.

See [General Simulation Definition Parameters](#) for more information about each of these parameters.

4. Click **Next**.
5. Create a new simulation model for each process you want to include in the simulation definition.

Simulation models can be shared across simulation definitions. However, the first time you create a simulation definition, you must create at least one simulation model for each process if you have not created one previously.

You can also create a new model in the simulation definition editor when you add an association between a model and a process. For more information, see [How to Associate a Simulation Model to a Simulation Definition](#).

- a. Click the **Add (+)** icon to create a new simulation model.

A simulation model defines the simulated behavior of a process. You can define multiple simulation models for a process, however only one simulation model is used for each process within a simulation definition.

- b. Provide information for each of the fields as shown in [Figure 8-4](#).

Figure 8-4 The New Simulation Model Editor

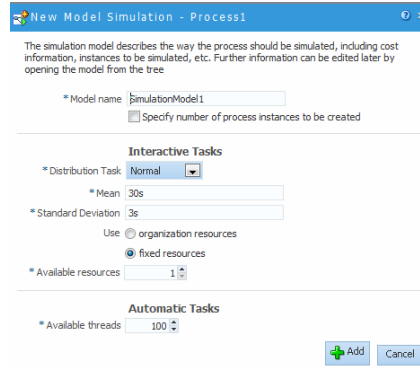

See [Simulation Model Parameters](#) for more information about these parameters.

c. Click **Add.**

Create additional simulation models as necessary. You should create at least one simulation model for each process in your project even if you do not include it in the simulation definition. This allows you to create additional simulation models later and add them to other simulation definitions.

6. Select the check box next to each process whose simulation model you want to include in the simulation definition.

If you have not created a simulation model for a process, you cannot select the process.

7. Click **Next.**

8. Optionally, click the **Add resource icon to add resources to the simulation definition.**

See [Resource Parameters](#) for information on the resource parameters you can define.

9. Click **Finish.**

What Happens When You Create a Simulation Definition

After creating a new simulation definition and simulation models, the simulation panel appears as shown in [Figure 8-5](#).

Figure 8-5 Project Welcome Page - Simulations: After Creating Simulation Definitions

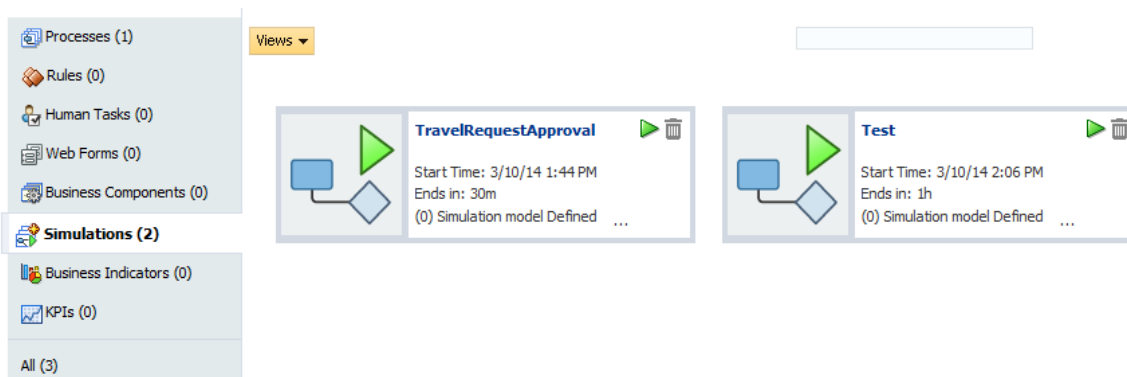

This panel displays all the simulation definitions defined in your project.

From this panel you can open a simulation definition and perform the following tasks:

- Edit a simulation definition.
See [How to Edit a Simulation Definition](#) for more information.
- Run a simulation.
See [How to Run a Simulation](#) for more information.
- Edit a simulation model.
See [How to Edit a Simulation Model](#) for more information.

How to Edit a Simulation Definition

After creating a simulation definition, you can edit it from the simulation panel.

To edit a simulation definition:

1. Click **Simulations** from the Project Welcome Page.
After clicking **Simulations**, the simulation panel appears, as shown in [Figure 8-5](#).
2. Click the name of the simulation definition you want to edit.
The simulation definition editor appears in a tabbed pane as shown in [Figure 8-6](#).

Figure 8-6 Simulation Definition Editor

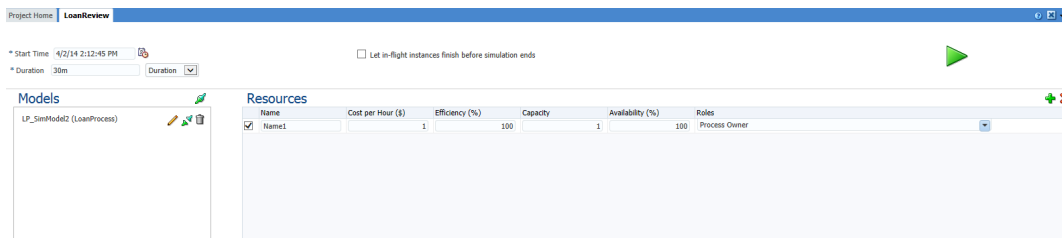

From this editor, you can add or remove simulation models from a simulation definition, add resources, and run simulations.

3. Edit the Start Time, Duration, and End Time as necessary.
See [General Simulation Definition Parameters](#) for more information about these parameters.
4. To add resources to a simulation definition, click the **Add Resource** icon, then edit the fields of the **Resources** table as necessary.
See [Resource Parameters](#) for more information about the parameters you can define for a resource.

How to Associate a Simulation Model to a Simulation Definition

Before creating a new simulation model, you must create at least one simulation definition. See [How to Create a Simulation Definition](#) for more information.

To associate a simulation model to a simulation definition:

1. Click **Simulations** from the Project Welcome Page.
2. Click the name of the simulation definition where you want to associate a simulation model.
New simulation models are created from the simulation definition editor. After creating a simulation model for a process, it can be shared with multiple simulation definitions.
3. Click the **Associate Model Simulation** icon in the **Model** pane to display the Associate Model dialog.
4. Select a process from the drop down list, then select a simulation model or click the **Add** icon to create a new model, as shown in [Figure 8-7](#).

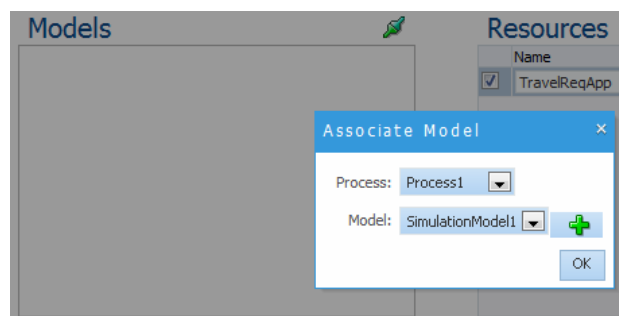
Figure 8-7 Associating a simulation model to a simulation definition

5. Click **OK**.
6. The simulation model appears in the list.

Working with Simulation Models

Simulation models allow you to simulate the behavior of an individual process. They allow you to define how a process behaves as part of a simulation definition.

You can define multiple simulation models for each process, creating different simulations based on different combinations of resource allocation and activity behavior.

How to Create a New Simulation Model

You can create multiple simulation models for a process. Different models can be included in different simulation definitions to determine performance based on different parameter settings.

Note:

You cannot directly create the first simulation model for a process. The first simulation model for a process must be created using the simulation definition wizard. After creating the initial simulation model, you can create additional models using the following procedures.

See [How to Create a Simulation Definition](#) for information about creating a simulation model when creating a simulation definition.

To create a new simulation model for a process

1. Click **Simulate** from the toolbar of the Project Welcome Page.
2. Select a simulation definition that contains the process where you want to create a new simulation definition.
3. Click the edit icon next to the simulation model.

The process opens in the simulation canvas. This canvas is similar to the process editor canvas. You can toggle back and forth between the process designer and simulation canvases using the drop down list in the process editor toolbar

4. In the process editor toolbar, click the **Add** icon.
5. Enter a name, then click **Create**.

The new simulation model is created. You can use this model when creating a new situation definition or editing an existing one. See [How to Associate a Simulation Model to a Simulation Definition](#) for more information.

How to Edit a Simulation Model

To edit a simulation model

1. Click **Simulate** from the toolbar of the Project Welcome Page.
2. From the drop down list, select the name of the simulation definition containing the simulation model you want to edit.
3. Click the **Edit** icon next to the simulation model you want to edit.

The process displays in the simulation canvas. This canvas is similar to the process editor canvas. You can toggle back and forth between the process designer and simulation canvases using the drop down list in the process editor toolbar.

 **Note:**

This drop down list only appears after you have defined at least one simulation model for a process.

4. Hover the mouse over the flow object whose simulation information you want to configure, then click the **Edit** icon of the flow object where you want to define resources.

The simulation definition pane appears as shown in [Figure 8-8](#).

Figure 8-8 The Simulation Model Editor Showing the Resource Definition Panel

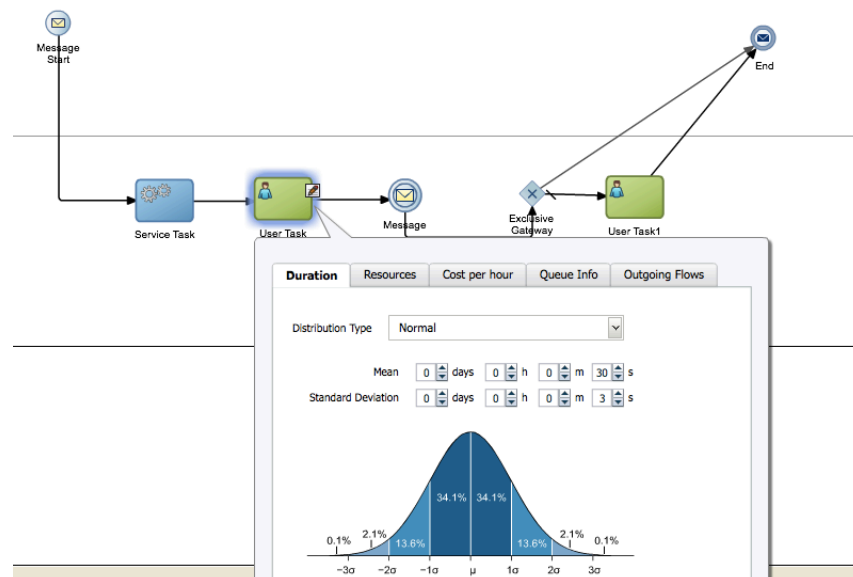

5. Edit the simulation parameters for the flow object by clicking the tab and editing the appropriate parameters. See [Start Event Parameters](#) and [Activity Parameters](#) for information on the parameters you can configure for specific flow objects.
6. After editing the parameters, click outside the popup window to save your changes.

Running Simulations

After defining a simulation model and simulation definitions, you can run the simulation to view the performance of your BPM project.

To run a simulation, you must have created at least one simulation definition and simulation model for each of the processes you want to test.

How to Run a Simulation

To run a simulation:

1. Click **Simulations** from the Project Welcome Page.
2. Click the name of the simulation definition that you want to run.
The simulation definition editor appears in a tabbed pane as shown in [Figure 8-6](#).
3. Click the **Run** icon, which displays as a green arrow at the top right-hand corner.

Analyzing the Results of a Simulation

The results of the simulation are displayed in a bar chart.

You can configure the results of the simulation by configuring the following:

- Activities
- Indicators

How to Analyze the Results of a Simulation Using a Chart

To analyze the results of the simulation using a bar chart:

1. From the Indicators list, select the type of indicators to monitor.

The available types of indicators are:

- Cost
- Time
- Units

2. From the list to the right of the indicators list, select the indicator options to monitor. Choose from the options listed in [Table 8-1](#).

Table 8-1 Simulation Results - Indicator Options

Indicator	Options
Cost	Total Cost
-	Average Total Cost
-	Resource Busy Cost
-	Resource Total Cost
Time	Cycle Time
-	Waiting Time
-	Working Time
-	Total Working Count
-	Average Process Time
Units	Queue Size
-	Working Count
-	Resource Utilization
-	Average Performance
-	Completed Operations
-	Completed Instances
-	Total Cost

3. Click the **Activities Only** check box to only include activities in the simulation results. The chart displays the indicator options you selected.
4. Click on any bar or process to view detailed activity results.

9

Using Process Player

Use process player to test the business processes within a Business Process Management (BPM) project.

- [Introduction to Process Player](#)
- [Using Process Player to Test the Behavior of Business Processes](#)

Introduction to Process Player

Process player provides an efficient way of testing the Business Process Model and Notation (BPMN) processes in your process-based business application. It uses a runtime environment, accessible from Oracle Business Process Composer, that emulates the real-world behavior of business processes. As the application runs, process player displays a visual representation of a BPMN process showing the path the process instance follows through the process flow. This allows process designers to easily create, test, and revise processes without having to save and deploy the BPM project and view it in Process Workspace.

Process player displays a BPMN process within the process editor as shown in [Figure 9-1](#).

Figure 9-1 Process Player User Interface

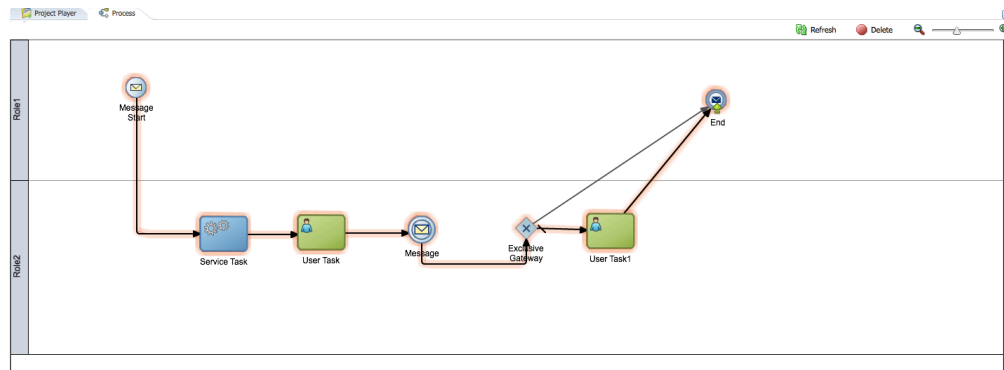

As a process instance progresses through a process flow, process player displays an animated view of the behavior of your process. The outline shows the path the process instance takes through the flow objects and sequence flows of your process. The specific path an instance takes through your process depends on the input data you provide for various flow objects. See [How Process Player Handles the Flow Objects of Your Process](#) for more information.

When running process player on a business process, Oracle Business Process Composer validates the project and deploys the current draft version of the BPM project to a player partition of the Oracle Business Process Management (Oracle BPM) runtime environment. When using process player, you do not have to publish or manually deploy the project to view changes while designing a process.

You can use process player to test the creation and behavior of process instances. You can create multiple instances of each process within your project

**Note:**

You can only run process player if you are currently editing the BPM project.

How Process Player Handles the Flow Objects of Your Process

As the process player runs through a process, it emulates the runtime behavior of some of the flow objects in your process.

- User tasks

When the process player reaches a user task in a process, it shows the role or user to select on its behalf. It shows all the possible outcomes as actions and if the web form is associated to the task it also gives you the option of launching the web form or manually selecting the outcome. If you choose to launch the web form, Oracle Business Process Composer deploys the web form and displays it in a separate viewer.

If no form is assigned, process player pauses to allow you to select the role you want to perform the task. It prompts you to select one of the outcomes defined for the human task. *Approve* and *Reject* are defined as default outcomes.

However, the list of possible outcomes depends on how outcomes are defined in the human task. See [How to Configure Basic Task Properties](#) for more information on defining the outcomes for a human task. After selecting an outcome, process player continues to the next flow object of your process.

If an Oracle Application Development Framework (Oracle ADF) form is assigned to the human task, you must deploy it to the run time environment using Oracle JDeveloper to be able to view it using process player. If the Oracle ADF form is deployed, Oracle Business Process Composer is able to access it when deploying to the process player partition.

After viewing the web form or Oracle ADF form, you must manually close the form viewer window to continue running your process.

- Message send events and send tasks

When process player reaches a message send event or a send task within a process, it performs these automatically. It then continues to the instance of the process being called and pauses at the corresponding message catch event or receive task. In both cases, you must manually return to the parent process. For example, if the send and receive pair is creating an instance on a different process of the same project you can return to the process player home, select the new instance for this process, run the child process, then return to the parent process. If the send and receive pair calls an external web-service you must manually enter the required web service message to continue running the process.

- Timer events

When process player reaches a timer event within a process, it pauses and waits until you click the **Run** icon of the flow object. Process player moves to the next flow object in the process.

- Call activities

When process player reaches a call activity, it calls the child process and creates a new instance of the process. Click the drill-down icon to view the child process.

- End events

When process player reaches an end event, it pauses and displays the drill-up icon. Clicking this icon causes process player to return to the parent process. If the current

process has no parent, process player returns to the process player home and deletes the process instance.

- Other flow objects

When process player reaches another flow object that causes the instance to wait for some operation or external event, process player pauses. To continue running the process click the **Refresh** icon located at the top of the process player home.

Enabling Process Player in Oracle Business Process Composer

Before process modelers can use process player to test the processes of a BPM project, an administrator must enable process player. See [Defining SOA Administrator Credentials to Enable Process Player](#) for more information.

Using Process Player to Test the Behavior of Business Processes

After the process player feature is enabled, you can access process player from the Project Welcome page and use it to test process behavior.

Process player is accessible from the main menu and the toolbar in the Project Welcome page. When project player is enabled and you are editing the project, the project toolbar displays an icon for accessing process player.

How to Map the Roles Defined in Your Process to Users in Your Organization

Before using process player, you must map the roles defined in your process to the users or groups of the organization infrastructure defined in your runtime environment. Process player uses the information of your organization to mimic the behavior of your business processes in real-world situations.

To map roles to users in your organization:

1. Open your project.
2. Start process player.
3. In the **Organization** pane, select the role of your process you want to map from the drop down list.

The drop down list displays all the roles defined in your process, as shown in [Figure 9-2](#).

Figure 9-2 Process Player - Organization Pane

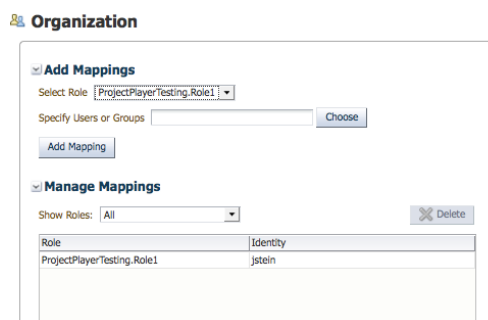

4. Select the user or group you want to map.
 - a. Click **Choose**.
 - b. Select **User** or **Groups** from the drop down list.
 - c. Enter the name of the user or group you want to search for, then click **Search**.
To see a list of all users or groups, leave the text area blank, then click **Search**.
 - d. In the table, select the user or group you want to map.
After selecting a user or group, it appears at the bottom of the chosen window.
 - e. Click **OK**.
5. Click **Add Mapping**.

The users or groups you mapped to the process role appear in the mappings table.

 **Note:**

You must map at least one user or group for each role in your process. If process player encounters a user task with an unmapped role, it cannot continue running the process beyond the human task.

How to Use Process Player to Run a Business Process

Before using process player to test the behavior of your business processes, ensure that you have mapped all the roles in your process to at least one user or group within your organization. See [How to Map the Roles Defined in Your Process to Users in Your Organization](#) for more information.

To use process player:

1. Open your project.
2. Access process player.
3. Select a process.
4. Click the **Play** icon located on the start event of your process.

Process player begins running the process. As it passes through each flow object and sequence flow, it outlines the path it takes through the process.

As process player continues running through your process, it stops when the process instance reaches one of the following flow objects:

- User tasks
- Call activities
- Message events
- Timer events

You must provide input for each of these flow objects before process player continues running the process. See [How Process Player Handles the Flow Objects of Your Process](#) for more information.

5. If process player pauses on a user task:
 - a. Click the **Play** icon on the user task.

- b. Select the user you want to perform the task.

 **Note:**

If the list of users appear empty, you must ensure that you have correctly mapped all of the roles of your process.

- c. Click **Run**, then select the outcome from the list.

The possible outcomes are defined by the human task associated with the current user task.

After you select the outcome, process player continues to the next flow object in your process.

6. If process player pauses on a message catch event or a receive task, it creates an instance of the child process.

- a. Click the **Run** icon.
- b. Select the **Project Player** tab.
- c. In the **Instances** table, select the newly created instance.

Oracle Business Process Composer prompts if you want to close the process player tab for the original process. Closing this tab has no effect on the process instances.

- d. Click **OK**.

Process player opens the new process instance and begins running the process from the message start event called from the parent process.

- e. Click the **Run** icon for any flow objects that pause process player, as outlined in previous steps.
- f. When process player reaches the message end event of the process, click the drill-up arrow to return to the parent process, as shown in [Figure 9-3](#).

Figure 9-3 The Drill-up Icon on a Message End Event



Process player closes the tab for this process and removes the process instance from the list of instances.

- g. From the list of process instances, open the process instance of the parent process.

After reopening the process instance of the parent process, process player continues running through the process from the point where the child process was called.

7. When process player reaches an end event in your process, click the drill-up icon, as shown in [Figure 9-3](#), to finish the process instance.

Process player returns to the process player editor and deletes the process instance.

Part V

Defining How Users Interact with Your Business Processes

Use Oracle Business Process Composer to define how users interact with your business processes. Learn how to create and use web forms, create form rules, and define human tasks.

- [Working with Web Forms](#)
- [Working with Web Form Rules](#)
- [Working with Human Tasks](#)

10

Working with Web Forms

Learn how to create web forms using Oracle Business Process Composer. Understand the web forms designer and procedures for creating web forms, adding web form controls, and editing web form control properties.

- [Introduction to Forms in Oracle BPM](#)
- [Introduction to the Web Forms Designer](#)
- [Introduction to Web Form Controls](#)
- [Introduction to Data Sources](#)
- [Walkthrough: Creating a Web Form Using the Form First Method](#)
- [Walkthrough: Creating a Web Form Using the Data First Method](#)
- [Working with Web Forms](#)

Introduction to Forms in Oracle BPM

Oracle Business Process Management (Oracle BPM) provides functionality that defines how end users interact with the applications defined by Business Process Model and Notation (BPMN) processes. There are three components within Oracle BPM that work together to define this user interaction: user tasks, human tasks, and forms.

- **User tasks:** BPMN flow objects that specify where user interaction is required in process. Oracle BPM supports different types of user tasks that determine the approval process required.
- **Human tasks:** Define how users interact with a process-based application. They define the user interface, data structures, and connectivity information. See [Working with Human Tasks](#) for more information.
- **Forms:** Define the interface that allow users to interact with your application. For business applications created with Oracle BPM these forms are displayed in Oracle Business Process Management Workspace.

Oracle BPM supports the following types of forms:

- **Web forms:** Define the user interface for a human task. They are based on standard technologies, including XHTML, CSS, and Javascript. Web forms are created by process analysts using Oracle Business Process Composer. They are included within a BPM project. This chapter describes how to create and use web forms.
- **Oracle Application Development Framework (ADF) task forms:** ADF components that define the user interface for a human task. ADF task forms are generally designed by process developers. They are created in Oracle JDeveloper and can be added to a BPM project using Oracle BPM Studio. See *Getting Started with Human Workflow in Developing Business Processes with Oracle Business Process Management Studio* for more information.

 **Note:**

Integrated WebLogic does not support web forms. You might get errors either during creation of web forms or during the deployment of the BPM project that contains web forms on Integrated WebLogic. Integrated WebLogic supports only ADF task forms.

Introduction to Web Forms

Web forms define the user interface that allow end users to interact with your business processes. Oracle Business Process Composer provides an editor for creating web forms. This enables process analysts to design the way users interact with a business process and also define the underlying data structure required by the application.

Web forms are based on standards, including XHTML, CSS, and Javascript which ensures compatibility across multiple platforms and browsers. At its core, a web form is an XHTML file. However, the form designer allows you to create and design a web form without interacting directly with the XHTML code. After creating a new form, use the web form designer to customize the form's appearance and behavior.

 **Note:**

- Do not add default values to ADF or Web Form when you design the forms. When the form is displayed in Workspace, forms get dynamic xml values and not the default values that you have entered in design time.
- Web Forms do not support digital signatures.

You can add the following to a web form:

- **Form controls:** Components that you can add directly to a form.
Form controls define the graphical elements of a web form and their layout. They also display data to users and receive data input. See [Introduction to Web Form Controls](#) for information about the types of form controls supported by Oracle BPM.
When you add, arrange, or remove a form control from a web form, the form editor automatically updates the underlying XHTML code.
- **Form rules:** Pieces of Javascript code that define the behavior of a web form or web form controls.
Oracle Business Process Composer provides a form rules editor that allows you to create and edit form rules. See [Working with Web Form Rules](#) for more information.

Form First and Data First Design

There are two use cases for creating web forms in Oracle BPM:

- **Form first**
In this use case, you create a web form first before any data elements are defined. This allows a business user to define the required user interface using Oracle Business Process Composer. In this use case, user-interface elements are created first without considering the required underlying data model.

After the form is created, Oracle BPM automatically generates the schema that defines the data required by the web form. This data schema is based on the web form controls added to the web form. When you assign the web form to a human task, this schema is automatically used to define the human task payload.

See [Walkthrough: Creating a Web Form Using the Form First Method](#) for procedural information about this use case.

- Data first

In this use case, you create a web form based on an existing human task payload. Oracle BPM generates data sources based on the payload. You can add web form controls to a form based on these data sources. One advantage of the data first model is that it allows you to reuse a schema across multiple forms.

After adding form controls from a data source, use the form designer to rearrange them within the form to define the necessary look and feel of the user interface.

See [Walkthrough: Creating a Web Form Using the Data First Method](#) for procedural information about this use cases.

Introduction to the Web Forms Designer

Web forms define the user interface of your process based application. Oracle Business Process Composer provides a web form editor for creating web forms.

Using the web forms editor you can:

- Add web form controls to a web form.
- Customize the appearance and layout of a web form.
- Create form rules that define the behavior of the controls on a web form.

[Figure 10-1](#) shows an example of the web form designer.

Figure 10-1 Oracle Business Process Composer - Web Form Designer

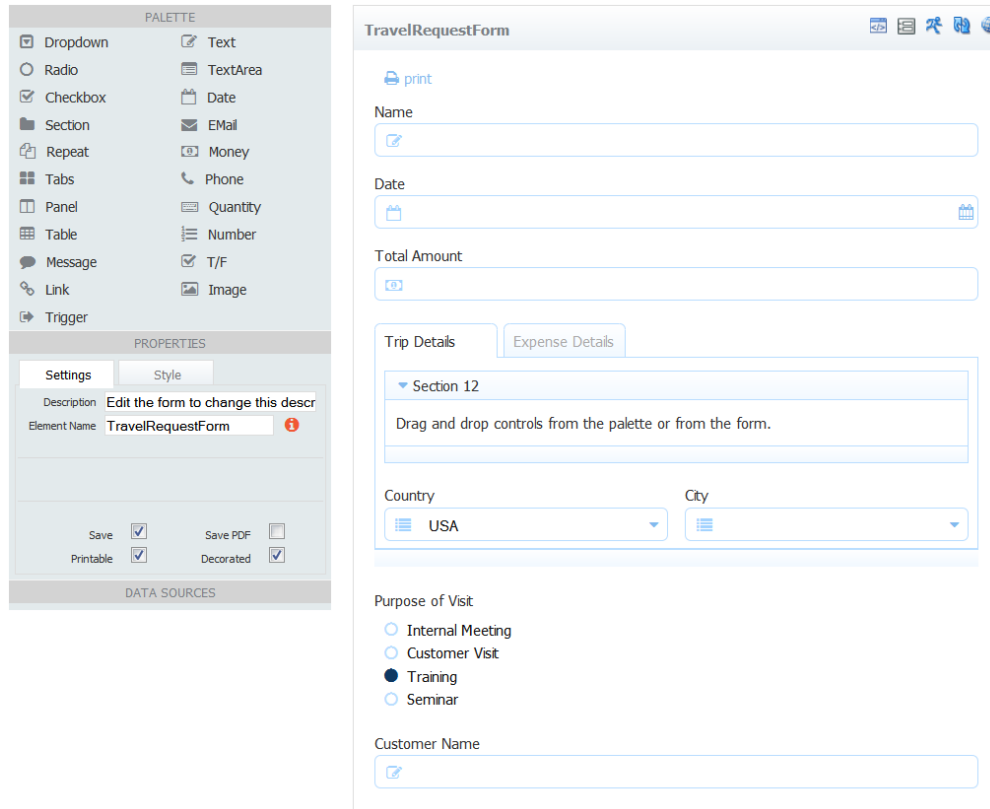

When you open a web form, the web form designer appears as a tabbed pane within Oracle Business Process Composer. The web forms designer is divided into the following areas:

- Web forms component palette
- Web form toolbar
- Forms canvas
- Properties editor
- Data sources

 **Note:**

Data sources are available only in web forms created through the *data first* use case. See [Walkthrough: Creating a Web Form Using the Data First Method](#) for information about creating web forms based on a human task payload.

 **Note:**

Customization of Themes / Skins for Web Forms is not supported in 12c.

Each area of the web forms designer is described in the following sections.

Introduction to the Web Forms Component Palette

The component palette contains the controls you can add to a form to define how your users interact with your business application. The form palette appears on the left side of the web form editor as shown in [Figure 10-1](#). You can add a form control to a web form by dragging the control from the palette to the form canvas.

See [Introduction to Web Form Controls](#) for a description of the web form controls that are available in Oracle BPM. See [How to Add Controls to a Web Form](#) for information dragging controls to a web form.

Introduction to the Web Form Editor Toolbar

The web form editor contains a toolbar that provides access to form-related features.

The web form editor toolbar contains the following buttons:

- **Edit rules:** Click to access the rules editor.
This button toggles between Edit rules and Edit form.
- **Edit form:** Click to access the form editor.
This button toggles between the form rules editor and the web form editor.
- **Test web form:** Opens the form in a browser window.
In this window, you can view how the web form appears to end users. You can also test the behavior of form rules.
- **Refresh:** Refreshes the external data source (human task payload) of the form.
If you make changes to the human task payload, you must refresh the data source of the web form. This button is only applicable to web forms created using the data first method. See [Walkthrough: Creating a Web Form Using the Data First Method](#) for more information.
- **Localization:** Opens the resource bundle editor.
This editor allows you to localize components of the web form and web form controls. Only languages that have been added using the project's Language setting are available. To configure language support, select the target language in the editor and add translation strings for the form's elements.
- **Business Objects:** Opens the Form Business Objects dialog.
Add business objects from the catalog to be available in your form. Once selected, business objects appear in the Data Sources part of the component palette. To use a business object in a form, drag it from the component palette to the form. See [Adding Business Objects to a Web Form](#) for more information.

Introduction to the Property Editor

Use the property editor to define the properties of a web form or web form control. When you click on a control in your form, the **Properties** area displays the control's properties so you can view and edit them.

The properties editor contains tabbed panes that display the properties of the web form or web form control grouped by function. [Figure 10-2](#) shows an example of the properties editor.

Figure 10-2 Web Form Designer - Properties Editor

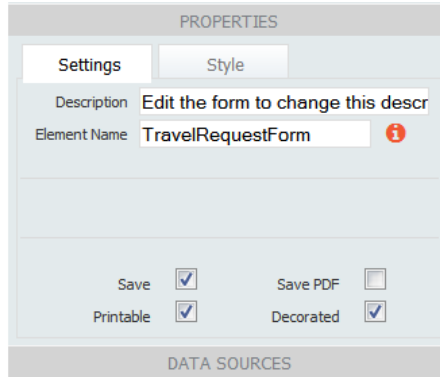

See [How to Edit the Properties of a Web Form](#) for procedures about editing a web form and web form control properties. See [Web Form and Web Form Control Property Reference](#) for information about each property.

Introduction to the Data Source Panel

The Data Source panel displays the list of data elements that can be incorporated into your form. See [Introduction to Data Sources](#) for more information.

From the data source panel, you can generate web form controls based on all the data elements in the payload or you can generate web form controls based on specific data elements. These can include business objects that you have previously selected from the catalog using the Form Business Objects dialog, accessed from the web form editor toolbar.



Note:

Data sources are only available in web forms created based on a human task payload. See [Walkthrough: Creating a Web Form Using the Data First Method](#) for information.

[Figure 10-3](#) shows how the data source panel appears in a web form created based on a human task payload.

Figure 10-3 Data Source Panel

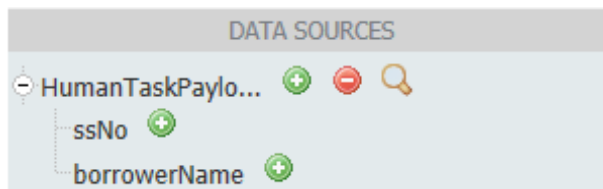

See [Introduction to Data Sources](#) for more information about data sources in Oracle BPM. See [Walkthrough: Creating a Web Form Using the Data First Method](#) for information on creating a web form based on a human task payload.

See [Adding Business Objects to a Web Form](#) for information on loading business objects from a catalog, and placing them on a web form.

Introduction to the Form Canvas

The right side of the web form designer is the form canvas. You can create a web form by dragging controls from the component palette to the form designer canvas. [Figure 10-4](#) shows an example of the form canvas containing several controls.

Figure 10-4 Form Canvas



The screenshot displays a web form titled "TravelRequestForm" within a browser window. The form includes several input fields and controls:

- A "print" button at the top left.
- A "Name" text input field with a small edit icon on the left.
- A "Date" date picker field with a calendar icon on the right.
- A "Total Amount" text input field with a currency symbol icon on the left.
- Two tabs: "Trip Details" (selected) and "Expense Details".
- A "Section 12" container with a dropdown arrow and the text "Drag and drop controls from the palette or from the form."
- Two dropdown menus: "Country" (set to "USA") and "City".
- A "Purpose of Visit" section with four radio button options: "Internal Meeting", "Customer Visit", "Training" (selected), and "Seminar".
- A "Customer Name" text input field with a small edit icon on the left.

Introduction to Web Form Controls

Web form controls are the user interface components that you add to a form to define the user interface of your business application. Web form controls are defined in HTML, but using the web form editor, you do not have to edit any of the underlying code.

Web form controls are described in the following sections. For information on the properties that you can configure for each web form control, see [Web Form Control Properties](#).

Input Controls

Input controls allow users to enter data (text, dates, numbers, and so on) into a form. Input controls automatically prevent users from entering the wrong data types. For example, if a user enters letters into a number control, the form displays an error message. This validation happens automatically. The function of each input control is described below.

To validate the content in each input control, Oracle BPM assigns a default XML schema data type to each control. [Table 10-1](#) shows the default data types for each input control.

Table 10-1 Input Controls - Default Data Types

Input Control	XML Schema Type
Text	xsd:string
Date	xsd:date
EMail	types:emailType, an xsd:string restriction pattern defined in types.xsd.
Money	types:number, an xsd:double restriction defined in types.xsd.
Phone	types:phoneType, an xsd:string restriction pattern defined in types.xsd.
Quantity	xsd:integer
Number	types:number, an xsd:double restriction defined in types.xsd.
Boolean	xsd:boolean

Text

The text control allows users to enter text and is primarily intended for short, one-line entries.

TextArea

The textarea control allows users to enter any text and is designed for longer, multi-line submissions. When a user enters data, a scroll bar appears, if necessary, to accommodate the text. The textarea control uses a property called **# of Rows** that controls the default number of lines visible in the input area.

In HTML there is no property for setting the maximum length on a textarea control. Therefore, this control does not have the maxlength property like the text control. If you must specify a maximum length, you should use the text control, or use a form rule to limit the amount of text a user can enter. See [Working with Web Form Rules](#) for more information.

Date, Time, Date/Time

The Date control allows users to enter information as a date, time or date plus time control. To use Date, Time and Date/Time controls, add a Date control to your form and use the Control Type property to choose from date, time or date/time. The control is configured accordingly.

The Date Control

Use the date control type to display the date input field with a calendar icon.

The default Date Format is Automatic. When Automatic is selected, both entry and display formatting of dates are locale specific. You still have the option to specify a particular date format that is independent of the locale by using the format field, but this is not recommended.

If a user clicks the calendar to choose the date, the date selected is displayed in the default mm-dd-yyyy format, for example 09-01-2014. Users can manually enter dates in any format, but they are then reformatted to mm-dd-yyyy.

Valid date formats use three different separators (. / -) and three date formats (dd/mm/yyyy, mm/dd/yyyy, and yyyy/mm/dd). The following examples show how dates can be specified:

- mm-dd-yyyy (07-26-1966)
- mm/dd/yyyy (07/26/1966)
- mm.dd.yyyy (07.26.1966)
- dd-mm-yyyy (26-07-1966)
- dd/mm/yyyy (26/07/1966)
- dd.mm.yyyy (26.07.1966)
- yyyy-mm-dd (1966-07-26)
- yyyy/mm/dd (1966/07/26)
- yyyy.mm.dd (1966.07.26)

The date is converted to the standard xsd:date format of yyyy-mm-dd in the submissions XML document using the following format:

```
<Order Date>2012-03-06</Order Date>
```

Dates are adjusted to be within 80 years before or 20 years after if the date is expressed with a two digit year. For example, using a pattern of "mm/dd/yy" and the current date/time of Jan 1, 1997, the string "01/11/12" would be interpreted as Jan 11, 2012 while the string "05/04/64" would be interpreted as May 4, 1964. During parsing, only year strings consisting of exactly two digits, will be parsed into the default century. Any other numeric string, such as a one digit string, a three or more digit string, or a two digit string that isn't all digits, is interpreted literally. The dates "01/02/3" or "01/02/003" are parsed using the same pattern as Jan 2, 3 AD. Similarly, "01/02/-3" is parsed as Jan 2, 4 BC. Web forms will always format for 4 digit years.

The Time Control

Use the time control type to display only the time input field on your form. The Time Format property drop down menu appears, allowing a user to select between four variations of military and standard conventions. The Time Format control defaults to hh:mm using military time, for example 18:30. Other format options include standard time (AM/PM).

Changing the control type to Time does not display the date picker.

The default Time Format is Automatic. When Automatic is selected, both entry and display formatting of times are locale specific. You still have the option to specify a particular time format that is independent of the locale by using the format field, but this is not recommended.

In addition to Automatic, the Time Format control has four standard formats using both military and standard time. There are two separators, the dot and the colon. Examples are shown below:

- hh:mm (18:30)

- hh.mm (18.30)
- hh:mm - AM/PM (06:30 PM)
- hh.mm - AM/PM (06.30 PM)
- hh:mm:ss (18:30:15)
- hh.mm.ss (18.30.15)
- hh:mm:ss - AM/PM (06:30:15 PM)
- hh.mm.ss - AM/PM (06.30.15 PM)

The local time is converted to UTC format in the submissions XML document. Here is an example: `<Order Time>15:42:00Z</Order Time>`. The capital "Z" after the time is necessary for proper initialization.

The Date/Time Control

Use the Date/Time control to display two input fields: one for the date and another for the time.

The default Date/Time Format is Automatic. When Automatic is selected, both entry and display formatting of dates and times are locale specific. You still have the option to specify a particular date/time format that is independent of the locale by using the format field, but this is not recommended.

A property drop down menu allows you to select from nine valid formats for the date of the control and four choices in military and standard time for the time. See [The Date Control](#) and [The Time Control](#) for more information.

Default formats for date and time remain mm-dd-yyyy and hh:mm.

- When you enter a date in the date part (or select with the picker), it automatically completes the time portion of the control with a value for 12:00 AM.

The value displayed depends on the time format selected:

- **00:00** displays if the selected time format is hh:mm
- **12:00 AM** displays if the selected time format is hh:mm - AM/PM
- **00:00:00** displays if the selected time format is hh:mm:ss
- **12:00:00 AM** displays if the selected time format is hh:mm:ss - AM/PM
- You cannot enter a time value without a date value.
- Changing the Control Type to Time does not display the date picker.
- The time input field cannot be labeled. You must ensure that the label for the date portion is descriptive enough to include the time portion.

If date and time labels for the appropriate input fields are required, two separate controls must be used or the label for the date portion should be extended over the time input field.

The local time is converted to and saved in UTC format and the date is converted to the standard xsd:date format of yyyy-mm-dd In the submission XML document, for example:

```
<OrderDate>2012-01-01T00:00:00Z</OrderDate>
```

The capital **Z** after the time is necessary for proper initialization.

Form rules can be applied to the Date/Time control in all variations. Form rules should execute in the form time zone.

Email

The Email form control allows users to enter a valid EMail address. The address must conform to the following syntax: <name>@<name>.<string>.

Money

Use the money form control to allow users to enter U.S. currency. Users can enter commas or decimal point. If a user does not enter them, the form displays these symbols automatically. For example if a user types 4000, the form will display the value as 4,000.00. The form also rounds all entries to two decimal places.

If a user types more than two digits after the decimal place the XML submissions document stores as many digits as the user entered but does not include the dollar symbol, decimal point, or commas.

Phone

The phone web form control allows users to enter a phone number using any of the following formats: xxx.xxx.xxxx, xxx-xxx-xxxx, xxx.xxxx, or xxx-xxxx. To enforce one of the 10-digit formats (to require an area code), edit the control's Pattern property.

Quantity

The quantity web form control allows users to enter quantities or any whole numbers (integers). The form displays an error message if users enter decimal points, commas, or anything other than an integer.

Number

The number web form control allows users to enter decimal numbers. Users may enter any number of digits after the decimal place.

Selection Controls

Selection controls allow users to select from a list of several options. Oracle BPM supports the following selection controls:

- Dropdown
- Radio
- check box
- True/False

 **Note:**

The web form control palette does not include a combo box control which is a drop down list in which a user can type a new value or option. Combo boxes are not part of standard XHTML.

However, it is possible to use a combination of drop downs, radio buttons, or check boxes with an "other" option in combination with form rules. If a user selects "other," the rule then displays a text control (such as details or new entry that the user can enter).

Dropdown

The dropdown control adds a drop down list to a form. By default the first choice in the drop down list is blank. You must define the other choices by editing the control's Options properties.

Radio

The radio control adds mutually exclusive radio buttons. You must define the number of radio buttons and the specific choices by editing the control Options properties.

After selecting a radio option as the default, to change it, you must remove that option from the control and tab out of the options property so that it is removed from the control. You can then add the option back to the control's option list.

Check Box

The check box control adds a set of check boxes allowing the user to select one or more options. Like other selection controls, you edit the control's Options properties to define the number of check boxes and define the options available.

Booleancheckbox

The booleancheckbox control allows a user to select a true or false value in a control instead of entering data. The control options default to "true=Yes" and "false=No". You can change the option labels to other values if necessary. However, the option values cannot be changed and remain true or false.

Selecting the **Yes** check box sets the value to true in the XML document for the control data while leaving it deselected defines a false value. No value appears in the XML document.

Group Controls

Use group controls to organize your forms based on the types of information you require to present to your users.

Sections

Use the sections control to create groups of controls that users can expand and collapse.

In a web form, users can click the expand icon to expand and collapse sections. You can specify a default value to determine if the section is initially expanded or collapsed.

After dragging a section control into your form, you can drag any other controls inside it, including panels and other section controls. If you have a required control inside a collapsed section, the section label turns red to cue users that they must expand the section and supply the required information. If you delete a section control while designing a form, all controls within the section are also deleted.

Optional Sections

Optional sections can cause the validity of a form to change dynamically. For example, consider the following form:

Figure 10-5 Optional Section

The screenshot shows a web form with the following elements:

- A text input field labeled "Name" containing the placeholder text "Your Name Here".
- A section control labeled "Address" with a downward arrow icon, indicating it is collapsed.
- Inside the "Address" section, there are four input fields:
 - "Street": A text input field.
 - "City": A text input field.
 - "State": A dropdown menu.
 - "Zip Code": A text input field.
- At the bottom of the form, there are two buttons: "Submit" and "Cancel".

The only required field in the form is **Name**. The entire **Address** section is optional. However, if the user chooses to enter an address, then the entire address is required as indicated by the yellow background when the user tabs to the **City** field. If the user enters a value in the **Street** field, the **City**, **State** and **Zip** fields will become invalid until valid values are entered in the three newly required fields.

Figure 10-6 Optional Section With Incomplete Data

The screenshot shows the same web form as in Figure 10-5, but with the following changes:

- The "Name" field is filled with "Your Name Here".
- The "Address" section is expanded.
- The "Street" field is filled with "500 East Main Street".
- The "City" field is highlighted with a yellow background, indicating it is required.
- The "State" and "Zip Code" fields are empty.
- The "Submit" and "Cancel" buttons are still present at the bottom.

If the user removes the value from the **Street** field, the form validity is automatically recalculated. The **Address** section is no longer invalid because it is optional. The generated XML instance document will also not contain an address element.

Tabs

You can use the tabs group control to create a tabbed view as shown in [Figure 10-7](#).

Figure 10-7 Web Form Containing Multiple Tabs

The screenshot shows a web browser window titled "LoanForm". At the top left, there is a "print" button. Below it, there are two tabs: "Borrower Details" (which is active and highlighted in light green) and "Loan Details". The "Borrower Details" tab contains the following controls:

- Borrower Name:** A text input field with a clear icon.
- Marital Status:** Two radio buttons, "Married" (unselected) and "Single" (selected).
- Date of Birth:** A date picker control.
- Phone:** A text input field with a phone icon and a clear icon.
- Social Security Number:** A text input field with a clear icon.
- State:** A dropdown menu.
- County:** A dropdown menu.
- Zip Code:** A text input field with a clear icon.

By default, when you drag the tab control into a form there are three individual tabs. To add or remove a tab, click the tab and then click the **Add (+)** or **Delete (-)** icon. Additional tabs are added to the right of the tab from which you clicked the add icon.

To rearrange the tab order, drag one tab on top of another tab. The tab you dragged moves to the right of the tab upon which it was dropped. You can drag in other controls, including other group controls, into any individual tabs. Users see only those controls in the currently selected tab.

To move a group of tabs to another area of a form, click the area to the right of the tab drag the entire group to the desired location.

Panels

The panels control creates columns within a web form. You can add multiple columns to a form by dragging in as many panels as necessary.

By default a panel's width is set to 49%. When you drag two panels into your form, the second panel is automatically aligned with the first panel. Panels have a 1px border to make their boundaries visible. Therefore, in a two-column layout you cannot make both widths 50%.

Since panels are group controls, you can drag other controls inside them. If you want to rearrange the order of your panels, you should remember that the drag-and-drop restriction that prevents you from dropping a control below a group control. If you have three columns and want the middle column at the far right, you must drag the middle column above whichever control is directly beneath the panel.

In a three or four column layout, to move one of the middle columns or the right-most column to the far left, you must drag and drop it above your left-most column.

Although panels have labels you can edit during design, the panel labels and panels themselves are not visible to users at runtime or when testing a form. Only the controls inside a panels are visible. These controls are organized visually according to the width of the panels.

If you delete a panel, any controls you've dragged inside it are automatically deleted.

Tables

Use the tables layout control to conserve space within a web form. This control allows you to arrange the form controls in a grid pattern.

You can edit the table name and column names. You can also drag and drop new controls from the palette, and set the widths of the columns. You can control the minimum and maximum number of rows in the table. The **Add** and **Remove** icons automatically appear to the left. You can also use form rules to calculate values, enable or disable fields, show or hide fields, and so on.

When you drag the table control into a form, by default, it has three rows and three columns. The columns contain the default names col 0, col 1 and col 2. All of the cells in the table are defined as required. The **Add** and **Delete** icons are displayed for each row in the table, allowing you to add and delete rows, depending on the Min/Max property values.

It is strongly recommended that column names in a table be unique.

Rearrange table columns by clicking on the arrow that appears when you click in the column heading of the column that you wish to move. Columns move to the right until the last column position in the table is reached.

Table controls have the following limitations:

- Table controls cannot be used in a repeat control.
- Table cell borders are not shown in print view.
- Table column names cannot be edited from the work area. Use the property editor.

Repeats

Repeating controls dynamically display multiple copies of a web form control. This is useful when you want to allow users to enter multiple information of the same type, for example, a phone number. A repeat control can dynamically display as many controls as required rather than having to explicitly add extra input controls. Repeat controls are used to repeat data elements and sections within a form.

You can add a repeat control to a web form, then drag and drop additional controls into the repeat control in the same way that you add controls to a tab, panel, or section. You can surround an individual control with a repeat control, or it can include an entire section control. This section control should contain all of the web form controls that must be repeated.

After adding a control to a repeat control, you can select the control to view and edit its properties. Web form controls added to a repeat control contain two additional properties:

- **Min#:** Specifies the minimum number of times the control can be repeated.
The default value for Min# is 0
- **Max#:** Specifies the maximum number of times the control can be repeated.
The default value of Max# is 1.

You must edit this value to define how many times the control is repeated. If you do not edit the value, the control does not repeat.

These properties define how the control appears to end users. When the value of these properties is greater than one, the user sees an add icon that automatically creates another control. In the form editor, clicking on the control automatically increments the property.

The Min# value defines the minimum number of controls that must be added and filled-in by the end user.

If a user adds controls beyond the number defined by Min#, they must fill in the data for the first controls up to the value of Min#. For example, if Min# is defined as 3 and the user adds 5 controls, the first 3 controls, in order starting from the top of the form, must contain data. If a user adds controls up to the number defined by Max#, the add icon is no longer displayed.

To explain to users how to add additional data elements, you can provide a message using a message control. The following example shows one way of doing this:

```
<center>Click on the  icon to add more phone  
numbers to the list.<br/></center>
```

When you edit the label or any properties of a control inside a repeat control, your changes are applied to every instance of the control inside the repeat control. If you delete a control inside the repeat control, all instances of the control are deleted.

Like panel controls, repeat controls are hidden when testing or using forms. Only the controls within the repeat control are visible.

There are some key differences between repeat controls and the other grouping controls:

- You cannot add button, message, or image controls.
- You cannot drag in message, image, link, tab, or table controls.
- A repeat control can contain only one web form control.

You cannot add tab controls, panels, or other repeat controls. To add multiple controls to a repeat control, you can add multiple controls to a section control, then add the section to a repeat control.

If you must add more controls to the section, you must drag the section out of the repeat control, add the additional controls, then drag the section control back into the repeat control. However, you can add a section control to a panel control without having to remove the section out of the repeat control.

When adding a repeat data element that is part of a data source, Oracle Business Process Composer automatically generates a repeating item in the control. The schema of the repeat control automatically enforces the minimum and maximum requirements.

Changing a Repeat Control to a Table

You can change a repeat control to a table control through the Control Type or Display As properties, depending on whether the repeat was dragged and dropped from the palette or added from schema. Refer to this documentation for the details.

When you change a repeat to a table or vice versa and there are referencing rules, it is recommended that you check the rules for the correct syntax and section names.

Other Controls

In addition to input, selection, and group controls, Oracle BPM provides other web form controls to define how users interact with a web form.

Message Control

Use the message control to add static text on your form. You must provide the text in the control's Message property. You can include XHMTL with your text. For example you may want two lines with different font sizes or colors.

The browser formats the XHMTL when users access the form. For example, if you want to create a header in a web form, you can use a combination of panels and message controls as shown below.

```
<center style="font-weight:bold;">  
Connecticut Surgeons, LLC  
</center>  
<center style="line-height:1.2em;">  
82 Anderson Road<br/>  
Branford, CT 06180<br/>  
</center>
```

You can choose a message type to display different pre-defined background colors, decorators or a border from the Message Type dropdown on the Setting tab of the property panel. These settings can override the values you have specified for BG Color and Label Color. For these values to take effect, select None for the Message Type.

Message Type values include:

- Default
- None
- Bordered
- Success
- Info
- Warning
- Error

Link Control

Use the Link Control to include a URL in your form. When a user clicks the link, the target URL opens in a separate browser window.

Button Control

Use the button control to add a button to your form. This control is primarily used in conjunction with form rules.

**Note:**

The button control does not work in repeating items.

Image Control

Use the image control to include an image (picture, logo, and so on) in your form. The image control allows you to add JPG, GIF, and PNG files or any other image type that your browser supports.

When you drag in the image control, a Browse button and an Upload Image button appear. Click Browse, navigate to the image you want, and click Upload Image. After uploading the image, the Browse and Upload Image buttons are no longer available. To change the image you must delete the image control and drag in a new one.

Before uploading images, you must ensure that they are sized to fit within a form. The standard form size is 600 pixels. You can resize an uploaded image by selecting the image control in the designer, clicking on the style tab in the properties panel, and setting the width.

Units are px, % or em. You must include the units. For example, specifying a value of 50% resizes the image to half the width of the form or panel.

Trigger Control

The trigger control adds a button to your form and is used in conjunction with rules. See [Using Dynamic Content in Form Rules](#).

 **Caution:**

Triggers do not work in repeating items.

You can change the color of the Trigger button on the Setting tab of the properties panel. You cannot center the text on a Trigger or remove the decorator. The New Line property is checked by default. The Button Color can be changed by selecting one of the choices in the Button Color dropdown on the Style tab.

Introduction to Data Sources

Data sources allow you to create web form controls based on existing data structures. In Oracle BPM these data structures are defined by a Human Task payload.

After creating a human task payload, you can create a new web form based on the payload data. See [Walkthrough: Creating a Web Form Using the Data First Method](#) for information about creating a web form based on payload data.

Web Form Controls Generated by Payload Data Types

[Table 10-2](#) shows the type of web form control generated for each data type supported by human task payloads.

Table 10-2 Human Task Data Types and Their Corresponding Web Form Control

Data type	Web form control
String	Text control

Table 10-2 (Cont.) Human Task Data Types and Their Corresponding Web Form Control

Data type	Web form control
Binary	Text control
Boolean	Booleancheckbox. If checked, the value is set to <i>true</i> and if unchecked it is set to <i>false</i> if the element is required. No value is specified if the control is optional. You can set the label of the true and false options through the Labels property. However only the first option, which maps to the <i>true</i> choice is displayed. If you add more then two labels the extra labels are automatically removed.
Int / Int64	Text control
Real / Decimal	Text control
Interval	Text control
Time	Date control
Components	Section Human task payload data created based on a business object is added to a section form control. Individual data elements within the component generate the same form controls as other data types. These are added to the section control. After adding them to a form, you can rearrange them as necessary.

Most of the controls generated from a human task payload are created as text controls. However, all validation for the controls are based on the original data type `datatype`. For example an `xsd:integer` type only allows numeric values.

Schema elements that specify element restrictions are generated as selection controls. The control is created as a dropdown if there are four or more valid choices and a radio button if there are fewer than four valid values. You can change the display type between radio, dropdown, and check box using the Display As property.

Modifying Web Form Controls Generated From Data Elements

After generating web form controls from data elements you can:

- Update the data payload of the human task and recreate the web form.
- Edit the controls in the web forms editor.

What You Can Edit Using the Web Form Editor

You can perform the following on a web form control after generating it from a data element:

- Edit the web form control's name.
You can edit the name that is displayed in the web form editor. However, the underlying XSD is not changed.
- Create or edit web form rules used by the web form control.
- Set default values for the web form control.
- Edit the layout of the web form controls within the web form.
You can move controls in sections or panels as required. However, you cannot add or remove a generated web form control from a repeat control.
- Edit the Display As property of the web form control.

See [Introduction to the Display As Property](#) for more information.

- Edit the web form control's label.

What You Cannot Edit Using the Web Form Designer

The following changes cannot be made when generating web form controls based on data elements:

- Make edits to web form controls that alter how the web form or web form controls are validated.
- Alter the number of repeats of a repeating control.
- Add additional web form controls that require changes to the underlying data source.

Introduction to the Display As Property

The Display As property is only supported by web form controls generated from a data source. Use the Display As property to change the way your control appears on a web form. For example, a text control can be changed to a dropdown control or vice versa. This changes the control's appearance on the form, but does not change how the control validates data. To modify how the control is validated, you must redefine the human task payload data and recreate the web form.

To see the control's underlying data type and the global element to which it is bound, hover over the property tab. The expanded Data Source displays the XSD path as a tool tip.

If you set the Display As property to a select web form control (radio, dropdown, or check box), the Label property is enabled. By adding strings into the labels property you can restrict the values allowed to be entered into this control when users use your form. When the form is submitted the value is equivalent to the selected option label.

Another way to set the labels is through a rule to dynamically initialize the options when the form loads. See [Working with Web Form Rules](#) for more information.

The Display As property is not available for the following controls when based on a data type:

- Message
- Repeat
- Date, Time, or Date/Time
- Boolean

Walkthrough: Creating a Web Form Using the Form First Method

You can use Oracle Business Process Composer to create a web form that is not based on pre-existing data.

See [Introduction to Web Forms](#) for information about the use cases for creating web forms.

To use the form first use case, you create a web form directly from the Project Home Page. After creating the web form, you use the web form designer to rearrange the form controls as required.

To create and edit a web form with no previously defined data:

1. Create a new web form using the Project Welcome Page.

- a. Ensure that you are editing the project.
- b. From the Project Welcome Page, select **Web Forms**.
- c. Click the New Web Form icon, then enter a name.
- d. Click **Create**.

2. Add controls to a web form.

After creating a new web form, you can add form controls as necessary to define how users interact with your application. See [How to Add Controls to a Web Form](#) for more information.

3. Edit the web form and web form control properties.

You can edit the properties of your web form and its controls to determine their behavior and appearance. See [How to Edit the Properties of a Web Form](#) for more information.

4. Add form rules to a web form.

You can add form rules to your web form to further customize and control its behavior. See [Working with Form Rules](#) for more information.

5. Test your web form.

You can use the web form designer to preview how your web form appears to end users. See [How to Test a Web Form](#) for more information.

6. Save your web form.

To save a web form, you must save the entire project. See [Managing Project Changes](#) for more information.

7. Assign your web form to a human task.

After completing your web form, you can assign it to a human task using the human task editor. When you assign the web form to a human task, the human task editor automatically generates the payload information based on the controls you added to the web form. If the human task already has an existing payload defined, it is replaced by a new payload defined by the web form.

See [How to Specify the Presentation of a Human Task](#) for information about assigning a web form to a human task.

Walkthrough: Creating a Web Form Using the Data First Method

You can use Oracle Business Process Composer to create a new web form based on an existing human task payload.

See [Introduction to Web Forms](#) for information about the use cases for creating web forms.

Human task payloads are created using the human task editor. When creating web forms based on a payload, the payload becomes read-only. The following conditions apply:

- You cannot update the payload signature after you create the web form.
In other words you cannot add or remove data objects nor change their type. However, if you have defined complex data types in the human task payload, you can modify them by editing the underlying business object.
- After creating a web form based on a human task payload, you cannot add web form controls to a form that require underlying data structures.

Any additional data required by adding web form controls to the web form using the form editor is not added to the underlying schema and is not available in the human task payload.

If you have not created the human task payload based on complex data objects, to modify the payload you must disassociate the human task from the web form, make the modifications to the payload, and create a new web form based on this new payload.

To create and edit a new web form based on an existing payload:

1. Create a new human task and define its payload.
 - a. Create a new human task.
See [How to Create New Human Task](#) for more information.
 - b. Create the payload you want to use as the base for the new web form.
See [How to Create and Configure the Data Payload for a Human Task](#) for more information.
 - c. Open the human task.
See [How to Open a Human Task](#) for more information.
 - d. Select the **Basic** tab.
 - e. In the **Presentation** area, select **Web Form**, then click the **Add** icon.
 - f. Enter the name of the web form, then select **Based on payload**.
 - g. Click **Create**.
The web form is created and assigned to the current human task.
 - h. Click **Edit** to edit the web form.
The web form editor displays a blank form.
2. Generate web form controls from payload data.
After creating a web form based on a payload, you can use the payload data to generate the corresponding web form controls. The payload data appears in the Data Structures pane on the left side of the web form editor.
See [How to Add Controls Based on Data Sources](#) for more information.
3. Add additional web form controls.
You can add additional form controls as necessary to define how users interact with your application. See [How to Add Controls to a Web Form](#) for more information.

 **Note:**

You can add additional controls to refine the look and feel of your web form. However, any data controls that you add are not reflected in the underlying payload.

4. Edit web form and web form control properties.
You can edit the properties of your web form and its controls to determine their behavior and appearance. See [How to Edit the Properties of a Web Form](#) for more information.
5. Add form rules to a web form.

You can add form rules to your web form to further customize and control its behavior. See [Working with Form Rules](#) for more information.

6. Test your web form.

As you are designing a web form, you can test its appearance and the behavior of form rule. See [How to Test a Web Form](#) for more information.

7. Save your web form.

To save a web form, you must save the entire project. See [Managing Project Changes](#) for more information.

Working with Web Forms

After creating a new web form, you can use the web form editor to add web form controls, edit form control properties, and test the web form.







The following sections describe how to add various types of controls to the form.

How to Add Controls to a Web Form

You can add controls to a web form by dragging and dropping from the web form control palette to the web form canvas. You can drag/drop above, below, to the left and right of most controls. If you are not dragging your control over a group control, your control will be placed at the top of your form.

As you drag a control, the position cursor changes to indicate its status.

Table 10-3 Web Form Position Cursor Icons

Position Cursor Icons	Description
Do Not Drop 	The control you are dragging can't be dropped over the area.
Drop 	Your cursor is over an area on the canvas where dropping a control is allowed.
Drop over 	Your control will be placed above the control over which you are hovering. You'll see this icon when you drag the control over the top half of an area into which the control can be dropped.
Drop under 	Your control will be placed below the control over which you are hovering. You'll see this icon when you drag the control over the bottom half of an area into which the control can be dropped.
Drop right 	Your control will be placed to the right of the control over which you are hovering. You'll see this icon when you drag the control over the right half of another control.
Drop under 	Your control will be placed will be placed to the left of the control over which you are hovering. You'll see this icon when you drag the control over the left half of another control.

Other important drag-and-drop rules:

- If you let go of a control while the Do Not Drop icon is showing, your control goes back to where it was - either back to the Palette or where it was in your form before you tried to move it.
- You can drag and drop above, below, to the left and right of most controls.

- You can drop controls above and below the Section, Tab, Table, Repeat and Panel.group controls.
- Panels can be dropped to the left or right of other panels, however, you cannot drop other controls in a similar manner to the left/right of panels.
- You can never drop two different controls into a repeat control—for example, you cannot drag in a quantity control if your repeat control already contains an EMail control.

If you require multiple controls inside a repeat control, first drag the controls into a section, then drop the section into the repeat. After the section is inside your repeat you may not add anything else to the section, so build the section first in this case. You also may never drop a panel, tab or another repeat control inside a repeat control.

To add controls from the component palette:

1. Open the web form where you want to add controls.
2. In the component palette click the control you want to add, then drag it to the form canvas.
As you begin to drag a control from the component palette, the position cursor changes depending on its position in the form canvas.
3. Release the mouse button to add the new control.

Creating Multi-Column Forms

You can create forms with multiple columns.

All control widths are specified in columns. The width is selected by clicking on a grid in the style tab.

When dropping controls from the palette on an empty canvas or above or below an existing control, the newly dropped control is 12 columns wide.

If you drag a control from the palette and drop it to the left or right of a control, the newly dropped control will take the width of the control you dropped on. The width of a control that is already in your form must be adjusted manually by the designer if the position of the control is changed.

To create a multi-column form:

Drag and drop panels from the palette and then drop additional controls inside of the panels. Panels can be dropped to the left or right of other panels. A newly dropped panel dropped to the left/right of another panel will take the width of the panel it was dropped on.

Alternatively, drag and drop the first control onto the canvas, modify the width to your specification and then drag and drop additional controls to the right of the previously dropped one. The controls will "wrap around" and line up in columns.

How to Add Controls Based on Data Sources

After creating a web form based on the payload data of a human task, you can automatically generate web form controls for the data elements defined in the payload. You can generate form controls from all of the data elements or individual data elements.

See [Walkthrough: Creating a Web Form Using the Data First Method](#) for more information.

Generating Form Controls for all Data Elements in a Payload

To generate form controls for all the data elements in a payload:

1. Open the web form you created based on a human task payload.
2. In the Data Sources pane, click the **Add (+)** icon to the right of the **HumanTaskPayload** node in the data elements tree as shown in [Figure 10-3](#).

Oracle Business Process Composer generates a web form control for each of the data elements in the payload. The controls are added to the web form above the currently selected control. See [Introduction to Data Sources](#) for information about which web form control is generated for each data type of the payload.

3. Edit the layout of the controls as necessary by dragging and dropping them within the web form.

 **Note:**

You cannot add a control generated from a data element into a repeat control.

Generating Form Controls for Individual Data Elements

To generate form controls for individual data elements in a payload

1. Open the web form you created based on a human task payload.
2. In the Data Sources pane, click the bullet to the left of the **HumanTaskPayload** node as shown in [Figure 10-3](#).

Oracle Business Process Composer displays a tree showing a list of the data elements within the payload.

3. For each of the data elements that you want to add to your form, select the **Add (+)** icon to the left of the data element.

Oracle Business Process Composer generates a form control for the data element. When adding data elements individually, the form controls are added directly at the beginning of the form. They are not added to a form panel.

4. Edit the layout of the controls as necessary by dragging and dropping them within the web form.

 **Note:**

You cannot add a control generated from a data element into a repeat control.

Adding Business Objects to a Web Form

Add business objects to a form from the Data Sources panel. The Data Sources panel includes business objects that you have added from the catalog using the Form Business Objects dialog, accessed from the web form editor toolbar.

To add business objects to a web form:

1. Edit your web form and click the **Business Objects** control on the web form editor toolbar.

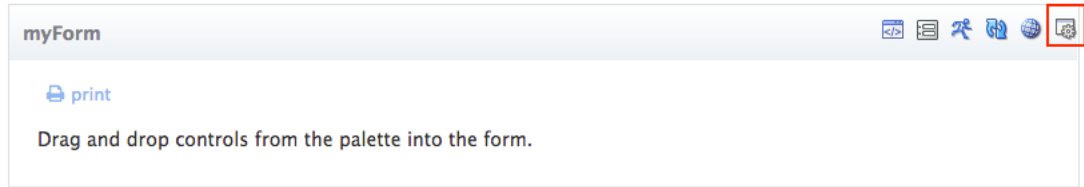

The **Forms Business Objects** dialog displays.

2. Select the business objects to include as data sources by using the controls on the dialog to move them to the **Selected** panel.

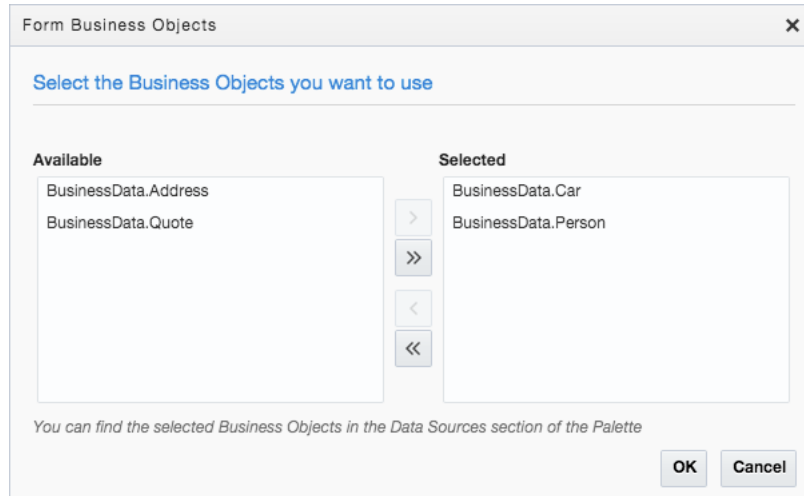

3. Click **OK** to close the **Forms Business Objects** dialog.
4. Drag business objects from the Data Sources panel of the palette to your form.

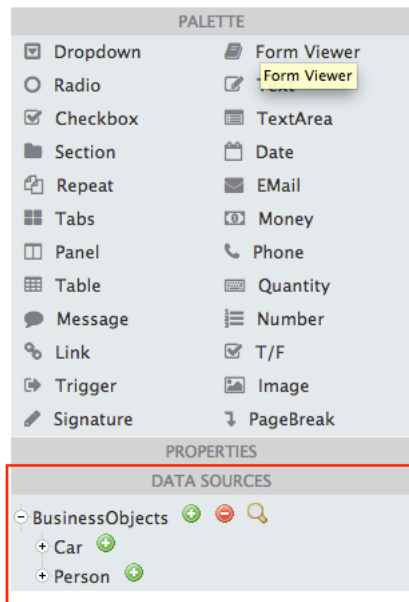

How to Show Which Web Controls Were Created from a Data Source

The web forms editor allows you to view which web form controls were automatically generated from a data source.

To show which web controls were created from a data source:

1. Open your web form.
2. Expand the **Data Sources** panel.
3. Click the **Show Form Controls** icon.

Each generated web form control is highlighted in the web form canvas.

How to Edit the Properties of a Web Form

You can edit the properties of a web form to configure general settings and style for the web form.

To edit the properties of a web form:

You can edit the properties of a web form to configure settings for the form as well as general style properties. See [Web Form Properties](#) for information on the properties supported by Oracle BPM.

1. Open the web form whose properties you want to edit.
2. Click the web form header at the top of the form canvas.

The properties tabs for the web form appear in the properties editor.

3. Edit the properties for the web form in the properties editor.

How to Edit the Properties of Web Form Controls

You can edit the properties of a web form control to configure how the control appears in your web form.

To edit the properties of a web form control:

You can edit the properties of individual form controls to configure its behavior and style. See [Web Form Control Properties](#) for information on the properties available for each form control.

1. Open the web form containing the control you want to edit.
2. In the form canvas, select the control.

When you select a control in the form canvas, it is highlighted.

3. In the properties editor select either the Settings or Style tab, then edit the properties as necessary.

See [Web Form Control Properties](#) for a description of each supported web form control property.

How to Delete a Web Form

You can delete a web form your BPM project from the Project Home Page.

 **Note:**

You cannot delete a web form that is associated with a human task. If you want to delete a web form associated with a human task, you must first disassociate it using the human task editor.

To delete a web form:

1. Go to the Project Home Page.
2. Select **Web Forms**, then position the cursor over the web form you want to delete.
3. Click the **Delete** icon, then click **OK** to confirm that you want to delete the web form.
4. Save your project.

How to Remove a Control from a Web Form

You can remove form controls from a web form using the web forms designer.

 **Note:**

After deleting a control it cannot be undone. You must add a new control to the web form and configure its properties.

Removing Controls

To remove a control from a web form or organizational control:

1. Open the web form whose control you want to delete.
2. Click on the control to select it.

When you select a control, it is highlighted.

 **Note:**

Ensure that you select the individual control you want to delete and not the organizational control.

3. Click the **Click to remove** button.

Removing Organizational Controls from a Web Form

To remove an organizational control from a web form:

1. Open the web form containing the organizational control you want to delete.
2. Click on the organizational control you want to delete.

When you select an organizational control, the control and all of the controls it contains are selected.

3. Click the **Delete** button.

 **Note:**

When you delete an organizational control, all the controls it contains are also deleted.

How to Test a Web Form

While designing a web form, you can test its behavior directly in the web form editor.

Each time you supply a value in a control, the form sends an asynchronous request to the server to validate the data. You do not have to complete the entire form before discovering data was entered incorrectly—try to type letters in a number control, for example, and you'll immediately see an error message. If your form includes rules that are associated with a particular control, the server applies these rules as soon as users enter data in the control.

For example, perhaps your form has a rule that enables the Guest Name control when you select the **Yes** radio button in the Are You Bringing a Guest?. In this case the Guest Name control is enabled immediately--while you are still completing the form.

To test a web form:

1. Open your web form.
2. Click the **Test Form** button in the web form editor toolbar.
3. Test your web form by entering a date, selecting items from dropdown controls, and so on.
4. Click the **Close (x)** button when you are done testing.

About Localization in Web Forms

Web Forms can be localized to support multiple additional languages.

In order for a language to be supported, it must be added at the project level first. See [Introduction to the Project Information Panel](#).

After a language has been added at the project level, translation strings for web form elements can be added in the web form editor. See [Introduction to the Property Editor](#).

11

Working with Web Form Rules

You can create and edit form rules within a web form using Oracle Business Process Composer. Form rules are pieces of Java-script code that allow you to define how users interact with your web forms. You must be familiar with the basics of Javascript to work with web form rules.

- [Introduction to Form Rules](#)
- [Working with Form Rules](#)

Introduction to Form Rules

Form rules are pieces of server-side Javascript code that allow you to define how users interact with your web forms by defining how web form controls are displayed and defining the types of data users can enter.

You can use form rules to define the behavior of a web form. Typical uses of form rules include:

- Adding dynamic behavior to a web form, including showing or hiding elements or enabling or displaying elements.

For example, you can add form rules that show or hide certain form controls or entire sections based on the state of other form controls. Displaying form fields in a context-sensitive manner reduces clutter and makes it easier for users to navigate your forms.
- Performing complex calculations.

For example, you can compute the total invoice price on an order form from values of other form fields such as item quantity and price.
- Performing complex validations.
- Populating a dynamic drop down list.

The following sections describe the basic functionality of Javascript within form rules. See [Web Form Rules Examples](#) for information about specific use cases of form rules.

Form Rule Javascript Syntax

In Oracle Business Process Management (Oracle BPM), a form rule is expressed in JavaScript code. Form rules are saved and can be run after you save your BPM project.

Form rules generally have the following form:

```
if (condition)
{
    true actions;
}
else
{
    false actions;
}
```

You can create more advanced form rules primarily for the purpose of looping over repeating items. Following are some basic characteristics of JavaScript that you should be aware of when writing form rules:

- **Case-sensitivity:** Javascript commands are case-sensitive.
For example, `var color1` and `var Color1` are two different variables
- **Loosely typed variables:** In Javascript variables are loosely typed.
Variable types do not have to be explicitly declared. For example, `var color = 'red';` and `var num = 33` cause the variable `color` to be a string type and `num` to be a numeric type.
- **End of line semicolons:** End-of-line semicolons are optional.
However, you should use semicolons to terminate lines as part of good coding practice. This often prevents mistakes.
- **Comments:** You can add comments to your code using either `//` or `/* */` syntax

Oracle BPM does not support the following Javascript syntax:

- **switch statement**

Additionally, Oracle BPM supports the following syntax with some limitations:

- **try-catch**

For example, in the following example, the value of the control named FN is set to 'got exception' because the JavaScript variable named `x` is undefined in this form rule.

```
if (form.load) {
  try {
    x.randomproperty = 'blah';
  } catch (e) {
    FN.value = 'got exception';
  }
}
```

However, catching an exception when a form control is not defined is not supported and may behave unexpectedly. This is because Oracle BPM catches the problem while parsing the form rule before the JavaScript interpreter catches the error.

In the following example, the control named `Color` does not exist in the form.

```
if (form.load) {
  try {
    Color.value = "red";
  } catch(e) {
    msg1.value = "error caught: " + e;
  }
}
```

Control Name

Form rules often must reference form controls. You must assign a control a name using the control's name property.

Names are case sensitive. If your control is named `FirstName` then you must write the form rule as `FirstName.value`. `firstname.value` does not work.

When using a control in a form rule, you must ensure that the control has a unique name. If multiple controls have the same name, the run time environment cannot determine which control the form rule refers. Form controls added to a form from the palette are usually

guaranteed to have a unique name. The web form editor does not allow you to change the name of a control to one that already exists in your form.

However, there are several contexts where you can have multiple controls with the same name:

- Controls added from XSD data sources
- Controls added from the custom palette
- Controls nested in sections

If there are two controls with the same label and at the same level, the control name is automatically made unique. If you try to edit the name such that it is no longer unique, the web forms designer prevents you from making the change.

When a control is dropped inside a section control, it is at a different nesting level than a control dropped outside a section. Two controls, one inside a section and another outside the section, are also at different nesting levels. The web form designer allows you to provide identical names to the controls.

If non-uniquely named controls are used in form rules there may be unexpected results. If you encounter errors in a form, you can edit the names of control names to make them unique.

**Note:**

Editing the name of a form XSD schema control has no effect on the XML instance document created when the form is submitted nor on the XML validation.

Form Rule Identifiers

Form rules refer to form controls using the Name property. If you have a control where the Name property is defined as `MyControl`, you can refer to properties of this control in form rules using the name as an identifier.

Form rule identifiers must always be of the following form:

```
Name.<property>
```

The following form rule identifier properties are supported:

- **visible:** Set to false to hide a control and true to make the control visible.
- **value:** Read or set the value of a control.
This property is not applicable to sections, tabs and other controls that do not have values displayed to the user.
- **enabled:** Set to false to disable a control so that a user can not change its value and true to enable it.
This is not applicable to sections and tabs.
- **expanded:** Set to false to collapse a group control (sections controls only) and true to expand a group control.
- **selected:** Set to true to designate a tab as the selected tab. (tab controls only).
- **valid:** The value of this property is true if the control contains a valid value otherwise its value is false.

Validity is based on the control's type. For instance a numeric control is invalid if the user enters a string value that cannot be converted to a number. This property can be set and read.

- **required:** Set to true to make a control required and display the red asterisk.

This property only affects palette controls and not controls generated from XSD schema data source.

This property is also valid for section controls. Setting a section required to false automatically sets all inner controls to not required.

- **options:** Enables dynamic setting select control options (radio, dropdown and check box controls only).
- **label:** Sets the label seen on any control including sections.
- **help:** Sets the help text.
- **hint:** Sets the hint seen on hover.
- **status:** Sets the error message display whenever the control's value is invalid.
- **clicked:** Used by the trigger controls. Its initial state is false.

When a user clicks a trigger its state turns true.

- **printable:** Set to false to remove the control from both the printable view and PDF submission document.

- **itemAdded:** Used by repeat controls. Its initial state is false.

When a user clicks "+" to add a repeat item AND when a repeat item is added through a Document URI as the form loads its state turns true.

- **itemRemoved:** Used by repeat controls. Its initial state is false.

When a user clicks "-" to delete a repeat item its state turns true.

- **itemIndex:** Used by repeat controls.

When an itemAdded or itemRemoved event fires, the value of itemIndex is set. For itemRemoved events itemIndex returns -1. For itemAdded events itemIndex gives you the index of the added item.

- **form.load:** This property is true when the form is first loading.

It is useful for setting default values through form rules that must be set before the user starts interacting with the form.

- **form.unload:** This property is true when the users clicks the form's submit button.

It is useful for setting control values just prior to the form's Doc Actions and Form Actions are executed.

Examples of identifiers used in form rules are:

- `FirstName.value`
- `BillingAddress.visible`
- `Email[1].value`
- `Email[i].visible`

The latter two are examples of repeating controls. repeating controls are discussed in more detail later. Note that the case of the properties is important. `FirstName.value` is a valid form rule identifier but `FirstName.Value` or `FirstName.vAlUe` are not.

Strings and Numbers

Because Javascript is a loosely typed language, there may be situations where you must add field values and the form rule performs string concatenation. There are several ways to tell the form rule to perform mathematical calculations instead of string manipulation. One simple way is by adding a *1 to the variable. `id = id*1 + 1;` ensures that `id` equals the current value plus one rather than the current value with a 1 appended. For example, if the current value was 4 and you didn't write `id*1` the result would be "41" rather than 5.

You might encounter a situation in a form rule in which money controls perform a string concatenation rather than an addition. To correct this:

- Open the form with the form rule in the designer, change the money controls to text controls, and then save the form.
- Open the form, change the text controls *back* to money controls, and then save the form again.

Dates and Times

To initialize a date control, the data must be in the correct format.

Here are some examples of correct date formats:

- `d1.value = "2012-01-13"; //yyyy-mm-dd`
- `d2.value = "01-13-2014"; //mm-dd-yyyy`
- `d3.value = "jan 13 2014"; //using string for month`

In general, it is not recommended to rely on either the browser's locale or the server's locale when writing date, time (time of day) and date/time literals in rules.

An example date and time rule follows:

```
if (form.load) {  
  date.value = "2014-02-29";  
  timeofday.value = "13:10:02";  
  datetime.value = "2014-02-29T18:10:02Z";  
}
```

This rule will initialize a date control in a form with 02-29-2014, a time control with 1:10 PM and a date and time control with 02-29-2014 in the date portion and 1:10 PM in the time portion.

Notice the special character "Z" at the end of the date/time value. This is equivalent to an offset of UTC-00:00 and indicates that the time of 18:10:02 is given in UTC. 18:10:02 UTC is equal to 1:10 PM Eastern Standard time.ind UTC.

Time and date/time controls also require correct formatting and an understanding of how web forms manages time zones. Web forms converts times into the browser's local time zone before displaying them in the form. However, if time data is not correctly formatted web forms will make multiple attempts to parse the time but will always display the time with NO time zone conversion. Here are examples of correct time formats:

- `t1.value = "20:30:00";`
- `d2t2.value = "20:30:00Z";`
- `t3.value = "20:30:00-04:00";`
- `dt1.value = "2012-08-23T20:30:00";`

Writing Conditions

One of the most common conditions is a form rule that executes as soon as the user enters a value in the control. The test for this condition depends on if the field is a string type or a numeric type.

String Types: text, textarea, date, phone

```
if (name.value.length > 0)
```

Numeric Types: money, quantity, number

```
if (name.value != null) or if (name.value > 0)
```

are both common test conditions.

Many times the condition `name.value.length > 0` can be dropped altogether and the form rule can be simplified. This form rule executes whenever a user enters a value into either the control named `firstname` or `lastname`.

```
fullname.value = firstname.value + ' ' + lastname.value;
```

Select Controls

Radio controls, dropdowns, and check boxes are all examples of select controls. Radio and dropdown controls are single select. That is, if one item in the dropdown is selected then all other items in the dropdown are deselected. The same is true for a radio. Only one radio button can be depressed at any time. Thus the `ID.value` of radios and dropdowns are similar to the other input and output controls. The value is a single item.

check box controls are multi-select. Multiple items can be selected at any given time. Thus the `ID.value` of a check box is an array. Therefore on check boxes a valid expression is `ID.value.length` which returns the number of items in the value array. And `ID[0].value` would retrieve the 1st item in the list and `ID[1].value` the 2nd and so on. If you have a check box control with only one check box and that check box is unchecked, the array contains no elements. For a check box control a useful expression is `ID.value.length == 0`. Note that `ID.length` is not a valid expression. Also since a check box control is an array it is not a valid expression to write `ID[0].value ==` . *Because if at option in the check box control is unchecked, its value is not be an empty string. It simply does not exist in the array.*

Initial Control State

Every control in your form has an initial default property state for the visible, expanded, value, valid, and enabled properties. However, you can change controls in the initial state in the form designer Edit tab. An initial state of a control can be modified several ways. One way is by simply tying a value into an input control. This sets the default value for the control when the form is first opened in use mode. Another way is by expanding or collapsing group controls. This sets the initial expanded state. The default state for the visible and enabled properties is set through the controls edit property panel. The edit property contains check boxes for visible and enabled for controls on which those properties make sense like input controls.

Form Rules and Repeating Controls

If you have a repeating control in a form that itself contains a repeating control, you cannot apply a form rule to the inner repeating control, since there's no way to tell which of the inner repeating items goes with which outer repeating item.

Using Dynamic Content in Form Rules

Real forms often require dynamic content in dropdown lists. Often based on the value entered into one form field, the values in other fields or options available in select controls must be dynamic.

Dynamic Content

Form rules enable invocation of http gets that return X-JSON headers with JSON objects. This allows complete flexibility in assignment of default values populated into form fields such as text controls and select (radios, dropdown, check box) controls. You can also use http.post(), http.delete(), and http.put() in form rules, although you must use URL parameters with them, as they do not all support payloads.

Here is an example that shows the syntax of the http.get. This form rule invokes the http get, which must return a JSON object. The method on the servlet can do whatever necessary such as querying a database given the itemName to retrieve the itemPrice. In this example the JSON object returned contains a field called price. The eval converts and assigns the JSON object to the javascript variable x. Then x can be used in the form rule as necessary. In this case it is used to set a value to the form field called Price.

```
eval('x=' + http.get('http://<webhost>/test/json/getPrice?itemName=' + itemName.value));
Price.value = x.price;
```

Another example is where the JSON object returned in the http.get response contains an array called clients. This array can then be used to set the options in a dropdown list.

```
eval('x=' + http.get('http://<webhost>/test/json/getClients'));
Clients.options = x.clients;
```

Here is another example of a servlet that returns a JSON object after authenticating a user and password.

```
@Override
public void doGet (HttpServletRequest request, HttpServletResponse response)
    throws ServletException, IOException
{
    try {
        String u = request.getParameter("username");
        String p = request.getParameter("password");
        if (authenticate(u, p) == null)
            response.addHeader("X-JSON", "{auth:false}");
        else
            response.addHeader("X-JSON", "{auth:true}");
    } catch (Exception e) {
        throw new ServletException(e);
    }
}
```

This servlet can be used in a form rule as follows:

```
if (signForm.clicked)
{
    eval('x=' + http.get('http://<webhost>/MYservices/signForm?username=' + u.value +
'&password=' + p.value));
    if (x.auth)
    {
        m.value = "<center>Authenticationn Succeeded</center>";
    }
}
```

```

    } else
    {
        m.value = "<center>Invalid username or password</center>";
    }
}

```

It is important to note that the `http.get` is accessing your http service through a URL. Certain characters must be encoded in order to correctly pass through an HTTP URL. You may not always be able to control the values your users enters into your form fields. If the value may contain one of these characters that value must be encoded.

For example, this `http.get` contains a password parameter. Since user passwords may contain characters such as `#` you should encode the value. The built-in javascript method `encodeURIComponent()` makes this easy.

```

eval('x=' + http.get('http://<webhost>/MYservices/signForm?username=' +
                    u.value + '&password=' + encodeURIComponent(p.value)));

```

You may also have to decode the URL parameter in your HTTP service. For example:

```

import java.net.URLDecoder;
String p = request.getParameter("password");
p = URLDecoder.decode(password, "UTF-8");

```

Reusing Dynamic Content

Fetching dynamic content from your back end system can be the source of degrading form performance. If your form must use the dynamic content multiple times you can improve performance by fetching the content once from the `http.get()` and saving the returned JSON string in a hidden text form control. You can then later read the text control value and eval it again rather than having to call your back end system multiple times.

For example, add a hidden text control to your form named `jsonUserData`. Add a single line to the form rule that retrieves the user data from your back end system through the `http.get()`:

```

jsonUserData.value = x;

```

In other form rules that also require the user data, rather than calling `http.get()` to your back end system again, add the following line to your form rule:

```

var val = jsonUserData.value;
eval('x' = val);

```

This has the affect of setting `x` to the same string as if you had again fetched content from your back end system.

Using Data and Built-in Methods in a Form Rule

You can access built-in data and methods within your web form rules.

Built-in Data

Oracle BPM provides certain data to your form rules. This includes information about the person currently using your form, the tenant and form information. You retrieve this data in your form rule using the `_data.getParameter('<data name>')` syntax.

The following is a list of the available data:

- `subject.id` - logged in user's username

- `subject.first.name` - logged in users's First Name
- `subject.last.name` - logged in users's Last Name
- `subject.roles` - list of all the roles for the logged in user (available in v4.1.5)

You can use a `form.load` form rule to pre-populate fields in your form with information about the currently logged in user. For example, if you have controls in your form named `ID`, `FirstName`, `LastName`, `Email` and `Roles`.

**Note:**

Setting the value of a control to an array or to a random JavaScript object is not allowed.

Built-in Methods

Oracle BPM provides built-in helper methods for common functionality required by form rules. Here is the list of available methods for working with dates and times:

- Time `frevvo.currentTime(form)` - returns the current time in the user's local time zone.
This method should only be used to set the value of a Time control.
- Date `frevvo.currentDate(form)` - returns the current date in the user's local time zone.
This method should only be used to set the value of a Date control.
- DateTime `frevvo.currentDateTime(form)` - returns the current date and time in the user's local time zone.
This method should only be used to set the value of a Date/Time control.

Here is an example of setting a Time control named `Tm`, a Date control named `Dt`, and a Date/Time control named `DtTm`.

```
Tm.value = frevvo.currentTime(form);  
Dt.value = frevvo.currentDate(form);  
DtTm.value = frevvo.currentDateTime(form);
```

The `currentTime()`, `currentDate()` and `currentDateTime()` does not work in a `form.load` form rule unless you specify a time zone on the form's Url through the `_formTz` Url parameter. This is because the form server must know the time zone in which to return the date and time. If you do not specify a `_formTz` the methods return null and the control values remain blank. For example, to specify Eastern time: `&_formTz=America/NewYork`.

Use the following methods to work with users and roles:

- boolean `isUniqueUserId (String userId, String tenantId)` - returns true if this user does not exist in the tenant and false if it does
- boolean `isUniqueRoleId (String roleId, String tenantId)` - returns true if this role does not exist in the tenant and false if it does

Understanding How Form Rules Work at Runtime

When using form rules within a web form, it is important to understand how form rules behave at runtime.

When are Form Rules Executed?

When you create or edit a form rule, Oracle BPM determines the list of controls and properties of those controls that the form rule depends upon. The form rule is automatically executed whenever there is a state change that is relevant to the form rule. Form rules are also executed sequentially in a top to bottom order as they are seen in the form rules panel.

Note that form rules can trigger the execution of other form rules. So, if a form rule, R1, sets the value of a control with Name A, and there is a form rule R2, that depends on A.value, then form rule R2 is triggered and executed.

A form rule typically refers to one or more form controls and their properties, and it is executed if any of those properties change value. Note that form rules are not fired when the page is loaded. For example, the following form rule is only executed when N1.value changes its value.

```
if (N1.value > 0 || N2.value > 0) {  
    T.value = N1.value + N2.value;  
}
```

Now assume a use case where you want to show a message when a user enters an invalid email. The form has a required Email input control (Name=E) and an action should be executed if the email control 'valid' property is 'false'. You can write the form rule as:

```
if (!E.valid) {  
    // code to show message here.  
}
```

The previous code does not work as expected as E is a required field and therefore E.valid initial value is 'false' since the field is initially empty. When the user enters an invalid Email address, E.valid still has the value 'false' and the form rule can not execute since there is no state change. The following code works properly.

```
if ((E.value.length > 0) && (!E.valid)) {  
    // code to show message here.  
}
```

The form rule depends on both the value of E.valid and E.value.length and therefore, when a string longer than zero characters is entered the form rule is executed and the message is shown.

Infinite Loops

It is easy to create form rules that enter a loop condition. For example, a form rule that updates A.value based on B.value and another form rule that updates B.value based on A.value. They can continually trigger each other.

The Oracle BPM server prevents this from happening by setting an execution time limit for each form rule. Any form rule that takes longer than 5 seconds to execute is forcibly stopped. Note that this is a very lengthy period of time for most computational tasks and the vast majority of form rules are not impacted by this constraint. However, since Oracle BPM is a hosted site that may be simultaneously used by numerous users, there is a time limit imposed on these computations.

Debugging Form Rules

This section describes ways of debugging forms.

Debugging Duplicate Control Names

When you're designing forms, the forms designer generally prevents you from giving controls duplicate names, but you can give controls the same name if the controls are contained within different section controls. For example, you can have two sections in a form named Home and Office, and each section can have a text control named Address. However, if you want to use either of the Address controls in a form rule, you have to give them unique names.

One way to tell if a form rule is breaking because of duplicate names is to look at the log in the Tomcat console. If you see a message similar to the following, it is probably a duplicate control name problem.

```
16:50:35,390 WARN RuleObserver:455 - Error evaluating rule [Translate.Translate Form Rule]:
Java arrays have no public instance fields or methods named "value." ([Translate.Translate
Form Rule]#2) if (form.load) {Name.value = 'Nancy';}
```

The phrase *Java arrays have no public instance fields or methods...* means Java is interpreting the controls with the same name as an array, not single controls.

Form Rule Profiling

Form rule execution can be profiled to determine how much time each form rule takes to execute. This can help you tune and improve performance in forms that use a lot of form rules. To turn on profiling set the rule-debug=profile on the url.

If your form rules are executing database queries to populate dynamic select controls (dropdown, radio, check box), form rule profiling can help you identify if the database queries are taking too long. You may see HTTP calls taking a long time to execute.

Working with Form Rules

Oracle Business Process Composer provides an editor that allows you to create and edit a form rule.

The following procedures describe how to create and test form rules.

How to Create a Form Rule

To create a new form rule:

1. Open the form where you want to create a new form rule.
2. In the form toolbar, click the **Rules** button.
3. Click **Create New Rule**.
4. Click **Edit**, then edit the fields in [Table 11-1](#) as required:

Table 11-1 Form Rule Fields

Element	Description
Name	Defines the name of the form rule. Change this to something meaningful.
Enabled	Select to enable the form rule within your form. If you deselect this option, the form rule is not applied to the form at runtime.

Table 11-1 (Cont.) Form Rule Fields

Element	Description
Description	Provides a description of the form rule. Modify the default to describe the behavior of the form rule and how it functions within the context of the form controls and other form rules within the form.
Rule	Defines the form rule.

5. After you have finished creating and editing the form rules, click **Edit** in the toolbar to return to the web forms designer.

How to Test a Form Rule

You can test the behavior of form rules while testing a web form. See [How to Test a Web Form](#) for more information.

12

Working with Human Tasks

Use human tasks to define how end users interact with your process-based application. Learn how to create and edit human tasks using Oracle Business Process Composer.

- [Introduction to Human Tasks](#)
- [Introduction to the Human Task Editor](#)
- [Working with Human Tasks](#)
- [Assigning a Human Task to a User Task](#)

Introduction to Human Tasks

Human tasks are a component of Oracle Human Workflow. Oracle Human Workflow is a component of the Oracle Service-Oriented Architecture (Oracle SOA) and Oracle Business Process Management (Oracle BPM) Suites that provides a runtime environment for managing user interaction with a process-based application. Human tasks define the user interaction, including the user interface and workflow.

Using Oracle Business Process Composer you can create new human tasks and configure its basic properties. However, for more advanced configuration of human tasks, you must use Oracle BPM Studio.

For more information about configuring human tasks using Oracle BPM Studio, see "Getting Started with Human Workflow" in *Developing Business Processes with Oracle Business Process Management Studio*.

Human tasks are defined as services within a BPM project and are stored in the business catalog.

Human tasks define the following:

- **Participants:** Specifies the users or groups of users that perform the work of the human task.
- **Approval patterns:** Specifies the order the work that is performed by the human task.
- **Access privileges:** Determines who has access to a task.
- **Payload:** Defines the data structures used by the human task.

The payload data is passed from the user task of a Business Process Model and Notation (BPMN) process to the human task.

- **Expiration:** Defines the duration of a human task.
- **Presentation:** Defines the user interface participants who are used to interact with a BPMN process. Presentations are defined by a form.

Oracle BPM supports two types of forms: web forms and Oracle Application Development Framework (ADF) task forms.

For more information about creating and using web forms using Oracle Business Process Composer, see [Working with Web Forms](#). For more information about creating ADF task

forms using Oracle BPM Studio, see "Getting Started with Human Workflow" in *Developing Business Processes with Oracle Business Process Management Studio*.

Introduction to Participant and Routing Types

Human tasks allow you to determine the order in which users perform different tasks within your application. This order is defined by the routing of the human task. Participants are the users or groups that are responsible for performing each task. You can use the routing slip section of the human task editor to specify the routing flow and participant for a human task.

Participant Types

Human tasks support the following patterns for common routing scenarios:

- Single approver

This is the simple case where a participant maps to a user, group, or role. See [Introduction to Participant Assignment](#) for more information.

For example, a vacation request is assigned to a manager. The manager must act on the request task three days before the vacation starts. If the manager formally approves or rejects the request, the employee is notified with the decision. If the manager does not act on the task, the request is treated as rejected. Notification actions that are similar to the formal rejection are taken.

- Parallel

This participant indicates that a set of people must work in parallel. This pattern is commonly used for voting.

For example, multiple users in a hiring situation must vote, to hire or reject an applicant. You specify the voting percentage that is required for the outcome to take effect, such as a majority vote or a unanimous vote.

- FYI

This participant also maps to a single user, group, or role, just as a single approver. However, this pattern indicates that the participant just receives a notification task and the business process does not wait for the participant's response. FYI participants cannot directly impact the outcome of a task, but in some cases can provide comments or add attachments.

For example, a regional sales office is notified that a candidate for employment has been approved for hire by the regional manager and their candidacy is being passed onto the state wide manager for approval or rejection.

- Serial

This participant indicates that a set of users must work in sequence. While working in sequence can be specified in the routing policy by using multiple participants in sequence, this pattern is useful when the set of people is dynamic. The most common scenario for this is management chain escalation, which is done by specifying that the list is based on a management chain within the specification of this pattern.

When you create a human task, it contains a default simple participant. You can use the human task editor to change the participant type or add additional participants. See [How to Change the Default Participant](#) for more information.

Routing Types

[Figure 12-1](#) shows a basic routing that contains only one participant.

Figure 12-1 Basic Routing with a Single Participant

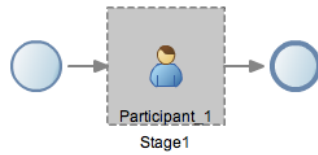

In addition to participant types, human tasks support more complex types of routing that give you more control. These routing types are:

- Sequential

In sequential routing different participants act on a task sequentially. [Figure 12-2](#) shows an example of sequential routing. In this example, Participant_1 is the first participant in the routing flow. After Participant_1 finishes acting on a task, the task is passed to Participant_2. After Participant_2 finishes acting on the task, the human task is completed.

Figure 12-2 Example of Sequential Task Routing

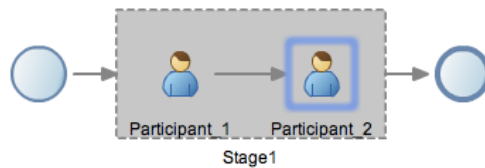

- Parallel

In parallel routing, participants act on a task simultaneously. [Figure 12-3](#) shows an example of parallel routing. In this example, both Participant_1 and Participant_2 act on the task at the same time.

Parallel routing allows you to define an outcome for the routing that determines how the task flow continues to the next participant after the parallel block. See [Outcome](#) for more information.

Figure 12-3 Example of Parallel Task Routing

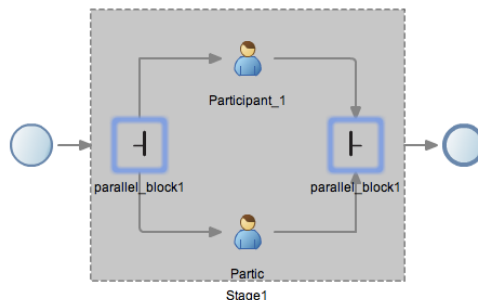

Outcome

Outcome specifies possible outcome arguments of the Human Task. Oracle BPM Worklist and Process Workspace display the possible outcomes you select as the available tasks to perform at runtime.

You can specify a voted-upon outcome that overrides the default outcomes selected in the Default Outcomes list. This outcome takes effect if the required percentage is reached. Outcomes are evaluated in a specific order.

You can define the following outcomes for a human task:

- Defer
- Yes
- Approve
- Accept
- Reject
- No

For more information about configuring the outcome for a human task, see [How to Configure Basic Task Properties](#). For more information about configuring outcomes in a parallel routing, see [How to Configure the Outcome for Parallel Routing](#).

You can also define custom outcomes using Oracle BPM Studio. For more information about how to define custom outcomes, see in Designing Human Tasks in Oracle BPM in *Developing Business Processes with Oracle Business Process Management Studio*.

Introduction to Participant Assignment

Participant assignment is the process of mapping human task participants to the people in your organization that use your application. This is done by mapping each participant to one of the following:

- Users

You can assign individual users to act upon tasks. For example, you may assign users *jlondon* or *jstein* to a particular task. Users are defined in an identity store configured with the SOA Infrastructure. These users can be in the embedded LDAP of Oracle WebLogic Server, Oracle Internet Directory, or a third-party LDAP directory.

As with users, groups are defined in the identity store of the SOA Infrastructure.

- Groups

You can assign groups to act upon tasks. Groups contain individual users who can claim and act upon a task. For example, users *jcooper* and *fkafka* may be members of the group *LoanAgentGroup* that you assign to act upon the task.

- Application Roles

You can assign users who are members of application roles to claim and act upon tasks.

See [How to Assign Users, Groups, and Roles to a Participant](#) for procedures on assigning users, groups, or roles to a human task participant.

Introduction to Duration

Duration defines how long a human task can remain idle before some other action is performed. Duration can be defined globally for the human task or for each human task participant.

See [How to Configure the Deadline \(Duration\) for a Human Task](#) for information on defining duration globally for a human task.

Introduction to the Human Task Editor

Oracle Business Process Composer provides a human task editor that enables you to create and edit human tasks.

The human task editor consists of a tabbed pane as shown in [Figure 12-4](#).

Figure 12-4 Human Task Editor

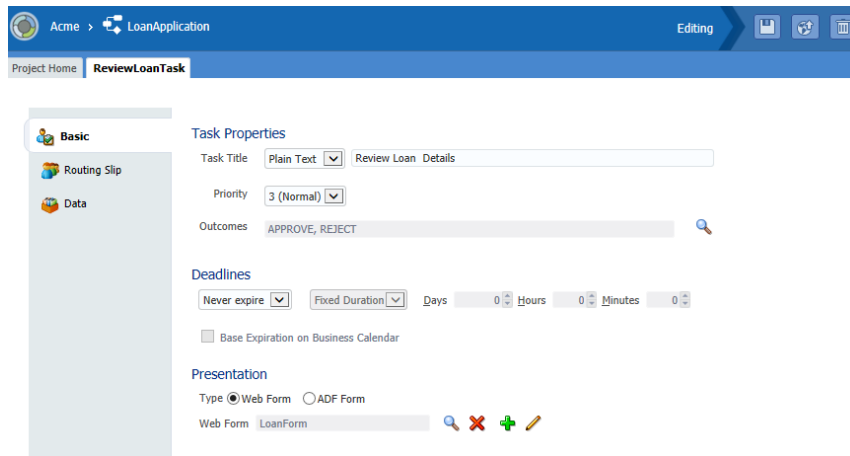

The human task editor contains the following tabs:

- Basic:** Allows you to configure the basic properties of a human task, define deadlines, and configure the presentation of the human task.

See [How to Configure Basic Task Properties](#) and [How to Specify the Presentation of a Human Task](#) for more information.
- Routing slip:** Allows you to define and configure the participants and routing types of the human task.

See [How to Change the Default Participant](#) and [How to Assign Users, Groups, and Roles to a Participant](#) for more information.
- Data:** Defines the data payload used by the human task.

See [How to Create and Configure the Data Payload for a Human Task](#) for more information.

Working with Human Tasks

Oracle Business Process Composer enables you to create new human tasks directly from the Project Welcome Page. Human tasks are defined as services and stored in the business catalog of a BPM project.

The following sections describe how to create, configure, and edit human tasks.

Walkthrough: Creating and Configuring a Human Task

The following procedures describe the general steps required to create and configure a human task.

1. Create a new human task.
You can create a new human task directly from the Project Welcome page. See [How to Create New Human Task](#) for more information.
2. Open the human task.
See [How to Open a Human Task](#) for more information.
3. Configure the basic properties and deadline for the human task.
4. Define the payload data for a human task.
5. Assign a form to the human task.
6. Assign the human task to a user task.

How to Create New Human Task

To create a new human task:

1. Open the project where you want to create a new human task.
2. Ensure the project is in edit mode.
3. From the Project Welcome page, select the **Human Tasks** tab.
4. Click the **New** icon.
5. Provide a name for the new human task, then click **Create**.

The new human task is displayed in the list of human tasks, as shown in [Figure 12-5](#).

Figure 12-5 Project Welcome Page - Human Tasks

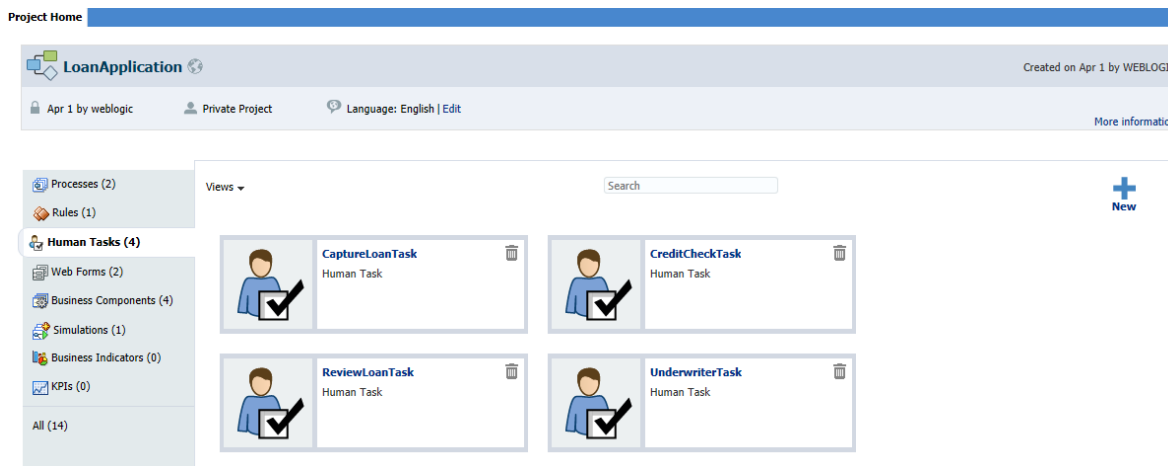

How to Open a Human Task

You can open an existing human task for viewing or editing.

To open an existing human task:

1. Open the project containing the human task you want to view or edit.
2. From the Project Welcome Page, select **Human Tasks**, as shown in [Figure 12-5](#).

3. Click the name of the human task you want to open.

The human task is opened in the human task editor. See [Introduction to the Human Task Editor](#) for more information.

How to Configure Basic Task Properties

Use the **Basic** area of the Human Task editor to configure the basic properties of the human task, including the task title, task priority and outcomes.

To configure basic task properties:

1. Open the human task.
2. In the human task editor, select **Basic**.
3. From the drop down list next to **Task Title**, select one of the following:
 - **Plain text:** Defines the task title using a text box.
After selecting this option, enter the task title in the text box.
 - **XPath:** Defines the task title based on an XPath function.
 - **Translation:** Defines a translated version of the task title.
The task title defines the title of the human task that is displayed in Process Workspace.
4. From the drop down list next to **Priority**, select a priority for the human task.
Valid values are between 1 (highest) and 5 (lowest). This value is displayed in Process Workspace.
5. Define the outcome for the human task:
 - a. Click the magnifying glass icon next to the **Outcomes** field.
 - b. Select the outcomes you want to configure.
You must select at least one outcome. See [Outcome](#) for more information.
 - c. Click **OK**.
6. Save the project to save your changes.

How to Configure the Deadline (Duration) for a Human Task

Use the task editor to define the duration for

To configure the deadline (duration) for a human task:

1. Open the human task.
2. In the human task editor select the **Basic** tab.
3. From the drop down list under **Deadlines**, select one of the following:
 - **Never expire:** Indicates that the human task has no deadline or expiration.
 - **Expire after:** Indicates that the human task expires after a specified duration.

When the option is selected, you can configure the following:

- **Fixed duration:** Defines the duration of the human task.

When this option is selected, you can define a specific number of days, hours, and minutes.

- **By expression:** Allows you to use an expression to define the duration of the human task.
- **Base expiration on Business Calendar:** Select this option to base the duration of the human task on a business calendar.
- **Renew after:** Extends that expiration date of a human task.

When this option is selected, you can configure the following:

- **Fixed duration:** Defines how long the expiration of the human task is extended.
When this option is selected, you can define a specific number of days, hours, and minutes.
- **By expression:** Allows you to use an expression to define how long the expiration of the human task is extended.
- **Maximum renewals:** Defines the number of times the expiration deadline can be renewed.
- **Base expiration on Business Calendar:** If selected, this option bases the duration of the human task on a business calendar.
- **Escalate after:** Escalates the task to a manager after the duration expires.

When this option is selected, you can configure the following:

- **Fixed duration:** Defines the duration of the human task.
When this option is selected, you can define a specific number of days, hours, and minutes.
- **By expression:** Allows you to use an expression to define the duration of the human task.
- **Maximum escalation levels:** Defines the number of levels the task can escalate after expiration.
- **Highest approval title:** Defines the title of the highest level in the management chain the escalation reaches.
- **Base expiration on Business Calendar:** If selected, this option bases the duration of the human task on a business calendar.

4. Save the project to save your changes.

How to Specify the Presentation of a Human Task

The presentation of a human task defines the user interface of your application. Presentations are associated with a form which define the user interface, data structures and connectivity information for a human task. Oracle BPM supports two types of forms: web forms and ADF task forms.

For more information about creating, editing, and using forms, see [Introduction to Forms in Oracle BPM](#).

Specifying the Presentation of a Human Task with an ADF Task Form

To specify the presentation of a human task using an ADF task form:

1. Open the human task.
2. Select the **Basic** tab.

3. Under **Presentation**, select **ADF Form**.
4. Enter the following connectivity information for the ADF form:
 - **Hostname**: Specifies the hostname of the server where the presentation is deployed.
 - **HTTP Port**: Specifies the port of the server where the presentation is deployed.
 - **HTTPS Port**: Specifies the secure port of the server where the presentation is deployed.
 - **URI**: Specifies the Uniform Resource Indicator of the presentation.
5. Click **OK**.

Specifying the Presentation of a Human Task with a Web Form

To specify the presentation of a human task using a web form:

1. Open the human task.
2. Select the **Basic** tab.
3. Under **Presentation**, select **Web Form**.
4. Click the **Browse** button.
The web form browser appears.
5. Click the name of the web form you want to select.

How to Change the Default Participant

When you create a new human task, it contains a default simple participant. Use the human task editor to change the type of the default participant.

To change the default participant of a human task:

1. If you are working on a shared project, ensure that you are in edit mode.
2. Open the human task, then select **Routing Slip**.
3. Click the participant, then click the **Delete (X)** icon as shown in [Figure 12-6](#) to delete the participant.

Figure 12-6 The Add and Remove Icons of a Participant

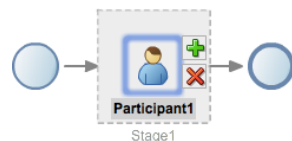

4. Click the routing slip box.
5. Click the **Add (+)** icon, then select a participant type.

See [Introduction to Participant and Routing Types](#) for information about each participant type.

The new participant appears in the routing slip box. See the following procedures for information about adding additional participants to a human task.

How to Add Participants and Routing to a Human Task

Use the human task editor to add participants or routing types to a human task.

To add participants to a human task:

1. If you are working on a shared project, ensure that you are in edit mode.
2. Open the human task, then select **Routing Slip**.
3. Click on the routing slip block.
4. Click the + icon, then select a participant type.

See [Introduction to Participant and Routing Types](#) for information about each participant type.

The new participant is added to the routing slip in the far right position.

How to Assign Users, Groups, and Roles to a Participant

Within a human task, participants abstractly define the users who are responsible for performing the work of a human task and its work flow. You can define how the participants and routing defined in the human task are mapped to the real-world participants of your organization by configuring participant selection.

The following ways of selecting participants are available:

- Names and expressions
- Lane participants
- Parametric roles



Note:

Although you can configure a human task to use parametric roles, you cannot create or configure the parametric roles using Oracle Business Process Composer. These must be created and assigned to the human task using Process Workspace or Oracle BPM Studio.

Each of these is covered in the following procedures.

Selecting Participants using Names and Expressions

To select participants using names and expressions:

1. If you are editing a shared project, ensure that you are in edit mode.
2. Open the human task, then select **Routing Slip**.
3. Double click on the participant.
4. In the drop down box next to **Build a list of participants using:** select **Names and Expressions**.
5. Under **Participant Names**, click the **Add** icon, then select one of the following:

- Add user:
- Add group:
- Add application role:

After selecting one of these options, it appears in the table. You can change the value, if necessary, using the drop down list in the table.

6. In the **Data Type** column, select either **By name** or **By Expression** from the drop down list.
7. Select a value for the participant:
 - a. Click the **Search** icon in the **Value** column.
 - b. From the drop down list select either **User**, **Groups**, or **Application Roles**.
 - c. Enter the name you want to search, then click **Search**.

To view a list of all names, groups, or roles, leave the text field empty, then click **Search**.
 - d. Select the check boxes next to the users, groups, or roles you want to add.
 - e. Click **OK**.

The name appears in the **Value** column.

Selecting Participants using Lane Participants

To select participants using lane participants:

1. If you are editing a shared project, ensure that you are in edit mode.
2. Open the human task, then select **Routing Slip**.
3. Double click on the participant.
4. From the drop down box next to **Build a list of participants using**, select **Lane Participants**.
5. Select one of the following:
 - Previous lane participants
 - Current lane participants

Selecting Participants using Parametric Roles

To select participants using parametric roles:

1. Ensure that you have created parametric roles for the project using Oracle BPM Studio.
2. If you are editing a shared project, ensure that you are in edit mode.
3. Open the human task, then select **Routing Slip**.
4. Double click on the participant.
5. From the drop down box next to **Build a list of participants using**, select **Parametric roles**.
6. In the **Data Type** column, select either **By name** or **By Expression** from the drop down list.
7. Select a value for the participant:

- a. Click the **Search** icon in the **Value** column.
- b. From the drop down list select either **User**, **Groups**, or **Application Roles**.
- c. Enter the name you want to search, then click **Search**.
To view a list of all names, groups, or roles, leave the text field empty, then click **Search**.
- d. Select the check boxes next to the users, groups, or roles you want to add.
- e. Click **OK**.

How to Configure the Outcome for Parallel Routing

You can configure the routing outcome for parallel blocks.

To configure the outcome for parallel routing:

1. If you are editing a shared project, ensure that you are in edit mode.
2. Open the human task, then select **Routing Slip**.
3. In the **Participants** editor, double-click on one of the intersections of the parallel block.

The Voted Outcomes editor appears as shown in [Figure 12-7](#).

Figure 12-7 Voted Outcomes Editor

The screenshot shows the 'Voted outcomes' editor for a parallel block. At the top, there are fields for 'Type' (set to 'Parallel') and 'Label' (set to 'parallel_block1'). Below these are icons for up, down, add, and delete. The main area contains a table with the following data:

Outcome	Outcome Type	Value
Any	By Percentage	50
APPROVE	By Percentage	50

Below the table, there is a note: 'A voted outcome will override the default outcome if the required percentage is reached. Outcomes will be evaluated in the order listed in the table.' There are several options: '* Default Outcome: REJECT', a radio button for 'Immediately trigger voted outcome when required percentage is met', and checkboxes for 'Share attachments and comments' and 'Limit allocated duration to:'. The duration is set to 0 Days, 0 Hours, and 0 Minutes. There are OK and Cancel buttons at the bottom.

4. Click the Add icon, then select one of the following outcomes:
 - Approve
 - Reject
5. In the table, enter a value for the outcome.
6. Select a value for Default Outcome from the drop-down list.
7. Click **OK**.

How to Create and Configure the Data Payload for a Human Task

Using the human task editor, you can define the data types used within the human task. This data is used to store the information entered during user interaction.

To create task data for a human task:

1. If you are editing a shared project, ensure that you are in edit mode.
2. Open the human task.
3. Select the **Data** tab.
4. Click the Add button.
5. Select an element or type from the list of primitives and components, as shown in [Figure 12-8](#).

Figure 12-8 Human Task: Data - Add Element Dialog

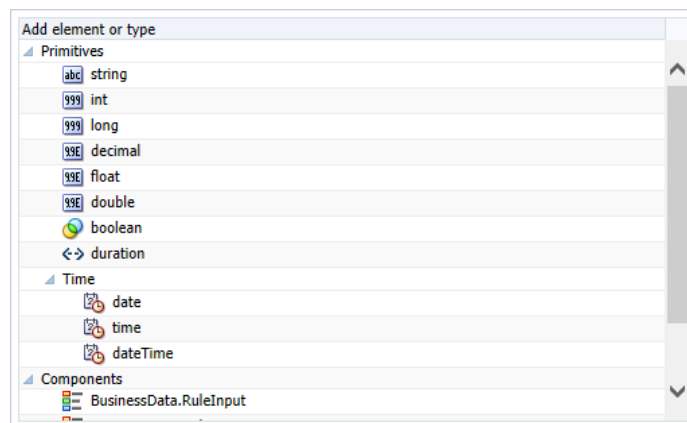

The task data appears in Task Data table.

6. Enter a name for the new task data in the table and select whether the new task data is editable or not.

Assigning a Human Task to a User Task

After creating a human task, it becomes part of the business catalog of a BPM project. To incorporate a human task within a BPMN process, you must assign it to a user task within the process.

To assign a human task to a user task:

1. If you are editing a shared project, ensure that you are in edit mode.
2. Open your business process.
3. Add a user task to the process.
4. Right-click on the user task, then select **Implement**.
5. Click the **Browse** icon next to the **Human Task** text box.

The human task browser appears.

6. Click the name of the human task you want to select.
After clicking the name, the human task appears in the human task text box.
7. Click **Apply Changes** in the Implementation editor.

Part VI

Handling Data in Your Business Application

Learn how to handle the data required within a process-based business application.

- [Working with Data Objects and Data Associations](#)
- [Using Complex Data Types to Define Data Structures](#)
- [Using Expressions to Control Data](#)
- [Tracking Business Data in Your Application](#)

13

Working with Data Objects and Data Associations

Learn how to use data objects to store the data used in a process-based business application and also learn how to use data associations to define how data is handled within a business process.

- [About Handling Data Used by Your Business Processes](#)
- [Introduction to Data Objects](#)
- [Working with Data Objects](#)
- [Introduction to Data Associations](#)

About Handling Data Used by Your Business Processes

Most business applications require users to create and manipulate data. In a sales quote application, for example, a user enters data related to the quote which includes information about the customer, quote, and other types of data. Additionally, an application may have to create and manipulate other data that is only used internally as part of the overall function of the application.

When creating business processes you must define the data the application uses. In Oracle Business Process Management (Oracle BPM), data is stored within a data object. Data objects are defined based on simple types that are similar to those found in most programming languages.

Data objects can also be defined based on complex data types. In Oracle BPM, a business object is a complex data type. Complex data types allow you to group together related data. For example, if you are creating an application that must store information about an employee, you may have to create a complex data type that stores the name, address, salary, and other information about the employee. Complex data types are similar to the concept of classes used in object-oriented programming languages like Java. For more information about complex data types, see [Using Complex Data Types to Define Data Structures](#).

How to Define the Data Used by an Oracle BPM Application

Defining how data is stored and manipulated is part of the overall design and development of an Oracle BPM application. The following high-level task outlines the typical process for defining the data used within an Oracle BPM application.

To Define the Data Used by Your Oracle BPM Application

1. Define the complex data types required by your project.

The first step in defining the data used within an Oracle BPM application is to define the required complex data types. Complex data types allow you to define the data structures used within your application. For more information about using complex data types, see [Using Complex Data Types to Define Data Structures](#).

2. Create the data objects used within your project.

For more information about creating data objects, see [How to Create a Data Object](#).

3. Define the expressions used to manipulate the data in your process.

For more information about defining expressions, see [Using Expressions to Control Data](#).

4. Define how information is passed between Business Process Model and Notation (BPMN) flow objects using data associations.

For more information about data associations, see [How to Configure Data Associations for a Flow Object](#).

5. Define the input and output for your process.

Introduction to Data Objects

Data objects are, in general, the variables used to store the information used by your business processes and Oracle BPM application. They are defined during the design and implementation stage of a process. Before deploying a BPM project you must define all of the data objects that the running application requires.

At runtime, new data objects are not created, but the value of the information they store is altered as users interact with your application. Running processes can store, access, and manipulate data. The values of data can also determine process branching.

Introduction to Basic and Complex Data Objects

Oracle BPM supports two types of data objects: basic and complex. Which type of data object you use depends on the type of data it must handle.

- Basic data objects

Basic data objects are based on simple data types. These are the core data types common in most programming languages. Table [Table 13-1](#) lists the basic data types supported by Oracle BPM.

Table 13-1 Simple Data Objects

Type	Description
Bool	Represents the logical values true or false.
Int	Represents an integer. For example: 23, -10, 0.
Decimal	Represents a number that can be expressed in decimal notation. For example: 3.14, 62, 0.023.
Real	Represents a floating-point numeric value. For example: 2e-1, 2.3E8.
String	Represents a sequence of characters. For example: "This is a string."
Time	Represents a specific time expressed as: year-month day hour:minute:second. For example: 1995-02-03 13:30:28-08:00.
Interval	Represents a duration of time expressed as a number in years, months, days, hours, minutes, and seconds. For example: 1d3h30m.
Binary	Used to store binary data, including images or videos.

- Complex data objects

Complex data objects allow you to create data structures that group together different types of data. Complex data objects are based on complex data types. Complex data types allow you to create data structures based on basic data objects.

For example, you can create a complex data object called employee that contains different types of data for employee like id, name, and age. The relationship between complex data types and complex data objects is analogous to the relationship between classes and instances in the Java programming language.

Figure 13-1 shows the relationship between basic and complex data objects.

Figure 13-1 Relationship Between Basic and Complex Data Objects

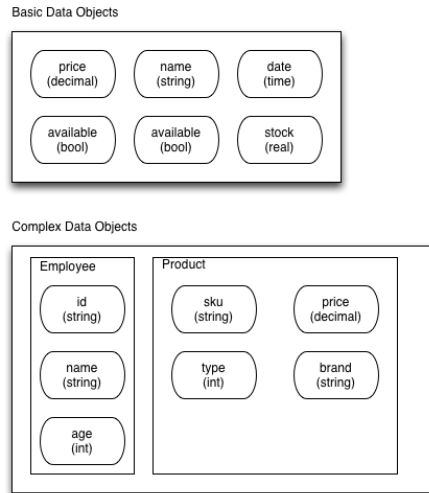

Before creating a complex data object, you must first define the complex data type that defines the data structure. For more information about using complex data types, see [Using Complex Data Types to Define Data Structures](#).

Introduction to Process and Project Data Objects

In addition to specifying a data object's data type, you must also select its scope. In Oracle BPM, the scope refers to from where in the process or project the data object can be accessed.

In Oracle BPM, there are two types of data object scope: process and project. Process data objects are data objects that are defined for a specific process. Similarly, project data objects are defined for an entire BPM project. Both project and process data objects can be created from both basic and complex types.

Process Data Objects

Process data objects allow you to define data objects that are used only within a single process. Process data objects can be used only within the process where they are defined.

When designing a process-based application, if you know that a data object is required only within a single process, it is better to define it as a process data object in order to conserve system resources.

Project Data Objects

Project data objects allow you to share data between processes. For example, within an Oracle BPM application, both a purchase order process and an approval request process may

track the data of the employee that created the request. The data created or modified in one process can be accessed by the other.

Project data objects can be used to ensure that all processes within an application have access to the same data. However, each process must assign and update the value of its data.

Although project data objects allow you to define data objects that are used by all processes in a project, they are not global data objects. Each process within your project uses its own version of the data object. Project data objects are not used to share data between processes. To share data between processes, you must create data associations. For more information about data associations, see [Introduction to Data Associations](#).

Another benefit of defining project data objects is that after publishing your project you can configure Oracle Business Process Management Workspace views to display the values of the variables. This is possible only when using project data objects.

Working with Data Objects

Data objects can also be defined based on complex data types. In Oracle BPM, a business object is a complex data type. Complex data types allow you to group together related data.

This section describes the procedures for working with data objects, including how to create new data objects and edit or delete existing ones.

How to Create a Data Object

The procedures in this section describe how to create a new process or project data object. If you must create a data object based on a complex data type, you must create the complex data type first. For more information about complex data types, see [Using Complex Data Types to Define Data Structures](#).

To create a data object from the Project Welcome Page:

1. Ensure that you are editing your project.
2. Go to the **Project Welcome Page**.
3. Open the process for which you want to create a data object.
4. Click the **Data Objects** icon in the toolbar to open the Data Objects dialog.

Click the name of the project or process, then select **Add** as shown in [Figure 13-2](#).

Figure 13-2 Process Editor - Data Objects

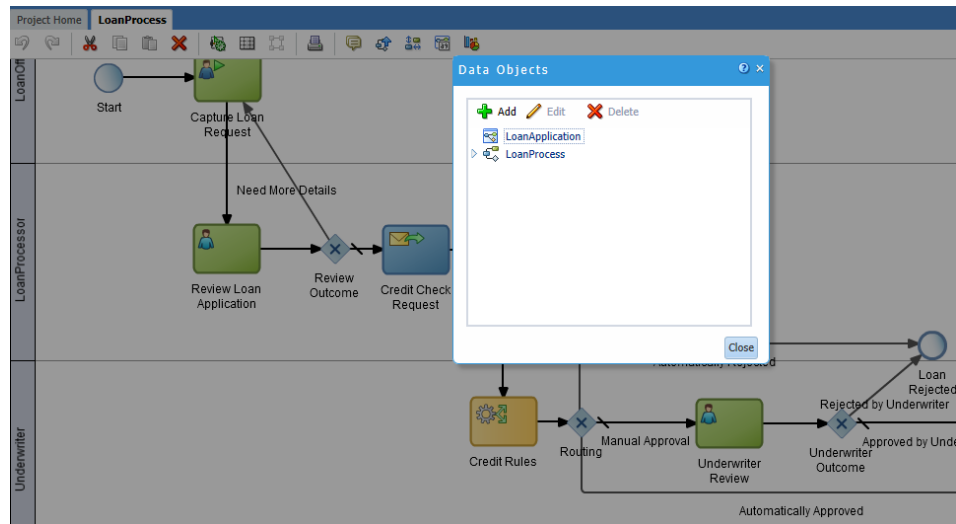

5. Enter a unique name for your data object.
 - If you are creating a basic data object, select any of the basic types from the drop-down list.
 - If you are creating a complex data object, select **<object>** from the drop-down list, then select the complex data type on which you want to base the complex data object.

For information about data object types supported by Oracle BPM, see [Introduction to Basic and Complex Data Objects](#).

6. Click **OK**.

How to Edit or Delete a Data Object

You can edit or delete process or project data objects.

To edit or delete a data object:

1. Ensure you are editing the project.
2. Open the process where you want to delete a data object.
3. Click the data objects icon in the process editor toolbar.
4. In the list of data objects, select the project or process data object you want to delete or edit, then:
 - To edit the data object, click **Edit**, then provide new name and change the data type as necessary.
 - To delete the data object, click **Delete**.
5. Click **OK**.

What Happens When You Delete or Edit a Data Object

After editing or deleting data objects, validate your project to verify that there are no references to the changed or deleted data objects.

After editing a data object, you must ensure that all references to it are still valid. For example, if you change a data object from type `int` to type `string`, you must verify that all of the expressions that use the data objects still function correctly.

After deleting a data object, you must ensure that all references to it are removed. This includes any data associations and expressions that use the data object. If you do not remove references to the deleted data object, the project does not validate.

Introduction to Data Associations

Data associations determine how information stored in data objects is handled.

These are the contexts in which data associations can be used:

- To and from another process or service invoked from a BPMN process.
- To and from a Human Task service.
- To and from an Oracle Business Rule.
- To and from a script task.

This BPMN flow object is used to pass data objects through data associations.

Table [Table 13-2](#) lists the flow objects where you can define data associations. It also lists the objects implemented.

Table 13-2 Flow Objects that Accept Data Associations

Flow Objects	Implementation
Message start and end events	Services and other BPMN processes
Message throw and catch events	Services and other BPMN processes
Send and receive tasks	Services and other BPMN processes
Script tasks	Do not contain an implementation, are used to pass data objects through data associations.
User tasks	Oracle Human Tasks
Business rule tasks	Oracle Business Rules
Service Tasks	Services and BPMN processes

Data associations are used to define the input and output arguments from a flow object to an external service or process. [Figure 13-3](#) shows the relationship between a flow object, its corresponding implementation, and external processes or services.

The arrows represent the input and output arguments to the external process or service. These are defined using data associations.

Figure 13-3 Relationship between a Flow Object, Implementation and an External Service or Process

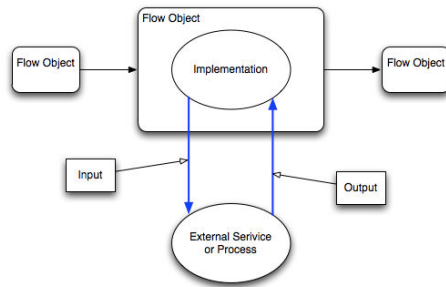

It is important to note that although the inputs and outputs are defined in the data associations for a flow object, they define values that are passed to the systems or services being called. These systems and services exist outside of the business process as shown in [Figure 13-4](#).

Figure 13-4 Data Associations within a process

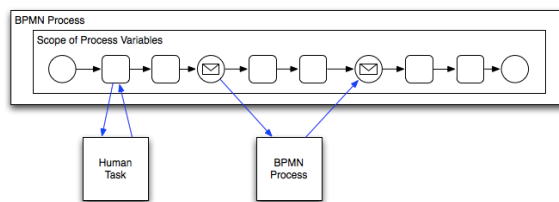

You can use expressions to evaluate and change the input and output values

Introduction to the Data Associations Editor

The data associations editor allows you to configure the input and output values passed between a flow object and its implementation, as shown in [Figure 13-5](#).

Figure 13-5 Data Association Editor

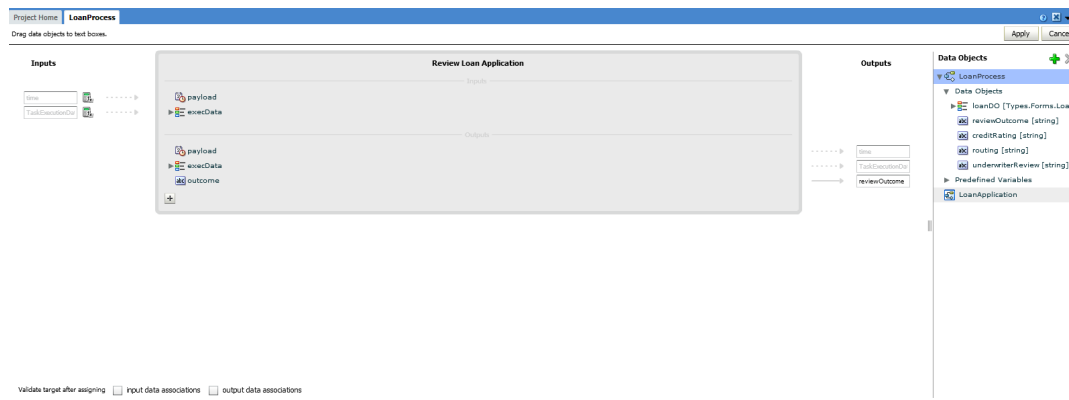

[Table 13-3](#) describes the different areas of the data associations editor.

Table 13-3 The Data Associations Editor User Interface

UI Area	Description
Inputs	Contains text boxes that display the data objects assigned as inputs to the service or process implemented in the flow object. Next to each text box is an icon that launches the expression editor.
Flow Object Interface	Lists the expected input arguments for the service or process implemented. The flow object interface also contains an expandable list of the data objects supplied as input and output. Within the flow object area, you can expand complex data objects to map to specific basic data objects within a complex data object.
Outputs	Contains text boxes that display the data objects assigned as outputs from the service or process implemented in the flow object.
Data Objects	Displays a list of all the data objects. This list is divided between process and project data objects.

How to Configure Data Associations for a Flow Object

You can configure data associations for flow objects.

To configure a data association for a flow object:

1. Open the process where you want to configure data associations.
2. Right-click a flow object that enables data associations, then select **Data Associations**.
See [Table 13-2](#) for the list of sequence flows that allow data associations.
3. From the data objects column on the right, select the data object you want to map as an input argument.
4. Click and drag the data object to an input text field.

Using Complex Data Types to Define Data Structures

Learn how to use complex data types to define the data structures required by your process-based business application. In Oracle Business Process Management (Oracle BPM), a business object is a complex data type. You define complex data types as part of the business catalog of a BPM project. After defining complex data types, you can use that to define complex data objects to store the data within your application.

- [Introduction to Complex Data Types](#)
- [Working with Complex Data Types](#)

Introduction to Complex Data Types

You can use complex data types to create the data structures required in your Oracle BPM application. Complex data types allow you to group related types of data together. This can help make your processes more manageable and readable to other users.

You can use Oracle Business Process Composer to create complex data types manually or based on an XML schema.

The structure of a complex data type is composed of three components:

- **Modules**
Modules are containers that allow you to create a hierarchical structure in your complex data type. Each complex data type must contain one top-level module. Within a module, you can create complex data types or other modules.
- **Complex data types**
Within a module you can define one or more complex data types. A complex data type can contain other complex data types or modules.
- **Attributes**
Attributes are the lowest level component of a complex data type. Attributes define the data types of the complex data type.

You can also add documentation to your complex data types and attributes. Adding documentation makes your data structures more understandable to other users who are collaborating on your BPM project.

The following example process defines two different complex data types to handle the required data. [Figure 14-1](#) shows how these appear in the business component editor.

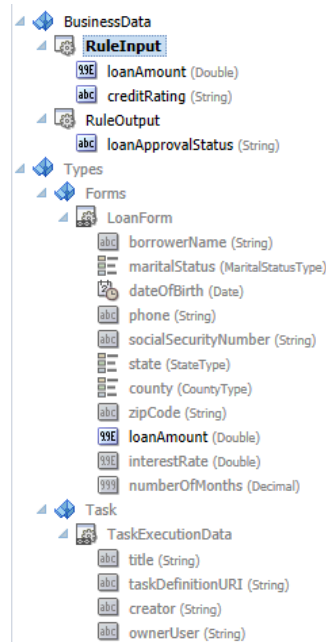
Figure 14-1 Complex Data Types Defined in the Example Project

Working with Complex Data Types

Using Oracle Business Process Composer you can create, edit, and delete complex data types and their modules and attributes.

You can use Oracle Business Process Composer to create complex data types manually or based on an XML schema.

How to Create a Complex Data Type Manually

You can manually create complex data types from the business components editor. When manually creating a complex data type, you can define the hierarchical relationship between modules and objects and the attributes used in the complex data type. A complex data type can include the following:

- Simple data types
- Arrays of data types
- Complex data types that use other complex data types as a component

Note:

After creating a module, complex data type, or attribute, you cannot change their names.

You can create the following new business components from the project components panel located on the Project Welcome page, as shown in [Figure 14-2](#):

- Business object

- Business exception
- Enum object

Figure 14-2 Project Welcome Page - Business Components

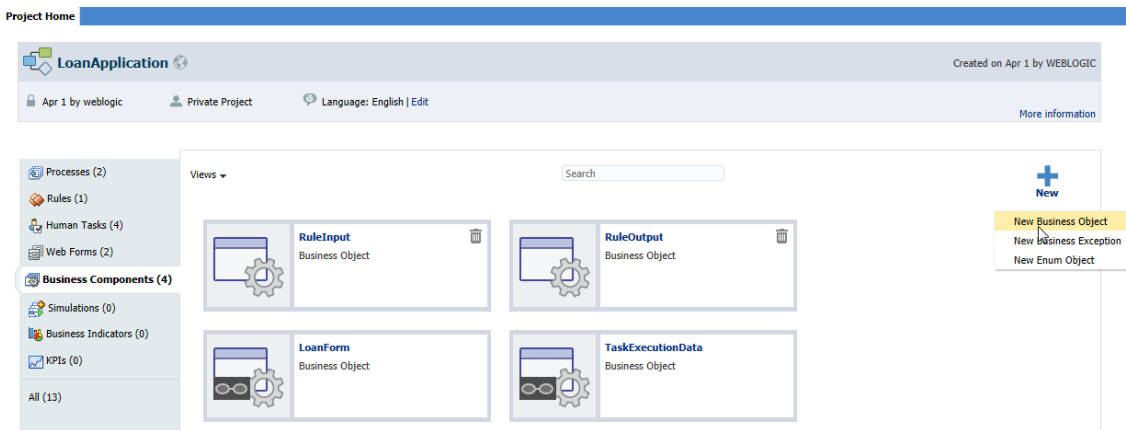

Creating a New Business Object

To create a new business object:

1. From the **Project Welcome Page**, click **Business Components**.
2. Click the New icon, then select **New Business Object** to open the New Business Object wizard, as shown in [Figure 14-3](#).

Figure 14-3 New Business Object Wizard

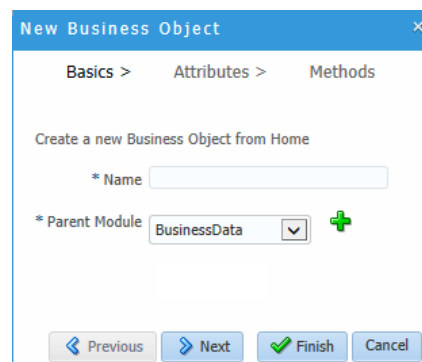

3. Enter a name for the new complex data type (business object).
4. Select a parent module from the drop down list.

You must select a parent module when creating a new complex data type. If no module currently exists, you must create a new one. To create a new module:

- a. Click the + icon.
 - b. Enter a name for the new module, then click **OK**.
5. Select the schema from the drop down list that appears when you select the **From XSD** check box.

6. Click **Finish** to create your new business object or continue to the next step if you want to add attributes and methods.
7. Click **Next** to add an attribute.

The Attributes dialog appears, as shown in [Figure 14-4](#).

Figure 14-4 New Business Object Wizard - Attributes Dialog

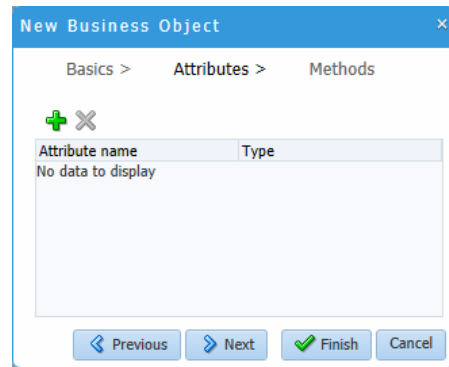

8. Click the new icon to add an attribute.
Enter the name and then click **Change Type** if you want to change the type from the default *String*.
9. Click **Finish** to create your new business object or continue to the next step if you want to add a method.
10. Click **Next**.
The Methods dialog appears. Click the new (+) icon to add a new method.
11. Click **Finish**.
The new complex data type appears in the Project Welcome Page under **Business Components**, as shown in [Figure 14-2](#).

Creating a New Exception

To create a new exception:

1. From the **Project Welcome Page**, click **Business Components**.
2. Click the New icon, then select **New Business Exception** to open the New Business Exception dialog, as shown in [Figure 14-5](#).

Figure 14-5 New Business Exception Dialog

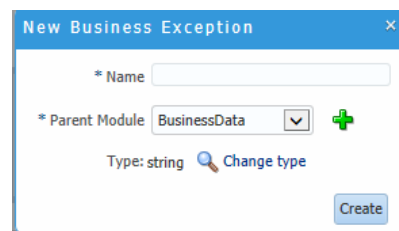

3. Enter a name for the new business exception.

4. Select a parent module from the drop down list.
You must select a parent module when creating a new complex data type. If no module currently exists, you must create a new one. To create a new module:
 - a. Click the **+** icon.
 - b. Enter a name for the new module, then click **OK**.
5. Click **Change Type** if you want to change the type from the default *String*.
6. Click **Create** to create your new exception.

Creating a New Enum Object

To create a new Enum object

1. From the **Project Welcome Page**, click **Business Components**.
2. Click the New icon, then select **New Enum Object** to open the New Enum Object wizard, as shown in [Figure 14-6](#).

An enum object (enumeration) is a special data object that enables a variable to be a set of predefined constants.

Figure 14-6 New Enum Object Wizard

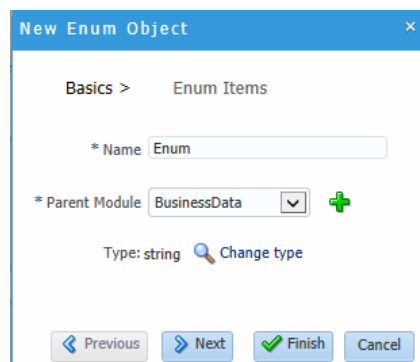

3. Enter a name for the new enum object.
4. Select a parent module from the drop down list.
You must select a parent module when creating a new complex data type. If no module currently exists, you must create a new one. To create a new module:
 - a. Click the **+** icon.
 - b. Enter a name for the new module, then click **OK**.
5. Click **Change Type** if you want to change the type from the default *String*.
6. Click **Finish** to create your new enum object or continue to the next step if you want to add enum items.
7. Click **Next** to add enum items.
The Enum Items dialog appears.
8. Click the new icon to add an Enum item. Enter the name and value, then click **OK**.
9. Click **Finish** to create your new enum object.

What Happens When You Create a Complex Data Type

After you define a complex data type, it appears in the list of complex data types under business components in the project components panel, as shown in [Figure 14-2](#). You can use the complex data type to create new complex data objects that are based on it. You can also use the complex data type to define other complex data types.

How to Edit a Complex Data Type

After creating a complex data type, you can add or change the type of its attributes and methods, or add documentation. You can also add exceptions, Enum objects and Enum items. The components you can add are based on the component you have highlighted in the hierarchy, as shown in [Figure 14-7](#)

Figure 14-7 Add New Business Component Example

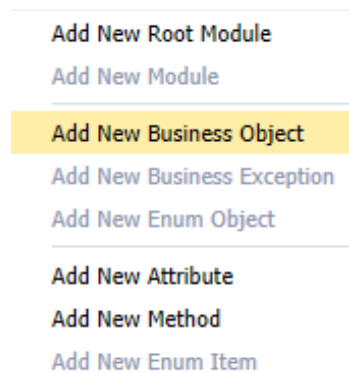

When you highlight a business component in the hierarchy, its details appear on the right-hand side of the business components editor. You can edit the details or add documentation.

If you right-click on a component in the hierarchy you can select to delete the component, move the component, or collapse a section of the hierarchy.

To add a new module, a new complex data type, or attribute:

1. Click the complex data type you just created.
The business components editor opens, as shown in [Figure 14-8](#).

Figure 14-8 Business Component Editor

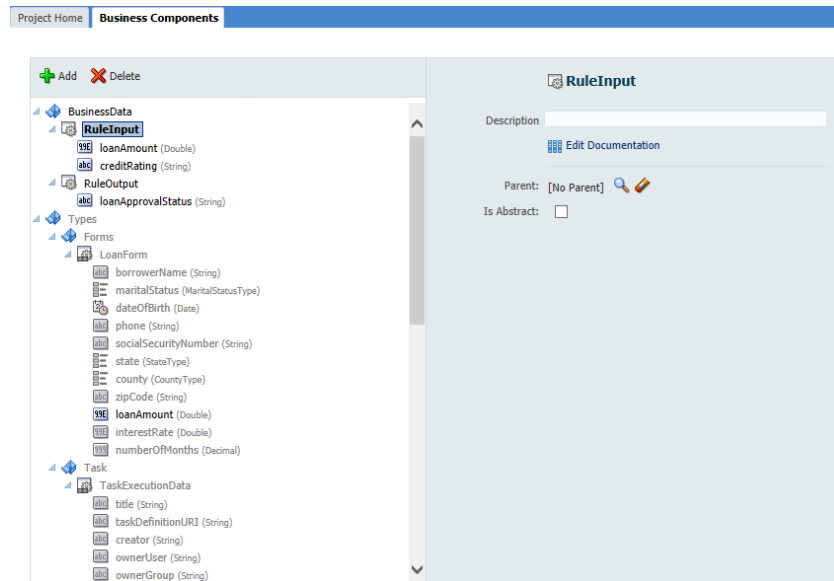

2. If necessary, create a new module within the complex data type:
 - a. Right click on the complex data type, then select **New Module**.
 - b. Enter a name for the new module, then select **OK**.
After creating a new module, you can create additional sub-modules if necessary.
3. If necessary, create a new complex data type:
 - a. Right-click on a module, then select **Add New Business Object**.
 - b. Enter a name, then click **OK**.
The new complex data type appears within the list of complex data types. You can create additional complex data types or sub-modules within the complex data type if necessary.
4. Add a new attribute.
 - a. Select a complex data type, then select **Add New Attribute** from the menu.
 - b. Enter a name for the attribute and select a type from the drop down menu.
5. Click **OK**.

How to Delete a Complex Data Type, Module, or Attribute

You can use the business component editor to delete a complex data type or its modules or attributes.

To Delete a Complex Data Type, Module, or Attribute:

1. From the Project Welcome Page, click **Business Components** as shown in [Figure 14-2](#).
2. Hover the cursor to the right of the complex data type you want to delete.
3. Click the **Delete** icon, then click **OK**.

 **Note:**

When you delete a complex data type, module, or attribute it cannot be recovered. When deleting a module or complex data type that contains other components, the components are also be deleted. However, if the deleted complex data type or module contains an attribute based on a complex data type, that complex data type is not deleted.

15

Using Expressions to Control Data

Learn how to use expressions to evaluate and change the data stored in a data object.

- [Introduction to Expressions](#)
- [Working with Expressions](#)

Introduction to Expressions

Expressions allow you to perform calculations on data objects.

Using Oracle Business Process Composer, you can define and edit expressions in the following contexts:

- Conditional sequence flows
- Complex gateways
- Timer events
- Data associations
- Notification tasks

Expressions do not allow you to directly reassign the values to data objects. However, you can use expressions to change the values passed to and from the implementation of a sequence flow. See [Introduction to Data Associations](#) for more information.

Introduction to the Expression Editor

The expression editor provides a simple way of creating expressions by allowing you to select data objects and operators from a list and insert them into your expression. You can also enter the expression manually if necessary.

[Figure 15-1](#) shows the expression editor user interface.

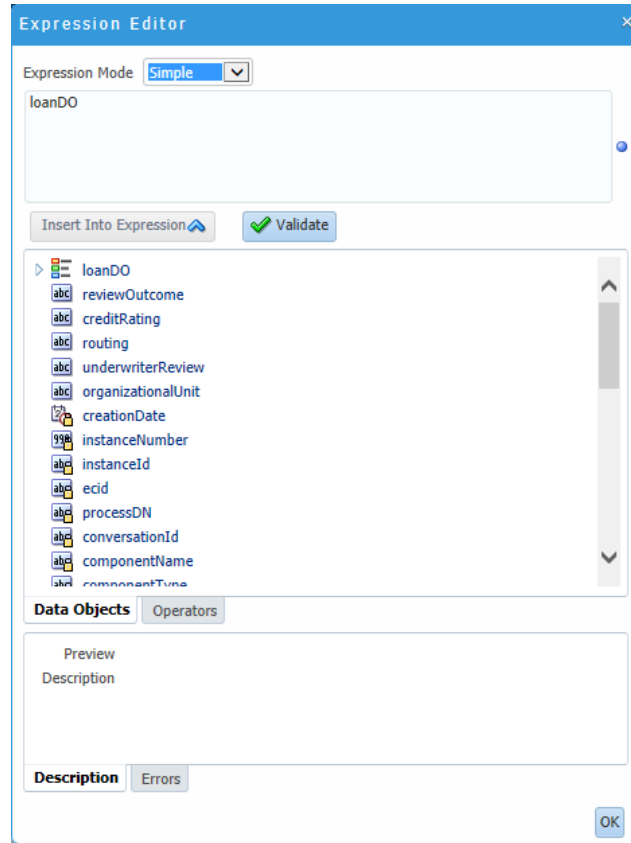
Figure 15-1 Oracle Business Process Composer Expression Editor**Table 15-1 The Expression Editor User Interface**

Area	Description
Expression field	Contains the text of the expression. You can edit this field directly, or use the Insert Into Expression tool.
Insert Into Expression	Inserts the selected data object or operator into the expression.
Data Object and Operator Chooser	Contain tabbed panes that allow you to select the data object or operator you want to insert into the expression.
Description tab	Provides a description of the selected operator.
Errors	Displays errors in the current expression.

Types of Expressions

Oracle Business Process Composer supports the following types of expressions:

- Simple
- Plain text
- XML Literal

Simple Expressions

Simple expressions are defined using a basic expression language supported by Oracle Business Process Management (Oracle BPM).

Operator Types

Simple expressions support the following operator types:

- Arithmetic Operators
- Unary Operators
- Equality and Relational Operators
- Conditional Operators

You can use these operators to write expressions and conditions to define your process flow. Generally these expressions perform their calculations based on the data objects in your process. You can write expressions and conditions using the value of the data objects, but you cannot modify their value.

The following examples of expressions use operators:

- `totalAmount - discount`
- `activationCount > 3`
- `unitsSold <= 1200`

[Table 15-2](#), [Table 15-3](#), [Table 15-4](#), and [Table 15-5](#) describe the supported operators in the simple expression builder.

Table 15-2 Arithmetic Operators

Operator	Name	Description
+	Addition	Adds numeric data types. Concatenates Strings.
-	Subtraction	Subtracts numeric data types.
*	Multiplication	Multiplies numeric data types.
/	Division	Divides numeric data types.
rem	Remainder	Calculates the remainder of a division in which the divisor does not exactly divide the dividend.
()	Precedence	Indicates the order of evaluation of an arithmetic expression.

Table 15-3 Unary Operators

Operator	Name	Description
+	Plus	Has no effect in the value of the numeric operand. Use it to indicate explicitly that a certain value is positive.
-	Minus	Negates an arithmetic expression.
*	Not	Logical complement operator. Negates the value of a boolean expression.

Table 15-4 Equality and Relational Operators

Operator	Name	Description
= or ==	Equal	Returns true if the first operand equals the second operand.
!=	Not Equal	Returns true if the first operand is not equal to the second operand.
>	Greater Than	Returns true if the first operand is greater than the second operand.
>=	Greater Than or Equal to	Returns true if the first operand is greater than or equal to the second operand.
<	Less Than	Returns true if the first operand is less than the second operand.
<=	Less Than or Equal to	Returns true if the first operand is less than or equal to the second operand.

Table 15-5 Conditional Operators

Operator	Name	Description
and	Conditional And	Returns true if both operands evaluate to true.
or	Conditional Or	Returns true if either operand evaluates to true.

Operator Precedence

Operator precedence indicates the order in which the compiler evaluates them. You can change operator precedence in an expression by using parenthesis.

In Oracle BPM the operator precedence is:

- Addition, Subtraction
- Multiplication, Division, Remainder
- Plus and Minus
- Less than, Greater Than, Less Than or Equal to, Greater Than or Equal to
- Equal, Not Equal
- Not
- Conditional And
- Conditional Or

Working with Expressions

Using Oracle Business Process Composer, you can create and edit expressions for conditional sequence flows and for data associations.

The following sections describe how to define expressions using Business Process Composer.

How to Define a Simple Expression for a Conditional Sequence Flow

Using Oracle Business Process Composer, you can create and edit expressions for conditional sequence flows. Conditional sequence flows use expression to determine the flow of your process.

To define an expression for a conditional sequence flow:

1. Open your process.
2. Ensure that the project is in edit mode.
3. Click the edit icon for the conditional sequence flow you want to edit.
4. Click **Implementation**.
5. Click **Edit**.

The expression editor window displays.

6. Add any required data objects and operators.

To add a data object to an expression:

- a. Select the **Data Objects** tab.
- b. Select a data object from the list.

If you add a basic data object that is part of a complex data objects, expand the complex data object and select the basic data object.

- c. Click **Insert Into Expression**

To add an operator to an expression:

- a. Select the **Operators** tab.
- b. From the expandable list, select the operator you want to add.
- c. Click **Insert Into Expression**.

7. Click the **Error** tab, then verify that there are no errors in your expression.
8. Click **OK**.
9. Click **Apply Changes** in the **Implementation** tab.

How to Define a Simple Expression in Data Associations

Using Oracle Business Process Composer, you can create and edit expressions for data associations. Data associations use expressions to alter the values of data objects passed as inputs and outputs.

To define an expression within a data association input or output:

1. Open your process.
2. Ensure that the project is in edit mode.
3. Right-click a flow object within your process then select **Data Associations**.
4. Click **Launch Expression Builder**.
5. Add any required data objects and operators.

To add a data object to an expression:

- a. Select the **Data Objects** tab.
- b. Select a data object from the list.
If you add a basic data object that is part of a complex data object, expand the complex data object and select the basic data object.
- c. Click **Insert Into Expression**
To add an operator to an expression:
 - a. Select the **Operators** tab.
 - b. From the expandable list, select the operator you want to add.
 - c. Click **Insert Into Expression**.
6. Click the **Error** tab, then verify that there are no errors in your expression.
7. Click **OK**.

16

Tracking Business Data in Your Application

Get an overview of different types of business data that Oracle Business Process Management (Oracle BPM) supports.

- [Working with Key Performance Indicators \(KPIs\)](#)
- [Working with Business Indicators and Counter Marks](#)
- [Measuring Process Performance Using Measurement Marks](#)

Working with Key Performance Indicators (KPIs)

Oracle BPM allows you to define key performance indicators (KPIs) within a BPM or a Business Architecture (BA) project. KPIs evaluate a specific activity or process within your organization.

You can define one or more KPIs to determine if the requirements of your processes are being met.

Introduction to Key Performance Indicators

KPIs evaluate a specific activity or process within your organization. You can define one or more KPIs to determine if the requirements of your processes are being met. Within Oracle BPM, a KPI defines the following:

- Measure, Counter, and running time defined within a Business Indicator
- Threshold
- Visualization

For example, a sales organization may define a KPI to track the total number of orders processed. If your target is 1000 orders per month, the measure is defined as 1000. If the orders are less than 1000, you can configure the KPI to show red (danger), where as any other range equal or above 1000 shows green.

KPI Lifecycle

You can create KPIs at design time using Oracle Business Process Composer. KPIs are available in both BPM and BA projects. Each has its own considerations:

- **Business Architecture:** You can create and configure KPIs with a BA project.

When you publish your project, the KPIs are stored within the Oracle Business Activity Monitoring (Oracle BAM) repository along with other components of the BA project. After publishing, the KPI is available within BA reports and Oracle BAM dashboards.

KPIs can be defined at all levels of a business architecture hierarchy: objectives, strategies, value chain models and value chain steps. If a value chain step is defined by a Business Process Model and Notation (BPMN) process, KPIs can also be defined at the process level. Oracle BPM process KPIs can be rolled-up to Strategies.

For information on how to create KPIs in a BA project, see [Working with Key Performance Indicators \(KPIs\)](#).

- **BPM Projects:** You can also create and configure KPIs within a BPM project.
KPIs defined in a BPM project contain a measure or business indicator defined for the BPMN process. When you deploy a BPM project, the KPI is also deployed to the runtime environment. The KPIs are created in Oracle BAM when the BPM project is deployed. Oracle BAM Process Analytics collate the runtime data and stores it in Oracle BAM data objects. These KPIs can be attached to a KPI watch-list in Oracle BAM or they can be used as part of BA roll-up KPIs. Actual value calculations are performed in Oracle BAM based on business process data objects.

Types of Key Performance Indicators

Oracle BPM supports different types of KPIs

- **External KPI:** Defines values based on data that is imported into Oracle BAM.
Data is imported into the `ORACLE_BUSINESSARCHITECTURE_ENTITY_DATA` data object. This imported data is used to calculate the actual value of the KPI within a given date range. This calculated value is then compared to the threshold defined for the KPI.
- **Manual KPI:** Allows users to enter explicit values at design time.
Business Architecture and Oracle BAM do not perform calculations on the value of the KPI. The value is compared to the threshold for this KPI.
- **Roll-up KPI:** Defines a parent child relationship between two entities.
A roll-up KPI is composed of multiple child KPIs. The value of the parent is calculated based on the values of the child KPIs. These values are compared to the threshold defined for the roll-up KPI.

Working with Business Indicators and Counter Marks

Business Indicators are project data objects you use to store the value of the KPIs of your process. Counter marks allow you to update the value of the counter business indicators defined for your process.

This section describes how to create business indicators and counter marks using Oracle Business Process Composer.

Introduction to Business Indicators and Counters

Business Indicators are project data objects you use to store the value of the KPIs of your process. Although Oracle BPM allows you to create business indicators using different types of data objects, within Oracle Business Process Composer you can only create business indicators that are used as attributes, counters, dimensions, and measures.

Counters keep track of the number of times an instance completes a certain activity. You must use them with counter marks. The counter variable does not store the actual value, its value is always 1. The value that specifies the number of times an instance completes an activity is updated directly in the Process Analytics databases. To monitor the value of a counter business indicator, you must create a dashboard based on a counter mark that is configured to track this counter business indicator.

Introduction to Counter Marks

Counter marks allow you to update the value of the counter business indicators defined for your process. A counter mark may update multiple counter mark business indicators. When a token arrives at an activity that has a counter mark defined, the Oracle BPM Service Engine updates the value of its associated counters in the Process Analytics databases. Each time the Oracle BPM Service Engine updates a counter business indicator, it adds one unit to the current value.

Note:

The actual value of the counter variable is stored in the Process Analytics databases. You must not use the counter variable in your process to perform any calculations because its default value never changes. The value of the counter variable is always equal to 1.

You can use counter marks for the following:

- **Auditing:** The number of activities the instance completed combined with other performance measurements are important information for auditing the process.
- **Identifying performance issues:** You can use a counter to identify performance issues within your process.

Your process might be taking longer than expected because the instances are following a different path than expected or because the loop in an activity is running more times than it should. You can identify these situations by comparing the actual number of completed activities to the number expected.

- **Identifying the process path the instance followed:** You can mark different paths using different counter business indicators.

When the instance reaches the end of the process, the path the instance followed has the greatest number of completed activities.

Typically you define one counter business indicator for each of the process paths you want to monitor. Then you add counter marks in all the activities that are part of that process path. Finally you associate the counter business indicators that correspond to the paths that activity is part of, to the counter mark.

How to Add a New Counter Mark to a Process

You can add new counter marks to activities and tasks within your process.

To add a new counter mark to a process

1. Right-click on the task or activity where you want to add a counter mark, as shown in [Figure 16-1](#).

Figure 16-1 Process Activity - Create Counter Mark

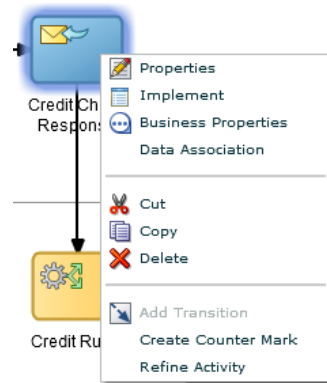

2. Select **Create Counter Mark**.

The Implementation panel appears at the bottom of the page, as shown in [Figure 16-2](#)

Figure 16-2 Process Activity - Implementation

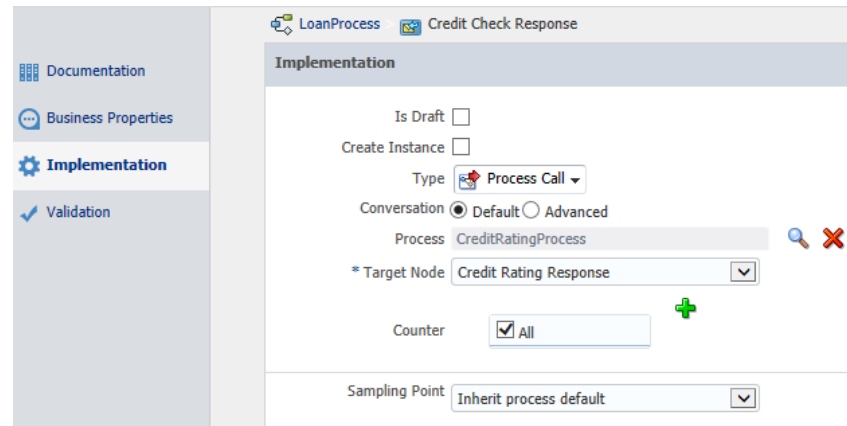

3. If required, create a new counter mark (business indicator).
 - a. Click the **Add** button.
 - b. Provide a name for the counter mark.
 - c. Click **OK**.
4. In the list of business indicators, select the check box next to the indicators you want to use for this flow object.
5. Click **Apply Changes**.

How to Delete a Counter Mark

You can delete the counter marks you have defined for a project by just right-clicking on the activity and choosing **Delete Counter Mark** or by using the following instructions.

To delete a counter mark:

1. Right-click on the activity or task where you want to edit a counter mark.
2. Select **Data Associations**.

- In the list of Data Objects, expand the name of the project.
This contains a list of all the project data object, as shown in [Figure 16-3](#)

Figure 16-3 Process Activity: Data Association - Data Objects

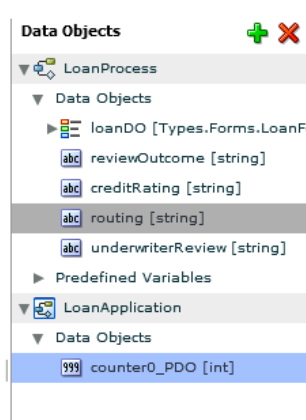

- Select the counter mark you want to delete.
- Click the delete icon.
- Click **OK** to confirm the deletion.
- Click **Apply**.

Measuring Process Performance Using Measurement Marks

You can measure process performance using measurement marks. Measurement marks allow you to measure a business indicator of type measure at a certain point in the process or in a section of the process.

For more information about using measurement marks and the Process Analytics database, see "Using Process Analytics" in the *Developing Business Processes with Oracle Business Process Management Studio*.

A measurement mark stores the following data into the Process Analytics databases:

- The value of the process default measures
- The value of the measure business indicators associated with that measurement mark
- The value of the dimensions defined in the process

You can use one measurement mark to measure multiple business indicators

When storing the value of a measure business indicator, the BPMN service engine also stores the value of the dimensions you defined in your process. Later, when you build the dashboards to monitor your process, you can use these dimensions to group the values into different categories. For example, you might want to view the total number of loan applications approved by region.

The types of measurement marks you can define are:

- Single measurement
- Interval start
- Interval stop

How to Add a Measurement Mark to a Process

You can add measurement marks to your business processes by dragging it from the component palette to the process editor canvas.

To add a single measurement mark to a process:

1. Open the BPMN process.
2. In the **Component Palette**, double-click the **Measurement** icon, then click and drag one of the following.
 - Measurement mark (Snapshot)
 - Start measurement mark
 - End measurement mark
3. Place the measurement mark near the sequence flow where you want to add a business indicator.

When the sequence flow turns blue, release the mouse measurement mark, as shown in [Figure 16-4](#).

Figure 16-4 Sequence Flow with Measurement Mark

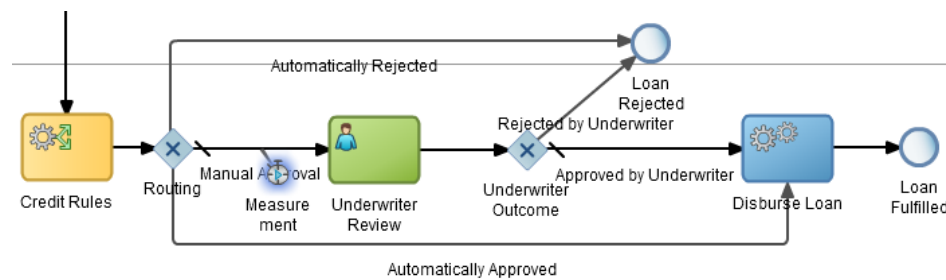

4. Right-click the measurement mark and select **Implement**.
5. In the **Name** field, enter a name to identify the measurement mark.
6. In the Business Indicators section, select a business indicator from the list of available business indicators and move it to the Selected list using the arrows between the two lists.

Note:

You can measure multiple business indicators in the same measurement mark.

Note:

If you do not select a business indicator, the measurement mark only stores the value of the default business indicators. If you want to add a business indicator without leaving the Measurement Mark Properties dialog, then click the **New** button under the **Selected** list.

7. Click **OK**.

Part VII

Implementing and Deploying a BPM Project

Get an overview of advanced functionality of Business Process Composer. As a process developer who manages the implementation details of a BPM project, learn how to make changes to the BPM project, when required.

- [Using Oracle Business Rules](#)
- [Communicating with Other Processes and Services](#)
- [Deploying a BPM Project](#)

Using Oracle Business Rules

Get an overview of Oracle Business Rules and learn how to use Oracle Business Process Composer to create and edit business rules.

- [Introduction to Oracle Business Rules](#)
- [Working with Oracle Business Process Composer Rules Editor](#)
- [Working with Business Rule Dictionaries](#)
- [Working with Dictionary Links](#)
- [Working with Rulesets](#)
- [Working with Decision Tables](#)
- [Working with Facts](#)
- [Working with Value Sets](#)
- [Working with Global Variables](#)
- [Working with Verbal Rules and Business Phrases](#)
- [Working with Decision Functions](#)
- [Working with Explorer](#)
- [Working with Translations](#)
- [Assigning a Rule to a Business Rules Task](#)
- [Editing Oracle Business Rules at Run Time](#)

Introduction to Oracle Business Rules

Oracle Business Rules allow process analysts to change policies that are expressed as business rules, with little or no assistance from a process developer. Applications using Oracle Business Rules support continuous changes that allow the applications to adapt to new government regulations, improvements in internal company processes, or changes in relationships between customers and suppliers.

Use business rules to define key decisions and policies for a business, including:

- Business policies such as spending policies and approval matrices.
- Constraints such as valid configurations or regulatory requirements.
- Computations such as discounts or premiums.
- Reasoning capabilities such as offers based on customer value.

For example, a car rental company might use the following business rule:

```
IF
Rental_application.driver age < 21
THEN
modify Rental_application(status: "Declined")
```

An airline might use a business rule such as the following:

```
IF
Frequent_Flyer.total_miles > 10000
THEN
modify Frequent_Flyer (status : "GOLD")
```

A financial institution could use a business rule such as:

```
IF
Application_loan.income < 10000
THEN
modify Application_loan (deny: true)
```

These examples represent individual business rules. In practice, you can use Oracle Business Rules to combine many business rules or to use more complex tests.

Oracle Business Rules provides multiple approaches to writing rules:

- **IF/THEN rules** - expressed as IF/THEN statements.
There are two ways of modeling IF/THEN rules. General rules use a pseudo-code language to express rule logic. Verbal rules use natural language statements to express rule logic.

- **Decision Tables**, which display multiple related rules in a single spreadsheet-style view. Business phrases are used to provide a natural language vocabulary for the construction of verbal rules' tests and actions. They are not used in general rules.

General rules, verbal rules, and Decision Tables are grouped in an Oracle Business Rules object called a ruleset. (See [Working with Rulesets](#).)

You group one or more rulesets and their facts and valuesets in an Oracle Business Rules object called a dictionary.

For a complete discussion of the concepts behind general and verbal rules, Decision Tables, and business phrases, see the "Working with Rulesets and Rules" chapter in *Designing Business Rules with Oracle Business Process Management*

Rules

Rules follow an IF-THEN structure and consist of two parts:

- **IF part:** A condition or pattern match.

The rule IF part is composed of conditional expressions and rule conditions that refer to facts. For example:

```
IF Rental_application.driver age < 21
```

The conditional expression compares a business term (Rental_application.driver age) to the number 21 using a less than comparison.

The rule condition activates the rule whenever a combination of facts makes the conditional expression true. In some respects, the rule condition is like a query over the available facts in the Rules Engine, and for every row returned from the query the rule is activated.

- **THEN part:** A list of actions.

The rule THEN part contains the actions that are run when the rule is fired. A rule is fired after it is activated and selected among the other rule activations using conflict resolution mechanisms such as priority. A rule might perform several kinds of actions. An action can add facts, modify facts, or remove facts. An action can run a Java method or perform a function which may modify the status of facts or create facts.

Rules fire sequentially, not in parallel. Rule actions often change the set of rule activations and therefore change the next rule to fire.

Decision Tables

A Decision Table is an alternative business rule format that is more compact and intuitive when many rules are required to analyze many combinations of property values. You can use a Decision Table to create a set of rules that covers all combinations or where no two combinations conflict.

For more information about decision tables, see [Working with Decision Tables](#), and the "Working with Rulesets and Rules" chapter in *Designing Business Rules with Oracle Business Process Management*

Working with Oracle Business Process Composer Rules Editor

The Business Rules Editor allows you to create, view and edit facts, functions, globals, value sets, links, decision functions, and business phrases within a business rules dictionary.

From the Project Welcome Page, go to the Components pane and select **Rules**. Click the name of the dictionary you want to open.

When you open a business rules dictionary, Oracle Business Process Composer displays the Rulesets page, as shown in [Figure 17-1](#).

A ruleset is an Oracle Business Rules container for rules and Decision Tables. A ruleset provides a namespace, similar to a Java package, for rules and Decision Tables. In addition you can use rulesets to partially order rule firing.

Figure 17-1 Business Rules Editor - Rulesets

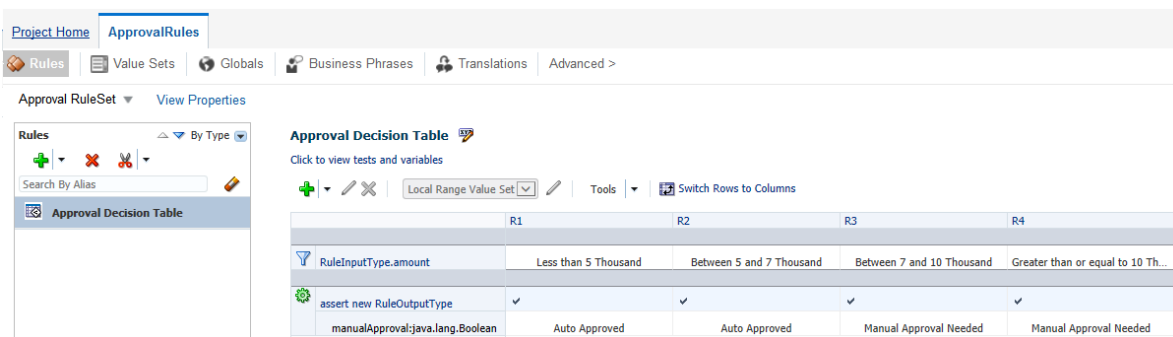

The Business Rules Editor page provides the tools for you to view rulesets and the data model, including:

- Value Sets
- Globals
- Business Phrases
- Explorer
- Facts
- Decision Functions
- Links

- Translations

To edit elements such as the value sets, and globals contained within the opened business rule dictionary, ensure that the project is in edit mode.

The Business Rules Editor page also provides the tools for you to perform the following actions:

- [Viewing and Editing Dictionary Settings](#)
- [Synchronizing Business Objects](#)

These are accessed from the **Actions** menu, shown in [Figure 17-2](#)

Figure 17-2 Business Rules Editor - Actions

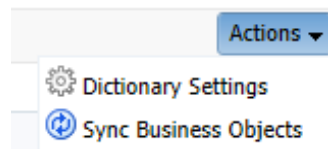

Introduction to Decision Points

Oracle Business Rules SDK (Rules SDK) provides APIs for writing applications that access, create, modify, and run rules in Oracle Business Rules dictionaries (and all the contents of a dictionary). The Rules SDK provides the Decision Point API to access and run rules or Decision Tables from a Java application.

Working with Business Rule Dictionaries

A business rule dictionary is an Oracle Business Rules container for facts, functions, globals, value sets, links, decision functions, and rulesets. A business rule dictionary is an XML file that stores the application's rulesets and the data model.

Dictionaries can link to other dictionaries. Using Oracle Business Process Composer you can create as many dictionaries as you require. A dictionary may contain any number of rulesets.

How to Create a New Business Rule Dictionary

Using Oracle Business Process Composer you can create as many business rule dictionaries as you require.

To create a new business rule dictionary:

1. From the Project Welcome Page, go to the Components pane and select **Rules**.
2. Click the new icon to display the New Business Rule dialog, as shown in [Figure 17-3](#).

Figure 17-3 New Business Rule Dialog

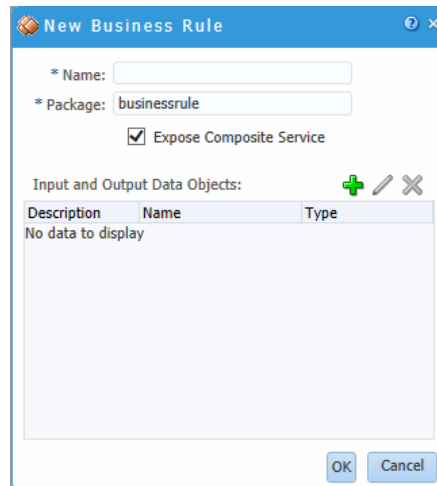

3. Enter a name and a package for the business rule dictionary.
These fields are required fields.
4. Select the **Expose Composite Service** check box if required.
5. Define the input and output data objects.
 - a. Click the **Add data object** button.
 - b. Select *Input* from the drop down list on the right side of the window.
 - c. Enter a name for the data object.
 - d. From the drop down list, select a data type.
The data type must not be a simple type, it must be a type defined as a business object.
 - e. Click **Add**.
The data object appears in **Input and Output Data Objects** table.
 - f. Click the **Add data object** button and then select *Output* from the drop down list.
 - g. Enter a name for the data object.
 - h. From the drop down list, select a data type.
The data type must not be a simple type, it must be a type defined as a business object.
 - i. Click **Add**.
The data object appears in **Input and Output Data Objects** table.
6. Click **OK**.

Viewing and Editing Dictionary Settings

You can view and edit dictionary settings using the Dictionary Settings dialog. The Settings dialog has three areas: **Execution**, **Choices**, and **Data Model**, as shown in [Figure 17-4](#).

Figure 17-4 Actions - Dictionary Settings

The screenshot shows a dialog box titled "Actions - Dictionary Settings". It is divided into three main sections:

- Execution:** "Rule Execution Algorithm" is set to "RETE" in a dropdown menu.
- Choices:** Under "Phrase Suggestions", three radio buttons are present: "Business Phrases" (unselected), "Auto Suggestions" (unselected), and "All" (selected). Below this, the "Include Chained Expressions" checkbox is checked.
- Data Model:** "Global Qualifier Pattern" is set to "{member} of {fact}" in a text field. To the right of the text field are two small icons: a globe and a green checkmark.

A "Save" button is located at the bottom right of the dialog box.

Use the **Execution** area to select the execution algorithm. Select either RETE or Non-RETE.

Oracle Business Rules uses the Rete algorithm to optimize the pattern matching process for rules and facts. The Rete algorithm stores partially matched results in a single network of nodes in working memory.

By using the Rete algorithm, Oracle Business Rules avoids unnecessary rechecking when facts are deleted, added, or modified. To process facts and rules, the Rete algorithm creates and uses an input node for each fact definition and an output node for each rule.

The Rete algorithm provides the following benefits:

- **Independence from rule order:** Rules can be added and removed without affecting other rules.
- **Optimization across multiple rules:** Rules with common conditions share nodes in the Rete network.
- **High performance inference cycles:** Each rule firing typically changes just a few facts and the cost of updating the Rete network is proportional to the number of changed facts, not to the total number of facts or rules.

The Non-Rete algorithm (NRE) is an alternative to the Rete algorithm that consumes less memory than the Rete algorithm. For many business rules use cases it also results in improved performance. The core of NRE algorithm is a new rule condition evaluation approach.

Use the **Choices** area to specify phrase suggestions that appear when you are using Verbal Rules. You can choose to see auto suggestions only, business phrases only, or both.

Use the **Data Model** area to specify the global qualifier pattern, also for Verbal Rules. The pattern must contain two fragments: {member}, {fact}. For example, {member} of {fact}.

To view or edit dictionary settings:

1. Open the business rule dictionary where you want to view or edit the dictionary settings.
2. Go to the toolbar and click **Actions, Dictionary Settings**, as shown in [Figure 17-4](#).
3. Make the required changes and then click **Save**.

Synchronizing Business Objects

If you change one of the business objects you used when you created your business rule dictionary then you must refresh or synchronize the business object in the Business Rules Editor for the changes to take effect.

To synchronize business objects:

1. Open the business rule dictionary where you want to synchronize business objects.
2. Go to the toolbar and click **Actions, Sync Business Objects**, as shown in [Figure 17-2](#).

The system automatically synchronizes the business objects used in the selected business rules dictionary.

Working with Dictionary Links

Using a dictionary with links to another dictionary is useful for data model sharing.

- **Data Model Sharing:** Share portions of a data model within a project. When you link to a dictionary in another project it is copied to the local project.

For example, consider a project where you would like to share some Oracle Business Rules functions. You can create a dictionary that contains the functions, and name it *DictCommon*. Then, you can create two dictionaries, *DictApp1* and *DictApp2* and link them both to *DictCommon*. Both can use the same Oracle Business Rules functions and when you want to change one of the functions, you only change the version in *DictCommon*. Both dictionaries use the updated function the next time RL Language is generated from either *DictApp1* or *DictApp2*.

In Oracle Business Rules a fully qualified dictionary name is called a `DictionaryFQN` and this consists of two components:

- **Dictionary Package:** The package name.
- **Dictionary Name:** The dictionary name

A dictionary refers to a linked dictionary using its `DictionaryFQN` and an alias. Oracle Business Rules uses the `DictionaryFQN` to find a linked dictionary.

The following are the naming constraints for combined dictionaries:

- The full names of the dictionaries, including the package and name, must be distinct.
In addition, the dictionary aliases must be distinct.
- The aliases of data model definitions of a particular kind, for example, function, Oracle RL class, or value set, must be unique within a dictionary.
- A definition may be qualified by the alias of its immediately containing dictionary.

Definitions in the top and built-in dictionaries do not have to be qualified. Definitions in other dictionaries must be qualified and this qualification is controlled by the prefix linked names property of the dictionary link.

- Ruleset names must be unique within a dictionary.

When RL Language for a ruleset is generated, the dictionary alias is not part of any generated name. For example, if the dictionary named *DictApp1* links to *DictApp2* to create a combined dictionary, and *DictApp1* contains `ruleset_1` with `rule_1` and *DictApp2* also

contains `ruleset_1` with `rule_2`, then in the combined dictionary both of these rules, `rule_1` and `rule_2` are in the same ruleset (`ruleset_1`).

- All rules and Decision Tables must have unique names within a ruleset.

For example, within a combined dictionary that includes dictionary *DictApp1* links to *DictApp2*, dictionary *DictApp1* may have a ruleset named `Ruleset_1` with a rule `rule_1`. If dictionary *DictApp2* also has a ruleset named `Ruleset_1` with a rule `rule_2`, then when Oracle Business Rules generates RL Language from the combined, linked dictionaries, both rules `rule_1` and `rule_2` are in the single ruleset named `Ruleset_1`. If you violate this naming convention and do not use distinct names for the rules within a ruleset in a combined dictionary, a validation warning is reported, similar to the following:

```
RUL-05920: Rule Set Ruleset_1 has two Rules with name rule_1
```

To view linked dictionaries:

1. Open the business rule dictionary where you want to view dictionary links.
2. Go to the toolbar and click **Links**, as shown in [Figure 17-5](#).

Figure 17-5 Business Rules Editor - Links

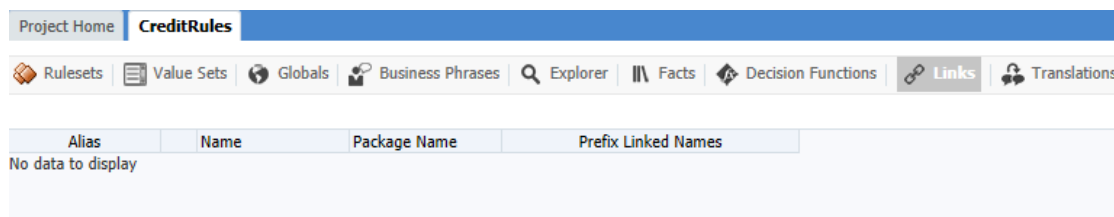

Working with Rulesets

Using Oracle Business Process Composer you can edit, add, and delete rulesets.

Note that when you create a new business rule dictionary, a default ruleset is automatically created

How to Add General Rules and Verbal Rules to a Ruleset

Use the Business Rules Editor to add, edit, and delete rules in a ruleset.

You author general rules, verbal rules and business phrases in Business Process Composer in the same fashion as in Oracle Business Process Management Studio. There are some differences in the way you interact with the GUI, such as the use of the keyboard when creating business phrases.

For a complete description of the concepts behind the configuration of general rules and verbal rules, see "Working with Rules" in *Designing Business Rules with Oracle Business Process Management*.

Adding a Rule to a Ruleset

To add a rule to a ruleset:

1. Open the business rule dictionary containing the ruleset where you want to add a rule.

2. Go to the toolbar and click **Rulesets**, then select the required ruleset from the listing of rulesets defined for this business rule.
3. Click the **New Rule** icon and select to add either a *General Rule*, or *Verbal Rule*.

Adding a General Rule

To add a general rule:

1. Click the **Advanced Property Editor** icon located to the right of the rule name to edit the name for this new rule, as shown in [Figure 17-6](#).

Figure 17-6 Business Rules Editor: Rulesets - New General Rule

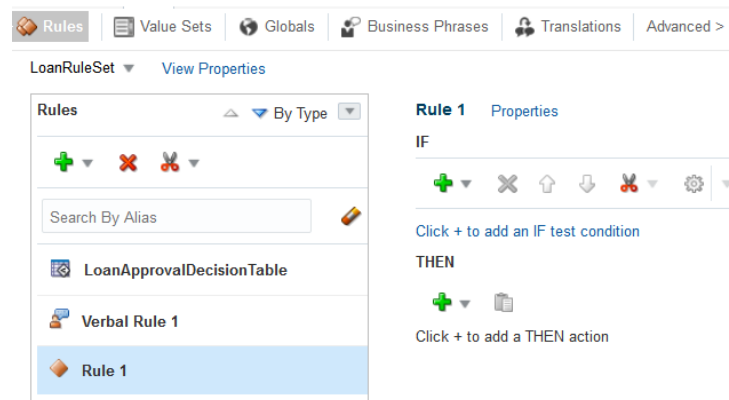

2. In the IF area, use the controls, icons, and selection boxes, including the Left Value expression icon, drop-down list for an operator, and Right Value expression icon to modify the condition.
3. In the THEN area for the rule, next to the rule action click Add Action.

Adding a Verbal Rule

To add a verbal rule:

1. Click the **Advanced Property Editor** icon located to the right of the rule name to edit the name for this new rule, as shown in [Figure 17-7](#)

Figure 17-7 Business Rules Editor: Rulesets - New Verbal Rule

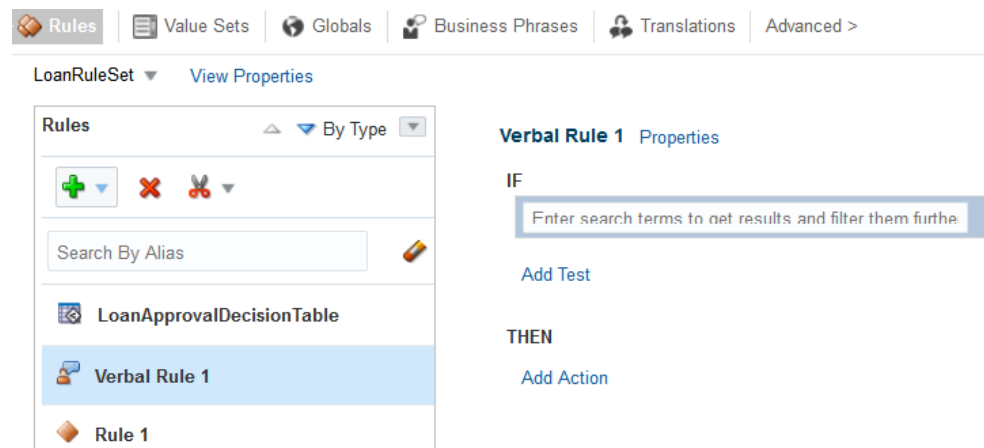

2. In the IF area, click **Add Test**. specify tests by entering business phrases.
3. In the THEN area for the rule, click **Add Action** to add the required action for this rule.

Working with Decision Tables

A Decision Table displays multiple related rules in a single spreadsheet-style view. In Business Rules Editor, a Decision Table presents a collection of related business rules with condition rows, rules, and actions presented in a tabular form that is easy to understand. Business users can compare cells and their values at a glance and can use Decision Table rule analysis features by clicking icons and selecting values in Business Rules Editor to help identify and correct conflicting or missing cases.

To help understand Decision Table concepts, consider a set of IF/THEN rules that determine if a loan application is approved or rejected.

The IF/THEN rules follow:

```
if loanAmount < 10,000 and creditRating = poor then loanApprovalStatus = manual_approval
if loanAmount < 10,000 and creditRating = good then loanApprovalStatus = auto_approved
if loanAmount [100,000..500,000] and creditRating = poor then loanApprovalStatus = auto_rejected
```

Figure 17-8 shows a Decision Table representation that includes these rules and shows areas for Decision Table conditions and actions.

Figure 17-8 Sample Decision Table with Conditions and Actions

Credit Decision Table 

Click to view tests and variables

Local Range Value Set  Tools 

	R1	R2	R3	R4	R5	R6
RuleInputType.loanAmount	Less than 10,000	Between 10,000 and 100,000;...	Less than 10,000	Between 10,000 and 100,000;...	Less than 10,000; Between 10,...	Between 100,000 and 500,000
RuleInputType.creditRating	"POOR"	"POOR"	"GOOD"	"GOOD"	"EXCELLENT"	"EXCELLENT"
assert new RuleOutputType	✓	✓	✓	✓	✓	✓
loanApprovalStatus:String	"MANUAL_APPROVAL"	"AUTO_REJECTED"	"AUTO_APPROVED"	"MANUAL_APPROVAL"	"AUTO_APPROVED"	"MANUAL_APPROVAL"

A ruleset contains a Decision Table; this provides a way to group the Decision Table along with IF/THEN rules. When rules and Decision Tables are grouped in a ruleset, the IF/THEN rules and the Decision Table rules all execute as a set of interrelated rules.

A rule in a Decision Table is not named. Although Business Rules Editor shows rules in a Decision Table with labels, for example, R1, R2, and R3, these rule labels are not names for individual rules but are labels derived from the current ordering of the rules in the Decision Table. Therefore, a rule with the label R1 can be moved to position 3 and then Business Rules Editor relabels this rule R3.

Decision Table Conditions

The Conditions area in a Decision Table includes one or more condition rows. Each condition row has a condition expression and, for each rule, a condition cell. A condition expression is an expression that you build in Business Rules Editor. The condition expression is often a fact property or a function result, but it can be any expression that has a type that can be associated with a value set. The value or the range for a given condition cell takes its value or its range from one or more values or ranges in the associated LOV or Ranges value set.

Decision Tables show rules in value order, and to change the order of rules you must change the order of values in the value sets. Therefore, the order of the values in the value set associated with a condition row determines the order of the condition cells, and therefore the order of the rules. You can control rule ordering in a Decision Table by changing the relative position of the values in an LOV value set associated with a condition row; however, you cannot reorder range values.

By default, when you create a condition row, Business Rules Editor creates a single condition cell and assigns the "?" value to the cell. A condition cell with the value "?" indicates that the value of the cell is undefined in the value set.

Decision Table Actions

Actions are associated with rules in a Decision Table. At runtime, when facts match for condition cells, the Rules Engine prepares to run the actions associated with the rule.

[Table 17-1](#) shows the types of actions you can choose in the Actions area. Therefore, in an action you can call a function, assert a new fact, retract a fact, or modify a fact, and so on. In the Actions area the cells corresponding to an individual action for a rule are called action cells.

Table 17-1 Decision Table Actions

Action	Description
assert new	Assert a new fact
assign	-
call	Call a function
modify	Modify a data value associated with a matched fact
retract	Retract a fact
assert	-
assert tree	-
assign new	-
expression	-
return	-
throw	-

When you add multiple actions the actions that you add in the Actions area are ordered; actions appearing in the higher rows run before actions in the following rows.

The Decision Table actions such as modify can refer to facts matched in the condition cells. Certain types of actions in the Actions area include a Parameterized check box. This check box specifies that a property from the action can have its value set in the action cell associated with a rule in the Decision Table. When the parameterized check box is selected, the value you supply for the expression value in the action, in the Actions area, becomes the default value for the property if a value is not supplied in the action cell. For example, see [Figure 17-9](#) where the value GOOD is assigned as the default value for the action property `loanApprovalStatus`.

Figure 17-9 Action Editor Showing Paramaterized Action with Default Value

Form:

Value: modify RuleOutputType

Target:

Name	Type	Value	Parameterized	Constant
loanApprovalStatus	String	"GOOD"	<input checked="" type="checkbox"/>	<input type="checkbox"/>

Arguments:

Always Selected:

In the Decision Table Actions area you can specify that an action cell do nothing. In this case, clear the action cell. When the action cell check box is cleared, this means do not perform this action when the pattern matches for the specified condition values in the Decision Table. Therefore, for each action cell you can specify whether the rule associated with the action cell should activate the action, or do not perform the action.

How to Add a Decision Table to a Ruleset

You add a Decision Table by performing several steps. These steps include:

- Create a Decision Table.
- Add conditions to the Decision Table.
- Add actions to the Decision Table.
- Use Decision Table operations to validate, correct, and modify the Decision Table.

To add a Decision Table:

A Decision Table displays multiple related rules in a single spreadsheet-style view.

1. Open the business rule dictionary containing the ruleset where you want to add a Decision Table.
2. Go to the toolbar and click **Rulesets**, then select the required ruleset from the listing of rulesets defined for this business rule.
3. Click the **New Rule** icon and select to add a *Decision Table*.
4. Click the **Advanced Property Editor** icon located to the right of the rule name to edit the name for this new rule.
5. Use the controls, icons, and selection boxes to create your decision table when many rules are required, as shown in [Figure 17-10](#).

Figure 17-10 Business Rules Editor: Rulesets - New Decision Table Rule

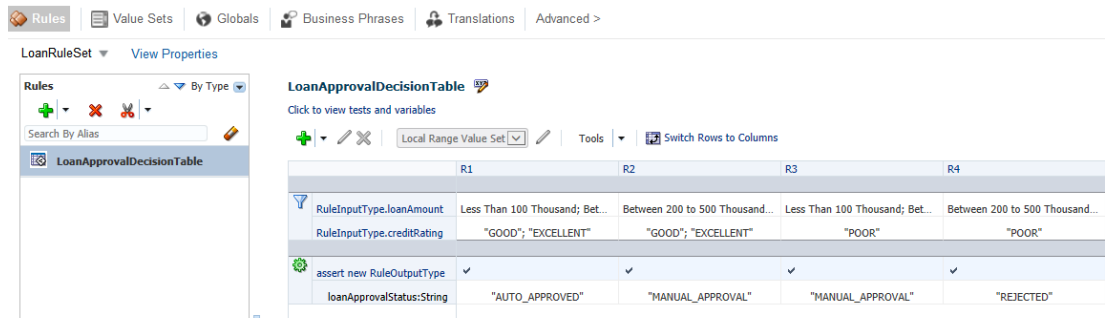

For more detailed information about how to create Decision Tables and the tools available, see *Designing Business Rules with Oracle Business Process Management*, "Working with Decision Tables".

Working with Facts

In Oracle Business Rules, facts are the objects that rules reason on. Each fact is an instance of a fact type. You must import or create one or more fact types before you can create rules. Facts are created and edited in BPM Studio. You can view facts in Composer.

In Oracle Business Rules a fact is an asserted instance of a class. The Oracle Business Rules runtime or a developer writing in the Oracle Rule Language (RL) uses the RL Language assert function to add an instance of a fact to the Oracle Business Rules Engine.



Note:

Oracle Rule Language (RL) is the native language for Oracle Business Rules

Using the Business Rules Editor you can view facts, as shown in [Figure 17-11](#).

Figure 17-11 Business Rules Editor - Facts

Name	Description	Qualifier Pattern	SuperClass	Kind	Source	Dictionary	System Name
RuleInputType			Object	XML	businessCatalog/BusinessData/RuleInput.xsd	LoanApprovalRu...	//xs:complexType[@name="RuleInputType"]
com_oracle_xmIn...			Object	XML	businessCatalog/BusinessData/RuleInput.xsd	LoanApprovalRu...	
com_oracle_xmIn...			Object	XML	businessCatalog/BusinessData/RuleOutput...	LoanApprovalRu...	
RuleOutputType			Object	XML	businessCatalog/BusinessData/RuleOutput...	LoanApprovalRu...	//xs:complexType[@name="RuleOutputType"]
String	Java immutable character strings. Bewar...		Object	JAVA		Built-in	oracle.rules.sdk2.datamodel.JavaFactType
BigDecimal	Immutable, arbitrary-precision signed de...		Number	JAVA		Built-in	oracle.rules.sdk2.datamodel.JavaFactType
BigInteger	Immutable arbitrary-precision integers.		Number	JAVA		Built-in	oracle.rules.sdk2.datamodel.JavaFactType
Double	A Double object. Unlike the primitive "do...		Number	JAVA		Built-in	oracle.rules.sdk2.datamodel.JavaFactType
Float	A Float object. Unlike the primitive "float...		Number	JAVA		Built-in	oracle.rules.sdk2.datamodel.JavaFactType
Integer	An integer object. Unlike the primitive "in...		Number	JAVA		Built-in	oracle.rules.sdk2.datamodel.JavaFactType
Long	A long integer object. Unlike the primitive...		Number	JAVA		Built-in	oracle.rules.sdk2.datamodel.JavaFactType

Fact types can be based on the following:

- **XML Facts:** XML Facts are imported from existing sources by specifying XML Schema.

In BPM Studio, you can add aliases to imported XML Facts or use XML Facts with RL Facts to change the data model according to your business requirements.

- **Java Facts:** Java Facts are imported from existing sources.

In BPM Studio, you can add aliases to Java Facts or use them with RL Facts to target the data model to business requirements. Java Facts are also used to import supporting Java classes for use with the rules or Decision Tables that you create.

- **RL Facts:** RL Facts are the only kind of facts that you can create directly and do not have an external source.

All other types of Oracle Business Rules facts are imported. An RL Fact is similar to a relational database row or a `JavaBean` with properties. An RL Fact contains a set of named, typed properties. Property values can be primitives such as String, another structured fact, or a list. RL Facts are useful for rapid and independent development and testing of decision logic. Input data that ultimately comes from an imported fact type (for example, an XML Schema) can be modeled using RL Facts before the imported schema is available or stable. Intermediate decisions that should not be returned to the application (for example, sub-decisions that categorize a customer as GOOD or BAD). It is usually best to import the fact types that are used for the input and output data of a decision. You can use RL Facts to extend a Java application object model by providing virtual dynamic types.

- **ADF Business Components Facts:** ADF Business Components Facts allow you to use ADF Business Components as Facts in rules and in Decision Tables.

By using ADF Business Components Facts you can assert view object graphs representing the business objects upon which rules should be based, and let Oracle Business Rules deal with the complexities of managing the relationships between the various related view objects in the view object graph.

In the Oracle Business Rules runtime such fact type instances are called facts.

Working with Value Sets

You can create value sets to define a list of values or a range of values of a specified type. After you create a value set you can associate the value set with a fact property of matching type. Oracle Business Rules uses the value sets that you define to specify constraints on the values associated with fact properties in rules or in Decision Tables.

You can also use value sets to specify constraints for variable initial values and function return values or function argument values.

Using Business Rules Editor you can add, edit, or delete value sets to a business rule dictionary.

How to Add a Value Set

Using the Business Rules Editor, you can edit, add, or delete value sets contained in a business rule dictionary

To add a new value set:

1. From the Project Welcome page, go to the Components pane and select **Rules**.
2. Click the name of the dictionary you want to open.

The dictionary appears in the Business Rules Editor, as shown in [Figure 17-1](#). Ensure that the project is in edit mode.

3. Go to the toolbar and click **Value Sets**.

This displays a table listing the value sets in the selected business rule, as shown in [Figure 17-12](#).

Figure 17-12 Business Rules Editor - Value Sets

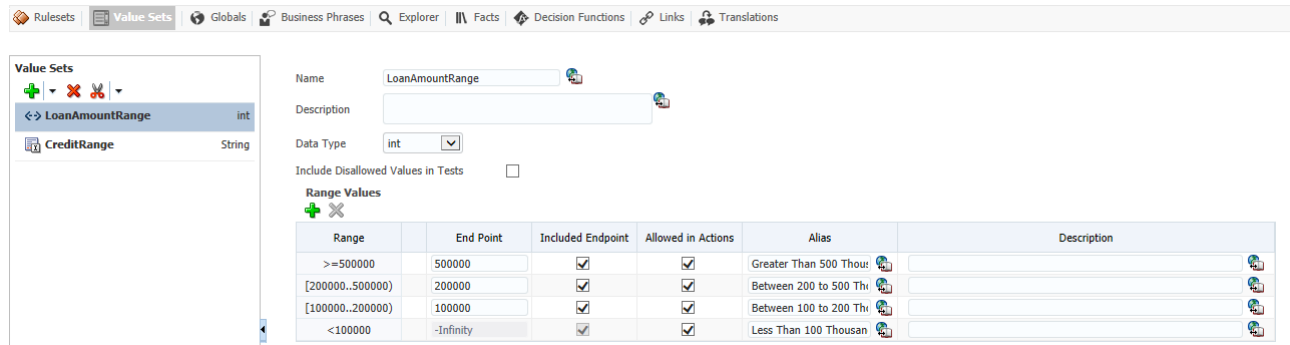

4. Click the **Add Value Set** drop-down list, then select the type of value set you want to create.
 - Value Set
 - Range Value Set
5. Select the value set from the list, then edit the value set as required.

Depending on the type of the value set, this displays a corresponding Edit value set page. [Figure 17-12](#) shows an example of a range value set.

How to Edit an Existing Value Set

In the Business Rules Editor, selecting **Value Sets** shows you a table listing the value sets in the dictionary. To edit a value set, select the appropriate row and click the edit icon. Depending on the type of the value set, Range, Enum, or LOV, this displays a corresponding Edit value set page.

You can create a range value set by clicking Add in the menu bar and selecting a type. This adds a new row in the value sets table. Adding a value automatically adds an end point for a range value and a value for an LOV value based on the data type. You can modify the newly added value end point or value. Note that the alias is modified when an end point or value is changed.

To delete a value set, select a row and click **Delete**.

To edit a value set:

1. Open the business rule dictionary where you want to edit the value set.
2. Go to the toolbar and select **Value Sets**.
This displays a table listing the value sets in the dictionary.
3. Select the appropriate value set row and click the edit value set icon.
4. Use the Value Set Editor to edit the appropriate fields in the value set.
5. Click **OK** to confirm the changes.

Working with Global Variables

Using Business Rules Editor you can add, edit, or delete global variables to a business rule dictionary. You can use global definitions to share information among several rules and functions.

For example, if a 10% discount is used in several rules you can create and use a global Gold Discount, so that the appropriate discount is applied to all the rules using the global.

How to Add a Global Variable

Using the Business Rules Editor, you can edit, add, or delete global variables contained in a business rule dictionary

To add a new global:

1. From the Project Welcome page, go to the Components pane and select **Rules**.
2. Click the name of the dictionary you want to open.

The dictionary appears in the Business Rules Editor, as shown in [Figure 17-1](#). Ensure that the project is in edit mode.

3. Go to the toolbar and click **Globals**.

This displays a table listing the globals in the selected business rule dictionary, as shown in [Figure 17-13](#).

Figure 17-13 Business Rule Editor - Globals

	Name	Description	Value	Value Set	Type	Final	Constant
(x)	Manual Approval Needed				boolean	<input checked="" type="checkbox"/>	<input checked="" type="checkbox"/>
(x)	Auto Approved		false	boolean	boolean	<input checked="" type="checkbox"/>	<input checked="" type="checkbox"/>

4. In the **Name** field, enter a name or accept the default value.
5. In the **Value** field, enter a value, select a value from the list, or click the Expression Builder icon to enter an expression.

For more information about using expressions, see [Using Expressions to Control Data](#).

6. Optionally, in the **Value Set** field, select a value from the list.
7. In the **Type** field, select the type from the list.
8. If the global is a nonfinal, then deselect the **Final** check box.

When unselected, this option specifies that the global is modifiable, for instance, in an assign action.

9. If the global is a constant, then select the **Constant** check box.

When selected, this option specifies that the global is a constant value. For more information, see [About Final and Constant Options](#).

About Final and Constant Options

The Globals variable includes the Constant and Final options that you can select. Consider the following when you use global variables:

- When you deselect Final, this specifies that the global is modifiable, for instance, in an assign action.
- When you select Final, this specifies that you can use the globals in a test in a rule (nonfinal globals cannot be used in a test in a rule).
- When you select Final, this specifies that the global is initialized one time at runtime and cannot be changed.

When you select the Constant option, this specifies the global is a constant. In Oracle Business Rules a constant is a string or numeric literal, a final global whose value is a constant, or a simple expression involving constants and +, -, *, and /.

Selecting the Constant option for a global has three effects:

- You do not have to surround string literals with double quotes.
- Only constants appear in the expression value choice list.
- The expression value must be a constant to be valid.

Selecting the Constant option is optional. Note that values, value range endpoints, and ruleset filter values are always constant.

How to Edit Globals

In the Business Rules Editor, selecting the **Globals** tab shows you a table listing the globals in the dictionary.

To edit a global variable, select the appropriate row and variables. You can edit the Name, Description, and Value fields. For the Value field, you can use the expression builder to set the value.

Working with Verbal Rules and Business Phrases

Verbal rules work hand in hand with business phrases to provide a flexible way author rules using natural language statements to express rule logic in domain specific sentences that are similar to spoken language. Business phrases provide the logic behind conditions that are used in the composition of the verbal rule.

You can write verbal rule tests and actions using derived business phrases as well as user-defined business phrases. Derived business phrases are automatically created using facts, globals and other information in the dictionary while user-defined phrases can be explicitly authored to augment derived phrases. Further, user-defined phrases can either be pre-created or created as required while composing the verbal rule.

As you write a verbal rule, you can use suggested business phrases, or instantiate your own on the fly and provide their implementation details later. Alternatively, you can create the business phrases you require for your verbal rule first, and then complete the verbal rule.

For more information about business phrases and how they work with verbal rules, as well as sample scenarios, see the "Working with Rulesets and Rules" chapter in *Designing Business Rules with Oracle Business Process Management*.

How to Create Business Phrases

In the Business Rules Editor, selecting the **Globals** tab shows you a table listing the globals in the dictionary.

To edit a global variable, select the appropriate row and variables. You can edit the Name, Description, and Value fields. For the Value field, you can use the expression builder to set the value.

To create a Business Phrase

1. Open the business rule dictionary where you want to add a Business Phrase.
2. Go to the toolbar and click **Business Phrases**.
3. Click the **Add Phrase** icon to add a *Test* business phrase.
Alternatively, you can create either a *Test* or *Action* business phrase from the dropdown.
4. Enter the business phrase details as shown in [Figure 17-14](#).

Figure 17-14 Business Rule Editor - Business Phrases

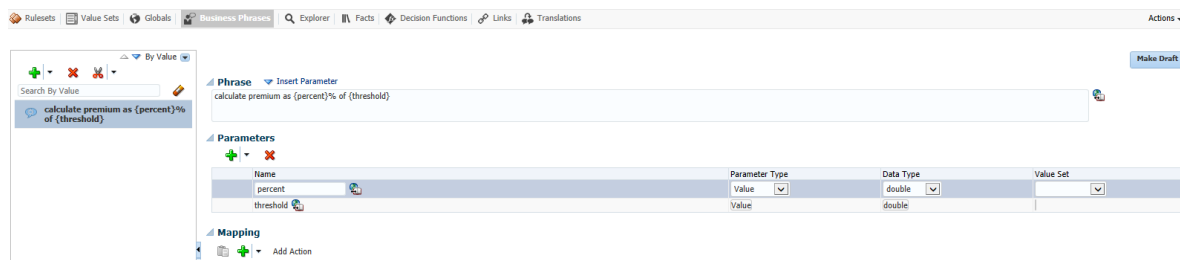

5. In the Phrase panel, enter the definition of the business phrase.
Placeholders for parameters that have not yet been defined can be included by typing their name wrapped in curly braces. For example:

```
{customer} is single
```

The corresponding parameters are added to the Parameters panel.
6. Define parameters in the **Parameters** panel.
Click Create (+) to add a new parameter. Specify its **Name**, **Form**, and **Type**. Optionally, specify a **Value Set**.
7. To add a parameter to the business phrase value, click **Insert Parameter** in the Phrase panel, and select the parameter from the dropdown list.
8. Define the mapping for the business phrase in the **Mapping** panel by adding Tests or Actions, depending on the type of business phrase.
Mappings are constructed by searching for and specifying conditions, facts, operands and so on, in the same fashion to how you construct a general rule test or action in 34Business Process Composer. See "[How to Add General Rules and Verbal Rules to a Ruleset](#)".
9. Mark the business phrase as draft if required.

Draft Business Phrases and Verbal Rules

Business phrases can be marked as being in draft status.

You can set or override the draft status of a business phrase by clicking **Make Draft** or **Clear Draft**.

The draft status of a verbal rule is derived from the business phrases it references and can not be manipulated directly. If a verbal rule contains business phrases marked draft, the rule is also marked draft. The verbal rule description panel indicates that the verbal rule is in draft mode. When all business phrases referenced by the verbal rule are no longer marked draft, the verbal rule is taken out of draft mode.

Draft business phrases and verbal rules are not validated and are not included in the dictionary for execution. This allows you to continue to use or test a dictionary as you refine your business phrases and verbal rules.

As you write a verbal rule you can compose business phrases that do not yet exist in the dictionary. These are automatically added to the list of business phrases and marked draft, and the verbal rule is marked draft as well.

Choosing or Adding Business Phrases in Verbal Rules

Verbal rules use business phrases to specify the IF and THEN tests and actions.

When defining a test or action in a verbal rule, you enter text which triggers a drop-down list of choices. From the list, you can select existing business phrases from the dictionary, automatically generated business phrases, or you can instantiate your a new business phrase based on what you typed, provide its implementation details later in the Business Phrases tab.

Instantiating New Business Phrases While Authoring a Verbal Rule

You can instantiate new business phrases while authoring a new verbal rule simply by typing them into a test or action and clicking **<Add New Business Phrase>**, instead of selecting one from the dropdown list. These business phrases are marked draft, and the verbal rules which use them are also marked as draft.

Click **Goto Phrase** to access the business phrase in the Business Phrases tab.

Choosing Business Phrases While Creating a Verbal Rule

A robust list including both previously user-defined and auto-generated derived business phrases, sorted by relevancy, is automatically provided as you author a test or action.

User-defined and derived business phrases are not visually distinguished from one another in the dropdown list.

You can refine the list if required. To display more choices, select a business phrase and press the right arrow key. The list is populated with business phrases related to the one you selected.

Working with Decision Functions

A decision function is a mechanism for publishing rules and rulesets as a reusable service that can be invoked from multiple business processes. It is the only gateway into the business logic held in business rules because neither business rules nor rulesets are accessible from the outside.

A decision function is a function that is configured declaratively. A decision function performs the following operations:

- Asserts inputs as rule facts into the Oracle Business Rules Engine working memory.

- Runs rulesets configured in the current decision function and in nested decision functions in order.
- Returns output facts from the Oracle Business Rules Engine working memory.

A decision function provides a contract for invoking rules from Java or Service-Oriented Architecture (SOA) (from an SOA composite application or from a BPEL process). The contract includes input fact types, rulesets to run, and output fact types.

To view and modify a Decision Function:

1. Open the business rule dictionary.
2. Go to the toolbar and click **Decision Properties**.
3. Select a decision function, as shown in [Figure 17-15](#).

Figure 17-15 Business Rules Editor - Decision Functions

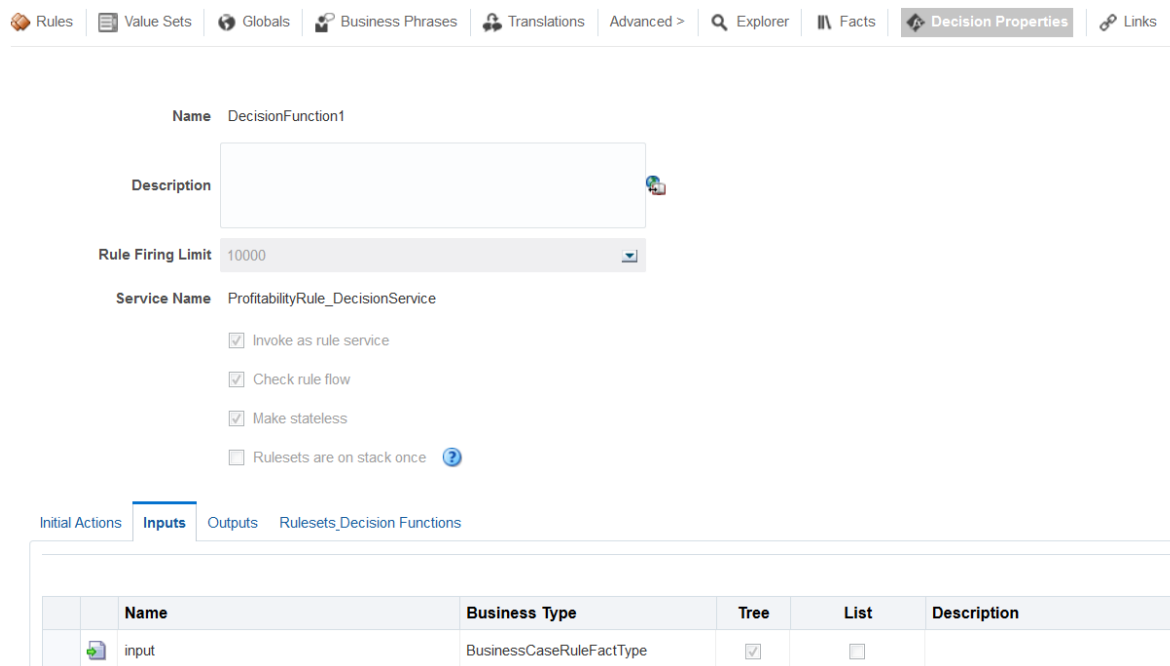

4. Enter a name for the Decision Function in **Name** field.
5. If desired, modify a description in the **Description** field.
6. Select unlimited or an integer value in the **Rule Firing Limit** field.

In some cases when you are debugging a decision function, you may want to enter a value for the rule firing limit. The Rule Firing Limit can also be used in primary rules processing when you want the execution to stop after a specified number of rules fire.

7. Enter the service name in the **Service Name** field if this decision function is to be invoked as a rule service.
8. The following controls are not editable from Composer:
 - **Name**
 - **Rule Firing Limit**
 - **Service Name**

- **Invoke as a rule service:** Is the decision function is to be invoked as a rule service.
 - **Check rule flow:** Verifies the following to generate validation warnings:
 - Types required by rules executed by the decision function are either inputs to the decision function or asserted by other rules.
 - Types generated by rules executed by the decision function are either inputs to other rules or outputs to the decision function.
 - Note that rule flow checking might not identify rule flow issues spanning Java code that is used in rules. In such cases, the warnings can be ignored by turning off rule flow checking.
 - **Stateless:** Specifies that the decision function is stateless
 - When this check box is selected, which indicates stateless operation. With stateless operation, at runtime, the rule session is released after each invocation of the decision function.
 - **Rulesets are on stack once:** If selected, Rulesets are not evaluated further once they are popped from the Ruleset stack. When this check box is selected, which indicates stateless operation. With stateless operation, at runtime, the rule session is released after each invocation of the decision function.
9. In the *Initial Actions* tab, click **Add** to add initial actions for the decision function. Select from the list, which includes:
- assertions
 - assignments
 - if, while, for, and so on
 - expression
 - synchronized
 - throw
10. These tabs are not editable from Composer:
- **Inputs** Enter an input name and press Enter or accept the default name.
 - **Outputs** Select the appropriate fact type from the list.
 - **Rulesets Decision Fucntions**

Working with Explorer

Use the Explorer tab to view business rules dictionary items.

To view items using Explorer:

1. Open the business rule dictionary where you want to edit items.
2. Go to the toolbar and click **Explorer**.

The items included in the selected business rules dictionary are listed, as shown in [Figure 17-16](#).

Figure 17-16 Business Rules Editor - Explorer

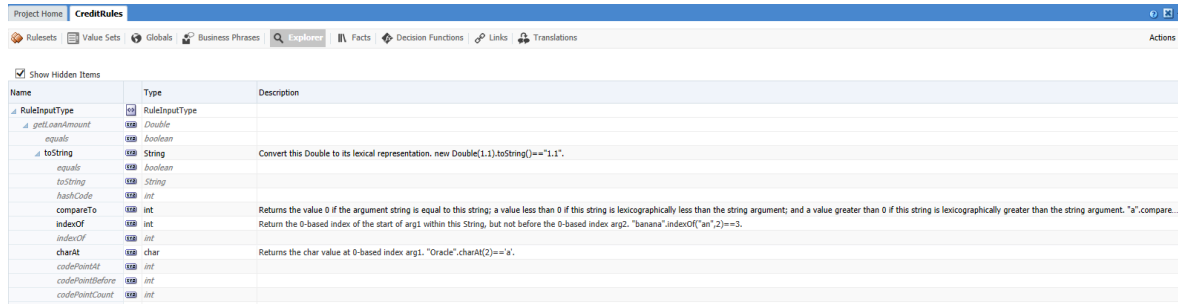

3. Select the **Show Hidden Items** to include hidden items in the list.

Working with Translations

Use the Translations tab to view the phrases included in the selected dictionary and their translated strings.

Note that in order to work with additional languages for this project, they must be added to the project.

For more information about how to add languages to a project, see [Introduction to the Project Information Panel](#).

To translate phrases:

1. Open the business rule dictionary where you want to translate phrases.
2. Go to the toolbar and click **Translations**.

The phrases included in the selected dictionary are listed. The languages specified for this project are also listed, as shown in [Figure 17-17](#).

Figure 17-17 Business Rules Editor - Translations

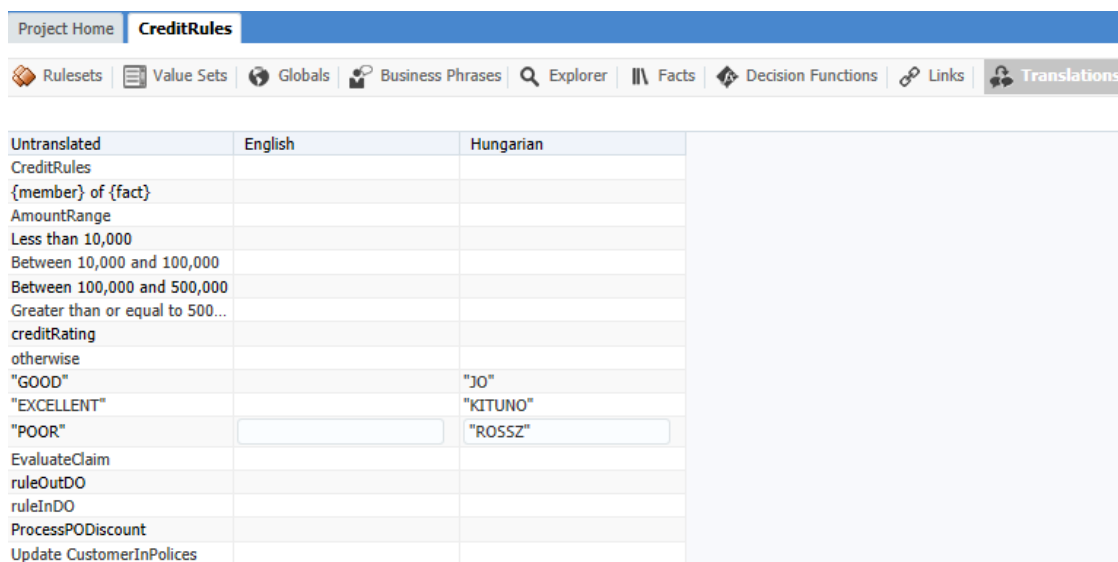

3. Click on the phrase that you want to translate and enter the translated string in the appropriate language column.

Assigning a Rule to a Business Rules Task

The business rules task is an Oracle BPMN element enables you to incorporate Oracle Business Rules within a process model. When editing a project based on a project template containing business rules in the business catalog, you can assign business rules to business rules task.

To assign a business rule to a business rules task:

1. Open the process containing the business rules task you want to edit.
2. Right-click the business rules task, then select **Properties**.
3. Select the **Implementation** tab.
4. Click **Change**. This displays the business rules browser containing a table of available business rules.
5. Double-click a rule from the table.
6. Click **OK**.

Editing Oracle Business Rules at Run Time

You can use Business Process Composer to open deployed Oracle BPM projects. Opening a deployed project enables you to edit the Oracle Business Rules contained in the project and deploy your changes back to Oracle BPM runtime.



Note:

When editing a deployed project, you can only edit the Oracle Business Rules for that project. You can view other project resources, but cannot edit them.

To open a deployed project:

1. From the **Project** menu select **Open a Deployed Project**.
If you are currently editing a project, your changes are automatically saved.
2. Select **Deployed Projects**, then select the project you want to open from the project list.
3. Expand **Repository**, then select the deployed project you want to open.
4. Click **Ok**.
5. In the Project Navigator, expand **Business Rules** then expand the rules dictionary where whose Oracle Business Rules you want to edit.
6. Click **Edit** in the rules editor.
7. **Edit** the rules as required, then click **Save**.
8. Click **Validate** to ensure the changes you made to the business rules are valid.
9. Click **Commit** to commit the changes to Oracle BPM runtime.
10. Click **Yes**.
11. From the **Project** menu, select **Close Project**.

18

Communicating with Other Processes and Services

Learn how to design your business processes to communicate with other processes and services.

- [Defining Process Input and Output](#)
- [Using the Send and Receive Tasks to Communicate Between Processes](#)
- [Using Message Throw and Catch Events to Communicate Between Processes](#)
- [Defining Conversations](#)
- [Working with Services](#)

Defining Process Input and Output

When you add operations to a Business Process Model and Notation (BPMN) process, you are defining points in the process that other processes or services can use to communicate with it. The communication between processes and other processes or services generally requires an input and returns an output.

The flow events that you use to define the BPMN process operations allow you to define input and output arguments. These input and output arguments define the process input and output.

How to Define the Input Arguments for a Process

When you create a process that begins with a message Start event, you must define the input arguments that are passed to the process.

To define the input arguments for a process:

1. Add a message Start event to your process.
2. Right-click on the message Start event, then select **Properties**.
3. Select the Trigger type as *Message*.

Oracle Business Process Composer creates a start event by default with a Trigger type of *None* so in order to implement it as a Message start event you must set the trigger in the Properties dialog.

4. Click the **Implementation** link to go to the Implementation tab.
5. Select **Define Interface**.
6. Click the **Add** icon.
7. Determine the name and type of the argument.
8. Click **Apply Changes**.

How to Define Data Associations for a Message Start Event

After you have defined the input arguments to your process, you must map them to data objects in your process.

To define data associations for a message start event:

1. Select the message Start event of your process.
2. Right click on the Start event and then click **Data Associations**.
3. Drag the data objects from the list on the right-hand side to the text boxes listed under **Outputs**.
4. Click **Apply**.

How to Define the Output Arguments for a Process

When you create a process that contains message End events, you must define the output arguments for each End event. These are the output arguments for the process.

To define the output arguments for a process:

1. Add a message End event to your process.
2. Right-click on the message End event, then select **Properties**.
3. Click the **Implementation** tab.
4. Select **Define Interface**.
5. Click the **Add** icon.
6. Determine the name and type of the argument.
7. Click **Apply Changes**.

How to Define Data Association for a Message End Event

After you have defined the output arguments for your process, you must map them to the data objects in your process.

To define data associations for a message end event:

1. Select a message End event in your process.
2. Right click on the End event and then click **Data Associations**.
3. Drag the data objects from the list on the right-hand side to the text boxes listed under **Inputs**.
4. Click **Apply**.

Using the Send and Receive Tasks to Communicate Between Processes

You can use the send and receive tasks to invoke another BPMN process and receive messages back from it. Processes that begin with a receive task and contain a send task are

exposed as services that can be used by other process and services within an Oracle Business Process Management (Oracle BPM) application.

Figure 18-1 outlines the basic behavior when using send and receive tasks to invoke a process and receive a response.

Figure 18-1 Using the Send and Receive Tasks to Communicate Between Processes

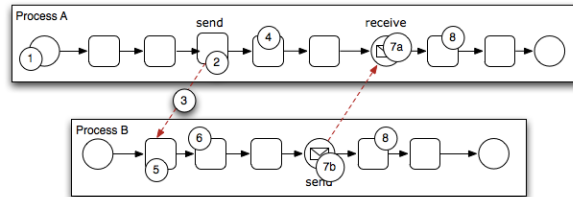

The following steps outline a possible scenario when using the send and receive tasks to communicate between processes.

1. Process A is invoked.
2. A token of Process A reaches the send task.
3. The send task invokes Process B.
This is defined by the implementation for the send task.
4. The token of process A proceeds to the next flow object in the process.
5. The receive task initiates a process instance of Process B.
The receive task must have the Create Instance property defined. See [Starting a Process with the Receive Task](#).
6. The newly created token proceeds through process B.
7. Depending on the specific behavior of your process, the following scenarios may occur:
 - a. If the token of Process A reaches a receive task paired with a send task from Process B, the token of Process A waits until a response is received.
After the response is received, the token of Process A continues to the next flow object.
 - b. If the token of Process B reaches a send task paired with a receive task in Process A, Process B sends a response to Process A.
The token of Process B continues to the next flow object.
8. Both processes continue running.
You can use subsequent send and receive pairs to define subsequent communication between the two processes.

Using Message Throw and Catch Events to Communicate Between Processes

You can use combinations of throw and catch events to invoke and communicate with other BPMN processes.

When using a throw event to invoke another process, the following conditions must be met:

- The process being invoked must be an asynchronous process.

Although you can use a message throw event to invoke a synchronous process, there is no mechanism for catching messages synchronously from the process.

If you invoke a synchronous process use the service task. See [Introduction to the Service Task](#) for more information.

- The first time you use a message throw event it must be paired to the message start event of the other process.

This is required to trigger the process instance. After the instance has been triggered, you can use subsequent message throw events that are caught by the second process.

Processes that begin with a message start event and end with a message end event are exposed as services that can be used by other processes and services within an Oracle BPM application.

Processes invoked from another process are not considered child processes. This is important to consider when designing processes that use the terminate end event as a process end point. For example, a terminate event in the calling process does not stop a processes invoked with a message throw event.

[Figure 18-2](#) shows the basic behavior when using message throw and catch events to invoke a process and receive a response.

Figure 18-2 Using Message Throw and Catch Events Between Processes

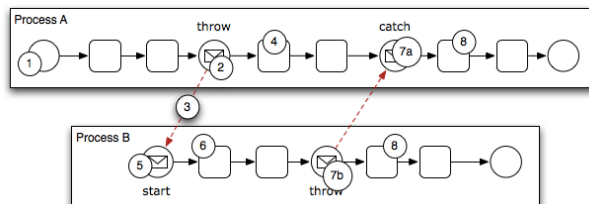

The following steps outline a possible scenario when using the message throw and catch events to communicate between processes.

1. Process A is invoked.
2. The token of Process A reaches a message throw event that is configured to invoke Process B.
3. The message throw event sends a message to the message start event of Process B.
4. The token of Process A proceeds to the next flow object.
5. The message start event triggers an instance of Process B.
6. The newly created token proceeds through Process B.
7. Depending on the behavior of your process, the following scenarios may occur:
 - a. If the token of Process A reaches a catch event paired with a throw event from Process B, the token of Process A waits until the message is received.

After the message is received, the token of Process A continues to the next flow object.

- b. If the token of Process B reaches a throw event paired with a catch event in Process A, Process B throws a message to Process A.

The token of Process B continues to the next flow object.

8. Both processes continue running.

You can use subsequent catch and throw event pairs to define subsequent communication between the two processes.

Defining Conversations

Conversations group the message exchange between two or more processes. The message exchange between processes is called collaboration. Within a project you can define multiple conversations that you can reuse amongst the processes in that project.

Introduction to Conversations

Conversations group the message exchange between two or more processes. The message exchange between processes is called collaboration. Within a project you can define multiple conversations that you can reuse amongst the processes in that project.

Collaboration diagrams allow you to view the process flow together with the interactions your process has with other participants in the conversation.

Your BPM project defines a conversation by default. If you do not want to define multiple conversations you must use this default conversation to gather all the message exchanges amongst the processes in your project.

You can only define one default conversation per project. However you can modify your project to use a different default conversation than the one it uses by default.

The different types of conversations allow you to specify the different types of interaction your process can establish with other processes or services. The following list describes the different types of conversations:

- **Define Interface:** Use to define the operations that other services and processes can invoke to interact with a BPMN process.
- **Use Interface:** Use to configure your process to use an interface from a component in the Business Catalog.
- **Process Call:** Use to invoke another BPMN process.
- **Service Call:** Use to invoke a service defined in your BPM project.

Working with Conversations

The following sections describe how to define and configure conversations using Oracle Business Process Composer.

How to Define a Conversation

1. Open your process.
2. Click the **Edit Conversation** button in the process editor toolbar.
3. Click the **Add Conversation** button.
4. Provide a name for the conversation.
5. Select the type of conversation you want to define.
6. Click **OK**.

How to Set the Default Conversation

1. Open your process.
2. Click the **Edit Conversation** button in the process editor toolbar.
3. Select a conversation from the list, then click the **Edit** button.
4. Click the **Default Conversation** check box.
5. Click **OK**.

How to Define a Conversation for a BPMN Flow Object

1. Open your process.
2. Right-click one of the following types of BPMN flow objects:
 - Message events (throw and catch)
 - Send and receive tasks
 - Service tasks

You can only define conversations for these BPM flow objects.

3. Select **Implement**.
4. In the **Implementation** tab, click the **Browse** button next to the **Conversation** text field.
5. Select a conversation from the list, then click **OK**.

How to View a Collaboration Diagram

To view the collaboration diagram for a process, click the **View Collaboration** button in the process editor toolbar.



Note:

In the collaboration view, you cannot make changes to the process. To return to normal process editing, click the **View Collaboration** button again.

Working with Services

Oracle Business Process Composer allows you to create new services in the business catalog. These services are based on standard web services.

The following sections describe how to create services using Oracle Business Process Composer.

How to Create New Services in the Business Catalog

Services based on web services are defined using a Web Services Description Language (WSDL) file. A WSDL file is an XML file used to describe how web services are implemented. When creating a new service using Oracle Business Process Composer, you can specify a WSDL file stored locally on your machine or one that is available online.

Process developers are responsible for providing a WSDL file or a URL location.

Creating New Services

To create a new service:

1. Open the project where you want to create a new service.
2. From the main menu, select **New** then **New Service**.
3. Provide the following information:
 - **Name:** Defines the name of the service as it appears in the business catalog.
 - **Type:** Defines the type of service being created.
 - **WSDL:** The source of the WSDL used to create the new service can be one of the following:
 - **URL:** Specifies the remote URL of the WSDL.
 - **File:** Specifies either a WSDL or ZIP file on your local file system.
If using a ZIP file, it can include only WSDL and XSD files. The WSDL file should have valid references.
 - **Port Type:** Port type specifies the service used.
A WSDL file exposes one or more port types.
 - **Callback Type:** Determines the call back type used for this web service.
This is only applicable to asynchronous services.
 - **Transaction Participation.**
 - **Version.**
4. Click **OK**.

Creating New Services in the Process Editor

To create a new service in the process editor:

1. Change the palette from BPMN to business catalog.
2. Click the **+** button located near services.
The New Service dialog appears.
3. Provide the required information.
4. Click **OK**.

19

Deploying a BPM Project

You can use Oracle Business Process Composer to deploy a project to the Oracle BPM runtime. Deployment is available only within the same environment where the Oracle Business Process Composer application is installed. Users who have been granted permission can deploy projects directly to runtime.

- [Who Can Deploy Projects](#)
- [How to Deploy a Project to Runtime](#)
- [How to Edit a Deployed Project](#)
- [How to Generate a Project SAR File](#)
- [How to Generate a Deployment Plan](#)

Who Can Deploy Projects?

Users who are granted project owner permissions can use Oracle Business Process Composer to deploy projects directly to Oracle BPM runtime. When the **Deploy Project** screen appears, enter the SOA admin role credentials. Without SOA admin credentials, deployment fails with an **unexpected error**.

How to Deploy a Project to Runtime

Project owners can deploy projects directly to Oracle BPM runtime.

To deploy a project to runtime:

1. Save any changes to your project.
2. Publish your project.

You do not want to deploy a project that has unpublished changes.

3. From the main menu select **Deployment**, then select **Deploy Project**.

Oracle Business Process Composer validates the project. If there are no errors in the project, the deployment process continues.

4. Provide the required information in the **Deploy Project** dialog, shown in [Figure 19-1](#).

Figure 19-1 Deploy Project Dialog

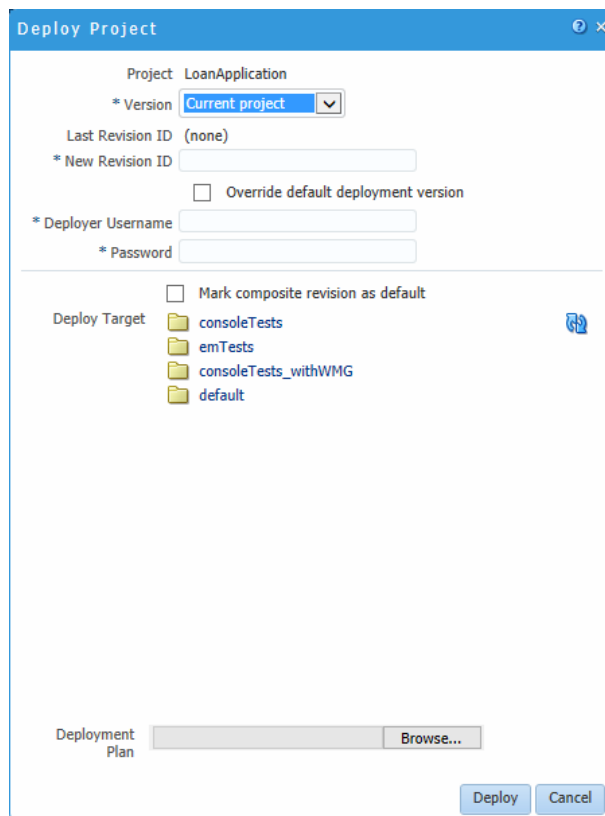

The properties in the Deploy Project dialog are described in [Table 19-1](#).

Table 19-1 The Deploy Project Dialog Properties

Property	Description
Project	Displays the name of the project.
Version	Use to select the version of the project you want to deploy. This can be the current version of the project or a project snapshot.
Last Revision ID	Displays the revision ID of the most recent deployed version of the project.
New Revision ID	Specifies a revision ID for the deployed application. This ID can must be of the form: n0[.n1[.n2[.n3[.n4]]]][-milestone-name[milestone-number]/_patch-number.
Override the default deployment version	Overrides the default deployment version.
Deployer Username	Used for deploying the Oracle BPM project to runtime.
Password	Specifies the password corresponding to the Deployer Username defined above.
Mark composite revision as default	Defines the current revision as the default revision.
Deploy target	Enables you to select the folder in Oracle MDS where the SOA composite application is deployed.

Table 19-1 (Cont.) The Deploy Project Dialog Properties

Property	Description
Deployment plan	Use to select a deployment plan. Click Browse to select a deployment plan on your local file system.

5. Click **Deploy**.

Oracle Business Process Composer deploys the project to runtime. This may take a few minutes.

6. After the deployment is complete, click **OK**.

The project is deployed to Oracle BPM runtime. The project is available from the list of deployed projects in the project browser.

How to Edit a Deployed Project

You cannot use Oracle Business Process Composer to edit deployed Oracle BPM projects. To edit a deployed project you must be granted the SOA Designer role and use SOA Composer.

For more information about editing deployed projects, see "Using SOA Composer with Oracle Business Rules at Runtime" in *Designing Business Rules with Oracle Business Process Management*.

How to Generate a Project SAR File

You can generate a project as a SOA archive (SAR) file from Oracle Business Process Composer. Your system administrator can use this file to deploy a project using the Oracle Enterprise Manager administration console.

To generate a project SAR file:

1. From the main menu, select **Deployment**, then select **Generate Project SAR file**.

Business Process Composer validates the project. If the project contains errors, these are displayed in the project validation tab.

2. Provide the required information in the **Generate Project SAR File** dialog, shown in [Figure 19-2](#).

Figure 19-2 Generate Project SAT File Dialog

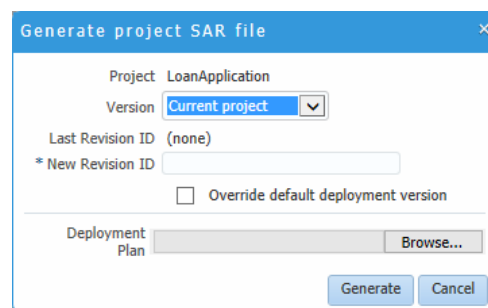

- Select the project version you want to use to generate the SAR file. This can be the current version of the project or a project snapshot.

- Enter a revision ID.
 - If required, select to override the default deployment version.
3. Click **OK**.
 4. If the project contains no errors, click **OK** to save the SAR file to your local file system.

How to Generate a Deployment Plan

A deployment plan is an XML configuration file that is used when deploying a BPM project from Oracle BPM Studio. Oracle Business Process Composer generates any unexpected errors when generating the XML file of the deployment plan.

 **Note:**

You should validate your project before creating a deployment plan. Oracle Business Process Composer does not perform any validation when generating the deployment plan.

To generate a deployment plan:

1. From the main menu, select **Deployment**.
2. Select **Generate Deployment Plan**.
3. Select a location on your local file system, then click **OK**.

Part VIII

Appendices

Get an overview of flow object references, web form and web form control property references, get examples of web form rules, and learn how to prepare processes to import into Oracle Business Process Management (Oracle BPM).

- [BPMN Flow Object Reference](#)
- [Web Form and Web Form Control Property Reference](#)
- [Web Form Rules Examples](#)
- [Preparing Processes for Import into Oracle BPM](#)

A

BPMN Flow Object Reference

Get a detailed description of the Business Process Model and Notation 2.0 (BPMN 2.0) flow objects that are supported in Oracle Business Process Management (Oracle BPM) and also Oracle BPM's implementation of the BPMN 2.0 standard. For information about the BPMN standard, including the formal specification, see <http://www.bpmn.org>.

The BPMN 2.0 flow objects described in this appendix are organized by the different types of tasks your business process must perform.

- [Defining the Start and End Point of a Process](#)
- [Adding User Interaction to Your Process](#)
- [Communicating With Other Processes and Services](#)
- [Adding Business Logic Using Oracle Business Rules](#)
- [Controlling Process Flow Using Sequence Flows](#)
- [Controlling Process Flow Using Gateways](#)
- [Controlling Process Flow Using Intermediate Events](#)
- [Using Subprocesses in Oracle BPM](#)
- [Changing the Value of Data Objects in Your Process](#)

Defining the Start and End Point of a Process

Start events are BPMN flow objects that define the starting point of a process. End events, in contrast, define the end point of a process.

This section describes the BPMN 2.0 flow objects that define the start and end of a process.

Introduction to Start and End Events

Start events are BPMN flow objects that define the starting point of a process. There are different types of start events that determine how process instances are created.

End events, in contrast, define the end point of a process. There are different types of end events that determine what happens when the process instance is completed.

 **Note:**

In Oracle BPM, all BPMN processes must have at least one start and one end event.

Because start events define the beginning of a process, they do not have incoming sequence flows. Likewise, end events cannot have outgoing sequence flows.

However, except for the none end and start events, start and end events can have input to and output from other business processes and services.

Specifying the Start Events for Different Types of Processes

When you create a new process, Oracle Business Process Composer creates a message start and message end event by default. You can change these defaults depending on the type of business process you want to create. [Table A-1](#) shows the default start and end events for each type of process.

Table A-1 Start and End Events for Each Process Type

Process Type	Default Start and End Event Types
Asynchronous service	Message start and end event
Synchronous service	Message start and end event
Manual process	None start and end event

See [Introduction to Business Processes](#) for more information on the different types of processes supported by Oracle BPM.

Subprocesses contain none start and end events by default. These are the required start and end events and cannot be changed.

Event subprocesses contain a message start and none end event by default. However, you can change the start event to reflect the type of event you are handling.

Using Multiple Start Events in a Process

You can define multiple start points in a BPMN process. Multiple start points allow you to specify multiple ways of creating a process instance, depending on which start event is used.

[Figure A-1](#) shows an example process that contains both a message start and timer start event.

Figure A-1 Using Multiple Start Events within a Process

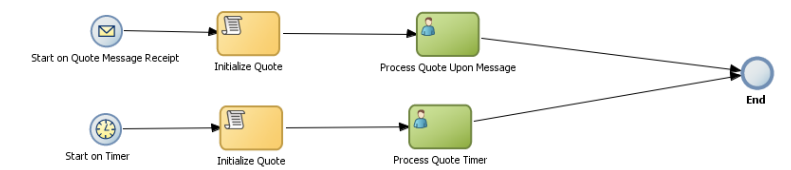

This process can be invoked using a message event when called from another process or service. It can also be started based on a time interval, invoking the timer start event, if the process instance must be created automatically.

Using multiple start events allows you to have multiple ways of starting a process without having to create two separate processes.

Using Multiple End Events in a Process

End events mark the end of a process path. When you have only one end event in your process and the token reaches the end event, the process is stopped when the end event is reached.

 **Note:**

Message end events can only be used to terminate processes initiated by a message start event. Additionally, if you have multiple message end events associated with a message start event, each of these message end events must have the same quantity and type of output arguments.

When using multiple end events, it is possible for different tokens to take different paths within a process. In typical cases, all parallel paths must reach an end event before the process is completed.

However, in the following special cases, a process instance can be stopped before all process paths have completed:

- **Error end event:** When an error end event is reached, all process activity is stopped. Like the error throw event, the error end event stops the flow of a process. See [Introduction to the Error End Event](#) for more information.
- **Terminate end event:** The terminate end event causes all work on a process to stop immediately. There is no error handling or other clean up of the running process. See [Introduction to the Terminate End Event](#) for more information.

Defining How a Process Instance is Triggered

Oracle BPM supports the following ways of triggering a process instance:

- Using a message, signal, or timer start event.
See the following sections for more information:
 - [Introduction to the Message Start Event](#)
 - [Introduction to the Signal Start Event](#)
 - [Introduction to the Timer Start Event](#)
- Using a none start event followed by a receive task.
The receive task must be configured to create a process instance. See [Introduction to the Receive Task](#) for more information.
- Using a none start event followed by a user task defined with the initiator pattern.
See [Introduction to the User Task](#) for more information.
- Using an event-based gateway that is configured to create a new process instance.
See [Using Guided Business Processes to Create Project Milestones](#) for more information.

Introduction to the None Start Event

Use the none start event when no instance trigger is specifically defined. The none start event can be used as a placeholder when the required start event of a process is unknown, not yet defined, or implemented later by process developers.

[Figure A-2](#) shows the default notation for the none start event

Figure A-2 The None Start Event



None start events also specify the beginning of a process where the process instance is created by another flow object. In general, the none start event does not trigger a new process instance.

However, when used with the following, the none start event does trigger a new process instance:

- **Receive task:** The receive task must have the Create Instance property set to true.
- **User task:** The user task implemented with the initiator pattern

Similar to other start events, the none start event cannot have incoming sequence flows. It can only have default out-going sequence flows.



Note:

None events are always used to define the beginning of subprocesses.

The None Start Event in Context

Figure A-3 shows an example of the none start event within the Sales Quote example project. In this example, the none start event defines the start of the process. Additionally, since the process contains a user task implemented with the initiator pattern, the none start event triggers a process instance.

Figure A-3 The None Start Event within the Sales Quote Example Process

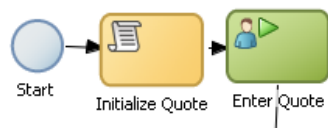

Data Associations

The none start event does not accept process input arguments.

Introduction to the Message Start Event

The message start event triggers a process instance when a message is received. This message can be sent from another BPMN or BPEL process or from a service.

Messages are types of data used to exchange information between processes. Just as data objects are used to define the data used within a project, messages are used to define the data used between processes or between a process and a service.

Figure A-4 shows the default notation of the message start event.

Figure A-4 The Message Start Event



Similar to other start events, the message start event cannot have incoming sequence flows. Message start events require a default outgoing sequence flow.

You can expose a BPMN process as a service that allows other processes and applications to invoke the process. To expose a process as a service, your process must begin with a message start event. Additionally, you must define the input arguments to the process, which are the data objects passed to the message start event. See [Defining Process Input and Output](#) for more information.

The Message Start Event in Context

[Figure A-5](#) shows a modified version of the Sales Quote process. Here, the process begins with a message start event that initiates the process instance.

Figure A-5 Message Start Event Within the Sales Quote Example Process

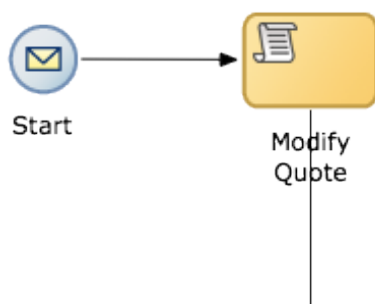

Using Process Input and Output Arguments

The message start event allows you to specify input and output arguments to a process. These arguments define the message that other processes or services must send to the process during invocation. See [Defining Process Input and Output](#) for information on how to configure process input and output arguments.

Introduction to the Signal Start Event

The signal start event is similar to a message start event in that it is based on communication from another process or service. However, the message start event responds to a message sent to a specific process. In contrast, the signal start event is a response to a signal broadcast to multiple processes.

Signals can be broadcast from a BPMN process using the signal throw event. Using a combination of signal throw events and signal start events, you can invoke multiple processes simultaneously.

The signal start and throw events are added to a process by process developers. For information on implementing the signal throw event, see "Introduction to Communicating

Between Processes Using Signal Events" in the *Developing Business Processes with Oracle Business Process Management Studio*.

Figure A-6 shows the default notation for the signal start event.

Figure A-6 The Signal Start Event



The Signal Start Event in Context

The signal start and throw events are added to a process and implemented by process developers.

Introduction to the Timer Start Event

The timer start event triggers the creation of a process instance based on a specific time condition. You can configure the timer start event to trigger a process instance based on the following:

- A specific date and time.
For example, a process could be triggered on December 31, at 11:59 P.M.
- A recurring interval.
For example, a process could be triggered every 10 hours, 5 minutes, 32 seconds.

Figure A-7 shows the default notation for the timer start event.

Figure A-7 The Timer Start Event



Introduction to the Error Start Event

The error start event is used as the start event of an inline handler. Using inline handlers you can define a separate process flow to handle errors that occur within your process.

Figure A-8 shows the default notation for the none end event.

Figure A-8 The Error Start Event





Note:

Error start events can only be used within inline handlers. They cannot be used within normal process flows.

You can define multiple inline handlers to handle error conditions. However, you cannot define multiple inline handlers that use the same exception.

Introduction to the None End Event

The none end event is used to mark the end of a process path. When a token reaches a none end event, it is consumed. If there are no other tokens within the process instance, the instance is complete.

The none event is used when your process is not required to perform any action after it completes. It can also be used as a placeholder by process analysts, to be changed later during implementation by a process developer.

Figure A-9 shows the default notation for the none end event.

Figure A-9 The None End Event



The none end event is always used to mark the end of a subprocess and event subprocess.

The None End Event in Context

Figure A-10 shows an example of the none end event within the Sales Quote example. In this example, the Sales Quote service task is used to save information about the sales quote to a database.

Figure A-10 The None End Event Within the Sales Quote Example



Because no other work can be performed when the token reaches the end of a process, a none end event is used. After all process tokens reach the none end event, the process instance completes.

Introduction to the Error End Event

The end error event is used when the end of a process is the result of an error condition.

Errors end events are typically used with the error boundary event. The error boundary event is used to change the process flow based on a specific error. This flow usually ends using an

error end event. See [Introduction to the Error Catch Event](#) for more information on using the error intermediate event.

[Figure A-11](#) shows the default notation for the error end event.

Figure A-11 The Error End Event



For more information, see the *Throwing Exceptions in Subprocesses or Reusable Processes in Developing Business Processes with Oracle Business Process Management Studio*.

Introduction to the Message End Event

The message end event is used to send a message to another process or service when the process is completed. The message end event is always used with either a message start event or message catch event.



Note:

When creating a process that has multiple end events, you must ensure that any tokens that reach a message end event were created by a message start event. For example, you cannot use a message end event to end a process instance initiated by a timer start event.

[Figure A-12](#) shows the default notation for the message end event.

Figure A-12 The Message End Event



For information on how to configure process output arguments using message end events, see [Defining Process Input and Output](#).

Introduction to the Terminate End Event

The terminate end event is used to immediately stop a process. When a terminate end event is reached, the process stops immediately. There is no error handling or additional cleanup performed.

Adding User Interaction to Your Process

Many business applications require interaction from process participants within your organization. This interaction can be as simple as entering information into a form or can involve multiple work flows and multiple users.

This section describes the BPMN 2.0 flow objects that are used to model how process participants interact with your business processes. It contains the following sections:

- [Introduction to Human Workflow](#)
- [Introduction to the User Task](#)
- [Introduction to the Manual Task](#)

Introduction to Human Workflow

Many end-to-end business processes require manual interaction with the process. For example, users may be required for approvals, exception management, or performing activities required to advance the business process.

Oracle Human Workflow provides comprehensive support for user participation by providing the following features:

- Manual interactions with processes, including assignment and routing of tasks to the correct users or groups
- Deadlines, escalations, notifications, and other features required for ensuring the timely performance of a task.
- Organization, filtering, prioritization, and other features required for process participants to productively perform their tasks.
- Reports, reassignments, load balancing, and other features required by supervisors and business owners to manage the performance of tasks.

For more information, see *Getting Started with Human Workflow* in the *Developing SOA Applications with Oracle SOA Suite*.

Introduction to Human Tasks

Human tasks are a component of Oracle Human Workflow. Human tasks allow you to interleave manual interactions with connectivity to systems and services within an end-to-end process flow. Human tasks are responsible for handling all interactions with users or groups participating in the business process. They do this by creating and tracking tasks for the appropriate users in the organization. Users typically access tasks through a variety of clients, including the worklist application, e-mail, portals, or custom applications.

Human tasks allow process developers to define how process participants interact with process-based applications created using Oracle BPM Suite and Oracle Service-Oriented Architecture (SOA) Suite.

Using human tasks, process developers can define the interface and workflow for end user interaction by creating the following:

- Roles and assignments
- Deadlines and escalations
- Presentations

Human tasks are reusable services that can be used within other processes that require the same UI. Human tasks are created using Oracle BPM Studio.

Introduction to the User Task

The user task represents a part of your process where a process participant is required to perform work. This can be a simple interaction, such as entering a form, or part of a more complicated workflow that requires input from multiple process participants.

Figure A-13 shows the default notation for the user task.

Figure A-13 The User Task



In the Oracle BPM Suite, process participants interact with your business application using the Process Workspace. The specific user interface elements, including the screens and panels that process what participants see, are created using human tasks.

When designing a process, process analysts often add the user task to a process diagram. Process developers then create the necessary human tasks and implement them as part of creating the overall process-based business application.

When a token reaches a user task, the corresponding human task is performed. The token waits until the human task is completed before continuing to the next flow object.

For information about implementing user tasks, see "Using Human Tasks" in the *Developing Business Processes with Oracle Business Process Management Studio*.

Similar to other flow objects, the user task may contain incoming and outgoing data associations.

User tasks may also contain incoming and default outgoing sequence flows.

The User Task in Context

In the Sales Quote example, the Enter Quote task, shown in Figure A-14, represents entering information about the quote.

Figure A-14 The Enter Quote User Task

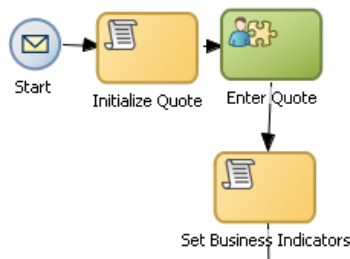

After the user enters information about the sales quote, the process flow passes through the outgoing sequence flow to the next flow object in the process.

Using Interactive Activities

Oracle BPM Studio allows you to add interactive activities to a process directly from the component palette. Interactive activities are short cuts based on the task routing and approval features of Oracle Human Workflow. See "Getting Started with Human Workflow" in *Developing SOA Applications with Oracle SOA Suite* for more information.

Table A-2 shows the interactive activities that are available in the Oracle Business Process Composer component palette.

Table A-2 Interactive Activities

Pattern	Description
Complex	Uses a complex routing flow that is defined within the human task.
Management	Uses the management chain pattern where the assignee is set to the management chain pattern for the process participant belonging to the group or role assigned to the swimlane.
FYI	Bases assignment on the participant, role, or group defined in the swimlane. Similar to the user interactive activity, but the FYI activity does not wait until completion before continuing.
Group	Uses the group vote pattern. The assignee for the task is automatically set to the role or group associated with the lane. This interactive activity can only be added to swimlanes that are assigned to roles or groups.
Initiator	The initiator pattern is used to create a process instance.

Introduction to the Manual Task

The manual task represents a task performed by process participants that is outside the scope of Oracle BPM. Manual tasks are used as placeholders within your process to show work that is not managed by the BPMN service engine at runtime. Additionally, manual tasks do not appear in the Process Workspace application.



Note:

Manual tasks are not managed by Oracle BPM. The Oracle BPM runtime does not track the start and completion of the manual task.

Figure A-15 shows the default notation for the manual task.

Figure A-15 The Manual Task



Manual tasks can only have one default incoming and one default outgoing sequence flow.

Unlike most BPMN 2.0 flow objects, the manual task does not allow you to manipulate data objects. Data objects associated with the previous flow element are passed through as is to the next flow element.

The Manual Task in Context

In the context of the Sales Quote example, a manual task can be added for printing and signing a copy of a formal contract as shown in [Figure A-16](#).

Figure A-16 Example of a Manual Task

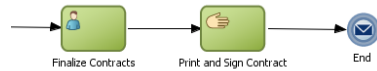

In this example, signing the formal contract is something that you may want to explicitly show as part of your business process. However, because it is not managed by the BPMN Service Engine, a manual task is used.

Introduction to the Update Task

The update task is used to perform an operation on one or more Human Tasks. For example, you can use the update task to perform actions like reassigning a task to another user.

[Figure A-17](#) shows the default notation for the update task.

Figure A-17 The Update Task



Communicating With Other Processes and Services

Oracle BPM allows you to define interactions across business processes within a process-oriented application. The following sections describe the BPMN flow objects used to model communication between processes.

This section describes how to use these flow objects to create process models using Oracle Business Process Composer. For information on how to implement these flow objects within a process-based application, see *Developing Business Processes with Oracle Business Process Management Studio*.

Introduction to the Service Task

The service task allows you to communicate with other processes and services. Process analysts can add the service task when they know that a process must invoke an external service or process.

Process developers can then implement the necessary services. You can use the service task to invoke the following:

- Other BPMN processes

- BPEL processes
- SOA service adapters
- Mediators that are exposed as services

The service task has similar behavior to the send and receive task pair and the message throw and catch event pair. The primary difference is that the service task is used to invoke processes and services synchronously. When the service task invokes a process or service, the token waits at the service task until a response is returned. After the response is received, the token continues to the next sequence flow in the process.

See "Using Service Tasks to Invoke Synchronous Operations in Services and BPMN Processes" in *Developing Business Processes with Oracle Business Process Management Studio* for more information on how to implement the service task with these types of processes and services.

Figure A-18 shows the default notation for the service task.

Figure A-18 The Service Task



The Service Task in Context

Figure A-19 shows an example of the service task used to save the finalized sales quote to a database.

Figure A-19 The Service Task within the Sales Quote Example Process

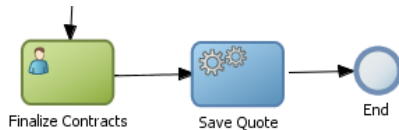

Introduction to the Notification Task

The notification task is similar to the service task. It uses a predefined service to perform different types of notification. You can use expressions to determine the users or groups who receive notifications generated by the notification task.

These different types of notification are:

- **IM:** Send an instant message to a user or group.

Figure A-20 shows the default notation of the IM notification task.

Figure A-20 The Instant Message Notification Task



- **Email:** Sends an email a user or group.
You can also include email attachments. [Figure A-21](#) shows the default notation of the email notification task

Figure A-21 The Email Notification Task



- **SMS:** Sends an SMS message to a user.
[Figure A-22](#) shows the default notation of the SMS notification task

Figure A-22 The SMS Notification Task



- **User:** Sends a notification to a user based on the available notification types.
For example, if a user has both SMS email configured, the notification task sends both. [Figure A-23](#) shows the default notation of the User notification task.

Figure A-23 The User Notification Task



Introduction to the Call Activity

The call activity allows you to call a reusable process from within the current process. The process being called becomes a child process of the calling process. When calling a reusable process, the call activity of the parent process waits until the child process completes before continuing.

[Figure A-24](#) shows the default notation for the call activity.

Figure A-24 The Call Activity



See [Introduction to Reusable Processes \(Reusable Subprocesses\)](#) for more information.

Data objects of the parent process are not automatically available to the reusable process. Data objects must be passed to and from the child process using argument mapping of the call activity.

Introduction to the Send Task

The send task sends a message to a system or process outside the current process. After this message is sent, the task is complete and the running of the process continues to the next task in the process flow.

The send task is frequently paired with the receive task to invoke a process or service and receive a response in return. The send and receive tasks are used to invoke processes and services asynchronously. If you are invoking a process or service synchronously, use the service task.

 **Note:**

The send and receive tasks perform functions similar to the throw and catch message events. However, you cannot use the send task to invoke a process that is initiated with a message start event.

Figure A-25 shows the default notation for the send task.

Figure A-25 The Send Task



For information on implementing the send task to invoke a process or service, see "Using Send and Receive Tasks to Define a Synchronous Operation in a BPMN Process" in *Developing Business Processes with Oracle Business Process Management Studio*.

For information about using the send and received tasks to communicate between processes, see [Using the Send and Receive Tasks to Communicate Between Processes](#).

Introduction to the Receive Task

In contrast to the send task, the receive task waits for a message from a system or process outside the current process. After this message is received, the task is complete and the running of the process continues to the next task in the process flow.

Figure A-26 shows the default notation for the receive task.

Figure A-26 The Receive Task



For information about implementing the send task to invoke a process or service, see "Using Send and Receive Tasks to Define a Synchronous Operation in a BPMN Process" in *Developing Business Processes with Oracle Business Process Management Studio*.

For information about using the send and receive tasks to communicate between processes, see [Using the Send and Receive Tasks to Communicate Between Processes](#).

Starting a Process with the Receive Task

You can use the receive task to trigger the start of a process. This is useful when you want to invoke a process from another process using a send task.

To start a process using the receive task, the following conditions must be met:

- The receive task is preceded by a none start event.
- Your process does not contain any other start events.
- The Create Instance property is enabled.

Introduction to the Message Throw Event

The message throw event allows you to send a message to another process or service.

[Figure A-27](#) shows the default notation for the message throw event.

Figure A-27 The Message Throw Event



The throw message event is used to invoke the following types of processes and services:

- Other BPMN processes
- BPEL processes
- SOA service adapters
- Mediators that are exposed as services

Process analysts may add message throw events to a process to define where a process must invoke another process or service. However, process developers are typically responsible for implementing the connectivity with other processes. Additionally, they are typically responsible for creating and implementing the services invoked by the message throw event.

For information about how to implement message throw events, see "Communicating With Other BPMN Processes and Services Using Message Events" in *Developing Business Processes with Oracle Business Process Management Studio*.

Message throw events are often used to invoke other BPMN processes by calling the message start event of another process. See [Introduction to the Message Start Event](#) for more information.

Message throw events are also frequently used with message catch events to receive a response from the process or service invoked. However, they are always used asynchronously. After the message throw event sends a message to another process or service, the token immediately moves to the next flow object of the process.

If your process receives a response synchronously, use the service task to invoke the process or service. See [Introduction to the Service Task](#) for more information.



Note:

The send and receive tasks perform functions similar to the throw and catch message events. However, you cannot use the message throw event to invoke a process that is initiated with a message receive task.

Introduction to the Message Catch Event

The message catch intermediate event allows you to receive a message from another process or service.

[Figure A-28](#) shows the default notation for the message catch event.

Figure A-28 The Message Catch Event



The message catch event is frequently used with the message throw event to communicate with another BPMN process. See [Using Message Throw and Catch Events to Communicate Between Processes](#) for information on how message throw events with message catch event.

For information about how to implement message throw events, see "Communicating With Other BPMN Processes and Services Using Message Events" in *Developing Business Processes with Oracle Business Process Management Studio*.

Adding Business Logic Using Oracle Business Rules

This section describes how to use the business rule task to incorporate Oracle Business Rules within your business processes.

For information about working with Oracle Business Rules using Oracle Business Process Composer, see [Using Oracle Business Rules](#).

Introduction to Oracle Business Rules

Business rules are statements that describe business policies or describe key business decisions.

Introduction to the Business Rule Task

The business rule task allows you to incorporate Oracle Business Rules within your process.

[Figure A-29](#) shows the default notation for the business rule task.

Figure A-29 The Business Rule Task



There are two primary use cases for incorporating Oracle Business Rules within your business process.

- Using structural rules

Structural rules allow you to perform calculations used within your business process. For example, you can use a business rule to calculate a credit score.

- Using operative rules

Operative rules are used to make changes to the flow of your process. A typical use of an operative rule is to perform a check of the rule conditions within the rules catalog. Then, as part of the output data association, assign a value to a data object using an expression.

In this scenario, the business rule task is immediately followed by a gateway that is used to branch the process path according to the value of the data object.

for information about how an operation rule is used, see [The Business Rule Task in Context](#).

The Business Rule Task in Context

[Figure A-30](#) shows an example of the business rule task within the Sales Quote example.

Figure A-30 The Business Rule Task within the Sales Quote Example Process

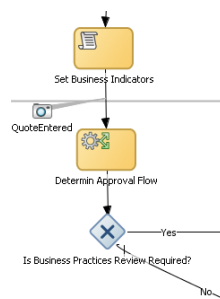

Controlling Process Flow Using Sequence Flows

Sequence flows define the order or sequence that work is performed within a process. Sequence flows connect the flow objects within your process and determine the path a process token follows through your process.

This section describes how to use sequence flows to define the behavior of your business process.

Introduction to Sequence Flows

Incoming sequence flows are the sequence flows that lead into a flow object. Outgoing sequence flows are the sequence flows that determine the process path out of a flow object.

Most flow objects contain both incoming and outgoing sequence flows. Exceptions to this are start and end events. Start events can only contain outgoing sequence flows. End events can only contain incoming sequence flows. Additionally, event subprocesses do not have either incoming or outgoing sequence flows.

Introduction to Unconditional Sequence Flows

Unconditional sequence flows represent the typical path between two flow objects. Default sequence flows are displayed as a line with an arrow as shown in [Figure A-31](#).

Figure A-31 The Unconditional Sequence Flow



Most flow objects can contain only one default outgoing sequence flow. Only parallel gateways can contain multiple unconditional sequence flows, which represent the parallel paths of your process.

Exclusive, inclusive, and conditional gateways cannot have unconditional outgoing sequence flows. These gateways use conditional and default sequence flows to determine the flow of your process.

Introduction to Conditional Sequence Flows

Conditional sequence flows are used to control the flow of a process based on certain conditions. Like unconditional sequence flows, conditional sequence flows are displayed by an arrowed line.

[Figure A-32](#) shows two outgoing conditional sequence flows and a default sequence flow.

Figure A-32 Conditional and Default Sequence Flows

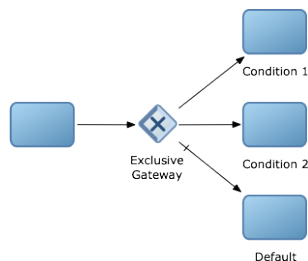

Not all flow objects can use outgoing conditional sequence flows. Only the following types of gateways can have outgoing conditional sequence flows:

- Exclusive gateways
- Inclusive gateway (split)

The conditions used within a conditional sequence flow are defined using expressions. For information about using the expression editor to define expressions, see [Using Expressions to Control Data](#).

Introduction to Default Sequence Flows

Like conditional sequence flows, default sequence flows are used as outgoing sequence flows to exclusive, inclusive, and conditional gateways. Default sequence flows represent the path your process takes out of these gateways when none of the conditions evaluate to true.

Default sequence flows are represented by an arrow with a tic mark on one end, as shown in [Figure A-32](#).

Controlling Process Flow Using Gateways

Gateways are flow elements that define the flow of your process. Gateways determine the path a token takes through a process. They define control points within your process by splitting and merging paths.

This section describes how to use gateways to control process flow and behavior.

Introduction to Gateways

Gateways define control points within your process by splitting and merging paths. When possible, gateways are used for paths that are exceptions to or deviate from the default path of the process.

Split-Merge Pairs

The following gateways require a split-merge pair:

- Parallel gateway
- Inclusive gateway
- Complex gateway

When you add one of these gateways to a BPMN process, Oracle BPM Studio automatically creates the split and merge flow objects.

Although the merge portion of the gateway is required, you do not have to ensure that all paths out of the split return to the merge.

Although it is possible to have process paths that split at a gateway without merging through the gateway, this is not usually good practice. For more details on the merge behavior of gateways, see the following sections for each gateway type.

**Note:**

If you delete the merge gateway from a process, the corresponding split gateway is also deleted.

Introduction to the Exclusive Gateway

The exclusive gateway allows you to split your process into two or more paths. However, the process only continues down one of these paths even if multiple outgoing sequence flows are present. Exclusive gateways can have conditional outgoing sequence flows and must have at least one default outgoing sequence flow.

You can define expressions that are used to determine if your process continues down a conditional sequence flow. See [Using Expressions to Control Data](#) for more information.

If your process has multiple outgoing sequence flows for an exclusive gateway, you can define the order in which they are evaluated. The order of evaluation is configured in the properties of the exclusive gateway.

If you have an exclusive gateway where more than one conditional sequence flow evaluates to true, the process continues down the first conditional sequence flow determined by this order.

Unlike other gateways, the exclusive gateway does not require a corresponding merge to be explicitly defined in your process after splitting.

Figure A-33 shows the default notation for the exclusive gateway.

Figure A-33 The Exclusive Gateway



The Exclusive Gateway in Context

Figure A-34 shows an example of the exclusive gateway used within the Sale Quote example. Here, the exclusive gateway is used to evaluate whether a review of business practices is required.

Figure A-34 The Exclusive Gateway within the Sales Quote Example Process

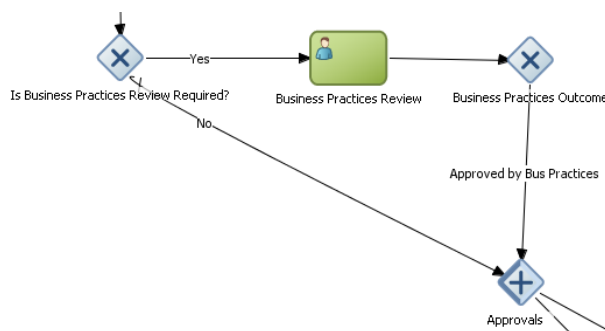

This evaluation is determined by the expression defined for the outgoing conditional sequence flow. If this evaluates to true, then the process flow proceeds down the Yes path. If it evaluates to false, then the process flow proceeds down the path of the default outgoing sequence flow.

Splitting and Merging Exclusive Gateways

When a token reaches an exclusive gateway the outgoing conditional sequence flows are evaluated until one of them evaluates to be true. You can define the specific order in which these are evaluated by configuring a property for the exclusive gateway. Based on this configuration, when the first conditional sequence flow evaluates to true, the token moves down this outgoing sequence flow to the next flow object. If you have multiple outgoing conditional sequence flows, you can determine the order in which they are evaluated. If none of the outgoing conditional sequence flows evaluate to true, then the token moves down the default outgoing sequence flow. Therefore, you must define a default outgoing sequence flow for the exclusive gateway.

The exclusive gateway can also merge incoming sequence flows. However, there is no synchronization with other tokens that may be coming from other paths within the process flow.

 **Note:**

If other tokens arrive at an exclusive gateway merge, then they are also passed through as is. If you are synchronizing tokens or perform evaluations on incoming sequence flows, you should use a different type of gateway.

Introduction to the Inclusive Gateway

The inclusive gateway allows you to split your process into two or more paths. Unlike the exclusive gateway, however, a token may flow down one or more of these paths depending on how the outgoing conditional sequence flows are evaluated.

You must define at least one default sequence flow for the inclusive gateway split. You can have multiple outgoing conditional sequence flows for an inclusive gateway split. The token proceeds along only those sequence flows that evaluate to true. If none of the sequence flows evaluate to true, then the token passes along the default sequence flow.

Figure A-35 shows the default notation for the inclusive gateway split.

Figure A-35 The Inclusive Gateway (Split)



Figure A-36 shows the default notation for the inclusive gateway merge.

Figure A-36 The Inclusive Gateway (Merge)



Splitting and Merging Inclusive Gateways

The inclusive gateway splits a process similar to the exclusive gateway, but allows tokens to proceed down multiple outgoing sequence flows. When a token arrives at an inclusive gateway, the expressions of its conditional sequence flows are evaluated.

Next, a token is generated for each of the conditional sequence flows that evaluate to true. A token is generated for the default sequence flow only if none of the conditional sequence flows evaluate to true.

These tokens are joined at the merge of the inclusive gateway. When a token reaches the merge gateway, it waits until all of the tokens generated by the split have reached the merge. After all of the tokens have reached the merge of the inclusive gateway, the merge is complete, and the token continues to the next sequence flow after the gateway.

Introduction to the Parallel Gateway

The parallel gateway allows you to split your process into two or more paths when you want your process flow to follow all paths simultaneously. The parallel gateway is useful when your process must perform multiple tasks in parallel.

Figure A-37 shows the default notation for the parallel gateway split.

Figure A-37 The Parallel Gateway (Split)



Figure A-38 shows the default notation for the parallel gateway merge.

Figure A-38 The Parallel Gateway (Merge)



The Parallel Gateway in Context

The Sales Quote example uses a parallel gateway during the approval stage of the process. Figure A-39 shows how the parallel gateway is used to perform two process paths simultaneously.

Figure A-39 Example of a Parallel Gateway

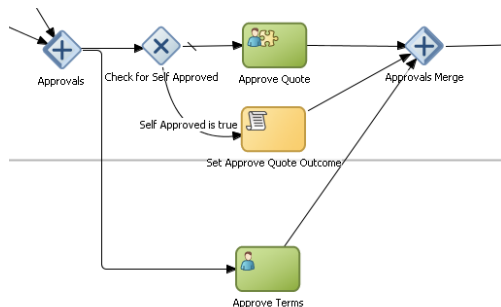

In this example, two different process paths are executed at the same time.

Splitting and Merging Parallel Gateways

When a token reaches a parallel gateway, the parallel gateway creates a token for each outgoing sequence flow. The split of the parallel gateway does not evaluate outgoing sequence flows.

You can also use the parallel gateway to merge process paths split by the parallel gateway. The merge of the parallel gateway waits for a token to arrive from each of the incoming

sequence flows. After all tokens arrive, only one token is passed to the outgoing sequence flow.

 **Note:**

Design your process so that a token arrives for each incoming sequence flow for the merging parallel gateway. If you do not, your process can freeze if the merge is expecting tokens that do not arrive.

Introduction to the Complex Gateway

The complex gateway splits a process similar to an inclusive gateway. However, it allows you to define an activation condition that determines if the instance can continue even if not all of the tokens have arrived at the complex gateway merge.

For example, you can configure a complex gateway to continue after two or more tokens have arrived. If only two out of the possible conditions in the inclusive gateway evaluate to true the process instance continues to the next activity. However, because the inclusive gateway immediately evaluates all the conditional sequence flows, all of the flow objects in these process paths are also run.

Figure A-40 shows the default notation for the complex gateway split.

Figure A-40 The Complex Gateway (Split)



Figure A-41 shows the default notation for the complex gateway merge.

Figure A-41 The Complex Gateway (Merge)



Introduction to the Event-Based Gateway

The event-based gateway allows you to branch your process flow based on the possibility that an event may occur. Depending on the context, this may be one of several types of events.

The event-based gateway allows you to anticipate the possibility that several types of events may occur at a specific point in your process. It is similar to the exclusive gateway, but instead of choosing a path based on expressions, the event-based gateway chooses a path based on the occurrence of an event within your process.

For example, in an order processing process, you may reach a point in your process when there is no stock currently available. The process may have to wait until stock is available, but cannot wait indefinitely. By using an event-based gateway, your process can wait for a message saying new stock has been received (using a message catch event) or it can

continue if no message is received after a certain amount of time has passed (using a timer event).

Figure A-42 shows the default notation for the event-based gateway.

Figure A-42 The Event-based Gateway



The event-based gateway is different from other gateways in that decisions about process flow are based on an event rather than data-specific conditions.

The event-based gateway is composed of the following:

- The event-based gateway
- Two or more target events

These can be of the following types:

- Message catch events

When initiating a process using a message catch event, the process must be invoked using a message throw event.

- Timer catch events

Generally only one timer event is used following an event-based gateway.

- Receive tasks

You can use the receive task to initiate a process instance following an event-based gateway. However the process must be invoked from a send task within the calling process.

Note:

You cannot mix message events and receive tasks within the same event-based gateway.

The target elements can only have incoming sequence flows from the event-based gateway. They cannot have sequence flows from other parts of the process. Although the event-based gateway allows you to plan that multiple events may occur in your process, within the process instance, only one event is triggered. When the first event in the event-based gateway is triggered, the path that comes after that event is followed.

When you add an event-based gateway to a process, by default it is created with a timer and message catch event.

Note:

If you delete an event-based gateway, any outgoing sequence flows are also deleted. The associated events are not deleted.

Starting a Process with an Event-Based Gateway

You can also use an event-based gateway at the beginning of a process to create a new process instance. This is similar to having multiple start events within a process.

To allow an event-based gateway to create a new process instance, you must ensure the following:

- You have enabled the Initiate property of the event-based gateway.
- There are no incoming sequence flows to the event-based gateway.

Although the event-based gateway can be used to create a new process instance, it does not accept data input from another process. Any data that must be passed to the process instance must be configured using the target events.

Controlling Process Flow Using Intermediate Events

Unlike start and stop events, intermediate events occur during the flow of your process.

This section describes intermediate events and describes how to use them to control the flow and behavior of your process.

Introduction to Intermediate Events

There are two types of intermediate events:

- Normal flow events

Normal flow events occur within the typical flow of your process.

- Boundary events

Boundary events trigger an interruption with your process. Boundary events are associated with flow objects and can be configured to interrupt their usual behavior.

Boundary events behave similar to sequence flows in that they are used to determine the path a process takes between flow objects.

Boundary events can be divided into two types: interrupting and non interrupting.

Introduction to the Timer Catch Event

Timer catch events allow you to control the flow of your process using a time condition. Possible uses of the time catch event include:

- Creating a delay before running an activity
- Configuring a deadline for an activity
- Configuring a deadline for a process
- Triggering additional activities after an elapsed time

[Figure A-43](#) shows the default notation for the timer catch event.

Figure A-43 The Timer Catch Event



You can use timer events as boundary events on an activity. Timer events can be defined as either interrupting or non interrupting boundary events.

When an interrupting timer event fires, the token leaves the main process flow to follow the flow the timer event defines. The flow that an interrupting timer event defines can return directly to the main process flow.

When a non interrupting event fires, a copy of the token is created and passes through the flow the timer event defines. The flow that a non interrupting event defines cannot return to the main process flow.

Introduction to the Error Catch Event

Error catch events are intermediate events used to handle an error that occurs within your process flow.



Note:

You can also use inline handlers to handle error conditions that occur within your process.

Error catch events are always used as boundary events and can be attached to the following:

- Service Tasks
- Call Activities
- User Tasks
- Send Tasks
- Receive Tasks
- Script Tasks
- Rules Tasks
- Subprocesses

Error catch events are always interrupting, meaning that they interrupt the usual flow of a process.

Figure A-44 shows the default notation for the error catch event attached as a boundary event on a service task.

Figure A-44 The Error Catch Event as a Boundary Event on a Service Task



When a service or process fails with an error, the error catch event is triggered. This causes the process flow to follow the path of the outgoing sequence flow of the error catch event.

You can use this flow to define how you handle the error. This is handled in two ways:

- The process flow returns to the main process flow.

Any work that must be performed is handled within the error process flow before returning to the main flow.

 **Note:**

If the boundary event is non-interrupting, the boundary flow cannot return to the main flow.

- The process flow continues to an end event.

The process is stopped immediately. Process control is returned to the service or process that initiated the process.

Using Subprocesses in Oracle BPM

You can use subprocesses to organize your business processes. Subprocesses allow you to group functional areas of your process together and also make your processes more readable.

Oracle BPM supports the following types of subprocesses:

- Reusable processes
- Embedded (also called inline) subprocesses
- Event subprocesses (also called inline handlers)

Introduction to Reusable Processes (Reusable Subprocesses)

Oracle BPM supports a type of process called reusable process. In BPMN terminology, this is sometimes referred to as a reusable subprocess. Reusable processes allow you to create processes that can be called from other BPMN processes.

Reusable processes allow you to create processes that can be called from other BPMN processes. For example, all your processes may have to charge a credit card, so you can create a charge credit card reusable subprocess

Reusable processes have the following characteristics:

- Must start with one none start event.
- Can contain multiple end events.
- Can only be called by other BPMN processes.

Introduction to Embedded Subprocesses (Inline Subprocesses)

Embedded subprocesses allow you to group BPMN flow objects together to make your process more readable. In Oracle BPM, subprocesses are embedded subprocesses. Subprocesses are contained as part of the parent subprocess. Embedded subprocesses must begin with a start none event and must end with a none end event.

Embedded subprocesses can be expanded or collapsed. [Figure A-45](#) shows how a collapsed subprocess appears within a process.

Figure A-45 Example of a Collapsed Embedded Subprocess



Figure A-46 shows how an expanded embedded subprocess appears within a process. When an embedded subprocess is expanded, you can edit the flow objects within it. You can also click and drag the edge of the embedded subprocess window to make the window larger or smaller.

Figure A-46 Example of an Expanded Embedded Subprocess

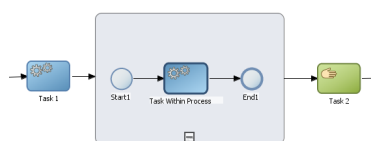

Similar to other types of processes, embedded subprocesses can have start and end events and contain a separate process flow. An embedded subprocess must begin with a none start event and end with a none end event. Embedded subprocesses cannot contain swimlanes.

Embedded subprocesses also behave similar to activities. They can have incoming and outgoing sequence flows. They also contain data associations that define the data objects used within the embedded subprocesses.

Embedded subprocesses can also contain timer, message, and error boundary events.

If necessary, your process can contain nested embedded subprocesses. However, use nested embedded subprocesses only when necessary to make your process more readable.

Embedded Subprocesses and Sequence Flows

The flow objects within an embedded subprocess cannot have sequence flows that connect to flow objects outside the subprocess.

Similar to other flow objects, embedded subprocesses have incoming and outgoing sequence flows.

Embedded Subprocesses in Context

Figure A-47 shows an example of a embedded subprocess. In this example, an embedded subprocess is used to group the service task used to process a sales quote.

Figure A-47 Example of an Embedded Subprocess

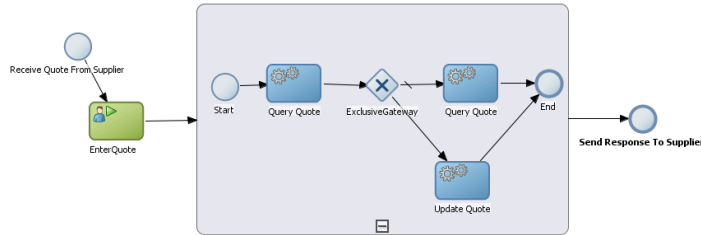

Looping Embedded Subprocesses

You can configure a subprocess to numerous times within the context of a process flow. This is something that a process analyst should consider when designing a process, but the implementation is performed by process developers.

Note:

Looping cannot be configured using Oracle Business Process Composer. You must use Oracle BPM Studio to configure the looping property of an embedded subprocess. See *Developing Business Processes with Oracle Business Process Management Studio* for more information.

Introduction to Event Subprocesses (Event Handlers)

An event subprocess are a type of subprocess that allows you to model possible conditions that happen outside of a normal process flow. Event subprocesses are also called event handlers.

Event subprocesses can have the following start events:

- Error start
- Timer start
- Message start

When you add an inline handler to your process, by default it is created with a message start event. You can change the type of start event if necessary.

Note:

Inline handlers can only contain one start event. However, you can have multiple inline handlers within your process.

Changing the Value of Data Objects in Your Process

This section describes how to use the script task to change the values of data objects within your process.

See [Working with Data Objects and Data Associations](#) for general information about data objects.

Introduction to the Script Task

The script task is used to change values of data objects within your process. The script task is used when you want to show this change explicitly within your business process or when you must change the values of data objects outside of another flow object. It is often used to set initial values of data objects at the beginning of a process.

[Figure A-48](#) shows the default notation for the script task.

Figure A-48 The Script Task



Script tasks are added to a process by process developers who are responsible for defining the behavior of data objects within a process and process-based application.

The Script Task in Context

[Figure A-49](#) shows two examples of the script task used at the beginning of the Sales Quote example. The Sales Quote example uses a script task to set initial values for data objects when the process instance is created and to set values for several business indicators.

Figure A-49 The Script Task within the Sales Quote Example

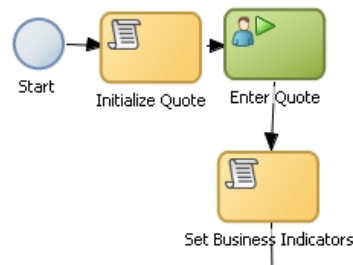

Project data objects are data objects that you define in a project. All processes within a project have access to the data object defined, though the value changes according to the process using them. In addition, the engine stores the value of those marked as business indicators to the process analytics databases if the project is configured to use them.

[Figure A-50](#) shows the data associations used to set initial values for the business indicators.

Figure A-50 Data Associations Used by the Set Business Indicators Script Task

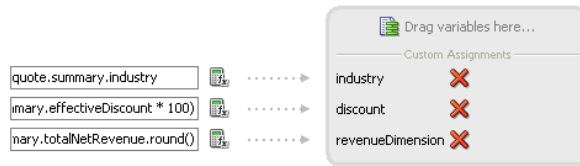

As with other flow objects that accept data associations, you can use expressions to change the values of data objects. [Figure A-51](#) shows how an expression is used to change the value of the discount project variable.

Figure A-51 Expression Used to Change the Value of Discount Project Variable

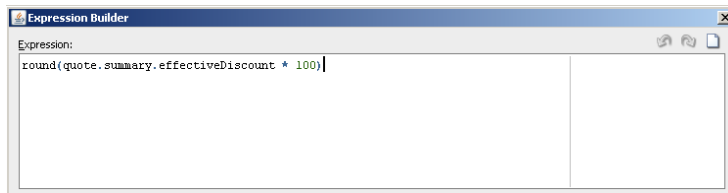

 **Note:**

If you implemented the script task using transformations using BPM Studio, they are not visible when opening the BPM project in Oracle Business Process Composer.

B

Web Form and Web Form Control Property Reference

Get an overview of the properties that are available for web forms and web form controls.

- [Web Form Properties](#)
- [Web Form Control Properties](#)

Web Form Properties

You can control the behavior and appearance of the web form by changing its properties.

Properties are edited using the properties editor which contains tabbed panes that group the web form properties by function.

Settings Tab

The properties listed in [Table B-1](#) are shown on the Properties control's Settings tab when a web form is selected in the designer.

Table B-1 Properties

Property	Description
Form Name	Defines the name of the form.
Description	<p>Provides a description of the web form. By default all forms use the description "Edit the form to change this description." Change this description to something specific to your form.</p> <p>The description appears as a tool tip when you mouse over the area just to the right of the form's share icon in the forms editor. The description is also visible when you view individual submission documents.</p>
Element Name	<p>Specifies the root element name in the submission xml of a form created from the designer palette. Must be a valid XML name.</p> <p>The name of the form is decoupled from the element name.</p> <p>If you want a form name with international characters, you must enter the international chars into the Element Name field.</p> <p>Note: If you change the element name, all existing submissions become invalid. The error message. "Submission is not valid. An incompatible change was made to the form/flow." is displayed.</p>
Save	<p>Causes all submissions for this form to be stored in forms' submission repository. This property is enabled by default.</p> <p>If you deselect this check box, the form submission is still logged in the submission repository and you are able to view the metadata about the submission (time/date submitted, success/failure conditions) but no form field data is saved.</p>

Table B-1 (Cont.) Properties

Property	Description
Printable	Displays a print icon at the top of your form. If you do not want users to print your form, disable this check box. You can control which form fields are visible in the PDF print view through the printable property in each web form control of your form.
Save PDF	Enables the user to save the file as a PDF. This property can only be enabled if the save property is enabled. When selected a PDF image of the file is also saved in the forms submission repository.
Decorated	Controls whether newly added controls have their control level decorator property set or unset. Does not affect controls already in the form.

Style Tab

The elements listed in [Table B-2](#) are shown on the Properties control Settings tab when a web form is selected in the designer.

Table B-2 Elements

Property	Description
Width	Specifies how wide your form is. The default "regular" width is 600px, but the drop down also includes thin (400px) and wide (800px). The custom option enables the box to the right of the Width drop down in which you can specify a width.
Height	Specifies an initial height for your form as it is loading into the browser. It does not dictate the actual height. In general, you do not have to edit the form's height property since the form can resize dynamically. However, if your form is very small it can improve the appearance as your form loads if you set height to the actual height of your form.
Controls	Determines whether the options you define for check box and radio controls are displayed vertically or horizontally.
Layout	Select a layout. The layout changes the appearance of your form. Layouts include: <ul style="list-style-type: none"> • Nouveau - takes advantage of newer browsers supporting modern CSS and is extremely well-suited to forms or flows running on mobile devices. • Compact - This is very similar to the Nouveau layout except for the reduction of vertical space between controls. • Tight - Vertical and horizontal space is dramatically reduced. Controls are positioned up against each other.
Style	Apply a style to your form by selecting a choice from the Style drop down. Styles are mainly concerned with colors but you can also specify other properties such as font name, size and color. Choices include <i>Blue</i> , <i>Neutral</i> , <i>Green</i> or <i>Aqua</i> . You can create custom styles. Customized styles also appear in the drop down list along with the pre-defined options.
Print Font	Use this property to optionally select the font used when rendering PDFs.

Web Form Control Properties

You can control the behavior and appearance of each web form control by changing its properties.

Properties are edited using the properties editor which contains tabbed panes grouping the properties by function.

Web Form Control Properties - Settings Tab

The settings tab defines the general properties of a control. [Table B-3](#) provides an alphabetical list of all the control properties that appear on the settings tab.



Note:

Not all of the properties on the settings tab are used by every web form control.

Table B-3 Control Properties - Settings Tab

Property	Description
Control Type	<p>Defines the type for this web form control. You can change the type of the web form control by selecting the type from the drop-down list.</p> <p>This property applies to the following web form controls:</p> <ul style="list-style-type: none"> • Selection controls (drop down lists, radios, and check boxes). • Most input controls (text, text area, Email, phone, quantity and number). • Date controls (Date, Time, or Date/Time). <p>This property is populated automatically when you first add a control to a web form. You can change this property if you want to switch a control in your form to a different type of control. This saves you from having to remove the original control and drag in a new one.</p> <p>You cannot change a selection control to an input control or vice versa. You can switch a check box to a drop down list, but you cannot use this property to change a check box to a text control.</p> <p>This property is also useful for verifying what kind of controls are in your form. You assign new labels to your controls after dragging them in. This property confirms what kind of controls are in your form regardless of the labels.</p> <p>Controls generated from schema elements have a Display As property instead of a Control Type property.</p>
CSS Class	<p>Defines the control's XHTML markup class name. You can use this CSS class to reference the control in any CSS when customizing themes.</p> <p>Use the built-in CSS class name 'f-page-break' to add a page break to the printed view of the form's PDF, or tiff by adding it to the control that should be at the top of a new page.</p>

Table B-3 (Cont.) Control Properties - Settings Tab

Property	Description
Date Format	<p>Defines the date format used in the form.</p> <p>This property applies only to Date controls and the Date portion of the Date/Time control. It supports European date formatting. Dates entered into the form are translated according to the chosen format and are reformatted to match the selected format.</p> <ul style="list-style-type: none"> • A date entered into a form field is reformatted to match the selected Date Format • A date entered into a form field is translated according to the selected format. For example, if you choose a European format of DD-MM-YYYY and enter 10-05-2009 the date value is translated as May 10, 2009. If you choose a US format of MM-DD-YYY the date value is translated as October 5, 2009. • If you choose a format of MM-DD-YYYY using either "-" "/" or "." as the separator, either separator is valid for that format but is translated to the selected separator. • Users can still enter dates such as Feb 3, 2001. They are translated into the specified format
Decorator	<p>If decorators are turned on for the form, when you drag an input control from the palette, it shows a default decorator icon on the left side of the control. The default depends on the type of control being dragged in. You can change the decorator for individual controls by selecting one from the dropdown list. The Textarea control is the only input control that does not have a decorator</p>
Display As	<p>Enables you to change the way your control looks on your form. For example, to change a text control to a drop down, select drop down from the list of allowable controls. This changes the control's appearance but does not affect how the control handles data. If you must modify the control's validation behavior, you must update the schema. The Display As property is not available for the following schema controls: <i>Message, Upload, Image, Video, Link, Date, Time, Date/Time</i>.</p> <p>This property applies only to controls generated from XSD schema elements. (If the control was dragged in from the palette, it has a Control Type property).</p>
Enable if Valid	<p>Enables the user to submit the form even if all of the data has not been validated.</p> <p>By default the form's submit button is unavailable until all required fields are filled and contain valid data. Deselect this property to allow the user to submit a form even if it is invalid.</p> <p>This property applies only to Submit controls.</p>
Enabled	<p>Determines whether the control is enabled or disabled when users first access your form. If you clear the Enabled check box, users may not enter a value in the control until the control is enabled. (You can enable the control using a Rule.)</p> <p>For example, you are creating a wedding invitation form and want to know if the people completing your form are bringing a guest. Your form includes a text control for the guest's name that becomes enabled only after users indicate (in another control) that they are coming to the wedding.</p> <p>Grouping controls cannot be disabled.</p>

Table B-3 (Cont.) Control Properties - Settings Tab

Property	Description
Error Msg	<p>Specifies an error message to be displayed if the user does not supply a valid value in the control. If you leave this property blank users receive generic feedback (an "invalid value" message, for example) if they supply an invalid value.</p> <p>For example, if you are using a pattern that requires the user to enter an area code of 203 or 860 in a phone control, you can use the Error Message property to let users know this explicitly if they try to enter a different area code.</p>
Help	<p>Specifies detailed help about a specific control. If help text is provided, an icon appears next to the control on your form. When the user clicks, the icon, the help text you supplied in the Help property is displayed in a floating box.</p>
Hide Label	<p>Determines whether the control's label is displayed on your form. Check to hide the label on your form; clear to show the control's label.</p>
Hint	<p>Enables you to create a tool tip that displays in your form when the user mouses over the control.</p>
Label	<p>Defines the label of the currently selected web form control. This label is displayed in your form beside or above the control. You can hide the label in the form by enabling the Hide Label property</p> <p>When you add a control to a web form, it is assigned an arbitrary and unique name. After creating a control, you can change this to the text you want to appear to the end-user of your web form.</p> <p>You can a control's label either on the form itself (by clicking the control and selecting the label) or by overlaying the arbitrary name in the Properties Label field.</p> <p>Message controls are the only controls without labels-they are used for static text, so a label is not required in addition to the static text.</p> <p>You can use plain text or arbitrary XHTML for the label name.</p>
Labels	<p>Enables you to change the control's labels. However, the XSD values for the control in the schema do not change. In other words, you can change what a user sees in the form, but not the underlying values. You cannot use the [value=label] syntax you use for palette controls to change the element values.</p> <p>This property applies only to controls generated from schema elements. (If you drag a control in from the palette, it has an Options property; if the control was generated from a schema element, it has a Labels property.)</p>
Max Length	<p>Limits how many characters, expressed as a positive integer, users can supply in the control. Text area controls do not support this property due to an HTML limitation. However, it is very easy to add this functionality to the <code>TextareaMaxLength</code> text area control using a business rule.</p> <p>This property is available for text controls and other input controls</p>
Message	<p>Enables you to include a message in your form. In addition to regular text, you may include in this property field arbitrary XHTML markup that is formatted and displayed by the browser. This property applies only to message controls and is where you enter the static text that appears on your form.</p>

Table B-3 (Cont.) Control Properties - Settings Tab

Property	Description
Message Type	<p>You can choose a message type to display different pre-defined background colors, decorators or a border from the Message Type dropdown on the Setting tab of the property panel. These settings can override the values you have specified for BG Color and Label Color. For these values to take effect, select None for the Message Type.</p> <p>Message Type values include:</p> <ul style="list-style-type: none"> • Default • None • Bordered • Success • Info • Warning • Error
Min # and Max # (Repeat)	<p>Specifies the minimum and maximum times the control can be repeated when inside a Repeat control. expressed as positive integers.</p> <p>The Min# value defines the minimum number of controls that must be added and filled-in by the end user. If the user does not fill in data for the minimum number of controls, the Submit button is not enabled.</p>
Min # and Max #	<p>Enables you to define the minimum and maximum values, expressed as positive integers, a user can input in a control.</p> <p>These properties appear as part of a Table Control or when your form has an input control inside a control and apply to the input control. If you specify a minimum value of 1 and maximum value of 10, users must enter values in at least one input control or they are unable to submit the form. They may enter values in up to ten input controls.</p> <p>The minimum and maximum properties for the Table Control allow the user to add or delete table rows in a form as required.</p> <p>Min # and Max # properties are not editable for controls generated from an uploaded schema, since the schema already specifies this through the <code>minOccurs</code> and <code>maxOccurs</code> attributes.</p>

Table B-3 (Cont.) Control Properties - Settings Tab

Property	Description
Name	<p>Defines the name of the currently selected control. This name is automatically generated and defaults to the control's label less any spaces and special characters. Spaces and special characters are removed in order to make the name valid for use in rules. For XML users, this makes the name valid as an XSD schema element name. Control names are truncated to 32 characters for all the controls except triggers and panels.</p> <p>If you have two controls at the same level with identical labels, the control's names are automatically made unique. If you try to edit the name such that it is no longer unique, Oracle Web Forms prevents the edit. In order to use a control in a rule the name must be unique in your form. When a control is dropped inside a section control, it is at a different nesting level than a control dropped outside a section.</p> <p>For example, two controls, one inside a section called Car and another in a section called Boat are also at different nesting levels. In both cases the form designer allows you to name the controls identically. Both Car and Boat can contain a control named VIN.</p> <p>The Name property is used in several different contexts in Oracle BPM. It:</p> <ul style="list-style-type: none"> • determines how you reference the control within form rules. • is used when initializing form fields through the <code>Web_Forms_data</code> URL parameter for controls added from the palette. Note: For controls added from XSD schema, you must use the underlying element name to initialize the control via <code>_data</code>. • determines how you refer to form fields from document URIs. • is used in Form Action Display Message and Go to URL templates. • is used in Doc Action Email Address templates. • is the name given to the XML element corresponding to the control you drag into your form from the palette. <p>You can change the names of controls from the schema, although schema controls maintain their underlying XSD element name. For example, suppose you are using controls from two schemas in a form and both contain a control named "FName". You can change the name of one of these controls to "FirstName" to make them unique within the form. This is helpful if you are adding rules to the form, or if you want to use the form as a template.</p> <p>Except for <code>_data</code>, controls from XSD use the same rules (as above) as controls from palette.</p>
New Line	<p>The New Line Property will be present for all controls that have the 12 column width selector. Selecting New Line causes the control to appear on a new line in the rendered form.</p> <p>Trigger and Link controls have this property checked by default.</p>

Table B-3 (Cont.) Control Properties - Settings Tab

Property	Description
Options	<p>Defines how to populate the choices the user sees in the control. This property appears for drop down, radio and check box controls.</p> <p>You may have option labels different from option values. The syntax for the options is <value>=<label>. The <label> specifies what is displayed on your form and the <value> specifies what is saved as the selected value when the user submits the form.</p> <p>When you first drag one of these controls into your form they have generic values: Option 1, Option 2 and Option 3. This matches the generic text you see in the Properties area. To supply your own values, simply replace the values in the Options property with the values you want. Add or remove options as required.</p> <p>If you do not enter both <value> and <label> using the <value>=<label> syntax, then the value defaults to the label. As soon as you move the focus away from the options property, options without values are automatically converted to the syntax.</p> <p>In this case the options are entered without values. In this case Oracle Web Forms defaults the value to the label.</p> <p>The order of choices in your control matches the order in the Properties area. If you have choices that require a logical order, ensure the order is correct in the Properties area. You can not sort the text you enter in the Options property field but you can cut and paste.</p> <p>In addition to the generic Option 1, 2 and 3 choices, a drop down control also includes a blank option that by default appears first in the list. This blank option appears regardless of the text you supply in the Options property. You cannot remove the blank option but you can make one of the other options the default.</p> <p>To specify an option string that includes the "=" character, precede the string with "a=". For example, to specify the label "good = gold" specify "a=good = gold" for the option string.</p> <p>Choices cannot be changed if they have been generated from an uploaded schema, because the schema specifies the choices. On controls generated from schema, you can not see the Options property in the Properties area. However, you can change the option Labels.</p>
Password	<p>Causes the text entered in the field to be blocked out as it is entered, in a way suitable for entry of a password.</p> <p>This property applies only to text controls and other input controls. If you check the Password check box, the text the user enters appears on the form as asterisks. However, it is submitted as normal text.</p>

Table B-3 (Cont.) Control Properties - Settings Tab

Property	Description
Pattern	<p>Enables you to define additional restrictions on the type of data a user inputs into a control.</p> <p>Most controls automatically ensure that users provide the correct data type, but patterns give you the flexibility to impose additional restrictions on what users enter in a particular control.</p> <p>In the Pattern field in the Properties area, type your pattern using XML schema regular expressions. A simple example is a pattern that restricts a text control to only allow strings formatted as a US zip code: <code>\d{5}\d{5}-\d{4}</code>. If you type this expression in the Patterns property, your form permits values entered into this field only if they are five digits or five digits followed by the '-' character, followed by 4 digits.</p> <p>When you define patterns, you don't have to restrict what the control handles automatically. It is not necessary to enter a pattern [a-z] for a Number control, since users can not type letters in a number field. Since essentially you would be attempting to expand the allowed data types in the control, Oracle Web Forms ignores this pattern if you enter it.</p> <p>You must first save the form before the pattern takes effect. Therefore, patterns cannot be tested in the form designer, only in use mode</p>
Placeholder	<p>Text entered in this field appears in your input control until data is entered. If data is removed, the placeholder text reappears. This feature does not work in IE8 or IE9.</p>
Printable	<p>Determines whether or not this form field appears in the in the PDF document view of the form. If unchecked, the field does not appear in either view.</p> <p>You can set the property on a section control and it automatically applies to all controls inside the section control. This is often used in web form rules.</p>
Required	<p>Specifies that a control is required. The Submit button is disabled and the form cannot be submitted until all required fields contains a valid value.</p> <p>Required controls are marked with a yellow gradient.</p> <p>You cannot mark grouping controls (tabs, sections, panels and s) required. However, sections can be marked required. If a Section has the required property checked, required controls within it show a yellow background in design and Use mode. If the Section has required unchecked, required controls within it do not show the yellow background color in design and Use mode. The yellow background color appears only when one of the required controls in the section is filled making it mandatory to fill other required controls within the section.</p> <p>Input controls that are direct children (directly inside) of controls also cannot be marked required, nor should they be, since the minimum and maximum properties define this. You may, however, make controls required when they are inside sections, tabs and panels.</p> <p>You cannot edit the required property for controls that have been generated from an uploaded schema, since the schema already specifies this through the <code>minOccurs</code> attribute. If a control from a schema appears as required and you don't want it to be required, edit the XSD and set <code>minOccurs=0</code>. Re-upload the XSD. Then the control no longer appears required.</p> <p>This property is useful when using rules to hide or show sections depending on something else in the form. If you hide the section you may have to set the required property to false.</p>

Table B-3 (Cont.) Control Properties - Settings Tab

Property	Description
Sensitive	Controls whether the value saved in the submissions repository is hidden when viewed in the forms in the web submissions user interface. The value is not currently encrypted in the database. Click the check box if the data users enter into this field contains sensitive data that should not be visible when viewed in the user interface.
Time Format	<p>Specifies the time format used by the control.</p> <p>This property applies only to the Time control created by selecting the Time or Date/Time option from the Date control drop down. It supports standard and military time formats. Time entries entered into the form are translated according to the chosen format and are reformatted to match the selected format.</p> <ul style="list-style-type: none"> • A time entry typed into a form field is reformatted to match the selected Time Format. • A time entered into a form field is translated according to the selected format. For example, if you choose a military time format of hh:mm:ss and enter 2:00 PM the time value is translated as 14:00:00.
Visible	Specifies whether the control is visible or hidden when users first access your form. To dynamically show or hide the control, write a Rule that controls its visibility based on the data entered in another control.
# of Rows	Defines the initial size of the text area. This property applies only to text area controls. Scroll bars appear automatically when the user reaches the # of rows specified.

Web Form Control Properties - Style Tab

Use the Style tab to define display-specific properties of the currently selected control. [Table B-4](#) provides an alphabetical list all of the properties available on the **Style** tab.



Note:

Not all of the properties listed below are available for every web form control.

Table B-4 Properties - Style Tab

Property	Description
BG Color	Enables you to specify the color that appears behind the control. Enter any valid CSS color name or its hexadecimal RGB equivalent. For example, if you want a red background, you can type the word RED or #aa2211.
Bold	Causes the control's label to be bold.
Button Color	Selects the color of a button control.
Center	Causes the content of the control to be centered. Applies to Message controls.
Date Picker	Enables an date picker control which pops up an interactive calendar. Applies to Date controls.
Expand/Collapse	Enables an expand/collapse control. Applies to Section controls.

Table B-4 (Cont.) Properties - Style Tab

Property	Description
Italic	Displays the controls label in italics.
Item Width	<p>Enables you to change the layout of the options from vertical (one radio or check box button below the next) to horizontal. This is useful to save vertical space on long forms. It is also useful to improve ease of use for forms with questions that each have the same set of options.</p> <p>This property is used by the radio and check box controls</p>
Label Color	<p>Enables you to change the font size and color for any specific control on the form. Specify the color by typing any valid CSS color name or its hexadecimal equivalent.</p> <p>These properties work well when you want your entire label to have the same size and color, but for more sophisticated labels you can type XHMTL in the control's label property field. For instance, use XHMTL if you want to apply two different font colors inside the same label. Typing XMHTML also gives you more font precision, since the label size property lets you pick generic font sizes only--small, medium, and so on. There may be controls for which you want a font size somewhere between the small and medium options in the drop down, for example.</p>
Label Size	Defines the size (in pixels) of the label.
Width	<p>Used to specify the width of the control.</p> <p>For input controls, the property specifies the width of the area in which users enter data; for example, you might narrow a control used for entering zip codes or widen a control for a full first, middle, and last name.</p> <p>All control widths are specified in columns, from a minimum of one column to a maximum of 12 columns wide. You can have any combination of controls widths on one line - (e.g. Three controls: 3, 4 and 5 grid columns wide respectively or four controls 2, 2, 4, and 4 grid columns wide.).</p> <p>The width is selected by clicking on a grid in the Style tab. When you drag and drop most controls from the palette on to the canvas, the control will be 12 columns wide. The trigger, link and panel controls are the exception - the default width of the trigger and link controls is 3 columns while the panel is 6. To change the width, click the number of divisions on the grid corresponding to how wide you want the control to be.</p> <p>When you make a control n columns wide (6, for example), the entire control takes up 6 columns. As a result, if there is space, controls will float up next to other controls. You can prevent this using the New Line property.</p> <p>The decorator does not affect the visible control width. The visible width of controls which add up to the same width of another control is exactly the same. For example, a control that is 2 grid columns wide + a control that is 4 grid columns wide is the same width as a control that is 6 columns wide.</p> <p>There is no Width property for sections or tables controls - they are always 12 columns wide. Repeats are also always 12 columns wide.</p> <p>For tab controls, you access the width property by clicking the unlabeled area to the right of the last tab in your tab group; the width you specify will be applied uniformly to each tab in group.</p> <p>When setting a control's width property you may use standard CSS-relative values; for example, 5%, 5em, 5ex or 5px.</p> <p>Note that control widths are ignored on the iPhone and the iPad even if you have explicitly specified them.</p>

C

Web Form Rules Examples

Learn how to use web form rules within a web form with the help of multiple examples and use cases.

For general information about form rules, see [Working with Web Form Rules](#) .

- [Calculate a Total](#)
- [Show/Hide a Billing Address](#)
- [Show/Hide Message](#)
- [Enable/Disable a Question](#)
- [Compute Subtotals for Repeating Items](#)
- [Compute an Invoice Total](#)
- [Textarea Max Length](#)
- [Textarea Newline and Break](#)
- [Dropdown Options](#)
- [Finding a Selected Options Index](#)
- [Synchronized Selects](#)
- [Clearing Dropdown Options](#)
- [Default Option](#)
- [Check Box Options - Assigning Color to Check Box Choices](#)
- [Check Box Options - Making a Control Visible/Invisible Based on Check Box Choices](#)
- [Check Box Initialization](#)
- [Displaying Selected Check Box Labels](#)
- [Repeating Check Boxes](#)
- [Display a Message Control Inside a Repeat Control](#)
- [String Concatenation](#)
- [Visible/Invisible](#)
- [Visible/Invisible Section](#)
- [Select Tab](#)
- [Next Tab](#)
- [Expand/Collapse Section](#)
- [Multiple Choice](#)
- [Dynamic Options](#)
- [Triggers and Dynamic Options](#)
- [Value Change and Dynamic Options](#)
- [Dynamic Control Initialization](#)

- [Verify User](#)
- [Calculate Net Worth](#)
- [Dates and Times](#)
- [Tenants, Roles and Users](#)
- [Repeat Item Added](#)
- [Repeat Item Added - Collapse Other Items](#)
- [Tables](#)
- [form.load](#)
- [form.unload](#)
- [Unique ID](#)
- [Repeat Item Initialization](#)
- [ItemAdded by Init Doc](#)

Calculate a Total

The following example assumes you have a form with three controls and you have assigned them Names N1, N2 and T respectively. When a user enters a value in either N1 or N2 you want to set the value of T to the sum of N1 and N2.

The rule would be written as

```
if (N1.value > 0 || N2.value > 0) {  
    T.value = N1.value + N2.value;  
}
```

This rule will automatically run whenever the user types something in N1 or N2 and will set the value of T appropriately. You can use any legal JavaScript operators in the expression such as subtraction or multiplication. However, it is important to ensure that the calculated value is valid in the context of type of T. For example, if T was of type integer and the computed value of the expression was decimal (such as 1.5), then the rule would be attempting to set an invalid value in T. This will generate an error. The rule will set the value as requested, but will mark the field as invalid and take appropriate action such as disabling the submit button, displaying the control with a red background, and so on.

Also, if controls are added to the form from the palette, it is important to ensure they have the correct type. For example, for a numeric calculation as described above, the controls should be of type Numeric.

Show/Hide a Billing Address

The following example assumes you have a form with two controls and you have assigned them names B and S respectively. B is a check box with a single option whose value is Yes. If checked the user wishes to enter a different billing address in S and you want to display S.

The form rule would be written as

```
if (B[0].value == 'Yes') {  
    S.visible = true;  
} else {  
    S.visible = false;  
}
```

This form rule will automatically run whenever the user checks or unchecks B and will show/hide the billing address section S. You can use any valid JavaScript expression to compute the visible property of S as long as it evaluates to a boolean true or false value. In this example, you would typically set the check box B to be initially unchecked and the section S to be initially hidden.

Show/Hide Message

In the following example, the form has a radio control named Facility and makes a message visible depending on the selected options.

```
if (Facility.value == 'Boston' ||
    CompanyFacility.value == 'New York')
{
    Msg.visible = true;
} else {
    Msg.visible = false;
}
```

Enable/Disable a Question

This example assumes you have a form with two controls and you have assigned them Names B and Q respectively. B is a check box with a single option - Yes. If checked the user is a smoker and you wish to ask an additional question in Q.

The rule would be written as

```
if (B[0].value == 'Yes') {
    Q.enabled = true;
} else {
    Q.enabled = false;
}
```

This rule will automatically run whenever the user selects or deselects B and will enable/disable the question in Q. Again, you could use any legal JavaScript expression to compute the enabled property of Q as long as it evaluates to a boolean true or false value.

In this example, you would typically set the check box B to be initially unchecked and the control Q to be initially disabled.

Compute Subtotals for Repeating Items

The following form rule is an example of working with repeating items. For example, if you have a form with a repeating section representing an Item that the user may purchase. Each section has a Price (with Name P), a Quantity (Name Q) and a Subtotal (Name S). There are multiple items on the page and the number of items on any given page is unknown. The price field is filled in automatically. When the user enters a value in the quantity field for any item, you wish to compute the subtotal.

The rule is written as follows:

```
for (var i = 0; i < S.value.length; i++) {
    if (Q[i].value > 0) {
        S[i].value = Q[i].value * P[i].value;
    } else {
        S[i].value = 0;
    }
}
```

This rule will automatically run whenever the user enters a value in the quantity field for any item. It will compute the subtotal for each item, for which the quantity is greater than 0 and fill in the subtotal field for that item with the computed value. If a particular item does not have a quantity, the subtotal is not computed.

Compute an Invoice Total

The following form rule is an example of working with repeating items. It assumes you have a control named Total with Name T. You want to set the value of Total to be the total invoice price, which is the sum of all the computed subtotals above.

This rule is written as:

```
var tot = 0;
for (var i = 0; i < S.value.length; i++) {
    tot = tot + S[i].value;
}
T.value = tot;
```

This rule runs whenever a subtotal is updated, for example, when it is updated through the rule above. It adds the values of all the subtotals to arrive at an invoice total. You must use a temporary variable to compute the total.

If you write the rule as:

```
T.value = 0;
for (var i = 0; i < S.value.length; i++) {
    T.value = T.value + S[i].value;
}
```

it will not work correctly. This is due to internal limitations in the way rules are evaluated. Note that this rule is working with controls inside a repeat control. To handle the case of a item being deleted from the repeat you require the following addition, assuming that the repeat control is named ExpenseRepeat. Table controls are repeats with a different layout. The same applies to the table controls. If your table is named Expense then the repeat is automatically named ExpenseRepeat.

```
if (ExpenseRepeat.itemRemoved) {;
```

Textarea Max Length

This example form has a textarea control named 'Desc' where the user can enter up to a 500 character description. In HTML there is no way to set a maxLength on a textarea control. Due to this limitation, the textarea control does not have a maxlength property like the text control does.

It is possible to do this using a form rule. On this control we also set the ErrorMsg property to the string 'You must limit your description to 500 characters'. This message is automatically displayed when the description control is set to invalid by the following business rule.

```
if (Desc.value.length > 500) {
    Desc.valid = false;
} else {
    Desc.valid = true;
}
```

You can customize the error message by adding the following line to your rule.

```
Desc.status = 'Invalid. Max 20 chars allowed and you have ' + Desc.value.length;
```

The error message will tell the user how many characters they are over the maximum allowed

Textarea Newline and Break

Users typically enter multi-line text into textarea controls. If you want to display that text in an HTML context, for example on a web page or in an html formatted email or in your form's form action display message you must replace newline characters with HTML breaks. This is due to the fact that line breaks entered into a web form textarea are represented by a single newline character `\n` while line breaks in an html context are represented by the html break characters.

The following example has a textarea control named Description and a hidden control named DF. The user types into the visible control named Description and a business rules converts the newline characters `\n` into html breaks.

```
var x = Description.value;
x = x.replace(/\n/g, "<br/>");
DF.value = x;
```

Dropdown Options

The following example automatically sets the option selected in one dropdown based on the option selected in another. This is often useful when you have a form with choices that were dynamically populated.

For example, imagine product choices which are descriptive text. When the user selects a product, your form must perform an action based on a product ID rather than the descriptive product text. A nice way to do this is to have the rule that dynamically populates the product choices dropdown also populate a product ID dropdown which remains an invisible control in the form. The product choices dropdown control was named P and the product ID dropdown control was named ID

The 1st rule "Load Products" populates both the visible and hidden dropdowns with options from a database.

```
Load Products:
-----
if (form.load) {
eval('x=' + http.get('http://localhost:8082/database/products'));

    var opts1 = [];
    var opts2 = [];

    for (var i=0; i < x.resultSet.length; i++) {
        if (x.resultSet[i]) {
            opts1[i] = x.resultSet[i].description;
            opts2[i] = x.resultSet[i].productId;
        }
    }

Products.options = opts1;
PID.options = opts2;
Products.value = opts1[0]; // default to 1st product option
PID.value = opts2[0];
}
```

Finding a Selected Options Index

The 2nd rule *Select Product ID* keeps the hidden PID dropdown synchronized with the visible Product description dropdown.

```
Select Product ID Rule:
-----
if (Products.value.length > 0)
{
    var i;
    for (x in Products.options) {
        if (Products.value == Products.options[x])
            i = Products.options.indexOf(Products.options[x]);
    }

    PID.value = PID.options[i] + '';
}
```

In v4 rules using hidden dropdowns to keep descriptive option labels visible to the user while keeping cryptic database values hidden are often no longer necessary. Dropdown options have values distinct from the human visible option labels. The above can now be achieved with a single simpler rule:

```
for (var i=0; i < x.resultSet.length; i++) {
    if (x.resultSet[i]) {
        opts1[i] = x.resultSet[i].productId+ '=' + x.resultSet[i].description;
    }
}
Rdocnum.options = opts1;
```

Here is another rule that dynamically populates both the product choices and product ID dropdowns. This rule calls a REST Service which returns an object rather than the result set returned by the database connector as shown above. See the section on dynamic content for more details.

```
if (S.value.length > 0) {
    eval('x=' + http.get('http://localhost:8182/products/?category=' + S.value));
    P.options = x.products;
    ID.options = x.ids;
}
```

Synchronized Selects

The Product Search example above is often used in conjunction with a hidden select control.

Imagine that your database table contains a list of products. Each product has product description also a unique product ID. The user must select a product from a dropdown on your form. You want to populate the dropdown with the product descriptions. The users do not have to see or know the product IDs but you must use the ID as the key into the database for other selects. To do this add another hidden dropdown to the form and populate it with the IDs. This example has a visible dropdown name Products and an invisible dropdown named PID. See the rule above that populates these dropdowns dynamically from the database.

This rule below keeps the PID selected option in sync with the selected Product.

```
var i;
for (x in Products.options) {
    // Determine the index of the selected product in the Products dropdown options
```

```
if (Products.value == Products.options[x])
    i = Products.options.indexOf(Products.options[x]);
}

// Changed the selected PID to match the selected Product
PID.value = PID.options[i] + '';
```

Clearing Dropdown Options

This sample resets a dropdown option to the automatically added blank option.

For dropdowns added from palette controls and from schema, Oracle Web Forms automatically adds a blank option so the dropdown initially shows no choice by default. To reset the dropdown, set the dropdown control's value to null not the empty string. The empty string will not work since the empty string is not a valid option. This form resets the dropdown named size whenever the value of the product option changes.

```
if (product.value.length > 0) {
    size.value = null;
}
```

Default Option

When your options are set dynamically as shown below in a business rule, you cannot set a default in on the form designer. You must set the default in the rule.

If your options have <value>=<label> where value is different from label, make sure you set the <control>.value to <value> not <label> and not <value>=<label>

```
if (form.load) {
    var cc = ['R=Red', 'B=Blue', 'G=Green'];
    Colors.options = cc;
    Colors.value = 'B';
}
```

Check Box Options - Assigning Color to Check Box Choices

Check box controls are different from all other Oracle Web Forms palette controls in that they are multi-select. Therefore the way to write rules with check box controls are in many ways similar to rules with repeat controls.

This rule has a check box controls with name colorPalette with the options: purple, green, blue, yellow, orange. The form also contains a text control with name colorChoice. This rule assigns colorChoice the choices selected from colorPalette.

```
var choices = '';
for (var i = 0; i < colorPalette.value.length; i++)
{
    choices = choices + colorPalette[i].value;
}
colorChoice.value = choices;
```

Notice that similar to repeat controls, due to an internal evaluation limitation, you must collect the choices in a variable inside the for loop. And then assign that control Name.value to that variable outside the for loop.

This rule is another example showing how check box controls are array types.

```

if (colorPalette.value.length > 0)
{
    colorChoice.value = 'Thank you for choosing colors';
}
else
{
    colorChoice.value = 'Please choose colors...';
}

```

Check Box Options - Making a Control Visible/Invisible Based on Check Box Choices

This rule makes visible/invisible a control based on which check box options a user selects.

This form contains a multi select check box named Structures. If the user selects the option "Detached Garage" or "House", we want to make visible a text field named Details.

Again since a check box is multi select, it is handled as an array. The array will contain all selected (checked) options.

It is important to note that when a check box is added to the form from the palette and its options are multiple words containing spaces, the option array has converted each space character to the '_' character. We must make the comparison as shown below. Check box controls from schema do not have space replaced with '_'.

```

var found = false;
for (var i = 0; i < Structures.value.length; i++)
{
    if (Structures[i].value == 'Detached_Garage' ||
        Structures[i].value == 'House') {
        found = true;
        break;
    }
}
if (found == true) {
    Details.visible = true;
} else {
    Details.visible = false;
    Details.value = null;
}

```

Note that when we hide Details we also clear its value. This is because the user may have selected one of the Structures check boxes that made Details visible AND entered a value into Details. And then they may have changed their minds and deselect the option that caused Details to become visible. If you don't want the value entered into Details to be in your form submission, clear the value when hiding it.

Check Box Initialization

Since check box options are multi-select, in order to select multiple options using a rule you must use this syntax.

In this example CB is the name of a check box controls with the following options: red, green, blue. This rule selects all of the options.

```
CB.value = ['red', 'green', 'blue'];
```

To clear all checked option in the control named CB:

```
CB.value = [];
```

Displaying Selected Check Box Labels

In this example, the rule displays the labels of the check boxes the user selects.

```
var selectedcolors = '';

for (var i = 0; i < RGB.value.length; i++)
{
    var v = RGB[i].value;
    for (x in RGB.options) {

        var opt = RGB.options[x];
        var val= opt.split('=')[0];
        var lab= opt.split('=')[1];
        if (v == val) {
            selectedcolors = selectedcolors + ' ' + lab;
        }
    }
}
```

Repeating Check Boxes

Check boxes inside controls must be treated as an array (each check box control's values) of check box option values which is inside another array (the repeating check box control itself).

This form example has a repeating section containing two controls -- Message, which is a text control and AreYouAttending, which is a check box control with a single option 'yes'. To access the selected options the syntax is:

AreYouAttending[i].value[0] == 'yes'

```
for (var i = 0; i < AreYouAttending.value.length; i++)
{
    if (AreYouAttending[i].value[0] == 'yes') {
        Message[i].value = Name.value +
            ' is attending event #' + i;
    }
}
```

Display a Message Control Inside a Repeat Control

If you put a message control inside a repeat control, you must add a rule to the message control to have the message repeat when a user clicks to add a new repeat item.

In the example below, the messages appear correctly in the first item, but a rule is necessary to have them appear when the user adds a second, third, or more items.

In the example below, the rule repeats both dynamic text (*Contest Nomination For: [Name]*) in the first message control and static text (*By signing this consent form...*) in the second message control.

```
if (Consent.itemAdded)
{
    var index = Consent.itemIndex;
    ConsentNominationForMsg[index].value = 'Contest Nomination For: ' + ClubName.value +
        ' by ' + NominatorSName.value;
```

```

    ConsentMsg[index].value = 'By signing this consent form you hereby agree that it is
acceptable to use a photo or video with your image.';
}

```

String Concatenation

Message controls can be used in business rules to create summary information on your form from values entered into earlier form fields.

This rule uses javascript variables to concatenate form field values, text strings and html to format a nice summary page:

```

var totalAssets = TotalAutoValue.value + TotalBankValue.value +
TotalRealEstateValue.value;

BasicSummaryMsg.value =
"<b>Name:</b> " + FirstName.value + " " + LastName.value + "<br/>" +
"<b>Phone:</b> " + Phone.value + "<br/>" +
"<b>Email:</b> " + EmailAddress.value;

if (MilitaryOrCivilian.value == 'Military') {
//Military
DetailedSummaryMsg.value =
"<b>Military Info:</b><br/>" + "Military ID: " + MilitaryID.value + "<br/>" +
"Rank: " + Rank.value + "<br/>" +
"CurrentTitle: " + CurrentTitle.value + "<br/>" +
"Years of Service: " + YearsOfService.value + "<br/>";
} else if (MilitaryOrCivilian.value == 'Civilian') {
//Civilian
DetailedSummaryMsg.value =
"<b>Civilian Info:</b><br/>" +
"SSN: " + SSN.value + "<br/>" +
"Current Employer: " + CurrentEmployer.value + "<br/>" +
"Current Title: " + CurrentTitle2.value + "<br/>" +
"Start Date: " + StartDate.value + "<br/>";
}

FinancialSummaryMsg.value =
"<b>Total Assets:</b> $" + totalAssets +
"<br/>" + "Total Bank Assets: $" + TotalBankValue.value + "<br/>" +
"Total Real Estate Value: $" + TotalRealEstateValue.value + "<br/>" +
"Total Auto Value: $" + TotalAutoValue.value + "<br/>";

```

Note when using field values from repeat controls you must use a javascript var and assign the concatenation to the var and then the var to the Oracle Web Forms message control value. For example imagine you have a message control named Summary and a repeat control named Account:

```

var acctSummary;
for (var i = 0; i < Account.value.length; i++) {
    if (Q[i].value > 0) {
        acctSummary = acctSummary + 'Account #' + i + ': ' + Account[i].value + '<br/>';
    }
}
Summary.value = acctSummary;

```

Visible/Invisible

This rule makes the message control `nickNameThankYou` visible when the user enters a value into the `nickName` input text control, and then hides the message control if the user deletes the value in `nickName`.

```
if (nickName.value.length > 0 )
{
    nickNameThankYou.visible = true;
}
else
{
    nickNameThankYou.visible = false;
}
```

Visible/Invisible Section

Often section controls contain many inner controls. For example imagine a form that contains a person's medical history. One of the questions on the form asks if the patient uses a hearing aid. If they answer yes, then you want to collect more details on their hearing aid usage such as left ear, right ear, bilateral; hearing aid brand; and so on. If they answer no then you want to hide all the questions specific to hearing aids. Also when they answer yes you want them to answer all the hearing aid related questions.

Avoid using message control inside of a section that contains other controls that you may want to make invisible. Since a message control always contains a value, it can cause a section, or other controls in a section, to become required, and this can disable the form's Submit button. If you must include a message control, place it outside the section. Another alternative is to write rules for the individual controls within a section to set them to visible/invisible or required/not required

Imagine this example form has a section named `HearingAid`. By default `HearingAid` visible is set to false in the form designer.

When they answer yes, you must set `HearingAid.visible=true` AND also each required field inside the section to `field.required = true`. If they then change the answer to no then another rule makes the `HearingAid.visible=false` also must set all `field.required=true` again. If the `HearingAid` section contains many child controls this rule becomes very long and tedious to write

We can simplify this by using the `required` property for sections. In the designer default all controls that must be answered inside `HearingAid` to `required`. Default the `HearingAid` section to not `required` and not `visible`. Your rule can be much simpler. By setting `HearingAid.required=false` all the inner controls recursively also become `required=false`.

```
if (useAid.value == 'no') {
    // Hide
    HearingAid.visible = false;
    HearingAid.required = false;
} else {
    // Show
    HearingAid.visible = true;
    HearingAid.required = true;
}
```

Select Tab

This rule makes a specific tab the selected tab based on the choice of a radio control.

The radio is named `SelectTab` and has three options: `person`, `auto`, `home`. The tabs are named `personTab`, `autoTab` and `homeTab`. Tabs also can be select based on trigger controls or other input controls using the same method.

```
if (SelectTab.value.length > 0)
{
    autoTab.selected = false;
    homeTab.selected = false;
    personTab.selected = false;

    if (SelectTab.value == 'Auto')
        autoTab.selected = true;
    else if (SelectTab.value == 'Home')
        homeTab.selected = true; else personTab.selected = true;
}
```

Next Tab

This form contains a trigger control at the bottom of each tab labeled "Next". When "Next" is clicked the trigger rule executes and makes the next tab the selected tab.

This assists the user in navigating through the form. The Tabs are named `T1`, `T2`, `T3`, `T4`. The trigger controls are named `C1`, `C2`, `C3`

```
// Navigate Tabs
if (C1.clicked) {
    T2.selected = true;
} else if (C2.clicked) {
    T3.selected = true;
} else if (C3.clicked) {
    T4.selected = true;
}
```

Expand/Collapse Section

This form has three sections. The first section is expanded and the 2nd and 3rd are collapsed. When the user files in the 1st section they click a "Next" trigger control which causes that section to collapse and the next section to expand.

The trigger controls are named `next1` and `next2` and the sections are named: `step1`, `step2`, `step3`. Try this membership form to see the rule in action.

```
if(next1.clicked)
{
    step1.expanded = false;
    step2.expanded = true;
}

if(next2.clicked)
{
    step2.expanded = false;
    step3.expanded = true;
}
```

Multiple Choice

This rule makes the appropriate input text controls visible depending on the choice a user makes in a radio option controls searchChoice.

```
if (searchChoice.value == 'Organizations')
{
    orgname.visible = true;
    firstname.visible = false;
    lastname.visible = false;
    clientId.visible = false;
}
else if (searchChoice.value == 'Individuals')
{
    orgname.visible = false;
    firstname.visible = true;
    lastname.visible = true;
    clientId.visible = false;
} else if (searchChoice.value == 'Client ID')
{
    orgname.visible = false;
    firstname.visible = false;
    lastname.visible = false;
    clientId.visible = true;
}
```

Dynamic Options

Select control options (radios, check boxes, dropdowns, T/F) can be set dynamically using rules rather than statically using the control's options property. However if the control comes from an XSD schema data source rather than one of the standard palette controls, then the designer must take care to not set the options to something outside of what is valid for that schema element.

For example if your XSD has a string enumeration and list valid options as 'red', 'green', and 'blue', then you should not use a rule to dynamically set the options to 'small', 'medium', 'large'. If you do then your form will not work correctly in use mode. If a user selects the option 'small' they will get a validation error on the form. This is because 'small' is not one of the options allowed by your underlying XSD schema.

Triggers and Dynamic Options

This rule is executed when the user clicks the trigger controls with Name "search".

It then dynamically sets options on a dropdown list control with Name *coffeeShopList*.

```
if (search.clicked)
{
    coffeeShopList.options = ['Koffee', 'Starbucks', 'Willoughbys', 'Dunkin Donuts']; }
```

Now replace the hard coded list of coffee shops with a rule that invokes an http.get. This must return an X-JSON header which containing a JSON object. The object is evaluated and assigned to the variable x. In this case the JSON object contains an options field of type array.

```
if (search.clicked)
{
    eval('x=' + http.get('http://<webhost>/getCoffeeShopList'));
```

```
    coffeeShopList.options = x.options;  
}
```

**Note:**

Triggers do not work in repeating items.

Value Change and Dynamic Options

This rule dynamically sets the options in a dropdown list based on the value selected in another form field. This form contains three fields named Products, Series and Model. The series options are set dynamically based on the product selection.

Also when a new product is selected we enable the series dropdown and both clear and disable the model dropdown. This form contains other rules which set the models based on the selected series. Look for the Oracle Web Forms Gallery form named HP Support - 2 under the dynamic forms keyword.

```
if (product.value == 'Laserjet Printers')  
{  
    series.options = [ ' ', 'Laserjet5 series', 'Laserjet6 series'];  
    series.enabled = true;  
    model.options = [];  
    model.enabled = false;  
}
```

Dynamic Control Initialization

This rule handles the case of setting multiple control values based on the selection of a single dropdown control. It handles this case better than using a long if/else construct.

First add options to the dropdown named SalesRep in the format <value>=<label> where <value> will be used as an index key into an array of details about each person.

```
Megan=Megan Smith  
Jim=Jim Brown  
Nancy=Nancy Jones  
Brian=Brian Jones
```

Next write a rule that first sets up a javascript array with the contact information for each person. The rules then uses the dropdown value to index into the contactInfo array to set the details for the selected person into four other form controls.

```
var contactInfo = {  
    "" : {  
        name : "",  
        email : "",  
        phone : "",  
        cell : ""  
    },  
    "Megan" : {  
        name : "Megan Smith",  
        email : MSmith@mycompany.com,  
        phone : "(203) 694-2439 Ext. 516",  
        cell : "(203) 337-3242"  
    },  
},
```

```

    "Jim" : {
      name : "Jim Brown",
      email : jim@comcast.net,
      phone : "203-208-2999",
      cell : ""
    },
    "Nancy" : {
      name : "Nancy Jones",
      email : nancy@snet.net,
      phone : "203-208-2991",
      cell : ""
    },
    "Brian" : {
      name : "Brian Jones",
      email : BJones@mycompany.com,
      phone : "203-748-6502",
      cell : ""
    }
  }
};

var repId = SalesRep.value;
SalesRepName.value = contactInfo[repId].name;
SalesRepEmail.value = contactInfo[repId].email;
SalesRepPhone.value = contactInfo[repId].phone;
SalesRepCell.value = contactInfo[repId].cell;

```

Verify User

This rule executes when the user enters a value into the Username text field. It invokes a URL that returns a JSON object that has a boolean field name "exists" that is set to true if the user already exists. If the user already exists, this rule then sets the value of a message control, makes that message control visible on the form and sets the Username valid property to false so that Username field displays as invalid to guide the user to make a correction.

```

if (U.value.length > 0) {
  eval('x=' + http.get('http://<webhost>/uniqueUser?username=' + U.value));
  if (x.exists) {
    M.value = 'User: ' + U.value + ' already exists';
    M.visible = true;
    U.valid = false;
  } else {
    M.visible = false;
  }
}

```

Calculate Net Worth

This form contains two rules. One is adding values entered into a column of assets and a column of liabilities and calculating netWorth. The 2nd rule is checking the value of netWorth and displaying an error message and marking netWorth invalid if liabilities exceed assets since the form designer does not want the form to be submitted in that state.

```

if (netWorth.value < 0)
{
  assetsExceedLiabilitiesMsg.visible = true;
  netWorth.valid = false;
}
else
{
  assetsExceedLiabilitiesMsg.visible = false;
}

```



```

    netWorth.valid = true;
}

```

When a rule sets <control>.invalid the control background turns red and the submit button greys out just as if the user had entered an invalid value into a phone control. Oracle Web Forms treats it exactly the same way. This is a good way to dynamically control your form's valid state.

Dates and Times

Working with dates and times is very common in most forms. The samples below show you how to create the most common business logic with dates and times.

Oracle Web Forms dates can be set in the user's local timezone by using the built-in date, time and date/time methods such as `frevvo.currentDateTime(form)`. Some of the samples below use the javascript `Date()` object. Since business rules run on the form server these dates will be in the timezone where the form server was installed. There are techniques below to convert to different timezones as necessary.

The Date/Time control must be initialized using array syntax from a business rule. For example to initialize a Date/Time control named DtTm to January 1st, 2012 at 4:20 am.

```
DtTm.value = ['5/15/2012', '4:20']
```

Rules initializing dates and time will not work in a form.load rule unless you specify a timezone on the form's Url using the `_formTz` URL parameter. This is because the form server must know the timezone in which to return the date and time. If you do not specify a `_formTz` the methods will return null and the control values will remain blank. For example, to specify Eastern time: `&_formTz=America/NewYork`.

Duration

This form initializes the hospital discharge date using a rule, and when the user enters the admission date a 2nd rule calculates the number of days the patient stayed in the hospital.

```

// Calculate Hospital Stay Duration
if (A.value != '' && D.value != '') {
    var da = A.value.split('-');
    var Ams = new Date(da[2],da[0]-1,da[1]);
    da = D.value.split('-');
    var Dms = new Date(da[2],da[0]-1,da[1]);

    if (Ams > Dms) {
        Days.value = 'Discharge date must be after Admission Date';
    } else {
        Days.value = (Dms - Ams) / (1000*60*60*24) + ' days';
    }
}

```

Today's Date and Time

Use Oracle Web Forms's built-in date and time methods to set your date, time, and date/time controls to the current date and time in the user's local timezone.

```

if (form.load) {
    Tm.value = frevvo.currentTime(form);
    Dt.value = frevvo.currentDate(form);
}

```

```

    DtTm.value = frevvo.currentDateTime(form);
}

```

The `currentTime()`, `currentDate()` and `currentDateTime()` will not work in a `form.load` rule unless you specify a timezone on the form's Url using the `_formTz` Url parameter. This is because the form server must know the timezone in which to return the date and time. If you do not specify a `formTz` the methods will return null and the control values will remain blank. For example `&formTz=America/New_York` will set the control values to the current date and time in the eastern timezone.

Date/Time Stamp

This rule sets a control named `Signature` to the value of a control named `Name` plus a date/time stamp. Note that it is better to use the Oracle Web Forms built-in date and time methods if you want to set the date to the user's local timezone. The following method will set the date to the form server's timezone.

```

var today=new Date()
var m = today.getMonth() + 1;
var d = today.getDate();
var y = today.getFullYear();
var h = today.getHours(); var min = today.getMinutes(); var todayStr = m + '-' + d + '-'
+ y + ' ' + h + ':' + min; Signature.value = 'Signed by ' + Name.value + ' on ' +
todayStr;

```

Invalid if Before Today

This rule makes the date control invalid if the date entered isn't before today's date.

```

var today = new Date();
var bd = DOB.value.split('-');
var bd_date = new Date(bd[0],bd[1]-1,bd[2]);

if (bd_date.getTime() > today.getTime()) {
    MyMsg.value = 'Birth Date must be earlier than today!!!!';
    DOB.valid = false;
} else {
    MyMsg.value = 'This is a good Birth Date: ' + DOB.value;
    DOB.valid = true;
}

```

Date Less than 14 Days from Today

This rule checks that the date entered into a control named `AppointmentDate` is no more than 14 days greater than today's date.

```

var date1 = DateUtil.today();
var date2 = Appointment.value;
date1 = date1.split("-");
date2 = date2.split("-");
var sDate = new Date(date1[0]+"/"+date1[1]+"/"+date1[2]);
var eDate = new Date(date2[0]+"/"+date2[1]+"/"+date2[2]);
var DaysApart = Math.round((eDate-sDate)/86400000);

if (DaysApart > 14) {
    Appointment.status = "Date should be within 14 days from today's date.";
} else if (DaysApart < 0) {
    Appointment.status = "Date should not be earlier to today's date.";
}

```

Date Less than 30 Days Ago

This rule checks that the date entered into a control named EventStartDate is 30 days or less from today.

```

if (EventStartDate.value != "") {
    var date1 = DateUtil.today();
    var date2 = EventStartDate.value;
    date1 = date1.split("-");
    date2 = date2.split("-");
    var sDate = new Date(date1[0]+"/"+date1[1]+"/"+date1[2]);
    var eDate = new Date(date2[0]+"/"+date2[1]+"/"+date2[2]);
    var days = Math.round((eDate-sDate)/86400000);

    if (!eval(parseInt(days) > parseInt(-30))) {
        EventStartDate.valid = false;
        EventStartDate.status = "The date entered can only go back a maximum of 30 days from
the current date. Please try again.";
    } else {
        EventStartDate.valid = true;
    }
}

```

Central Timezone adjusted for Daylight Savings

This rule adjust today's date in UTC timezone to Central timezone and adjust for daylight savings time. This additional conversion is most commonly required for Online users as the javascript Date() and Oracle Web Forms' DateUtil.today() both return today's date in UTC timezone.

```

// Converts UTC to either CST or CDT
if (form.load)
{
    var today = new Date();
    var DST = 1; // If today falls outside DST period, 1 extra hr offset
    var Central = 5; // Minimum 5 hr offset from UTC
    // Is it Daylight Savings Time?
    //
    var yr = today.getFullYear();
    // 2nd Sunday in March can't occur after the 14th
    var dst_start = new Date("March 14, "+yr+" 02:00:00");
    // 1st Sunday in November can't occur after the 7th
    var dst_end = new Date("November 07, "+yr+" 02:00:00");
    var day = dst_start.getDay(); // day of week of 14th
    // Calculate 2nd Sunday in March of this year
    dst_start.setDate(14-day); day = dst_end.getDay(); // day of the week of 7th
    // Calculate first Sunday in November of this year dst_end.setDate(7-day);
    // Does today fall inside of DST period?
    if (today >= dst_start && today < dst_end) { DST = 0;
}

// Adjust Date for Central Timezone
today.setHours(today.getHours() - Central - DST);

var m = today.getMonth() + 1;
var d = today.getDate();
var da = today.getDay();
var y = today.getFullYear();
var h = today.getHours();
var min = today.getMinutes();
if (min < 10) { min = '0' + min;}

```

```

    var timezone = ['CDT', 'CST'];
    var dom = ['Sunday', 'Monday', 'Tuesday', 'Wednesday',
              'Thursday', 'Friday', 'Saturday'];
    var todayStr = dom[da] + ' ' + m + '-' + d + '-' + y + ' ' + h + ':' + min + ' ' +
    timezone[DST];

    DateTime.value = todayStr;
}

```

Hours >= 4 and <= 6 Apart

This rule makes sure the end time is at least 4 hours great then the start time but no more then 6 hours later then the start time. Also start time must be on or after 1:00. The times must be entered in military units. TS is the name of the Time Start control and TE is the name of the Time End control.

- Use Text controls for the start and end times
- Use this pattern in the control to ensure valid military times 1:00 or greater: `([1-9]1[0-9])2[0-4]:([0-5][0-9])`

```

if (TS.value.length > 0 && TE.value.length > 0) {
    var sTime = TS.value.split(':');
    var sHour = sTime[0];
    var sMin = sTime[1];
    var sMins = sHour * 60 + parseInt(sMin);

    var eTime = TE.value.split(':');
    var eHour = eTime [0];
    var eMin = eTime [1];
    var eMins = eHour * 60 + parseInt(eMin);

    if ((eMins - sMins) < 4*60 || (eMins - sMins) > 6*60)
    {
        TE.valid = false;
    } else {
        TE.valid = true;
    }
}

```

Times

The date control can be set to either just a date, just a time, or a combined date/time. Here are several examples of initializing a time control name Tm;

```

// Both set the control name Tm to the same time
Tm.value = '8:30 pm'; // uses am/pm notation
Tm.value = ' 20:00'; // uses military time

// Initialize a date/time requires an array syntax
DtTm.value = ["Aug 1, 2001", "10.00"];

// Copying values
Tm2.value = Tm.value;
Dt2.value = Dt.value;
DtTm2.value = DtTm.value;

```

Tenants, Roles and Users

Oracle Web Forms has several built-in methods that enable you to access information about your form server such as the list of tenants; users in a tenant; and roles in a tenant. Some of these methods return a boolean true/false value. Others return a JSON string. Here is a sample of how to use these methods.

```
if(form.load)
{
    eval('x=' + frevvo.listTenants());
    Tenants.options = x.tenants; // Init a dropdown list of all tenants on this form server
}

if(tenant.value.length > 0)

// Check if a tenant already exists
if (frevvo.isUniqueRoleId(role.value, tenant.value) == true) {
    ErrMsg.value = 'The role ' + role.value + ' already exists in tenant ' +
tenant.value;
}
// Init dropdown with all tenant users
eval('x=' + frevvo.listUsers(tenant.value));
Users.options = x.users;
// Init dropdown with all tenant roles
eval('x=' + frevvo.listRoles(tenant.value));
Roles.options = x.roles;
// Init dropdown will all tenant roles except admin roles
eval('x=' + frevvo.listRoles(tenant.value, false));
RolesNA.options = x.roles;
}

// Verify that a role already exists in the tenant
if(role.value.length > 0)
{
    t.value = frevvo.isUniqueRoleId(role.value, tenant.value);
    if (frevvo.isUniqueRoleId(role.value, tenant.value) == false) {
        ErrMsg.value = 'The role ' + role.value + ' already exists in tenant ' +
tenant.value;
    }
}
```

Repeat Item Added

This rule executes when a new item is added to a form.

Imagine your form contains a repeating section named Employee with name E. Note that the name E is set on the control and not on the Section control. The Employee section control contain many controls such as Name, Phone, and so on, as well as a dropdown control labeled Manager with named M. It also contains a radio control labeled Employee Shift named ES whose options have been set to 'Day' and 'Evening'.

Oracle Web Forms will execute this rule each time a user clicks "+" on the form to add a new item. We want the Employee Shift ES to default to the value 'Day', and to populate the Manager dropdown dynamically with values from the Oracle Web Forms Database Connector.

Typically, a form will have a form.load rule to initialize dropdown options for the first item visible on your form.

```
if (form.load)
{
    var baseURL = 'http://www.myhost.com:8080/database/';

    // Manager Dropdown
    eval('x=' + http.get(baseURL + 'Manager'));
    var opts = ['']; // default 1st option to blank
    for (var i=0; i < x.resultSet.length; i++) {
        if (x.resultSet[i]) {
            opts[i+1] = x.resultSet[i].lastname+ ", " + x.resultSet[i].firstname;
        }
    }

    // item index 0 is on the form by default
    M[0].options = opts;
    ES[0].value = 'Day'; // default the employee shift to Day
}
```

When a new item is added as a result of a user clicking the "+" icon, we save the overhead of going back to the database to retrieve dynamic options.

```
if (E.itemAdded)
{
    var index = E.itemIndex; // which item is this in the list

    // No need to go back to the database for options.
    // We already retrieved them in form.load rule for item index 0
    M[index].options = M[0].options;
    ES[index].value = 'Day'; // default the employee shift to day }
}
```

Tables are repeats. The same rule can be written for a table control. The name of a table's repeat is always <TableName>Repeat. For example if you name your table Children, the repeat is named ChildrenRepeat.

Repeat Item Added - Collapse Other Items

This rule executes when a new item is added to a form. This form contains a repeating section with a templated label.

You can collapse the other items when adding a new item to keep the list small and grid-like. Medrepeat is the name of the repeatcontrol. Medication is the name of the section control inside the repeat.

```
if (MedRepeat.itemAdded)
{
    var index = MedRepeat.itemIndex;
    for (var i = 0; i < Medication.value.length; i++) {
        if (i != index)
            Medication[i].expanded = false;
        else
            Medication[i].expanded = true;
    }
}
```

Tables

Tables are identical to controls when referenced in business rules. Tables are a grid layout of repeating items

. All the rule examples in this chapter that discuss s apply also to tables. The one important note is that you cannot explicitly name the control inside your table. The control inside a table is automatically named as <TableName>. For example a table named Expense automatically has a control named Expense. The rule Expense.itemAdded and Expense.itemIndex references an item added to your table and that item's index respectively.

form.load

Rules can be used to initialize field values. This is a very useful feature and is often used to dynamically populate dropdown options from a database. Rules using form.load are triggered when a form first loads and when a workflow is loaded from a task list.

Rules using itemAdded only execute for repeat items added when the user clicks +, and for those added from an initial instance document (See Document URIs). It does "not" execute for those items that you have added to your form in the Form Designer. You can either add defaults directly through the form designer or add a 2nd rule to your form as follows.

These two rules together initialize the dropdown fields inside a control that is already in the form through the Form Designer, as well as those added each time a user clicks "+" on the control to add a new item. These controls are initialized based on a value set in another field.

```
'''1st Rule - Default Items'''
if (form.load)
{
    // The form contains two repeat items by default.

    if (department.value == 'Marketing') {
        Managers[0].options = ['Joe', 'Mary', 'Stan', 'Cindy'];
        Managers[1].options = ['Joe', 'Mary', 'Stan', 'Cindy'];
    }

    if (department.value == 'Sales') {
        Managers[0].options = ['Lou', 'George', 'Wendy'];
        Managers[1].options = ['Lou', 'George', 'Wendy'];
    }
}

'''2nd Rule - Items Added'''
if (Erepeat.itemAdded)
{
    var index = Erepeat.itemIndex; // which item is this in the list
    ES[index].value = 'Day'; // default the employee shift to day

    // Use options already selected in form.load rule
    Managers[index].options = Manager[0].options;
}
}
```

This rule is useful in a workflow where you want to make a the tab named Review visible only for the workflow activity named Manager Review.

```
if (form.load) {
    if (_data.getParameter('flow.activity.name') == 'Manager Review') {
        Review.visible = true;
    }
}
}
```

form.unload

Rules can be used to finalize field values after the users clicks the form's submit button but before the Form and Doc Action execution. Rules using form.unload are triggered when the

form user clicks the submit button and for workflows when the user clicks continue to go to the next activity or finish to complete the flow.

One common example use is for an order form order number. You may only want to assign a unique sequential order number to each order submission. You could initialize the form's order number when the form loads using `form.load`. However if someone starts filling in the order form but never submit it you do not want to consume the next order number in sequence if it will never be used. Using `form.unload` you can assign the number after the submit button click but before the form data is submitted.

Here `OrderNum` is the name of a invisible control.

```
if (form.unload)
{
    eval('x=' + http.get('http://<webhost>/json/getNextOrdernum'));
    OrderNum.value = x.num;
}
```

Unique ID

Forms such as invoices, bills of lading, and so on often must be stamped with a unique ID. The Sequential Number example is one approach, however it has some limitations. One is that you must guarantee that only one person at a time is filling out your form.

Here is a simpler method if your unique IDs do not have to be sequential. The data named `form.id` is guaranteed to be unique for every new form instance. You can just use it as follows:

```
if (form.load)
{
    InvoiceNum.value = _data.getParameter('form.id');
}
```

Repeat Item Initialization

The rule above was one example of initializing a newly added repeating control with a default list of options. This same concept is useful if you want to initialize a repeating control's value.

When you add a repeat control to your form in the Form Designer you can set a default value in any of those repeating controls visible in the designer. However when the user clicks "+" while using the form to add an additional item the default entered in the Form Designer is not automatically used in this new item. In order to accomplish this you can add a simple rule as follows:

This rule initializes the value of one of the fields in the repeat control to a default of '0'. `RepeatTrack` is the name of the repeat control contained the input control named `albumOnly`. This rule executes each time a new `RepeatTrack` item is added when the user clicks "+".



Note:

`ItemAdded` and `itemIndex` are properties of the Repeat control.

```
if (RepeatTrack.itemAdded)
{
    var index = RepeatTrack.itemIndex;
    albumOnly[index].value = 0;
}
```

To initialize repeat items already on your form in the Form Designer by default, either enter your initial default values directly into the in the Form Designer or add this rule.

```
if (form.load)
{
    for (var i=0; i < albumOnly.value.length; i++) {
        albumOnly[i].value = 0;
    }
}
```

This rule takes into account a repeat where min > 1. If min is 0 or 1, you can simplify this further by removing the from loop and simply have albumOnly[0].value = 0 inside the if (form.load).

ItemAdded by Init Doc

ItemAdded also executes when Oracle Web Forms adds items found in an init doc. You may want to only initialize items added when the user clicks "+" on the form and not those added from an initial document.

This form contains a Mailing Label that repeats. Each label requires a unique ID assigned. However, after the form is submitted the assigned IDs are saved in the database through the form's Doc URI. When the form loads it adds items automatically from rows in the database. They already have assigned IDs. We only have to assign new IDs in the sequence when the user manually adds a new Mailing Label by clicking the "+" button on the form. MLrepeat is the name of the Mailing Label repeat. MLmid is the name of the ID field in the form.

```
if (MLrepeat.itemAdded)
{
    var index = MLrepeat.itemIndex;
    // This rule is fired both when the user clicks "+"
    // and when frevvo adds items found in the init doc.
    // Need to assign new mid only when user clicks "+"

    // New items added via "+" will have a zero length value.
    if (MLmid[index].value.length == 0) {
        // Assign unique ID to label so it can be referenced
        // in RI Mailing Labels field
        // Count the number of existing mailing labels on the form
        var maxId = 0;
        for (var i=0; i < MLmid.value.length; i++)
        {
            if (MLmid[i].value > maxId) {
                maxId = MLmid[i].value;
            }
        }
        var next = parseInt(maxId) + 1;
        MLmid[index].value = next.toFixed(0);
    }
}
```

D

Preparing Processes for Import into Oracle BPM

Learn how to improve the results of importing process models created in Microsoft Visio and tools that support XPD (Process Definition Language).

- [Preparing a Visio File to Import as a BPMN Process](#)
- [Customizing XPD Import Using XSLT](#)

Preparing a Visio File to Import as a BPMN Process

You can import Visio files directly into Business Process Composer.

Business Process Composer maps Visio elements to Business Process Model and Notation (BPMN) flow objects using special mapping files named `VisioMasterMap.xml` and `VisioUserMap.xml`. However, Oracle only supports modifying the Visio mapping when using Business Process Management (BPM) Studio within Oracle JDeveloper.

The instructions in this section describe how to customize the mapping for BPM Studio. After importing models into BPM Studio, you can move the models to Business Process Composer by exporting your project and then importing it into Business Process Composer.

The mapping files define the target BPMN flow object for each Visio element. These files are located in the following directory within the Fusion Middleware home directory:

```
.../soa/plugins/jdeveloper/extensions/oracle.bpm.converter.
```

Note:

Do not edit `VisioMasterMap.xml` directly because this file may be overwritten during an upgrade. You can override the mappings in this file by creating and editing a separate file called `VisioUserMap.xml`.

To change the default mapping defined in `VisioMasterMap.xml`:

1. Locate the `VisioUserMap_SAMPLE.xml` file and rename it to `VisioUserMap.xml`.
2. Edit the renamed file with your changes.

This file extends or overrides the master map.

Note:

The file must be named `VisioUserMap.xml` and must be placed in the same directory as the `VisioMasterMap.xml` file.

3. After parsing `VisioMasterMap.xml`, Business Process Composer checks to see if `VisioUserMap.xml` exists.

It then modifies its rules accordingly.

`VisioUserMap.xml` must have the same root element as the default defined in `VisioMasterMap.xml` file, including the reference to the `VisioMasterMap.xsd`. `VisioUserMap.xml` must have the same format as the master map, which may be used as a reference.

Entries added to the user map must either add new mappings or overwrite existing entries in the main map. For example:

```
<?xml version = '1.0' encoding = 'UTF-8'?>
<Masters xmlns:xsi="http://www.w3.org/2001/XMLSchema-instance"
xsi:schemaLocation="http://www.oracle.com/oracle/tutor/visio/masterMapElements
VisioMasterMap.xsd"
xmlns="http://www.oracle.com/oracle/tutor/visio/masterMapElements">
<!-- custom <Master/> elements go here -- >
</Masters>
```

 **Note:**

`VisioUserMap.xml` should contain only the extended or overridden entries and should not contain all the original entries.

Working of Visio Shape Mapping

Microsoft Visio is a diagramming tool that allows users to draw any kind of diagram. However, only process models can be imported into Business Process Composer. Since Visio includes several different process modeling templates and stencils and there are many more available from third parties, the converter attempts to map each Visio shape object (rectangles, lines, polygons, and so on) to an appropriate BPMN symbol. It does this by using the `VisioMasterMap.xml` and `VisioUserMap.xml` files.

Each shape added to a Visio drawing page from a stencil is tagged with the name of the master object from which it was created. For example, if a Visio user drags several rectangle shapes named *Task* from a stencil onto the page and then renames them, each shape still has the master name *Task* associated with it. You can see this in Visio by selecting a shape and then choosing **Format > Special** from the menu.

 **Note:**

If you don't see the menu item **Format > Special**, select **Tools > Options > Advanced**, and check the box **Run in developer mode**. This option may be in a different location depending on your version of Visio.

If a shape does not have a master, which is the case for objects drawn directly from the **Drawing** toolbar (such as plain rectangles and circles), the converter looks at the shape Name field, which you can also see in the **Format > Special** dialog.

Oracle Business Process Composer then looks for an entry in `VisioUserMap.xml` and `VisioMasterMap.xml` that matches the shape master name. For example, if the shape master is **Task**, the converter finds the following map entry:

```
<Master Name="task"> <BPMNObject>Task</BPMNObject> </Master>
```

This tells the converter that all shapes with a master of Task should be imported as a BPMN Task symbol.



Note:

Master names are not case sensitive, so **task** matches Visio masters task, Task, and TASK.

Master map entries can also define additional BPMN properties. The following entry maps the Visio master named **gateway** to the BPMN Gateway symbol, but also sets some BPMN attribute values:

```
<Master Name="gateway"> <BPMNObject>Gateway</BPMNObject> <Attributes>
<Attribute Name="ExclusiveType" Value="Data"/> <Attribute Name="GatewayType"
Value="Exclusive"/> <Attribute Name="MarkerVisible" Value="false"/> </
Attributes> </Master>
```

Attributes can be set to a text, numeric, or boolean value (true and false) depending on what the BPMN standard requires.

Attribute values can also be derived from properties defined in the Visio shape itself. The following master map entry for a task shape in the Visio 2010 BPMN stencil sets the BPMN attributes **TaskType** and **Implementation** from corresponding shape properties.

```
<Master Name="Vis2010 Task" Extends="Vis2010 Activity"> <BPMNObject>Task</
BPMNObject> <Attributes> <Attribute Name="TaskType" Value="Prop.BpmnTaskType"
SrcType="visio" /> <Attribute Name="Implementation"
Value="Prop.BpmnImplementation" SrcType="visio" /> </Attributes> </Master>
```

The XML attribute "srcType" tells the converter how to interpret the attribute value. Setting srcType to *visio* indicates that the value is defined in the Visio object's "ShapeSheet". To view the ShapeSheet of a Visio shape, select the shape and choose **Window > Show ShapeSheet**. The most common properties are defined in the Custom Properties and User-defined Cells sections, which correspond the Prop and User prefixes respectively. Property names can also be derived from the XML tag hierarchy in Visio files saved in the *.vdx format.

Conditional Mapping

The master map files also support conditional mapping. This is useful when two different Visio stencils use the same master names, but use different Visio properties to store BPMN attribute values. For example, the following entry uses a condition to detect whether an Intermediate Event shape from the TrisoTech BPMN stencil is a *Throwing* or *Catching* event:

```
<Master Name="Intermediate Event" Extends="Triso Object">
<BPMNObject>IntermediateCatchEvent</BPMNObject> <Conditions> <Condition
Name="Direction" Value="Prop.direction" SrcType="visio" Equals="Catching" /> </
Conditions> <Attributes> <Attribute Name="Trigger"
Value="Prop.IntermediateEvent_trigger" SrcType="visio" /> </Attributes> </
Master>
```

A special condition attribute of NotNull (not case sensitive) can be used to test if a specific Visio property exists. The following master map entry is matched if the master name is Start Event and it contains a property named Prop.StartEvent_Trigger:

```
<Master Name="Start Event"> <BPMNObject>Event</BPMNObject> <Conditions>
<!-- this condition confirms that this is from Trisotech stencil --> <Condition
Name="Is Triso shape" Value="Prop.StartEvent_Trigger" SrcType="visio"
Equals="NotNull" /> </Conditions> <Attributes> <Attribute Name="EventType"
Value="Start" SrcType="bpmn" /> <Attribute Name="Trigger"
Value="Prop.StartEvent_Trigger" SrcType="visio" /> <Attribute Name="isInterrupting"
Value="Prop.StartEvent_Interrupting" SrcType="visio" /> </Attributes> </Master>
```

If there are more than one master map entry with the same name, the first one encountered with conditions that are all true is used. If no conditional entries match, the first unconditional master map entry for the master name is used. The VisioUserMap.xml file is processed first, so any matching master map entries in this file supersedes all other entries with the same name in VisioMasterMap.xml.

A special master map entry name of "*" is used to match all masters. This must only be used with conditions. This is useful for Visio templates that allow the user to change the BPMN object type (such as from Task to Sub Process) after adding the shape to the diagram. In this scenario, the shape master is set to the original master, even though the shape has been changed to look like a different symbol. For example, the following entries use the "*" wildcard to match entries based only on a shape property value:

```
<Master Name="*" Extends="Vis2010 Task"> <Conditions> <Condition
Name="Activity Type" Value="Prop.BpmnActivityType" SrcType="visio" Equals="Task" /> </
Conditions> </Master> <Master Name="*" Extends="Vis2010 Subprocess">
<Conditions> <Condition Name="Activity Type" Value="Prop.BpmnActivityType"
SrcType="visio" Equals="Sub-Process" /> </Conditions> </Master>
```

If a Visio master name or shape name is not matched by any entry in VisioUserMap.xml or VisioMasterMap.xml, the BPMN object type is determined by examining the shape attributes. The basic rules are:

- If a shape is a connector (usually a line used to connect other shapes), it is imported as a SequenceFlow.
- A rectangle shape that contains text, but has no border and no fill color is imported as a Text Annotation.
- A shape that is a circle or an ellipse is imported as an event.
- A rectangle that encloses other shapes is imported as an expanded Sub Process if no sequence flows cross the boundary of the shape.

If a sequence flow connects to a shape inside the boundary of the rectangle, it is treated as a BPMN Group symbol, but since Oracle BPM does not support the Group symbol, it will be ignored.

- Any shape that does not match the above rules is imported as a Task.

 **Note:**

Be careful when using the Visio Group command to combine shapes. This is sometimes convenient when moving and rearranging shapes in Visio, but confuses the converter since a group of shapes is treated as a single object during import and does not have a master, so is likely to be imported as a single task.

Visio Modelling Tips

Consider the following tips when you create your Visio files:

- Use a good stencil.
- Ensure all shapes are based on a master shape.
- Glue all connectors to other shapes on both ends.
- Do not create flows by connecting shorter lines end-to-end.
 Use one continuous connector for each flow.
- Do not group objects manually.
- Always label shapes and lines by selecting and typing.
 Do not create separate text boxes.
- Do not invent new symbols that do not cleanly map to BPMN objects.
- Verify that all masters that you use are defined in VisioMasterMap.xml or VisioUserMap.xml.
- Do not use on-page and off-page connectors or link events.
 They are not supported by BPM.

Updating VisioUserMap.XML

This section describes a possible scenario for importing a Visio file into a BPMN process.

To update VisioUserMap.xml:

In this example, the original Visio file contains a shape with the master Report that we want to map to a Send task. Since Report is not currently mapped in VisioMasterMap.xml, the shape is being imported as an abstract task. By default, VisioMasterMap.xml maps this shape to a Send task. If you use it strictly as an input or output object, it is more accurate to map it to a BPMN data object.

1. In the VisioMasterMap.xml file, find the master definition, which appears as:

```
<Master Name="document" Extends="task">
  <Attributes>
    <Attribute Name="TaskType" Value="Send"/>
  </Attributes>
</Master>
```

This definition is followed by additional master elements that use the *Like* attribute to clone the first definition and map additional Visio objects as mentioned below:

```
<Master Name="sequential data" Like="data object"/>
<Master Name="data" Like="data object"/>
<Master Name="report" Like="report" />
```

2. To add or modify a mapping for a Visio **Report** element, add the following code to the VisioUserMap.xml file:

```
<Master Name="Report" Like="report"/>
```

An object can be mapped to an existing BPMN object with additional or different attributes by using the **Extends** attribute, as shown here:

```
<Master Name="flow">
  <BPMNObject>SequenceFlow</BPMNObject>
</Master>

<Master Name="conditional flow" Extends="flow">
  <Attributes>
```

```
<Attribute Name="ConditionType" Value="Expression"/>
</Attributes>
</Master>
```

In this example, the Visio object *conditional flow* is mapped to the SequenceFlow BPMN flow object, but has added the attribute *ConditionType* to the value *Expression*.

Valid BPMN Element Values

The following are valid values for the <BPMNObject> element:

- Task:
 - UserTask
 - ManualTask
 - ReceiveTask
 - SendTask
 - ServiceTask
 - ScriptTask
 - BusinessRuleTask
- Subprocess:
 - AdHocSubprocess
 - CallActivity
- Event:
 - StartEvent
 - EndEvent
 - IntermediateCatchEvent
 - IntermediateThrowEvent
 - BoundaryEvent
- Gateway:
 - ExclusiveGateway
 - InclusiveGateway
 - ParallelGateway
 - ComplexGateway
 - EventBasedGateway
- DataObject:
 - DataObjectReference
- Group:
- Annotation
 - TextAnnotation
- Lane
- Pool:

- Participant
- MessageFlow
- SequenceFlow
- Association
- null



Note:

When you assign the null value to a Visio element, no BPMN flow object is created.

BPMN Element Attributes

The following tables show valid values for BPMN attributes based on the basic BPMN types of BPMN flow objects:

Task attributes and values

[Table D-1](#) shows the valid attributes and values for BPMN tasks.

Table D-1 Task Attributes and Values

Attribute	Values
TaskType	None, Script, Reference, Service, User, Manual, Send, Receive
LoopType	Standard, MultiInstance
isForCompensation	true, false
Implementation	Any text
OperationRef	Any text

Subprocess attributes and values

[Table D-2](#) shows the valid attributes and values for BPMN subprocesses

Table D-2 Subprocess Attributes and Values

Attribute	Values
isExpanded	true, false
isATransaction	true, false
LoopType	Standard, MultiInstance
isForCompensation	true, false
AdHoc	true, false
IsCollapsed	true, false
SubprocessType	Embedded, Reusable, Reference
ExpandedWidth	number
ExpandedHeight	number

Table D-2 (Cont.) Subprocess Attributes and Values

Attribute	Values
ModelReference	text
CalledElement	text
TriggeredByEvent	true, false
LoopMaximum	number
LoopCounter	number
LoopCondition	text
MultiInstanceCondition	text
MultiInstanceIsSequential	true, false

Event attributes and values

[Table D-3](#) shows the valid attributes and values for BPMN events.

Table D-3 Event Attributes and Values

Attribute	Values
EventType	Start, Intermediate, End
Trigger	Escalate, None, Message, Timer, Conditional, Signal, Multiple, Error, Cancel, Compensation, Link, Terminate
EventDirection	Throw, Catch
IsInterrupting	true, false
CancelActivity	true, false
TimeCycle	text
TimeDate	text

Gateway attributes and values

[Table D-4](#) shows the valid attributes and values for BPMN gateways.

Table D-4 Gateway Attributes and Values

Attribute	Values
GatewayType	Parallel, Inclusive, Exclusive, Complex
ExclusiveType	Event, Data
MarkerVisible	true, false

Sequence flow attributes and values

[Table D-5](#) shows the valid attributes and values for BPMN sequence flows.

Table D-5 Sequence Flow Attributes and Values

Attribute	Values
ConditionType	None, Expression, Default
ConditionExpression	text

Association attributes and values

[Table D-6](#) shows the valid attributes and values for BPMN data objects.

Table D-6 Association Attributes and Values

Attribute	Value
Direction	None, One, Both
AssociationDirection	None, One, Both

Pool attributes and values

[Table D-7](#) shows the valid attributes and values for BPMN pools.

Table D-7 Pool Attributes and Values

Attribute	Values
BoundaryVisible	true, false
IsHorizontal	true, false

Lane Attributes and Values

[Table D-8](#) shows the valid attributes and values for BPMN Lanes.

Table D-8 Lane Attributes and Values

Attribute	Values
BoundaryVisible	true, false
IsHorizontal	true, false

Handling Extraneous Text

When Business Process Composer imports a Visio file, it creates a separate process for each pool that it finds in the source file. Since BPMN models can also depict a process without a visible pool boundary, Visio shapes that are not inside a pool or lane, including legends, titles, and so on, are added to a separate process. This may result in a BPM process containing only extraneous elements that are not process objects. To avoid converting these shapes, you can add entries to the VisioUserMap.xml file that map the corresponding shape masters to null, which causes the converter to ignore the shape. If the shape doesn't have a master, the converter looks for an entry that matches the shape name as defined in Visio's **Format Special** dialog. For example, if your Visio file contains an object named SheetName, mapping that value to null in VisioUserMap.xml causes it to be ignored during import:

```
<Master Name="SheetName">
  <BPMNObject>null</BpmnObject>
</Master>
```

Customizing XPD L Import Using XSLT

XPD L is an interchange format created by the Workflow Management Coalition for exchanging process model information between workflow automation tools. BPM supports importing XPD L revisions 1.0, 2.0, 2.1, and 2.2.

There are currently many process modeling tools that support XPD L, but not all tools implement the standard in the same way. Oracle BPM supports XPD L files that adhere strictly to the official XPD L specification (available at <http://www.xpd l.org>) and uses Extensible Stylesheet Language Transformation (XSLT) to transform non-conforming formats into the format that BPM expects. The XPD L importer also recognizes several extended attributes that triggers special transformation logic for common differences so that complex XSLT logic is not required.

Common Transformation Requirements

The most common transformations include the following:

- Adjust object coordinates from being relative to a parent container to being relative to the upper-left corner of the drawing page.
- Adjust object coordinates to represent the upper-left corner of the object.
- Recreate sequence flow routing.
- Create missing elements and attributes.
- Removing elements.
- Move element and attribute values from a vendor-specific namespace to the XPD L namespace.

Overview of Transformation Logic

This section includes instructions on handling some of the common requirements. The examples can help you create your own transformation rules to handle any other requirements you may encounter.

When importing XPD L files using BPM Studio, the import process uses special files located in the following folder:

```
ORACLE_HOME>/soa/plugins/jdeveloper/extensions/oracle.bpm.converter
```

The file XSLFilePaths.xml serves as map between various vendor formats and the appropriate XSL file to use for the transformation. Following is a sample entry in this file:

```
<XSLFilePath Vendor="Bizagi Process Modeler">BizagiPatch.xml</XSLFilePath>
```

The Vendor attribute must match the value of the XML element /Package/PackageHeader/ Vendor in the source file. Following is an example fragment from a Bizagi XPD L file that matches the line above:

```
<?xml version="1.0" encoding="utf-8"?><Package xmlns:xsd=http://www.w3.org/2001/XMLSchema
xmlns:xsi=http://www.w3.org/2001/XMLSchema-instance
Id="bf8a25f5-275d-4546-8d07-dfa02666c51d" Name="Sample" xmlns="http://
www.wfmc.org/2009/XPD L2.2"> <PackageHeader> <XPD LVersion>2.2</XPD LVersion>
```

```
<Vendor>Bizagi Process Modeler</Vendor>    <Created>2013-07-29T19:17:31.931003-07:00</
Created>    <ModificationDate>2013-07-29T19:18:53.207857-07:00</ModificationDate>
<Description>Phases</Description>    <Documentation /> </PackageHeader>
```

As an alternative to the Vendor attribute, you may specify a Condition attribute that contains a valid XPATH expression. If the expression evaluates to true for a source file, the corresponding XSL file is used. Following is an example that uses the Condition attribute:

```
<XSLFilePath Condition="substring(/Package/PackageHeader/Vendor/text(), 0,
22)='Metastorm ProVision 6'">ProvisionPatch.xsl</XSLFilePath>
```

This expression compares the first 22 characters of the Vendor attribute to the string "Metastorm ProVision 6". This technique may be used to match a combination of Vendor and Version, for example.

After a specific XSL file is identified, the importer applies the XSLT transformation against the source file and then imports the transformed XML. If no Vendor or Condition matches the source file, the importer uses the file patch.xsl.

Special Attributes

The XPDL importer looks for optional attributes, defined using XPDL's extensibility feature, that serve as instructions to the importer for handling special cases that are difficult to code as XSLT. These attributes must be located in the **/Package/ExtendedAttributes** section as follows:

```
<Package>    <Extended Attributes>    <ExtendedAttribute Name="attribute
name" Value="value" />    <Extended Attributes></Package>
```

Table D-9 Extended Attributes and Valid Values

Attribute Name	Valid Values	Default Values	Description
redrawConnections	true, false	false	Ignore sequence flow path attributes and create new paths programmatically.
activitiesObjectPin	Upperleft Lowerleft Center	Upperleft	Indicates that the X, Y coordinates of an activity (flow node) correspond to either the upper-left corner of the rectangular bounds of the symbol, the lower-left corner, or the center of the symbol.
lanesRelativeToPools	true, false	false	Indicates that the X, Y coordinates of lane objects are relative to their parent pool.
activitiesRelativeToLanes	true, false	false	Indicates that the X, Y coordinates of activities are relative to their parent lane.
activitiesRelativeToPools	true, false	false	Indicates that the X, Y coordinates of activities are relative to their parent lane. NOTE: activitiesRelativeToLanes and activitiesRelativeToPools cannot both be set to true.
subProcessChildPositionRelative	true, false	false	Indicates that the X, Y coordinates of activities that are inside of a subprocess are relative to the subprocess.

Table D-9 (Cont.) Extended Attributes and Valid Values

Attribute Name	Valid Values	Default Values	Description
recalculatePoolsAndLanesPositions	true, false	false	Forces the importer to calculate the X, Y coordinate of pools and lanes based on the position and height of the pools and lanes that precede it. This must be set to true if the source model does not include positional coordinates for pools and lanes.

Object Coordinates

The XPDL specification states that all object coordinates specify the upper-left corner of the object's bounding rectangle on a page coordinate system with the origin (0,0) in the upper-left corner of the page. For the purposes of this example, the height of pool 1 in [Figure D-1](#) is 100 units, pool 2 is 200 units tall, and each lane in Pool 2 is 100 units tall.

Figure D-1 Example BPMN Process

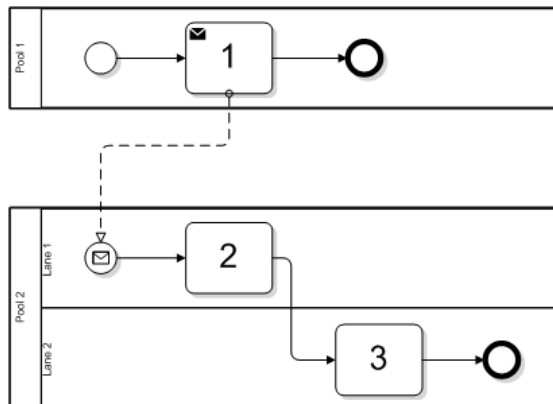

Using the global coordinate system of the XPDL specification, the X, Y coordinates of the objects depicted in the diagram are as follows:

- Pool 1 - (0,0)
- Pool 2 - (0, 200)
- Lane 1 - (40, 200)
- Lane 2 - (40, 300)
- Task 1 - (175, 15)
- Task 2 - (175, 215)
- Task 3 - (325, 315)

A source file specifying these coordinates is imported correctly into BPM with no transformation required, since all coordinates are relative to the upper-left corner of the page.

Consider a tool where object coordinates stored in the XPDL are relative to their parent pool and lane. In this case, the coordinates are:

Pool 1 - (0,0)
 Pool 2 - (0, 200)
 Lane 1 - (40, 0)
 Lane 2 - (40, 100)
 Task 1 - (175, 15)
 Task 2 - (175, 15)
 Task 3 - (325, 15)

Note that lane 1 in Pool 2 has a Y coordinate of 0. Since this tool stores lane positions relative to their parent pool, a value of 0 indicates that the top edge of the lane coincides with the top edge of the pool. Likewise, the Y coordinate of Lane 2 is 100, indicating that it is 100 units below the top edge of the pool.

Each task has a Y coordinate of 15, indicating that its upper-left corner is 15 units below the top edge of its respective lane.

In order for this diagram to be correctly imported into Oracle BPM, the following extended attribute values must be set:

Table D-10 Extended Attribute Values

Attribute Name	Value
lanesRelativeToPools	true
activitiesRelativeToLanes	true

The XSLT code to add these attributes to the XPD L are as follows:

```
<xsl:template match="Package/ExtendedAttributes">
  <xsl:copy>
    <xsl:copy-of select="@*" />
    <ExtendedAttribute
Name="lanesRelativeToPools" Value="true" />
    <ExtendedAttribute
Name="activitiesRelativeToLanes" Value="true" />
  </xsl:copy>
</xsl:template>
```

A minor variation is when lanes are relative to their parent pools, but activities are relative to their parent pool, not their parent lane. In this scenario, the object coordinates may be as follows:

Pool 1 - (0,0)
 Pool 2 - (0, 200)
 Lane 1 - (40, 0)
 Lane 2 - (40, 100)
 Task 1 - (175, 15)
 Task 2 - (175, 15)
 Task 3 - (325, 115)

Pool 1 - (0, 0)

The only difference is that the Y value of Task 3 is 115 instead of 15. In this scenario, the extended attributes must be set to:

Table D-11 Extended Attributes and Values

Attribute Name	Value
lanesRelativeToPools	true
activitiesRelativeToPools	true

Activity Local Coordinate System

The XPDL specification dictates that activity positions represent the location of the upper-left corner of the bounding rectangle on the page coordinate system. However, some tools use the center of the object as the location on the page. This is known as the local coordinate system of the object.

The easiest way to understand this is to imagine pinning a postcard onto a cork board with a push pin. The hole that the pin makes in the board represents the position of the card on the board. Measuring from the left edge of the board to the pin provides the X coordinate and measuring from the top edge of the board to the pin provides the Y coordinate. However, the placement of the pin in the card itself also contributes to the correct positioning of the card. If the pin is placed in the extreme upper-left corner of the card, the position will be different than when the pin is directly in the center of the card.

Using the BPMN example in [Figure D-1](#), an XPDL tool that uses the center of an activity as the local pin location have task coordinates as follows:

Task 1 - (220, 50)
 Task 2 - (220, 250)
 Task 3 - (370, 350)

The X coordinates are shifted to the right by 45 units (task boxes are 90 units wide) and the Y coordinates are in the vertical center of each lane, (which are 00 units high).

When an XPDL tool uses the center of activities as the basis for their position on the page, after importing into BPM they are shifted down and to the right by half their width and height because the importer is expecting all coordinates to represent the position of the upper-left corner. To correct this, you must set the following attribute:

```
activitiesObjectPin CENTER
```

The XSLT code for this is:

```
<xsl:template match="Package/ExtendedAttributes">  <xsl:copy>          <xsl:copy-of
select="@*" />          <ExtendedAttribute Name="activitiesObjectPin"
Value="CENTER" />      <xsl:apply-templates/>          </
xsl:copy> </xsl:template>
```

Removing Invisible Elements

Oracle BPM considers all graphical elements of the source XPDL file to be visible elements, even if their visibility is set to false. Therefore, you may find some differences as formerly invisible elements are visible in the converted BPMN process, like the activity elements shown here:

```
<xpdl:Activity Name="ProcessGroup" Id="ProcessGroup">
<xpdl:NodeGraphicsInfos>          <xpdl:NodeGraphicsInfo ToolId="XYZ" LaneId="PMCoE"
IsVisible="false">
```

```

        <xpdl:Coordinates XCoordinate="7740.0"
          YCoordinate="80.0"/>
xpdl:NodeGraphicsInfos>      ...</xpdl:Activity>

```

In this example the activity's visibility is set to false, but when this model is imported into Oracle BPM, you can see this activity. To eliminate invisible elements include a style sheet template to remove them:

```

<xsl:template match="xpdl:Activity">
  <xsl:variable name="isVisible">
  <xsl:choose>
    <xsl:when test="xpdl:NodeGraphicsInfos/xpdl:NodeGraphicsInfo/
  @isVisible = 'false'">
      <xsl:text>>false</xsl:text>
    </xsl:when>
    <xsl:otherwise>
      <xsl:text>>true</xsl:text>
    </xsl:otherwise>
  </xsl:choose>
  </xsl:variable>
  <xsl:if test="$isVisible = 'true'">
  <xsl:copy>
    <xsl:copy-of select="@*" />
    <xsl:apply-
  templates/>
  </xsl:copy>
  </xsl:if></xsl:template>

```

Handling Proprietary Namespaces

Some XPDL tools use a proprietary namespace in addition to the standard XPDL namespace. This is often to support special features and attributes of their tool, but sometimes information is stored in a proprietary namespace that should be in the XPDL namespace.

Considering the following XPDL file header, which defines multiple namespaces:

```

<?xml version="1.0" encoding="UTF-8"?>
  <Package Id="1"
  xsi:schemaLocation="http://www.wfmc.org/2004/XPDL2.0alpha
  http://www.wfmc.org/standards/docs/TC-1025_bpmnxdp_24.xsd"
  xmlns="http://www.wfmc.org/2004/XPDL2.0alpha"
  xmlns:xs="http://www.w3.org/2001/XMLSchema"
  xmlns:xpdl="http://www.wfmc.org/2004/XPDL2.0alpha"
  xmlns:ix="http://www.igrafx.com/2007/igrafx-document"
  xmlns:xsi="http://www.w3.org/2001/XMLSchema-instance"
  xmlns:igxpd1="http://www.igrafx.com/2008/igrafx-xpdl2">

```

The body of the XML document uses the default namespace for standard XPDL elements, but uses the igxpd1 namespace for defining document pages.

```

<igxpd1:Page Name="Update Spreadsheet" ID="Page1" IgnorePools="true">
  <PageLayout xmlns:i="http://www.igrafx.com/2007/igxpd1doc"
  xmlns="http://www.igrafx.com/2007/igrafx-document">
    <Page UseDocumentSettings="false" Orientation="Landscape"
  Width="16837" Height="11905">
      <FitTo PagesWide="1" PagesTall="1" />
    </Page>
  </PageLayout>
</igxpd1:Page>
<igxpd1:Page Name="Submit Instructions" ID="Page2" IgnorePools="true">
  <PageLayout xmlns:i="http://www.igrafx.com/2007/igxpd1doc"
  xmlns="http://www.igrafx.com/2007/igrafx-document">
    <Page UseDocumentSettings="false" Orientation="Landscape"
  Width="16837" Height="11905">
      <FitTo PagesWide="1" PagesTall="1" />
    </Page>
  </PageLayout>
</igxpd1:Page>
</igxpd1:Pages>

```

The XPDL importer does not recognize any namespace other than the XPDL namespace and expects to find a **Pages** element in that namespace. To support this requirement, create an XSLT template that creates the XPDL Pages element and children by copying the information from the custom namespace elements.

```

<xsl:template match="//xpdl21:Package">
  <xsl:copy>
  <xsl:copy-of select="@*" />
  <xsl:if test="child::igxpd1:Pages">
  <xsl:element name="Pages">
    <xsl:for-each select="//igxpd1:Pages/igxpd1:Page">
      <xsl:element name="Page">
        <xsl:attribute name="Id">
          <xsl:value-of select="./@ID"/>
        </xsl:attribute>
        <xsl:attribute name="Name">
          <xsl:value-of select="./@Name"/>
        </xsl:attribute>
      </xsl:element>
    </xsl:for-each>
  </xsl:if>
  </xsl:copy>

```



```
xsl:element>                </xsl:if>                <xsl:apply-templates/>                </
xsl:copy>                </xsl:template>
```

The result is a new section in the default namespace as shown below:

```
<Pages>                <Page Id="Page1" Name="Update Spreadsheet" />                <Page Id="Page2"
Name="Submit Instructions" /></Pages>
```

Supporting Multiple XPDL Versions

If you are using a tool that has been upgraded to support newer versions of XPDL, you may have models that have been saved using different XPDL formats. When creating XSLT templates for multiple XPDL versions, you may have to include rules for each namespace.

For example, consider a tool that saved files in XPDL 2.1 format and later in XPDL 2.2 format and used different namespace values of `xpdl21` and `xpdl22` respectively. The XSLT file must define both namespaces and they must match the namespaces that appear in the tool's XPDL files.

```
<xsl:stylesheet version="1.0"                xmlns:xsl="http://www.w3.org/1999/XSL/
Transform"                xmlns:xpdl21="http://www.wfmc.org/2008/XPDL2.1"
xmlns:xpdl22="http://www.wfmc.org/2009/XPDL2.2">
```

You then define separate templates for each namespace, such as:

```
<!-- Set extended Attribute for xpdl 2.1 -->                <xsl:template match="xpdl21:Package/
xpdl21:ExtendedAttributes">                <xsl:copy>                <xsl:copy-of
select="@*" />                <xpdl21:ExtendedAttribute
Name="subProcessChildPositionRelative" Value="true" />                <xpdl21:ExtendedAttribute
Name="activitiesObjectPin" Value="CENTER" />                <xsl:apply-
templates/>                </xsl:copy> </xsl:template>                <!-- Set
extended Attribute for xpdl 2.2 -->                <xsl:template match="xpdl22:Package/
xpdl22:ExtendedAttributes">                <xsl:copy>                <xsl:copy-of
select="@*" />                <xpdl22:ExtendedAttribute Name="redrawConnections"
Value="true" />                <xpdl22:ExtendedAttribute Name="subProcessChildPositionRelative"
Value="true" />                <xpdl22:ExtendedAttribute Name="activitiesObjectPin"
Value="CENTER" />                <xsl:apply-templates/>                </
xsl:copy> </xsl:template>
```

The logic for each XPDL format can be the same or different depending on the requirements.

Testing and Debugging XSLT

Oracle highly recommends that you create and test your custom XSLT using a programming IDE (Interactive Development Environment), such as Oracle JDeveloper, that supports validation of the XSLT and interactive execution so that you can view the output XPDL and fix issues easily.