

Oracle® Banking Trade Finance

Configuring JMS on Weblogic Server 12c



Release 14.7.4.0.0

F99214-01

June 2024

The Oracle logo, consisting of a solid red square with the word "ORACLE" in white, uppercase, sans-serif font centered within it.

ORACLE®

Oracle Banking Trade Finance Configuring JMS on Weblogic Server 12c, Release 14.7.4.0.0

F99214-01

Copyright © 2007, 2024, Oracle and/or its affiliates.

Primary Authors: (primary author), (primary author)

Contributing Authors: (contributing author), (contributing author)

Contributors: (contributor), (contributor)

This software and related documentation are provided under a license agreement containing restrictions on use and disclosure and are protected by intellectual property laws. Except as expressly permitted in your license agreement or allowed by law, you may not use, copy, reproduce, translate, broadcast, modify, license, transmit, distribute, exhibit, perform, publish, or display any part, in any form, or by any means. Reverse engineering, disassembly, or decompilation of this software, unless required by law for interoperability, is prohibited.

The information contained herein is subject to change without notice and is not warranted to be error-free. If you find any errors, please report them to us in writing.

If this is software, software documentation, data (as defined in the Federal Acquisition Regulation), or related documentation that is delivered to the U.S. Government or anyone licensing it on behalf of the U.S. Government, then the following notice is applicable:

U.S. GOVERNMENT END USERS: Oracle programs (including any operating system, integrated software, any programs embedded, installed, or activated on delivered hardware, and modifications of such programs) and Oracle computer documentation or other Oracle data delivered to or accessed by U.S. Government end users are "commercial computer software," "commercial computer software documentation," or "limited rights data" pursuant to the applicable Federal Acquisition Regulation and agency-specific supplemental regulations. As such, the use, reproduction, duplication, release, display, disclosure, modification, preparation of derivative works, and/or adaptation of i) Oracle programs (including any operating system, integrated software, any programs embedded, installed, or activated on delivered hardware, and modifications of such programs), ii) Oracle computer documentation and/or iii) other Oracle data, is subject to the rights and limitations specified in the license contained in the applicable contract. The terms governing the U.S. Government's use of Oracle cloud services are defined by the applicable contract for such services. No other rights are granted to the U.S. Government.

This software or hardware is developed for general use in a variety of information management applications. It is not developed or intended for use in any inherently dangerous applications, including applications that may create a risk of personal injury. If you use this software or hardware in dangerous applications, then you shall be responsible to take all appropriate fail-safe, backup, redundancy, and other measures to ensure its safe use. Oracle Corporation and its affiliates disclaim any liability for any damages caused by use of this software or hardware in dangerous applications.

Oracle®, Java, MySQL, and NetSuite are registered trademarks of Oracle and/or its affiliates. Other names may be trademarks of their respective owners.

Intel and Intel Inside are trademarks or registered trademarks of Intel Corporation. All SPARC trademarks are used under license and are trademarks or registered trademarks of SPARC International, Inc. AMD, Epyc, and the AMD logo are trademarks or registered trademarks of Advanced Micro Devices. UNIX is a registered trademark of The Open Group.

This software or hardware and documentation may provide access to or information about content, products, and services from third parties. Oracle Corporation and its affiliates are not responsible for and expressly disclaim all warranties of any kind with respect to third-party content, products, and services unless otherwise set forth in an applicable agreement between you and Oracle. Oracle Corporation and its affiliates will not be responsible for any loss, costs, or damages incurred due to your access to or use of third-party content, products, or services, except as set forth in an applicable agreement between you and Oracle.

Contents

Preface

Purpose	v
Weblogic 12c New Features	vi
Components Diagram & Data Flow	vii

1 Pre-Requisites

1.1 Machines	1-1
1.2 Dynamic Clusters and Managed Servers	1-1
1.3 DataSource	1-2
1.4 Shared Folder	1-3

2 JMS Configuration

2.1 Persistence Store Creation	2-1
2.2 JMS Server Creation	2-2
2.3 Cluster Configuration for Service Migration	2-4

3 JMS Module Creation

3.1 Module Creation	3-1
3.2 Sub Deployment Creation	3-2
3.3 Resource Creation	3-4
3.3.1 Queue Creation	3-4
3.3.2 Connection Factory Creation	3-7

4 Server Restart

5 Foreign Server Creation

5.1 Module Creation	5-1
5.2 Foreign Server Creation	5-2

6 Application Deployment

7 Frequently Asked Questions

7.1	Application and JMS Cluster Deployed on Same Cluster	7-2
7.2	Application Shows Warning upon Restart of Managed Servers	7-2
7.3	Securing File Store Data	7-2
7.4	t3s Protocol	7-3
7.5	How to Test the Deployment	7-3
7.6	Increase Maximum Number of Message-Driven Bean Threads	7-4
7.6.1	Modify weblogic-ejb-jar.xml	7-5
7.6.2	Work Manager Creation	7-5
7.7	How High Availability is Achieved	7-8
7.8	How to setup for Scheduler/Notifications	7-9
7.9	What other modules uses JMS Queue's	7-9
7.10	References	7-9

Index

Preface

Below is brief description on major components in Weblogic JMS Server architecture.

- [Purpose](#)
- [Weblogic 12c New Features](#)
- [Components Diagram & Data Flow](#)

Purpose

The purpose of this document is to explain the steps required for JMS Configuration in cluster mode for

1. FCUBS 12.1
2. WebLogic Server 12.1.3.0.0

JMS Server

JMS server acts as management container for JMS queue and topic resources defined within JMS modules that are targeted to specific that JMS server. A JMS server's main responsibility is to maintain persistent storage for these resources, maintain the state of durable subscriber and etc. JMS servers can host a defined set of modules and any associated persistent storage that reside on a WebLogic Server instance.

JMS Module

JMS modules are application-related definitions that are independent of the domain environment. JMS modules group JMS configuration resources (such as queues, topics, and connections factories).

These are outside domain configuration. JMS modules are globally available for targeting to servers and clusters configured in the domain and therefore are available to all the applications deployed on the same targeted. JMS modules contain configuration resources, such as standalone queue and topic destinations, distributed destinations, and connection factories.

Subdeployment

Subdeployment is also known as Advanced Targeting. Subdeployment resource is a bridge between the group of JMS resources and JMS Servers. When you create a JMS resource you need to choose one Subdeployment.

JMS Resources

1. **Queue** defines a point-to-point destination type, which are used for asynchronous peer communications. A message delivered to queue is distributed to only one customer.
2. **Topic** defines a publish/subscribe destination type, which are used for asynchronous peer communication. A message delivered to topic is distributed to all topic consumers.

3. **Distributed queue** defines a set of queues that are distributed on multiple JMS servers, but are accessible as a single, logical queue to JMS clients
4. **Distributed topic** defines a set of topics that are distributed on multiple JMS servers, but which as accessible as a single, logical topic to JMS clients.
5. **Uniform Distributed Queue:** queue members are created uniformly from a common configuration.

Persistence store

A persistent store provides a built-in, high-performance storage solution for weblogic server subsystems and services that required persistence. There are two type of mechanism to store the message.

1. File based persistence store → Message is stored in a file
2. DB based persistence store → Message is stored in Database.

Weblogic 12c New Features

Before weblogic 12c JMS Servers and stores are targeted to individual WLS Servers. Scaling up requires configure the JMS server, the store and target it to new WLS Server.

In 12c JMS Servers and stores are targeted to WLS cluster. Scaling up requires to add a WLS server to the cluster.

Figure 1 Architecture Previous to 12c

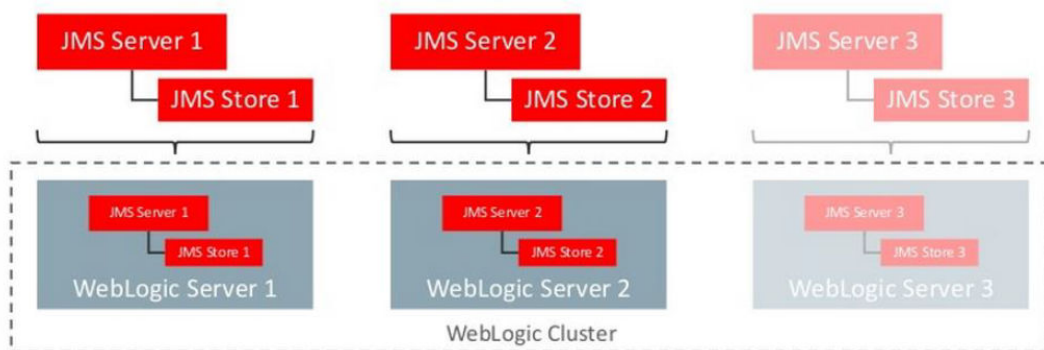
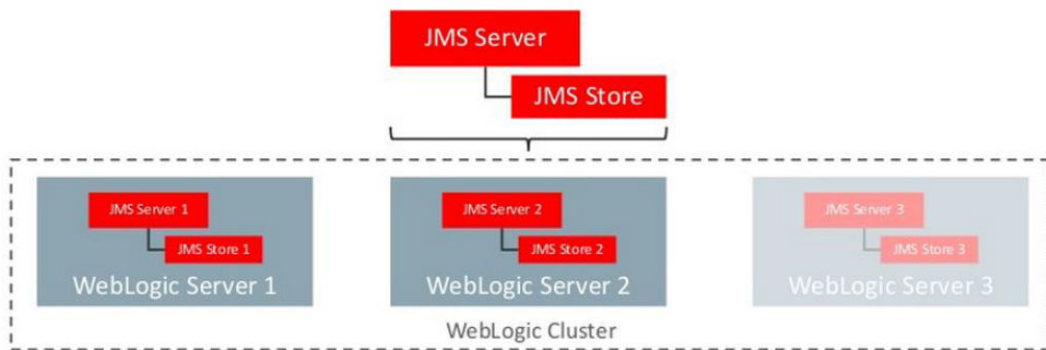
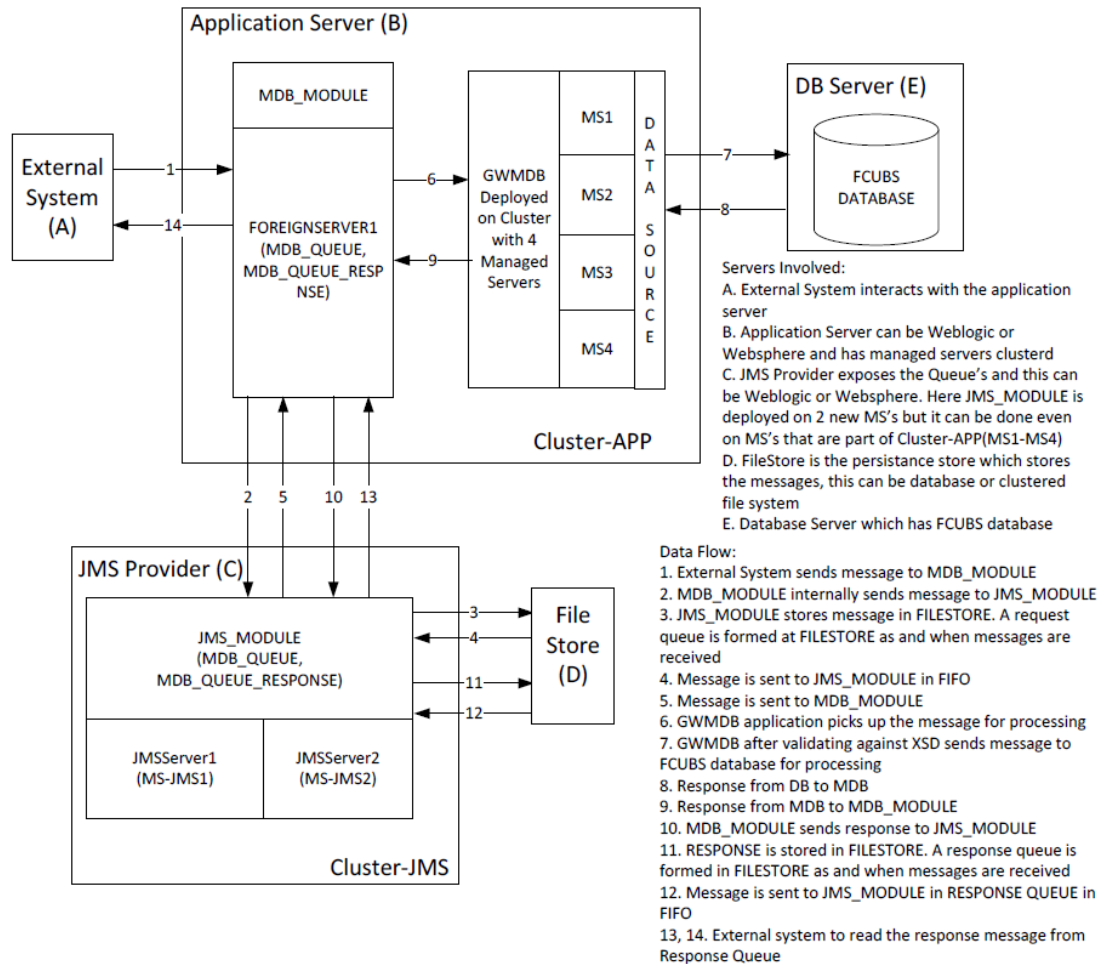

Figure 2 Architecture in 12c



Components Diagram & Data Flow

Below is the flow diagram which indicates various components that are used and the document explain steps to create.



1

Pre-Requisites

The document assumes that the below are created before proceeding JMS creation.

- [Machines](#)
- [Dynamic Clusters and Managed Servers](#)
- [DataSource](#)
- [Shared Folder](#)

1.1 Machines

Figure 1-1 MAC-1 & MAC-2

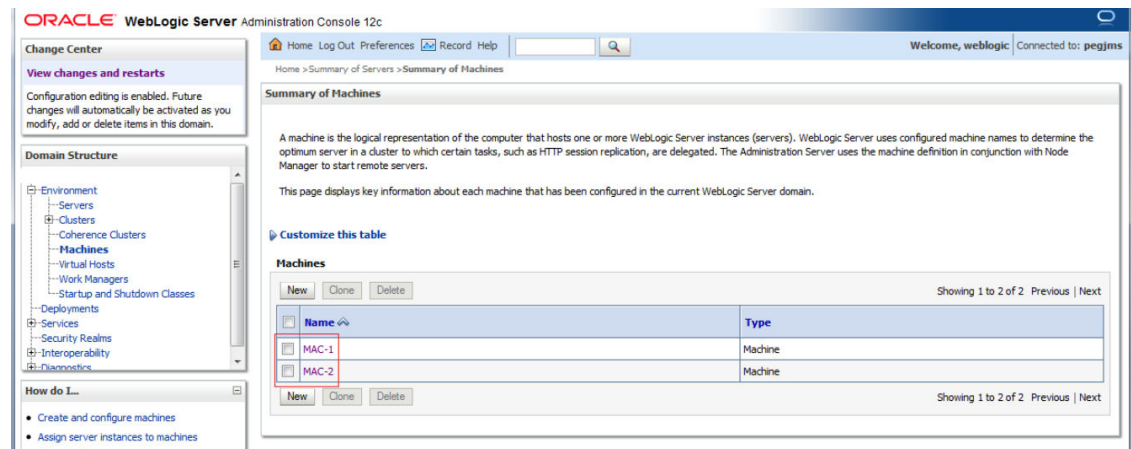

1.2 Dynamic Clusters and Managed Servers

Ensure Dynamic cluster for FCUBS (4 Managed Servers) and Dynamic cluster for JMS Deployment (2 Managed Servers).

Summary of Clusters

This page summarizes the clusters that have been configured in the current WebLogic Server domain.

A cluster defines groups of WebLogic Server servers that work together to increase scalability and reliability.

Clusters (Filtered - More Columns Exist)

Name	Cluster Address	Cluster Messaging Mode	Migration Basis	Default Load Algorithm	Replication Type	Cluster Broadcast Channel	Servers
Cluster-App		Unicast	Database	Round Robin	(None)		DC_FCUBS_1, DC_FCUBS_2, DC_FCUBS_3, DC_FCUBS_4
Cluster-JMS		Unicast	Database	Round Robin	(None)		DC_JMS_1, DC_JMS_2

Summary of Servers

This page summarizes each server that has been configured in the current WebLogic Server domain.

Servers (Filtered - More Columns Exist)

Name	Type	Cluster	Machine	State	Health	Listen Port
AdminServer(admin)	Configured			RUNNING	OK	7001
DC_FCUBS_1	Dynamic	Cluster-App	MAC-1	SHUTDOWN	Not reachable	7101
DC_FCUBS_2	Dynamic	Cluster-App	MAC-2	SHUTDOWN	Not reachable	7102
DC_FCUBS_3	Dynamic	Cluster-App	MAC-1	SHUTDOWN	Not reachable	7103
DC_FCUBS_4	Dynamic	Cluster-App	MAC-2	SHUTDOWN	Not reachable	7104
DC_JMS_1	Dynamic	Cluster-JMS	MAC-1	SHUTDOWN	Not reachable	7106
DC_JMS_2	Dynamic	Cluster-JMS	MAC-2	SHUTDOWN	Not reachable	7107

1.3 DataSource

Ensure that DataSource required for the MDB ear is created with Target as Cluster-App.

Summary of JDBC Data Sources

This page summarizes the JDBC data source objects that have been created in this domain.

Data Sources (Filtered - More Columns Exist)

Name	Type	JNDI Name	Targets
FLEXTST.WORLD	Generic	FLEXTST.WORLD	Cluster-App

1.4 Shared Folder

A shared folder for File Store Creation is required and this folder should be accessible across both the servers (eg, NFS mount).

2

JMS Configuration

- Persistence Store Creation
- JMS Server Creation
- Cluster Configuration for Service Migration

2.1 Persistence Store Creation

1. Navigate to Services > Persistent Stores > New > **Create FileStore**.

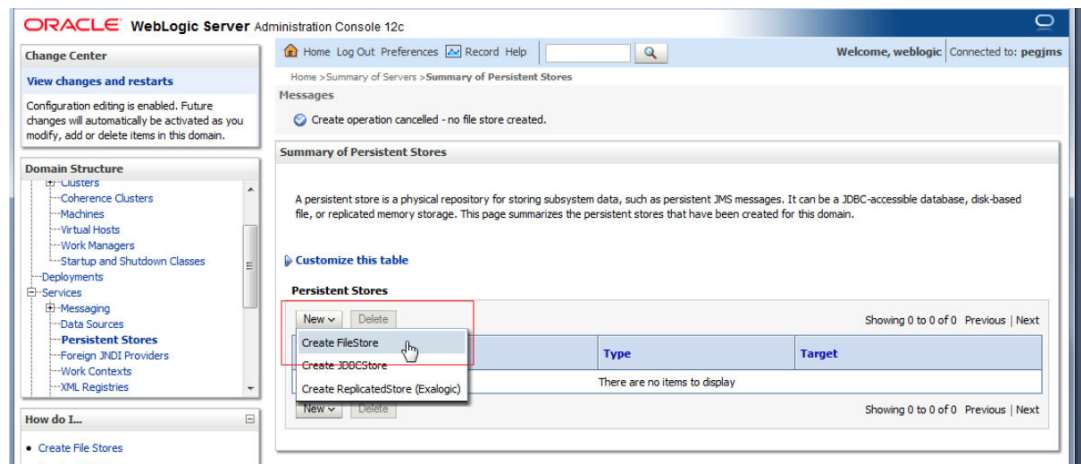
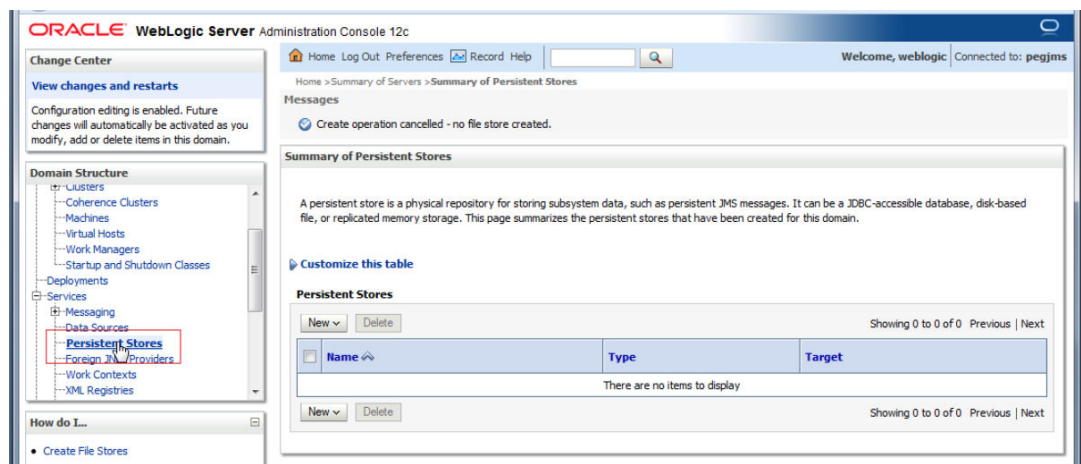

2. Select **Cluster-JMS** under target drop-down and Click on **OK**.

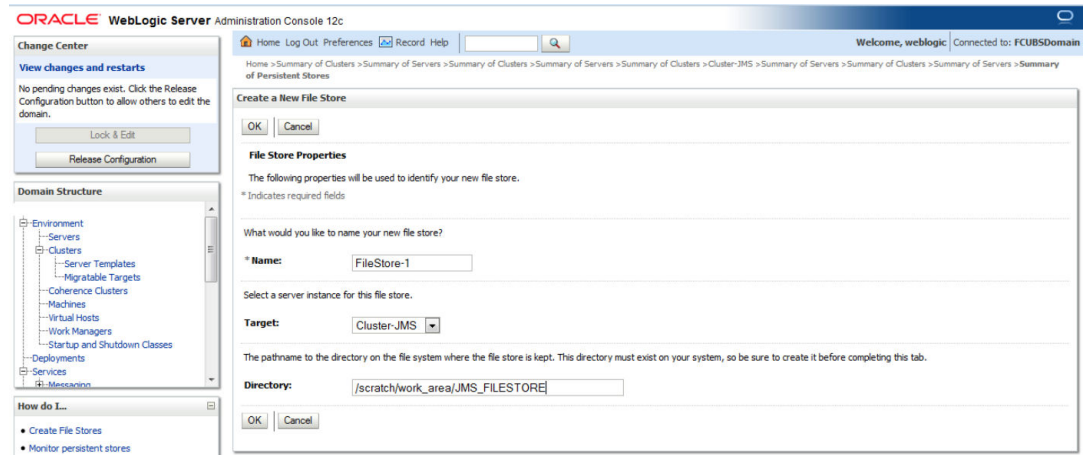

3. FileStore-1 is created.

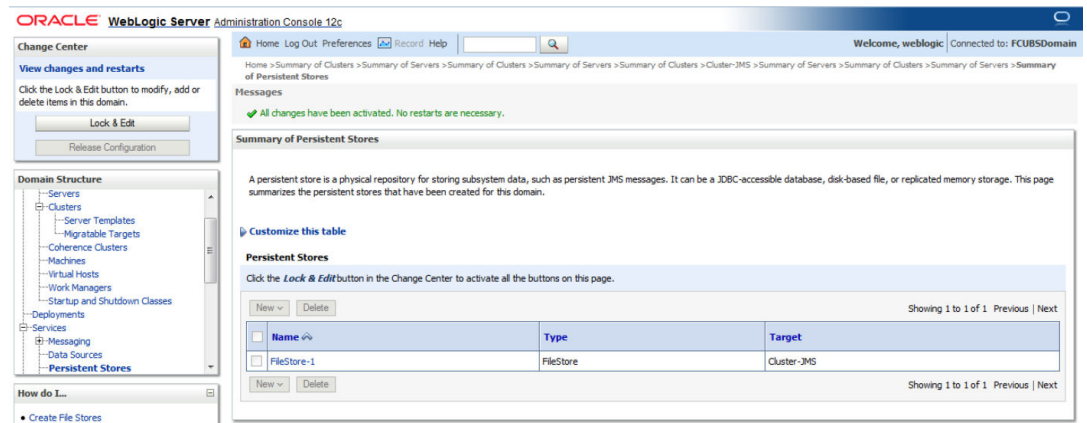

2.2 JMS Server Creation

1. Navigate to Services > Messaging > JMS Servers > Click on **New**.

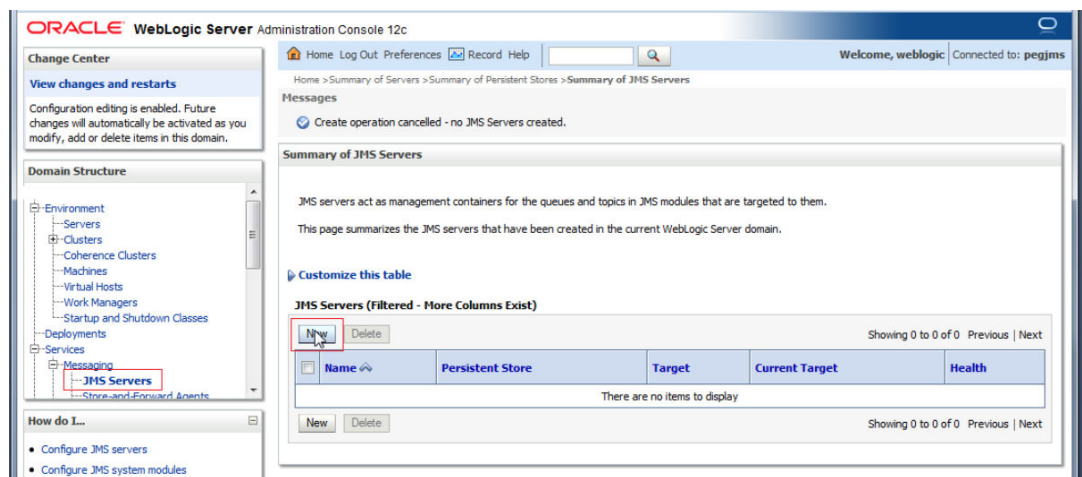

2. Select FileStore-1, Click **Next**.

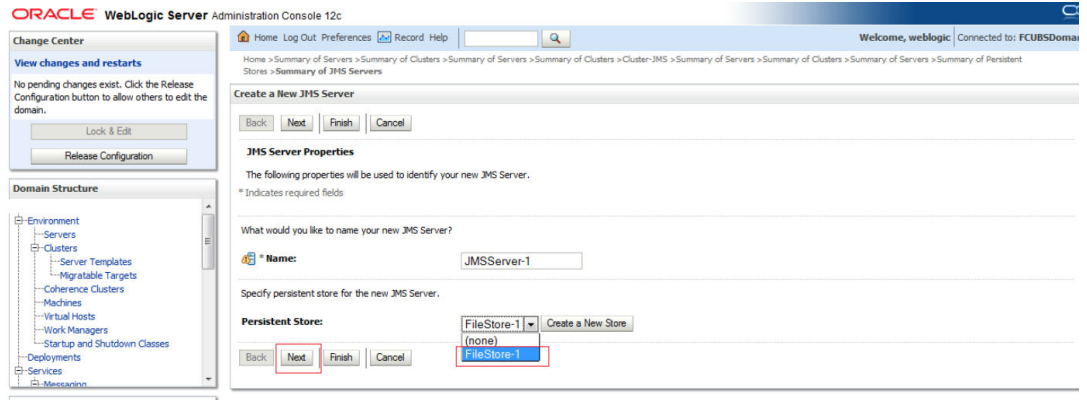

3. Select Target as Cluster-JMS and click on **Finish**.

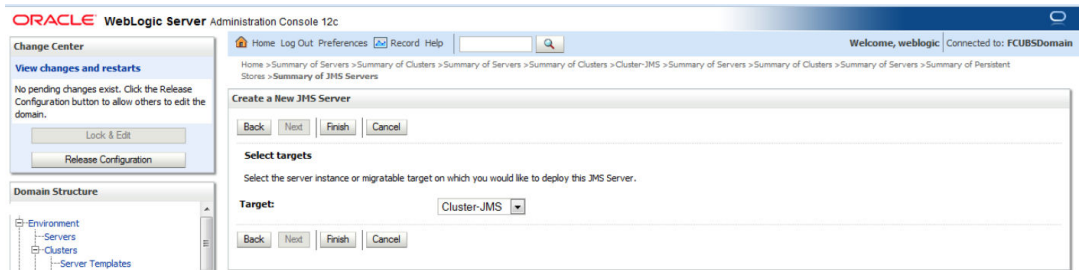
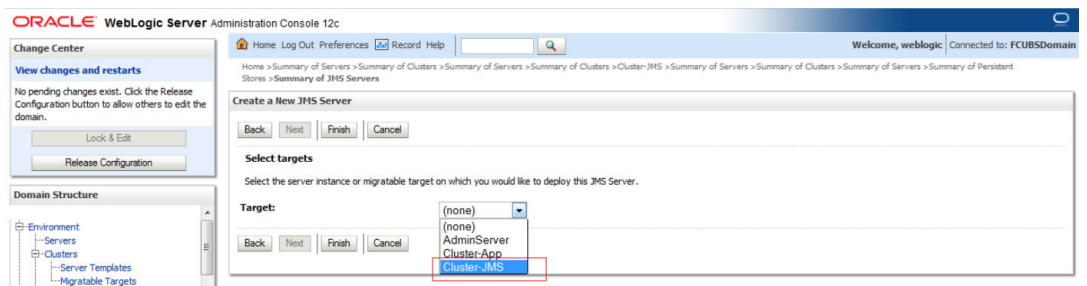

4. JMS-Server-1 is created.

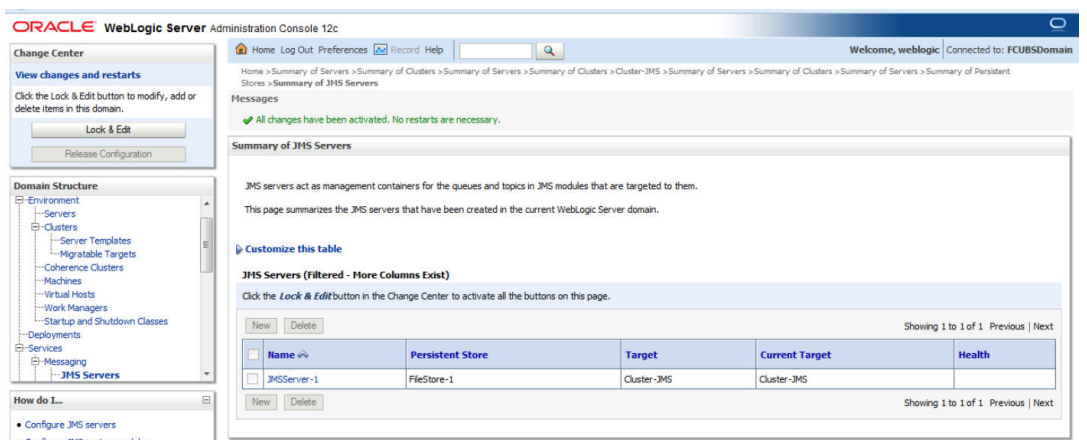

- In NFS below filestores can be seen.

```
[root@      JMS_FILESTORE]# ll
total 2056
-rw-r----- 1 wll2c oinstall 1049088 Jun 16 14:10 FILESTORE-1@DC_JMS_1000000.DAT
-rw-r----- 1 wll2c oinstall 1049088 Jun 16 14:10 FILESTORE-1@DC_JMS_2000000.DAT
[root@      JMS_FILESTORE]# pwd
/scratch/work_area/JMS_FILESTORE
[root@      JMS_FILESTORE]#
```

2.3 Cluster Configuration for Service Migration

- Click on Environment > Clusters > Cluster-JMS

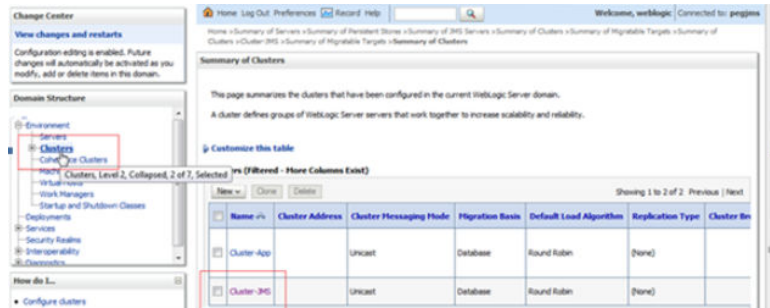

- Click on **Migration** Tab.

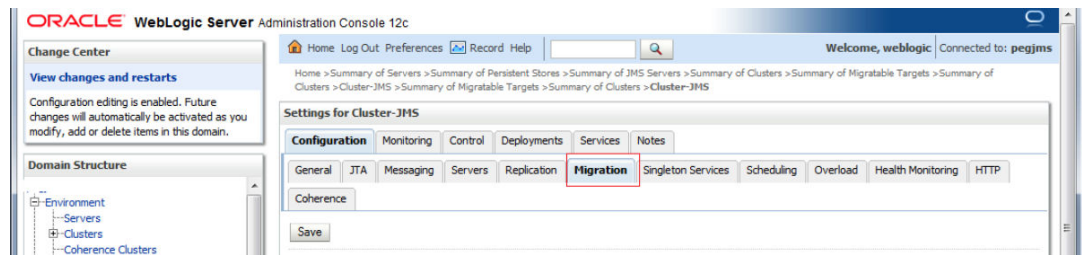

- Change Migration Basis to Consensus and Click on **Save**.

3

JMS Module Creation

- Module Creation
- Sub Deployment Creation
- Resource Creation

3.1 Module Creation

1. Navigate to Services > Messaging > JMS Modules and Click on **New**.

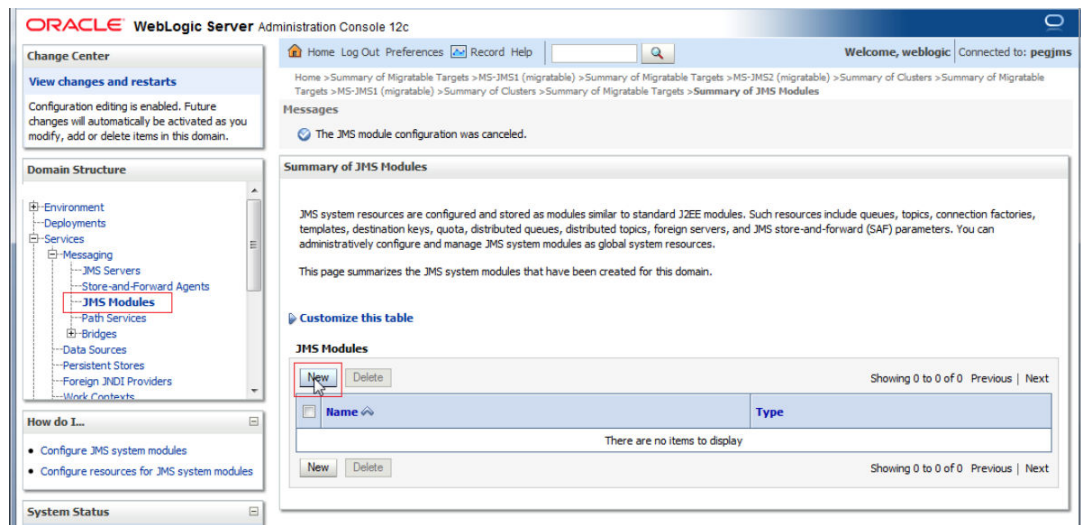

2. Enter name as JMS_MODULE and Click on **Next**.

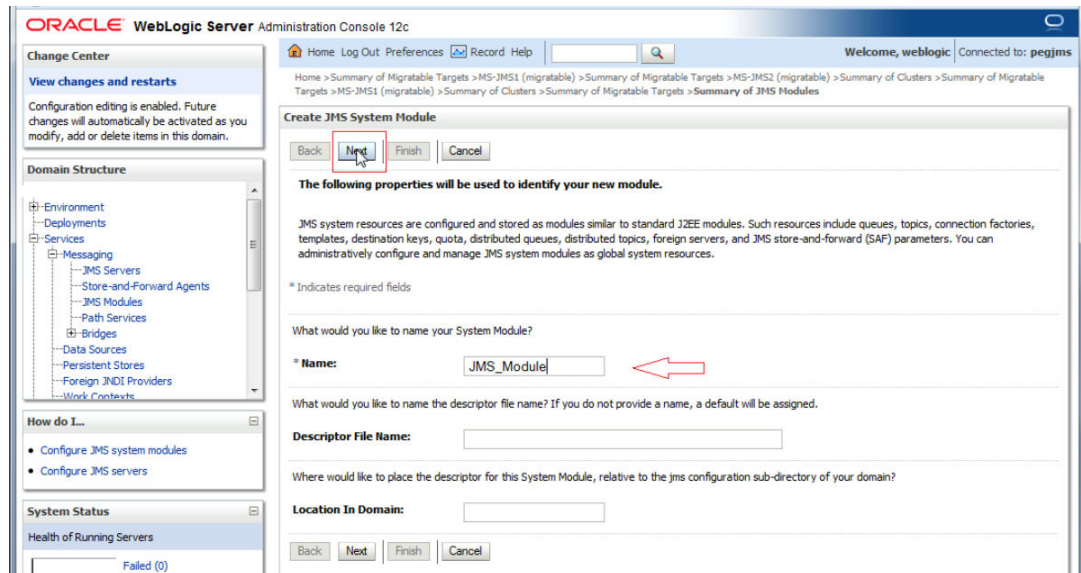

3. Select Target as Cluster-JMS and Click on **Next**.

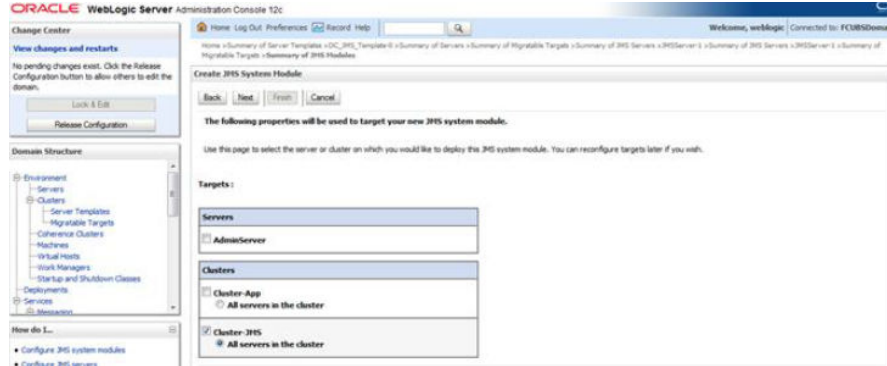

4. Select the checkbox and Click on **Finish**.

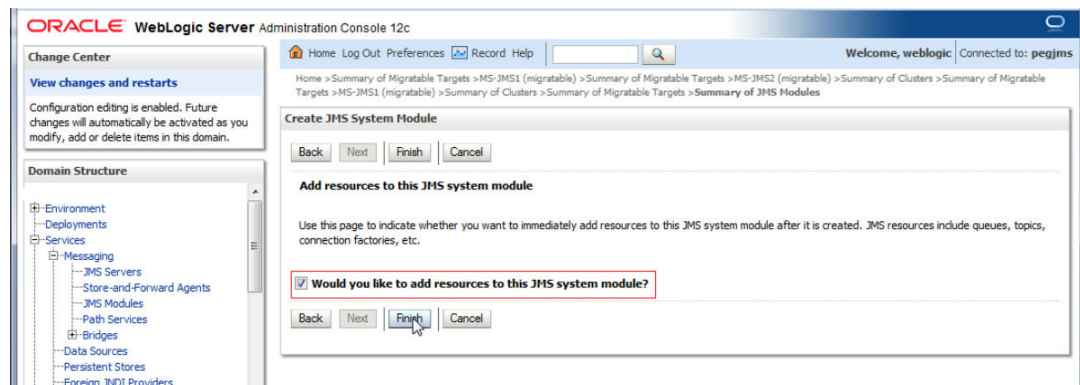

5. JMS_MODULE is created.

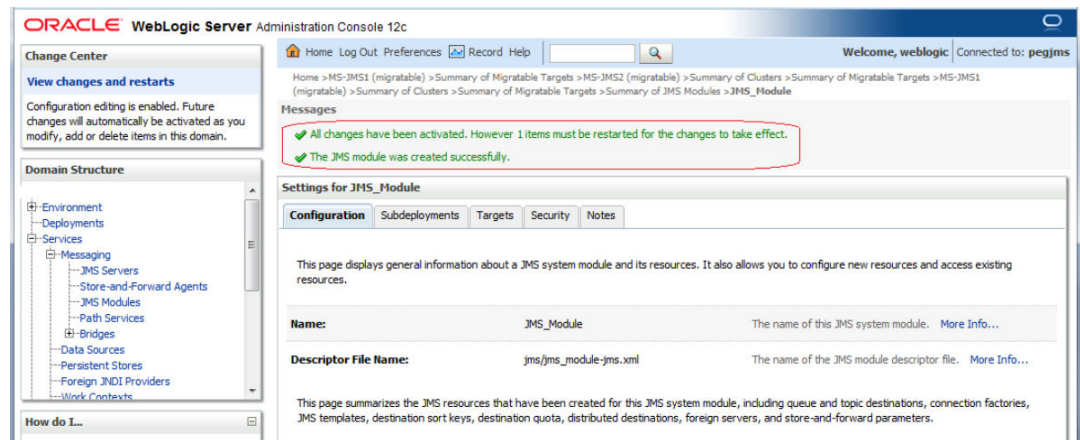

3.2 Sub Deployment Creation

1. In JMS_MODULE, Click on **SubDeployment** tab, Click on **New**.

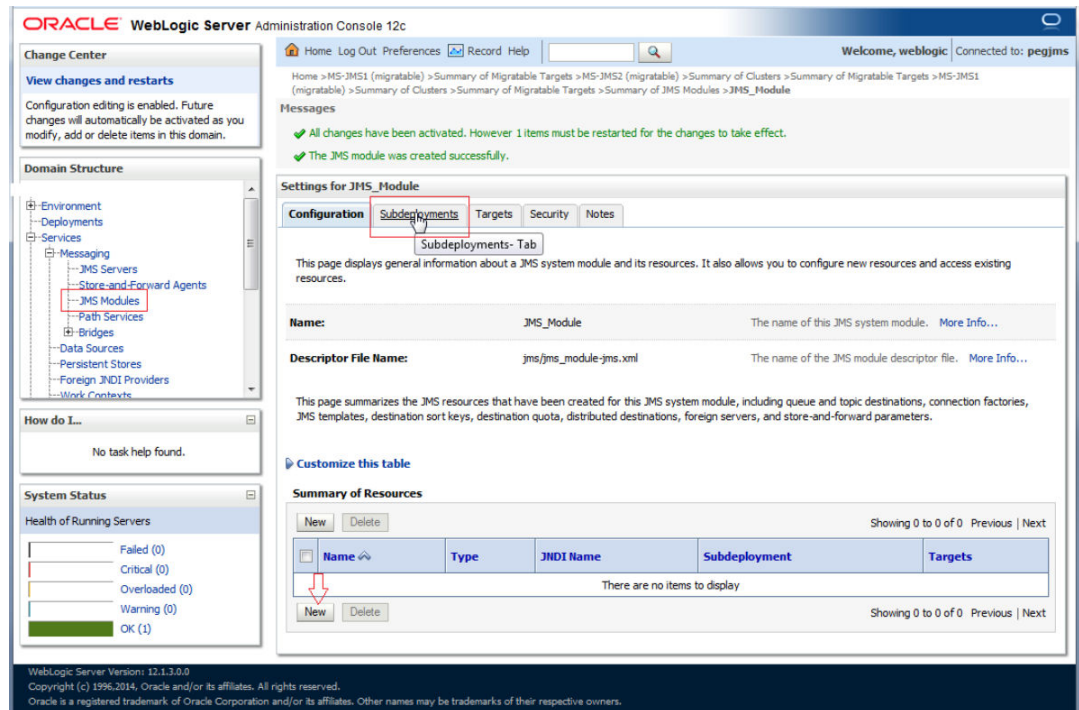

2. Enter name as JMS_SUB and click on Next.

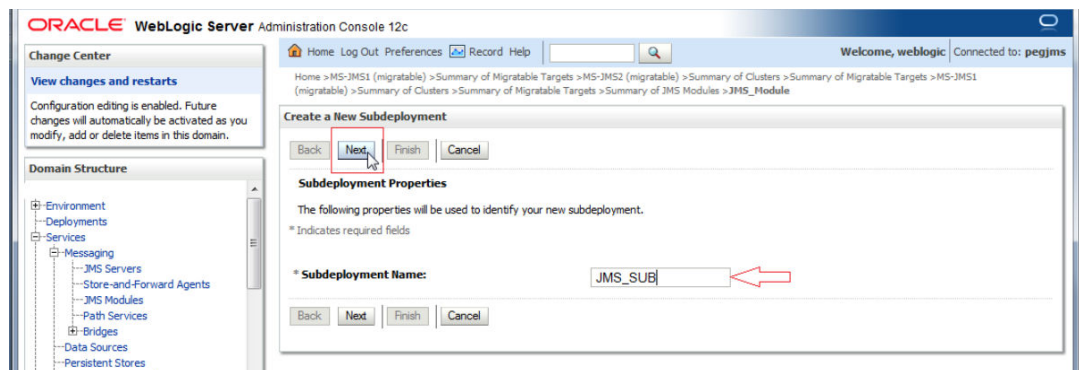

3. Select Target as Cluster-JMS and Click on Finish.

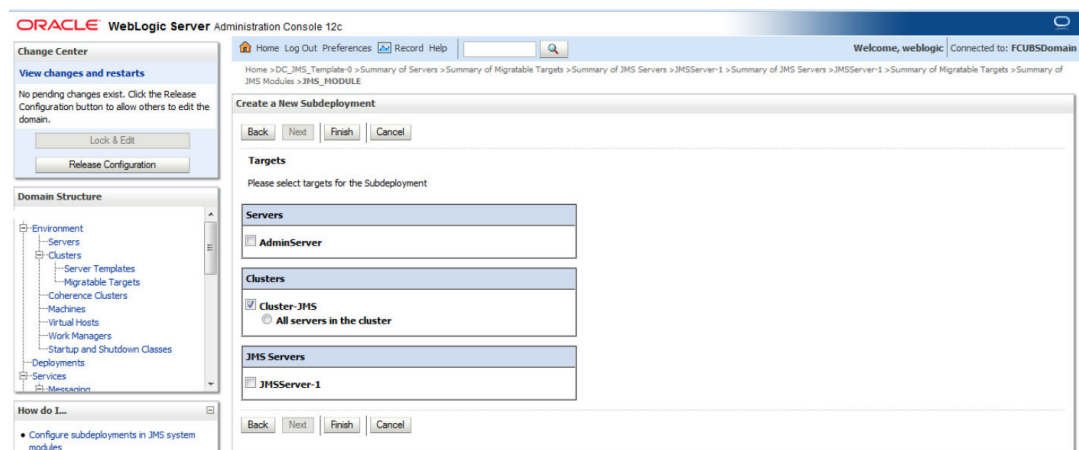

4. Sub-Deployment is created

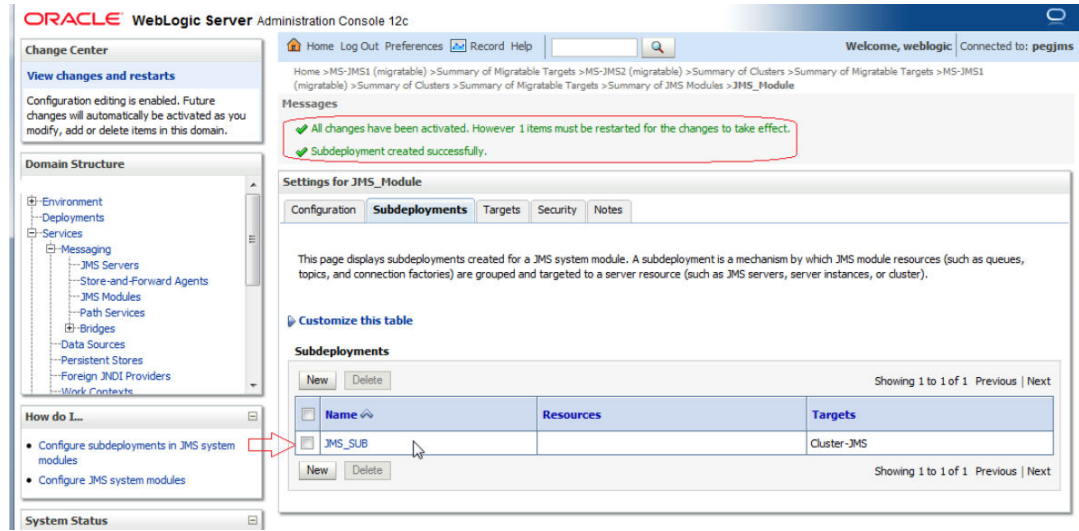

3.3 Resource Creation

- Queue Creation
- Connection Factory Creation

3.3.1 Queue Creation

1. In JMS_MODULE Click on **New**.

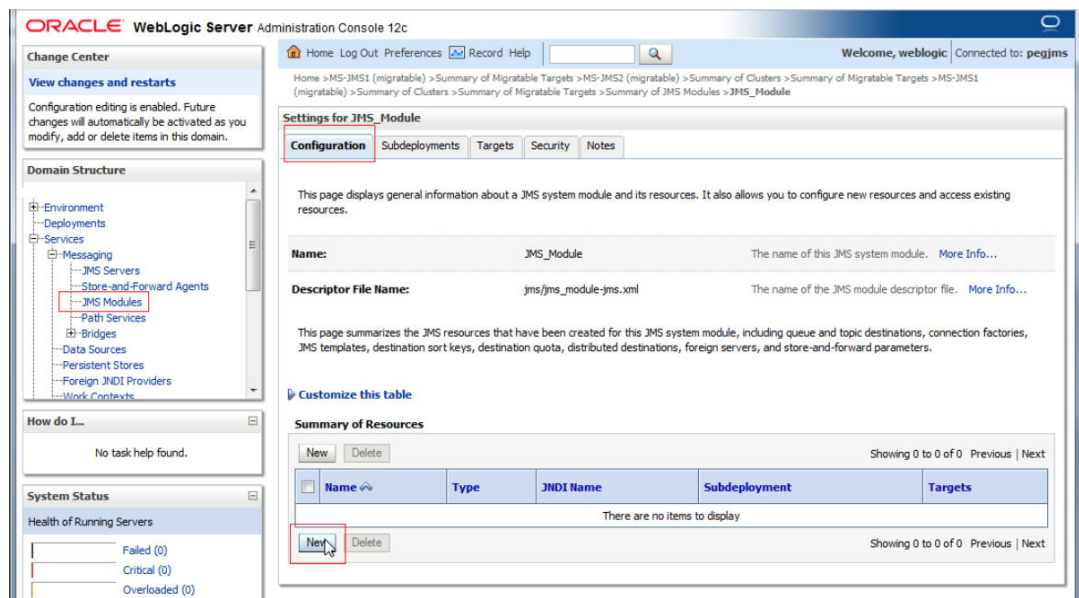

2. Select Distributed Queue and Click on **Next**.

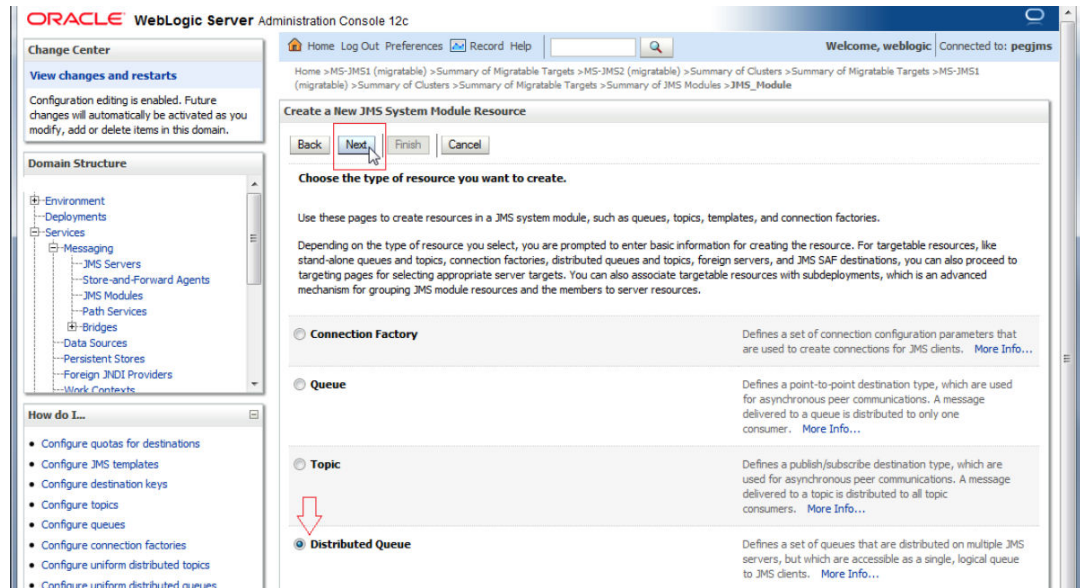

3. Enter the queue name and Click on Next.

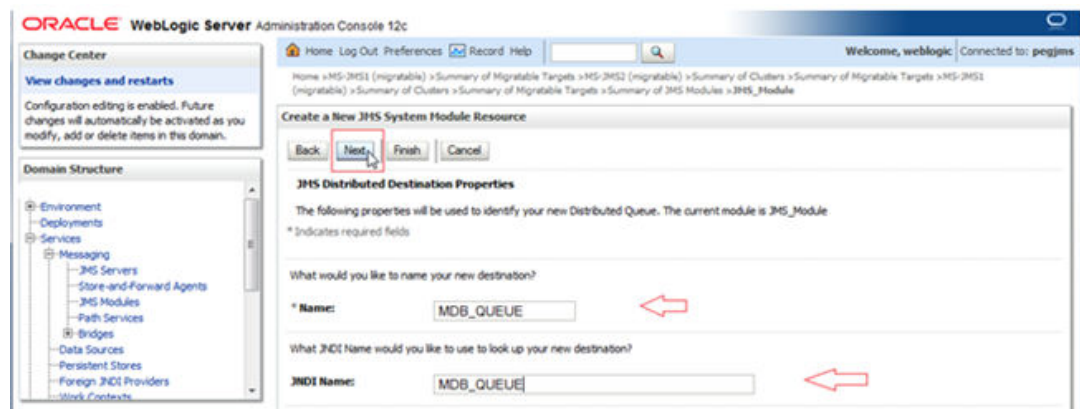

4. Click on **Advance Targeting**.

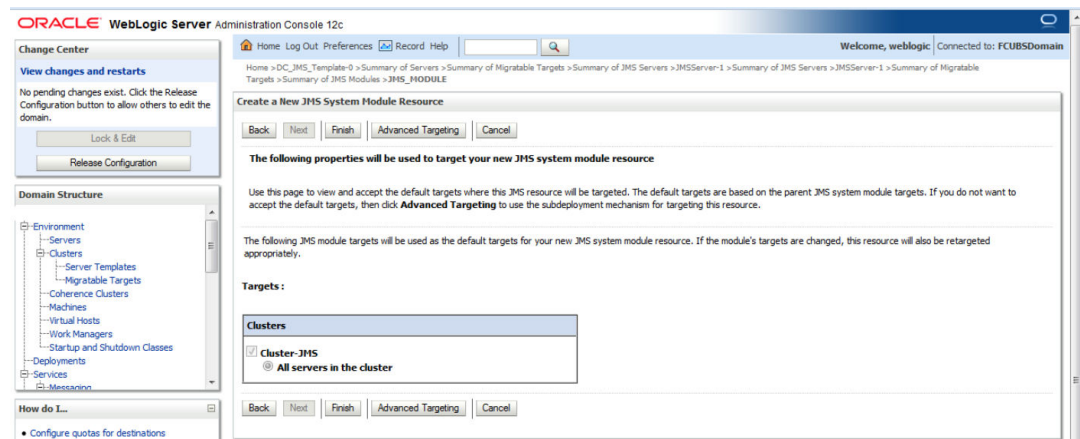

5. Select Subdeployment as JMS_SUB and Click on **Finish**.

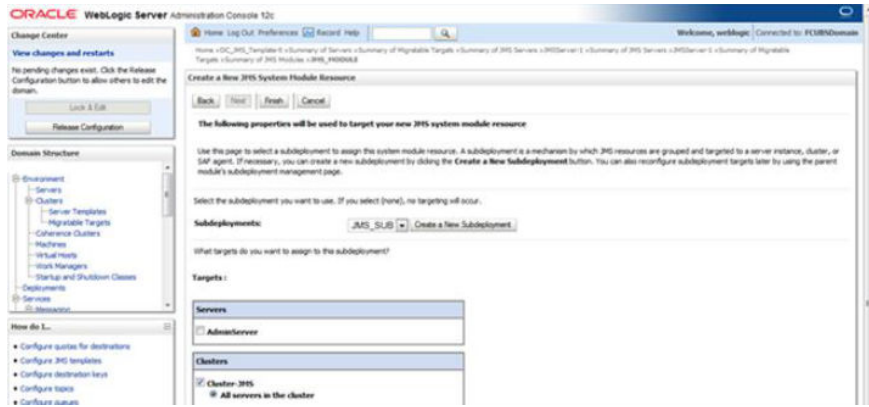

6. MDB_QUEUE is created

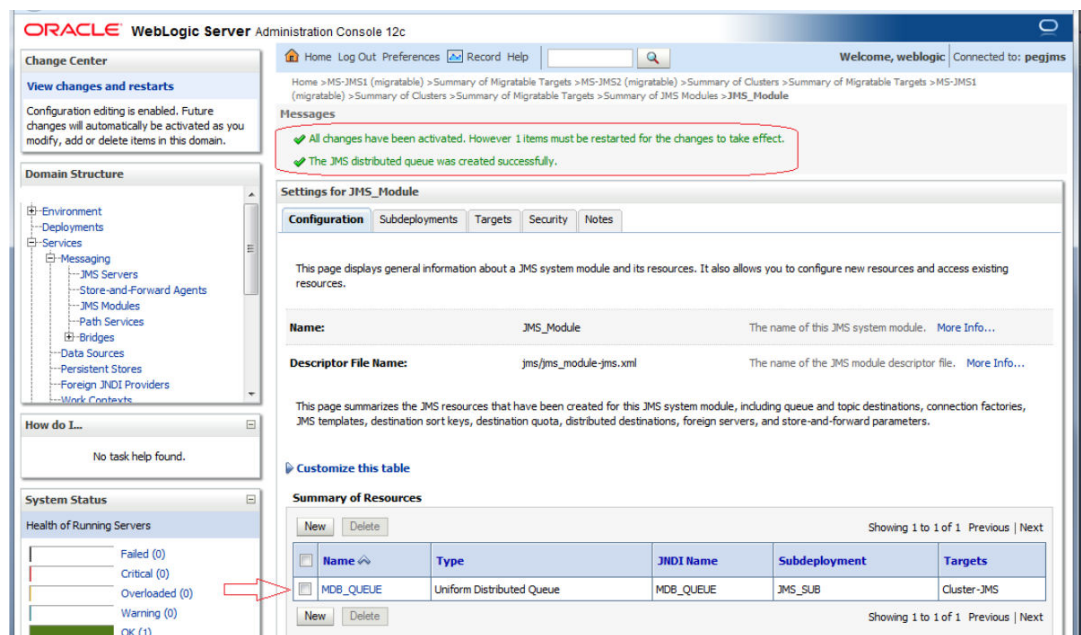

7. Similarly Create MDB_QUEUE_RESPONSE and MDB_QUEUE_DLQ

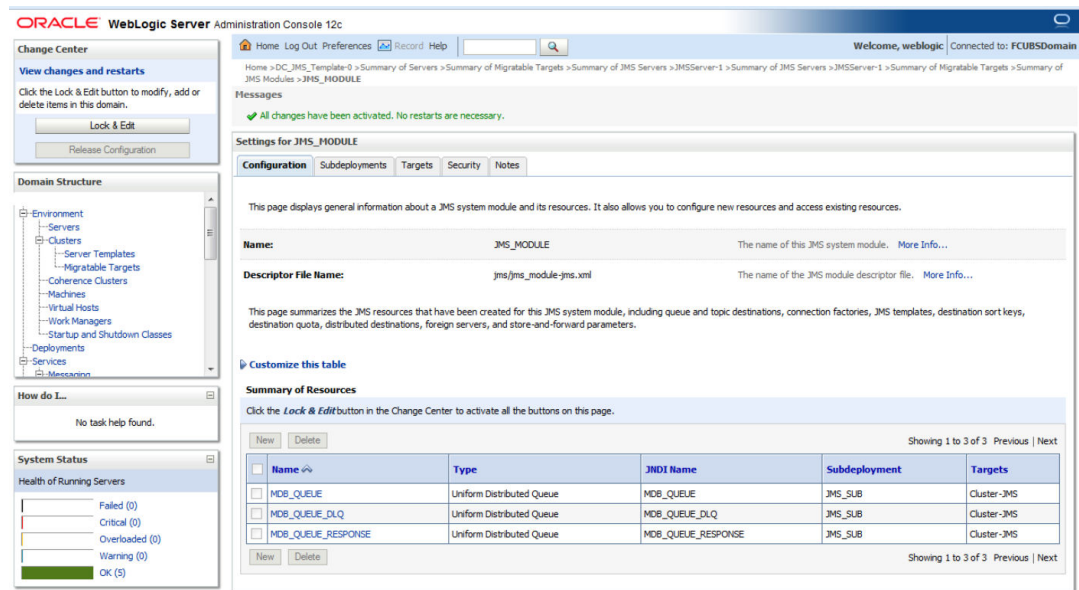

3.3.2 Connection Factory Creation

1. In JMS_MODULE, Click on **New**.

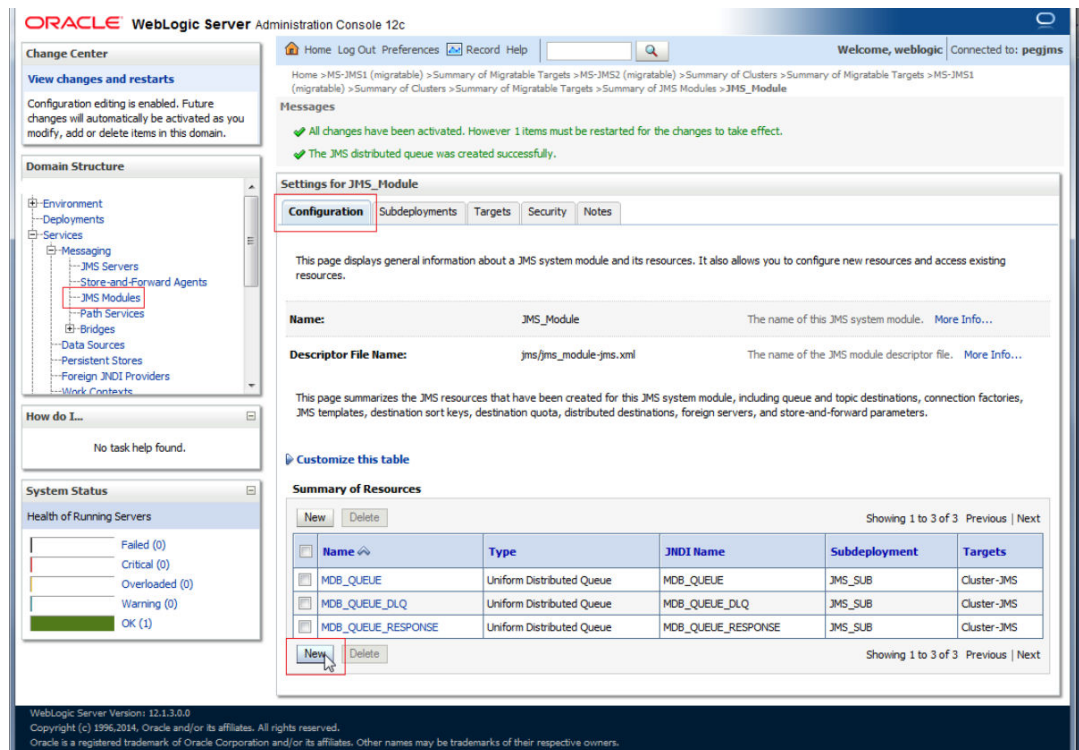

2. Select Connection Factory and click on **Next**.

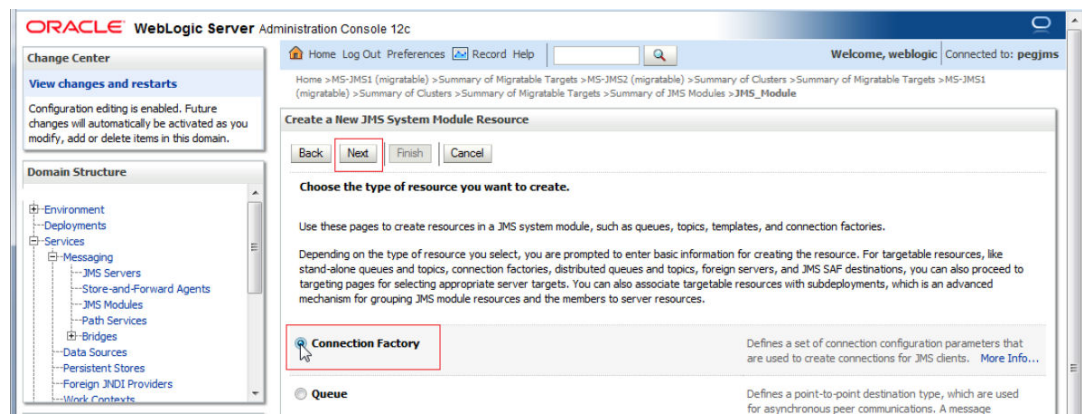

3. Enter the Name and Click on **Next**.

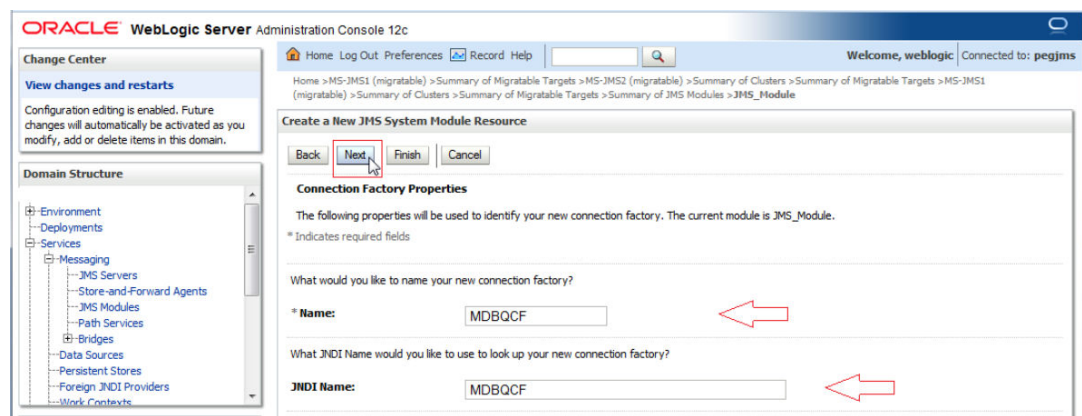

4. Click on **Advance Targeting**.

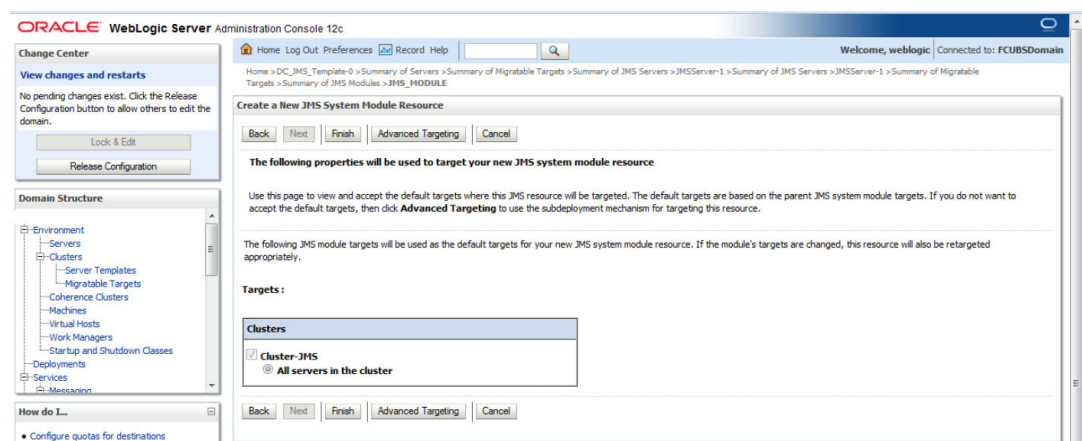

5. Select **JMS_SUB** and Click on **Finish**.

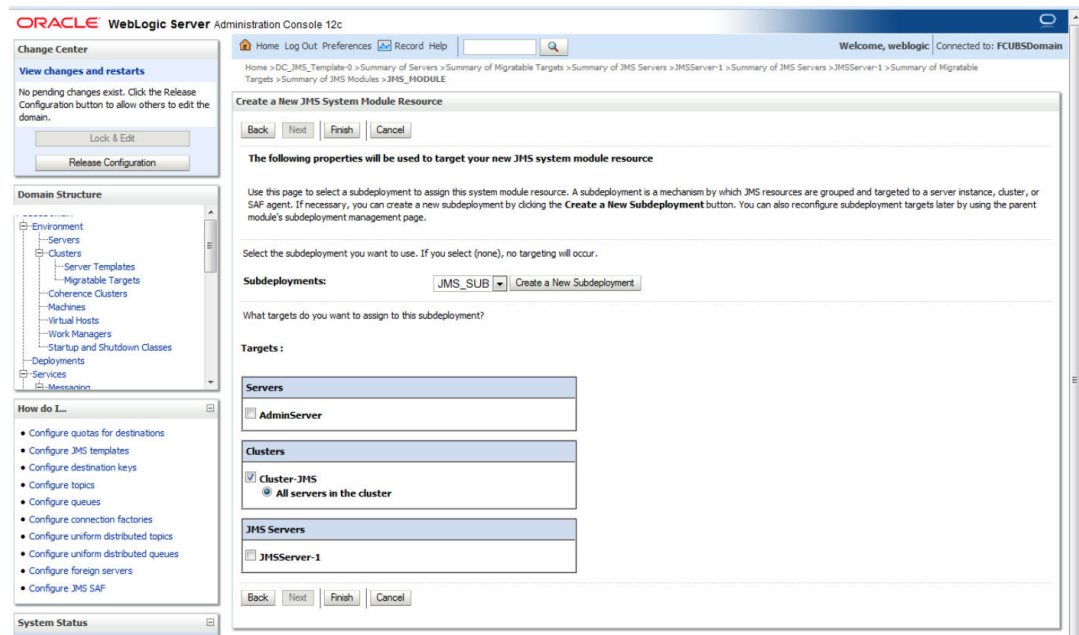

6. Connection Factory is Created.

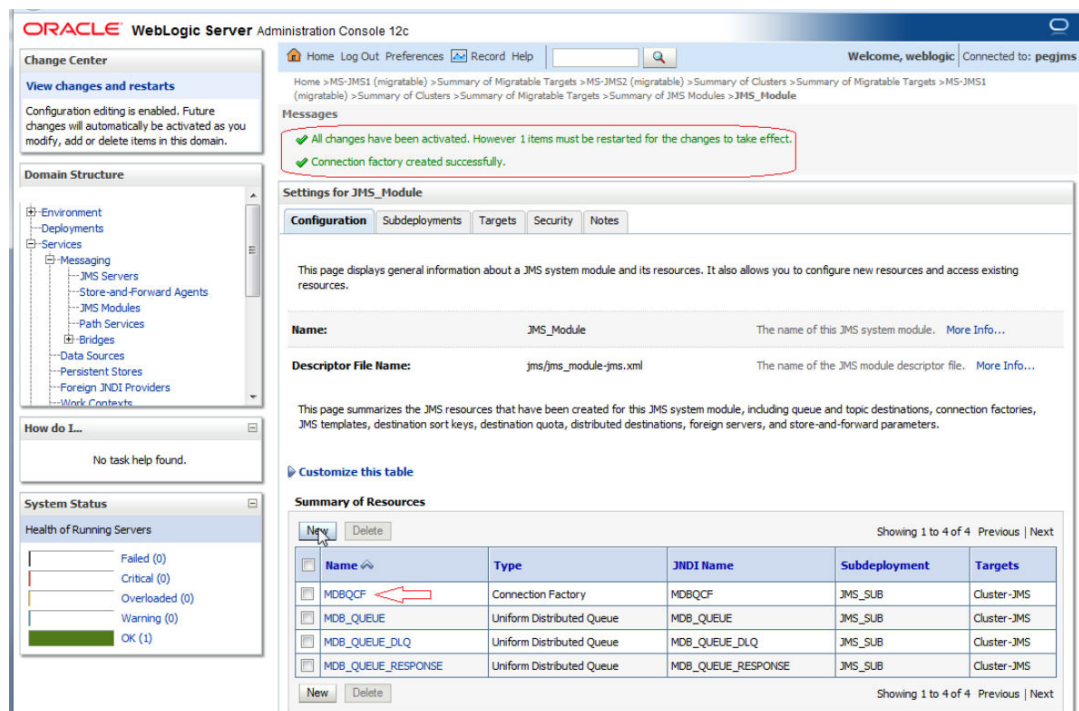

4

Server Restart

1. Increase the heap size of both DC_JMS_1 and DC_JMS_2 cluster.

ORACLE WebLogic Server Administration Console 12c

Home Log Out Preferences Record Help

Welcome, weblogic Connected to: FCUBSDomain

Home > Summary of JMS Servers > JMSServer-1 > Summary of JMS Servers > JMSServer-1 > Summary of Migratable Targets > Summary of JMS Modules > JMS_MODULE > ConnectionFactory-0 > placeholder > Summary of Servers

Summary of Servers

Configuration Control

A server is an instance of WebLogic Server that runs in its own Java Virtual Machine (JVM) and has its own configuration. This page summarizes each server that has been configured in the current WebLogic Server domain.

Customize this table

Servers (Filtered - More Columns Exist)

Click the **Lock & Edit** button in the Change Center to activate all the buttons on this page.

Name	Type	Cluster	Machine	State	Health	Listen Port
AdminServer (admin)	Configured			RUNNING	OK	7001
DC_FCUBS_1	Dynamic	Cluster-App	MAC-1	SHUTDOWN	Not reachable	7101
DC_FCUBS_2	Dynamic	Cluster-App	MAC-2	SHUTDOWN	Not reachable	7102
DC_FCUBS_3	Dynamic	Cluster-App	MAC-1	SHUTDOWN	Not reachable	7103
DC_FCUBS_4	Dynamic	Cluster-App	MAC-2	SHUTDOWN	Not reachable	7104
DC_JMS_1	Dynamic	Cluster-JMS	MAC-1	SHUTDOWN	Not reachable	7106
DC_JMS_2	Dynamic	Cluster-JMS	MAC-2	SHUTDOWN	Not reachable	7107

2. Select the cluster 'DC_JMS_Template-0' and

ORACLE WebLogic Server Administration Console 12c

Home Log Out Preferences Record Help

Welcome, weblogic Connected to: FCUBSDomain

Home > JMSServer-1 > Summary of Migratable Targets > Summary of JMS Modules > JMS_MODULE > ConnectionFactory-0 > placeholder > Summary of Servers > Summary of Server Templates > DC_JMS_Template-0 > Summary of Server Templates

Summary of Server Templates

This page summarizes each server template that has been configured in the current WebLogic Server domain. A server template contains common, non-default attributes that you can apply to a set of server instances, which then inherit the template configuration. Server templates enable you to easily manage configuration for a group of server instances in one centralized location.

Customize this table

Server Templates

Click the **Lock & Edit** button in the Change Center to activate all the buttons on this page.

Name	Cluster	Machine	Listen Port	Listen Address
DC_FCUBS_Template	Cluster-App		7100	
DC_JMS_Template-0	Cluster-JMS		7105	

3. Click on **Server Start** Tab and in Arguments Section enter `-XX:MaxPermSize=512m`

The screenshot displays the Oracle WebLogic Server Administration Console interface. The main content area is titled "Settings for DC_JMS_Template-0" and is divided into several tabs: Configuration, Protocols, Logging, Debug, and Notes. The "Server Start" tab is selected and highlighted with a red box. Below the tabs, there is a "Save" button and a descriptive paragraph about the Node Manager utility. The configuration fields are as follows:

- Java Home:** A text input field with a "More Info..." link.
- Java Vendor:** A text input field with a "More Info..." link.
- BEA Home:** A text input field with a "More Info..." link.
- Root Directory:** A text input field with a "More Info..." link.
- Class Path:** A large text area with a "More Info..." link.
- Arguments:** A text input field containing the value `-XX:MaxPermSize=512m`, highlighted with a red box. It includes a "More Info..." link.

On the left side of the console, there are several panels: "Change Center" with "View changes and restarts" and "Release Configuration" buttons; "Domain Structure" showing a tree view of the environment; "How do I..."; "System Status" showing "Health of Running Servers" with counts for Failed (0), Critical (0), and Overloaded (0).

4. **Restart** the AdminServer and DC_JMS_1 and DC_JMS_2 managed servers.

5

Foreign Server Creation

- Module Creation
- Foreign Server Creation
- Foreign Server Configuration

5.1 Module Creation

1. JMS_Modules and Click on **New**.

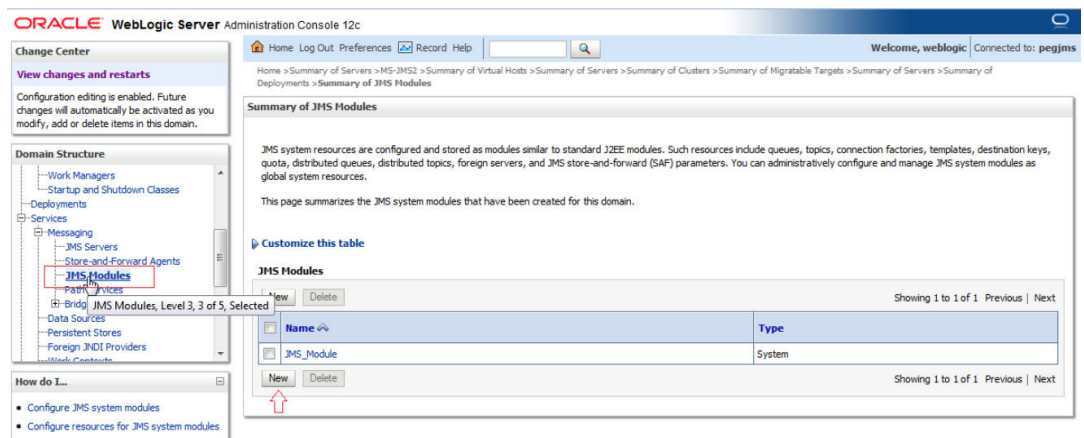

2. Enter name as **MDB_MODULE** and click on **Next**.

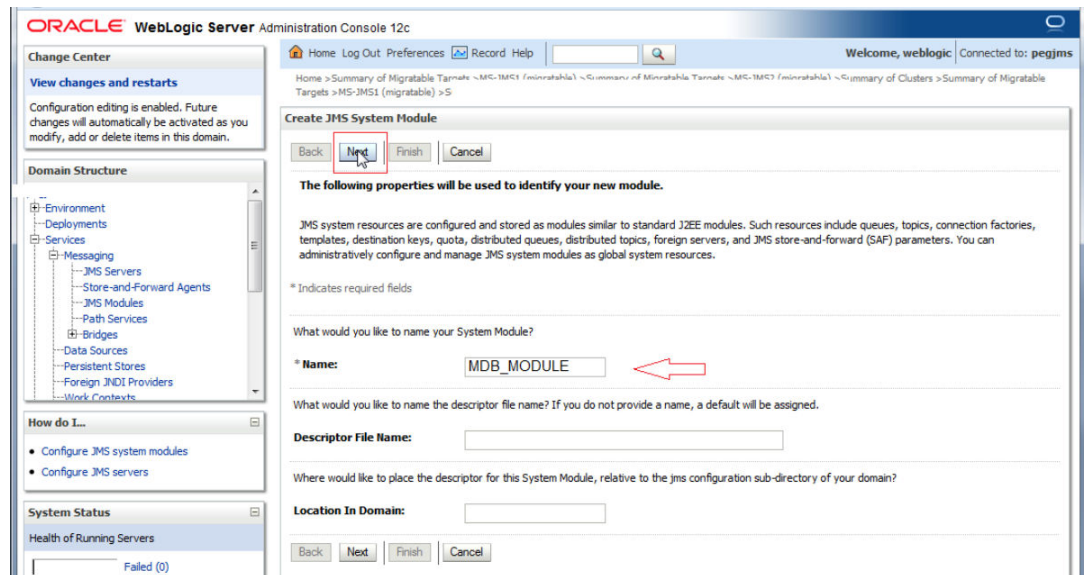

3. Select target as **Cluster-App** and click on **Next**.



4. Select CheckBox and Click on **Finish**.

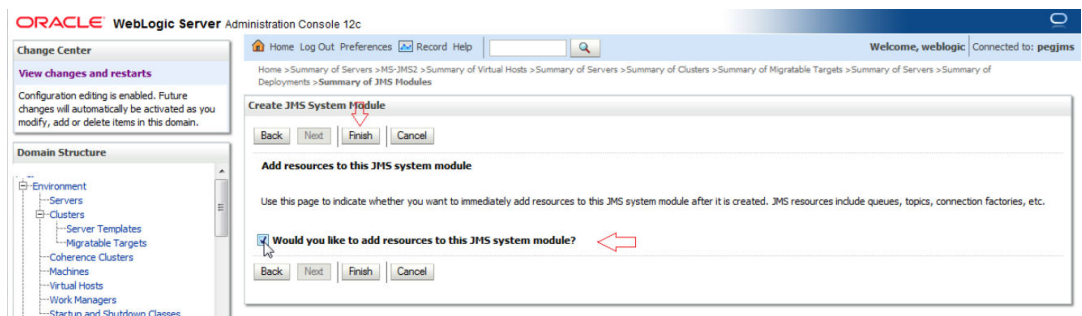

5. MDB_MODULE is created.

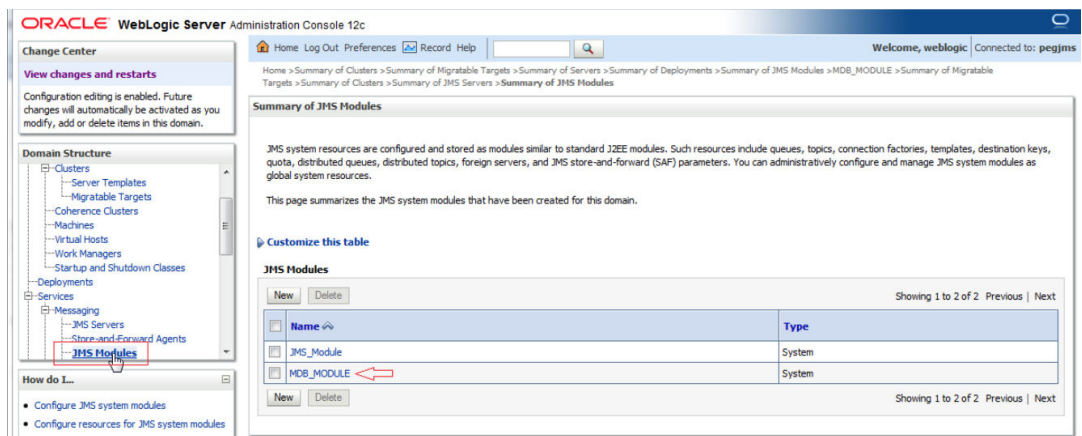

5.2 Foreign Server Creation

1. In MDB_MODULE, Click on New Resource, Select **Foreign Server**.

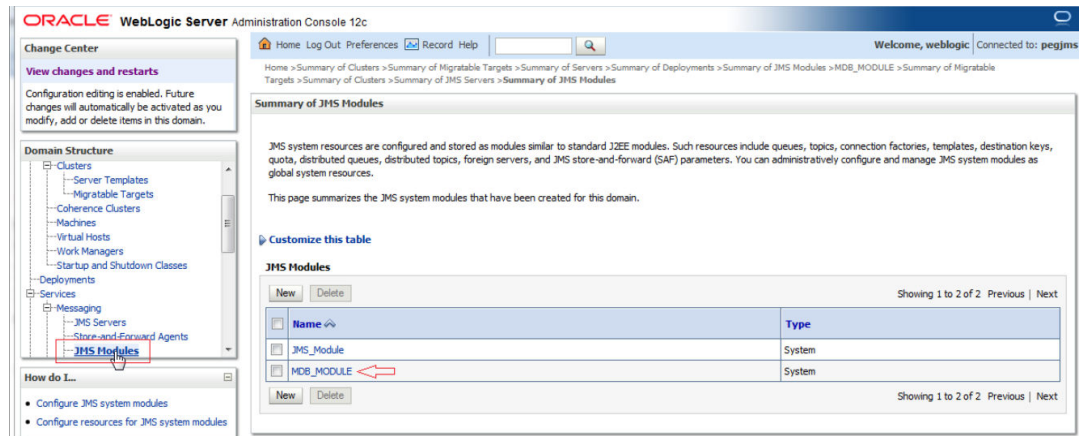

2. Click on Configuration **New**.

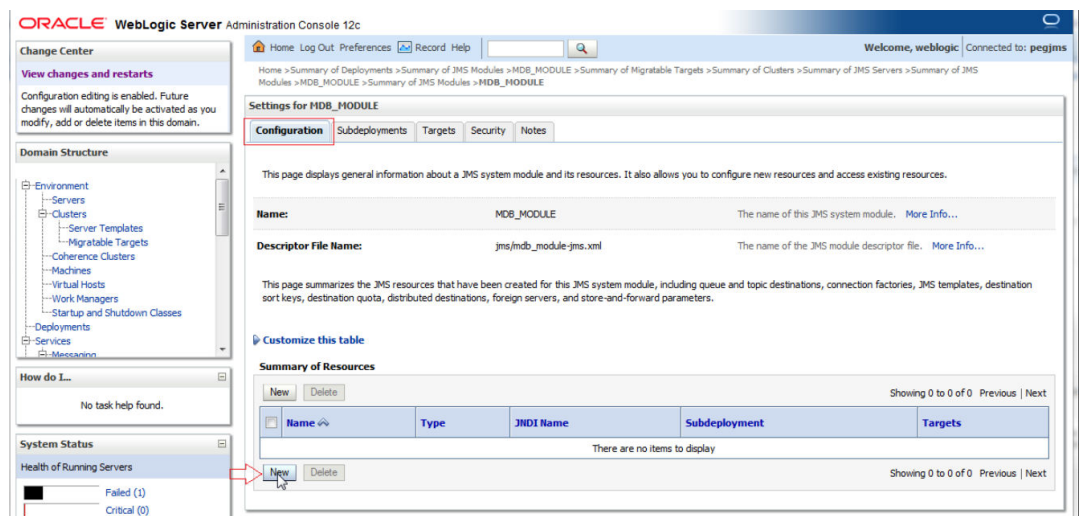

3. Select **Foreign Server** and Click on **Next**.

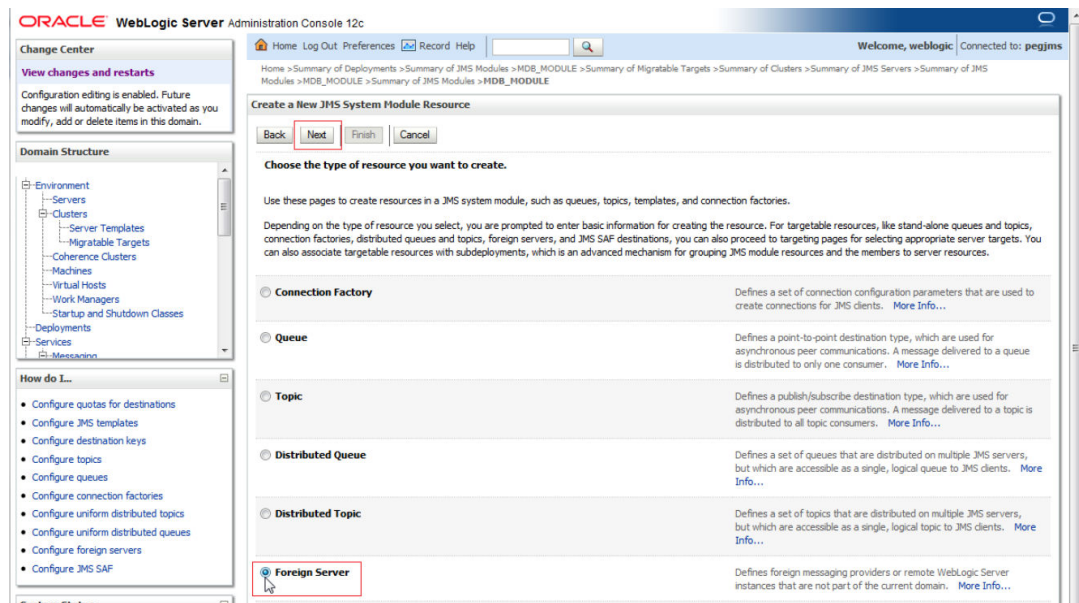

4. Enter name and Click on **Next**.

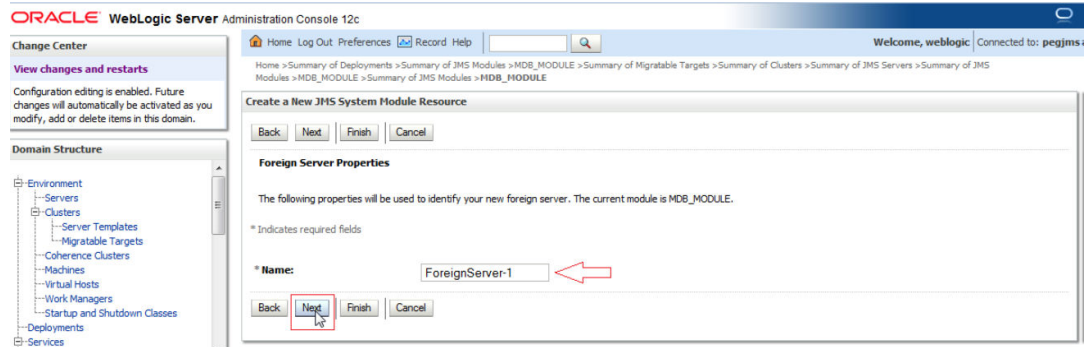

5. Click on **Advanced Targeting**.

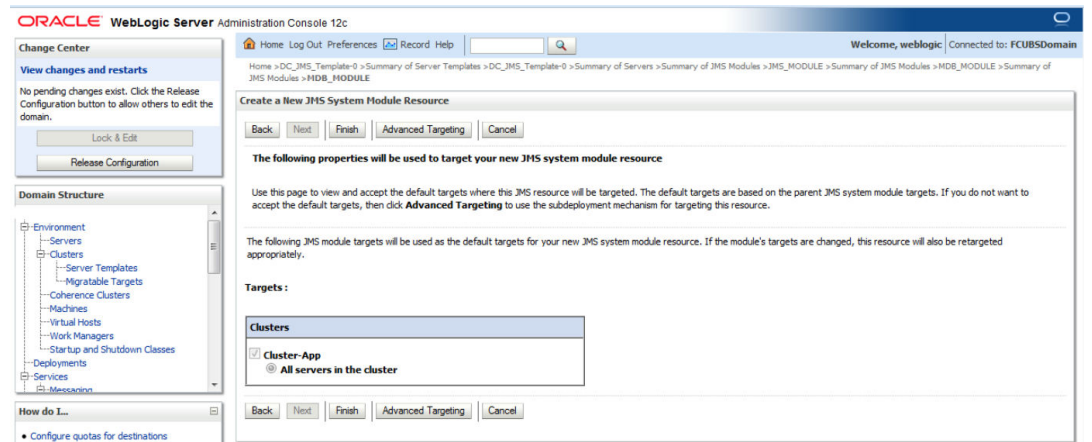

6. Click on **Create New Subdeployment**.

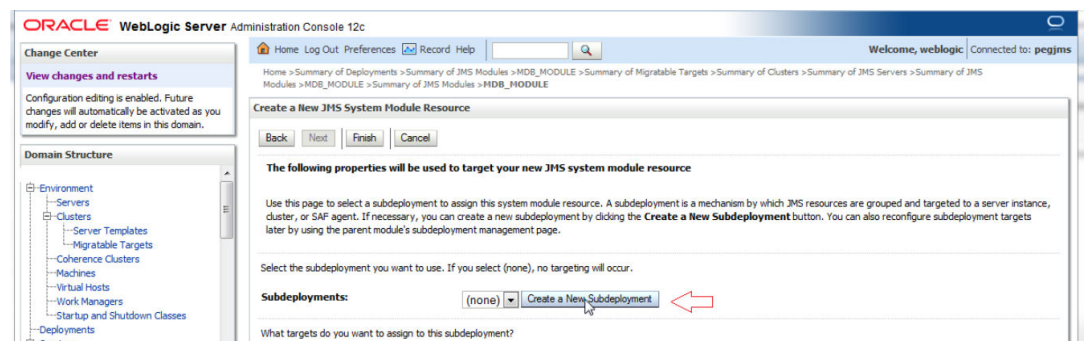

7. Enter Name as **MDB_SUB** and Click on **OK**.

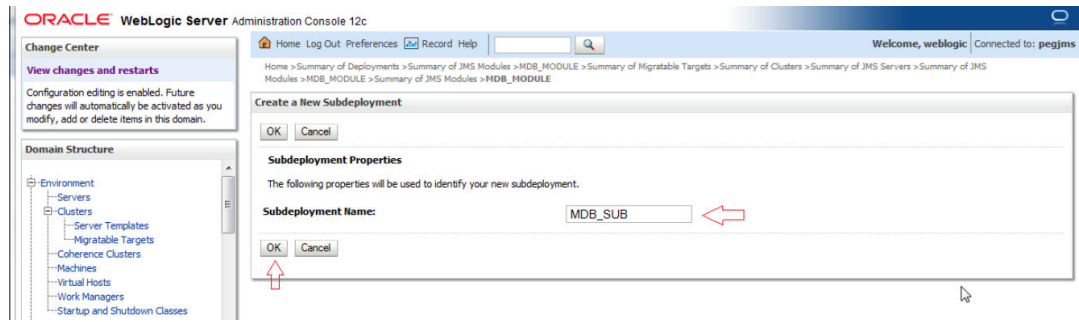

8. Select Target as **Cluster-App** and Click on **Finish**.

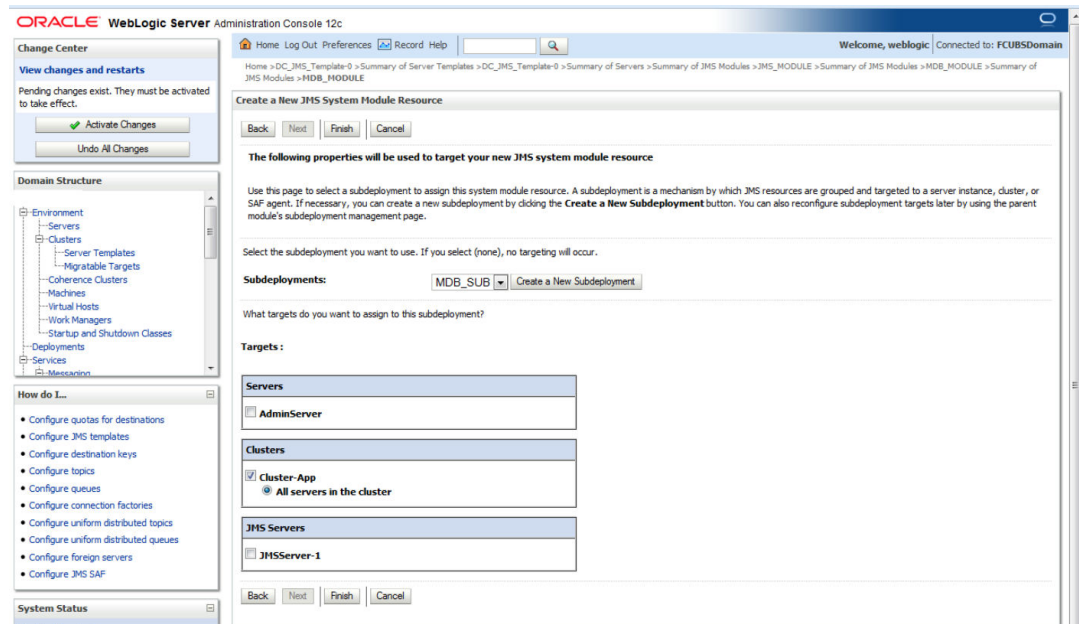

9. Foreign Server is created.

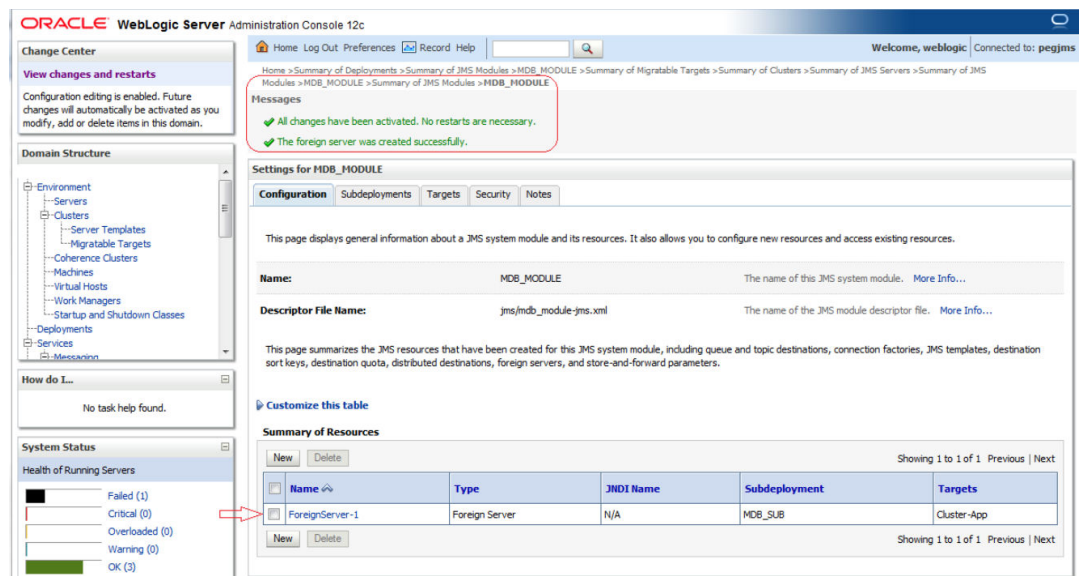

5.3 Foreign Server Configuration

1. Click on **ForeignServer-1**.

The screenshot shows the Oracle WebLogic Server Administration Console. The left sidebar contains navigation menus for Change Center, Domain Structure, How do I..., and System Status. The main content area displays the configuration for the MDB_MODULE. A message indicates that all changes have been activated successfully. Below this, the 'Settings for MDB_MODULE' page is shown, with tabs for Configuration, Subdeployments, Targets, Security, and Notes. The 'Configuration' tab is active, showing a table of resources. The 'ForeignServer-1' resource is highlighted, and a red arrow points to its name in the table.

Name	Type	JNDI Name	Subdeployment	Targets
ForeignServer-1	Foreign Server	N/A	MDB_SUB	Cluster-App

2. Enter the JNDI URL as Cluster URL(JMS Managed Servers) and Click on **Save**.

The screenshot shows the Oracle WebLogic Server Administration Console with the configuration page for ForeignServer-1. The 'Connection Factories' tab is selected. The 'JNDI Connection URL' field is highlighted with a red box, and a red arrow points to the 'Save' button. The 'JNDI Connection URL' field contains the value 'jms/10.104.148.185:7106:10.104.148.109:7107'.

3. Click on **Connection Factories** tab.

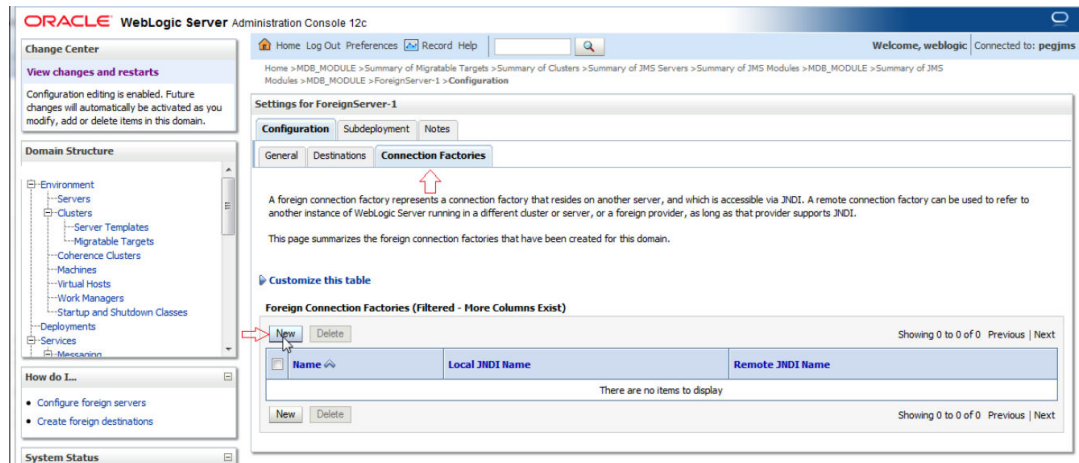

4. Create MDBQCF Connection Factory.

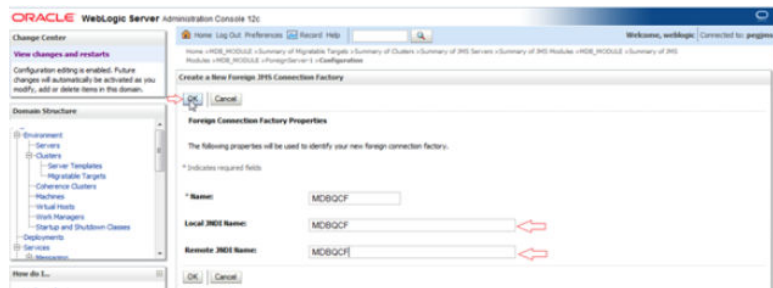

5. Click on Destination tab.



6. Create MDB_QUEUE.

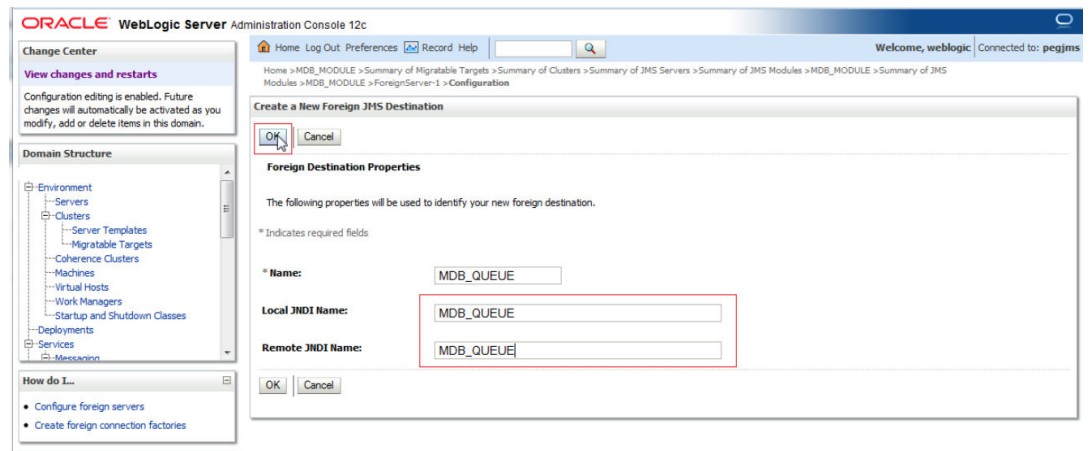
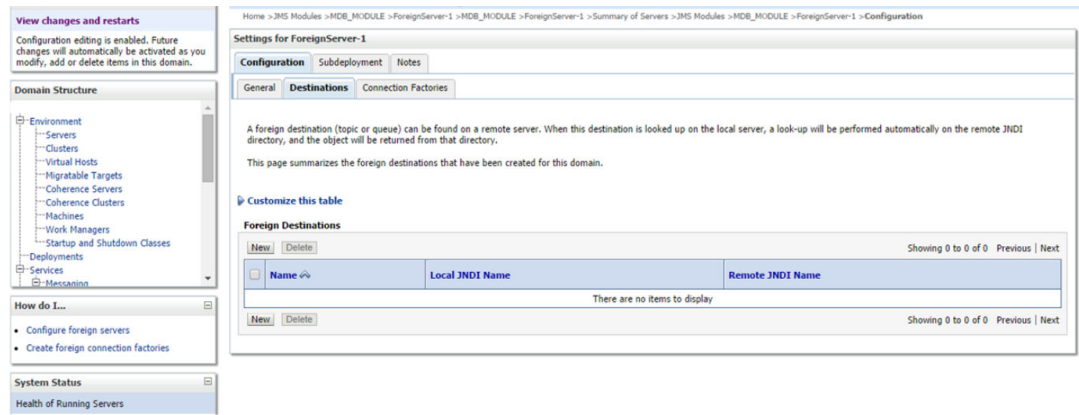

7. Similarly Create **MDB_QUEUE_RESPONSE**, **MDB_QUEUE_DLQ**.

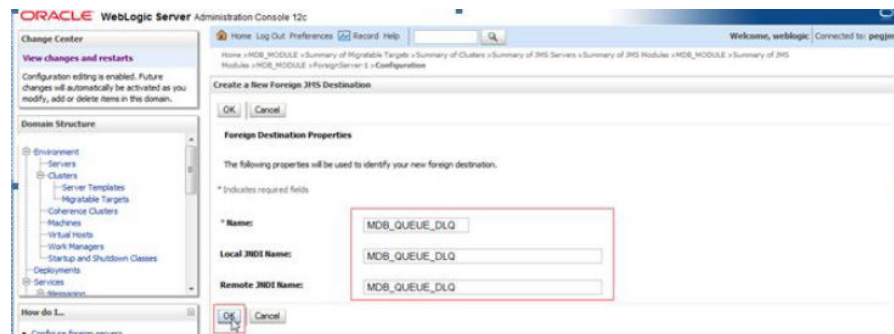

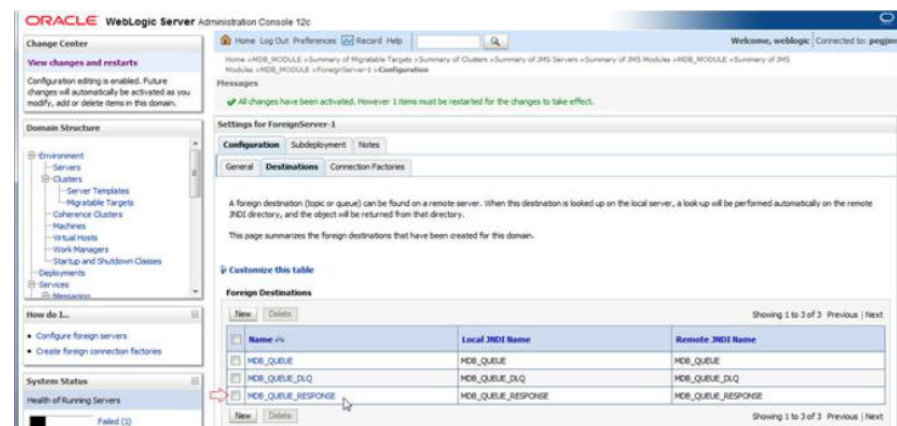
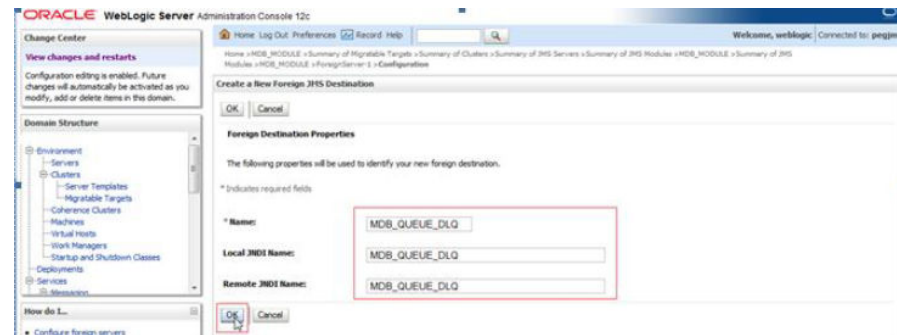
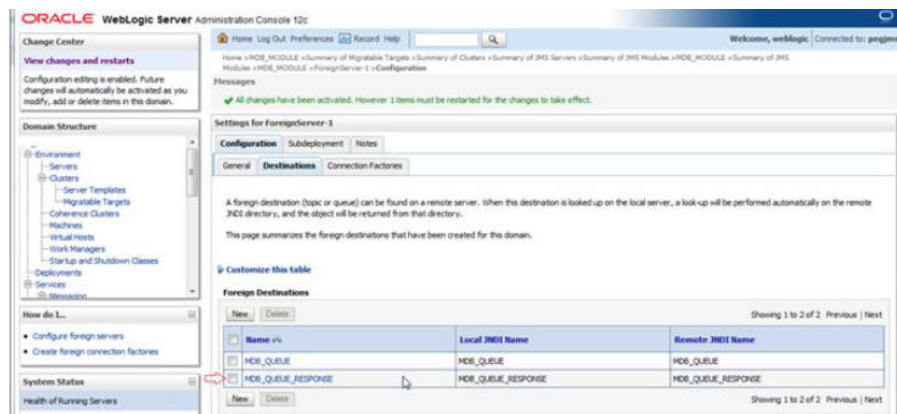

- After all the resources are created, **Restart** the Admin and Managed Servers.

6 Application Deployment

1. Deploy the EAR with Target as Cluster-App.

The screenshot shows the 'Settings for GWMDB' page in the WebLogic Administration Console. The 'Targets' tab is selected, and the 'Target Assignments' table is visible. The table lists the components and their current targets.

Component	Type	Current Targets
GWMDB	Enterprise Application	Cluster-App
GW_MDB_Bean.jar	EJB	(None specified)

2. Health Should be OK if JMS is configured properly, otherwise Warning will be displayed.

The screenshot shows the 'Summary of Deployments' page in the WebLogic Administration Console. The 'Control' tab is selected, and the 'Deployments' table is visible. The table lists the installed applications and modules, their state, health, type, and deployment order.

Name	State	Health	Type	Deployment Order
FCUBSApp	Active	OK	Enterprise Application	100
GWEJB	Active	OK	Enterprise Application	100
GWMDB	Active	OK	Enterprise Application	100
java-rs(1.1,1.9)	Active		Library	100
SWEJB	Active	OK	Enterprise Application	100

7

Frequently Asked Questions

1. Deploy the EAR with Target as Cluster-App.

Change Center

View changes and restarts

Configuration editing is enabled. Future changes will automatically be activated as you modify, add or delete items in this domain.

Domain Structure

- Environment
 - Servers
 - Clusters
 - Virtual Hosts
 - Migratable Targets
 - Coherence Servers
 - Coherence Clusters
 - Machines
 - Work Managers
 - Startup and Shutdown Classes
 - Deployments
- Services
 - Messaging

How do I...

- Start and stop a deployed Enterprise application

Home Log Out Preferences Record Help

Welcome, weblogic Connected to: base_domain

Home > JMS Modules > MDB_MODULE > ForeignServer-1 > JMS Modules > Summary of Deployments > Summary of Servers > Summary of Deployments > Summary of Servers > Summary of Deployments > GWMDB

Settings for GWMDB

Overview Deployment Plan Configuration Security **Targets** Control Testing Monitoring Notes

Use this page to specify the WebLogic Server instances and clusters to which you want to deploy this Enterprise application. These settings determine where the application is deployed at server startup time.

Target Assignments

Change Targets Showing 1 to 1 of 1 Previous Next

Component	Type	Current Targets
GWMDB	Enterprise Application	Cluster-App
GW_MDB_Bean.jar	EJB	(None specified)

Change Targets Showing 1 to 1 of 1 Previous Next

2. Health Should be OK if JMS is configured properly, otherwise Warning will be displayed.

Change Center

View changes and restarts

Configuration editing is enabled. Future changes will automatically be activated as you modify, add or delete items in this domain.

Domain Structure

- Environment
 - Deployments
 - Services
 - Messaging
 - JMS Servers
 - Store-and-Forward Agents
 - JMS Modules
 - Path Services
 - Bridges
 - Data Sources
 - Persistent Stores
 - Foreign JNDI Providers
 - Work Contexts

How do I...

- Install an Enterprise application
- Configure an Enterprise application
- Update (redeploy) an Enterprise application
- Start and stop a deployed Enterprise application
- Monitor the modules of an Enterprise application

Home Log Out Preferences Record Help

Welcome, weblogic Connected to: base_domain

Home > Summary of Environment > Summary of Servers > Summary of Deployments > JMS Modules > MDB_MODULE > Summary of Environment > Summary of Servers > Summary of Deployments > GWMDB > Summary of Deployments

Summary of Deployments

Control Monitoring

This page displays a list of Java EE applications and stand-alone application modules that have been installed to this domain. Installed applications and modules can be started, stopped, updated (redeployed), or deleted from the domain by first selecting the application name and using the controls on this page.

To install a new application or module for deployment to targets in this domain, click the Install button.

Customize this table

Deployments

Install Update Delete Start Stop Showing 1 to 5 of 5 Previous Next

Name	State	Health	Type	Deployment Order
FCUBSApp	Active	OK	Enterprise Application	100
GWJEB	Active	OK	Enterprise Application	100
GWMDB	Active	OK	Enterprise Application	100
java-rs(1.1,1.9)	Active		Library	100
SWEJEB	Active	OK	Enterprise Application	100

Install Update Delete Start Stop Showing 1 to 5 of 5 Previous Next

- Application and JMS Cluster Deployed on Same Cluster
- Application Shows Warning upon Restart of Managed Servers
- Securing File Store Data
- t3s Protocol
- How to Test the Deployment
- Increase Maximum Number of Message-Driven Bean Threads
- How High Availability is Achieved
- How to setup for Scheduler/Notifications
- What other modules uses JMS Queue's
- References

7.1 Application and JMS Cluster Deployed on Same Cluster

Application and JMS Module can be deployed on the same cluster. In this document both are on different clusters, however it is possible to deploy on the one cluster. When it is deployed on same cluster then.

1. Foreign Server Creation is not required.
2. Targets should be given accordingly during SubDeployment Creation.

7.2 Application Shows Warning upon Restart of Managed Servers

Managed Servers Start Order:

1. Stop all managed servers.
2. Start only the JMS Cluster managed servers.
3. After these are started then start the App Cluster managed servers.

Even after proper JMS setup when the managed servers are restarted Health of the Application is Warning.

The screenshot shows the Oracle WebLogic Server Administration Console. The main area displays a 'Summary of Deployments' table. The table has columns for Name, State, Health, Type, and Deployment Order. The 'GWHDB' application is highlighted with a red box, showing a 'Warning' health status. The other applications listed are FCUBSApp, GWEJB, JMS (12.1.1.1.2.3), and SWEJB, all with 'Active' states and 'OK' health.

Name	State	Health	Type	Deployment Order
FCUBSApp (12.0.3.0)	Active	OK	Enterprise Application	100
GWEJB	Active	OK	Enterprise Application	100
GWHDB	Active	Warning	Enterprise Application	100
JMS (12.1.1.1.2.3)	Active	OK	Library	100
SWEJB	Active	OK	Enterprise Application	100

1. Force Stop the Application.
2. Then Start the Application, this would resolve the Warning and the Health of Deployment is changed to **OK**.

7.3 Securing File Store Data

In order to properly secure file store data, set appropriate directory permissions on all file store directories. If data encryption is required, use appropriate third-party encryption software.

7.4 t3s Protocol

To secure the communication with the JMS Server use t3s protocol instead of t3. This is applicable when connecting to the connection factory to send or receive messages and also in the JNDI Connection URL provided in foreign server creation.

Note:

when using the t3s protocol SSL Listen Port Enabled should be checked in server template and the port number used in the URL should be secure port.

7.5 How to Test the Deployment

1. Navigate to Services \square JMS Modules \square JMS_MODULE \square MDB_QUEUE \square MONITORING.

The screenshot shows the 'Settings for MDB_QUEUE' page in the Oracle JMS console. The breadcrumb navigation is: Home \square ForeignServer-1 \square Configuration \square MDB_QUEUE \square JMS Modules \square JMS_MODULE \square MDB_QUEUE \square Summary of JMS Messages \square JMS Modules \square JMS_MODULE \square MDB_QUEUE. The page has tabs for Configuration, Security, **Monitoring**, Subdeployment, and Notes. It contains a table titled 'Destinations (Filtered - More Columns Exist)' with the following data:

Name	Consumers Current	Consumers High	Consumers Total
JMS_MODULE:JMS-1@MDB_QUEUE	64	64	64
JMS_MODULE:JMS-2@MDB_QUEUE	64	64	64

2. Select any one Server and Click on **Show Messages**.

The screenshot shows the 'Summary of JMS Messages' page. It includes a 'Message Selector' field and an 'Apply' button. Below is a table titled 'JMS Messages (Filtered - More Columns Exist)' with the following data:

ID	CorrId	Time Stamp	State String	JMS Delivery Mode	Message Size
There are no items to display					

3. Click on **New** and enter the Message in Body and Click on **OK**.

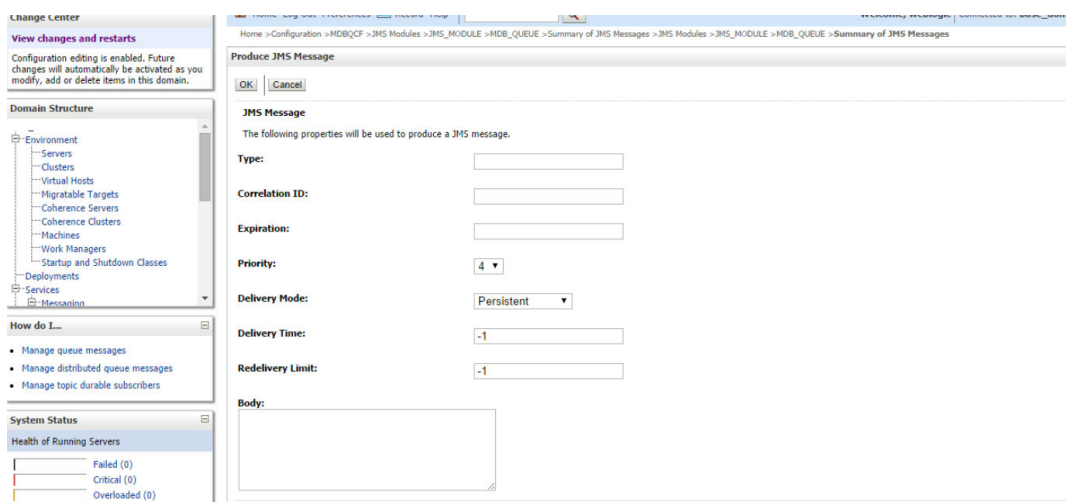

4. Message is Sent.

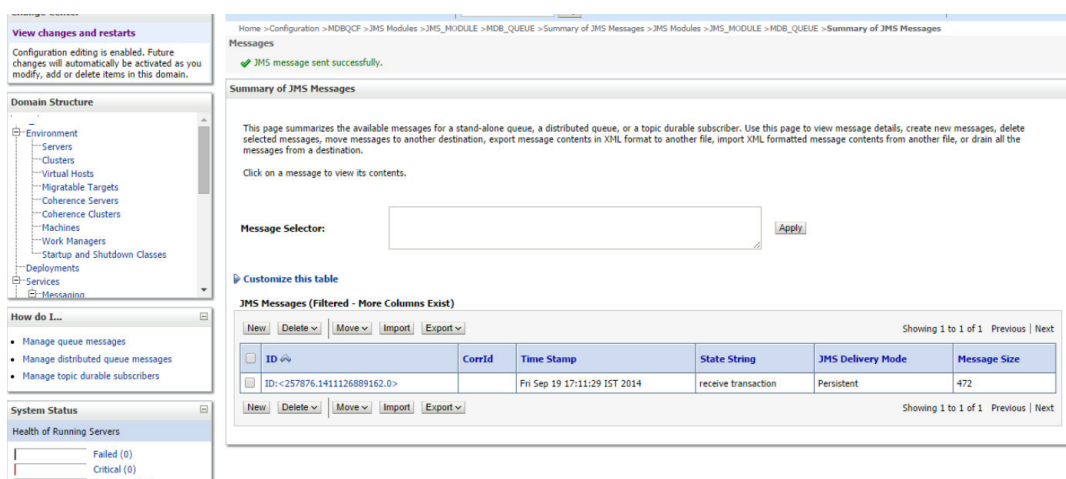

5. Verify at backend or in the MDB log if the message is processed successfully.

7.6 Increase Maximum Number of Message-Driven Bean Threads

Default number of consumers for an MDB is 16. To increase or restrict this number create Custom Work Manager with a Max Threads Constraint in conjunction with MDBs. The solution is to create a work manager with a max threads constraint and assign the proxy services dispatch policy to this work manager.

Steps to create custom work manager

1. Modify the MDB deployment description and deploy the EAR.
2. Create Custom Workmanager and add constraints to limit the number of the max MDB threads
 - [Modify weblogic-ejb-jar.xml](#)
 - [Work Manager Creation](#)

7.6.1 Modify weblogic-ejb-jar.xml

1. Add below line to the weblogic-ejb-jar.xml of the MDB Ear.

```
<dispatch-policy>GWMDBWM</dispatch-policy>
```

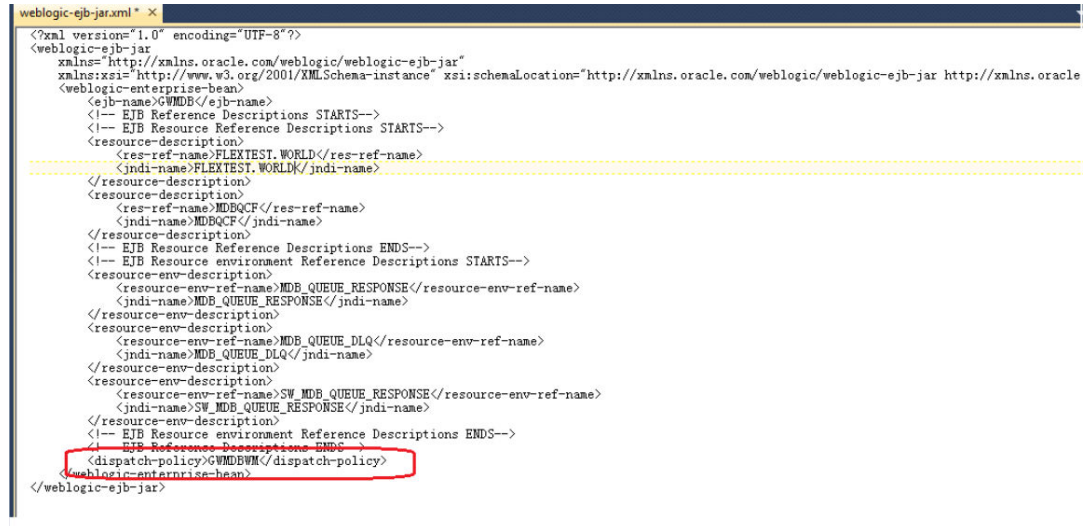

```

weblogic-ejb-jar.xml * x
<?xml version="1.0" encoding="UTF-8"?>
<weblogic-ejb-jar
  xmlns="http://xmlns.oracle.com/weblogic/weblogic-ejb-jar"
  xmlns:xsi="http://www.w3.org/2001/XMLSchema-instance" xsi:schemaLocation="http://xmlns.oracle.com/weblogic/weblogic-ejb-jar http://xmlns.oracle
  <weblogic-enterprise-bean>
    <ejb-name>GWMDB</ejb-name>
    <!-- EJB Reference Descriptions STARTS-->
    <!-- EJB Resource Reference Descriptions STARTS-->
    <resource-description>
      <res-ref-name>FLEXTEST_WORLD</res-ref-name>
      <!-- EJB Resource Reference Descriptions ENDS-->
      <!-- EJB Resource environment Reference Descriptions STARTS-->
      <resource-env-description>
        <resource-env-ref-name>MDB_QUEUE_RESPONSE</resource-env-ref-name>
        <!-- EJB Resource environment Reference Descriptions ENDS-->
        <resource-env-description>
          <resource-env-ref-name>MDB_QUEUE_DLQ</resource-env-ref-name>
          <!-- EJB Resource environment Reference Descriptions ENDS-->
          <resource-env-description>
            <resource-env-ref-name>SW_MDB_QUEUE_RESPONSE</resource-env-ref-name>
            <!-- EJB Resource environment Reference Descriptions ENDS-->
            <!-- EJB Resource environment Reference Descriptions ENDS-->
            <dispatch-policy>GWMDBWM</dispatch-policy>
          </weblogic-enterprise-bean>
        </weblogic-ejb-jar>
  
```

2. Remove if any of the below tags present in weblogic-ejb-jar.xml
max-beans-in-free-pool and initial-beans-in-free-pool
3. Save the ear file and redeploy the EAR file.

7.6.2 Work Manager Creation

1. Login into weblogic console, navigate to Domain > Environment > WorkManager Create new workmanager with the name GWMDBWM(as mentioned in property file) by following below steps:

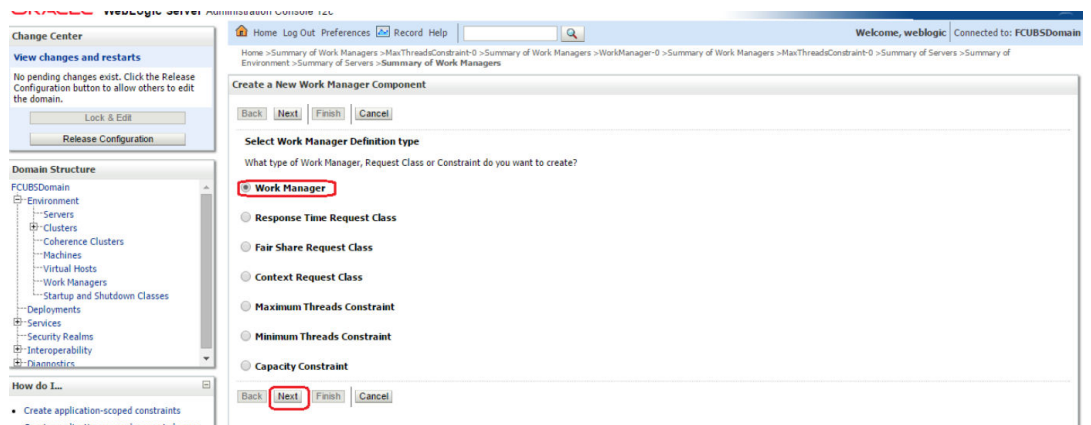

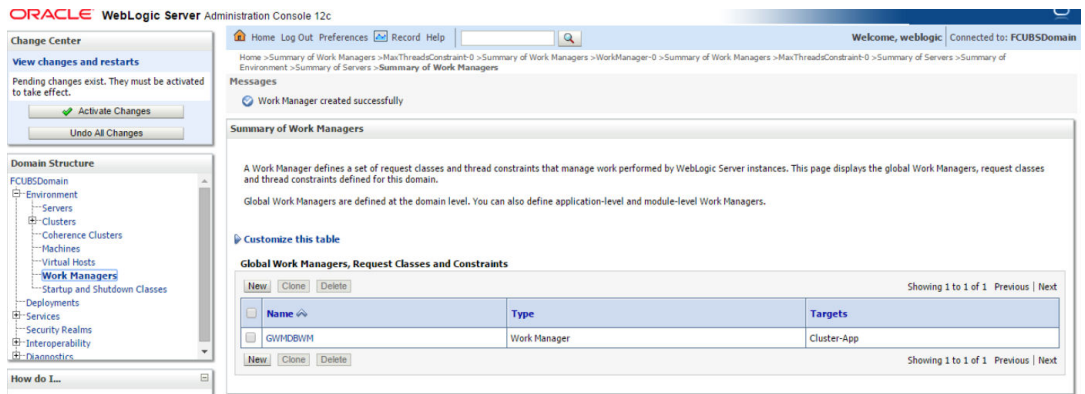
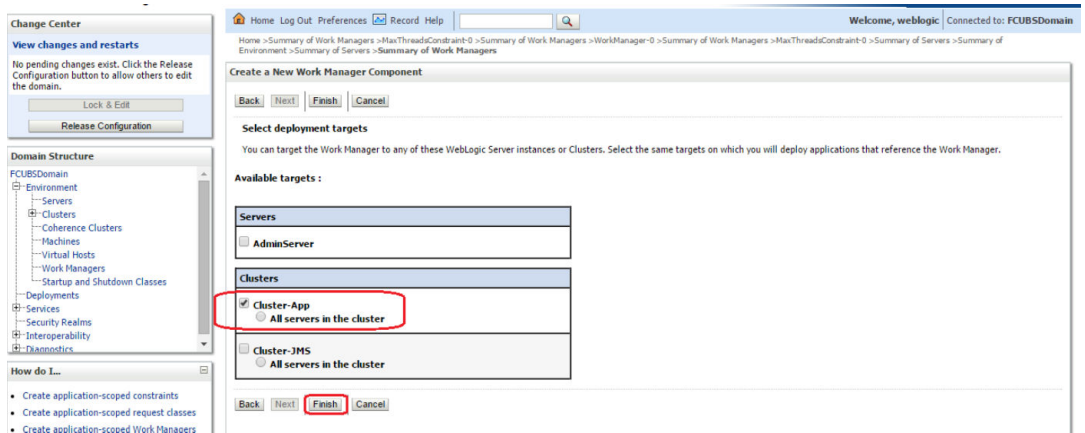
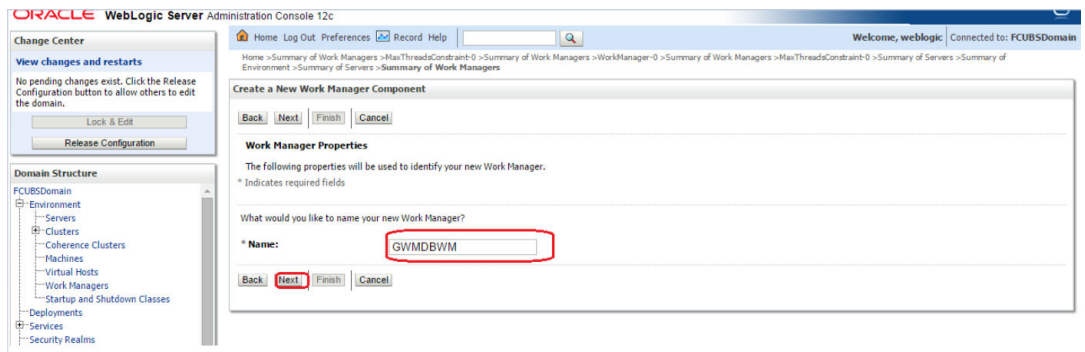

2. Create new Max Thread Constraint and in the Count field give the desired thread count.

Change Center
View changes and restarts
Pending changes exist. They must be activated to take effect.
[Activate Changes] [Undo All Changes]

Domain Structure
FCUBSDomain
Environment
Servers
Clusters
Coherence Clusters
Machines
Virtual Hosts
Work Managers
Startup and Shutdown Classes
Deployments
Services
Security Realms
Interoperability
Diagnostics

How do I...
• Create application-scoped constraints
• Create application-scoped request classes
• Create application-scoped Work Managers

Create a New Work Manager Component
[Back] [Next] [Finish] [Cancel]

Select Work Manager Definition type
What type of Work Manager, Request Class or Constraint do you want to create?

- Work Manager
- Response Time Request Class
- Fair Share Request Class
- Context Request Class
- Maximum Threads Constraint**
- Minimum Threads Constraint
- Capacity Constraint

[Back] [Next] [Finish] [Cancel]

Change Center
View changes and restarts
Pending changes exist. They must be activated to take effect.
[Activate Changes] [Undo All Changes]

Domain Structure
FCUBSDomain
Environment
Servers
Clusters
Coherence Clusters
Machines
Virtual Hosts
Work Managers
Startup and Shutdown Classes
Deployments
Services
Security Realms
Interoperability
Diagnostics

How do I...
• Create application-scoped constraints

Create a New Work Manager Component
[Back] [Next] [Finish] [Cancel]

Maximum Threads Constraint Properties
The following properties will be used to identify your new Max Threads Request Class.
* Indicates required fields

What would you like to name the new Maximum Threads Constraint?

* Name: [MaxThreadsConstraint-0]

What is the maximum number of concurrent threads to allocate for requests? Enter either a fixed thread count or the name of a Data Source whose size will be used for the constraint.

Count: [25]

Data Source: []

[Back] [Next] [Finish] [Cancel]

Change Center
View changes and restarts
Pending changes exist. They must be activated to take effect.
[Activate Changes] [Undo All Changes]

Domain Structure
FCUBSDomain
Environment
Servers
Clusters
Coherence Clusters
Machines
Virtual Hosts
Work Managers
Startup and Shutdown Classes
Deployments
Services
Security Realms
Interoperability
Diagnostics

How do I...
• Create application-scoped constraints
• Create application-scoped request classes
• Create application-scoped Work Managers

Create a New Work Manager Component
[Back] [Next] [Finish] [Cancel]

Select deployment targets
You can target the Work Manager to any of these WebLogic Server instances or Clusters. Select the same targets on which you will deploy applications that reference the Work Manager.

Available targets:

- Servers**
 AdminServer
- Clusters**
 Cluster-App
 All servers in the cluster
- Cluster-JMS
 All servers in the cluster

[Back] [Next] [Finish] [Cancel]

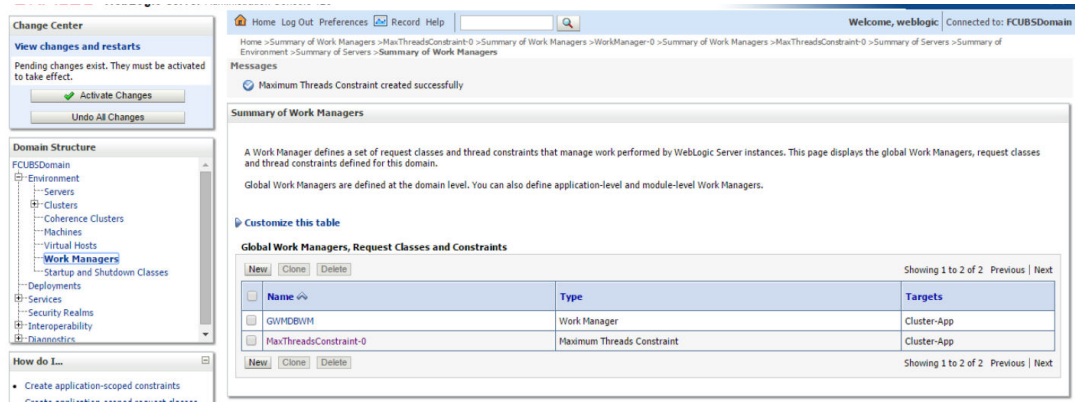

3. Modify the newly created workmanager and assign the Maximum Thread Constraint that is created in above step.

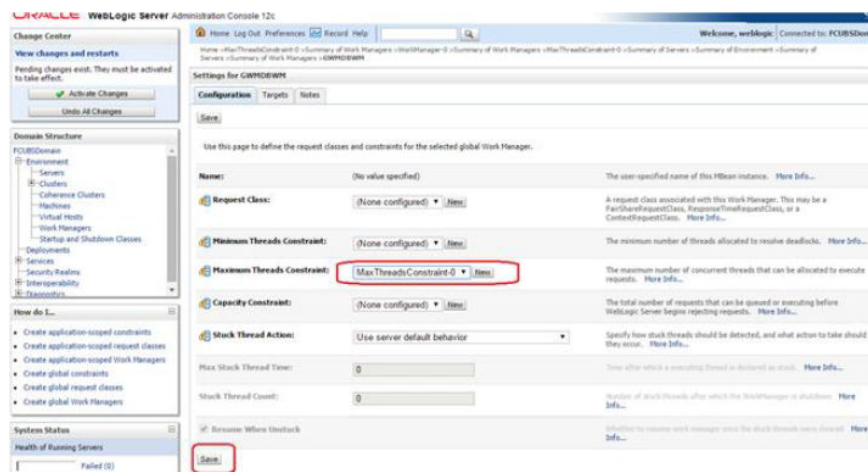
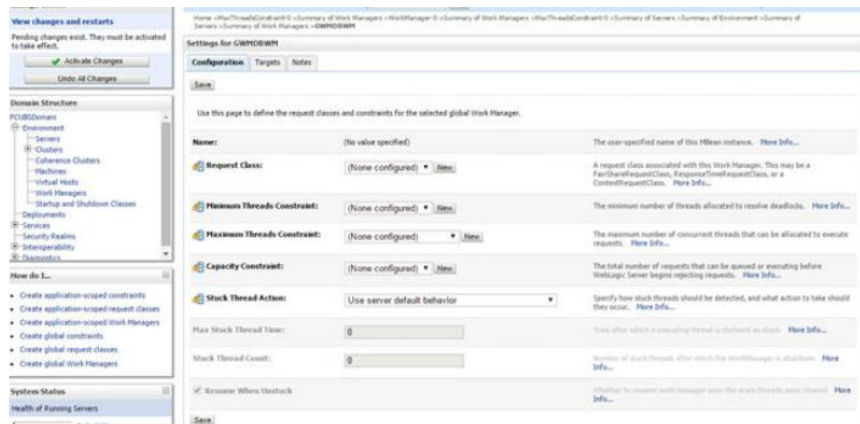

4. Restart managed servers and notice the change in the number of consumers for the QUEUE'S.

7.7 How High Availability is Achieved

1. Application Server:

MDB_MODULE and the GWEJB ear are deployed in a cluster. Cluster has 4 managed servers, if any server goes down then the messages are processed by other managed servers.

2. JMS Provider:

JMS is deployed on 2 managed servers, JMSServer1 and JMSServer2, if any one goes down other will handle the messages.

3. FileStore:

File store is a cluster file system or database where if one node goes down then other will handle the requests.

4. DB Server:

Database is installed in RAC mode where it has more than 1 node, if a node goes down then other nodes will handle messages.

7.8 How to setup for Scheduler/Notifications

The above document can be used for setting up JMS for scheduler/notifications but additional queues and connection factory needs to be created.

7.9 What other modules uses JMS Queue's

JMS is used by following modules, relevant queues and factories needs to be created additionally,

1. EMS for swift messages
2. GI for upload
3. ELCM
4. BIP

7.10 References

1. FCUBS_12.1_Weblogic12c_Middleware_Practices.doc
2. GATEWAY_Applications_WL.doc
3. Resource_Creation_WL.doc

Glossary

Index