

Oracle® Banking Payments Messaging System User Guide



Release 14.7.0.0.0

G26160-02

February 2025

The Oracle logo, consisting of a solid red square with the word "ORACLE" in white, uppercase, sans-serif font centered within it.

ORACLE®

Copyright © 2017, 2025, Oracle and/or its affiliates.

This software and related documentation are provided under a license agreement containing restrictions on use and disclosure and are protected by intellectual property laws. Except as expressly permitted in your license agreement or allowed by law, you may not use, copy, reproduce, translate, broadcast, modify, license, transmit, distribute, exhibit, perform, publish, or display any part, in any form, or by any means. Reverse engineering, disassembly, or decompilation of this software, unless required by law for interoperability, is prohibited.

The information contained herein is subject to change without notice and is not warranted to be error-free. If you find any errors, please report them to us in writing.

If this is software, software documentation, data (as defined in the Federal Acquisition Regulation), or related documentation that is delivered to the U.S. Government or anyone licensing it on behalf of the U.S. Government, then the following notice is applicable:

U.S. GOVERNMENT END USERS: Oracle programs (including any operating system, integrated software, any programs embedded, installed, or activated on delivered hardware, and modifications of such programs) and Oracle computer documentation or other Oracle data delivered to or accessed by U.S. Government end users are "commercial computer software," "commercial computer software documentation," or "limited rights data" pursuant to the applicable Federal Acquisition Regulation and agency-specific supplemental regulations. As such, the use, reproduction, duplication, release, display, disclosure, modification, preparation of derivative works, and/or adaptation of i) Oracle programs (including any operating system, integrated software, any programs embedded, installed, or activated on delivered hardware, and modifications of such programs), ii) Oracle computer documentation and/or iii) other Oracle data, is subject to the rights and limitations specified in the license contained in the applicable contract. The terms governing the U.S. Government's use of Oracle cloud services are defined by the applicable contract for such services. No other rights are granted to the U.S. Government.

This software or hardware is developed for general use in a variety of information management applications. It is not developed or intended for use in any inherently dangerous applications, including applications that may create a risk of personal injury. If you use this software or hardware in dangerous applications, then you shall be responsible to take all appropriate fail-safe, backup, redundancy, and other measures to ensure its safe use. Oracle Corporation and its affiliates disclaim any liability for any damages caused by use of this software or hardware in dangerous applications.

Oracle®, Java, MySQL, and NetSuite are registered trademarks of Oracle and/or its affiliates. Other names may be trademarks of their respective owners.

Intel and Intel Inside are trademarks or registered trademarks of Intel Corporation. All SPARC trademarks are used under license and are trademarks or registered trademarks of SPARC International, Inc. AMD, Epyc, and the AMD logo are trademarks or registered trademarks of Advanced Micro Devices. UNIX is a registered trademark of The Open Group.

This software or hardware and documentation may provide access to or information about content, products, and services from third parties. Oracle Corporation and its affiliates are not responsible for and expressly disclaim all warranties of any kind with respect to third-party content, products, and services unless otherwise set forth in an applicable agreement between you and Oracle. Oracle Corporation and its affiliates will not be responsible for any loss, costs, or damages incurred due to your access to or use of third-party content, products, or services, except as set forth in an applicable agreement between you and Oracle.

Contents

1 Preface

Purpose	1-1
Audience	1-1
Documentation Accessibility	1-1
Critical Patches	1-2
Diversity and Inclusion	1-2
Conventions	1-2
Related Resources	1-2
Screenshot Disclaimer	1-2
Acronyms and Abbreviations	1-3
Basic Actions	1-3
Symbols, Definitions and Abbreviations	1-4

2 Overview

Message Flow Diagrams	2-1
Key Features of Messaging	2-4
Rule Parameter	2-4
Rule Definition	2-5
Rule Group	2-5
Rule Priority	2-6

3 File Exchange

Basic Maintenance for File Exchange	3-1
File Transmission over SWIFTNet	3-2
Connector Network Linkage Maintenance	3-3
Connector Network Linkage Maintenance Summary	3-16
Connector File Type Linkage Maintenance	3-17
Connector File Type Linkage Maintenance Summary	3-18

4 SWIFT Messages

Outgoing Message Browser	4-1
--------------------------	-----

Outgoing Message Browser Summary	4-1
Outgoing Message Browser Screen	4-3
Incoming Message Browser	4-5
Viewing Incoming Message Browser Summary	4-5
View Message	4-6
View Transaction	4-7
View Queue (STP Layer)	4-7
Incoming Message Browser	4-8
Bulking and De-bulking	4-9
Local Authentication	4-10
SWIFT LAU Key Summary	4-10
Detailed Processing Logic for Incoming SWIFT LAU	4-12
SWIFT FIN Header Configuration	4-13
SWIFT FIN HEADER Preferences	4-13
SWIFT FIN HEADER Preferences Summary	4-14
SWIFT FIN HEADER Host Preferences	4-14
SWIFT FIN HEADER Host Preferences Summary	4-15
SWIFT FIN Header Processing	4-16

5 SWIFT Messages Via Blockchain

SWIFT Message Routing Parameter Detailed	5-1
SWIFT Message Routing Parameter Summary	5-2
DLT Message Browser Summary	5-2
Retry	5-3
SWIFT Message Processing	5-4

6 Fedwire Messages

Fedwire Message Mapping	6-1
Fedwire Message Mapping Summary	6-1
SWIFT Message Notifications	6-2

1

Preface

- [Purpose](#)
- [Audience](#)
This manual is intended for the following User/User Roles:
- [Documentation Accessibility](#)
- [Critical Patches](#)
- [Diversity and Inclusion](#)
- [Conventions](#)
- [Related Resources](#)
- [Screenshot Disclaimer](#)
- [Acronyms and Abbreviations](#)
- [Basic Actions](#)
- [Symbols, Definitions and Abbreviations](#)
The following are some of the Symbols you are likely to find in the manual:

Purpose

This guide is designed to help acquaint you with the Oracle Banking Payments application. This guide provides answers to specific features and procedures that the user need to be aware of the module to function successfully.

Audience

This manual is intended for the following User/User Roles:

Table 1-1 User Roles

Role	Function
Implementation & IT Staff	Implementation & Maintenance of the Software

Documentation Accessibility

For information about Oracle's commitment to accessibility, visit the Oracle Accessibility Program website at <http://www.oracle.com/pls/topic/lookup?ctx=acc&id=docacc>.

Access to Oracle Support

Oracle customers that have purchased support have access to electronic support through My Oracle Support. For information, visit <http://www.oracle.com/pls/topic/lookup?ctx=acc&id=info> or visit <http://www.oracle.com/pls/topic/lookup?ctx=acc&id=trs> if you are hearing impaired.

Critical Patches

Oracle advises customers to get all their security vulnerability information from the Oracle Critical Patch Update Advisory, which is available at [Critical Patches](#), [Security Alerts and Bulletins](#). All critical patches should be applied in a timely manner to make sure effective security, as strongly recommended by [Oracle Software Security Assurance](#).

Diversity and Inclusion

Oracle is fully committed to diversity and inclusion. Oracle respects and values having a diverse workforce that increases thought leadership and innovation. As part of our initiative to build a more inclusive culture that positively impacts our employees, customers, and partners, we are working to remove insensitive terms from our products and documentation. We are also mindful of the necessity to maintain compatibility with our customers' existing technologies and the need to ensure continuity of service as Oracle's offerings and industry standards evolve. Because of these technical constraints, our effort to remove insensitive terms is ongoing and will take time and external cooperation.

Conventions

The following text conventions are used in this document:

Convention	Meaning
boldface	Boldface type indicates graphical user interface elements associated with an action, or terms defined in text.
<i>italic</i>	Italic type indicates book titles, emphasis, or placeholder variables for which you supply particular values.
monospace	Monospace type indicates commands within a paragraph, URLs, code in examples, text that appears on the screen, or text that you enter.

Related Resources

For more information on any related features, refer to the following documents:

- *Getting Started User Guide*
- *Oracle Banking Security Management System User Guide*
- *Oracle Banking Microservices Platform Foundation User Guide*
- *Routing Hub Configuration User Guide*
- *Oracle Banking Common Core User Guide*
- *Interest and Charges User Guide*
- *Oracle Banking Liquidity Management Configuration Guide*
- *Oracle Banking Liquidity Management File Upload User Guide*

Screenshot Disclaimer

Personal information used in the interface or documents is dummy and does not exist in the real world. It is only for reference purposes.

Acronyms and Abbreviations

The list of the acronyms and abbreviations that are used in this guide are as follows:

Table 1-2 Acronyms and Abbreviations

Abbreviation	Description
DDA	Demand Deposit Accounts
ECA	External Credit Approval
EOD	End of Day
IBAN	International Bank Account Number

Basic Actions

The basic actions performed in the screens are as follows:

Table 1-3 Basic Actions

Actions	Description
New	Click New to add a new record. The system displays a new record to specify the required data. The fields marked with asterisk are mandatory. - This button is displayed only for the records that are already created.
Save	Click Save to save the details entered or selected in the screen.
Unlock	Click Unlock to update the details of an existing record. The system displays an existing record in editable mode. - This button is displayed only for the records that are already created.
Authorize	Click Authorize to authorize the record created. A maker of the screen is not allowed to authorize the same. Only a checker can authorize a record. - This button is displayed only for the already created records. For more information on the process, refer Authorization Process.
Approve	Click Approve to approve the initiated record. - This button is displayed once the user click Authorize .
Audit	Click Audit to view the maker details, checker details of the particular record. - This button is displayed only for the records that are already created.
Close	Click Close to close a record. This action is available only when a record is created.
Confirm	Click Confirm to confirm the action performed.
Cancel	Click Cancel to cancel the action performed.
Compare	Click Compare to view the comparison through the field values of old record and the current record. - This button is displayed in the widget once the user click Authorize .
View	Click View to view the details in a particular modification stage. - This button is displayed in the widget once the user click Authorize .

Table 1-3 (Cont.) Basic Actions

Actions	Description
View Difference only	Click View Difference only to view a comparison through the field element values of old record and the current record, which has undergone changes. - This button is displayed once the user click Compare .
Expand All	Click Expand All to expand and view all the details in the sections. - This button is displayed once the user click Compare .
Collapse All	Click Collapse All to hide the details in the sections. - This button is displayed once the user click Compare .
OK	Click OK to confirm the details in the screen.

Symbols, Definitions and Abbreviations

The following are some of the Symbols you are likely to find in the manual:

Table 1-4 Symbols





Icons	Function
	Exit
	Add row
	Delete row
	Option List

Table 1-5 Common Icons and its Definitions

Icon Names	Applicable Stages	Operation
Minimize	Initiation, Approval and Hand-off Retry	Users can minimize the transaction input screen. When the screen is minimized, it appears as to a separate tab within the same web page.
Maximize	Initiation, Approval and Hand-off Retry	User can maximize the transaction input screen.
Close	Initiation, Approval and Hand-off Retry	Users can close the transaction input screen. The system displays a warning message to the user that any unsaved data would be lost. User can either choose to ignore the message and close the screen or choose to 'save and close' the transaction.

2

Overview

This document details bulker, de-bulker, router and the SWIFTNet connectivity framework to be built in the Oracle Banking Payments to send the bulked files to the SWIFTNet network through SAG with the File Act protocol.

The files are bulked and stored on Application server. The file from Application server is transmitted to SWIFT over FTA.

The system technically bulk MT messages and routes them to configured destination.

The system transmits and receives bulked files from SWIFT Network using SAG interface, through the FTA (Folder) connector.

This chapter contains the following sections:

- [Message Flow Diagrams](#)
- [Key Features of Messaging](#)
- [Message Flow Diagrams](#)
- [Key Features of Messaging](#)

Routing rules is defined for each module. Using these routing rules the messages are sent to the mapped destinations.

Message Flow Diagrams

The below flow diagram depicts the flow of outgoing message:

Figure 2-1 Outgoing Message

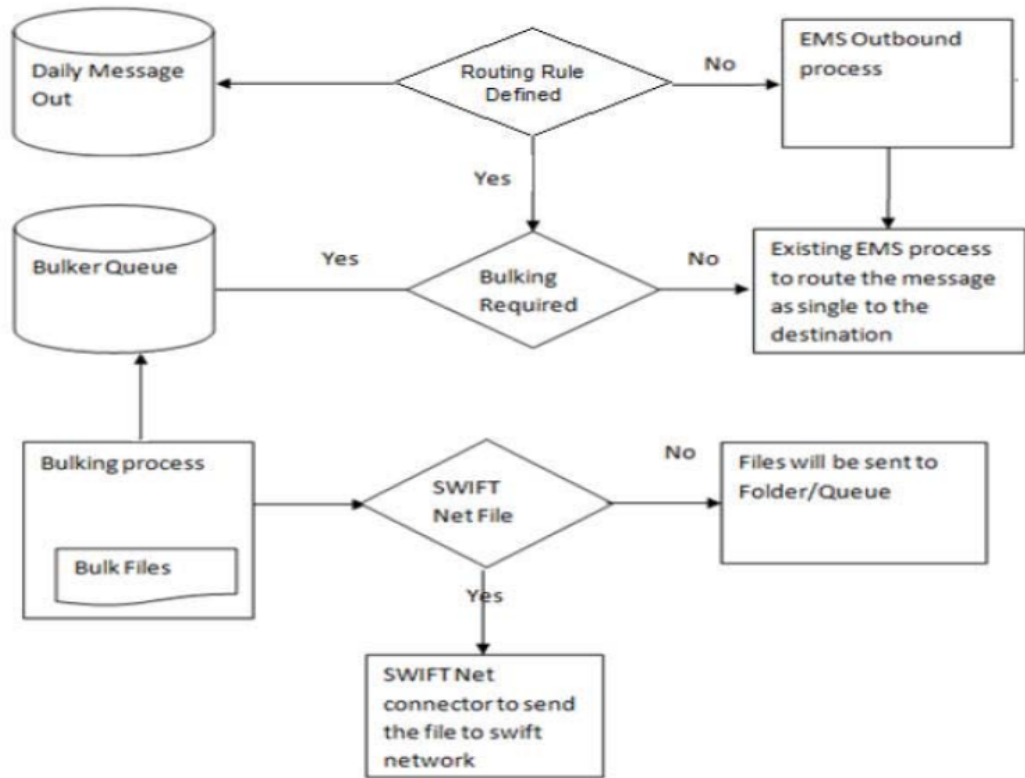

The below diagram depicts the flow of incoming message:

Figure 2-2 Incoming Message

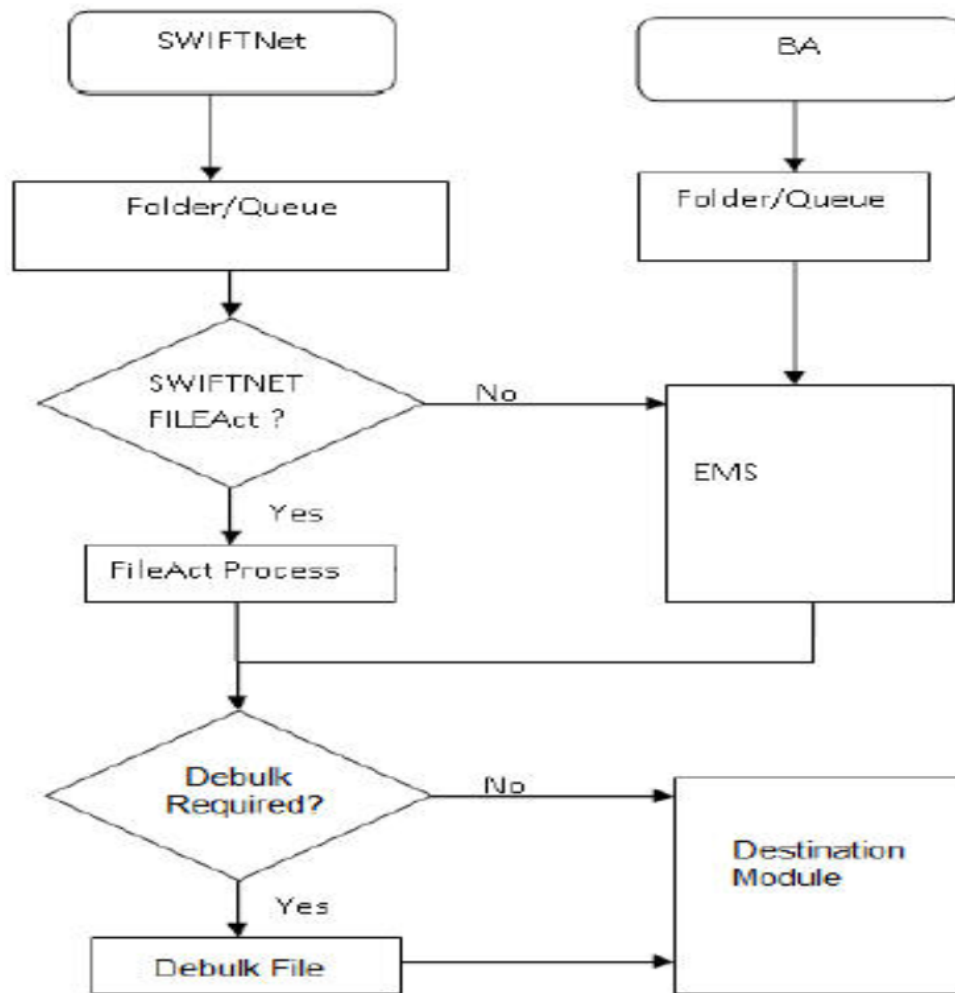

The below diagram depicts the flow diagram of data exchange with SWIFTNet:

Figure 2-3 Data Exchange

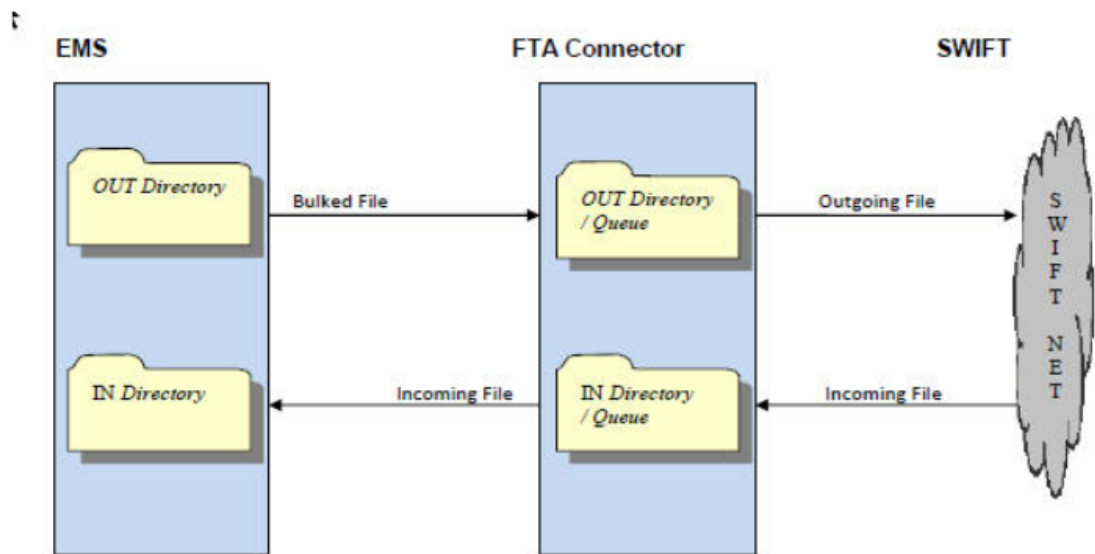

Key Features of Messaging

Routing rules are defined for each module. Using these routing rules the messages are sent to the mapped destinations.

To achieve this multiple maintenance are introduced.

- **Rule Definition** – This screen is used to define the rule and respective destination
- **Rule Group** – This maintenance is used to map the modules to different rule groups
- **Rule Priority** – This maintenance is used to prioritize the rules

The following functionality is developed to support the routing of messages to different destinations:

- **Rule Parameter**
Rule parameters is part of day zero set up. There is no user interface to maintain this.
- **Rule Definition**
Rule configuration maintenance is provided to define the rule and to map it to a specific destination.
- **Rule Group**
You can group one or more modules into different groups. Based on the rule groups a module is associated with, mapped rules are executed to identify the qualifying rule definition and thus destination for any message.
- **Rule Priority**
You can provide Priority of rules belonging to a rule group. Based on this priority, rules are executed to identify the qualifying rule definition and thus destination for any message.

Rule Parameter

Rule parameters is part of day zero set up. There is no user interface to maintain this.

The following set of standard rule parameters is used for all type of rule definition:

- Amount
- Currency
- Media
- Network Code
- Sender BIC
- Receiver BIC
- Message Type
- Module Name

Rule Definition

Rule configuration maintenance is provided to define the rule and to map it to a specific destination.

Standard set of parameters are available while defining a rule. You can also provide values manually for evaluating the rules. On same screen option is provided to map rule to its destination. Each rule must belong to a rule group.

Messaging provides a router implementation which evaluates configured rules and identifies the destination for a message dynamically. The Routing capabilities in messaging include ability to define/modify rule configurations based on a set of pre-defined routing parameters. These parameters are stored in the Database and for each routing configuration; the values for these routing parameters is calculated at run time, thus enabling dynamic routing configuration.

Destination for any message is mapped on the rule definition screen. This is done by specifying the rules which unambiguously lead to the selection of a single destination to be used for outward transmission of data from messaging.

Routing configuration supports routing based on the messaging standard parameters.

Routing rule can be mapped to following entities in the system.

- Connectivity Lines
- Bulker
- De-bulker
- Folder
- Queue

Rule Group

You can group one or more modules into different groups. Based on the rule groups a module is associated with, mapped rules are executed to identify the qualifying rule definition and thus destination for any message.

Each module can belong to only one rule group to avoid ambiguous results.

The modules for which routing rules should be used for identifying the destination is added to a default rule group as part of day zero script.

When a message is received from a modules that is not a part of any rule group, the existing EMS flow is considered to identify its destination.

Rule Priority

You can provide Priority of rules belonging to a rule group. Based on this priority, rules are executed to identify the qualifying rule definition and thus destination for any message.

First rule that matches the message properties is used to identify the destination for that message.

3

File Exchange

- [Basic Maintenance for File Exchange](#)
A message is routed to the specific SWIFT connector, bulker, folder or queue if they meet certain user-defined criteria.
- [File Transmission over SWIFTNet](#)

Basic Maintenance for File Exchange

A message is routed to the specific SWIFT connector, bulker, folder or queue if they meet certain user-defined criteria.

Routing Rules are defined for each module. Using these routing rules, the messages are sent to the mapped destinations.

To achieve this, the following maintenance are introduced:

- **Rule Definition** - To define rules and respective definitions
- **Rule Group** - To map modules to different groups
- **Rule Priority** - To prioritize rules

Below listed key maintenances are referred for File exchange processing:

- Distinguished Name Definition (MSDDSTNM)
 - The Distinguished Name (DN) serves to uniquely identify any entity that sends or receives messages over SWIFTNet.
 - Distinguished name follow an X.500-compliant naming convention. Refer the SWIFTNet Naming and Address Guide from SWIFT for more details.
- SWIFTNet Service Definition (MSDSWTSR)
 - This screen is used to capture SWIFTNet service details.
 - SWIFT Net service should be a valid SWIFT Net service to which the bank has registered to send the message.
 - When the message is sent through the File Act, the service name attribute is sent with the envelope.
 - This service name defined from this screen gets listed in the protocol parameters to choose the service name, which is used for constructing the envelope to send to SWIFT Net.
- Protocol Parameter Definition (MSDPTPRM)
 - This screen is used to capture protocol parameters for FTA protocol used to connect to SWIFT Net. These are additional SWIFTNet connectivity attributes, which are required for SWIFTNet file transfer and communication with SWIFT Network.
- Rule Definition (MSDRLDFN)
 - The Rule Definition screen is provided in EMS module to capture the Rule details.
- Rule Group Definition (MSDRLGRP)

- Rule Group Definition screen is provided to capture the Rule group details. A logical grouping of the routing rules can be done using this group name.
- Populate Rules button populates all the routing rules defined which can be moved or swapped.
- On click of 'populate rules' all the rules marked for the group are listed and priority of which can be changed.
- From the populated list select a rule priority for swapping and enter another priority visible on search result in Move to/Swap to field to swap the selected rule priority with the priority entered.
- From the populated list select a priority for moving and enter another priority visible on search result in Move to/Swap to field to move the selected rule priority with the priority entered.
- Rule Group Mapping (MSDRLMAP)
 - Modules can be mapped to the rule groups defined.
 - In case a rule group is mapped to the module then all the rules from rule group are executed and the destination is derived.
 - If there is no rule group mapping for the module then the normal EMS flow should get executed.

For more details about fields of above mentioned maintenance screens, refers to Common Core - Electronic Messaging Service User Guide.

File Transmission over SWIFTNet

The following are the list of functionalities that are part of File Transmission over SWIFTNet:

- A framework that provides the SWIFTNet connectivity for the bulked SWIFT FIN files that were generated by bulker
- New Maintenance functions to capture configurations that are required to connect SWIFTNet via SAG File Act
- Monitoring and tracking function to track FileAct processing within the system

Below listed key maintenances are referred for File exchange processing:

- File Transfer Adapter Connector Configuration (MSDFTACN)
 - File Transfer Adapter Connector Configuration (MSDFTACN)
 - They define the mode of transmission and the parameters required to actually perform the message transmission.
- Connectivity Operation Manager (MSDCNMGR)
 - This screen is used to start and stop the connectivity lines.
 - You can search for the connectivity lines and perform the operation start/stop on the line searched.
- Outbound File Browser (MSSFLBRW)
 - This screen is used to view the bulk files generated for the bulk criteria maintained in the system.
 - You can search based on the Bulk criteria (rule) name, Generated date, File Name and Status.

- File details like name of the bulker file, status, bulk rule name, file generated time, bulk reference number, Size of the file; number of transactions bulked is shown in the details.
- File can be resent to the destination if the file status is not processed.
- Inbound File Browser screen (MSSIFBRW)
 - This new screen can be used to view the bulk files received from SWIFT Net through the FileAct connectors.
 - You can search based on the File Name, Received date time and status of the file.
 - Files received through FileAct connectors is sent to the EMS after parsing the payload file.
 - De-bulking of the file happen in the EMS.

For more details about fields of above mentioned maintenance screens, refers to Common Core - Electronic Messaging Service User Guide.

- [Connector Network Linkage Maintenance](#)
- [Connector File Type Linkage Maintenance](#)

Connector Network Linkage Maintenance

The Connector Network Linkage Maintenance screen allows user to link the SWIFTNet connector with the Network defined in OBPM.

1. On Homepage, specify **PMDCONNW** in the text box, and click next arrow.
Connector Network Linkage Maintenance screen is displayed.

Figure 3-1 Connector Network Linkage Maintenance

2. On **Connector Network Linkage Maintenance** screen, specify the fields.
For more information about the fields, refer to field description below:

Table 3-1 Connector Network Linkage Maintenance - Field Description

Field	D e s c r i p t i o n
Host Code	T h i s f i e l d i s d e f a u l t e d a s t h e l o g g e d i n H o s t.

Table 3-1 (Cont.) Connector Network Linkage Maintenance - Field Description

Field	Description
Host Code Description	System default of the Host Description of the Host Code default

Table 3-1 (Cont.) Connector Network Linkage Maintenance - Field Description

Field	D e s c r i p t i o n
	e d .

Table 3-1 (Cont.) Connector Network Linkage Maintenance - Field Description

Field	D e s c r i p t i o n
Connector Name	S p e c i f y t h e C o n n e c t o r N a m e f r o m t h e l i s t o f v a l u e s . A l l o p e n a n

Table 3-1 (Cont.) Connector Network Linkage Maintenance - Field Description

Field	D e s c r i p t i o n
	d a u t h o r i z e d c o n n e c t o r s m a i n t a i n e d a n d l i n k e d t o t h e H o s t i

Table 3-1 (Cont.) Connector Network Linkage Maintenance - Field Description

Field	D e s c r i p t i o n
	n t h e m a i n t e n a n c e F T A C o n n e c t o r C o n f i g u r a t i o n (F u n c t i o n I D

Table 3-1 (Cont.) Connector Network Linkage Maintenance - Field Description

Field	D e s c r i p t i o n
	:MSDFTACN) andMQHAC Connector Configuration (Function ID:

Table 3-1 (Cont.) Connector Network Linkage Maintenance - Field Description

Field	D e s c r i p t i o n
	M S D M Q H A C) a r e l i s t e d .

Table 3-1 (Cont.) Connector Network Linkage Maintenance - Field Description

Field	Description
Connector Type	Specify the Connector Type of the Connector Name selected

Table 3-1 (Cont.) Connector Network Linkage Maintenance - Field Description

Field	D e s c r i p t i o n
	d .

Table 3-1 (Cont.) Connector Network Linkage Maintenance - Field Description

Field	Description
Network Code	Specify the Network Code from the list of values. All open and

Table 3-1 (Cont.) Connector Network Linkage Maintenance - Field Description

Field	D e s c r i p t i o n
	u t h o r i z e d N e t w o r k c o d e s o f p a y m e n t t y p e S E P A C T a n d S E P A D D

Table 3-1 (Cont.) Connector Network Linkage Maintenance - Field Description

Field	D e s c r i p t i o n
	a r e l i s t e d

- [Connector Network Linkage Maintenance Summary](#)

Connector Network Linkage Maintenance Summary

1. On Homepage, specify **PMSCONNW** in the text box, and click next arrow.
Connector Network Linkage Maintenance Summary screen is displayed.

Figure 3-2 Connector Network Linkage Maintenance Summary

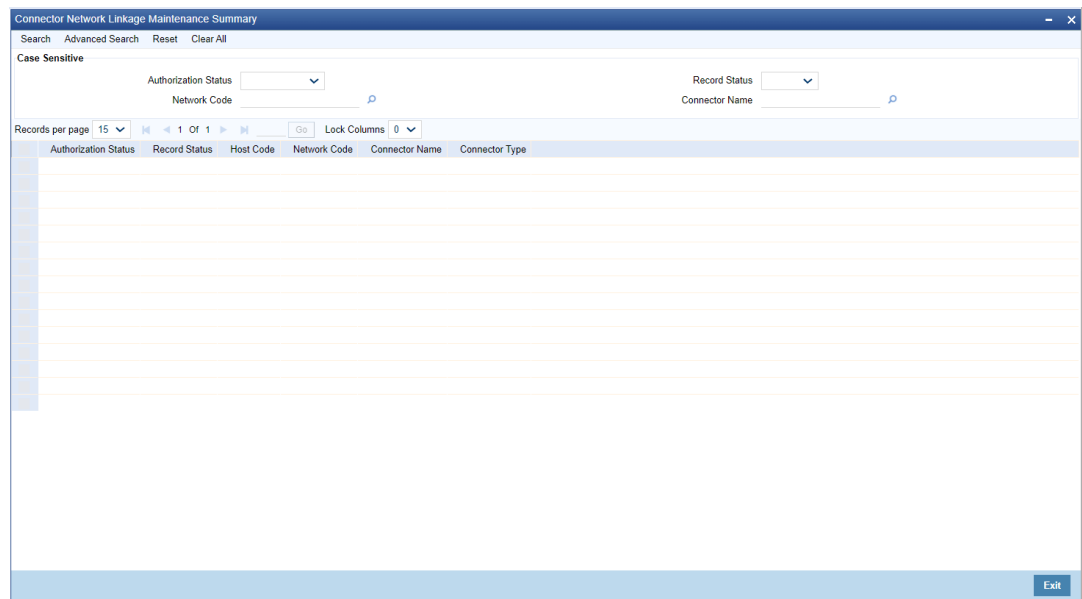

2. Search using one or more of the following parameters:
 - Authorization Status
 - Record Status

- Host Code
 - Network Code
 - Costumer Name
3. Once you specified the parameters, click the Search button.
System displays the records that match the search criteria.

Connector File Type Linkage Maintenance

The Connector File Type Linkage Maintenance screen allows user to link the SWIFTNet connector with the File Type defined Non CSM SEPA CT/SEPA DD files.

1. On Homepage, specify **PMDCONFL** in the text box, and click next arrow.
Connector File Type Linkage Maintenance screen is displayed.

Figure 3-3 Connector File Type Linkage Maintenance

2. On **Connector File Type Linkage Maintenance** screen, specify the fields.
For more information about the fields, refer to field description below:

Table 3-2 Connector File Type Linkage Maintenance - Field Description

Field	Description
Host Code	This field is defaulted as the logged in Host.
Host Code Description	System defaults the Host Description of the Host Code defaulted.
Connector Name	Specify the Connector Name from the list of values. Lists the combinations of all open and authorized maintenance available in PMDCONNW for the connector name and Network.
Connector Type	Specify the Connector Type of the Connector Name selected.
Network Code	System defaults the Network Code of the Connector Name selected.
File Type	Specify the File Type from the list of values. Based on the Network payment type, File Type list is populated.

Table 3-2 (Cont.) Connector File Type Linkage Maintenance - Field Description

Field	Description
File Format Type	Select the only value 'XML' for the File Type from the drop-down list.
Schema Path	Specify the Schema Path.
Schema Name	Specify the Schema Name.

- [Connector File Type Linkage Maintenance Summary](#)

Connector File Type Linkage Maintenance Summary

1. On Homepage, specify **PMSCONFL** in the text box, and click next arrow.
Connector File Type Linkage Maintenance Summary screen is displayed.

Figure 3-4 Connector File Type Linkage Maintenance Summary

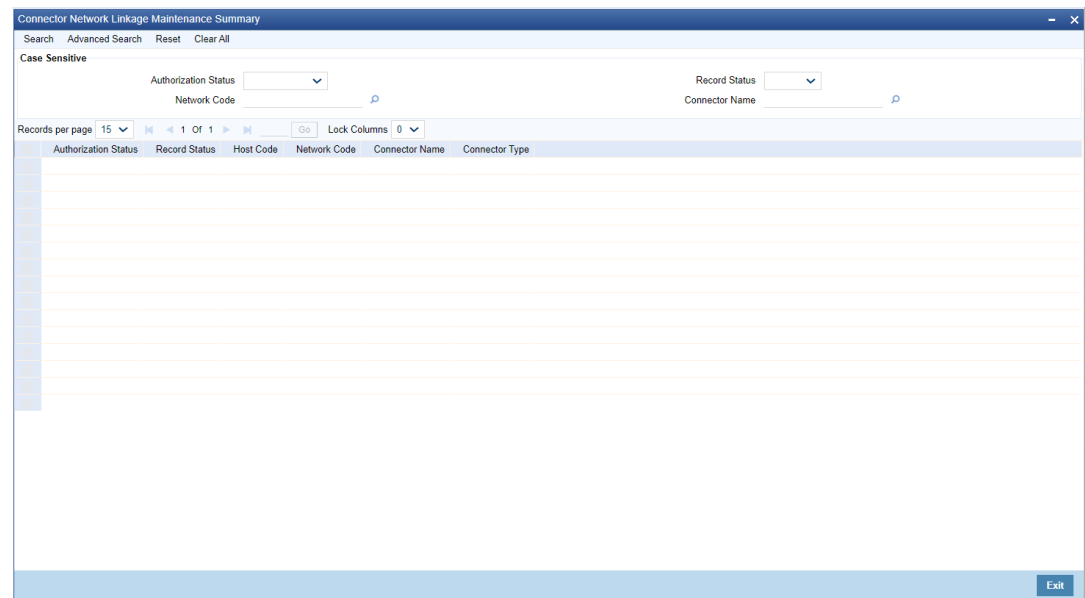

2. Search using one or more of the following parameters:
 - Authorization Status
 - Record Status
 - Costumer Name
 - File Type
 - Network Code
3. Once you specified the parameters, click the Search button.
System displays the records that match the search criteria.

4

SWIFT Messages

- [Outgoing Message Browser](#)
- [Incoming Message Browser](#)
- [Bulking and De-bulking](#)
- [Local Authentication](#)
- [SWIFT FIN Header Configuration](#)

Outgoing Message Browser

- [Outgoing Message Browser Summary](#)
- [Outgoing Message Browser Screen](#)

Outgoing Message Browser Summary

1. On Homepage, specify **PMSOUTBR** in the text box, and click next arrow.
Outgoing Message Browser Summary screen is displayed.

Figure 4-1 Outgoing Message Browser Summary

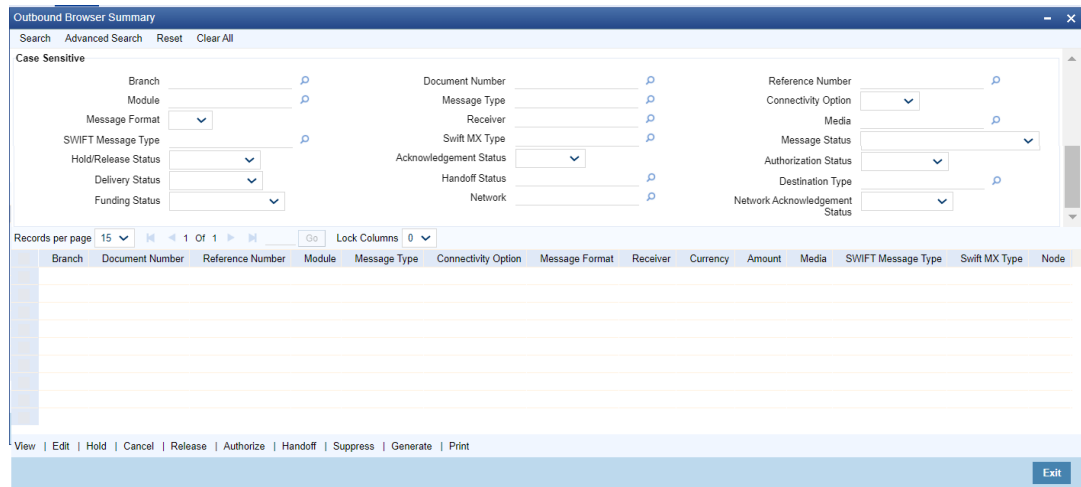

2. Search using one or more of the following parameters:
 - Branch
 - Document Number
 - Reference Number
 - Module
 - Message Type

- Connectivity Option
- Message Format
- Receiver
- Media
- SWIFT Message Type
- Swift MX Type
- Message Status
- Hold/Release Status
- Acknowledgment Status
- Authorization Status
- Delivery Status
- Handoff Status
- Destination Type
- Funding Status
- Network
- Network Acknowledgement Status

 **Note:**

Queue Access rights is applicable for Outgoing Browser Summary (PMSOUTBR). Refer to Exception Queues user guide, for details on Queue Access Rights.

3. Once you specified the parameters, click the Search button.
System displays the records that match the search criteria.
4. Double click a record after selecting a record to view the detailed screen.
5. Perform the following actions:
 - View - Displays the selected message
 - Edit - Edit and change message content, if not handed off yet
 - Hold - Hold a message, if generated & not handed off yet
 - Cancel - Cancel a message, which is not handed off yet
 - Release - Release a message, if withheld due to a hold rule
 - Suppress - Suppress a message, if not handed off yet
 - Authorize - Authorize the edited message
 - Handoff - Handoff a message to SWIFT alliance, if not released yet
 - Generate - Generate a message which is un-generated status
 - Print - Print a generated message

 **Note:**

- Only Release/Suppress Actions are allowed on messages that are marked as 'Withheld' and requires authorization by another user.
- Messages that are marked as 'Withheld' can be manually released any time, even before the release rule start time. Release time gets updated on authorization of manual release.
- If a payment message marked as 'Withheld' is Released on any other business day after 'Message Date', then the system shows 'This payment message cannot be released' information message. Such payment messages are allowed to be suppressed from the outbound browser.
- Any message with Message Status Un-generated can be generated using the Generate action.
- A generated or handed off message can be printed using Print action.
- SWIFT LAU generated for the outgoing SWIFT MT message for payments can be viewed from the Payments Outgoing message browser screen.
- SWIFT LAU is displayed in summary result which shows the LAU generated for the message.

Outgoing Message Browser Screen

The outgoing browser screen allows user to track the status of the message and along with bulk criteria and bulk reference number.

If the message is not satisfied with any of the bulk rule defined in the system, then bulk status is marked as NA (Bulking not applicable).

1. You can double click a record after selecting a record in Outgoing Message Browser Summary (PMSOUTBR) screen to view the details in Message Outgoing Browser (PMDOUTBR) screen.

Message Outgoing Browser screen is displayed.

Figure 4-2 Message Outgoing Browser

2. On **Message Outgoing Browser** screen, specify the fields.

For more information about the fields, refer to field description below:

Table 4-1 Message Outgoing Browser - Field Description

Field	Description
Operation	System displays the type of Operation.
Any or Original	System displays if the message was 'Any' or 'Original'.
Message Details	--
Document Number	Specify the Document Number.
Message Status	System displays the Message Status.
Reference Number	Specify the Reference Number.
Hold/Release Status	System displays if the message is in Hold or Released status.
Module	Specify the Module Name.
Acknowledgment Status	System displays the Acknowledgment Status of the message.
Message Type	Specify the Message Type.
External Reference	Specify the External Reference details.
Receiver	Specify the Receiver details.
Delivery By	Specify the Delivery details of the message.
Currency	Specify the Currency that is specified in the message.
RTGS Network	Specify the RTGS Network.
Testing Status	System checks this box, if the message requires Testing.
DCN List	Specify the DCN List details.
Receiver Details	--
Name	Specify the Name of the Receiver.
Node	Specify the Receiver Node.
Location	Specify the Location of the Receiver.
Branch	Specify the Branch of the Receiver.

Table 4-1 (Cont.) Message Outgoing Browser - Field Description

Field	Description
Address	Specify the Address details of the Receiver in the lines provided from 1 o 4.
SWIFT Message Type	Specify the SWIFT Message Type.
Priority	System displays the Priority of the message.
Hold Mail	System check this box, if the Mail must be held.
Exception	Specify the Exception details.
Media	Specify the Media details.
Test Word Details	--
Test-word	Specify the Test Word details.
Test Amount	Specify the Test Amount.
Test Date	Specify the Date of Testing.
Test Currency	Specify the currency used for testing.
Test Word Narrative	Specify the Test Word details.
Network	Specify the Network.

Incoming Message Browser

- [Viewing Incoming Message Browser Summary](#)
- [Incoming Message Browser](#)

Viewing Incoming Message Browser Summary

The Inbound Browser Summary screen allows user to view Payments incoming messages.

SWIFT LAU received from incoming message and the check sum calculated by system (LAU_Validation) are displayed in the incoming browser.

1. On Homepage, specify **PMSINBRW** in the text box, and click next arrow.

Inbound Browser Summary screen is displayed.

Figure 4-3 Inbound Browser Summary

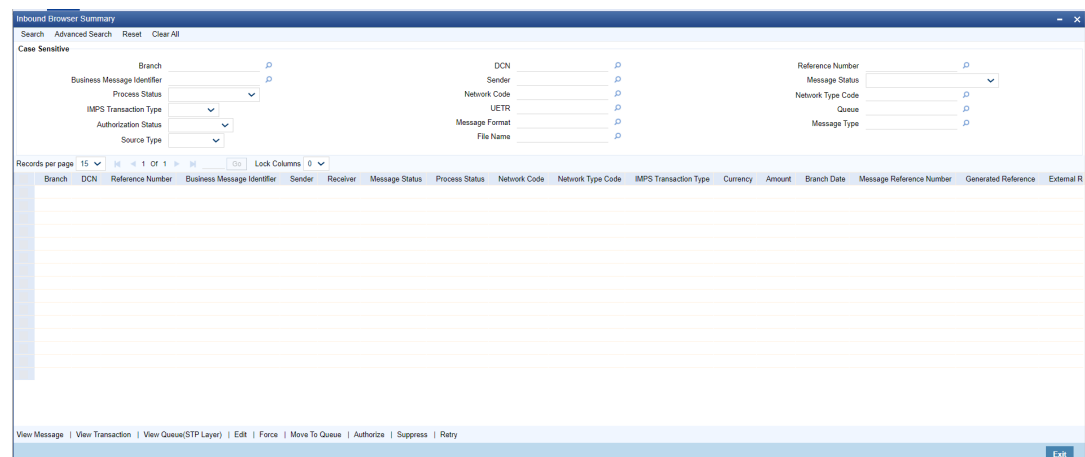

2. Search using one or more of the following parameters:
 - Branch
 - DCN
 - Reference Number
 - Business Message Identifier
 - Sender
 - Message Status (Suppressed/ Pending Cover Match / Repair / Pending Network Resolution / Moved to Unmatched Queue / Move to Non STP Queue / Move to Process Exception Queue//Move to Business Override Queue/STP Cancelled)
 - Process Status (Unprocessed / Processed / Repair / Exception)
 - Queue
 - Network Code
 - Network Type Code
 - Transaction Type (Incoming / Outgoing)
 - UETR
 - Authorization Status (Authorized / Unauthorized)
 - Message Format
 - Message Type
 - Source Type

 **Note:**

- Queue Access rights is applicable for Incoming Browser Summary (PMSINBRW). Refer to Exception Queues user guide, for details on Queue Access Rights.
- If the Payments incoming messages has UETR then system populates UETR value in the search result section.
- Incoming MT210 message received via SWIFT is logged in Inbound Browser Summary (PMSINBRW) screen with process status “Unprocessed”.
- Incoming MT210 message would be matched to another Inbound SWIFT payment message (MT202, MT205) that is expected to be received later.

3. Once you specified the parameters, click the Search button.
System displays the records that match the search criteria.
 - [View Message](#)
 - [View Transaction](#)
 - [View Queue \(STP Layer\)](#)

View Message

Users can view the message received from SWIFT/RTGS network for the selected record.

Figure 4-4 Inbound Browser Summary - View Message

View Transaction

You can view the Inbound/Outbound transaction view screen based on the Process Status, Message Status, Network Type Code, and Transaction Type (Incoming / Outgoing) of the selected payment message:

- For MT 103/202/205/202COV/205COV messages, on clicking the View Transaction tab, the system launches Inbound / Outbound Cross Border / RTGS Transaction View screens when the incoming MT messages are fully processed (Process Status as 'Processed' and Message Status as Blank). If the Incoming MT messages are in any STP Layer exception queue (or) the Message Status is 'STP Cancelled', then the system displays Inbound SWIFT View (PSDIVIEW) screen.
- For SWIFT CBPRPlus messages, on clicking the View Transaction tab, the system launches Inbound / Outbound SWIFT CBPRPlus Transaction View screens when the incoming SWIFT CBPRPlus messages are fully processed (Process Status as 'Processed' and Message Status as Blank). If the Incoming SWIFT CBPRPlus messages are in any STP Layer exception queue (or) the Message Status is 'STP Cancelled', then the system displays STP Layer Inbound Transaction View screens.
- For TARGET2 messages, on clicking the View Transaction tab, the system launches Inbound / Outbound TARGET2 ISO Transaction View screens when the incoming TARGET2 messages are fully processed (Process Status as 'Processed' and Message Status as Blank). If the Incoming TARGET2 messages are in any STP Layer exception queue (or) the Message Status is 'STP Cancelled', then the system displays STP Layer Inbound Transaction View screens.

View Queue (STP Layer)

For MT / MX messages, on clicking the View Queue (STP Layer) tab, the system launches the STP Layer exception queue when the Incoming messages are moved to any STP Layer exception queue.

Incoming Message Browser

The Incoming Message Browser allows user to view the incoming message details like source type and SWIFTNet connector name.

1. You can Double click a record after selecting a record in Incoming Message Browser Summary (PMSINBRW) screen to view the details in Incoming Message Browser (PMDINBRW) screen.

Incoming Message Browser screen is displayed.

Figure 4-5 Incoming Message Browser

2. On **Incoming Message Browser** screen, specify the fields.
For more information about the fields, refer to field description below:

Table 4-2 Incoming Message Browser - Field Description

Field	Description
Document Number	Specify the Document Number.
Reference No	Specify the Reference Number of the document.
Sender	Specify the Sender.
Media	Specify the required Media.
SWIFT Message Type	Specify the required SWIFT Message Type.
Queue	Specify the Queue name.
Required Execution Date	Specify the Required Execution Date.
Operation	Select the required Operation.
Name	Specify the Name.
Address	Specify the Address details in the lines provided from 1 to 4.
Location	Specify the required Location.
Status	Specify the required Status.
Currency	Specify the required Currency.
Amount	Specify the Amount.

Table 4-2 (Cont.) Incoming Message Browser - Field Description

Field	Description
Value Date	Specify the Value Date.
External Reference	Specify the External Reference Number.
Multi Credit Reference	Specify the Multi Credit Reference details.
Branch	Specify the required Branch.
Media Control System	Specify the Media Control System.
Node	Specify the required Node.
Testword	Specify the Testword.
Repair Reason	Specify the Repair Reason.
Reason Description	Specify the description of the Reason.
Suppress Details	:
Process Status	Specify the status of the Process.
PDE Flag	Check the PDE flag if required.
Remarks	Specify the any Remarks of the Suppress details.
Suppress Message	Specify the Suppress Message details.
Cover Match Status	Specify the status of the Cover Match.
Suppress Status	Specify the Status of the Suppress.
Funding Exception Status	Specify the status of the Funding Exception.
Authorization Status	Check the Authorization Status box, if required.

Bulking and De-bulking

The following are the list of functionalities that are part of Bulker Framework:

- Ability to bulk the outgoing SWIFT MT messages with a configurable delimiter based on parameters like Message Type, Value Date, Currency, Receiver BIC and Sender BIC.
- Option to schedule automatic bulking with a start and end time with time frequency so that the bulking process runs between start and end time for configured frequency.
- Ability to configure size or volume based bulking.
- File name prefix should be configurable in the system.
- The system supports option to compress the bulk file before sending it to the SWIFTNet network.

Below listed key maintenances are referred for Bulking and De-bulking of SWIFT MT Messages processing:

- Bulk Preference Definition (MSDBLKRL)
 - Bulk Preference Definition screen is used to configure the preferences to be used during the bulking process.
 - It also defines the scheduling parameters to automate the bulking process, like start time, end time and frequency.
 - Compression required and compression type is applicable only for SWIFTNet connectivity not for other destination types.
- Bulker Monitor (MSDBLKMN)

- This is the screen to monitor the bulk scheduler execution.
- You can view the bulk preference name and the execution start time, end time, execution status and no of files generated.
- You can initiate the ad-hoc bulking for the selected bulk preference.
- To initiate the adhoc manual bulking the detail screen has to be invoked and click on the adhoc bulking button to trigger the adhoc bulking for the chosen bulk preference.
- To initiate the adhoc manual bulking the detail screen has to be invoked and click on the adhoc bulking button to trigger the adhoc bulking for the chosen bulk preference.

For more details about fields of above mentioned maintenance screens, refers to Common Core - Electronic Messaging Service User Guide.

Local Authentication

SWIFT Alliance LAU is enabled in order to secure messaging between Oracle Banking Payments and SWIFT.

If there is any interference with the message as it is transmitted between source and destination, the checksum fails, indicating the message integrity has been breached.

Below listed key maintenances are referred for File exchange processing:

- SWIFT LAU Key Maintenance (MSDLAUMN)
 - This screen can be accessed for maintenance from Head Office only.
 - Specific users with necessary roles can access the maintenance screen. Switching LAU 'ON' or 'OFF' affects all the outgoing SWIFT messages in FCUBS. SWIFT LAU maintenance data is referred by EMS for calculation of checksum for outbound or inbound messages.
 - Message direction must be chosen based on the key is maintained for Outgoing or Incoming SWIFT message.

For more details about fields of above mentioned maintenance screens, refers to Common Core - Electronic Messaging Service User Guide.

- [SWIFT LAU Key Summary](#)
- [Detailed Processing Logic for Incoming SWIFT LAU](#)

SWIFT LAU Key Summary

1. On Homepage, specify **MSSLAUMN** in the text box, and click next arrow.
SWIFT LAU Key Summary screen is displayed.

Figure 4-6 SWIFT LAU Key Summary

The screenshot shows a web application window titled "SWIFT LAU Key Summary". The interface includes a search section with a "Case Sensitive" checkbox and three dropdown menus for "Authorization Status", "Record Status", and "Message Direction". Below the search area is a table with the following columns: "Authorization Status", "Record Status", "Host Code", "Message Direction", "SWIFT LAU Required", "Key First Part", and "Key Second Part". The table is currently empty. At the bottom right of the window, there is an "Exit" button.

2. Search using one or more of the following parameters:
 - Authorization Status
 - Record Status
 - Host Code
 - Message Direction
3. Once you have specified the search parameters, click 'Search' button. System displays the records that match the search criteria for the following:
 - Authorization Status
 - Record Status
 - Host Code
 - Message Direction
 - SWIFT LAU Required
 - Key First Part
 - Key Second Part
 - Detailed Processing Logic for Outgoing SWIFT LAU
 - The messaging module is enhanced to incorporate the new S-block in the SWIFT message. And the same is generated for all outbound messages from FCUBS with message status 'G'.
 - The messaging module fetches the records in outgoing browser with MSG_STATUS = 'G' and generates S-Block data.
 - For all outbound messages, the generated checksum is appended in S-Block and can be viewed from Outgoing Message Browser front end screen.
 - Successful generation of S-Block data and message hand-off to out folder updates the message status to 'H'

- EMS does not update message status to 'H' in Outgoing message browser if, there is failure to append the S block data in the message and the status of message remains 'G'.

EMS next hand-off job picks the messages with status 'G' and regenerates S Block data and appends same in the message which also updates message status to 'H'.

Refer the Process Flow diagram below:

Figure 4-7 Process Flow Diagram

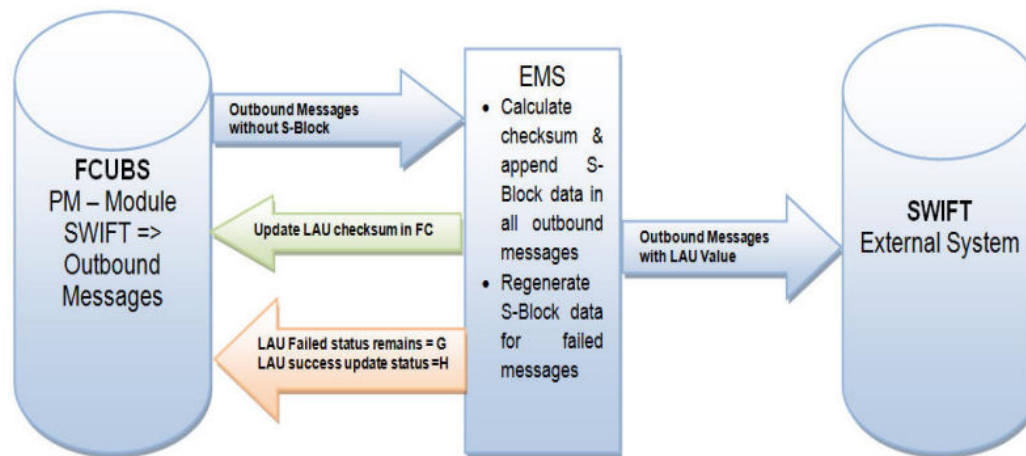

Detailed Processing Logic for Incoming SWIFT LAU

- The messaging module is enhanced to validate inbound messages with S block data.
- Received encrypted S-Block checksum values are validated.
- You can view both, check sum received & generated in SWIFT_LAU & LAU_VALIDATION fields respectively. Messages with status 'R' in Incoming message browser hold differences in check sum data between SWIFT_LAU and LAU_VALIDATION data.
- Incoming message without any data in S Block is uploaded in incoming browser with status 'R' and there is no data updated in SWIFT_LAU field where as EMS generated checksum gets updated in LAU_VALIDATION field.

Refer the Process Flow diagram below:

Figure 4-8 Detailed Processing Logic for Incoming SWIFT LAU

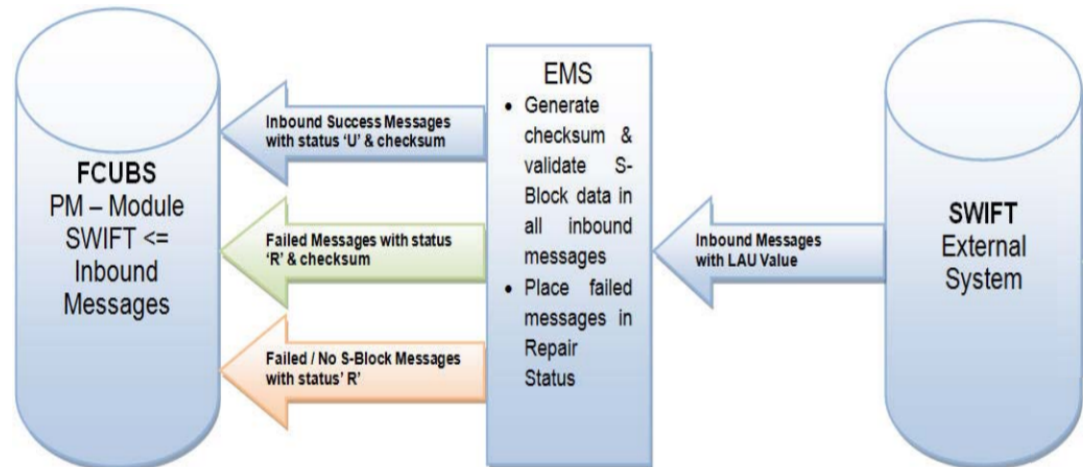

SWIFT FIN Header Configuration

You can configure delivery monitoring flag in the FIN message application header. Based on the configuration provided the customer can do the maintenance to receive/not receive MT011 delivery notifications.

- [SWIFT FIN HEADER Preferences](#)
- [SWIFT FIN HEADER Host Preferences](#)
- [SWIFT FIN Header Processing](#)

SWIFT FIN HEADER Preferences

This screen supports processing of delivery notification messages.

1. On Homepage, specify **PXDFNHDR** in the text box, and click next arrow.
SWIFT FIN HEADER Preferences screen is displayed.

Figure 4-9 SWIFT FIN HEADER Preferences

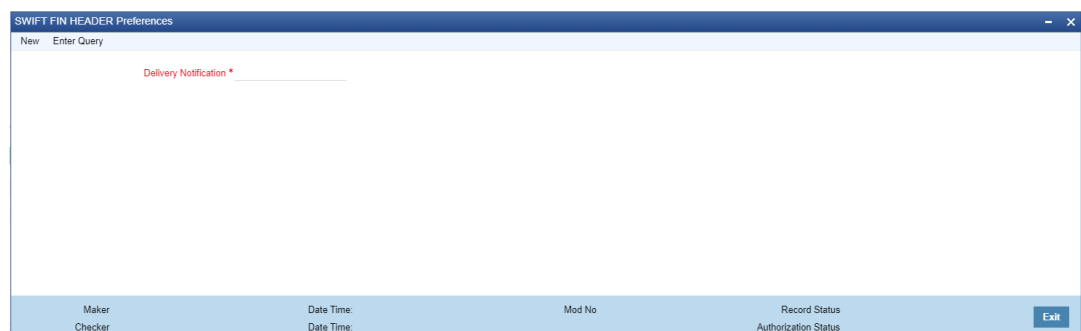

2. On **SWIFT FIN HEADER Preferences** screen, specify the fields.
For more information about the fields, refer to field description below:

Table 4-3 SWIFT FIN HEADER Preferences - Field Description

Field	Description
Delivery Notification	Specify the Delivery Notification from the following list of values: <ul style="list-style-type: none"> • Required • Not Required

- [SWIFT FIN HEADER Preferences Summary](#)

SWIFT FIN HEADER Preferences Summary

1. On Homepage, specify **PXSFNHDR** in the text box, and click next arrow. **SWIFT FIN HEADER Preferences Summary** screen is displayed.

Figure 4-10 SWIFT FIN HEADER Preferences Summary

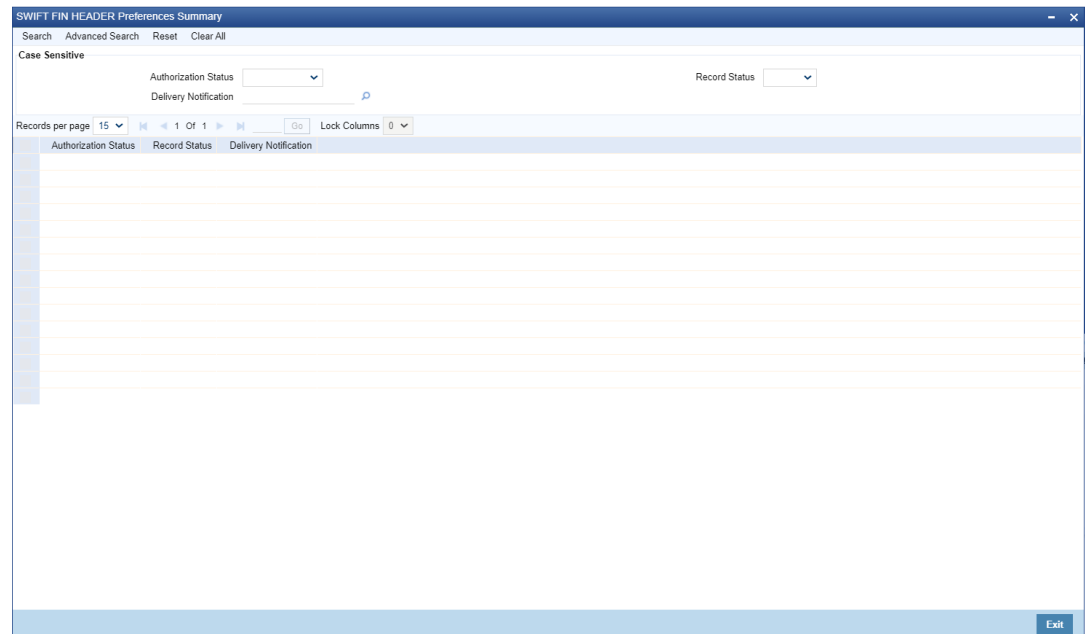

2. Search using one or more of the following parameters:
 - Authorization Status (Authorized / Unauthorized / Rejected)
 - Record Status (Open / Closed)
 - Delivery Notification
3. Once you specified the parameters, click the Search button. System displays the records that match the search criteria.
4. Double click a record after selecting a record to view the detailed screen.

SWIFT FIN HEADER Host Preferences

This screen supports processing of delivery notification messages.

1. On Homepage, specify **PXDFNHST** in the text box, and click next arrow. **SWIFT FIN HEADER Host Preferences** screen is displayed.

Figure 4-11 SWIFT FIN HEADER Host Preferences

2. On **SWIFT FIN HEADER Host Preferences** screen, specify the fields. For more information about the fields, refer to field description below:

Table 4-4 SWIFT FIN HEADER Host Preferences - Field Description

Field	Description
Host Code	System defaults the Host code of the logged in user.
Network Code	This field list all the Network codes maintained for payment types 'Cross Border' and 'RTGS' in the host.
Delivery Notification	Specify the Delivery Notification from the following list of values: <ul style="list-style-type: none"> • Required • Not Required
Network Description	System defaults the Network Description based on the Network Code selected.
Network Type Description	System defaults the Network Type Description based on the Network Code selected.

- [SWIFT FIN HEADER Host Preferences Summary](#)

SWIFT FIN HEADER Host Preferences Summary

1. On Homepage, specify **PXSFNHDR** in the text box, and click next arrow. **SWIFT FIN HEADER Host Preferences Summary** screen is displayed.

Figure 4-12 SWIFT FIN HEADER Host Preferences Summary

2. Search using one or more of the following parameters:
 - Authorization Status (Authorized / Unauthorized / Rejected)
 - Record Status (Open / Closed)
 - Host Code
 - Network Code
 - Delivery Notification
3. Once you specified the parameters, click the Search button.
System displays the records that match the search criteria.

SWIFT FIN Header Processing

Below is the list of messages applicable on Swift Fin Header preferences and Host preferences:

Table 4-5 SWIFT FIN Header - List of Messages

Message Type	Message Description
MT103/103 REMIT/103 STP	Single Customer Credit Transfer
MT202	General Financial Institution Transfer
MT205	Financial Institution Transfer Execution
MT202COV	General Financial Institution Transfer
MT205COV	Financial Institution Transfer Execution
MT200	Financial Institution Transfer for its Own Account
MT210	Notice to Receive

While generating the outgoing MT message, system checks for Delivery Notification maintenance done in the FIN Header Host Preference (PXDFNHST) screen.

If there is no host level message preference maintained, then system checks the FIN Header Preference (PXDFNHDR) screen.

Level 1	SWIFT FIN Header Host Preference
Level 2	SWIFT FIN Header Preference

Based on the Message Priority (i.e. Value provided in Bank priority field) of outgoing transaction input screen and Delivery Notification field value, the Delivery Monitoring field of FIN message application header gets populated.

- When Message Priority value is U:
 - If Delivery Notification value is 'Required, Field value gets populated with 3
 - If Delivery Notification value is Not Required, Field value gets populated as 1
- When Message Priority value is N:
 - If Delivery Notification value is 'Required, Field value gets populated with 2
 - If Delivery Notification value is Not Required, Field value gets blank

 **Note:**

When value of the delivery notification is sent as blank then system do not receive MT011 (i.e. Delivery Notification) from SWIFT.

5

SWIFT Messages Via Blockchain

Cross border Outbound transactions initiated from a particular Branch, with as specific Receiver BIC, Message Type, Transfer Currency and Source Code are processed using block chain network and not via SWIFT network. You can verify the details of transaction initiated in source environment are received in destination environment for the combination maintained.

- [SWIFT Message Routing Parameter Detailed](#)
- [DLT Message Browser Summary](#)
- [SWIFT Message Processing](#)

SWIFT Message Routing Parameter Detailed

1. On Homepage, specify **PMDMSGRT** in the text box, and click next arrow.
SWIFT Message Routing Parameter Detailed screen is displayed.

Figure 5-1 SWIFT Message Routing Parameter Detailed

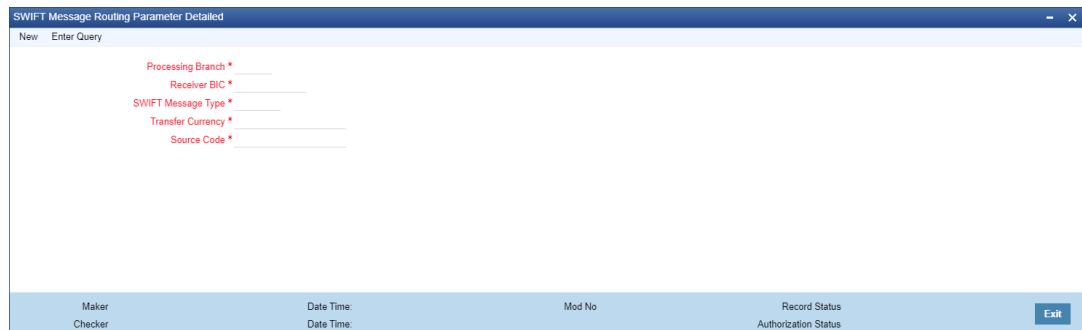

2. On **SWIFT Message Routing Parameter Detailed** screen, specify the fields.
For more information about the fields, refer to field description below:

Table 5-1 SWIFT Message Routing Parameter Detailed - Field Description

Field	Description
Transaction Branch	Specify the Transaction Branch in which the transaction is to be booked. Alternatively you can select a valid Transaction Branch from the list of values displayed.
Receiver BIC	Specify a valid Receiver BIC, which is the internal SWIFT routing receiver BIC. Alternatively you can select a valid Receiver BIC from the list of values displayed.
SWIFT Message Type	Specify the SWIFT Message Type, for which the SWIFT Routing parameter is to be maintained. Alternatively you can select a valid Receiver BIC from the list of values displayed.
Transfer Currency	Specify the Transfer Currency. Alternatively, you can select a currency code from the list of values displayed.

Table 5-1 (Cont.) SWIFT Message Routing Parameter Detailed - Field Description

Field	Description
Source Code	Specify the Source Code. Alternatively, you can select the Source Code from the list of values displayed.

- [SWIFT Message Routing Parameter Summary](#)

SWIFT Message Routing Parameter Summary

1. On Homepage, specify **PMSMSGRT** in the text box, and click next arrow.
SWIFT Message Routing Parameter Summary screen is displayed.

Figure 5-2 SWIFT Message Routing Parameter Summary

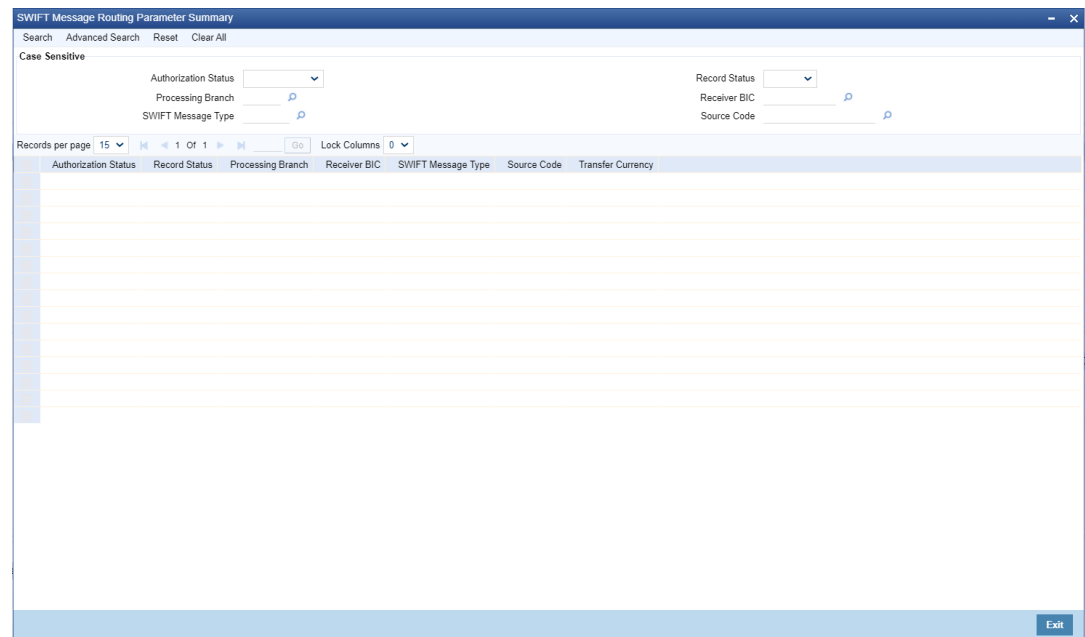

2. Search using one or more of the following parameters:
 - Authorization Status
 - Record Status
 - Processing Branch
 - Receiver BIC
 - SWIFT Message Type
 - Source Code
3. Once you specified the parameters, click the Search button.
System displays the records that match the search criteria.

DLT Message Browser Summary

1. On Homepage, specify **PMSHYLTR** in the text box, and click next arrow.
DLT Message Browser Summary screen is displayed.

Figure 5-3 DLT Message Browser Summary

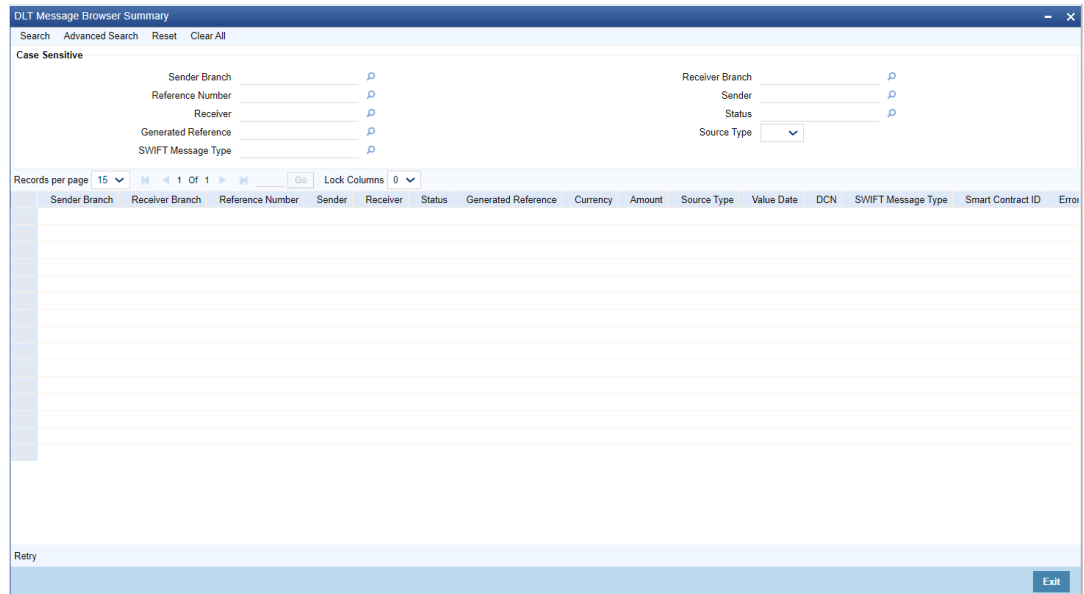

2. Search using one or more of the following parameters:
 - Sender Branch
 - Receiver Branch
 - Reference Number
 - Sender
 - Receiver
 - Status
 - Generated Reference
 - Source Type
 - SWIFT Message Type
3. Once you specified the parameters, click the Search button.
System displays the records that match the search criteria.
4. Double click a record after selecting a record to view the detailed screen.
5. Perform the following actions:
 - [Retry](#)

Retry

Retry action is allowed for all the outbound messages with Rejected/Failed status. You are required to have user/role level queue access rights, to take this action. Source Type needs to be 'Out'.

1. Resubmit the payment message for OFBA to pick up and process the message. This action is allowed for a configured number of times.

Figure 5-4 DLT Message Browser Summary - Retry

The screenshot shows a dialog box titled "DLT Message Retry". It contains several input fields for message details. On the left side, there are five fields: "DCN", "Generated Reference", "Receiver Branch", "Sender Branch", and "Smart Contract ID". On the right side, there are four fields: "Message Status" (with a dropdown menu currently showing "Rejected"), "Status", "Error Code", and "Error Description". At the bottom right corner, there are two buttons: "Ok" and "Exit".

2. User can view the following fields:
 - DCN
 - Generated Reference
 - Receiver Branch
 - Sender Branch
 - Smart Contract ID
 - Message Status
 - Error Code
 - Error Description
3. Status field is shown as the current status. Please select the option to 'Ready'.
4. On clicking of OK, the message is populated in the OFBA polling table for pick up by OFBA. The message status is then updated as 'Ready'.
5. On receiving the response from OFBA table, the ACK/NACK status is updated in the SWIFT Message Notification Browser (MSSNOTIB).
6. Retry of failed/rejected messages are allowed for the maximum number of retry count value maintained against the parameter 'MAX_OFBA_RETRY_COUNT' (PMDSYSPM). The factory shipped value for maximum retry value is 10.

SWIFT Message Processing

The system refers to the SWIFT Message Routing maintenance (PMDMSGRT) to decide whether to generate SWIFT CBPRPlus outbound message and send via OFBA or not.

The system checks transaction Source Code, Booking Branch, Instructed Agent BICFI as Receiver BIC, Transfer Currency, and MX Message Type as the SWIFT Message Type against the routing maintenance.

If the maintenance is satisfied, then the message is handed off via OFBA. The 'Connectivity Option' value is updated as 'DLT'. The message is not handed off via the EMS OUT scheduler.

6

Fedwire Messages

- [Fedwire Message Mapping](#)

Fedwire Message Mapping

1. On Homepage, specify **MSDFQMAP** in the text box, and click next arrow.
Fedwire Message Mapping screen is displayed.

Figure 6-1 Fedwire Message Mapping

The screenshot shows a web application window titled "Fedwire Message Mapping". At the top left, there are buttons for "New" and "Enter Query". Below these are five input fields: "Media *", "American Banker Associations Number *", "Branch Name", "Message Type * FWR", and "Branch *". At the bottom of the window, there is a status bar with fields for "Maker", "Checker", "Date Time", "Date Time", "Mod No", "Record Status", and "Authorization Status", along with an "Exit" button.

2. On **Fedwire Message Mapping** screen, specify the fields.
For more information about the fields, refer to field description below:

Table 6-1 Fedwire Message Mapping - Field Description

Field	Description
Media	Specify the required Media from the list of values.
American Banker Associations Number	Specify the required ABA Number from the list of values.
Message Type	System displays the Message Type by default.
Branch	Select the required Branch from the list of values.
Branch Name	This field is displayed when you select the Branch.

- [Fedwire Message Mapping Summary](#)
- [SWIFT Message Notifications](#)

Fedwire Message Mapping Summary

1. On Homepage, specify **MSSFQMAP** in the text box, and click next arrow.
Fedwire Message Mapping Summary screen is displayed.

Figure 6-2 Fedwire Message Mapping Summary

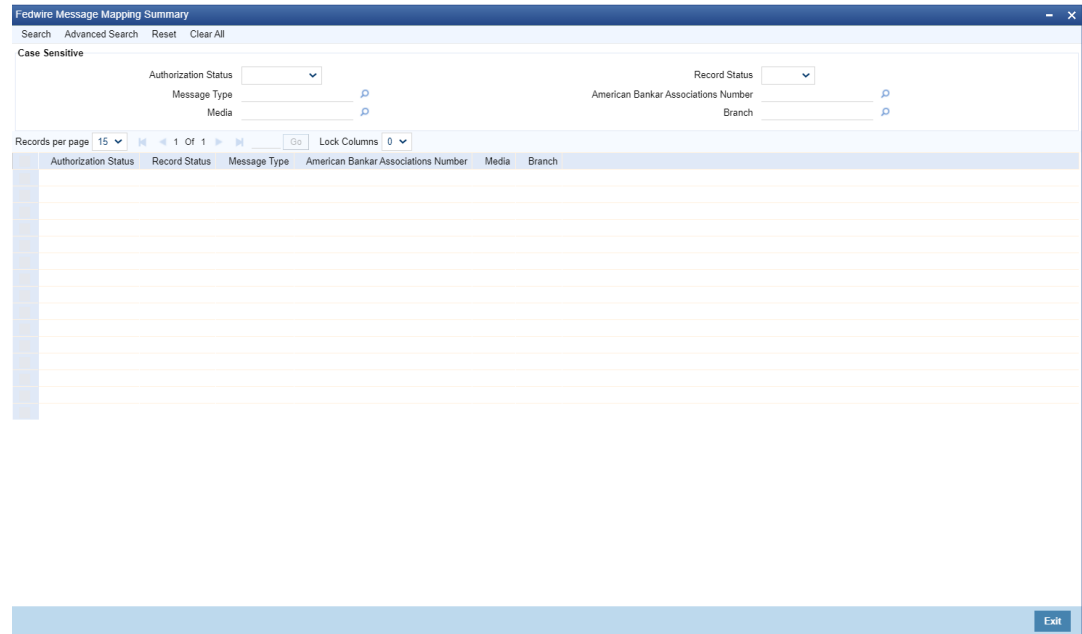

2. Search using one or more of the following parameters:
 - Authorization Status
 - Record Status
 - Message Type
 - American Banker Associations Number
 - Media
 - Branch
3. Once you specified the parameters, click the Search button.
System displays the records that match the search criteria.

SWIFT Message Notifications

1. On Homepage, specify **MSDNOTIB** in the text box, and click next arrow.
SWIFT Message Notifications screen is displayed.

Figure 6-3 SWIFT Message Notifications

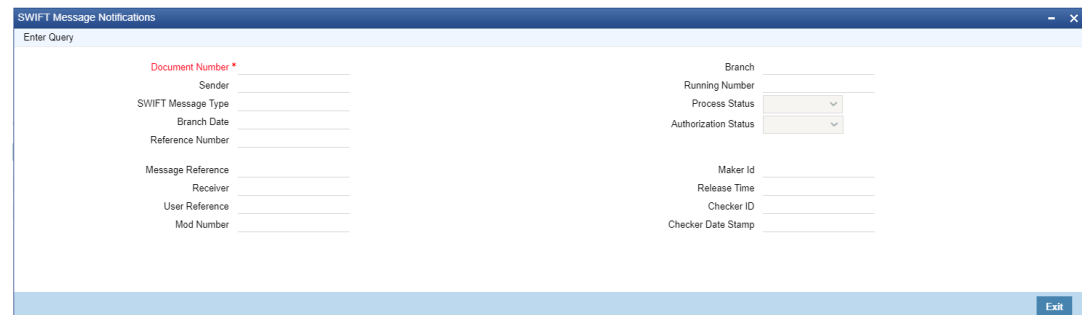

2. On **SWIFT Message Notifications** screen, specify the fields.

For more information about the fields, refer to field description below:

Table 6-2 SWIFT Message Notifications - Field Description

Field	Description
Document Number	Specify the Document Number and click on Execute Query button to view the details pertaining to it.

Following details are displayed on clicking Execute Query button:

- Branch
- Sender
- Running Number
- SWIFT Message Type
- Process Status
- Branch Date
- Authorization Status
- Reference Number
- Message Reference
- Maker Id
- Receiver
- Release Time
- User Reference
- Checker ID
- Mod Number
- Checker Date Stamp

Glossary

MSDFQMAP

[Fedwire Message Mapping](#)

MSDNOTIB

[SWIFT Message Notifications](#)

MSSFQMAP

[Fedwire Message Mapping Summary](#)

MSSLAUMN

[SWIFT LAU Key Summary](#)

PMDCONFL

[Connector File Type Linkage Maintenance](#)

PMDCONNW

[Connector Network Linkage Maintenance](#)

PMDINBRW

[Incoming Message Browser](#)

PMDMSGRT

[SWIFT Message Routing Parameter Detailed](#)

PMDOUTBR

[Outgoing Message Browser Screen](#)

PMSCONFL

[Connector File Type Linkage Maintenance Summary](#)

PMSCONNW

[Connector Network Linkage Maintenance Summary](#)

PMSHYLTR

[DLT Message Browser Summary](#)

PMSINBRW

[Viewing Incoming Message Browser Summary](#)

PMSMSGRT

[SWIFT Message Routing Parameter Summary](#)

PMSOUTBR

[Outgoing Message Browser Summary](#)

PXDFNHDR

[SWIFT FIN HEADER Preferences](#)

PXDFNHST

[SWIFT FIN HEADER Host Preferences](#)

PXSFNHDR

[SWIFT FIN HEADER Preferences Summary](#)