

# Oracle® Communications Order and Service Management

## Cloud Native System Administrator's Guide



Release 7.4.1  
F35685-01  
November 2020

The Oracle logo, consisting of a solid red square with the word "ORACLE" in white, uppercase, sans-serif font centered within it.

ORACLE®

Oracle Communications Order and Service Management Cloud Native System Administrator's Guide,  
Release 7.4.1

F35685-01

Copyright © 2020, Oracle and/or its affiliates.

This software and related documentation are provided under a license agreement containing restrictions on use and disclosure and are protected by intellectual property laws. Except as expressly permitted in your license agreement or allowed by law, you may not use, copy, reproduce, translate, broadcast, modify, license, transmit, distribute, exhibit, perform, publish, or display any part, in any form, or by any means. Reverse engineering, disassembly, or decompilation of this software, unless required by law for interoperability, is prohibited.

The information contained herein is subject to change without notice and is not warranted to be error-free. If you find any errors, please report them to us in writing.

If this is software or related documentation that is delivered to the U.S. Government or anyone licensing it on behalf of the U.S. Government, then the following notice is applicable:

U.S. GOVERNMENT END USERS: Oracle programs (including any operating system, integrated software, any programs embedded, installed or activated on delivered hardware, and modifications of such programs) and Oracle computer documentation or other Oracle data delivered to or accessed by U.S. Government end users are "commercial computer software" or "commercial computer software documentation" pursuant to the applicable Federal Acquisition Regulation and agency-specific supplemental regulations. As such, the use, reproduction, duplication, release, display, disclosure, modification, preparation of derivative works, and/or adaptation of i) Oracle programs (including any operating system, integrated software, any programs embedded, installed or activated on delivered hardware, and modifications of such programs), ii) Oracle computer documentation and/or iii) other Oracle data, is subject to the rights and limitations specified in the license contained in the applicable contract. The terms governing the U.S. Government's use of Oracle cloud services are defined by the applicable contract for such services. No other rights are granted to the U.S. Government.

This software or hardware is developed for general use in a variety of information management applications. It is not developed or intended for use in any inherently dangerous applications, including applications that may create a risk of personal injury. If you use this software or hardware in dangerous applications, then you shall be responsible to take all appropriate fail-safe, backup, redundancy, and other measures to ensure its safe use. Oracle Corporation and its affiliates disclaim any liability for any damages caused by use of this software or hardware in dangerous applications.

Oracle and Java are registered trademarks of Oracle and/or its affiliates. Other names may be trademarks of their respective owners.

Intel and Intel Inside are trademarks or registered trademarks of Intel Corporation. All SPARC trademarks are used under license and are trademarks or registered trademarks of SPARC International, Inc. AMD, Epyc, and the AMD logo are trademarks or registered trademarks of Advanced Micro Devices. UNIX is a registered trademark of The Open Group.

This software or hardware and documentation may provide access to or information about content, products, and services from third parties. Oracle Corporation and its affiliates are not responsible for and expressly disclaim all warranties of any kind with respect to third-party content, products, and services unless otherwise set forth in an applicable agreement between you and Oracle. Oracle Corporation and its affiliates will not be responsible for any loss, costs, or damages incurred due to your access to or use of third-party content, products, or services, except as set forth in an applicable agreement between you and Oracle.

# Contents

	<b>Preface</b>	
	Audience	xv
	Documentation Accessibility	xv
<b>1</b>	<b>OSM System Administration Overview</b>	
	OSM System Administration Tasks	1-1
	About OSM System Administration Programs	1-1
<b>2</b>	<b>Changing GUI Application Appearance and Functionality</b>	
	About Configuring the User Experience	2-1
	About Behaviors	2-1
	Changing Web Client Appearance and Functionality	2-2
	Changing the Default Timeout Setting	2-2
	Setting Table Height	2-3
	Configuring the Data View Performance in the Order Management Web Client	2-3
	Configuring the Display Size of Text Fields	2-4
	Setting Default Action on Orders and Tasks in the Task Web Client	2-4
	Customizing the Appearance of Read-Only Text Fields	2-5
<b>3</b>	<b>Setting Up OSM Security</b>	
	About OSM Security	3-1
	Secure Solution Data Storage	3-1
	Adding Users to OSM	3-2
	Creating Workgroups as Roles in Design Studio	3-2
	Assigning Users to Workgroups	3-3
	Using WebLogic Server Authenticators with OSM	3-4
	User-Level Authenticator Support	3-4
	Group-Level Authenticator Support	3-4
	Authenticator User and Group Assignment Considerations	3-5
	Setting Up a Caching Realm	3-5

Secure Credential Management	3-6
Using the EncryptPasswords Utility	3-6
About the EncryptPasswords Utility	3-6
Running the EncryptPasswords Utility	3-7
Removing an Encrypted Password	3-8
Using the Credential Store	3-8
About the Credential Store	3-8
How OSM Retrieves Credentials from the Credential Store	3-9
Managing Credentials in the Credential Store	3-9
Developing Cartridges to Use the Credential Store	3-10
Developing Automation Plug-ins to Use the Credential Store	3-11
Defining Data Providers in OSM Cartridges to Use the Credential Store	3-11
Using the Credential Store with Custom Data Providers	3-11
Using the Credential Store with Built-In Data Providers	3-12
Upgrading Existing Cartridge Code to Use the Credential Store	3-12
Using Built-in SOAP Adapter as a Data Provider Class	3-12
Administering Users and Workgroups	3-13

## 4 Configuring OSM with oms-config.xml

---

Working with oms-config Parameters in OSM Cloud Native	4-1
oms-config.xml Parameters	4-1

## 5 Configuring the Task Processor

---

About Configuring the Task Processor	5-1
Configuring the Task Processor for Performance	5-1

## 6 Managing the OSM Database Schema

---

Implementing a Strategy for OSM Information Lifecycle Management	6-1
Creating Tablespaces	6-2
Using Partitioning	6-4
Benefits of Partitioning	6-5
Improved Manageability	6-5
Increased Availability	6-5
Increased Concurrency	6-5
Support for Active-Active Oracle RAC	6-6
Increased Query Performance	6-8
Pitfalls of Partitioning	6-8
Order Search Performance	6-8
Purge Performance	6-9

Shared Pool	6-9
Development and Testing Environments	6-9
Order Purge Strategies	6-9
Partition-Based Order Purge Strategy	6-10
Partition Purge Example	6-10
Advantages and Disadvantages of Partition-Based Purge	6-13
Row-Based Order Purge Strategy	6-13
Row-Based Order Purge Example	6-15
Advantages and Disadvantages of Row-Based Order Purge	6-15
Hybrid Purge Strategy	6-16
Partitioning Realms	6-16
Partitioning Realms Configuration	6-17
Mapping Orders to Partitioning Realms	6-19
Enabling and Disabling Partitioning Realms	6-21
Renaming a Partitioning Realm	6-22
Refreshing Partitioning Realms Configuration	6-22
Adding Partitions for New Partitioning Realms	6-22
partition_auto_creation Disabled	6-23
partition_auto_creation Enabled	6-23
Purge Strategy for Partitioning Realms	6-23
Default Partitioning Realm	6-24
Non-Partitioned Schemas	6-24
Order ID Blocks	6-24
Cartridge Management Strategy	6-25
Sizing Partitions	6-26
Sizing Hash Sub-Partitions	6-26
Sizing Range Partitions for Partition-Based Order Purge	6-27
Purge Performance	6-28
Estimating Storage	6-28
"All-In" Order Volume	6-30
Partition Size Restrictions	6-30
Retention Policy	6-31
Time-to-Close Wait	6-31
Oracle RAC	6-33
Purge Frequency	6-34
Sizing Range Partitions for Row-Based Order Purge	6-35
Sizing Range Partitions for Zero Downtime	6-36
Sizing Range Partitions for Infrequent Maintenance	6-37
Online vs. Offline Maintenance	6-38
Managing Order Data	6-39
Adding Partitions (Online or Offline)	6-39

Using Row-Based Order Purge	6-41
Purging a Single Order by Order ID	6-42
Purging Orders that Satisfy Given Criteria	6-42
Scheduling Order Purge	6-43
Stopping and Resuming an Order Purge	6-43
Using Partition-Based Order Purge	6-43
Differences Between Purging and Dropping Partitions	6-44
Purging Partitions (Online or Offline)	6-44
Purging Entire Partitions That Do Not Contain Open Orders (Online or Offline)	6-46
Purging Partitions Partially (Offline Only)	6-46
Dropping Partitions (Offline Only)	6-50
Dropping Empty Partitions (Online or Offline)	6-51
Reclaiming Unused Space in Volatile Tables	6-51
Order Purge Policies	6-52
Purging Related Orders Independently	6-52
Auditing and Monitoring Order Purges	6-54
Audit Tables	6-55
Managing Exchange Tables for Partition-Based Order Purge	6-55
About OSM Purge Tables	6-55
About OSM Backup Tables	6-57
Creating Exchange Tables (Online or Offline)	6-57
Purging Exchange Tables (Online or Offline)	6-58
Dropping Exchange Tables (Online or Offline)	6-58
Estimating Partition Disk Space (Online or Offline)	6-58
Managing Cartridges	6-59
Using Fast Undeploy	6-60
Purging Metadata of Undeployed Cartridges	6-61
Configuration Parameters	6-61
range_partition_size	6-62
subpartitions_number	6-62
default_xchg_capacity	6-63
xchg_retained_orders_thres	6-63
degree_of_parallelism	6-63
degree_of_parallelism_rebuild_indexes	6-63
degree_of_parallelism_rebuild_xchg_indexes	6-63
purge_job_class	6-64
parallel_execute_chunk_size	6-64
partition_auto_creation	6-64
purge_policy_rebuild_unusable_indexes	6-65
purge_policy_purge_related_orders_independently	6-65

purge_policy_consolidate_partitions	6-65
purge_policy_time_to_close_wait	6-66
purge_audit_retention_days	6-67
deferred_segment_creation	6-67
purge_commit_count	6-68
About PL/SQL API	6-68
DBMS Output	6-68
Specifying Purge Criteria	6-68
Parallel Execution	6-71
Concurrency Restrictions	6-71
PL/SQL API Reference	6-72
Setup and Tuning Procedures	6-72
om_part_maintain.setup_xchg_tables (Online or Offline)	6-72
om_part_maintain.drop_xchg_tables (Online or Offline)	6-73
om_part_maintain.set_dop (Online or Offline)	6-73
om_part_maintain.set_dop_rebuild_indexes (Online or Offline)	6-73
om_part_maintain.set_dop_rebuild_xchg_indexes (Online or Offline)	6-73
Maintenance Procedures and Functions	6-74
om_part_maintain.add_partition (Offline Only)	6-74
om_part_maintain.add_partitions (Offline Only)	6-74
om_part_maintain.drop_partitions (Offline only)	6-75
om_part_maintain.drop_empty_partitions (Online or Offline)	6-76
om_part_maintain.purge_partitions (Online or Offline)	6-78
om_part_maintain.purge_entire_partition (Online or Offline)	6-82
om_part_maintain.estimate_ptn_purged_space (Online or Offline)	6-83
om_part_maintain.purge_xchg_bck_tables (Online or Offline)	6-83
om_part_maintain.purge_xchg_prg_tables (Online or Offline)	6-83
om_new_purge_pkg.delete_order (Online or Offline)	6-84
om_new_purge_pkg.purge_orders (Online or Offline)	6-84
om_new_purge_pkg.schedule_order_purge_job (Online or Offline)	6-86
om_new_purge_pkg.select_orders (Online or Offline)	6-86
om_new_purge_pkg.purge_selected_orders (Online or Offline)	6-87
om_new_purge_pkg.stop_purge (Online or Offline)	6-88
om_new_purge_pkg.resume_purge (Online or Offline)	6-88
Advanced Procedures	6-89
om_part_maintain.backup_selected_ordr (Offline)	6-89
om_part_maintain.restore_orders (Offline)	6-90
Troubleshooting Functions	6-90
om_part_maintain.get_partitions (Online or Offline)	6-90
om_part_maintain.is equipartitioned (Online or Offline)	6-90
Recovery Procedures	6-90

om_part_maintain.equipartition (Offline only)	6-91
om_part_maintain.purge_orphan_order_data (Online or Offline)	6-91
om_part_maintain.rebuild_unusable_indexes (Online or Offline)	6-91
om_part_maintain.rebuild_index (Online or Offline)	6-92
om_part_maintain.sys\$undo_restore_table (Offline)	6-92
om_part_maintain.sys\$undo_restore_orders (Offline)	6-93
Database Reference	6-93
Database Views	6-93
OM_AUDIT_PURGE_ALL	6-93
OM_AUDIT_PURGE_LATEST	6-95
Database Tables	6-95
OM_AUDIT_PURGE	6-95
OM_AUDIT_PURGE_ORDER	6-97
OM_AUDIT_PURGE_PARAM	6-98
Troubleshooting and Error Handling	6-99
Error Handling for add_partitions	6-100
Error Handling for drop_partitions	6-100
Error Handling for purge_partitions	6-101
Troubleshooting	6-101
Error Handling	6-103
Error Handling for rebuild_unusable_indexes	6-104
Error Handling for setup_xchg_tables	6-104
Performance Tuning	6-104
Tuning degree_of_parallelism	6-105
Tuning degree_of_parallelism_rebuild_indexes	6-105
Tuning degree_of_parallelism_rebuild_xchg_indexes	6-105
Tuning Parallel Job Execution	6-105
Tuning parallel_execute_chunk_size	6-106
Tuning Row-Based Purge	6-107
Database Terms	6-107

## 7 Managing Optimizer Statistics

---

About Optimizer Statistics	7-1
Gathering Optimizer Statistics	7-1
Gathering Statistics Online	7-1
Automated Optimizer Statistics Collection	7-1
Gathering Fixed Object Statistics	7-2
Gathering System Statistics	7-3
Gathering Cartridge Metamodel Statistics	7-3
Gathering Order Statistics	7-3



High Volatility Order Tables	7-3
Low Volatility Order Tables	7-4
Medium Volatility Order Tables	7-4
Enabling Incremental Statistics	7-5
Gathering High-Volatility-Table Statistics	7-6
Gathering Low-Volatility-Table Statistics	7-6
Preparing a New Partition	7-6
Populating New Partition Statistics	7-6
Using Statistics from Another Partition	7-7
Using Statistics from a Statistics Table	7-8
Using Statistics from Another System	7-8
Locking Partition Statistics	7-8
Configuring a Partition When It Is No Longer the Active Partition	7-9
Optimizer Statistics Error Handling Using Datapump	7-9
Optimizer Statistics Management Performance Tuning	7-10
Using Parallel Collection for Gathering Statistics	7-10
Cursor Invalidations	7-10
Optimizer Statistics Management PL/SQL API Reference	7-11
Setup and Tuning Procedures	7-11
om_db_stats_pkg.lock_volatile_order_stats	7-11
om_db_stats_pkg.unlock_volatile_order_stats	7-11
om_db_stats_pkg.set_table_prefs_incremental	7-11
om_db_stats_pkg.set_table_volatility	7-12
Maintenance Procedures	7-12
om_db_stats_pkg.gather_cartridge_stats	7-12
om_db_stats_pkg.gather_order_stats	7-12
om_db_stats_pkg.gather_volatile_order_stats	7-12
om_db_stats_pkg.copy_order_ptn_stats	7-13
om_db_stats_pkg.lock_order_ptn_stats	7-13
om_db_stats_pkg.unlock_order_ptn_stats	7-13
Advanced Procedures	7-14
om_db_stats_pkg.export_order_ptn_stats	7-14
om_db_stats_pkg.import_order_ptn_stats	7-14
om_db_stats_pkg.exdp_order_ptn_stats	7-15
om_db_stats_pkg.impdp_order_ptn_stats	7-15
Troubleshooting Procedures	7-16
om_db_stats_pkg.lstj_copy_order_ptn_stats	7-16
om_db_stats_pkg.get_order_ptn_stats	7-16
om_db_stats_pkg.list_order_ptn_stats	7-16
om_db_stats_pkg.check_order_ptn_stats	7-17
Recovery Procedures	7-17

## 8 Backing Up and Restoring OSM Files and Data

---

About Backing Up and Restoring OSM Files and Data	8-1
Backup and Restore Overview	8-1
Backup and Restore Schedule	8-1
Oracle Database	8-1
Backup and Restore Considerations	8-1
Oracle Database Backup Considerations	8-1
RMAN Considerations	8-2
Oracle Flashback Technology Considerations	8-2
Mirroring Technology Considerations	8-2

## 9 Monitoring and Managing OSM

---

About Monitoring and Managing OSM	9-1
Accessing the WebLogic Server Administration Console	9-1
Using the WebLogic Console to Determine the Status of the OSM Application	9-2
Refreshing OSM Metadata	9-2
Monitoring and Analyzing Performance	9-2
Monitoring Performance Using WebLogic Server Administration Console	9-2
Monitoring the Managed Server	9-3
Analyzing Garbage Collection	9-4
Monitoring the Database	9-4
Managing Logs	9-4
Secure vs Non-Secure Log Filtering	9-4
Managing Database Connections	9-4
Using JMS Queues to Send Messages	9-5
Sending Data to External Systems Using Plug-Ins	9-6
About OSM and XA Support	9-6
Using Work Managers to Prioritize Work	9-6
Default Work Managers and Components	9-7
Overriding the Internet Explorer Language in the OMS Web Clients	9-8

## 10 Exporting and Importing OSM Schema Data

---

About Exporting and Importing OSM Schema Data	10-1
Exporting and Importing the OSM Model Data Only	10-1
Exporting OSM Model Data	10-2
Preparing the Target OSM Schema Before Import	10-4
Creating the Target OSM Schema	10-4

Adding Partitions	10-4
Importing OSM Model Data	10-5
Exporting and Importing the OSM Model and a Single Order	10-6
Exporting OSM Order Data	10-6
Preparing to Export Order Tables for a Single Order	10-6
Exporting Order Tables That Define an Order Sequence ID	10-7
Exporting the OSM Model Data	10-8
Importing the OSM Model and Order Data	10-8
Exporting and Importing a Range of Orders and the OSM Model	10-9
Exporting the OSM Order Data Range	10-9
Preparing to Export Order Tables for a Range of Orders	10-10
Exporting Order Tables That Define an Order Sequence ID	10-11
Exporting the OSM Model Data	10-12
Importing OSM Model and Order Data	10-12
Exporting and Importing a Range of OSM Orders Only	10-13
Exporting an Additional Range of Orders	10-13
Preparing to Export Order Tables for a Range of Orders	10-14
Exporting a Range of Orders from Order Tables That Define an Order Sequence ID	10-15
Importing an Additional Range of Orders	10-16
About Order Export Queries	10-17
Changing PAR File Parameters	10-17
About Import Parameters	10-19
Troubleshooting Export/Import	10-21

## 11 Configuring Time Zone Settings

---

Configuring Time Zone Settings	11-1
--------------------------------	------

## 12 Troubleshooting OSM

---

Information You Need for Troubleshooting	12-1
General Checklist for Resolving Problems	12-1
Diagnosing Some Common Problems with OSM	12-2
Cannot Log in or Access Certain Functionality	12-2
System Appears Slow	12-2
Error: "Java.lang.StackOverflowError" when Using Task Web Client	12-2
Unexpected Logout from Web Client	12-3
Error: "Login failed. Please try again."	12-3
Automation Plug-ins Are Not Getting Called	12-3
Delayed JMS Messages	12-3
Error Message For Events From a JMS Topic in a Cluster	12-4

Unexpected Values for JMS Properties	12-4
Unable to Bring Up Managed Server After Database Failure	12-4
JBoss Cache Timeouts	12-4
OSM Fails to Process Orders Because of Metadata Errors	12-5
DataDictionary Expansion Level	12-5
Quick Fix Button Active During Order Template Conflicts in Design Studio	12-5
Cannot Create New Orders on a New Cartridge Version	12-5
Error: "exact fetch returns more than requested number of rows"	12-6
Error: "unique constraint violated"	12-6
Getting Help with OSM Problems	12-6
Before You Contact Support	12-6
Reporting Problems	12-7

## 13 OSM Log Messages

---

OSM Catalog Messages	13-1
Automation Catalog Messages	13-19

## 14 Using the XML Import/Export Application

---

About the XML Import/Export Application	14-1
About Using the XML Import/Export Application	14-2
About XML Import/Export Batch Scripts and Ant Commands	14-3
About XML Import/Export Ant Commands and Syntax	14-3
About XML Import/Export Batch Scripts and Syntax	14-4
Configuring the XML Import/Export Environment Files	14-5
Configuring the build.properties File for Ant Commands	14-5
Configuring the config.bat Script for Batch Scripts	14-6
Configuring the config.xml File XML Import/Export Nodes and Elements	14-6
About Importing and Exporting Metadata	14-9
About Exporting Metadata	14-9
About the Order of Exported Metadata	14-10
About Export Layout Options	14-11
Keeping the ID Integrity in SQL Rules	14-12
Configuring and Running an Export	14-13
About Importing Metadata	14-14
Configuring and Running an Import	14-15
Sample Procedure for Adding a New Workgroup Definition (Role)	14-17
Sample Procedure for Adding a Task to a Workgroup (Role)	14-18
About Purging MetaData and Data	14-20
Undeploying Cartridges and Purging the Database Schema	14-21

About Purging Orders	14-23
Purging Orders with the orderPurge.bat Script on Windows	14-23
Running Ant with the orderPurge.xml file On UNIX or Linux to Purge Orders	14-26
About Migrating Orders	14-29
Configuring and Running an Order Migration	14-30
About Validating the Metadata Model and Data	14-32
Configuring and Running an XML Document Validation	14-32
Validating an XML Document During the Import or Export Process	14-33
About Creating a Graphical Representation of the Metadata Model	14-33
Configuring and Creating a Graphical Representation of a Metadata Model	14-33
Viewing the Graphical Representation	14-34

## A OSM Credential Store API Command Reference

---

OSM User Security and Credential Store Commands	A-1
OSM User Security and Credential Store API Reference Material	A-2
CredStore	A-2
PasswordCredStore	A-3
CredStoreException	A-5
SoapAdapter	A-6
ObjecteIHTTPAdapter	A-7
ViewRuleContext	A-8
AutomationContext	A-10

## B Tools for Performance Testing, Tuning, and Troubleshooting

---

WebLogic Server Administration Console	B-1
OSM Task Web Client	B-1
SoapUI	B-1
Design Studio	B-1
GCViewer	B-2
ThreadLogic	B-2

## C OSM Installed Components

---

Productized Cartridges	C-1
WebLogic Installed Components	C-1
WebLogic Deployments	C-1
WebLogic Configuration	C-1
Coherence Clusters	C-1
Work Managers	C-1
JMS Servers	C-2

JMS Module	C-2
Queues and Topics	C-2
Quotas	C-3
Connection Factories	C-4
Destination Key	C-4
JMS Template	C-4
Data Sources	C-5
Users and Groups	C-5
Database Configuration	C-6

# Preface

This document describes system administration tasks for Oracle Communications Order and Service Management (OSM) Cloud Native.

## Audience

This document is intended for system administrators, system integrators, Database Administrators (DBA), and other individuals who are responsible for managing OSM and ensuring that the software is operating in a secure manner. This guide assumes that users have a working knowledge of the relevant operating system, Oracle Database, Oracle WebLogic Server, and Java J2EE software.

## Documentation Accessibility

For information about Oracle's commitment to accessibility, visit the Oracle Accessibility Program website at <http://www.oracle.com/pls/topic/lookup?ctx=acc&id=docacc>.

### Access to Oracle Support

Oracle customers that have purchased support have access to electronic support through My Oracle Support. For information, visit <http://www.oracle.com/pls/topic/lookup?ctx=acc&id=info> or visit <http://www.oracle.com/pls/topic/lookup?ctx=acc&id=trs> if you are hearing impaired.

# 1

## OSM System Administration Overview

This chapter provides an overview of Oracle Communications Order and Service Management (OSM) system administration tasks.

### OSM System Administration Tasks

As an OSM system administrator, you can perform the following tasks:

- Install and configure OSM.
- Monitor and manage OSM. See "[Monitoring and Managing OSM](#)" for more information.
- Read OSM log messages. See "[OSM Log Messages](#)" for more information.
- Troubleshoot OSM. See "[Troubleshooting OSM](#)" for more information.
- Configure the task processor. See "[Configuring the Task Processor](#)" for more information.
- Partition the OSM Database schema. See "[Managing the OSM Database Schema](#)" for more information.
- Import, export, purge, and migrate data and metadata. See "[Exporting and Importing OSM Schema Data](#)" for more information.

### About OSM System Administration Programs

Use the following programs for OSM system administration:

- Use the Oracle WebLogic Server Administration Console to monitor system components.
- Use the XML Import/Export application to do the following:
  - Export and import the metadata used for defining the order model
  - Purge orders from the database
  - Validate the OSM data model
  - Create a graphical representation of a data model
  - Purge data from the database
  - Migrate data

Additionally, some operations are available using the tools provided with the OSM cloud native toolkit.



# 2

## Changing GUI Application Appearance and Functionality

This chapter describes how to change the appearance and functionality of Oracle Communications Order and Service Management (OSM) GUI applications.

### About Configuring the User Experience

OSM supports the customization of the information presented to and collected from web client users to match a wide variety of user roles and tasks. This makes it easy to customize the user experience for edits and data validation without having to code Java Server Pages (JSPs).

The web client user experience can be customized in various ways:

- Adding default values and calculating values from different fields on the order
- Viewing and selecting data dynamically from a source outside of OSM
- Adding fonts, colors, and other formatting; adding conditional formatting
- Organizing order data in tables and tabs
- Adding your own custom HTML-based online help (with hyperlinks) and tool tips for your users
- Presenting data in one or more presentation languages
- Enforcing formats of input data, required fields and so on
- Hiding and showing fields relative to other fields
- Adding check boxes and radio buttons
- Conditionally making fields read-only or read-write
- Provide custom information, warning, and error messages to the user to help them

### About Behaviors

Behaviors provide the mechanism to exercise greater control over validation and presentation of order data to Task, and Order Management web client users. (In earlier versions of OSM, this capability was called the View Framework.) Behaviors are used mainly in the context of manual tasks that you manage with the Task web client.

There are nine behavior types that enable you to dynamically control a specific aspect of the order data model. (You can also add new behavior types using Oracle Communications Design Studio). The included behavior types are:

- **Calculation:** Computes the value of a field value based on a formula that references order data.
- **Constraint:** Specifies a condition that must be met for the data to be considered valid.

- **Data Instance:** Declares an instance that can be used by other behaviors.
- **Event:** Specifies an action that is performed when data is modified.
- **Information:** Specifies the label, hint, and help information for the element instance.
- **Lookup:** Specifies a set of dynamically generated choices from which you can select.
- **Read Only:** Dynamically determines whether a value can be modified or not.
- **Relevant:** Dynamically determines whether data is visible or hidden.
- **Style:** Specifies the visual appearance of fields.

Behaviors can be created only for manual tasks. They can be created at the data element level (most general), order level (more specific), or task level (most specific). After the behavior is created in Design Studio, you can model the actions you want it to perform through its properties settings.

See *OSM Developer's Guide* and *Design Studio Modeling OSM Processes* for more information about behaviors.

You can use Design Studio to define additional behaviors.

## Changing Web Client Appearance and Functionality

You can change the behavior of the Order Management web client and Task web client in several ways.

### Changing the Default Timeout Setting

To change the default timeout setting:

1. Unpack the **oms.ear** file. See *OSM Developer's Guide* for more information.
2. Open the **SDK/Customization/osmwebui/WEB-INF/web.xml** file.
3. Search for the following parameter:  
`session-timeout`
4. Change the value of the **session-timeout** parameter to your desired value (in minutes).
5. Save and close the file.
6. Repack **oms.ear**. See *OSM Developer's Guide* for more information.
7. Add the **oms.ear** file to the OSM container image. See "Creating OSM Cloud Native Images" in *OSM Cloud Native Deployment Guide*.

#### Note:

Changing the **session-timeout** parameter changes the automatic timeout for both the Order Management web client and the Task web client.

## Setting Table Height

You can specify a fixed or variable table height, depending on the value of the **is\_tablelayout\_height\_fixed** parameter in the **oms-config.xml** file. You can set the value of **is\_tablelayout\_height\_fixed** to **True** or to **False**. If **is\_tablelayout\_height\_fixed** is set to **True**, you can also set the **height\_of\_tablelayout** parameter to specify the fixed height for tables.

The default value of **is\_tablelayout\_height\_fixed** is **True**.

Using fixed table heights can create excessive white space in and between tables. Setting **is\_tablelayout\_height\_fixed** to **False** causes table height to be solely determined by the number of rows in the table and can help eliminate white space.

To set the table height:

1. Update the oms-config parameters through the specification files. See "[Working with oms-config Parameters in OSM Cloud Native](#)" for more information.
2. Set the desired value for the **is\_tablelayout\_height\_fixed** parameter by doing one of the following:

- To set the table height to fixed, set **is\_tablelayout\_height\_fixed** to **True**.

You may desire a fixed height that is different from the default. If so, change the fixed height of all tables.

To change the fixed height of all tables, set the **height\_of\_tablelayout** parameter to the desired value in pixels. The default is 400 pixels.

- To set the table height to variable, set **is\_tablelayout\_height\_fixed** to **False**.

Table height will now vary for each table, depending on the number of rows in the table.

## Configuring the Data View Performance in the Order Management Web Client

You can change the performance of the data view in the Order Management web client using the osm-config parameters.

To set the data view performance parameters:

1. Update the oms-config parameters through the specification files. See "[Working with oms-config Parameters in OSM Cloud Native](#)" for more information.
2. To set the database fetch limit, which sets a limit to the number of rows that can be requested at one time, set the **jdbc\_fetch\_size** parameter to the desired number of rows.
3. To set the limit for the number of instances a multi-instance data element may have before its display is forced into table format, set the **oracle.communications.ordermanagement.table-layout.threshold** parameter to the desired maximum number of instances.

## Configuring the Display Size of Text Fields

You can control the size of the displayed area for text fields, and whether text fields will have scroll bars, using the **no\_of\_rows\_in\_textarea\_without\_scroll** and **max\_no\_of\_rows\_in\_textarea\_with\_scroll** parameters in the **oms-config.xml** file.

The **no\_of\_rows\_in\_textarea\_without\_scroll** parameter indicates the maximum number of rows that the field can accommodate without a scroll bar.

The **max\_no\_of\_rows\_in\_textarea\_with\_scroll** parameter indicates the maximum number of rows that the field can accommodate if the number of rows exceeds the value of the **no\_of\_rows\_in\_textarea\_without\_scroll** parameter.

However, the scroll bar disappears and the field displays all the rows, if their number exceeds the value of the **max\_no\_of\_rows\_in\_textarea\_with\_scroll** parameter.

For example:

- If the value of **no\_of\_rows\_in\_textarea\_without\_scroll** is greater than the value of **max\_no\_of\_rows\_in\_textarea\_with\_scroll**, and the number of rows is less than or equal to the value of **no\_of\_rows\_in\_textarea\_without\_scroll**, the field displays all the rows without a scroll bar.
- If the value of **no\_of\_rows\_in\_textarea\_without\_scroll** is greater than the value of **max\_no\_of\_rows\_in\_textarea\_with\_scroll**, and the number of rows is greater than the value of **no\_of\_rows\_in\_textarea\_without\_scroll**, the field displays in its text area, rows whose number equals the value of the **no\_of\_rows\_in\_textarea\_without\_scroll** parameter. However, the field accommodates all the other rows and provides a scroll bar.
- If the value of **no\_of\_rows\_in\_textarea\_without\_scroll** is less than the value of **max\_no\_of\_rows\_in\_textarea\_with\_scroll**, and the number of rows is less than or equal to the value of **max\_no\_of\_rows\_in\_textarea\_with\_scroll**, the field accommodates all the rows and provides a scroll bar.
- If the value of **no\_of\_rows\_in\_textarea\_without\_scroll** is less than the value of **max\_no\_of\_rows\_in\_textarea\_with\_scroll**, and the number of rows is greater than the value of **max\_no\_of\_rows\_in\_textarea\_with\_scroll**, the field displays all the rows in its text area. In this case, the scroll bar is not displayed.

## Setting Default Action on Orders and Tasks in the Task Web Client

You can specify a particular action as the default action to perform on orders and tasks in the Worklist and Query screens for all users who have not set the default action in the Options page of the Task web client. You can achieve this by configuring a parameter in the **oms-config.xml** file. However, users can change the global default action configured by the administrator to an action of their choice by setting the **Default Action** field in the Options page. By default, the global default action parameter is not set to any action and the application considers the option set by individual users as the default action to perform.

To set a default action on orders and tasks for all users:

1. Update the **oms-config** parameters through the specification files. See "[Working with oms-config Parameters in OSM Cloud Native](#)" for more information.
2. Set the **DefaultUserAction** parameter to the desired action.

Valid values (actions) that you can specify are:

- NoGlobalDefault (This is the default if no action is set.)
- AcceptEditTask
- AddRemark
- RaiseException
- ViewOrderData
- ViewOrderProcessHistory
- ViewNotificationHistory
- CopyOrder

If no action is set for the parameter, the application considers the option (action) that is set by individual users in the Default Action field in the Options screen.

## Customizing the Appearance of Read-Only Text Fields

You can customize the appearance of the text (field labels). You can change the font style, size, color, and background color. You can customize specific text or all text across the pages.

You can customize specific text in the pages by using VF Style Rules. With VF Style Rules, you can modify the CSS properties (font style, color, and background) for any specific field. When you define a VF style rule for a particular read-only field, only that particular field is customized.

To customize all read-only text:

1. Unpack the **oms.ear** file.
2. Open the **SDK/Customization/oms-war/customScreen.css** file.
3. Add the **oeValueNodeReadOnly** parameter and specify the properties as shown below:

```
.oeValueNodeReadOnly {  
  FONT-SIZE: 10pt;  
  color:blue;  
}
```

4. Run **PackOMS** to generate the new **oms.ear** file.
5. Add the **oms.ear** to the OSM container image. See "Creating a Basic OSM Cloud Native Instance" in *OSM Cloud Native Deployment Guide* for more details.

You can also customize the appearance of read-only fields by using reusable class definitions. With reusable class definitions, you can apply some properties to some text and a different set of properties to the other text fields. For example, you can apply a 10pt font size and blue color to some fields, and a 14pt font style and red color to the other fields.

To customize text fields by using reusable class definitions:

1. Create a list of CSS classes. Specify all the properties for each class as shown below and add the classes to the **customScreen.css** file.

```
.customReadOnlyValueBlue {  
  FONT-SIZE: 10pt;  
  color:blue;
```

```
}  
  
.customReadOnlyValueRed {  
FONT-SIZE: 14pt;  
color:red;  
}
```

2. In Design Studio, add the Style behavior for the read-only fields that you want to customize:

For example:

- For the fields that you want to apply blue, add **customReadOnlyValueBlue** in the **CSS Class Name** field of the **Value** grouping.
  - For the fields that you want to apply red, add **customReadOnlyValueRed** in the **CSS Class Name** field of the **Value** grouping.
3. Update the **oms.ear** file with the modified **customScreen.css** file.
  4. Deploy the modified cartridges.
  5. Add the **oms.ear** file to the OSM container image. See "Creating a Basic OSM Cloud Native Instance" in *OSM Cloud Native Deployment Guide* for more details.

# 3

## Setting Up OSM Security

This chapter describes how to set up security on your Oracle Communications Order and Service Management (OSM) system.

### About OSM Security

When you manage OSM security, you can perform the following tasks:

- Add users to groups. See "Provisioning Cartridge User Accounts" in *OSM Cloud Native Deployment Guide*.
- Set up Secure Sockets Layer (SSL). See "Setting up Secure Communication with SSL/TLS" in *OSM Cloud Native Deployment Guide*.
- Use WebLogic Server's LDAP or another authenticator that is integrated with WebLogic Server. See "Setting Up Authentication" in *OSM Cloud Native Deployment Guide*.

 **Note:**

If you use an external security implementation such as LDAP, you should also use a caching realm to improve performance. See "[Setting Up a Caching Realm](#)" for more information.

- Manage credentials securely using the EncryptPasswords utility or the Oracle Fusion Middleware Credential Store Framework (CSF). See "[Secure Credential Management](#)."
- Manage workgroups. See *OSM Order Management Web Client User's Guide* for more information.

For more information about WebLogic Server security realms, refer to the WebLogic Server Console documentation.

 **Note:**

OSM supports LDAP Version 2.

### Secure Solution Data Storage

As a fulfillment system, OSM does not need a fixed data model, and so is not required or typically used to store sensitive data other than that used for OSM user authentication.

You can secure OSM user credentials as described in this chapter, but if your implementation requires OSM to store or log other sensitive data that appears on orders, Oracle recommends that you encrypt the data outside of OSM. Because the encryption happens outside of OSM, you are responsible for developing and maintaining the encryption method.

## Adding Users to OSM

To add a user to OSM:

- Create workgroups as roles in Oracle Communications Design Studio.
- Assign users to workgroups in the OSM Administrator.

For information about the users and groups created for OSM, see "[Users and Groups](#)".

## Creating Workgroups as Roles in Design Studio

In Design Studio, you create roles and assign permissions to give users in that role access to related functions in the Task and Order Management web clients and the OSM Web Service and XML APIs.



### Note:

You assign individual users to roles using the Administration area of the Order Management web client. See *OSM Order Management Web Client User's Guide* for more information.

[Table 3-1](#) describes the client functions to which you provide access.

**Table 3-1 Client Permissions**

Function	Description	Applies To
Create Versioned Orders	Enables users to create orders for different versions of cartridges. If not granted this permission, users can only create orders for the default version of the cartridge. This permission relates to: <ul style="list-style-type: none"> <li>• In the Task web client: creating a new order</li> <li>• In the Web Service API: using the CreateOrderBySpecification calls</li> <li>• In the XML API: using the CreateOrder XML API call</li> </ul>	Task web client Web Service API XML API
Exception Processing	Enables users to alter the flow of a process by applying exception statuses at any time throughout the process. This permission relates to: <ul style="list-style-type: none"> <li>• In the Task web client: raising exceptions on a task</li> <li>• In the XML API: using the SetException call</li> </ul>	Task web client XML API
Online Reports	Enables users to view summarized reports on all orders and tasks on the system. This permission relates to: <ul style="list-style-type: none"> <li>• In the Task web client: using the reporting feature</li> </ul>	Task web client



Table 3-1 (Cont.) Client Permissions

Function	Description	Applies To
Order Priority Modification	<p>Enables users to modify the priority of an order or of a task in an order.</p> <p>This permission relates to:</p> <ul style="list-style-type: none"> <li>In the Order Management web client: setting the order priority</li> <li>In the Task web client: setting the task priority</li> <li>In the Web Service API: changing the order priority using the UpdateOrder call</li> <li>In the XML API: changing the order or task priority using the UpdateOrder call</li> </ul>	<p>Order Management web client</p> <p>Task web client</p> <p>Web Service API</p> <p>XML API</p>
Reference Number Modification	<p>Enables users to modify the reference number of an order.</p> <p>This permission relates to:</p> <ul style="list-style-type: none"> <li>In the Order Management web client and Task web client: Modifying the reference number of an order</li> <li>In the Web Service API and XML API: changing the reference number using the UpdateOrder call</li> </ul>	<p>Order Management web client</p> <p>Task web client</p> <p>Web Service API</p> <p>XML API</p>
Search View	<p>Enables users to access the order Query function.</p> <p>This permission relates to:</p> <ul style="list-style-type: none"> <li>In the Order Management web client: using the main search screen for the client</li> <li>In the Task web client: using the Search functionality (for example, clicking the Query button from the Worklist)</li> <li>In the Web Service API: using the FindOrder call</li> <li>In the XML API: using the Query call</li> </ul>	<p>Order Management web client</p> <p>Task web client</p> <p>Web Service API</p> <p>XML API</p>
Task Assignment	<p>Enables users to assign tasks to others.</p> <p>This permission relates to:</p> <ul style="list-style-type: none"> <li>In the Task web client: assigning a task to another user</li> <li>In the XML API: using the AssignOrder calls</li> </ul>	<p>Task web client</p> <p>XML API</p>
Worklist Viewer	<p>Enables users to access the Worklist function.</p> <p>This permission relates to:</p> <ul style="list-style-type: none"> <li>In the Task web client: accessing the worklist</li> <li>In the XML API: using the Worklist call</li> </ul>	<p>Task web client</p> <p>XML API</p>

In addition to granting web client permissions, you can also grant permissions at the order level (by associating a role to an order type) and the task level.

See the discussion about creating new roles in *Design Studio Modeling OSM Processes* for more information. After you create a role, you must assign permissions to the role entities. See "Role Editor Role Tab" in *Design Studio Modeling OSM Processes* for more information about permissions for role entities.

## Assigning Users to Workgroups

See the discussion about assigning users to a workgroup in *OSM Order Management Web Client User's Guide* for more information.

## Using WebLogic Server Authenticators with OSM

OSM supports using either the WebLogic Server's embedded LDAP directory or another authenticator that is external to, and integrated with, WebLogic Server. The latter is referred to in this section as an external authenticator. This section provides information about how these directories work with OSM.

### Note:

If multiple authentication providers are configured in WebLogic Server, all the authentication providers (even if they are configured as optional in WebLogic Server) should be active. If any of the authentication providers is not active, an exception will be raised and the users will not be able to log in to OSM.

## User-Level Authenticator Support

OSM fully supports external authenticators and embedded LDAP directories at the user level. A user that exists in either the WebLogic server's embedded LDAP directory or in an external authenticator receives the privileges of any group to which it is assigned in WebLogic Server. Also, users can be assigned to workgroups in the Administration area of the OSM Order Management web client and will receive the appropriate permissions for the workgroup.

## Group-Level Authenticator Support

OSM also supports external authenticators and embedded LDAP directories at the group level. A group that exists in either the WebLogic server's embedded LDAP directory or in an external authenticator receives the privileges of any OSM group to which it is assigned in WebLogic Server. Also, groups can be assigned to workgroups in the Administration area of the OSM Order Management web client and will receive the appropriate permissions for the workgroup.

A child LDAP group will inherit the following from its parent LDAP group:

- Permissions from OSM roles in Design Studio
- Permissions from groups assigned in the WebLogic Administration Console
- Tasks
- Filters
- Flexible headers

It is not possible to restrict a child group from inheriting from the parent group.

 **Note:**

If a user is assigned (directly or indirectly) to multiple groups which have different query tasks for the same order, it is not predictable which query task view the user will see when querying the order.

## Authenticator User and Group Assignment Considerations

There are some considerations and best practices to take into account when assigning users and groups to OSM workgroups/roles.

- The first step in assigning permissions for external authenticator and embedded LDAP users and groups is to assign them to either the OMS\_client or OSM\_automation groups in WebLogic Server.
- Only users and groups which have been assigned directly to the OMS\_client or OSM\_automation groups in WebLogic Server will be available to assign to workgroups in the Administration area of the OSM Order Management web client. For example, if UserA1 is a member of GroupA, and GroupA has been assigned to the OMS\_client group in WebLogic Server, only GroupA will be displayed in the OSM Order Management web client. However, when GroupA is assigned to a workgroup, UserA1 (and all of the users in GroupA) will inherit the permissions of the workgroup.

Both users and groups will be displayed the same in the OSM Order Management web client. There is no indication which elements are users and which are groups.

- If new users are added to the authenticator, they will not be able to access OSM functionality until the OSM Metadata is refreshed. For information about refreshing OSM metadata, see "[Refreshing OSM Metadata](#)".
- Oracle recommends that you assign automation users to the OSM\_automation WebLogic Server group directly, rather than as members of a group. If you decide to assign automation users using a group instead of individually, you must ensure that you do not remove from the WebLogic Server group any users that are specified in the "Run As" property of an automation plug-in.

## Setting Up a Caching Realm

If you use an external security implementation such as LDAP, you should also use a caching realm to improve performance. A caching realm holds the results of security checks in memory so that subsequent checks are not required to communicate directly with an external security server. The default settings for caching realms are appropriate for small numbers of users in the external realm; however, they do not help if your external security implementation has large numbers of users.

To set up a caching realm:

1. Log in to the WebLogic Administration Console.
2. In the Domain Structure tree, select **Security Realms**.  
The Summary of Security Realms page is displayed.
3. Click the name of your security realm. The default name is **myrealm**.

The settings for the security realm are displayed.

From this window, you can change the settings for your realm.

For more information about setting up security in WebLogic Server, see [Oracle Fusion Middleware Administering Security for Oracle WebLogic Server](#).

## Secure Credential Management

This section describes how to secure credentials for accessing external systems. OSM provides two distinct secure credential management solutions, each appropriate to the type of credential to be secured:

- **EncryptPasswords utility:** This utility is used to secure the credentials required to run other OSM utilities that require those credentials, for example the XML Import/Export tool. Oracle recommends that you use this if you are running utilities unattended. If you are running the utilities attended, Oracle recommends that you provide the required credentials interactively as prompted by the utility, rather than using the EncryptPasswords utility. Because the utility is assumed to run unattended, it must be able to decrypt credentials without user intervention. Therefore, the output of the EncryptPasswords utility should be considered obfuscated and not encrypted. Secure the files containing the output with appropriate file-system-level restrictions. For more information, see "[Using the EncryptPasswords Utility](#)."
- **Credential Store:** This utility is used to secure credentials required to access systems with which your OSM solution interacts. It builds on CSF, adding OSM-specific features. For more information, see "[Using the Credential Store](#)."

## Using the EncryptPasswords Utility

You use the **EncryptPasswords** utility to encrypt the user name and password credentials of XML Import/Export application users.

## About the EncryptPasswords Utility

When you install the XML Import/Export application, you can optionally provide passwords for the OSM database, the XML API interface, and the WebLogic domain administration server. To set and reset those passwords, you run the **EncryptPasswords** utility. See "[Running the EncryptPasswords Utility](#)" for information about running the utility.

The **EncryptPasswords** utility (located in the **SDK/XMLImportExport** directory) is a password management utility that secures the credentials that the XML Import/Export application uses. The **EncryptPasswords** utility encrypts the credentials, preventing their accidental exposure.

Running the **EncryptPasswords** utility prompts you to enter the user name and password credentials of each XML Import/Export application user that requires access to the OSM database, the XML API interface, and the WebLogic domain administration server. It then stores the user names and passwords for these users in encrypted format in the configuration file which the XML Import/Export application uses to provide these credentials (for example, **SDK/XMLImportExport/config/config.xml**). When the XML Import/Export application runs, it decrypts the passwords as part of loading its configuration file.

The **EncryptPasswords** utility can be run only by a user who has write access to the XML files in which the credentials are stored.

Ant build files for the **EncryptPasswords** utility are located in the following directories:

- **SDK/CartridgeManagementTool/production**
- **SDK/CartridgeManagementTool/development**

The Ant build files have targets corresponding to each of the batch files in the **SDK/XMLImportExport** directory that include the **EncryptPasswords** functionality.

## Running the EncryptPasswords Utility

Run the **EncryptPasswords** utility script:

- As part of the initial setup of the XML Import/Export application
- Each time the user name or password credentials of an XML Import/Export application user changes

### Note:

To run the **EncryptPasswords** utility, you must have write access to the XML files in which the XML Import/Export application user credentials are stored.

To run the EncryptPasswords utility:

1. Create a config file that complies with the **SDK/XMLImportExport/config/config.xsd** file.

The same directory also contains a sample file: **config\_sample.xml**.

### Note:

The configuration file must contain the `<user>` and `<password>` elements, but the values of these elements do not matter because the script will prompt for these values.

2. Do one of the following:

- **UNIX and Linux:**

Run the following command:

```
EncryptPasswords.sh XMLConfig [-dbUser] [-xmlapiUser] [-wlsUser]
```

for example:

```
EncryptPasswords.sh config/config.xml -dbUser
```

- **Windows:**

Run the following command:

```
EncryptPasswords XMLConfig [-dbUser] [-xmlapiUser] [-wlsUser]
```

for example:

```
EncryptPasswords config\config.xml -dbUser -xmlapiUser
```

where *XMLConfig* indicates the configuration XML file you created in the previous step, and the following optional parameters indicate which passwords should be encrypted:

- **-dbUser**: the OSM database password
- **-xmlapiUser**: the XML API interface password
- **-wlsUser**: the WebLogic domain administration server password

When you set a user's credentials, you specify only the systems that they use for the XML Import/Export application operations they perform. For example, if the user only imports or exports cartridges, you only need to specify the **-dbUser** flag.

3. When prompted by the script, enter the user names and passwords that you selected when running the script.

When you type in passwords, nothing will be displayed on the screen.

## Removing an Encrypted Password

To remove a user name and password for a user that no longer requires credentials, open the XML file where the credentials are stored and remove them manually. If you do not remove them manually, the user name and password combination continues to exist in the XML file.

## Using the Credential Store

You use the credential store to store credentials that OSM uses to interact with external systems.

## About the Credential Store

A credential store is a central repository you can use to store credentials such as user names and passwords. OSM can use a credential store for the credentials needed to log in to and send requests to external systems (meaning any resources or systems that are out of the scope of your OSM cartridge-owned code and resources). These credentials can be used by OSM and OSM applications.

In OSM cloud native, the type of credential store that OSM uses is offered through the Kubernetes Secret.

Use the OSM credential store APIs when developing your OSM cartridges so your OSM applications can access and read credentials from the credential store in a secure form. For example, use the OSM credential store APIs when you define data provider classes in your cartridges which must access web service and database systems with credentials. See "[Developing Cartridges to Use the Credential Store](#)" and "[OSM Credential Store API Command Reference](#)" for more information about using the credential store in your cartridge development.

Oracle recommends you to use the credential store as a repository for credentials and use the OSM credential store APIs in OSM-related code to access the repository in a secure form. Oracle strongly recommends you do not hard-code user names and passwords in cartridge code and that you update any current cartridges that have hard-coded credentials to use the OSM credential store APIs. See "[Developing](#)

[Cartridges to Use the Credential Store](#)" for more information about security options and recommendations.

For information about Platform Security Services and managing credentials in the credential store, see [Oracle Fusion Middleware Securing Applications with Oracle Platform Security Services](#).

## How OSM Retrieves Credentials from the Credential Store

The credential store for OSM applications contains credentials that are stored using a Kubernetes secret with key names. OSM applications, such as OSM web clients and OSM cartridge applications, retrieve credentials from the Kubernetes secret based on key names. Automation plug-ins are used to call OSM credential store APIs to retrieve the credentials. OSM applications then use the credentials to gain access to external systems.

OSM credential store APIs are used inside automation plug-ins to retrieve credentials and to gain access to external systems. OSM cartridge code can call the `credStoreAdmin` command to create and configure the required entries, such as map name, user name, and password, for OSM applications in the credential store. For more information, see "Provisioning Cartridge User Accounts" *OSM Cloud Native Deployment Guide*.

OSM plug-in users in a cartridge application, such as automation plug-ins or external instance adapters access the OSM credential store map and read the credentials.

The following steps summarize how an automation plug-in in OSM cloud native retrieves credentials from the credential store for an automation task that requires the credentials to access an external system:

1. The automation plug-in script uses the **`getCredential`** or **`getOsmCredentialPassword`** method of the AutomationContext API.
2. The automation plug-in user accesses the correct Kubernetes secret and reads the credentials required to access the external system.
3. The automation plug-in user accesses the correct credential store map and reads the credentials required to access the external system.

If the credentials are not in the store, the API fails with an exception and the automation task fails.

4. If the credentials are in the store, the user name and password variables in the plug-in script will be set with values retrieved from the credential store.
5. The message is sent to the external system with the credential information.
6. The automation task completes.

## Managing Credentials in the Credential Store

To learn how to create credential store secrets and provide the instance configuration so that OSM cloud native can access the credentials, see "Provisioning Cartridge User Accounts" in *OSM Cloud Native Deployment Guide*.

## Developing Cartridges to Use the Credential Store

When your OSM cartridges require data from external systems, trigger actions at external systems, or provide data to external systems, credential information may be required by the external system. The external system can be any resource or system that is out of the scope of your OSM-cartridge-owned codes and resources.

When you develop OSM cartridges, Oracle recommends you use the credential store to allow plug-in code to access credential information in a secured way. You can use the OSM credential store APIs for code that requires credential retrieval.

OSM uses the credential store offered through WebLogic Server; however, you are not required to use this credential store to secure credentials. You can use other methods of securing credentials. Oracle strongly recommends you do not hard-code user credential information in OSM code such as in plug-in script files and cartridge model description files. Passing and storing passwords in plain text poses a security risk. Follow proper security guidelines to develop OSM cartridges to protect data over communication channels. Oracle recommends using SSL communication between OSM and an external system, particularly for web services of external systems.

The following are examples of external systems used in OSM cartridges that may require credential information:

- OSM Web Service
- Databases
- JMS queues and topics (except JMS queues deployed by the cartridge)
- Web services of any system

To develop your OSM cartridges to use the credential store, see the following:

- Use "[AutomationContext](#)" in your automation plug-in code to retrieve credentials from the credential store. See "[Developing Automation Plug-ins to Use the Credential Store](#)" for more information.
- Use the operation APIs in "[ViewRuleContext](#)" in XQuery scripts to access credentials stored in the credential store.
- Use "[PasswordCredStore](#)" in your JAVA classes to retrieve user names and passwords from the credential store.
- Use the attributes for credential store in "[SoapAdapter](#)" to retrieve credentials from the credential store when sending a SOAP request using HTTP/HTTPS.
- Use the attributes for credential store in "[ObjectelHTTPAdapter](#)" to retrieve credentials from the credential store when sending a request to Objectel. See "[Defining Data Providers in OSM Cartridges to Use the Credential Store](#)" for more information.
- See "[OSM Credential Store API Command Reference](#)" for a description of the OSM credential store APIs.

See "[Using the Credential Store](#)" for information about the credential store.



## Developing Automation Plug-ins to Use the Credential Store

Some OSM credential store APIs can be used in custom automation plug-in Java classes. Use these APIs when you define custom automation plug-in classes to access an external system with credentials. You can also call OSM credential store APIs from your automation context classes. The XQuery plug-in code for an automation or activation task can use credential store APIs to retrieve credentials from the credential store. See "[AutomationContext](#)" for example code for developing automation plug-ins in OSM cartridges to retrieve credentials from the credential store.

External instance adapters and automation plug-in classes (XQuerySender and XSLTSender) provided by Oracle to send messages and requests to external systems support the OSM credential store APIs.

## Defining Data Providers in OSM Cartridges to Use the Credential Store

You must set up a data provider class in your cartridge if it requires credential information for an external system so it can read the required credentials from the credential store.

## Using the Credential Store with Custom Data Providers

When you add a data provider class in a cartridge that requires credential information for an external system, the data provider class can call OSM credential store APIs to read the required credentials from the credential store. Your data provider class must implement the `retrieveInstance()` method of the `ExternalInstanceAdapter` interface.

To read the required credential from the credential store when you define your own data provider class (provider type is "Custom"), use the following APIs in the `retrieveInstance()` method in your Java class:

### Note:

This example assumes you are using your own map. If you use the default map (**osm**) and key names for the OSM application, you can use simpler code:

```
String password = context.getOsmCredentialPassword(username)
```

```
public Element retrieveInstance(final ViewRuleContext context, final Map<String,
Object> parameters) throws Exception {
    // DoCustomLogic

    String mapname = getStringParam(parameters, "para.mapname", null);
    String keyname = getStringParam(parameters, "para.keyname", null);
    String username = "";
    String password = "";

    if (mapname != null && keyname != null) {
        try {
            String credential = context.getCredential(mapname, keyname);
```

```

        int index = credential.indexOf("/");
        username = credential.substring(0, index-1);
        password = credential.substring(index);
    } catch (Exception e) {
        // DoCredStoreExceptionHandling
    }
}
// DoAuthenticationWithUsernamePassword
// DoCustomerRequest
// DoResponseHandling
}

```

## Using the Credential Store with Built-In Data Providers

Oracle provides pre-defined or built-in data provider classes "[SoapAdapter](#)" and "[ObjectelHTTPAdapter](#)" which contain the code required for using the credential store. To use the credential store when you use these built-in adapters, add the input parameters required for the credential store in your data provider.

[Table 3-2](#) shows the parameters that are required for each adapter type.

**Table 3-2 Parameters for SoapAdapter and ObjectelHTTPAdapter**

Adapter	Parameter Name	contextType	Default Value
SoapAdapter	oms:credentials.mapname	XPATH	myMap
SoapAdapter	oms:credentials.keyname	XPATH	myUser
ObjectelHTTPAdapter	obj:mapname	XPATH	osm
ObjectelHTTPAdapter	obj:keyname	XPATH	osm

## Upgrading Existing Cartridge Code to Use the Credential Store

Upgrade your existing OSM cartridge code to use the credential store by using the OSM credential store APIs. Upgrade your custom data provider classes and XQuery plug-in code to use the OSM credential store APIs for retrieval of credentials. See "[Developing Cartridges to Use the Credential Store](#)" for information about developing cartridges to use the credential store.

In addition to upgrading your cartridge code, provision the credential store for the WebLogic Server domain for OSM applications with required credentials (see "[Managing Credentials in the Credential Store](#)") and configure the Java Platform Security policy for the WebLogic Server domain to allow OSM access to the credential store.

## Using Built-in SOAP Adapter as a Data Provider Class

Credential information is required to send a SOAP request. If your existing automation plug-in code that is used to test the SOAP adapter has hard-coded passwords, you can use the built-in **SOAPAdapter** class as a data provider class in your cartridges to remove the need for the hard-coded passwords.

When you use the default map for OSM applications, automation plug-in users pass in only the user name in the parameter. When you use your custom credential store map, automation plug-in users also pass in the credential map name and key name for credentials in the parameter.

To update existing automation plug-in code that tests SOAPAdapter to remove hard-coded passwords:

1. Remove hard-coded passwords from the existing "oms:credentials:password" input parameter.
2. Ensure that credentials exist in the credential store under map="**osm**" key=**osmUser\_SoapRequest\_username**.
3. Test that the SOAP adapter works correctly after the update.

## Administering Users and Workgroups

You can add users to WebLogic Server groups by following the procedure in "Provisioning Cartridge User Accounts" in *OSM Cloud Native Deployment Guide*.

# 4

## Configuring OSM with oms-config.xml

This chapter explains how to configure Oracle Communications Order and Service Management (OSM) using the **oms-config.xml** file and provides a detailed reference of available parameters.

### Working with oms-config Parameters in OSM Cloud Native

In OSM cloud native, all oms-config parameters can be updated in the specification files. The parameter name and value can be set in either the shape, instance, or project specification files. For more details, see *OSM Cloud Native Deployment Guide*.

### oms-config.xml Parameters

Table 4-1 describes the parameters that can be configured in the **oms-config.xml** file.

**Table 4-1 Description of oms-config.xml Parameters**

Name	Description	Type	Min	Max	Default
DefaultUserAction	The default action to perform on orders and tasks in the Worklist and Query screens for all users who have not set the default action in the Options page of the Task web client  Valid values (actions) for the global default action parameter that OSM administrators can specify are: <ul style="list-style-type: none"><li>NoGlobalDefault (This is the default if no action is set.)</li><li>AcceptEditTask</li><li>AddRemark</li><li>RaiseException</li><li>ViewOrderData</li><li>ViewOrderProcessHistory</li><li>ViewNotificationHistory</li><li>CopyOrder</li></ul>	String	NA	NA	NoGlobalDefault
node_removal_allowed_on_redeploy	Enables removal of nodes on redeploy.	boolean	NA	NA	false
excel_export_row_limit	Maximum number of records (Worklist data and Query results) that can be exported to a CSV file.	integer	1	100000	50000

Table 4-1 (Cont.) Description of oms-config.xml Parameters

Name	Description	Type	Min	Max	Default
excel_export_memory_size	Memory cap for the export function in the Worklist and Query pages. Any export operation that consumes memory more than the specified value is not carried out. The value of the memory cap should be specified in MB.	integer	500	2000	800
excel_export_cluster_limit	Maximum number or limit of total number of concurrent export requests that can be received on the database	integer	1	100	NA
max_worklist_rows	Maximum number of rows shown in the worklist. Changing this parameter can affect system performance. Oracle recommends that you not change this parameter to a value significantly larger than the default.	integer	1	10000	200
max_query_rows	Maximum number of rows returned in the Query Results page in the Task web client. Changing this parameter can affect system performance. Oracle recommends that you not change this parameter to a value significantly larger than the default.	integer	1	10000	200
max_notification_rows	Maximum number notifications returned in one request in the Task web client. Changing this parameter can affect system performance. Oracle recommends that you not change this parameter to a value significantly larger than the default.	integer	1	10000	200
worklist_page_size	Maximum number of rows shown on each Worklist page in the Task web client.	integer	5	100	20
userlist_page_size	Maximum number of rows shown on each User List page in the Task web client.	integer	5	100	20
query_results_page_size	Maximum number of lines shown on one page in the Query Results page in the Task web client.	integer	5	100	20
notifications_page_size	Maximum number of lines shown on the Notifications page in the Task web client.	integer	5	100	20
jdbc_fetch_size	JDBC fetch size.	integer	1	10000	100
max_read_only_field_length	Maximum length of a read-only field in the Order editor.	integer	1	512	30

Table 4-1 (Cont.) Description of oms-config.xml Parameters

Name	Description	Type	Min	Max	Default
remark_change_timeout_hours	Time in hours after the date and time a remark is added to an order that changes are no longer allowed to the remark.	integer	-1	1000	1
attachment_file_system_name	Name of the T3 file service configured in WebLogic that manages order attachments for OSM.	string	NA	NA	NA
max_attachment_size	Maximum size in MB of documents attached to orders in the Task web client. Changing this parameter impacts OSM WebLogic host machine file system usage.	integer	1	100	3
database_timezone_offset	Offset in seconds of the database server's time zone. The database time zone offset is used to calculate the time zone of the database, which may be different from the time zone of the application. The maximum offset is 14 hours. The default value is ignored: this parameter is defaulted to the database server's time zone offset. Oracle recommends that you do not change this parameter from the installation setting.	integer	-50400	50400	NA
admin_email_address	Default email address to which to send notifications. The default value set by <b>oms-parameter-default</b> is ignored. Oracle recommends that you not change this parameter from the installation setting.	string	NA	NA	NA
email_server	IP address or server name of the email server used to send OSM notifications. Oracle recommends that you not change this parameter from the installation setting.	string	NA	NA	127.0.0.1
email_server_port	Port number of the email server used to send OSM notifications. Oracle recommends that you not change this parameter from the installation setting.	string	NA	NA	993
email_server_authentication	Enables use of SSL authentication when connecting to the email server when set to <b>true</b> .	boolean	NA	NA	true
email_server_ssl	Enables SSL connection to the email server when set to <b>true</b> .	boolean	NA	NA	true
url_root	The base URL for the OSM web applications.	string	NA	NA	oms

Table 4-1 (Cont.) Description of oms-config.xml Parameters

Name	Description	Type	Min	Max	Default
create_order_show_namespace	If set to <b>false</b> , no list is displayed in the Task web client to select a namespace when creating an order.	boolean	NA	NA	true
load_users_from_database	In the XML API, you can call ListUsers. This tells the handler to either load the users from the database or from the J2EE security server (WebLogic).	boolean	NA	NA	false
workstream_refresh_interval	In the Task web client, the number of milliseconds to wait before attempting to retrieve the next available task in a workstream.  Changing this parameter can affect system performance.  Oracle recommends that you do not change this parameter from the installation setting.	integer	500	60000	1000
max_workstream_retry	In the Task web client, the number of retries to attempt to retrieve the next available task in a workstream before redirecting the user back to the Worklist screen.  Changing this parameter can affect system performance.  Oracle recommends that you do not change this parameter from the installation setting.	integer	1	1000	30
workstream_predefined_statuses_display_fixed	Controls how task completion status buttons are displayed in the workstream order editor.  If set to <b>true</b> , predefined task statuses are displayed on a separate line in their predefined order. User-defined statuses are displayed on the next line. The display order of user-defined statuses is controlled by the model designer.  If set to <b>false</b> , all task completion statuses are displayed in a single line. The display order of all task completion statuses is controlled by the model designer.	boolean	NA	NA	true
hide_dirty_order	Normally, after a task is completed and you return to the worklist, the task is displayed in bold italics to indicate it has been completed. If set to <b>true</b> , the completed task will not be displayed in the worklist.	boolean	NA	NA	false

Table 4-1 (Cont.) Description of oms-config.xml Parameters

Name	Description	Type	Min	Max	Default
disable_edit_on_server_refresh	If set to <b>true</b> , if a server refresh occurs while an order is being edited, the edit function becomes disabled.	boolean	NA	NA	true
login_screen	Initial screen displayed when the Task web client is started. Valid values include: <ul style="list-style-type: none"> <li>about</li> <li>default</li> <li>home</li> <li>query</li> <li>worklist</li> </ul>	string	NA	NA	worklist
auto_logout_warning_offset_minutes	Number of minutes prior to session timeout (auto-logout) to display a warning message to the user. A value of <b>-1</b> indicates no warning is issued. Oracle recommends that you do not change this parameter from the installation setting.	integer	1	1440	5
com.mslv.oms.util.xml.XMLHelper.DocumentBuilderFactory	Do not use unless instructed to do so by Oracle.	string	NA	NA	oracle.xml.jaxp.JXPathDocumentBuilderFactory
custommenuaction_model_location	Name of the configuration file containing metadata definitions for a custom menu action.	string	NA	NA	NA
event_poller_interval	Time in milliseconds OSM waits before polling for new events.	integer	100	60000	5000
event_poller_mutex_timeout	Do not use unless instructed to do so by Oracle.	integer	0	60000	10000
enable_log_stacktraces	Enables and disables logging stack traces. If set to <b>true</b> , stack trace printing in the log is enabled. If set to <b>false</b> , it is disabled.	boolean	NA	NA	true
com.mslv.oms.handler.order.cache.OrderCacheManager	Cache manager.	string	NA	NA	com.mslv.oms.handler.order.cache.jboss.JBossOrderCacheManager
com.mslv.oms.security.HandlerFactoryRegistry.HandlerFactory	Name of the process that manages the handling of high activity orders in clustered systems.	string	NA	NA	com.mslv.oms.security.HandlerFactory
com.mslv.oms.handler.cluster.ClusteredHandlerFactory.HighActivityOrder.CollectionCycle.Enabled	Enables high-activity order collection cycles.	boolean	NA	NA	true



Table 4-1 (Cont.) Description of oms-config.xml Parameters

Name	Description	Type	Min	Max	Default
com.mslv.oms.handler.cluster.ClusteredHandlerFactory.HighActivityOrder.CollectionCycle.InitialDelay	The amount of time in milliseconds to wait before the first collection cycle. This wait period allows servers to start and the system to stabilize before statistics used to determine high activity orders are collected.	integer	1000	3600000	10000
com.mslv.oms.handler.cluster.ClusteredHandlerFactory.HighActivityOrder.CollectionCycle.Duration	Time in milliseconds to spend collecting high-activity order statistics per collection cycle.	integer	1000	60000	10000
com.mslv.oms.handler.cluster.ClusteredHandlerFactory.HighActivityOrder.CollectionCycle.Interval	The interval in milliseconds between consecutive of the collection cycle.	integer	1000	3600000	60000
com.mslv.oms.handler.cluster.ClusteredHandlerFactory.HighActivityOrder.RequestPerSecondThreshold	The number of requests per second per order that must be processed for an order to be considered a high-activity order and eligible for special load balancing.	integer	1	1000	50
com.mslv.oms.security.HandlerCallbackFactoryRegistry.HandlerCallbackFactory	Do not use unless instructed to do so by Oracle.	string	NA	NA	com.mslv.oms.security.HandlerCallbackFactory
com.mslv.oms.security.OrderViewAccessProvider	Registers a security callback for the OrderViewAccessException exception.	string	NA	NA	NA
com.mslv.oms.cartridgemgmt.DeployCartridgeMDB.CartridgeDeploymentTransactionTimeout	Default transaction timeout interval in seconds for Oracle Communications Design Studio cartridge deployment. Design Studio can override the default value through the environment property.	integer	120	3600	3600
com.mslv.oms.cartridgemgmt.cache.DeployCartridgeCache.DeployCartridgeRequestTimeToLiveMinutes	Default eviction timeout interval in minutes for Design Studio cartridge deployment requests to be cleaned up from the cache. Design Studio can override the default value through the environment property.	integer	5	360	30
com.mslv.oms.cartridgemgmt.cache.DeployCartridgeCache.DeployCartridgeLocalCacheSize	Do not use unless instructed to do so by Oracle.	integer	10	10000	1000
com.mslv.oms.logging.ThreadLogAppenderMaxBufferSize	Do not use unless instructed to do so by Oracle.	integer	1000	20000	10000
com.mslv.oms.model.transformer.OrderTransformer.ModelURL	Do not use unless instructed to do so by Oracle.	string	NA	NA	NA

**Table 4-1 (Cont.) Description of oms-config.xml Parameters**

Name	Description	Type	Min	Max	Default
oracle.communications.ordermanagement.cluster.BusinessRequestBalancer.OrderRelease.Timeout	The time in seconds to wait for a non-exclusive lock to be placed on an order.  A non-exclusive lock is required prior to OSM attempting to process an order. Exclusive locks are acquired by OSM when an order is about to be ejected from the order cache or when an order is being transferred from one node in an OSM cluster to a different node. Exclusive locks prevent non-exclusive locks from being acquired.	integer	200	500	200
oracle.communications.ordermanagement.cluster.BusinessRequestBalancer.OrderOwnershipLock.Timeout	Timeout interval, in seconds, for acquiring an exclusive cluster-wide lock on an order.	integer	30	60	30
oracle.communications.ordermanagement.cluster.BusinessRequestBalancer.ServerState.Scanning.Interval	Time in milliseconds to wait between scanning server states. This value is used to determine how frequently the WebLogic server is checked to see if it is in a RUNNING state prior to enabling application services such as intracluster communication or the JMS server. These services cannot be safely enabled until after the WebLogic server is in a RUNNING state.	integer	1000	10000	5000
oracle.communications.ordermanagement.orchestration.generation.ControlDataLocation	Specifies the node in an orchestration order's order template that contains control data for order items. The data at this location is automatically populated by OSM when the orchestration plan is generated.	string	NA	NA	ControlData/OrderItem
oracle.communications.ordermanagement.orchestration.generation.TransformOrderItemLocation	Specifies the node in an orchestration order's order template that contains control data for transformed order items. The data at this location is automatically populated by OSM when the orchestration plan is generated.	string	NA	NA	ControlData/TransformedOrderItem
oracle.communications.ordermanagement.util.net.CatalogUriResolver.DefaultXmlCatalogsUris	List of URIs specifying the XML Catalogs that are used system-wide. On all OS platforms, entries are separated by a semicolon (;).	string	NA	NA	NA
oracle.communications.ordermanagement.config.ModelResourceClasspath	List of URIs specifying either JAR files or directories containing class files that will be made available to the OSM class loader. On all OS platforms, entries are separated by a semicolon (;).	string	NA	NA	NA

Table 4-1 (Cont.) Description of oms-config.xml Parameters

Name	Description	Type	Min	Max	Default
order_editor_submit_mode_threshold	The response time of the Order Editor page increases with the number of nodes in an order. To avoid slow response times, the <b>order_editor_submit_mode_threshold</b> parameter is configured to a threshold value for node instances saved in the system. If the number of saved instances increases this threshold value, the system automatically switches from AJAX to form-submit mode when edited orders are saved or submitted for processing.	integer	1	9999999	9999999
is_tablelayout_height_fixed	If set to <b>true</b> , the table height equals the value of height_of_tablelayout. If set to <b>false</b> , the table height adjusts according to the number of rows in the table.	boolean	NA	NA	true
height_of_tablelayout	Height in pixels of the table layout.	string	NA	NA	400px
no_of_rows_in_textarea_without_scroll	Maximum number of rows that a text field can accommodate without a scroll bar.	integer	3	1000	3
max_no_of_rows_in_textarea_with_scroll	Maximum number of rows that a text field can accommodate with a scroll bar.	integer	3	1000	3
normalize_space_for_lookup_rule	Determines whether spaces are normalized within XML values that are used in the results of a Lookup behavior. If set to <b>true</b> , the results are normalized by trimming leading and trailing spaces and replacing repeating spaces with a single space, in accordance with the normalize-space XPath function as defined on the World Wide Web Consortium (W3C) website here: <a href="http://www.w3.org/TR/xpath/#function-normalize-space">http://www.w3.org/TR/xpath/#function-normalize-space</a> .	boolean	NA	NA	true
com.mslv.oms.handler.completeorder.CompleteOrderHandlerEJB.OrchPlanLock.Timeout	Time in seconds that OSM will wait while trying to acquire an exclusive lock on an orchestration plan.  This lock is required only when OSM detects that all order components within the orchestration plan have completed and the order can complete.	integer	1	3600	30

Table 4-1 (Cont.) Description of oms-config.xml Parameters

Name	Description	Type	Min	Max	Default
oracle.communications.ordermanagement.orchestration.generation.DumpOrchestrationPlan	If set to <b>true</b> , OSM saves a copy of every generated orchestration plan in XML format to the file <i>orderId_orderType_orchestrationSequence_orchestrationPlanOutput.xml</i> . <b>Note:</b> This parameter should be set to <b>true</b> only at the request of Oracle Support for diagnostic purposes.	boolean	NA	NA	false
webui_order_info_pane_order_item_sort_ascending	Do not use unless instructed to do so by Oracle.	boolean	NA	NA	true
webui_order_info_pane_order_component_sort_ascending	Do not use unless instructed to do so by Oracle.	boolean	NA	NA	true
time_out_override_for_jms_adapter	The amount of time to wait before throwing the JMS response timeout.	integer	15000	300000	15000
oracle.communications.ordermanagement.cache.UserPreferenceCache	Specifies the name of the Coherence cache configuration to use for user preference information. By default, a local cache is used for non-clustered environments. For clustered environments a "near cache" is used to ensure changes to user preference information is automatically synchronized between cluster nodes.	string	NA	NA	near
oracle.communications.ordermanagement.RuleDelayTaskPoller.StartupDelay	Do not use unless instructed to do so by Oracle.	integer	1000	600000	900000
oracle.communications.ordermanagement.RuleDelayTaskPoller.Interval	Specifies the pause time in milliseconds between consecutive times that the rule is run and delay task processors.	integer	1000	60000	5000
oracle.communications.ordermanagement.RuleDelayTaskPoller.MaxRuleTaskProcessors	Specifies the maximum number of rule task processors.	integer	1	50	1
oracle.communications.ordermanagement.RuleDelayTaskPoller.MaxDelayTaskProcessors	Specifies the maximum number of delay task processors.	integer	0	50	1
allow_undeploy_component_cartridge_in_solution	By default, component cartridges that are used by composite cartridges in the run-time environment cannot be undeployed. During the development of a composite cartridge, however, you may need to undeploy a component cartridge used by the composite cartridge. To enable the undeployment of one or more component cartridges used by a composite cartridge, set this value to <b>true</b> .	boolean	NA	NA	false

Table 4-1 (Cont.) Description of oms-config.xml Parameters

Name	Description	Type	Min	Max	Default
oracle.communications.order management.security.GlobalQ ueryRoles	<p>Contains the names of the applicable OSM workgroups (known as roles in Design Studio) separated by a semicolon, a comma, and a colon (;,:).</p> <p><b>Note:</b> Including a workgroup name in this parameter makes OSM behave (for that for that workgroup) the way it did prior to OSM 7.0.3.1. It should only be used for backward compatibility.</p> <p><b>If a workgroup is not included in this parameter</b>, a user can query an order type/source only if the user is a member of a workgroup with one of the following permissions for the order type/source:</p> <ul style="list-style-type: none"> <li>• Permission to create the order (creation task)</li> <li>• Permission on at least one task</li> <li>• Permission on at least one flex header where the flex header node is in that order's order template</li> <li>• At least one query view assigned.</li> </ul> <p>In addition to the conditions above, the workgroup which provides the user with the permission above must also have the <b>Search View</b> permission assigned.</p> <p><b>If a workgroup is included in this parameter</b>, the permissions will operate as they did prior to OSM 7.0.3.1: users can query all order types/sources, without meeting any of the conditions above. Having the workgroup included in this parameter also overrides filters defined for the workgroup. So, a user who is a member of a workgroup defined in this parameter is able to query all order types and order sources, regardless of any filters configured.</p> <p><b>Note:</b> Users can always see default and defaultOrchestration cartridges, regardless of any other conditions, and regardless of whether their workgroup is included in this parameter.</p>	string	NA	NA	NA

**Table 4-1 (Cont.) Description of oms-config.xml Parameters**

Name	Description	Type	Min	Max	Default
oracle.communications.ordermanagement.order.UseUnionOfFiltersAcrossRoles	Filters are OR'ed across roles and the results are a union of data across all the results. If a user is a member of a workgroup with privileges on an order within a cartridge and that workgroup has no filters, the user can see all orders in that cartridge. To see all the results AND'ed so that an intersection of the results is obtained, the names of the specific workgroup should be given in the configuration file separated by a semicolon, a comma, and a colon (;,:). This parameter has been added for backward compatibility with older versions of OSM.	string	NA	NA	NA
oracle.communications.ordermanagement.ws.CreateOrder.UseTinyTree	Do not use unless instructed to do so by Oracle.	boolean	NA	NA	true
oracle.communications.ordermanagement.orchestration.generation.UseTinyTree	Do not use unless instructed to do so by Oracle.	boolean	NA	NA	true
oracle.communications.ordermanagement.amendment.DataEnrichmentAware	Determines whether OSM is aware of changes to order data from Task web client users assigned to manual tasks or from automation plug-ins. If set to <b>true</b> , OSM compares revision order data to the current order including any changes from manual tasks or automation plug-ins. If set to <b>false</b> , OSM compares revision orders to the last submitted order data excluding changes from manual tasks or automation plug-ins.	boolean	NA	NA	true
oracle.communications.ordermanagement.transaction.order.lock	If set to <b>true</b> , OSM will attempt to lock the order while executing order fulfillment state updates during an update order request. This is to prevent a race condition between two threads trying to execute fulfillment state updates.	boolean	NA	NA	true
oracle.communications.ordermanagement.transaction.order.lock.waittime	Wait time in milliseconds for the OSM order lock for oracle.communications.ordermanagement.transaction.order.lock.	integer	1000	30000	3000
oracle.communications.ordermanagement.orchestration.generation.CompressOrchestrationPlan	Do not use unless instructed to do so by Oracle.	boolean	NA	NA	true
oracle.communications.ordermanagement.order.CompressXMLValues	Do not use unless instructed to do so by Oracle.	boolean	NA	NA	true

Table 4-1 (Cont.) Description of oms-config.xml Parameters

Name	Description	Type	Min	Max	Default
soap_adapter_preemptive_authentication	The SOAP Adapter does not support preemptive authentication by default. If preemptive authentication is used incorrectly, it can lead to significant security issues. You must evaluate the potential benefits versus the security risks of preemptive authentication in the context of your specific application environment. If you set this value to <b>true</b> , you can configure HttpClient to authenticate preemptively by prepopulating the authentication data cache.	boolean	NA	NA	false
oracle.communications.ordermanagement.security.access.summary	Grants access to the <b>Summary</b> tab in the Order Management web client, by workgroup names. Only users of specific workgroups can view the <b>Summary</b> tab. Separate values with commas, semicolons, or colons. Values can contain the asterisk wildcard character, where the asterisk can match a string of characters (for example, a value of <b>user*</b> matches workgroup names user1, user2, user3, and so on).	string	NA	NA	* (meaning all workgroups)
oracle.communications.ordermanagement.security.access.data	Grants access to the <b>Data</b> tab in the Order Management web client, by workgroup names. Only users of specific workgroups can view the <b>Data</b> tab. Separate values with commas, semicolons, or colons. Values can contain the asterisk wildcard character, where the asterisk can match a string of characters (for example, a value of <b>user*</b> matches workgroup names user1, user2, user3, and so on).	string	NA	NA	* (meaning all workgroups)
oracle.communications.ordermanagement.security.access.orchestration-plan	Grants access to the <b>Orchestration Plan</b> tab in the Order Management web client, by workgroup names. Only users of specific workgroups can view the <b>Orchestration Plan</b> tab. Separate values with commas, semicolons, or colons. Values can contain the asterisk wildcard character, where the asterisk can match a string of characters (for example, a value of <b>user*</b> matches workgroup names user1, user2, user3, and so on).	string	NA	NA	* (meaning all workgroups)

Table 4-1 (Cont.) Description of oms-config.xml Parameters

Name	Description	Type	Min	Max	Default
oracle.communications.order.management.security.access.dependencies	Grants access to the <b>Dependencies</b> tab in the Order Management web client, by workgroup names. Only users of specific workgroups can view the <b>Dependencies</b> tab. Separate values with commas, semicolons, or colons. Values can contain the asterisk wildcard character, where the asterisk can match a string of characters (for example, a value of <b>user*</b> matches workgroup names user1, user2, user3, and so on).	string	NA	NA	* (meaning all workgroups )
oracle.communications.order.management.security.access.amendments	Grants access to the <b>Amendments</b> tab in the Order Management web client, by workgroup names. Only users of specific workgroups can view the <b>Amendments</b> tab. Separate values with commas, semicolons, or colons. Values can contain the asterisk wildcard character, where the asterisk can match a string of characters (for example, a value of <b>user*</b> matches workgroup names user1, user2, user3, and so on).	string	NA	NA	* (meaning all workgroups )
oracle.communications.order.management.security.access.activity	Grants access to the <b>Activity</b> tab in the Order Management web client, by workgroup names. Only users of specific workgroups can view the <b>Activity</b> tab. Separate values with commas, semicolons, or colons. Values can contain the asterisk wildcard character, where the asterisk can match a string of characters (for example, a value of <b>user*</b> matches workgroup names user1, user2, user3, and so on).	string	NA	NA	* (meaning all workgroups )
oracle.communications.order.management.security.access.data-tree	Controls how users see the Order Info region in the Order Management web client, by workgroup names. The Order Info region can be seen by all users, but only users of specific workgroups can expand the order item child items. Separate values with commas, semicolons, or colons. Values can contain the asterisk wildcard character, where the asterisk can match a string of characters (for example, a value of <b>user*</b> matches workgroup names user1, user2, user3, and so on).	string	NA	NA	* (meaning all workgroups )



Table 4-1 (Cont.) Description of oms-config.xml Parameters

Name	Description	Type	Min	Max	Default
oracle.communications.ordermanagement.table-layout.threshold	This feature introduced a threshold system parameter above which multi-instance group nodes will automatically be displayed as a table. The system parameter will be read from the existing <b>oms-config.xml</b> configuration file at application startup and metadata refresh, as with current system parameters. A non-integer value or a negative value disables this feature.	integer	-1	64000	50
oracle.communications.ordermanagement.table-layout.size	The number of rows displayed in the table in a single view (that is, without scrolling), can be configured.	integer	0	50	10
oracle.communications.ordermanagement.table-layout.fetch-size	The number of rows fetched at a time from the server is configurable; which means that not all the rows that are available for the component on the server are fetched and displayed on the client. The number of rows that are displayed on the client are just enough to fill the viewport. More rows are fetched as the user scrolls the component vertically.	integer	5	100	25
oracle.communications.ordermanagement.webui.text.cols.size	Do not use unless instructed to do so by Oracle.	integer	30	80	48
oracle.communications.ordermanagement.webui.xml.cols.size	Do not use unless instructed to do so by Oracle.	integer	72	144	80
oracle.communications.ordermanagement.webui.xml.rows.size	Do not use unless instructed to do so by Oracle.	integer	4	10	5
oracle.communications.ordermanagement.webui.max.xmlcomponents.per.row	Do not use unless instructed to do so by Oracle.	integer	1	4	2
oracle.communications.ordermanagement.webui.max.auto.expend.tree.levels	Do not use unless instructed to do so by Oracle.	integer	1	128	3
oracle.communications.ordermanagement.webui.max.components.per.row	Do not use unless instructed to do so by Oracle.	integer	1	4	3
oracle.communications.ordermanagement.webui.sort.component.type	Do not use unless instructed to do so by Oracle.	boolean	NA	NA	false

Table 4-1 (Cont.) Description of oms-config.xml Parameters

Name	Description	Type	Min	Max	Default
oracle.communications.ordermanagement.resource.FullScopeAccess	<p>The level of access to system resources. This parameter has one of the following values:</p> <ul style="list-style-type: none"> <li>• <b>_strict_access_</b> This value indicates that no cartridges will have full scope access to system resources.</li> <li>• <b>*</b> (asterisk) This value indicates that all cartridges will have full scope access to system resources.</li> <li>• <i>cartridgeMnemonic:version,cartridgeMnemonic:version, etc.</i> This type of value indicates that only the listed cartridges will have full scope access. For example, if the value is:  OSM_Cart1:1.0.0.0.0,OSM_Cart1:2.0.0.0.0  it means that versions 1.0.0.0 and 2.0.0.0 of the OSM_Cart1 cartridge have full scope access to system resources, and no other cartridges have that access.</li> </ul>	string	NA	NA	_strict_access_
show_all_data_history_logs_for_orderdetails	<p>Controls which events the Order Management web client displays on the <b>Activity</b> tab of the Order Details page.</p> <p>If set to <b>false</b>, the <b>Activity</b> tab displays only events that occur after the order is created. If set to <b>true</b>, the <b>Activity</b> tab displays all events, including those that occur before the order is created.</p> <p>If this parameter is not present in the <b>oms-config.xml</b> file, the <b>Activity</b> tab behaves as though the property is set to <b>false</b>.</p>	boolean	NA	NA	false

Table 4-1 (Cont.) Description of oms-config.xml Parameters

Name	Description	Type	Min	Max	Default
OrderCacheMaxEntries	<p>Maximum number of orders that can be in the cache in a managed server at one time.</p> <p>When there is an attempt to exceed the maximum cache size, the order with the longest period of inactivity is forcefully ejected from the cache to make room for orders being loaded into the cache.</p> <p>A value of <b>0</b> means the cache size is unlimited. The only way that orders can be removed from the cache when the value of this parameter is <b>0</b> is when the value of the OrderCacheInactivityTimeout is reached.</p>	integer	0	8640000 0	1000
OrderCacheInactivityTimeout	<p>Maximum number of seconds that an order can be inactive (no attempt to access or update it) before being ejected from the cache.</p> <p>A value of <b>0</b> means there is no inactivity timeout.</p>	integer	0	8640000 0	3600
ClosedOrderCacheMaxEntries	<p>Maximum number of orders that recently changed from an open state to a closed state that can exist in a managed server at any time.</p> <p>When there is an attempt to exceed the closed order size, the recently closed order with the longest period of inactivity is forcefully ejected from the cache. A typical strategy for this value is to set it to a specific fraction of the OrderCacheMaxEntries value.</p> <p>For example, the default is 50, which is 5% of the default of OrderCacheMaxEntries.</p> <p>This value along with the ClosedOrderCacheTimeout value is to set a number of seconds that represents the grace period that recently closed orders remain in cache, after which they are ejected.</p>	integer	0	8640000 0	50

Table 4-1 (Cont.) Description of oms-config.xml Parameters

Name	Description	Type	Min	Max	Default
ClosedOrderCacheTimeout	<p>Maximum number of seconds that recently closed orders remain in the cache after they have changed from an open state to a closed state.</p> <p>This allows sufficient time for post-processing that might happen after an order is completed or aborted, but encourages closed orders to otherwise be ejected from cache more quickly than if they were ejected based on the OrderCacheInactivityTimeout parameter. Typically, this is set to a relatively low value, such as 60 seconds. To be effective, this value should be much smaller than the OrderCacheInactivityTimeout value.</p>	integer	0	8640000 0	60
fast_cartridge_undeploy	<p>If set to <b>true</b>, cartridges are undeployed from OSM but cartridge metadata and order data are not purged from the database.</p> <p>After undeploying a cartridge, its status in the OSM database is set to <b>UNDEPLOYED</b>.</p> <p>If set to <b>false</b>, when cartridges are undeployed, cartridge order data and metadata are removed from the database, which can take time if there are a large number of orders.</p>	boolean	NA	NA	true
cartridge_operation_timeout	Timeout interval, in seconds, for completion of cartridge deployment. Deployment will be terminated when this time is reached.	integer	-1	3600	1800
oracle.communications.order.management.xml.file.encoding	Specifies the standard text encoding OSM uses to parse XML attachments.	string	NA	NA	UTF-8
oracle.communications.order.management.compliance.snapshot.output.directory	Specifies the directory that contains the system configuration snapshot files that are captured while you are running the compliance tool.	string	NA	NA	osm_compliance/snapshots
oracle.communications.order.management.compliance.evaluator.output.directory	Specifies the directory that contains the evaluation results files after you run the compliance tool.	string	NA	NA	osm_compliance/results

Table 4-1 (Cont.) Description of oms-config.xml Parameters

Name	Description	Type	Min	Max	Default
oracle.communications.ordermanagement.compliance.evaluator.snapshot.directory	Specifies the directory that contains the generated snapshot files that need to be evaluated.  If this directory contains multiple sub-directories that contain snapshot files, the sub-directories are sorted alphabetically and the last one is used in the evaluation process. Each directory name is a timestamp of when the snapshot was captured, in the format: <b>yyyymmdd-hhmmss</b> .	string	NA	NA	osm_compliance/snapshots
oracle.communications.ordermanagement.compliance.evaluator.rule.directory	Specifies the directory that contains the rules that the snapshot is to be evaluated against. Directory rules run in addition to internal rules.	string	NA	NA	osm_compliance/rules
oracle.communications.ordermanagement.compliance.configuration.override.file	File to override the configuration file for the compliance tool.	string	NA	NA	NA

Table 4-1 (Cont.) Description of oms-config.xml Parameters

Name	Description	Type	Min	Max	Default
AutomationConcurrencyModels	<p>You can specify a delimited list of OACC policy xml files that the system can use to limit the concurrency of automation plug-ins. Each policy specifies which automation plug-ins are limited, the scope of the policy, and the maximum allowed concurrency level. All automation plug-ins not targeted by a policy have unlimited concurrency.</p> <p>For example:</p> <pre>&lt;oms-parameter&gt;   &lt;oms-parameter-name&gt;AutomationConcurrencyModels&lt;/oms-parameter-name&gt;   &lt;oms-parameter-value&gt;file:/// Users/sample/automationConcurrencyModel.xml&lt;/oms-parameter-value&gt; &lt;/oms-parameter&gt;</pre> <p>You can put the policy file in any reachable location and the policy file can have any name when being referenced from <b>oms-config.xml</b>. You can also include OACC policy files directly in the resource folder of OSM cartridges instead of referencing them from <b>oms-config.xml</b>. If both the referenced <b>oms-config.xml</b> OACC policy file and the local cartridge OACC policy file have the same name, then the <b>oms-config.xml</b> policy file overrides the local version.</p> <p>For more information about OACC policy files, see <i>OSM Developer's Guide</i>.</p>	List of files	NA	NA	NA
oracle.communications.ordermanagement.order.OperationalOverrideFileURLs	<p>Location of operational jeopardy configuration override files. The format of this parameter is a comma-separated list of file names (including paths). Files should be located in the same file system as the <b>oms-config.xml</b> file. For example:</p> <pre>/u01/settings/osm/operational-jeopardy-config1.xml,/u01/settings/osm/operational-jeopardy-config2.xml</pre> <p>By default this field is blank, which means that operational jeopardy configuration is not turned on.</p>	string	NA	NA	NA

Table 4-1 (Cont.) Description of oms-config.xml Parameters

Name	Description	Type	Min	Max	Default
oracle.communications.ordermanagement.scheduler.MaxDelay.OrderJeopardyTimer	Maximum number of milliseconds for the generic timer to wait before triggering items on its list. Changing this parameter can affect system performance.	integer	0	86400000	30000
oracle.communications.ordermanagement.scheduler.MaxEventCount.OrderJeopardyTimer	Maximum number of items processed in a single call to the generic timer. Changing this parameter can affect system performance.	integer	1	10000	10
oracle.communications.ordermanagement.scheduler.MaxDelay.OrderJeopardyTimerCleanup	Do not use unless instructed to do so by Oracle.	integer	60000	86400000	3600000
oracle.communications.ordermanagement.scheduler.MaxPausedTime.OrderJeopardyTimerCleanup	Do not use unless instructed to do so by Oracle.	integer	1	2147483647	86400000
adaptivePolling.ceiling	Adaptive event polling determines how the om_jms_event table, which contains records of OSM-generated events, is polled. To increase performance, adaptive polling provides a mechanism for polling only the most active database partitions generally, with only periodic polling of all of the partitions.  This parameter specifies how many times to query only the most active partitions before performing the full query again. Set to 0 to turn off adaptive polling and run the full query every time.	integer	0	100	10
adaptivePolling.maxPartitions	Adaptive event polling determines how the om_jms_event table, which contains records of OSM-generated events, is polled. To increase performance, adaptive polling provides a mechanism for polling only the most active database partitions generally, with only periodic polling of all of the partitions.  This parameter specifies the number of partitions to include in the query of only the most active partitions.	integer	1	30	2
oracle.communications.ordermanagement.wm.ProcessRequest.Timeout	Do not use unless instructed to do so by Oracle.	integer	60000	300000	60000

Table 4-1 (Cont.) Description of oms-config.xml Parameters

Name	Description	Type	Min	Max	Default
oracle.communications.ordermanagement.monitoring.adml.dir	Do not use unless instructed to do so by Oracle.	string	NA	NA	\${common.components.home}/modules/oracle.dms_12.2.1/adml
oracle.communications.ordermanagement.monitoring.date.displayformat	Do not use unless instructed to do so by Oracle.	string	NA	NA	yy-MM-dd HH:mm:ss
oracle.communications.ordermanagement.monitoring.movingaverage.windowsize	Do not use unless instructed to do so by Oracle.	integer	1	100000	1000
oracle.communications.ordermanagement.order.contingency	Amount of contingency buffer, measured in minutes, that is added to a calculated order duration to determine the projected delivery date of an order.	integer	0	525600	0
oracle.communications.ordermanagement.ws.FindOrderRequest.FindOrderMaxOrderThreshold	Maximum number of rows that are returned in the results of the FindOrder web service operation. For more information, see "FindOrder" in <i>OSM Developer's Guide</i> .	integer	1	64000	1000
oracle.communications.ordermanagement.ws.FindOrderOperationImpl.MaxFlexHeaderCountInOrderBy	The number of flexible headers that can be sent in an order by clause in a web service request. If the number of flexible headers is greater than this value, the web service request will be rejected.	integer	1	100	1
oracle.communications.ordermanagement.ui.compatibilityMode	Do not use unless instructed to do so by Oracle.	boolean	NA	NA	false



Table 4-1 (Cont.) Description of oms-config.xml Parameters

Name	Description	Type	Min	Max	Default
oracle.communications.ordermanagement.OrderPartitioningRealmConfigFileURLs	<p>Location of order partitioning realm configuration files. The format of this parameter is a comma-separated list of file names (including paths). Files should be located in the same file system as the <b>oms-config.xml</b> file. For example:</p> <pre>/u01/settings/osm/ order_partitioning_realms_config1.xml,/u01/settings/osm/ order_partitioning_realms_config2.xml</pre> <p>By default this field is blank, which means that no additional partitioning realms for orders are configured in the system beyond those installed by default.</p> <p>See "<a href="#">Partitioning Realms</a>" for more information about this configuration.</p>	string	NA	NA	NA
communications.ordermanagement.webui.render_timeline_tab_for_orderdetails	<p>Enables and disables the <b>Timeline</b> tab in the Order Management Web Client. For more information about the Order Lifecycle Management UI and the <b>Timeline</b> tab, see <i>OSM Order Management Web Client User's Guide</i>.</p> <p>If set to <b>true</b>, the <b>Timeline</b> tab is displayed in the Order Management Web Client UI. If set to <b>false</b>, the tab is not displayed.</p>	boolean	NA	NA	true
oracle.communications.ordermanagement.EventPoller.MaxProcessingTime	Time, in seconds, for requests from a single poll of table om_jms_event to process. Events that have not been processed before this time expires will be processed during the next poll.	integer	1000	600000	25000
oracle.communications.ordermanagement.EventPoller.MaxEventErrorCount	Number of attempts to retry processing an event when event processing has failed.	integer	1	1000	10
oracle.communications.ordermanagement.AutomationResponseMessageParkingEnabled	Determines whether OSM saves external responses for later delivery if the task receiver cannot process them when they are received (for example, because the order is being amended).	boolean	NA	NA	true
application_scope_id	For internal use only.	string	NA	NA	NA

# 5

## Configuring the Task Processor

This chapter describes how to configure the task processor to improve performance and handle rule-processing errors for Oracle Communications Order and Service Management (OSM).

In most cases, you can use the default configuration for the task processor.

### About Configuring the Task Processor

The task processor evaluates rules, event delays, and timer delays to determine when to transition to the next task in a process. The task processor is implemented as one or more task processor threads running on WebLogic servers. There are two types of task processors: the rule task processor evaluates orders at rules and the delay task processor evaluates orders at delays. You can configure additional task processors to improve performance.

### Configuring the Task Processor for Performance

You can use the oms-config parameters to tune the number and type of task processors.

There are two types of task processors:

- Rule Task Processor, which evaluates only rules.
- Delay Task Processor, which evaluates only delays.

You may want to reconfigure the number or type of task processors as the amount of data you handle grows.

For rule task processors, the following parameters apply:

- **oracle.communications.ordermanagement.RuleDelayTaskPoller.MaxRuleTaskProcessors**. Specifies the maximum number of rule task processors; minimum value 1; maximum 50; default value is 1.
- **oracle.communications.ordermanagement.RuleDelayTaskPoller.Interval**. Specifies the pause time in milliseconds between two invocations of the rule and delay task processors; minimum value 1000; maximum value 60000; default value is 5000.

For delay task processors, the following parameters apply:

- **oracle.communications.ordermanagement.RuleDelayTaskPoller.MaxDelayTaskProcessors**. Specifies the maximum number of delay task processors; minimum value 0; maximum 50; default value is 1.
- **oracle.communications.ordermanagement.RuleDelayTaskPoller.Interval**. Specifies the pause time in milliseconds between two invocations of the rule and delay task processors; minimum value 1000; maximum value 60000; default value is 5000.

There must be at least one rule task processor running. The number of delay task processors can be 0 or above.

If there is a backlog of rule or delay tasks, you can increase the number of rule or delay task processors.

OSM will adjust the number of rule and delay task processors to use no more than 10% of the connection pool size that is configured for the WebLogic instance. The adjusted numbers are written in the managed server's log file. If the adjusted number of rule and delay task processors does not meet your performance requirement, increase the connection pool size or decrease the parameter **oracle.communications.ordermanagement.RuleDelayTaskPoller.Interval**.

# 6

## Managing the OSM Database Schema

This chapter describes how to manage an Oracle Communications Order and Service Management (OSM) database schema.

### Implementing a Strategy for OSM Information Lifecycle Management

Information Lifecycle Management (ILM) is a process for managing information through its lifecycle in a manner that optimizes storage and access. This section discusses how to implement an OSM-specific strategy for ILM.

An OSM deployment includes these database schemas:

- The core schema, which contains order cartridge metadata, order data, configuration, and other data.
- The rule engine schema, which contains logic for rule processing.
- The reporting schema, which is used for reporting.

All schemas are installed and upgraded together (although you might have to install the reporting schema manually depending on your release and patch level).

OSM provides tools to help you manage data classes rather than individual tables, so you do not need a detailed understanding of the OSM schemas. The core schema is the only schema that contains data that accumulates, ages, becomes obsolete, and eventually must be purged:

- **Cartridge metadata:** Static metadata that is populated in the OSM database when the cartridge is deployed or redeployed. This data does not grow or change when orders are created or processed. For each cartridge there is a Java EE application deployed to the OSM Oracle WebLogic Server domain. Cartridge metadata and the associated Java EE applications consume resources and take time to initialize on server startup.
- **Order data:** The bulk of OSM data. Storage sizing depends on order volume, order size, retention policies, and your order purge strategy. OSM supports partitioning, which helps you manage order data efficiently.

The remainder of the data includes relatively small volumes of configuration and other data that is static, is updated infrequently, or it is managed by OSM.

The following sections discuss important aspects of an ILM strategy:

- "[Creating Tablespaces](#)": Presents options and provides recommendations for creating tablespaces for OSM schemas.
- "[Using Partitioning](#)": Provides an overview of partitioning in OSM and discusses the benefits and pitfalls of partitioning. Oracle strongly recommends partitioning in all production deployments or production test environments, particularly those with high order volumes or any volume of large or complex orders. Moreover, partitioning is required if you plan to use active-active Oracle RAC.

- ["Order Purge Strategies"](#): Helps you decide on an order purge strategy. This is one of the most important decisions that you must make, not only before going into production but also before you start performance testing.
- ["Partitioning Realms"](#): Discusses the use of logical partitions in the OSM schema to assist in purging or dropping orders.
- ["Cartridge Management Strategy"](#): Recommends a strategy for managing cartridges.
- ["Sizing Partitions"](#): Discusses how to size partitions for order data. Partition sizing depends on your order purge strategy.
- ["Online vs. Offline Maintenance"](#): Gives a brief overview of which maintenance operations can be performed online.

## Creating Tablespaces

The OSM DB Installer expects the following permanent database tablespaces specified in the project specification:

```
db:
  datasourcesPrimary:
    # Add one entry in servers per node in the primary RAC cluster.
    # To facilitate proper load balancing, provide the nodes' addresses
and not
    # the SCAN addresses.
    servers:
      - host: osmdev-oracle-db.default.svc.cluster.local
        port: 1521
    # Default log level. Valid value
    #
    ## The levels in descending order are:
    ## SEVERE (highest value)
    ## WARNING
    ## INFO
    ## CONFIG
    ## FINE
    ## FINER
    ## FINEST (lowest value)
    ##
    logLevel: "WARNING"
    #
    # The remaining parameters must match the values used when the PDB was
    # created. Failure to match will result in dbInstaller errors
    #
    # The default tablespace name of OSM schema
    defaultTablespace: "OSM"
    # The temporary tablespace name of OSM schema
tempTablespace: "TEMP"
    # The time zone offset in seconds
    timezoneOffsetSeconds: "-28800"
    # The model data tablespace name of OSM schema
    modelDataTablespace: "OSM"
    # The model index tablespace name of OSM schema
    modelIndexTablespace: "OSM"
```

```
# The order data tablespace name of OSM schema
orderDataTablespace: "OSM"
# The order index tablespace name of OSM schema
orderIndexTablespace: "OSM"
```

You can choose different tablespaces or a single tablespace. Typically model data and indexes are separate from order data and indexes.

If your schema is partitioned, you can also create new table partitions in different tablespaces for increased administration and availability, for example on a rotation basis. If a tablespace is damaged, the impact and restoration effort could be limited to one or just a few partitions. See "[Adding Partitions \(Online or Offline\)](#)" for more information.

Oracle recommends the following:

- Create tablespaces dedicated to OSM, so that OSM performance and availability are not affected by other applications, for example due to I/O contention or if a tablespace must be taken offline. Store the datafiles of these tablespaces on different disk drives to reduce I/O contention with other applications.
- Create locally managed tablespaces with automatic segment space management by specifying `EXTENT MANAGEMENT LOCAL` and `SEGMENT SPACE MANAGEMENT AUTO` in the `CREATE TABLESPACE` statement. Both options are the default for permanent tablespaces because they enhance performance and manageability.
- Configure automatic database extent management by using the `AUTOALLOCATE` clause of the `CREATE TABLESPACE` statement. This is the default. For production deployments, avoid `UNIFORM` extent management for OSM order data and indexes because the volume of data varies widely from table to table.
- If you use smallfile tablespaces, do not create hundreds of small datafiles. These files need to be checkpointed, resulting in unnecessary processing. Note that Oracle Database places a limit on the number of blocks per datafile depending on the platform. The typical limit is 222-1, which limits the datafile size to 32GB for 8k blocks.

Additional considerations if you use bigfile tablespaces:

- If data is stored in bigfile tablespaces instead of traditional tablespaces, the performance of database opens, checkpoints, and DBWR processes should improve. However, increasing the datafile size might increase time to restore a corrupted file or create a new datafile. You can mitigate the risk of corruption by using multiple tablespaces for partitions, for example on a rotating basis.
- Bigfile tablespaces are intended to be used with Automatic Storage Management (Oracle ASM) or other logical volume managers that supports striping or RAID, and dynamically extensible logical volumes.
- Avoid creating bigfile tablespaces on a system that does not support striping because of negative implications for parallel query execution and RMAN backup parallelization.
- Using bigfile tablespaces on platforms that do not support large file sizes is not recommended and can limit tablespace capacity.

For more information about managing tablespaces, see *Oracle Database Administrator's Guide*.

# Using Partitioning

OSM database partitioning enhances the performance, manageability, and availability of data in an OSM deployment.

The OSM DB Installer enables partitioning automatically. The following figure provides details about the OSM partition tables that accumulate order-related information using range partitioning based on OSM order ID ranges.

**Figure 6-1 OSM Partitioning**

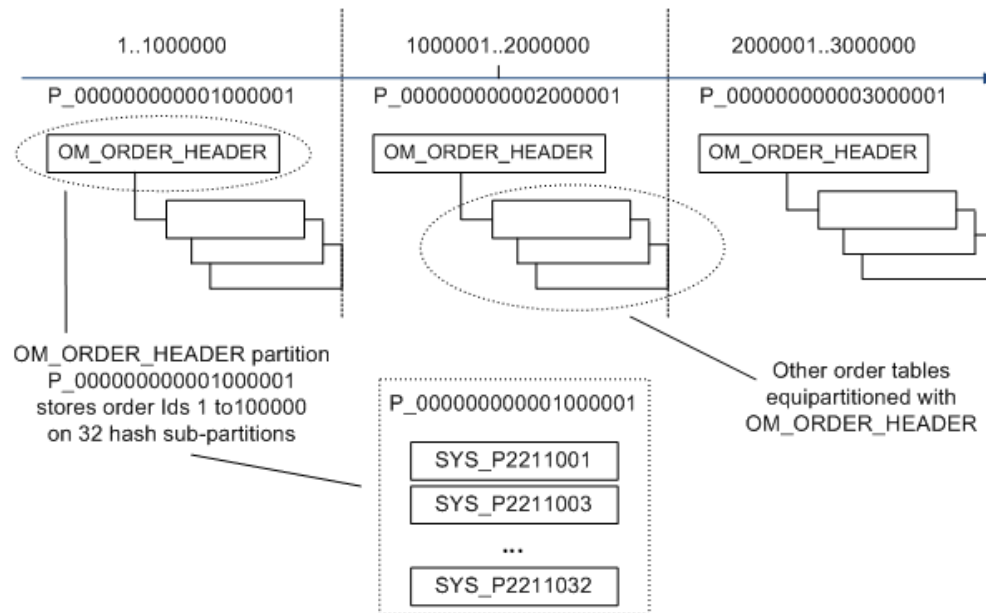

The **OM\_ORDER\_HEADER** table stores a synopsis for each order, such as the order ID, priority, state, milestone timestamps, and so on. This table is range-hash partitioned by order ID. More precisely:

- The non-inclusive upper bound of each range partition is an order ID. For example, if the upper bound of the first partition is 1,000,001 and partitions are sized to contain 1,000,000 order IDs each, the first partition contains orders with an order ID between 1 and 1,000,000, the next partition contains orders with an order ID between 1,000,001 and 2,000,000, and so on.
- Hash sub-partitioning reduces I/O contention. In production deployments, range partitions typically have 16, 32, or 64 sub-partitions.
- Range partition names are generated by OSM and they include the partition upper bound. For example, the upper bound of partition `P_000000000001000001` is 1,000,001. Sub-partition names are generated by Oracle Database (for example, `SYS_P2211001`).

The rest of the tables that accumulate order data are equipartitioned with **OM\_ORDER\_HEADER**. They are either range-hash partitioned or reference partitioned.

You can use the partitioning realms feature to separate orders with different operational characteristics into different partitions. See "[Partitioning Realms](#)" for more information.

For more information about the different types of partitioning, see *Oracle Database VLDB and Partitioning Guide*.

## Benefits of Partitioning

Partitioning your OSM schema allows you to subdivide tables and indexes into smaller segments. This provides the following benefits:

- [Improved Manageability](#)
- [Increased Availability](#)
- [Increased Concurrency](#)
- [Support for Active-Active Oracle RAC](#)
- [Increased Query Performance](#) (for certain queries)

### Improved Manageability

Improved manageability is the result of partition independence, plus managing smaller segments is easier, faster and less resource intensive. The benefits increase with the schema size, because partitioning allows you to divide large tables and indexes into smaller more manageable segments.

You can purge several weeks' worth of order data in minutes by dropping or purging a partition, without affecting other partitions. You can set up routine purges of older partitions containing obsolete and complete orders, while creating and bringing on-line new partitions as existing partitions fill up.

Data Definition Language (DDL) operations on tables and indexes are less resource intensive and less likely to fail if they are performed one partition at a time. For example, consider a 128 GB non-partitioned index and a partitioned index of the same size with 32 partitions. The partitioned index can be rebuilt one partition at a time (32 transactions), whereas rebuilding the non-partitioned index is a single transaction that requires 32 times more free space. If the rebuild fails, the entire transaction is rolled back.

### Increased Availability

Partitioning increases availability mainly by reducing downtime in the event of error. For example, the time to recover from a corruption in a large table could be reduced significantly if that table was partitioned and the corruption was isolated to a single partition.

### Increased Concurrency

Hash sub-partitioning increases concurrency by reducing I/O contention, specifically by spreading DML statements (data modifications) over several physical sub-partitions. Contention is usually manifested as "buffer busy" waits in Automatic Workload Repository (AWR) reports.



Note that range partitioning does not help with contention because new orders are created in the same range partition. The only exception is if you use active-active Oracle RAC, in which case order creation is spread over two or more range partitions.

## Support for Active-Active Oracle RAC

If you use active-active Oracle RAC, range partitioning is critical for good performance. Therefore, active-active Oracle RAC is supported only if your OSM schema is partitioned.

If you use a single instance database, new orders are assigned order IDs and are all stored in the same partition. When that partition is exhausted, new orders are created in the next partition, and so on. To avoid conflicts in order ID generation, each OSM server running in a WebLogic cluster is assigned one or more "slots" and generates only order IDs mapped to its slots based on a proprietary algorithm. For example, in a cluster with two equally weighted managed servers, each server might generate every other order ID. (The order ID generation algorithm is internal and may be different from release to release.)

If you configure OSM to use Oracle RAC in active-passive mode or a single node of Oracle RAC, order IDs are generated as described above. However, if you configure OSM to use Oracle RAC in active-active mode with N nodes, new orders are created concurrently in N partitions. The goals are load balancing and increased scalability and performance. These are achieved by dividing managed servers into N groups, so that each group interacts with a single Oracle RAC instance. Directing interactions from a given managed server to a specific RAC instance is achieved using JDBC multi data sources. OSM does not support an Active GridLink data source given that this configuration has a severe impact on OSM performance. The reason for this is that, with Active GridLink, OSM cannot direct interactions from a given managed server to a specific primary RAC instance.

Figure 6-2 shows an example with four managed servers divided into two groups. Each group is configured with a different multi data source in **failover** mode. However, the primary data source in each multi data source points to a different Oracle RAC instance in an alternating fashion.

Figure 6-3 shows that each group generates order IDs from a different range, so that the orders created by each group are stored in different partitions, for example, P\_0000000000100001 and P\_0000000000200001. In this way:

- All database transactions on an order that take place on a single managed server also take place on a single database instance. This minimizes cluster waits by avoiding buffer cache transfers among database instances.
- The workload is balanced across Oracle RAC nodes and WebLogic Managed Servers.

**Figure 6-2 OSM Data Source Configuration for Active-Active Oracle RAC**

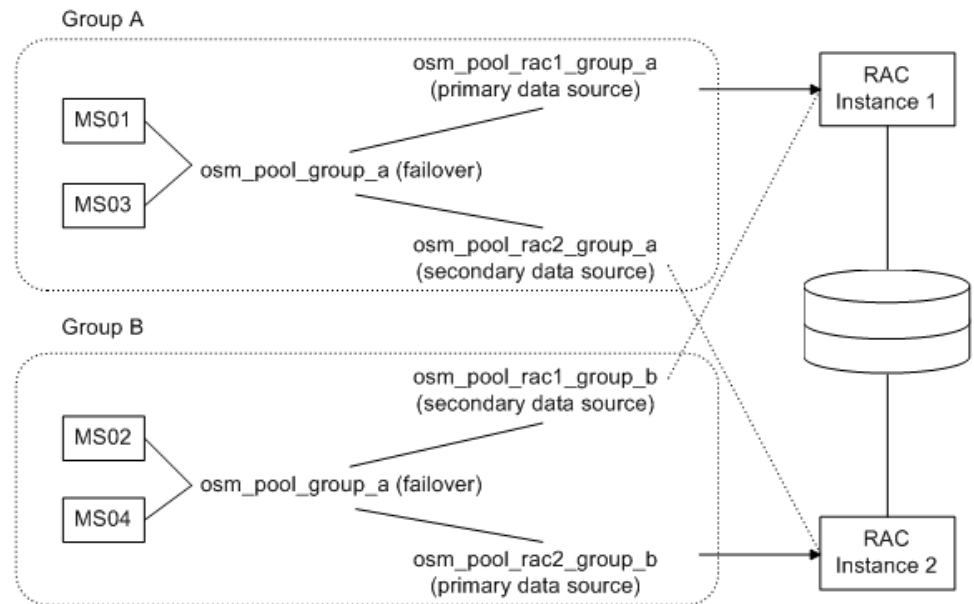

**Figure 6-3 OSM Order ID Generation for Active-Active Oracle RAC**

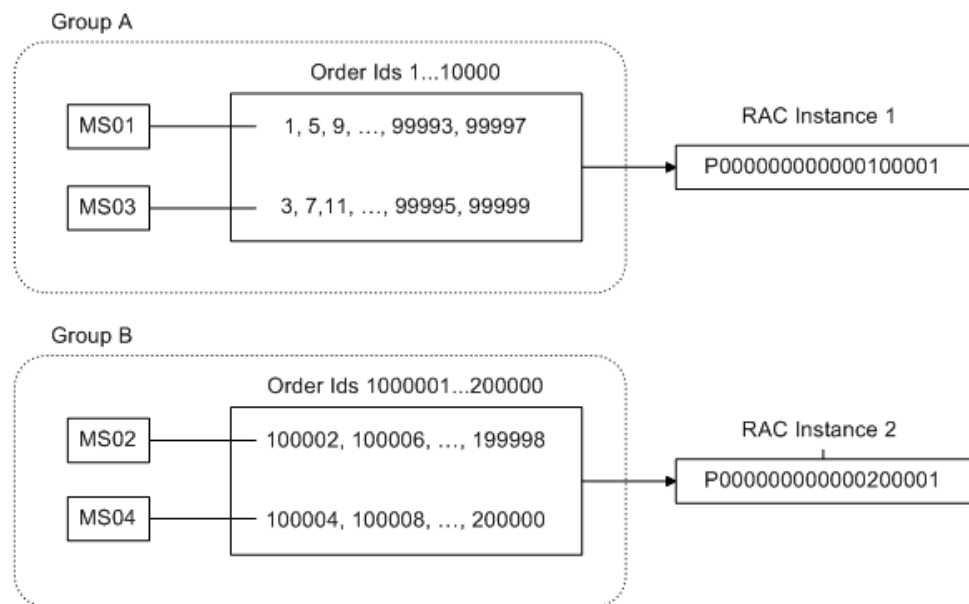

The downside of creating orders concurrently in N partitions is that some order IDs are skipped, which causes partitions to be only partially filled when they are considered exhausted. For example, Figure 3 shows that MS01 and MS03 skip order IDs 2, 6, 10, 14, and so on. This is because these are mapped to slots owned by MS02 and MS04. However, MS02 and MS04 do not generate those order IDs because they generate

order IDs from a different range. As a result, each partition is only half-full when it is exhausted.

The overall size of order ID gaps depends on the number of Oracle RAC nodes, regardless of how the load is balanced across those nodes. For example, when you remove managed server MS4 from the cluster of the previous example, so that each managed server processes 1/3 of the load, the managed servers are still divided into two groups. This means that partition P\_0000000000100001 contains 2/3 of the order IDs and P\_0000000000200001 contains the remaining 1/3. Thus, when P\_0000000000100001 is exhausted, it will be 1/3 empty. Because MS2 skips slots assigned to MS1 and MS3, its partition will be exhausted at about the same time and it will be 2/3 empty. Although the two Oracle RAC nodes are not balanced (they process 2/3 and 1/3 of the load each), on average both partitions are half empty.

In summary, if you switch from a single database to N-node active-active Oracle RAC, the number of partitions increases N-fold, whereas the actual number of order IDs stored in a partition decreases N-fold. Storage consumption is about the same.

For more information, refer to the OSM High-Availability Guidelines and Best Practices in the OSM Installation Guide.

## Increased Query Performance

OSM query performance benefits the least from partitioning because queries are designed to use indexes and return quickly. In fact, a very large number of physical partitions could negatively effect query performance, as discussed in "[Pitfalls of Partitioning](#)." However, there are the following performance benefits:

- Many indexes are based on order ID and are therefore right-handed. Partitioning alleviates imbalances by dividing indexes into smaller segments.
- Queries that perform index range scans can be run in parallel if the index is partitioned. Parallel query execution could dramatically improve the performance of maintenance operations, reporting, and ad-hoc user searches.

## Pitfalls of Partitioning

Tables that store order data are equipartitioned with **OM\_ORDER\_HEADER**. The rest of the tables are not partitioned. Therefore, the number of physical partitions in an OSM schema is at least  $T \times R \times H$ , where T is the number of partitioned tables, R is the number of **OM\_ORDER\_HEADER** range partitions, and H is the number of hash sub-partitions per range partition (excluding LOB index partitions). For example, an OSM schema with 48 order tables, 10 **OM\_ORDER\_HEADER** range partitions, and 32 hash sub-partitions has at least 15360 physical partitions. If you let the number of physical partitions increase unchecked, you are likely to run into the performance problems discussed below, even if the space used by most partitions is very small. It is recommended that you review the "[Sizing Partitions](#)" section for sizing guidelines.

## Order Search Performance

The majority of OSM queries return quickly because they perform index unique scans or range scans on a single partition. Most query access is based on order ID, which is the partitioning key, and a database technique called partition pruning that narrows access to a single or a small subset of partitions. Partitioning does not benefit such queries because the performance increase achieved by scanning smaller index partitions is negligible. In contrast, a large number of partitions could have a negative

impact on queries that iterate over all or a large subset of local index partitions. This happens when order ID is not part of the query criteria and therefore partition pruning cannot be used. In order search, probing a large number of small index segments is slower than probing a small number of large index segments.

## Purge Performance

A very large number of partitions could significantly slow down partition purge. Experience shows that the tipping point is around 300,000 physical partitions, although this varies depending on the specific OSM installation environment.

The time to purge a partition using EXCHANGE PARTITION operations depends on the number of hash sub-partitions. For example, if you decrease the number of sub-partitions from 64 to 32, the duration of the EXCHANGE PARTITION stage of the purge decreases to nearly half.

A partitioned table is considered in the library cache as one object, regardless of the number of partitions. Partition purge operations use DDL statements, which invalidate the cursors associated with the underlying partitioned tables. When a cursor is re-parsed, all the partition metadata for the underlying tables must be reloaded and the amount of time increases with the number of partitions. This is less of an issue when you drop a partition, because the DROP PARTITION statement is cascaded. However, partition purge also uses EXCHANGE PARTITION, which is not cascaded in 11g. A partition purge executes several exchange operations per reference-partitioned table, causing repeated metadata reloads that could significantly slow down the purge (for example, from minutes to hours).

## Shared Pool

Oracle Database stores partitioning metadata in the data dictionary, which is loaded in the row cache of the shared pool. A very large number of partitions could stress the shared pool. If the shared pool is undersized, you could run into ORA-4031 errors (unable to allocate shared memory), especially while purging partitions.

## Development and Testing Environments

Starting with Oracle Database 11.2.0.2, the initial extent size for partitioned tables is 8 MB. If you have many hash sub-partitions, partitioned tables can consume a lot of space even if they contain very little data. For example, even with deferred segment allocation, injecting a few orders could quickly expand a table with 64 sub-partitions to 512 MB. Although this is not typically an issue for production environments, which should already have sufficient storage available, it could be an issue in development or testing environments with limited storage capacity. In such environments, you can use a smaller number of sub-partitions (for example 4), or use a tablespace with uniform extent allocation and a small extent size (for example, 64 KB).

## Order Purge Strategies

The database size increases as orders enter the system. If left unchecked, the size becomes difficult for database administrators to manage and you might eventually run out of space. A purge strategy is an important decision to make before going into production. If you choose a continuous order purge strategy, you should incorporate it in your order load tests. Partition sizing depends on the purge strategy.

OSM supports these purge strategies:

- [Partition-Based Order Purge Strategy](#)
- [Row-Based Order Purge Strategy](#)
- [Hybrid Purge Strategy](#)

## Partition-Based Order Purge Strategy

The **om\_part\_maintain** PL/SQL package allows you to drop and "purge" partitions. These operations are based on efficient DDL statements that modify the table structure, such as `DROP PARTITION` and `EXCHANGE PARTITION`. They are designed to reclaim large amounts of space as fast and efficiently as possible. You can purge several weeks' worth of order data in minutes. However, they usually require downtime and a regular maintenance schedule.

When a partition is dropped, all its data is deleted and space is immediately reclaimed. Populated partitions can be dropped offline only. Empty partitions can be dropped either offline or online.

Often a partition cannot be dropped because it contains orders that do not satisfy the purge criteria (for example, closed orders that are still in retention and open orders). In this case, you can use "partition purge". This operation is more versatile than dropping because it allows you to retain some orders and consolidate multiple partitions. In addition, if all orders in a partition are closed and satisfy the purge criteria, you might be able to purge it online.

The following sections provide additional information about this strategy:

- ["Partition Purge Example"](#): Provides an example of the strategy.
- ["Advantages and Disadvantages of Partition-Based Purge"](#): Discusses the pros and cons of partition-based purge.
- ["Sizing Range Partitions for Partition-Based Order Purge"](#): Provides partition sizing guidelines.
- ["Using Partition-Based Order Purge"](#): Partition-based order purge is discussed in more detail.

## Partition Purge Example

The following figures show a partition purge example over a period of 14 weeks with three maintenance windows.

- The purge frequency is biweekly.
- Each partition is sized to contain about 2 weeks' worth of orders.
- The order retention period is 4 weeks (after closure).
- Purge performance tests show that the period of downtime is acceptable if less than 2% of the orders in the partition are retained (including both open orders and closed orders in retention) but the system can tolerate up to 5%. The statistics (or estimates) suggest that 98% of the orders close within 3 weeks.

For this example, to purge an exhausted partition you must wait for at least 7 weeks (3 weeks for 98% of the orders to close and 4 weeks retention). Because the partition size is equal to 2 weeks of orders, you can schedule the first maintenance window after 9 weeks in production. After that, maintenance is biweekly. Before going

into production, you should also add enough partitions to store orders until the first maintenance window.

Figure 6-4 shows the first maintenance window. P1 is purged and less than 2% of its orders are retained, including closed orders that are still in retention. Because a partition contains 2 weeks' worth of orders, you also add at least one partition (only P6 shown).

Partitions P2, P3, P4, and P5 are not purged:

- It is not cost-effective to purge P2: It contains a high percentage of open orders and closed orders that are still in the retention period (for example 15%).
- It is not cost-effective to purge P3: The second half of P3 is within the retention period, so it contains a very high percentage of open orders, and closed orders that are still in the retention period (for example 75%).
- P4 and P5 are ineligible for purge: All orders are either open or within the retention period. In addition, P5 is where new orders are created (shown half full).

In other words, 3.5 partitions are not purged. If you follow an uninterrupted biweekly schedule, the number of partitions that are not purged is always about 3.5.

**Figure 6-4 Partition Purge Maintenance, Window 1**

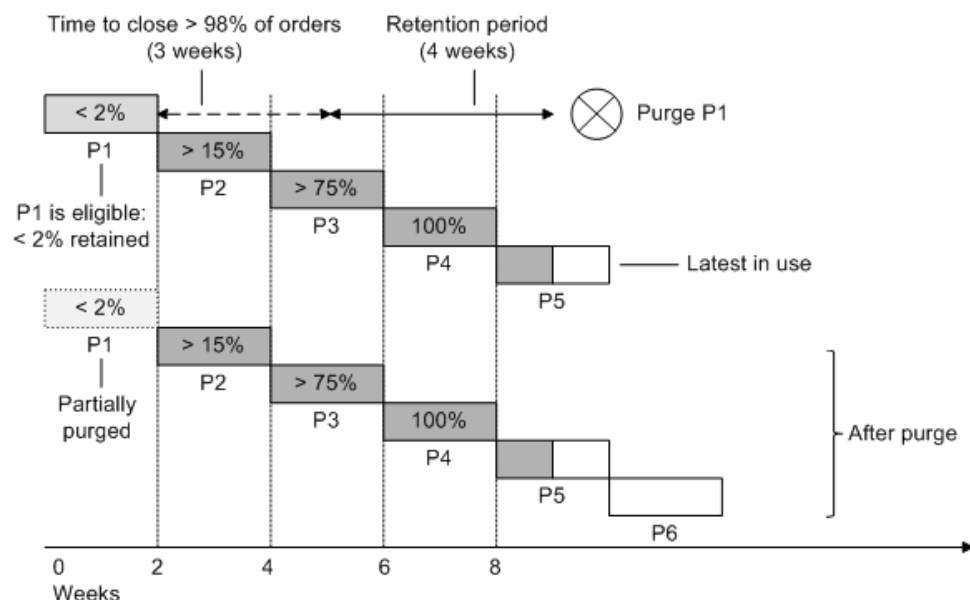

Figure 6-5 shows the second maintenance window (after 2 weeks). Because a partition contains 2 weeks' worth of orders, P5 is exhausted and P6 is half full. As in the previous maintenance, it is cost-effective to purge only one partition that has not yet been purged, which is P2 in this example. You also add at least one partition (not shown). Notice that the number of partitions that are not purged is 3.5 again.

Figure 6-5 Partition Purge Maintenance, Window 2

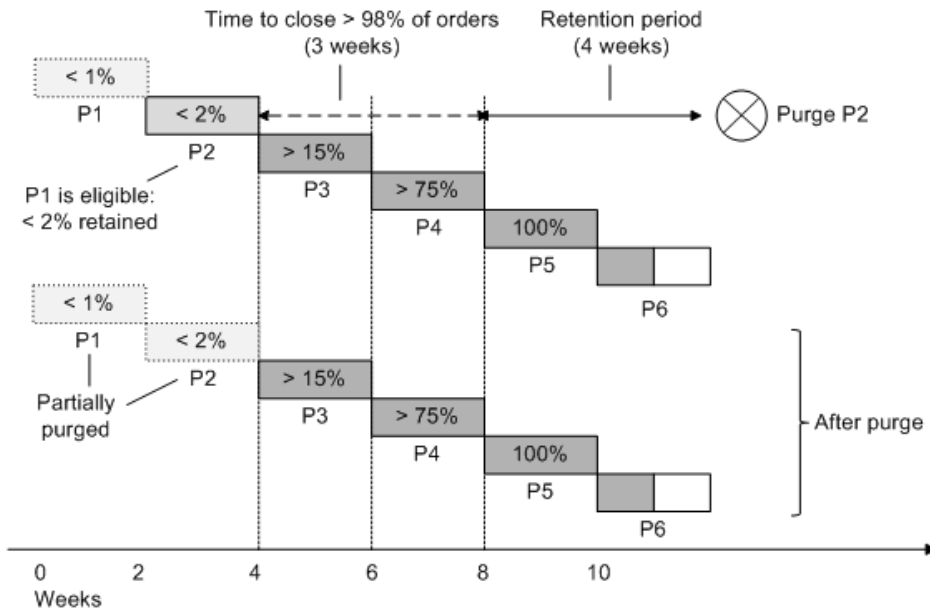
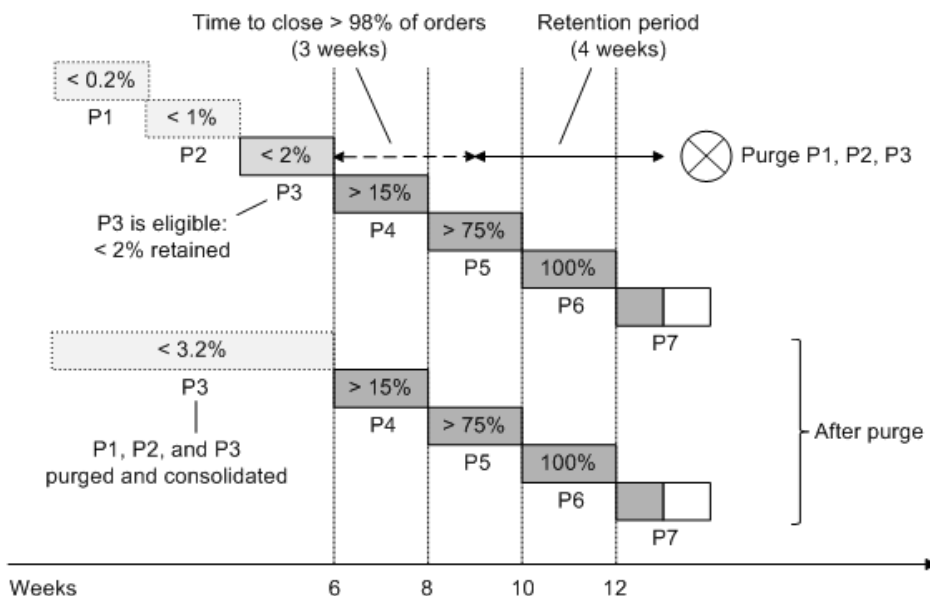

Figure 6-6 shows the third maintenance window. As in the previous maintenance, it is cost-effective to purge only one partition (P3) that has not yet been purged, and 3.5 partitions are not purged. This time, however, the previously purged partitions P1 and P2 are purged again and consolidated with P3 (3-to-1 consolidation). The number of orders retained with this consolidation is less than 3.2%, which is less than the 5% tolerance limit. Periodic consolidation is recommended to maintain a low number of partitions and maximize reclaimed space.

Figure 6-6 Partition Purge Maintenance, Window 3



## Advantages and Disadvantages of Partition-Based Purge

Advantages of the partition purge strategy:

- The ability to reclaim large amounts of space (for millions of orders) in a very short period of time (normally measured in minutes). Partition drop and purge operations are based on efficient DDL statements, such as DROP PARTITION and EXCHANGE PARTITION.
- If your database and storage are well-tuned for order processing, you do not need extra hardware for purging (CPU, RAM and I/O bandwidth). Because the purge happens when OSM is offline and not processing orders, all the system resources are available for purging.
- You can place partitions on different tablespaces for increased administration and availability. For example, if a tablespace is damaged, the impact and restoration effort could be limited to one or just a few partitions, possibly an old partition with few open orders.
- You can choose the correct partition size to facilitate administration and maintenance according to your needs.

Disadvantages of the partition purge strategy:

- This strategy requires downtime. The amount of downtime depends on the purge frequency, purge performance, and several additional factors discussed in "[Sizing Range Partitions for Partition-Based Order Purge](#)." In general, with relatively little extra storage you can reduce the frequency of purge cycles considerably. For example, you might be able to switch from biweekly to monthly maintenance with only a 20% increase in storage. This is discussed in detail in the "[Purge Frequency](#)" section. If you require 24x7 operations, consider row-based order purge.
- If you have very high volumes of orders and you cannot afford frequent downtime, the large storage size could become hard to manage.
- This strategy does not work well if you have a mix of long-lived orders and a relatively high-volume of short-lived orders. Because the high-volume orders reside together with long-lived orders, the latter dictate the purge strategy. Unless long-lived orders are a fraction of the total volume, it might not be cost-effective to purge a partition soon after all short-lived orders are closed. (This is because retaining a large number of long-lived orders would increase considerably the purge time and therefore the downtime.) Also, as explained in "[Pitfalls of Partitioning](#)," if you let the number of partitions increase significantly, performance of partition purge operations suffers. In this case, consider a hybrid purge strategy or row-based order purge.

To mitigate the disadvantages of this strategy, choose the partition size carefully and adjust it as conditions change. As a rule of thumb, size your partitions to contain as many orders as will be purged in one purge maintenance window. For sizing guidelines, refer to the "[Sizing Range Partitions for Partition-Based Order Purge](#)" section.

## Row-Based Order Purge Strategy

If you cannot take periodic downtime to purge orders, consider row-based order purge, which is implemented by the **om\_new\_purge\_pkg** package. Because you can run



order purge online, it allows for continuous business operations. You can also use it as an auxiliary purge strategy, as discussed in "[Hybrid Purge Strategy](#)," and for ad-hoc deletes (for example, if you need to purge and resubmit an order).

Because order purge uses deletes instead of DDL statements, you can run order purge online with minimal contention with normal order processing:

- Order processing can take place concurrently because all indexes remain usable, foreign keys remain enabled and validated, and only the orders that satisfy the purge criteria are affected (as opposed to partition-based purge, which moves around orders that do not satisfy the purge criteria).
- Contention is minimal because deletes acquire row level locks (as opposed to partition-based purge, which uses DDL operations that acquire object level locks).

As row-based order purge allows OSM to stay online and perform normal order processing while purge operations are taking place concurrently, this increases the total workload of the system. The database and storage IO must be sized to handle the additional workload of deleting orders concurrently with order processing. For sizing guidelines refer to "[Sizing Range Partitions for Row-Based Order Purge](#)."

To use order purge as your main purge strategy (or in a hybrid strategy), schedule it to run as a background activity that continuously frees space to be reused by new orders. Ideally you should free space at the same rate it is consumed. The space freed by deletes in a table or index segment does not lower the high water mark (the boundary between used and unused space) of that segment. It can be reused by inserts into the same segment but it is not released to the tablespace. Therefore the primary purge target should be the partition(s) where new orders are created. (In the case of active-active Oracle RAC with N nodes, orders are created on N partitions concurrently.) For example, you could run it once daily during the lowest volume period with high parallelism, several times a day for shorter periods or continuously throughout the day with low parallelism.

Partitions should be sized with a wide range of order Ids to store several months' worth of orders. Partition sizing depends on the retention policy, the order life time, and how you reclaim the space occupied by old partitions. This leads to the following two variations of this strategy:

- **Zero downtime:** If you have a strict 24x7 requirement, you could delete orders from old partitions until they are empty, which enables you to drop them online. The downside is that it might be a long wait before you can fully reclaim that space by dropping the empty partitions, especially if you have orders that remain open for several months or even years (as mentioned earlier, deletes do not lower the segment high water mark and the space freed by deletes cannot be used for new orders because new orders are created on the latest partition).
- **Infrequent maintenance** (for example, once a year): If you have a near 24x7 requirement with occasional maintenance windows, you could use those windows to drop or purge old partitions offline.

The following sections provide additional information about this strategy:

- [Row-Based Order Purge Example](#)
- [Advantages and Disadvantages of Row-Based Order Purge](#)
- [Using Row-Based Order Purge](#)

## Row-Based Order Purge Example

Figure 6-7 show a row-based order purge example over a period of several months. The retention period is 2 weeks, and the maximum lifetime of an order is 5 weeks. Closed orders are deleted daily, as they come out of retention. Some of the orders close within a day, and the order aging curve allows order purge to target an additional 25% of the orders each week for any week prior to the past two weeks.

This means that by the end of week 6, all orders created in the first week have been purged. By the end of week 7, all orders created in the first two weeks have been purged. This pattern continues until the partition is exhausted on the Nth week. Then it repeats for the next partition.

**Figure 6-7 Partition Lifetime Using Row-Based Order Purge**

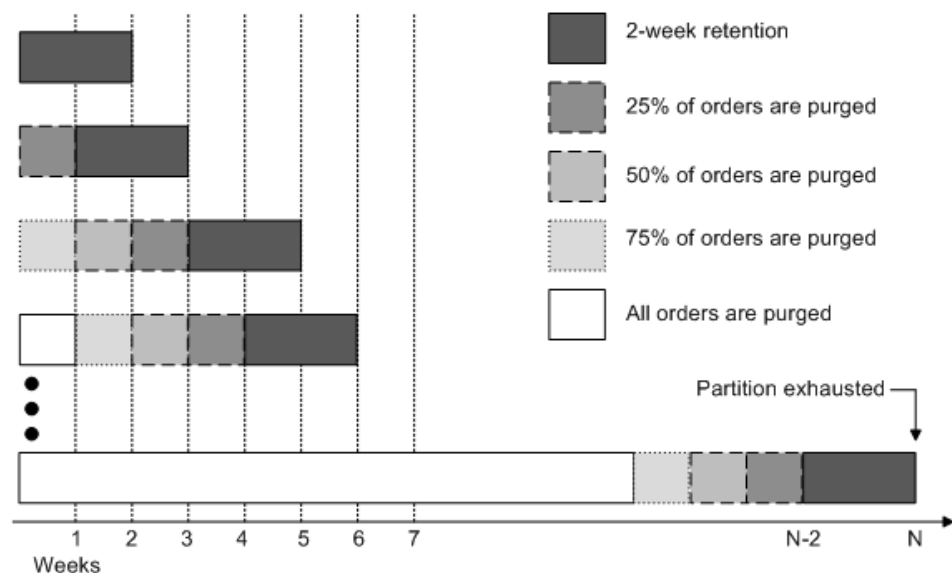

## Advantages and Disadvantages of Row-Based Order Purge

The key advantage of this strategy is that you can run it online and therefore it can support 24x7 operations.

The disadvantages of row-based order purge:

- Row-based order purge is the least efficient way to purge because delete is an expensive DML statement. Deleting row by row is CPU intensive and consumes I/O bandwidth, so you must plan for spare capacity. Normally this is not an issue because you size your hardware for peak volume. However, if you do not have enough idle or low-volume periods for purge to catch up with new order creation, you will have to add hardware (for example, CPUs and storage links).
- The space freed by deletes in a table or index segment does not lower the high water mark of that segment. It can be reused by inserts into the same segment but it is not released to the tablespace. Therefore you must run order purge as frequently as possible (at least once a day) to free space at the same rate it is

consumed by new orders, which has an objective of restraining the growth of the high water mark.

- If order purge runs continuously, it might be harder to manage. You must be prepared to deal with unexpected load spikes and adjust the order purge schedule if load patterns change. And you might have to disable order purge for occasional maintenance tasks or batch jobs.
- Row-based order purge makes it difficult to troubleshoot performance issues. If you run into performance issues with normal order processing, you might have to stop order purge to reproduce the problem in isolation. This is not an issue if you configure a purge job class that runs on a dedicated database service (see ["purge\\_job\\_class"](#)).

## Hybrid Purge Strategy

You can use both partition purge and order purge, and realize the benefits of both strategies. For example, consider a hybrid strategy if you have a mixed load of long-lived orders and short-lived orders, and you can afford periodic downtime. In this example:

- Use order purge to delete short-lived orders aggressively from the partition(s) where new orders are created. The space freed by deletes will be reused by new orders. The goal is to restrain the growth of the high water mark (the boundary between used and unused space) in table and index segments. This will allow you to have larger partitions and less frequent purge maintenance.
- Drop/purge partitions periodically (for example, once a month) to purge long-lived orders and the remaining short-lived orders. Follow the partition sizing guidelines for partition-based order purge, which are discussed in ["Sizing Range Partitions for Partition-Based Order Purge."](#)

## Partitioning Realms

You can use the partitioning realms feature to separate orders into different partitions when those orders have different operational characteristics, for example, short-lived orders versus long-lived orders. This enables you to group orders into partitions that can be purged or dropped more effectively.

The partitioning realms feature is used for logical partitioning, which is supported for even non-partitioned schemas.

A new order that is received by OSM requires an **order\_seq\_id** before it is persisted in the database. Each partitioning realm reserves ranges of **order\_seq\_id** values to be used by orders that are assigned to that realm. Mapping rules within each partitioning realm determine which orders are assigned to the partitioning realm. If an order does not map to any partitioning realm it is assigned to a pre-defined default realm. The default realm is called **default\_order**.

Orders automatically map to default realms that are pre-defined in the database. You do not have to configure partitioning realms unless you have a specific requirement to do so. For more information, see ["Default Partitioning Realm."](#)

## Partitioning Realms Configuration

Partitioning realms are created and maintained in the system using XML configuration files. Some aspects of partitioning realms that are defined in the configuration files are also saved in the database, which is required for database maintenance operations, such as purging.

The configuration files are referenced in the **oms-config.xml** file using the following parameter:

```
oracle.communications.ordermanagement.OrderPartitioningRealmConfigFileURLs
```

### Note:

The partitioning realms files must be located in the same file system as the **oms-config.xml** file.

Sample order partitioning realms configuration files are provided in the OSM SDK in the **SDK/Samples/PartitioningRealms** directory. An XML Schema Definition (XSD) for partitioning realms is also located in this directory.

[Example 6-1](#) is a sample partitioning realm file. This sample file contains only one order partitioning realm, but files can contain configuration for multiple realms, if required.

### Example 6-1 Sample Order Partitioning Realms File

```
<partitioningRealmModel xmlns="http://xmlns.oracle.com/communications/
ordermanagement/partitioningRealms" realmType="ORDER">
  <partitioningRealm name="sample_order_realm" enabled="true">
    <description>Sample for demonstrating realm configuration</description>
    <purgeStrategy>ANY</purgeStrategy>
    <parameters>
      <rangePartitionSize>500000</rangePartitionSize>
    </parameters>
    <mappings>
      <includes>
        <cartridgeNamespace>MyTestCartridge</cartridgeNamespace>
        <orderName>MyOrder</orderName>
      </includes>
    </mappings>
  </partitioningRealm>
</partitioningRealmModel>
```

[Table 6-1](#) lists and describes the elements and attributes that can be included in the partitioning realms file.

**Table 6-1 Partitioning Realms File Elements and Attributes**

Element or Attribute	Description
<b>realmType</b>	The type of realm contained in this configuration file. Valid value is <b>ORDER</b> . This element is mandatory.

Table 6-1 (Cont.) Partitioning Realms File Elements and Attributes

Element or Attribute	Description
<b>name</b>	The name of the realm. The name is not case-sensitive and must be unique in the system. This element is mandatory.
<b>enabled</b>	Indicates whether the realm is enabled or disabled. Disabled realms are never mapped to orders and do not have new partitions added automatically. The <b>enabled</b> attribute is optional and the default value is <b>true</b> (enabled) if not present.
<b>description</b>	This contains the description of the realm. This element is optional.
<b>purgeStrategy</b>	Indicates the purge strategies supported by this realm. Valid values are <b>PARTITION-BASED</b> , <b>ROW-BASED</b> , and <b>ANY</b> . The element is optional and the default is <b>ANY</b> if not present. See <a href="#">"Purge Strategy for Partitioning Realms"</a> for more information.
<b>parameters</b>	Contains parameters specific to the partitioning realm. These parameters override the values in the om_parameter table. All the parameters are optional. If they are not specified, the value from the om_parameter table is used. Currently supported parameter is rangePartitionSize.
<b>rangePartitionSize</b>	The range partition size represents the number of orders to use when adding new partitions for this realm. This element maps to the <b>range_partition_size</b> parameter in the om_partitioning_realm_param table. This element is optional. If not specified, the <b>range_partition_size</b> value from the om_parameter table is used.
<b>mappings</b>	Contains <b>includes</b> rules that map new orders to this partitioning realm. Multiple <b>includes</b> elements can be used to map multiple different cartridges or order types to a single realm. The valid child elements are <b>includes</b> and <b>excludes</b> . See <a href="#">"Mapping Orders to Partitioning Realms"</a> for more information. This parameter is technically optional, but if it is not included, the partition will not be used for any orders.
<b>includes</b>	Contains the elements used to map new orders to this realm. The valid child elements are: <b>cartridgeNamespace</b> , <b>cartridgeVersion</b> , and <b>orderName</b> . This parameter is optional. For more information about using the <b>includes</b> element, see <a href="#">"Mapping Orders to Partitioning Realms."</a>
<b>excludes</b>	(Not shown in example) Contains the elements used to exclude new orders from this realm. The valid child elements are: <b>cartridgeNamespace</b> , <b>cartridgeVersion</b> , and <b>orderName</b> . This parameter is optional.
<b>cartridgeNamespace</b>	A regular expression used to match the cartridge namespace of a new order. This parameter is optional.
<b>cartridgeVersion</b>	(Not shown in example) A regular expression used to match the cartridge version of a new order. This is valid only when the <b>cartridgeNamespace</b> element is also included. Oracle does not recommend using <b>cartridgeVersion</b> because that would require the realm mappings need to be updated when cartridges are upgraded to a new version. This parameter is optional.

**Table 6-1 (Cont.) Partitioning Realms File Elements and Attributes**

Element or Attribute	Description
<b>orderName</b>	A regular expression used to match the order name (or order type) of a new order. This parameter is optional.

## Mapping Orders to Partitioning Realms

The **mappings** element of the partitioning realms configuration is used to map new orders to a specific partitioning realm. The mappings associate orders to partitioning realms by comparing order data to match criteria (regular expressions) for each partitioning realm. If a match is NOT found for an order, the order is assigned to the **default\_order** partitioning realm. The **default\_order** partitioning realm cannot contain any mappings. See "[Default Partitioning Realm](#)" for more information.

For example, the following partitioning realms XML configuration sets the partitioning realm to **short\_lived\_orders** for any order with a cartridgeNamespace that starts with "Mobile." Any order that is not in a cartridge with a name that starts with "Mobile" will be assigned the **default\_order** partitioning realm.

```
<partitioningRealmModel realmType="ORDER">
  <partitioningRealm name="short_lived_orders">
    <mappings>
      <includes>
        <cartridgeNamespace>Mobile.*</cartridgeNamespace>
      </includes>
    </mappings>
  </partitioningRealm>
</partitioningRealmModel>
```

The following fields can be used as match criteria in the partitioning realms mapping file:

- Cartridge Namespace
- Cartridge Version
- Order Name

### Note:

The cartridge namespace and version are the deployed cartridge namespace and version. For standalone cartridges, use the standalone cartridge namespace and version. For composite cartridges, use the composite cartridge namespace and version.

Using the cartridge version in mappings is not recommended because mappings can be broken when cartridges are upgraded and will then require more frequent maintenance.

### About the includes Element

If there are multiple match criteria specified within an **includes** element, ALL the criteria in the **includes** element must match. In other words, the criteria

within an **includes** element are part of an AND condition. In this example, only **LTEMobileService** orders from the **Mobile** are mapped to the **short\_lived\_orders** partitioning realm. Other orders from the same cartridge are not mapped to this partitioning realm.

```
<partitioningRealmModel realmType="ORDER">
  <partitioningRealm name="short_lived_orders">
    <mappings>
      <includes>
        <cartridgeNamespace>Mobile</cartridgeNamespace>
        <orderName>LTEMobileService</orderName>
      </includes>
    </mappings>
  </partitioningRealm>
</partitioningRealmModel>
```

If there are multiple **includes** elements, only one of the **includes** criteria must match in order for the realm to map. In other words, multiple **includes** elements are part of an OR condition.

For example, with the following configuration the **short\_lived\_orders** partitioning realm is mapped to orders from both **Mobile** and **Broadband** cartridges.

```
<partitioningRealmModel realmType="ORDER">
  <partitioningRealm name="short_lived_orders">
    <mappings>
      <includes>
        <cartridgeNamespace>Mobile</cartridgeNamespace>
      </includes>
      <includes>
        <cartridgeNamespace>Broadband</cartridgeNamespace>
      </includes>
    </mappings>
  </partitioningRealm>
</partitioningRealmModel>
```

When there are multiple partitioning realms defined in a configuration file, they are processed sequentially. The first partitioning realm to match the order data is used. In the following example, the **long\_lived\_orders** realm would never be mapped because **short\_lived\_orders** realm maps to all cartridges starting with "Mobile".

```
<partitioningRealmModel realmType="ORDER">
  <partitioningRealm name="short_lived_orders">
    <mappings>
      <includes>
        <cartridgeNamespace>Mobile.*</cartridgeNamespace>
      </includes>
    </mappings>
  </partitioningRealm>
  <partitioningRealm name="long_lived_orders">
    <mappings>
      <includes>
        <cartridgeNamespace>MobileCartridge</cartridgeNamespace>
      </includes>
    </mappings>
  </partitioningRealm>
</partitioningRealmModel>
```

### About the `excludes` Element

To exclude an order from getting mapped to a realm you can add an **excludes** element under the mappings. The **excludes** element takes precedence over the **includes** element. In other words, if an order matches both **includes** element criteria and **excludes** element criteria, the order is not mapped to the partitioning realm. In the following example, all orders that start with "Mobile" are mapped to the **short\_lived\_orders** realm, except **Mobile4GService** orders.

```
<partitioningRealmModel realmType="ORDER">
  <partitioningRealm name="short_lived_orders">
    <mappings>
      <includes>
        <orderName>Mobile.*</orderName>
      </includes>
      <excludes>
        <orderName>Mobile4GService</orderName>
      </excludes>
    </mappings>
  </partitioningRealm>
</partitioningRealmModel>
```

## Enabling and Disabling Partitioning Realms

New realms that you add are disabled. Typically, you add realms, add partitions to those realms, and then enable them. See "[Partitioning Realms](#)" and "[partition\\_auto\\_creation](#)" for more information.

You can enable and disable realms by changing the **enabled** attribute in the partitioning realm configuration to **true** (enabled) or **false** (disabled). If a partitioning realm is disabled, it is no longer used for mapping incoming orders, therefore any partition or order ID block that is assigned to that partitioning realm is no longer used.

Enabled partitioning realms cannot be removed from the partitioning realm configuration file. If an enabled partitioning realm is removed from the configuration file, a validation error occurs the next time you restart the system or refresh OSM metadata.

You cannot disable the default partitioning realm: **default\_order**.

To remove a partitioning realm from the configuration file:

1. In the configuration file, set the **enabled** attribute to **false** to disable the partitioning realm.
2. Do one of the following:
  - Restart OSM.
  - Refresh the OSM metadata.The partitioning realm is disabled in the database.
3. Remove or comment out the realm XML configuration that you want to remove.



 **Note:**

This removes the XML configuration for the realm, however the realm still exists in the database. You cannot remove partitioning realms from the database.

## Renaming a Partitioning Realm

A partitioning realm can be renamed by adding the **oldName** attribute to the partitioning realm configuration and changing the **name** attribute to the new name. For example:

```
<partitioningRealm oldName="MyOldRealmName" name="MyNewRealmName"/>
```

After you change the name in the XML configuration file, refresh the OSM metadata.

You cannot rename the default partitioning realm: **default\_order**.

## Refreshing Partitioning Realms Configuration

Refreshing OSM metadata loads and updates the partitioning realms configuration. When you make changes to the partitioning realms configuration, you must refresh the OSM metadata for the change to take effect. There are several ways to refresh the OSM metadata. See "[Refreshing OSM Metadata](#)" for more information.

If there is a validation error in the partitioning realms configuration, the behavior depends on the following factors:

- If the server is starting up, an invalid partitioning realms configuration causes a **CRITICAL** health policy error which prevents OSM from starting. You can find the cause of the validation error in the log files. The problem in the partitioning realms configuration must be fixed before you attempt to restart OSM.
- If the server is already running, an invalid partitioning realms configuration causes errors in the logs and the loading of the partitioning realms configuration is abandoned. The OSM server continues to run using the last known good realm configuration. In other words, the partitioning realm configuration changes are ignored. You can find the cause of the validation error in the log files. The problem in the partitioning realm configuration must be fixed before you attempt to refresh the OSM metadata.

## Adding Partitions for New Partitioning Realms

The steps to add a partition for a new partitioning realm depends on whether the **partition\_auto\_creation** value is enabled or disabled. In production and performance environments, Oracle recommends that you disable the **partition\_auto\_creation** attribute and add partitions manually before they are required.

When you create new partitioning realms, a new partition is needed to hold orders associated with the new realm. When you start OSM or refresh metadata, all enabled partitioning realms are assigned an order ID generator. The order ID generator is responsible for creating new `order_seq_ids` for new orders in OSM. When order ID generators are initialized they are assigned an **om\_order\_id\_block**, which represents a range of `order_seq_ids` reserved for that order ID generator. Each

**om\_order\_id\_block** maps to a partition in the database schema. This is why every enabled partitioning realm requires a partition.

## partition\_auto\_creation Disabled

If **partition\_auto\_creation** is disabled, partitioning realms must be created in a disabled state before adding partitions.

To add partitions with the **partition\_auto\_creation** attribute disabled:

1. Create the new partitioning realm by setting the **enabled** attribute to **false** in the partitioning realm XML configuration file.
2. Refresh the OSM metadata or restart OSM.

This creates the partitioning realm in the system in a disabled state.

3. Add one or more partitions for the new (disabled) realm using the **om\_part\_maintain.add\_partitions** procedure. In addition to the name of the new partitioning realm, you must set the **a\_force** argument to **true** to create a partition for a disabled partitioning realm. If you do not enter **true** for the **a\_force** argument, an exception is raised because, by default, partitions cannot be added to disabled realms.

```
exec om_part_maintain.add_partitions(a_count, a_tablespace,  
a_realm_mnemonic, true)
```

4. When you are ready to use the new partitioning realm, set the **enabled** attribute to **true** in the partitioning realm XML configuration.
5. Refresh the OSM metadata or restart OSM.

This enables partitioning realm in the system.

## partition\_auto\_creation Enabled

If **partition\_auto\_creation** is enabled, you can create partitioning realms in an enabled state. Partitions are created automatically for the partitioning realm.

To add partitions with the **partition\_auto\_creation** attribute enabled:

1. Create the new partitioning realm by setting the **enabled** attribute to **true** in the partitioning realm XML configuration file.
2. Refresh the OSM metadata or restart OSM.

This creates the partitioning realm in the system in an enabled state.

A partition is automatically created for the new partitioning realm.

3. (Optional) Add one or more partitions for the new realm using the **om\_part\_maintain.add\_partitions** procedure.

```
exec om_part_maintain.add_partitions(a_count, a_tablespace, a_realm_mnemonic)
```

## Purge Strategy for Partitioning Realms

The purge strategy associated with a partitioning realm determines the type of purge supported by the realm. Set the `purgeStrategy` value in the partitioning realms file to specify the purge strategy. See "[Partitioning Realms Configuration](#)" for more information about the partitioning realms file.

Valid purgeStrategy values are the following:

- **ROW-BASED**: Only row-based purge operations can be used in this realm. Partition-based purge procedures will ignore partitions with a purge strategy of **ROW-BASED**, unless they are empty. If a partition is empty, it can be dropped regardless of the configured purge strategy.
- **PARTITION-BASED**: Only partition-based purge operations can be used on this realm. Row-based purge procedures will ignore orders in a realm with a purge strategy of **PARTITION-BASED**. The only exceptions are procedures that let the user specify the orders to purge, such as the **delete\_order** and **purge\_selected\_orders** procedures; these procedures will delete the order regardless of the realm's purge strategy.
- **ANY**: There are no restrictions on the purge method used. This is the default purge strategy.

## Default Partitioning Realm

The default partitioning realm is for all orders that do not map to a user-configured partitioning realm. The following default partitioning realm is created in OSM:

- **default\_order**

The default partitioning realm is not included in the configuration files, but can be included if you want to change some properties of the default realm.

When working with the default realm, you **cannot** change the following:

- The default realm cannot be disabled.
- The default realm cannot be renamed.
- The default realm cannot contain any mappings.
- The **realmType** of default realm cannot be changed.

When working with default realms, you **can** change the following:

- The description of default realm can be changed.
- The purge strategy can be changed.
- The **rangePartitionSize** of the default realm can be changed. By default, the **default\_order** realm does not have a **rangePartitionSize** and uses the **range\_partition\_size** parameter in the **om\_parameter** table.

## Non-Partitioned Schemas

You can use partitioning realms in non-partitioned environments to improve the performance of row-based purging. Grouping orders based on how long they take to close allows orders to be purged together. Purging sequential orders reduces database IO during the purge.

## Order ID Blocks

Use the **OM\_ORDER\_ID\_BLOCK** table to determine which orders belong to which realms. When new partitions are added, a new row is inserted into this table to track the order ID range and associated partitioning realm.

The following example query lists all the block ranges and their associated partitioning realm:

```
select b.first_order_id,
       b.last_order_id,
       r.mnemonic,
       b.status,
       r.realm_type,
       b.dbinstance
from om_order_id_block b,
     om_partitioning_realm r
where b.realm_id = r.realm_id
order by b.last_order_id;
```

Where:

- **first\_order\_id**: The first order ID in the block.
- **last\_order\_id**: The last order ID in the block.
- **mnemonic**: The name of the partitioning realm associated with the block.
- **status**: One of **USED**, **ACTIVE**, or **AVAILABLE**.
  - **ACTIVE**: A block of IDs that is actively being used for new orders.
  - **USED**: A block of IDs that is no longer being used to generate new IDs.
  - **AVAILABLE**: A new, empty block that is available for use.
- **realm\_type**: Must be **ORDER**.
- **dbinstance**: The number of the Oracle RAC instance. A value of -1 means the block is unassigned to an Oracle RAC node.

To determine which realm a specific order is associated with, run the following query (replacing **order\_seq\_id** with the order that you want to query):

```
select r.mnemonic,
       r.realm_type
from om_order_id_block b,
     om_partitioning_realm r
where order_seq_id between b.first_order_id and b.last_order_id
and b.realm_id = r.realm_id;
```

## Cartridge Management Strategy

Following are the main components to a deployed cartridge:

- The cartridge metadata that is populated in the OSM database when the cartridge is deployed or redeployed.
- The order data populated in the OSM database whenever an order is created and as it is being processed.

Cartridge metadata consumes little space in the database. However, it consumes memory resources, takes time to load into the OSM server on startup, and is re-loaded when cartridges are deployed.

Follow these guidelines to reduce the memory footprint and startup time of OSM, and to deploy and undeploy cartridges quickly online:

- Undeploy obsolete cartridges from time to time to reduce the memory footprint and startup time of OSM.
- Use Fast Undeploy to undeploy cartridges instead of conventional undeploy. Fast Undeploy allows you to undeploy cartridges quickly online by undeploying the Java EE application only. Instead of purging cartridge metadata, it sets the cartridge status in the database to UNDEPLOYED. Fast Undeploy also offloads purging of order data to your order purge strategy, which does not need to distinguish between deployed and undeployed cartridges.
- Consider purging metadata of an undeployed cartridge only if it has no associated orders. If you are purging fast-undeployed cartridges online, you cannot purge any cartridges that have orders.

For more information see "[Managing Cartridges](#)."

## Sizing Partitions

The following values, which you enter on the **Database Schema Partition Information** installer screen, specify the size and number of partitions created during and after an OSM installation.

- **Orders per Partition:** Specifies the number of orders that the Oracle Database allows in a range partition. This is also referred to as the range partition size.
- **Number of Sub-partitions:** Specifies the number of hash sub-partitions in a range partition.

You can change the values that you selected during the installation process by updating the **range\_partition\_size** and **subpartitions\_number** OSM database parameters.

You can configure different **range\_partition\_size** parameters for each partitioning realm. This allows you to tailor the partition size for the partitioning realm purge strategy. For example, you could use row-based purged with oversized partitions for a realm defined for high-volume, short-lived orders, and partition-based purge with smaller partitions for low-volume, long-lived orders. You configure the realm-specific **range\_partition\_size** using partitioning realm configuration files. For more information, refer to the configuration section of "[Partitioning Realms](#)."

Updates to these parameters do not affect existing partitions. For more information about these parameters, see "[Configuration Parameters](#)."

Sizing of partitions depends on the purge strategy and several other factors, as discussed in the following sections:

- [Sizing Hash Sub-Partitions](#)
- [Sizing Range Partitions for Partition-Based Order Purge](#)
- [Sizing Range Partitions for Row-Based Order Purge](#)

## Sizing Hash Sub-Partitions

Hash sub-partitioning increases concurrency by reducing I/O contention, specifically by spreading DML statements (data modifications) over several physical sub-partitions. Contention is usually manifested as "buffer busy" waits in AWR reports.

Oracle strongly recommends that you set the number of sub-partitions to the smallest power of 2 that either eliminates "buffer busy" waits or reduces them to low single digits (for example, less than 2%). Typical values in production environments are 16, 32, and 64.

- Using values other than powers of 2 results in data skew, that is, data unevenly distributed across partitions.
- Increasing unnecessarily the number of sub-partitions could have a negative impact on purge performance. Test with 16 and 32 before trying 64. For more information refer to "[Pitfalls of Partitioning](#)."

Oracle recommends that you conduct performance tests at the expected peak workload to find the right number of sub-partitions for your environment. Periodically, also review the "buffer busy" waits in AWR reports from production. Consider increasing the **subpartitions\_number** parameter if there are signs of increased I/O contention. Similarly, if there are no signs of contention and you experience performance issues due to a very large number of partitions, consider decreasing it if the total number of physical partitions is very large. The new value will be used when you add partitions (existing partitions are not affected).

In development and testing environments with limited storage capacity you should use a small number of hash sub-partitions, such as 2 or 4. For more information, see "[Development and Testing Environments](#)."

## Sizing Range Partitions for Partition-Based Order Purge

If your purge strategy is partition-based, typical range partition sizes vary between 100 thousand and 1 million. Creating partitions that are overly large makes it more difficult to free space by purging partitions that contain orders that no longer need to be retained. Creating partitions that are too small increases the frequency that new partitions must be created and the duration of maintenance windows, and could cause issues with performance and resource consumption.

As a rule of thumb, each range partition should be sized to contain as many orders as will be purged in one purge maintenance window. For example, if you target to purge partitions every month, you could size your partitions to contain the average expected monthly volume. The feasibility of purge frequency will need to be validated based mainly on the amount of storage available and the duration of the outage that may be required to run the purge maintenance window.

Several factors influence sizing. Because these factors are correlated, it is recommended that you create a few scenarios by adjusting those parameters that are under your control. This document uses the example in the "[Partition Purge Example](#)" section to discuss sizing criteria in detail.

- [Purge Performance](#)
- [Estimating Storage](#)
- ["All-In" Order Volume](#)
- [Partition Size Restrictions](#)
- [Retention Policy](#)
- [Time-to-Close Wait](#)
- [Oracle RAC](#)
- [Purge Frequency](#)

## Purge Performance

The main factors that affect partition-based purge downtime are purge frequency and purge performance.

There are a number of ways to improve purge performance:

- If range partitions are undersized, according to the guideline that each range partition should ideally contain as many orders as will be purged in one purge maintenance window, consider increasing the partition size. For example, the time to purge a 200 GB partition is only slightly more than the time to purge a 100 GB partition. This guideline also helps minimize partition consolidations.
- Decrease the number of hash sub-partitions. The time to purge a 200 GB partition with 64 hash sub-partitions is nearly double the time to purge a 200 GB partition with 32 sub-partitions. For more information refer to "[Pitfalls of Partitioning](#)" and "[Sizing Hash Sub-Partitions](#)."
- Decrease the overall number of physical partitions. For more information refer to "[Pitfalls of Partitioning](#)."
- Increase the time-to-close wait to reduce the number of retained orders.
- Tune purge operations, for example increase the degree of parallelism.
- Tune the database and operating system.
- Tune storage. For example, consider enabling more storage ports or converting disks from RAID-5 to RAID-10, which has better write performance.
- If, after exhausting all of the above options, performance is still inadequate, consider hardware upgrades depending on the nature of the bottleneck (for example, CPU, RAM, I/O bandwidth).

## Estimating Storage

To determine the size of partitions, you need to also consider the amount of storage that is allocated to OSM. This is necessary to provision sufficient storage capacity, ensure that you are comfortable managing it, and validate the trade-off between storage and the frequency and duration of maintenance windows (outages).

It is recommended that you conservatively estimate the amount of required storage. Consider possible changes in sizing criteria and purge frequency, such as a volume or order size increase due to a rollout of new services, orders requiring more space due to additional functional requirements introduced during a solution or product upgrade or a purge embargo during holidays. Add contingency for unforeseen events that might delay purging or lead to increased space consumption.

For the purpose of estimating minimum storage requirements, consider the following partition breakdown:

- The oldest partitions that have been purged at least once.
- Partitions that have never been purged, including exhausted partitions and the latest partition(s) where new orders are created. (If you use Oracle RAC with N nodes in active-active mode, orders are created concurrently on N partitions as explained in the Oracle RAC section.)

The oldest partitions that have been purged at least once normally contain a small number of orders. It is recommended that you consolidate these partitions regularly

(every few purges). If you do, the total space consumed by those partitions should be a fraction of a single partition.

Partitions that have never been purged consume the bulk of your storage. The number of these partitions depends on the partition size, the order retention period, the time-to-close wait, the purge frequency and whether you use active-active Oracle RAC. At the time of purge, these partitions can be further distinguished as **eligible** and **ineligible** for purge. If you follow a regular schedule, you can estimate the space consumed by these partitions as follows:

- Where P is the partition size (for example, 4 week's worth of data), R the retention period, T the time-to-close wait, and F the purge frequency (all using the same units, such as days or weeks).
- Where N is the number of active-active Oracle RAC nodes. If you use a single instance database, N=1.
- Where S is the space consumed by a single partition. Refer to the ["All-In" Order Volume](#) section for estimating S.
- To estimate the number of partitions that are eligible for purge:  $F / P \times N$
- To estimate the number of partitions that are ineligible for purge:  $(T + R) / P \times N$
- To estimate the total number of partitions that have never been purged:  $(F + T + R) / P \times N$
- To estimate the total space consumed by these partitions:  $(F + T + R) / P \times N \times S$
- If you use a single instance database and the partition size is the same as the purge frequency, the above formula can be simplified:  $(P + T + R) / P \times S$

Oracle strongly recommends that you increase your estimate by some contingency based on your ability to quickly add storage if necessary, reschedule a failed purge, and other risks (for example, by 25% or the amount of space reclaimed by each purge).

#### Example:

[Figure 6-8](#) is an example of estimating minimum storage requirements.

- Partition size (P): 2 weeks' worth of orders
- Purge frequency (F): Biweekly
- Time-to-close (T): 3 weeks
- Retention period (R): 4 weeks

The number of partitions that have never been purged before is:

$$(F + T + R) / P \times N = (2 + 3 + 4) / 2 \times 1 = 4.5$$

Assuming that the space consumed by a single partition is about 200 GB, the total space consumed by those partitions is about 900 GB. Specifically, the four exhausted partitions P3-P6 consume about 800 GB, while the half-full partition P7 consumes about 100 GB. Partitions P1 and P2 have already been purged at least once.

Assuming that you do not purge a partition unless at least 98% of its orders are closed, P1 and P2 consume less than 4 GB each (2% of 200 GB). In total, the used space is about 908 GB. The used space should fluctuate between roughly 712 GB after a purge and 908 GB, as long as there are no unexpected events or delays. In addition, you must add some contingency in case you miss a maintenance window, for example, 200 GB.



Figure 6-8 Estimating Minimum Space Consumption

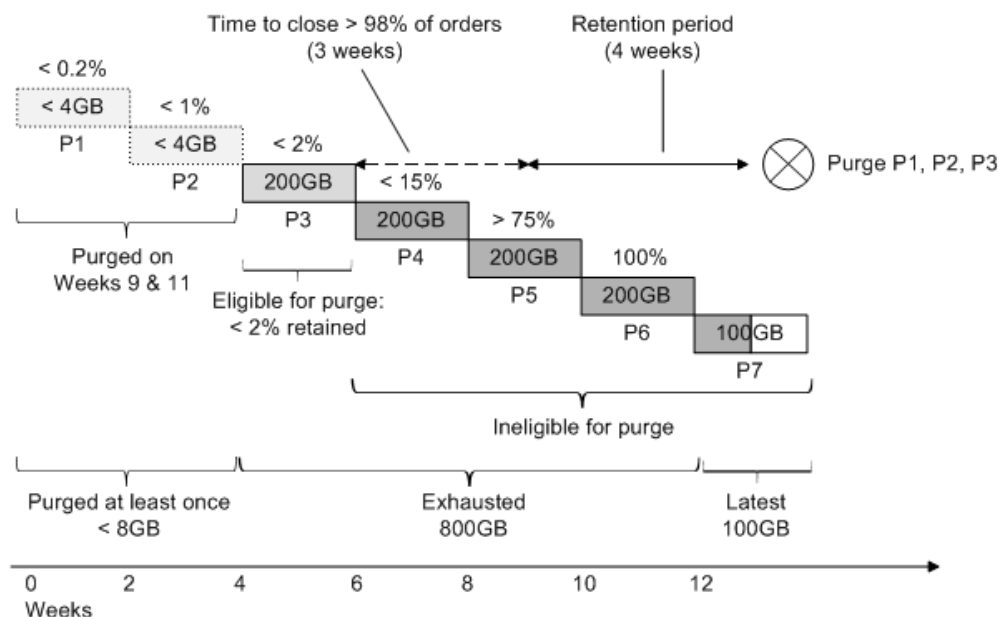

## "All-In" Order Volume

To estimate the space consumed by a single partition, you must first estimate the "all-in" order volume. "All-in" means a representative order mix, including SOM orders created by COM orders (if they are stored in the same schema), revision orders, fallouts, technical orders, and so on. Some cartridge implementations might generate a lot of small orders that consume a disproportionate share of order IDs compared to their size (for example, for trouble tickets).

This is how you could estimate the space consumed by a single partition:

- Estimate the average all-in order volume over a period that accounts for volume fluctuations. One week is a good starting point, because it includes weekends.
- Populate a partition with a representative mix of orders and states for the same period. If that period is too long due to storage or time constraints, you may use a shorter period. However, it is important that you use a substantial data set to improve the accuracy of estimates - typically at least one day's worth of orders.
- Use the `om_part_maintain.estimate_ptn_purged_space` procedure to estimate the space that would be reclaimed if you purged the entire partition, and extrapolate for various partition sizes. For more information, see "[Estimating Partition Disk Space \(Online or Offline\)](#)."

## Partition Size Restrictions

If the estimated space consumed by a range partition is too big to manage? For example, suppose you want to purge monthly and your estimates show that a month's worth of orders will consume about 400 GB. If you do not want to manage partitions as big as 400 GB but you want to stick to a monthly purge frequency, decrease the partition size (for example, to two weeks' worth of orders). The downside is an

increase in purge time, normally measured in minutes. Refer to the "Purge Frequency" section for an example.

## Retention Policy

The retention policy is one of the most important sizing factors, yet you have the least control over it because normally it is determined by the business. The retention period starts counting after an order is closed. Therefore, in order to determine when an exhausted partition will be both eligible and cost-effective to purge, add the retention period to the "time-to-close" wait period.

### Example:

Figure 6-9 shows the impact of the retention period. Decreasing the retention period by 2 weeks requires less storage, equal to the space consumed by a single partition. This is because each partition is sized to contain 2 weeks' worth of orders. Similarly, if you increased the retention period to 6 weeks, you would consume additional space for 2 weeks' worth of orders and you would have to maintain an extra partition.

**Figure 6-9 Impact of Retention Policy**

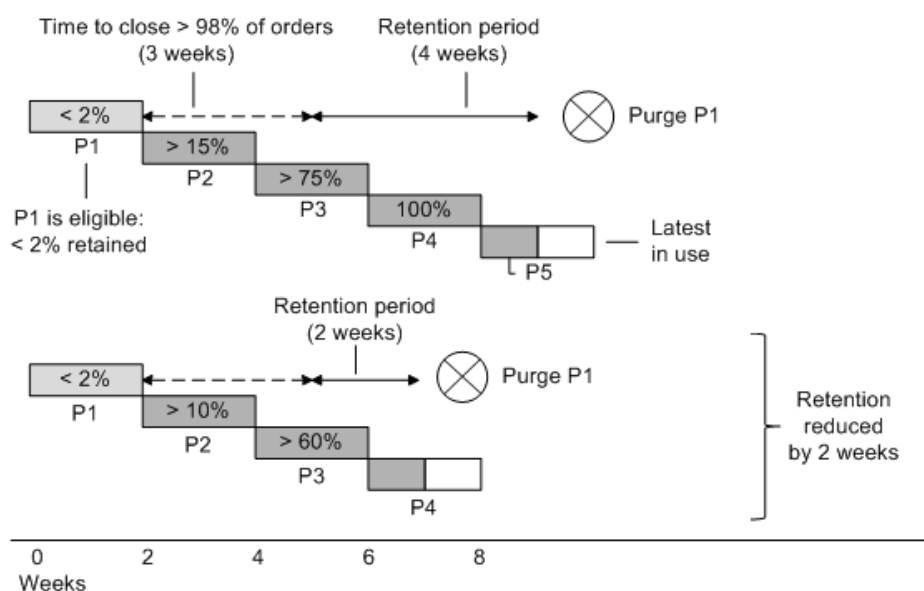

## Time-to-Close Wait

Time-to-close wait is the period until "most" orders in the partition are closed. The objective is to wait until a partition purge is cost-effective. **As a starting point, you should wait until at least 98% of the orders are closed.** Your final decision is a trade-off between storage and purge performance (duration of outage), as discussed below.

The first concern is the impact to purge performance of the time-to-close wait. When you purge a partition, retained orders are temporarily copied into so-called backup tables, and they are later restored (copied back) into the partition. These copy operations could add significant downtime to the maintenance window depending

on the volume of retained data, your hardware, and the degree of parallelism. You can decrease execution time by increasing parallelism. In general, you should aim to maximize resource utilization in order to improve purge performance. However, increased parallelism comes with more overhead. For example, you might find out that if you double the parallelism, the execution time is reduced by only one third. And there is a tipping point where parallelism overhead outweighs gains. Therefore it is recommended that you tune the degree of parallelism and evaluate the performance of purge operations on production quality hardware - ideally of the same caliber as your production hardware. For additional information about tuning, see the "Performance Tuning" section.

It is easier to use percentages in your initial time-to-close calculations (for example, the time to close 98% of orders). Performance tests help to nail it down to absolute numbers. For example, suppose your acceptable range for copying retained orders (backup and restore) is 15-30 minutes, and that according to performance tests this is enough to retain 10000-20000 orders. In order to allow for partition consolidations, you could use 10000 in your calculations, which also provides a safety buffer. For example, if the partition size in one of your scenarios is one million orders, 10000 orders is 1%. In this case, time-to-close is the time it takes to close 99% of the orders.

With regard to storage, a shorter time-to-close wait is better. Decreasing the time-to-close wait alone by X days is the same as decreasing the retention period alone by X days or decreasing both by X days in total.

**Example:**

Figure 6-10 shows the impact of the time-to-close wait period. Each partition is sized to contain 2 weeks' worth of orders. All things being equal, decreasing this wait by 2 weeks requires less storage, equal to the space consumed by a single partition. Alternatively, the number of retained orders increased five times to about 10%, which might add several minutes to the duration of a maintenance window. You must decide whether these storage savings justify a longer outage (perpetually).

**Figure 6-10 Impact of Time-to-Close Wait Period**

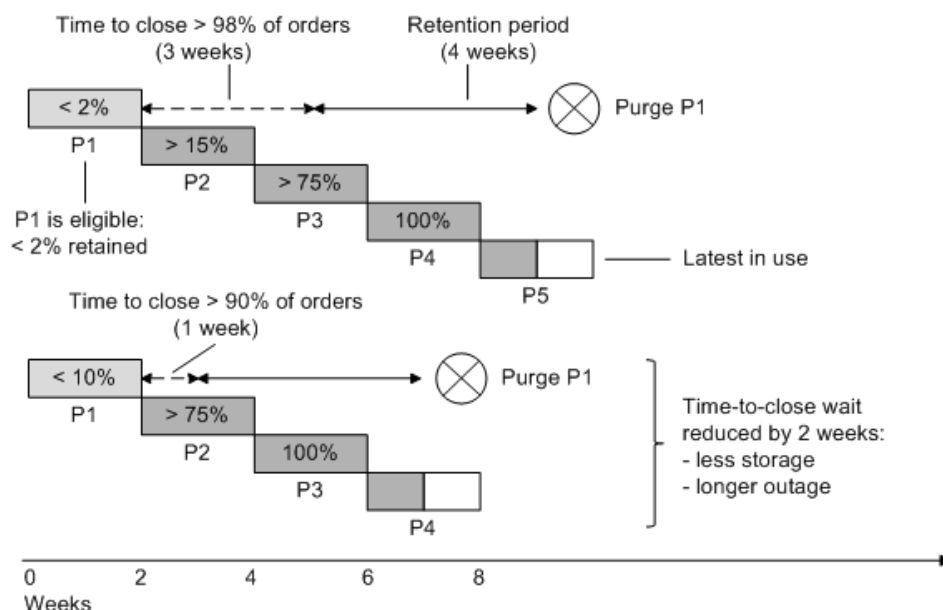

## Oracle RAC

As explained in the section "[Support for Active-Active Oracle RAC](#)," if you switch from a single database to Oracle RAC with N active-active nodes, the number of partitions increases N-fold whereas the actual number of order Ids stored in a partition decreases N-fold. This means that:

- The space consumed by N partitions is about the same as that consumed previously by a single partition.
- You do not necessarily need to change the partition size, storage capacity, the purge frequency, or any other purge-related policies.
- During a purge window, you must purge N partitions instead of one and consolidate them N-to-1.

Consolidating partitions might sound contrary to the way OSM is designed to use partitions on active-active Oracle RAC. However, it is unlikely that order processing on a consolidated partition will experience cluster waits. The number of retained orders is normally small, the consolidated order Ids are far apart, and there is typically little activity on those orders. If a significant increase in cluster waits proves to be the result of partition consolidation, consider avoiding consolidation when a partition is purged for the first time.

Another concern is that a large number of physical partitions could potentially cause performance issues, as discussed in the "[Pitfalls of Partitioning](#)" section.

Using Oracle RAC in active-passive mode is similar to using a single instance database. The only difference is that order creation might be switched to another partition and then back to the original in the events of failover and failback, although a switch might not occur right away or even not at all. This means that you may end up with a sparsely populated partition, which at some point could be consolidated with another partition.

### Example:

[Figure 6-11](#) compares a single instance database to active-active Oracle RAC. Specifically, OSM is configured to use two nodes in active-active mode. The Oracle RAC database may have additional nodes that are either not used by OSM or they are used in passive mode. The partition size, time-to-close wait, retention period and purge frequency are the same. However, OSM uses twice as many partitions on Oracle RAC, which are half-full when they are exhausted (half of the order Ids are skipped). This means that you must purge and consolidate two partitions instead of one to reclaim the same amount of space.

Figure 6-11 Single-Instance Database vs. Two-Node Active-Active Oracle RAC

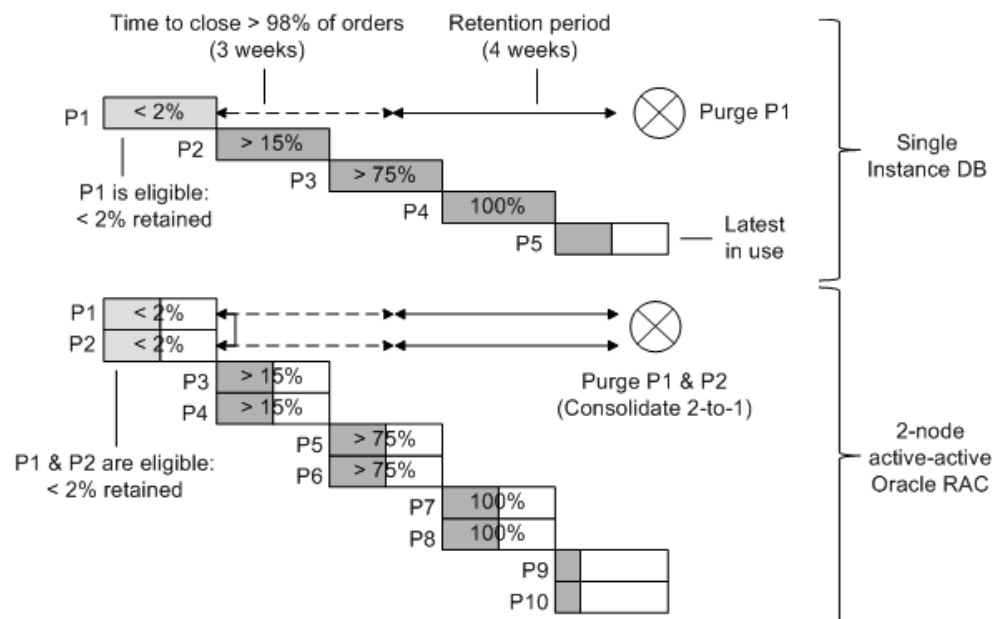

## Purge Frequency

As explained in "Estimating Storage," if you follow a regular purge schedule, the number of partitions purged during each maintenance window is  $F/P$  for a single instance database, where  $F$  is the purge frequency (for example, 30 days) and  $P$  is the partition size (for example, 30 days' worth of orders). As a starting point, it is recommended that you size each range partition to contain as many orders as will be purged in one purge maintenance window, that is,  $F=P$ . As you evaluate scenarios for different purge frequencies, adjust the partition size accordingly so that  $F=P$ . If the partition size is less than the purge frequency, you will have to consolidate partitions  $N$ -to-1, where  $N = F/P$ . This will add some extra time to purge maintenance (normally measured in minutes). You might do this if you are uncomfortable using large partitions. In this case, if you like a constant (predictable) consolidation ratio, choose the partition size so that  $N=F/P$  is an integral number.

A desire to purge as infrequently as possible is likely limited by the storage capacity and/or the administrative burden of managing a very large schema (whatever your criteria may be for "large"). Fortunately, you can often decrease the purge frequency  $N$ -fold with a relatively small increase in storage capacity. For simplicity, consider a single instance database and assume that the purge frequency is the same as the partition size. As explained in Estimating Storage, in this case you can use the following formula to estimate the storage consumed by partitions that have never been purged, where  $P$  is the partition size (for example, in days),  $T$  is the time-to-close wait,  $R$  is the retention period, and  $S$  is the space consumed by a single partition:

$$(P + T + R) / P \times S = (1 + (T + R) / P) \times S$$

Based on this formula, if the period  $T + R$  is large compared to  $P$ , you could double or triple the partition size and the purge frequency with a relatively small increase in storage. This is demonstrated with the following example.

**Example (from biweekly to monthly maintenance):**

Suppose that you have a 4-week retention period, a 3-week time-to-close wait and a biweekly purge frequency. The partition size is also 2 weeks. The following formula is used to calculate the storage consumed by never-purged-before partitions, where S is the space consumed by a single partition:

$$(P + T + R) / P \times S = (P + 3/2P + 2P) / P \times S = 4.5 \times S$$

Now suppose that you want to reduce the purge frequency to every 4 weeks. You can double the partition size and estimate the storage capacity:

$$(P + T + R) / P \times S = (P + 3/4P + P) / P \times 2 \times S = 5.5 \times S$$

This means that the extra storage is S. Thus, you can achieve a 100% reduction in downtime for 22% increase in storage capacity or 2 weeks' worth of orders. This is demonstrated in the figure below.

Note that because there is no change in the time-to-close wait, the larger partition will have more retained orders depending on the order aging curve. If the difference is large enough to have a material impact in the purge time, you may want to consider increasing the time-to-close wait slightly at the cost of a bit more extra storage.

**Figure 6-12 Impact of Doubling Partition Size and Reducing Purge Frequency to Half**

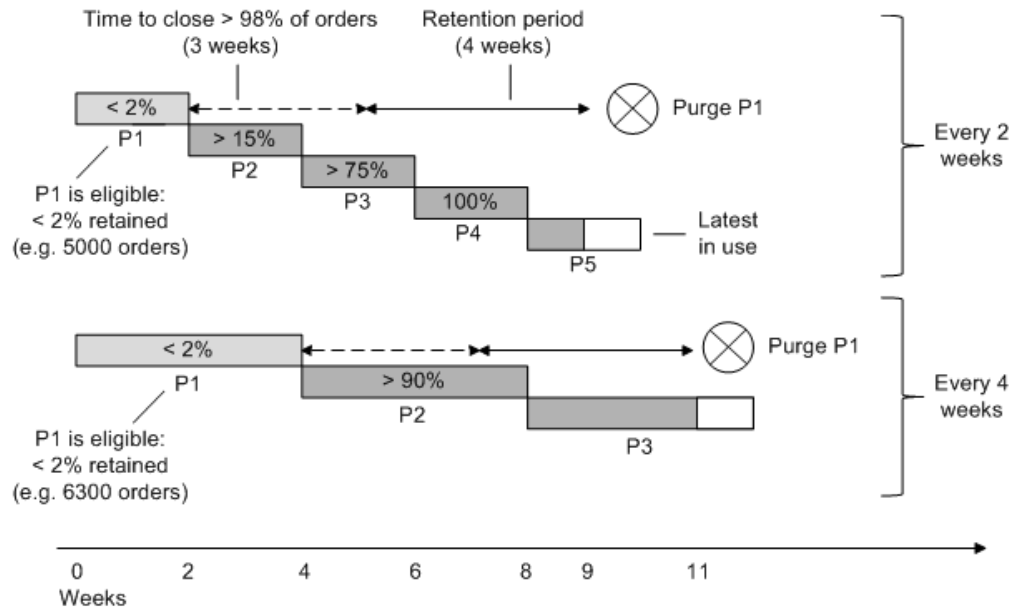

**Sizing Range Partitions for Row-Based Order Purge**

Sizing range partitions for row-based order purge is different from sizing for partition-based purge. Partitions sized for row-based purge must have a wide range of order Ids to store several months' worth of orders.

The main characteristic of this strategy is that closed orders, when they come out of their retention period, must be deleted from the partition(s) where new orders are

created. The objective is to maximize reuse of the free space, to restrain the growth of the segment high water mark. In addition, the space freed by deletes in an exhausted partition cannot be reused because new orders are created on a different partition. The space consumed by an exhausted partition can be released to the tablespace by using other operations, for example by dropping or shrinking the partition.

This means that your goal should be to minimize the number of exhausted partitions. The main criteria are the maximum order lifetime (OLT), the retention period, and your availability requirements. Here are some guidelines for sizing partitions for row-based order purge:

- If you have little or no operational experience using this purge strategy, be conservative by starting with a partition size you are comfortable with, and increase it as you gain experience (if necessary).
- If you cannot afford outages, the partition size should be large enough to contain the order volume over a period that is greater than or equal to the sum of the maximum order lifetime and the retention period. This approach requires the least amount of storage, as discussed in "[Sizing Range Partitions for Zero Downtime](#)."
- If the maximum order lifetime is too long (years), the above recommendation would result in oversized partitions that could take years to exhaust. If you do not have operational experience using row-based order purge and/or you feel uncomfortable with oversized partitions, and you can afford some occasional downtime (for example, every 6 months or once a year), you can size partitions for infrequent maintenance as discussed in "[Sizing Range Partitions for Infrequent Maintenance](#)."
- The partition sizing for a single instance database and active-active Oracle RAC is the same. As explained in "[Support for Active-Active Oracle RAC](#)," if you switch from a single database to Oracle RAC with N active-active nodes, the number of partitions will increase N-fold, whereas the actual number of order Ids stored in a partition will decrease N-fold.

## Sizing Range Partitions for Zero Downtime

If you cannot afford outages, you can size partitions to avoid outages as follows:

- Size partitions to contain the order volume over a period that is greater than or equal to the sum of the maximum order lifetime and the retention period.
- Keep purging orders from exhausted partitions until they are empty (using row-based order purge).
- Drop empty exhausted partitions online.

This approach requires the least amount of storage because it restricts the number of partitions to two at any point in time (2xN if you use Oracle RAC with N nodes in active-active mode). Specifically, the previous partition is purged empty and dropped online before the current partition is exhausted. [Figure 6-13](#) illustrates this by example.

Figure 6-13 Sizing Partitions to Avoid Outages

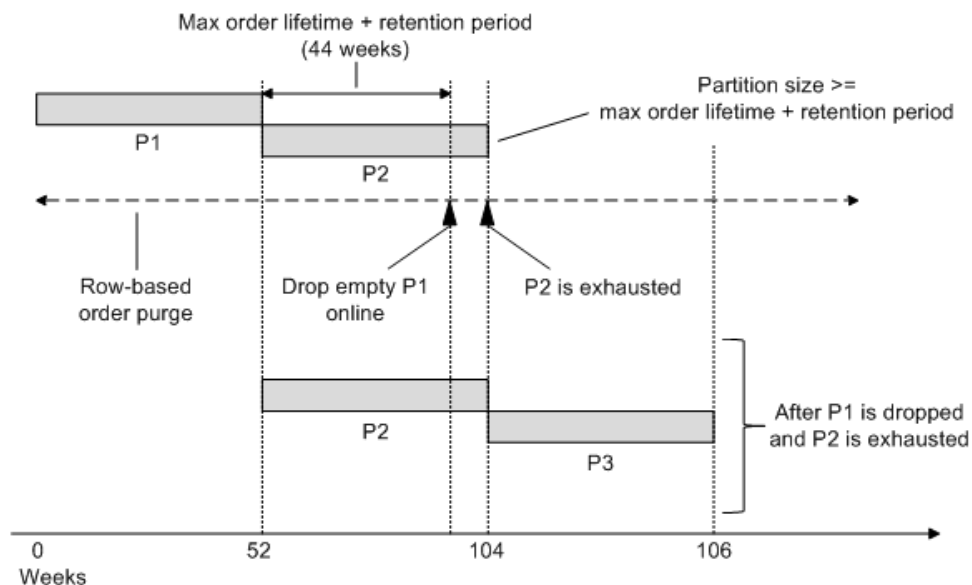

If both the retention period and the maximum order lifetime are relatively short, there is more flexibility in sizing partitions. You do not necessarily need oversized partitions because you can drop them online in a relatively short period after they are exhausted.

If the current partition is exhausted and the previous partition has still long-lived open orders that are expected to remain open for much longer, you might have to schedule a maintenance window to purge that partition using partition-based purge.

## Sizing Range Partitions for Infrequent Maintenance

If you have a near 24x7 availability requirement with occasional maintenance windows, you could use those windows to drop or purge old partitions offline (for example, every 6 months or once a year).

If the retention period or the maximum time-to-close wait are long, you should plan the partition size with the next maintenance window in mind, so that eventually you are able to either drop it or purge it cost-effectively (for example less than 2% of the orders will be retained).

As a rule, the partition size (P) should be less than the period until the next maintenance window (M), minus the time-to-close wait (T), minus the retention period (R), as shown below. In this case, time-to-close is the wait period until "most" orders in the partition are closed, as discussed in "[Time-to-Close Wait](#)."

$$P < M - (T + R)$$

If there is uncertainty about the date of the next maintenance window and/or that date is based on external factors and it will be immovable, it is a good idea to make the partition a bit smaller as contingency.



The partition size must also be (a lot) greater than the sum of the retention period and the time-to-close wait, otherwise it would be exhausted before there is an opportunity to delete a substantial amount of orders:

$$P > T + R$$

Note that the partition size may vary, at least initially, because it depends on a maintenance schedule. Instead of pre-allocating two or more partitions, you may want to wait until the current partition is closer to being exhausted and there is less uncertainty about the next maintenance window.

**Example:**

Suppose 98% of the orders close within 1 week, the retention period is 4 weeks, and you have a maintenance window every 24 weeks. You want the first partition to be exhausted after 19 weeks or less (24 - 1 - 4). Using 1 week as contingency, 18 weeks is a good size. After that, the partition size is 24 weeks (the same as the purge frequency), everything else being the same.

## Online vs. Offline Maintenance

All database maintenance operations that can be performed online, which means OSM is running, can also be performed offline. However, some operations can be performed offline only.

In order to execute a procedure offline you must either stop all WebLogic servers where OSM is deployed (for example, all managed servers) or stop the OSM application and cartridges. Beginning with OSM 7.2.0.9, database management procedures stop and restart OSM database jobs automatically.

Table 6-2 summarizes which operations can be performed online. Offline execution is always faster than online execution. If a procedure supports online execution, it is recommended only under low volume. In particular, online execution of partition management operations causes lock contention in the database and waits, such as **cursor: pin S wait on X**. Under high volume, such contention could result in severe performance degradation, transaction timeouts, and even order failures.

**Table 6-2 Summary of Online Versus Offline Maintenance Operations**

Operation	Online	Offline
Add a partition	Avoid if possible	Recommended
Row-based order purge	OK	OK
Drop a populated partition	Not supported	OK
Drop an empty partition	Not supported	Recommended
Partition purge	<ul style="list-style-type: none"> <li>Purging a partition partially is not supported online.</li> <li>Purging an entire partition is supported conditionally. For a list of these conditions, see the <b>om_part_maintain.purge_partitions</b> procedure.</li> </ul>	OK

**Table 6-2 (Cont.) Summary of Online Versus Offline Maintenance Operations**

Operation	Online	Offline
Exchange table maintenance (exchange tables are used by partition purge)	OK	OK
Cartridge Fast Undeploy	OK, but if done using XML Import/Export (rather than Design Studio), you need to refresh the OSM metadata as well. See " <a href="#">Refreshing OSM Metadata</a> " for more information.	OK
Cartridge conventional undeploy	Not supported	OK

## Managing Order Data

The most common maintenance operations are adding partitions and purging orders to reclaim storage.

See "[Adding Partitions \(Online or Offline\)](#)" for information about how to add partitions.

As discussed in "[Order Purge Strategies](#)," there are two main purge strategies, namely row-based order purge and partition-based order purge. These are discussed in more detail in these sections:

- "[Using Row-Based Order Purge](#)": Explains how row-based order purge works and how to use it.
- "[Using Partition-Based Order Purge](#)": Explains how partition-based order purge works and how to purge and drop partitions.
- "[Order Purge Policies](#)": Discusses purge policies.
- "[Managing Exchange Tables for Partition-Based Order Purge](#)": Describes exchange tables and explains how to create and manage them. Exchange tables are required for purging partitions. They are not used when dropping partitions or using row-based order purge.
- "[Estimating Partition Disk Space \(Online or Offline\)](#)": Explains how to estimate the amount of space that could be reclaimed during a maintenance window, the amount of space consumed by a partition, or the average order size in a partition.

## Adding Partitions (Online or Offline)

You can add partitions manually using the following procedures:

- **om\_part\_maintain.add\_partition**
- **om\_part\_maintain.add\_partitions**

For production and performance environments, Oracle strongly recommends that you add partitions manually either when OSM is offline or during periods of low system activity. This is particularly important if you use Oracle RAC.

- Adding partitions online causes lock contention in the database and waits, such as **cursor: pin S wait on X**. Under high volume, such contention could result in severe performance degradation, transaction timeouts, and even order failures.
- OSM can also add a partition automatically when a new order ID does not map to any partition. This is to prevent order creation failures if all partitions are exhausted. However, it is strongly recommended that you create partitions manually and disable automatic creation for all production and performance environments, especially if you use Oracle RAC, in order to avoid automatic creation under high volume. Automatic creation of partitions can be disabled with the **partition\_auto\_creation** parameter.
- The size of new partitions is specified by the **range\_partition\_size** parameter. Specifically, the upper bound of a new partition is the greatest partition upper bound plus the value of **range\_partition\_size**.
- (Optional) You can specify the tablespace of each new partition as the input argument to **om\_part\_maintain.add\_partition**. Using a different tablespace for each partition (usually a circular list) facilitates administrative tasks, such as backups.
- (Optional) You can specify the mnemonic of the partitioning realm the partition is associated with as the input argument to **om\_part\_maintain.add\_partition**. If a realm is not specified, the new partition is assigned to the **default\_order** realm. If the partitioning realm specified in the argument is disabled, an error will occur and the partition will not be added. To override this error and create the partition for the disabled partitioning realm, set the optional **a\_force** argument to **true**.

The installer creates the first partition. Always create a sufficient number of new partitions to handle the orders for a given period until the next maintenance window that includes a safety buffer in case an unexpected increase in order volume occurs or you skip a maintenance window.

If you have configured OSM to use Oracle RAC with  $N$  database nodes in active-active mode, you must add partitions in multiples of  $N$ . This is because OSM creates orders on the last  $N$  partitions concurrently. For example, if you use a 2-node Oracle RAC database in active-active mode, new orders are created on the last two partitions. If OSM is configured with a single instance database, an Oracle RAC database in active-passive mode or Oracle RAC One Node, new orders are created on the last partition only.

For more information, see "[range\\_partition\\_size](#)," "[om\\_part\\_maintain.add\\_partition \(Offline Only\)](#)," and "[om\\_part\\_maintain.add\\_partitions \(Offline Only\)](#)."

**Example (Add 2nd partition):** Consider a new installation with **range\_partition\_size** equal to 100,000. The upper bound of the partition created by the installer is 100001 (the upper bound of a partition is non-inclusive). The following statement adds a second partition with upper bound 200001 on tablespace OSMTS.

```
execute om_part_maintain.add_partition('OSMTS');
```

**Example (Add Nth partition,  $N > 2$ ):** The following statement adds three more partitions on the same tablespace as the most recently added partition with upper bounds 300001, 400001 and 500001.

```
execute om_part_maintain.add_partitions(3);
```

## Using Row-Based Order Purge

As discussed in "[Row-Based Order Purge Strategy](#)," you can use row-based order purge as an online purge strategy. Row-based order purge uses deletes to purge individual orders, whereas partition-based purge uses ALTER TABLE ... DROP PARTITION and ALTER TABLE ... EXCHANGE PARTITION to change the table structure.

The space freed by deletes in a table or index segment does not lower the high water mark of that segment. That space can be reused by inserts into the same segment but the space is not released to the tablespace. Therefore, you must run order purge as frequently as possible (at least once a day) to free space at the same rate it is consumed by new orders. The objective is to restrain the growth of the high water mark.

Figure 6-14 shows how row-based order purge deletes orders in two stages. The API also provides procedures that allow you to execute each stage separately, as follows:

1. Selects the order Ids that satisfy given purge criteria into the OM\_ORDER\_ID\_FOR\_PURGE staging table.
2. Deletes the selected orders.

**Figure 6-14 How Row-Based Order Purge Works**

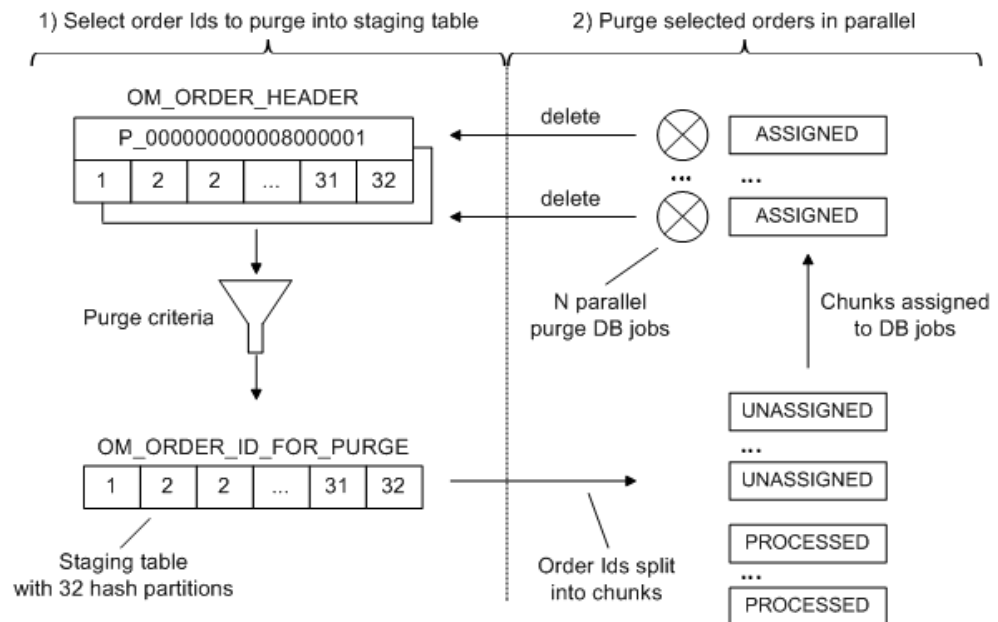

In the first stage, order purge scans `OM_ORDER_HEADER` and inserts the order Ids of all orders that satisfy the given purge criteria into the `OM_ORDER_ID_FOR_PURGE` staging table. You can restrict the scope of the search to an order ID range, for example to the latest partition(s) where new orders are created.

In the second stage, the selected orders are purged in parallel using the `dbms_parallel_execute` package. More precisely:

- Order purge splits the work into smaller pieces by dividing the data blocks of **OM\_ORDER\_ID\_FOR\_PURGE** into chunks. Then it spawns N database jobs to purge the chunks in parallel, where N is the degree of parallelism (possibly 1). Each job processes one chunk at a time by deleting one order at time, automatically committing every few deletes. In the event of error (for example, a deadlock), the job continues with the next chunk.
- After finishing the processing of all chunks, order purge retries processing of any failed chunks until either all chunks are processed successfully (all orders in the chunk are purged) or a pre-defined retry threshold is reached.
- At the end of a successful purge, order purge clears **OM\_ORDER\_ID\_FOR\_PURGE**.

This approach ensures that a) an order is either purged entirely or not at all b) a purge may succeed partially even in the event of errors and c) the purge handles recoverable errors, such as deadlocks.

For performance reasons, the staging table is hash partitioned. To minimize contention among purge jobs, **OM\_ORDER\_ID\_FOR\_PURGE** must have the same number of partitions as the number of hash sub-partitions in an **OM\_ORDER\_HEADER** range partition. Otherwise, order Ids in different **OM\_ORDER\_ID\_FOR\_PURGE** blocks that are processed by different purge jobs might be stored in the same **OM\_ORDER\_HEADER** block.

The default degree of parallelism is specified by the **degree\_of\_parallelism** configuration parameter. The number of chunks generated depends on a number of factors, including the number of **OM\_ORDER\_ID\_FOR\_PURGE** hash partitions, the volume and distribution of data in the staging table, and the desired chunk size. The latter is specified by **parallel\_execute\_chunk\_size**, which is an advanced configuration parameter (you rarely need to change the default).

Row-based order purge is implemented by the **om\_new\_purge\_pkg** package. This package allows you to:

- Purge a single order by order ID.
- Purge orders that satisfy given purge criteria.
- Schedule an order purge.
- Stop and resume an order purge.
- Row-based purge operations are audited. Purge audit views allow you to monitor order purges. For more information see "[Auditing and Monitoring Order Purges](#)."

## Purging a Single Order by Order ID

The **om\_new\_purge\_pkg.delete\_order** procedure allows you to delete an order by its order ID. This is convenient when you want to delete only one order or a small number of orders (for example, to resubmit).

Note that this procedure does not issue commit, in contrast to most purge procedures. You must manually issue commit or rollback.

## Purging Orders that Satisfy Given Criteria

If you need to purge large quantities of orders (for example, if row-based order purge is your purge strategy), purging orders one by one serially using **delete\_order** would

be very slow. Use one of the following procedures instead, which allow you to purge orders in parallel:

- The **om\_new\_purge\_pkg.purge\_orders** procedure purges all orders that satisfy given purge criteria, including your retention policy (for example, you can purge all orders that were closed 30 days ago or more). First, it finds the order IDs that satisfy the purge criteria. Then it spawns database jobs to purge the selected orders in parallel, as discussed in Understanding Row-Based Order Purge.
- The **om\_new\_purge\_pkg.select\_orders** and **om\_new\_purge\_pkg.purge\_selected\_orders** procedures are equivalent to **purge\_orders** but offer more flexibility because you can execute the order selection and order purge steps separately. For example, you can select the orders to purge piecemeal by executing **select\_orders** several times. You can also update the **OM\_ORDER\_ID\_FOR\_PURGE** staging table manually, especially if you have complex purge criteria that are not supported by **purge\_orders** and **select\_orders**.

If the purge is performed while OSM is online, adjust the degree of parallelism to ensure that the database can handle the additional workload of deleting orders concurrently with order processing.

Both **purge\_orders** and **purge\_selected\_orders** provide the **a\_stop\_date** parameter, which allows you to specify an end date and time for the purge. This is useful if you want to run order purge during specific periods (for example, during a low-volume period at night).

## Scheduling Order Purge

The **om\_new\_purge\_pkg.schedule\_order\_purge\_job** procedure allows you to schedule a one-time execution of order purge. The purge is scheduled using the **dbms\_job** package. If row-based order purge is your main strategy, this procedure is inadequate. In this case it is recommended that you use the Oracle Database scheduler to schedule periodic execution of order purge.

## Stopping and Resuming an Order Purge

The **om\_new\_purge\_pkg.stop\_purge** procedure allows you to stop an order purge. This might be necessary, for example, if the host is too busy or you want to perform other maintenance. This procedure returns immediately. However, the purge will stop after all currently assigned chunks are processed, possibly after several minutes.

Later you can resume the same purge by executing **om\_new\_purge\_pkg.resume\_purge**. You can also restart the purge with different parameters by executing **om\_new\_purge\_pkg.purge\_selected\_orders** (for example, if you want to change the time when the purge window ends or the degree of parallelism), or start a new purge.

## Using Partition-Based Order Purge

As discussed in "[Partition-Based Order Purge Strategy](#)," partition-based order purge allows you to purge several weeks' worth of order data in minutes by dropping or "purging" partitions. These operations are based on efficient DDL statements that modify the table structure, such as ALTER TABLE ... DROP PARTITION and ALTER TABLE ... EXCHANGE PARTITION.

The following sections discuss partition-based purge in detail:

- ["Differences Between Purging and Dropping Partitions"](#): summarizes the differences between purging and dropping partitions.
- ["Purging Partitions \(Online or Offline\)"](#): describes how to purge partitions. When you purge a partition, all the data that satisfies given purge criteria is deleted and storage is immediately reclaimed. This operation allows you purge a partition partially, that is, to retain orders that do not satisfy given purge criteria. It also allows you to consolidate multiple partitions into one. The limitation is that the partition must be purged offline. However, if all orders in a partition are closed and satisfy the purge criteria, you might be able to purge the entire partition online.
- ["Dropping Partitions \(Offline Only\)"](#): describes how to drop partitions. When you drop a partition, all its data is deleted and storage is immediately reclaimed. The limitations are that the partition must be dropped offline and it must have no open orders.
- ["Dropping Empty Partitions \(Online or Offline\)"](#): describes how to drop empty partitions online.

## Differences Between Purging and Dropping Partitions

These are the main differences between purging and dropping partitions:

- You cannot drop a partition if it has open orders. However, you can purge a partition if the number of retained orders does not exceed a configurable threshold. In this case, OSM copies retained orders to the so-called backup tables prior to the partition exchange, and restores them afterwards.
- To purge partitions you must create exchange tables first. This must be done once after a new installation and subsequently after schema changes. Exchange tables are not used when dropping partitions or when using row-based order purge.
- If you have only one partition, you cannot drop it unless you add another partition first. This restriction does not apply to purging.
- You can only drop partitions when the OSM is offline, so you must plan for downtime. If a partition does not have any open orders and all orders satisfy the purge criteria, you might be able to purge the partition online. However, note that purging online is slower than offline, and results in increased contention and lower throughput because DDL operations lock the entire table in exclusive mode. Therefore, you should only purge online during the lowest volume hours and only after you have tested it successfully in your environment.

## Purging Partitions (Online or Offline)

When you purge a partition, all the data that satisfies given purge criteria is deleted and storage is immediately reclaimed. This operation allows you purge a partition partially, that is, to retain orders that do not satisfy given purge criteria. This is done using `ALTER TABLE ... EXCHANGE PARTITION` statements. The `EXCHANGE PARTITION` statement exchanges a partition with a table (known as the exchange table). The exchange operation swaps the segments of the partition with the segments of the exchange table but does not delete or move data between segments. When the exchange table is empty, the partition is purged, but the partition remains associated with the partitioned table, for example, it still appears in `user_tab_partitions`. In general, the `EXCHANGE PARTITION` statement is a fast operation because it updates metadata only in the data dictionary (unless the table has global indexes and the

exchange operation is performed with the UPDATE GLOBAL INDEXES option). However, to reclaim the storage previously used by the partition you must also purge the exchange tables. To purge partitions and reclaim storage space, do the following using PL/SQL stored procedures:

1. Create exchange tables (once after a new installation and subsequently after schema changes). For more information see "[Managing Exchange Tables for Partition-Based Order Purge.](#)"
2. During periodic maintenance windows, do the following:
  - Purge partition and possibly consolidate partitions. See "[Partition-Based Order Purge Strategy](#)" for examples. Typically this is an offline operation because a small percentage of orders must be retained (for example, open orders and closed orders that are still in the retention period). See "[Purging Partitions Partially \(Offline Only\)](#)" for more information. If all orders in a partition are closed and satisfy the purge criteria, you might be able to purge the entire partition online, see "[Purging Entire Partitions That Do Not Contain Open Orders \(Online or Offline\)](#)" for more information.
  - Add partitions. You can add partitions online under low volume, however adding partitions offline is less likely to cause problems. See "[Adding Partitions \(Online or Offline\)](#)" for more information.
  - Purge exchange tables to reclaim storage space. You can purge the exchange tables at any time to reclaim storage (preferably during off-peak hours). If the database has enough spare CPU and IO capacity, this operation does not affect performance, even when it is performed online, because it does not cause contention (the exclusive locks acquired on the exchange tables do not block other processing). For more information see "[Managing Exchange Tables for Partition-Based Order Purge.](#)"

**Figure 6-15 Typical Maintenance Using Partition-Based Order Purge**

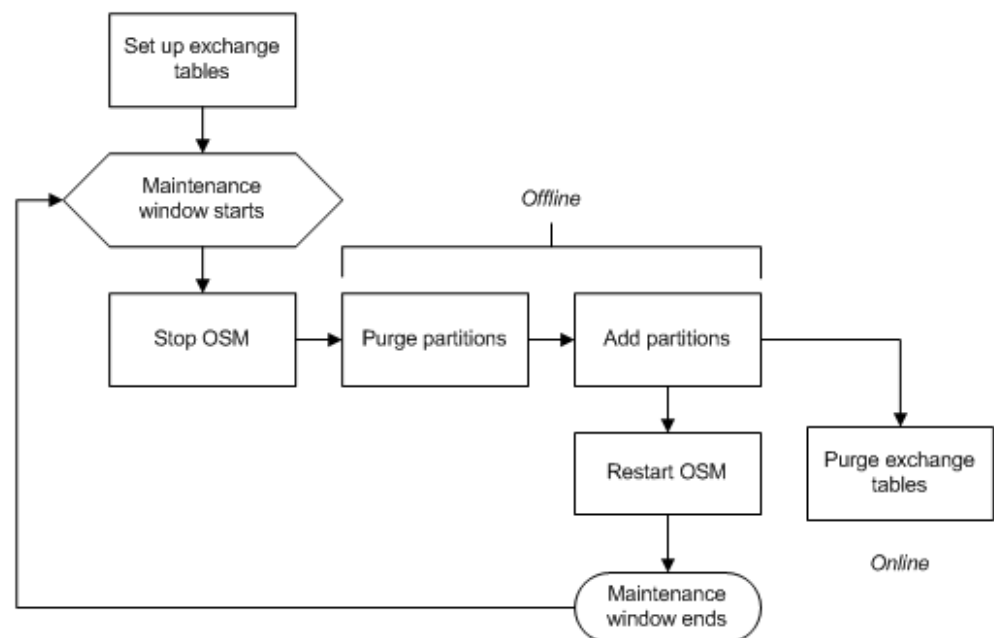



## Purging Entire Partitions That Do Not Contain Open Orders (Online or Offline)

You can entirely purge partitions that do not contain any open orders with the **om\_part\_maintain\_purge\_partitions** procedure. If purging online, this procedure exchanges each partition you want to purge with empty purge table(s), effectively swapping the data of that partition out of the table. If purging offline, partitions that can be entirely purged are dropped, unless you disallow it. However, the partition where retained orders are consolidated is always exchanged, even if that partition has no retained orders itself.

- Purging partitions online causes lock contention in the database and waits, such as cursor: pin S wait on X. Under high volume, such contention could result in severe performance degradation, transaction timeouts, and even order failures.
- You can disallow dropping partitions by passing **a\_drop\_empty\_ptns=false**. However, this prevents partitions from being consolidated and affects purge performance.
- The name and upper bound of an exchanged partition do not change.
- If the exchanged partition and the purge table are on different tablespaces then after the exchange the two tablespaces are swapped (there is no movement of data).
- If the parameter **purge\_policy\_purge\_related\_orders\_independently** is set to 'N' and the partition contains orders that are associated directly or indirectly with orders that do not satisfy the purge criteria (for example, open follow-on orders in a different partition), the partition cannot be purged entirely. For more information, see the purge policy section in "[Purging Related Orders Independently](#)."

For more information, see **om\_part\_maintain.purge\_partitions**.

## Purging Partitions Partially (Offline Only)

The **om\_part\_maintain.purge\_partitions** procedure can purge partitions that contain orders that must be excluded from purging (retained), such as open orders and orders that do not satisfy the purge criteria. This is permitted if the OSM application is offline and the number of retained orders in a partition is "small", that is, it does not exceed a pre-defined threshold.

In addition, **purge\_partitions** can move retained orders from multiple partitions into a single partition in order to maximize reclaimed space, reduce the number of partitions and minimize downtime. This is done by purging successive partitions in iterations. The maximum number of partitions purged in each iteration is limited by the purge capacity. More precisely, **purge\_partitions** purges successive partitions that qualify for purging as follows:

- Copies the orders that do not satisfy the purge criteria from those partitions into the backup tables.
- Purges each partition entirely by exchanging it with purge tables.
- Drops N-1 of those partitions.
- Restores the retained orders from the backup tables into the Nth partition with their order IDs unchanged.

For more information, see "[om\\_part\\_maintain.purge\\_partitions \(Online or Offline\)](#)."

**Example:** Assume that the purge capacity is 3, and consider these partitions, as shown in Figure 6-16:

- P\_00000000000600001: All orders satisfy the purge criteria. This partition can be purged entirely.
- P\_00000000000700001: This partition can be purged but some orders do not satisfy the purge criteria.
- P\_00000000000800001: This partition can be purged but some orders do not satisfy the purge criteria.
- P\_00000000000900001: This partition cannot be purged because the number of orders that do not satisfy the purge criteria exceeds a configured threshold.

**Figure 6-16 Purging Partitions That Contain Orders That Must be Excluded from Purging**

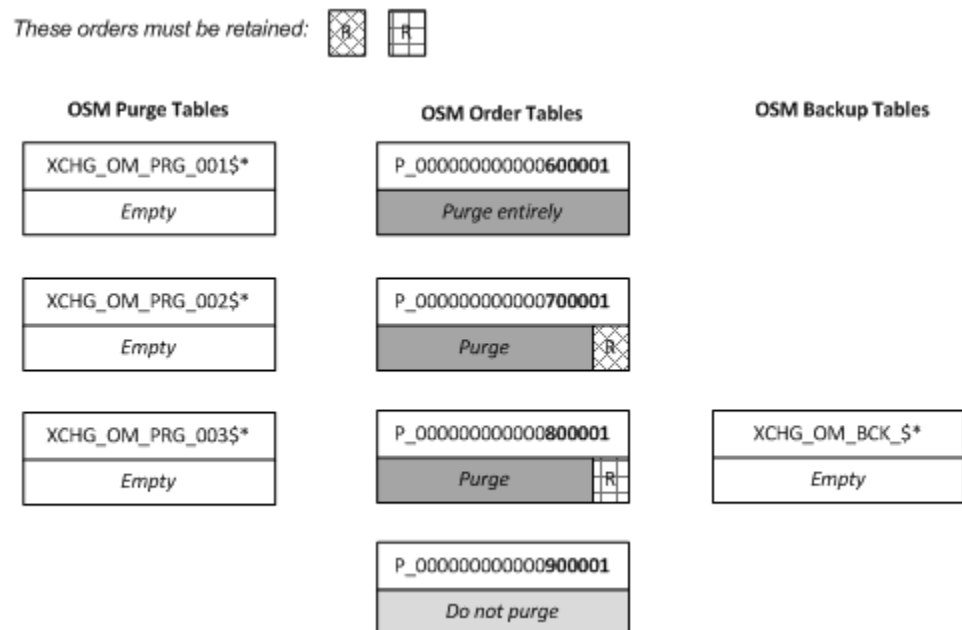
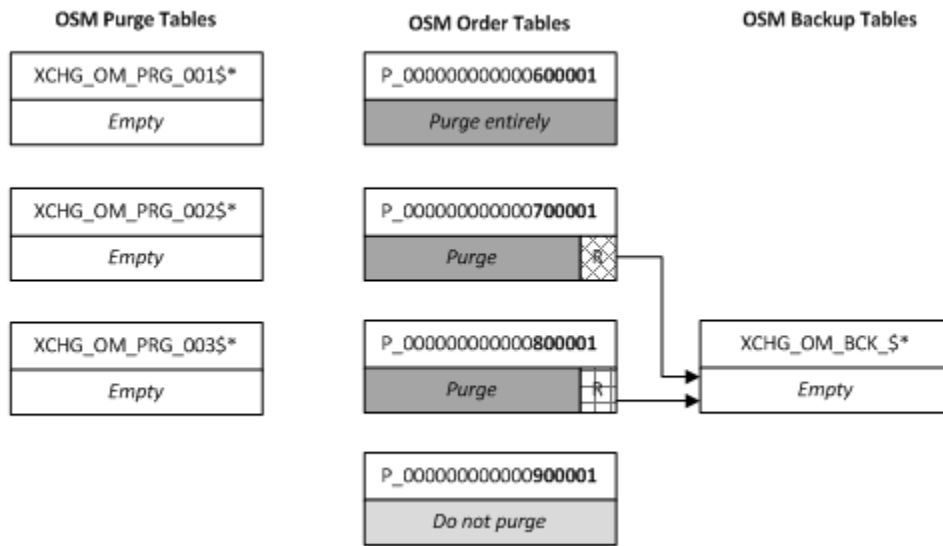

Figure 6-17 to Figure 6-21 show how **purge\_partitions** purges these partitions step by step:

1. It copies the orders that do not satisfy the purge criteria from P\_00000000000700001 and P\_00000000000800001 into the backup tables.
2. It purges partitions P\_00000000000600001, P\_00000000000700001 and P\_00000000000800001 by exchanging them with the purge tables.
3. It drops partitions P\_00000000000600001 and P\_00000000000700001, which are now empty.
4. It restores the retained orders from the backup tables into partition P\_00000000000800001.
5. (Optional) It purges the purge tables and continues the same process for any remaining partitions. This is possible only if you allowed it to purge the purge tables. Otherwise, it cannot proceed because the purge capacity is exhausted.

**Figure 6-17 Step 1: Back Up Retained Orders**



**Figure 6-18 Step 2: Purge the Partitions**

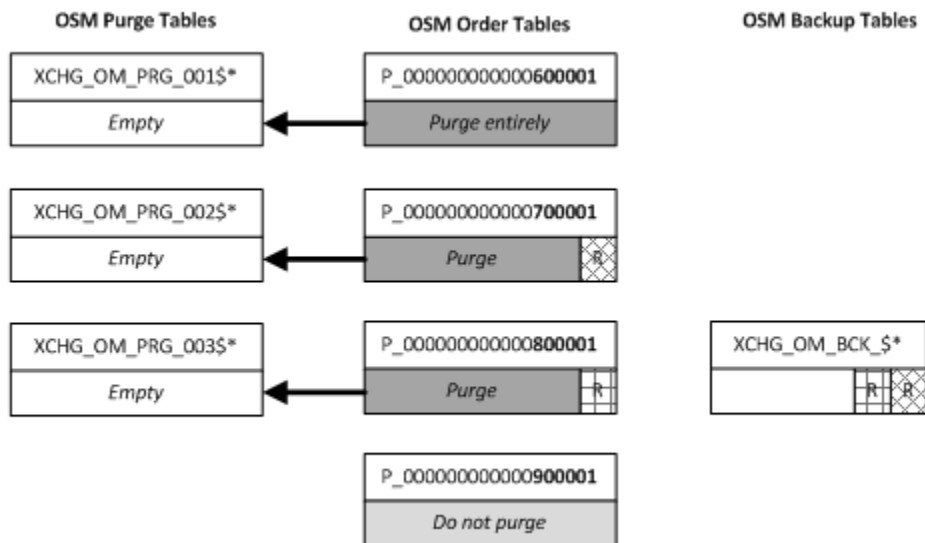

**Figure 6-19 Step 3: Drop the Partitions**

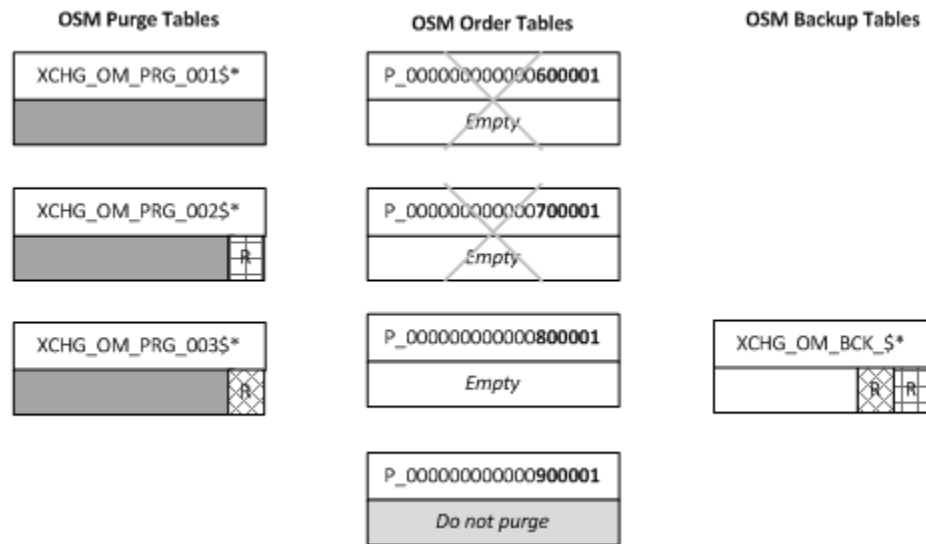

**Figure 6-20 Step 4: Restore the Retained Orders from the Backup Tables**

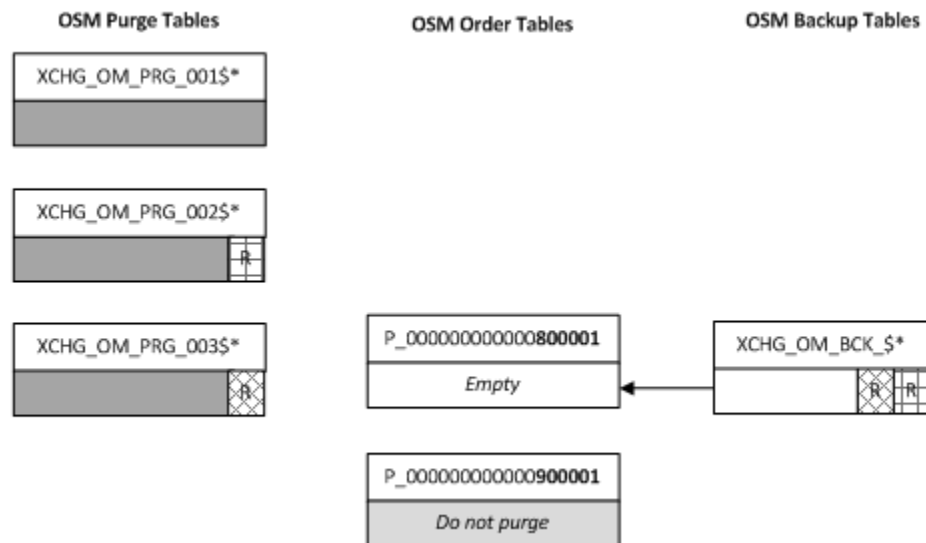

**Figure 6-21 Step5: (Optional) Purge the Purge Tables to Reclaim Space**

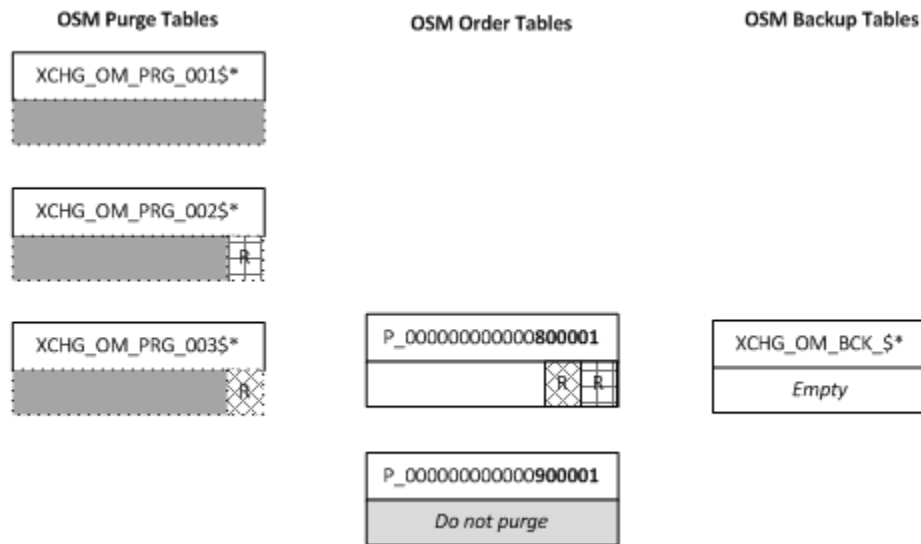

## Dropping Partitions (Offline Only)

If most of your orders are short-lived, you may be able to purge orders by dropping old partitions. This is the most efficient way to reclaim space but it involves downtime. During a maintenance window, stop OSM, drop old partitions, add enough partitions to store new orders until your next maintenance window, and restart OSM, as shown in [Figure 6-22](#). Exchange tables are not used when you drop partitions.

**Figure 6-22 Dropping and Adding Partitions**

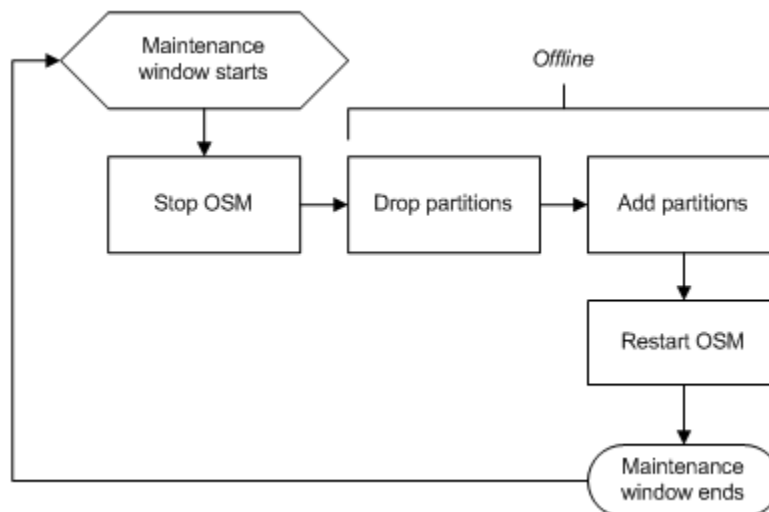

When you drop a partition, all its data is deleted and storage is immediately reclaimed. You can use the stored procedure `om_part_maintain.drop_partitions` to drop partitions that contain orders with order IDs within a specified range if you no longer require the

order data they contain and they have no open orders. If the schema contains only a single partition then Oracle Database does not allow you to drop it.

If the parameter **purge\_policy\_purge\_related\_orders\_independently** is set to 'N' and the partition contains orders that are associated directly or indirectly with orders that do not satisfy the purge criteria (for example, open follow-on orders in a different partition), the partition cannot be dropped. For more information, see the purge policy section in "[Purging Related Orders Independently](#)."

Because global indexes become unusable when partitions are dropped, this procedure also rebuilds unusable indexes and index partitions. This can be done in parallel.

For more information, see "[om\\_part\\_maintain.drop\\_partitions \(Offline only\)](#)."

#### Example:

Consider an OSM schema with partitions P\_00000000001000001, P\_00000000002000001, P\_00000000003000001 and so on. If P\_00000000003000001 has open orders then the following statement will drop only P\_00000000001000001 and P\_00000000002000001.

```
execute om_part_maintain.drop_partitions(4000000);
```

## Dropping Empty Partitions (Online or Offline)

Eventually, you must drop empty purged partitions for performance and operational reasons. Dropping empty partitions is relatively fast because they have few segments. You can use one of the following procedures:

- **om\_part\_maintain.purge\_partitions** drops empty partitions by default, unless specified otherwise.
- **om\_part\_maintain.drop\_empty\_partitions** (online and offline): Oracle recommends this procedure because it does not disable foreign keys and therefore can be executed online. For more information, see "[om\\_part\\_maintain.drop\\_empty\\_partitions \(Online or Offline\)](#)."
- **om\_part\_maintain.drop\_partitions** (offline only): For more information, see "[om\\_part\\_maintain.drop\\_partitions \(Offline only\)](#)."

## Reclaiming Unused Space in Volatile Tables

Some volatile tables in the OSM database can grow to take up an inappropriate amount of space. To determine whether this is happening in your database, you can use the Segment Advisor in the database to determine the tables with the most free space, to help you decide whether to reclaim that free space. For more information about the Segment Advisor, see *Oracle Database Administrator's Guide*.

The tables that are most likely to have free space are:

- OM\_ORDER\_STATE\_PENDING
- OM\_JMS\_EVENT

If you find that these tables have free space, you can reclaim the space using the following commands:

```
alter table OM_ORDER_STATE_PENDING enable row movement;  
alter table OM_ORDER_STATE_PENDING shrink space;
```

```
alter table OM_JMS_EVENT enable row movement;  
alter table OM_JMS_EVENT shrink space;
```

These commands must be run only offline, when OSM is in a maintenance window. The commands may take several minutes to run.

## Order Purge Policies

Purge policies are configured in the **om\_parameter** table.

### Purging Related Orders Independently

By default, related orders are purged independently. This means that the decision whether an order can be purged is based solely on whether that order satisfies the purge criteria or not, regardless of any dependencies. For example, if the predecessor of an open follow-on order satisfies the purge criteria, the predecessor order can be purged even though the follow-on must be retained.

Beginning with OSM 7.2.0.10 and 7.2.2.3.5, you can disable this policy by setting the **purge\_policy\_purge\_related\_orders\_independently** parameter to the value N in the **om\_parameter** table. When this policy is disabled, an order with related orders can be purged only if all directly and indirectly related orders are ready to purge, that is they satisfy the purge criteria (for example, **a\_delete\_before** and **a\_order\_states**). However, the order IDs of the related orders may be within a different partition, or even outside the given purge range.



#### Note:

Currently this policy is supported by partition-based purge only.



#### Note:

Setting **purge\_policy\_purge\_related\_orders\_independently** to N may add several minutes to the time it takes to purge or drop a partition.

#### Example (Purging related orders independently):

Assume that **purge\_policy\_purge\_related\_orders\_independently** is set to N and that you want to purge all orders in partition P\_00000000000300001 that were closed before midnight on the specified date of February 13, 2014:

```
execute om_part_maintain.purge_partitions(  
    a_online => false,  
    a_delete_before => trunc(to_date('02/13/2014', 'MM/DD/YY')),  
    a_order_states => om_new_purge_pkg.v_closed_orders  
    a_order_id_lt => 300001);
```

Figure 6-23 shows some of the orders in partition P\_00000000000300001 and the related orders:

- Order 291001 is purged because it satisfies the purge criteria and has no related orders.
- Order 291002 satisfies the purge criteria and is related to 391002, which is amended by 491002. Both 391002 and 491002 satisfy the purge criteria and are therefore ready to purge although they are outside the given purge range. Therefore order 291002 is purged even though 391002 and 491002 are not.
- Order 291003 is retained because it is indirectly related to 491003, which has a completion date that is after the specified date.
- Order 291004 is retained because it is indirectly related to 491004, which is open.

**Figure 6-23 Related Orders that Satisfy the Purge Criteria**

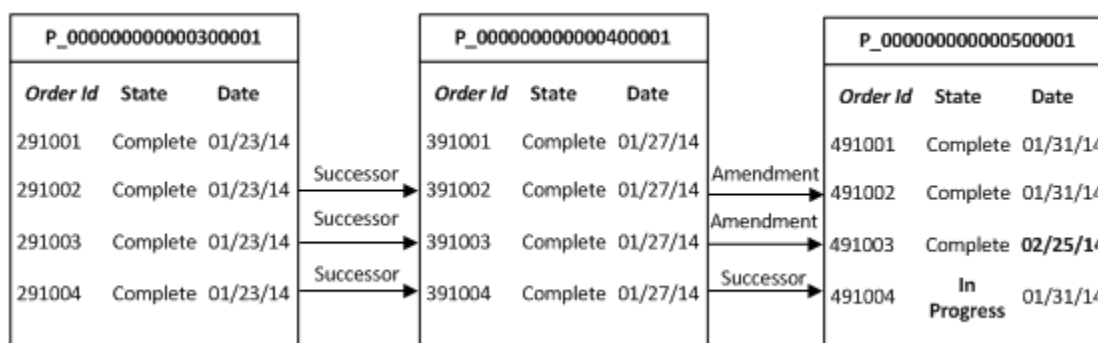

The following types of relationships are considered when looking for related orders:

- Successor Orders
- Predecessor Orders
- Amendment Orders
- Base Orders (for amendments)

Keep the following in mind when

**purge\_policy\_purge\_related\_orders\_independently** is set to N:

- Both direct and indirect relationships are considered.
- It does not matter if the related orders are within the range of order IDs being purged; it matters only whether they match the purge criteria (**a\_delete\_before** and **a\_order\_states** parameters).
- When purging partitions online, if any order in a partition has a related order that does not match the purge criteria, the partition cannot be purged. Purging online requires that there are no orders retained in the partition.
- When dropping partitions, if any order in a partition has a related order that does not match purge criteria, the partition cannot be dropped. Dropping partitions requires that there are no orders retained in the partition.
- If the total number of orders to be retained exceeds the threshold defined by the parameter **xchg\_retained\_orders\_thres** (default 10000), the partition is not purged. This includes orders that satisfy the purge criteria but they must be retained because they are related to orders that do not satisfy that criteria.



## Auditing and Monitoring Order Purges

OSM monitors all row-based order purge operations in the database but not partition-based purge operations. OSM audits the following operations:

- **om\_new\_purge\_pkg.purge\_orders**
- **om\_new\_purge\_pkg.purge\_selected\_orders**
- **om\_new\_purge\_pkg.delete\_order**
- **om\_new\_purge\_pkg.purge\_cartridge\_orders**

### Note:

You do not manually run the **om\_new\_purge\_pkg.purge\_cartridge\_orders** package. Design Studio runs this package when the **PURGE\_ORDER\_ON\_UNDEPLOY** cartridge management variable is set to **true** and you undeploy a cartridge. Design Studio does not run this package when the **FAST\_CARTRIDGE\_UNDEPLOY** cartridge management variable is set to **true** when you undeploy a cartridge.

OSM assigns each purge operation a unique purge ID that OSM associates with all audit records. You can monitor in-progress purges, review past purges, and analyze purge performance using the following views:

- "**OM\_AUDIT\_PURGE\_LATEST**": This view returns information about the latest order purge.
- "**OM\_AUDIT\_PURGE\_ALL**": This view returns information about all order purges.

You must set the **nls\_date\_format** database initialization parameter for queries to return the time portion in audit views that have DATE datatype columns. For example:

```
alter session set nls_date_format = 'DD-MM-YYYY HH24:MI:SS';
```

**Example (Monitoring an order purge):** You can use the **OM\_AUDIT\_PURGE\_LATEST** view to monitor the latest order purge. If a purge is running, you can use a query like this one to find out the purge rate and estimated completion time.

```
select status,
       est_or_actual_end_date,
       percent_complete,
       orders_purged_per_minute as purge_rate,
       parallelism
from om_audit_purge_latest;
```

STATUS	EST_OR_ACTUAL_END_DATE	PERCENT_COMPLETE	PURGE_RATE	PARALLELISM
RUNNING	15-09-2015 08:23:39	95.45	1911	16

## Audit Tables

In most cases, the purge audit views provide sufficient data; however, you may need to query the underlying tables. For example you may need to review the orders that were purged, or the purge criteria, or both for troubleshooting purposes. OSM stores audit records in these tables:

- "**OM\_AUDIT\_PURGE**": This is the main audit table. It stores the operation name, status, critical dates and other data.
- "**OM\_AUDIT\_PURGE\_ORDER**": Stores a synopsis of each purged order with a timestamp.
- "**OM\_AUDIT\_PURGE\_PARAM**": Stores the purge criteria, the parameters supplied to the purge procedure, and a snapshot of relevant session and configuration parameters when the purge was started.

By default, OSM retains the audit data for at least 90 days. The minimum retention period is specified by the **purge\_audit\_retention\_days** configuration parameter in the **om\_parameter** table. Order purge procedures purge obsolete audit records automatically before adding new audit records.

If you have partitioned the OSM schema, then OSM partitions the purge audit tables on a monthly basis. OSM manages the audit partitions automatically. The first order purge operation in a month automatically adds a new partition for the month. Order purge procedures drop partitions with obsolete audit records automatically before adding new audit records.

## Managing Exchange Tables for Partition-Based Order Purge

Partition purge can purge a partition by exchanging it with tables that are known as exchange table. The exchange operation swaps the segments of the partition with the segments of the exchange table but does not delete or move data between segments. In general, the EXCHANGE PARTITION statement is a fast operation because it updates metadata only in the data dictionary (unless the table has global indexes and the exchange operation is performed with the UPDATE GLOBAL INDEXES option). However, to reclaim the storage previously used by the partition you must also purge the exchange tables.

There are two types of exchange tables used for purging:

- Purge tables
- Backup tables

## About OSM Purge Tables

Purge tables are used for purging partitions using exchange. For each partition to be purged, **purge\_partitions** decides whether to drop it or exchange it. For example, when purging online, it is possible to drop only empty partitions. When purging offline, the partition where retained orders are consolidated must be exchanged, whereas the remaining partitions can be dropped.

The structure of each purge table is similar to the structure of the corresponding partitioned table. The number of purge tables that OSM creates depends on how many partitions you want to be able to exchange without having to purge the purge tables. This is called the **exchange purge capacity**.

For example, if the purge capacity is 3 then OSM creates 3 sets of purge tables as follows:

- If an OSM table is range-hash partitioned, OSM creates 3 hash-partitioned purge tables.
- If an OSM table is range partitioned, OSM creates 3 non-partitioned purge tables.
- If an OSM table is reference-partitioned, OSM creates 3xN non-partitioned purge tables, where by default N is the number of hash sub-partitions of the oldest **OM\_ORDER\_HEADER** partition. You can override the default N when you setup the exchange tables.

The format of a purge table name is **XCHG\_OM\_PRG\_p\$*xchg\_table\_id*\$r**, where:

- The **XCHG\_OM\_PRG\_** allows quick identification of purge tables.
- *p* is sequence number between 1 and the purge capacity, referred to as the logical exchange partition (formatted to 3-digits 001 to 999). Each partition to be exchanged is mapped to a logical exchange partition. This means that the maximum supported purge capacity is 999. This is the first generated component so that purge table names are grouped by partition when sorted.
- *xchg\_table\_id* is an OSM-generated sequence ID for each partitioned table, called the exchange table ID (formatted to 3 digits). OSM stores the exchange table IDs in the **om\_xchg\_table** table when OSM creates exchange tables. OSM purges this table when it drops exchange tables. You do not need to know the exchange table IDs.
- *r* is a 3-digit suffix that identifies which reference partition is exchanged when the table is reference partitioned; otherwise this value is omitted. *r* is referred to as the reference partition position because reference partitions are exchanged in order based on their position.

#### Example:

Figure 1 shows how OSM maps **OM\_ORDER\_HEADER** partitions to exchange tables when purging partitions. OSM maps **OM\_ORDER\_HEADER** to exchange table ID 001. All range-hash partitioned tables and the corresponding exchange tables have 64 hash partitions. The purge table capacity is 2, for example, there are two purge tables for **OM\_ORDER\_HEADER**. Assuming that the purge tables are empty, OSM can purge partitions P\_00000000008000000 and P\_00000000009000000 by exchanging them with exchange tables having logical exchange partitions 001 and 002, respectively.

Figure 6-24 Partition to Purge Table Mapping Example

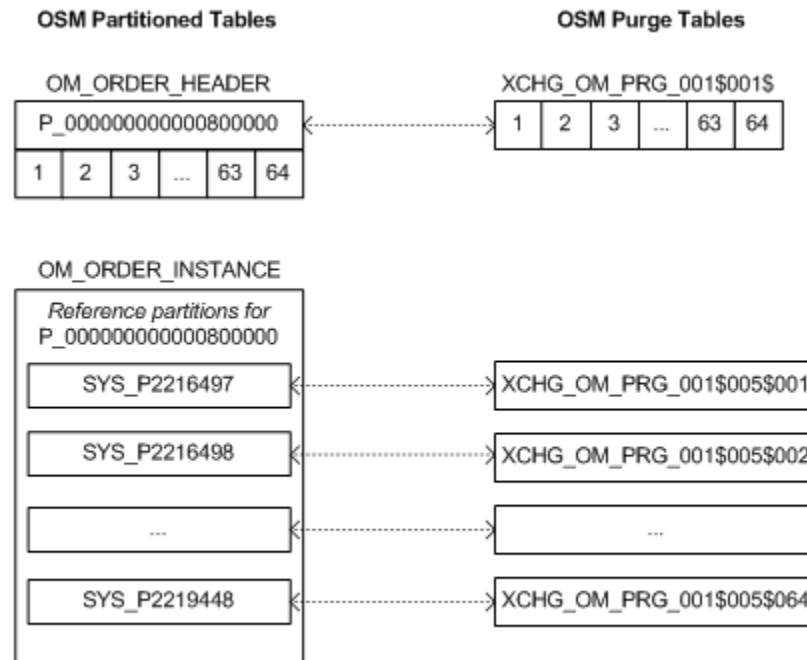

## About OSM Backup Tables

Backup tables are used for making a backup of orders to be retained before purging a partition. Orders are restored from the backup tables after the partition is purged. The structure of each backup table is similar to the structure of the corresponding partitioned table. Backup tables are always hash-partitioned in order to enable parallel inserts.

OSM creates a single set of backup tables, one for each partitioned table (whereas the number of purge tables depends on the purge capacity). The format of a backup table name is `XCHG_OM_BCK_`*xchg\_table\_id*, where:

- *xchg\_table\_id* is the OSM-generated exchange table ID (formatted to 3 digits). This is identical to the exchange table ID used for purge tables.
- `XCHG_OM_BCK_` allows quick identification of backup tables.

## Creating Exchange Tables (Online or Offline)

You must manually create exchange tables using the `om_part_maintain.setup_xchg_tables` procedure after you install the OSM schema. You must re-create them after upgrades, schema import, and after any ad hoc schema changes.

For more information see "[om\\_part\\_maintain.setup\\_xchg\\_tables \(Online or Offline\)](#)."

### Example

If you want to exchange 3 partitions without having to purge exchange tables, run the **om\_part\_maintain.setup\_xchg\_tables** procedure as shown below. The procedure creates one set of backup tables and 3 sets of purge tables.

```
execute om_part_maintain.setup_xchg_tables(3);
```

## Purging Exchange Tables (Online or Offline)

Eventually, you must reclaim the storage for exchanged partitions. You can do this with the **om\_part\_maintain.purge\_xchg\_prg\_tables** procedure, which executes a TRUNCATE TABLE statement for each purge table with the DROP STORAGE option to reclaim the space. For more information see "[om\\_part\\_maintain.purge\\_xchg\\_prg\\_tables \(Online or Offline\)](#)."

It is not necessary to purge backup tables. These are purged automatically immediately after all order data is restored with the REUSE STORAGE option to retain the space of deleted rows. If you want to purge the backup tables without restoring orders, or if you want to reclaim their space, you can do this with the "[om\\_part\\_maintain.purge\\_xchg\\_bck\\_tables \(Online or Offline\)](#)" procedure.

## Dropping Exchange Tables (Online or Offline)

You can drop exchange tables with the **om\_part\_maintain.drop\_xchg\_tables** procedure. By default, OSM automatically drops exchange tables before re-creating them.

For more information, see "[om\\_part\\_maintain.drop\\_xchg\\_tables \(Online or Offline\)](#)."

## Estimating Partition Disk Space (Online or Offline)

Beginning with 7.2.2.4, the function **estimate\_ptn\_purged\_space** returns the estimated amount of disk space (in bytes) that could be reclaimed by purging or dropping partitions. You can use this function to estimate:

- The amount of space that could be reclaimed during a maintenance window.
- The amount of space consumed by a partition, including global indexes.
- The average order size in a partition.

The **estimate\_ptn\_purged\_space** function simulates a purge execution and determines the total numbers of bytes used by successive partitions that qualify for purging. The following valuable information about the purge simulation is available in the DBMS output:

The partitions that qualify for purging and whether they are purged entirely or partially.

- Number of orders purged.
- Number of orders retained.
- Average size of an order (bytes).
- Estimated amount of space used by retained orders (bytes).
- Estimated amount of space reclaimed (bytes).

Consider the following when executing the **estimate\_ptn\_purged\_space** function:

- Exchange tables must be created before calling this function.
- This function can be executed offline or online.
- This function assumes that you will execute **purge\_partitions** with arguments **a\_drop\_empty\_ptns** and **a\_purge\_xchg\_prg\_tables** set to true.
- The average order size is used to calculate the space used by retained orders. If retained orders are not typical sized orders the estimate returned from this function may not closely match the actual space reclaimed.

#### Example (Estimate the space that could be reclaimed in a maintenance window):

Consider an OSM schema with partitions P\_00000000001000001, P\_00000000002000001 and P\_00000000003000001. The following statement estimates the space that could be reclaimed if partitions P\_00000000001000001 and P\_00000000002000001 were purged of all orders that were closed more than 30 days ago.

```
declare
begin
  dbms_output.put_line('Space Reclaimed(bytes):' ||
om_part_maintain.estimate_ptn_purged_space(
  a_delete_before=> trunc(sysdate)-30,
  a_order_states=>om_new_purge_pkg.v_closed_orders,
  a_order_id_lt=>2000001,
  a_order_id_ge=>1));
end;
```

#### Example (Estimate the space consumed by a partition):

Consider an OSM schema with partitions P\_00000000001000001, P\_00000000002000001, and P\_00000000003000001. The following statement estimates the space consumed by the first two partitions (including their share of global indexes).

```
declare
begin
  dbms_output.put_line('Partition size:' ||
om_part_maintain.estimate_ptn_purged_space(
  a_delete_before=> om_const_pkg.v_no_date,
  a_order_states=>om_new_purge_pkg.v_all_orders,
  a_order_id_lt=>2000001,
  a_order_id_ge=>1));
end;
```

## Managing Cartridges

The main components to a deployed cartridge are:

- The static cartridge metadata that is populated in the OSM database when the cartridge is deployed or redeployed. This data does not grow or change when orders are created or processed. Cartridge metadata is loaded into the OSM server at startup and re-loaded when cartridges are deployed.
- The dynamic order data that is populated in the OSM database whenever an order is created and as it is being processed.

 **Note:**

OSM does not create ear files for automation plug-ins. The WebLogic server console does not display automation plug-in ear files. Use the console logs to debug issues.

Your primary goals should be to minimize the memory needs and startup time of OSM and to deploy, redeploy, and undeploy cartridges quickly online. Because cartridge metadata consumes relatively little space in the database, purging cartridge metadata is not a major concern.

Cartridge metadata consumes memory resources and takes time to initialize on startup. You can minimize the memory needs and startup time of OSM by undeploying old cartridges that are no longer required from the run-time production environment.

To undeploy and redeploy cartridges quickly online, use Fast Undeploy instead of conventional undeploy.

## Using Fast Undeploy

A cartridge can be undeployed when all associated orders are closed. There are two ways to undeploy a cartridge:

- Using conventional undeploy, which removes from the database both the cartridge metadata and all associated orders. This operation can be extremely expensive if you have a large volume of order data.
- Beginning with OSM 7.2.0.9, a new Fast Undeploy option is provided to rapidly undeploy a cartridge without removing the cartridge metadata and the associated order data from the database. When an OSM cartridge is undeployed using Fast Undeploy, OSM behaves the same as if the cartridge was undeployed using a conventional undeploy, that is, as if the cartridge and associated orders do not exist. The benefit of Fast Undeploy is that it allows the undeploy operation to complete quickly regardless of the number of orders that may have been created against that cartridge. Fast Undeploy is the default undeploy mode.

Oracle strongly recommends that you use Fast Undeploy instead of conventional undeploy. This enables you to undeploy unwanted cartridges quickly while offloading data purge to regular partitioned-based or row-based order purge, based on your data retention policies and maintenance schedule. This is useful both in development and production environments.

When you redeploy a cartridge, you have the option to undeploy the cartridge first. If you deployed the cartridge using fast undeploy, this operation is called a fast redeploy because the cartridge is fast undeployed before it is redeployed.

Fast Undeploy removes cartridges from the OSM WebLogic domain only. You must later remove undeployed cartridges from the database. For performance reasons, it is recommended that you remove undeployed cartridges only after all associated orders have been purged. Because cartridge metadata consumes relatively little space in the database, this can be an infrequent operation.

## Purging Metadata of Undeployed Cartridges

A cartridge that was undeployed using Fast Undeploy has UNDEPLOYED status in the database. Use the following statement to query the database for undeployed cartridges:

```
select * from om_cartridge where status = 'UNDEPLOYED';
```

To purge all cartridges that were undeployed using Fast Undeploy, use the following statement:

```
exec om_cartridge_pkg.drop_obsolete_cartridges;
```

You can run this procedure when OSM is online or offline. This procedure does not purge any cartridges associated with orders and it does not purge any component cartridges unless all associated solution cartridges are also selected for purge. The DBMS output displays the cartridges that were purged and, for those cartridges with an UNDEPLOYED status but not purged, the reason the procedure did not purge the cartridge. For more information about DBMS output, see "[DBMS Output](#)."

To purge a single undeployed cartridge, use the following statement:

```
exec om_cartridge_pkg.drop_cartridge(cartridge_id);
```

You can run this procedure only when OSM is offline.

## Configuration Parameters

The following configuration parameters affect partition maintenance operations. These parameters are defined in the **om\_parameter** table.

### Note:

You can override the parameters marked with (\*) for a specific partitioning realm in the partitioning realm configuration file. OSM persists partitioning realm-specific parameters in the **om\_partitioning\_realm\_param** table. For more information, see "[Partitioning Realms](#)."

- Parameters in the **om\_parameter** table:
  - \* **range\_partition\_size**
  - **subpartitions\_number**
  - **default\_xchg\_capacity**
  - **xchg\_retained\_orders\_thres**
  - **degree\_of\_parallelism**
  - **degree\_of\_parallelism\_rebuild\_indexes**
  - **degree\_of\_parallelism\_rebuild\_xchg\_indexes**
  - **purge\_job\_class**
  - **parallel\_execute\_chunk\_size**



- **partition\_auto\_creation**
- **purge\_policy\_rebuild\_unusable\_indexes**
- **purge\_policy\_purge\_related\_orders\_independently**
- **purge\_policy\_consolidate\_partitions**
- **purge\_policy\_time\_to\_close\_wait**
- **purge\_audit\_retention\_days**
- **purge\_commit\_count**
- **deferred\_segment\_creations** (Oracle Database initialization parameter)

## range\_partition\_size

This parameter is present in both the **om\_partitioning\_realm\_param** table and **om\_parameter** table. The value in **om\_partitioning\_realm\_param** is specific to a partitioning realm and takes precedence over the value in table **om\_parameter**. This parameter specifies the size of new partitions.

The initial value in the **om\_parameter** table for this parameter is specified during installation. You can change it with the following SQL statement, where N is the new value (for example 100000):

```
update om_parameter
set value = N
where mnemonic = 'range_partition_size';
commit;
```

Updates to this parameter do not affect existing partitions. The upper bound of a new partition is the greatest partition upper bound plus the value of this parameter.

The value of this parameter in table **om\_partitioning\_realm\_param** is inserted and updated by changes in partitioning realm configuration xml. Refer the Partitioning Realm section for details.

## subpartitions\_number

Specifies the number of hash sub-partitions. You choose the initial value of this parameter during installation. You can change it with the following SQL statement, where N is the new value (for example, 32).

```
update om_parameter
set value = N
where mnemonic = 'subpartitions_number';
commit;
```

Updates to this parameter do not affect existing partitions. If you change this parameter and you use **om\_part\_maintain.purge\_partitions** for purging, you must re-execute **om\_part\_maintain.setup\_xchg\_tables** when it is time to purge partitions that were added after the change. This is because the number of hash partitions of the purge tables must match the number of hash sub-partitions of the range partitions to be purged.

## default\_xchg\_capacity

Specifies the default purge capacity if **om\_part\_maintain.setup\_xchg\_tables** is called with an unspecified capacity. If it is not configured, the default is 3.

## xchg\_retained\_orders\_thres

If the number of orders to be excluded from purging in a partition exceeds this threshold, the partition cannot be purged for performance reasons. The default is 10000. You can override the default in the **om\_parameter** table.

## degree\_of\_parallelism

Specifies the default degree of parallelism for statements that are executed in parallel. It applies to queries, DML, and DDL statements. However, the degree of parallelism for rebuilding indexes is configured by the **degree\_of\_parallelism\_rebuild\_indexes** and **degree\_of\_parallelism\_rebuild\_xchg\_indexes** parameters. If this parameter is not specified, the default degree of parallelism is 4.

This parameter is also used for recreating global partitioned indexes when the RECREATE GLOBAL policy is used. However, the degree of parallelism for rebuilding index partitions is configured by the **degree\_of\_parallelism\_rebuild\_indexes** and **degree\_of\_parallelism\_rebuild\_xchg\_indexes** parameters. For more information, see "[purge\\_policy\\_rebuild\\_unusable\\_indexes](#)." You can use the "[om\\_part\\_maintain.set\\_dop \(Online or Offline\)](#)" procedure to set this parameter.

For more information, see "[Parallel Execution](#)."

## degree\_of\_parallelism\_rebuild\_indexes

Specifies the default degree of parallelism for rebuilding index partitions of OSM tables except exchange tables. If this parameter is not specified, the default degree of parallelism is 2. This is less than the default value for **degree\_of\_parallelism** because you cannot rebuild an entire partitioned index with a single statement. You must rebuild each partition or sub-partition, which contains only a fraction of the data. Therefore the overhead of increased parallelism may have negative impact on rebuild performance. For example, performance tests might show that an optimal value for **degree\_of\_parallelism** is 32 whereas the optimal value for **degree\_of\_parallelism\_rebuild\_indexes** is only 4.

You can use the "[om\\_part\\_maintain.set\\_dop\\_rebuild\\_indexes \(Online or Offline\)](#)" procedure to set this parameter.

The degree of parallelism for rebuilding indexes of exchange tables is configured with the **degree\_of\_parallelism\_rebuild\_xchg\_indexes** parameter.

## degree\_of\_parallelism\_rebuild\_xchg\_indexes

Specifies the default degree of parallelism for rebuilding index partitions of exchange tables. If this parameter is not specified, the default degree of parallelism is 1. This is because you cannot rebuild an entire partitioned index with a single statement. You must rebuild each partition or sub-partition, which contains only a fraction of the

data. Because the size of exchange indexes is usually small rebuilding them serially is usually faster.

You can use the "[om\\_part\\_maintain.set\\_dop\\_rebuild\\_xchg\\_indexes \(Online or Offline\)](#)" procedure to set this parameter.

## purge\_job\_class

This parameter in the **om\_parameter** table specifies the class for purge jobs. A database job must be part of exactly one class. The default value is `DEFAULT_JOB_CLASS`, which is also the default database job class. If your database is Oracle RAC, jobs in the `DEFAULT_JOB_CLASS` class can run on any node.

If you use a partition purge strategy, restricting purge jobs to a single node significantly improves performance. Specifically, if the jobs that restore retained orders run on all nodes, cluster waits could account for 40% or more of the database time. Cluster waits increase with the degree of parallelism and the number of nodes. You can eliminate cluster waits by restricting job execution on a single node as follows:

1. Create a database service, for example, `OSM_MAINTAIN`, with a single preferred node and any number of available nodes. Refer to Oracle Database documentation for instructions about how to create a service using Oracle Enterprise Manager or `srvctl`.
2. Create a job class, for example, `OSM_MAINTAIN`, and associate it with the new service:

```
exec dbms_scheduler.create_job_class(
    'OSM_MAINTAIN', service => 'OSM_MAINTAIN');
```

3. Grant `EXECUTE` permission on the job class to the OSM user:
4. Grant `execute` on `sys.OSM_MAINTAIN` to `<user>`;
5. Set the **purge\_job\_class** to the job class.

Purge jobs will be spawned on the preferred node for this database service, if it is running; otherwise on an available node.

If you use a row-based order purge strategy, running purge jobs on all nodes does not negatively affect performance. In fact, you may want to distribute the purge load on all nodes. However, if you do not want order purge to compete for resources with order processing, this parameter allows you to run order purge on a different node. For example, if you have an Oracle RAC database with 3 nodes, you could use two nodes for order processing and the third node for continuous order purge.

## parallel\_execute\_chunk\_size

This is an advanced parameter that specifies the chunk size for parallel execution using jobs. For more information, see "[Tuning parallel\\_execute\\_chunk\\_size](#)."

## partition\_auto\_creation

This parameter in the **om\_parameter** table specifies whether OSM is enabled to add a partition automatically when a new order ID does not map to any partition. Valid values are `Y` (enabled) and `N`. Oracle strongly recommends that you plan to add partitions manually and disable automatic creation for all production and performance environments, especially if you use Oracle RAC. Adding partitions online causes high

contention in the database, **resource busy** exceptions and transaction timeouts that could result to failed orders and instability of OSM (especially during a busy period).

## purge\_policy\_rebuild\_unusable\_indexes

This parameter in the `om_parameter` table specifies the default policy for rebuilding unusable indexes. Possible values are:

- **om\_part\_maintain.c\_rebuild\_idx\_recreate\_global** (RECREATE GLOBAL): This means that the preferred method to rebuild a global partitioned index that became unusable after a partition maintenance operation is to drop and recreate the entire index. This is the default, unless the global index is not partitioned, it supports a unique constraint, or OSM is offline. Recreating a global partitioned index scans the table only once and it can be done efficiently with a high degree of parallelism, so it is more efficient and much faster than rebuilding each index partition separately. The default degree of parallelism for recreating global indexes is specified by the **degree\_of\_parallelism** parameter.
- **om\_part\_maintain.c\_rebuild\_idx\_rebuild** (REBUILD): This means that the preferred method to rebuild global partitioned indexes is one partition at a time using ALTER INDEX REBUILD PARTITION. The default degree of parallelism for rebuilding index partitions is specified by the **degree\_of\_parallelism\_rebuild\_indexes** parameter.

## purge\_policy\_purge\_related\_orders\_independently

This parameter in the `om_parameter` table specifies whether orders should be purged independently of any related orders they may have. Valid values are Y (purge independently is enabled) and N (purge independently is disabled). By default, orders are purged independently. For more information, see the purge policy section in "[Purging Related Orders Independently](#)."

 **Note:**

Setting **purge\_policy\_purge\_related\_orders\_independently** to N may add several minutes to the time it takes to purge or drop a partition.

## purge\_policy Consolidate\_partitions

This parameter in the `om_parameter` table specifies the number of partitions to consolidate into a single partition when purging. Valid values are between 1 and 10 and the default value is 3. For example, a value of 5 means the purge procedure can combine the retained orders of up to 5 successive partitions into a single partition and drop the other 4 partitions.

In order for partitions to be consolidated, the following conditions must be satisfied:

- Partitions can be dropped (argument **a\_drop\_empty\_ptns** is true)
- Purging is done offline (argument **a\_online** is false)
- Purge capacity is not exhausted

## purge\_policy\_time\_to\_close\_wait

This purge policy can improve the performance of row-based purges and decrease purge rate fluctuations. The policy specifies a delays time before beginning to purge eligible orders so that the majority of the orders that were created on the same day are closed. The goal is to decrease I/O. For example, if 80% of orders complete in 4 days and the remaining 20% complete slowly over a much longer period, you could set `purge_policy_time_to_close_wait` to 4.

**Example 1 (temporal affinity disabled):** In this example, the retention period is 10 days and the row-based order purge runs daily. The purge procedure runs at 10:30 PM with the `a_order_states` argument set to closed orders only (`v_closed_orders`) and the `a_delete_before` argument set to `sysdate-10` (the current date/time minus 10 days). This purges all orders that were closed 10 days ago before 10:30 PM. If 60% of orders close within the same day and 30% close on the next day before 10:30 PM then 90% of orders close within 2 days.

If temporal affinity is disabled, closed orders are purged as follows. For simplicity, ignore the 10% of orders that are closed slowly over several days and therefore they are purged at a slower rate.

- No orders are purged on days 1 to 10 because they are all either open or in the 10 day retention period.
- Orders purged at 10:30 PM on day 11: All orders that closed before 10:30 PM on day 1 (60% of the orders created on day 1).
- Orders purged at 10:30 PM on day 12: All orders that closed before 10:30 PM on day 2 (60% of the orders created on day 2 and 30% of orders created on day 1).
- Orders purged at 10:30 PM on day 13: All orders that closed before 10:30 PM on day 3 (60% of the orders created on day 3 and 30% of orders created on day 2).
- ...
- Orders purged at 10:30 PM on day N: All orders that closed before 10:30 PM on day N-10 (60% of the orders created on day N-10 and 30% of orders created on day N-11).

**Example 2 (temporal affinity enabled and 90% of the orders closed within 2 days):** In the previous example, if the `purge_policy_time_to_close_wait=1` (1 day), purging would be delayed by one day. 90% of the orders created on a day would be purged at the same time as the orders that were created and closed on the same day. The purge procedure runs at 10:30 PM and the same `a_order_states` and `a_delete_before` settings are configured in the same way as example 1. However, this configuration purges all orders that were created 11 days before 10:30 PM and were closed 10 days before 10:30 PM. The creation date criterion is based on 1 day time-to-close wait and 10 days retention period.

- No orders are purged on days 1 to 10 because they are all either open or in the 10 day retention period.
- No orders purged on day 11: The orders closed on day 1 are out of retention but they have to wait an extra day.
- Orders purged at 10:30 PM on day 12: All orders created before 10:30 PM on day 1 and closed before 10:30 PM on day 2 (90% of the orders created on day 1).

- Orders purged at 10:30 PM on day 13: All orders created before 10:30 PM on day 2 and closed before 10:30 PM on day 3 (90% of the orders created on day 2).
- ...
- Orders purged at 10:30 PM on day N: All orders created before 10:30 PM on day N-11 and closed before 10:30 PM on day N-10 (90% of the orders created on day N-11).

**Example 3 (temporal affinity enabled and 90% of the orders closed within 3 days):** This is similar to the previous example, except that we want a 2 day delay instead of 1 (**purge\_policy\_time\_to\_close\_wait=2**).

- No orders are purged on days 1 to 10 because they are all either open or in the 10 day retention period.
- No orders purged on day 11: The orders closed on day 1 are out of retention but they have to wait.
- No orders purged on day 12: The orders closed on day 1 and 2 are out of retention but they have to wait.
- Orders purged at 10:30 PM on day 13: All orders created before 10:30 PM on day 1 and closed before 10:30 PM on day 3 (90% of the orders created on day 1).
- Orders purged at 10:30 PM on day 14: All orders created before 10:30 PM on day 2 and closed before 10:30 PM on day 4 (90% of the orders created on day 2).
- Orders purged at 10:30 PM on day N: All orders created before 10:30 PM on day N-12 and closed before 10:30 PM on day N-10 (90% of the orders created on day N-12).

## purge\_audit\_retention\_days

This parameter in the **om\_parameter** table specifies the minimum number of days to retain purge audit data. The default is 90 days. OSM automatically purges the audit data after the data exceeds this time limit. For more information, see "[Auditing and Monitoring Order Purges](#)."

## deferred\_segment\_creation

Oracle Database introduced deferred segment creation in 11gR2. If the **deferred\_segment\_creation** initialization parameter is set to true (the default), it forces the database to wait until the first row is inserted into a table/partition before creating segments for that table/partition and its dependent objects. In general, deferred segment creation saves disk space for unused tables/partitions. The main benefit to OSM is that it minimizes the time it takes to create a partition. However, in high volume deployments, especially on Oracle RAC, deferred segment creation can lead to serious performance issues when the database is forced to create the deferred segments of a partition in order to store new orders. This occurs when the previous partition is exhausted. The result is high "library cache lock" waits that could last for an extended period of time (frequently more than 30 minutes). In high volume deployments, it is strongly recommended that you disable deferred segment creation.

To disable deferred segment creation, log in to the database as the SYS user and execute the following statements:

```
alter system set deferred_segment_creation=false scope=both sid='*';  
execute dbms_space_admin.materialize_deferred_segments('<schema_name>');
```

## purge\_commit\_count

Specifies how frequently each purge job issues a commit command. For example, the value 10 means that 10 orders are purged before a commit is done. Unless you perform extensive performance purge tests to determine the optimal value for this parameter, Oracle recommends that you leave it at the default value. If not present, the value 10 is used.

## About PL/SQL API

This section provides an overview of PL/SQL API.

## DBMS Output

It is strongly recommended that you spool DBMS output to a file, especially for partition maintenance operations. The DBMS output includes valuable information for troubleshooting and performance tuning, such as elapsed execution times and error traces.



### Note:

The DBMS output is sent to the client at the end of execution. Oracle Database does not provide any mechanism to flush output during the execution of a procedure.

For example, if you use SQL\*Plus:

```
SQL> set serveroutput on
SQL> spool part_maintain.out
SQL> execute om_part_maintain.drop_partitions(4000000);
SQL> execute om_part_maintain.add_partitions(2);
SQL> spool off;
```

## Specifying Purge Criteria

Order purge procedures allow you to specify the following purge criteria:

**Table 6-3 Order Purge Criteria**

Criteria	Parameters	Partition-Based Purge	Row-Based Order Purge
Order state	<b>a_order_states</b>	Yes	Yes
Order timestamp	<b>a_delete_before</b>	Yes	Yes
Order ID range	<b>a_order_id_lt</b>	Yes	Yes
Order type	<b>a_order_type_mnemonic</b>	No	Yes
Order source	<b>a_order_source_mnemonic</b>	No	Yes

**Table 6-3 (Cont.) Order Purge Criteria**

Criteria	Parameters	Partition-Based Purge	Row-Based Order Purge
Order cartridge	<b>a_namespace_mnemonic</b> <b>a_version_mnemonic</b>	No	Yes

[Table 6-4](#) and [Table 6-5](#) that follow represent order states and pre-defined aggregate order states that can be supplied to purge script. You can choose to supply order state, pre-defined aggregate order state, or a custom aggregate state to purge script. Order states and predefined aggregate order states are defined in the **om\_new\_purge\_pkg** package.

- Example of an order state to purge cancelling orders:  
**om\_new\_purge\_pkg.v\_cancelling\_orders**
- Example of a pre-defined aggregate order state to purge all closed and cancelled orders:  
**om\_new\_purge\_pkg.v\_closed\_or\_cancelled\_orders**
- Example of a custom aggregate order state to purge failed and aborted orders:  
**om\_new\_purge\_pkg.v\_failed\_orders +**  
**om\_new\_purge\_pkg.v\_aborted\_orders**

 **Note:**

While forming a custom aggregate state, ensure the following:

- Use only order state, but not the pre-defined aggregate order states.
- Do not use the same state twice.

[Table 6-4](#) shows the order state constants and their corresponding values.

**Table 6-4 Order State Constants and Values**

Constant	Value
v_completed_orders	1
v_aborted_orders	2
v_not_started_orders	4
v_suspended_orders	8
v_cancelled_orders	16
v_wait_for_revision_orders	32
v_failed_orders	64
v_waiting_orders	128
v_in_progress_orders	256
v_amending_orders	512



**Table 6-4 (Cont.) Order State Constants and Values**

Constant	Value
v_cancelling_orders	1024

Table 6-5 shows the pre-defined aggregate order states and their corresponding values.

**Table 6-5 Predefined Aggregate Order States and Values**

Constant	Value
v_closed_orders	3 (v_completed_orders + v_aborted_orders)
v_closed_or_cancelled_orders	19 (v_completed_orders + v_aborted_orders + v_cancelled_orders)
v_not_running_orders	252 (v_waiting_orders + v_failed_orders + v_wait_for_revision_orders + v_cancelled_orders + v_suspended_orders + v_not_started_orders)
v_compensating_orders	1536 (v_cancelling_orders + v_amending_orders)
v_running_orders	1792 (v_compensating_orders + v_in_progress_orders)
v_open_orders	2044 (v_running_orders + v_not_running_orders)
v_all_orders	2047 (v_open_orders + v_closed_orders)

The **a\_delete\_before** parameter allows you to further narrow the purge criteria based on the order timestamp (for example, you might want to retain closed orders for at least 30 days). Table 6-6 shows which timestamp in the **om\_order\_header** table is compared to **a\_delete\_before** depending on **a\_order\_states** and the order status.

**Table 6-6 Order Purge Based on Timestamp, Order State, and Order Status**

a_order_states	Order Status	Timestamp
v_all_orders	N/A	a_ord_creation_date
v_closed_orders	7 (complete) or 9 (aborted)	a_ord_completion_date
v_completed_orders	7	a_ord_completion_date
v_aborted_orders	9	a_ord_completion_date
v_suspended_orders	2	a_ord_txn_completion_date
v_cancelled_orders	3	a_ord_txn_completion_date
v_in_progress_orders	4	a_ord_txn_completion_date
v_amending_orders	5	a_ord_txn_completion_date
v_cancelling_orders	6	a_ord_txn_completion_date
v_wait_for_revision_orders	8	a_ord_txn_completion_date
v_failed_orders	10	a_ord_txn_completion_date
v_not_started_orders	1 (not started)	a_ord_creation_date

## Parallel Execution

The **om\_part\_maintain** API performs many operations in parallel:

- Parallel queries and most DML and DDL statements are executed in parallel using parallel servers, which apply multiple CPU and I/O resources to the execution of a single database operation. Examples include copying orders into the backup tables and rebuilding unusable indexes.
- Some operations are executed in parallel using the **dbms\_parallel\_execute** package, which divides work into chunks processed in parallel by database jobs. Row-based order purge and the restore stage of **purge\_partitions** are performed this way. If your database is Oracle RAC, it is recommended that you create a database job class to restrict job execution on a single node to eliminate cluster waits. For more information, see "[purge\\_job\\_class](#)."

Procedures that support parallelism use the **a\_parallelism** parameter, which allows you to specify the desired degree of parallelism for those statements that can be executed in parallel.

The degree of parallelism can be:

- Greater than 1: Statements that can be executed in parallel are executed with the specified degree of parallelism.
- 1: All statements are executed serially.
- 0: The degree of parallelism is computed by the database and it can be 2 or greater. Statements that can be executed in parallel always run in parallel.
- Less than 0: The degree of parallelism is computed by the database and it can be 1 or greater. If the computed degree of parallelism is 1, the statement runs serially. Indexes are always rebuilt in parallel.

If you leave **a\_parallelism** unspecified, OSM uses the default parallelism configured by these parameters:

- **degree\_of\_parallelism**
- **degree\_of\_parallelism\_rebuild\_indexes**
- **degree\_of\_parallelism\_rebuild\_xchg\_indexes**

## Concurrency Restrictions

Exchange table, partition management, and purge procedures acquire an exclusive user lock to prevent concurrent execution of other management procedures, which could result in unrecoverable errors. Each OSM schema uses a different lock specifically for this package. The lock is released automatically at the end of execution. The database also releases user locks automatically when a session terminates.

Specifically, the following procedures acquire an exclusive lock to prevent concurrent execution:

- **setup\_xchg\_tables**
- **drop\_xchg\_tables**
- **purge\_xchg\_prg\_tables**

- **purge\_partitions**
- **drop\_empty\_partitions**
- **drop\_partitions**
- **add\_partition** and **add\_partitions**
- **equipartition**
- **purge\_orders**
- **select\_orders**
- **purge\_selected\_orders**
- **resume\_purge**

## PL/SQL API Reference

The PL/SQL API provides procedures and functions for:

- Setup and tuning
- Maintenance
- Troubleshooting and recovery

### Setup and Tuning Procedures

This section provides information about setup and tuning PL/SQL API procedures.

#### om\_part\_maintain.setup\_xchg\_tables (Online or Offline)

This procedure creates exchange tables for purging partitions with **om\_part\_maintain.purge\_partitions**.

```
procedure setup_xchg_tables(
    a_xchg_purge_capacity natural default null,
    a_tablespace varchar2 default null,
    a_force boolean default false,
    a_subpartition_count_override positive default null) ;
```

If you purge partitions, you must create exchange tables after a new installation and each time you upgrade the schema. If the exchange tables are not up to date, **om\_part\_maintain.purge\_partitions** reports an error. If you only drop partitions, exchange tables are not required.

This procedure first calls **drop\_xchg\_tables** to drop all existing exchange tables and reclaim space. If **a\_force** is false and an exchange table is not empty, it throws an exception. Upon successful completion, it sets the **sys\$xchg\_purge\_capacity** and **sys\$xchg\_purge\_seq** system parameters to the purge capacity and 1, respectively (in the **om\_parameter** table).

The parameters are:

- **a\_xchg\_purge\_capacity**: Specifies the exchange capacity in the range 0-999. If it is not specified, it uses the value of the **default\_xchg\_capacity** parameter configured in the **om\_parameter** table. If **default\_xchg\_capacity** is not set, the default capacity is 3. If the specified capacity is 0 then it creates backup tables

but not purge tables. If the specified or configured capacity is illegal, it throws an exception.

- **a\_tablespace**: Specifies the tablespace where you want the exchange tables to be created. If you do not specify it, the database default tablespace is used.
- **a\_force**: Specifies whether existing exchange tables should be dropped even if they are non-empty. If this is false and an exchange table is not empty, an exception is thrown. In this case, exchange tables are left in an inconsistent state (new exchange tables are not created but existing exchange tables might be partially dropped).
- **a\_subpartition\_count\_override**: Specifies the number of hash partitions for exchange tables. Oracle Database does not allow a range-hash partition to be exchanged with the hash-partitioned table if the number of hash partitions of the range partition and the table do not match. By default, the number of hash partitions of the exchange tables for **om\_order\_header** is the same as the number of hash sub-partitions of the oldest **om\_order\_header** partition. If you need to purge partitions with a different number of hash sub-partitions (because you changed the `subpartitions_number` parameter), re-execute **setup\_xchg\_tables** and supply the right value for this parameter.

## om\_part\_maintain.drop\_xchg\_tables (Online or Offline)

This procedure drops all exchange tables. It is executed automatically when you execute **setup\_xchg\_tables**.

```
procedure drop_xchg_tables(a_force boolean default false) ;
```

The implementation first purges exchange metadata. Specifically, it purges the **om\_xchg\_table** table, and sets **sys\$xchg\_purge\_capacity** and **sys\$xchg\_purge\_seq** in the **om\_parameter** table to 0.

The DROP TABLE statements are executed with the PURGE option, so the space is released immediately (you cannot recover the exchange tables from the recycle bin).

If **a\_force** is false and an exchange table is not empty, it throws an exception. In this case exchange tables are left in an inconsistent state.

## om\_part\_maintain.set\_dop (Online or Offline)

This procedure sets the **degree\_of\_parallelism** parameter in the **om\_parameter** table to the specified degree of parallelism.

```
procedure set_dop(a_parallelism binary_integer);
```

## om\_part\_maintain.set\_dop\_rebuild\_indexes (Online or Offline)

This procedure sets the **degree\_of\_parallelism\_rebuild\_indexes** parameter in the **om\_parameter** table to the specified degree of parallelism.

```
procedure set_dop_rebuild_indexes(a_parallelism binary_integer);
```

## om\_part\_maintain.set\_dop\_rebuild\_xchg\_indexes (Online or Offline)

This procedure sets the **degree\_of\_parallelism\_rebuild\_xchg\_indexes** parameter in the **om\_parameter** table to the specified degree of parallelism.

```
procedure set_dop_rebuild_xchg_indexes(a_parallelism binary_integer);
```

## Maintenance Procedures and Functions

This section provides information about maintenance procedures and functions.

### om\_part\_maintain.add\_partition (Offline Only)

This procedure adds a single partition.

```
procedure add_partition(a_tablespace varchar2 default null,
                       a_realm_mnemonic varchar2 default null,
                       a_force boolean default false);
```

The implementation is equivalent to this call:

```
add_partitions(1, a_tablespace);
```

### om\_part\_maintain.add\_partitions (Offline Only)

This procedure adds one or more partitions. At the end, it also rebuilds any unusable indexes as a precaution (normally indexes should remain usable).

```
procedure add_partitions(
    a_count positiven,
    a_tablespace varchar2 default null,
    a_realm_mnemonic varchar2 default null,
    a_force boolean default false);
```

The upper bound of each new partition is the greatest partition upper bound plus the value of the **range\_partition\_size** parameter. If found, the **range\_partition\_size** for the realm is used (found in table **om\_partitioning\_realm\_param**). If not found, the **range\_partition\_size** in table **om\_parameter** is used. The upper bound is used in the partition name. For example, if the new partition's upper bound is 100,000, the partition name is P\_000000000000100000 (always formatted to 18 characters).

This procedure inserts a new row into table **om\_order\_id\_block** to represent the range of **order\_seq\_ids** for the new partition. In addition to the order ID range, the order ID block contains the status (for example, **AVAILABLE** for the newly added partition), the dbinstance (-1 until the block changes to **ACTIVE**), and the partitioning realm associated with the block.

You must run this procedure offline. Running this procedure online causes high contention in the database and transaction timeouts that could result in failed orders and instability of OSM.

The parameters are:

- **a\_count**: The number of partitions to add.
- **a\_tablespace**: The tablespace for the new partitions. This procedure modifies the default tablespace attribute of partitioned tables with the specified tablespace before adding partitions. If you do not specify the tablespace or the input argument is null, each partition is created on the default tablespace of the partitioned table (for example, on the same tablespace as the most recently added partition).
- **a\_realm\_mnemonic**: The partitioning realm mnemonic (case-insensitive) that the new partition belongs to. If the value is **null**, the partition is assigned to the

**default\_order** realm. If the realm is disabled, an error occurs; you can ignore this error by entering **true** in the **a\_force** argument.

- **a\_force**: If the value of this parameter is **true**, partitions can be added for disabled realms. This is useful because partitioning realms are often created in a disabled state, therefore partitions can be added for the realm before enabling the partitioning realm.

**Dropping newly added partitions**: If you want to drop several new partitions, perhaps because you want to re-create them (for example, with a different number of hash sub-partitions and/or on a different tablespace) or because you inadvertently added a large number of partitions, you can drop those partitions that are still empty using **drop\_empty\_partitions**.

## om\_part\_maintain.drop\_partitions (Offline only)

```
procedure drop_partitions(
    a_order_id_lt number,
    a_order_id_ge integer default null,
    a_parallelism_rebuild_indexes binary_integer default null) ;
```

This procedure drops partitions that satisfy the following conditions:

- The order IDs mapped to this partition are within the specified range.
- All orders are either closed (complete or aborted) or canceled.
- If the **om\_parameter\_purge\_policy\_purge\_related\_orders\_independently** is set to 'N' and the partition contains orders with related open orders, the partition cannot be dropped. For more information, see the purge policy section in "[Purging Related Orders Independently](#)."
- The partition belongs to a partitioning realm with a purge strategy of **PARTITION-BASED** or **ANY**. For more information, see the purge strategy section in "[Partitioning Realms](#)."

More precisely:

- It disables all foreign keys that reference the partitioned tables.
- It drops partitions that satisfy the aforementioned conditions. However, if all partitions satisfy those conditions, the partition with the greatest upper bound is not dropped. Oracle Database requires that a partitioned table have at least one partition. For example, if you have only one partition, you cannot use **drop\_partitions** to reclaim space. In this case, use **om\_part\_maintain.purge\_partitions**.
- It re-enables the disabled foreign keys (with NOVALIDATE, for performance reasons).
- It rebuilds unusable indexes and index partitions in parallel.
- It deletes any remaining order data that references orders in the partitions dropped.

Oracle recommends that you back up the OSM schema prior to executing this procedure.

This procedure must be executed offline.

The parameters are:

- **a\_order\_id\_lt**: Specifies a non-inclusive upper bound for the range of order IDs mapped to the partitions to be dropped. If it is not null then only partitions with an upper bound less than or equal to this value are considered. (The upper bound of a partition is non-inclusive, that is, the order IDs mapped to that partition are strictly less than its upper bound.)
- **a\_order\_id\_ge**: Specifies an inclusive lower bound for the range of order IDs mapped to the partitions to be dropped. If it is not null then only partitions with a lower bound greater than or equal to this value are considered. (The lower bound of a partition is the upper bound of the previous partition, if any; otherwise 1.)
- **a\_parallelism\_rebuild\_indexes**: Specifies the degree of parallelism for rebuilding unusable indexes. It is recommended that you leave it null. The implementation will choose the optimal method for each unusable index depending on the index type and configuration parameters. For more information, see ["purge\\_policy\\_rebuild\\_unusable\\_indexes."](#)

## om\_part\_maintain.drop\_empty\_partitions (Online or Offline)

This procedure drops empty partitions with mapped order IDs within the specified range.

```
procedure drop_empty_partitions(
    a_order_id_lt integer default null,
    a_order_id_ge integer default null);
```

This procedure is similar to **drop\_partitions** except that:

- It ignores non-empty partitions. It exits when it encounters a partition with an upper bound greater than **a\_order\_id\_lt**.
- It does not delete data from non-partitioned tables. It assumes it is already deleted.
- It does not disable foreign keys.
- It can be executed online. However, in this case you might experience high contention due to exclusive locks acquired by Oracle Database. Oracle recommends that you execute this procedure either offline or off-peak.

If all partitions are empty and within the specified range, the partition with the greatest upper bound are not dropped. This is because Oracle Database requires that each partitioned table have at least one partition.

The parameters are:

- **a\_order\_id\_lt**: Specifies a non-inclusive upper bound for the range of order IDs mapped to the partitions to be dropped. If it is not null then only partitions with an upper bound less than or equal to this value can be dropped. (The upper bound of a partition is non-inclusive, that is, the order IDs mapped to that partition are strictly less than its upper bound.)
- **a\_order\_id\_ge**: Specifies an inclusive lower bound for the range of order IDs mapped to the partitions to be dropped. If it is not null then only partitions with a lower bound greater than or equal to this value can be dropped. (The lower bound of a partition is the upper bound of the previous partition, if any; otherwise 1.)

Exceptions:

- **ORA-20166**: There is another in-progress maintenance operation.

- **ORA-20170:** Failed to suspend database jobs.
- **ORA-20171:** OSM is running.

**Example (dropping empty partitions after a purge):** Assume that **purge\_partitions** left some partitions empty as shown in the table below.

```
select partition_name, high_value
from user_tab_partitions
where table_name = 'OM_ORDER_HEADER'
order by partition_name;
```

**Table 6-7 Example: Dropping Empty Partitions**

PARTITION_NAME	HIGH_VALUE	Empty?
P_000000000000100001	100001	Yes
P_000000000000200001	200001	--
P_000000000000300001	300001	Yes
P_000000000000400001	400001	Yes
P_000000000000500001	500001	--

The following statement drops P\_000000000000100001, ignores P\_000000000000200001, drops P\_000000000000300001, and stops at P\_000000000000400001 because the upper bound of this partition is greater than 300001:

```
execute om_part_maintain.drop_empty_partitions(300001);
```

**Example (dropping newly added partitions):** Suppose you want to drop several new partitions, perhaps because you want to re-create them (for example, with a different number of hash sub-partitions and/or on a different tablespace) or because you inadvertently added a large number of partitions. Specifically, assume that you want to drop partitions P\_000000000000600001, P\_000000000000700001 and P\_000000000000800001 shown in the table below.

**Table 6-8 Example: Dropping Newly Added Partitions**

PARTITION_NAME	HIGH_VALUE	Mapped Order IDs	Empty?
P_000000000000200001	200001	1-200000	--
P_000000000000400001	400001	200001-400000	Yes
P_000000000000500001	500001	400001-500000	--
P_000000000000600001	600001	500001-600000	Yes
P_000000000000700001	700001	600001-700000	Yes
P_000000000000800001	800001	700001-800000	Yes

Execute the following statement:

```
execute om_part_maintain.drop_empty_partitions(
    a_order_id_ge => 500001);
```



## om\_part\_maintain.purge\_partitions (Online or Offline)

```

procedure purge_partitions(
    a_online           boolean,
    a_delete_before   date,
    a_order_states    integer default om_new_purge_pkg.v_closed_orders
    a_order_id_lt     integer default null,
    a_order_id_ge     integer default null,
    a_stop_date       date default om_const_pkg.v_no_date,
    a_drop_empty_ptns boolean default true,
    a_purge_xchg_prg_tables boolean default false,
    a_parallelism     binary_integer default null) ;

```

This procedure purges the partitions that satisfy these conditions:

- If executed online:
  - All of the orders are either closed (complete or aborted) or canceled.
  - All of the contained orders satisfy the purge criteria specified by the **a\_delete\_before** and **a\_order\_states** arguments.
  - All of the contained order IDs are within the purge range specified by **a\_order\_id\_lt** and **a\_order\_id\_ge**. The range of mapped order IDs does not need to be a subset of the specified range. What matters is the range of actual order IDs.
- If executed offline:
  - Some or all of the contained orders satisfy the purge criteria specified by the **a\_delete\_before** and **a\_order\_states** arguments.
  - Some or all of the contained order IDs are within the purge range specified by **a\_order\_id\_lt** and **a\_order\_id\_ge**. The range of mapped order IDs does not need to be a subset of the specified range. What matters is the range of actual order IDs.
  - The number of orders to be excluded from purging (for example, those orders that do not satisfy the previous two conditions) does not exceed the threshold specified by the **xchg\_retained\_orders\_thres** parameter.
  - The partition belongs to a partitioning realm with a purge strategy of **PARTITION-BASED** or **ANY**. For more information, see the purge strategy section in "[Partitioning Realms](#)."

Oracle recommends that you back up the OSM schema prior to executing this procedure and that you gather statistics after you finished purging.

If you execute this procedure online, you might experience high contention due to exclusive locks acquired by Oracle Database. Oracle recommends that you execute this procedure either offline or off-peak.

If you execute this procedure offline, you can purge a partition that contains orders that do not satisfy the purge criteria as long as the number of retained orders in that partition does not exceed the threshold specified by the **xchg\_retained\_orders\_thres** parameter. In this case, the retained orders are copied to the backup tables prior to the exchange operation and they are restored (copied again) into the partitioned tables after the exchange operation. Because these are relatively expensive operations, the threshold ensures that they will complete in a timely fashion. Both backup and restore are executed in parallel as specified by the **a\_parallelism** argument.

If this procedure is executed offline, it disables foreign keys. This is necessary when purging partitions with retained orders. Disabling foreign keys is unsafe to do when the OSM application is online as it can result in data integrity violations. Therefore disabling foreign keys requires OSM be offline until they are re-enabled.

Partitions are purged one by one end-to-end, that is, from all partitioned tables. For example, if you want to purge partitions P\_00000000001000001, P\_00000000002000001, and P\_00000000003000001 then P\_00000000001000001 will be purged first from all partitioned tables, then P\_00000000002000001 and so on.

This procedure can consolidate retained orders from multiple partitions into a single partition, to maximize reclaimed space, reduce the number of partitions, and minimize downtime. This is done by purging successive partitions in iterations. The maximum number of partitions consolidated in each iteration is limited by the parameter **purge\_policy\_consolidate\_partitions**. More precisely, this procedure purges successive partitions that qualify for purging as follows:

1. Copies the orders that do not satisfy the purge criteria from those partitions into the backup tables. This is a relative fast operation because it is performed in parallel and the backup tables have few indexes and constraints.
2. Purges each partition entirely by exchanging it with purge tables. This is a fast operation because EXCHANGE PARTITION only updates metadata in the data dictionary.
3. Drops N-1 of those partitions. This is a fast operation because the partitions are now empty.
4. Restores the retained orders from the backup tables into the Nth partition with their order IDs unchanged. This is also performed in parallel using the **dbms\_parallel\_execute** package. However, this step is slower than backup because the partitioned tables have more indexes and constraints.

The EXCHANGE PARTITION operation is performed with the following options:

- **INCLUDING INDEXES**: This means that local index partitions or subpartitions are also exchanged. This ensures that local indexes remain usable during the exchange, for example, they do not have to be rebuilt.
- **WITHOUT VALIDATION**: By default, the exchange operation is performed **WITH VALIDATION**, which means that Oracle Database returns an error if any rows in the exchange table do not map into partitions or subpartitions being exchanged. This check is unnecessary when the exchange table is empty.
- If this procedure is executed online and the table has global indexes that enforce unique constraints then the exchange is performed with the following options:
  - **UPDATE GLOBAL INDEXES**: This means that global indexes are updated during the exchange and therefore remain usable. Otherwise, unusable global indexes that enforce unique constraints would result in ORA-01502 exceptions. (By default, unusable global indexes that do not enforce unique constraints are ignored and therefore are not an issue – this is controlled by the **SKIP\_UNUSABLE\_INDEXES** initialization parameter. Therefore, if a table has no such global indexes or if this procedure is executed offline, rebuilding unusable global indexes is deferred for performance reasons.)
  - **PARALLEL**: This means that global indexes are updated in parallel for performance reasons. It does not alter the global indexes to parallel.

After each partition is purged end-to-end, the **sys\$*xchg\_purge\_seq*** counter in the **om\_parameter** table increments to the next logical exchange partition. When the logical exchange partition exceeds the purge capacity, this counter cycles to 1.

The procedure exits when:

- Time expires.
- It encounters a partition with a lower bound greater than or equal to the upper bound of the specified range.
- The number of hash sub-partitions of the next **om\_order\_header** partition is different than the number of partitions of the corresponding exchange table. The number of hash partitions of each exchange table is the same as the same number of hash sub-partitions of the oldest partition of the corresponding range-hash partitioned table. If newer partitions have a different number of hash sub-partitions (because you changed the `subpartitions_number` parameter) then you will not be able to purge the newer partitions until you drop the older partitions and re-execute **setup\_xchg\_tables**.

All disabled constraints are re-enabled at the end (with `NOVALIDATE` for performance reasons).

The parameters are:

- **a\_online**: Specifies whether this procedure is being executed online. If it is true, it ignores partitions with open orders and partitions with orders that do not satisfy the purge criteria (only entire partitions can be purged online).
- **a\_delete\_before**: Only orders with a timestamp older than this date and time are eligible for purging. For more information, see "[Specifying Purge Criteria](#)."
- **a\_order\_states**: Only orders with one of these states are eligible for purging. By default, only closed orders are eligible for purging. For more information, see "[Specifying Purge Criteria](#)."
- **a\_order\_id\_lt** and **a\_order\_id\_ge**: If **a\_order\_id\_ge** is not null then only orders with order ID greater than or equal to this value are eligible for purging. If **a\_order\_id\_lt** is not null then only orders with order ID less than to this value are eligible for purging. If **a\_order\_id\_lt** is null, it will be defaulted to the non-inclusive upper bound of the latest used partition. (This ensures that new empty partitions beyond the currently active partition are not dropped accidentally.) If a partition contains both order IDs in this range and outside this range then the partition cannot be purged unless the out-of-range orders can be retained (for example, the purge is done offline and the total number of retained orders in that partition does not exceed the threshold specified by the **xchg\_retained\_orders\_thres** parameter).
- **a\_stop\_date**: If it is not null then the procedure exits when the date and time are reached. This is done on a best-effort basis, since a premature exit could leave data in inconsistent state. The time is checked periodically. The elapsed time between checks could be as high as the time it takes to purge as many partitions as the spare purge capacity. Only non-critical deferrable operations are skipped when the time expires, such purging exchange tables.
- **a\_drop\_empty\_ptns**: Specifies whether empty partitions should be dropped. The default is true, since dropping empty partitions is a fast operation. In this case, this procedure can purge as many successive partitions at a time as the spare capacity, which reduces the time it takes to restore orders and therefore downtime.

If this argument is false, each partition to be purged must go through the backup-purge-restore process separately.

- **a\_purge\_xchg\_prg\_tables:** Specifies whether exchange tables should be purged as well. If it is true then it purges exchange tables, as long as time has not expired and at least one partition was purged. This is a relatively slow operation, so the default is false. In this case, the number of partitions that can be purged by a single execution of this procedure is limited by the space purge capacity.
- **a\_parallelism:** Specifies the degree of parallelism for backup and restore operations. If it is null, it uses the parallelism configured by the **degree\_of\_parallelism** parameter. For more information, see "[Parallel Execution](#)."

**Exceptions:** This procedure performs a number of checks to ensure it can proceed with purge. If a check fails, it throws one of the following exceptions:

- **ORA-20142:** The schema is not equi-partitioned. Execute the equi-partition procedure.
- **ORA-20160:** The schema is not partitioned. You can only use this procedure if your schema is partitioned.
- **ORA-20162:** There are no exchange tables. Execute the **setup\_xchg\_tables** procedure.
- **ORA-20163:** The exchange tables are not up-to-date. This means that the schema has been upgraded after the exchange tables were created. Re-execute the **setup\_xchg\_tables** procedure.
- **ORA-20166:** There is another in-progress maintenance operation.
- **ORA-20170:** Failed to suspend database jobs.
- **ORA-20171:** The procedure was executed with **a\_online=false** and it detected that OSM is running.

**Example (purge all orders that were closed at least 180 days ago):** Suppose you want to purge all complete or aborted orders that were closed at least 180 days ago. Assuming that most partitions contain some orders that do not satisfy these criteria, you decided to execute **purge\_partitions** offline. You also want to defer dropping empty partitions and purging the exchange tables until the system is restarted. This is how you can do it:

```
begin
  om_part_maintain.purge_partitions(
    a_online => false,
    a_delete_before => trunc(sysdate) - 180,
    a_order_states => om_new_purge_pkg.v_closed_orders,
    a_drop_empty_ptns => false,
    a_purge_xchg_prg_tables => false,
    a_parallelism => 4) ;
end;
```

**Example (ignore old partitions that contain only a few orders):** This example adds to the scenario of the previous example. Assume that old partitions with non-inclusive upper bound up to 5600000 contain a small number of orders that can be purged but cannot be purged entirely (for example, because they still contain open orders). Purging those partitions would be unproductive, since it could exhaust the exchange capacity. Therefore you decided to use the **a\_order\_id\_ge** parameter to ignore them for now:

```

begin
  om_part_maintain.purge_partitions(
    a_online => false,
    a_delete_before => trunc(sysdate) - 180,
    a_order_states => om_new_purge_pkg.v_closed_orders,
    a_order_id_ge => 5600000,
    a_drop_empty_ptns => false,
    a_purge_xchg_prg_tables => false,
    a_parallelism => 4) ;
end;

```

## om\_part\_maintain.purge\_entire\_partition (Online or Offline)

```

procedure purge_entire_partition(
  a_online          boolean,
  a_partition_name  varchar2,
  a_purge_xchg_prg_tables boolean default false,
  a_purge_orphan_data boolean default true) ;

```

This procedure purges the given partition entirely (all orders). The partition is not dropped. The following two calls are equivalent, assuming that the partition size is 100000:

```

execute om_part_maintain.purge_entire_partition(
  a_online => true,
  a_partition_name => 'P_000000000000400001');

execute om_part_maintain.purge_partitions(
  a_online => true,
  a_delete_before => om_const_pkg.v_no_date,
  a_order_states => om_new_purge_pkg.v_all_orders,
  a_order_id_lt => 400001,
  a_order_id_le => 300001,
  a_stop_date => null,
  a_drop_empty_ptns => false);

```

### Parameters:

- **a\_online:** Specifies whether this procedure is being executed online. If this parameter is true, it ignores partitions with open orders and partitions with orders that do not satisfy the purge criteria (only entire partitions can be purged online).
- **a\_partition\_name:** The name of the partition to purge.
- **a\_purge\_xchg\_prg\_tables:** Specifies whether exchange tables should be purged as well. If this parameter is true, it purges exchange tables, as long as time has not expired and at least one partition was purged. This is a relatively slow operation, so the default is false. In this case, the number of partitions that can be purged by a single execution of this procedure is limited by the space purge capacity.
- **a\_purge\_orphan\_data:** Specifies whether you want orphan data to be purged after the partition is purged. The default is true. You may want to defer purging of orphan data if you used **om\_part\_maintain.backup\_selected\_ords** to manually backup selected orders, which you plan to restore with **om\_part\_maintain.restore\_orders**.

## om\_part\_maintain.estimate\_ptn\_purged\_space (Online or Offline)

```
function estimate_ptn_purged_space(          a_delete_before date,
a_order_states integer default om_new_purge_pkg.v_closed_orders,
a_order_id_lt integer default null,        a_order_id_ge integer default
null)return number;
```

This function estimates amount of disk space (in bytes) that is reclaimed by purging or dropping partitions.

This function simulates the execution of **om\_part\_maintain.purge\_partitions**, therefore refer to the purge partitions API reference for a description of the parameters, exit conditions, and possible exceptions.

**Example (estimate the space reclaimed by purging all orders that were closed at least 180 days ago):**

```
declarebeginbms_output.put_line('Space Reclaimed (bytes): '||om_part_maintain.
estimate_ptn_purged_space(          a_delete_before => trunc(sysdate) -
180,          a_order_states => om_new_purge_pkg.v_closed_orders)) ;end;
```

**Example (estimate the space reclaimed by dropping partitions):** The following example shows how to estimate the space reclaimed by dropping all partitions with an upper bound less than or equal to 300001. Note that the **a\_delete\_before** and **a\_order\_states** parameters have been set to values that include all orders in the partition.

```
declarebeginbms_output.put_line('Space Reclaimed (bytes): '||
om_part_maintain. estimate_ptn_purged_space(          a_delete_before
=> om_const_pkg.v_no_date,          a_order_states =>
om_new_purge_pkg.v_all_orders,          a_order_id_lt => 300001)) ;end;
```

## om\_part\_maintain.purge\_xchg\_bck\_tables (Online or Offline)

```
procedure purge_xchg_bck_tables(a_drop_storage boolean default false);
```

This procedure purges all exchange backup tables. Normally you do not need to execute this procedure because backup tables are purged automatically when all order data is restored. The implementation executes TRUNCATE TABLE, so purged data cannot be restored. If **a\_drop\_storage** is true, backup tables are truncated with the DROP STORAGE option to reclaim space. Otherwise, they are truncated with the REUSE STORAGE option to retain the space from the deleted rows. If you never reclaim the space, its size is limited by the largest volume of order data copied into the backup tables. By default, space is reused for performance reasons and in order to minimize downtime: First, inserts are more efficient if space is already allocated. Second, purging the backup tables is faster if space is reused.

## om\_part\_maintain.purge\_xchg\_prg\_tables (Online or Offline)

```
procedure purge_xchg_prg_tables;
```

This procedure purges all exchange purge tables to reclaim space. It does not purge backup tables. The implementation executes TRUNCATE TABLE ... DROP STORAGE, so purged data cannot be restored.

## om\_new\_purge\_pkg.delete\_order (Online or Offline)

```
procedure delete_order(a_order_seq_id integer);
```

This procedure unconditionally deletes the given order from the database. Note that this procedure does not issue commit, in contrast to most purge procedures. It is the responsibility of the user to issue commit or rollback.

This operation is audited.

## om\_new\_purge\_pkg.purge\_orders (Online or Offline)

```
procedure purge_orders(
    a_status          out integer,
    a_delete_before   date,
    a_order_states    integer,
    a_stop_date       date      default om_const_pkg.v_no_date,
    a_order_id_lt     integer default null,
    a_order_id_ge     integer default null,
    a_order_source_mnemonic varchar2 default null,
    a_order_type_mnemonic varchar2 default null,
    a_namespace_mnemonic varchar2 default null,
    a_version_mnemonic varchar2 default null,
    a_cartridge_id    integer default null,
    a_commit_count    integer default null,
    a_parallelism     binary_integer default null);
```

This procedure purges orders that satisfy the given criteria. It is the main implementation of row-based order purge. Orders are purged by database job. The procedure finds the order Ids that satisfy the purge criteria, inserts them into the **OM\_ORDER\_ID\_FOR\_PURGE** staging table, splits them into chunks, and distributes the chunks to database jobs for parallel purge. Each chunk is processed by deleting one order at a time with periodic commits. This approach ensures that a) an order is either purged entirely or not at all and b) a purge may succeed partially even in the event of errors.

This operation is audited.

Executing this procedure is equivalent to executing **select\_orders** and **purge\_selected\_orders**. However, **purge\_orders** always starts a new purge by clearing the **OM\_ORDER\_ID\_FOR\_PURGE** staging table, whereas **select\_orders** only adds orders Ids to the staging table.

[Table 6-9](#) describes the possible outcomes. The **a\_status** output parameter is set accordingly.

**Table 6-9 Possible Outcomes**

Outcome	a_status	OM_ORDER_ID_FOR_PURGE
No orders satisfy the purge criteria.	om_new_purge_pkg.v_status_nopurge	Empty
The purge finished successfully and all orders that satisfied the purge criteria were purged.	om_new_purge_pkg.v_status_finished	Cleared

Table 6-9 (Cont.) Possible Outcomes

Outcome	a_status	OM_ORDER_ID_F OR_PURGE
The purge finished with errors (some orders were not purged). This procedure throws an exception. Note that this procedure retries purging of failed chunks a few times. An exception means that the retries also failed (or only partially succeeded). You can run <b>resume_purge</b> to retry.	N/A	Contains all order Ids that satisfy the purge criteria.
The purge finished prematurely because the expiration date specified by <b>a_stop_date</b> was reached.	om_new_purge_pkg.v_status_expired	Cleared
The purge was stopped by the user (using <b>stop_purge</b> ), and it can be resumed using <b>resume_purge</b> .	om_new_purge_pkg.v_status_stopped	Contains all order Ids that satisfy the purge criteria.

Parameters:

- **a\_status**: Returns the purge status.
- **a\_delete\_before**: Only orders with a timestamp older than this date and time are eligible for purging. See "[Specifying Purge Criteria](#)" for more information.
- **a\_order\_states**: Only orders with one of these states are eligible for purging. See "[Specifying Purge Criteria](#)" for more information.
- **a\_stop\_date**: The end of the purge window. If it is not null then the procedure exits when this date and time are reached. The time is checked after each order delete.
- **a\_order\_id\_lt** and **a\_order\_id\_ge**: If **a\_order\_id\_ge** is not null, only orders with order ID greater than or equal to this value are eligible for purging. If **a\_order\_id\_lt** is not null then only orders with order ID less than this value are eligible for purging. If either of these is set to **om\_new\_purge\_pkg.v\_ptn\_scope\_latest**, the purge scope is restricted to the latest partition(s) where new orders are created.
- **a\_order\_source\_mnemonic**: If it is not null, only orders with this order source are eligible for purging. Wildcards are not supported.
- **a\_order\_type\_mnemonic**: If it is not null, only orders with this order type are eligible for purging. Wildcards are not supported.
- **a\_namespace\_mnemonic**: If it is not null, only orders in this cartridge namespace are eligible for purging. Wildcards are not supported.
- **a\_version\_mnemonic**: This is used in combination with **a\_namespace\_mnemonic**. If it is not null, only orders in the specified cartridge namespace and version are eligible for purging. Wildcards are not supported.
- **a\_cartridge\_id**: If it is not null, only orders in the specified cartridge are eligible for purging.
- **a\_parallelism**: Specifies the degree of parallelism (the number of database jobs performing the purge). If it is null, it uses the parallelism configured by the



**degree\_of\_parallelism** parameter. If it is 1, the purge is executed serially (with a single database job). See "[Parallel Execution](#)" for more information.

- **a\_commit\_count**: Specifies how often each job should issue a commit command. Unless you performed extensive performance purge tests to determine the optimal value for this parameter, it is recommended that you leave it **null**. If the value is **null**, the job uses the commit count that is configured in the **purge\_commit\_count** parameter.

**Example:** The following execution purges orders with a time limit of 15 minutes and a parallelism of 8. The purge criteria specify all orders that were closed 30 days ago or more.

```
declare
    v_status integer;
begin
    om_new_purge_pkg.purge_orders(
        a_status=>v_status,
        a_stop_date => sysdate + 15/24/60, -- 15m
        a_delete_before=>trunc(sysdate) - 30,
        a_order_states=> om_new_purge_pkg.v_closed_orders,
        a_parallelism => 8);
end;
```

## om\_new\_purge\_pkg.schedule\_order\_purge\_job (Online or Offline)

```
procedure schedule_order_purge_job(
    a_start_date          date,
    a_delete_before       date,
    a_order_states        integer,
    a_stop_date           date      default om_const_pkg.v_no_date,
    a_order_id_lt         integer default null,
    a_order_id_ge         integer default null,
    a_order_source_mnemonic varchar2 default null,
    a_order_type_mnemonic varchar2 default null,
    a_namespace_mnemonic  varchar2 default null,
    a_version_mnemonic    varchar2 default null,
    a_cartridge_id        integer default null,
    a_commit_count        integer default null,
    a_parallelism         binary_integer default null);
```

This procedure schedules an execution of **purge\_orders** using the **dbms\_job** package. The **a\_start\_date** parameter specifies the start date and time.

## om\_new\_purge\_pkg.select\_orders (Online or Offline)

```
procedure select_orders(
    a_selected_count      out integer,
    a_delete_before       date,
    a_order_states        integer,
    a_order_id_lt         integer default null,
    a_order_id_ge         integer default null,
    a_order_source_mnemonic varchar2 default null,
    a_order_type_mnemonic varchar2 default null,
    a_namespace_mnemonic  varchar2 default null,
    a_version_mnemonic    varchar2 default null,
    a_cartridge_id        integer default null);
```

This procedure inserts into the staging table **OM\_ORDER\_ID\_FOR\_PURGE** the order Ids that satisfy the given purge criteria. This is useful when you cannot identify all

orders to be purged in a single execution of **purge\_orders**, and you do not want to execute multiple purges. In this case:

- You can populate **OM\_ORDER\_ID\_FOR\_PURGE** piecemeal by executing **select\_orders** several times with different purge criteria. You can also insert or delete order Ids from this table manually.
- After you finish populating this table, execute **purge\_selected\_orders**.

Parameters:

- **a\_selected\_count**: Returns the number of order Ids inserted into **OM\_ORDER\_ID\_FOR\_PURGE** by this call. This count ignores order Ids that were already inserted into this table, even if they match the given purge criteria.
- The rest of the parameters specify the purge criteria and they are the same as in **purge\_orders**.

**Example:** The following selects for purge all orders in cartridge namespace X that were closed 7 days ago and reside on the latest partition(s) (where new orders are created).

```
declare
  v_status integer;
  v_selected_count integer;
begin
  om_new_purge_pkg.select_orders(
    a_selected_count=>v_selected_count,
    a_delete_before=>trunc(sysdate) - 7,
    a_order_states=>om_new_purge_pkg.v_closed_orders,
    a_order_id_ge=>om_new_purge_pkg.v_ptn_scope_latest,
    a_namespace_mnemonic => 'X');
end;
```

## om\_new\_purge\_pkg.purge\_selected\_orders (Online or Offline)

```
procedure purge_selected_orders(
  a_status      out integer,
  a_purged_count out integer,
  a_stop_date   date default om_const_pkg.v_no_date,
  a_commit_count number default null,
  a_parallelism binary_integer default null);
```

This procedure purges the orders specified in the staging table **OM\_ORDER\_ID\_FOR\_PURGE**. It works like **purge\_orders** except that the purge criteria are not supplied (the orders are already selected).

You can also use this procedure to restart a stopped purge with different parameters (for example, if you want to change the time when the purge window ends or the degree of parallelism).

See "[om\\_new\\_purge\\_pkg.purge\\_orders \(Online or Offline\)](#)" for possible outcomes.

This operation is audited.

Parameters:

- **a\_status**: Returns the purge status.
- **a\_purged\_count**: The number of orders purged.

- **a\_stop\_date**: The end of the purge window. If it is not null then the procedure exits when this date and time are reached. The time is checked after each order delete.
- **a\_commit\_count**: Specifies how often each job should issue a commit command. Unless you performed extensive performance purge tests to determine the optimal value, Oracle recommends that you leave it **null**. If it is **null**, it uses the commit count value that is configured in the **purge\_commit\_count** parameter.
- **a\_parallelism**: Specifies the degree of parallelism (the number of database jobs performing the purge). If it is null, it uses the parallelism configured by the **degree\_of\_parallelism** parameter. If it is 1, the purge is executed serially (with a single database job). See "[Parallel Execution](#)" for more information.

## om\_new\_purge\_pkg.stop\_purge (Online or Offline)

```
procedure stop_purge;
```

This procedure stops the current order purge if one is running. This procedure call returns when the purge stops, which normally takes a few seconds.

Later you can resume the same purge by running **resume\_purge**, restart the purge with different parameters by running **purge\_selected\_orders** (for example, if you want to change the time when the purge window ends or the degree of parallelism), or start a new purge.

## om\_new\_purge\_pkg.resume\_purge (Online or Offline)

```
procedure resume_purge(
    a_stop_date date default null,
    a_commit_count number default null,
    a_parallelism binary_integer default null);
```

This procedure resumes a stopped order purge or an order purge that finished with errors.

If you do not supply any arguments or if the given arguments are the same as those of the initial purge operation, this procedure resumes processing of existing chunks that are either unassigned or finished processing with errors, using the same degree of parallelism. If you do supply new or changed arguments, this procedure regenerates chunks allows you to change certain parameters of the purge operation. For example:

- You can resume a stopped the purge operation with the **a\_stop\_date** parameter if you want to change the end of the purge window.
- You can resume a stopped purge operation with the **a\_parallelism** parameter if you want to lower the degree of parallelism of an online purge operation (for example, due to an unexpected increase in order volume).

Parameters:

- **a\_stop\_date**: This parameter specifies the end of the purge window. If it is null, the initial value supplied to the purge operation remains in effect.
- **a\_commit\_count**: This parameter specifies how often each job should commit. If it is null, the initial value supplied to the purge operation remains in effect.
- **a\_parallelism**: This parameter specifies the degree of parallelism (the number of database jobs performing the purge). If it is null, the initial value supplied to the purge operation remains in effect.

 **Note:**

Do not use `resume_purge` to expand the scope of a purge. **resume\_purge** does not regenerate order ID chunks and any order IDs that fall outside the range of existing unassigned chunks are not be purged. If you want to expand the scope of a purge, add order IDs to **OM\_ORDER\_ID\_FOR\_PURGE** and run **purge\_selected\_orders** instead.

## Advanced Procedures

This section provides information about advanced procedures.

### om\_part\_maintain.backup\_selected\_orcls (Offline)

```
procedure backup_selected_orcls(
    a_parallelism binary_integer default null);
```

The **purge\_partitions** procedure inspects each partition in the given range and inserts into the **OM\_ORDER\_ID\_FOR\_BACKUP** table the order IDs of the orders that do not satisfy the purge criteria. The specified orders are copied into the backup tables and they are restored after the partitions are purged. The **backup\_selected\_orcls** and **restore\_orders** procedures allow you to do the same for arbitrary order IDs, for example, if you want to retain orders for a particular cartridge.

 **Note:**

This procedure does not modify data in partitioned tables.

**Example:** The following example shows how to purge partition P\_000000000000400001 but retain all orders in the HSI cartridge. Error handling is omitted for simplicity. Note that orphan data is purged after orders are restored, which is the reason why the **a\_purge\_orphan\_data** argument of **purge\_entire\_partition** is false.

```
declare
    v_jobs_suspended dbms_sql.number_table;
begin
    om_job_pkg.disable_suspend_jobs(60, v_jobs_suspended) ;
    insert into om_order_id_for_backup
        (select h.order_seq_id
         from om_cartridge c,
              om_order_header partition (P_000000000000400001) h
         where c.namespace_mnemonic = 'HSI'
              and h.cartridge_id = c.cartridge_id
        );
    om_part_maintain.backup_selected_orcls(a_parallelism=>4);
    om_part_maintain.purge_entire_partition(
        a_online => false,
        a_partition_name => 'P_000000000000400001',
        a_purge_orphan_data => false);
    om_part_maintain.restore_orders(a_parallelism=>4);
    om_part_maintain.purge_orphan_order_data();
```

```
om_job_pkg.enable_resume_jobs(v_jobs_suspended);  
end;
```

## om\_part\_maintain.restore\_orders (Offline)

This procedure restores orders from the backup tables into the partitioned tables, and purges the backup tables.

```
procedure restore_orders(  
    a_parallelism binary_integer default null);
```

Normally you do not have to use this procedure because **purge\_partitions** restores orders automatically. However, it might be needed for recovery purposes, as discussed in the "[Troubleshooting and Error Handling](#)" section. It can also be used in conjunction with **backup\_selected\_orcs** to exclude arbitrary order IDs from a purge.

## Troubleshooting Functions

This sections provides information about troubleshooting functions.

### om\_part\_maintain.get\_partitions (Online or Offline)

This function returns all **om\_order\_header** range partitions as well as any partitions missing from **om\_order\_header** (if the schema is not equi-partitioned).

```
function get_partitions return om_t_order_partitions;
```

The returned information includes the table name, partition name, number of subpartitions, tablespace name, and partition upper bound. If the table name is not **OM\_ORDER\_HEADER**, the specified partition is missing. This function is useful for troubleshooting.

### om\_part\_maintain.is\_equipartitioned (Online or Offline)

This function tells whether the schema is equi-partitioned and returns missing partitions.

```
function is_equipartitioned(  
    a_missing_ptns out om_t_order_partitions)  
return boolean;
```

It returns false if the number of range partitions differs from table to table or the schema is not partitioned. The implementation does not compare the number of subpartitions.

If number of range partitions differs from table to table, this could be the result of interrupted or failed attempts to add or drop partitions. If the schema is not equi-partitioned, EXCHANGE PARTITION cannot be used for purging partitions; therefore **om\_part\_maintain.purge\_partitions** returns right away. In this case, use **om\_part\_maintain.equipartition** to partition your schema.

## Recovery Procedures

This section provides information about recovery procedures.

## om\_part\_maintain.equipartition (Offline only)

This procedure equi-partitions the schema by adding the partitions in the specified collection that are missing from the schema.

```
procedure equipartition(  
    a_missing_ptns in om_t_order_partitions default null);
```

Partitions are added through ALTER TABLE ADD PARTITION and ALTER TABLE SPLIT PARTITION operations. It throws an exception if the schema is not partitioned.

Parameters:

- **a\_missing\_ptns**: The missing partitions to be added. If it is null, the procedure calls **is\_equipartitioned** to find all missing partitions.

Exceptions:

- **ORA-20166**: There is another in-progress maintenance operation.
- **ORA-20170**: Failed to suspend database jobs.
- **ORA-20171**: OSM is running.

**Error handling**: After you resolve the issue, re-execute this procedure.

## om\_part\_maintain.purge\_orphan\_order\_data (Online or Offline)

```
procedure purge_orphan_order_data;
```

This procedure is not part of regular maintenance operations. It purges orphan order data from tables that are not range-partitioned (specifically, order data with an order ID that is less than the minimum order ID in **om\_order\_header**). Orphan data could be the result of a failed execution of **purge\_partitions** or **drop\_partitions**.

## om\_part\_maintain.rebuild\_unusable\_indexes (Online or Offline)

```
procedure rebuild_unusable_indexes(  
    a_table_name_like varchar2 default 'OM_%',  
    a_parallelism binary_integer default null,  
    a_online boolean default true,  
    a_preferred_method varchar2 default null);
```

```
procedure rebuild_unusable_indexes(  
    a_indexes dbms_sql.varchar2s,  
    a_parallelism binary_integer default null,  
    a_online boolean default true,  
    a_preferred_method varchar2 default null);
```

These procedures rebuild unusable indexes, and unusable index partitions and sub-partitions. They are called automatically by other procedures that may leave indexes in an unusable state, especially global indexes, such as **drop\_partitions**, **purge\_partitions**, and **equipartition**.

Parameters:

- **a\_table\_name\_like**: Restricts the scope of the operation to indexes of the specified table name(s). You may use wildcards. The default is OM\_% (for example, exchange tables are ignored).

- **a\_indexes**: The names of the indexes to be rebuilt.
- **a\_parallelism**: Specifies the degree of parallelism. Indexes are altered back to NOPARALLEL afterward they are rebuilt. It is recommended that you leave it null. The implementation will choose the optimal method for each unusable index depending on the index type and configuration parameters. For more information see **purge\_policy\_rebuild\_unusable\_indexes**.
- **a\_online**: Tells whether indexes should be rebuilt online in order to avoid failure from contention.
- **a\_preferred\_method**: The preferred rebuild method. Valid values are:
  - **om\_part\_maintain.c\_rebuild\_idx\_rebuild** (REBUILD)
  - **om\_part\_maintain.c\_rebuild\_idx\_recreate\_global** (RECREATE GLOBAL).
 For more information see **purge\_policy\_rebuild\_unusable\_indexes**.

## om\_part\_maintain.rebuild\_index (Online or Offline)

```
procedure rebuild_index(
    a_index_name varchar2,
    a_parallelism binary_integer default null,
    a_online boolean default true,
    a_preferred_method varchar2 default null,
    a_only_if_unusable boolean default true);
```

This procedure rebuilds the specified index.

Parameters:

- **a\_index\_name**: The index name.
- **a\_parallelism**: Specifies the degree of parallelism. The index is altered back to NOPARALLEL afterward it is rebuilt. It is recommended that you leave it null. The implementation will choose the optimal method depending on the index type and configuration parameters. For more information see **purge\_policy\_rebuild\_unusable\_indexes**.
- **a\_online**: Tells whether the index should be rebuilt online in order to avoid failure from contention.
- **a\_preferred\_method**: The preferred rebuild method. Valid values are:
  - **om\_part\_maintain.c\_rebuild\_idx\_rebuild** (REBUILD)
  - **om\_part\_maintain.c\_rebuild\_idx\_recreate\_global** (RECREATE GLOBAL).
 For more information see **purge\_policy\_rebuild\_unusable\_indexes**.

## om\_part\_maintain.sys\$undo\_restore\_table (Offline)

This is an internal procedure that should be used strictly for recovery purposes.

```
procedure sys$undo_restore_table(
    a_table_name          varchar2,
    a_parallelism binary_integer default null);
```

 **Note:**

This is an internal procedure that should be used strictly for recovery purposes.

If **om\_part\_maintain.purge\_partitions** fails while restoring retained orders into a partitioned table, the procedure automatically invokes **om\_part\_maintain.sys\$undo\_restore\_table** to delete the partially restored rows from that table. This leaves the table in a clean state and prevents unique key violations when another restore attempt is made. The **OM\_SQL\_POINTER** table shows the error and points to the line in **OM\_SQL\_LOG** where execution failed. That line includes a call to **om\_part\_maintain.sys\$restore\_table** with the name of a partitioned table as input argument. If you have any doubts whether all the partially restored data was deleted from that table successfully, execute **om\_part\_maintain.sys\$undo\_restore\_table** manually.

## om\_part\_maintain.sys\$undo\_restore\_orders (Offline)

```
procedure sys$undo_restore_orders(
    a_parallelism binary_integer default null);
```

This procedure invokes **om\_part\_maintain.sys\$undo\_restore\_table** for each partitioned table to delete all the order data that was restored from the backup tables. This is a slow operation because it uses DELETE statements. But it might be necessary if **purge\_partitions** fails because there is an issue with the data to be restored from the backup tables. In this case you must call **om\_part\_maintain.sys\$undo\_restore\_orders**, fix the data in the backup tables, and finally restore the orders. This procedure has no effect if the backup tables were purged. For more information, see "[Troubleshooting and Error Handling](#)."

## Database Reference

The following sections provide information about database views and database tables.

### Database Views

The following sections provide information about database audit views.

#### OM\_AUDIT\_PURGE\_ALL

The **OM\_AUDIT\_PURGE\_ALL** view returns information about all order purges in descending order (the latest purge is returned first).

[Table 6-10](#) lists and describes the columns in the **OM\_AUDIT\_PURGE\_ALL** table.

**Table 6-10 OM\_AUDIT\_PURGE\_ALL Table**

Column	Datatype	NULL	Description
PURGE_SEQ_ID	NUMBER(18)	NOT NULL	The system-generated unique ID assigned to the purge operation.



Table 6-10 (Cont.) OM\_AUDIT\_PURGE\_ALL Table

Column	Datatype	NULL	Description
OPERATION_NAME	VARCHAR(64)	NOT NULL	The name of the operation (for example, <b>om_new_purge_pkg.purge_orders</b> )
STATUS	VARCHAR2(20)	NOT NULL	The purge status. <ul style="list-style-type: none"> <li>STARTED: This short-lived initial status occurs when the purge operation is selecting the orders to be purged.</li> <li>RUNNING: This status occurs when the purge operation is purging the orders.</li> <li>STOPPED: This status occurs when the <b>om_new_purge_pkg.stop_purge</b> stops a purge operation.</li> <li>EXPIRED: This status occurs when the purge exceeds the end of the purge window specified by the <b>a_stop_date</b> argument.</li> <li>FINISHED: This status occurs when the purge finishes successfully. All orders that satisfy the purge criteria are purged.</li> <li>FINISHED_WITH_ERROR: This status occurs when the purge finishes with some errors. Some orders that satisfy the purge criteria are not purged.</li> <li>FAILED: This status occurs when the purge failed. No orders are purged.</li> <li>NO_PURGE: This status occurs when no order satisfies the purge criteria.</li> </ul>
START_DATE	DATE	NOT NULL	The start date and time of the purge.
PURGE_DURATION_MINUTES	NUMBER(9)	NOT NULL	The purge run time in minutes. If the purge status is STARTED or RUNNING, this duration includes the current elapsed time, for example, since the purge was started or last resumed. This behavior is unlike the PURGE_DURATION_SECS column of the underlying <b>OM_AUDIT_PURGE</b> table, where the current elapsed time is not included.
EST_OR_ACTUAL_END_DATE	DATE	N/A	The actual or estimated end date and time. If the purge is completed (for example, with status FINISHED, FINISHED_WITH_ERROR or FAILED), the actual end date and time appears. Otherwise the estimated date and time appears based on the purge rate and the purge status: <ul style="list-style-type: none"> <li>STARTED: The estimated date and time is NULL because the purge rate is unknown.</li> <li>RUNNING: The end date and time is estimated based on the number of orders to be purged and the current purge rate. The estimated date and time may exceed the end of the purge window, if specified.</li> <li>STOPPED: The estimated date and time is calculated as if the status is RUNNING. In other words, it tells you when the purge would finish if you resumed it immediately. (This is useful if you need to find out whether it would finish before a certain time.)</li> </ul>
PURGE_WINDOW_END_DATE	DATE	N/A	The end of the purge window as specified by the <b>a_stop_date</b> argument of the purge procedure.

Table 6-10 (Cont.) OM\_AUDIT\_PURGE\_ALL Table

Column	Datatype	NULL	Description
STOPPED_DATE	DATE	N/A	The last date and time when the purge was stopped.
RESUMED_DATE	DATE	N/A	The last date and time when the purge was resumed.
SELECTED_ORDER_COUNT	NUMBER(9)	NOT NULL	The number of orders selected for purge.
SELECTED_ORDER_PURGE_COUNT	NUMBER	NOT NULL	The number of orders selected for purge that have been purged so far (cascaded deletes are excluded).
PERCENT_COMPLETE	NUMBER	NOT NULL	The completion percent based on SELECTED_ORDER_COUNT and SELECTED_ORDER_PURGED_COUNT.
ORDERS_PURGED_PER_MINUTE	NUMBER	NOT NULL	The purge rate per minute.
ORDERS_INJECTED_PER_MINUTE	NUMBER	NOT NULL	The rate per minute that orders are created in OSM while the order purge executes. This value allows you to identify any purge overlaps with high order volume periods.
PARALLELISM	NUMBER	NOT NULL	The effective purge degree of parallelism. You can specify this value on the operation using the optional <b>a_parallelism</b> argument. If the argument is null, the purge procedures uses the parallelism configured by the <b>degree_of_parallelism</b> parameter. If <b>degree_of_parallelism</b> is not set, the default parallelism is 4.
ERROR_MESSAGE	VARCHAR2(4000)	N/A	The reason of failure if the purge failed or finished with errors.

## OM\_AUDIT\_PURGE\_LATEST

The **OM\_AUDIT\_PURGE\_LATEST** views is identical the **OM\_AUDIT\_PURGE\_ALL** view except that it returns information only about the latest purge (see "[OM\\_AUDIT\\_PURGE\\_ALL](#)"). This view is useful for monitoring.

## Database Tables

The following sections provide information about audit related database tables.

### OM\_AUDIT\_PURGE

The **OM\_AUDIT\_PURGE** table describes each order purge. Each audited purge operation adds a record to this table to monitor the purge operation as soon as the purge starts.

[Table 6-11](#) describes the **OM\_AUDIT\_PURGE** table. This table is partitioned by **START\_DATE**. Each partition corresponds to a different month.

Table 6-11 OM\_AUDIT\_PURGE Table

Column	The system-generated unique ID assigned to the purge operation.	NULL	Description
PURGE_SEQ_ID	The name of the operation (for example, <b>om_new_purge_pkg.purge_orders</b> )	NOT NULL	A system-generated unique ID assigned to the purge operation.
OPERATION_NAME	VARCHAR2(64)	NOT NULL	The name of the purge operation (for example, <b>om_new_purge_pkg.purge_orders</b> ).
STATUS	VARCHAR2(20)	NOT NULL	The purge status. <ul style="list-style-type: none"> <li>STARTED: This short-lived initial status occurs when the purge operation is selecting the orders to be purged.</li> <li>RUNNING: This status occurs when the purge operation is purging the orders.</li> <li>STOPPED: This status occurs when the <b>om_new_purge_pkg.stop_purge</b> stops a purge operation.</li> <li>EXPIRED: This status occurs when the purge exceeds the end of the purge window specified by the <b>a_stop_date</b> argument.</li> <li>FINISHED: This status occurs when the purge finishes successfully. All orders that satisfy the purge criteria are purged.</li> <li>FINISHED_WITH_ERROR: This status occurs when the purge finishes with some errors. Some orders that satisfy the purge criteria are not purged.</li> <li>FAILED: This status occurs when the purge failed. No orders are purged.</li> <li>NO_PURGE: This status occurs when no order satisfies the purge criteria.</li> </ul>
START_DATE	DATE	NOT NULL	The start date and time of the purge.
PURGE_DURATION_SECONDS	NUMBER(9)	NOT NULL	The purge execution time in seconds. This value is updated when the purge completes. If the status is RUNNING, it does not include the elapsed time because the purge is started or resumed. If the purge was stopped and resumed, it includes the total execution time excluding idle periods.
INJECTED_ORDER_COUNT	NUMBER(9)	NOT NULL	The number of orders injected while the purge was running online. This value helps identify any purge overlaps with high order volume periods.
SELECTED_ORDER_COUNT	NUMBER(9)	NOT NULL	The number of orders selected for purge.
END_DATE	DATE	N/A	The date when the purge ended. This is set when the status is FINISHED, FINISHED_WITH_ERROR, EXPIRED or FAILED.

Table 6-11 (Cont.) OM\_AUDIT\_PURGE Table

Column	The system-generated unique ID assigned to the purge operation.	NULL	Description
STOP_REQUESTED_DATE	DATE	N/A	The last date and time when the user submitted a purge stop request.
STOPPED_DATE	DATE	N/A	The last date and time when the purge was stopped.
RESUMED_DATE	DATE	N/A	The last date and time when the purge was resumed.
ERROR_MESSAGE	VARCHAR2(4000)	N/A	The reason of failure if the purge failed or finished with errors.

## OM\_AUDIT\_PURGE\_ORDER

The **OM\_AUDIT\_PURGE\_ORDER** table stores a synopsis for each purged order including the order ID and all attributes that are used to determine whether an order satisfies the purge criteria. Orders are added to this table as they are purged and become visible as transactions commit. This ability allows you to monitor the purge rate.

[Table 6-12](#) describes the **OM\_AUDIT\_PURGE\_ORDER** table. This table is reference-partitioned with **OM\_AUDIT\_PURGE** as the parent table.

Table 6-12 OM\_AUDIT\_PURGE\_ORDER Table

Column	Datatype	NULL	Description
PURGE_SEQ_ID	NUMBER(18)	NOT NULL	The system-generated unique ID assigned to the purge operation.
ORDER_SEQ_ID	NUMBER(18)	NOT NULL	The order ID.
CASCADE_DELETE	VARCHAR2(1)	N/A	Indicates whether the order was deleted because of a cascaded delete. For example, whether this is an amendment order of a deleted base order.
DELETED_DATE	DATE	NOT NULL	The date and time when the order was deleted.
ORDER_TYPE_ID	NUMBER(9)	NOT NULL	Copied from <b>OM_ORDER_HEADER</b> .
ORDER_SOURCE_ID	NUMBER(9)	NOT NULL	Copied from <b>OM_ORDER_HEADER</b> .
REFERENCE_NUMBER	VARCHAR2(255)	NOT NULL	Copied from <b>OM_ORDER_HEADER</b> .
ORD_STATE_ID	NUMBER(9)	NOT NULL	Copied from <b>OM_ORDER_HEADER</b> .
CARTRIDGE_ID	NUMBER(6)	NOT NULL	Copied from <b>OM_ORDER_HEADER</b> .
ORD_CREATION_DATE	DATE	NOT NULL	Copied from <b>OM_ORDER_HEADER</b> .

Table 6-12 (Cont.) OM\_AUDIT\_PURGE\_ORDER Table

Column	Datatype	NULL	Description
ORD_START_DATE	DATE	NOT NULL	Copied from <b>OM_ORDER_HEADER</b> .
ORD_COMPLETION_DATE	DATE	NOT NULL	Copied from <b>OM_ORDER_HEADER</b> .
ORD_TXN_COMPLETION_DATE	TIMESTAMP	N/A	Copied from <b>OM_ORDER_HEADER</b> .
VERSION	NUMBER(9)	N/A	Copied from <b>OM_ORDER_HEADER</b> .

## OM\_AUDIT\_PURGE\_PARAM

The **OM\_AUDIT\_PURGE\_PARAM** table stores the purge arguments and criteria supplied to the purge procedure and a snapshot of relevant session and configuration parameters at the time the purge was started. The following parameters are included:

- Arguments of the purge procedure that specify purge criteria, such as **a\_delete\_before**, **a\_order\_states**, **a\_order\_id\_lt**, **a\_order\_id\_ge**, **a\_order\_source\_mnemonic**, **a\_order\_type\_mnemonic**, **a\_namespace\_mnemonic**, **a\_version\_mnemonic**, and **a\_cartridge\_id**.
- Arguments of the purge procedure other than purge criteria, such as **a\_stop\_date**, **a\_parallelism** and **a\_commit\_count**.
- Database session parameters that identify who executed the purge and where, such as **BG\_JOB\_ID**, **FG\_JOB\_ID**, **HOST**, **INSTANCE\_NAME**, **OS\_USER**, **SERVICE\_NAME**, **SESSION\_USER**, and **SID**.
- Purge-related configuration parameters in the **om\_parameter** table, such as **degree\_of\_parallelism**, **parallel\_execute\_chunk\_size**, **oms\_timezone**, and **purge\_job\_class**.

[Table 6-13](#) describes the **OM\_AUDIT\_PURGE\_PARAM** table. This table is reference-partitioned with **OM\_AUDIT\_PURGE** as the parent table.

Table 6-13 OM\_AUDIT\_PURGE\_PARAM Table

Column	Datatype	NULL	Description
PURGE_SEQ_ID	NUMBER(18)	NOT NULL	The system-generated unique ID assigned to the purge operation.
PARAMETER_NAME	VARCHAR2(254)	NOT NULL	The parameter name.
PARAMETER_TYPE	VARCHAR2(1)	NOT NULL	The parameter type: <ul style="list-style-type: none"> <li>P: This is a parameter of the purge procedure that specifies a purge criterion.</li> <li>U: This is a parameter of the purge procedure other than a purge criterion.</li> <li>S: This is a database session parameter.</li> <li>C: This is a purge-related configuration parameter.</li> </ul>
PARAMETER_VALUE	VARCHAR2(255)		The parameter value.

## Troubleshooting and Error Handling

 **Note:**

In the event of failure during a purge operation, Oracle strongly recommends that you stop OSM and perform all troubleshooting and recovery offline

The PL/SQL API provides functions and procedures to troubleshoot and recover from errors. Most procedures for managing partitions use **om\_sql\_log\_pkg**, which is an internal package that enables procedures to persist and execute SQL statements so that execution can be resumed in the event of an error. This is particularly useful for DDL statements.

The **om\_sql\_log\_pkg** package persists SQL statements in the **om\_sql\_log** table, which includes the following columns:

- **sid**: The session ID. The default value is the current session ID, for example, **sys\_context('USERENV', 'SID')**. This allows concurrent execution.
- **name**: This is usually the name of the procedure that generated the SQL statement. It is useful to Oracle Support.
- **line**: This is a line number used for ordering the SQL statements to be executed.
- **sql\_text**: The SQL statement.

SQL statements persisted in **om\_sql\_log** are executed by **om\_sql\_log\_pkg.exec**. This procedure executes all SQL statements with the specified session ID, ordered by line number. If you do not specify the session ID, it uses the current one. During execution, the line number of the current statement is updated in the **om\_sql\_pointer** table. This allows you to monitor execution. Upon successful execution, it deletes all statements with that session ID. In the event of failure, however, it inserts in the **om\_sql\_pointer** table the error message with the session ID and line number of the failed statement. In this case, when **om\_sql\_log\_pkg.exec** is re-executed, it resumes execution with the failed statement.

Therefore you can troubleshoot and recover from a failed partition maintenance operation even if it was executed by a scheduled job. The contents of **om\_sql\_log** and **om\_sql\_pointer** allow for faster assistance from Oracle Support. After you fix the root cause of a failure, in some cases you can resume the operation from the point of failure. This ensures that your data is not left in an inconsistent state (although in some cases you might have to take additional actions if you want to complete that operation).

If you resume a failed operation from a different database session, or you abandon that operation, you must manually delete the rows for the failed session by executing the following statement:

```
execute om_sql_log_pkg.remove(sid);
```

where *sid* is the session ID specified by the error in **om\_sql\_pointer**.

**Example (Monitoring execution):** You can monitor execution by retrieving from **om\_sql\_log** the current statement of each session. If the **error\_code** section is populated, the execution failed.

```
select l.*, p.error_code, p.error_message
from om_sql_log l, om_sql_pointer p
where l.sid = p.sid and l.line = p.line;
```

**Example:** You can review the set of SQL statements of a partition maintenance operation that failed in the current session as follows:

```
select * from om_sql_log
where sid = sys_context('USERENV', 'SID')
order by line;
```

## Error Handling for add\_partitions

The **add\_partitions** procedure logs the DDL statements to be executed in the **om\_sql\_log** table. If the reason for the failure is unknown, you can check **om\_sql\_log** and **om\_sql\_pointer** for clues. If **om\_sql\_pointer** contains an error, it is likely because partition creation succeeded only partially and the schema is therefore no longer equi-partitioned. After you resolve the issue, you can finish the operation as follows:

- If the failure occurred while rebuilding unusable indexes, the new partitions have been created. Execute **om\_sql\_log\_pkg.exec(sid)** to finish rebuilding, where *sid* is the session ID specified by the error in **om\_sql\_pointer**.
- If the failure occurred during the partition creation phase, execute **om\_sql\_log\_pkg.exec(sid)** to finish partition creation. Then execute **om\_part\_maintain.rebuild\_unusable\_indexes** with **a\_online** set to true or false depending on whether OSM is running or not.
- When in doubt, execute **om\_part\_maintain.is\_equipartitioned** to check whether the schema is equi-partitioned. If it is not, you can execute **om\_part\_maintain.equipartition** to fix it.

## Error Handling for drop\_partitions

In the event of error, **drop\_partitions** re-enables disabled foreign keys and throws the exception again. However, execution failures could result in partitioning inconsistencies, orphan order data and unusable indexes or index partitions. After you resolve the issue, you can take the following actions:

- The recommended action is to re-execute the procedure with the same argument. If this is not possible (for example, because you cannot afford further downtime), do the following:
  - You must at least execute **rebuild\_unusable\_indexes** to ensure indexes are usable.
  - (Optional) You can execute **purge\_orphan\_order\_data** to delete orphan order data. Otherwise orphan data is deleted by the next execution of **purge\_partitions** or **drop\_partitions**.
  - Execute **om\_job\_pkg.resume\_jobs** to resume database jobs.
- When in doubt, execute **is\_equipartitioned** to check whether the schema is equi-partitioned. If it is not, you can execute **equipartition** to fix it.

## Error Handling for `purge_partitions`

In the event of unexpected error, **`purge_partitions`** re-enables any disabled constraints and throws the exception again. However, execution failures could result in partitioning inconsistencies, orphan order data and even data loss if you do not follow the error handling procedure to recover.

## Troubleshooting

In the event of an unexpected error, **`purge_partitions`** re-enables any disabled constraints and throws the exception again. However, execution failures could result in partitioning inconsistencies, orphan order data, and even data loss if you do not follow recovery procedures.

If you spooled the output of the stored procedure to a file (recommended), review the file to determine the reason and point of failure. If the purge capacity is greater than 1, the file also indicates which purge tables were involved. You can identify the point of failure by reviewing the started and finished messages that mark the beginning and end of procedure execution.

A failure may occur in these procedures:

- **`sys$bpd_r_backup`**: Copies the orders that do not satisfy the purge criteria into the backup tables.
- **`sys$bpd_r_purge`**: Purges one or more partitions entirely by exchanging them with purge tables.
- **`sys$bpd_r_drop`**: Drops N-1 empty partitions, where N is the number of purged partitions.
- **`sys$bpd_r_restore`**: Restores the retained orders from the backup tables into the Nth partition.
- **`rebuild_unusable_indexes`**: Rebuilds all or specific unusable indexes as required. It is executed:
  - By **`sys$bpd_r_backup`** prior to copying orders into the backup tables.
  - By **`sys$bpd_r_restore`** prior to restoring retained orders.
  - At the end, prior to **`sys$purge_orphan_order_data`**.
- **`sys$purge_orphan_order_data`**: Purges orphan order data (executed at the end).
- **`sys$purge_xchg_prg_tables`**: If the **`a_purge_xchg_prg_tables`** argument is true, it is executed at the end to purge the purge tables. It may also be executed prior to purging a group of successive partitions, if the purge capacity is exhausted.

If the procedure output is not available, inspect the following for clues.

- Most of the time you can determine the error and the point of failure by reviewing the **`om_sql_log`** and **`om_sql_pointer`** tables.
  - **`om_sql_pointer`** points to the SID (session ID) and line of the failed statement in **`om_sql_log`**. If there are several errors in **`om_sql_pointer`**, check the **`error_date`** column to find the SID of the most recent error.



- If **om\_sql\_log** includes EXCHANGE PARTITION statements, execution failed in **sys\$bpdr\_purge**. Partitions are in an inconsistent state.
- If **om\_sql\_log** includes INSERT statements into the backup tables, execution failed in **sys\$bpdr\_backup**. Partitions are in a consistent state.
- If **om\_sql\_log** includes calls to **sys\$restore\_table**, execution failed in **sys\$bpdr\_restore**. Partitions contain partially restored orders.
- If **om\_sql\_log** includes statements to rebuild indexes, execution failed in **rebuild\_unusable\_indexes**.
- Review the backup tables:
  - If the backup tables are empty then there are a number of possibilities, such as a) no orders were retained, b) the failure occurred prior to **sys\$bpdr\_backup**, or c) **sys\$bpdr\_restore** purged the backup tables after a successful restore.
  - If the backup tables are not empty then the failure occurred either during or after **sys\$bpdr\_backup** and possibly during **sys\$bpdr\_restore**.
  - If none of the order IDs in XCHG\_OM\_BCK\_001\$ exist in OM\_ORDER\_HEADER then most likely the failure occurred during or after **sys\$bpdr\_purge**. Check the remaining partitioned tables listed in the OM\_XCHG\_TABLE table. If you cannot find those order IDs in any of those tables then **sys\$bpdr\_purge** completed successfully (the data was exchanged into the purge tables). There is also a remote possibility that the failure occurred in **sys\$bpdr\_restore** while restoring retained orders into OM\_ORDER\_HEADER (the first table to be restored). In this case, **user\_parallel\_execute\_tasks** should include a task with **task\_name** equal to **restore:om\_order\_header**.
  - If some but not all of the order IDs in XCHG\_OM\_BCK\_001\$ exist in OM\_ORDER\_HEADER then the failure occurred in **sys\$bpdr\_restore** while restoring retained orders into OM\_ORDER\_HEADER (the first table to be restored). In this case, **user\_parallel\_execute\_tasks** should include a task with **task\_name** equal to **restore:om\_order\_header**.
  - If all of the order IDs in XCHG\_OM\_BCK\_001\$ exist in OM\_ORDER\_HEADER, check whether all the data in the remaining backup tables exist in the corresponding partitioned tables (the OM\_XCHG\_TABLE table specifies the exchange table ID for each partitioned table). If this is not the case then the failure occurred during **sys\$bpdr\_purge** or **sys\$bpdr\_restore**.
- Review the purge tables, especially those that correspond to OM\_ORDER\_HEADER (for example, XCHG\_OM\_PRG\_001\$001\$). If they do not contain any data, most likely the purge failed before the **sys\$bpdr\_purge** procedure. If the purge capacity is greater than 1, check the **sys\$xchg\_purge\_seq** parameter in the **om\_parameter** table to find out which set of purge tables was used for the latest purge.
- Review the affected partitions. If a partition in the purge range is empty, most likely it was exchanged with the purge tables (it is also possible that it was previously empty). Check the purge tables to confirm.
- Review the **user\_parallel\_execute\_tasks** view in the OSM core schema. If the view contains any tasks with **task\_name** equal to **restore:tableName**, execution failed in **sys\$bpdr\_restore** while restoring data into the **tableName** table (assuming the previous execution of **purge\_partitions** was successful).

## Error Handling

When you determine the point of failure, as discussed in "Troubleshooting," and you resolve the issue, you can recover and finish the purge operation as follows:

- If the failure occurred during **sys\$bpd\_r\_backup**, the partitions are in a consistent state. Execute **om\_part\_maintain.purge\_xchg\_bck\_tables** and **om\_sql\_log\_pkg.remove(SID)** to purge the backup tables, **om\_sql\_log** and **om\_sql\_pointer**.
- If the failure occurred during **sys\$bpd\_r\_purge**, the partitions are in an inconsistent state (partially purged):
  1. Execute **om\_sql\_log\_pkg.exec(SID)** to finish the purge (exchange), where *SID* is the session ID of the failed execution (the SID is recorded in **om\_sql\_pointer** together with the error message).
  2. If you were consolidating partitions N-to-1, drop the N-1 partitions before the Nth partition, which was exchanged. To drop those partition, use the following statements instead of `drop_partitions`:
 

```
ALTER TABLE OM_ORDER_HEADER DROP PARTITION partition_name;
ALTER TABLE OM_SEQUENCE DROP PARTITION partition_name;
```
  3. If the backup tables are not empty, execute **om\_part\_maintain.restore\_orders** with the desired degree of parallelism to rebuild unusable indexes and restore the retained orders.
- If the failure occurred during **sys\$bpd\_r\_drop** while consolidating partitions: When you consolidate partitions N-to-1, **purge\_partitions** copies retained orders into the backup tables, purges (exchanges) the Nth partition, drops N-1 partitions, and restores the retained orders into the Nth partition.
  - If the **om\_sql\_log** table contains the DROP PARTITION statements, execute **om\_sql\_log\_pkg.exec(SID)**, where *SID* is the session ID of the failed execution (the SID is recorded in **om\_sql\_pointer** together with the error message). In some releases, the DROP PARTITION statements are not logged in the **om\_sql\_log** table. In this case, you can find them in the DBMS output. If you do not have the DBMS output, execute these statements:
 

```
ALTER TABLE OM_ORDER_HEADER DROP PARTITION partition_name;
ALTER TABLE OM_SEQUENCE DROP PARTITION partition_name;
```
  - If the backup tables are not empty, execute **om\_part\_maintain.restore\_orders** with the desired degree of parallelism to rebuild unusable indexes and restore the retained orders.
- If the failure occurred during **sys\$bpd\_r\_restore** and you fixed the root cause, Oracle recommends that you finish the restore operation. The partitions are in an inconsistent state (retained orders are not fully restored). The backup tables are not affected and they contain all retained orders. To resume the restore operation from the point of failure:
  1. Run **om\_part\_maintain.disable\_ptned\_fks** to disable foreign keys of partitions tables.
  2. In the event of failure, **sys\$bpd\_r\_restore** automatically deletes the partially restored data from the last partitioned table in order to ensure that a second attempt will not fail due to unique key violations. However, Oracle recommends that you run **om\_part\_maintain.sys\$undo\_restore\_table(t)**

anyway, where *t* is the name of the partitioned table that caused the failure. This procedure deletes the data restored into the given table.

3. Run **om\_sql\_log\_pkg.exec(SID)** to finish the restore, where *SID* is the session ID of the failed execution (the SID is recorded in **om\_sql\_pointer** together with the error message).
  4. Run **om\_part\_maintain.reenable\_ptned\_fks** to re-enable foreign keys.
- If the root cause lies with the data to be restored, you must execute **om\_part\_maintain.sys\$undo\_restore\_orders** to delete all restored data from the partitioned tables. This is a slow operation because it uses DELETE statements. Then fix the orders retained in the backup tables, and execute **om\_part\_maintain.restore\_orders** with the desired degree of parallelism to rebuild unusable indexes and restore the retained orders.
  - Oracle recommends that you always execute **om\_part\_maintain.rebuild\_unusable\_indexes**.
  - (Optional) In any case, you can execute **om\_part\_maintain.purge\_orphan\_order\_data** to delete orphan order data. Otherwise orphan data will be deleted by the next execution of **purge\_partitions** or **drop\_partitions**.
  - Execute **om\_job\_pkg.resume\_jobs** to resume database jobs.

## Error Handling for rebuild\_unusable\_indexes

This procedure logs the DDL statements to be executed in the **om\_sql\_log** table. In the event of an error, it is important that you re-execute **om\_sql\_log\_pkg.exec** to finish the rebuild operation. Otherwise:

- Unusable indexes are likely to impact performance. Moreover, unusable indexes that enforce unique constraints report **ORA-01502** errors. Error reporting is disabled for other unusable indexes, unless **SKIP\_UNUSABLE\_INDEXES** is set to false (the default is true).
- An index may be left in PARALLEL state, which could result in undesirable behavior.

## Error Handling for setup\_xchg\_tables

This procedure logs the DDL statements to be executed in the **om\_sql\_log** table. If the reason of failure is unknown, check **om\_sql\_pointer** and **om\_sql\_log** for clues. When you resolve the issue, you can take one of the following actions:

- Re-execute **setup\_xchg\_tables** with **a\_force=true**.
- Execute **drop\_xchg\_tables** to drop any partially created exchange tables.

## Performance Tuning

This section explains how to tune the following:

- **degree\_of\_parallelism**
- **degree\_of\_parallelism\_rebuild\_indexes**
- **degree\_of\_parallelism\_rebuild\_xchg\_indexes**

- Parallel job execution
- Row-based purge

## Tuning `degree_of_parallelism`

This parameter specifies the default DOP for queries, DML, and most DDL operations. In particular, it affects the performance of order backup and restore statements performed by **purge\_partitions**. You can use the following procedure to evaluate the optimal **degree\_of\_parallelism** without performing a purge.

To evaluate the optimal **degree\_of\_parallelism**:

1. Clear the **om\_order\_id\_for\_backup** table.

```
delete from om_order_id_for_backup;
```

2. Select a representative number of order IDs that does not exceed the value of **xchg\_retained\_orders\_thres** from a single partition. For example, if you frequently retain 10,000 orders when you purge partitions:

```
insert into om_order_id_for_backup (  
  select order_seq_id  
  from om_order_header partition (P_000000000003000001)  
  where rownum <= 10000);  
commit;
```

3. Back up the selected order IDs with the desired parallelism (for example, 16) and record the elapsed time:

```
exec om_part_maintain.backup_selected_ords(16);
```

4. Purge the backup tables:

```
exec om_part_maintain.purge_xchg_bck_tables;
```

5. Repeat with a different degree of parallelism and compare the elapsed times until you find the optimal DOP.

## Tuning `degree_of_parallelism_rebuild_indexes`

The best way to determine the optimal DOP for **degree\_of\_parallelism\_rebuild\_indexes** is through trials. Try purging or dropping partitions with different settings for this parameter, and review the DBMS output to compare the elapsed times for rebuilding indexes.

## Tuning `degree_of_parallelism_rebuild_xchg_indexes`

The optimal DOP for **degree\_of\_parallelism\_rebuild\_xchg\_indexes** is normally 1 (the default) because these indexes are very small and they are rebuilt one partition at a time. There is rarely a reason to increase this value.

## Tuning Parallel Job Execution

You can use these parameters to tune parallel job execution:

- **degree\_of\_parallelism**: Specifies the degree of parallelism for the majority of database operations performed by parallel jobs and parallel servers. For more information, see "[Tuning degree\\_of\\_parallelism](#)."

- **purge\_job\_class**: Specifies the job class for purge operations. If your database is Oracle RAC, it is important that you configure this as described in the `purge_job_class` section.
- **parallel\_execute\_chunk\_size**: This is an advanced parameter that you rarely need to tune, especially beginning with 7.2.0.10.2, 7.2.2.5, and 7.2.4.2. For more information see the following section.

## Tuning `parallel_execute_chunk_size`

The implementation of **purge\_partitions** uses the **dbms\_parallel\_execute** package to restore retained orders, which uses database jobs to cause execution to be in parallel. Order data is restored one table at a time, and each table is divided into chunks. Each job is assigned a chunk, commits the transaction, gets the next chunk, and so on. The process repeats for the next table. For example, if the degree of parallelism is 32 and 64 chunks are created, 32 chunks will be processed concurrently by jobs and they will be committed at about the same time before the remaining 32 chunks are processed.

The number of chunks created depends primarily on the volume of data, the number of sub-partitions and the specified chunk size. The default value of **parallel\_execute\_chunk\_size** is 2000 blocks. If the size of the retained order data is small to moderate, this chunk size normally results in as many chunks as sub-partitions (for example, 32 or 64), which is found to work well.

Beginning with 7.2.0.10.2, 7.2.2.5, and 7.2.4.2, each table to be restored is divided separately into chunks. This means that the number of chunks is different for each table. However, the volume of data for each chunk is about the same, regardless of the table. This results in shorter transactions (more frequent commits) that require less UNDO. Therefore, the default **parallel\_execute\_chunk\_size** (2000 blocks) results in good performance, regardless of the volume of data retained, and there is rarely a need to change it.

Prior to 7.2.0.10.2, 7.2.2.5, and 7.2.4.2, the number of restore chunks is the same for all tables because chunks are generated from the **XCHG\_OM\_BCK\_\$001\$** table. However, the volume of data for each chunk varies from table to table. If the volume of retained order data is very large (for example, tens of thousands of orders), the chunks for large tables such as **OM\_ORDER\_INSTANCE** are large transactions that generate a lot of UNDO and therefore require a large UNDO tablespace.

In this case, it might be better to increase the number of chunks in order to increase the frequency of commits and reduce the UNDO size. For example, if your performance tests show that committing every 500 orders is more efficient in terms of elapsed time and/or UNDO size, and you normally retain about 100000 orders, the optimal number of chunks would be 200. To increase the number of chunks you must decrease the **parallel\_execute\_chunk\_size**.

If you are not sure how chunks are generated at your patch level, review the restore statements. If they are joins, chunks are generated as in 7.2.0.10 or earlier.

Prior to 7.2.0.10.2, 7.2.2.5 and 7.2.4.2, use the following procedure to find out how different **parallel\_execute\_chunk\_size** settings affect the number of chunks created. If you are using 7.2.0.10.2, 7.2.2.5, 7.2.4.2 or later, there is rarely a need to tune **parallel\_execute\_chunk\_size**. However, if you want to do so, you can substitute **om\_order\_header** and **xchg\_om\_bck\_\$001\$** in the following procedure with any other partitioned table and the corresponding **xchg\_om\_bck\_table** to find out the number of chunks that will be created for that partitioned table.

To find out how different **parallel\_execute\_chunk\_size** settings affect the number of chunks created (7.2.0.10.2, 7.2.2.5, 7.2.4.2, or earlier):

1. Ensure the exchange tables are created.
2. Populate the backup tables with a large number of orders to retain, preferably all in the same partition (substitute x and y, so that the range (x, y) contains the desired number of orders):

```
insert into xchg_om_bck_$001$
  (select * from om_order_header where order_seq_id between x and y) ;
```

3. Repeat the following executions and with different values for **chunk\_size** (20, 100, 200, and so on), until the query returns a count close to the desired number of chunks:

```
exec dbms_parallel_execute.create_task('CHECK_CHUNK_TASK') ;
exec dbms_parallel_execute.drop_chunks('CHECK_CHUNK_TASK') ;
exec dbms_parallel_execute.create_chunks_by_rowid(
  'CHECK_CHUNK_TASK', user, 'XCHG_OM_BCK_$001$', by_row => false,
  chunk_size =>20) ;
select count(*) from user_parallel_execute_chunks
where task_name = 'CHECK_CHUNK_TASK'
order by chunk_id;
exec dbms_parallel_execute.drop_task('CHECK_CHUNK_TASK') ;
```

4. When you are done testing, purge the backup tables:

```
exec om_part_maintain.purge_xchg_bck_tables;
```

## Tuning Row-Based Purge

Row-based purges are I/O intensive. The `purge_policy_time_to_close_wait` policy can reduce I/O, improve performance, and decrease purge rate fluctuations. For more information see "[purge\\_policy\\_time\\_to\\_close\\_wait](#)."

## Database Terms

This chapter uses the following database terms:

- **Automatic Workload Repository (AWR):** A built-in repository in every Oracle database. Oracle Database periodically makes a snapshot of its vital statistics and workload information and stores them in AWR.
- **closed and open orders:** An order is closed if it is complete or aborted. Otherwise it is open. Open orders restrict certain operations. For example, if a partition has open orders, you cannot purge it online. Those restrictions are relaxed for cancelled orders: cancelled orders are treated as closed.
- **DDL (Data Definition Language):** Includes database statements that define or change a data structure, such as CREATE TABLE or ALTER INDEX.
- **DML (Data Manipulation Language):** Includes database statements that manipulate data, such as SELECT, INSERT, UPDATE, and DELETE.
- **exhausted partition:** Each OSM partition stores a range of order IDs. The upper bound of the range is specified by the (non-inclusive) partition upper bound. Order IDs increase monotonically. When the next order ID reaches or exceeds the upper bound of the current partition, the partition is said to be exhausted.

- **high water mark:** The boundary between used and unused space in a database segment
- **OLTP (Online Transaction Processing):** OLTP systems are optimized for fast and reliable transaction handling. Compared to data warehouse systems, most OLTP interactions involve a relatively small number of rows, but a larger group of tables.
- **Oracle RAC (Real Application Clusters):** A database option that allows multiple concurrent database instances to share a single physical database.
- **partitioning:** The ability to decompose very large tables and indexes into smaller and more manageable pieces called partitions.
- **retained orders:** Retained orders excluded from purging, for example, because they are still in the retention period or they do not satisfy other purge criteria.
- **retention period:** The period of time an order should be kept after it is closed. This varies depending on policies, laws, and regulations prescribed by the business or governments. After its retention period, an order is eligible for purge.
- **tablespaces, segments, and extents:** A database is divided into one or more logical storage units called **tablespaces**. Tablespaces are divided into logical units of storage called **segments**. Each segment consists of a set of **extents** allocated for a specific database object, such as a table, index, or partition. An extent is a logically contiguous allocation of space. A partitioned table has a segment for each partition. For example, a range-hash partitioned table with two range partitions and 32 hash sub-partitions per range partition has 64 segments.

# 7

## Managing Optimizer Statistics

This chapter contains best practices for gathering optimizer statistics for the Oracle Communications Order and Service Management (OSM) product. Using the best practices in this chapter will result in better and more stable execution plans for SQL objects in the OSM database.

### About Optimizer Statistics

Optimizer statistics are a collection of data that describe the database and the objects in the database. These statistics are used by the optimizer to choose the best execution plan for each SQL statement. Statistics are stored in the data dictionary and can be accessed using data dictionary views such as `USER_TAB_STATISTICS`.

Oracle Database internally prioritizes the database objects that require statistics, so that those objects that most need updated statistics are processed first. For more information about optimizer statistics, see the Oracle Database documentation.

Knowledge article 1369591.1, *Master Note: Optimizer Statistics*, has links to many other useful sources of information about optimizer statistics. It is available on the Oracle support website at:

<https://support.oracle.com>

### Gathering Optimizer Statistics

This section discusses methods of gathering optimizer statistics for OSM.

#### Gathering Statistics Online

The procedures provided by the `om_db_stats_pkg` package and native Oracle database statistics procedures can all be executed online. However, when gathering statistics during peak hours you should temporarily lower the value of the `DEGREE` preference as described in "[Using Parallel Collection for Gathering Statistics](#)."

#### Automated Optimizer Statistics Collection

The automatic database optimizer statistics collection maintenance task is enabled by default. This typically triggers launch of an automatic database optimizer statistics collection job during a predefined maintenance window.

Partition statistics can be locked, and Oracle recommends that you:

- Leave the automatic statistics collection enabled.
- Some maintenance operations (such as purging partitions and deploying, undeploying, and purging cartridges) render the statistics stale. Schedule these maintenance operations to complete before automatic optimizer statistics collection starts.



For a list of steps and procedures that can be used to bootstrap and maintain the OSM Database Optimizer Statistics Management process with OSM releases that support locking of partition statistics, see knowledge article 1925539.1, *New OSM Database Optimizer Statistics Management*, on the Oracle support website for additional information:

<https://support.oracle.com>

You can determine if the automatic optimizer statistics collection maintenance task is enabled by running the following commands as a SYSDBA user:

```
set serveroutput on
SELECT client_name, status FROM dba_autotask_operation;
```

You can disable the automatic optimizer statistics collection maintenance task by running the following commands as a SYSDBA user:

```
BEGIN
  DBMS_AUTO_TASK_ADMIN.DISABLE(
    client_name => 'auto optimizer stats collection',
    operation => NULL,
    window_name => NULL);
END;
/
```

You can enable the automatic optimizer statistics collection maintenance task by running the following commands as a SYSDBA user:

```
BEGIN
  DBMS_AUTO_TASK_ADMIN.ENSABLE(
    client_name => 'auto optimizer stats collection',
    operation => NULL,
    window_name => NULL);
END;
/
```

## Gathering Fixed Object Statistics

When fixed object statistics are missing, the database optimizer uses predefined default values that may not be adequate for your system, and this could lead to less than optimal execution plans. For example, RMAN, Data Guard, Streams, and Grid Control make heavy use of fixed tables through DBA and V\$ views and they often experience performance issues when fixed object statistics have not been collected. Another common symptom is extreme TEMP space usage driven by poor plans against fixed tables.

The automatic database optimizer statistics collection job does not gather fixed object statistics.

Oracle recommends that you gather fixed object statistics:

- When bootstrapping the OSM database optimizer statistics process
- After an OSM upgrade
- After deploying or undeploying cartridges
- Following a significant increase in order volume
- Following a change in partition size

You can gather fixed object statistics when there is a representative load on the system (ideally at peak utilization) by running the following commands as a SYSDBA user:

```
execute DBMS_STATS.GATHER_FIXED_OBJECTS_STATS;
```

## Gathering System Statistics

System statistics enable the optimizer to more accurately determine the cost of each operation in an execution plan by using information about the actual system hardware that is executing the statement, such as CPU speed and I/O performance.

The automatic database optimizer statistics collection job does not gather system statistics.

Oracle recommends that you gather system statistics:

- When bootstrapping the OSM database optimizer statistics process.
- Following a significant increase in order volume.
- Following changes in your database CPU speed or IO subsystem.

You can gather system statistics when there is a representative load on the system (ideally at peak utilization) by running the following commands as a SYSDBA user:

```
execute DBMS_STATS.GATHER_SYSTEM_STATS;
```

## Gathering Cartridge Metamodel Statistics

OSM stores cartridge metamodel information in database tables and statistics on these tables should be kept up-to-date to ensure optimal order processing performance. Gather cartridge metamodel statistics:

- When bootstrapping the OSM database optimizer statistics process.
- After deploying or undeploying cartridges.
- After an OSM upgrade.

You can gather cartridge metamodel statistics by running the following commands as an OSM order management user:

```
set serveroutput on  
execute om_db_stats_pkg.gather_cartridge_stats;
```

## Gathering Order Statistics

The procedure to follow to gather statistics on OSM order tables varies depending on table volatility. The contents of a volatile order table are primarily impacted by the current order volume. For these tables, once an order has been processed, the associated data is automatically deleted.

### High Volatility Order Tables

The following order tables are always highly volatile because their contents are very short-lived. These tables may have thousands of rows at peak workload, but have little or no data when there is reduced order activity in the system.

- OM\_JMS\_EVENT

- OM\_JMS\_THREAD
- OM\_ORDER\_STATE\_PENDING
- OM\_ORDER\_STATE\_EVENT\_PENDING
- OM\_COORD\_NODE\_INSTANCE

You should not enable incremental statistics on highly volatile tables. However, Oracle recommends that you lock statistics for these tables, using the following command:

```
execute om_db_stats_pkg.lock_volatile_order_stats;
```

## Low Volatility Order Tables

The majority of order tables retain data until that data is purged. These tables are configured with a low level of volatility. Oracle recommends that you enable incremental statistics for low volatility tables.

## Medium Volatility Order Tables

Some order tables have both partitions that retain order data and volatile partitions from which data is deleted after it is processed. For historical reasons, these tables are configured with a medium level of volatility. However, due to process improvements that have been identified over time, all medium volatility tables should be reconfigured either as high volatility or low volatility tables based on the characteristics of your solution.

By default, the following tables are configured with a medium level of volatility:

- OM\_ORDER\_FLOW
- OM\_AUTOMATION\_CTX
- OM\_AUTOMATION\_CORRELATION
- OM\_ORDER\_POS\_INPUT
- OM\_UNDO\_BRANCH\_ROOT
- OM\_ORCH\_DEPENDENCY\_PENDING

If most of your orders complete in less than 1 hour, it is recommended that you manage these tables in the same manner as high volatility tables. Otherwise, it is recommended that you manage them in the same manner as low volatility tables.

In other words, if most of your orders complete in less than 1 hour, when bootstrapping the OSM database optimizer statistics process, execute the following as the OSM order management user:

```
execute om_db_stats_pkg.unlock_volatile_order_stats;
execute om_db_stats_pkg.set_table_volatility('OM_ORDER_FLOW',
      om_const_pkg.v_volatility_high);
execute om_db_stats_pkg.set_table_volatility('OM_AUTOMATION_CTX',
      om_const_pkg.v_volatility_high);
execute om_db_stats_pkg.set_table_volatility('OM_AUTOMATION_CORRELATION',
      om_const_pkg.v_volatility_high);
execute om_db_stats_pkg.set_table_volatility('OM_ORDER_POS_INPUT',
      om_const_pkg.v_volatility_high);
execute om_db_stats_pkg.set_table_volatility('OM_UNDO_BRANCH_ROOT',
      om_const_pkg.v_volatility_high);
execute om_db_stats_pkg.set_table_volatility('OM_ORCH_DEPENDENCY_PENDING',
```

```

om_const_pkg.v_volatility_high);
execute om_db_stats_pkg.lock_volatile_order_stats;

```

However, if most of your orders complete in more than 1 hour, execute the following instead:

```

execute om_db_stats_pkg.unlock_volatile_order_stats;
execute om_db_stats_pkg.set_table_volatility('OM_ORDER_FLOW',
om_const_pkg.v_volatility_low);
execute om_db_stats_pkg.set_table_volatility('OM_AUTOMATION_CTX',
om_const_pkg.v_volatility_low);
execute om_db_stats_pkg.set_table_volatility('OM_AUTOMATION_CORRELATION',
om_const_pkg.v_volatility_low);
execute om_db_stats_pkg.set_table_volatility('OM_ORDER_POS_INPUT',
om_const_pkg.v_volatility_low);
execute om_db_stats_pkg.set_table_volatility('OM_UNDO_BRANCH_ROOT',
om_const_pkg.v_volatility_low);
execute om_db_stats_pkg.set_table_volatility('OM_ORCH_DEPENDENCY_PENDING',
om_const_pkg.v_volatility_low);
execute om_db_stats_pkg.lock_volatile_order_stats;

```

## Enabling Incremental Statistics

Once table volatility has been properly reconfigured, and during the bootstrapping the OSM database optimizer statistics process, it is recommended that, as the OSM order management user, you enable incremental statistics for low volatility tables.

```

execute om_db_stats_pkg.set_table_prefs_incremental(a_incremental => true,
a_volatility => om_const_pkg.v_volatility_low);

```

You should then confirm that INCREMENTAL\_STALENESS is configured, using the following command:

```

SELECT dbms_stats.get_prefs(pname=>'INCREMENTAL_STALENESS',
tabname=>'OM_ORDER_INSTANCE') FROM dual;

```

If the query above generates an error or doesn't return USE\_STALE\_PERCENT, USE\_LOCKED\_STATS, use the following commands to set the value:

```

set serveroutput on
BEGIN
  FOR T IN
    (SELECT IT.TABLE_NAME
     FROM OM_$INSTALL$TABLE IT, USER_TABLES UT
     WHERE IT.VOLATILITY = om_const_pkg.v_volatility_low AND UT.TABLE_NAME =
IT.TABLE_NAME AND UT.PARTITIONED = 'YES'
    )
  LOOP
    dbms_stats.set_table_prefs(user, T.TABLE_NAME, 'INCREMENTAL_STALENESS',
'USE_STALE_PERCENT, USE_LOCKED_STATS');
  END LOOP;
END;
/

```

If this generates an error, review the list of database patches installed on your system. Otherwise, you can confirm that INCREMENTAL\_STALENESS is now configured correctly by re-running the confirmation command you ran earlier, that is:

```

SELECT dbms_stats.get_prefs(pname=>'INCREMENTAL_STALENESS',
tabname=>'OM_ORDER_INSTANCE') FROM dual;

```

## Gathering High-Volatility-Table Statistics

Gather high-volatility-table statistics:

- When bootstrapping the OSM database optimizer statistics process
- After deploying or undeploying cartridges
- After an OSM upgrade
- Following a significant increase in order volume
- After changing partition size
- When a new partition becomes active

As the OSM order management user, gather high-volatility-table statistics when the workload is representative, preferably as near to the peak as possible, given that the database must have spare resources:

```
set serveroutput on
execute DBMS_STATS.SET_SCHEMA_PREFS(user, 'DEGREE', 2);
execute om_db_stats_pkg.gather_volatile_order_stats(a_force_volatile => true)
execute DBMS_STATS.SET_SCHEMA_PREFS(user, 'DEGREE', 'DBMS_STATS.AUTO_DEGREE');
```

## Gathering Low-Volatility-Table Statistics

Gather low-volatility-table statistics:

- When bootstrapping the OSM database optimizer statistics process
- "On a regular basis (for example, once a week) if the automatic database optimizer statistics collection maintenance task is disabled

As the OSM order management user, gather low-volatility-table statistics during a period of low system activity:

```
set serveroutput on
exec om_db_stats_pkg.gather_order_stats(a_volatility =>
om_const_pkg.v_volatility_low, a_force => false);
```

## Preparing a New Partition

Before using a new (blank) partition, you should pre-populate the partition with optimizer statistics and then lock the statistics.

## Populating New Partition Statistics

Pre-populating statistics on new partitions is of critical importance for avoiding the issues that will otherwise arise when the partition becomes active. For more information about this issue, see the following Oracle Blog entry:

<https://blogs.oracle.com/optimizer/maintaining-statistics-on-large-partitioned-tables>

## Using Statistics from Another Partition

You can manually copy statistics to a new partition using the **om\_db\_stats\_pkg.copy\_order\_ptn\_stats** procedure. This procedure allows you to specify the partition from which to obtain statistics, as well as the partition to which to copy statistics.

Copy statistics from a mature partition to empty partitions:

- When bootstrapping the OSM database optimizer statistics process
- When creating new partitions

To avoid copying partial statistics, make sure that statistics are not being collected when copying statistics from another partition. You can check whether an automatic optimizer statistics collection job is in progress by running the following commands as a SYSDBA user:

```
set serveroutput on
declare
v_gathering_status integer;
begin
  begin
    select 1
      into v_gathering_status
    from dba_autotask_client_job
    where client_name = 'auto optimizer stats collection'
      and job_scheduler_status = 'RUNNING'
      and rownum = 1;
    dbms_output.put_line('Auto optimizer stats collection is running');
    return;
  exception
  when no_data_found then
    null;
  end;
  dbms_output.put_line('Auto optimizer stats collection is not running');
end;
/
```

If statistics collection is running, wait until it completes.

Then you can copy statistics to a new partition by running the following commands as the OSM order management user:

```
declare
  v_copied boolean;
begin
  om_db_stats_pkg.copy_order_ptn_stats(v_copied,
    a_src_partition_name => 'P_000000000000400001',
    a_dst_partition_name => 'P_000000000000700001');
end;
```

If you have changed the partition size and want to copy stats from an older partition of different size, you can use scale factor to scale the stats. Use the following commands:

Example of scaling up stats into destination partition:

```
declare
  v_copied boolean;
begin
```

```

om_db_stats_pkg.copy_order_ptn_stats(v_copied,
  a_src_partition_name => 'P_000000000000400001',
  a_dst_partition_name => 'P_000000000000700001',
  scale_factor => '2');
end;

```

Example of scaling down stats into destination partition:

```

declare
  v_copied boolean;
begin
  om_db_stats_pkg.copy_order_ptn_stats(v_copied,
    a_src_partition_name => 'P_000000000000400001',
    a_dst_partition_name => 'P_000000000000700001',
    scale_factor => '0.5');
end;

```

### Note:

Because the **scale\_factor** parameter is a varchar2 argument, it must be provided in single quotes. The value can be any positive decimal number.

To copy recent and valid statistics to the most recently created order partition, as well as to the corresponding partitions of all reference-partitioned tables, you can use:

```

declare
  v_copied boolean;
begin
  om_db_stats_pkg.copy_order_ptn_stats(v_copied);
end;

```

## Using Statistics from a Statistics Table

You can also use the **om\_db\_stats\_pkg.export\_order\_ptn\_stats** to export partition statistics to a statistics table and then use **om\_db\_stats\_pkg.import\_order\_ptn\_stats** to import them to a partition. You could use this to save one or more snapshots of representative partition statistics and then use the underlying statistic tables as templates.

## Using Statistics from Another System

OSM DB Installer can be used to set up the database partition statistics. For details, see "Setting Up Database Optimizer Statistics" in *OSM Cloud Native Deployment Guide*.

## Locking Partition Statistics

After copying statistics to a new empty partition, statistics should be locked on that partition if the automatic optimizer statistics collection maintenance task is enabled. Also note that this capability is not available in some OSM releases.

You can manually lock partition statistics using the **om\_db\_stats\_pkg.lock\_order\_ptn\_stats** procedure. For example, as the OSM order management user:

```
execute om_db_stats_pkg.lock_order_ptn_stats ('P_000000000000400001');
```

You should lock statistics on an empty partition after copying statistics into that partition and you should leave statistics locked on that partition when it becomes active.

## Configuring a Partition When It Is No Longer the Active Partition

You can manually unlock partition statistics using the `om_db_stats_pkg.unlock_order_ptn_stats` procedure. For example, as the OSM order management user:

```
execute om_db_stats_pkg.unlock_order_ptn_stats ('P_000000000000400001');
```

You should unlock statistics on a partition when it matures (that is, once it is no longer active). This should be done following a switch to a new active partition.

## Optimizer Statistics Error Handling Using Datapump

Optimizer statistics management error handling is available for automated copy partition statistics jobs and datapump jobs.

The `om_db_stats_pkg.exdpdp_order_ptn_stats` and `om_db_stats_pkg.impdp_order_ptn_stats` procedures submit datapump jobs to save or load partition statistics to or from the file system.

While it is unlikely that these jobs will fail and become stuck, you can determine if datapump jobs are stuck by running the following commands as a SYSDBA user:

```
select owner_name, job_name, operation, job_mode, state, attached_sessions
from dba_datapump_jobs
where job_name not like 'BIN$%'
order by owner_name, job_name;
```

As the OSM order management user, you can remove stuck export jobs using the following:

```
declare
    dpj number;
begin
    dpj := dbms_datapump.attach('EXPORT_ORDER_PTN_STATS', user);
    dbms_datapump.stop_job(dpj, 1, 0);
end;
```

You can remove stuck import jobs using the following commands:

```
declare
    dpj number;
begin
    dpj := dbms_datapump.attach('IMPORT_ORDER_PTN_STATS', user);
    dbms_datapump.stop_job(dpj, 1, 0);
end;
```



# Optimizer Statistics Management Performance Tuning

This section presents various ways to tune optimizer statistics management performance.

## Using Parallel Collection for Gathering Statistics

As your OSM database grows, it is important that you gather statistics in parallel. Otherwise the automatic statistics collection might not be able to process all tables and partitions. By default, Oracle Database uses the same number of parallel server processes specified as the Degree of Parallelism attribute of the table in the data dictionary. Because the degree of parallelism is 1 for all OSM tables and indexes, Oracle recommends that you set the DEGREE as a schema preference.

To do this, run the following command as the OSM order management user:

```
execute DBMS_STATS.SET_SCHEMA_PREFS(user, 'DEGREE', 'DBMS_STATS.AUTO_DEGREE');
```

However, if you gather statistics manually while the database is processing a workload (for example, when gathering statistics for high volatility tables), you should temporarily set a low value for DEGREE.

Note that the actual degree of parallelism can be between 1 (serial execution) for small objects to DEFAULT\_DEGREE for large objects.

### Caution:

Do not change the degree of parallelism attribute of any OSM table or index. This is not supported.

## Cursor Invalidations

When statistics are modified by DBMS\_STATS, new cursors that are not yet cached in the shared pool use updated statistics to get execution plans. However, existing cursors that are cached in the shared pool cannot update their execution plans. Instead, such cursors are invalidated and new versions, children cursors, are created. This results in execution plans based on the updated statistics. This involves a hard-parse operation that is more expensive than a soft-parse, which simply reuses a cached cursor. For this reason, Oracle Database spreads cursor invalidations over a time period long enough for hard-parses not to cause noticeable spikes in resource usage. This time period is 5 hours by default and it is controlled by the **\_optimizer\_invalidation\_period** initialization parameter (in seconds).

If your database has performance issues that are caused by bad execution plans because of stale or missing statistics, 5 hours is a long time to wait. Oracle therefore recommends that you decrease the value of **\_optimizer\_invalidation\_period**. For example, the following command sets **\_optimizer\_invalidation\_period** to 600 seconds.

```
alter system set "_optimizer_invalidation_period"=600 scope=both;
```

If 10 minutes turns out to be too short to avoid significant spikes caused by parsing in your environment, increase the value accordingly.

## Optimizer Statistics Management PL/SQL API Reference

This section describes: setup and tuning, maintenance, advanced, troubleshooting, and recovery procedures.

### Setup and Tuning Procedures

This section describes setup and tuning procedures.

#### om\_db\_stats\_pkg.lock\_volatile\_order\_stats

This procedure locks statistics on volatile order tables.

```
procedure lock_volatile_order_stats;
```

An order table is considered volatile if its volatility level is set to **om\_const\_pkg.v\_volatility\_high**.

#### om\_db\_stats\_pkg.unlock\_volatile\_order\_stats

This procedure unlocks statistics on volatile order tables.

```
procedure unlock_volatile_order_stats;
```

An order table is considered volatile if its volatility level is set to **om\_const\_pkg.v\_volatility\_high**.

#### om\_db\_stats\_pkg.set\_table\_prefs\_incremental

This procedure sets the **INCREMENTAL** statistics preference for partitioned OSM tables that have the specified volatility level.

```
procedure set_table_prefs_incremental(  
    a_incremental boolean,  
    a_volatility number);
```

Parameters:

- **a\_incremental**: Specifies whether you want statistics to be gathered incrementally on partitioned OSM tables that have the specified volatility level. When set to true, the PUBLISH preference is also set to true because this is required for incremental statistics collection.
- **a\_volatility**: Specifies the volatility level of partitioned OSM tables for which the **INCREMENTAL** statistics preference should be set.

Exception:

- **ORA-20165**: Illegal argument: Invalid volatility level.

## om\_db\_stats\_pkg.set\_table\_volatility

This procedure sets the volatility level for an OSM table. The volatility level for OSM tables is configured in OM\_\$INSTALL\$TABLE.

Parameters:

- **a\_table\_name**: Specifies the name of the table on which to set the volatility level.
- **a\_volatility**: Specifies the volatility level to set. Valid values are **om\_const\_pkg.v\_volatility\_none**, **om\_const\_pkg.v\_volatility\_low**, **om\_const\_pkg.v\_volatility\_medium**, and **om\_const\_pkg.v\_volatility\_high**.

## Maintenance Procedures

This section describes maintenance procedures.

### om\_db\_stats\_pkg.gather\_cartridge\_stats

This procedure gathers statistics for cartridge metadata tables.

```
procedure gather_cartridge_stats;
```

### om\_db\_stats\_pkg.gather\_order\_stats

This procedure gathers statistics for order tables configured with the specified volatility level.

```
procedure gather_order_stats(  
    a_volatility number default null,  
    a_force boolean default false);
```

Parameters:

- **a\_volatility**: The level of volatility of order tables for which statistics should be gathered. Null by default, which means all volatility levels.
- **a\_force**: Specifies whether you want statistics to be gathered on order tables even if their statistics are locked. The default is false.

Exception:

- **ORA-20165**: Illegal argument: Invalid volatility level.

### om\_db\_stats\_pkg.gather\_volatile\_order\_stats

This procedure gathers statistics for volatile order tables.

```
procedure gather_order_stats(  
    a_force boolean default false);
```

Parameters:

- **a\_force**: Specifies whether you want statistics to be gathered on volatile order tables even if their statistics are locked. The default is false. An order table is deemed volatile if its volatility level is set to **om\_const\_pkg.v\_volatility\_high**.

## om\_db\_stats\_pkg.copy\_order\_ptn\_stats

This procedure copies order partition statistics from the specified source order partition to the specified destination order partition.

```
procedure copy_order_ptn_stats(  
    a_copied out boolean,  
    a_dst_partition_name varchar2 default null,  
    a_src_partition_name varchar2 default null);
```

Parameters:

- **a\_copied**: Output parameter indicating whether statistics were successfully copied.
- **a\_dst\_partition\_name**: Specifies the name of the order partition to which you want to copy statistics. If you do not specify this parameter, the most recently added partition is used.
- **a\_src\_partition\_name**: Specifies the name of the order partition from which you want to copy statistics. If not specified, a partition with the most recent valid statistics is used, if available. If no valid partition statistics are available, **a\_copied** is set to false.

Exceptions:

- ORA-20142: Operation is not allowed: OSM schema is not partitioned.
- ORA-20165: Illegal argument: Partition does not exist.
- ORA-20165: Illegal argument: The source partition cannot be the same as the destination partition
- ORA-20144: Function returned unexpected value. Internal error. Contact support: Cannot find the newest partition.

## om\_db\_stats\_pkg.lock\_order\_ptn\_stats

This procedure locks order partition statistics for the specified partition. Statistics of the corresponding partitions of reference partition tables are also locked.

```
procedure lock_order_ptn_stats(  
    a_partition_name varchar2);
```

Parameters:

- **a\_partition\_name**: Specifies the name of the order partition to lock.

Exceptions:

- ORA-20165: Illegal argument: Partition does not exist.

## om\_db\_stats\_pkg.unlock\_order\_ptn\_stats

This procedure unlocks order partition statistics for the specified partition. Statistics of the corresponding partitions of reference partition tables are also unlocked.

```
procedure unlock_order_ptn_stats(  
    a_partition_name varchar2);
```

Parameters:

- **a\_partition\_name**: Specifies the name of the order partition to unlock.

Exceptions:

- **ORA-20165**: Illegal argument: Partition does not exist.

## Advanced Procedures

This section describes advanced procedures.

### om\_db\_stats\_pkg.export\_order\_ptn\_stats

This procedure exports order partition statistics from the specified order partition to the specified statistics table. If that table already exists, it is dropped before exporting statistics to the statistics table.

```
procedure export_order_ptn_stats(  
    a_exported out boolean,  
    a_src_partition_name varchar2 default null,  
    a_stat_table_name varchar2 default c_om_order_stat_table);
```

Parameters:

- **a\_exported**: Output parameter indicating whether statistics were successfully exported.
- **a\_src\_partition\_name**: Specifies the name of the order partition from which you want to export statistics. If not specified, a partition with the most recent valid statistics is used, if available. If no valid partition statistics are available, **a\_exported** is set to **false**.
- **a\_stat\_table\_name**: Specifies the name of the statistics table to which to export statistics. Defaults to **c\_om\_order\_stat\_table** ('OM\_ORDER\_STAT\_TABLE'). If this statistics table already exists, it is dropped and recreated before exporting statistics from the specified partition; if it is not a statistics table, the table is not dropped and an exception is raised.

Exceptions:

- **ORA-20142**: Operation is not allowed: OSM schema is not partitioned.
- **ORA-20165**: Illegal argument: Partition does not exist.
- **ORA-20165**: Illegal argument: Invalid table name.
- **ORA-20165**: Illegal argument: Table is not a statistics table.

### om\_db\_stats\_pkg.import\_order\_ptn\_stats

This procedure imports order partition statistics from the specified statistics table to the specified destination order partition.

```
procedure import_order_ptn_stats(  
    a_imported out boolean,  
    a_dst_partition_name varchar2 default null,  
    a_stat_table_name varchar2 default c_om_order_stat_table);
```

Parameters:

- **a\_imported**: Output parameter indicating whether statistics were successfully imported.
- **a\_dst\_partition\_name**: Specifies the name of the order partition to which you want to import statistics. If you do not specify this parameter, the most recently added partition is used.
- **a\_stat\_table\_name**: Specifies the name of the statistics table from which to import statistics. The default becomes **c\_om\_order\_stat\_table** ('OM\_ORDER\_STAT\_TABLE').

Exceptions:

- **ORA-20142**: Operation is not allowed: OSM schema is not partitioned.
- **ORA-20165**: Illegal argument: Partition does not exist.
- **ORA-20165**: Illegal argument: Invalid table name.
- **ORA-20165**: Illegal argument: Table is not a statistics table.
- **ORA-20144**: Function returned unexpected value. Internal error. Contact support: Cannot find the newest partition.

## om\_db\_stats\_pkg.expdp\_order\_ptn\_stats

This procedure saves order partition statistics from the specified statistics table to the DATA\_PUMP\_DIR directory. A .dmp suffix is added to the table name to form the name of the file to which statistics will be saved; for example, OM\_ORDER\_STAT\_TABLE.dmp. If that file already exists, it is deleted before saving statistics to the file system.

```
procedure expdp_order_ptn_stats(
    a_saved out boolean,
    a_stat_table_name varchar2 default c_om_order_stat_table);
```

Parameters:

- **a\_saved**: Output parameter indicating whether statistics were successfully saved.
- **a\_stat\_table\_name**: Specifies the name of the statistics table from which to obtain statistics. The default becomes **c\_om\_order\_stat\_table** ('OM\_ORDER\_STAT\_TABLE').

Exceptions:

- **ORA-20165**: Illegal argument: Invalid table name.
- **ORA-20165**: Illegal argument: Table does not exist.
- **ORA-20165**: Illegal argument: Table is not a statistics table.
- **ORA-20142**: Operation is not allowed: Failed to save partition statistics to file system.

## om\_db\_stats\_pkg.impdp\_order\_ptn\_stats

This procedure loads order partition statistics into the specified statistics table from the DATA\_PUMP\_DIR directory. A .dmp suffix is added to the table name to form the name of the file from which statistics will be loaded; for example, OM\_ORDER\_STAT\_TABLE.dmp.

```
procedure impdp_order_ptn_stats(  
    a_loaded out boolean,  
    a_stat_table_name varchar2 default c_om_order_stat_table);
```

 **Note:**

If partitioned statistics came from another system, they can be imported only if user names are the same in both the source and destination systems.

**Parameters:**

- **a\_loaded**: Output parameter indicating whether statistics were successfully loaded.
- **a\_stat\_table\_name**: Specifies the name of the statistics table into which you want to load statistics. The default becomes **c\_om\_order\_stat\_table** ('OM\_ORDER\_STAT\_TABLE'). If this statistics table already exists, it is dropped and recreated before loading statistics from the file system. If it is not a statistics table, the table is not dropped and an exception is raised.

**Exceptions:**

- **ORA-20165**: Illegal argument: Invalid table name.
- **ORA-20165**: Illegal argument: File not found in DATA\_PUMP\_DIR directory.
- **ORA-20165**: Illegal argument: Table is not a statistics table.
- **ORA-20142**: Operation is not allowed: Failed to load partition statistics from file system.

## Troubleshooting Procedures

This section describes the troubleshooting procedures.

### om\_db\_stats\_pkg.lstj\_copy\_order\_ptn\_stats

This procedure lists active **copy\_order\_ptn\_stats** jobs. The output includes a job ID that can be used to remove the job using **remj\_copy\_order\_ptn\_stats**.

```
procedure lstj_copy_order_ptn_stats;
```

### om\_db\_stats\_pkg.get\_order\_ptn\_stats

This procedure lists statistics for table partitions that match the given filter criteria.

```
procedure get_order_ptn_stats;
```

### om\_db\_stats\_pkg.list\_order\_ptn\_stats

This procedure outputs statistics for table partitions that match the given filter criteria to **dbms\_output**.

```
procedure list_order_ptn_stats;
```

## om\_db\_stats\_pkg.check\_order\_ptn\_stats

This procedure validates the statistics on the schema to check for any errors. There are two versions of this procedure: one outputs it to dbms\_output and the other returns it as a collection of strings (for external use).

```
procedure check_order_ptn_stats;
```

This procedure looks for the following conditions and creates the appropriate level message (in brackets) if the condition is violated:

- Missing statistics on Order Data Tables (CRITICAL)
- Empty or active partitions with unlocked statistics (CRITICAL)
- Mature partitions with locked statistics (WARNING)
- Statistics are locked with 0 rows on tables that should never have 0 rows when a partition is used to store orders (e.g., OM\_ORDER\_HEADER) (CRITICAL)
- Statistics are locked with a small number of rows on tables that should have a large number of rows in order to be representative of a partition used to store a large number of orders (e.g., OM\_ORDER\_HEADER) (CRITICAL)
- Incremental statistics do not work with locked partition statistics (CRITICAL)
- Incremental statistics are not enabled on low or medium volatility tables (MAJOR)
- Incremental statistics are enabled on high volatility tables (MAJOR)
- Statistics are not locked on high-volatility tables (CRITICAL)
- Statistics are locked on low or medium volatility tables (WARNING)
- Attempting to check for partition statistics problems while statistics are being collected (WARNING)

## Recovery Procedures

This section describes the recovery procedures.

### om\_db\_stats\_pkg.remj\_copy\_order\_ptn\_stats

This procedure removes the specified **copy\_order\_ptn\_stats** job.

```
procedure remj_copy_order_ptn_stats (  
    a_job_id number);
```

Parameter:

- **a\_job\_id**: Specifies the ID of the job to remove.

Exception:

- **ORA-20155**: Job does not exist.



# 8

## Backing Up and Restoring OSM Files and Data

This chapter helps you understand how Oracle Communications Order and Service Management (OSM) is related to the Oracle Database backup and restore procedures.

### About Backing Up and Restoring OSM Files and Data

It is critical that you have a schedule and procedures for backing up and restoring your production-ready OSM system. This chapter includes a suggested schedule and backup and restore considerations, as well as information about the components involved in the backup. You must consider your own business needs when determining your backup and restore strategy.

### Backup and Restore Overview

Consider OSM information from the Oracle Database for backing up and restoring OSM.

### Backup and Restore Schedule

#### Oracle Database

You should perform a complete backup of the OSM database after installation. The suggested schedule for post-install backups is to take an incremental (level 0 in RMAN) backup of the database monthly, a cumulative (level 1 in RMAN) backup weekly and a differential (level 1 in RMAN) backup daily. It is currently not possible to take consistent backups of database and transaction logs, because the transaction logs are file-based. For highest reliability use a highly available fault-tolerant storage (for example, SAN) for database and transaction log file stores.

### Backup and Restore Considerations

Overall considerations for OSM backup and restore include:

- Test backup and restore procedures in a test or staging environment before they are used in production.

### Oracle Database Backup Considerations

The Oracle Database Server provides several means of backing up information. The two recommended methods for ordinary backup and restore are provided in this section. There are no special considerations for OSM in determining the actual procedure for a backup or restore. Information about how to use the backup and

restore methods considered in this section can be found in the Oracle Database documentation.

Database backup and restore procedures should be performed by a qualified database administrator.

## RMAN Considerations

Recovery Manager (RMAN) is an Oracle Database utility that backs up, restores, and recovers Oracle databases. It backs up individual datafiles, and provides complete and incremental backup options. Following are some issues you should consider for using RMAN:

- Because it backs up datafiles, this method is most appropriate for use when OSM is not sharing any tablespaces with other applications. If OSM is sharing its tablespaces with other applications, they will be backed up at the same time. This means that if the OSM data is restored, the information for any other applications will be restored as well. This may not be desired.
- You should back up all of the permanent tablespaces that you have defined for OSM. For example, if you have different tablespaces for data and indexes, you should remember to back up both of them.
- RMAN may be slower than Flashback. This might be an issue in a large production environment.

## Oracle Flashback Technology Considerations

Oracle Flashback Technology comprises a group of features that support the viewing of past states of data without needing to restore backups. It provides the ability to restore an entire database or individual tables from a set point in time. Following are some issues you should consider if you choose to employ this backup method:

- Because it backs up the entire database, this method is most appropriate for use when OSM is not sharing the database with other applications. If OSM is sharing the database instance with other applications, this method does not allow you to restore only the OSM portion of the database. This can cause data for other applications to be overwritten with older data.
- The Flashback Database command does not restore or perform media recovery on files, so you cannot use it to correct media failures such as disk crashes.
- Some editions of the Oracle Database software may not include this feature.

## Mirroring Technology Considerations

Split mirrored hardware and software solutions provide a higher level of performance than RMAN and Oracle Flash Technology. Mirroring technology, such as the Oracle Sun ZFS Storage Appliance, enables very fast backup and restore that you can run online without overloading the system. You can use mirror splitting to back up ASM disks, the RDBMS data files, redo logs, and control files.

Oracle recommends that you consider a mirroring technology over other technologies for larger OSM installations. Using a mirroring solution in large OSM installations, provides the following benefits:

- Before you purge a partition or upgrade OSM, Oracle recommends that you backup the database in case of a failure. Mirroring technology enables fast database backup and restore operations. This ability greatly reduces the time it takes to prepare for a purge or upgrade and reduces the time it takes to recover from purge or upgrade failures.
- Taking a database snapshot for testing an upgrade procedure, troubleshooting a problem, and so on, becomes much less time consuming.

# 9

## Monitoring and Managing OSM

This chapter describes how to monitor and manage the Oracle Communications Order and Service Management (OSM) system using the Oracle WebLogic Server Administration Console.

This chapter provides guidelines and best practices for monitoring an OSM deployment. This includes functional monitoring of particular orders or processes, and performance monitoring to assist in tuning. In order to effectively monitor OSM, you require a broad knowledge of many components, such as the OSM Managed Server, the Java Virtual Machine (JVM), the WebLogic Server, and the Oracle Database.

### About Monitoring and Managing OSM

Many OSM monitoring tasks must be performed on various schedules. Some tasks should be performed daily, whereas others can be done weekly or even monthly. Many tasks can be done automatically, by configuring thresholds that raise warnings when the thresholds are exceeded. The output of many of the tasks can be interpreted as snapshots, whereas others should be interpreted only in the context of a series of data.

For each monitoring task in this chapter, there is a description of the item that the task monitors, why the item should be monitored, what tool(s) you should use to monitor the item, and information about what to monitor, including guidance on selecting values, such as thresholds.

The monitoring tasks are grouped into monitoring the application, monitoring input/output (I/O), and monitoring the host.

### Accessing the WebLogic Server Administration Console

The WebLogic Server Administration Console is a web-based application that allows system administrators, support staff, and others to view the OSM application and associated configuration remotely. In OSM cloud native, use WebLogic Server Administration Console to verify the configuration that has been applied and to see that the OSM application is in a good state.

To access the Oracle WebLogic Server Administration console do one of the following:

- If you are not connecting via Secure Socket Layer (SSL), enter the following URL into your browser:

```
http://admin.host:port/console
```

The base hostname required to access this instance is *instance.project.osm.org*. See "Planning and Validating Your Cloud Environment" in *OSM Cloud Native Deployment Guide* for details about hostname resolution.

- If you are connecting via SSL, enter the following URL into your browser:

```
https://admin.host:SSLport/console
```

When started, the WebLogic Server Administration Console prompts for a password. This should be the password for a user that is a member of the **Administrators** group in WebLogic. One such user is the WebLogic administration user that was created when the domain was created. By default, the name of this user is **weblogic**.

After you have successfully logged in, the WebLogic console Home window is displayed.

## Using the WebLogic Console to Determine the Status of the OSM Application

After you have logged into the WebLogic console, you can access information about the status of the WebLogic servers and OSM deployments.

To access the status of the OSM server and deployments:

1. Log in to the WebLogic Server Administration Console.
2. In the Domain Structure tree, expand **Environment**, and then click **Servers**.  
The Summary of Servers window is displayed. Server statuses are contained in the Health column of the table.
3. In the Domain Structure tree, click **Deployments**.  
The Summary of Deployments window is displayed. Deployment statuses are contained in the Health column of the table.

## Refreshing OSM Metadata

When you are working with OSM, you may come across instructions to refresh the OSM metadata. There are different ways to do this. You can use whichever of them is easiest for you, as long as you meet any prerequisites.

To refresh the OSM metadata, do any **one** of the following:

- If you have access to the Order Management web client, click **Refresh Server Cache** in the Administration area.
- Scale up the number of managed servers.

## Monitoring and Analyzing Performance

This section describes several tools that are specific to OSM, as well as some general tools, that gather data when your system has performance-related issues.

### Monitoring Performance Using WebLogic Server Administration Console

The WebLogic Server Administration Console provides a real-time view of system performance.

 **Note:**

For more information about tuning OSM production systems, see *OSM Installation Guide*.

To access the performance monitor:

1. Start the WebLogic Server Administration Console.
2. Click **Environment**, then **Servers**, and then select a server from the list.  
This displays the General Configuration page for the selected server.
3. Click **Monitoring**.
4. Click the **Health** tab to view the health status for all OSM related sub-systems. If the status is not **OK**, review the reason and, if required, access the server log for more information.

Health status severity levels are shown in the bottom left pane of the console under System Status. (OK, Warn, Overloaded, Critical, Failed)

5. Click the **Performance** tab to view JVM memory utilization statistics for the server.

Refresh the screen several times to sample values for Health Free Percent. If memory usage remains elevated (for example, not falling to 50% or less while the system is under load), analyze the garbage collection logs and follow the recommendations described in the *OSM Memory Tuning Guidelines* (Doc ID: 2028249.1) knowledge article on My Oracle Support. For example, undeploy cartridges that are no longer needed or add a new managed server to the WebLogic Server cluster.

6. Click the **Threads** tab to monitor thread activity for the server. An important column to monitor is **Pending Requests**. A count of zero is optimal, meaning no user requests are stuck or waiting to be processed.
7. Click the **Workload** tab to monitor the Work Managers configured for the server.  
Check Deferred Requests in the Max Threads Constraint table. If Deferred Requests does not go back to **0**, you may need to tune the system (for example, add a new managed server to the WebLogic Server cluster or allocate more threads to OSM work managers).
8. Click the **JTA** tab to monitor transaction activity on the server. Ideally, there should be no Roll Back statistics in the summary; if so, view the server log file for more information.

## Monitoring the Managed Server

The high-level analytical tools and considerations for monitoring the managed server include the following:

- In the Weblogic administration console, ensure all servers are marked as **OK** in system status. If the server(s) listed have another status (for example, **Overloaded** or **Critical**) you must investigate immediately to determine the particular sub-system of the server that is under stress. Also, check the server logs.

- Use the **Reporting** page in OSM Task web client to monitor the orders that are in progress and task statistics. For information about the Reporting page, see *OSM Task Web Client User's Guide*. You can also analyze OSM order completion rates using a script. For more information, see "[Tools for Performance Testing, Tuning, and Troubleshooting](#)".

## Analyzing Garbage Collection

Garbage collection logs for the performance test runs include important information about the heap usage for the particular test. Use this data for later analysis and adjustment of the JVM heap and for tuning garbage collection. Use GCViewer to analyze garbage collection data that you have collected using Oracle JDK. For more information about GCViewer, see "[GCViewer](#)".

## Monitoring the Database

When you monitor the operating system on the database server, make sure the system has enough idle CPU and Input/Output (I/O) wait times are low (nothing more than few percent of I/O waits are acceptable).

You can monitor the database by using Oracle Enterprise Manager, a web-based tool that allows you to manage Oracle software. For more information about Enterprise Manager, see Oracle Enterprise Manager Cloud Control documentation.

## Managing Logs

For details about managing logs in OSM cloud native, see "Exploring Alternate Configuration Options" in *OSM Cloud Native Deployment Guide*.

## Secure vs Non-Secure Log Filtering

A stack trace is a list of the method calls that an application is in the middle of at the time an exception is thrown. Running OSM with stack trace logging enabled can be important for debugging an application during runtime.

Using the **oms-config.xml** parameter, **enable\_log\_stacktraces**, you can enable or disable logging stack traces. By default, this parameter is enabled. If there is a security concern about having log stack traces enabled, you can disable this parameter. For more information about setting this parameter, see "[Configuring OSM with oms-config.xml](#)".

## Managing Database Connections

In OSM, database connections are managed through database pools that are set up in WebLogic.

The database pool connections can be configured through the shape specification file. See "Working with Shapes" in *OSM Cloud Native Deployment Guide*.

## Using JMS Queues to Send Messages

OSM uses JMS **Queues** and **Topics**, which are both JMS Destinations. **Queues** follow a point-to-point communication paradigm, while **Topics** follow the publish and subscribe paradigm.

 **Note:**

In an OSM clustered environment, you must use JMS queues as a JMS destination to receive JMS events. Do not use JMS topics in an OSM clustered environment.

When OSM sends data to an external system, such as UIM or ASAP, it does so by sending JMS messages to the appropriate JMS request queue of an external system.

If the external system is not processing the requests from OSM, the queues get backlogged. It is important to be able to monitor the size of the JMS queues in order to know whether or not they are backing up.

To monitor the JMS queues:

1. Login to the WebLogic Administration Console  
Click **Services/Messaging/JMS Servers/oms\_jms\_server**.  
The General Configuration page is displayed.
2. Click the **Monitoring** tab and then click **Active Destinations**.  
A list of active destinations targeted to the server is displayed.

 **Note:**

The default view of the table does not contain the **Consumers Current** column. We recommend that you customize the table using the **Customize** link to include this column, along with any other customizations you may want to make.

The **Consumers Column** column defines the current number of listeners on the destination. If a destination does not have any listeners, the external system does not receive the messages.

The **Messages Current** column defines the current number of unprocessed messages in the JMS destination. A large number of messages (for example, 10,000) in this destination is a problem. It means that the system is not keeping up, that the messages are not getting processed, or that the messages are getting processed but errors are occurring and the messages are getting put back on the destination.

OSM has the following JMS destinations present:

- oms\_behavior\_queue: Used for customizing task assignment



- oms\_events: Internal destination used for events such as automation, notifications, and task state changes
- oms\_order\_events: Used for order state changes such as OrderCreateEvent, OrderStateChangeEvent, AmendmentStartedEvent, OrderCancelledEvent
- oms\_order\_updates: Internal destination used for processing amendments
- oms\_signal\_topic: Internal destination used to trigger a metadata refresh

## Sending Data to External Systems Using Plug-Ins

If there are external systems deployed to the same WebLogic instance as OSM, when you monitor the JMS destinations, watch for the following.



### Note:

The important columns are Consumers, Messages, and Messages Received.

If the number in the messages column for these queues continues to grow, the external system may not be processing the messages sent by OSM. You must check to see if the external system is working properly.

If the number of consumers for the queues is 0, the external system may not have configured its listeners properly. Check to see if the external system is configured properly.

## About OSM and XA Support

The OSM database does not support XA transactions because the Oracle thin-client driver used for JDBC connections does not support XA. However, the OSM WebLogic Server configuration uses an XA emulation feature in order to get a two-phase commit across JMS/JDBC automation transactions.

Even though OSM uses a non-XA driver for database transactions, external XA resources can still participate in transactions. For example, JMS bridges can be XA-enabled for an outside application, but the OSM side of the transaction still uses the non-XA emulated two-phase commit. Note that this also applies to JMS queues that support Application Integration Architecture (AIA) cartridges.

## Using Work Managers to Prioritize Work

In OSM cloud native, work managers are configured as part of defining a shape. WebLogic Server uses a single thread pool in which all types of work are executed. Work managers allow you to define rules and run-time metrics that WebLogic Server uses to prioritize this work.

For more information about using work managers to optimize scheduled work, see "Using Work Managers to Optimize Scheduled Work" in *Oracle Fusion Middleware Administering Server Environments for Oracle WebLogic Server*.

## Default Work Managers and Components

This section list the default work managers and components in an OSM instance.

**Table 9-1 Default Work Managers and Components**

Work Manager or Component	Configuration Properties	Description
Maximum Threads Constraint	<b>Name:</b> osmAutomationMaxThreadConstraint	Used by the work manager osmAutomationWorkManager to reserve a separate pool of threads for core order processing.
Maximum Threads Constraint	<b>Name:</b> osmGuiMaxThreadConstraint	Used by the work managers osmTaskClientWorkManager and osmOmClientWorkManager to reserve a separate pool of threads for the web clients.
Maximum Threads Constraint	<b>Name:</b> osmGuiMinThreadConstraint	Used by the work managers osmTaskClientWorkManager and osmOmClientWorkManager to guarantee that a minimum number of threads are reserved for the web clients.
Maximum Threads Constraint	<b>Name:</b> osmHttpApiMaxThreadConstraint	Used by the work managers osmWsHttpWorkManager and osmXmlWorkManager to reserve a separate pool of threads for APIs invoked over http.
Maximum Threads Constraint	<b>Name:</b> osmJmsApiMaxThreadConstraint	Used by the work manager osmWsJmsWorkManager to reserve a separate pool of threads for the WS/JMS API
Work Manager	<b>Name:</b> osmAutomationWorkManager <b>Maximum Threads Constraint:</b> osmAutomationMaxThreadConstraint	Used to process work performed by automation tasks.
Work Manager	<b>Name:</b> osmTaskClientWorkManager <b>Maximum Threads Constraint:</b> osmGuiMaxThreadConstraint <b>Minimum Threads Constraint:</b> osmGuiMinThreadConstraint	Used to process requests from manual users using the Task web client.
Work Manager	<b>Name:</b> osmWsJmsWorkManager <b>Maximum Threads Constraint:</b> osmJmsApiMaxThreadConstraint	Used to process OSM JMS Web Service requests.
Work Manager	<b>Name:</b> osmWsHttpWorkManager <b>Maximum Threads Constraint:</b> osmHttpApiMaxThreadConstraint	Used to process OSM HTTP Web Service requests.
Work Manager	<b>Name:</b> osmOmClientWorkManager <b>Maximum Threads Constraint:</b> osmGuiMaxThreadConstraint <b>Minimum Threads Constraint:</b> osmGuiMinThreadConstraint	Used to process requests from manual users using the Order Management web client.

Table 9-1 (Cont.) Default Work Managers and Components

Work Manager or Component	Configuration Properties	Description
Work Manager	<b>Name:</b> osmXmlWorkManager <b>Maximum Threads Constraint:</b> osmHttpApiMaxThreadConstraint <b>Minimum Threads Constraint:</b> Not configured	Used to process requests coming from external clients for the OSM XML API.

For details on configuring these values, see "Working with Shapes" in *OSM Cloud Native Deployment Guide*.

## Overriding the Internet Explorer Language in the OMS Web Clients

If the Internet Explorer installation that is used to access the OMS web clients is set to a language other than English, and this language matches one of the properties files included in the **oms.ear** file, the web client prompts are displayed in the non-English language.

The language used in the web clients is controlled by the **resources.properties** file. Additional language property files in the **oms.ear** file include:

- **resources\_cs.properties** (Czech language properties file)
- **resources\_zh.properties** (Chinese language properties file)

To remove support for a non-English language, unpack the **oms.ear** file, remove the corresponding properties file, repack the **oms.ear** file. For more information about working with **oms.ear** file, see *OSM Developer's Guide*.

For example, if the browser is set to use the Czech language, and the **resources\_cs.properties** file exists in the **oms.ear** file, the web client prompts are displayed in Czech. Removing the **resources\_cs.properties** file causes the web client prompts to be displayed in English, even though the browser language setting is still configured to the Czech language.

# 10

## Exporting and Importing OSM Schema Data

This chapter provides information about how to selectively export and import schema data, which include orders and model data (cartridge data), from an Oracle Communications Order and Service Management (OSM) database.

### About Exporting and Importing OSM Schema Data

You can export an OSM schema using standard Oracle Database tools. Exporting OSM schema data is useful for providing support personnel with the information that they require to troubleshoot a failed order, or range of orders. You can export an entire OSM schema, however it is typically very large, with hundreds of thousands of orders. Exporting a large schema is rarely practical because of its size, the resources it would consume, and the time it might take to export. It is more feasible to selectively export specific orders or a range of orders.

This chapter provides information about exporting and importing order and model data from one database to another using the OSM export/import utility package. Exporting only the data that is causing an issue allows support to more quickly locate and resolve issues. You can use the utilities in the package to dynamically generate the files required for exporting data, and to prepare and finalize the schema for import.

#### Note:

The utilities do not provide an effective means of backing up and restoring database data. For more information about how to do this, see "[Backing Up and Restoring OSM Files and Data](#)".

You can follow several scenarios to export and import OSM data, depending on the reason and the type of data that you need.

- [Exporting and Importing the OSM Model Data Only](#)
- [Exporting and Importing the OSM Model and a Single Order](#)
- [Exporting and Importing a Range of Orders and the OSM Model](#)
- [Exporting and Importing a Range of OSM Orders Only](#)

### Exporting and Importing the OSM Model Data Only

You can export and then import only the OSM model data (cartridge data). To do this, you use the export/import utilities to generate a PAR file with options for exporting the OSM model.

 **Note:**

Model tables that are system-managed, or that contain system-managed parameters, are excluded from the export because these tables are created by the database installer and already exist in the target schema.

## Exporting OSM Model Data

To export model data only:

1. Open a terminal and log in to SQL\*Plus as the OSM core schema user.
2. Verify that the export/import utility package (**om\_exp\_imp\_util\_pkg**) exists by running the following command:

```
select count(*) from user_objects where object_type = 'PACKAGE' and
OBJECT_NAME = 'OM_EXP_IMP_UTIL_PKG';
```

```

COUNT(*)
-----
1
```

If the count that is returned is 1, the package exists and you do not need to create it. If the count is zero, you must create the package.

 **Note:**

If the export/import utility package does not exist in the database, you can run the installer to create it. For information about running the installer, see *OSM Installation Guide*.

When you run the OSM installer, make sure that you select the "Database Schema" component to create the export/import utility package.

3. Open another terminal and take the OSM server offline.
4. Return to the original terminal and allow the output to be generated by running the following command:

```
set serveroutput on
```

5. Prevent extra white space in the generated PAR file by running the following command:

```
set trimspool on
```

Extra white space in the PAR file causes the export to fail.

6. Specify the file where you want to capture the generated output by running the following command. The database creates this file in the folder you were in when you logged into the sqlplus session:

```
spool osm_exdp_model_parfile.txt
```

7. Export the model by running the **om\_exp\_imp\_util\_pkg.generate\_expdp\_model\_parfile** procedure:  
`exec om_exp_imp_util_pkg.generate_expdp_model_parfile`
8. Stop capturing the generated output by running the following command:  
`spool off`
9. Log off the SQL\*Plus session. For example:  
`exit`
10. Using a text editor, remove the following lines from the **osm\_expdp\_model\_parfile.txt** file:
  - `exec om_exp_imp_util_pkg.generate_expdp_model_parfile`
  - PL/SQL procedure successfully completed.
  - `spool off`
11. (Optional) Modify PAR file parameters as needed in **osm\_expdp\_model\_parfile.txt** file. For more information, see "[Changing PAR File Parameters](#)".
12. Export the model tables by running the following command:  
`expdp SourceOSMCoreSchemaUserName PARFILE=osm_expdp_model_parfile.txt`
13. Print the schema data to a text file by doing the following:
  - a. Log in to SQL\*Plus as the OSM core schema user.
  - b. Allow the output to be generated by running the following command:  
`set serveroutput on`
  - c. Specify the file where you want to capture the generated output by running the following command:  
`spool osm_expdp_schema_info.txt`
  - d. Print the schema by running the **om\_exp\_imp\_util\_pkg.print\_schema\_info** procedure:  
`exec om_exp_imp_util_pkg.print_schema_info;`
  - e. Stop capturing the generated output by running the following command:  
`spool off`

 **Note:**

Keep this text file with the OSM database dump (dmp) files because the file contains information that will be used when you import the dmp files.

The Data Pump Export utility unloads data and metadata into a set of operating system files called a dump file set, which is then imported using the Data Pump Import utility. For more information about Oracle Data Pump utility and the dmp files, see "Oracle Data Pump Export" in *Oracle Database Utilities*.

14. Restart the OSM server you exported the data from.

## Preparing the Target OSM Schema Before Import

Before you import the OSM model data that you exported from a source schema, you must prepare the OSM target schema to which you want to import that data.

### Creating the Target OSM Schema

If the target schema does not already exist, run the OSM installer (of the same OSM version as the source schema) to create it. If you require a fully functional environment, you must also manually create any Weblogic resources such as users, groups, any custom queues, and so on.

### Adding Partitions

If the target schema is partitioned and you are importing order data, you must ensure that the order IDs that you want to import map to existing partitions. If any order ID is greater than or equal to the greatest partition upper bound, add one or more partitions as needed.

If the source schema uses partitioning realms (for example, for short-lived orders), the size and order of the partitions and the partitioning realms that they are associated with on the source system, must be duplicated on the target system. Partitions associated with partitioning realms must be added after OSM model data is imported because the partitioning realms are imported with OSM model data. See "[Partitioning Realms](#)" for more information.

If the source schema has the partitions and partitioning realms that are shown in [Table 10-1](#), for example, the same size of partitions and realms must be created on the target schema. For this example, you run the following commands after you create the partitioning realms in the target schema using OSM model import:

```
exec om_part_maintain.add_partition(a_tablespace, 'default_order');
exec om_part_maintain.add_partition(a_tablespace, 'short_lived_orders');
```

where *a\_tablespace* is the tablespace for new partitions. This procedure modifies the default tablespace attribute of partitioned tables with the specified tablespace before adding partitions. If you do not specify the tablespace, or if the **a\_tablespace** value is **null**, each partition is created on the default tablespace of the partitioned table (for example, on the same tablespace as the most recently added partition).

[Table 10-1](#) shows an example of a set of partitions that use the partitioning realms feature.

**Table 10-1 Example Set of Partitions That Use Partitioning Realms**

Partition Name	Partition Size	order_seq_id Lower Bound	order_seq_id Upper Bound	Partitioning Realm
P_0000000000001000 01	100000	1	100000	default_order
P_0000000000106000 01	500000	10100001	10600000	short_lived_order ers

For information about using partitioning realms, see "[Partitioning Realms](#)". For more information about adding partitions, see "[Managing the OSM Database Schema](#)".

To add partitions to a schema:

1. Log in to SQL\*Plus as the OSM core schema user.
2. Add partitions by running the following command:

```
exec om_part_maintain.add_partitions(n, tablespace, realm_mnemonic)
```

where:

(*n*) is the number of partitions that you want to add

(*tablespace*) is the tablespace for the new partition(*realm\_mnemonic*) is the mnemonic of the partitioning realm associated with this partition. This value is used only for schemas that use partitioning realms. The default realm is **default\_order** if this value is not provided.

3. Query the **user\_tab\_partitions** table to view the newly added partitions.

```
select * from user_tab_partitions where table_name = 'OM_ORDER_HEADER' ;
```

 **Note:**

If you are not on the latest version of your OSM release, the **add\_partitions** procedure might not work. In this case, see "[Adding Partitions \(Online or Offline\)](#)" for information about how to add partitions.

## Importing OSM Model Data

After you prepare the target schema, import the OSM model data and finalize the target schema by running the target schema setup script.

For information about Oracle Data Pump and the dmp files, see Oracle Database documentation.

To import OSM model data:

1. Open a terminal and take the OSM server offline.
2. (Optional) Purge the existing OSM model by running the following command:

```
exec om_exp_imp_util_pkg.purge_model
```

 **Note:**

Purging the data before importing it to the target schema ensures there are no constraint violations when importing duplicate data.

3. Open another terminal, log in to SQL\*Plus as the OSM core schema user.
4. Disable constraints and triggers, and stop jobs by running the following command:

```
exec om_exp_imp_util_pkg.pre_impdp_setup
```

This command ensures that there are no errors when importing OSM data.

5. From another terminal, import the model tables. For example:



```
impdp TargetOSMCoreSchemaUserName DIRECTORY=DATA_PUMP_DIR
DUMPFILER=osm_expdp_model%U.dmp LOGFILE=osm_impdp_model.log
REMAP_SCHEMA=SourceOSMCoreSchemaUserName:TargetOSMCoreSchemaUserName
REMAP_TABLESPACE=SourceOSMTablespace:TargetOSMTablespace
```

- Finalize the target OSM schema by running the following command:

```
exec om_exp_imp_util_pkg.post_impdp_setup
```

This enables the constraints and triggers, and resubmits the jobs that were disabled and stopped before importing the OSM data.

- Restart the OSM server.

## Exporting and Importing the OSM Model and a Single Order

In some cases, you might want to analyze a single known order from a large schema, and you can selectively export that specific order. To extract a single order for analysis in another environment, you need to export both the order and the model. First you export the order and then you export the model.

### Exporting OSM Order Data

Order data is saved in order tables. To select the order data that you want to export, query the order ID. Most tables store the order ID in the **order\_seq\_id** column. If there are exceptions that use a different name for the order ID column, you must export and import these separately.

### Preparing to Export Order Tables for a Single Order

To prepare to export order tables:

- Log in to SQL\*Plus as the OSM core schema user.
- Verify that the export/import utility package (**om\_exp\_imp\_util\_pkg**) exists by running the following command:

```
select count(*) from user_objects where object_type = 'PACKAGE' and
OBJECT_NAME = 'OM_EXP_IMP_UTIL_PKG';
```

```

COUNT(*)
-----
1
```

If the count that is returned is 1, the package exists and you do not need to create it.

#### Note:

If the export/import utility package does not exist in the database, you can run the installer to create it. For information about running the installer, see *OSM Installation Guide*.

When you run the OSM installer, make sure that you select the "Database Schema" component to create the export/import utility package.

3. Verify that the order that you want to export is not open by running the following SQL commands:

```
set serveroutput on
exec om_exp_imp_util_pkg.print_open_order_count(a_min_order_id =>
orderid_min, a_max_order_id => orderid_max);
```

where both *orderid\_min* and *orderid\_max* are the ID of the order that you want to export. For example: **a\_min\_order\_id => 123456**, **a\_max\_order\_id => 123456**. For more information, see "[About Order Export Queries](#)".

The following message is displayed:

```
There are no open orders
```

If the order specified is open and the server should be taken offline, the following message is displayed:

```
The open order count is: 1
```



#### Note:

Oracle recommends that you always check for open orders before you export order data.

4. If the order that you want to export is open, take the OSM server offline.
5. Allow the output to be generated by running the following command:
6. Prevent extra white space in the generated PAR file by running the following command:

```
set serveroutput on
```

```
set trimspool on
```

Extra white space in the PAR file causes the export to fail.

## Exporting Order Tables That Define an Order Sequence ID

To export order tables that define an ID in the *order\_seq\_id* column:

1. Follow all the steps of the procedure in "[Preparing to Export Order Tables for a Single Order](#)".
2. Specify the file where you want to capture the generated output by running the following command:

```
spool osm_exdp_orders_parfile.txt
```

3. Export orders by running the **om\_exp\_imp\_util\_pkg.generate\_exdp\_order\_parfile** procedure.

```
exec om_exp_imp_util_pkg.generate_exdp_order_parfile;
```

4. Stop capturing the generated output by running the following command:

```
spool off
```

5. Modify the PAR file option query in **osm\_exdp\_orders\_parfile.txt** to select the single order that you want to export.

For example, modify `where order_seq_id > 0` to `where order_seq_id = 123456`; where `123456` is the ID of the order that you want to export. For more information, see "[About Order Export Queries](#)".

- (Optional) Modify PAR file parameters as needed in **osm\_expdp\_model\_parfile.txt**. For more information, see "[Changing PAR File Parameters](#)".
- Export the order tables by running the following command:  

```
expdp SourceOSMCoreSchemaUserName PARFILE=osm_expdp_orders_parfile.txt
```
- Restart the OSM server.

## Exporting the OSM Model Data

After you export the single order, export the OSM model data. For more information, follow the procedure to export the model data in the topic "[Exporting and Importing the OSM Model Data Only](#)".

### Note:

Model tables that are system-managed, or contain system-managed parameters, are excluded from the export because these tables are created by the database installer and already exist in the target schema.

## Importing the OSM Model and Order Data

Before you import the OSM model data, prepare the target schema. For more information, see "[Preparing the Target OSM Schema Before Import](#)".

After you prepare the target schema, you import first the OSM model data, and then the OSM order data that you previously exported. Most tables store the order ID in the **order\_seq\_id** column. There are a few exceptions that you must export and import separately.

To import the OSM data:

- Stop the OSM server that you want to import to.
- (Optional) Purge existing OSM orders by running the following command:

```
exec om_exp_imp_util_pkg.purge_orders
```

### Note:

The orders must match the model. Purging the data before importing it to the target schema ensures there are no constraint violations when importing duplicate data.

- (Optional) Purge the existing OSM model by running the following command:

```
exec om_exp_imp_util_pkg.purge_model
```

 **Note:**

Purging the data before importing it to the target schema ensures there are no constraint violations when importing duplicate data.

4. Log in to SQL\*Plus as the OSM core schema user.
5. Disable constraints and triggers, and stop jobs by running the following command:

```
exec om_exp_imp_util_pkg.pre_impdp_setup
```

Running this command ensures that there are no errors when importing OSM data.

6. Import the model data by running the following command:

```
impdp TargetOSMCoreSchemaUserName DIRECTORY=DATA_PUMP_DIR
DUMPFILE=osm_expdp_model%U.dmp LOGFILE=osm_impdp_model.log
REMAP_SCHEMA=SourceOSMCoreSchemaUserName:TargetOSMCoreSchemaUserName
REMAP_TABLESPACE=SourceOSMTablespace:TargetOSMTablespace
```

For more information about these parameters, see "[About Import Parameters](#)".

7. Import order tables that define an order sequence ID by running the following command:

```
impdp TargetOSMCoreSchemaUserName DIRECTORY=DATA_PUMP_DIR
DUMPFILE=osm_expdp_orders%U.dmp LOGFILE=osm_impdp_orders.log
REMAP_SCHEMA=SourceOSMCoreSchemaUserName:TargetOSMCoreSchemaUserName
REMAP_TABLESPACE=SourceOSMTablespace:TargetOSMTablespace TRANSFORM=oid:n
```

For more information about these parameters, see "[About Import Parameters](#)".

8. Finalize the OSM target schema by running the following command:

```
exec om_exp_imp_util_pkg.post_impdp_setup
```

This enables the constraints and triggers, and resubmits the jobs that were disabled and stopped before importing the OSM data.

9. Restart the OSM server.

## Exporting and Importing a Range of Orders and the OSM Model

You can replicate an OSM schema using a subset, or range, of orders from a large schema.

### Exporting the OSM Order Data Range

Order data is saved in order tables. To select the order data that you want to export, query the order ID. Most tables store the order ID in the **order\_seq\_id** column. There are a few exceptions, which must be exported and imported separately.

Print the schema data. For more information see, "[Exporting OSM Order Data](#)".

## Preparing to Export Order Tables for a Range of Orders

To prepare to export order tables:

1. Log in to SQL\*Plus as the OSM core schema user.
2. Verify that the export/import utility package (**om\_exp\_imp\_util\_pkg**) exists by running the following command:

```
select count(*) from user_objects where object_type = 'PACKAGE' and  
OBJECT_NAME = 'OM_EXP_IMP_UTIL_PKG';
```

```
      COUNT(*)  
-----  
          1
```

If the count that is returned is 1, the package exists and you do not need to create it.

### Note:

If the export/import utility package does not exist in the database, you can run the installer to create it. For information about running the installer, see *OSM Installation Guide*.

When you run the OSM installer, make sure that you select the **Database Schema** component to create the export/import utility package.

3. Verify that none of the orders that you want to export are open by running the following SQL commands:

```
set serveroutput on  
exec om_exp_imp_util_pkg.print_open_order_count(a_min_order_id =>  
orderid_min);
```

where *orderid\_min* is the minimum bound value of a range of order IDs. For more information, see "[About Order Export Queries](#)".

The following message is displayed:

```
There are no open orders
```

If any of the orders within the range specified are open and the server should be taken offline, the following message is displayed:

```
The open order count is: n
```

where *n* is the number of open orders.

### Note:

Oracle recommends that you always check for open orders before you export data.

4. If any of the orders that you want to export are open, take the OSM server offline.
5. Allow the output to be generated by running the following command:

```
set serveroutput on
```

6. Prevent extra white space in the generated PAR file by running the following command:

```
set trimspool on
```

Extra white space in the PAR file causes the export to fail.

## Exporting Order Tables That Define an Order Sequence ID

To export order tables that define an order sequence ID:

1. Follow all the steps of the procedure in "[Preparing to Export Order Tables for a Single Order](#)".
2. Specify the file where you want to capture the generated output by running the following command:

```
spool osm_expdp_orders_parfile.txt
```

3. Export the orders by running the **om\_exp\_imp\_util\_pkg.generate\_expdp\_order\_parfile** procedure. For example:

```
exec om_exp_imp_util_pkg.generate_expdp_order_parfile(a_min_order_id =>
100000);
```

```
DIRECTORY=DATA_PUMP_DIR
DUMPFIL=osm_expdp_orders%U.dmp
FILESIZE=1GB
LOGFILE=osm_expdp_orders.log
CONTENT=DATA_ONLY
PARALLEL=1
QUERY=" where order_seq_id >= 100000"
TABLES=(
OM_ATTACHMENT,
OM_HIST$DATA_CHANGE_NOTIF,
OM_HIST$FALLOUT,
OM_HIST$FALLOUT_NODE_INSTANCE,
OM_HIST$FLOW,
OM_HIST$NOTIFICATION,
OM_HIST$ORDER_HEADER,
OM_HIST$ORDER_INSTANCE,
OM_HIST$ORDER_STATE
...
OM_JMS_THREAD,
OM_SYSTEM_EVENT
)
```

PL/SQL procedure successfully completed.

4. Run the following command, which stops capturing the generated output:
- ```
spool off
```
5. (Optional) Modify PAR file options as needed in **osm\_expdp\_model\_parfile.txt**. For more information, see "[Changing PAR File Parameters](#)".
  6. Export the order tables by running the following command:

```
expdp SourceOSMCoreSchemaUserName PARFILE=osm_expdp_orders_parfile.txt
```

7. Restart the OSM server.

## Exporting the OSM Model Data

After you export the orders, you can export the OSM model data. For information about exporting the model data, follow the procedure in the topic "[Exporting and Importing the OSM Model Data Only](#)".

### Note:

Model tables that are system-managed, or contain system-managed parameters, are excluded from the export because these tables are created by the database installer and already exist in the target schema.

## Importing OSM Model and Order Data

Before you import the OSM model data, prepare the target schema. For more information, see "[Preparing the Target OSM Schema Before Import](#)".

After you prepare the target schema, you import first the OSM model data, and then the OSM order data that you previously exported. As with the export procedure, most tables store the order ID in the **order\_seq\_id** column. There are a few exceptions that must be exported and imported separately. Use the order table import procedure that corresponds to the table in which the order ID that you want to import is stored.

To import the OSM data:

1. Stop the OSM server that you want to import to.
2. (Optional) Purge existing OSM orders by running the following command:

```
exec om_exp_imp_util_pkg.purge_orders
```

### Note:

The orders must match the model. Purging the data before importing it to the target schema ensures there are no constraint violations when importing duplicate data.

3. (Optional) Purge the existing OSM model by running the following command:

```
exec om_exp_imp_util_pkg.purge_model
```

### Note:

Purging the data before importing it to the target schema ensures there are no constraint violations when importing duplicate data.

4. Log in to SQL\*Plus as the OSM core schema user.

5. Disable constraints and triggers, and stops jobs by running the following command:

```
exec om_exp_imp_util_pkg.pre_impdp_setup
```

Running this command ensures that there are no errors when importing OSM data.

6. Import order tables that use a different name for the order ID column by running the following command:

```
impdp TargetOSMCoreSchemaUserName DIRECTORY=DATA_PUMP_DIR  
DUMPFILE=osm_expdp_model%U.dmp LOGFILE=osm_impdp_model.log  
REMAP_SCHEMA=SourceOSMCoreSchemaUserName:TargetOSMCoreSchemaUserName  
REMAP_TABLESPACE=SourceOSMTablespace:TargetOSMTablespace
```

For more information about these parameters, see "[About Import Parameters](#)".

7. Import order tables that define an order sequence ID by running the following command:

```
impdp TargetOSMCoreSchemaUserName DIRECTORY=DATA_PUMP_DIR  
DUMPFILE=osm_expdp_orders%U.dmp LOGFILE=osm_impdp_orders.log  
REMAP_SCHEMA=SourceOSMCoreSchemaUserName:TargetOSMCoreSchemaUserName  
REMAP_TABLESPACE=SourceOSMTablespace:TargetOSMTablespace TRANSFORM=oid:n
```

For more information about these parameters, see "[About Import Parameters](#)".

8. Finalize the OSM target schema by running the following command:

```
exec om_exp_imp_util_pkg.post_impdp_setup
```

This enables the constraints and triggers, and resubmits the jobs that were disabled and stopped before importing the OSM data.

9. Restart the OSM server.

## Exporting and Importing a Range of OSM Orders Only

If you have a target schema that already contains a subset of orders and the OSM model data, you can use the information in this section to export and import a range of OSM orders only.

### Note:

This section does not provide information about importing OSM model data to a target schema. If you want to do that, see "[Importing OSM Model Data](#)."

## Exporting an Additional Range of Orders

Order data is saved in order tables. To select the range of order data that you want to export, query the order IDs at each end of the range. Most tables store the order ID in the **order\_seq\_id** column. There are a few exceptions, which must be exported and imported separately.



## Preparing to Export Order Tables for a Range of Orders

To prepare to export order tables for a range of orders:

1. Log in to SQL\*Plus as the OSM core schema user.
2. Verify that the export/import utility package (**om\_exp\_imp\_util\_pkg**) exists by running the following command:

```
select count(*) from user_objects where object_type = 'PACKAGE' and
OBJECT_NAME = 'OM_EXP_IMP_UTIL_PKG';
```

```

COUNT(*)
-----
1
```

If the count that is returned is 1, the package exists and you do not need to create it.

### Note:

If the export/import utility package does not exist in the database, you can run the installer to create it. For information about running the installer, see *OSM Installation Guide*.

When you run the OSM installer, make sure that you select the **Database Schema** component to create the export/import utility package.

3. Verify that the orders that you want to export are not open by running the following SQL commands:

```
set serveroutput on
exec om_exp_imp_util_pkg.print_open_order_count(a_min_order_id =>
orderid_min);
```

where *orderid\_min* is the minimum bound value of a range of order IDs. For more information, see "[About Order Export Queries](#)".

If the orders within the range specified are not open and the server does not need to be taken offline, the following message is displayed:

```
There are no open orders
```

If any of the orders within the range specified are open and the server should be taken offline, the following message is displayed:

```
The open order count is: n
```

where *n* is the number of open orders.

### Note:

Oracle recommends that you always check for open orders before you export data.

4. If any of the orders that you want to export are open, take the OSM server offline.
5. Allow the output to be generated by running the following command:

```
set serveroutput on
```

6. Prevents extra white space in the generated PAR file by running the following command:

```
set trimspool on
```

Extra white space in the PAR file causes the export to fail.

## Exporting a Range of Orders from Order Tables That Define an Order Sequence ID

To export a range from order tables that define an order sequence ID:

1. Follow all the steps of the procedure in "[Preparing to Export Order Tables for a Range of Orders](#)".
2. Specify the file where you want to capture the generated output by running the following command:

```
spool osm_expdp_orders_parfile.txt
```

3. Export orders by running the **om\_exp\_imp\_util\_pkg.generate\_expdp\_order\_parfile** procedure. For example:

```
exec om_exp_imp_util_pkg.generate_expdp_order_parfile(a_min_order_id =>
100000, a_max_order_id => 200000);
```

```
DIRECTORY=DATA_PUMP_DIR
DUMPFIL=osm_expdp_orders%U.dmp
FILESIZE=1GB
LOGFILE=osm_expdp_orders.log
CONTENT=DATA_ONLY
PARALLEL=1
QUERY=" where order_seq_id between 100000 and 200000"
TABLES=(
OM_ATTACHMENT,
OM_HIST$DATA_CHANGE_NOTIF,
OM_HIST$FALLOUT,
OM_HIST$FALLOUT_NODE_INSTANCE,
OM_HIST$FLOW,
OM_HIST$NOTIFICATION,
OM_HIST$ORDER_HEADER,
OM_HIST$ORDER_INSTANCE,
OM_HIST$ORDER_STATE
...
OM_JMS_THREAD,
OM_SYSTEM_EVENT
)
```

PL/SQL procedure successfully completed.

4. Stop capturing the generated output by running the following command:

```
spool off
```

5. (Optional) Modify PAR file parameters as needed in **osm\_expdp\_orders\_parfile.txt**. For more information, see "[Changing PAR File Parameters](#)".

6. Export the order tables by running the following command:

```
expdp SourceOSMCoreSchemaUserName PARFILE=osm_expdp_orders_parfile.txt
```

7. Restart the OSM server.

You can use a variety of queries to selectively export the orders that you want. For more information, see "[About Order Export Queries](#)".

## Importing an Additional Range of Orders

Before you import the OSM order data, prepare the target schema. For more information, see "[Preparing the Target OSM Schema Before Import](#)".

After you prepare the target schema, you import first the OSM order data that you previously exported. As with the export procedure, most tables store the order ID in the **order\_seq\_id** column. There are a few exceptions, which must be exported and imported separately. Use the order table import procedure that corresponds to the table in which the order ID that you want to import is stored.

To import order data:

1. Stop the target OSM server.
2. Log in to SQL\*Plus as the OSM core schema user.
3. Disable constraints and triggers, and stops jobs by running the following command:

```
exec om_exp_imp_util_pkg.pre_impdp_setup
```

Running this command ensures that there are no errors when importing OSM data.

4. Import order tables that use a different name for the order ID column by running the following command:

```
impdp TargetOSMCoreSchemaUserName DIRECTORY=DATA_PUMP_DIR  
DUMPFILE=osm_expdp_orders%U.dmp LOGFILE=osm_impdp_orders.log  
REMAP_SCHEMA=SourceOSMCoreSchemaUserName:TargetOSMCoreSchemaUserName  
REMAP_TABLESPACE=SourceOSMTablespace:TargetOSMTablespace TRANSFORM=oid:n
```

For more information about these parameters, see "[About Import Parameters](#)".

5. Import order tables that define an order sequence ID by running the following command:

```
impdp TargetOSMCoreSchemaUserName DIRECTORY=DATA_PUMP_DIR  
DUMPFILE=osm_expdp_orders%U.dmp LOGFILE=osm_impdp_orders.log  
REMAP_SCHEMA=SourceOSMCoreSchemaUserName:TargetOSMCoreSchemaUserName  
REMAP_TABLESPACE=SourceOSMTablespace:TargetOSMTablespace TRANSFORM=oid:n
```

For more information about these parameters, see "[About Import Parameters](#)".

6. Finalize the target OSM schema by running the following command:

```
exec om_exp_imp_util_pkg.post_impdp_setup
```

This enables the constraints and triggers, and resubmits the jobs that were disabled and stopped before importing the OSM data.

7. Restart the OSM server.

## About Order Export Queries

You can use a variety of queries to select the orders that you want to export. [Table 10-2](#) provides examples of queries that you can use to select the orders to export.

**Table 10-2 Example Queries for Selecting Orders to Export**

| Example Query                                                                                                            | Data to Export                                                                                                                                                                    |
|--------------------------------------------------------------------------------------------------------------------------|-----------------------------------------------------------------------------------------------------------------------------------------------------------------------------------|
| <pre>exec om_exp_imp_util_pkg.generate_exp dp_order_parfile;</pre>                                                       | <p>Exports all orders when exporting order tables that define an order sequence ID.</p> <p>You can also use this example and edit the PAR file to customize the QUERY option.</p> |
| <pre>exec om_exp_imp_util_pkg.generate_exp dp_order_parfile(a_max_order_id =&gt; 2000);</pre>                            | <p>This example exports all orders below order ID 2000 for order tables that define an order sequence ID.</p>                                                                     |
| <pre>exec om_exp_imp_util_pkg.generate_exp dp_order_parfile(a_min_order_id =&gt; 1000);</pre>                            | <p>This example exports all orders above order ID 1000 for order tables that define an order sequence ID.</p>                                                                     |
| <pre>exec om_exp_imp_util_pkg.generate_exp dp_order_parfile(a_min_order_id =&gt; 1000, a_max_order_id =&gt; 2000);</pre> | <p>This example exports all orders between order ID 1000 and order ID 2000 for order tables that define an order sequence ID.</p>                                                 |

## Changing PAR File Parameters

You can change the parameters in the generated export parameter file (PAR file). The PAR file is generated in the directory where you start SQL\*Plus.

[Table 10-3](#) describes the parameters in the PAR file.

### Note:

There are other parameters in the PAR file but if you change these, the export will not be successful.

For more information about the parameters that are available in the command line mode of the data pump export, see "Oracle Data Pump Export" in *Oracle Database Utilities*.

**Table 10-3 PAR File Parameters**

| PAR File Parameter | Default               | Description                                                                                                                                                                                                                                                                                                                                                                                                                                                                                                                                                                                                                                                                                                                                                                                                                                                                                                                                                                                                                                                                                                                                                                                                          |
|--------------------|-----------------------|----------------------------------------------------------------------------------------------------------------------------------------------------------------------------------------------------------------------------------------------------------------------------------------------------------------------------------------------------------------------------------------------------------------------------------------------------------------------------------------------------------------------------------------------------------------------------------------------------------------------------------------------------------------------------------------------------------------------------------------------------------------------------------------------------------------------------------------------------------------------------------------------------------------------------------------------------------------------------------------------------------------------------------------------------------------------------------------------------------------------------------------------------------------------------------------------------------------------|
| CONTENT            | ALL                   | Enables you to filter what export unloads: data only, metadata only, or both.<br><b>Note:</b> If you change this parameter in any of the export scenarios in this chapter, the export will <b>not</b> be successful.                                                                                                                                                                                                                                                                                                                                                                                                                                                                                                                                                                                                                                                                                                                                                                                                                                                                                                                                                                                                 |
| DIRECTORY          | DATA_PUMP_DIR         | Specifies the directory to which export writes the dump file and the log file.<br><b>Note:</b> For exports or imports performed in an Oracle RAC environment using Automatic Storage Management, change this parameter to point to the shared location. For more information, see "Oracle RAC Considerations" in the Oracle Database Data Pump documentation.<br><b>Note:</b> If you are using a pluggable database (PDB) you cannot use the default DATA_PUMP_DIR directory. You must specify a different variable and directory for the PDB instance. Each PDB instance that you want to use expdp and impdp with must have its own data pump directory.<br>The following sqlplus commands create and set permissions on a new variable PDB directory variable:<br><pre>create directory pdb_variable_name as 'path'; grant read, write on directory pdb_variable_name to osm_core_schema;</pre> where: <ul style="list-style-type: none"><li>• <i>pdb_variable_name</i> is the name of the PDB directory variable</li><li>• <i>path</i> is the path to the data pump directory (for example /samplepath/pdbdatapumpdir)</li><li>• <i>osm_core_schema</i> is the core OSM schema (for example ordermgmt)</li></ul> |
| DUMPFIL            | osm_expdp_model%U.dmp | Specifies the name and, optionally, the directory of objects of dump files for an export job.                                                                                                                                                                                                                                                                                                                                                                                                                                                                                                                                                                                                                                                                                                                                                                                                                                                                                                                                                                                                                                                                                                                        |
| FILESIZE           | 1 GB                  | Specifies the maximum size of each dump file.                                                                                                                                                                                                                                                                                                                                                                                                                                                                                                                                                                                                                                                                                                                                                                                                                                                                                                                                                                                                                                                                                                                                                                        |
| INCLUDE            | N/A                   | Enables you to filter the metadata that is exported by specifying objects and object types for the current export mode.<br><b>Note:</b> If you change this parameter in any of the export scenarios in this chapter, the export will <b>not</b> be successful.                                                                                                                                                                                                                                                                                                                                                                                                                                                                                                                                                                                                                                                                                                                                                                                                                                                                                                                                                       |

Table 10-3 (Cont.) PAR File Parameters

| PAR File Parameter | Default             | Description                                                                                                                                                                                                                                                                                                                                                                                                                   |
|--------------------|---------------------|-------------------------------------------------------------------------------------------------------------------------------------------------------------------------------------------------------------------------------------------------------------------------------------------------------------------------------------------------------------------------------------------------------------------------------|
| LOGFILE            | osm_expdp_model.log | Specifies the name and, optionally, the directory for the log file of the export job.                                                                                                                                                                                                                                                                                                                                         |
| PARALLEL           | 1                   | Specifies the maximum number of processes of active execution operating on behalf of the export job.                                                                                                                                                                                                                                                                                                                          |
| CLUSTER            | Y                   | This parameter is not available in the generated PAR file. This parameter determines whether Data Pump can use Oracle Real Application Cluster's (Oracle RAC) resources and start workers on other Oracle RAC instances. To force Data Pump Import to use only the instance where the job is started, add CLUSTER=N in the PAR file. Otherwise, ignore this parameter. In Oracle database for import, the default value is Y. |

## About Import Parameters

You can add parameters in-line to data pump import command (impdp).

[Table 10-4](#) describes the parameters you can use when impdp.

For more information about the parameters that are available in the command line mode of the data pump import, see "Oracle Data Pump Import" in *Oracle Database Utilities Guide*.

**Table 10-4 Import In-line Parameters**

| PAR File Parameter | Description                                                                                                                                                                                                                                                                                                                                                                                                                                                                                                                                                                                                                                                                                                                                                                                                                                                                                                                                                                                                                                                                                                                                                                                                                                                  |
|--------------------|--------------------------------------------------------------------------------------------------------------------------------------------------------------------------------------------------------------------------------------------------------------------------------------------------------------------------------------------------------------------------------------------------------------------------------------------------------------------------------------------------------------------------------------------------------------------------------------------------------------------------------------------------------------------------------------------------------------------------------------------------------------------------------------------------------------------------------------------------------------------------------------------------------------------------------------------------------------------------------------------------------------------------------------------------------------------------------------------------------------------------------------------------------------------------------------------------------------------------------------------------------------|
| DIRECTORY          | <p>Specifies the directory to which import finds the dump file and the log file generated by the export.</p> <p><b>Note:</b> For imports performed in an Oracle RAC environment using Automatic Storage Management, change this parameter to point to the shared location. For more information, see the Data Pump Oracle RAC Considerations section of the Oracle Database documentation.</p> <p><b>Note:</b> If you are using a pluggable database (PDB) you cannot use the default DATA_PUMP_DIR directory. You must specify a different variable and directory for the PDB instance. Each PDB instance that you want to use impdp with must have its own data pump directory.</p> <p>The following sqlplus commands create and set permissions on a new variable PDB directory variable:</p> <pre>create directory pdb_variable_name as 'path'; grant read, write on directory pdb_variable_name to osm_core_schema;</pre> <p>where:</p> <ul style="list-style-type: none"> <li>• <i>pdb_variable_name</i> is the name of the PDB directory variable</li> <li>• <i>path</i> is the path to the data pump directory (for example / samplepath/pdbdatapumpdir)</li> <li>• <i>osm_core_schema</i> is the core OSM schema (for example ordermgmt)</li> </ul> |
| DUMPFIL            | Specifies the name and, optionally, the directory of objects of dump files for an import job.                                                                                                                                                                                                                                                                                                                                                                                                                                                                                                                                                                                                                                                                                                                                                                                                                                                                                                                                                                                                                                                                                                                                                                |
| LOGFILE            | Specifies the name and, optionally, the directory for the log file of the import job.                                                                                                                                                                                                                                                                                                                                                                                                                                                                                                                                                                                                                                                                                                                                                                                                                                                                                                                                                                                                                                                                                                                                                                        |
| TRANSFORM          | <p>Specifies whether the types being created should be assigned a new object identifier (OID). For example:</p> <pre>TRANSFORM=oid:n</pre>                                                                                                                                                                                                                                                                                                                                                                                                                                                                                                                                                                                                                                                                                                                                                                                                                                                                                                                                                                                                                                                                                                                   |
| REMAP_SCHEMA       | <p>This parameter specifies the source schema and the target schema from which all objects are loaded to.</p> <p>When importing, if the source and target schema are the same, the <b>REMAP_SCHEMA</b> option does not need to be specified.</p>                                                                                                                                                                                                                                                                                                                                                                                                                                                                                                                                                                                                                                                                                                                                                                                                                                                                                                                                                                                                             |
| REMAP_TABLESPACE   | <p>This parameter remaps all objects selected for import with persistent data in the source tablespace to be created in the target tablespace.</p> <p>When importing, if the source and target schema are the same, the <b>REMAP_TABLESPACE</b> option does not need to be specified.</p>                                                                                                                                                                                                                                                                                                                                                                                                                                                                                                                                                                                                                                                                                                                                                                                                                                                                                                                                                                    |
| CLUSTER            | <p>This parameter is not available in the generated PAR file. This parameter determines whether Data Pump can use Oracle Real Application Cluster's (Oracle RAC) resources and start workers on other Oracle RAC instances. To force Data Pump Import to use only the instance where the job is started, add CLUSTER=N in the PAR file. Otherwise, ignore this parameter. In Oracle database for import, the default value is Y.</p>                                                                                                                                                                                                                                                                                                                                                                                                                                                                                                                                                                                                                                                                                                                                                                                                                         |

## Troubleshooting Export/Import

Errors might occur during the process of exporting or importing data.

[Table 10-5](#) lists some common export errors and their solutions. For more information about troubleshooting errors that might occur when exporting or importing data, see the troubleshooting section of the knowledge article about exporting and importing data [Doc ID 1594152.1], available from the Oracle support website:

<https://support.oracle.com>

For information about Oracle RAC and data pump import, see "Oracle RAC Considerations" and "Oracle Data Pump Import" in *Oracle Database Utilities*.

For information about predefined roles in an Oracle Database installation, and about guidelines for securing user and accounts privileges, see *Oracle Database Security Guide*.

**Table 10-5 Common Export Errors**

| Error                                                                                                                                                                                                                                                                              | Cause                                                                                                                                                                                                                                                                                           | Solution                                                                                                                                                                                                                                                                                                                                                          |
|------------------------------------------------------------------------------------------------------------------------------------------------------------------------------------------------------------------------------------------------------------------------------------|-------------------------------------------------------------------------------------------------------------------------------------------------------------------------------------------------------------------------------------------------------------------------------------------------|-------------------------------------------------------------------------------------------------------------------------------------------------------------------------------------------------------------------------------------------------------------------------------------------------------------------------------------------------------------------|
| ORA-39097: Data Pump job encountered unexpected error -12801<br>ORA-39065: unexpected master process exception in MAIN<br>ORA-12801: error signaled in parallel query server PZ99, instance <instanceDetails> (4)<br>ORA-01460: unimplemented or unreasonable conversion requested | There is an issue with the Oracle Data Pump export tool and Oracle RAC databases.<br><br>For more information, see the knowledge article about the issue [Doc ID 13099577.8], available from the Oracle support website:<br><a href="https://support.oracle.com">https://support.oracle.com</a> | Update the following database parameters:<br><br><pre>ALTER SYSTEM set parallel_force_local=true</pre> <pre>ALTER SYSTEM set parallel_max_servers=0</pre> <pre>ALTER SYSTEM set parallel_min_servers=0</pre>                                                                                                                                                      |
| UDE-00014: invalid value for parameter, 'include'                                                                                                                                                                                                                                  | The include parameter used in the export options PAR file contains more than 4,000 characters. This is normally due to extra white space at the end of each line when the file is spooled.                                                                                                      | As a workaround, execute the following command in SQL Plus before generating the options PAR files:<br><br><pre>SQL&gt; SET TRIMSPOOL ON</pre>                                                                                                                                                                                                                    |
| ORA-39002: invalid operation<br>ORA-39070: Unable to open the log file.<br>ORA-29283: invalid file operation<br>ORA-06512: at "SYS.UTL_FILE", line 536<br>ORA-29283: invalid file operation                                                                                        | The location specified for the export DIRECTORY option is not accessible.                                                                                                                                                                                                                       | Update the DIRECTORY option specified in the export command.<br><br>For exports or imports performed in an Oracle RAC environment using Automatic Storage Management, the DIRECTORY option should be updated to point to the shared location.<br><br>For more information, see the Data Pump: Oracle RAC Considerations section of Oracle Database documentation. |



**Table 10-5 (Cont.) Common Export Errors**

| Error                                                                                                                                                                                                                                                                                                                | Cause                                                                                                                                                                                                                                                                                                                                                                                                                                                                                    | Solution                                                                                                                                                          |
|----------------------------------------------------------------------------------------------------------------------------------------------------------------------------------------------------------------------------------------------------------------------------------------------------------------------|------------------------------------------------------------------------------------------------------------------------------------------------------------------------------------------------------------------------------------------------------------------------------------------------------------------------------------------------------------------------------------------------------------------------------------------------------------------------------------------|-------------------------------------------------------------------------------------------------------------------------------------------------------------------|
| ORA-39001: invalid argument value<br>ORA-39000: bad dump file specification<br>ORA-31641: unable to create dump file "+DATA/osm_expdp_model.dmp"<br>ORA-17502: ksfcre:4 Failed to create file +DATA/osm_expdp_model.dmp<br>ORA-15005: name "osm_expdp_model.dmp" is already used by an existing alias                | A previously generated version of the dmp file already exists.                                                                                                                                                                                                                                                                                                                                                                                                                           | Remove the previously generated version of the dmp file.<br>or<br>Specify the following option in the export PAR file to overwrite it:<br><br>REUSE_DUMPFILES=YES |
| ORA-31693: Table data object "<OSMCoreSchemaUserName>". "OM_ORDER_HEADER": "P_000000000000005001". "SYS_SUBP612617" failed to load/unload and is being skipped due to error:<br>ORA-06502: PL/SQL: numeric or value error: character string buffer too small<br>ORA-01403: no data found<br>ORA-01403: no data found | The data pump export job name is too long.<br><br>If no job name is specified when doing the export, the job name is automatically generated based on the schema name. If the schema name is long the job name can exceed the limit of 26 characters and causes this error.<br><br>For more information, see the knowledge article about the issue [Doc ID 1502119.1], available from the Oracle support website:<br><a href="https://support.oracle.com">https://support.oracle.com</a> | Specify the JOB_NAME option in the export PAR file. Make sure the value specified for the option is less than 26 characters long.<br><br>JOB_NAME=osm_expdp_job   |

Table 10-6 lists some common import errors and their solutions.

**Table 10-6 Common Import Errors**

| Error                                                                                                                                                                                                                                                                                                                                                                   | Cause                                                                                                                                                                                                                                                                                 | Solution                                                                                                                                                                                                                    |
|-------------------------------------------------------------------------------------------------------------------------------------------------------------------------------------------------------------------------------------------------------------------------------------------------------------------------------------------------------------------------|---------------------------------------------------------------------------------------------------------------------------------------------------------------------------------------------------------------------------------------------------------------------------------------|-----------------------------------------------------------------------------------------------------------------------------------------------------------------------------------------------------------------------------|
| ORA-31693: Table data object "OSMCoreSchemaUserName". "OM_ORCH_PLAN": "SYS_SUBP44607" failed to load/unload and is being skipped due to error:<br>ORA-29913: error in executing ODCIEXTTABLEOPEN callout<br>ORA-29400: data cartridge error<br>ORA-39779: type "<OSMCoreSchemaUserName>". "OM_T_ORCH_PROCESS" not found or conversion to latest version is not possible | The types being created should be assigned a new object identifier (OID).<br><br>For more information, see the knowledge article about the issue [Doc ID 351519.1], available from the Oracle support website:<br><a href="https://support.oracle.com">https://support.oracle.com</a> | Make sure the following option is specified when importing. This option assigns new OIDs.<br><br>TRANSFORM=oid:n<br><br>For more information, see the Data Pump: Import TRANSFORM section of Oracle Database documentation. |

**Table 10-6 (Cont.) Common Import Errors**

| Error                                                                                                                                                                                                                                                                                               | Cause                                                                                                                                                                                                                                                    | Solution                                                                                                                                                                                                                                                                                                                                                                                                                                  |
|-----------------------------------------------------------------------------------------------------------------------------------------------------------------------------------------------------------------------------------------------------------------------------------------------------|----------------------------------------------------------------------------------------------------------------------------------------------------------------------------------------------------------------------------------------------------------|-------------------------------------------------------------------------------------------------------------------------------------------------------------------------------------------------------------------------------------------------------------------------------------------------------------------------------------------------------------------------------------------------------------------------------------------|
| ORA-31693: Table data object " <code>&lt;OSMCORESCHEMAUSERNAME&gt;."&lt;OSMTABLENAME&gt;:"SYS_P44941"</code> failed to load/unload and is being skipped due to error:<br>ORA-29913: error in executing ODCIEXTTABLEFETCH callout<br>ORA-14400: inserted partition key does not map to any partition | The order IDs being imported are greater than the greatest partition upper bound.                                                                                                                                                                        | Resolve this error by adding partitions.<br>For more information, see <a href="#">"Adding Partitions"</a> .                                                                                                                                                                                                                                                                                                                               |
| ORA-31693: Table data object " <code>&lt;OSMCORESCHEMAUSERNAME&gt;."&lt;OSMTABLENAME&gt;</code> " failed to load/unload and is being skipped due to error:<br>ORA-00001: unique constraint ( <code>&lt;OSMCORESCHEMAUSERNAME&gt;.&lt;OSMTABLENAME&gt;</code> ) violated                             | The table already contains the data that is being imported.                                                                                                                                                                                              | Before you import, clean up the table using one or more of the following purge commands:<br><br><pre>SQL&gt; exec om_exp_imp_util_pkg.purge_order s</pre> <pre>SQL&gt; exec om_exp_imp_util_pkg.purge_model</pre> <pre>SQL&gt; exec om_exp_imp_util_pkg.purge_sche ma</pre>                                                                                                                                                               |
| ORA-39001: invalid argument value<br>ORA-39046: Metadata remap REMAP_TABLESPACE has already been specified.                                                                                                                                                                                         | The same source tablespace has been specified more than once for the REMAP_TABLESPACE option.                                                                                                                                                            | This might happen when the OSM Core and Rule Engine schema use the same tablespace. In this case, you need to specify the REMAP_TABLESPACE for this tablespace only once.                                                                                                                                                                                                                                                                 |
| ORA-00932: inconsistent datatypes: expected OM_T_ORCH_PROCESS got OM_T_ORCH_PROCESS                                                                                                                                                                                                                 | There is a known issue with data pump import that causes imports with REMAP_SCHEMA and TYPE definitions to generate this error.                                                                                                                          | Follow the steps outlined in the scenario <a href="#">"Exporting and Importing a Range of Orders and the OSM Model"</a> . When generating the order PAR files, select the option to export all orders, that is, <code>order_target_seq_id &gt; 0</code> .                                                                                                                                                                                 |
| UDI-31626: operation generated ORACLE error 31626<br>ORA-31626: job does not exist<br>ORA-39086: cannot retrieve job information<br>ORA-06512: at "SYS.DBMS_DATAPUMP", line 3326<br>ORA-06512: at "SYS.DBMS_DATAPUMP", line 4551<br>ORA-06512: at line 1                                            | This is an issue with data pump import privileges.<br>For more information, see the knowledge article about the issue [Doc ID 1459430.1], available from the Oracle support website: <a href="https://support.oracle.com">https://support.oracle.com</a> | Apply Patch 13715680<br>Or<br>Follow the workaround in the notes of the associated bug to add the missing privileges. For more information, see bug 13715680 on the Oracle support website. <a href="https://support.oracle.com">https://support.oracle.com</a><br>The missing privileges are:<br><br><pre>SQL&gt; GRANT lock any table TO datapump_imp_full_database; SQL&gt; GRANT alter any index TO datapump_imp_full_database;</pre> |

Table 10-6 (Cont.) Common Import Errors

| Error                                                                                                                                                                                                                                                                                                                                                                                                                                                                                                                                                                                            | Cause                                                                                                                                                                                                                                                                                                                                                                                                                                                                                                                                                                                                         | Solution                                                                                                                                                                                                                                                                                                                                                                                                                                                                                                                                                                                                                                                                                                                                                                                                                 |
|--------------------------------------------------------------------------------------------------------------------------------------------------------------------------------------------------------------------------------------------------------------------------------------------------------------------------------------------------------------------------------------------------------------------------------------------------------------------------------------------------------------------------------------------------------------------------------------------------|---------------------------------------------------------------------------------------------------------------------------------------------------------------------------------------------------------------------------------------------------------------------------------------------------------------------------------------------------------------------------------------------------------------------------------------------------------------------------------------------------------------------------------------------------------------------------------------------------------------|--------------------------------------------------------------------------------------------------------------------------------------------------------------------------------------------------------------------------------------------------------------------------------------------------------------------------------------------------------------------------------------------------------------------------------------------------------------------------------------------------------------------------------------------------------------------------------------------------------------------------------------------------------------------------------------------------------------------------------------------------------------------------------------------------------------------------|
| <p>ORA-31693: Table data object "&lt;InvalidSourceOSMCoreSchemaUserName&gt;".OM_SQL_LOG" failed to load/unload and is being skipped due to error:</p> <p>ORA-00001: unique constraint (&lt;InvalidSourceOSMCoreSchemaUserName&gt;.XPKOM_SQL_LOG) violated</p> <p>ORA-31693: Table data object "&lt;InvalidSourceOSMCoreSchemaUserName&gt;".OM_MODEL_CLOB" failed to load/unload and is being skipped due to error:</p> <p>ORA-29913: error in executing ODCIEXTTABLEFETCH callout</p> <p>ORA-00001: unique constraint (&lt;InvalidSourceOSMCoreSchemaUserName&gt;.XPKOM_MODEL_CLOB) violated</p> | <p>Import fails if the wrong source schema name is specified.</p> <p>If the wrong source schema user name is specified in the REMAP_SCHEMA option, data pump tries to import the data to the actual source schema. If the source schema exists in the target instance, the constraint violations are shown.</p>                                                                                                                                                                                                                                                                                               | <p>Verify that the correct source OSM core schema user name is specified in the import command:</p> <pre>impdp TargetOSMCoreSchemaUserName DIRECTORY=DATA_PUMP_DIR DUMPFILE=osm_expdp_orders%.dmp LOGFILE=osm_impdp_orders.log REMAP_SCHEMA=SourceOSMCoreSchemaUserName:TargetOSMCoreSchemaUserName REMAP_TABLESPACE=SourceOSMTablespace:TargetOSMTablespace TRANSFORM=oid:n</pre>                                                                                                                                                                                                                                                                                                                                                                                                                                       |
| <p>ORA-31631: privileges are required</p> <p>ORA-39122: Unprivileged users may not perform REMAP_SCHEMA remappings.</p>                                                                                                                                                                                                                                                                                                                                                                                                                                                                          | <p>The schema user being used for import does not have the <b>imp_full_database</b> role.</p> <p>This role is required for imports only if you cannot use the system user because of the REMAP_SCHEMA bug.</p> <p>For more information, see the knowledge article about the issue [Doc ID 1367290.1], available from the My Oracle support website: <a href="https://support.oracle.com">https://support.oracle.com</a></p> <p>REMAP_SCHEMA is not required if you do the import on a different database instance and the schema user is unchanged (uses the same ID and permissions as the source user).</p> | <p>Grant <b>imp_full_database</b> role to the OSM core schema user. The following command grants this role:</p> <pre>SQL&gt; GRANT imp_full_database TO &lt;OSMCoreSchemaUserName&gt;;</pre> <p><b>Caution:</b> This role provides a user with access to any data in any schema in the database. Use caution when granting this role to users.</p> <p>For more information, see "Predefined Roles in an Oracle Database Installation" in <i>Oracle Database Security Guide</i>.</p> <p>Oracle recommends removing this role after the import is complete. For more information, see "Guidelines for Securing User Accounts and Privileges" in <i>Oracle Database Security Guide</i>.</p> <p>The following command removes this role:</p> <pre>SQL&gt; REVOKE imp_full_database FROM &lt;OSMCoreSchemaUserName&gt;;</pre> |

# 11

## Configuring Time Zone Settings

This chapter describes how to configure time zone settings in Oracle Communications Order and Service Management (OSM). This is an optional configuration task.

### Configuring Time Zone Settings

The database that OSM uses should always be set to a time zone that does not use daylight savings time. See "Installing and Configuring the Oracle RAC Database" in *OSM Installation Guide* for more information.

The `oms_timezone` parameter, in the `om_parameter` table of the database, must also be set to a time zone that does not use daylight savings time. This setting must be defined in seconds offset to UTC (Coordinated Universal Time, formerly Greenwich Mean Time) for the time zone for your OSM database. For example, if you are setting this parameter for Eastern Standard Time, use the value **-18000** (60 seconds x 60 minutes = 3600 seconds—or one hour—x 5 for five hours offset from UTC/GMT). The `oms_timezone` parameter is used by the OSM database.

The OSM server uses the `database_timezone_offset` parameter in the **oms-config.xml** file. This must be set to be exactly the value used for the `oms_timezone` parameter in the `om_parameter` table.

# 12

## Troubleshooting OSM

This chapter provides guidelines to help you troubleshoot problems with your Oracle Communications Order and Service Management (OSM) system.

### Information You Need for Troubleshooting

When you are diagnosing and resolving problems, you must be able to obtain the following information:

- Database AWR report for a particular period of time.
- Database ASH report for a particular period of time.
- Oracle WebLogic Server administration server logs and output files.
- WebLogic Server managed server logs and output files.
- WebLogic Server node manager's logs and output files.
- JVM garbage collector logs.
- JVM heap dumps.
- JVM thread dumps (several in succession).
- OSM model and a single order extracted from the database schema. For more information, see "[Exporting and Importing the OSM Model and a Single Order.](#)"
- Java Flight Recorder (JFR) recordings.

### General Checklist for Resolving Problems

If you have a problem with your OSM system, go through the following checklist before you contact Oracle Technical Support:

- What exactly is the problem? Can you isolate it? For example, if an order causes a problem on one computer, does it give the same result on another computer?  
Oracle Technical Support needs a clear and concise description of the problem, including when it began to occur.
- What do the log files say?  
This is the first thing that Oracle Technical Support asks for. Check the error log for the OSM component you are having problems with.
- Have you read the documentation?  
Look through the list of common problems and their solutions in "[Diagnosing Some Common Problems with OSM](#)" and "Chapter 12 Debugging and Troubleshooting" in *OSM Cloud Native Deployment Guide*.
- Has anything changed in the system? Did you install any new hardware or new software? Did the network change in any way? Does the problem resemble

another one you had previously? Has your system usage recently jumped significantly?

- Is the system otherwise operating normally? Has response time or the level of system resources changed? Are users complaining about additional or different problems?

## Diagnosing Some Common Problems with OSM

This section describes common problems and their solutions.

### Cannot Log in or Access Certain Functionality

If you cannot log in or access certain functionality, check the following possible causes:

- Are you a valid user in the WebLogic Server security realm?
- Is the OSM web application deployed?
- Are all OSM Enterprise Java Beans (EJB) deployed?
- Are the OSM database resources deployed?
- Do you belong to the correct groups in the WebLogic Server security realm?
- Do you belong to any OSM workgroup?

### System Appears Slow

If the functionality of OSM appears to be present, but performance is slow, check the following possible causes:

- The amount of memory being used (check the memory configuration in the WebLogic server startup script on the workstation where you have deployed OSM).
- The CPU and disk usage on the machine hosting the OSM database.
- The database performance (for example, using AWR reports).
- For slow worklist access, check the number of flexible headers on your worklist. The number of flexible headers has a direct negative effect on worklist performance.

### Error: "Java.lang.StackOverflowError" when Using Task Web Client

You may see the error "Java.lang.StackOverflowError" in the log files. If this happens, you can address the problem by tuning the thread stack size parameter.

 **Note:**

The procedures below set the value to 2 MB. This is a suggested value to start with, but you should adjust the value if necessary, according to your needs.

In your instance, project or shape specification file, add or append the following parameter and adjust the value as necessary:

```
shape:  
  user_mem_args: "-Xss2m"
```

## Unexpected Logout from Web Client

If your system is running on a WebLogic Server cluster, and the following conditions apply:

- a user is viewing an order in the Order Management web client or Task web client
- that order is hosted on a managed server that fails or is shut down

the user will be logged out of the web client and will have to log back in. See the discussion of order affinity in *OSM Installation Guide* for more information about orders being hosted on a particular managed server.

## Error: "Login failed. Please try again."

If the error "Login failed. Please try again" is displayed when trying to log in through the web client and you have entered the correct user name and password, you probably do not belong to the correct groups in the WebLogic Server security realm.

To resolve this issue, log in to the WebLogic Administration Console using the administrator account. Make sure you have been added to the group **OMS\_client**. Try to log in again.

## Automation Plug-ins Are Not Getting Called

If the custom automation plug-ins are not getting called, check the following possible causes:

- Is the Automation configuration deployed properly?
- Are the JMS resources deployed?
- Are the JMS destinations, queues, and topics configured properly?

## Delayed JMS Messages

Clock synchronization issues may cause JMS request and response messages to remain in a queue in a delayed state.

When a message is sent, it is stamped with the time on the sender's machine. When the message arrives at the JMS destination, if the recipient's machine has a clock that is running several minutes slower, the timestamp is displayed as a future time and the WebLogic server decides to delay the message until the future time arrives.

To prevent this problem, use network time protocol (NTP) servers to synchronize clocks across all machines in a cluster.

## Error Message For Events From a JMS Topic in a Cluster

The following message can occur when attempting to process an event from a JMS topic:

```
<Message-Driven EJB:  
YourCartridgeName_1.0.0.0_YourPluginName_orderCompleteEventMDB's transaction  
was rolled back. The transaction details are: ...
```

OSM does not support JMS topics within an OSM clustered environment. For more information about OSM queue configuration, see the discussion of OSM integration with external systems in *OSM Installation Guide*.

## Unexpected Values for JMS Properties

There are some situations in which OSM may set the JMS properties on a message to values that you do not expect.

- Sometimes messages in the queue that were received from external systems will have JMS properties that were not set by the external system.

This is because when OSM sends a request to an external system, any messages received in response must be correlated back to an appropriate automator. When a message is first received, before it is placed on the queue, OSM finds the handling task's context based on the correlation data in the message. OSM adds this context, and some additional data associated with the message-driven bean (MDB) that received the message, to the message using additional JMS message properties. You can see the context data by browsing the messages in the queue using the WebLogic Server Administration console.

When OSM runs in a cluster, this message is sometimes redirected to a message queue hosted on a different managed server from the one that sent the request.

- Sometimes messages have values that seem wrong. For example, a message might have JMS properties with `pluginJndiName=X` and `cartridgeNamespace=Y`, but plug in X is not in a cartridge with namespace Y.

These property values are implementation details and will not necessarily match what you expect. For example, because different plug ins can share the same MDB, the `pluginJndiName` property may not contain the name of the plug in that actually handles the message.

## Unable to Bring Up Managed Server After Database Failure

OSM fails to start if the Oracle database is unreachable. In addition, if the database is Oracle RAC, both database nodes specified by the data source URLs must be reachable. When WebLogic Server starts, failure of a database node is handled gracefully (processing fails over to the other node).

## JBoss Cache Timeouts

Long full garbage collections can cause JBoss timeout errors to appear in the log files.



## OSM Fails to Process Orders Because of Metadata Errors

Metadata errors can occur in any cartridge with orchestration model entities and can cause order processing failures. Search for the string **Metadata Errors** in the Console view of the Cartridge Management editor in Design Studio. If you are not using Design Studio to deploy cartridges, look in the WebLogic Server logs for the same string.

## DataDictionary Expansion Level

If you are having issues deploying cartridges, the cause may be related to the DataDictionary expansion level. In Oracle Communications Design Studio, under Windows preferences, increase the DataDictionary expansion level to 10. In some cases, you may need to increase the level to more than 10.

## Quick Fix Button Active During Order Template Conflicts in Design Studio

Conflicts can occur when order templates are created in Design Studio. Presently, Quick Fix does not work for order template conflicts, even if the **Quick Fix** button is active. All order template conflicts must be resolved manually.

## Cannot Create New Orders on a New Cartridge Version

Order creation can fail on a new version of an existing cartridge, even after you have updated all required entities, and built and deployed the cartridge.

When the createOrder request fails, you receive a response like the following example:

```
<env:Envelope xmlns:env="http://schemas/soap/envelope/">
  <env:Header/>
  <env:Body>
    <env:Fault
      xmlns:ord="http://URL/communications/ordermanagement">
      <faultcode>ord:fault</faultcode>
      <faultstring>Failed to create and start the order due to
      java.lang.RuntimeException: OMSEException: encountered error
      starting orchestration caused by:Cannot find task for notification
      id</faultstring>
      <faultactor>unknown</faultactor>
      <detail>
        <InvalidOrderSpecificationFault
          xmlns="http://URL/communications/ordermanagement">
          <Description>Failed to create and start the order due to
          java.lang.RuntimeException: OMSEException: encountered error
          starting orchestration caused by:Cannot find task for notification
          id</Description>
        </InvalidOrderSpecificationFault>
      </detail>
    </env:Fault>
  </env:Body>
</env:Envelope>
```

To resolve this issue:

1. Open the solution cartridge.
2. Click the Dependency tab of the model project.
3. Remove all the dependencies that are displayed for the project.
4. Re-add all the dependencies.
5. Restart Design Studio.

## Error: "exact fetch returns more than requested number of rows"

You may see the error "exact fetch returns more than requested number of rows" in the log files if there are memory issues relating very large orders causing contention issues in orchestration XQuery calls when multiple orchestration plans are running at the same time. The default orchestration plan concurrency level is 3. You can reduce this value as described below.

To resolve this issue, decrease the orchestration plan concurrency level in your project specification file.

```
export JAVA_OPTIONS="${JAVA_OPTIONS} -  
Doracle.communications.ordermanagement.orchestration.generation.model.Co  
ncurrencyLevel=2
```

## Error: "unique constraint violated"

You may see the "unique constraint violated" error in the log files if you retry to purge order data that you already tried to purge once but failed.

```
ORA-00001: unique constraint ...violated  
ORA-06512: at "<database_schema>.OM_SQL_LOG_PKG", line 335  
ORA-06512: at "<database_schema>.OM_PART_MAINTAIN", line 5012  
ORA-06512: at "<database_schema>.OM_PART_MAINTAIN", line 5599  
ORA-06512: at "<database_schema>.OM_PART_MAINTAIN", line 5778  
ORA-06512: at "<database_schema>.OM_PART_MAINTAIN", line 6191  
ORA-06512: at "<database_schema>.OM_PART_MAINTAIN", line 6360  
ORA-06512: at "<database_schema>.OM_PART_MAINTAIN", line 6886  
ORA-06512: at line 1
```

This error occurs because there are non-empty exchange tables that are created by the failed purge operation that you performed the first time.

To resolve this issue, you must purge the exchange tables manually before you retry purging.

## Getting Help with OSM Problems

If you cannot resolve your problems with OSM, contact Oracle Technical Support.

## Before You Contact Support

The first troubleshooting step is to look at the error log for the application or process that reported the problem. Consult "[General Checklist for Resolving Problems](#)" before reporting the problem to Oracle.

## Reporting Problems

If "[General Checklist for Resolving Problems](#)" does not help you to resolve the problem, write down the pertinent information:

- A clear and concise description of the problem, including when it began to occur.
- Relevant portions of the log files.
- Recent changes in your system, even if you do not think they are relevant.
- List of all the OSM components and patches installed on your system.
- Have ready all specification files (project, instance and shape) used to create the OSM instance.

When you are ready, report the problem to Oracle.

# 13

## OSM Log Messages

This chapter details the Oracle Communications Order and Service Management (OSM) log messages. The sections included in this chapter are:

- OSM Catalog Messages
- Automation Catalog Messages

### OSM Catalog Messages

Table 13-1 shows OSM Catalog messages.

**Table 13-1 OSM Catalog Messages**

| Error Code | Severity | Description                                                                                                                                                                                                                                                                                                                                                                                                                                      |
|------------|----------|--------------------------------------------------------------------------------------------------------------------------------------------------------------------------------------------------------------------------------------------------------------------------------------------------------------------------------------------------------------------------------------------------------------------------------------------------|
| 600000     | error    | <b>Message Body</b><br>Order type/source is not found. The order type={1} /source={0} either does not exist, or is not available to the user.<br><b>Message Details</b><br>The order type={1}/ source={0} either does not exist, or is not available to the user.<br><b>Method</b><br>logSourceTypeNotFound(String source, String type)                                                                                                          |
| 600001     | error    | <b>Message Body</b><br>Order is not found. The order with orderid={0} and orderHistId={1} does not exist, or is not available to the user.<br><b>Message Details</b><br>The order with orderid={0} and orderHistId={1} does not exist, or is not available to the user.<br><b>Cause</b><br>The orderHistId might not be up to date.<br><b>Action</b><br>Refresh server.<br><b>Method</b><br>logOrderNotFound(String orderId, String orderHistId) |
| 600002     | error    | <b>Message Body</b><br>Order template is not found. The order template does not exist, or is not available to the user.<br><b>Message Details</b><br>The order template does not exist, or is not available to the user.<br><b>Method</b><br>logOrderTemplateNotFound()                                                                                                                                                                          |

Table 13-1 (Cont.) OSM Catalog Messages

| Error Code | Severity | Description                                                                                                                                                                                                                                                                                                                                                                                                                                                                                                                                                                                          |
|------------|----------|------------------------------------------------------------------------------------------------------------------------------------------------------------------------------------------------------------------------------------------------------------------------------------------------------------------------------------------------------------------------------------------------------------------------------------------------------------------------------------------------------------------------------------------------------------------------------------------------------|
| 600003     | error    | <p><b>Message Body</b><br/>Remark is not found. The given remark (orderid={0}, histid={1} remarkid={2}) does not match a remark in OMS.</p> <p><b>Message Details</b><br/>The given remark (orderid={0}, histid={1} remarkid={2}) does not match a remark in OMS.</p> <p><b>Cause</b><br/>Remark might have been deleted from the server or cannot be found in a specified location.</p> <p><b>Action</b><br/>Contact your local administrator.</p> <p><b>Method</b><br/>logRemarkNotFound(String orderId, String orderHistId, String remarkId)</p>                                                  |
| 600004     | error    | <p><b>Message Body</b><br/>Header for mnemonic path is not found. The header for mnemonic path={0} does not exist, or is not available to the user.</p> <p><b>Message Details</b><br/>The header for mnemonic path={0} does not exist, or is not available to the user.</p> <p><b>Method</b><br/>logHeaderNotFound(String mnemonicPath)</p>                                                                                                                                                                                                                                                          |
| 600005     | error    | <p><b>Message Body</b><br/>The format of the order data is not correct. The message details the error location.<br/>Invalid data = {0}</p> <p><b>Message Details</b><br/>Invalid data = {0}</p> <p><b>Method</b><br/>logOrderDataInvalid(String orderdata)</p>                                                                                                                                                                                                                                                                                                                                       |
| 600006     | error    | <p><b>Message Body</b><br/>An attempt to update an order was made without first retrieving the order with an Accept parameter of true. Order (orderid={0} histid={1}) has not been accepted by user={2}.</p> <p><b>Message Details</b><br/>Order (orderid={0} histid={1}) has not been accepted by user={2}</p> <p><b>Cause</b><br/>An attempt to update an order was made without accepting the order.</p> <p><b>Action</b><br/>You should accept the order first, then update the order.</p> <p><b>Method</b><br/>logOrderNotAcceptedByUser(String orderId, String orderHistId, String userId)</p> |

Table 13-1 (Cont.) OSM Catalog Messages

| Error Code | Severity | Description                                                                                                                                                                                                                                                                                                                                                                                                                                                                                                                                                                                                                                                                                                                                                                                                                                                                                                     |
|------------|----------|-----------------------------------------------------------------------------------------------------------------------------------------------------------------------------------------------------------------------------------------------------------------------------------------------------------------------------------------------------------------------------------------------------------------------------------------------------------------------------------------------------------------------------------------------------------------------------------------------------------------------------------------------------------------------------------------------------------------------------------------------------------------------------------------------------------------------------------------------------------------------------------------------------------------|
| 600007     | error    | <p><b>Message Body</b><br/>Order update failed. The order (orderid={0} histid={1}) could not be updated due to a data format error. The message details the reason for failure. Data={2}</p> <p><b>Message Details</b><br/>The order (orderid={0} histid={1}) could not be updated due to a data format error. The message details the reason for failure. Data={2}</p> <p><b>Cause</b><br/>Data format error.</p> <p><b>Action</b><br/>Make sure all your data are in correct format and comply with their masks.</p> <p><b>Method</b><br/>logOrderUpdateFailed(String orderId, String histid, String data)</p>                                                                                                                                                                                                                                                                                                |
| 600008     | error    | <p><b>Message Body</b><br/>Mandatory check failed. A mandatory field was not given a value when attempting to create, assign, complete, or suspend an order. {2} number of data was missing for order with order id={0}, order history id={1}. The first missing/extra node is node id={3} and order type={4}.</p> <p><b>Message Details</b><br/>Mandatory check failed. A mandatory field was not given a value when attempting to create, assign, complete, or suspend an order. {2} number of data was missing for order with order id={0}, order history id={1}. The first missing/extra node is node id={3} and order type={4}</p> <p><b>Cause</b><br/>Not all mandatory fields are filled.</p> <p><b>Action</b><br/>Fill in data for all mandatory fields.</p> <p><b>Method</b><br/>logMandatoryCheckFailed(String orderId, String orderHistID, String num, String firstNodeID, String firstNodeType)</p> |
| 600009     | error    | <p><b>Message Body</b><br/>Transition is invalid. The order (orderid={0} histid={1}) cannot be transitioned to state={2}. Use ListStatesNStatuses.Request to get a list of valid states.</p> <p><b>Message Details</b><br/>The order (orderid={0} histid={1}) cannot be transitioned to state={2}. Use ListStatesNStatuses.Request to get a list of valid states.</p> <p><b>Cause</b><br/>Cannot transition to the selected state.</p> <p><b>Action</b><br/>Use the ListStatesNStatuses XML API request to get a list of valid states. See <i>OSM Developer's Guide</i> for information.</p> <p><b>Method</b><br/>logTransistionInvalid(String orderId, String histid, String state)</p>                                                                                                                                                                                                                        |

Table 13-1 (Cont.) OSM Catalog Messages

| Error Code | Severity | Description                                                                                                                                                                                                                                                                                                                                                                                                                                                                                                                                                                                                                                                                                                                                                                                                                                       |
|------------|----------|---------------------------------------------------------------------------------------------------------------------------------------------------------------------------------------------------------------------------------------------------------------------------------------------------------------------------------------------------------------------------------------------------------------------------------------------------------------------------------------------------------------------------------------------------------------------------------------------------------------------------------------------------------------------------------------------------------------------------------------------------------------------------------------------------------------------------------------------------|
| 600010     | error    | <p><b>Message Body</b><br/>Unable to accept order. When retrieving an order for update, the order (orderid={0} histid={1}) cannot be accepted by the current user={2}</p> <p><b>Message Details</b><br/>When retrieving an order for update, the order (orderid={0} histid={1}) cannot be accepted by the current user={2}.</p> <p><b>Cause</b><br/>The orderid and histid are not up to date, or the order has been accepted by another user.</p> <p><b>Action</b><br/>Refresh the server to get new orderid and histid. If the order is currently accepted by another user, you cannot perform Accept operation.</p> <p><b>Method</b><br/>logUnableToAccept(long orderid, long histid, String userid)</p>                                                                                                                                       |
| 600011     | error    | <p><b>Message Body</b><br/>User is not found. The order orderid={0} histid={1} cannot be assigned to userid={2}.</p> <p><b>Message Details</b><br/>The order orderid={0} histid={1} cannot be assigned to userid={2}.</p> <p><b>Cause</b><br/>User is not found.</p> <p><b>Action</b><br/>Try to assign the order to another user.</p> <p><b>Method</b><br/>logUserNotFound(String orderid, String histid, String userid)</p>                                                                                                                                                                                                                                                                                                                                                                                                                     |
| 600012     | error    | <p><b>Message Body</b><br/>Invalid state mnemonic. The order (orderid={0} histid={1}) cannot be suspended with the given state (state={2}) mnemonic. Note: Only user-defined states are valid. If you want to complete or assign an order, you must use the appropriate request.</p> <p><b>Message Details</b><br/>The order (orderid={0} histid={1}) cannot be suspended with the given state (state={2}) mnemonic. Note: Only user-defined states are valid. If you want to complete or assign an order, you must use the appropriate request.</p> <p><b>Cause</b><br/>You are calling suspendOrder with an invalid user defined state.</p> <p><b>Action</b><br/>Supply a valid user defined state, or try to use other appropriate requests.</p> <p><b>Method</b><br/>logInvalidStateMnemonic(String orderid, String histid, String state)</p> |

Table 13-1 (Cont.) OSM Catalog Messages

| Error Code | Severity | Description                                                                                                                                                                                                                                                                                                                                                                                                                                                                                                                                                              |
|------------|----------|--------------------------------------------------------------------------------------------------------------------------------------------------------------------------------------------------------------------------------------------------------------------------------------------------------------------------------------------------------------------------------------------------------------------------------------------------------------------------------------------------------------------------------------------------------------------------|
| 600013     | error    | <p><b>Message Body</b><br/>Invalid status mnemonic. The order (orderid={0} histid={1}) cannot be completed with the given status mnemonic (status={2}).</p> <p><b>Message Details</b><br/>The order (orderid={0} histid={1}) cannot be completed with the given status mnemonic (status={2}).</p> <p><b>Cause</b><br/>The status might not be valid for the current task.</p> <p><b>Action</b><br/>Supply a valid status.</p> <p><b>Method</b><br/>logInvalidStatusMnemonic(String orderid, String histid, String status)</p>                                            |
| 600014     | error    | <p><b>Message Body</b><br/>Remark cannot be modified. The time interval in which a created remark can be modified has elapsed. The remark can no longer be modified. (orderid={0} histid={1} remarkid={2} userid={3})</p> <p><b>Message Details</b><br/>Remark cannot be modified. The time interval in which a created remark can be modified has elapsed. The remark can no longer be modified. (orderid={0} histid={1} remarkid={2} userid={3})</p> <p><b>Method</b><br/>logRemarkCannotBeModified(String orderid, String histid, String remarkid, String userid)</p> |
| 600015     | error    | <p><b>Message Body</b><br/>Request Unknown. The request type could not be identified. Type given={0}</p> <p><b>Message Details</b><br/>The request type could not be identified. Type given={0}</p> <p><b>Method</b><br/>logRequestUnkown(String type)</p>                                                                                                                                                                                                                                                                                                               |
| 600016     | error    | <p><b>Message Body</b><br/>Request parameter error. A parameter for the request is missing or invalid. The message details the parameter in question Parameter = {0}, request type = {1}.</p> <p><b>Message Details</b><br/>A parameter for the request is missing or invalid. The message details the parameter in question Parameter = {0}, request type = {1}.</p> <p><b>Method</b><br/>logRequestParameterError(String parameter, String requestType)</p>                                                                                                            |
| 600017     | error    | <p><b>Message Body</b><br/>Not authorized. The user={0} is not authorized to make the request={1}.</p> <p><b>Message Details</b><br/>The user={0} is not authorized to make the request={1}.</p> <p><b>Cause</b><br/>The user is not authorized to perform the operation.</p> <p><b>Method</b><br/>logNotAuthorized(String userid, String request)</p>                                                                                                                                                                                                                   |



Table 13-1 (Cont.) OSM Catalog Messages

| Error Code | Severity | Description                                                                                                                                                                                                                                                       |
|------------|----------|-------------------------------------------------------------------------------------------------------------------------------------------------------------------------------------------------------------------------------------------------------------------|
| 600018     | error    | <p><b>Message Body</b><br/>Database connection failed.</p> <p><b>Method</b><br/>logDatabaseConnectionFailed()</p>                                                                                                                                                 |
| 600019     | error    | <p><b>Message Body</b><br/>Security violation by user = {0}</p> <p><b>Cause</b><br/>User is not authorized to perform this operation.</p> <p><b>Method</b><br/>logSecurityViolation(String userid)</p>                                                            |
| 600020     | error    | <p><b>Message Body</b><br/>Naming exception was thrown while looking up JNDI name={0}.</p> <p><b>Cause</b><br/>JNDI name might not exist.</p> <p><b>Action</b><br/>Contact your local administrator.</p> <p><b>Method</b><br/>logNamingException(String name)</p> |
| 600021     | error    | <p><b>Message Body</b><br/>Remote exception thrown, while access object = {0}</p> <p><b>Message Details</b><br/>Remote exception was thrown while working with an EJB.</p> <p><b>Method</b><br/>logRemoteException(String name)</p>                               |
| 600022     | error    | <p><b>Message Body</b><br/>EJB Create exception thrown while creating object={0}.</p> <p><b>Message Details</b><br/>EJB Create exception thrown.</p> <p><b>Method</b><br/>logEJBCreateException(String name)</p>                                                  |
| 600023     | error    | <p><b>Message Body</b><br/>Unknown exception thrown, message={0}.</p> <p><b>Message Details</b><br/>Unknown exception thrown, message={0}.</p> <p><b>Method</b><br/>logUnknownException(String message)</p>                                                       |

Table 13-1 (Cont.) OSM Catalog Messages

| Error Code | Severity | Description                                                                                                                                                                                                                                                                                                                                                                                                                                                                                                                        |
|------------|----------|------------------------------------------------------------------------------------------------------------------------------------------------------------------------------------------------------------------------------------------------------------------------------------------------------------------------------------------------------------------------------------------------------------------------------------------------------------------------------------------------------------------------------------|
| 600024     | error    | <p><b>Message Body</b><br/>Cannot deliver JMS message to queue = {0}</p> <p><b>Message Details</b><br/>Cannot deliver JMS message.</p> <p><b>Cause</b><br/>JMS Queue might be down.</p> <p><b>Method</b><br/>logCannotDeliverMessage(String arg)</p>                                                                                                                                                                                                                                                                               |
| 600025     | error    | <p><b>Message Body</b><br/>Invalid XML document, doc={0}.</p> <p><b>Message Details</b><br/>Invalid XML document, doc={0}.</p> <p><b>Cause</b><br/>XML document has syntax errors.</p> <p><b>Action</b><br/>Fix the syntax errors.</p> <p><b>Method</b><br/>logInvalidXMLDocument(String doc)</p>                                                                                                                                                                                                                                  |
| 600028     | debug    | <p><b>Message Body</b><br/>SQL: {0}</p> <p><b>Message Details</b><br/>SQL statement execution</p> <p><b>Method</b><br/>logSQL(String sql)</p>                                                                                                                                                                                                                                                                                                                                                                                      |
| 600029     | debug    | <p><b>Message Body</b><br/>{0}</p> <p><b>Message Details</b><br/>Log of a request with all its parameters, based on a toString()</p> <p><b>Method</b><br/>logRequestWithParameters(com.nortel.oms.request.Request request)</p>                                                                                                                                                                                                                                                                                                     |
| 600030     | debug    | <p><b>Message Body</b><br/>Creating order node: mnemonic path {0}, node id {1}, node type {2}, node index {3}, parent index {4}, double value {5}, value {6}, parent new? {7}</p> <p><b>Message Details</b><br/>Node information was sent to the database</p> <p><b>Cause</b><br/>An order node has been created</p> <p><b>Action</b><br/>None</p> <p><b>Method</b><br/>logNodeCreate(String mnemonicPath, long nodeId, String nodeType, long nodeIndex, long parentIndex, double doubleValue, String value, String parentNew)</p> |

Table 13-1 (Cont.) OSM Catalog Messages

| Error Code | Severity | Description                                                                                                                                                                                                                                                                                                                                                                                                                                                                                                                                                                                                                                                                                                       |
|------------|----------|-------------------------------------------------------------------------------------------------------------------------------------------------------------------------------------------------------------------------------------------------------------------------------------------------------------------------------------------------------------------------------------------------------------------------------------------------------------------------------------------------------------------------------------------------------------------------------------------------------------------------------------------------------------------------------------------------------------------|
| 600031     | debug    | <p><b>Message Body</b><br/>Deleting Order Node: node ID {0}, node type {1}, node index {2}, old double value {3}, old text value {4}</p> <p><b>Message Details</b><br/>Node information was sent to the database</p> <p><b>Cause</b><br/>An order node has been deleted</p> <p><b>Action</b><br/>None</p> <p><b>Method</b><br/>logNodeDelete(long nodeId, String nodeTypeCode, long nodeIndex, double oldDoubleValue, String oldValue)</p>                                                                                                                                                                                                                                                                        |
| 600032     |          | <p><b>Message Body</b><br/>Updating Order Node: mnemonic path {0}, node ID {1}, node type {2}, node index {3}, old double value {4}, old text value {5}, new double value {6}, new text value {7}</p> <p><b>Message Details</b><br/>Node information was sent to the database</p> <p><b>Action</b><br/>None</p> <p><b>Method</b><br/>logNodeUpdate(String mnemonicPath, long nodeId, String nodeTypeCode, long nodeIndex, double oldDouble, String oldText, double newDouble, String newText)</p>                                                                                                                                                                                                                 |
| 600035     | debug    | <p><b>Message Body</b><br/>Data validation failed in order editor. Node (name={0} nodeId={1} nodetype={2} nodeIndex={3} nodeDataType={4} mask={5}) does not comply with mask. Order ID={6} and user={7}</p> <p><b>Message Details</b><br/>Node (name={0} nodeId={1} nodetype={2} nodeIndex={3} nodeDataType={4} mask={5}) does not comply with mask. Order ID={6} and user={7}</p> <p><b>Cause</b><br/>Data supplied do not comply with their masks.</p> <p><b>Action</b><br/>Must supply data with correct format.</p> <p><b>Method</b><br/>logOrderEditorDataValidationFailed(String name, String nodeId, String nodeType, String nodeIndex, String nodeDataType, String mask, String orderID, String user)</p> |
| 600036     | debug    | <p><b>Message Body</b><br/>Order editor - Create a node.</p> <p><b>Message Details</b><br/>Order editor: create a node (nodeId={0} nodeType={1} parentWebID={2})</p> <p><b>Method</b><br/>logOrderEditorCreateNode(String nodeId, String nodeType, String parentWebID)</p>                                                                                                                                                                                                                                                                                                                                                                                                                                        |

Table 13-1 (Cont.) OSM Catalog Messages

| Error Code | Severity | Description                                                                                                                                                                                                                                                                                                                                                                                                                                                                                                                                          |
|------------|----------|------------------------------------------------------------------------------------------------------------------------------------------------------------------------------------------------------------------------------------------------------------------------------------------------------------------------------------------------------------------------------------------------------------------------------------------------------------------------------------------------------------------------------------------------------|
| 600037     | debug    | <p><b>Message Body</b><br/>Order editor - delete a node</p> <p><b>Message Details</b><br/>Order editor - delete a node (webID={0})</p> <p><b>Method</b><br/>logOrderEditorDeleteNode(String webID)</p>                                                                                                                                                                                                                                                                                                                                               |
| 600038     | debug    | <p><b>Message Body</b><br/>Notification Engine - create message.</p> <p><b>Message Details</b><br/>Creation of event message</p> <p><b>Method</b><br/>logNotificationEngineCreateMsg(String arg)</p>                                                                                                                                                                                                                                                                                                                                                 |
| 600039     | debug    | <p><b>Message Body</b><br/>Could remove an event from the DB. Event Id = {0}</p> <p><b>Method</b><br/>logEventEngineRemoveEvent(long eventID)</p>                                                                                                                                                                                                                                                                                                                                                                                                    |
| 600055     | warning  | <p><b>Message Body</b><br/>An exception occurred while removing the session for user {0}. Reason: {1}.</p> <p><b>Message Details</b><br/>While logging out user {0}, an exception was thrown when calling EJBObject.remove().</p> <p><b>Cause</b><br/>The server does not allow the session to be removed, or a communication error occurred.</p> <p><b>Method</b><br/>logEJBRemoveException(String username, Throwable th)</p>                                                                                                                      |
| 600063     | error    | <p><b>Message Body</b><br/>Error loading screen definitions from {0}. Reason: {1}.</p> <p><b>Message Details</b><br/>The screen definition file {0} could not be loaded. The screen definition file is required to construct the web pages.</p> <p><b>Cause</b><br/>The OMS application has not been deployed or built properly.</p> <p><b>Action</b><br/>Make sure that the screndefinitions.xml file is in the oms.ear file: oms.ear/oms.war/WEB-INF/conf/</p> <p><b>Method</b><br/>logCouldNotLoadScreenDefinitions(String url, Throwable th)</p> |

Table 13-1 (Cont.) OSM Catalog Messages

| Error Code | Severity | Description                                                                                                                                                                                                                                                                                                                                                                                                              |
|------------|----------|--------------------------------------------------------------------------------------------------------------------------------------------------------------------------------------------------------------------------------------------------------------------------------------------------------------------------------------------------------------------------------------------------------------------------|
| 600066     | warning  | <p><b>Message Body</b><br/>Poller cannot locate listener {0}. Reason: {1}.</p> <p><b>Message Details</b></p> <p><b>Cause</b><br/>Poller Servlet was deployed before listener {0}.</p> <p><b>Action</b><br/>None</p> <p><b>Method</b><br/>logGetPollerListener(String listener, Throwable th)</p>                                                                                                                         |
| 600069     | error    | <p><b>Message Body</b><br/>Could not unsubscribe for {0} event.</p> <p><b>Message Details</b><br/>Event unsubscription for {0} event has failed.</p> <p><b>Cause</b><br/>JMS queue might be down.</p> <p><b>Action</b><br/>Use the WebLogic Server Console to verify JMS deployment.</p> <p><b>Method</b><br/>logEventTypeUnsubscribeException(String eventType)</p>                                                     |
| 600071     | debug    | <p><b>Message Body</b><br/>Filter value {1} does not have the proper format ({3}) for {0}.</p> <p><b>Message Details</b><br/>A filter could not be generated using the value {0}, formatter for {1} and mask {3}</p> <p><b>Cause</b><br/>User error</p> <p><b>Action</b><br/>Expected. You must retry.</p> <p><b>Method</b><br/>logFilterFormatError(String headerName, String filterValue, String mask)</p>             |
| 600072     | debug    | <p><b>Message Body</b><br/>{3} invalid. Wildcards are not permitted for operation {1} for header {0}</p> <p><b>Message Details</b><br/>{3} invalid. Wildcards are not permitted for operation {1} for header {0}</p> <p><b>Cause</b><br/>User input. Expected error.</p> <p><b>Action</b><br/>You must retry.</p> <p><b>Method</b><br/>logFilterWildcardError(String headerName, String operationType, String value)</p> |

Table 13-1 (Cont.) OSM Catalog Messages

| Error Code | Severity | Description                                                                                                                                                                                                                                                                                                                                                                                                                                     |
|------------|----------|-------------------------------------------------------------------------------------------------------------------------------------------------------------------------------------------------------------------------------------------------------------------------------------------------------------------------------------------------------------------------------------------------------------------------------------------------|
| 600073     | error    | <p><b>Message Body</b><br/>SSL is not enabled.</p> <p><b>Message Details</b><br/>SSL is not enabled.</p> <p><b>Cause</b><br/>SSL is not enabled.</p> <p><b>Action</b><br/>You must have SSL enabled for your server through WebLogic console.</p> <p><b>Method</b><br/>logSSLDisabled()</p>                                                                                                                                                     |
| 600076     | error    | <p><b>Message Body</b><br/>Unable to connect to remote file system for accessing attachments.</p> <p><b>Message Details</b><br/>Unable to connect to T3 remote file system for accessing attachments.</p> <p><b>Cause</b><br/>Targeted server might be down.</p> <p><b>Action</b><br/>Contact your local administrator.</p> <p><b>Method</b><br/>logT3ConnectionException()</p>                                                                 |
| 600077     | error    | <p><b>Message Body</b><br/>Unable to add attachment with id={0} in remote file system.</p> <p><b>Message Details</b><br/>Unable to add attachment with id={0} in remote file system using T3 file services.</p> <p><b>Cause</b><br/>IO Exception.</p> <p><b>Method</b><br/>logT3AddAttachmentException(String attachmentID)</p>                                                                                                                 |
| 600078     | error    | <p><b>Message Body</b><br/>Unable to delete attachment with id={0} in remote file system. Attachment with id={0} does not exist.</p> <p><b>Message Details</b><br/>Unable to delete attachment with id={0} in remote file system using T3 file services. Attachment with id={0} does not exist.</p> <p><b>Cause</b><br/>The attachment does not exist.</p> <p><b>Method</b><br/>logT3DeleteAttachmentNotFoundException(String attachmentID)</p> |
| 600079     | error    | <p><b>Message Body</b><br/>Unable to read attachment with id={0} in remote file system.</p> <p><b>Message Details</b><br/>Unable to read attachment with id={0} in remote file system using T3 file services.</p> <p><b>Method</b><br/>logT3ReadAttachmentException(String attachmentID)</p>                                                                                                                                                    |

Table 13-1 (Cont.) OSM Catalog Messages

| Error Code | Severity | Description                                                                                                                                                                                                                                                                                                                                                                                                                                                                                                                                                                                                                                                                                                                                                                                   |
|------------|----------|-----------------------------------------------------------------------------------------------------------------------------------------------------------------------------------------------------------------------------------------------------------------------------------------------------------------------------------------------------------------------------------------------------------------------------------------------------------------------------------------------------------------------------------------------------------------------------------------------------------------------------------------------------------------------------------------------------------------------------------------------------------------------------------------------|
| 600086     |          | <p><b>Message Body</b><br/>Retrieve PendingOrdersReport</p> <p><b>Message Details</b><br/>Retrieve PendingOrdersReport with orderTypesID={0}, orderSourceID={1}, summaryLevel={2}</p> <p><b>Method</b><br/>logPendingOrdersReport(String orderTypesID, String orderSourceID, String summaryLevel)</p>                                                                                                                                                                                                                                                                                                                                                                                                                                                                                         |
| 600088     | error    | <p><b>Message Body</b><br/>Unable to add attachment with id={0} in remote file system. Attachment with id={0} already exists.</p> <p><b>Message Details</b><br/>Unable to add attachment with id={0} in remote file system using T3 file services. Attachment with id={0} already exists.</p> <p><b>Cause</b><br/>The attachment already exists.</p> <p><b>Action</b><br/>None</p> <p><b>Method</b><br/>logT3AddAttachmentAlreadyExists(String attachmentID)</p>                                                                                                                                                                                                                                                                                                                              |
| 600089     | error    | <p><b>Message Body</b><br/>Unable to add attachment with id={0} in remote file system. Attachment with id={0} exceeds maximum file size specified in the configuration file.</p> <p><b>Message Details</b><br/>Unable to add attachment with id={0} in remote file system using T3 file services. Attachment with id={0} exceeds maximum file size specified in the configuration file.</p> <p><b>Cause</b><br/>Your attachment size is too big.</p> <p><b>Action</b><br/>Increase the size of the <b>max_attachment_size</b> parameter in the <b>oms-config.xml</b> file. See "<a href="#">Configuring OSM with oms-config.xml</a>" for more information about editing the <b>oms-config.xml</b> file.</p> <p><b>Method</b><br/>logT3AddAttachmentExceedMaxFileSize(String attachmentID)</p> |
| 600090     | error    | <p><b>Message Body</b><br/>Unable to read attachment with id={0} in remote file system. Attachment with id={0} does not exist.</p> <p><b>Message Details</b><br/>Unable to read attachment with id={0} in remote file system using T3 file services. Attachment with id={0} does not exist.</p> <p><b>Cause</b><br/>The attachment does not exist.</p> <p><b>Action</b><br/>None</p> <p><b>Method</b><br/>logT3ReadAttachmentNotFound(String attachmentID)</p>                                                                                                                                                                                                                                                                                                                                |

Table 13-1 (Cont.) OSM Catalog Messages

| Error Code | Severity | Description                                                                                                                                                                                                                                                                                                                                                                                                                                                                                                                                                                                                                                                                                                       |
|------------|----------|-------------------------------------------------------------------------------------------------------------------------------------------------------------------------------------------------------------------------------------------------------------------------------------------------------------------------------------------------------------------------------------------------------------------------------------------------------------------------------------------------------------------------------------------------------------------------------------------------------------------------------------------------------------------------------------------------------------------|
| 600091     |          | <p><b>Message Body</b><br/>SSL port is not found.</p> <p><b>Message Details</b><br/>SSL port is not found.</p> <p><b>Cause</b><br/>Either server is not found, or there is no SSL port set up for the current server.</p> <p><b>Action</b><br/>Make sure SSL port was set up through WebLogic console.</p> <p><b>Method</b><br/>logSSLPortNotFound()</p>                                                                                                                                                                                                                                                                                                                                                          |
| 600092     | error    | <p><b>Message Body</b><br/>MBean home is not found.</p> <p><b>Message Details</b><br/>MBeanHome.ADMIN_JNDI_NAME cannot be found.</p> <p><b>Cause</b><br/>MBeanHome.ADMIN_JNDI_NAME cannot be found.</p> <p><b>Action</b><br/>None</p> <p><b>Method</b><br/>logMBeanHomeDisabled()</p>                                                                                                                                                                                                                                                                                                                                                                                                                             |
| 600093     | error    | <p><b>Message Body</b><br/>DataSource connection to database could not be found.</p> <p><b>Message Details</b><br/>The EJB requesting a connection to the database does not have a DataSource configured. This caused the data access object to fail.</p> <p><b>Cause</b><br/>The database could not be located on server startup, or the EJB deployment descriptor ejb-jar.xml is missing a resource-ref to jdbc/DataSource, or WebLogic-ejb-jar.xml is missing a resource-descriptor tag to ordermanager/oms1/internal/jdbc/DataSource</p> <p><b>Action</b><br/>Determine if the database is available. Determine if EJB has correct deployment descriptor</p> <p><b>Method</b><br/>logDataSourceNotFound()</p> |
| 600098     | error    | <p><b>Message Body</b><br/>The current server name cannot be found</p> <p><b>Message Details</b><br/>The current server name cannot be found</p> <p><b>Cause</b><br/>MBean cannot find current run time server</p> <p><b>Action</b><br/>None</p> <p><b>Method</b><br/>logserverNameNotFound()</p>                                                                                                                                                                                                                                                                                                                                                                                                                 |



Table 13-1 (Cont.) OSM Catalog Messages

| Error Code | Severity | Description                                                                                                                                                                                                                                                                                                                                                                                                                                                       |
|------------|----------|-------------------------------------------------------------------------------------------------------------------------------------------------------------------------------------------------------------------------------------------------------------------------------------------------------------------------------------------------------------------------------------------------------------------------------------------------------------------|
| 600099     | error    | <p><b>Message Body</b><br/>Get max_read_only_field_length property from oms-config.xml has failed.</p> <p><b>Message Details</b><br/>Get max_read_only_field_length property from oms-config.xml has failed.</p> <p><b>Cause</b><br/>max_read_only_field_length entry does not exist in oms-config.xml.</p> <p><b>Action</b><br/>Make sure max_read_only_field_length entry exists in oms-config.xml.</p> <p><b>Method</b><br/>logGetMaxReadOnlyLengthError()</p> |
| 600103     | error    | <p><b>Message Body</b><br/>OMS is not enabled to send {0} event to the automated agent.</p> <p><b>Cause</b><br/>Either it is disabled in oms-config.xml file or the {1} key is not found in the file.</p> <p><b>Action</b><br/>Make sure it is {1} key in the oms-config.xml file is set to true.</p> <p><b>Method</b><br/>logDisabledJMSEvent(String event, String key)</p>                                                                                      |
| 600104     | error    | <p><b>Message Body</b><br/>Exception thrown while trying to enable or disable {0} event.</p> <p><b>Method</b><br/>logExceptionFindListenerForJMSEvent(String event)</p>                                                                                                                                                                                                                                                                                           |
| 600105     | warning  | <p><b>Message Body</b><br/>Cannot send messages. JMS connection is down.</p> <p><b>Cause</b><br/>JMS connection is down.</p> <p><b>Action</b><br/>Use the WebLogic Server Console to verify JMS deployment.</p> <p><b>Method</b><br/>logJMSTopicConnectionDown()</p>                                                                                                                                                                                              |
| 600108     | error    | <p><b>Message Body</b><br/>An OMS Exception has been thrown. Reason: {0}</p> <p><b>Method</b><br/>logOMSException(Throwable th)</p>                                                                                                                                                                                                                                                                                                                               |
| 600109     | debug    | <p><b>Message Body</b><br/>Lock successful</p> <p><b>Message Details</b><br/>Exclusive access to events table granted</p> <p><b>Method</b><br/>logEventTableLockSuccess()</p>                                                                                                                                                                                                                                                                                     |

Table 13-1 (Cont.) OSM Catalog Messages

| Error Code | Severity | Description                                                                                                                                                                                                                                                                                                                                                                                                                                                                                                                                                                                                                                                                                                                                     |
|------------|----------|-------------------------------------------------------------------------------------------------------------------------------------------------------------------------------------------------------------------------------------------------------------------------------------------------------------------------------------------------------------------------------------------------------------------------------------------------------------------------------------------------------------------------------------------------------------------------------------------------------------------------------------------------------------------------------------------------------------------------------------------------|
| 600110     | debug    | <p><b>Message Body</b><br/>Lock failed</p> <p><b>Message Details</b><br/>Access to events table denied</p> <p><b>Cause</b><br/>Other instance of Poller servlet holds the lock</p> <p><b>Action</b><br/>Wait for the current operation to end, and try again.</p> <p><b>Method</b><br/>logEventTableLockFailure()</p>                                                                                                                                                                                                                                                                                                                                                                                                                           |
| 600111     | error    | <p><b>Message Body</b><br/>Invalid value ({1}) is specified for ({0}) in configuration file. Defaulting to ({2}).</p> <p><b>Message Details</b><br/>Provided value for a parameter is missing or is invalid. A default value is found in oms-config-defaults.xml file and is defaulted to.</p> <p><b>Cause</b><br/>Value out of range - nonexistent path - invalid timezone id - incorrect boolean value</p> <p><b>Action</b><br/>Check max and min values in oms-config-defaults.xml file - correct the path string - find the correct id for your timezone - check how boolean values are represented in oms-config-defaults.xml file</p> <p><b>Method</b><br/>logInvalidValueForParameter(String property, String value, String default)</p> |
| 600112     | error    | <p><b>Message Body</b><br/>Invalid value ({1}) is specified for ({0}) in configuration file and no default value found for it in oms-config-defaults.xml file.</p> <p><b>Message Details</b><br/>Provided value for parameter is missing or is invalid. A default value is not found in oms-config-defaults.xml to default to.</p> <p><b>Cause</b><br/>oms-config-default.xml file cannot be accessed or it does not provide necessary information for the property in question</p> <p><b>Action</b><br/>verify oms-config.xml and oms-config-defaults.xml files. check the installation. check the spelling of parameters in oms-config.xml file</p> <p><b>Method</b><br/>logInvalidValueAndNoDefault(String property, String value)</p>       |
| 600114     | error    | <p><b>Message Body</b><br/>Error reading configuration parameters XML file(URL: {0}) - {1} - {2}</p> <p><b>Message Details</b><br/>An error happened while accessing or reading the indicated configuration file.</p> <p><b>Cause</b><br/>passing error - a malformed URL F119G120E120- G120I/O exception</p> <p><b>Method</b><br/>logErrorLoadingConfigXMLFile(String url, String cause, String msg)</p>                                                                                                                                                                                                                                                                                                                                       |

Table 13-1 (Cont.) OSM Catalog Messages

| Error Code | Severity | Description                                                                                                                                                                                                                                                                                                                                                                                        |
|------------|----------|----------------------------------------------------------------------------------------------------------------------------------------------------------------------------------------------------------------------------------------------------------------------------------------------------------------------------------------------------------------------------------------------------|
| 600115     | error    | <p><b>Message Body</b><br/>In class {0}, an SQL Statement was not closed after use. It will now be closed.</p> <p><b>Cause</b><br/>AbstractProxy.close() was not called after using SQL connection</p> <p><b>Action</b><br/>Report problem to development</p> <p><b>Method</b><br/>logStatementNotClosed(String classname)</p>                                                                     |
| 600116     | error    | <p><b>Message Body</b><br/>In class {0}, an SQL Connection was not closed after use. It will now be closed.</p> <p><b>Cause</b><br/>AbstractProxy.close() was not called after using SQL connection</p> <p><b>Action</b><br/>Report problem to development</p> <p><b>Method</b><br/>logConnectionNotClosed(String classname)</p>                                                                   |
| 600117     | warning  | <p><b>Message Body</b><br/>The view node {0} of type {1} has an invalid default value of {2}. The value has been ignored.</p> <p><b>Cause</b><br/>The default value is not entered correctly, or is incorrect for the data type.</p> <p><b>Action</b><br/>Change default value.</p> <p><b>Method</b><br/>logInvalidDefaultOrderNodeValue(String mnemonicPath, String nodeType, String default)</p> |
| 600118     | error    | <p><b>Message Body</b><br/>Unable to locate resource bundle.</p> <p><b>Cause</b><br/>Resource does not exist.</p> <p><b>Action</b><br/>Make sure there exist a resource file named {0}_ {1}.properties with key(s) {2}.</p> <p><b>Method</b><br/>log18NMissingResourceException(String baseName, String locale, String key)</p>                                                                    |
| 600119     | error    | <p><b>Message Body</b><br/>Poller failed in init, message={0}.</p> <p><b>Method</b><br/>logPollerInitFailure(String msg)</p>                                                                                                                                                                                                                                                                       |
| 600120     | error    | <p><b>Message Body</b><br/>Processing of timeout event failed, message={0}.</p> <p><b>Method</b><br/>logPollerProcessTimeoutFailed(String msg)</p>                                                                                                                                                                                                                                                 |

Table 13-1 (Cont.) OSM Catalog Messages

| Error Code | Severity | Description                                                                                                                                                                                                                                                                                                                                                     |
|------------|----------|-----------------------------------------------------------------------------------------------------------------------------------------------------------------------------------------------------------------------------------------------------------------------------------------------------------------------------------------------------------------|
| 600121     | error    | <p><b>Message Body</b><br/>Unexpected system exception processing XML request: {0}</p> <p><b>Cause</b><br/>Unexpected system exception processing XML request: {0}</p> <p><b>Action</b><br/>Report to development</p> <p><b>Method</b><br/>logXMLAPIProcessorError(Throwable th)</p>                                                                            |
| 600122     | debug    | <p><b>Message Body</b><br/>XMLAPI Servlet, message={0}.</p> <p><b>Method</b><br/>logXMLAPIServletTrace(String msg)</p>                                                                                                                                                                                                                                          |
| 600123     | error    | <p><b>Message Body</b><br/>Could not load XMLAPI Servlet request mappings. Servlet will be unavailable.</p> <p><b>Cause</b><br/>xml-request-mappings.xml file is missing.</p> <p><b>Action</b><br/>check web application WEB-INF/conf directory.</p> <p><b>Method</b><br/>logRequestMappingUnavailable(Exception reason)</p>                                    |
| 600127     | warning  | <p><b>Message Body</b><br/>Error reading XML Document: {0}</p> <p><b>Method</b><br/>logErrorReadingXML(Exception cause)</p>                                                                                                                                                                                                                                     |
| 600128     | warning  | <p><b>Message Body</b><br/>An error occurred processing XML request: {0} {1} : message {2}</p> <p><b>Method</b><br/>logXMLApplicationException(int code, String desc, String msg, Exception ex)</p>                                                                                                                                                             |
| 600129     | warning  | <p><b>Message Body</b><br/>SQL Exception {0} : {1}</p> <p><b>Method</b><br/>logSQLException(int errorCode, String message, Throwable th)</p>                                                                                                                                                                                                                    |
| 600132     | error    | <p><b>Message Body</b><br/>Unable to add attachment. Attachment exceeds maximum file size={0} specified in the configuration file.</p> <p><b>Message Details</b><br/>Unable to add attachment. Attachment exceeds maximum file size={0} specified in the configuration file.</p> <p><b>Method</b><br/>logAddAttachmentExceedMaxFileSize(String maxFileSize)</p> |

Table 13-1 (Cont.) OSM Catalog Messages

| Error Code | Severity | Description                                                                                                                                                                                                                                                                                                                                                                                                                                             |
|------------|----------|---------------------------------------------------------------------------------------------------------------------------------------------------------------------------------------------------------------------------------------------------------------------------------------------------------------------------------------------------------------------------------------------------------------------------------------------------------|
| 600133     | error    | <p><b>Message Body</b><br/>Invalid oms configuration on attachments. Attachment file system must not be null or empty. Maximum attachment size must be bigger than zero.</p> <p><b>Message Details</b><br/>Invalid oms configuration on attachments. Attachment file system must not be null or empty. Maximum attachment size must be bigger than zero.</p> <p><b>Method</b><br/>logInvalidOmsConfigurationOnAttachments()</p>                         |
| 600134     | error    | <p><b>Message Body</b><br/>Missing T3 file service with name={0}.</p> <p><b>Message Details</b><br/>Missing T3 file service with name={0}.</p> <p><b>Cause</b><br/>Missing configuration of T3 file server name in WebLogic console.</p> <p><b>Action</b><br/>Contact your local administrator to set T3 file server.</p> <p><b>Method</b><br/>logMissingT3FileServiceName(String fileName)</p>                                                         |
| 600135     |          | <p><b>Message Body</b><br/>T3 file service with name={0} must target exactly to one server.</p> <p><b>Message Details</b><br/>T3 file service with name={0} must target exactly to one server.</p> <p><b>Cause</b><br/>T3 file service was targeted to more than one server.</p> <p><b>Action</b><br/>Contact your local administrator to set up T3 file server properly.</p> <p><b>Method</b><br/>logDuplicateT3FileServiceTarget(String fileName)</p> |
| 600136     | error    | <p><b>Message Body</b><br/>Invalid T3 file service path.</p> <p><b>Message Details</b><br/>Invalid T3 file service path.</p> <p><b>Cause</b><br/>Invalid T3 file service path.</p> <p><b>Action</b><br/>Make sure T3 file service path is valid.</p> <p><b>Method</b><br/>logInvalidT3FileServicePath()</p>                                                                                                                                             |

Table 13-1 (Cont.) OSM Catalog Messages

| Error Code | Severity | Description                                                                                                                                                                                                                                                                                                                                                                                                                                                                                                                              |
|------------|----------|------------------------------------------------------------------------------------------------------------------------------------------------------------------------------------------------------------------------------------------------------------------------------------------------------------------------------------------------------------------------------------------------------------------------------------------------------------------------------------------------------------------------------------------|
| 600138     | error    | <p><b>Message Body</b><br/>Targeted server = [{0}] for the T3 File Service with name = [{1}] is not running.</p> <p><b>Message Details</b><br/>Targeted server = [{0}] for the T3 File Service with name = [{1}] is not running.</p> <p><b>Cause</b><br/>Targeted server = [{0}] for the T3 File Service with name = [{1}] is not running.</p> <p><b>Action</b><br/>Make sure the targeted server is running.</p> <p><b>Method</b><br/>logTargetedserverForT3FileServiceNotRunning(String t3TargetserverName, String fileSystemName)</p> |
| 600139     | debug    | <b>Message Body</b> {0}                                                                                                                                                                                                                                                                                                                                                                                                                                                                                                                  |

## Automation Catalog Messages

Table 13-2 shows Automation Catalog messages.

Table 13-2 Automation Catalog Messages

| Error Code | Severity | Description                                                                                                                                                                                                                                                |
|------------|----------|------------------------------------------------------------------------------------------------------------------------------------------------------------------------------------------------------------------------------------------------------------|
| 700002     | debug    | <p><b>Message Body</b><br/>parseXmlData(String xmlData)</p> <p><b>Method</b><br/>Parse the XML data {0}</p>                                                                                                                                                |
| 700004     | debug    | <p><b>Message Body</b><br/>lookupOMSBean(String jndiName)</p> <p><b>Method</b><br/>Lookup the OMSSession Bean with jndiName={0}</p>                                                                                                                        |
| 700007     | debug    | <p><b>Message Body</b><br/>receiveTask(long orderId, long orderHistoryId, String taskMnemonic)</p> <p><b>Method</b><br/>Receive Task with orderId={0} orderHistoryId={1} and task mnemonic={2}</p>                                                         |
| 700008     | debug    | <p><b>Message Body</b><br/>completeTaskOnExit(long orderId, long orderHistId, String taskMnemonic,String comepletStat)</p> <p><b>Method</b><br/>Complete task On Exit with orderId={0}, orderHistoryId={1}, taskMnemonic={2} and Completion Status={3}</p> |
| 700009     | debug    | <p><b>Message Body</b><br/>assignTask(long orderId,long orderHistoryId, String taskMnemonic, String userId)</p> <p><b>Method</b><br/>Assign Task to {3} with orderId={0} orderHistId ={1} and TaskMnemonic ={2}</p>                                        |

**Table 13-2 (Cont.) Automation Catalog Messages**

| <b>Error Code</b> | <b>Severity</b> | <b>Description</b>                                                                                                                                                                                                                |
|-------------------|-----------------|-----------------------------------------------------------------------------------------------------------------------------------------------------------------------------------------------------------------------------------|
| 700010            | debug           | <p><b>Message Body</b><br/>suspendTask(long orderId,long orderHistoryId, String taskMnemonic, String suspendState)</p> <p><b>Method</b><br/>SuspendTask to state={3} with OrderID={0}, OrderHistId={1} and Task Mnemonic={2}</p>  |
| 700011            | debug           | <p><b>Message Body</b><br/>acceptTask(long orderId, long orderHistoryId, String taskMnemonic)</p> <p><b>Method</b><br/>Accept Task with OrderId={0} orderHistoryId={1} and taskMnemonic={2}</p>                                   |
| 700012            | debug           | <p><b>Message Body</b><br/>updateOrderData1(long orderId,long orderHistId,String TaskMnem, String updateData)</p> <p><b>Method</b><br/>UpdateOrderData with orderId={0} orderHistoryId={1}, TaskMnemonic={2} and XML Data={3}</p> |
| 700014            | debug           | <p><b>Message Body</b><br/>The orderData id={0} and Data:{1}</p> <p><b>Method</b><br/>printOrderDataAsXML(long OrderId, String OrderData)</p>                                                                                     |
| 700016            | debug           | <p><b>Message Body</b><br/>Lookup the Automator: type={0} and jndiName={1}</p> <p><b>Method</b><br/>lookupAutomator(String type, String jndiName)</p>                                                                             |
| 700019            | debug           | <p><b>Message Body</b><br/>Get a JMS Message with EventType={0}, Mnemonic={1}</p> <p><b>Method</b><br/>getAMessage(String type, String mnemonic)</p>                                                                              |
| 700020            | debug           | <p><b>Message Body</b><br/>Set the outMessage Correlation to={0} the correlationId={1}</p> <p><b>Method</b><br/>setCorrelationId(String correlation, String correlationId)</p>                                                    |
| 700021            | debug           | <p><b>Message Body</b><br/>Send Notification Email message to :{0}, subject:{1}, MessageBody{2}</p> <p><b>Method</b><br/>sendEmailNotification(String to, String subject, String msgBody)</p>                                     |
| 700023            | error           | <p><b>Message Body</b><br/>An automation exception has occurred At {0}, the reason is :{1}</p> <p><b>Cause</b><br/>See message body.</p> <p><b>Method</b><br/>AutomationException(String msg, Throwable th)</p>                   |

Table 13-2 (Cont.) Automation Catalog Messages

| Error Code | Severity | Description                                                                                                                                                                                       |
|------------|----------|---------------------------------------------------------------------------------------------------------------------------------------------------------------------------------------------------|
| 700024     | error    | <b>Message Body</b><br>Naming Exception has occurred at {0} reason {1}<br><b>Cause</b><br>Cannot find user plug-in from JNDI tree.<br><b>Method</b><br>namingException(String name, Throwable ex) |
| 700033     | error    | <b>Message Body</b><br>{0} {1}<br><b>Cause</b><br>See message body for details.<br><b>Method</b><br>logAutomationException(String desc, Throwable exception)                                      |



# Using the XML Import/Export Application

This chapter provides information about the XML Import/Export application (XMLIE), which is used to manage data and metadata in the Oracle Communications Order and Service Management (OSM) database schema.

## About the XML Import/Export Application

XMLIE is included with the OSM SDK that is available in the download pack for OSM cloud native. Extract the SDK tar file to get access to the XMLIE tools.

OSM cloud native has replacement mechanisms for some of the XMLIE operations.

 **Note:**

Do not run the **import**, **fastUndeploy**, **userAdmin** and **credStoreAdmin** operations using the XMLIE scripts, but instead use the new mechanism.

You can find more details in "Differences Between OSM Cloud Native and OSM Traditional Deployments".

There are two types of information in an OSM database schema:

- **Metadata:** Information that defines the order model. For example, the definitions of processes, orders, and tasks.
- **Data:** Information that represents orders. For example, order nodes, attributes, and values.

Using XMLIE, you can perform actions such as import and export metadata, purge metadata and data, and migrate data. You can also use XMLIE to validate the metadata model and to create a graphical representation of the metadata.

 **Note:**

Although actions such as importing and exporting metadata, purging both metadata and data, and migrating data can be done using XMLIE, Oracle Communications Design Studio is the preferred application for running these functions.

 **Note:**

XMLIE can work with a localized database, but the application must also be localized. See *OSM Developer's Guide* for information on localizing OSM, including localizing XMLIE.

If you are running the OSM application on a UNIX or Oracle Linux platform, you must run XMLIE by using a set of Ant scripts. If you are running the OSM application on a Windows platform, you must run XMLIE by using a set of batch scripts.

## About Using the XML Import/Export Application

The following steps provide a high-level overview of using XMLIE:

1. Configure the XMLIE environment files:
  - For Ant commands, configure the **SDK/XMLImportExport/build.properties** file. See "[Configuring the build.properties File for Ant Commands](#)."
  - For batch scripts, configure the **SDK/XMLImportExport/config.bat** script. See "[Configuring the config.bat Script for Batch Scripts](#)."
2. Copy the **SDK/XMLImportExport/config/config\_sample.xml** file and rename it to **SDK/XMLImportExport/config/config.xml** in the same directory.

 **Note:**

The **SDK/XMLImportExport/config/config\_sample.xml** file is a sample XMLIE configuration file that can be used as a template for the **config.xml** configuration file.

The **config.xml** file name is arbitrary. If you customize the name of the **config.xml** file, ensure that you substitute the customized name wherever you must specify the **config.xml** file (for example, when using the import and export commands in the **import.bat** and **export.bat** scripts).

This chapter uses the default **config.xml** file name in all examples.

3. Configure the **SDK/XMLImportExport/config/config.xml** file.

Both the XMLIE Ant commands and batch scripts use this file to define:

- Connections to other components  
For example, database connection XML node that provides the OSM schema user name, password, and connection details.
- How the Ant commands and batch scripts work  
For example, the **import.bat** script is configured using the **import** node in the **config.xml** file. This node contains elements that specify whether the imported data is validated, what actions to take if the database is not empty, and what actions to take if the XML model you are importing already exists in the database.

- The data or metadata on which the commands are to act  
For example, you can configure a selective import that only imports one specific element into an existing OSM cartridge using the **selection** element. See "[Configuring the config.xml File XML Import/Export Nodes and Elements.](#)"
- 4. You can create an empty text file with an **.xml** extension and then use the **export.bat** script or the **ant export** command to populate the file. Then you can edit it for use with other batch scripts or Ant commands.

 **Note:**

This chapter uses *xmlModelFile* as the documentation placeholder name for this file.

5. Run the Ant command or batch script.

## About XML Import/Export Batch Scripts and Ant Commands

The following sections describe the XMLIE batch scripts and Ant commands.

### About XML Import/Export Ant Commands and Syntax

OSM supports the following Ant commands and syntax for UNIX and Linux systems:

- **ant export:** exports all cartridges, all cartridges within a given namespace, or one specific cartridge.
- **ant import:** imports the XML model.
- **ant purge:** completely purges the target database.
- **ant undeploy:** undeploys the given cartridge if no pending orders exist.
- **ant forceUndeploy:** forces to undeploy the given cartridge including pending orders.
- **ant convert:** upgrades the old XML model to latest version.

 **Note:**

This command is deprecated. Use the **ant import** command instead because it automatically upgrades models during an import.

- **ant refresh:** refreshes the metadata in the WebLogic Server.
- **ant htmlModel:** converts an XML metadata document to HTML and graphical format.
- **ant userAdmin:** adds users from WebLogic groups and OSM workgroups.

 **Note:**

Do not use this command. Instead, use the mechanism described in "Differences Between OSM Cloud Native and OSM Traditional Deployments".

Before you can run these Ant commands, you must configure the Ant environment **build.properties** file and the **config.xml** file. For more information see "[Configuring the XML Import/Export Environment Files](#)" and "[Configuring the config.xml File XML Import/Export Nodes and Elements](#)."

You can use the following scripts to encrypt passwords:

- **EncryptPasswords.sh**: This encrypts passwords in the **config.xml** file. For more information, see "[Using the EncryptPasswords Utility](#)."
- **CreateEncryptPasswords.sh**: This encrypts passwords for use in the userAdmin and credStoreAdmin credential store commands.

## About XML Import/Export Batch Scripts and Syntax

OSM supports the following batch scripts for Windows systems in the **SDK/XMLImportExport** folder:

- **import.bat**: Imports an XML metadata document into an OSM database.
- **export.bat**: Exports an OSM database to an XML metadata document.
- **migrate.bat**: Migrates order data from one version of a cartridge to another version of the same cartridge.
- **purge.bat**: Purges the entire OSM schema (metadata and orders) or undeploys a specific cartridge.
- **orderPurge.bat**: Purges orders that satisfy purge criteria; can be run on an immediate or scheduled basis.
- **validate.bat**: Validates an XML model document.
- **modeldoc.bat**: Converts an XML metadata document to HTML and graphical format.
- **EncryptPasswords.bat**: Encrypts passwords contained in the **config.xml** file. For more information, see "[Using the EncryptPasswords Utility](#)."
- **CreateEncryptPasswords.bat**: Encrypts passwords for use in the userAdmin and credStoreAdmin credential store commands.
- **convertmodel.bat**: Migrates a model from older versions and uses the following syntax:

```
convertmodel.bat xmlModelFile
```

 **Note:**

This script is deprecated. Use the **import.bat** script instead because it automatically upgrades models during an import.

- **userAdmin.bat**: Adds users to WebLogic from WebLogic groups and OSM workgroups based on an XML definition.

 **Note:**

Do not use this script. Instead, use the mechanism described in "Differences Between OSM Cloud Native and OSM Traditional Deployments".

 **Note:**

Passing an unencrypted password as a command line argument to the XML Import/Export tool scripts is no longer possible. The **-p db\_password** and **-clientpassword xmlAPI\_password** arguments, which were previously deprecated, have now been removed. You must either use encrypted passwords in the config.xml file (using the EncryptPassword utility) or interactively provide the unencrypted password when prompted. For security recommendations, see "Configuring the config.xml File XML Import/Export Nodes and Elements."

Before you can run these scripts, you must configure the environment **config.bat** script and the **config.xml** file. For more information see "Configuring the XML Import/Export Environment Files" and "Configuring the config.xml File XML Import/Export Nodes and Elements."

## Configuring the XML Import/Export Environment Files

The following sections describe the files you need to edit to configure the environment for the XMLIE Ant commands and batch scripts.

### Configuring the build.properties File for Ant Commands

The paths to the **config.xml** file and the XML model document, along with cartridge and environment properties used by the XMLIE Ant commands, must be specified in the **SDK/XMLImportExport/build.properties** file. Unlike the XMLIE batch scripts, you do not have to specify these paths in the command line.

To configure the **build.properties** file for Ant commands:

1. Open the **SDK/XMLImportExport/build.properties** file.
2. Update the following variables:

```
middlewareHome=MW_home
java.maxmemory=java_max_memory
xmlie.root.dir=root_dir
xmlie.root.modelDocument=model_document
xmlie.root.configDocument=config_document
xmlie.root.namespace=namespace
xmlie.root.version=version
xmlie.root.htmlDir=html_dir
```

where:

- *MW\_home* is the location where Oracle Fusion Middleware was installed
- *java\_max\_memory* is the maximum heap to be used by JVM
- *root.dir* is the path of XMLIE directory
- *model\_document* is the path for XML model document
- *config\_document* is the path for **config.xml**
- *namespace* is the OSM cartridge namespace
- *version* is the cartridge version
- *html\_dir* is the path for HTML model directory

 **Note:**

You can also refer to the **README.txt** file found under **SDK/XMLImportExport** for information on configuring the **build.properties** file for Ant scripts.

For example:

```
middlewareHome=C:/oracle/middleware
java.maxmemory=512m
xmlie.root.dir=./
xmlie.root.modelDocument=./data.xml
xmlie.root.configDocument=./config/config.xml
xmlie.root.namespace=test
xmlie.root.version=4.0
xmlie.root.htmlDir=./htmlModel
```

3. If you want to configure order purge parameters in the **build.properties** file, see "[Running Ant with the orderPurge.xml file On UNIX or Linux to Purge Orders](#)."
4. If you want to configure cartridge migration parameters in the **build.properties** file, see "[Configuring and Running an Order Migration](#)."

## Configuring the config.bat Script for Batch Scripts

To configure the batch script environment, go to the **SDK/XMLImportExport** directory and configure the user-configurable variables (for example, JAVA\_OPTS) in the **config.bat** file.

## Configuring the config.xml File XML Import/Export Nodes and Elements

To configure the **config.xml** file:

1. Open the **SDK/XMLImportExport/config/config\_sample.xml** file.
2. Create a **config.xml** file by copying **config\_sample.xml** to **config.xml**.

 **Note:**

The **sample\_config.xml** file contains references to absolute paths that start with "C:\". Be sure to configure these paths to reflect your environment.

3. Configure the database connection node in the **config.xml** file. This node is required for most Ant commands and batch scripts.

```
<databaseConnection>
  <user>osm_schema</user>
  <password>osm_schema_pwd</password>
  <dataSource>jdbc:oracle:thin:@ip_address:osm_db_port:osm_db_sid</
dataSource>
</databaseConnection>
```

where:

- *osm\_schema* and *osm\_schema\_pwd* are the OSM schema user name and password.
- *ip\_address*, *osm\_db\_port*, and *osm\_db\_sid* are the OSM database IP address, port number, and SID.

 **Note:**

To export or import the symbols, change the character set and database connection to something like the following sample:

```
<encoding>UTF-8</encoding>
<dataSource>
jdbc:oracle:oci:(description=(address=(host=host1.example.com)
(protocol=tcp)(port=1521)) (connect_data=(SID=ORASID)))
</dataSource>
```

4. Configure the XML API connection node to specify the connection information to be used by operations that utilize the XML API. For example, migration Ant commands or batch scripts require this node.

```
<xmlAPIConnection>
  <user>weblogic_user</user>
  <password>weblogic_pwd</password>
  <url>http://ip_address:port</url>
</xmlAPIConnection>
```

where

- *weblogic\_user* and *weblogic\_pwd* are the user name and password of the user performing the migration. This user must have access to all source orders being migrated and to target order's type/source order entry task (if *closeSource* set to true, see "[About Migrating Orders](#)" for details).
- *ip\_address*, and *port* are the WebLogic Administration server IP address and port number.

5. Configure the WebLogic Administrator credentials and connection information node. This node is required for Ant commands and batch scripts that modify OSM user credentials:

```
<j2eeAdminConnection>
  <j2eeServiceName>weblogic</j2eeServiceName>
  <user>weblogic_user</user>
  <password>weblogic_pwd</password>
  <protocol>protocol</protocol>
  <hostname>ip_address</hostname>
  <port>port</port>
</j2eeAdminConnection>
```

where

- *weblogic\_user* and *weblogic\_pwd* are the user name and password of the WebLogic with Administrator privileges.
  - *protocol* is the protocol to use to connect to the WebLogic server. If not included, the t3 protocol will be used. If you would like to connect to the WebLogic server using SSL, set this value to **t3s**.
  - *ip\_address*, and *port* are the WebLogic Administration server IP address and port number.
6. Configure the XMLIE log file location node:

```
<log logFileUrl="file:/filename_path" overwrite="boolean"/>
```

where:

- *filename\_path* is the path to the log file that includes the file name of the log file.
  - *boolean* can be true or false. If set to true (default), XMLIE overwrites the log file every time the application starts. If set to false, XMLIE creates a cumulative log by saving the log from session to session and adding new messages to it.
7. Do one of the following:
    - For exporting metadata from an OSM database, configure the export node. See ["About Exporting Metadata."](#)
    - For importing metadata to the OSM database, configure the import node. See ["About Importing Metadata"](#).
    - For purging metadata and order data in an OSM database, configure the purge node. See ["About Purging MetaData and Data."](#)
    - For migrating orders between OSM cartridges, configure the migrate node. See ["About Migrating Orders."](#)
    - For validation Metadata from an existing XML file, configure the validation node. See ["About Validating the Metadata Model and Data."](#)
    - For creating a graphical HTML representation see ["About Creating a Graphical Representation of the Metadata Model."](#)
  8. (Optional) If XMLIE is to be run unattended, secure the EncryptPassword utility and the configuration file that contains user credentials.

For enhanced security, each of the XMLIE operations that require user passwords prompts you for those passwords during invocation. If XMLIE is to be run



unattended, you can alternatively encrypt those passwords and store them in the XMLIE configuration file (typically **config.xml**).

If passwords are to be stored in the XMLIE configuration file, do the following:

- a. Set the permissions of the configuration file to be readable only by select administrative users. Refer to your OS documentation for instruction.
- b. Run the EncryptPassword utility so that user name and password credentials for all XMLIE users are encrypted for safe storage. For more information, see ["Using the EncryptPasswords Utility."](#)

 **Note:**

If you plan to run XMLIE in an unattended mode, you must first run the EncryptPasswords utility; otherwise, you cannot perform many of the application functions and OSM gives an error indicating that you must run the EncryptPasswords utility.

## About Importing and Exporting Metadata

You can transfer metadata from one OSM database to another when setting up a new OSM environment. For example, you may want to set up multiple OSM environments of the same version, such as development, test, and production environments. Or, you may want to set up a new version of an OSM production environment based on a previous version of an OSM production environment.

Transferring metadata from one OSM database to another is a combination of an export from the one OSM database followed by an import to another. You can also import and export selected parts of the metadata, as opposed to all of the metadata.

 **Note:**

The actions that XMLIE runs are supported in Design Studio. Any metadata changes made using XMLIE will be overwritten when deploying the same cartridge using Design Studio.

The following sections describe import and export commands and configurations.

## About Exporting Metadata

XMLIE provides the **export.bat** script or the **ant export** command, which is used to export metadata from an OSM database. Exported metadata is stored in an XML file (the *xmlModelFile*). You can export metadata using Design Studio; however, this functionality remains available through XMLIE as well.

You can export the entire metadata database, or you can use the export **selection** element to specify the metadata to export based on:

- All entities or selected entities from a specific cartridge
- All cartridges in a namespace

Each OSM cartridge is uniquely identified by namespace and version, so exporting all of the cartridges in a namespace includes all versions of the cartridge within the namespace.

 **Note:**

A selective export exports all of the data, then it applies a filter according to the selection. Consequently, selective exports take the same amount of time as full exports.

## About the Order of Exported Metadata

When the order of the resulting list makes no logical or significant difference, XMLIE places the metadata files in ascending alphabetical order. This ensures that when you do repeated exports of the same database, the metadata files will always appear in the same order, which makes it easier to merge metadata changes with future development.

In [Example 14-1](#), the definition of entities (for example, each state) is now sorted alphabetically by name:

### Example 14-1 Definition of Entities (each state) Sorted Alphabetically by Name

```
<state name="accepted">
<description>Accepted</description>
</state>
<state name="assigned">
<description>Assigned</description>
</state>
<state name="completed">
<description>Completed</description>
</state>
<state name="received">
<description>Received</description>
</state>
...
```

In [Example 14-2](#), the references to entities (for example, each state) is now sorted alphabetically by name:

### Example 14-2 References to Entities (states or statuses) Sorted Alphabetically by Name:

```
<task name="enter_payment_information" xsi:type="genericTaskType">
<description>Enter Payment Information</description>
<state>accepted</state>
<state>completed</state>
<state>received</state>
<status>back</status>
<status>next</status>
</task>
```

In [Example 14-3](#), the Import/Export application does not sort by name because the order matters (that is, there is a logical difference). Country appears after last\_name because the designer specified country to appear after last\_name:

**Example 14-3 Not Sorted By Name**

```

<masterOrderTemplate>
<dataNode element="account_information">
<dataNode element="first_name"/>
<dataNode element="last_name"/>
<dataNode element="country">
<viewRule xsi:type="eventRuleType">
<event>value-changed</event>
<action>refresh</action>
</viewRule>
</dataNode>

```

## About Export Layout Options

When you perform a selective export, you can specify different export layouts by using the export command to create one or multiple files, and where to put the files. You have the following options:

- Use the **singleDocument** layout to export to a single file that contains all of the exported entities.
- Use the **cartridge** layout to export to one main document and a single folder for each exported cartridge. Each cartridge folder contains a version folder.

Figure 14-1 shows the **cartridge** layout.

**Figure 14-1 Cartridge Layout**



- You can use the **entity** layout to export to:
  - One main document
  - A folder for each cartridge included in the export (you can specify that the export include entities from more than one cartridge)
  - A folder for the cartridge version
  - A single folder for each entity type exported. Under the entity type folders are the individual entity XML files

Figure 14-2 shows the **entity** layout.

Figure 14-2 Entity Layout

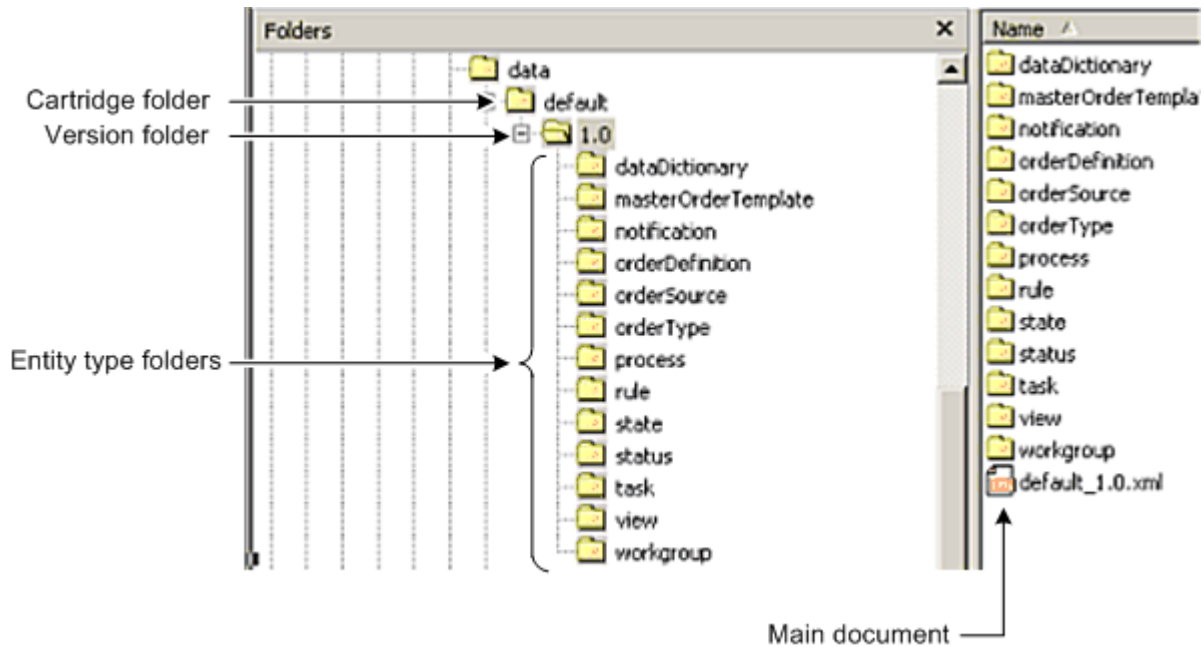

## Keeping the ID Integrity in SQL Rules

### Note:

This section is applicable only if you are upgrading up to OSM 7.0 from a previous release. SQL rules and text rules were replaced in OSM 7.0. SQL rules are supported in Design Studio. The SQL rule is imported as a separate file that can be edited as a text document.

The SQL based rule type in OSM can contain entity IDs (mostly node IDs), which must be replaced with new IDs during data migration. IDs must be exposed as entity attributes, helping the application find them in SQL based rules, and replace them with new ones while importing them into a fresh environment. IDs in a document otherwise serve no purpose and should be ignored. You can set this feature to false by setting the `exposeEntityID`, in the `config.xml` file for XMLIE, to false, thereby reducing the model document size.

### Note:

This is a function of the export behavior.

Text rules can reference any entity ID. Generally, however, node IDs used in these known patterns for other possible entity ID conversion routines require user assistance to tokenize the rule text for proper parsing and conversion. A token suggested before the ID must be tokenized for IDs except known patterns (all node functions and stored procedures in `om_ordinst_value_pkg` package):

```
/*$entityType*/
```

#### Example 14-4 Original Rule

```
declare vall date;
delay_flag   varchar2(10);
begin
select timestamp_out into vall
from om_hist$order_header hist, om_task task, om_state st
where hist.task_id = task.task_id
and node_id = /*$dataNode*/76983
and hist.hist_order_state_id = st.state_id and st.state_mnemonic = 'completed'
and hist.order_seq_id = :order_seq_id;

delay_flag :=
om_ordinst_value_pkg.get_node_value_like(:order_seq_id,76983,:coord_set_id);
if ( rtrim(delay_flag)='yes' ) or (vall &lt;= (sysdate - 2/24)) then
:rule_result := 'true';
else
:rule_result := 'false';
end if;
end;
```

#### Example 14-5 Modified Rule

The import operation detects IDs and replaces them with new IDs.

```
declare vall date;
delay_flag   varchar2(10);
begin
select timestamp_out into vall
from om_hist$order_header hist, om_task task, om_state st
where hist.task_id = task.task_id
and node_id = /*$dataNode*/new_id
and hist.hist_order_state_id = st.state_id and st.state_mnemonic = 'completed'
and hist.order_seq_id = :order_seq_id;

delay_flag := om_ordinst_value_pkg.get_node_value_like(:order_seq_id,
new_id,:coord_set_id);
if ( rtrim(delay_flag)='yes' ) or (vall &lt;= (sysdate - 2/24)) then
:rule_result := 'true';
else
:rule_result := 'false';
end if;
end
```

## Configuring and Running an Export

To configure and run an export:

1. Configure the **config.xml** file for use with the **ant export** command.

```
<export validateModel="validation" exposeEntityID="entityID"
layout="layout_action" readOnlyFileAction="readOnly_action">
</export>
```

where:

- **validation**: Options are:
  - **true**: Validates the XML model before performing the export.

- **false**: Does not validate the XML model before performing the export. (default).

**▲ Caution:**

Oracle recommends you do not skip the model validation, so this parameter should always be set to *true*.

- *entityID*: Options are:
    - **true**: Exposes the EntityID in the exported file. (default)
    - **false**: Conceals the Entity ID in the exported file.
  - *layout\_action*: Options are:
    - **singleDocument**: Exports everything to a single file. (default)
    - **cartridge**: Creates a single file for each cartridge exported.
    - **entity**: Creates a single file for each entity exported.
  - *readOnly\_action*: Options are:
    - **ignore**: The Export operation will not overwrite read-only files. (default)
    - **replace**: The Export operation will overwrite read-only files.
2. (Optional) Add the **selection** element within the **export** node to export targeted entities to OSM metadata using an XPath expression. Use the following syntax to define the selection element:

```
<export validateModel="validation" exposeEntityID="entityID"
layout="layout_action" readOnlyFileAction="readOnly_action">
  <selection>/oms:model/oms:cartridge[@namespace="namespace" and
@version="version"]/oms:entity</selection>
  <selection>/oms:model/oms:entity</selection>
</export>
```

where

- *namespace*: The namespace for the cartridge.
  - *version*: The cartridge version.
  - *entity*: The entity you are targeting. For example, workgroup, region, and schedule.
3. Do the following:
- If you are using Ant, run the following command:
 

```
ant export
```
  - If you are using a batch script, run the following command:
 

```
export.bat xmlModelFile config/config.xml
```

## About Importing Metadata

OSM cloud native provides a cartridge import mechanism that reduces the import time. See "Working with Cartridges" for further details.

XMLIE provides the **import** command, which is used to import metadata into an OSM database. If you import metadata, make sure that the elements you import do not conflict with existing metadata that is part of a Design Studio OSM cartridge. Otherwise you may encounter version conflict, overwrite existing elements, and create other discrepancies.

You can import the entire metadata database using the import node or you can use the import **selection** element within an **import** node to specify the metadata to import based on:

- All entities or selected entities from a specific cartridge
- All cartridges in a namespace  
Each OSM cartridge is uniquely identified by namespace and version, so exporting all of the cartridges in a namespace includes all versions of the cartridge within the namespace.
- System level parameters

By enabling selective imports, you can grant concurrent access to a single model or cartridge for multiple developers. Using this method, developers can import just the entities on which they are working at that moment, which gives other developers access to other entities within the cartridge.

The import operation is performed in one transaction. Consult your Oracle Database Administrator (DBA) for the appropriate setup for the rollback segment.

 **Note:**

User workgroups are not part of the metadata model, so they must be re-entered after an import.

 **Note:**

After importing or exporting a cartridge, you must remap the e-mail notifications that were associated with individual users. For best results, associate notifications only with workgroups because user names differ between environments.

## Configuring and Running an Import

To configure and run an import:

1. Configure the **config.xml** file:

```
<import validateModel="validation"  
nonEmptyDatabaseAction="database_action"entityConflictAction="entity_action">  
</import>
```

where:

- *validation*: Options are:
  - **true**: Validates the XML model before performing the import.

- **false**: Does not validate the XML model before performing the import. (default)

**▲ Caution:**

Oracle recommends you do not skip the model validation, so this parameter should always be set to *true*.

- *database\_action*: Options are:
  - **ignore**: The import completes even if it detects that the database is non-empty. (default)
  - **abort**: The import terminates if it detects that the database is non-empty.
  - **purge**: The import purges the existing database if it detects that the database is non-empty.

If a model includes some changes for existing entities in the database, the import checks for order dependency. If those changes do not violate database constraints for pending orders, the import completes successfully. If the modified entities violate the existing orders, the violation is reported as known application exceptions with descriptive messages.

- *entity\_action*: The **entityConflictAction** import parameter value specifies the import behavior when the application encounters a conflict for an existing entity in the database. For example, a conflict occurs if you import a new model that contains one or more entities that already exist in the database. Options are:
  - **abort**: If an entity conflict exists, the import process stops.
  - **replace**: The import replaces conflicted entities, that is, entities that already exist. (default)
  - **ignore**: The import does not replace conflicted entities.

2. (Optional) Add the **selection** element within the **import** node to import targeted entities to an OSM cartridge using an XPath expression. Use the following syntax to define the selection element:

```
<import validateModel="validation"
nonEmptyDatabaseAction="database_action"entityConflictAction="entity_action">
  <selection>/oms:model/oms:cartridge[@namespace="namespace" and
@version="version"]/oms:entity</selection>
  <selection>/oms:model/oms:system_entity</selection>
</import>
```

where

- *namespace*: The namespace for the cartridge.
- *version*: The cartridge version.
- *entity*: The entity you are targeting. For example, workgroup, region, and schedule.

3. Do the following:

- a. If you are using Ant, run the following command:

```
ant import
```



- b. If you are using a batch script, run the following command:

```
import.bat xmlModelFile config/config.xml
```

## Sample Procedure for Adding a New Workgroup Definition (Role)

You can add a new workgroup definition (a workgroup is called a role in Design Studio) without having to redeploy a cartridge by using XMLIE.

### Note:

The workgroup definition is a system level entity that can be applied to multiple different cartridges. If you add a new workgroup using XMLIE, make sure you do not overwrite existing workgroup definitions.

To add a new workgroup definition using XMLIE:

1. In the **SDK\XMLImportExport\config\config.xml** file, add a selection element to an export node that targets the workgroupDefinition entity.

For example:

```
<export validateModel="false" exposeEntityID="false" layout="singleDocument"
  readOnlyFileAction="ignore">
  <selection>/oms:model/oms:workgroupDefinition</selection>
</export>
```

2. Save and exit the file.
3. In the **SDK\XMLImportExport\** folder, create an XML document to store the XML workgroup information from the cartridge you are targeting. For example: **workgroupDefinition.xml**.
4. Run the **SDK\XMLImportExport\export.bat** script:

For example:

```
export.bat C:\osminstall\SDK\XMLImportExport\workgroupDefinition.xml
C:\osminstall\SDK\XMLImportExport\config\config.xml
```

5. When the export is complete, open the XML file containing the workgroup information and add a new workgroupDefinition element and all child elements. For example:

```
<?xml version = '1.0' encoding = 'ISO-8859-2'?>
<model xmlns="http://www.metasolv.com/OMS/OrderModel/2002/06/25"
  xmlns:osm="http://xmlns.oracle.com/communications/ordermanagement/model"
  xmlns:xsi="http://www.w3.org/2001/XMLSchema-instance"
  xsi:schemaLocation="http://www.metasolv.com/OMS/OrderModel/2002/06/25
  file:///D:/OSMSTA~1/SDK/XMLIMP~1/models/OmsModel.xsd">
  <workgroupDefinition name="newWorkgroup">
    <description>newWorkgroup</description>
    <permissions>
      <createdVersionedOrders />
      <exceptionProcessing />
      <onlineReports />
      <priorityModification />
      <referenceNumberModification />
      <searchView />
    </permissions>
  </workgroupDefinition>
</model>
```

```

        <taskAssignment />
        <worklistViewer />
    </permissions>
    <calendar>
        <weeklyWorkHours>no_schedule</weeklyWorkHours>
        <region>no_region</region>
    </calendar>
</workgroupDefinition>
</model>

```

6. Save and exit the file.
7. Run the **SDK\XMLImportExport\import.bat** script:

For example:

```

import.bat C:\osminstall\SDK\XMLImportExport\workgroupDefinition.xml
C:\osminstall\SDK\XMLImportExport\config\config.xml

```

#### Note:

In this scenario, the XML model file contains only those elements that need to be imported. If the model file contained other elements that did not need to be imported, you can add a selection element to the import node in the **SDK\XMLImportExport\config\config.xml** file that targets the workgroupDefinition entity in the model file.

For example:

```

<import validateModel="false"
nonEmptyDatabaseAction="ignore"entityConflictAction="replace">
    <selection>/oms:model/oms:workgroupDefinition</selection>
</import>

```

## Sample Procedure for Adding a Task to a Workgroup (Role)

You can add a task to a workgroup (a workgroup is called a role in Design Studio) without having to redeploy a cartridge by using XMLIE.

#### Note:

This procedure assumes that you have already created the task that you want to assign to a workgroup.

To add a task to a workgroup using XMLIE:

1. In the **SDK\XMLImportExport\config\config.xml** file, add a selection element to an export node that targets the workgroup entity in the cartridge you want to add a task to.

For example:

```

<export validateModel="false" exposeEntityID="false" layout="singleDocument"
readOnlyFileAction="ignore">
    <selection>/oms:model/oms:cartridge[@namespace="bb_ocm_demo" and

```

```
@version="1.0.0.0.1"]/oms:workgroup</selection>
</export>
```

2. Save and exit the file.
3. In the **SDK\XMLImportExport** folder, create an XML document to store the XML workgroup information from the cartridge you are targeting. For example: **workgroup.xml**.
4. Run the **SDK\XMLImportExport\export.bat** script:

For example:

```
export.bat C:\osminstall\SDK\XMLImportExport\workgroup.xml
C:\osminstall\SDK\XMLImportExport\config\config.xml
```

5. When the export is complete, open the XML file containing the workgroup information and add a new task element. For example:

```
<?xml version = '1.0' encoding = 'ISO-8859-2'?>
<model xmlns="http://www.metasolv.com/OMS/OrderModel/2002/06/25"
  xmlns:osm="http://xmlns.oracle.com/communications/ordermanagement/model"
  xmlns:xsi="http://www.w3.org/2001/XMLSchema-instance"
  xsi:schemaLocation="http://www.metasolv.com/OMS/OrderModel/2002/06/25
  file:///D:/OSMSTA~1/SDK/XMLIMP~1/models/OmsModel.xsd">
  <schemaVersion>7.2.0</schemaVersion>
<version>
  <label>7.2.0.0.366</label>
  <majorVersion>1.0</majorVersion>
</version>
<cartridge namespace="bb_ocm_demo" version="1.0.0.0.1">
  <description>BB OCM Demo</description>
  <default>true</default>
  <timestamp>2012-05-28T13:05:12</timestamp>
  <workgroup name="demo">
    <column name="Phone #">
      <path>/subscriber_info/primary_phone_number</path>
    </column>
    <column name="Name">
      <path>/subscriber_info/name</path>
    </column>
    <permissions>
      <orderEntry>
        <orderType>add_adsl_siebel</orderType>
        <orderSource>add_adsl_siebel</orderSource>
      </orderEntry>
      <task>activate_dslam</task>
      <task executionModes="do">add_adsl_siebel_creation</task>
      <task>add_capacity</task>
      <task>assign_port</task>
      <task>demo_query</task>
      <task>send_customer_survey</task>
      <task>ship_modem_self_install_pkg</task>
      <task>verify_adsl_service_availability</task>
      <task>verify_order</task>
      <task>new_task</task>
    </permissions>
  </workgroup>
</cartridge>
</model>
```

6. Save and exit the file.
7. Run the **SDK\XMLImportExport\import.bat** script:

For example:

```
import.bat C:\osminstall\SDK\XMLImportExport\workgroup.xml  
C:\osminstall\SDK\XMLImportExport\config\config.xml
```

 **Note:**

In this scenario, the XML model file contains only those elements that need to be imported. If the model file contained other elements that did not need to be imported, you can add a selection element to the import node in the **SDK\XMLImportExport\config\config.xml** file that targets the workgroup entity in the model file.

For example:

```
<import validateModel="false"  
nonEmptyDatabaseAction="ignore"entityConflictAction="replace">  
  <selection>/oms:model/oms:cartridge[@namespace="bb_ocm_demo" and  
@version="1.0.0.0.1"]/oms:workgroup</selection>  
</import>
```

## About Purging MetaData and Data

XMLIE provides the **purge.bat**, **purgeOrder.bat** scripts and **ant purge**, **ant undeploy**, and **ant forceundeploy** commands, which are used to purge metadata and data from an OSM schema. For example, you may need to purge an existing schema prior to importing a new model, or you may need to purge the data from a test environment at the beginning of each new phase of testing.

Using the **purge.bat** script or purge Ant command, you can remove everything (all metadata and data) from the schema, or you can remove data from a specified cartridge. Using the **purgeOrder.bat** script or **ant purge** command, you can remove all the data. The **purgeOrder.bat** script and **ant purge** command do not affect metadata.

Oracle recommends that you purge all order data related to a cartridge before purging a cartridge. Purging large amounts of order data or cartridges should only be done during off-peak hours.

 **Note:**

You must shut down the WebLogic Server before executing the **purge** command or an exception is thrown.

The **purge.bat** script and **ant purge** command are not transactional so any unexpected failure may leave the schema in an invalid state. If this occurs, repeat the **purge.bat** script or **ant purge** command until it completes successfully.

## Undeploying Cartridges and Purging the Database Schema

OSM cloud native provides a **fast undeploy** mechanism using the OSM DB Installer. See "Working with Cartridges" for further details.

You can undeploy a cartridge using either **fast undeploy** or **undeploy**. When you use fast undeploy, which is the default functionality, the cartridge is undeployed from OSM, but cartridge metadata and order data are not purged from the database. The fast undeploy functionality is useful in development and test environments where you need to deploy and undeploy cartridges frequently.

When you use the undeploy functionality (where the **fast\_cartridge\_undeploy** parameter is set to **False**), the cartridge is undeployed and its metadata and order data are purged from the database, which can be time-consuming depending on how complex the cartridge is and whether it has a significant number of orders.

For information about changing the **fast\_cartridge\_undeploy** parameter in the **oms-config.xml** file, see "[Configuring OSM with oms-config.xml](#)."

To purge the entire schema (metadata and orders) or undeploy a specific cartridge using Ant commands:

1. Consult "[Online vs. Offline Maintenance](#)" to ensure that the system is in the appropriate state (online or offline) for the operation you intend to perform.
2. Do one of the following:

### Note:

You can target an entire schema for the **undeploy**, **forceundeploy**, and **purge** commands, or you can specify a namespace or a namespace and version by configuring the following **build.properties** parameters:

- **xmlie.root.namespace**
- **xmlie.root.version**

For more information about these parameters, see "[Configuring the build.properties File for Ant Commands](#)."

- To purge a target schema, run the following command:

```
ant purge
```

- To undeploy a cartridge using fast undeploy, but only if no pending orders exist, run the following command:

```
ant fastUndeploy
```

- To undeploy a cartridge, but only if no pending orders exist, run the following command:

```
ant undeploy
```

- To undeploy a cartridge using fast undeploy, even if pending orders exist, run the following command:

```
ant forceFastUndeploy
```

- To undeploy a cartridge, even if pending orders exist, run the following command:

```
ant forceUndeploy
```

3. If you used the fast undeploy option and OSM was online, refresh the metadata for OSM. See "[Refreshing OSM Metadata](#)" for more information.

To purge the entire schema (metadata and orders) or undeploy a specific cartridge using batch scripts:

1. Consult "[Online vs. Offline Maintenance](#)" to ensure that the system is in the appropriate state (online or offline) for the operation you intend to perform.
2. Do one of the following:

- To completely purge a target schema, use the following batch script:

```
purge.bat config\config.xml force
```

If you run this script without the **force** attribute, the **purge.bat** script fails if any pending orders exist on the cartridge you are purging. If you run this script with the **force** attribute, the script purges the cartridge and all pending orders.

- To undeploy every version of a cartridge with a specified namespace, but only if no pending orders exist, use the following batch script:

```
purge.bat config\config.xml -n namespace
```

where *namespace* is the OSM cartridge namespace.

- To undeploy a specified version of a cartridge, but only if no pending orders exist, use the following batch script:

```
purge.bat config\config.xml -n namespace -v version
```

where *namespace* and *version* are the OSM namespace and cartridge version.

- To undeploy every version of a cartridge, run the following batch script:

```
purge.bat config\config.xml force -n namespace
```

where *namespace* is the OSM cartridge namespace.

- To undeploy a specific cartridge version, use the following batch script:

```
purge.bat config\config.xml force -n namespace -v version
```

where *namespace* and *version* are the OSM namespace and cartridge version.

- To undeploy every version of a cartridge using fast undeploy, but only if no pending orders exist, use the following batch script:

```
fastUndeploy.bat config\config.xml -n namespace
```

where *namespace* is the OSM cartridge namespace.

- To undeploy a specific cartridge version using fast undeploy, but only if no pending orders exist, use the following batch script:

```
fastUndeploy.bat config\config.xml -n namespace -v version
```

where *namespace* and *version* are the OSM namespace and cartridge version.

- To undeploy every version of a cartridge using fast undeploy, even if pending orders exist, use the following batch script:

```
fastUndeploy.bat config\config.xml force -n namespace
```

where *namespace* is the OSM cartridge namespace.

- To undeploy a specific cartridge version using fast undeploy, even if pending orders exist, use the following batch script:

```
fastUndeploy.bat config\config.xml force -n namespace -v version
```

where *namespace* and *version* are the OSM namespace and cartridge version.

3. If you used the fast undeploy option and OSM was online, refresh the metadata for OSM. See "[Refreshing OSM Metadata](#)" for more information.

## About Purging Orders

OSM provides the following ways to remove orders:

- XMLIE order purge - You can purge orders using criteria such as one or more order states, purge before date, order source, order type, namespace, version, start date, and stop date using XMLIE order purge.
- Dropping old partitions that contain completed orders.

### Note:

Oracle recommends dropping old partitions that contain completed orders as the best way to purge orders (see "[Dropping Partitions \(Offline Only\)](#)" for more information). If you cannot use this method because of pending orders, you can use the XMLIE order purge script as a slower alternative.

## Purging Orders with the orderPurge.bat Script on Windows

You can configure the **orderPurge.bat** script to:

- purge orders based on one or more order states
- purge orders from a specific cartridge (namespace/version) or all cartridges
- schedule the purge to run during off-peak hours or run it immediately

Use the following commands to perform the indicated order purge operation.

1. Use the following syntax to run an immediate order purge:

```
orderPurge.bat xmlConfigFile doPurge "purge_before=before_purge"
"order_states=order_states" "namespace=namespace" "version=version"
"order_type=order_type" "order_source=order_source"
"commitCount=commitCount"
"orderIdLessThan=order_id_upper" "orderIdGreaterOrEq=order_id_lower"
"parallelism=op_number"
```

 **Note:**

All date parameters must be specified in the format:

**yyyy-mm-ddThh24:mi:ss Z**

For example: 2011-06-28T13:39:00 EST

Where:

- *before\_purge*: Use this data parameter with the **order\_state** parameter. For example, to purge orders completed 30 days ago, specify **order\_state="COMPLETED"** and **purge\_before=2011-06-28T13:39:00 EST** (or a date that is 30 days before the current date). Options are:
  - **all**: All orders that were created before this date are considered for the purge
  - **any closed state**: All orders whose completion date is before this date are considered for the purge.
  - **any open state**: All orders that were created and transitioned to the state specified before this date are considered for the purge.
- If no **purge\_before** date is specified, the date is set to 5 seconds before the purge starts.
- *order\_states*: An order state must be specified. Options are one or more of the following comma separated values:
  - **all**
  - **open**
  - **not\_running**
  - **running**
  - **not\_started**
  - **suspended**
  - **cancelled**
  - **compensating**
  - **amending**
  - **cancelling**
  - **closed**
  - **completed**
  - **aborted**
  - **in\_progress**
  - **waiting\_for\_revision**
  - **waiting**
  - **failed**

For example: "not\_started,completed"



- *namespace*: Must be specified. Valid values are either a namespace mnemonic or ALL (applies to all cartridges). For example, to purge all orders regardless of other conditions, specify **order\_state="ALL"** and **namespace="ALL"**.
- *version*: If namespace is ALL, version is ignored. If namespace is specified but no version is specified, the purge applies to all versions of the namespace.
- *order\_type*: The order type mnemonic. If specified, only orders with this type are purged.
- *order\_source*: The order source mnemonic. If specified, only orders with this source are purged.
- *commitCount*: The number of orders to purge before committing the transaction to the database. If specified, this can improve the performance of the order purge by breaking it up into smaller transactions.
- *order\_id\_upper*: The order ID number used with the **orderIdLessThan** parameter which specifies the exclusive upper order ID bound to purge.
- *order\_id\_lower*: The order ID number used with the **orderIdGreaterOrEq** parameter which specifies the inclusive lower order ID bound to purge.
- *op\_number*: The number of purge operations to run in the database in parallel. The value can be a power of two of the set 1, 2, 4, 8, 32, or 64.

For example:

```
orderPurge.bat config/config.xml doPurge "purge_before=2011-01-01T23:59:59
EST"
"order_states=COMPLETED,NOT_STARTED" "namespace=abc" "version=1.0"
"order_type=x" "order_source=y" "commitCount=10" "orderIdLessThan=10"
"orderIdGreaterOrEq=50" "parallelism=64"
```

2. Use the following syntax to run a scheduled order purge:

 **Note:**

The syntax for the scheduled order purge is identical to the immediate order purge except for the **start\_date** and **stop\_date** attributes.

```
orderPurge.bat xmlConfigFile doPurge "purge_before=before_purge"
"order_states=order_states" "namespace=namespace" "version=version"
"order_type=order_type" "order_source=order_source"
"commitCount=commitCount"
"orderIdLessThan=order_id_upper" "orderIdGreaterOrEq=order_id_lower"
"parallelism=op_number" "stop_date=stop_date" "start_date=start_date"
```

Where the parameters match the ones in step 1, with the addition of the following:

- *stop\_date*: The time when the purge should stop, even if all orders satisfying the purge criteria have been purged (for example, stop the purge before peak hours). If no *stop\_date* is specified, the purge stops when all orders satisfying the purge criteria have been purged.
- *start\_date*: For scheduled purges only - the time when the purge should start (must be later than the current time). When the *start\_date* is reached, the purge starts automatically. If no *start\_date* is specified, the purge is immediate.

For example:

```
orderPurge ./config/config.xml schedulePurge
"purge_before=2011-01-01T23:59:59 EST" "order_states=COMPLETED,NOT_STARTED"
"namespace=abc" "version=1.0"
"order_type=x" "order_source=y" commitCount=10
"start_date=2007-01-01T23:59:59 EST"
```

3. Use the following syntax to list all scheduled order purges that have not started:

```
orderPurge.bat xmlConfigFile listPurges
```

For example:

```
orderPurge.bat ./config/config.xml listPurges
```

4. Use the following syntax to remove an order purge that has not started:

```
orderPurge.bat xmlConfigFile removePurge "job_id"
```

where *job\_id* is the job ID of the scheduled purge.

For example:

```
orderPurge.bat config/config.xml removePurge "job_id=12345"
```

## Running Ant with the orderPurge.xml file On UNIX or Linux to Purge Orders

To purge orders from an OSM schema using Ant:

1. Open the **SDK/XMLImportExport/build.properties** file.
2. If you want to perform an immediate purge of some or all orders before a certain date using the **immediateOrderPurge** attribute for the **ant purge** command, edit the following arguments:

```
xmlie.orderPurge.purgeBefore=before_purge
xmlie.orderPurge.orderStates=order_states
xmlie.orderPurge.namespace=namespace
xmlie.orderPurge.version=version
xmlie.orderPurge.orderType=order_type
xmlie.orderPurge.orderSource=order_source
xmlie.orderPurge.commitCount=commitCount
xmlie.orderPurge.orderIdLessThan=order_id_upper
xmlie.orderPurge.orderIdGreaterOrEq=order_id_lower
xmlie.orderPurge.parallelism=op_number
```

Where

- *before\_purge*: Use this data parameter with the **order\_state** parameter. For example, to purge orders completed 30 days ago, specify **order\_state="COMPLETED"** and **purge\_before=2011-06-28T13:39:00 EST** (or a date that is 30 days before the current date). Options are:
  - **all**: All orders that were created before this date are considered for the purge
  - **any closed state**: All orders whose completion date is before this date are considered for the purge.
  - **any open state**: All orders that were created and transitioned to the state specified before this date are considered for the purge.

If no **purge\_before** date is specified, the date is set to 5 seconds before the purge starts.

- *order\_states*: An order state must be specified. Options are one or more of the following comma separated values:
  - **all**
  - **open**
  - **not\_running**
  - **running**
  - **not\_started**
  - **suspended**
  - **cancelled**
  - **compensating**
  - **amending**
  - **cancelling**
  - **closed**
  - **completed**
  - **aborted**
  - **in\_progress**
  - **waiting\_for\_revision**
  - **waiting**
  - **failed**

For example: "not\_started,completed"

- *namespace*: Must be specified. Valid values are either a namespace mnemonic or ALL (applies to all cartridges). For example, to purge all orders regardless of other conditions, specify **order\_state="ALL"** and **namespace="ALL"**.
- *version*: If namespace is ALL, version is ignored. If namespace is specified but no version is specified, the purge applies to all versions of the namespace.
- *order\_type*: The order type mnemonic. If specified, only orders with this type are purged.
- *order\_source*: The order source mnemonic. If specified, only orders with this source are purged.
- *commitCount*: The number of orders to purge before committing the transaction to the database. If specified, this can improve the performance of the order purge by breaking it up into smaller transactions.
- *order\_id\_upper*: The order ID number used with the **orderIdLessThan** parameter which specifies the exclusive upper order ID bound to purge.
- *order\_id\_lower*: The order ID number used with the **orderIdGreaterOrEq** parameter which specifies the inclusive lower order ID bound to purge.
- *op\_number*: The number of purge operations to run in the database in parallel. The value can be a power of two of the set 1, 2, 4, 8, 32, or 64.

For example:

```
xmlie.orderPurge.purgeBefore=2006-06-30T23:59:59 EST
xmlie.orderPurge.orderStates=COMPLETED
xmlie.orderPurge.namespace=default
xmlie.orderPurge.version=1.0.0.0.0
xmlie.orderPurge.orderType=ot
xmlie.orderPurge.orderSource=os
xmlie.orderPurge.commitCount=10
xmlie.orderPurge.orderIdLessThan=10
xmlie.orderPurge.orderIdGreaterOrEq=50
xmlie.orderPurge.parallelism=64
```

3. If you want to schedule a purge of some or all orders on a certain date using the **scheduleOrderPurge** attribute for the **ant purge** command, edit the following additional arguments:

```
xmlie.orderPurge.startDate=start_date
xmlie.orderPurge.stopDate=stop_date
```

Where:

- *stop\_date*: The time when the purge should stop, even if all orders satisfying the purge criteria have been purged (for example, stop the purge before peak hours). If no *stop\_date* is specified, the purge stops when all orders satisfying the purge criteria have been purged.
- *start\_date*: For scheduled purges only - the time when the purge should start (must be later than the current time). When the *start\_date* is reached, the purge starts automatically. If no *start\_date* is specified, the purge is immediate.

For example:

```
xmlie.orderPurge.purgeBefore=2006-06-30T23:59:59 EST
xmlie.orderPurge.orderStates=COMPLETED
xmlie.orderPurge.namespace=default
xmlie.orderPurge.version=1.0.0.0.0
xmlie.orderPurge.orderType=ot
xmlie.orderPurge.orderSource=os
xmlie.orderPurge.commitCount=10
xmlie.orderPurge.orderIdLessThan=10
xmlie.orderPurge.orderIdGreaterOrEq=50
xmlie.orderPurge.parallelism=64
xmlie.orderPurge.startDate=2007-01-01T00:01:01 EST
xmlie.orderPurge.stopDate=2007-12-31T23:59:59 EST
```

4. If you want to remove an scheduled order purge that has not started using the **removeOrderPurge** attribute for the **ant purge** command, edit the following arguments:

```
xmlie.orderPurge.jobId=job_id
```

where *job\_id* is the job ID of the scheduled purge.

For example:

```
xmlie.orderPurge.jobId=0
```

 **Note:**

Orders that satisfy the purge criteria are purged and related details such as the number of orders purged are logged in the XMLIE log file (as configured in config.xml). If an error occurs, the purge stops. Errors and exceptions are output to the command line and are logged in the log files.

5. Use the following syntax to run an immediate order purge:

```
ant immediateOrderPurge
```

6. Use the following syntax to run a scheduled order purge:

```
ant scheduleOrderPurge
```

7. Use the following syntax to list all scheduled order purges that have not started:

```
ant listOrderPurges
```

8. Use the following syntax to remove an order purge that has not started:

```
ant removeOrderPurge
```

## About Migrating Orders

XMLIE provides the **ant migrate** command and a **migrate.bat** script to migrate (copy) orders from one version of a cartridge to another. You can only migrate orders between versions of the same namespace, not between different namespaces. You can also migrate order data, reference numbers, remarks, attachments and specify a single order type/source to migrate, or all order types/sources within the cartridge.

For example, you may need to migrate orders within a cartridge when upgrading to a new version of OSM. Migrated orders are placed at the first process task, regardless of where the original order was in the process flow.

You cannot migrate orders across environments, for example, from a production environment to a test environment.

XMLIE migrates orders in three steps:

1. Create a new order and copy data from the source order to the target order.

All order field data is copied provided the field has a value in the source order and the field is defined in the target order's creation task data. Order reference numbers and remarks/attachments are also copied if **copyReference** and **copyRemarks** are set to true. The migrated order is placed at the first process task, not at the equivalent task in the original order.

2. Once the copy is complete, close the source order (**closeSource** set to true).

 **Note:**

If you choose to close the source order, the Exception Processing function must be associated with your workgroup.

3. Submit the target order (**submitTarget** set to true).

Orders are migrated individually. If an error occurs in any of these steps and **errorAction** is set to abort, processing stops immediately. Prior steps are not rolled back. If **errorAction** is set to ignore, any remaining steps are skipped and the process starts over at step 1 with the next available order to be migrated.

**Note:**

Order migration should only be done within a window where no other order processing will occur.

It is extremely important that the target order creation task data contain all of the fields in the source order. The fields must be the same data type and have the same mnemonic and length to be considered equal. Any field that exists in the source order but not in the target creation task data is ignored. Fields that are defined in the target creation task data that have no associated data in the source order remain blank.

The most common failure scenarios are:

- The specified target version or type/source combination does not exist. This is a fatal exception because no orders can be migrated. Processing halts immediately regardless of the **errorAction** setting.
- The target order does not submit because the target creation task data contains mandatory fields that were not set in the source order.

## Configuring and Running an Order Migration

To configure and run an order migration:

1. Configure the **config.xml** file **migrate** and **userInteraction** elements.

```
<migrate submitTarget="submitTarget" closeSource="closeSource"  
copyReference="copyReference" copyRemarks="copyRemarks"  
errorAction="errorAction"/>  
<userInteraction confirmation="confirmation"/>
```

where:

- *submitTarget*: Options are:
  - **true**: Submits the target order following migration. (default)
  - **false**: Leaves the target order in the creation task.
- *closeSource*: Options are:
  - **true**: Closes the source order following migration. If you choose to close the source order, the Exception Processing function must be associated with your workgroup. (default)
  - **false**: Leaves the source order unchanged by the migration operation.
- *copyReference*: Options are:
  - **true**: Sets the order reference number of the target order to that of the source order. (default)
  - **false**: Leaves the target order reference number empty.

- *copyRemarks*: Options are:
    - **true**: Copies the source order remarks and attachments to the target order. (default)
    - **false**: Does not copy remarks and attachments.
  - *errorAction*: Options are:
    - **abort**: Stops processing immediately. (default)
    - **ignore**: Attempts to migrate the next available order.
  - *confirmation*: Used for validation while migrating, so if there are any warnings/errors it might ask user for confirmation. Options are:
    - **true**: Confirms the warning/error message if any.
    - **false**: Does not confirm the warning/error messages if any.
2. If you are using batch scripts, use the following syntax to migrate an order from one version of a cartridge to another version of the same cartridge:

```
migrate.bat config/config.xml -sourcenamespace namespace -sourceversion
version sourceordertype type -sourceordersource source -targetversion version
```

where:

- *namespace*: Must be specified. Valid values are the namespace mnemonic.
- *version*: Must be specified. The versions of the source namespace and the target namespace.
- *type*: The order type mnemonic. If specified, only orders with this type are migrated.
- *source*: The order source name. If specified, only orders with this source are migrated.

For example:

```
migrate.bat config/config.xml -sourcenamespace default -sourceversion 1.0 -
targetversion 2.0
```

and

```
migrate.bat config/config.xml -sourcenamespace default -sourceversion 1.0
-sourceordertype request for long distance -sourceordersource client care
-targetversion 2.0
```

3. If you are using the **ant migrate** command, do the following:
- a. Open the **SDK/XMLImportExport/build.properties** file.
  - b. Edit the following arguments:

```
xmlie.root.namespace=namespace
xmlie.root.version=version
xmlie.root.sourceordertype=type
xmlie.root.sourceordersource=source
xmlie.root.targetorderversion=version
```

where:

- *namespace*: Must be specified. Valid values are the namespace mnemonic.

- *version*: Must be specified. The versions of the source namespace and the target namespace.
- *type*: The order type mnemonic. If specified, only orders with this type are migrated.
- *source*: The order source name. If specified, only orders with this source are migrated.

For example:

```
xmlie.root.namespace=bb_ocm_demo  
xmlie.root.version=1.0.0.0.0  
xmlie.root.sourceordertype=Add Order  
xmlie.root.sourceordersource=Add Order  
xmlie.root.targetorderversion=1.0.0.0.1
```

- c. Use the following syntax start a migration from one version of a cartridge to another version of a cartridge:

```
ant migrate
```

## About Validating the Metadata Model and Data

XMLIE provides the **validate** command, which is used to assure metadata model validity for an OSM schema. Using the **validate** command, you can perform the following:

- **Model validation**: The XML schema model defines most entity relationships and constraints.
- **Pending order validation**: This validation is applied during the import process (**import.bat**). It performs validations that have not been covered by **validate.bat**.

### Note:

When you perform a validation, you must supply a well-formed model, otherwise you may encounter undefined exceptions.

- The application applies an XML schema validation as well as some additional rules that could not be implemented in the XML schema. You can use any XML application to validate the model against the schema, but for additional validations, the explicit validation (using **validate.bat**) or implicit validation (before import or after export), assures model correctness and completeness.

You can validate the metadata model before the import takes place, or change **config.xml** so that the validation takes place during the import.

## Configuring and Running an XML Document Validation

To configure and run a validation:

1. Configure the **config.xml** file.

```
<validation validateAgainstDB="validateAgainstDB"  
validateDocument="validateDocument" validationReportURI="filename_path"/>
```

where:



- *validateAgainstDB*: Options are:
    - **true**: Validates the XML document against existing orders in the database schema to ensure it is compatible. (default)
    - **false**: Does not perform an XML model validation against the database schema.
  - *validateDocument*: Options are:
    - **true**: Validates the XML document against the OSM XML schema to ensure it is well formed. (default)
    - **false**: Does not perform the XML document validation.
  - *filename\_path* is the path to the validation log file that includes the file name of the validation log file.
2. Do one of the following:
    - a. If you are using Ant commands, do the following:

```
ant validate
```
    - b. If you are using batch scripts, do the following:

```
validate.bat xmlModelFile config\config.xml
```

## Validating an XML Document During the Import or Export Process

To validate an XML document *during* the import or export process, set the configuration file **validateModel** parameter to **true**. See "[Configuring and Running an Import](#)" and "[Configuring and Running an Export](#)" for syntax information and examples.

## About Creating a Graphical Representation of the Metadata Model

XMLIE provides the **modeldoc** command, which is used to convert an OSM metadata XML document into an HTML presentation. The HTML presentation is a graphical representation of the metadata model which is much easier to understand and navigate than the metadata XML document. You can use the resulting HTML presentation to view the relationships between and dependencies of the various metadata elements using standard HTML presentation navigation methods.

If you are going to use the **modeldoc.bat** script or the **ant htmlModel** command to create HTML representations of cartridge metadata, some configuration needs to be set up in order for Graphviz to support these commands and scripts.

## Configuring and Creating a Graphical Representation of a Metadata Model

To configure and create a graphical representation of a metadata model:

1. Download and install GraphViz. For more information see *OSM Installation Guide*.
2. Update the **SDK\XMLImportExport\config.bat** script with an environment variable containing the path to the third-party GraphViz library.

For example:

```
set GRAPHVIZ=C:\Applications\ATT\Graphviz\bin
```

3. If you are using the **SDK\XMLImportExport\modeldoc.bat** script, update the Java command line in the **modeldoc.bat** file with an entry referring to the environment variable containing the path to the third-party GraphViz library:

```
%JAVA_HOME%/bin/java %JAVA_OPTS% -classpath %CLASSPATH% %APP_PROPERTIES%
com.mslv.oms.metadatahandler.operation.ModelDocOperator %XML_MODEL%
%GRAPHVIZ% ./modeldoc
```

 **Note:**

The **modeldoc.bat** script, due to external limitations, is not case sensitive. Because of this, it does not work if two entities' documents go into the same directory and their names are differentiated only by capitalization, for example two tasks in the same process with names like **IsDebugEnabled** and **isDebugEnabled**.

This limitation is only for the **modeldoc.bat** script, not for the **ant htmlModel** command, used on UNIX and Linux systems.

4. If you are using the **ant htmlModel** command, configure the **graphiz** property in the **SDK\XMLImportExport\build.xml** file to specify the directory where the third-party GraphViz software is installed. For example:

```
<property name="graphiz" value="./bin/ATT/Graphviz/bin"/>
```

5. If you are using batch scripts, run the following script:

```
modeldoc.bat xmlModelFile HTMLModelDirectoryPath
```

where *HTMLModelDirectoryPath*: Specifies the path to the directory for the HTML model files for the **modeldoc.bat** script.

6. If you are using the **ant htmlModel** command, run the following command:

```
ant htmlModel
```

## Viewing the Graphical Representation

To view the HTML presentation, open the resulting HTML index file and begin navigating through the metadata model using the automatically generated hyperlinks.

 **Note:**

To view the HTML presentation, your browser must support Adobe SVG Viewer.

# A

## OSM Credential Store API Command Reference

This appendix describes how to secure credentials for accessing external systems by using a credential store, through the Oracle Fusion Middleware Credential Store Framework (CSF). Oracle Communications Order and Service Management (OSM) applications, such as OSM web clients and OSM cartridge applications, often are required to provide credential information to gain access and log in to external systems. The credential information must be secure and cannot be hard-coded in OSM code.

The following table lists the OSM credential store APIs and credential store-related classes:

**Table A-1 Credential Store API Commands and Classes**

Command or Class	Description
<a href="#">CredStore</a>	This is the credential store object, which is the domain credential store class and contains a single instance of the CredentialStore object.
<a href="#">PasswordCredStore</a>	This is the password credential store object.
<a href="#">CredStoreException</a>	This is the credential store exception object.
<a href="#">SoapAdapter</a>	The attributes in this class provide the attributes for the credential store when you define SOAP data provider instances in your cartridges.
<a href="#">ObjectelHTTPAdapter</a>	The attributes in this class provide the attributes for the credential store when you define Objectel HTTP data provider instances in your cartridges.
<a href="#">ViewRuleContext</a>	This interface object provides operations for the credential store.
<a href="#">AutomationContext</a>	This interface object provides operations for retrieving information from the credential store in automations.

## OSM User Security and Credential Store Commands

To develop OSM cartridges to use the credential store offered through CSF (see "[Using the Credential Store](#)"), use the OSM credential store APIs. OSM credential store APIs are wrapper APIs to the CSF APIs. Use the OSM credential store APIs in your OSM-related code that requires credential retrieval, such as in data providers and automation plug-ins.

# OSM User Security and Credential Store API Reference Material

To develop OSM cartridges to use the credential store offered through CSF (see "[Using the Credential Store](#)"), use the OSM credential store APIs. OSM credential store APIs are wrapper APIs to the CSF APIs. Use the OSM credential store APIs in your OSM-related code that requires credential retrieval, such as in data providers and automation plug-ins.

## CredStore

Credential store object.

The credential store object is the domain credential store class which contains a single instance of the CredentialStore object. The JpsServiceLocator APIs in CSF look up the single instance of the CredentialStore object.

Package name: com.mslv.oms.security.credstore

### Package name

com.mslv.oms.security.credstore

### Attributes

Name: store

Type: oracle.security.jps.service.credstore.CredentialStore

Description: A reference object to the Java Platform Security credential store object.

### Business Object Operations

#### getInstance

Description: Return an instance of the object. Only a single instance of the class is ever created. If "store" is not initiated, look up the credential store from class "oracle.security.jps.service.credstore.CredentialStore".

Operation Outputs: Output Name: store; Type: CredStore; Description: An instance of the CredentialStore object.

#### getJPSCredentialStore

Description: Retrieving attribute "store".

Operation Outputs: Output Name: store; Type: oracle.security.jps.service.CredentialStore.

Output of new methods

An instance of the object is returned by getInstance(). At the first time invocation, object will be initiated, and a credential store of class oracle.security.jps.service.credstore.CredentialStore is resolved through the CSF lookup API.

### Error Conditions

Improper Java Platform Security configuration can cause credential store lookup to fail.

### Usage Notes

This API can be used directly if you have your own implementation JAVA class of "[ViewRuleContext](#)" and "[AutomationContext](#)."

## PasswordCredStore

Password credential store object.

Use `com.mslv.oms.security.credstore.PasswordCredStore` APIs in your JAVA classes to retrieve user name and password from the credential store.

### Package Name

`com.mslv.oms.security.credstore`

### Attributes

- **credstore**  
Type: `CredStore`  
Description: A reference object to OSM credential store object.
- `OSM_CREDENTIAL_MAPNAME`  
Type: String (static final)  
Sensitive: Value is "osm"  
Description: Pre-defined map name for OSM application in credential store.
- `OSM_CREDENTIAL_KEYNAME_PREFIX`  
Type: String (static final)  
Sensitive: Value is "osmUser\_"  
Description: Prefix of key names used for OSM users in credential store.

### Business Object Operations

#### Operation Name: `getPasswordCredential`

##### Description

Return a `PasswordCredential` object stored with specified map and key names.

##### Input Parameters

###### **mapName**

Type: String

Description: Map name of the stored password credential object

###### **keyName**

Type: String

Description: Key name of the stored password credential object

**Operation Outputs**  
**passwordCredential**

Type: PasswordCredential

Description: An object of oracle.security.jps.service.credstore.PasswordCredential, which contains credential information stored under map and key name pair.

**Operation Name: getCredential**

**Description**

Return a string of user name and password for specified map and key names.

**Input Parameters**

**mapName**

Type: String

Description: Map name of the stored password credential object

**keyName**

Type: String

Description: Key name of the stored password credential object

**Operation Outputs**

Type: String

Description: A string contains user name and password information stored under map and key name pair. Format is "user name/password".

**Operation Name: getOsmCredentialPassword**

**Description**

Return password value for specified OSM user. This API is used to access credentials stored in the credential store using the default map and key names that follow OSM naming convention:

- Map name is **osm**
- Key name is **osmUser\_username**

**Input Parameters**

**username**

Type: String

Description: OSM user name.

**Operation Outputs**

Type: String

Description: A string contains password value for specified OSM user. OSM user name and password values are stored under credential store with map value *OSM\_CREDENTIAL\_MAPNAME*, and key value starts with *OSM\_CREDENTIAL\_KEYNAME\_PREFIX*, following with user name.

**Operation Name: getCredentialAsXML**

**Description**

Return user name and password in XML format for specified map and key names.

**Input Parameters**

**mapName**

Type: String

Description: Map name of the stored password credential object

**keyName**

Type: String

Description: Key name of the stored password credential object

### Operation Outputs

Type: org.w3c.dom.Element

Description: An element that contains user name and password information stored under map and key name pair.

### Output of Methods

These methods will return a PasswordCredential/String/Element object if the credential store contains a credential with specified map name and key name. If a match is not found, null value will be returned.

### Error Conditions

Improper Java Platform Security configuration can cause "read" operation on the credential store to fail due to "no permission" error. Incorrect map and key names can cause "no credential found" problem.

### Usage Notes

This API can be used directly if you have your own implementation JAVA class of "[ViewRuleContext](#)" and "[AutomationContext](#)."

### Example: Retrieve Password from OSM Default Map Given User Name

```
PasswordCredStore pwdCredStore;  
try {  
    pwdCredStore = new PasswordCredStore();  
    return pwdCredStore.getOsmCredentialPassword(username);  
} catch (final Exception e) {  
    throw new AutomationException("Fail to find password credential with  
specified map and key name.", e);  
}
```

### Example: Retrieve Password from Custom Map Given Map and Key Names Used to Store the Credentials

```
PasswordCredStore pwdCredStore;  
try {  
    pwdCredStore = new PasswordCredStore();  
    return pwdCredStore.getCredentialAsXML(map, key);  
} catch (final Exception e) {  
    throw new AutomationException("Fail to find password credential with  
specified map and key name.", e);  
}
```

## CredStoreException

Credential store exception object.

### Package Name

com.mslv.oms.security.credstore

### Attributes

Name: target

Type: Exception

Description: Target exception is the original exception caught in the three OSM credential store classes: CredStore, PasswordCredStore, JPSPasswordCredential.

### Business Object Operations

#### Operation Name: `getTargetException`

##### Description

Get attribute "target".

##### Operation Outputs exception

Type: Exception

### Usage Notes

This API can be used directly if you have your own implementation JAVA class of "[ViewRuleContext](#)" and "[AutomationContext](#)."

## SoapAdapter

Use the attributes for the credential store when you define data provider instances in your cartridges.

For detailed information on data provider adapters, see the discussion on behaviors "Modeling Behaviors" in *OSM Modeling Guide*.

### Description

Built-in adapter.

### Attributes

- CREDENTIAL\_MAPNAME\_PARAM

Type: String

Description: Defines the parameter name to be specified in data provider for SOAP. A constant with value "oms:credentials.mapname".

- CREDENTIAL\_KEYNAME\_PARAM

Type: String

Description: Defines the parameter name to be specified in data provider for SOAP. A constant with value "oms:credentials.keyname".

### Business Object Operations

#### Operation Name: `retrieveInstance`

##### Description

This method includes support to retrieve credential information from the credential store, from map and key name parameters if provided.

### Business Logic

The business logic for `retrieveInstance` is as follows:



- If "oms:credentials.username" is provided in parameters:  
If "oms:credentials.password" is also provided in parameter, then input values are used directly.  
If "oms:credentials.password" is not provided in the parameter, call context API "getOsmCredentialPassword(username)" to retrieve the password value from the credential store and use it in the SOAP request.
- Otherwise, if "oms:credentials.mapname" and "oms:credentials.keyname" are provided in the parameters, call context API "getCredential(mapname, keyname)" to retrieve user name and password, and use them in the SOAP request.

### Error Conditions

Invalid map and key names can cause credential lookup to return a "null" object.

Message text is "Password credential with map name %s and key name %s does not exist in the credential store."

### Usage Notes

Do not use operation APIs directly in this object.

## ObjectelHTTPAdapter

Use the attributes for the credential store when you define data provider instances in your cartridges.

For detailed information on data provider adapters, see "Modeling Behaviors" in *OSM Modeling Guide*.

### Description

Built-in adapter. Objectel HTTP adapter.

### Attributes

- CREDENTIAL\_MAPNAME\_PARAM  
Type: String  
Description: Defines the parameter name to be specified in data provider for Objectel HTTP type. A constant with value "obj:mapname".
- CREDENTIAL\_KEYNAME\_PARAM  
Type: String  
Description: Defines the parameter name to be specified in data provider for Objectel HTTP type. A constant with value "obj:keyname".
- mapname  
Type: String  
Description: Value specified for map name parameter.
- keyname  
Type: String  
Description: Value specified for key name parameter.

## Business Object Operations

### Operation Name: parseParameters

#### Description

This method includes support to parse parameters for credential store map and key names. Add context to input parameter. Same method in the super class will be changed as well.

#### Input Parameters

Context

Type: ViewRuleContext

### Operation Name: sendCommand

#### Description

This method includes support to retrieve credential information from the credential store, from map and key name parameters if provided.

#### Business Logic

The business logic for sendCommand is as follows:

- If "obj:user\_name" is provided in the parameters:  
If "obj:password" is also provided in the parameter, then input values are used directly.  
If "obj:password" is not provided in the parameter, call context API "getOsmCredentialPassword(username)" to retrieve password value from the credential store and use it in the SOAP request.
- Otherwise, if "obj:mapname" and "obj:keyname:" are provided in parameters, call context API "getCredential(mapname, keyname)" to retrieve user name and password and use them in the SOAP request (after the command, the code will send a SOAP message via HTTP to the specified URL).

#### Usage Notes

Do not use operation APIs directly in this object.

#### Error Conditions

Invalid map and key names can cause credential lookup to return a "null" object.

Message name: ViewRuleFailedException

Message text: "Password credential with map name %s and key name %s does not exist in the credential store."

## ViewRuleContext

Use operation APIs defined in this interface object for the credential store.

#### Description

Interface object.

## Business Object Operations

### Operation Name: `getCredential`

#### Description

Return a string of user name and password for specified map and key names.

#### Input Parameters

##### **map**

Type: String

Description: Map name

##### **key**

Type: String

Description: Key name

#### Operation Outputs

Type: String

Description: A string contains user name and password information stored under map and key name pair. Format is "user name/password".

Details on operation `getCredential()`:

```
/**
 * Get user name and password values in string format from credential store,
 * given map and key values.
 *
 * @param map
 *     Map name of the credential stored in domain credential store.
 * @param key
 *     Key name of the credential stored in domain credential store.
 * @return A String that contains user name and password values, separated by "/"
 * @throws CredStoreException
 *     If the application cannot access credential store, or if there is no
 *     permission to read the credential store with given map and key values,
 *     or if the credential is expired.
 */
String getCredential(final String map, final String key) throws
TransformerException;
```

### Operation Name: `getOsmCredentialPassword`

#### Description

Return password value for specified OSM user. This API is used to access credentials stored in the credential store using the default map and key names that follow OSM naming convention:

- Map name is **osm**
- Key name is **osmUser\_username**

#### Input Parameters

##### **username**

Type: String

Description: OSM user name.

#### Operation Outputs

Type: String

Description: Return password value for specified OSM user. OSM user name and password values are stored under credential store with

map value `OSM_CREDENTIAL_MAPNAME`, and key value starts with `OSM_CREDENTIAL_KEYNAME_PREFIX`, following with user name.

### Error Conditions

Improper Java Platform Security configuration can cause creation of PasswordCredStore to fail.

Message Name: ViewRuleFailedException

Message Text: "Fail to create PasswordCredStore."

### Usage Notes

This API is often used in XQuery scripts.

## AutomationContext

Use operation APIs from AutomationContext interface to retrieve credentials in XQuery code for automation tasks.

See ["Example: Retrieve Password from OSM Default Map Given User Name."](#)

See ["Example: Retrieve Password from Custom Map Given Map and Key Names Used to Store the Credentials."](#)

### Description

Interface object.

### Business Object Operations

#### Operation Name: getCredentialAsXML

##### Description

Get user name and password values in XML format given map and key values of the credential.

##### Input Parameters

###### map

Type: String

Description: Map name

###### key

Type: String

Description: Key name

##### Operation Outputs

Type: org.w3c.dom.Element

Description: An element that contains user name and password information stored under map and key name pair.

Details on operation getCredentialAsXML():

```
/**
 * Get user name and password values in XML format given map and key values of
 * the credential.
 *
 * @param map
```

```

*      Map name of the credential stored in domain credential store.
* @param key
*      Key name of the credential stored in domain credential store.
*
* @return User name and password for the user in this XML format:
*      <Credential xmlns="urn:com:metasolv:oms:xmlapi:1">
*          <Username>NAME</Username>
*          <Password>PASSWORD</Password>
*      </Credential>
* @throws CredStoreException
*      If the application cannot access credential store, or if there is no
*      permission to read the credential store with given map and key values,
*      or if the credential is expired.
*/
Document getCredentialAsXML(final String map, final String key) throws
AutomationException, RemoteException;

```

**Operation Name: getOsmCredentialPassword**  
**Description**

Return password value for specified OSM user. This API is used to access credentials stored in the credential store using the default map and key names that follow OSM naming convention:

- Map name is **osm**
- Key name is **osmUser\_username**

**Input Parameters**  
**username**

Type: String  
Description: OSM user name.

**Operation Outputs**  
Type: String

Description: Password value for specified OSM user. OSM user name and password values are stored under credential store with map value *OSM\_CREDENTIAL\_MAPNAME*, and key value starts with *OSM\_CREDENTIAL\_KEYNAME\_PREFIX*, following with user name.

**Error Conditions**

Fail to read credential store due to improper Java Platform Security configuration or invalid map and key names.

Message Name: AutomationException

Message Text: "Fail to create PasswordCredStore. Password credential with map name %s and key name %s does not exist in the credential store."

**Example: Retrieve Password from OSM Default Map Given User Name**

```

declare variable $context external;
let $osmPwd := context:getOsmCredentialPassword($context, $username)

```

### Example: Retrieve Password from Custom Map Given Map and Key Names Used to Store the Credential



#### Note:

This example assumes your map name is (**osmTest**).

```
declare namespace oms="urn:com:metasolv:oms:xmlapi:1";
declare variable $context external;

let $customCred := context:getCredentialAsXML($context, "osmTest", $username)/
oms:Credential
let $customerName := $customCred/oms:Username/text()
let $customPwd := $customCred/oms:Password/text()
```

# B

## Tools for Performance Testing, Tuning, and Troubleshooting

This appendix presents information about the tools that are available for performance testing, tuning, and troubleshooting for your Oracle Communications Order and Service Management (OSM) system.

### WebLogic Server Administration Console

Oracle WebLogic Server Administration Console is a web-based, graphical user interface that enables you to monitor the WebLogic server.

For more information, see "[About Monitoring and Managing OSM](#)" and WebLogic Server documentation.

### OSM Task Web Client

The OSM Task web client provides a web-based user interface for order tracking and reporting. For more information, see *OSM Task Web Client User's Guide*.

### SoapUI

SoapUI is a tool that you can use to submit an XML order to a run-time OSM environment. Doing this confirms that OSM is able to receive and respond to order requests. In this case, you can submit test orders associated with a test cartridge.

When submitting sample orders to run-time environments, the root level of the sample order XML document must be either a **CreateOrder** or **CreateOrderBySpec** request.

For more information about submitting orders with SoapUI, see *OSM Developer's Guide*.

For more information about SoapUI, and to download the software, see the following website:

<http://www.soapui.org/>

### Design Studio

Design Studio is an Eclipse-based design environment for OSM cartridge development. The Cartridge Management view displays a list of the cartridges that are deployed to your OSM system. The Deployed Versions table lists which cartridge version and build combination is currently deployed in the target environment for the selected cartridge.

For more information, see *Design Studio Concepts*.

---

## GCViewer

GCViewer is a free open source tool to view data that is produced by verbose garbage collection. For more information about GCViewer versions and to download, see the following websites:

<http://www.tagtraum.com/gcviewer.html>

<https://github.com/chewiebug/GCViewer>

<http://sourceforge.net/projects/gcviewer/files/gcviewer-1.36.jar/download>

<https://github.com/chewiebug/GCViewer/wiki/Changelog>

## ThreadLogic

ThreadLogic is an open source visual thread dump analyzer that provides an in-depth analysis of WebLogic Server thread dumps. ThreadLogic can also merge and analyze multiple thread dumps and provide enhanced reporting that lets you view whether threads are progressing across thread dumps.

You run ThreadLogic, version 1.1.205, using the following command:

```
java -jar ThreadLogic-1.1.205.jar
```

You can open the thread dumps or merge thread dumps by selecting several and then right-clicking and choosing **Diff Selection**. For an overview of ThreadLogic, see the following website:

<http://www.ateam-oracle.com/analyzing-thread-dumps-in-middleware-part-4-2/>



# C

## OSM Installed Components

This appendix describes the components that are automatically configured for OSM cloud native.

### Productized Cartridges

The OSM DB Installer deploys the following cartridge:

- Job Order cartridge: Enables the job control order feature. For information about using job orders, see *OSM Modeling Guide*.

### WebLogic Installed Components

This section lists and describes the OSM WebLogic installed components and configurations.

### WebLogic Deployments

[Table C-1](#) lists the WebLogic deployments.

**Table C-1 WebLogic Deployments**

Deployment Name	Description
cartridge_management_ws	Application used to deploy, undeploy, and query cartridges.
oms	The Order and Service Management application.

### WebLogic Configuration

This section lists and describes the WebLogic configuration.

### Coherence Clusters

The following coherence cluster is configured:

- `osmCohClustproject-instance`  
where *project-instance* is the project and instance name of your OSM cloud native instance.

### Work Managers

See "[Using Work Managers to Prioritize Work](#)" for information about work managers.

[Table C-2](#) lists and describes the work managers that are configured.

**Table C-2 Configured Work Managers**

Name	Type	Description
osmAutomationWorkManager	Work manager	Used to process work performed by automation tasks.
osmOmClientWorkManager	Work manager	Used to process requests from manual users using the Order Management web client.
osmTaskClientWorkManager	Work manager	Used to process requests from manual users using the Task web client.
osmWsHttpWorkManager	Work manager	Used to process OSM HTTP WebService requests.
osmWsJmsWorkManager	Work manager	Used to process OSM JMS WebService requests.
osmXmlWorkManager	Work manager	Used to process requests coming in from external clients for the OSM XML API.
osmAutomationMaxThreadConstraint	Maximum Thread Constraint	Used to ensure that the maximum thread size is not more than the JDBC connection pool size.
osmGuiMaxThreadConstraint	Maximum Thread Constraint	N/A
osmHttpApiMaxThreadConstraint	Maximum Thread Constraint	N/A
osmJmsApiMaxThreadConstraint	Maximum Thread Constraint	N/A
osmGuiMinThreadConstraint	Minimum Thread Constraint	N/A

## JMS Servers

The following JMS server is configured:

- oms\_jms\_server

## JMS Module

The following JMS module is configured:

- oms\_jms\_module: Contains the JMS system resources for OSM.

## Queues and Topics

### Distributed Destinations in a Cluster

In a clustered WebLogic deployment, a distributed destination is created for each queue and topic. This distributed destination then has members created (a queue or topic) on each of the managed servers.

For example, in a clustered deployment that contains two managed servers called **MS1** and **MS2**, the **osm\_behavior\_queue** queue has the following:

- A distributed destination called **osm\_behavior\_queue**
- Two members called **oms\_jms\_server@ms1@osm\_behavior\_queue** and **oms\_jms\_server@ms2@osm\_behavior\_queue**

**Table C-3 Queues and Topics Configured for OSM**

Name	Type	JNDI	Description
osm_behavior_queue	Queue	mslv/oms/oms1/internal/jms/behaviors	Used to customize task assignment.
osm_cartridge_deploy	Queue	mslv/provisioning/internal/ejb/deployCartridgeQueue	Internal use only.
osm_events	Queue	mslv/oms/oms1/internal/jms/events	Internal use only.
osm_order_events	Topic	mslv/provisioning/external/orderevents	Where order lifecycle events are published.
osm_order_updates	Queue	mslv/provisioning/internal/ejb/orderupdates	Internal use only.
osm_signal_topic	Topic	mslv/oms/oms1/internal/jms/InternalSignalTopic	Internal use only.
osm_ws_cluster_correlates	Queue	oracle/communications/ordermanagement/WebServiceClusterCorrelateQueue	Used to route OSM service requests, in the context of an existing order in a WebLogic Server cluster, to the managed server that owns the order.
osm_ws_cluster_requests	Queue	oracle/communications/ordermanagement/WebServiceClusterRequestQueue	Used to receive requests for order amendments in a WebLogic Server cluster. Can also be used for new order creation requests.
osm_ws_cluster_responses	Queue	oracle/communications/ordermanagement/WebServiceClusterResponseQueue	Used to fetch a correlated message from the web service cluster correlate queue, analyze the original JMS properties, and forward the response to the original JMSReplyTo.
osm_ws_requests	Queue	oracle/communications/ordermanagement/WebServiceQueue	Used to receive order creation and amendment requests in a single-server WebLogic Server environment. Can also be used for new order creation requests for a WebLogic Server cluster.
osmErrorQueue	Queue	oracle/communications/ordermanagement/osm/ErrorQueue	N/A
ErrorQueue	Queue	oracle/error_queue	N/A

## Quotas

Quotas are used to control the allotment of system resources available to OSM destinations (queues or topics).

Table C-4 lists and describes the quotas that are configured.

**Table C-4 Configured Quotas**

Quota Name	Destination Name
oms_behavior_queue.Quota	oms_behavior_queue
oms_cartridge_deploy.Quota	oms_cartridge_deploy
oms_events.Quota	oms_events
oms_order_events.Quota	oms_order_events
oms_order_updates.Quota	oms_order_updates
oms_signal_topic.Quota	oms_signal_topic
oms_ws_cluster_correlates.Quota	oms_ws_cluster_correlates
oms_ws_cluster_requests.Quota	oms_ws_cluster_requests
oms_ws_cluster_responses.Quota	oms_ws_cluster_responses
oms_ws_requests.Quota	oms_ws_requests
OrchestrationDependenciesQueue.Quota	OrchestrationDependenciesQueue
osmErrorQueue.Quota	osmErrorQueue

## Connection Factories

The following connection factories are configured:

- osm\_connection\_factory
- osmExternalClientConnectionFactory: Use this connection factory to submit OSM Web Service and XML API requests (including order creation) from an external system.
- oms\_events\_connection\_factory

## Destination Key

The following destination key is configured:

- osmDescendingPriorityDestinationKey

For information about configuring destination keys, see [Oracle Fusion Middleware Administration Console Online Help for Oracle WebLogic Server](#).

## JMS Template

A JMS template for the OSM destinations is created. This template applies recommended defaults for the following settings:

- Redelivery Limit
- Redelivery Delay
- Error Destination

The following JMS template is configured:

- osmJmsTemplate

For information about JMS templates, see [Oracle Fusion Middleware Administration Console Online Help for Oracle WebLogic Server](#).

## Data Sources

The following standalone data sources are configured:

- osm-app-conn-pool-0
- osm-infra-conn-pool

## Users and Groups

This section describes the users and groups that are configured for OSM cloud native.

A security realm consists of a set of configured security providers, users, groups, security roles, and security policies that protect WebLogic resources. To access WebLogic resources that belong a security realm, a user must be defined in that realm.

The OSM cloud native default configuration creates the following accounts in the WebLogic Security Realm.

The following tables list the users, groups, and their descriptions.

**Table C-5 Application Accounts**

Account	Description	Assigned Groups
OSM Administrator account	The OSM Administrator account name and password are specified during OSM installation. The default is <b>omsadmin</b> .	OMS_user_assigner OMS_workgroup_manager OMS_client OMS_xml_api OMS_ws_api OMS_ws_diag
oms-automation	Used for processing OSM automation and email notifications.	OSM_automation
osm-internal	Used for internal processing when operation must be performed on behalf of the application rather than on behalf of the user.	Administrators OSM_automation
Design Studio administrator account	The Design Studio administrator account and password for managing OSM cartridges are specified during OSM installation. Two users ( <b>deployadmin</b> and <b>sceadmin</b> ) are created.	Cartridge_Management_WebService
WebLogic	The default administrative account for WebLogic.	Administrators

**Table C-6 Groups in the Server Security Realm**

Group Name	Description
Cartridge_Management_WebService	OSM cartridge management access. This group also allows access to the features in the View Cartridges option in the Order Management web client. See <i>OSM Order Management Web Client User's Guide</i> for information about this feature. This belongs to the Administrator group.
OMS_cache_manager	Monitoring and control of order cache.
OMS_client	Provides access to Order Management, Task, and Order Lifecycle Manager web clients.
OMS_user_assigner	Users in this group can do the following: <ul style="list-style-type: none"> <li>• Associate users with workgroups</li> <li>• Manage notifications</li> <li>• Manage system events</li> <li>• Refresh the metadata cache</li> </ul>
OMS_workgroup_manager	Users in this group can do the following: <ul style="list-style-type: none"> <li>• Modify workgroup schedules</li> <li>• Delete workgroups</li> <li>• Manage notifications</li> <li>• Manage system events</li> <li>• Refresh the metadata cache</li> </ul>
OMS_ws_api	WebService API access
OMS_ws_diag	WebService diagnostic access
OMS_xml_api	XML API access
OSM_automation	This role is granted to the user that is allowed to execute the automation plug-in. The Installer automatically assigns the oms-automation user to this group, and Design Studio automatically assigns users specified in the Run-As property of the automation plug-in.
OSM_USER_manager	Manage user accounts
osmEntityClientGroup	Entity UI access
osmRestApiGroup	OSM REST API
OMS_log_manager	Manage log settings

## Database Configuration

The OSM DB Installer creates the following database schemas:

- Core schema
- Rule engine schema
- Reporting schema

[Table C-7](#) shows the roles and permissions that are granted to database schema users.

**Table C-7 Roles and Permissions Granted to Database Schema Users**

Schema	Roles and Permissions
Core	resource create session create table create view create synonym create sequence alter session unlimited tablespace create job create any context execute on dbms_lock select on v_\$parameter
Rule engine	resource create session create table create view create synonym create sequence alter session unlimited tablespace
Reporting	resource create session create view create synonym unlimited tablespace