

Oracle® Communications Network Charging and Control Advanced Control Services Help



Release 15.0.0
F83496-01
October 2023

The Oracle logo, consisting of a solid red square with the word "ORACLE" in white, uppercase, sans-serif font centered within it.

ORACLE®

Copyright © 2023, Oracle and/or its affiliates.

This software and related documentation are provided under a license agreement containing restrictions on use and disclosure and are protected by intellectual property laws. Except as expressly permitted in your license agreement or allowed by law, you may not use, copy, reproduce, translate, broadcast, modify, license, transmit, distribute, exhibit, perform, publish, or display any part, in any form, or by any means. Reverse engineering, disassembly, or decompilation of this software, unless required by law for interoperability, is prohibited.

The information contained herein is subject to change without notice and is not warranted to be error-free. If you find any errors, please report them to us in writing.

If this is software, software documentation, data (as defined in the Federal Acquisition Regulation), or related documentation that is delivered to the U.S. Government or anyone licensing it on behalf of the U.S. Government, then the following notice is applicable:

U.S. GOVERNMENT END USERS: Oracle programs (including any operating system, integrated software, any programs embedded, installed, or activated on delivered hardware, and modifications of such programs) and Oracle computer documentation or other Oracle data delivered to or accessed by U.S. Government end users are "commercial computer software," "commercial computer software documentation," or "limited rights data" pursuant to the applicable Federal Acquisition Regulation and agency-specific supplemental regulations. As such, the use, reproduction, duplication, release, display, disclosure, modification, preparation of derivative works, and/or adaptation of i) Oracle programs (including any operating system, integrated software, any programs embedded, installed, or activated on delivered hardware, and modifications of such programs), ii) Oracle computer documentation and/or iii) other Oracle data, is subject to the rights and limitations specified in the license contained in the applicable contract. The terms governing the U.S. Government's use of Oracle cloud services are defined by the applicable contract for such services. No other rights are granted to the U.S. Government.

This software or hardware is developed for general use in a variety of information management applications. It is not developed or intended for use in any inherently dangerous applications, including applications that may create a risk of personal injury. If you use this software or hardware in dangerous applications, then you shall be responsible to take all appropriate fail-safe, backup, redundancy, and other measures to ensure its safe use. Oracle Corporation and its affiliates disclaim any liability for any damages caused by use of this software or hardware in dangerous applications.

Oracle®, Java, and MySQL are registered trademarks of Oracle and/or its affiliates. Other names may be trademarks of their respective owners.

Intel and Intel Inside are trademarks or registered trademarks of Intel Corporation. All SPARC trademarks are used under license and are trademarks or registered trademarks of SPARC International, Inc. AMD, Epyc, and the AMD logo are trademarks or registered trademarks of Advanced Micro Devices. UNIX is a registered trademark of The Open Group.

This software or hardware and documentation may provide access to or information about content, products, and services from third parties. Oracle Corporation and its affiliates are not responsible for and expressly disclaim all warranties of any kind with respect to third-party content, products, and services unless otherwise set forth in an applicable agreement between you and Oracle. Oracle Corporation and its affiliates will not be responsible for any loss, costs, or damages incurred due to your access to or use of third-party content, products, or services, except as set forth in an applicable agreement between you and Oracle.

Contents

1	ACS Main Screen	
	ACS Configuration Options	1-1
2	Passwords	
	Changing Password	2-1
3	Customers	
	Tiered Customer Structure	3-1
	Security Rules	3-1
	Adding Customers	3-2
	Editing Customers	3-3
	Deleting Customers	3-4
4	Customer Resource Limits	
	Setting the Resource Limits	4-1
	Edit Customer Resource Limits Fields	4-1
	Set Number Allowed Fields	4-2
	Set Number Allowed Columns	4-2
	Public Set Access	4-3
5	Customer Contacts	
	Customer Contacts Fields	5-1
	Adding Customer Contacts	5-1
	Editing Customer Contacts	5-1
	Deleting Customer Contacts	5-2
6	Users	
	Supplied User	6-1

Users Fields	6-1
Adding Users	6-3
Editing Users	6-3
Deleting Users	6-3

7 Control Plan Change

Tab Areas	7-1
Activating Alternative Control Plan Changes	7-1
Deactivating Alternative Control Plan Changes	7-2
Activating Termination Number Substitution	7-2
Deactivating Termination Number Substitution	7-2
Adding a Termination Number Substitution	7-3
Editing a Termination Number Substitution	7-3
Deleting a Termination Number Substitution	7-3

8 Geography Sets

Geography Set Definition	8-1
Geography Entry Definition	8-1

9 Geography Sets and Entries

Adding Geography Sets	9-1
Adding Geography Entries	9-1
Editing Geography Entry Prefixes	9-2
Deleting Geography Entries	9-3
Deleting Geography Sets	9-3

10 Geography Regions

Adding Geography Regions	10-1
Displaying all Nodes in a Region	10-1
Disconnecting from a Region	10-1
Finding a Geography entry	10-2

11 Holidays

About Updated Holiday Set Data in Control Plans	11-1
Adding Holiday Sets	11-1
Editing Holiday Sets	11-2
Deleting Holiday Sets	11-2

Adding Holiday Entries	11-3
Editing Holiday Entries	11-3
Deleting Holiday Entries	11-4

12 Announcements

Announcement Set Fields	12-1
Adding Announcement Sets	12-1
Editing Announcement Sets	12-2
Deleting Announcement Sets	12-2
Announcement Entries	12-3
Announcement Entry Fields	12-3
Adding Announcement Entries	12-4
Editing Announcement Entries	12-5
Deleting Announcement Entries	12-6

13 Variable Announcement Rule Sets

How VARS is Used in an Announcement Entry	13-1
Variable Announcement Rule Set Fields	13-2
Adding a VARS	13-2
Editing a VARS	13-3
Deleting a VARS	13-3

14 VARS Mapping

VARS Mapping Fields	14-1
Adding a VARS Mapping	14-1
Editing VARS Mappings	14-2
Deleting a VARS Mapping	14-2

15 Feature Sets

Adding Feature Sets	15-1
Editing Feature Sets	15-1
Deleting Feature Sets	15-2

16 Profile Tag Details

Profile Tag Types	16-1
Filtering Profile Tags	16-3
Adding Profile Tags	16-3

	Editing Profile Tags	16-4
	Deleting Profile Tags	16-4
17	Profile Tag Mapping	
	Adding Profile Tag Mappings	17-1
	Deleting Profile Tag Mapping	17-1
	Editing Profile Tag Mapping	17-1
18	Table Lookup Mapping	
	Public and Private Table Lookup Datasets	18-1
	Searching a Dataset for a Prefix or a Mapping Code	18-1
19	Triggers	
	Trigger Fields	19-1
	Adding Control Plan Triggers	19-2
	Editing Control Plan Triggers	19-2
	Deleting Control Plan Triggers	19-3
	Adding Trigger Tags	19-3
	Editing Trigger Tags	19-3
	Editing Trigger Profiles	19-4
20	Notifications	
	Notification Types	20-1
	Finding Notification Type	20-1
	Template Matching	20-2
	Languages	20-2
	Adding a Notification Type	20-2
	Editing a Notification Type	20-4
	Deleting a notification	20-4
	Rules for Recharge Notifications	20-4
21	Notification Template Editor	
	Adding a Notification Template	21-1
	Editing a Notification Template	21-2
	Deleting a Notification Template	21-3

22 Value Formatting Types

Defined Definitions	22-1
Boolean Format Type	22-2
Date/Time Format Type	22-2
Integer Format Type	22-3
Prefix Tree Format Type	22-3
String format type	22-4
Setting Boolean Configuration	22-4
Setting DateTime Configuration	22-5
Date Formats	22-5
Date Format Key	22-6
Time Formats	22-6
Time Format Key	22-6
Setting Integer Configuration	22-6
Setting Prefix Tree Configuration	22-7
Setting String Configuration	22-8

23 Termination Ranges

Adding Termination Ranges	23-1
Editing Termination Ranges	23-1
Deleting Termination Ranges	23-2

24 Number Translations

Adding Number Translations	24-1
Editing Number Translations	24-1
Deleting Number Translations	24-2

25 Default Termination Numbers

Allocating Default Termination Numbers	25-1
--	------

26 Event Counters

Adding Event Counters	26-1
Editing Event Counters	26-1
Deleting Event Counters	26-2

27	Tariff Codes	
	Adding Tariff Codes	27-1
	Editing Tariff Codes	27-1
	Deleting Tariff Codes	27-2
28	Incoming Number Restrictions	
	Use with Call Filtering Node	28-1
	Use with Prefix Tree Branching Node	28-1
	Number Restrictions Tab Fields	28-2
	Editing Incoming No. Restrictions	28-2
29	Outgoing Number Restrictions	
	Use with Call Filtering Node	29-1
	Use with Prefix Tree Branching Node	29-1
	Number Restrictions Tab Fields	29-2
	Editing Outgoing No. Restrictions	29-2
30	Least Cost Routing	
	Using Least Cost Routing	30-1
31	Service Numbers	
	Service Number Fields	31-1
	Adding Service Numbers	31-3
	Editing a Service Number	31-3
	Deleting a Service Number	31-4
	Associating FCI Data with a Service Number	31-4
32	CLI Numbers	
	CLI Number Fields	32-1
	Adding CLI Numbers	32-3
	Editing a CLI Number	32-3
	Deleting a CLI Number	32-3

33	Control Plan Schedule	
	Using Control Plan Schedules	33-1
34	Control Plans	
	Using Control Plans on the Numbers screen	34-1
	Editing a Control Plan	34-2
	Deleting a Control Plan	34-3
	Renaming a Control Plan	34-3
	Scheduling a Control Plan	34-3
	Editing Termination Numbers	34-4
35	Templates	
	Using Templates on the Numbers Screen	35-1
	Editing a Control Plan Template	35-2
	Copying a Control Plan Template	35-2
	Deleting a Control Plan Template	35-2
	Renaming a Control Plan Template	35-3
	Creating a new Control Plan Template	35-3
	Creating a Control Plan based on a Template	35-3
	Creating a Control Plan	35-4
36	Search for Numbers	
	Searching for Numbers	36-1
	Search for Numbers Fields and Buttons	36-1
	Search Criteria	36-2
37	Language	
	Languages and Announcements	37-1
	Language Fields	37-1
	Setting the Language Maps	37-2
	Changing Language Maps	37-2
	Removing Languages	37-2
38	Access Management	
	Access Management Fields	38-1
	Adding Access to an ACS Customer	38-1

Removing Access to an ACS Customer	38-1
------------------------------------	------

39 Networks

Networks Tab Fields	39-1
Adding Networks	39-2
Editing Networks	39-2
Deleting Networks	39-2
Adding Network Keys	39-2
Editing Network Keys	39-3
Deleting Network Keys	39-3

40 Default Termination Range

Default Termination Range fields	40-1
Adding a Default Termination Range	40-1
Editing a Default Termination Range	40-2
Deleting a Default Termination Range	40-2

41 Global Configuration

Global Configuration Fields	41-1
Editing the Global Configuration Settings	41-2

42 ACS Event Chart Screen

Viewing Event Charts	42-1
Printing Events Charts	42-1

43 Getting Started with the Control Plan Editor

About Control Plans	43-1
About Types of Control Plans	43-1
Control Plan Update Interval	43-1
About Control Plan Structures and Data	43-2
About Control Plan Names and Properties	43-2
Understanding the CPE User Interface	43-3
About the CPE User Interface	43-3
ACS Customer List and Node Field	43-3
Feature Palette	43-4
Canvas	43-4
Search Results	43-4

Node Inspector	43-5
About Setting and Resetting View Preferences	43-6
Changing the CPE Canvas Magnification	43-7
Using the CPE Canvas Grid	43-7
Displaying User and Control Plan Information	43-7
Working in Multiple Control Plans Simultaneously	43-8
Working with Feature Nodes	43-8
Finding Feature Nodes in the Feature Palette	43-8
Adding Feature Nodes to a Control Plan	43-8
About Viewing Feature Node Properties	43-9
Modifying Viewable Properties for Feature Nodes	43-9
Switching Between Feature Node Title Styles	43-10
Resizing Feature Nodes	43-10
Copying and Pasting Feature Nodes	43-10
About Connecting Feature Nodes	43-11
Viewing Node Exit Bubble Help	43-11
Editing Feature Node Exits	43-12
Connecting Feature Nodes	43-12
Simultaneously Connecting All Unconnected Exits	43-12
Selecting the Exits to Connect	43-12
About Configuring the Type of Connector Line	43-13
Deleting a Feature Node Connection	43-13
Deleting a Single Connection Between Two Feature Nodes	43-13
Simultaneously Deleting Multiple Connections Between Two Feature Nodes	43-14
Searching for Feature Nodes in the CPE Canvas	43-14
Searching for Unconfigured Feature Nodes	43-14
Searching for Feature Nodes Based on Search Criteria	43-14
Reloading Customer Data	43-15
Printing Control Plans	43-15
Printing a Control Plan by Using the OS Dialog	43-15
Printing a Control Plan by Using the Postscript Dialog	43-16
Keyboard Shortcuts	43-16
Keyboard Shortcuts for Using the CPE	43-16
Keyboard Shortcuts for Adding Feature Nodes	43-17
Keyboard Shortcuts for Navigating Feature Node Configuration Windows	43-18

44 Creating and Managing Control Plans

Creating Control Plans	44-1
Creating a Control Plan from a Blank Canvas	44-1
Creating a Control Plan from an Existing Structure	44-3

Adding Sub-control Plans to a Control Plan	44-5
Adding Comments to a Control Plan	44-6
Validating Control Plans	44-6
Saving a Control Plan with Errors	44-7
Saving a Control Plan with Warnings	44-7
Viewing the Compiler Build Report	44-7
Modifying Control Plans	44-7
Modifying a Control Plan	44-8
Adding Feature Node Comments	44-10
Removing Feature Nodes from a Control Plan	44-10
Deleting Control Plans	44-10
Deleting an Inactive Control Plan	44-11
Deleting an Unused Control Plan Structure	44-12
Importing and Exporting Control Plans	44-12
About Importing and Exporting Control Plans	44-12
Exporting a Control Plan to File	44-13
Control Plan Export and Import Validation	44-13
Importing a Control Plan from File	44-13
Troubleshooting Control Plans Using Control Plan Tracing	44-14
Tracing a Control Plan	44-14

45 Feature Nodes and Feature Sets

Adding Feature Sets	45-1
---------------------	------

46 Nodes in Depth

Account Code Entry	46-4
Node exits – Account Code Entry	46-4
Configuring the node – Account Code Entry	46-4
Activate Control Plan	46-5
Node exits – Activate Control Plan	46-6
Configuring the node – Activate Control Plan	46-6
Example use of Activate Control Plan node	46-7
Attempt Terminate to Pending TN	46-8
Shortcut keys – Attempt Terminate to Pending TN	46-8
Node exits – Attempt Terminate to Pending TN	46-8
Configuring the node – Attempt Terminate to Pending TN	46-9
Attempt Terminate to Pending TN with Duration	46-9
Node exits – Attempt Terminate to Pending TN with Duration	46-9
Configuring the node – Attempt Terminate to Pending TN with Duration	46-10

Attempt Termination	46-10
Shortcut keys – Attempt Termination	46-11
Node exits – Attempt Termination	46-11
Configuring the node – Attempt Termination	46-11
Branch on Bearer Type	46-12
Node exits – Branch on Bearer Type	46-12
Configuring the node – Branch on Bearer Type	46-12
Branch On Call Forwarding Pending	46-14
Node exits – Branch On Call Forwarding Pending	46-14
Configuring the node – Branch On Call Forwarding Pending	46-14
Branch on Event Report Request BCSM Code	46-14
Node exits – Branch on Event Report Request BCSM Code	46-15
Configuring the node – Branch on Event Report Request BCSM Code	46-15
Example of the use of the Branch on Event Report Request BCSM Code node	46-17
Branch on Indicator	46-18
Node exits – Branch on Indicator	46-19
Configuring the node – Branch on Indicator	46-19
Interpretation of values – Branch on Indicator	46-19
Branch on Protocol	46-20
Node exits – Branch on Protocol	46-20
Configuring the node – Branch on Protocol	46-20
Branch on Service Key	46-20
Node exits – Branch on Service Key	46-20
Configuring the node – Branch on Service Key	46-21
Calculation	46-22
Node exits – Calculation	46-22
Configuring the node – Calculation	46-23
Call Filtering	46-24
Node exits – Call Filtering	46-24
Configuring the node – Call Filtering	46-24
Call Forwarded Branching	46-25
Node exits – Call Forwarded Branching	46-25
Configuring the node – Call Forwarded Branching	46-25
Example of the use of the Call Forwarded Branching node	46-25
Call Initiation	46-26
Node exits – Call Initiation	46-27
Specifying values in profile selection fields	46-27
Configuring the node – Call Initiation	46-27
Call Progression	46-28
Node exits – Call Progression	46-28
Configuring the node – Call Progression	46-29

Calling Party	46-29
Shortcut keys – Calling Party	46-29
Node exits – Calling Party	46-29
Configuring the node – Calling Party	46-29
Calling Party Category	46-30
Shortcut keys – Calling Party Category	46-30
Node exits – Calling Party Category	46-30
Configuring the node – Calling Party Category	46-30
ISUP: Enumerated Values for Calling Party Category	46-31
Change CDR	46-32
System-generated EDR tags	46-32
Node exits – Change CDR	46-32
Configuring the node – Change CDR	46-33
Change Ordered Prefix Tree Entry	46-33
Node exits – Change Ordered Prefix Tree Entry	46-34
Configuring the node – Change Ordered Prefix Tree Entry	46-34
Check Limitations	46-35
Node exits – Check Limitations	46-35
Configuring the node – Check Limitations	46-35
Check Prefix Tree Capacity	46-36
Node exits – Check Prefix Tree Capacity	46-36
Configuring the node – Check Prefix Tree Capacity	46-36
Collect Date to Tag	46-37
Node exits – Collect Date to Tag	46-37
Response defaults – Collect Date to Tag	46-38
Configuring the node – Collect Date to Tag	46-38
Configuring the date only interaction (Collect Date to Tag)	46-39
Configuring the time only interaction (Collect Date to Tag)	46-40
Configuring the date and time data target (Collect Date to Tag)	46-41
Collect Digits to Buffer	46-41
Node exits – Collect Digits to Buffer	46-41
Configuring the node – Collect Digits to Buffer	46-41
Collect Digits to Pending TN	46-43
Node exits – Collect Digits to Pending TN	46-43
Configuring the node – Collect Digits to Pending TN	46-43
Collect Digits to Sub-tag	46-45
Node exits – Collect Digits to Sub-tag	46-45
Configuring the node – Collect Digits to Sub-tag	46-45
Compare Profile Data	46-46
Node exits – Compare Profile Data	46-46
Content comparison rules – Compare Profile Data	46-47

Configuring the node – Compare Profile Data	46-47
Control Plan Notes	46-48
Node exits – Control Plan Notes	46-48
Editing Control Plan Notes	46-48
Copy	46-48
Profile Field Conversion Rules – Copy	46-49
Node exits – Copy	46-51
Include Pending TN Type (Copy)	46-51
Treat Target as Prefix (Copy)	46-52
Use Stored Sub-Tag (Copy)	46-52
Configuring the node – Copy	46-53
Copy Hunting List	46-54
Node exits – Copy Hunting List	46-54
Configuring the node – Copy Hunting List	46-55
Create Prefix Tree	46-55
Delimiters – Create Prefix Tree	46-55
Node exits – Create Prefix Tree	46-56
Configuring the node – Create Prefix Tree	46-56
Day of Week	46-57
Shortcut keys – Day of Week	46-57
Node exits – Day of Week	46-57
Configuring the node – Day of Week	46-57
Adding a branch/range mapping – Day of Week	46-57
Day of Year	46-58
Shortcut keys – Day of Year	46-58
Node exits – Day of Year	46-58
Adding a branch/range mapping – Day of Year	46-59
Configuring the node – Day of Year	46-59
Adding holiday set entries – Day of Year	46-59
Adding explicit date ranges – Day of Year	46-60
Delete Profile Field	46-60
Node exits – Delete Profile Field	46-61
Configuring the node – Delete Profile Field	46-61
Dialled Number	46-61
Node exits – Dialled Number	46-61
Configuring the node – Dialled Number	46-61
Disconnect Call	46-62
Shortcut keys – Disconnect Call	46-62
Node exits – Disconnect Call	46-62
Configuring the node – Disconnect Call	46-62
Dynamic Switch	46-63

Node exits – Dynamic Switch	46-63
Configuring the node – Dynamic Switch	46-63
End	46-63
Shortcut keys – End	46-64
Node exits – End	46-64
Configuring the node – End	46-64
Event Branching	46-64
Node exits – Event Branching	46-64
Configuring the node – Event Branching	46-64
Event Counting	46-65
Node exits – Event Counting	46-65
Configuring the node – Event Counting	46-65
Event Setting	46-65
Node exits – Event Setting	46-65
Configuring the node – Event Setting	46-65
Geographical Routing	46-66
Shortcut keys – Geographical Routing	46-66
Node exits – Geographical Routing	46-66
Geographic routing	46-66
Nested subtrees	46-66
Allocating individual prefixes vs allocating folders	46-67
Default branch	46-67
Add a geographic entry or Region to an exit branch – Geographical Routing	46-67
Remove geography entries from a branch subtree – Geographical Routing	46-68
Finding a number in the geographic tree – Geographical Routing	46-69
Example control plan – Geographical Routing	46-69
Get Hunting List	46-69
Node exits – Get Hunting List	46-70
Configuring the node – Get Hunting List	46-70
Get Hunting Number	46-70
Node exits – Get Hunting Number	46-71
Configuring the node – Get Hunting Number	46-71
Example – Get Hunting Number	46-71
Junction	46-73
Node exits – Junction	46-73
Configuring the node – Junction	46-73
Load Profile	46-73
Node exits – Load Profile	46-73
Configuring the node – Load Profile	46-73
Example use of Load Profile node	46-74
Loop Limit	46-75

Node exits – Loop Limit	46-75
Configuring the node – Loop Limit	46-75
Modify	46-76
Node exits – Modify	46-76
Configuring the node – Modify	46-76
NP Destination Selection	46-76
Node exits – NP Destination Selection	46-77
Configuration fields – NP Destination Selection	46-78
Configuring the node – NP Destination Selection	46-78
NP Home Routing	46-79
Node exits – NP Home Routing	46-79
Configuring the node – NP Home Routing	46-79
NP Least Cost Routing	46-79
Node exits – NP Least Cost Routing	46-80
Configuration fields – NP Least Cost Routing	46-80
Configuring the node – NP Least Cost Routing	46-80
NP Map Trigger	46-80
Node exits – NP Map Trigger	46-80
Configuration fields – NP Map Trigger	46-81
Configuring the node – NP Map Trigger	46-81
Number Lookup and Translation	46-82
Node exits – Number Lookup and Translation	46-82
Configuring the node – Number Lookup and Translation	46-82
Example – Number Lookup and Translation	46-84
Number Matching	46-84
Node exits – Number Matching	46-84
Search patterns – Number Matching	46-84
Configuring the node – Number Matching	46-86
Example – Number Matching	46-87
Number Normalisation	46-87
Node exits – Number Normalisation	46-87
Configuring the node – Number Normalisation	46-88
PIN Authorisation	46-88
Node exits – PIN Authorisation	46-88
Configuring the node – PIN Authorisation	46-89
Play Announcement	46-90
Shortcut keys – Play Announcement	46-90
Node exits – Play Announcement	46-90
Configuring the node – Play Announcement	46-90
Play Ordered Prefix Tree Entry	46-91
Selection keys – Play Ordered Prefix Tree Entry	46-91

Node exits – Play Ordered Prefix Tree Entry	46-91
Configuration fields – Play Ordered Prefix Tree Entry	46-92
Configuring the node – Play Ordered Prefix Tree Entry	46-93
Play Variable Part Announcement	46-94
Node exits – Play Variable Part Announcement	46-94
Configuring the node – Play Variable Part Announcement	46-95
Prefix Branching	46-96
Node exits – Prefix Branching	46-96
Editing the node – Prefix Branching	46-96
Prefix Tree Branching	46-96
Node exits – Prefix Tree Branching	46-96
Configuring the node – Prefix Tree Branching	46-97
Prefix Tree Entry Extraction	46-97
Looping – Prefix Tree Entry Extraction	46-97
Loop process – Prefix Tree Entry Extraction	46-98
Node exits – Prefix Tree Entry Extraction	46-98
Configuration fields – Prefix Tree Entry Extraction	46-98
Configuring the node – Prefix Tree Entry Extraction	46-99
Presence Branching	46-99
Node exits – Presence Branching	46-100
Configuring the node – Presence Branching	46-100
Profile Branching	46-101
Node exits – Profile Branching	46-101
Configuring the node – Profile Branching	46-101
Profile Counting	46-102
Node exits – Profile Counting	46-102
Configuring the node – Profile Counting	46-102
Profile Date Compare	46-103
Node exits – Profile Date Compare	46-103
Configuring the node – Profile Date Compare	46-103
Profile Date Store	46-103
Node exits – Profile Date Store	46-104
Configuring the node – Profile Date Store	46-104
Adding months example – Profile Date Store	46-105
Proportional Distribution	46-105
Shortcut keys – Proportional Distribution	46-105
Node exits – Proportional Distribution	46-106
Configuring the node – Proportional Distribution	46-106
Selection Dependent Routing	46-106
Shortcut keys – Selection Dependent Routing	46-106
Node exits – Selection Dependent Routing	46-107

Configuring the node – Selection Dependent Routing	46-107
Setting the Fast Timeout Period – Selection Dependent Routing	46-108
Send Notification	46-109
Node exits – Send Notification	46-109
Configuring the node – Send Notification	46-110
Send Short Message	46-110
Node exits – Send Short Message	46-110
Configuring the node – Send Short Message	46-110
Service Handover	46-111
Node exits – Service Handover	46-111
Configuring the node – Service Handover	46-111
Set	46-112
Node exits – Set	46-112
Configuring the node – Set	46-112
Set Carrier Code	46-112
Node exits – Set Carrier Code	46-113
Configuring the node – Set Carrier Code	46-113
Set Cut and Paste	46-114
Node exits – Set Cut and Paste	46-114
Configuring the node – Set Cut and Paste	46-114
Set Indicator	46-114
Node exits – Set Indicator	46-114
Configuring the node – Set Indicator	46-115
Interpretation of values – Set Indicator	46-115
Set Pending TN from Profile	46-115
Node exits – Set Pending TN from Profile	46-116
Configuring the node – Set Pending TN from Profile	46-116
Set Presence	46-116
Node exits – Set Presence	46-117
Configuring the node – Set Presence	46-118
Set Tariff Code	46-118
Node exits – Set Tariff Code	46-118
Configuring the node – Set Tariff Code	46-119
Sleep	46-119
Node exits – Sleep	46-119
Configuring the node – Sleep	46-119
Start	46-119
Shortcut keys – Start	46-119
Node exits – Start	46-120
Configuring the node – Start	46-120
Statistic	46-120

Node exits – Statistic	46-120
Configuring the node – Statistic	46-120
Statistic Increment	46-121
Node exits – Statistic Increment	46-121
Configuring the node – Statistic Increment	46-121
Sub Control Plan	46-121
Node exits – Sub Control Plan	46-121
Configuring the node – Sub Control Plan	46-122
Table Lookup	46-122
About table lookup datasets	46-122
Node exits – Table Lookup	46-122
Configuring the node – Table Lookup	46-123
TCAP Handover	46-123
Node exits – TCAP Handover	46-123
Specifying values in profile selection fields – TCAP Handover	46-124
Configuring the node – TCAP Handover	46-124
Terminate to Pending TN	46-125
Shortcut key – Terminate to Pending TN	46-125
Node exits – Terminate to Pending TN	46-125
Configuring the node – Terminate to Pending TN	46-125
Terminate Unchanged	46-125
Node exits – Terminate Unchanged	46-125
Configuring the node – Terminate Unchanged	46-126
Test Pending TN Type	46-126
Node exits – Test Pending TN Type	46-126
Configuring the node – Test Pending TN Type	46-126
Time of Day	46-127
Shortcut keys – Time of Day	46-127
Node exits – Time of Day	46-127
Configuring the node – Time of Day	46-127
Transmission Type Branching	46-127
Node exits – Transmission Type Branching	46-127
Configuring the node – Transmission Type Branching	46-128
Unconditional Termination	46-128
Shortcut keys – Unconditional Termination	46-128
Node exits – Unconditional Termination	46-128
Configuring the node – Unconditional Termination	46-128

1

ACS Main Screen

The Advanced Control Services main screen is displayed when you successfully log in to the ACS UI. This screen displays icons that represent the configuration options available in ACS. Click a button in the Advanced Control Services main screen to open the configuration screen for that option.



Note:

This Help set contains ACS component related information. Other component Help sets are available at the following index page:

<https://docs.oracle.com/en/industries/communications/network-charging-control/15.0.0/index.html>

You can also use the search functionality in the index page to search for any keyword across multiple Help sets.

ACS Configuration Options

The following table describes the Advanced Control Services configuration options.

Configuration Option	Function
Control Plans	Accesses the Control Plan Editor Overview where you configure your ACS control plans.
Numbers	Accesses the Numbers screen where you configure the access numbers that trigger control plans such as service numbers (SN) or caller line identifier (CLI) numbers.
Configuration	Accesses the Configuration screen where you configure the ACS resources used in control plans such as geography sets, holidays and announcements.
Resources	Accesses the Resources screen where you configure service provider resources such as termination ranges and number translations.
Customer	Accesses the Customer screen where you configure service provider information such as resource limits and contact information.
Tools	Accesses the Tools screen where you configure system defaults such as system languages, SMS user access, networks, and termination ranges.
Password	Note: This option is not available to users who access ACS through the SMS. For SMS logins, ACS uses the SMS security mechanism, so the user's password must be changed through the SMS. Accesses the Change Password screen. Users who can access this screen can set up user passwords.

2

Passwords

For security reasons, the first time a customer uses ACS, they should change the user name and password of the administrator user that the system provides for them. It is important to inform the customer of this. This option is not available to users who open ACS through the Service Management System (SMS).

Note: This is part of the ACS internal security mechanism, which is not required when run through the SMS.

Changing Password

Note: This procedure can only be performed if you access the system via the ACS login screen. If you log in to ACS through the SMS you will be unable to change your password using this procedure.

Follow these steps to change your ACS user password.

1. Click **Password** on the ACS main screen.
Result: The Change Password screen appears.
2. Enter your current password.
3. Enter your new password.
4. Enter your new password again in the **Confirm Password** field.
5. Click **Save**.

3

Customers

This topic explains how to configure customers in ACS.

Tiered Customer Structure

ACS allows the telco to directly provision individual resource-limited customers, or alternatively to create a wholesale customer with a (larger) set of resource limits, and delegate to them the ability to create individual customers, the sum of whose resource limits must never exceed those of the wholesaler. This feature is called tiered customer management. A reseller is a wholesaler that may in turn create and manage 'normal' customers, and/or other wholesale customers (agents). Agents can only create normal customers.

The concept of telco-managed customers is unchanged by the advent of tiered customer management. Telco managed customers are simply customers that never log into ACS but are managed explicitly (and without resource limits) by the Telco.

The hierarchy of customer management thus looks like this:

- Telco
- Reseller
- Agent
- Customer

Resellers and agents are both implemented as ACS customers, because they both need to have resource limits allocated to them. Resellers and agents can only set resource limits for all their customers up to a combined total value that is less than or equal to their own resource limits.

This allows them to be a kind of super-user in relation to those ACS customers attached to them, for example. those customers that directly refer to them as their parent customer, or indirectly (via one level of indirection only) as in the case of a reseller who can also see the customers attached to their agents.

Resellers and agents may select any of their attached customers in the main customer combo box at the top of various windows and 'become' that customer. It means the reseller/agent has the means to edit their customers' configurations as desired.

Security Rules

When a customer is created, if the **Create User for Customer** check box is selected, an administrator user, with level 5 permission, is also created. See [Adding Customers](#). A reseller may choose to change the permission level of an agent, to restrict what the agent is able to do.

As well as performing all tasks defined in Security level permissions, a user with permission level:

- 5 or more (Reseller) can create and edit agents and customers, as long as the resource limits allocated to them do not exceed those given to the reseller by the telco. Within the tiered hierarchy, a reseller may allocate, or move to other agents, customers under them. A reseller cannot allocate customers to other resellers or their agents.
- 4 cannot create agents, but can create normal customers.

See Defining the Security Levels for details of ACS security levels.

Adding Customers

Follow these steps to add new a customer to the database.

1. On the **Customer** tab, click **New**.
Result: The New Customer screen is displayed.
2. In the **Customer Name** field, enter the name of the new customer.
3. In the **Description** field, enter a description of the new customer.
4. In the **Customer Reference** field, enter a reference number for the new customer.

Note: This field is optional, unless the parameter shown below is present in the **acs.jnlp** (if you have logged on to ACS directly) or **sms.jnlp** (if you have logged on through the SMS application) file, in which case it becomes mandatory.

```
<param name=requireCustomerReference value="TRUE" />
```

5. Select the **Customer Type** from the drop down box. This can be:
 - Normal
 - Reseller [R]
 - Agent [A]

6. Select what customer type the new customer is attached to
 - Normal - Can attach to any of the options.
 - Reseller - Attached to telco.
 - Agent - Can attach to a reseller.

Note: Only the Telco (super-user) can see the **Telco** option.

7. A **Resource Multiplier** can be specified for a reseller or an agent.

The resource multiplier is used to scale the default resource limits that will be allocated to the new customer. See [Setting the Resource Limits](#) for details.

Default values are:

- Reseller – 10
 - Agent – 5
8. If:
 - All the new customers' calls for service numbers and CLIs will use an override control plan that is owned by the telco, select the **Use override control plan** check box and go to Step 9.

- An override control plan is not required, leave this box cleared and go directly to Step 10.
9. If you selected the **Use override Control Plan** check box in Step 8, select the **Override Control Plan** that is to be used from the list.
 10. From the **Language** drop down list, select the applicable language for your customer.
 11. If required, enter a PIN in the **PIN** field.
 12. If required, enter a management ID in the **Management ID** field.
 13. If the customer is to be managed by the ACS administrator, select the **Managed Customer** check box. By default this is selected.
Important: This indicates that this is not a self managed customer.
 14. If you want ACS to allocate a user for your new customer, select the **Create User for Customer** check box.
Note: If the **Create user for Customer** check box is selected the user name "Administrator" and password "admin" will be allocated. It is important that the customer changes the password for this user when they use the system for the first time.
When a new customer is added, a user of privilege level 5 will be supplied by the system.
 15. In the **Termination Number Range Rules** screen section, select:
 - **Own Range** to use the termination ranges set up on the [Termination Ranges](#) tab of the ACS Resources screen.
 - **Default Range** to use the default termination range set up on the [Default Termination Range](#) tab of the ACS Tools screen.
 - **No Checking** to accept the termination numbers without validation (Default).
 16. Click **Save**.
Result: The new customer's details are saved in the database.
To change the default resource limits, go to [Customer Resource Limits](#) for details.

Related topic

[Customers](#)

Editing Customers

Follow these steps to edit customer information in the database.

1. In the table on the **Customer** tab, select the customer to edit.
2. Click **Edit**.
Result: The Edit Customer Details screen is displayed.
3. Change the customer details as required. See [Adding Customers](#) for details about the fields.
Note: You cannot change the override control plan.
If you wish to change a reseller or agent that this customer is attached to, first clear the combo box and press **Enter** to display the list to pick from.
4. Click **Save**.
Result: The details are saved and the screen will return to the main window.

Related topic

[Customers](#)

Deleting Customers

Follow these steps to delete a customer from the database.

Warning: Deleting a customer record will delete all other configuration used by the customer.

1. In the table on the **Customer** tab, select the customer to delete.
2. Click **Delete**.

Result: The Confirm Delete prompt is displayed.

3. Click **OK**.

Result: The customer is removed from the database.

Note: You cannot delete a customer if it is:

- A reseller (Type R) with an agent or customer
- An agent (Type A) with a customer

You will see an error message. You must delete, or re-attach to other resellers or agents, all attached customers and/or agents first. See Tiered hierarchy.

4

Customer Resource Limits

The **Resource Limits** tab of the ACS Customer screen is used to manage and display the resource limitations for each of your customers.

Only ACS system administrators have access to this tab. Users with privilege levels less than 6 will not see this tab.

Setting the Resource Limits

Follow these steps to set the resource limits for each of a customer.

1. On the **Resource Limits** tab, select the customer record to edit the resource limits for.
2. Click **Edit**.

Result: The Edit Customer Resource Limits screen is displayed. The groups within the **Public Set Access** frame are populated with the names of sets made public on the appropriate tabs on the ACS Configuration screen.

3. Select the maximum number for each of the fields in the **Set Number Allowed** frame.

Refer to [Set Number Allowed Fields](#) and [Set Number Allowed Columns](#) for a description for each field.

Note: As you change the value in a field, the **Available from Parent**, **Available To Customer** and **Changes Pending** fields are updated to track the change made.

4. Managed customers gain default access to all **Public Set Access** options.

Alternatively, select the appropriate check boxes to allocate sets for each group in the [Public Set Access](#) frame.

5. Click **Save**.

Result:

If there is available resource, the details are saved and the screen will return to the main window.

If you have set a number to less than the available resources (that is, the Available field displays a negative value), you will see an error. You will need to change the value before saving.

Related topic

[Customer Resource Limits](#)

Edit Customer Resource Limits Fields

Here are the descriptions of fields and areas on the Edit Customer Resource Limits screen.

Set Number Allowed Fields

Field	Sets the maximum number of...	Range	Default
Users	Users that the customer can configure.	0 - 1000	20
Event Counters	Statistics counters that the customer can configure. See Event Counters .	0 - 100000	10
Feature nodes in Control Plan	Feature nodes that the customer can use in a single control plan (including all sub control plans).	0 - 2000	100
Control Plans	Control plans that the customer can use.	1 - 1000000	20
Control Plan Structures	Control plan structures that the customer may create. Control plans are made up of control plan data and a control plan structure. It is possible for many control plans to use the same structure, provided they each have their own data.	3 - 1000000	20
Announcement Sets	Announcement sets that the customer can configure. See Announcements . Tip: You should set this value to 3 or more.	0 - 1000	1
Announcement Entries	Announcement entries that the customer can configure per announcement set. See Announcement Entries .	0 - 100000	20
Holiday Sets	Holiday sets that the customer can configure. See Holidays .	0 - 1000	1
Holiday Entries	Holiday entries that the customer can configure. See Adding Holiday Entries .	0 - 10000	20
Geography Sets	Geography sets that the customer can configure. See Geography Sets .	0 - 1000	1
Geography Entries	Geography entries that the customer can configure. See Geography Sets and Entries .	0 - 20000	20

Set Number Allowed Columns

This table describes the function of each read-only display field to the right of the **Set Number Allowed** fields.

Column	Description
Available From Parent	Displays how many of each resource limit is available from the parent level. If the user is at the top level, this column will display two dots, meaning not applicable.
Directly Used	Displays how many of the allocated resources are being (directly) used by the customer.
Delegated	Displays how many have been delegated (as limits) to sub-customers - this will only have non-zero values for resellers and agents. These resources consume the customer's available count in the same way as direct usage.

Column	Description
Available To Customer	Displays how many of each resource limit is still available for the customer to either use or delegate.
Changes Pending	The numbers in the first four columns total that in the set number allowed field for that resource. As you change the number, the Available to Customer and Changes Pending fields for that resource will change to track the difference. After you save, this field will reset to blank.

Public Set Access

The groups of check boxes in the **Public Set Access** frame display all the public sets that are available to the customer. Select the check boxes to allocate the specific public sets that the customer will be allowed to access. Refer to:

- [Feature Sets](#)
- [Announcements](#)
- [Geography Sets](#)
- [Holidays](#)

Tip: Only previously configured sets will appear in each list of sets.

5

Customer Contacts

The **Contacts** tab of the ACS Customer screen is used to manage and display the contact information for each customer.

The customer displayed in the **Customer** field is the customer for which the contacts are displayed and managed.

Customer Contacts Fields

This table describes the function of each field.

Field	Description
Contact Name	The name of this contact
Telephone Number	The main telephone number for this contact Note: You can only enter digits in the number fields.
Mobile	The mobile telephone number for this contact
Pager	The pager number for this contact
Fax	The fax number for this contact
E-mail	The email address for this contact
Comments	Any required comments about this contact

Adding Customer Contacts

Follow these steps to add new customer contacts for a customer.

1. On the **Contacts** tab, click **New**.
Result: The New Customer Contacts screen is displayed.
2. Enter details for the contact, as described in [Customer Contacts Fields](#).
3. Click **Save**.

The new customer contact's details are saved in the database.

Related topic

[Customer Contacts](#)

Editing Customer Contacts

Follow these steps to edit customer contact information for the customer.

1. From the **Contacts** tab, select the customer contact to edit.
2. Click **Edit**.

Result: The Edit Customer Contacts screen is displayed.

3. Change the contact details, as described in [Customer Contacts Fields](#).
4. Click **Save**.

Result: The details are saved and the screen will return to the main window.

Related topic

[Customer Contacts](#)

Deleting Customer Contacts

Follow these steps to delete a customer contact for a customer.

1. From the **Contacts** tab, select the customer contact to delete.
2. Click **Delete**.

Result: The Confirm Delete prompt is displayed.

3. Click **OK**.

Result: The customer contact record is removed from the database.

6

Users

The **Users** tab of the ACS Customer screen is used to configure and display users for each customer.

A user is an individual who can access ACS on behalf of the customer. A customer is the person or company who purchases their telecommunication services from the telco.

Only users of privilege level 5 and above may add, edit or delete other users. Users of below level 5 privilege may be prevented from seeing this tab by leaving the **Users may access this screen** check box clear.

Note: This tab can only be accessed by the ACS system administrator.

Supplied User

For customers who wish to access ACS themselves, users must be set up. For customers who are to be completely managed by the telecommunications provider, the **Managed Customer** check box should be selected for the customer on the Edit Customer screen; this will allow the telco to skip the following set up steps:

- Set up a privilege level 5 user in the **Users** tab
- Add termination ranges for the customer in the **Termination Ranges** tab on the ACS Resources screen
- Allocate the resources that the customer can use in the **Resource Limits** tab

Each customer must have at least one user of privilege level 5 to enable them to effectively use the ACS service themselves. When a new customer is added to ACS, the system assigns a level 5 user with a user name and password of *Administrator*. Using this user ID, the customer may set up other users of privilege level 5 or below as they wish. Additional users are set up on the **Users** tab of the Customer screen.

Important: For security reasons, the first time the customer uses ACS, they should change the username and password of the administrator user that the system provides for them. It is important to inform the customer of this.

Users Fields

This table describes the function of each field in the ACS Users dialog.

Field	Description
User Name	The user name must be unique for the customer, although there may be several customers with a user "Mary Smith", there may only be one user "Mary Smith" for each customer.

Field	Description
Privilege Level	<p>Use the list to select the privilege level for the user. Privilege levels are described in Defining the Security Levels.</p> <p>When creating new users, they may be assigned a privilege level. Level 5 and 6 users may create users of privilege levels 1-5.</p>
Password	<p>This field allows you to enter the user's password. For security reasons, this will not display the characters that are actually entered. The password will be displayed as a line of asterisks. Users are required to enter a password.</p>
Confirm Password	<p>This field allows you to enter the user's password for a second time, to confirm that the entry of the password is correct.</p> <p>If the entries in both the logon Password and the Confirm Password fields are not the same, then the user cannot be saved.</p> <p>For security reasons, the password will be displayed as a line of asterisks. The user may not be saved until a password has been entered and confirmed correctly.</p>
User Locked	<p>The check box indicates the lock status for the user. This check box has two functions:</p> <ul style="list-style-type: none">• It shows if the user is currently locked out of the system. A user may become locked out of the system if they have attempted to log on unsuccessfully three times.• It allows a user of privilege level 5 or above to manually unlock a user who has become locked out of the system if required; otherwise they will be automatically unlocked in 12 hours. <p>A locked user may not log on, even with the correct password, until they are unlocked. This added security mechanism prevents unauthorized users from guessing at a password until they get it correct, thus gaining unauthorized access to the system.</p> <p>Note: You cannot manually lock a user. If necessary, to prevent a user from accessing the system, the system administrator should either delete the user or change their password.</p> <p>The User Locked check box is part of the ACS internal security mechanism. If ACS has been opened through the SMS, this functionality will not be available because the SMS security mechanism will be used instead.</p>

Field	Description
Java Config	Allows you to set Java configuration parameters to customize the ACS User Interface (UI) for the user. For example, you can define initial settings for the Control Plan Editor (CPE) window by setting the CPE parameter. For more information, see the discussion on Configuring Control Plan Editor in <i>CPE User's Guide</i> .

Adding Users

Follow these steps to add a new user.

1. On the **Users** tab, click **New**.
Result: The New Users screen is displayed.
2. Create the user details by filling in the fields, as described in [Users Fields](#).
3. Click **Save**.
Result: The details are saved and you return to the **Users** tab.
4. If you wish users with privilege level 5 or less to have access this screen, select the **Users may access this screen** check box (in the main **Users** tab).

Related topic

[Users](#)

Editing Users

Follow these steps to edit an existing user.

1. On the **Users** tab, select the user to edit.
2. Click **Edit**.
Result: The Edit Users screen is displayed.
3. Change the details, as described in [Users Fields](#), as required.
4. Click **Save**.
Result: The details are saved and you return to the **Users** tab.

Related topic

[Users](#)

Deleting Users

Follow these steps to delete a user.

1. On the **Users** tab, select the user to delete.
2. Click **Delete**.
Result: The Confirm Delete prompt is displayed.

3. Click **OK**.

Result: The user is removed from the database.

7

Control Plan Change

The **Control Plan Change** tab allows you:

- To replace the termination number in the termination node of a control plan
- For each service number on the ACS Numbers screen, to override the scheduled control plan, with the predefined alternative control plan

Note: To override a scheduled control plan, the alternative control plan name must follow this syntax:

```
<ServiceNumber><alternativeCallPlanNamePostfix>
```

For example, if service number 0800123456 uses control plan "ABC", the alternative control plan for this service number must be named 0800123456_ *alternativeCallPlanNamePostfix*.

Where *alternativeCallPlanNamePostfix* is the value specified in the *alternativeCallPlanNamePostfix* parameter of the **acs.conf** file. For more information, see *ACS Technical Guide*.

Tab Areas

This table describes the function of each area of the tab.

Field	Description
Alternative control plans	Allows you to activate or deactivate the alternative control plans.
State	Text displays the current state of control plan activation: <ul style="list-style-type: none">• "Normal status: no control plan changes in effect."• "Emergency control plans activated."
Termination number substitution	Allows you to activate or deactivate the termination number substitution. You can add, edit, and delete the termination number/replacement number pair.
State	Text displays the current state of number substitution: <ul style="list-style-type: none">• "Normal status, no termination number changes in effect."• "Termination numbers substituted."

Activating Alternative Control Plan Changes

Follow these steps to activate the alternative control plan changes.

1. On the **Control Plan Change** tab, in the **Alternative control plans** area, if currently deactivated, you can click **Activate**.

Result: The Activation Confirmation dialog appears.

2. Click **Activate**.

Result: Activates the control plans. The text (see [Tab Areas](#)) at the top of the following tabs changes to display the new state of activation and substitution:

- **Control Plan Change** tab
- **Service Numbers** tab of the Numbers screen (if any are activated)

Deactivating Alternative Control Plan Changes

Follow these steps to deactivate the alternative control plan changes.

1. On the **Control Plan Change** tab, in the **Alternative control plans** area, if currently activated, you can click **Deactivate**.

Result: The Deactivation Confirmation dialog appears.

2. Click **Deactivate**.

Result: Deactivates the control plans. The text (see [Tab Areas](#)) at the top of the following tabs changes to display the new state of activation and substitution:

- **Control Plan Change** tab
- **Service Numbers** tab of the Numbers screen (if any are activated)

Activating Termination Number Substitution

Follow these steps to activate the termination number substitution.

1. On the **Control Plan Change** tab, in the termination number substitution area, if currently deactivated, you can click **Activate**.

Result: The Activation Confirmation dialog appears.

2. Click **Activate**.

Result:

- The termination number substitution is activated
- The text (see [Tab Areas](#)) changes to display the new state of activation and substitution at the top of the **Control Plan Change** tab and the **Service Numbers** tab of the Numbers screen (if any are activated)

Deactivating Termination Number Substitution

Follow these steps to deactivate the termination number substitution.

1. On the **Control Plan Change** tab, in the **Termination number substitution** area, if currently activated, you can click **Deactivate**.

Result: The Deactivation Confirmation dialog appears.

2. Click **Deactivate**.

Result: The:

- Termination number substitution is deactivated
- The text (see [Tab Areas](#)) changes to display the new state of activation and substitution at the top of the:
 - **Control Plan Change** tab

- **Service Numbers** tab of the Numbers screen (if any are activated)

Adding a Termination Number Substitution

Follow these steps to add a termination number substitution.

1. On the **Control Plan Change** tab, click **New...**
Result: The New Termination Number substitution screen is displayed.
2. Enter the termination number and the replacement number.
3. Click **Save**.

Related topic

[Control Plan Change](#)

Editing a Termination Number Substitution

Follow these steps to edit a termination number substitution.

1. On the **Control Plan Change** tab, select a termination number/replacement number pair from the table and click **Edit...**
Result: The Edit Termination Number substitution screen is displayed.
2. Make changes to the termination number and the replacement number.
3. Click **Save**.

Related topic

[Control Plan Change](#)

Deleting a Termination Number Substitution

Follow these steps to delete a termination number substitution.

1. On the **Control Plan Change** tab, select a termination number/replacement number from the table and click **Delete**.
Result: The Deletion Confirmation dialog is displayed, with a confirmation of the termination and replacement number pair.
2. Click **Delete** to delete the substitution.

Related topic

[Control Plan Change](#)

8

Geography Sets

The **Geography** tab of the ACS Configuration screen is used to add, edit and remove geography sets and their respective entries.

Note: It is never possible to delete a geography set or entry that is currently in use by a compiled control plan. Deleting a geography set will delete all entries in that set. Editing a geography set or entry will cause all compiled control plans that use that geography set to be recompiled.

Geography Set Definition

A geography set is a group of geography entries. A geography set may belong to a specific customer, or may be public — usable by any customer. Here are some example geography sets:

- North/South Island (Public)
- Major City Breakdown (Public)
- Pizza delivery company nearest call center to each major exchange (service provider specific).

Geography Entry Definition

A geography entry is a calling area defined by a prefix in the dialed number. The prefix is a code for the given location and can be used in whatever way ACS requires. For example, in the geographic routing feature node it is matched to the calling party number.

9

Geography Sets and Entries

Adding Geography Sets

Follow these steps to add a new geography set.

1. On the **Geography** tab, click **New Set**.

Result: The New Geography Set screen is displayed.

2. In the **Geography Set** field, enter the name of the set.

Geography set names must be unique for each customer. Sets do not need to be unique between customers unless they are to be public, in which case they must be unique.

The name can be up to 50 alphanumeric characters in length, but may not be left blank.

3. If you require a:

- Public geography set (that is, you want the new set to be available to all users), select the **Public** box
- Customer-specific geography set, leave the box not selected

4. **Note:** A private set may not be edited and made public, nor may a public set be edited to become private.

5. Click **Save** to add the geography set to the database.

Result: The new geography set will be available in the drop-down list

Related topic

[Geography Sets and Entries](#)

Adding Geography Entries

Follow these steps to add a new geography entry to a geography set.

1. On the **Geography** tab, select the geography set to edit from the **Geography Set** drop down list.

2. Click **Edit Set**.

Result: The Edit Geography Set screen is displayed.

3. Select the folder you would like to add the new entry to.

Result: Once selected, the folder name is displayed in the **Location** field.

4. Click **Add Entry**.

Result: The Add Entry Screen appears.

5. In the **Name for New Entry:** field, enter the name of the new geography entry.

6. Click **Save**.

Result: The geography entry will be added as a branch under the geography set name.

7. Select the new geography entry from the Edit Geography Set screen.
8. If required, enter a prefix for the entry in the **Prefix** field.
9. Click **Accept Changes**.

Note: If the geography entry contains nested entries, a prefix is not required and the **Accept Changes** button remains unavailable. If the geography entry does not contain nested entries, the **Accept Changes** button becomes available when the **Prefix** field is populated.

10. Click **Save**.

Result: The geography set changes are added to the database.

Note: If the set is used in a compiled control plan, the compiler will attempt to recompile all control plans that use the set and will display the compiler report. The compiler report gives details of all the control plans that were affected by the change and provides a report on status of each control plan.

Related topic

[Geography Sets and Entries](#)

Editing Geography Entry Prefixes

Follow these steps to add or edit prefixes for existing geography entries.

1. On the **Geography** tab, select the geography set to edit from the **Geography Set** drop down list.

2. Click **Edit Set**.

Result: The Edit Geography Set screen is displayed.

3. Select the entry you would like to change the prefix for.

Result: Once selected, the entry name is displayed in the **Location** field.

4. In the **Prefix** field, make the necessary changes to the prefix.

5. Click **Accept Changes**.

Note: The **Accept Changes** only becomes available for entries that have no nested entries below them.

6. Click **Save**.

Result: The geography set changes are saved to the database.

Note: If the edited geography set is used in a compiled control plan, the compiler will attempt to recompile all control plans that use the set and will display the compiler report. The compiler report gives details of all the control plans that were affected by the change and provides a report on status of each control plan.

Related topic

[Geography Sets and Entries](#)

Deleting Geography Entries

Follow these steps to remove a geography entry.

1. In the Edit Geography Set screen, select the geography entry to delete.

2. Click **Remove Entry**.

Result: The geography entry is deleted.

3. Click **Save**.

Result: The geography set changes are saved to the database.

Note: Deleting a geography entry will cause all compiled control plans that use that geography set to be recompiled and will display the compiler report. The compiler report gives details of all the control plans that were affected by the change and provides a report on status of each control plan.

Deleting Geography Sets

Follow these steps to remove an existing geography set from the database.

1. On the **Geography** tab, select the geography set to delete from the **Geography Set** drop down list.

2. Click **Delete Set**.

Result: The Confirm Delete prompt is displayed.

3. Click **OK**.

Result: The geography set is deleted.

Tip: It is not possible to delete a geography set that is used in a control plan. To delete this geography set, the control plans that use the geography set must first be changed to use another set. Once this set is not used by any node in any control plan, then it may be deleted.

10

Geography Regions

Adding Geography Regions

Follow these steps to create a geography region, and add geography entry prefixes to that region.

1. On the **Geography** tab, click **Edit Regions**.

Result: The Edit Geography Regions screen is displayed.

2. In the **Available regions** field, enter the name of the region.

This field may be used to search for and select existing regions or create new regions.

3. From the **Geography Tree**, select the geography entry or geography prefix that is to be part of the selected region.

4. Click **Connect** to connect the selected geography entry or prefix to the selected region.

Note: Where a geography entry is connected to a region, then all prefixes below that entry are also connected to the same region unless a prefix is specifically connected to a different region.

5. Add all entries and prefixes to the region as required.

6. Once the region is complete, click **Cancel** to return to the **Geography** tab.

Note: All changes to a region are automatically saved to the database.

Displaying all Nodes in a Region

Follow these steps to display all nodes (that is, geography entries and prefixes) that are connected to a specified region.

1. In the **Available Regions** combo box, either enter a new name or select a name from the drop-down list.

Note: The combo box may be used to search for and select existing regions or create new regions. See Combo boxes for details on how to use this field.

2. Click **Show Connections**.

Result: The entries and prefixes that are connected to the region will be highlighted in the **Geography Tree**.

Disconnecting from a Region

Follow these steps to disconnect a geography entry or prefix from a region.

1. From the **Geography** tab, click **Edit Regions**.

Result: The Edit Geography Regions screen opens, with the **Geography Tree** tab active.

2. From the geography tree, select the geography entry or prefix to disconnect.
Result: If the geography entry or prefix has nodes associated with it, node names will appear in the **Regions connected to selected nodes** field of the **Geography Tree** tab.
3. In the **Regions connected to selected nodes** field, click the node to disconnect.
4. Click **Disconnect**.
5. Click **Cancel** to return to the **Geography** tab.
Note: The changes will still be saved to the database.

Finding a Geography entry

Follow these steps to locate a geography entry (node) in a geography tree by name.

1. On the **Geography** tab, click **Edit Regions**.
Result: The Edit Geography Regions screen is displayed.
2. In the **Find nodes named** field, enter the name of the node (geography entry) to searched for.
3. Click **Find**.
Result: Entries that match the search criteria will be displayed on the **Names** tab.
4. Select the entries to be located in the geography tree and click **Show In Tree**.
Result: The **Geography Tree** tab is displayed with the selected entries highlighted.

11

Holidays

You use the **Holidays** tab to configure holiday sets and holiday records for each of your customers.

A holiday set is a set of day-of-year records that mark specific days as being "holiday" days.

About Updated Holiday Set Data in Control Plans

Customers can use holiday set data in Day Of Year feature node configurations in their control plans (for example, to route calls to a messaging service when their businesses are closed).

When you update the entries in a holiday set, all the control plans that reference the updated holiday set in a Day Of Year feature node are recompiled automatically. However, if a control plan was already in the control plan cache when the holiday set data was updated, because the control plan is being triggered by platform traffic, then the updates will not be available until the recompiled control plan is reloaded into the cache. This creates a delay between recompilation and new data being available on the SLC.

Control plans are reloaded into the control plan cache at regular intervals, and when the SLEE is restarted. You may be able to configure the frequency with which the control plan cache is flushed for some services. For example, you configure when to flush the control plan cache for the CCS service by configuring the following parameters in the `ccsSvcLibrary` section of the `eserv.config` configuration file:

- `callPlanAndDataCacheFlushTime`
- `callPlanAndDataCacheMaxAge`

For more information, see *CCS Technical Guide*.

For information about control plan configuration, see *CPE User's Guide*.

Adding Holiday Sets

Follow these steps to add a new holiday set.

1. On the **Holidays** tab, click **New Set**.

Result: The New Holiday Set screen is displayed.

2. In the **Holiday Set** field, enter the name of the set.

Note: Each holiday set name must be unique for a particular customer - but two different customers may have sets with the same name. If the holiday set is to be saved as a public set, then the name must be unique. The set name may be up to 50 alphanumeric characters in length, but cannot be left blank.

3. In the **Description** field, enter a description of the set.
4. If you require a:
 - Public holiday set, select the **Public** check box.

- Customer-specific holiday set, leave the box not selected.
5. **Note:** A private set may not be edited and made public, nor may a public set be edited to become private.
 6. Click **Save** to add the new holiday set to the database.

Related topic

[Holidays](#)

Editing Holiday Sets

Follow these steps to edit an existing holiday set.

1. On the **Holidays** tab, select the holiday set to edit from the **Holiday Set** drop down list.
2. Click **Edit Set**.

Result: The Edit Holiday Set screen is displayed.

3. Make the necessary changes to the description.

Note: You cannot change the Holiday Name or change the public/customer-specific status.

4. Click **Save**.

Result: The holiday set changes are saved to the database.

Note: Editing a holiday set or holiday entry causes all compiled control plans that use that holiday set to recompile. The compiler report gives details about the status of each affected control plan.

Related topic

[Holidays](#)

Deleting Holiday Sets

Follow these steps to delete an existing holiday set.

Note: Deleting a holiday set will delete all holiday entries in that set. It is not possible to delete a holiday set that is currently in use by a compiled control plan.

1. From the **Holidays** tab, select the holiday set to delete.
2. Click **Delete Set**.

Result: The Confirm Delete prompt is displayed.

3. Click **OK**.

Result: The holiday set is removed from the database.

Tip: It is not possible to delete a holiday set that is used in a control plan. To delete this holiday set, the control plans that use the holiday set must first be changed to use another set. Once this set is not used by any node in any control plan, then it may be deleted.

Related topic

[Holidays](#)

Adding Holiday Entries

Follow these steps to add a new holiday entry to an existing holiday set.

1. On the **Holidays** tab, select the holiday set to add a new holiday entry to from the **Holiday Set** drop down list.

2. Click **New**.

Tip: The **New** button is located at the bottom of the screen. The new button at the top of the screen is **New Set**.

Result: The New Holiday screen is displayed.

3. In the **Name** field, enter the name of the holiday entry.
4. From the **Start Date** and **End Date** drop down boxes, select a start and end date.

Tip: Holiday entries may not overlap. Each day may only belong to one holiday within the holiday set.

5. In the **Description** field, enter a description of the holiday entry.
6. Click **Save** to add the holiday entry to the holiday set selected in step 1.

Note: Adding an entry to a set that is used in compiled control plans will cause all control plans that use that set to be recompiled and will display the compiler report. The compiler report gives details of all the control plans that were affected by the change and provides a report on status of each control plan.

Related topic

[Holidays](#)

Editing Holiday Entries

Follow these steps to edit an existing holiday entry in a holiday set.

1. On the **Holidays** tab, select the holiday set which contains the holiday entry to edit.
2. From the table, select the holiday entry to edit.
3. Click **Edit**.

Tip: The **Edit** button is located at the bottom of the screen. The edit button at the top of the screen is **Edit Set**.

Result: The Edit Holiday screen is displayed.

4. Make the necessary changes to the Start and End dates and description.

Note: You cannot edit the **Name** field.

5. Click **Save**.

Result: The holiday entry changes are saved to the database.

Note: Editing a holiday set or holiday entry will cause all compiled control plans that use that holiday set to be recompiled and will display the compiler report. The compiler report gives details of all the control plans that were affected by the change and provides a report on status of each control plan.

Related topic

Holidays

Deleting Holiday Entries

Follow these steps to delete an existing holiday entry from a holiday set.

1. On the **Holidays** tab, select the holiday set which contains the holiday entry to delete.
2. From the table, select the holiday entry to delete.
3. Click **Delete**.

Tip: The **Delete** button is located at the bottom of the screen. The delete button at the top of the screen is **Delete Set**.

Result: The Confirm Delete prompt is displayed.

4. Click **OK**.

Result: The holiday entry is removed from the holiday set in the database.

Tip: It is not possible to delete a holiday entry that is used in a control plan. To delete this holiday entry, the control plans that use it must first be changed to use another holiday entry. Once this entry is not used by any node in any control plan, then it may be deleted.

Note: Deleting a holiday entry will cause all compiled control plans that use that holiday set to be recompiled and will display the compiler report. The compiler report gives details of all the control plans that were affected by the change and provides a report on status of each control plan.

Related topic

[Holidays](#)

12

Announcements

All the announcements that are used in your customer control plans must belong to an announcement set. Announcement sets are a convenient way of grouping common announcements together.

An announcement set may belong to a specific customer or may belong to no customer, in which case the announcements it contains are public (that is, they can be used by any customer). For example:

- General announcements (public)
- Please hold announcements (public)
- Warehouse mail order announcements (customer-specific)
- Warehouse head office announcements (customer-specific)

Note: It is not possible to delete an announcement set that is currently in use by a compiled control plan. Deleting an announcement set will delete all announcement records in that set. Editing an announcement set or announcement entry will cause all compiled control plans that use that announcement set to be recompiled.

Announcement Set Fields

This table describes each field of an Announcement Set screen.

Field	Description
Announcement Set	The name of the set. Note: This field cannot be changed after it is first saved.
Description	A description of the set.
Public	Controls the availability of this set. If selected, the set is a public announcement set and can be used by all users of the system. If not selected, the set is customer-specific and can only be used by the ACS customer which created it. Notes: <ul style="list-style-type: none">• A private set may not be edited and made public, nor may a public set be edited to become private.• This field cannot be changed after it is first saved.

Adding Announcement Sets

Follow these steps to add a new announcement set.

1. On the **Announcements** tab, click **New Set**.
Result: The New Announcement Set screen is displayed.
2. Configure this record by entering data in the fields on this screen.
For information about the fields on this screen, see [Announcement Set Fields](#).
3. Click **Save** to save the details to the database.
Result: The new announcement set will be available from the announcement set drop down list.

Related topic

[Announcements](#)

Editing Announcement Sets

Follow these steps to edit an existing announcement set.

1. On the **Announcements** tab, select the announcement set to edit from the **Announcement Set** drop down list.
2. Click **Edit Set**.
Result: The Edit Announcement screen is displayed.
3. Edit the fields to make the required changes.
For information about the fields in this screen, see [Announcement Set Fields](#).
4. Click **Save**.
Result: The announcement set changes are saved to the database.
Note: Editing an announcement set will cause all compiled control plans that use that announcement set to be recompiled and will display the compiler report. The compiler report gives details of all the control plans that were affected by the change and provides a report on status of each control plan.

Related topic

[Announcements](#)

Deleting Announcement Sets

Follow these steps to delete an existing announcement set.

Warning: Deleting an announcement set will delete all announcement entries in that set.

1. On the **Announcements** tab, select the announcement set to delete from the **Announcement Set** drop down list.
2. Click **Delete Set**.
Result: The Confirm Delete prompt is displayed.
3. Click **OK**.
Result: The announcement set and all its announcement entries are removed from the database.

Tip: It is not possible to delete an announcement set that is used in a control plan. To delete this announcement set, the control plans that use the announcement set must first be changed to use another set. Once this set is not used by any node in any control plan, then it may be deleted.

Announcement Entries

Announcement entries are contained within an announcement set. The telecommunications provider must record each announcement onto a Specialized Resource Function (SRF). This announcement must be assigned a:

- Resource Name (the name or location of the SRF on which it is stored)
- Resource ID (the identification of the audio file on the SRF that gives the exact location of the announcement)

The ACS system requires the following for each announcement entry:

- Language
- Resource Name
- Resource ID

This allows ACS to determine exactly where the announcement recording is located and the language in which it is recorded - as shown in the diagram below:

	Language	Resource Name	Resource ID
Announcement 1	English	Nap 1	2234
	French	Nap 1	2235
	German	Nap 3	2236

A preferred language is set for each ACS customer. This is the language in which all announcements are played in control plans for that customer. If an announcement mapping does not exist for the selected language, the system will use the announcement mapping for the system's default language for that particular instance.

The system needs an address to locate the announcement. For this reason, the Announcements screen should not be closed until at least one of the announcement mappings defined uses the default language.

When a control plan encounters this announcement, it will attempt to use the customer's preferred language. If no mapping exists for that announcement/language, then it will attempt to use the default language. If a mapping does not exist for the announcement in the default language, then the announcement cannot be played (a system error will be logged and the call will be terminated).

Announcement Entry Fields

This table describes the function of each field.

Field	Description
Name	The name of the new announcement entry. Note: This field cannot be changed after it has been saved for the first time.
Description	A description of the new announcement entry.

Field	Description
Language	The default language for the announcement. This field is populated by the Language tab on the ACS Tools screen.
Resource Name	The name of the SRF which will play the announcement. Note: This must match the <i>srfName</i> parameter in the acs.conf file. See <i>ACS Technical Guide</i> .
Resource ID	The ID number of the audio file of the announcement.
VARs Mapping	The VARs mapping to use to construct the announcement. This field is populated by the VARs Mapping tab.

Adding Announcement Entries

Follow these steps to add announcement entries to an existing announcement set.

1. On the **Announcements** tab, select the announcement set to add an announcement entry to.
2. Click **New**.

Tip: The **New** button is located at the bottom of the screen. The new button at the top of the screen is **New Set**.

Result: The New Announcements screen is displayed.

For a description of each field on this screen, see [Announcement Entry Fields](#).

3. Complete the **Name** and **Description** fields.
4. In the **Mapping Editor** section, add the announcement mapping. Select a language and type of mapping for the announcement entry:
 - For standard announcements, select the **Resource ID + Resource Name** option. Go to Step 5.
 - For announcements that have variable announcement rules specified, select the **VARs Mapping** option. Go to Step 6.

For more information, see [VARs Mapping](#).

5. If **Resource ID + Resource Name Mapping** was selected in step 4:
 - Configure the **Resource Name** and **Resource ID**.
 - Click **Add**.
 - Go to step 8.

Result: The language and resource mapping are added to the announcement entry.

6. If **VARs Mapping** was selected at step 4:
 - Select a name from the **VARs Mapping** drop-down list.
 - Click **Add**.

Result: The language and VARs mapping are added to the announcement entry.

7. Click **Save**.

Result: The announcement entry will be added to the announcement set selected in step 1.

Note: Adding an entry to a set that is used in compiled control plans will cause all control plans that use that set to be recompiled and will display the compiler report. The compiler report gives details of all the control plans that were affected by the change and provides a report on status of each control plan.

Related topic

[Announcements](#)

Editing Announcement Entries

Follow these steps to edit an existing announcement entry, or remove a language mapping.

1. On the **Announcements** tab, select the announcement set which contains the announcement entry to edit.
2. From the table, select the announcement entry to edit.
3. Click **Edit**.

Tip: The **Edit** button is located at the bottom of the screen. The edit button at the top of the screen is **Edit Set**.

Result: You see the Edit Announcements screen.

4. If required, change the description in the **Description** field. For more information about the fields on this screen, see [Announcement Entry Fields](#).
5. To change a language mapping, select the mapping to change.
Result: The mapping is displayed in the Mapping Editor area.
Update the fields and click **Add**.
6. To add a new mapping, enter new details in the Mapping Editor section.

Select a language and type of mapping for the announcement entry:

For standard announcements, select the **Resource ID + Resource Name** option. Go to Step 6.

- For announcements that have variable announcement rules specified, select the **VARs Mapping** option. Go to Step 7.

7. If **Resource ID + Resource Name Mapping** was selected in step 5:
 - Configure the **Resource Name** and **Resource ID**.
 - Click **Add**.
 - Skip step 7.

Result: The language and resource mapping will be added to the announcement entry.

8. If **VARs Mapping** was selected at step 5:
 - Select a name from the **VARs Mapping** drop-down list.
 - Click **Add**.

Result: The language and VARs mapping will be added to the announcement entry.

9. To remove a mapping from the table, select it and click **Remove**.
10. Click **Save**.

Result: The announcement entry changes are saved to the database.

Note: Editing an announcement entry will cause all compiled control plans that use that announcement set to be recompiled and will display the compiler report. The compiler report gives details of all the control plans that were affected by the change and provides a report on status of each control plan.

Related topic

[Announcements](#)

Deleting Announcement Entries

Follow these steps to delete an announcement entry from a selected announcement set.

1. On the **Announcements** tab, select the announcement set which contains the announcement entry to delete.
2. From the table, select the announcement entry to delete.
3. Click **Delete**.

Tip: The **Delete** button is located at the bottom of the screen. The delete button at the top of the screen is **Delete Set**.

Result: The Confirm Delete prompt is displayed.

4. Click **OK**.

Result: The announcement entry is removed from announcement set in the database.

Tip: It is not possible to delete an announcement entry that is used in a control plan. To delete this announcement entry, the control plans that use it must first be changed to use another announcement entry. Once this entry is not used by any node in any control plan, then it may be deleted.

Note: Deleting an announcement entry will cause all compiled control plans that use that announcement set to be recompiled and will display the compiler report. The compiler report gives details of all the control plans that were affected by the change and provides a report on status of each control plan.

13

Variable Announcement Rule Sets

The **VARs** tab is used to define the rules for a Variable Announcement Rule Set (VARs). VARs are used for announcements that vary depending on the grammatical rules of the language. Variable announcement rule sets allow these grammatical rules to be observed within the played announcement.

The VARs name (set name) is unique. It is used by the **VARs Mapping** tab to identify which VARs to map. Each rule is comprised of at least one or more expressions. Multiple expressions are concatenated with either a logical AND or logical OR.

Each expression conforms to the following syntax:

variablePart operator1 argument1 [operator2 argument2]

The syntax supports a maximum of five tokens. The last two tokens (operator2, argument2) are optional. These are only required depending on the operator1 operation. 'variablePart' represents one of the variable announcement parts.

A grouping policy can be optionally applied to each rule where the order of evaluation is important.

How VARs is Used in an Announcement Entry

The following example illustrates how a VARs is used in an announcement entry.

An announcement contains two placeholder parts:

"On *date* your balance is *variable*"

The *variable* part of the announcement will play a different audio file depending upon the number of free SMSs that the subscriber has remaining.

- 0 free SMSs (rule 1)
- 1 free SMS (rule 2)
- A pair of SMSs (rule 3)
- *n* free SMSs (rule 4)

The *variable* part is set up on the **VARs** tab as follows:

- Rule 1 is

IF [Part 2] = 0

- Rule 2 is

IF [Part 2] = 1

- Rule 3 is

IF [Part 2] = 2

- Rule 4 is IF [Part 2] > 2

Using the **VARs Mapping** tab, each rule is mapped to the resource name (that is, SRF) and resource ID of each audio file.

Using the **Announcements** tab, the VARs mapping is specified for an announcement entry.

Variable Announcement Rule Set Fields

This table describes the function of each field.

Field	Description
Add Rule	You can construct up to four parts to a rule using the operator fields.
Part	Select the part of the expression that the line applies to.
Comparison operators	Select from: = equal to != not equal to > greater than < less than >= greater than or equal to <= less than or equal to % percentage + plus - minus * multiply / divide
Boolean operators	Select from: • AND • OR
Grouping Policy	Allows you to place brackets around the selected parts of the expression where the order of evaluation is important.
Existing Rules	Displays each rule and its boolean expression.

Adding a VARs

Follow these steps to add a new VARs and add rules to the rule set.

1. From the **VARs** tab, click **New**.

Result: The New Variable Announcement Rule Set screen is displayed. See [Variable Announcement Rule Set Fields](#) for a description of each field.

2. In the **Set Name** field, enter the VARs name.

3. In the **Add Rule** area, configure the new rule by constructing the boolean expression.
4. Click **Add**.
The new rule will be added to the VARS and will be displayed in the **Existing Rules** table.
5. Click **Save** to save the changes to the database.

Related topic

[Variable Announcement Rule Sets](#)

Editing a VARS

Follow these steps to edit an existing VARS.

1. On the **VARS** tab, select the VARS to edit.
2. Click **Edit**.
Result: The Edit Variable Announcement Rule Set screen is displayed. See [Variable Announcement Rule Set Fields](#) for a description of each field.
3. Make the changes required.
To add a rule, follow the procedure described in [Adding a VARS](#).
To remove a rule, select it in the **Existing Rules** table and click **Remove**.
To change a rule:
 - a. Select the rule in the table.
Result: The details will be displayed in the **Add Rule** area.
 - b. Change the rule details and click **Update**.
4. Click **Save** to save the changes to the database.

Related topic

[Variable Announcement Rule Sets](#)

Deleting a VARS

Follow these steps to delete an existing VARS.

1. On the **VARS** tab, select the VARS to delete.
2. Click **Delete**.
Result: The Confirm Delete prompt is displayed.
3. Click **OK** to delete the VARS record.

14

VARS Mapping

The **VARS Mapping** tab on the ACS Configuration screen is used to map each rule in a VARS to a unique resource name and resource ID combination. This combination is used to determine the elementary message ID that is forwarded to the switch.

The mapping name is unique. It is used by the [Announcement Entries](#) to determine which VARS to map to.

VARS Mapping Fields

This table describes the function of each field.

Field	Description
Mapping Name	The name of the mapping.
Rule Set	The name of the rule set. Note: This field cannot be changed after it has been saved for the first time.
Rule	List of VARS rules, with the rule description, as listed on the VARS tab. For more information, see Variable Announcement Rule Sets .
Resource Name	The name of the SRF which will play the announcement. Note: This must match the <code>srfName</code> parameter in the <code>acs.conf</code> file. See <i>ACS Technical Guide</i> .
Resource ID	The ID number of the audio file of the announcement.
Mappings	Displays the mappings for each rule against the Resource name and ID.

Adding a VARS Mapping

Follow these steps to add a new VARS mapping.

1. On the **VARS Mapping** tab, click **New**.

Result: The New Variable Announcement Rule Set Mapping screen is displayed.

For a description of each field on this screen, see [VARS Mapping Fields](#).

2. In the **Mapping Name** field, enter the name for this VARS mapping.

Tip: The VARS mapping name must be unique for the customer, although two different customers may have the same VARS mapping name.

3. From the **Rule Set** drop down list, select the VARS which contains the rule to map to a resource.

Tip: This drop down list only contains previously configured VARS. To add a new VARS, see [Variable Announcement Rule Sets](#).

4. In the **Map Rule** section, select the rule from the top left drop down box.
5. In the **Resource Name** field, enter the name of the SRF which will play the announcement.
Note: This must match the `srfName` parameter in the **acs.conf** file. See *ACS Technical Guide*.
6. In the **Resource ID** field, enter the ID number of the audio file which contains the announcement.
7. Click **Map** to process the VARS mapping rule.
Result: The mapped rule will appear in the **Mappings** table.
Tip: You must enter a VARS mapping for each rule in the rule set.
8. Click **Save** to save the new VARS mapping to the database.

Related topic

[VARS Mapping](#)

Editing VARS Mappings

Follow these steps to edit an existing VARS mapping.

1. On the **VARS Mapping** tab, select the VARS mapping to edit.
2. Click **Edit**.
Result: The Edit Variable Announcement Rule Set Mapping screen is displayed.
For a description of each field on this screen, see [VARS Mapping Fields](#).
3. Amend the VARS mapping as required.
Tip: To display the details of an existing mapping in the **Map Rule** area, select it from the **Mappings** table. Click **Map** to update the mapping's details.
4. Click **Save** to save the changes to the database.

Related topic

[VARS Mapping](#)

Deleting a VARS Mapping

Follow these steps to delete an existing VARS mapping.

1. On the **VARS Mapping** tab, select the VARS mapping to delete.
2. Click **Delete**.
Result: The Confirm Delete prompt is displayed.
3. Click **OK** to remove the VARS mapping from the database.

Feature Sets

Feature node sets must be set up to allow customers to use feature nodes in their control plans.

You use the **Feature Sets** tab to configure and maintain the ACS feature sets. A feature set is a convenient way of grouping feature nodes. Customers are generally allocated one or more feature sets. The feature nodes from those feature sets can be used in any control plan the customer creates.

When a feature set (or group of feature sets) has been configured for a customer, only the feature nodes associated with the set (or sets) will be available in the control plan feature palette. The customer will only be able to use these nodes when they are creating their control plans.

Feature sets are created and maintained by the ACS system administrator. Therefore, this screen is only available to the ACS system administrator.

Adding Feature Sets

Follow these steps to add a new feature node set.

1. On the **Feature Sets** tab, click **New Set**.

Result: The New Feature Node Set screen is displayed.

2. Enter the name of the new feature set in the **New set name** field.
3. Click **Save**.

Result: The new feature set is saved to the database.

Tip: The feature node set is created with all nodes cleared. Follow the procedure below to **Edit** the feature node set.

Related topic

[Feature Sets](#)

Editing Feature Sets

Follow these steps to edit a feature set, and configure the feature nodes available to the selected customer.

1. On the **Feature Sets** tab, select the feature set you require from the feature node list.
2. Click **Edit Set**.

Result: The Edit Feature Node Set screen is displayed.

3. The screen contains all the available feature nodes. For ease of use, all nodes have been grouped according to use, under one of these tabs.. Navigate between the tabs and select the check boxes beside each node to select the feature nodes you require for your customer.

To make a feature node:

- Available to the customer, ensure the relevant check box is selected.
- Not available to the customer, ensure the relevant check box is not selected.

4. Click **Save** to save the feature set changes to the database.

Note: When the feature set is saved, ACS will recompile any control plans that use that feature set. If feature nodes that are used in compiled control plans are removed from a feature node set, customers who use this set may no longer be able to successfully compile their control plans.

Related topic

[Feature Sets](#)

Deleting Feature Sets

Follow these steps to delete an existing feature set.

1. On the **Feature Sets** tab, select the feature set from the feature node set drop down list.
2. Click **Delete Set**.

Result: The Confirm Delete prompt is displayed.

3. Click **OK** to remove the feature set from the database.

Warning: You cannot delete a feature set that is being used in a current customer control plan.

16

Profile Tag Details

In a service application like CCS, you may want to set up subscriber profile groups. One of the fields of a subscriber profile group is the profile field. The contents of the profile field are obtained from an ACS customer profile group.

To use subscriber profiles, you must first set up customer profiles in ACS. You do this from the **Profile Tag Details** tab of the ACS configuration screen.

Profiles can also be established for:

- Prefix trees
- Ordered prefix trees
- Arrays

For detailed information, see the Profile Blocks and Fields topic in *Feature Nodes Reference Guide*.

Profile Tag Types

The tag names for profile fields are defined on the **Profile Tag Details** tab in the ACS Configuration screen.

The following hard coded profile data types are supported:

Data Type	Description
Announcement Data	(Ann Id, Lang) -> SDF Name and SDF Ann ID. Used by the Global Profile - Internal use
Array	An array is a series of elements of the same type placed in contiguous memory locations that can be individually referenced by adding an index to a unique identifier. Example: Tag 123456 array:
Boolean	true, false (1 or 0)
Byte	A single byte integer (0 to 255).
Date	A date, in Unix time, that is, seconds since January 1 1970 GMT.
Discount Specification	4 bytes for 1st discount, 4 bytes for 2nd discount, 8 bytes for maximum charge in the subunit of the currency, for example, in cents.
Hunting Config	An array of structure, each structure containing the details for each number in a hunting list. <ol style="list-style-type: none">1. Addr - numeric string. This is the telephone number to ring.2. VPN Network ID - unsigned 32-bit integer. 0 meaning off-net.3. Timeout - unsigned 32-bit integer. This is how long to let it ring for before going on the the next number.
Integer	64-bit signed or 32-bit signed integer. 32 bits will be used for values which can be represented by 32 bits.

Data Type	Description
Limited Numeric String	<p>A limited numeric string. Valid characters are 0-9.</p> <p>Note: The limit and the value are each stored in a separate profile block, but with the same tag code:</p> <ul style="list-style-type: none"> The limit is stored in either the product type profile, or customer profile. The value is stored in the profile block configured in the Check Limitations feature node. <p>For example, if tag 78787878 is a limited numeric string, the maximum length can be stored as an integer under tag 78787878 in the product type profile and the actual value can be stored as a string under tag 78787878 in the subscriber profile.</p>
Long Triple	<p>Consisting of 3 signed 4 byte integers (12 bytes).</p> <p>Used for switch node exits in the control plan Profile.</p>
Limited Ordered Prefix Tree	<p>A limited ordered prefix tree is made up of a limited list of numbers.</p> <p>Note: The limit and the value are each stored in a separate profile block, but with the same tag code. These are stored in the profile blocks configured in the Check Prefix Tree Capacity feature node.</p>
Miscellaneous	Can contain anything
Numeric String	A string, but can contain only numbers. Valid characters are 0-9.
Number List	Sub-profile block containing prefix string maps. Used in the Number Lookup and Translation node.
Ordered Prefix String	An ordered prefix tree comprising an ordered list of numbers
Patterns	Stores patterns, in the format used by the Number Matching node
Prefix Tree	<p>Mapping of digit prefixes to integer.</p> <p>Example: "111" maps to 10 "222" maps to 20</p>
Prefix String Map	<p>Mapping of digit prefixes to digit string.</p> <p>Example: "111" maps to "234" "222" maps to "456"</p>
Price	<p>The price, without the currency symbol or decimal point.</p> <p>Example: "1143" for \$11.43</p>
Profile Block	A mapping of integer tags
Raw Data	Arbitrary bytes of any length
Short	Signed 16-bit integer
String	A non limited ASCII string
Time	<p>The 24 hour time, without the colon between hours and minutes.</p> <p>Example: "2357" for 23:57</p>
Unsigned 32-bit Integer	32-bit unsigned integer
Unsigned 64-bit Integer	64-bit unsigned integer
VARs	Used in the Global Profile. Stores variable announcement rule set in the same format as that created on VARs tab of ACS Configuration screen.
VARs Mapping	Used in the Global Profile. Stores variable announcement rule set mapping in the same format as that created on VARs Mapping tab of ACS Configuration screen.

Data Type	Description
VXML Announcement	Voice XML announcement location. A string containing a URL. Used in the DAP Play VXML Announcement node.
Zone	A set of shape definitions for the area covered by the zone. Shapes may be circular or rectangular and are defined by their coordinates. Note: You can set up and populate zone tags but they may only be used if the Location Capabilities Pack (LCP) is installed.

Filtering Profile Tags

You can filter Profile tags to reduce the time it takes to locate tags in the list, allowing you to define and create services more efficiently. You can filter Profile tags by the name, type, or tag (ID) value or you can specify **Name, Type & Tag** to search all three columns. The procedure is the same for each option.

Follow these steps to filter Profile tags on the Profile Tag Details screen:

1. In the **Filter by** text-input field, enter the value that you want to match in the list. You can enter a value that matches either the entire target value, or a portion of it. For example, you might have several items in the list that have abc as part of the name and you want to select all of them.
2. Select the column you want to search from the **Name, Type & Tag** drop down list. If you select the **Name, Type & Tag** item, ACS attempts to match the value against all three columns.
3. Select the **Prefix only** checkbox if you want to match your search value against only the beginning of the target value. For example, if you entered abc as your search value and you want to match only values in the **Name** column that *begin* with "abc", select the **Prefix only** checkbox. If, however, you want to match both abcdef and fedabc in the **Name** column, do not select **Prefix only**.

Selection occurs as soon as you enter a value in the **Filter by** text-input field, based on the current criteria in the **Name, Type & Tag** drop down list and the **Prefix only** checkbox. If you change the search criteria, selection occurs again based on the new values that you specify.

Adding Profile Tags

Follow these steps to add new profile tags to the list .

1. On the **Profile Node Details** tab, click **New**.
Result: The New Profile Tag screen displays.
2. In the **Profile Tag Name** field, enter a name to identify the tag.
3. In the **Profile Tag Type** drop-down list, select the required property.
4. In the **Profile Tag** and **Parent Profile Tag** fields, enter the decimal value of the tags.
Note: These values should be within the value range allocated.
5. In the **Parameter Type** drop down list, select one of the following parameter types:
 - Undefined – Use this setting if you are creating the profile tag for any profile block other than Call Context. This is the default.

- **Input** – Used by the Call Context profile block only. When incoming profile data is mapped to the Call Context profile block, the data value is inserted in the InitialDP for the call.
- **Output** – Used by the Call Context profile block only. When outgoing profile data is mapped to the Call Context profile block, nothing happens.

Note: The Call Context profile block is supported for backwards compatibility only. If you map this profile tag to a Call Context profile block, you will see a "-" in the **Profile Block Type** field of the **Profile Tag Mapping** tab.

6. Click **Save**.

Result: The new profile tag appears in the list and is stored in the database.

Related topic

[Profile Tag Details](#)

Editing Profile Tags

To edit an existing profile tag, follow these steps.

1. On the **Profile Tag Details** tab, select the profile you require from the profile list.
2. Click **Edit**.

Result: The Edit Profile Tag screen displays.

3. Make the changes required.

Warning: If you change the profile tag type for a profile tag that is accessed by a feature node in your control plans, then you must perform the following steps to ensure the new data type is used by the feature node. For each affected control plan and feature node:

- a. Re-open and then save the feature node configuration in the control plan.
- b. Save and recompile the control plan.

4. Click **Save**.

Result: The updated profile tag row appears in the list and its details are stored in the database.

Related topic

[Profile Tag Details](#)

Deleting Profile Tags

Follow these steps to remove a profile tag.

1. On the **Profile Tag Details** tab, select the profile from the profile list.
2. Click **Delete**.

Result: The Confirm Delete screen displays.

3. Click **Ok**.

Result: The profile tag is removed from both the list and the database.

17

Profile Tag Mapping

The **Profile Tag Mapping** tab enables you to map a profile tag to a profile block.

For more information about profiles, see *CPE User's Guide*.

Adding Profile Tag Mappings

Follow these steps to add a new profile tag mapping.

1. On the **Profile Tag Mapping** tab, click **New**.
Result: The New Tag/Profile Mapping screen displays.
2. From the **Profile Block** drop-down list, select the profile block.
3. From the **Profile Tag** drop-down list box, select the required tag.
4. Click **Save**.
Result: The new profile tag mapping appears in the list and is stored in the database.

Related topic

[Profile Tag Mapping](#)

Deleting Profile Tag Mapping

Follow these steps to remove a profile tag mapping.

1. On the **Profile Tag Mapping** tab, select the mapping from the list.
2. Click **Delete**.
Result: The Confirm Delete screen displays.
3. Click **Ok**.
Result: The profile tag mapping is removed from both the list and the database.

Editing Profile Tag Mapping

Follow these steps to edit an existing profile tag mapping.

1. On the **Profile Tag Mapping** tab, select the profile you require from the profile list.
2. Click **Edit**.
Result: The Edit Tag/Profile Mapping screen displays.
3. Make the changes required.
4. Click **Save**.
Result: The updated profile tag row appears in the list and its details are stored in the database.

Related topic

[Profile Tag Mapping](#)

Table Lookup Mapping

The **Table Lookup Mapping** tab enables you to search a customer's table lookup datasets for prefix number and code mappings.

Each available table lookup dataset contains the prefixes and code mappings for a group of related codes, for example, for a specific geographic area or suburb.

Public and Private Table Lookup Datasets

A table lookup dataset can be public or private. A privately owned table lookup dataset belongs to a specific customer. It is only available to that customer and the parent customers linked to that customer in the customer hierarchy. A publicly owned table lookup dataset is available to all customers.

Searching a Dataset for a Prefix or a Mapping Code

To search a customer's table lookup dataset for a prefix number or a mapping code:

1. In the ACS Configuration window, select the customer from the **Customer** list.
2. On the **Table Lookup Mappings** tab, select the required table lookup dataset from the **Dataset** list.
3. (Optional) To search for prefixes that are mapped to a specific code, enter the code or the initial digits of the code in the **Lookup Result** field.
4. (Optional) To search for the codes mapped to a specific prefix number, enter the prefix or the initial digits of the prefix in the **Lookup Input** field.
5. Click **Search**.

The table on the **Table Lookup Mapping** tab lists the prefixes and codes that match the criteria you entered. The prefixes are listed in the **Lookup Input** field and their corresponding codes are listed in the **Lookup Result** field.

Tip: To view all the prefixes and code mappings in a dataset leave both search fields blank.

19

Triggers

Oracle Communications Billing and Revenue Management (BRM) is able to trigger end user notifications at any point during a call or session based on actual and forecast usage, to ensure the notifications are delivered at the earliest possible moment. The following real-time notification scenarios are currently possible with BRM:

- Threshold notifications (for example, low balance threshold breach)
- Subscription expiry warning notifications
- Recurring usage notifications (for example, notifications for every specified number of MB of usage)
- Tariff change notifications (for example, peak -to off-peak rate change, or free minutes exhaustion)

Note: Tariff change notifications are not currently supported in NCC.

NCC receives the BRM in-session notifications (embedded in authorization and reauthorization responses) through the BRM Charging Driver (BCD). The BCD actions extract any BRM notifications and stores them in specified ACS profile fields.

Each authorization or reauthorization response from BRM may contain zero or more in-session notifications. The notifications can trigger control plans at the point they are received. It is possible to deliver a notification or announcement for each in-session notification provided in each response.

You use the **Triggers** tab to configure control plan trigger definitions for each of your customers. A trigger specifies the control plan to use and the profile tags to pass to the triggered control plan in its incoming session data.

Trigger Fields

This table describes the function of each field.

Field	Description
Name	The name of the trigger.
Public	A control plan trigger definition can be made public, which will make it available to any service provider, or private, which will make it available only to the owning service provider.
Control Plans	The control plan invoked by this trigger definition. The control plan is run when the trigger is invoked by NCC, for example; to handle BRM in-session notifications. The control plan drop down list displays all the control plans a subscriber can use. Tip: This list can be shortened by using the Search By field and then Search .

Field	Description
Search By	Use initial characters of the control plan name or combine with % (match on any number of characters), or _ (match on a single character). Examples: Search for e%SMS will find all control plan names beginning with e and containing SMS. Search for e_han%SMS will find all control plan names beginning with e, containing the string han in positions 3 to 5, and containing SMS. The list can be further restricted by entering a maximum number of names to show in the Max Rows field.
Profile Tags	This table displays a list of source profile tags to be copied into the Incoming Session Data of the triggered control plan.

Adding Control Plan Triggers

Follow these steps to add a new control plan trigger.

1. On the **Triggers** tab, click **New**.
Result: The New Trigger screen displays.
2. Configure this record by entering data in the fields on this screen.
For information about the fields on this screen, see [Trigger Fields](#).
3. [Add Trigger Tags](#) or [Edit Trigger Tags](#), or [Edit Trigger Profiles](#) for the trigger tags listed in the table.
4. Click **Save**.
Result: The new trigger appears in the list and is stored in the database.

Related topic

[Triggers](#)

Editing Control Plan Triggers

Follow these steps to edit an existing control plan trigger.

1. On the **Triggers** tab, select the trigger you require from the table.
2. Click **Edit**.
Result: The Edit Trigger screen displays.
3. Make the changes required. For information about the fields on this screen, see [Trigger Fields](#).
4. [Add Trigger Tags](#) or [Edit Trigger Tags](#), or [Edit Trigger Profiles](#) for the trigger profiles listed in the table.
5. Click **Save**.

Result: The updated trigger appears in the list and its details are stored in the database.

Related topic

[Triggers](#)

Deleting Control Plan Triggers

Follow these steps to delete a control plan trigger.

1. On the **Triggers** tab, select the trigger to delete from the table.
2. Click **Delete**.

Result: The confirm delete dialog displays.

3. Click **OK** to confirm.

Related topic

[Triggers](#)

Adding Trigger Tags

Follow these steps to add a source profile tag to the list of tags for this trigger.

1. On the New Trigger or Edit Trigger window, click **New**.

Result: The New trigger tag window is displayed. Note that the Edit trigger tag window displays the same fields.

2. Select from the **Data Type**, **Location** and **Field** drop down lists the profile field containing the source tag.

The in-session notification tags are prefixed with `ISN`.

3. To select the override target field, select the **Override Target Field** check box, then select the field from the drop down.
4. Click **Save**.

Related topic

[Triggers](#)

Editing Trigger Tags

Follow these steps to edit the source profile tag details.

1. On the New Trigger or Edit Trigger window, select the trigger tag to edit in the table.
2. Click **Edit**.

Result: The Edit trigger tag window is displayed.

3. Update the fields, described in [Adding Trigger Tags](#), as required.
4. Click **Save**.

Related topic

[Triggers](#)

Editing Trigger Profiles

Follow these steps to delete trigger profile tags from a trigger.

1. On the New Trigger or Edit Trigger window, select the trigger profile tag to delete in the table.
2. Click **Delete**.
Result: The delete confirmation dialog is displayed.
3. Click **Apply** to confirm.

Related topic

[Triggers](#)

20

Notifications

You can create templates for notification messages.

Templates are used by some ACS feature nodes. They can also be used by other applications (for example, CCS).

Examples of activities that other applications can use notification templates for are:

- Control plans
- Business process logic (BPL tasks)
- Credit transfers
- Periodic charges
- Profile updates
- Real-time notifications
- Heavy user bonuses.

Templates incorporate provision for selecting the way the notification message is transported, whether it is through Messaging Manager or a notification interface.

Notification Types

In ACS, SMS notification templates are classified and stored by application and type. A combination of application and type is called a notification type. A notification type may contain more than one notification template but each template must use a different language.

Finding Notification Type

This function is used to lessen the number of rows in the table.

Follow these steps to find an existing notification template.

1. 1 On the **Notifications** tab, select the **Filter by Notification Name** check box.

Result: The **Search** button and search criteria field become available.

2. 2 Enter the search criteria in the text field.

Note: The search is not case sensitive, the characters must appear sequential, but start anywhere in the Notification name.

For example, `ON` will return any Notification that has `ON` or `on` somewhere in the name.

3. 3 Click **Search**.

Result: All matches will be listed in the tab table.

Template Matching

Template matching is based on customer ID, template ID and language ID (either the subscriber's language, or the language specified in the node dialog) in the following order:

Customer	Template	Language
Control Plan	Node	Node or subscriber profile
Control Plan	Node	Global default
NULL (Global)	Node	Node or subscriber profile
NULL (Global)	Node	Global default

Note:

- When the notification feature node is executed it shall attempt to retrieve the template based upon the language ID, template ID and customer ID.
- If no template is found for the specified language, the node will attempt to find a template based on the customer, default language and template ID
- If no template is found for the customer and language, the node will attempt to find a global template based on language and template ID

Languages

Templates can be prepared in multiple languages. If possible, a notification is sent in the language of the receiving party. If the language of the receiving party is not on the notification template, a message in the default language is sent.

The default language is defined for the customer or service provider.

You set up other languages using the ACS Tools screen. See [Language](#).

Adding a Notification Type

Follow these steps to create a notification type.

1. In the upper part of the **Notifications** tab, click **New**.
Result: The New Notification Type screen is displayed.
2. In the **Customer** field, select the customer specific or global option for notification delivery.

Note: This field is only available when the user has permission to edit global notifications.

3. In the **Application Name** field, type a name that identifies the application to you.

Notes:

- You must not leave the **Application Name** field blank.
- You may enter up to 16 alphabetical or numerical characters.
- The name may have to match the application that sends the notification. For example, CCS notifications from the VWS all have application name `ccs`.

4. In the **Notification Type** field, enter a name that identifies the type of notification to you.

Notes:

- You must not leave the **Notification Type** field blank.
- You may type up to 32 alphabetical or numerical characters.

Result: The **Save** button becomes active.

5. In the **Delivery Mechanism** section, select the:

- **Transport** from the drop down list - this is the method by which the notification is sent.
- **Message Class** from the drop down list - this determines whether a SMS is stored in the phone's SIM (that is, normal behavior), or presented to the subscriber as a flash message and not stored.
- **Subscriber Opt-Out** from the drop down list - this determines what notification types the subscriber can opt out from receiving.

Notes:

- The message class list changes depending on the transport selected, and is used for SMS notifications only.
- Opt-Out option --Not Used-- means that subscribers cannot opt out of this notification.

6. In the **Sender Address** frame, perform one of the following actions:

- Select the profile location containing the sender address from the **Data Type**, **Location** and **Field** drop down lists
- Enter a specific address - select **Fixed Value** from the **Data Type** drop down list and then type the address in the **Fixed Value** field.

7. In the **Delivery Time** frame, optionally set a delivery time restriction:

- Select the **Not Before** check box to force delivery of the message to be after the time selected in the two drop down lists of hours and minutes.
- Select the **Not After** check box to force delivery of the message to before the time selected in the two drop down lists of hours and minutes.

Notes:

- The delivery time options apply to VWS notifications only.
- If the Not Before time is after the Not After time, then notifications are delivered between the not before time on one day and the not after time on the next day.

8. Click **Save**.

Result: The new notification type is added to the **Notifications** tab table.

Tip: If the search feature has been used and the new entry is not a match against the search criteria, it will not appear in the table. Either change the search criteria or deselect the **Find by** check box.

Note: The list of data types is fixed at installation time for each feature node or screen.

Further reference:

- For information about profile blocks (data type, location, and field) and how to use them, see Profile Blocks and Tags.

- The primary tag lists are configured in the **SMS > Services > ACS Service > Configuration > Profile Tag Details** and **Profile Tag Mapping** tabs (see *ACS User's Guide, Profile Tag Details* for more information).

Related topic

[Notifications](#)

Editing a Notification Type

To edit a notification type, follow these steps.

1. On the **Notifications** tab, find the notification type to edit. See [Finding Notification Type](#).
2. Select the notification type to change in the table row.
3. Click **Edit**.

Result: The Edit Notification Type screen is displayed.

4. Change the relevant drop down list options as required.
5. Click **Save**.

Note: The list of data types is fixed at installation time for each feature node or screen.

Further reference:

- For information about profile blocks (data type, location, and field) and how to use them, see *Profile Blocks and Tags*.
- The primary tag lists are configured in the **SMS > Services > ACS Service > Configuration > Profile Tag Details** and **Profile Tag Mapping** tabs (see *ACS User's Guide, Profile Tag Details* for more information).

Related topic

[Notifications](#)

Deleting a notification

To delete a notification type, follow these steps.

1. On the **Notifications** tab, find the notification type to delete. See [Finding Notification Type](#).
2. Select the notification type to delete in the table row.
3. Click **Delete**.

Result: The Delete Notification? screen displays.

4. Click **Delete**.

Result: The notification type is removed from the Notifications table.

Rules for Recharge Notifications

When a user recharges the account, the system searches the database for the notification to trigger. The search is based on a search string formed by a combination

of voucher name, EDR scenario, balance type, and service provider. The search string is formed in the following order and looked for in the database:

1. If the voucher name exist in the database, follow this order:
 - a. Voucher Name + EDR Scenario + Service Provider
 - b. Voucher Name + EDR scenario + NULL
 - c. Skip to search string 3.
2. If voucher name does not exist in the database, follow this order:
 - a. "AccountRecharge" + BalanceTypeString + Service Provider
 - b. "AccountRecharge" + BalanceTypeString + NULL
3. "AccountRecharge" + Service Provider
4. "AccountRecharge" + NULL

Notification Template Editor

Notification templates are used to create messages containing variable information embedded within them.

For example, a message might be:

```
Your current balance is 20 dollars.
```

Where the 20 dollars would be a variable part that changes every time the template is used.

Adding a Notification Template

To create a notification template, follow these steps.

1. On the **Notifications** tab, find the notification type to add templates to. See [Finding Notification Type](#).
2. Select the notification type to add templates to from the table row.
3. In the lower part of the screen, click **New**.
Result: The New Notification Template screen is displayed.
Note: Variable parts are only available if **Open Notifications** has been activated
4. If necessary, select a language from the **Language** drop-down list box.
Note: You must select a language which has not already been assigned to a notification template listed under the notification type you chose in step 1.
5. In the work area, enter the text of the message that the template will contain.

Notes:

- You may enter up to 512 alphabetical or numerical characters.
- If the Arabic language was selected at step 3, you may enter Arabic characters. However whichever language is selected you can enter any Unicode characters.
- You must not leave the work area blank.

Result: The **Save** button becomes active.

6. If a template containing variable parts is required, use the icon list on the left side to insert the required parts. Click and drag an icon to the place in the text that it is required and release the mouse.

Result: The Notification Variable screen opens, with the variable part option selected in **Source Group** field matching the icon name.

Each variable part can have one of several configuration options, depending on the field/profile tag selected as the source of the variable part. See [Value Formatting Types](#) for more information.

This is the list of variable parts available in the **Source Group** field.

- **Balance** - enables you to insert balance information into the template.
- **Charge** - enables you to insert charging information into the template.
- **Periodic** - enables you to insert periodic charge information into the template.
- **Profile** - enables you to insert subscriber information into the template.
- **Recharge** - enables you to insert recharge information into the template.
- **Reward** - enables you to insert rewards information into the template.
- **SPM** - enables you to insert subscriber management information into the template.
- **Session** - enables you to insert session information into the template.
- **Wallet** - enables you to insert subscriber wallet information into the template.

See Variable part fields for information about which variable part type is available for each source group.

7. Click **Preview** to review what the notification will be like.

Result: The Template Preview dialog displays the notification.

8. Click **OK**.

Result: The notification template is stored in the database, classified for the notification type you chose at Step 1.

Note: When saved, each field entry used for a variable part has an associated ON profile tag defined which is used to store the value of the field when an open notification reaches the SLC.

Related topic

[Notification Template Editor](#)

Editing a Notification Template

Follow these steps to edit a notification template.

1. On the **Notifications** tab, find the notification type associated with the template requiring changes. See [Finding Notification Type](#).
2. Select the notification type to edit from the table row.
Result: All the templates for the notification are listed.
3. Select the template to change by clicking in the template table row.
4. In the lower part of the screen, perform one of the following actions:
 - Click **Delete** to remove the template
 - Click **Edit** to change the template

Result: If editing, the Edit Notification Template screen is displayed.

Notes:

Each variable part can have one of several configuration options, depending on the field or profile tag selected as the source of the variable part. See [Value Formatting Types](#) for more information.

This is the list of variable parts.

- **Balance** – Enables balance information to be inserted into the template.
 - **Charge** – Enables charging information to be inserted into the template.
 - **Periodic** – Enables periodic charge information to be inserted into the template.
 - **Profile** – Enables subscriber information to be inserted into the template.
 - **Recharge** – Enables recharge information to be inserted into the template.
 - **Reward** – Enables rewards information to be inserted into the template.
 - **SPM** – Enables subscriber management information to be inserted into the template.
 - **Session** – Enables session information to be inserted into the template.
 - **Wallet** – Enables subscriber wallet information to be inserted into the template.
5. If required, select a different language from the **Language** drop-down list.

Note: You must not select a language already assigned to a notification template listed under the notification type you chose at step 1. If you do, an error message appears when you try to save the notification template at step 6.

6. Edit the **Text** field as needed.

The template variable part icons can be:

- Moved to another position – Click on the icon and drag the red line to the new insertion point.
 - Deleted – Click on the icon to open the Notification Variable dialog and then click **Delete**.
 - Added – Click on the required icon and drag it to the desired location in the text.
 - Edited – Click on the icon to open the Notification Variable dialog. The relevant Notification Variable screen for the variable part opens.
7. Click **Preview** to review what the notification will be like.

Result: The Template Preview dialog displays the notification.

8. Click **OK**.

Note: When saved, each field entry used for a variable part has an associated ON profile tag defined which is used to store the value of the field when an open notification reaches the SLC.

Related topic

[Notification Template Editor](#)

Deleting a Notification Template

Follow these steps to delete a notification template.

1. On the **Notifications** tab, find the notification type associated with the template requiring deletion. See [Finding Notification Type](#).
2. Select the notification type to edit from the table row.
Result: All the templates for the notification are listed.
3. Select the template to delete, by clicking in the template table row.
4. In the lower part of the screen, click **Delete**.

Result: The Confirm Delete screen is displayed.

5. Click **Ok**.

Result: The notification template is removed from the database.

Value Formatting Types

Any notification template can have any number of variable parts, configured using the Notification Variable screen. Each variable part can have one of several configuration options, depending on the field/ profile tag selected as the source of the variable part. See [Notification Template Editor](#) for more information about notification templates.

Notes:

- Each of the variable parts may have extra fields to choose from in the top panel. For example, when you choose a `Balance` source group, you get a combo-box to choose which balance type you want. When you select `Profile`, you get the standard combo-boxes to choose a profile tag.
- Some of the variable parts let you choose **Server to determine** in the formatting panel. This means use the formatting specified for that type of data in another part of the system, see [Defined Definitions](#) for examples.

The available format types for variable parts are:

- [Setting Boolean Configuration](#)
- [Setting DateTime Configuration](#)
- [Setting Integer Configuration](#)
- [Setting Prefix Tree Configuration](#)
- [Setting String Configuration](#)

Defined Definitions

These are examples of definitions defined elsewhere in the system. This is not an exhaustive list, just a sample.

Definitions on the **Wallet Management > Balance Type Translations** tab for balance formatting:

- Balance / Value
- Charge / Value
- Recharge / Value

Definitions on the **Wallet Management > Balance Type Translations** tab for balance expiry formatting for:

- Balance / Expiry
- Recharge / Expiry

Definition on the **Wallet Management > Wallet Name Translation** tab for:

- Wallet / Expiry

Boolean Format Type

Follow these steps to designate location and formatting for a boolean variable part.

1. In the **Variable Source** frame, select the variable part source from the **Field** drop down list.

Warning: The **Source Group** drop down list shows the variable part type associated with the icon selected in the Notification Template screen and should be not be changed.

2. Select the **Balance Type** from the drop down list.

Note: The field balance type matches the **Field** selected.

3. Enter a **Default Value** that is used when there is no content or problem with the source location.

4. Configure the **Value Formatting (..)** frame, appropriate to the variable source. See:

- [Setting Boolean Configuration](#)
- [Setting DateTime Configuration](#)
- [Setting Integer Configuration](#)
- [Setting Prefix Tree Configuration](#)
- [Setting String Configuration](#)

Related topic

[Value Formatting Types](#)

Date/Time Format Type

Follow these steps to designate location and formatting for a date/time variable part.

1. In the **Variable Source** frame, select the variable part source from the **Field** drop down list.

Warning: The **Source Group** drop down list shows the variable part type associated with the icon selected in the Notification Template screen and should be not be changed.

2. Enter a **Default Value** that is used when there is no content or problem with the source location.

3. Configure the **Value Formatting (..)** frame, appropriate to the variable source. See:

- [Setting Boolean Configuration](#)
- [Setting DateTime Configuration](#)
- [Setting Integer Configuration](#)
- [Setting Prefix Tree Configuration](#)
- [Setting String Configuration](#)

Related topic

[Value Formatting Types](#)

Integer Format Type

Follow these steps to designate location and formatting for an integer variable part.

1. In the **Variable Source** frame, select the variable part source from the **Field** drop down list

Warning: The **Source Group** drop down list shows the variable part type associated with the icon selected in the Notification Template screen and should be not be changed.

2. Select the source **Balance Type** from the drop down list.

Note: The field balance type matches the **Field** selected.

3. Enter a **Default Value** that is used when there is no content or problem with the source location.

4. Configure the **Value Formatting (..)** frame, appropriate to the variable source. See:

- [Setting Boolean Configuration](#)
- [Setting DateTime Configuration](#)
- [Setting Integer Configuration](#)
- [Setting Prefix Tree Configuration](#)
- [Setting String Configuration](#)

Related topic[Value Formatting Types](#)

Prefix Tree Format Type

Follow these steps to designate profile location and formatting for a variable part.

1. In the **Variable Source** frame, leave the **Source Group** and **Field** with their default profile and empty values.

Warning: The **Source Group** drop down list shows the variable part type associated with the icon selected in the Notification Template screen and should be not be changed.

2. Select the source location using the **Data Type**, **Location** and **Field** drop down lists.

3. Enter a **Default Value** that is used when there is no content or problem with the source location.

4. Configure the **Value Formatting (..)** frame, appropriate to the variable source. See:

- [Setting Boolean Configuration](#)
- [Setting DateTime Configuration](#)
- [Setting Integer Configuration](#)
- [Setting Prefix Tree Configuration](#)
- [Setting String Configuration](#)

Note: The list of data types is fixed at installation time for each feature node or screen.

Further reference:

- For information about profile blocks (data type, location, and field) and how to use them, see Profile Blocks and Tags.
- The primary tag lists are configured in the **SMS > Services > ACS Service > Configuration > Profile Tag Details** and **Profile Tag Mapping** tabs (see *ACS User's Guide, Profile Tag Details* for more information).

Related topic

[Value Formatting Types](#)

String format type

Follow these steps to designate string location and formatting for a variable part.

1. In the **Variable Source** frame, select the variable part source from the **Field** drop down list.

Warning: The **Source Group** drop down list shows the variable part type associated with the icon selected in the Notification Template screen and should be not be changed.

2. Enter a **Default Value** that is used when there is no content or problem with the source location.
3. Configure the **Value Formatting (..)** frame, appropriate to the variable source. See:

- [Setting Boolean Configuration](#)
- [Setting DateTime Configuration](#)
- [Setting Integer Configuration](#)
- [Setting Prefix Tree Configuration](#)
- [Setting String Configuration](#)

Related topic

[Value Formatting Types](#)

Setting Boolean Configuration

Follow these steps to set boolean formatting.

1. In the **Value Formatting (Boolean)** section of the Notification Variable screen, select the options for setting the boolean values.
2. To use a predefined format, select **Use predefined format**, then select the format from the drop down list.
3. To specify a format, select **Use these terms**, then enter what text will be displayed for true and false values.

4. To save the changes, click **Save**.

To exit without saving anything, click **Cancel**.

To remove the variable part from the notification, click **Delete**.

Related topic

[Value Formatting Types](#)

Setting DateTime Configuration

Follow these steps to format a date/time variable part.

1. In the **Value Formatting (Date/Time)** section of the Notification Variable screen, select the options for setting the date and time values.
2. To use a definite date and time, select **Absolute date**, then select the predefined date and time format from the drop down list.

For date and time format descriptions see [Date formats](#) and [Time formats](#).

3. To insert the amount of time between now and the date/time being formatted, select **Elapsed time**, then select the check boxes as required.

Examples:

- Select **Months**, and **Days** for "x months, y days"
- Select **Weeks**, **Days**, **Hours** for "x weeks, y days, z hours"

Note: Change the joiner value to make grammatically correct messages, for example replace , with `and` for the Days row would change the example to "x weeks, y days and z hours"

4. To save the changes, click **Save**.

To exit without saving anything, click **Cancel**.

To remove the variable part from the notification, click **Delete**.

Related topic

[Value Formatting Types](#)

Date Formats

This table list the date formats and their examples.

Format	Format Example
d/MM/yyyy	10/07/2009
MM/d/yyyy	07/10/2009
dddd, d MMMM yyyy	Friday, 10 July 2009
d MMMM yyyy	10 July 2009
d/MM/yy	10/07/09
MM/d/yy	07/10/09
yyyy-MM-dd	2009-07-10
d-MMM-yy	10-Jul-09
d.MM.yyyy	10.07.2009
d MMM. yy	10 Jul. 09
d MMMM yyyy	10 July 2009
MMMM yy	July 09
MMM-yy	Jul-09

Date Format Key

This table describes the symbols used in the date formats.

Symbol	Description
d	Day of month
dd	Two-digit day of month
dddd	Name of day of week
MM	Two-digit month
MMM	Abbreviated month name
MMMM	Full month name
yy	Two-digit year
yyyy	Four-digit year

Time Formats

This table lists the time formats and their examples.

Format	Format Example
h:mm am/pm	4:03 pm
h:mm:ss am/pm	4:03:54 pm
hh:mm am/pm	04:03 pm
hh:mm:ss am/pm	04:03:54 pm
HH:mm	16:03
HH:mm:ss	16:03:54

Time Format Key

This table describes the symbols used in the time formats.

Symbol	Description
h	Hour, 0-12
hh	Two-digit hour, 0-12
HH	Hour, 0-23
mm	Two-digit minute
ss	Two-digit second
am/pm	am/pm indicator

Setting Integer Configuration

Follow these steps to format an integer variable part.

1. In the **Value Formatting (Integer)** section of the Notification Variable screen, select the option for setting the integer value.

2. To use a predefined format, select **Use predefined format** and then select the format from the drop down list.
3. To specify a format, select **Use this format** and then enter the values as relevant.
 - **Divide by** – The number to divide by to convert the output value from small units to large units. This specifies how to interpret the number being presented.
 - **Digits (whole part)** – The number of digits before an assumed decimal point, this is the minimum space allocated width of the whole part of the number. May cause padding to the left.
 - **Digits (fractional part)** – The number of digits after the decimal point.
 - **Decimal place separator** – The character that signifies the decimal point, this will be skipped if there is no fractional part.
 - **Prefix characters** – Characters to add to the front of the number.
 - **Suffix characters** – Characters to add after the number, this will be skipped if there is no fractional part.

For example:

Received number to be formatted: 12345

- Divide by: 100
- Digits (whole part): 4
- Digits (fractional part): 2
- Decimal place separator: ,
- Prefix characters: \$
- Suffix characters: c

Output: \$ 123,45c

4. To save the changes, click **Save**.
To exit without saving anything, click **Cancel**.
To remove the variable part from the notification, click **Delete**.

Related topic

[Value Formatting Types](#)

Setting Prefix Tree Configuration

Follow these steps to format a prefix tree variable part.

1. In the **Value Formatting (Prefix Tree)** section of the Notification Variable screen, select the option for setting the prefix tree values.
2. Enter the prefix tree field **Separator** to use in the notification. The prefix tree will be presented as a list of items separated by the text in this box.
3. To save the changes, click **Save**.

To exit without saving anything, click **Cancel**.

To remove the variable part from the notification, click **Delete**.

Note: The list of data types is fixed at installation time for each feature node or screen.

Further reference:

- For information about profile blocks (data type, location, and field) and how to use them, see Profile Blocks and Tags.
- The primary tag lists are configured in the **SMS > Services > ACS Service > Configuration > Profile Tag Details** and **Profile Tag Mapping** tabs (see *ACS User's Guide, Profile Tag Details* for more information).

Related topic

[Value Formatting Types](#)

Setting String Configuration

Follow these steps to format a string variable part.

1. In the **Value Formatting (String)** section of the Notification Variable screen, select the options for setting the string values.
2. Select the **Format and trim as follows** option as required:
 - **as-is** – Whatever the profile or default content is already saved as.
 - **UPPER CASE** – Source is changed to all upper case characters.
 - **lower case** – Source is changed to all lower case characters.
 - **Title Case** – Source is changed to upper case characters for start of each word.
3. Optionally, select the **Trim to max length** check box, then enter the maximum length allowed.

Note: The source string will be truncated to this value by removing characters from the end of the string.

4. To save the changes, click **Save**.

To exit without saving anything, click **Cancel**.

To remove the variable part from the notification, click **Delete**.

Related topic

[Value Formatting Types](#)

Termination Ranges

Termination number ranges are set up on the **Termination Ranges** tab of the ACS Resources screen.

A termination range is a mask used to validate the input of a termination number.

The ACS system administrator must assign termination number ranges for each customer. A customer may use their own termination numbers in their control plans, but they cannot edit the termination ranges that are assigned to them. Only the ACS system administrator can edit termination number ranges.

Tip: It is not necessary to set termination ranges in this screen if the customer is a managed customer (that is, the Adding customers check box on the Customer screen was selected).

Termination ranges can only be added, edited or deleted by the ACS system administrator. When editing a termination number range that is currently being used by a compiled control plan, the control plan will be recompiled and the compiler report will be displayed. There may be several control plans to be compiled, so this process may take some time.

Note: It is not possible to delete a termination range that is currently in use by a customer control plan. Editing a termination range will cause all compiled control plans that use that range to be recompiled.

Adding Termination Ranges

Follow these steps to add a new termination range.

1. On the **Termination Ranges** tab, click **New**.

Result: The New Termination Range screen is displayed.

2. In the **Range Model Prefix** field, enter the prefix for the termination number, for example an area code, such as 04, restricting the number to that national area code.
3. From the **Minimum Digits** and **Maximum Digits** boxes, select the minimum and maximum length of the termination number.
4. Click **Save**.

Result: The details are saved and the screen returns to the main window.

If the new termination number is used in a compiled control plan, the compiler report will be displayed. The compiler report gives details of all the control plans that this change caused to be recompiled and their status.

Related topic

[Termination Ranges](#)

Editing Termination Ranges

Follow these steps to edit an existing termination range.

1. On the **Termination Ranges** tab, select a termination range to edit.
2. Click **Edit**.
3. Make the required changes to the fields.
4. Click **Save**.

Result: The Edit Termination Range screen is displayed.

Result: The details are saved and the screen will return to the main window.

If the new record is used in a compiled control plan, the compiler report will be displayed. The compiler report gives details of all the control plans that this change caused to be recompiled and their status.

Related topic

[Termination Ranges](#)

Deleting Termination Ranges

Follow these steps to delete an existing termination range.

1. From the **Termination Ranges** tab, select the termination range you want to delete.
2. Click **Delete**.
3. Click **OK**.

Result: The Confirm Delete prompt is displayed.

Result: The termination range is removed from the database.

Number Translations

Use the **Number Translations** tab on the ACS Resources screen to map numbers to a termination range. Several numbers may map to the same termination range if required. Number translations are used in the Number Lookup node.

This node will look up a number that has been entered by the caller and translate it to a termination number.

The number translation mappings may be viewed by all users, but may only be added, edited, or deleted by users with permission level 4 and above.

Adding Number Translations

Follow these steps to configure number translations.

1. On the **Number Translation** tab, click **New**.

Result: The New Number Translation screen is displayed.

2. In the **Input Number** field, enter the input number.

Note: The input number must be unique for the customer and will accept up to 20 valid characters, where valid characters are 0-9, A-F, * and #.

3. From the **Number Range** drop down list, select the termination range.

4. In the **Termination Number** field, enter the termination number.

5. Click **Save**.

Result: The details are saved and the screen returns to the main window.

Related topic

[Number Translations](#)

Editing Number Translations

Follow these steps to edit an existing number translation.

1. On the **Number Translation** tab, select from the table the number translation record to edit.

2. Click **Edit**.

Result: The Edit Number Translation screen is displayed.

3. Change the details as required.

4. Click **Save**.

Result: The changes are saved to the database.

Related topic

[Number Translations](#)

Deleting Number Translations

Follow these steps to delete an existing number translation.

1. From the **Number Translation** tab, select the number translation to delete.
2. Click **Delete**.
Result: The Confirm Delete prompt is displayed.
3. Click **OK**.
Result: The number translation is removed from the database.

Default Termination Numbers

You use the **Default Termination No** tab of the ACS Resources screen to allocate default termination numbers for your customers.

Default termination numbers are used where a search does not locate a termination number in a control plan.

A customer can only have one default termination number, and it is necessary that the termination number is within the range of termination numbers that have been allocated to that customer.

Allocating Default Termination Numbers

Follow these steps to allocate a default termination number.

1. On the **Default Termination No** tab, select the customer to allocate a default termination number to.
 2. Click **Edit**.
- Result:** The Edit Default Termination Number screen is displayed.
3. From the **Number Range** drop down list, select the number range of the termination number.
 4. In the **Termination Number** field, enter the termination number.
 5. Click **Save**.

Result: The details are saved.

If the new record is used in a compiled control plan, the compiler report will be displayed. The compiler report gives details of all the control plans that this change caused to be recompiled and their status.

Related topic

[Default Termination Numbers](#)

Event Counters

The **Event Counters** tab of the ACS Resources screen displays the event counters for each customer. Each event counter is maintained separately.

Event counters simply count an event. They may be accessed at runtime and can be used, for example, for televoting. Counters can be queried in real-time on the Statistics Chart screen.

It is not possible to delete an event counter that is currently in use by a compiled control plan. Editing an event counter will cause all compiled control plans that use that record to be recompiled.

The ACS system administrator allocates customers a maximum number of counters on the Edit Customer Resource Limits screen. Users of sufficient privilege (level 4 and above) may add, delete, and rename their event counters within that limit.

Adding Event Counters

Follow these steps to add a new event counter.

1. On the **Event Counters** tab, click **New**.

Result: The New Event Counter screen is displayed.

2. In the **Counter** field, enter the name of the event counter.

Note: Event counter names must be unique for that customer, that is, two customers may have counters called 'Stats1', but a customer may not have two counters called 'Stats1'.

3. Click **Save**.

Result: The details are saved and you return to the **Event Counters** tab.

Related topic

[Event Counters](#)

Editing Event Counters

Follow these steps to edit an existing event counter.

1. On the **Event Counters** tab, select from the table the event counter record to edit.

2. Click **Edit**.

Result: The Edit Event Counter screen is displayed.

3. Change the details as required.

4. Click **Save**.

Result: The changes are saved to the database.

Related topic

Event Counters

Deleting Event Counters

Follow these steps to delete an existing event counter.

1. On the **Event Counters** tab, select the event counter to delete.
2. Click **Delete**.
Result: The Confirm Delete prompt is displayed
3. Click **OK**.
Result: The event counter is removed from the database.

Tariff Codes

Use the **Tariff Codes** tab on the ACS Resources screen to add new tariff codes for your customer. Tariff codes are used to return charging information to the switch. This information can be sent either in an SCI or an FCI operation.

The component type (SCI or FCI) will determine how the tariff code is delivered to the service switching point (SSP).

If the component type is set to:

- SCI, then the tariff code will be sent to the switch in an INAP Send Charging Information operation
- FCI, then the tariff code will be sent to the switch in an INAP Furnish Charging Information operation

Tariff codes are used by the Set Tariff Code node to send charging information to the switch.

Adding Tariff Codes

Follow these steps to add a new tariff code for your customer.

1. On the **Tariff Codes** tab, click **New**. **Result:** The New Tariff Code screen is displayed.
2. In the **Tariff Name** field, enter a name for the new tariff code.
3. In the **Tariff Code** field, enter a code for the new tariff code.
4. Select whether the tariff code should be marked to be sent in an SCI component or FCI component.

Note: The tariff code is a hexadecimal code that is usually provided by the switch manufacturer. The tariff code can only be added by the system administrator or ACS Level 6 users.

5. Click **Save**.

Result: The details are saved and the screen returns to the **Tariff Codes** tab.

Related topic

[Tariff Codes](#)

Editing Tariff Codes

Follow these steps to edit an existing tariff code.

1. On the **Tariff Codes** tab, select the tariff code to edit.
2. Click **Edit**.

Result: The Edit Tariff Code screen is displayed.

3. Change the details as required.

4. Click **Save**.

Result: The changes are saved to the database.

Related topic

[Tariff Codes](#)

Deleting Tariff Codes

Follow these steps to delete an existing tariff code.

1. On the **Tariff Codes** tab, select the tariff code to delete.

2. Click **Delete**.

Result: The Confirm Delete prompt is displayed.

3. Click **OK**.

Result: The tariff code is removed from the database.

Incoming Number Restrictions

Allowed and barred numbers in the ACS Resources screen are provisioned on a per customer basis.

Each customer has one incoming and one outgoing list. Each of these lists must be classed as either “Allowed” or “Barred”.

- **Allowed** numbers are allowed only if they occur in the list. If the list is empty then no numbers are allowed – everything is barred.
- **Barred** numbers are barred only if they occur in the list. If the list is empty then no numbers are barred – everything is allowed.

Use with Call Filtering Node

While the primary use of the lists is to allow or bar, based on service number (incoming, or CLI (outgoing) they may in fact be used to compare against any type of number available in the [Call Filtering](#) feature node in the ACS Control Plan Editor.

The lists can be applied in control plans by selecting the service number profile or CLI profile in the Call Filtering node in the CPE. As mentioned earlier, these lists may be used to match against any type of number but are labeled “Incoming” and “Outgoing” for convenience.

Examples:

1. You have an INCOMING ALLOWED list containing the numbers 555-1234, 555-1235, and 555-1236. Calls to the service numbers 555-1234, 555-1235, and 555-1236 are allowed but calls to all other numbers are not allowed, so a call to 444-5555 would not be allowed.
2. You have an INCOMING BARRED list containing the same numbers. Calls to the service numbers listed will not be allowed; calls to all other service numbers are allowed.
3. You have an OUTGOING ALLOWED list containing the same numbers. An outgoing call to CLI 555-1234 would be allowed (as would 555-1235 and 555-1236). Outgoing calls to any other CLI would be barred.
4. You have an OUTGOING BARRED list containing the same numbers. An outgoing call to CLI 555-1234 would be barred (as would 555-1234 and 555-1236). Outgoing calls to any other CLI would be allowed.

Use with Prefix Tree Branching Node

The [Prefix Tree Branching](#) node allows you to select incoming or outgoing list data and branch on whether the number is in that list or not. Used in conjunction with other nodes, such as [Profile Branching](#), you can determine whether it is the barred or allowed list and branch accordingly.

Number Restrictions Tab Fields

Here is a description of the fields used when setting incoming and outgoing number restrictions.

Field	Description
Restriction List	Displays the list of restricted numbers in the number profile. You can: <ul style="list-style-type: none"> • Add new numbers to the list using the New Number field • Delete numbers in this list by highlighting the number and clicking Delete
List Type	Each ACS customer has one incoming and one outgoing restriction list. The list must be classed as either "Allowed" or "Barred". If list type is: <ul style="list-style-type: none"> • Allowed – Numbers are allowed only if they occur in the list. If the list is empty then no numbers are allowed - everything is barred. • Barred – Numbers are barred only if they occur in the list. If the list is empty then no numbers are barred - everything is allowed.
Ignore	Select this check box if you want to ignore the restricted numbers list displayed.
New Number	Use this field to add a new number to the restricted numbers list. Enter the new number then click Add to send it to the list.

Editing Incoming No. Restrictions

Follow these steps to edit numbers in an incoming number restrictions list.

Tip: You can set number restrictions at the SN or CLI level in the Numbers screen.

1. On the **Incoming No. Restrictions** tab, select the type of list from the **List Type** drop down list. If you select **Allowed**, only listed numbers will be allowed. If you select **Barred**, all numbers are allowed, except for the listed numbers.
2. If you want the incoming number restrictions to be ignored for this customer, select the **Ignore** check box.
3. In the **New Number** field, enter a number to add to the list and click **Add**.
Result: The number will be added to the restriction list.
4. From the **Restriction List**, select a number to remove and click **Remove**.
Result: The number will be removed from the restriction list.
5. Click **Save**.
Result: The changes will be saved to the database.

Outgoing Number Restrictions

Allowed and barred numbers in the ACS Resources screen are provisioned on a per customer basis.

Each customer has one incoming and one outgoing list. Each of these lists must be classed as either “Allowed” or “Barred”.

- **Allowed** numbers are allowed only if they occur in the list. If the list is empty then no numbers are allowed – everything is barred.
- **Barred** numbers are barred only if they occur in the list. If the list is empty then no numbers are barred – everything is allowed.

Use with Call Filtering Node

While the primary use of the lists is to allow or bar, based on service number (incoming, or CLI (outgoing) they may in fact be used to compare against any type of number available in the [Call Filtering](#) feature node in the ACS Control Plan Editor.

The lists can be applied in control plans by selecting the service number profile or CLI profile in the Call Filtering node in the CPE. As mentioned earlier, these lists may be used to match against any type of number but are labeled “Incoming” and “Outgoing” for convenience.

Examples:

1. You have an INCOMING ALLOWED list containing the numbers 555-1234, 555-1235, and 555-1236. Calls to the service numbers 555-1234, 555-1235, and 555-1236 are allowed but calls to all other numbers are not allowed, so a call to 444-5555 would not be allowed.
2. You have an INCOMING BARRED list containing the same numbers. Calls to the service numbers listed will not be allowed; calls to all other service numbers are allowed.
3. You have an OUTGOING ALLOWED list containing the same numbers. An outgoing call to CLI 555-1234 would be allowed (as would 555-1235 and 555-1236). Outgoing calls to any other CLI would be barred.
4. You have an OUTGOING BARRED list containing the same numbers. An outgoing call to CLI 555-1234 would be barred (as would 555-1234 and 555-1236). Outgoing calls to any other CLI would be allowed.

Use with Prefix Tree Branching Node

The [Prefix Tree Branching](#) node allows you to select incoming or outgoing list data and branch on whether the number is in that list or not. Used in conjunction with other nodes, such as [Profile Branching](#), you can determine whether it is the barred or allowed list and branch accordingly.

Number Restrictions Tab Fields

Here is a description of the fields used when setting incoming and outgoing number restrictions.

Field	Description
Restriction List	Displays the list of restricted numbers in the number profile. You can: <ul style="list-style-type: none"> • Add new numbers to the list using the New Number field • Delete numbers in this list by highlighting the number and clicking Delete
List Type	Each ACS customer has one incoming and one outgoing restriction list. The list must be classed as either "Allowed" or "Barred". If list type is: <ul style="list-style-type: none"> • Allowed – Numbers are allowed only if they occur in the list. If the list is empty then no numbers are allowed - everything is barred. • Barred – Numbers are barred only if they occur in the list. If the list is empty then no numbers are barred - everything is allowed.
Ignore	Select this check box if you want to ignore the restricted numbers list displayed.
New Number	Use this field to add a new number to the restricted numbers list. Enter the new number then click Add to send it to the list.

Editing Outgoing No. Restrictions

Follow these steps to edit numbers in an outgoing number restrictions list.

Tip: You can set number restrictions at the SN or CLI level in the Numbers screen.

1. On the **Outgoing No. Restrictions** tab, select the type of list from the **List Type** drop down list. If you select **Allowed**, only listed numbers will be allowed. If you select **Barred**, all numbers are allowed, except for the listed numbers.
2. If you want the outgoing number restrictions to be ignored for this customer, select the **Ignore** check box.
3. In the **New Number** field, enter a number to add to the list and click **Add**.
Result: The number will be added to the restriction list.
4. From the **Restriction List**, select a number to remove and click **Remove**.
Result: The number will be removed from the restriction list.
5. Click **Save**.
Result: The changes will be saved to the database.

30

Least Cost Routing

Use the **Least Cost Routing** tab on the ACS Resources screen to manage and maintain least cost routing configuration. Least cost routing enables calls to be routed differently by replacing prefixes to the destination address.

The tab updates the Simple LCR fields in the "Customer" profile. They are applied in control plans using any of the following feature nodes:

- [Terminate to Pending TN](#)
- [Attempt Terminate to Pending TN](#)
- [Attempt Terminate to Pending TN with Duration](#)

Using Least Cost Routing

Follow these steps to add or edit the least cost routing for the selected customer.

1. Select the customer for whom least cost routing is to be added.
2. Enter the prefixes that are to be used for least cost routing.
 - Old National: The 'National' prefix that is to be matched in the normalized number for least cost routing to be applied.
 - New National: The prefix that is to replace the "Old National prefix" in numbers that matched the old national prefix.
 - Old International: The 'International' prefix that is to be matched in the normalized number for least cost routing to be applied.
 - New International: The prefix that is to replace the "Old International prefix" in numbers that matched the old international prefix.

3. Click **Save** to commit the changes to the database.

Note: This least cost routing will be applied to all calls for the selected customer.

31

Service Numbers

A service number is the number that is dialed by other parties when they contact the customer.

Note: Service numbers can only be deleted by an ACS system administrator.

Service Number Fields

This table describes the function of each field when adding and editing a service number.

Field	Description
Number	<p>Use to specify the number that will be dialed by a caller, (for example: 0800747733). The number may be up to 32 numeric characters in length (dependant on your network configuration) but may not be left blank.</p> <p>Warning: Each individual service number must be unique.</p> <p>New service numbers can only be added by the ACS administrator.</p>
Allocated To	<p>The name of the reseller or agent this number is allocated to.</p> <p>Note: This field is only visible if you are a reseller, or agent, (See Tiered Customer Structure) and you have logged into ACS as a standalone application (See Accessing ACS as a Standalone Application).</p>
Network	<p>Select the network or accept the 'Any' network default.</p> <p>Control plans are selected based on a service number and network pair. This allows users of the same service numbers on different networks to be routed to different call plans, if required. Any number of network keys may be configured as identifiers for each network. Networks are set up on the Networks tab of the ACS Tools screen.</p> <p>The system matches the set keys with the information contained in an incoming call to identify the originating network and route the call accordingly.</p>
Number Range	<p>Select an existing number range for the customer if required. This is dependent on what termination range policy is set at the customer level. This number range is used by the follow me number (described below).</p>

Field	Description
Follow Me Number	Used to put the follow me number into the service number profile, which is used by the Set Pending TN From Profile node. See <i>CPE User's Guide</i> for more information about follow me numbers. Note: This must be within the selected number range (described above) or if no number range selected, may be left blank.
Language	The default language for interactions (announcements and notifications) with this number.
PIN	Use to specify the PIN that will be put into the service number profile, which is used by PIN Authorisation node.
Play Toll Free Beep	Select to play the toll free beep. The toll free beep announcement set and entries are set up on the Global Configuration tab of the ACS Tools screen.

Access Code Management

Field	Description
Code Length	Select the minimum and maximum number of digits for the access codes for the customer.
Access Code	Enter the access code and then click Add to send it to the list.

Access Code Policy

Field	Description
Use Default	Use the default access code policy that is set up on the Global Configuration tab of the ACS Tools screen.
Not Required	The user is not required to enter an access code.
Required and Verified	The user is required to enter an access code and the code will be verified against the above access code list.
Required and Not Verified	The user is required to enter an access code but the code will not be verified against the above access code list.

Restriction Number Management

Field	Description
List Type	<p>The service number has an incoming restriction list. The list must be classed as either "Allowed" or "Barred" but cannot be both.</p> <p>If list type is:</p> <ul style="list-style-type: none"> • Allowed: populate this list with numbers/prefixes that are to be allowed for use. All numbers/prefixes outside of this list will not be allowed. For example, from a prefix list of 09, 07, 04 and 03, if you enter 07 into the allowed list then all other prefixes will not be allowed - except 07. • Barred: Set the number to bar at an individual service number level. <p>Tip: The actual filtering is implemented using the Prefix Tree Branching feature node in a control plan.</p>
Number	<p>Use this field to add a new number to the barred/allowed numbers list. Enter the new number then click Add to send it to the list.</p> <p>Tip: You can enter the full number, a partial number or a prefix in this field.</p>
Ignore	<p>Select this check box if you want to ignore the barred/allowed numbers list displayed.</p>

Adding Service Numbers

Follow these steps to create a new service number.

1. On the **Service Numbers** tab, click **New** to the right of the **Service Number** field.
Result: The New Service Number screen is displayed.
2. Populate the appropriate fields with the required data, referring to [Service Number Fields](#) for detailed input descriptions.
3. Click **Save**.
Result: The new service number is created and you are returned to the **Service Numbers** tab.

Related topic

[Service Numbers](#)

Editing a Service Number

Follow these steps to edit an existing service number.

1. From the **Service Numbers** tab, select the number to edit from the **Service Number** field.
2. Click **Edit**.
Result: The Edit Service Number screen is displayed.
3. Populate the appropriate fields with the required data, referring to [Service Number Fields](#) for detailed input descriptions.
4. Click **Save**.
Result: The edited service number is saved and you are returned to the **Service Numbers** tab.

Related topic

[Service Numbers](#)

Deleting a Service Number

Follow these steps to delete an existing service number.

1. From the **Service Numbers** tab, select the number to delete from the drop down list.
2. Click **Delete**.

Result: The Confirm Delete prompt is displayed.

3. Click **OK** to confirm the deletion of the number.

Result: The service number is deleted and you are returned to the **Service Numbers** tab.

Related topic

[Service Numbers](#)

Associating FCI Data with a Service Number

Follow these steps to specify the FCI data that you want to associate with a service number.

Note: The FCI data is stored in the FCI profile fields in the service number profile block.

1. In the ACS UI, open the Numbers window and select the ACS customer from the **Customer** list.
2. On the **Service Numbers** tab, select the service number you want from the **Service Number** list.
3. Click **Edit**.

The Edit Service Number window opens.

4. In the **FCI Data Management** area, enable or disable FCI inap interaction by selecting or deselecting **FCI On**.
5. Specify the FCI service code in the **FCI Service Code** field. Enter an integer in the range 0 (zero) to 65535.
6. Specify the FCI country code in the **FCI Country Code** field. Enter a string of up to three hexadecimal digits.
7. Click **Save**.

The FCI data for the selected service number is saved to the FCI profile tags in the service numbers profile block.

CLI Numbers

A calling line identifier (CLI) number is used to identify the phone number that call originates from.

Note: CLI numbers can only be deleted by an ACS system administrator.

CLI Number Fields

This table describes the function of each field when adding and editing a CLI number.

Field	Description
Number	Caller line identification (CLI). This is the telephone number of the calling party.
Allocated To	The name of the reseller or agent this number is allocated to. Note: This field is only visible if you are a reseller or agent (See Tiered Customer Structure) and you have logged into ACS as a standalone application (See Accessing ACS as a Standalone Application).
Network	Select the network or accept the 'Any' network default. Control plans are selected based on a service number and network pair. This allows users of the same service numbers on different networks to be routed to different call plans, if required. Any number of network keys may be configured as identifiers for each network. Networks are set up on the Networks tab of the ACS Tools screen. The system matches the set keys with the information contained in an incoming call to identify the originating network and route the call accordingly.
Number Range	Select an existing number range for the customer if required. This is dependant on what termination range policy is set at the customer level. This number range is used by the follow me number (described below).
Follow Me Number	Used to put the follow me number into the CLI profile, which is used by the Set Pending TN From Profile node. See <i>CPE User's Guide</i> for more information about follow me numbers. Note: This must be within the selected number range (described above) or if no number range selected, may be left blank.

Field	Description
Language	The default language for interactions (announcements and notifications) with this number.
PIN	Use to specify the PIN that will be put into the CLI number profile, which is used by PIN Authorisation node.
Play Toll Free Beep	Select to play the toll free beep. The toll free beep announcement set and entries are set up on the Global Configuration tab of the ACS Tools screen.

Access Code Management

Field	Description
Code Length	Select the minimum and maximum number of digits for the access codes for the customer.
Access Code	Enter the access code and then click Add to send it to the list.

Access Code Policy

Field	Description
Use Default	Use the default access code policy that is set up on the Global Configuration tab of the ACS Tools screen.
Not Required	The user is not required to enter an access code.
Required and Verified	The user is required to enter an access code and the code will be verified against the above access code list.
Required and Not Verified	The user is required to enter an access code but the code will not be verified against the above access code list.

Restriction Number Management

Field	Description
List Type	<p>The CLI number has an outgoing restriction list. The list must be classed as either "Allowed" or "Barred" but cannot be both.</p> <p>If list type is:</p> <ul style="list-style-type: none"> • Allowed: Populate this list with numbers/prefixes that are to be allowed for use. All numbers/prefixes outside of this list will not be allowed. For example, from a prefix list of 09, 07, 04 and 03, if you enter 07 into the allowed list then all other prefixes will not be allowed - except 07. • Barred: Set the number to bar at an individual service number level. <p>Tip: The actual filtering is implemented using the Prefix Tree Branching feature node in a control plan.</p>

Field	Description
CLI	Use this field to add a new number to the barred/allowed numbers list. Enter the new number then click Add to send it to the list. Tip: You can enter the full number, a partial number or a prefix in this field.
Ignore	Select this check box if you want to ignore the barred/allowed numbers list displayed.

Adding CLI Numbers

Follow these steps to create a new CLI number.

1. On the **CLI Numbers** tab, click **New** to the right of the **CLI Number** field.
Result: The New CLI Number Screen is displayed.
2. Populate the appropriate fields with the required data, referring to [CLI Number Fields](#) for detailed input descriptions.
3. Click **Save**.
Result: The new CLI number is created and you are returned to the **CLI Numbers** tab.

Related topic

[CLI Numbers](#)

Editing a CLI Number

Follow these steps to edit an existing CLI number.

1. From the **CLI Numbers** tab, select the number that to edit from the **CLI Number** field.
2. Click **Edit**.
Result: The Edit CLI Number Screen is displayed.
3. Populate the appropriate fields with the required data, referring to [CLI Number Fields](#) for detailed input descriptions.
4. Click **Save**.
Result: The edited CLI number is saved and you are returned to the **CLI Numbers** tab.

Related topic

[CLI Numbers](#)

Deleting a CLI Number

Follow these steps to delete an existing CLI number.

1. From the **CLI Numbers** tab, select the number to delete from the drop down list.
2. Click **Delete**.
Result: The Confirm Delete prompt is displayed.
3. Click **OK** to confirm the deletion of the number.

Result: The CLI number is deleted and you are returned to the **CLI Numbers** tab.

Related topic

[CLI Numbers](#)

33

Control Plan Schedule

The ACS Numbers screen enables you to perform the following control plan scheduling tasks for a service number or CLI number.

Call Schedule

- Schedule or un-schedule a control plan
- Delete historical control plan schedules

What is a Control Plan?

A control plan is similar to a flow chart. Control plans essentially define the decisions and actions that are made when a call is routed from source to destination. A control plan may consist of multiple unique decision points or actions called feature nodes. Control plans are constructed in ACS using the ACS Control Plan Editor (CPE).

Important: This topic provides CPE overview information in direct relevance to the Numbers screen in ACS and its functions only. Refer to *CPE User's Guide* for further information.

Using Control Plan Schedules

Follow these steps to un-schedule control plans for service numbers or CLI numbers from the ACS Numbers screen and to delete historical schedule entries.

The table allows many scheduling entries to be entered for the selected number, but each instance must have a different effective date. This allows a customer to schedule changes to the control plans a service number or CLI number uses.

Tip: This topic provides CPE overview information in direct relevance to the Numbers screen in ACS, and its functions, only. You must see *CPE User's Guide* for further information.

1. On the relevant tab of the Numbers screen, select the number that scheduling changes are required for, in the Numbers area of the screen.

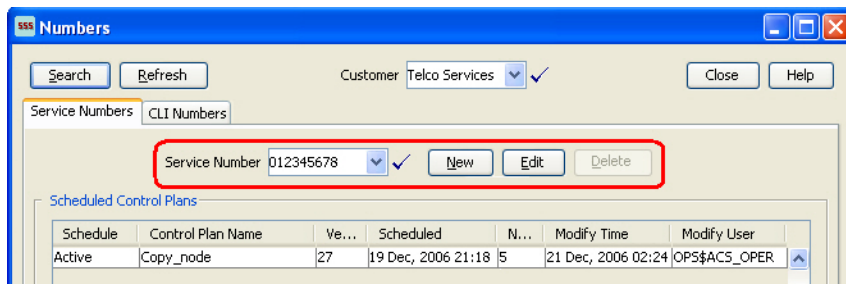

2. Select an existing scheduled control plan from the **Scheduled Control Plans** table.

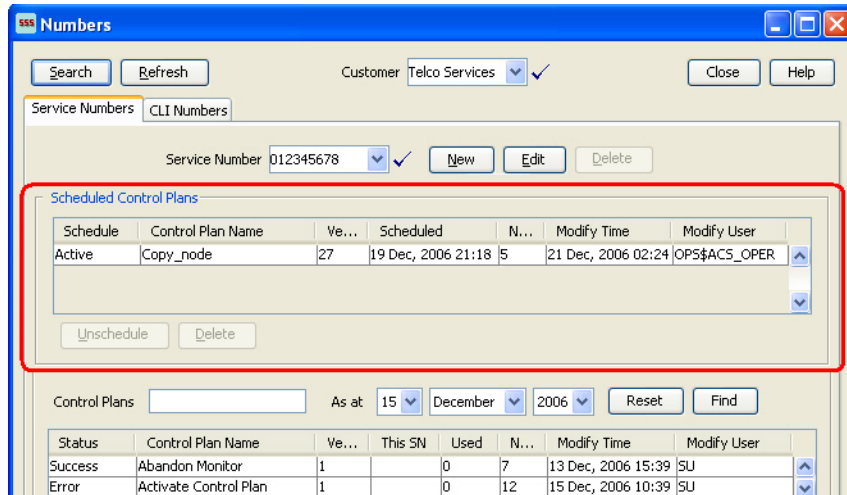

Tip: When you select a scheduled control plan, the control plan is highlighted in the **Control Plans** table, and the template is highlighted in the **Templates** table.

3. The following functions are now available to you on the **Scheduled Control Plans** frame of the screen, as shown on the example screen above:
 - **Unschedule** – Go to step 4 to detach a control plan from the current service.
 - **Delete** – Go to Step 5 to remove the selected control plan from the system.
4. Click **Unschedule** to detach this control plan from the current service.

Result: The control plan now displays as historical and is therefore no longer scheduled for activity within the current service.

5. With the control plan selected on the **Scheduled Control Plans** table, click **Delete**.

Tip: Only historical control plans are able to be deleted from this table as they are no longer scheduled for activity within the current service.

Warning: Unsheduling all control plans for a service number or CLI number will discontinue processing of calls for that number.

Click **Delete** to confirm.

6. See Using Templates on the Numbers Screen for more Numbers screen information.

Control Plans

The **Control Plans** frame of the ACS Numbers screen enables you to perform the following control plan functions for a service number or CLI number.

Control Plans

- Edit an existing control plan by launching the CPE
- Rename an existing control plan
- Schedule a control plan
- Edit termination numbers for a control plan that contains only one termination node
- Delete an existing control plan

Important: This topic provides ACS Control Plan Editor overview information in direct relevance to the Numbers screen in ACS and its functions only. Refer to *CPE User's Guide* for further information.

Using Control Plans on the Numbers screen

Follow these steps to manage control plans for service numbers or CLI numbers from the ACS Numbers screen.

Important: This topic provides CPE overview information in direct relevance to the Numbers screen in ACS, and its functions, only. Refer to *CPE User's Guide* for further information.

1. In the **Control Plans** frame on the Numbers screen perform one of the following actions:
 - Select an existing control plan from the table
 - Enter the control plan name in the **Control Plans** field and click **Find**

Notes:

- The **As atdate** fields are available to aid you in your search for the 'most recent' version(s) of a control plan.
- Click **Reset** to restore the date default and clear your search results from the **Control Plans** field.
- Press **Enter** to restore the full control plan list in the table, after performing a search which displays only a selection of control plans.

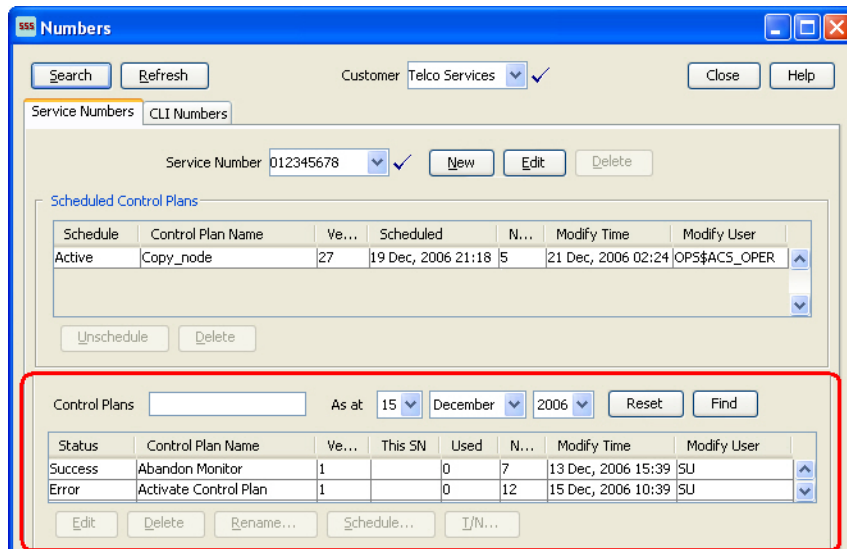

Tip: When you select a control plan, the control plan's template is also highlighted in the **Templates** table below.

2. The following functions are now available to you on the **Control Plans** frame of the screen, as shown on the example screen above:
 - **Edit** – See [Editing a Control Plan](#).
 - **Delete** – See [Deleting a Control Plan](#).
 - **Rename** – See [Renaming a Control Plan](#).
 - **Schedule** – See [Scheduling a Control Plan](#).
 - **T/N** – See [Editing Termination Numbers](#).

Tip: See [Using Templates on the Numbers Screen](#) for more ACS Numbers screen information.

To create a new control plan from this screen, you click **New Control Plan** in the **Templates** frame. See [Creating a Control Plan](#).

Editing a Control Plan

Follow these steps to edit a control plan, using the **Numbers** screen.

1. Highlight the control plan to edit in the table in the control plans area of the **Numbers** screen, and click **Edit**.

Result: The Edit Control Plan prompt appears.

2. Make your selection:
 - Click **Read Only** to open the template (on which the control plan was created) as read only. This means that the structure cannot be changed; no nodes can be added or deleted.
 - Click **Writable** to open the template (on which the control plan was created) in edit mode. This means that you are able to change the structure; nodes can be added and deleted.

Result: The control plan is opened in the ACS Control Plan Editor window.

3. Make your edits and **Save** as per the standard CPE procedure.

Result: You are returned to the ACS Numbers screen, with the updated control plan displayed in the control plan table.

Related topic

[Control Plans](#)

Deleting a Control Plan

Follow these steps to delete a control plan, using the Numbers screen.

1. With the control plan selected in the table in the **Control Plans** frame of the Numbers screen, click **Delete**.

Notes:

- The **Delete** button is not enabled if a control plan is displayed on the **Scheduled Control Plans** table, irrespective of schedule status (Scheduled, Active or Historical).
- This action completely removes the control plan from the system, it will not be able to be reinstated. The **Delete** button in the **Scheduled Control Plans** frame above simply removes the scheduling of the control plan for use within the system at the scheduled time, and leaves the control plan within the system for future use if required.

Result: You see a delete confirmation prompt.

2. Click **Delete** to confirm.

Result: The control plan is deleted from the system.

Related topic

[Control Plans](#)

Renaming a Control Plan

Follow these steps to rename a control plan, using the Numbers screen.

1. With the control plan selected in the table in the **Control Plans** frame of the Numbers screen, click **Rename**.

Result: The Rename Control Plan screen is displayed.

2. In the **New name** field, enter the new control plan name and click **Save**.

Result: You are returned to the Numbers screen, with the updated control plan displayed in the **Control Plans** table.

Related topic

[Control Plans](#)

Scheduling a Control Plan

Follow these steps to schedule a control plan, using the Numbers screen.

1. With the control plan selected in the table in the **Control Plans** frame of the Numbers screen, click **Schedule**.

Result: The Schedule Control Plan screen is displayed.

2. From the **Date** and **Time** drop down boxes, select the date and time required and click **Save**.

Result: You are returned to the Numbers screen, with the control plan now displaying in the **Scheduled Control Plans** table.

Notes:

- Each control plan scheduled must have a unique date and time pair so that the system can determine which control plan to use at any given time.
- The date and time entered in this screen determine when the system is to begin using this control plan for calls made to the service number or CLI number.

This scheduling entry will be used until the next scheduling entry (in time order) becomes active; the system date is 'equal to' or 'after' the date/time pair set for this schedule entry.

Related topic

[Control Plans](#)

Editing Termination Numbers

If a control plan contains only one termination node, follow these steps to edit the termination number, using the Numbers screen.

1. With the control plan selected in the table in the **Control Plans** frame of the Numbers screen, click **T/N**.

Result:

If the control plan:

- Contains a termination node, the Configure Termination screen appears. Go to Step 2.
- Has no termination nodes, you see an error.

2. From the **Number Range** drop down box, select the number range.

In the **Termination Number** field, enter or edit the termination number for the control plan.

Click **Save**.

Result: You are returned to the Numbers screen and a new instance of the control plan appears in the **Control Plan** table.

Note: You are now able to schedule this control plan as required.

Related topic

[Control Plans](#)

Templates

The **Templates** frame of the ACS Numbers screen enables you to perform the following control plan template functions for a service number or CLI number.

Control plan templates:

- Create a new control plan template by launching the CPE
- Edit an existing template by launching the CPE
- Rename an existing template within the Numbers screen
- Create a new control plan based on an existing template by launching the CPE
- Delete an existing and unattached (not used by a control plan) template

Important: This topic provides ACS Control Plan Editor overview information in direct relevance to the Numbers screen in ACS and its functions only. Refer to *CPE User's Guide* for further information.

Using Templates on the Numbers Screen

Follow these steps to manage control plan templates for service numbers or CLI numbers from the Numbers screen.

Important: This topic provides CPE overview information in direct relevance to the Numbers screen in ACS, and its functions, only. Refer to *CPE User's Guide* for further information.

1. In the **Templates** frame on the Numbers screen, perform one of the following actions:
 - Select an existing template from the **Templates** table
 - Enter the template name in the **Templates** field and press **Enter**
2. **Tip:** To clear your search results from the **Templates** table, delete the search data in the **Templates** field and press **Enter**. The **Templates** table now displays the full template list.
Tip: If the template selected is associated with a control plan then the control plan is also highlighted in the **Control Plans** table above.
3. The following functions are now available to you on the **Templates** frame of the screen, as shown on the example screen above:
 - **Edit** – See [Editing a Control Plan Template](#).
 - **Copy** – See [Copying a Control Plan Template](#).
 - **Delete** – See [Deleting a Control Plan Template](#).
 - **Rename** – See [Renaming a Control Plan](#).
 - **New Template** – See [Creating a new Control Plan Template](#)
 - **Use Template** – See [Creating a Control Plan based on a Template](#).
 - **New Control Plan** – See [Creating a Control Plan](#).

Tip: See the [Using Control Plans on the Numbers screen](#) procedure for more Numbers screen information.

Editing a Control Plan Template

Follow these steps to edit a control plan template, using the Numbers screen.

1. Highlight the control plan template to edit in the table in the **Templates** frame of the Numbers screen, and click **Edit**.

Result: The selected template is opened in the ACS Control Plan Editor window.

2. In the CPE, make your edits and **Save** the control plan template.

Result: You are returned to the Numbers screen in ACS, with the updated template displayed in the templates table.

Related topic

[Templates](#)

Copying a Control Plan Template

Follow these steps to copy a control plan template, using the Numbers screen.

1. With the control plan template selected in the table in the **Templates** frame of the Numbers screen, click **Copy**.

Result: The control plan template will be copied, compiled and saved; you see a screen, showing the progress of the copy procedure.

2. Click **Close**.

Result: You are returned to the Numbers screen, with the new control plan template, named "Copy of *original control plan template name*", displayed in the **Control Plan Template** table.

Related topic

[Templates](#)

Deleting a Control Plan Template

Follow these steps to delete a control plan template, using the Numbers screen.

1. With the control plan template selected in the table in the **Templates** frame of the Numbers screen, click **Delete**.

Result: The Really delete? prompt is displayed.

2. Click **Delete** to confirm and the template is removed from the **Templates** table.

Click **Don't Delete** to retain the template.

Result: You are returned to the ACS Numbers screen.

Related topic

[Templates](#)

Renaming a Control Plan Template

Follow these steps to rename a control plan template, using the Numbers screen.

1. With the control plan template selected in the table in the **Templates** frame of the Numbers screen, click **Rename**.

Result: The Rename Template - *template name* screen is displayed.

2. In the **New name** field, enter the new template name and click **Save**.

Result: You are returned to the Numbers screen, with the updated template displayed in the **Templates** table.

Related topic

[Templates](#)

Creating a new Control Plan Template

Follow these steps to create a new template, using the Numbers screen.

1. On the Numbers screen, click **New Template**.

Result: The New Template prompt appears.

2. Make your selection:

- Click **Control Plan and Template** to create a new template and control plan.
- Click **Template Only** to create a new template only.

3. **Result:** The CPE is then launched displaying the new template and/or control plan, as illustrated in Editing a Control Plan Template.

4. Create your new template and/or control plan and click **Save** as per the standard CPE procedure.

Result: You are returned to the Numbers screen in ACS, with the new template and/or control plan displayed in the **Templates** table.

Creating a Control Plan based on a Template

Follow these steps to create a new control plan based on a template, using the Numbers screen.

1. With the control plan template selected in the table in the **Templates** frame of the Numbers screen, click **Use Template** to create a new control plan based on the selected template.

Result: The New Control Plan based on Existing Template prompt appears.

2. Make your selection:

Click **Read Only** to open the template (that is to be used for the control plan) as read only. This means that the structure cannot be changed; no nodes can be added or deleted.

Click **Writable** to open the template (that is to be used for the control plan) in edit mode. This means that you are able to change the structure; nodes can be added and deleted.

Result: The CPE is launched displaying the new template and/or control plan, as illustrated in Editing a Control Plan Template.

Tip: The "Control Plan Name" will be the service number or CLI number selected.

3. Create your new control plan and click **Save** as per the standard CPE procedure.

Result: You are returned to the Numbers screen in ACS, with the new template and/or control plan displayed in the **Templates** and/or **Control Plans** table.

Related topic

[Templates](#)

Creating a Control Plan

Follow these steps to create a control plan, using the Numbers screen.

1. With the control plan template selected in the table in the **Templates** frame of the Numbers screen, click **New Control Plan**.**Result:** The CPE is then launched ready for a new template and/or control plan to be created.

Tip: The "Control Plan Name" will be the service number or CLI number selected.

2. Create your new control plan and click **Save** as per the standard CPE procedure.

Result: You are returned to the Numbers screen in ACS, with the new template and/or control plan displayed in the **Templates** and/or **Control Plans** table.

Related topic

[Templates](#)

Search for Numbers

The Search for Numbers screen allows you to search the database for records that match the criteria entered into the fields on the screen. You can provide pattern criteria for the service number and CLI numbers to look for, as well as for other associated values, including customer name, customer number and active control plan.

To access the Search for Numbers screen, on the Numbers screen, click **Search**.

Searching for Numbers

Follow these steps to search for a specific database record, using the Search for Numbers screen.

1. Enter the search criteria into all required fields.
Tip: Any fields left blank will show all records in the database. Blank fields do not limit the search at all.
2. Click **Find** to display the results in the database that match all entered fields.
3. Select the line in the Search Results table that is required.

Click **Select**.

Result: The Search for Numbers screen will close and the **CLI Numbers** or **Service Numbers** tab of the Numbers screen will be populated with the selected database record.

Search for Numbers Fields and Buttons

This table describes the function of each field and button.

Field	Description
Customer Name	Allows you to specify a pattern to match customer names. The search will match any customer name starting with the provided pattern.
Customer Number	Allows you to specify a pattern to match customer numbers (also called customer references). The search will match any customer number starting with the provided pattern.
Service Number	Allows you to specify a pattern to match service numbers. The search will match any existing service number containing the pattern as a prefix.
CLI Number	Allows you to specify a pattern to match CLI numbers. The search will match any existing CLI containing the pattern as a prefix.

Field	Description
Active Control Plan	Allows you to specify a pattern to match existing control plans. The search will match any existing control plan containing the pattern as a sub-string (not has to be necessarily a prefix).
Find	Click this button to launch the search function. The button will be disabled if no pattern is provided through any of the text fields.
Reset	Click this button to clear the content of all text fields.
Search filter options	This group of options will further restrict the entries to be displayed by the Search Results table: <ul style="list-style-type: none"> • Show all will displayed all found data • Customer only will just display customer name and customer Number • Service numbers only will restrict the output to matched service numbers • CLI numbers only will restrict the output to matched CLI numbers
Search Results	This table shows the results from the search after clicking the find button. It presents five columns to show the customer name, customer number, service number, CLI number and active control plan.
Select	When this button is clicked after you have selected one entry from the Search Results table, the screen closes and the selected data is displayed in the corresponding Service Numbers or CLI Numbers panel in the Numbers screen.

Search Criteria

The entries in the **Search Results** table will be displayed according to the following criteria:

- CLI and service numbers are searched independently and displayed together in the same table
- In order for a CLI or service number to be displayed, the customer name, customer number, service number and active control plan must be matched
- An empty pattern in a field is considered to be an automatic match for that field
- An empty pattern in the **Active Control Plan** field will match the active control plan for any CLI or service number including those without an active control plan
- In any case, you must fill in at least one pattern field in order to make the **Find** button active

Language

You use the **Language** tab on the Tools screen to specify the languages that you require for ACS.

Note: ACS has the English language set as the default option.

If you require additional languages then you must add them using the steps outlined in this section. To view the system Language options you need to click the **Tools** button in the ACS main screen. The Tools screen is displayed with the **Language** tab open by default.

Languages and Announcements

The table on the **Language** tab displays the languages that are currently available in the system.

Languages are used mainly by announcements. Each recording of an announcement that is entered into the system must have a language associated with it. This allows the announcements to be selected for a customer by language. It is important to define a default language for the entire system.

Note: Languages can only be edited and maintained by the ACS system administrator. Details cannot be edited directly into the table. If you want to make any changes to the language entries, you must click **Edit**.

Language Fields

Here is a description of the fields used when setting a language.

Field	Description
Name	The language currently configured for ACS
Message Index	The language that will be used for customer text messaging. This index number is specified when the message is being sent and ACS applies the appropriate language.
SRF Index	Some SRF (Specialized Resource Function) announcement boxes support an optional language parameter. This parameter can be used with features such as speaking account balances to ensure that the appropriate language translation algorithm is used. If you are using an SRF box that does not support this parameter, or if you are not using announcements with dynamically generated content, then this field does not need to be specified.
Change Customer	The customer name
Changer User	The name of the user who allocated or edited the record
Change Date	The date when the record was allocated or last edited

Setting the Language Maps

Follow these steps to configure your ACS language maps.

1. On the **Language** tab, click **New**.
Result: The Language screen displays.
See [Language Fields](#) for details.
2. In the **Language** field, enter the new name of the language.
3. If you are using Short Text Messaging, enter the appropriate index number in the **Message Index** field.
4. If you are using SRF, enter the appropriate index number in the **SRF Index** field.
5. Click **Add**.
Result: The new language map appears in the list.
6. Select the **Default Language** for the language mapping.
7. Click **Save** to save the changes to the database.

Related topic

[Language](#)

Changing Language Maps

Follow these steps to change your ACS language maps.

1. On the **Language** tab, click **Edit**.
Result: The Language screen is displayed.
See [Language Fields](#) for details.
2. Select the language from the table.
3. Change the details in the fields, as required.
4. Click **Change** to implement changes.
5. Click **Save** to record your changes.

Related topic

[Language](#)

Removing Languages

Follow these steps to remove a language from your ACS language maps.

1. On the **Language** tab, click **Edit**.
Result: The Language screen is displayed.
2. Select the language from the table and click **Remove**.
Result: The Confirm Language Removal prompt is displayed.
3. Click **Ok**.

4. Click **Save** to record your changes.

Access Management

You use the **Access Management** tab in the Tools screen to allocate the customers that are visible to the SMS user. This screen has a limiting function as SMS users automatically have full access to all ACS customers, an SMS user's access is only limited when ACS customers are selected and placed in this list. Therefore an empty Selected ACS Customers list gives full access to all SMS users.

Access Management Fields

Here is a description of the fields used when managing access.

Field	Description
SMS Application User	Use this field to select the SMS application user whose ACS customers you wish to view or configure You can search for a user on this box. Refer to Searching the database. Any records found are displayed in the area below this field.
Available ACS Customers	Use this box to search for the available ACS customers that have been configured for the current SMS application user. Refer to Searching the database. Any records found are displayed in the area below this field.
Selected ACS Customers	Use this field to search for the selected ACS customers that have been configured for the current SMS application user. Refer to Searching the database. Any records found will be displayed in the area below this field.

Adding Access to an ACS Customer

Follow these steps to add access to an ACS customer.

1. From the **SMS Application User** drop down list, select the user for whom the ACS customer access is to be granted.
2. Search and select the customer(s) that you wish to give the SMS application user access to in the **Available ACS Customers** field.

Click **Add**.

Result: The new customer(s) will appear in the Selected ACS Customers list.

The SMS application user will now be able view and manage data for the ACS customer(s) added to the Selected ACS Customers list only.

Removing Access to an ACS Customer

Follow these steps to remove access to an ACS customer.

1. Select the SMS application user, for whom the ACS customer access is to be granted, from the drop down list.
2. Search and select the customer(s) that you wish to give the SMS application user access to in the **Available ACS Customers** field.

Click **Remove**.

Result: The new customer(s) will be removed from the Selected ACS Customers list.

Networks

You use the **Networks** tab of the Tools screen to configure networks in ACS.

This tab displays all the networks that have been configured in the system.

Note: Each network is maintained separately.

Only ACS users with permission level 6 or above can access this tab.

Control plans are selected based on a service number (SN) and network pair. This allows users of the same SN on different networks to be routed to different control plans, if required. Any number of network keys may be configured as identifiers for each network. The system matches the set keys with the information contained in an incoming call to identify the originating network and route the call accordingly.

It is not possible to delete a network that is currently in use by a compiled control plan. Editing a network will cause all compiled control plans that use that record to be recompiled.

Networks Tab Fields

Here is a description of the fields used when managing networks.

The table on the tab displays the network keys that have been configured for the selected network. Any number of network keys may be configured as identifiers for each network. The system matches the set keys with the information contained in an incoming call, to identify the originating network and route the call accordingly.

Note: While no two network keys can be identical, it is possible for the individual node, port, or service key ranges to overlap. For example, two network keys may have overlapping node and port ranges, as long as the service key ranges do not overlap.

Field	Description
Network	Use to navigate through the list of configured networks
Node Start	The number of the first node in the range of nodes for the selected network
Node End	The number of the last node in the range of nodes for this network
Port Start	The number of the first port in the range of ports for this network
Port End	The number of the last port in the range of ports for this network
SK Start	The number of the first service key in the range of service keys for this network
SK End	The number of the last service key in the range of service keys for this network
Change Customer	The customer name
Change User	The name of the user who allocated or edited the record
Change Date	The date when the record was allocated or last edited

Adding Networks

Follow these steps to add a new network.

1. On the **Networks** tab, click **New** (beside the Network drop-down list).
Result: The New Network screen is displayed.
2. In the **Network** field, enter the name of the new network.
3. In the **Description** field, enter a description of the new network.
4. Click **Save**.
Result: The changes are saved and you return to the **Networks** tab.

Related topic

[Networks](#)

Editing Networks

Follow these steps to edit an existing network.

1. On the **Networks** tab, select the network to edit from the Network table.
2. Click **Edit** (beside the Network drop-down list).
Result: The Edit Network screen is displayed.
3. Change the network name and description as required.
4. Click **Save**.
Result: The changes are saved and you return to the main window.

Related topic

[Networks](#)

Deleting Networks

Follow these steps to remove a redundant network configuration.

1. On the **Networks** tab, select the Network to delete from the Network table.
2. Click **Delete** (beside the Network drop-down list).
Result: The Confirm Delete prompt is displayed.
3. Click **OK**.
Result: The network is removed from the database.

Adding Network Keys

Follow these steps to add a new network key to the selected network configuration.

1. On the **Networks** tab, select the network to add a key to from the **Network** drop down list.
2. Click **New** at the bottom of the tab.

Result: The New Network Key screen is displayed.

See [Networks Tab Fields](#) for details.

Tip: You are not required to enter ranges, but if the start of a range is entered, an end of a range must also be entered. The end of a range must be greater than or equal to the start of a range.

3. In the **Node Start** and **Node End** fields, enter the start and end of the node range. The node is the originating point code.
4. In the **Port Start** and **Port End** fields, enter the start and end of the port range. The port is the destination subsystem number.
5. In the **SK Start** and **SK End** fields, enter the start and end of the service key range.
6. Click **Save**.

Result: The details are saved and you return to the **Networks** tab.

Related topic

[Networks](#)

Editing Network Keys

Follow these steps to edit network keys.

1. On the **Networks** tab, select the network to edit from the **Network** drop down list.
2. Select the network key from the table.
3. Click **Edit** at the bottom of the tab.

Result: The Edit Network Key screen is displayed.

4. Change the details as described in [Networks Tab Fields](#).
5. Click **Save**.

Result: The changes are saved and you return to the main window.

Related topic

[Networks](#)

Deleting Network Keys

Follow these steps to remove redundant network keys from the selected network.

1. On the **Networks** tab, select the network to edit from the **Network** drop down list.
2. Select the network key from the table.
3. Click **Delete** at the bottom of the tab.

Result: The Confirm Delete prompt is displayed.

4. Click **OK**.

Result: The network key record is deleted from the database.

Default Termination Range

The **Default Termination Range** tab enables you to add, edit and delete the default termination number ranges that apply to the following feature nodes:

- Unconditional Termination
- Attempt Termination
- No Lookup and Translation
- Follow Me Number

These default ranges are assigned to the customer on the New Customer dialog box of the ACS Customer screen. See [Adding Customers](#).

Note: For more information about setting up individual customer termination number ranges see the [Termination Ranges](#) tab of the ACS Resources screen procedure.

Default Termination Range fields

Here is a description of the fields used when managing default termination ranges.

Field	Description
Termination Number Range	The default termination number ranges that are currently configured for ACS.
Prefix	The prefix of the termination number.
Minimum Digits	The minimum number of digits permitted for the termination number.
Maximum Digits	The maximum number of digits permitted for the termination number.

Adding a Default Termination Range

Follow these steps to add a new default termination range.

1. On the **Default Termination Range** tab, click **New**.

Result: The New Termination Range screen is displayed.

See [Default Termination Range fields](#) for details.

2. In the **Prefix** field, enter the prefix for the termination number.
3. In the **Minimum Digits** field, enter the minimum number of digits.
4. In the **Maximum Digits** field, enter the maximum number of digits.

Result: As you type, the **Range Model** field displays the termination range, with the minimum digits after the prefix displayed as Xs and the maximum digits displayed as Ys, for example 0800XXYYYY.

5. Click **Save**.

Related topic

[Default Termination Range](#)

Editing a Default Termination Range

Follow these steps to edit an existing default termination range.

1. On the **Default Termination Range** tab, select the default termination range to edit.
2. Click **Edit**.
Result: The Edit Termination Range screen is displayed.
3. Change the value as required. See [Default Termination Range fields](#) for details.
4. Click **Save**.

Related topic

[Default Termination Range](#)

Deleting a Default Termination Range

Follow these steps to remove an existing default termination range.

1. On the **Default Termination Range** tab, from the table, select the default termination range to delete.
2. Click **Delete**.
Result: The Confirm Delete prompt is displayed.
3. Click **OK**.

Global Configuration

The **Global Configuration** tab enables you to:

- Set the announcement set and entry to be used for the Beep announcement.
Important: These announcements must be on a CS2 INMAP capable SSP in order to work correctly. See *ACS Technical Guide* for more information.
- Choose to display the time, date and version numbers or just the time and date on the **Control Plans** table on the ACS Numbers Screen.
- Set the default access code policy that is referenced from the **Access Code List** on the [Service Numbers](#) tab and [CLI Numbers](#) tab on the ACS Numbers screen.
- Increase or decrease the maximum number of ACS self management sessions allowed.

Global Configuration Fields

The following tables describe the function of each field on the **Global Configuration** tab.

Beep Announcement Fields

Field	Description
Announcement Set	The announcement set to be used for the Beep announcement.
Announcement Entry	The announcement entry to be used for the Beep announcement. Note: See Announcements for more information about announcement entries.

Control Plan Display Fields

Field	Description
Version Numbers, Time and Date	Select to display the version numbers on the control plan tables on the ACS Numbers screen.
Time and Date Only	The time and date is always displayed. Select this option to ensure that the versions numbers are not displayed on the Control Plan tables on the ACS Numbers screen. Note: See ACS Numbers for more information about managing control plans on the ACS Numbers screen.

Default Access Code Policy Fields

This function applies to the **Access Code Entry** node.

Field	Description
Not Required	The user is not required to enter an access code.

Field	Description
Required and Verified	The user is required to enter an access code and the code will be verified against the list in the Access Code Management frame on the Service Number screen or CLI screen.
Required and Not Verified	The user is required to enter an access code but the code will not be verified. Note: See Service Numbers and CLI Numbers for more information.
Max ACS Database Sessions	Increase or decrease the maximum number of ACS self management sessions allowed. Warning: Ensure that this number <i>does not exceed</i> the total maximum number of system sessions allowed. Contact your system administrator for more information.

Editing the Global Configuration Settings

Follow these steps to edit the Global Configuration settings.

Note: There is only one set of Global Configuration settings within the system.

- On the **Global Configuration** tab click **Edit**.
Result: The Edit Global Configuration screen appears.
See the [Global Configuration Fields](#) for this screen for more information.
- In the Beep Announcement frame, for the Beep announcement, from the drop down lists, select the appropriate:
 - Announcement set
 - Announcement entry
- In the Control Plan Display frame, select the option you wish to have displayed on the control plan. The options are:
 - Version Numbers, Time and Date**
 - Time and Date Only**
- In the Default Access Code Policy frame, select the option for the appropriate default access code policy. The options are:
 - Not Required**
 - Required and Verified**
 - Required and Not Verified**
- In the **Max ACS Database Sessions** field, enter or select the required maximum number of database sessions that can exist at the same time.
- Click **Save** to save the new settings.
Result: The screen will return to the **Global Configuration** tab; note that this will now display the most recent setting update information above the buttons at the bottom of the screen.

Related topic

[Global Configuration](#)

ACS Event Chart Screen

The ACS Event Chart screen allows you to generate, display and print statistical 2-D and 3-D graphs of event counters.

Tip: The event counters are set up on the [New Event Counter screen](#).

Viewing Event Charts

Follow these steps to view event charts.

1. On the ACS Event Chart screen, select the **Customer** and press **Enter**.
Result: The system will return a list of all statistics generated for the selected customer.
2. Select the required event counter from the **Counters** list.
3. To view the graph in:
 - 3D, select the **3-D Style** check box
 - 2D, leave the check box not selected
4. If you wish to display deltas on the graph, select the **Show Deltas** check box.
5. You can change the intervals that the statistic graph view is updated in the **Interval (secs)** box.
6. Press **Enter**.
Result: The statistical graph will be displayed in the bottom area of the screen.

Printing Events Charts

Once you have generated a chart on the screen, you can print it by clicking **Print**.

Getting Started with the Control Plan Editor

About Control Plans

You use the ACS Control Plan Editor (CPE) to create control plans. Control plans define how to perform service-logic, based on factors such as the type of service, geographic location, time of day, and so on. You can use control plans for routing calls, subscriptions and activations, sending notifications, charging for a voice or a data session, providing IVR and self-care logic, and so on.

A control plan is a service-logic flowchart that consists of a collection of connected feature nodes. Each feature node defines a particular decision point or action that occurs in the service-logic. You build a control plan by adding the feature nodes that provide the decisions and actions you need, to a work space, called the control plan canvas. You then connect the feature nodes in the canvas to define the service-logic.

Feature nodes provide service functions such as playing announcements, sending notifications, and branching based on session data. A feature node can have one or more exits which are connected to other feature nodes using branches. An exit from a feature node may only have one branch connected to it, but many branches can connect in to a feature node. The exit that a session takes when leaving a feature node is determined by the functionality of that feature node and the session data. For example, for a voice call, a Day Of Week feature node may have an exit that is applicable for one or more days of the week. The day that a call is made on determines the exit taken from the feature node, and the service logic will follow the branch connected to that exit to determine which action to take for that day.

See *CPE User's Guide* for more information about control plans.

About Types of Control Plans

You can configure a control plan to be public, private, or global:

- A public control plan is available to and can be used by all customers. You specify whether a control plan is public when you create the control plan.
- A private control plan belongs to and is used by a particular customer only. A control plan that is not public or global is private by default.
- A global control plan is associated with a specific service configured for use in NCC, and applies to all customers who use that service.

You specify whether a control plan is global when you save the control plan by giving it a name that corresponds to the service to which it applies. Global control plans are automatically assigned to the operator's default customer account.

Control Plan Update Interval

Control plans are stored in the database when saved and then cached at intervals in the SLC. The cached control plans are used at run-time for service-logic processing. This means

that changes to control plans may not be immediately available for service-logic processing. Because new control plans do not exist in the cache already, a new control plan will be loaded into the cache the first time it is required, and so should be available for use immediately.

The control plan update interval may be configurable for some services. For information on configuring the control plan update interval for a service, see the technical guide for that service.

About Control Plan Structures and Data

A control plan consists of a control plan structure and control plan data. The structure is the service-logic flowchart (the collection of feature nodes in the control plan and the connections between them). The data is the feature node configuration data that you set after you add feature nodes to a control plan.

You can create multiple control plans that use the same control plan structure, but different feature node configuration data. You might do this when you want to use the same control plan structure for similar services, but base the routing on different session criteria for each service.

When you save a control plan, you specify a name for both the structure and the data. You can save both using the same name. If you want to reuse the control plan structure with a different set of data, then save the control plan structure and data using a different name for each. The system identifies a control plan by the name you give to the control plan data.

About Control Plan Names and Properties

When you save a control plan, the version number, compile status, and public status of the control plan is saved with the name. The CPE displays these properties in dialog boxes where you select from a list of control plan names. The syntax is:

name(Vn, compile_status, public_status)

Where:

- *name* is the name of the control plan
- *n* is the version number of the control plan
- *compile_status* is one of the following:
 - **S**: Successfully saved without errors
 - **E**: Saved with errors

Note: Only successfully compiled control plans with a compile status **S** can be activated for use with a service.
- *public_status* is the value **Public** if a control plan structure is public or is based on a public structure. If the control plan is private, this property is not displayed.

For example:

Prepaid_Charging_Service(V2, S, Public)

Understanding the CPE User Interface

About the CPE User Interface

The following figure shows the Control Plan Editor (CPE) user interface (UI):

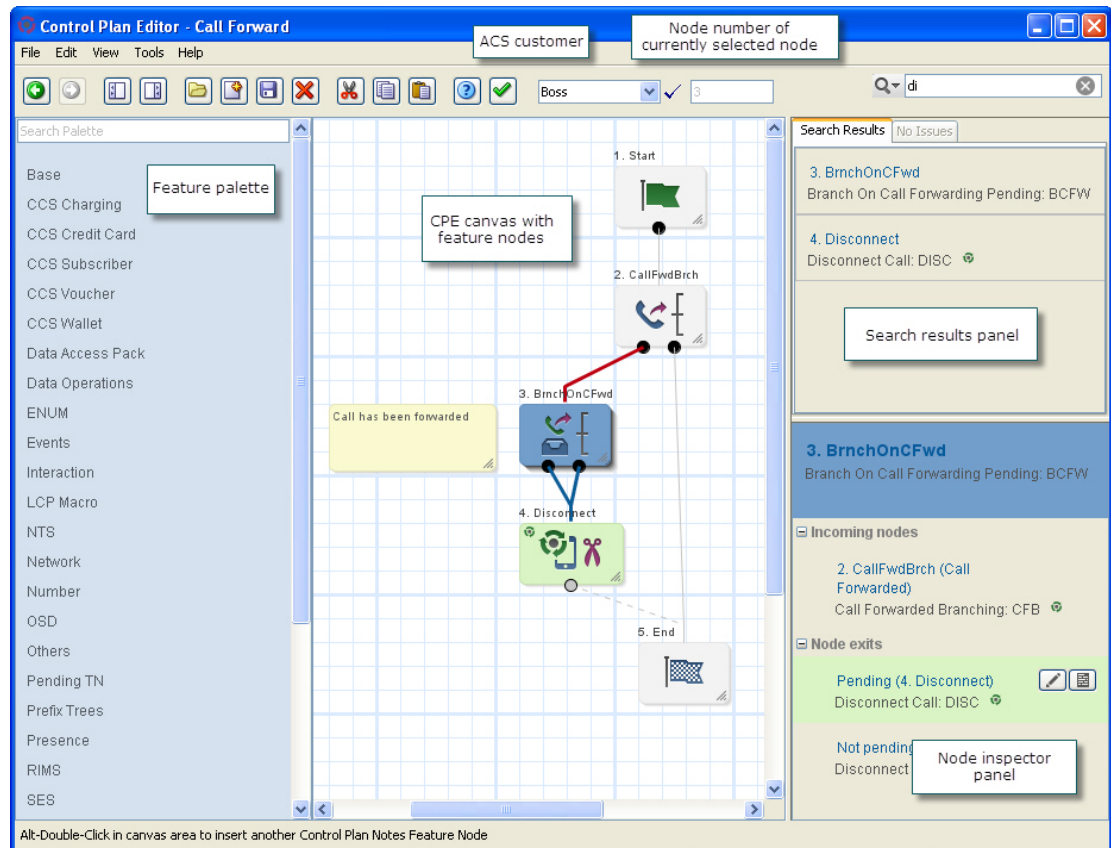

The following sections describe the main areas of the CPE UI.

ACS Customer List and Node Field

To the right of the toolbar buttons is the **Customer** list. This list is accessible to ACS administrators with privilege levels 6 or 7, and to all users who access ACS from the SMS UI. This list displays the user name at the top and the names of the other ACS customer accounts you have permission to access. Select another customer in the list and the feature palette will display the feature nodes that have been set up for that customer.

Note: The CPE closes the control plan currently displayed in the canvas when you select another customer.

The **Node** field displays the number of the feature node that is currently selected in the control plan canvas. Each feature node is assigned a sequential number when you add it to the canvas. This number is useful for searching and troubleshooting. To select a different feature node in the canvas, type the number or name of the feature node in the **Node** field and click Enter.

When saving a control plan, a report is generated that highlights any errors in the control plan and specifies the number of the feature node in which the error occurred.

Note: The feature node number may not necessarily indicate how many feature nodes have been used in the control plan. When you delete a feature node from a control plan, that node's number is not reassigned. However, if you delete the feature node with the highest node number, that number will be reassigned to the next feature node that you add.

Feature Palette

On the left of the UI is the feature palette, which contains the names of feature groups. A feature group is a set of feature nodes that are related to a common function.

To display the feature palette if it is not visible, or to hide the feature palette from view,

click the Palette button on the toolbar: 

Note: If you open an existing control plan as read-only, the feature palette is not displayed.

Float your cursor over the feature group name to display the feature nodes in the group. You can filter which feature nodes are displayed by using the Search Palette box at the top of the feature palette panel. See [Finding Feature Nodes in the Feature Palette](#).

You can display a short description of a feature node in the feature group by floating your cursor over the feature node. The description appears at the bottom of the feature group.

Note: The feature groups and feature nodes you see in the CPE are those that the CPE system administrator has previously set up for you. If you do not see a feature node or feature group that supplies the functionality that you need, contact your CPE system administrator.

Canvas

In the center is the CPE canvas where you build your control plans. You drag feature nodes from the feature groups to the control plan canvas. All control plans begin with a Start feature node. Each path in a control plan must end with an End feature node.

To add feature nodes to a control plan and connect them, see [Working with Feature Nodes](#).

Search Results

The search results lists the feature nodes found in the canvas when you perform a search. You enter the search criteria in the search field above the search results panel. See [Searching for Feature Nodes in the CPE Canvas](#) for more information about searching for feature nodes.

Tips:

- To locate a feature node on the canvas that is listed in the search results, pass the mouse pointer over the feature node name in the search results panel. The CPE highlights the feature node in green in the search results panel and in your control plan on the canvas.

- Select a feature node in the search results tab to select it in the canvas and display information about the feature node's connections in the node inspector panel.

Search Results Panel

On the right of the UI is the search results panel. It contains the following tabs:

- Search Results
- Issues

To display or hide the search results panel, click the Inspector button on the toolbar: .

Note: This also updates the CPE view preferences for your user. For more information, see [About Setting and Resetting View Preferences](#).

Issues

The CPE displays a list of issues that may prevent the control plan in the canvas from compiling on the **Issues** tab of the search results panel. The following list is an example of the types of issues:

- The feature node has no incoming connections.
- The feature node has one or more unconnected exits.
- The feature node contains invalid configuration data.
- The feature node version differs from the latest.

If you open or import a control plan that contains feature nodes with issues, this tab displays in the search results panel.

Tips: If you click on an issue in the list, the feature node is selected and centered on the canvas.

The CPE automatically updates the issues list by removing feature nodes from the list as you configure them. If there are no issues, the tab is inactive.

Node Inspector

Below the search results panel is the node inspector panel. When you select a feature node or a connector line in the canvas, the node inspector displays the following information about the selected feature node or the feature nodes connected to the connector line:

- The feature node number and name; for example, **5. Set WalType** for the Set Wallet Type feature node.
- Node type and node fast key; for example, **Set Wallet Type: swt**, where **Set Wallet Type** is the feature node type and **swt** is the feature node fast key. Fast keys are abbreviations for the feature nodes that you can use as search criteria when tracing control plans in the canvas. For more information about control plan tracing, see [Troubleshooting Control Plans Using Control Plan Tracing](#).
- Any comments configured for the listed feature nodes. For more information about adding feature node comments, see [Adding Feature Node Comments](#).
- A list of incoming nodes and the names of their exit branches. Incoming nodes are the feature nodes connected to the selected node and that come just before the selected feature node in the control plan.

- A list of node exits. Node exits are the selected feature node's exit branches that lead to other feature nodes in the control plan. If an exit is connected to a feature node, that feature node is listed in the node inspector. If an exit is not connected to another feature node, the node exit in the node inspector will be red.

Tips:

- To browse the feature node selection history and display information in the node inspector about a previously selected node, click the arrow keys on the toolbar.
- To locate a feature node on the canvas that is listed in the node inspector, pass the mouse pointer over the feature node name in the node inspector. The CPE highlights the feature node in green in the node inspector panel and in your control plan on the canvas.
- To display information about a connected feature node, select the feature node in the node inspector. The CPE also selects and centers the feature node in the canvas.
- To display or hide the inspector panel, click the Inspector button on the toolbar:



Note: This also updates the CPE view preferences for your user. For more information, see [About Setting and Resetting View Preferences](#).

About Setting and Resetting View Preferences

You set the CPE view preferences for your user ID each time you:

- Change the feature node title style. See [Switching Between Feature Node Title Styles](#) for more information.
- Display or hide the grid, or change the grid proportions. See [Using the CPE Canvas Grid](#) for more information.
- Display or hide the node inspector panel. See [Node Inspector](#) for more information.

The CPE saves the view preferences configuration for your user ID. The next time you access the CPE, the Control Plan Editor window displays using your saved view preferences.

You can configure the CPE view preferences for individual SMS users and ACS users. For more information, see *CPE User's Guide*.

The Control Plan Editor window displays using the default view preferences if no view preferences have been set for your user. The default view preferences are those configured for the SU user. If no view preferences have been set for the SU user, then the following defaults are used:

- Display feature nodes in the canvas with all view options selected.
- Display the grid and set the grid proportions to 20.
- Display the inspector panel.

To reset your user view preferences to the default view, select **Reset to Default View** from the **View** menu.

Note: Selecting **Reset to Default View** also makes the feature palette visible in the CPE window, and sets the canvas magnification to actual size.

Changing the CPE Canvas Magnification

The canvas magnification controls the visual size of feature nodes in the canvas.

To change the canvas magnification, from the **View** menu select one of the following:

- **Actual Size** to display CPE canvas at the standard size
- **Zoom In** to scale up the CPE canvas and decrease the viewing area
- **Zoom Out** to scale down the CPE canvas and increase the viewing area
- **Zoom To Fit** to make all feature nodes in the control plan visible on the canvas

Tip: Double click the canvas background to:

- Zoom to fit a control plan that is bigger than the canvas.
- Zoom back to actual size a zoomed out control plan and center the control plan on the double click point.
- Left double click also deselects the currently selected feature nodes. To retain the current selection, right double click.

Using the CPE Canvas Grid

The CPE canvas grid can help you to align the feature nodes in the canvas whether or not the grid is visible. The grid options control the grid size and behavior:

- To display the grid, select **Grid** from the **View** menu.
- To hide the grid, deselect **Grid** from the **View** menu.
- To change the grid proportions:
 1. Select **Grid granularity** from the **Tools** menu.
The Snap-To-Grid dialog box appears.
 2. Move the control pointer to change the grid proportion.
 3. Click **OK**.
- To automatically align feature nodes to the grid, select **Snap All To Grid** from the **Tools** menu.
- To resize feature nodes in the canvas so that their height and width are a multiple of the grid size, select **Resize All To Grid** from the **Tools** menu.
For example, if the grid granularity is 50, then all feature nodes in the canvas will be resized so that their heights and widths are the nearest multiple of 50. A node that is currently 61 high and 132 wide will be resized to 50 high and 150 wide.

Tip: Hiding or displaying the grid, or changing the grid proportions, updates the CPE view preferences for your user. For more information, see [About Setting and Resetting View Preferences](#).

Displaying User and Control Plan Information

Your user information includes your user name, customer name, permission level and session ID. The control plan information includes the names of the current control plan structure and data, the number of feature nodes in the control plan, whether the control plan

has been modified, and the date of the last modification. This information may be needed by your technical support person if you encounter any technical issues.

To view user and control plan information, select **Properties** on the **Tools** menu or click the **Properties** icon in the toolbar.

Working in Multiple Control Plans Simultaneously

You can work in multiple control plans at the same time. This is useful for comparing control plans or copying and pasting feature nodes from one control plan to another.

To open multiple control plans, you start a new instance of the CPE for each control plan you want to open:

In the CPE, select **New Window** from the **File** menu.

Working with Feature Nodes

Finding Feature Nodes in the Feature Palette

To help you find the feature nodes you want to add to a control plan, you can filter which feature nodes are displayed in the feature palette.

To filter which feature nodes are displayed in the feature palette, enter the search criteria in the **Search Palette** field at the top of the feature palette panel. As you type, the CPE dynamically updates the feature nodes available in each group by matching the entered text against the following data:

- Feature node name
- Feature node fast key
- Feature node configuration parameter names
- Feature node exits

For example, if you enter "vo" in the search field, then the groups in the feature palette will include only those feature nodes with the text "vo" in their name (for example, "voucher type recharge") or in their associated data.

If there are no matching feature nodes in a group, then the feature group will disappear from the feature palette.

Note: The Base group of feature nodes is always available and cannot be filtered.

Tips:

- The number of matching feature nodes in each remaining group is displayed in brackets next to the feature group name.
- To clear the search criteria and restore the unfiltered feature palette, click the  icon in the **Search Palette** field.

Adding Feature Nodes to a Control Plan

To add a feature node to a control plan, do one of the following:

- Drag the feature node icon from the feature group to the canvas.

- Click on the feature node icon in the feature group and then click in the canvas.

About Viewing Feature Node Properties

The feature node icons on the CPE canvas display the following properties by default:

- The feature node title above each feature node. By default the title includes the feature node number and node name.
- A representative icon image for the feature node.
- The connector lines that connect feature nodes. Connector lines are solid if telephony is active for that branch or dotted if telephony is not active. When the feature node is selected:
 - Red lines indicate input paths.
 - Blue lines indicate exit paths.
- The telephony icon on feature nodes that use telephony capabilities.
- For feature nodes that contain comments, a yellow comment box at the top right corner of the feature node.
- The feature node exits. Each feature node exit has a name. Feature node exits are:
 - Solid if telephony is allowed
 - Hollow if telephony is not allowed
 - Colored red if the exit is unconnected

Except for feature node exits, you can specify which of these properties is displayed. See [Modifying Viewable Properties for Feature Nodes](#).

This figure shows the viewable properties for the Change Pin feature node.

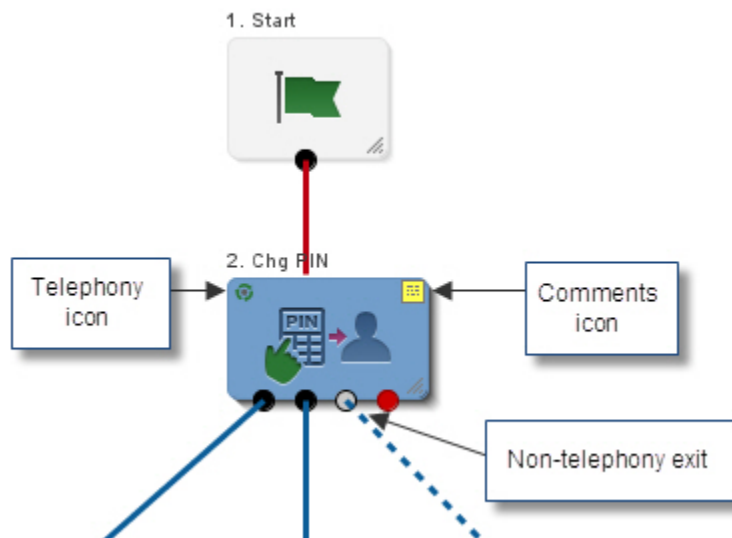

Modifying Viewable Properties for Feature Nodes

All feature node icon properties in the CPE canvas are visible by default. See [About Viewing Feature Node Properties](#) for more information about the properties.

To change the viewable properties for feature nodes:

From the **View** menu, select or deselect one or more of the following options:

- **All** displays all node properties.
- **Node Title** displays feature node titles above the feature nodes.
- **Icons** displays the icon images on feature node icons.
- **Connections** displays the connector lines between feature nodes.
- **Telephony** displays the telephony icon for feature nodes that have telephony capabilities, and identifies the feature node exits that do not allow telephony. When **Telephony** is selected, non-telephony exits appear grayed out on feature nodes.

Switching Between Feature Node Title Styles

The feature node icons in the CPE canvas can display one of the following node title formats:

- Feature node number and name
- Feature node name only
- Feature node number only
- No title

To change the format of the node title, select **Next Node Title Style** from the **View** menu to change to the next format in the list.

To quickly switch to the next node title format, type "N".

Tip: Changing the node title format updates the CPE view preferences for your user. For more information, see [About Setting and Resetting View Preferences](#).

Resizing Feature Nodes

You may want to resize certain feature nodes in the CPE canvas. You can make them bigger so that they are easier to locate and their properties are easier to see. Or you can make them smaller so that you can see more feature nodes on the CPE canvas without scrolling.

To resize a feature node, click and drag the resizing handle in the bottom right of the feature node.

Copying and Pasting Feature Nodes

You can copy one or more feature nodes and paste them into the same control plan or into another control plan in a different CPE window. The feature node configurations are also copied.

You can use the standard copy-and-paste keyboard shortcuts or toolbar icons to copy and paste feature nodes. You can also search the CPE canvas for specific feature nodes and then select **Select All Found Nodes** from the **Edit** menu to select those feature nodes for copying. For information about searching, see [Searching for Feature Nodes in the CPE Canvas](#).

About Connecting Feature Nodes

The exits for a feature node define all the possible routes that the service-logic may take after passing through the feature node. All the exits for a feature node must be connected to another feature node in the control plan. You can connect multiple exits to the same feature node if required. For example, you might connect the Abandoned, Routing Failure, and Abort exits of the Attempt Termination feature node to the same End feature node.

Some feature nodes require an active session with the connected user to perform their function, for example, to play an announcement. These telephony feature nodes will have some exits that support telephony and some, such as the exit for call abandoned, that do not support telephony. You can only connect exits that support telephony to a telephony feature node.

You can configure the number of exits for some feature nodes, such as the Dynamic Switch feature node. Configuring an additional exit allows you to define an additional branch in the service-logic. See [Editing Feature Node Exits](#) for more information.

Viewing Node Exit Bubble Help

The feature nodes in the CPE canvas incorporate bubble help boxes for each feature node exit. Exits are the dots at the bottom of the feature node icons. The bubble help includes information about the exit branch.

To specify whether to display exit bubble help, select or deselect the **Display Node Exit Info** option from the **Tools** menu.

To view exit bubble help, pass the mouse pointer over an exit. Information about the exit connection appears. The text in quotes is the name of the exit. If the feature node has two or more unconnected exits, then the bubble help includes help about connecting all the exits for the feature node.

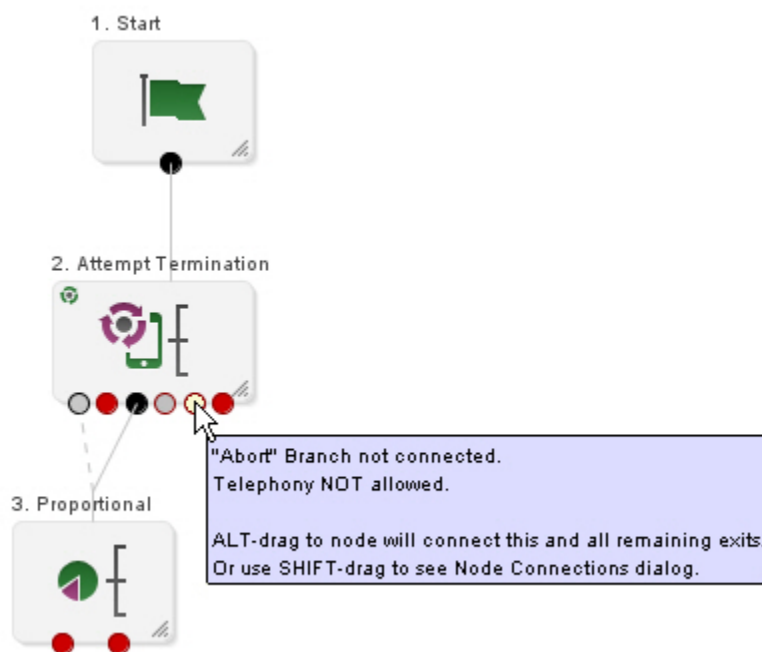

Editing Feature Node Exits

You can edit the number of available exits for some feature nodes to provide additional branches in the service-logic.

Note: This option is unavailable for feature nodes that have a fixed number of exits.

To edit the number of exits for a feature node:

1. Select the feature node in the CPE canvas that you want to edit.
2. Do one of the following to open the Edit Node Structure dialog box:
 - Press **Alt+Enter**.
 - Right-click on the feature node and select **Edit Node Exits**.
3. The Edit Node Structure dialog box opens.
4. In the **Branch** field, enter the number of exits the feature node should have or use the arrow buttons to change the number of exits.
5. Click **Save**.

The Edit Node Structure dialog box closes and the feature node icon has the configured number of exits.

Connecting Feature Nodes

You connect two feature nodes by dragging a line from an exit on the source feature node to the target feature node.

You can also:

- Simultaneously connect all unconnected exits
- Select the exits to connect

Simultaneously Connecting All Unconnected Exits

To simultaneously connect all the unconnected exits in the source feature node to a target feature node, press the **Alt** key while clicking on an unconnected exit and dragging a line to the target feature node.

Note: If the target feature node uses telephony, only those exits from the source feature node that allow telephony will be connected to the target feature node.

Selecting the Exits to Connect

To select multiple exits in the source feature node and connect them to a target feature node:

1. Press the **Shift** key and click and drag a line from an unconnected exit in the source feature node to the target feature node.
The **Manage Node Exits** dialog box appears.
2. Select one of the following options to enable the feature node exit check boxes:

- **Unfilled exits only** to enable the check boxes for all remaining feature node exits.
- **Any valid exit** to enable the check boxes for all valid feature node exits.

Tip: Invalid connections are connections from a non-telephony exit to a telephony node.

3. Do one of the following:
 - To quickly connect the enabled exits to the target feature node, click one of the following buttons in the Mass connect section:
 - **All** to connect all the available exits
 - **Telephony** to connect exits that support telephony
 - **Non-Telephony** to connect exits that do not support telephony
 - To connect only some of the enabled exits to the target feature node, check the boxes for the exits you want to connect in the Connect these exits section.
4. Click **Done**.

About Configuring the Type of Connector Line

There are two types of feature node connector line:

- Angled connector lines bend around feature nodes where possible instead of crossing over them. This is the default. Angled connector lines are colored when highlighted:
 - Red lines indicate input paths.
 - Blue lines indicate exit paths.
- HV connector lines use a combination of horizontal and vertical lines to connect feature nodes and may cross over other feature nodes. HV connector lines can be black or colored when highlighted.

You can configure the type of connector line to use for SMS users, ACS users, and individual users. For more information, see *CPE User's Guide*.

Note: The control plan structure is not affected by the type of connector line.

Deleting a Feature Node Connection

You can delete a single connection or simultaneously delete multiple connections between two feature nodes.

Deleting a Single Connection Between Two Feature Nodes

To delete a single connector line between two feature nodes:

1. Click the exit in the source feature node for the connection you want to delete.
The connector line is selected.
2. Do one of the following:
 - Click the **Delete** icon on the toolbar.
 - Grab the connector line and drag it away from the target node.

The selected connection is deleted.

Simultaneously Deleting Multiple Connections Between Two Feature Nodes

To simultaneously delete multiple connections between two feature nodes

1. Press the **Shift** key and click and drag a line from an exit in the source feature node to the feature node from which to delete connections. Do this even if there is already a connector line from all exits.
The **Manage Node Exits** dialog box appears.
2. Do one of the following:
 - To delete all the connections between the two nodes, in the **Mass connect** panel, click **None**.
 - To delete only some connections between the two nodes, deselect the check boxes for the exits that you want to disconnect.
3. Click **Done**.

Searching for Feature Nodes in the CPE Canvas

You can search the CPE canvas for feature nodes that are unconfigured or for feature nodes that match you search criteria. An unconfigured feature node is a feature node that meets any of the following conditions:

- It has no incoming connections
- It has one or more exit ports that are not connected to another feature node
- It contains invalid configuration data
- It has not been saved (the feature node is red)

Note: Unconfigured feature nodes are automatically listed in the **Issues** tab.

Tip: To locate a feature node on the canvas that is listed in the search results, pass the mouse pointer over the feature node name in the search results. The CPE highlights the node in green in the search results and in your control plan on the canvas.

Searching for Unconfigured Feature Nodes

To search for feature nodes that are unconfigured, select **Unconfigured Nodes** from the list next to the **Search Canvas** field. The CPE displays a list of the unconfigured nodes in the search results panel.

Tip: The CPE automatically updates the search results by removing nodes from the list as you configure them.

Searching for Feature Nodes Based on Search Criteria

The CPE searches on all feature node properties by default.

To search for feature nodes in the CPE canvas that match your search criteria:

1. (Optional) From the list next to the **Search Canvas** field, select one of the following options:

- A feature node property, such as **Name** or **Type**, to search for feature nodes with that specific property.
 - **Parameters** to search for feature nodes that have certain configuration parameters.
 - **Geo Routing** to search for feature nodes that route a specified number or number prefix through a non-default exit branch of the Geographical Routing feature node.
- Note:** You configure the default exit branch when you configure the Geographical Routing feature node.
2. In the **Search Canvas** field, enter the search criteria. To search:
 - Feature node properties, enter the property details.
 - Parameters, enter the parameter name.
 - Geo-routing, enter the geo-routing number prefix and press Enter.

The CPE lists the matching feature nodes in the search results panel.

Tips:

- To clear your search criteria and the search results, click the  icon in the **Search Canvas** field.
- Select a feature node in the search results panel to display information about the feature node in the node inspector panel.

Reloading Customer Data

Customer data is data that you or another administrator configure in the ACS UI, such as geography sets and announcements sets.

You should periodically reload customer data from the database to ensure that your control plan feature nodes contain the most current data. If you or another administrator update customer data in the ACS UI while you are working on your control plans, that data is only available after you reload it.

For example, if you updated an announcement set, then reload customer data to make the changes available in the CPE.

To reload customer data, select **Reload Customer Data** from the **Tools** menu.

Printing Control Plans

You can print a control plan using the standard dialog for your operating system or by using the postscript dialog.

Printing a Control Plan by Using the OS Dialog

To print a control plan by using the standard dialog for your operating system:

1. Open the control plan to print.
2. From the **File** menu, select **Print** and then **Sun Dialog**.

The print dialog box for your operating system opens.

Note: The Sun print dialog defaults to the standard dialog for the current operating system.

3. Configure the printing options as required.
4. Click **Print**.

Printing a Control Plan by Using the Postscript Dialog

To print a control plan by using the postscript dialog:

1. Open the control plan to Print.
2. From the **File** menu, select **Print** and then **Postscript Dialog**.
The Print Control Plan dialog box appears.
3. Configure the printing options as required, noting the following:
 - The print command on a Windows system is "print" where a print command exists. If you have difficulty, see your system administrator.
 - In the **Print command options**, enter the port of the target printer. The default port is **lpt1**. If **lpt1** is not mapped to the appropriate printer, see your system administrator to set the correct mapping.
 - The margin widths are measured in printer's points, which is approximately 1/72 inch.
 - The **Scale** field is currently not used.
 - If the **Fit to page** check box is selected, the control plan is printed in proportion to its appearance on the screen.
4. Click **Print**.

Tip: To end a print job after it has started printing, click **Cancel** in the print progress dialog.

Keyboard Shortcuts

The CPE provides the following keyboard shortcuts in addition to the standard shortcuts for copying, cutting, and pasting:

- [Keyboard shortcuts for using the CPE](#)
- [Keyboard shortcuts for adding feature nodes](#)
- [Keyboard shortcuts for navigating feature node configuration windows](#)

Keyboard Shortcuts for Using the CPE

The shortcut keys work from anywhere in the CPE window unless you have clicked in an area of the window where you can enter data, such as in a search field.

Here are the shortcut keys for using the CPE.

Action	Keys
Exit from the CPE after prompting you to save the existing control plan.	Alt + F4
Scroll around the CPE canvas or the feature palette.	Arrow keys
Change which feature node is selected.	Alt + arrow keys

Action	Keys
Select all the valid unconnected exits on a feature node and connect them to a target feature node.	Alt + drag node exit
Display the Manage Node Exits screen, enabling you to select the exits to connect. See Selecting the Exits to Connect .	Shift + drag node exit
Select a series of feature nodes.	Ctrl + arrow keys
Select the numbered feature node in addition to the feature nodes currently selected in the CPE canvas Tip: To select a feature node that has more than one digit, press the number keys in close succession.	Number keys
Open the configuration window for the selected feature node.	Enter
Open the Edit Node Structure dialog box if the number of exits can be changed for the selected feature node.	Alt + Enter
Select all the feature nodes in the CPE canvas.	Ctrl + A
Copy the selected feature nodes.	Ctrl + C
Switch the display of feature node parameters on and off.	Ctrl + D
Display parameter data for a feature node.	Ctrl + right click
Switch the canvas grid on and off.	G
Change the feature node title format to the next format in the list.	N
Switch the display of the telephony icon on the feature node on and off.	T
Display the Save dialog box for exporting a control plan to file.	Ctrl + E
Select all the feature nodes found by a canvas search that are listed in the search results.	Ctrl + F
Clean up the control plan margins and center the control plan in the CPE canvas.	Ctrl + H
Display the Open dialog box for importing files.	Ctrl + M
Clear the existing control plan from the canvas and display a blank canvas.	Ctrl + N
Open the Open Existing Control Plan dialog box.	Ctrl + O
Open the postscript Print Control Plan dialog box.	Ctrl + P
Save the current control plan.	Ctrl + S
Open the operating system Print dialog box.	Ctrl + U
Paste the copied feature nodes to the bottom right of the selected feature node.	Ctrl + V
Remove the selected feature nodes.	Ctrl + X
Display feature nodes on the canvas at their default size.	Ctrl + 0 (zero)
Decrease the magnification level (zoom out) of the canvas.	Ctrl + - (minus)
Increase the magnification level (zoom in) of the canvas.	Ctrl + = (equals)
Move the control plan around the canvas.	Alt + click and drag canvas background

Keyboard Shortcuts for Adding Feature Nodes

You can add these feature nodes to a control plan using the specified shortcut keys.

Feature Node	Keys
Attempt Termination	Alt+A
Attempt Terminate to Pending TN	Alt+Shift+A
Calling Party	Alt+C
Calling Party Category	Alt+Shift+C
Proportional Distribution	Alt+D
End	Alt+E
Geographical Routing	Alt+Shift+G
Selection Dependant Routing	Alt+M
Play Announcement	Alt+P
Disconnect Call	Alt+R
Start	Alt+S
Tip: If there is already a Start node in the control plan, pressing this key combination selects the Start node.	
Time of Day	Alt+T
Unconditional Termination	Alt+U
Unconditional Terminate to Pending TN	Alt+Shift+U
Day of Week	Alt+W
Day of Year	Alt+Y
Insert another copy of the most recently added feature node at the current location on the canvas.	Alt + double click

Keyboard Shortcuts for Navigating Feature Node Configuration Windows

In the feature node configuration windows, you can navigate around the buttons and fields using the following keyboard shortcuts:

Action	Key Combination
Move to the next field or button.	Tab
Move to the previous field or button.	Shift+Tab
Move to the next group of fields and/or buttons.	Ctrl+Tab
Move to the previous group of fields and/or buttons.	Ctrl+Shift+Tab
Activate the selected button or save data entered in a field.	Space or Enter
Display any keys that have been assigned to the buttons on a feature node configuration dialog box. To activate the button, press Alt and the underlined character.	Alt

Creating and Managing Control Plans

Creating Control Plans

You can create a control plan from a blank canvas or create a control plan from an existing control plan structure.

Creating a Control Plan from a Blank Canvas

When creating a control plan from a blank canvas, you can configure feature nodes as you add them to the control plan or any time after adding them.

To create a new control plan from a blank canvas:

1. From the Control Plan Editor **File** menu, select **New**.

The CPE displays a new control plan in the canvas, consisting of a single Start node.

2. Locate the feature nodes in the feature palette that you want to add to the control plan and drag them to the canvas.

Tips:

- To quickly find a feature node, enter search criteria for the feature node in the **Search Palette** field.
 - You can copy and paste feature nodes from another control plan. The feature node configuration will also be copied.
3. Position the feature nodes to define the service-logic and then connect them by dragging lines from the exits on each feature node to the next feature node or nodes in the control plan.
Note: All feature node exits must be connected before the control plan is valid.
 4. Configure the feature nodes in the control plan. For each feature node, perform the following steps:
 - a. Open the feature node configuration dialog box by doing one of the following:
 - Double-click the feature node.
 - Right-click the feature node and select **Edit Node Data**.
 - Click the **Edit Node Data** button for the feature node in the search results or in the node inspector panel.
 - b. Enter the configuration data required by the control plan. For information on the configuration fields click the **Help** button in the feature node configuration dialog box.
 - c. Click **Save**.

Note: You must configure all the feature nodes to complete the control plan.

5. Verify that the control plan is complete.

- a. Click the check mark button on the toolbar:



The **Check Report** dialog box appears, displaying a message that verifies whether or not the control plan is complete.

- b. Click **OK**.
- c. If the control plan is complete, proceed to the next step. If the control plan is not complete, complete the control plan before proceeding to the next step.

Tip: On the canvas, unconfigured feature nodes are colored pink. To find all unconfigured feature nodes, select **Unconfigured nodes** from the search canvas list.

6. Click the **Save** button in the tool bar or select **Save** from the **File** menu.
The Save Data/Structure dialog box appears.
7. In the **Plan Structure** field, enter a unique name for the control plan structure.
8. In the **Control Plan Data** field, enter a name for the control plan data:
 - If you want to reuse the control plan structure with different set of data, give the data a unique name.
 - To make the control plan a global service control plan, give the control plan data the name **Global Screeningservice_name**, where *service_name* is the name of the service to which the control plan applies. For example, **Global Screening ACS**. The service name must correspond to the service name defined in the **acs.conf** configuration file for the appropriate application.
9. (Optional) In the **MF Identifier** field, specify an MF identifier of up to eight digits for the control plan.
Note: You use the MF identifier in the Activate Control Plan feature node in dial-up management control plans such as the ACS Management control plan.
10. (Available only to ACS administrators with privilege level 6 or 7.)
To make the control plan structure a public control plan structure, select the **Public Structure** check box.
11. (Optional) If you want the structure to appear as a template in the ACS Numbers window, select the **Show In Template Grid** check box.
12. (May not be available to all users.)
If the control plan is to be invoked by a third party or imported through WSDL, select the WSDL operation from the **Generate WSDL for operation** list.
13. Click **Save**.

The CPE validates, compiles, and then saves the new control plan. For information about control plan validation, see [Validating Control Plans](#).

Related Information

- For information about simultaneously connecting multiple node exits from a source feature node to a target feature node, see [Connecting Feature Nodes](#).
- For information about deleting connections between feature nodes, see [Deleting a Feature Node Connection](#).

- For more information about control plans, see *CPE User's Guide*.
- For information about viewing a control plan WSDL file in the OSD Operations tab, see *OSD User's and Technical Guide*.
- For information about importing a control plan WSDL file into DAP, see *DAP User's Guide*.
- For information about control plan templates, see *ACS User's Guide*.

Creating a Control Plan from an Existing Structure

You can use an existing control plan structure to create a new control plan. You can also modify the existing structure and save it as a new structure.

For information about control plan structure and data, see [About Control Plan Structures and Data](#).

To create a new control plan from an existing control plan structure:

1. From the Control Plan Editor **File** menu, select **New Plan from Existing Structure**.

The New Control Plan From Existing Structure dialog box opens, displaying a list of all control plan structures.

Note: You may restrict the list of control plan structures by using the search and filtering functions. You may perform steps 2 and 3 in either order.

2. (Optional) You can restrict the list by searching for existing structure names containing specific characters to use:

- Use the **Control Plan Name** and enter initial characters of the structure name or combine with % (match on any number of characters), or _ (match on a single character).

Examples:

Search for e%SMS will find all structure names beginning with e and containing SMS.

Search for e_han%SMS will find all structure names beginning with e, containing the string han in positions 3 to 5, and containing SMS.

- The list can be further restricted by entering a maximum number of names to show in the **Max Rows** field.

Click the **Search** button.

3. (Optional) Filter the list of available control plan structures:

- From the **Structure Status** options, select one of the following:
 - **Show All Regardless Of Structure Status** to list all control plan structures
 - **Show Only Public** to list only public control plan structures
 - **Show Only Private** to list only private control plan structures
- From the **Availability Status** options, select one of the following:
 - **Show All Regardless Of Availability Status** to list all control plan structures
 - **Show Only Saved with errors** to list only control plan structures for unsuccessfully compiled control plans
 - **Show Only Saved without errors** to list only control plan structures for successfully compiled control plans

4. Select the required control plan structure in the list.
5. If you will be editing the control plan structure then deselect the **Open Structure as Read-Only** check box.
6. Click **Open**.
The CPE displays the control plan structure in the canvas.
7. If you opened the control plan structure for editing, then update the structure as required by adding or deleting feature nodes.
8. Edit the configuration for the feature nodes in the control plan as required. For each feature node, perform the following steps:
 - a. Open the feature node configuration dialog box by doing one of the following:
 - Double-click the feature node.
 - Right-click the feature node and select **Edit Node Data**.
 - Click the **Configure** button for the feature node in the search results or in the node inspector panel.
 - b. Enter the configuration data required by the control plan. For information on the configuration fields, click the **Help** button in the feature node configuration dialog box.
 - c. Click **Save**.

Tip: To quickly find a feature node in the control plan, enter search criteria for the feature node in the **Search Canvas** field.

9. Verify that the control plan is complete.
 - a. Click the check mark button on the toolbar:



The Check Report dialog box appears, displaying a message that verifies whether or not the control plan is complete.

9. Verify that the control plan is complete.
 - b. Click **OK**.
 - c. If the control plan is not complete, complete it before proceeding to the next step.

Tip: On the canvas, unconfigured feature nodes are colored pink. To find all unconfigured feature nodes, select **Unconfigured nodes** from the search canvas list.

10. Click the **Save** button in the tool bar or select **Save** from the **File** menu.

The Save Data/Structure dialog box appears.

11. If you changed the control plan structure, then in the **Plan Structure** field, enter a unique name for the control plan structure.

Important: If you change the control plan structure and then save the control plan structure with the same name, any other control plans linked to this structure will be invalidated.

12. In the **Control Plan Data** field, enter a name for the control plan data:

- If you changed the control plan structure, or if you did not change the control plan structure and you want to reuse it with different set of data, give the data a unique name.
- To make the control plan a global service control plan, give the control plan data the name **Global Screeningservice_name**, where *service_name* is the name of the service to which the control plan applies. For example, **Global Screening ACS**. The service name must correspond to the service name defined in the **acs.conf** configuration file for the appropriate application.

Important: If you change the control plan data and then save the control plan data using an existing name, this version of the data will be overwritten.

13. (Optional) In the **MF Identifier** field, specify an MF identifier of up to eight digits for the control plan.

Note: You use the MF identifier in the Activate Control Plan node in dial-up management control plans such as the ACS Management control plan.

14. (Available only to ACS administrators with privilege level 6 or 7.)

If you changed the control plan structure and want to make the structure a public control plan structure, select the **Public Structure** check box.

15. (Optional) If you want the structure to appear as a template in the ACS Numbers window, select the **Show In Template Grid** check box.

16. (May not be available to all users.)

If the control plan is to be invoked by a third party or imported through WSDL, select the WSDL operation from the **Generate WSDL for operation** list.

17. Click **Save**.

The CPE validates and compiles the new control plan, and then saves it. For more information about control plan validation, see [Validating Control Plans](#).

Related Information

- For information about simultaneously connecting multiple node exits from a source feature node to a target feature node, see [Connecting Feature Nodes](#).
- For information about deleting connections between feature nodes, see [Deleting a Feature Node Connection](#).
- For more information about control plans, see *CPE User's Guide*.
- For information about viewing a control plan WSDL file in the OSD Operations tab, see *OSD User's and Technical Guide*.
- For information about importing a control plan WSDL file into DAP, see *DAP User's Guide*.
- For information about control plan templates, see *ACS User's Guide*.

Adding Sub-control Plans to a Control Plan

A sub-control plan is a control plan that is processed as part of the main control plan. When the sub-control plan finishes processing the session data, it passes the session data back to the main control plan to continue processing.

To add a sub-control plan to a control plan:

1. Open the control plan for which you want to add a sub-control plan if it is not open already.
Important: Because you will be modifying the control plan structure, ensure you deselect the **Open Structure as Read-Only** check box in the Open Existing Control Plan dialog box.
2. In the feature palette, open the **Others** group of feature nodes and click and drag a **Load Sub Control Plan** feature node to the canvas.
3. Double-click the **Load Sub Control Plan** feature node icon.
The Configure Load Sub Control Plan window opens.
4. From the list next to the **View** button, select the control plan you want to run as a sub-control plan.
5. Click **Save**.
The Configure Load Sub Control Plan window closes and you are returned to the control plan in the canvas.
6. Connect the Load Sub Control Plan feature node to other feature nodes in the service-logic where you want the sub-control plan to be triggered.

Related Information

- For more information about the Load Sub Control Plan feature node, see *Network Charging and Control Feature Nodes Reference Guide*.
- For information about connecting feature nodes, see [Connecting Feature Nodes](#).
- For more information about sub-control plans, see *CPE User's Guide*.

Adding Comments to a Control Plan

You can annotate a control plan with comments so that other users can quickly see what the control plan does. You add comments to control plans by using Control Plan Notes.

Note: You do not connect Control Plan Notes to feature nodes in the service-logic.

To add a comment to a control plan:

1. In the feature palette, open the **Base** group of feature nodes and click and drag the **Control Plan Notes** icon to the canvas. Place the note where you want the comment to appear.
2. Double click the note box.
The Edit Comments dialog box appears.
3. Type your comment in the text area, and click **OK**.

Validating Control Plans

When you save a control plan, it is automatically validated and compiled if there are no errors.

To successfully compile a control plan, all the feature nodes in the control plan must contain valid configuration data and all the feature node exits must be connected.

A control plan can be saved with errors if it contains either unconnected exits or if a feature node in the control plan has been configured with invalid data. Control plans saved with errors have the status "E".

Only successfully compiled control plans that do not contain errors may be assigned to a service, and used to provide service-logic. Successfully compiled control plans have the status "S".

Note: If you opened the control plan structure or the control plan data as Read-Only, the read-only part will not be compiled or saved because it contains no changes.

When you save a control plan, the compiler compiles the control plan structure first, and then the control plan data. If the compiler finds any errors in the control plan structure, then the control plan data will not compile. You must fix the errors and try again.

Saving a Control Plan with Errors

If you save a control plan and it contains an unconfigured feature node, the following message is displayed in an Information dialog box

```
Information, Node NodeNumber is not configured.
```

Where `NodeNumber` is the number of the unconfigured feature node. You can click:

- **Cancel** to close the Information dialog box.
- **Delete** to delete the unconfigured feature node.
- **Configure** to open the configuration window for the feature node.
- **Save Anyway** to save the control plan with errors.

Saving a Control Plan with Warnings

If you save a control plan and it contains a feature node with warnings, the following message is displayed in an Information dialog box

```
This plan has one or more warnings
```

You can click:

- **Cancel** to close the Information dialog box.
- **Attempt Compile** to compile the plan.
- **Save Only** to save the control plan without compiling it.

Viewing the Compiler Build Report

The compiler displays the progress of the compilation, and whether the compile succeeded or failed.

Modifying Control Plans

Modify a control plan to edit the control plan structure, or the control plan data, or both.

Modifying a Control Plan

To modify a control plan:

1. From the Control Plan Editor **File** menu, select **Open**.

The Open Existing Control Plan dialog box opens, displaying a list of all control plans.

Note: You may restrict the list of control plans by using the search and filtering functions. You may perform steps 2 and 3 in either order.

2. (Optional) You can restrict the list by searching for control plan names containing specific characters:
 - Use the **Control Plan Name** and enter initial characters of the control plan name or combine with % (match on any number of characters), or _ (match on a single character).
Examples:
Search for `e%SMS` will find all structure names beginning with `e` and containing `SMS`.
Search for `e_han%SMS` will find all structure names beginning with `e`, containing the string `han` in positions 3 to 5, and containing `SMS`.
 - The list can be further restricted by entering a maximum number of names to show in the **Max Rows** field.
3. Click the **Search** button.
4. (Optional) Filter the list of available control plans:
 - From the **Structure Status** options, select one of the following:
 - **Show All Regardless Of Structure Status** to list all control plans
 - **Show Only Public** to list only public control plans
 - **Show Only Private** to list only private control plans
 - From the **Availability Status** options, select one of the following:
 - **Show All Regardless Of Availability Status** to list all control plans
 - **Show Only Saved with errors** to list only unsuccessfully compiled control plans
 - **Show Only Saved without errors** to list only successfully compiled control plans
5. In the list of control plans, select the control plan to modify.
6. If you will be editing the control plan structure then deselect the **Open Structure as Read-Only** check box.
7. Click **Open**.
The CPE displays the control plan in the canvas.
8. If you opened the control plan structure for editing, add and delete feature nodes as required.
9. Connect exits to and from any unconnected feature nodes you added to the control plan.

10. Edit the configuration for the feature nodes in the control plan as required. Double click the feature node to open its configuration dialog box.
11. Verify that the control plan is complete.

- a. Click the check mark button on the toolbar. 

The Check Report dialog box appears, displaying a message that verifies whether or not the control plan is complete.

- b. Click **OK**.
- c. If the control plan is complete, proceed to the next step. If the control plan is not complete, complete the control plan before proceeding to the next step.

Tip: On the canvas, unconfigured feature nodes are colored pink. To find all unconfigured feature nodes, select **Unconfigured nodes** from the search canvas list.

12. Click the **Save** button in the tool bar or select **Save** from the **File** menu.

The Save Data/Structure dialog box appears.

13. If you changed the control plan structure and you don't want to overwrite the original structure, then in the **Plan Structure** field, enter a unique name for the control plan structure.

Important: If you change the control plan structure and then save the control plan structure with the same name, any other control plans linked to this structure will be invalidated.

14. If you do not want to overwrite the original control plan data, then in the **Control Plan Data** field, enter a new name for the control plan data.

15. (Optional) In the **MF Identifier** field, specify an MF identifier of up to eight digits for the control plan.

Note: You use the MF Identifier in the Activate Control Plan node in dial-up management control plans such as the ACS Management control plan.

16. (Available only to ACS administrators with privilege level 6 or 7.)

If you changed the control plan structure and want to make the control plan structure a public control plan structure, select the **Public Structure** check box.

17. (Optional) If you want the structure to appear as a template in the ACS Numbers window, select the **Show In Template Grid** check box.

18. (May not be available to all users.)

If the control plan is to be invoked by a third party or imported through WSDL, select the WSDL operation from the **Generate WSDL for operation** list.

19. Click **Save**.

The CPE validates, compiles and then saves the control plan. For more information about control plan validation, see [Validating Control Plans](#).

Related Information

- For more information about configuring a specific feature node, click the **Help** button in the feature node's configuration window.
- For information about finding feature nodes in the control plan, see [Searching for Feature Nodes in the CPE Canvas](#).

- For information about simultaneously connecting multiple node exits from a source feature node to a target feature node, see [Connecting Feature Nodes](#).
- For information about deleting connections between feature nodes, see [Deleting a Feature Node Connection](#).
- For information about deleting a feature node, see [Removing Feature Nodes from a Control Plan](#)
- For more information about control plans, see *CPE User's Guide*.
- For information about viewing a control plan WSDL file in the OSD Operations tab, see *OSD User's and Technical Guide*.
- For information about importing a control plan WSDL file into DAP, see *DAP User's Guide*.
- For information about control plan templates, see *ACS User's Guide*.

Adding Feature Node Comments

You can add comments of up to 2000 characters in length for each feature node in the control plan.

To add a comment to a feature node.

1. Open the Comments dialog box by doing one of the following:
 - Double click the feature node to open its configuration dialog box and click the **Comments** button.
 - Click the Comments button that appears when you place the mouse pointer over the feature node in the search results panel or the node inspector panel:



2. Type a comment for the feature node.
3. Click **Save**.

Removing Feature Nodes from a Control Plan

When you remove a feature node from a control plan, the CPE also deletes all the connections to and from the feature node.

To remove one or more feature nodes, select the feature nodes you want to remove, and click the Delete button on the toolbar:



Deleting Control Plans

You can delete the following:

- Control plans that are inactive. A control plan is inactive until it is activated by assigning it to a Service Number or CLI. When you delete an inactive control plan,

the CPE deletes only the control plan data; it does not delete the control plan structure. See [Deleting an Inactive Control Plan](#).

- Control plan structures that are unused. A control plan structure is unused if it does not have any control plan data records linked to it. See [Deleting an Unused Control Plan Structure](#).

For more information on control plan structures and data, see [About Control Plan Structures and Data](#).

Deleting an Inactive Control Plan

To delete an inactive control plan:

1. From the Control Plan Editor **File** menu, select **Delete Data**.

The Delete Non-Active Control Plan dialog box opens, listing the inactive control plans.

Note: You may restrict the list of control plans by using the search and filtering functions. You may perform steps 2 and 3 in either order.

2. (Optional) You can restrict the list by searching for existing control plan names containing specific characters to use:

- Use the **Control Plan Name** and enter initial characters of the structure name or combine with % (match on any number of characters), or _ (match on a single character).

Examples:

Search for e%SMS will find all structure names beginning with e and containing SMS.

Search for e_han%SMS will find all structure names beginning with e, containing the string han in positions 3 to 5, and containing SMS.

- The list can be further restricted by entering a maximum number of names to show in the **Max Rows** field.

3. Click the **Search** button.

4. (Optional) Filter the list of control plans available for deletion:

- a. In the **Structure Status** section, select the control plan structure status to display only control plans with the selected status.
- b. In the **Availability Status** section, select the control plan availability status to display only control plans with the selected status.

5. In the control plan list, select the control plan to delete.

Tip: Use the **Shift** or **Ctrl** key when selecting control plans to select multiple control plans.

6. Click **Delete**.

A confirmation message is displayed.

7. Click **OK**.

The Delete Non-Active Control Plan dialog box closes and the control plan data record for the selected control plan is deleted.

Note: The CPE does not delete the control plan structure.

Deleting an Unused Control Plan Structure

To delete an unused control plan structure:

1. From the Control Plan Editor **File** menu, select **Delete Structure**.

The Delete Unused Structure dialog box opens, listing the control plan structures that have no control plan data linked to them.

Note: You may restrict the list of control plan structures by using the search and filtering functions. You may perform steps 2 and 3 in either order.

2. (Optional) You can restrict the list by searching for existing structure names containing specific characters:
 - Use the **Control Plan Name** and enter initial characters of the structure name or combine with % (match on any number of characters), or _ (match on a single character).
- Examples:**
- Search for `e%SMS` will find all structure names beginning with `e` and containing `SMS`.
- Search for `e_han%SMS` will find all structure names beginning with `e`, containing the string `han` in positions 3 to 5, and containing `SMS`.
- The list can be further restricted by entering a maximum number of names to show in the **Max Rows** field.
3. Click the **Search** button.
 4. (Optional) Filter the list of control plan structures available for deletion:
 - a. In the **Structure Status** section, select the control plan structure status to display only control plans with the selected status.
 - b. In the **Availability Status** section, select the control plan availability status to display only control plans with the selected status.
 5. In the control plan structure list, select the structure to delete.
 6. Click **Delete**.

A prompt giving the number of feature nodes in the control plan is displayed.

7. Click **OK**.

The Delete Unused Structure dialog box closes and the control plan structure is deleted.

Importing and Exporting Control Plans

About Importing and Exporting Control Plans

Export a control plan to a file to save the control plan so that you can import it into another database or to the same database but for another customer.

When you export a control plan, you create a **.cpl** text file. You can open and edit a **.cpl** file using any plain text editor. A summary of the control plan is provided at the beginning of the file. To add a comment to the text, start the line with a “#” character.

Additionally, you can export a control plan to an image file. The supported formats are PNG, JPEG, and GIF. The default format is PNG.

For more information about saving and compiling control plans, see [Validating Control Plans](#).

Exporting a Control Plan to File

To export a control plan to a file:

1. From the Control Plan Editor **File** menu, select **Open**.
The Open Existing Control Plan dialog box opens.
2. (Optional) Filter the list of available control plans:
 - a. In the **Structure Status** section, select the control plan structure status to display only control plans with the selected status.
 - b. In the **Availability Status** section, select the control plan availability status to display only control plans with the selected status.
3. In the control plan list, select the control plan you want to export and click **Open**.
The control plan is displayed in the canvas.
4. From the **File** menu, select **Export to file**.
The **Save** dialog box opens.
5. Navigate to the folder where you want to save the control plan.
6. In the **File name** field, enter the control plan name.
The CPE saves the control plan to the specified file name, and adds a text-based summary of the control plan to the beginning of the file.
7. Click **Save**.

Control Plan Export and Import Validation

When a control plan is exported on one SMS and then imported into another, you are exposed to the probable database differences between the two environments, because the exported parameter format of many CPE feature nodes makes explicit reference to database ID values.

During the export process, most of database IDs used within feature nodes are translated to a plain text name. When imported in to the new environment, these names are then associated with a new database ID within that environment.

Some feature nodes store database IDs inside profile tag selector objects. The exported form of these nodes cannot be made platform independent. For these feature nodes, on control plan import, there are warnings in that the plan contains problematic nodes, identifying each one by number and name.

Importing a Control Plan from File

When you import a control plan for a customer, the customer's feature node set should include all the feature nodes in the control plan. Otherwise, the CPE displays a warning for each feature node that the customer does not have, informing you that a specific feature node is not available, and that the control plan may not be saved with that feature node in it.

To import a control plan from file:

1. From the Control Plan Editor **File** menu, select **Import from file**.
The Open dialog box opens.
2. Navigate to the folder containing the control plan file you want to import.
The CPE displays the control plan file in the **File name** field.
3. Click **Open**.
The CPE imports the control plan and displays it in the CPE canvas in the Control Plan Editor window.
The control plan is validated. If any feature nodes contain errors or warnings the **Issues** tab, listing the issues, is displayed in the search results panel. All feature nodes containing issues are colored orange.
4. Resolve any issues identified.
5. Save the control plan.
This compiles the control plan and thus ensures that the control plan is valid for the customer for whom it has been imported.

Troubleshooting Control Plans Using Control Plan Tracing

The control plan tracing feature of the CPE helps you to locate errors in your control plan by finding which feature nodes in the control plan are referenced during service-logic processing. You typically copy data from a CDR to use in the control plan trace.

For more information about control plan tracing, see *CPE User's Guide*.

Tracing a Control Plan

To trace the feature nodes referenced in a session:

1. If necessary, open the control plan applicable to the trace you want to perform.
Note: If you want to modify the control plan structure, deselect the **Open Structure as Read-Only** check box in the Open Existing Control Plan dialog box.
2. From the drop down list next to the canvas search field, select the **Control Plan Trace** search type.
3. In the search field, type the control plan trace string, or copy and paste it from a text file such as a CDR. The control plan trace string must have the following format:

```
fastkey-number, fastkey-number, fastkey-number, fastkey-number, ...
```

Where:

- `fastkey` is the short code used by the CPE for the feature node. For example, `AT` is the Attempt Termination feature node fast key.
- `number` is the number assigned to a feature node in the control plan. This number identifies the required feature node when the same type of feature node occurs more than once in the control plan.

Note: The CPE will automatically perform a control plan trace if you enter a search value that starts with "ST-". ST is the fast key for the Start feature node, and using this value implies a control plan trace.

The feature nodes referenced in the trace are highlighted in the control plan, and are listed in the search results.

4. To clear the control plan trace string, in the search field click the X icon:



Feature Nodes and Feature Sets

This chapter explains how to select feature nodes for use in control plans.

A control plan consists of multiple different decision points or actions. These decision points are represented graphically by symbolic icons known as “feature nodes”. Control plans are constructed using the ACS Control Plan Editor.

This chapter contains the following topics.

[Adding Feature Sets](#)

Adding Feature Sets

The ACS Configuration screen enables feature sets to be maintained. A feature set is a convenient way of grouping feature nodes.

Customers are allocated one or more feature sets. The feature nodes from those feature sets can be used in any control plan the customer creates. Only the feature nodes available in the feature sets assigned to a customer will be displayed on the control plan feature palette in the Control Plan Editor for that customer.

Feature sets are created and maintained by the system administrator. Therefore, this screen is only available to the system administrator. The system administrator allocates the feature node sets maintained in this screen to customers.

It is not possible to delete a feature set that is used in a current customer control plan.

When the **Edit** button is clicked, the screen will have the check boxes for the nodes that are currently in the feature node set ticked. If the **New** button was clicked, a new set may be created, the **Feature Node Set** field will be blank and all nodes will be clear.

Nodes in Depth

This chapter lists all the feature nodes that may be available. The actual nodes available are dependent on the application in which the Control Plan Editor is operating. In some cases, additional nodes may have been created and installed to fit a specific customer need. These custom nodes do not appear in this list.

This chapter contains the following topics.

[Account Code Entry](#)

[Activate Control Plan](#)

[Attempt Terminate to Pending TN](#)

[Attempt Terminate to Pending TN with Duration](#)

[Attempt Termination](#)

[Branch on Bearer Type](#)

[Branch On Call Forwarding Pending](#)

[Branch on Event Report Request BCSM Code](#)

[Branch on Indicator](#)

[Branch on Protocol](#)

[Branch on Service Key](#)

[Calculation](#)

[Call Filtering](#)

[Call Forwarded Branching](#)

[Call Initiation](#)

[Call Progression](#)

[Calling Party](#)

[Calling Party Category](#)

[Change CDR](#)

[Change Ordered Prefix Tree Entry](#)

[Check Limitations](#)

[Check Prefix Tree Capacity](#)

[Collect Date to Tag](#)

[Collect Digits to Buffer](#)

[Collect Digits to Pending TN](#)

Collect Digits to Sub-tag
Compare Profile Data
Control Plan Notes
Copy
Copy Hunting List
Create Prefix Tree
Day of Week
Day of Year
Delete Profile Field
Dialled Number
Disconnect Call
Dynamic Switch
End
Event Branching
Event Counting
Event Setting
Geographical Routing
Get Hunting List
Get Hunting Number
Junction
Load Profile
Loop Limit
Modify
NP Destination Selection
NP Home Routing
NP Least Cost Routing
NP Map Trigger
Number Lookup and Translation
Number Matching
Number Normalisation
PIN Authorisation
Play Announcement
Play Ordered Prefix Tree Entry

Play Variable Part Announcement
Prefix Branching
Prefix Tree Branching
Prefix Tree Entry Extraction
Presence Branching
Profile Branching
Profile Counting
Profile Date Compare
Profile Date Store
Proportional Distribution
Selection Dependent Routing
Send Notification
Send Short Message
Service Handover
Set
Set Carrier Code
Set Cut and Paste
Set Indicator
Set Pending TN from Profile
Set Presence
Set Tariff Code
Sleep
Start
Statistic
Statistic Increment
Sub Control Plan
Table Lookup
TCAP Handover
Terminate to Pending TN
Terminate Unchanged
Test Pending TN Type
Time of Day
Transmission Type Branching

Unconditional Termination

Account Code Entry

The Account Code entry node prompts for an account number to be entered and collects the digits. Collected digits are placed in the Account Code buffer.

The access code entered by the caller is added to the Call Data Record.

Account Codes are also known as access codes. You can set the access code policy for service numbers and CLIs in ACS.

Note: Depending on the Access Code Policy that is selected for the Service Number or CLI, the account code entered using this node may be one of:

- Not required
- Required and verified
- Required and not verified

See Service Number and CLI New Numbers fields, accessed from the ACS Numbers screen, for details about Access Mode Management and Access Code Policy.

Node exits – Account Code Entry

This node has one entry and three exits. The number of exits cannot be changed.

Exit	Cause	Description
1	Success	The Account Code was entered and collected successfully.
2	Not Allowed	The Account Code entered is invalid.
3	Abandoned	The Account Number or Code entered was not found by the system.

Configuring the node – Account Code Entry

Follow these steps to configure the Account Code Entry node, to set or amend the Main Account Number Announcement.

1. The main announcement is the announcement that will be played to prompt for an Account number.

In the Main Announcement area, select the **Announcement Set** which contains the main announcement you want to play to the caller.

Result: The **Announcement Entry** field becomes available.

2. From the **Announcement Entry** drop-down list, select the main announcement you want to play to the caller.
3. Set the **Repetition** field to the number of times you wish to repeat the announcement, by increasing or decreasing the value in the spin box. The allowable values are from 1 (default) to 127. If set to zero, the announcement will be repeated for the length of the duration set.

4. Set the **Duration** field to the length of time in seconds that the announcement is to be played. The allowable values are from 0 (default) to 32767. If set to zero, the announcement will be played for its full length.

5. Amending the Retry announcement on Invalid Entry.

The retry announcement will be played if the Account Number entered after the main announcement is not valid.

In the Retry Announcement area, select one of the following as described in steps 1 - 4:

- **Announcement Set** which contains the retry announcement
 - **Announcement Entry** for the retry announcement you want to play, and set
 - **Repetition** to the number of times to repeat the retry announcement
 - **Duration** to the length of time, in seconds, that the retry announcement is to be played.
6. Set the **Number of Retries** field to the number of times that the node will attempt to collect the correct Account Number from the caller, before routing the call to the Not Allowed branch. This value may be between 0 and 10.
 7. Click **Save**.

Note: **Save** is not available until all the required information has been selected or entered.

Note: The announcement set and announcement entry lists are populated with data that is specified using the **Announcements** tab of the ACS Configuration screen.

For more information about configuring announcement sets and announcement entries, see the **Announcements** tab of the ACS Configuration screen.

Activate Control Plan

This node enables a caller to schedule a control plan using a touch tone phone. It should be used as part of an IVR control plan (for example, the ACS Management Control Plan).

The caller specifies which control plan to schedule by entering the control plan's control plan ID (that is, MF Identifier). The node can also be set up to enable the caller to specify the time and date the control plan will become active. If a time is not specified, the control plan becomes active immediately.

The control plan can be scheduled against either an SN or CLI according to the following rules:

- If the **Load Profile** node most recently triggered in the control plan loaded an SN or CLI profile, the control plan will be scheduled against a number of the same type.
- If neither the SN nor CLI profile has been loaded, the node will schedule against the type of number specified in the pending TN type buffer.

For more information about:

- MF Identifier, see MF Identifier.
- Pending TN type buffer, see Pending termination number variables.

Node exits – Activate Control Plan

This node has one entry and three exits. The number of exits cannot be changed.

Exit	Cause	Description
1	Success	The control plan was activated successfully.
2	Not Updated	There was a problem with activating the control plan. In addition to other possible faults, this exit is taken if the node cannot establish whether to schedule the control plan against an SN or a CLI.
3	Abandoned	The caller abandoned the call.

Configuring the node – Activate Control Plan

Follow these steps to configure the Activate Control Plan node.

- From the Main Announcement area, select the **Announcement Set** which contains the main announcement you want to play to the caller. The main announcement will be played to prompt for a Control Plan ID (MF identifier).
Result: The **Announcement Entry** field becomes available.
- From the **Announcement Entry** drop-down list, select the main announcement you want to play to the caller.
- Set the **Repetition** field to the number of times to repeat the main announcement while the system waits for the caller to take an action. If set to zero, the announcement will be repeated for the length of the duration set.
- Set the **Duration** field to the length of time, in seconds, that the announcement is to be played. If set to zero, the announcement will be played for its full length.
- The retry announcement contains the announcement you want to play to the caller if an invalid ID is entered after the main announcement.

In the Retry Announcement area, select one of the following as described in steps 1 - 4:

- **Announcement Set** which contains the retry announcement
 - **Announcement Entry** for the retry announcement you want to play, and set the
 - **Repetition** to the number of times to repeat the retry announcement
 - **Duration** to the length of time, in seconds, that the retry announcement is to be played
- Set the **Number of Retries** field to the number of times that the node will attempt to collect the correct ID from the caller, before routing the call to the Not Updated branch. This value may be between 0 and 10.
 - If you:

- want to prompt the caller to set an activation date, tick the **Prompt for Activation Time?** check box.
 - do not want to prompt the caller to set an activation date, go to step 11.
8. From the **Timezone Type** drop-down list, select the timezone you want to use.
If you select the Explicit Unix TZ option, you need to select a specific region from the **Unix Timezone** field.
For more Time zone information, see Time Zones.
 9. The Date Announcement area contains the announcement you want to play to the caller. Select one of the following as described in steps 1 - 4:
 - **Date Announcement Set** which contains the main announcement
 - **Date Announcement Entry** for the main announcement you want to play, and set the
 - **Repetition** to the number of times to repeat the announcement
 - **Duration** to the length of time, in seconds, that the announcement is to be played.
 10. The Retry Date Announcement area contains the announcement you want to be repeat while the system waits for the caller to take an action. Select one of the following as described in steps 1 - 4:
 - **Date Announcement Set** which contains the retry announcement
 - **Date Announcement Entry** for the retry announcement you want to play, and set the
 - **Repetition** to the number of times to repeat the announcement
 - **Duration** to the length of time, in seconds, that the announcement is to be played.
 11. Click **Save**.

Note: **Save** is not available until all the required information has been selected or entered.

Note: The announcement set and announcement entry lists are populated with data that is specified using the **Announcements** tab of the ACS Configuration screen.

For more information about configuring announcement sets and announcement entries, see the **Announcements** tab of the ACS Configuration screen.

Example use of Activate Control Plan node

Here is an example of using the Activate Control Plan Node to activate a Control Plan for a Service Number or CLI.

For detailed information on the ACS Management Control Plan, see the chapter - Dial-up Control Plan Management in ACS.

1. A customer is set up with an 0800 number and the self management screens.
2. The customer creates 2 control plans.
3. The customer phones a number attached to the ACS management control plan to change which control plan is active for the number.

Here is an example of a Configure Activate Control Plan screen in ACS management control plan that does this. See the ACS Management Control Plan example in *ACS User's Guide* to see the entire control plan.

In this example, the caller is prompted to enter the:

- Control Plan ID (MF Identifier) and the
- Date to activate the Control Plan.

Attempt Terminate to Pending TN

The Attempt Terminate to Pending TN node attempts to terminate to the number currently held in the PendingTN variable.

For information about the PendingTN variable, see Pending termination number variables.

Shortcut keys – Attempt Terminate to Pending TN

The shortcut keys to add an Attempt Termination to Pending TN node are **Alt+Shift+A**

Node exits – Attempt Terminate to Pending TN

This node has one entry and six exits. The number of exits cannot be changed.

Some nodes require telephony (that is, Play Announcement, Unconditional Termination, Disconnect, Attempt Termination, Selection Dependant Routing, Unconditional Terminate to Pending TN). Such nodes may follow Exits 2 and 3 of the Attempt Terminate to Pending TN node. They may not follow exits 1, 4, 5 and 6.

Exit	Cause	Description
1	Success	The call was successfully connected to the specified termination number.
2	Busy	The Termination Number held in the Pending TN Buffer was busy (that is, in use), so the call was routed to Exit 2.
3	No Answer	The call was routed to the Termination Number specified in the Pending TN Buffer and that phone rang for the specified Timeout time and then was routed down Exit 3.
4	Abandoned	The person placing the call hung up, so the call was routed to Exit 4.
5	Abort	The call will be sent to this exit in the case of network failure.
6	Routing Failure	Due to congestion, the call was forwarded to this exit.

Configuring the node – Attempt Terminate to Pending TN

Follow these steps to configure the Attempt Terminate to Pending TN node.

1. From the **National/International Prefix Location** drop down lists, select the profile **Data Type** and **Location** to read Least Cost Routing configuration from.
The location list displays all available fields for the data type selected.
For more information about profile blocks, see Profile Blocks and Tags.
If you do not want to use [Least Cost Routing](#) on this destination number, select:None Selected.
2. You must set the **Timeout** value for the node. This is the number of seconds that is allowed to pass before the call is routed down the No Answer branch. The Timeout value may be between 0 and 180 seconds.
3. Click **Save**.

Attempt Terminate to Pending TN with Duration

This node is used to connect the call up to a maximum duration and without charging the caller, for example connecting to a subscription weather service announcement.

Node exits – Attempt Terminate to Pending TN with Duration

This node has one entry and eight exits. The number of exits cannot be changed.

Note: These exit descriptions are specific to the responses received from an Oracle VWS billing engine. For specific information about how responses from other billing engines map to these exits, see the technical guide for the interface for billing engine being used.

Exit	Cause	Description
1	Busy	The Destination Party was busy and the call could not be connected.
2	No Answer	Destination Party did not answer.
3	RS Failure	Route Select Failure. The network could not connect the Caller to the Destination Party.
4	Disconnect A-Party	The Caller hangs up to end the call.
5	Disconnect B-Party	The Destination Party hangs up to end the call.
6	Abort	The call was aborted at some time during the processing of this node.
7	Abandon	The call was abandoned.
8	Node Error	General case for an un-handled state in this node.

Configuring the node – Attempt Terminate to Pending TN with Duration

Follow these steps to configure the node.

1. In the **No Answer Timeout** field, specify the number of seconds the switch should wait for the called party to accept the connection before assuming there was no answer. Value range: 0-2047
2. In the **Maximum Call Duration** field, specify the maximum number of 'deciseconds' before the call is disconnected.
3. Tick **Record Call in CDR** if you wish to generate a 'Call Information' report at the end of the call. This call information can then be used in the EDR.
Note: Selecting this option may impact other nodes within this control plan. If the **Record Call in CDR** check box is ticked, all subsequent attempt termination nodes will request a CIR.
4. From the **Profile IdentifierData Type** and **Location** drop down lists, select the profile to read Least Cost Routing configuration from. The location list displays all available fields for the data type selected.
For more information about profile blocks, see Profile Blocks and Tags.
If you do not want to use [Least Cost Routing](#) on this destination number, select None Selected.
5. Click **Save**.

Attempt Termination

The Attempt Termination node will attempt to terminate the call to a specified termination number but, if for some reason cannot terminate it to that number correctly, it takes a branch determined by the status of the call so that (for example) call diversion can be performed by the next node.

Termination numbers are specified as ranges of numbers in the ACS Configuration screens. The numbers shown in the Configure Attempt Termination screen are the ranges of termination numbers that have been specified for the logged in customer. If the customer for whom the call plan is being created is a managed customer, the termination numbers that have not been specified for the customer may be used in the node.

Note: The Attempt Termination feature node can be set to automatically display the TN as the feature node name by setting the `useTNForNodeName` parameter in the `acs.jnlp` file. If this parameter is set, then you may not manually edit the feature node name. For more information, see *Advanced Control Services Technical Guide*.

Shortcut keys – Attempt Termination

The shortcut keys to add an Attempt Termination node are **Alt+A**.

Node exits – Attempt Termination

This node has one entry and six exits. The number of exits cannot be changed.

Some nodes require telephony (that is, Play Announcement, Unconditional Termination, Disconnect, Attempt Termination, Selection Dependant Routing, Unconditional Terminate to Pending TN). Such nodes may follow Exits 2 and 3 of the Attempt Termination node. They may not follow exits 1, 4, 5 and 6.

Exit	Cause	Description
1	Success	The call was successfully connected to the specified termination number.
2	Busy	The Termination Number was busy (that is, in use) so the call was routed to Exit 2.
3	No Answer	The call was routed to the specified Termination Number, that phone rang for the specified Timeout time and then was routed down Exit 3.
4	Abandoned	The person placing the call hung up, so the call was routed to Exit 4.
5	Abort	The call will be sent to this exit in the case of network failure.
6	Routing Failure	Due to congestion, the call was forwarded to this exit.

Configuring the node – Attempt Termination

Follow these steps to edit the Attempt Termination node.

1. To specify a termination number for the node, select the range in which the number lies from the ranges shown.

Result: The prefix digits will be entered into the Termination Number entry field.

2. Use the **Termination Number** entry field to complete the number.

The Xs in the range signify the minimum number of digits that are required and the Ys signify the maximum number of digits in the range.

3. Type the number of seconds that the call is to ring at the termination number before it is routed down the No Answer branch of the node.
4. Click **Save** to commit that termination number to the node.

Note: The **Save** button will only become available when a number that is within the selected range is displayed in the Termination Number entry field.

Branch on Bearer Type

The Branch on Bearer Type (Bearer Capability) node will route calls to different branches depending on the incoming calling party bearer capability or the high layer characteristic and the node configuration.

Node exits – Branch on Bearer Type

This node has one entry and may have 4 through 10 exits. You can configure the number of exits within this range as required, using the **Edit Node Exits** option on the shortcut menu. See [Editing Feature Node Exits](#).

Node exits 1 through 3 are set by the system and may not be changed.

Exit	Cause	Description
1	No Match Found	No match was found for any rule in the Bearer Capacity structure extracted from the Initial Detection Point.
2	Bearer Not Available	The bearer specified in the node was not available in the Bearer Capacity structure extracted from the Initial Detection Point.
3	Error	A error occurred.
4 to 10	Exit 4	These exits are followed depending on the rules attached to them.

Configuring the node – Branch on Bearer Type

Follow these steps to edit the Branch on Bearer node.

1. Edit the node exits to add exits as required. See [Editing node exits](#) for details.

Note: The new number of exits is represented on the node icon, but *not* on the configuration screen exit list.

2. Open the Configure Branch on Bearer screen.

Result: The Bearer Type Branching tree lists all the exits that have been added, as in the example below, showing 7 exits.

By default, Branch 1 and Branch 2 are pre-configured.

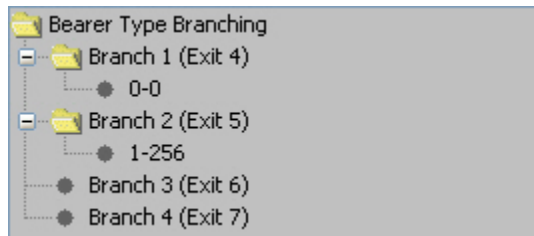

Note: The number of branches to configure will always be the total number of exits configured, minus the three pre-configured branches. In this example node, there are 7 exits, therefore there are 4 configurable branches.

3. In the **Bearer Component** frame, select the option on which to branch.
 - **Layer 1 Protocol** -
 - **Info Transfer Rate** -
 - **Info Tran capability** -
 - **Transfer Mode** -
 - **Coding Standard** -
 - **High Layer Character** - matches on Octet 4 of the High Layer Characteristics bearer field.

4. Branches are made up of rules. A rule is either a range of bearer types or a single value.

The maximum number you can enter in the rules is 256. Before you can add rules to any other branches, you must edit the rules for Branch 2 (that is, 1-256) and change 256 to the number appropriate to the branch. This will allow you to add rules to the branches.

To edit a rule, right-click on a rule and click **Edit**.

Result: The Edit Rules dialog will appear.

To create a rule:

- Of a single value, you can enter the value in the left hand field only, or the same number in both fields.
- For a range of numbers, enter values in both fields. The 'from' value must be lower than the 'to' value.

Note: The numbers must not overlap any other rule ranges. Make the change and click **OK**.

5. To add rules to a branch, right-click on the branch. From the pop-up menu displayed, select **Add**. You see the Add Rules screen.
6. Create the rule as required.
7. Click **OK**.

Result: One of the following will occur:

- The new rule will be added to the rule list.
- If a rule conflicts with an existing rule, a warning dialog box will appear providing more detail about the conflict.

Note: You may create as many rules per Branch as you require.

8. Edit or delete rules under each branch.

To delete a rule, right-click on a rule and click **Delete**.

Result: The rule is deleted from the branch.

9. When rules have been added to all branches, the **Save** button will become available.

Click **Save**.

Result: The node data is saved.

Notes:

- After configuration, you may add or remove exits for the node using Edit Node Exits, then edit the node branches again.
- If you remove exits, when you open the Configure Branch on Bearer screen again you will see a warning, such as this example.
Click **OK** to continue, then edit the node.

Branch On Call Forwarding Pending

The Branch On Call Forwarding Pending node branches depending on whether there is a call forward pending or not.

This node uses the `callForwardingSS-Pending` parameter flag to determine which branch to take. See standard 3GPP TS 29.078, version 5.0.0 for full details.

Node exits – Branch On Call Forwarding Pending

This node has one entry and two exits. The number of exits cannot be changed.

Exit	Cause	Description
1	Pending	There is a call forward pending.
2	Not Pending	There is not a call forward pending.

Configuring the node – Branch On Call Forwarding Pending

This node requires no configuration data. You may change the **Node name**, if required.

Branch on Event Report Request BCSM Code

The BoEC node branches depending on the result of the previous Request Report BCSM Event operation. The TDP codes that the node recognizes are from these events:

- oDisconnect
- tDisconnect
- oCalledPartyBusy
- tCalledPartyBusy
- RouteSelectFailure

Note: The "o" and "t" indicate Originating and Terminating respectively.

Node exits – Branch on Event Report Request BCSM Code

This node has one entry and initially five exits. You can manually add up to another five exits, making a total of 10 exits.

Exit	Label	Cause
1	No match found	The cause code being passed to the node is not defined in any of the node's branch rules.
2	Code not available	ACS did not pass a cause code to the node.
3	Error	A software error occurred.
4	Call Forwarded	ACS has been advised that a terminating call has been forwarded.
5 through 10	Exit 5 through Exit 10	Determined by branch rules specified for the exit.

Note: The call-forwarded exit scenario for this node is identical to that of the Call Forwarded Branching node. Refer to the section on the [Call Forwarded Branching](#) node; in particular the node exits.

Configuring the node – Branch on Event Report Request BCSM Code

Branches are made up of Cause code rules. A rule is either a range of Event Report Request BCSM Codes or a single value. Each branch can have as many rules as required, provided that the cause code has not been configured in another rule within this node.

Cause codes are defined in the following two documents.

- ETS 300 374-1
*Intelligent Network (IN);
Intelligent Network Capability Set 1 (CS1);
Core Intelligent Network Application Protocol (INAP);
Part 1: Protocol specification*
European Telecommunications Standards Institute
In particular, see `EventSpecificInformationBCSM` on page 47.
- ITU-T Recommendation Q.850
*Usage of Cause and Location
in the Digital Subscriber Signalling
System No. 1 and the Signalling
System No. 7 ISDN User Part*
International Telecommunications Union

Follow these steps to edit the Branch on ERB Cause Code node.

1. Edit the node exits to add up to another five exits as required. See Editing node exits for details.

Note: The new number of exits is represented on the node icon, but NOT on the configuration screen exit list.

2. Open the Configure Branch on ERRB Cause Code screen.

Result: The ERRB Cause Code Branching tree lists all the exits that have been added, as in the example below, showing 7 exits.

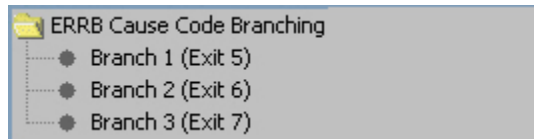

Note: The number of branches to configure will always be the total number of exits configured, minus the 4 pre-configured branches. In this example node, there are 7 exits, therefore there are 3 configurable branches.

3. To add rules to a branch, right-click on the Branch. From the pop-up menu displayed, select **Add**. You see the Add Rules screen.
4. Create the rule as required.

To create a rule:

- a. of a single value, you can enter the value in the left hand field only, or the same number in both fields.
- b. for a range of numbers, enter values in both fields. The 'from' value must be lower than the 'to' value.

Note: The numbers must not overlap any other rule ranges. The maximum value of a rule is 256.

5. Click **OK**.

Result: Either:

- the new rule will be added to the rule list, or
- if a rule conflicts with an existing rule, a warning dialog box will appear providing more detail about the conflict.

Note: You may create as many rules per Branch as you require.

6. Edit or delete rules under each branch. To:

- edit a rule, right-click on a rule and click **Edit**.
Result: The Edit Rules dialog will appear.
Make the change and click **OK**
- delete a rule, right-click on a rule and click **Delete**.
Result: The rule is deleted from the branch.

7. When rules have been added to all branches, the **Save** button will become available.

Click **Save**.

Result: The node data is saved.

Note: After configuration, you may add or remove exits for the node using Edit Node Exits, then edit the node branches again.

If you remove exits, when you open the Configure Branch on Bearer screen again you will see a warning, such as this example.

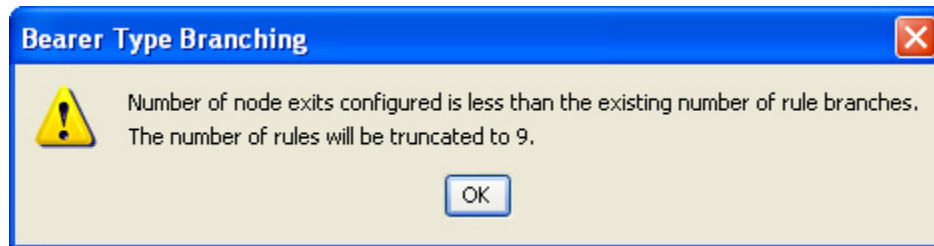

Click **OK** to continue, then edit the node.

Example of the use of the Branch on Event Report Request BCSM Code node

For a terminating call, suppose you want to select the following outcomes, depending on the values of cause numbers.

- If ACS was notified of call-forwarding, you want to play an announcement about call-forwarding.
- For cause number 1, you want to play an announcement about the telephone number being unallocated.
- For cause numbers 17 through 20, you want to play an announcement about the telephone number being either busy, unresponsive, unanswered or unanswerable because the telephone is switched off.
- For all other cause numbers, you want to simply disconnect the call.

To implement this scenario, you could set up the control plan shown below.

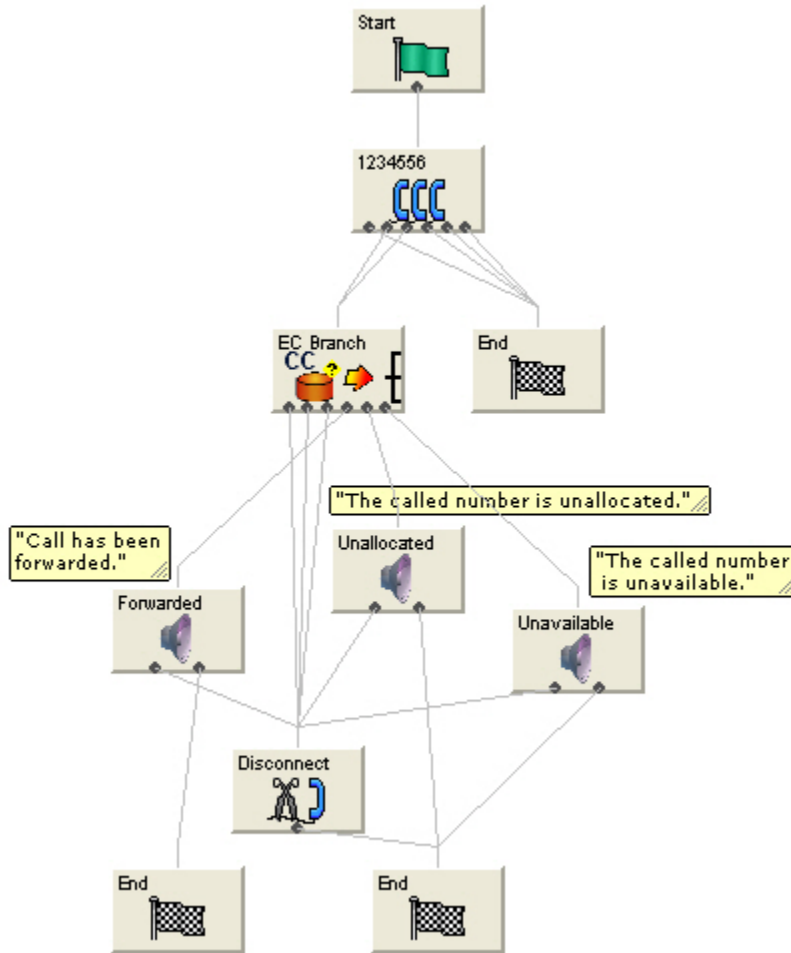

You would set up the configurable exits of the branch on ERRB Cause Code node as shown below.



The non-configurable exit branches would remain as shown below.

1	No match found	2	Code not available
3	Error	4	Call Forwarded

Branch on Indicator

The Branch on Indicator node allows you to take an exit based on one of the indicators of a specified number:

- Number incomplete
- Screening
- Presentation restricted

Node exits – Branch on Indicator

This node has one entry and five exits. The number of exits cannot be changed.

Exit	Cause	Description
1	Value 0	Bit value of 0
2	Value1	Bit value of 1
3	Value 2	Bit value of 2
4	Value 3	Bit value of 3
5	Error	Error

The interpretation of the value depends on the indicator selected.

Configuring the node – Branch on Indicator

Follow these steps to edit the node configuration.

1. Select the indicator option:
 - Presentation Restricted
 - Screening
 - Number Incomplete
2. Select the number from the drop down list.
 - CallingPartyNumber
 - AdditionalCallingPartyNumber
 - OriginalCalledPartyID
 - RedirectingPartyID
 - LocationNumber
 - LocationInformationLocationNumber
3. Click **Save**.

Interpretation of values – Branch on Indicator

This table describes the meaning of each value, depending on the indicator selected.

Value	Presentation Restricted	Screening	Number Incomplete
0	The presentation is allowed	User provided, but not verified	Complete
1	The presentation is restricted	User provided, verified and passed	Incomplete
2	The address is not available	User provided, verify failed	NA
3	Spare	Network provided	NA

Branch on Protocol

The Branch on Protocol node allows you to determine the protocol used by the current call and branch accordingly.

Node exits – Branch on Protocol

This node has one entry and six exits. The number of exits cannot be changed.

Exit	Cause	Description
1	CS1	CS1 Protocol
2	Nokia	(for future use)
3	CAP 2	CAP 2 protocol
4	CAP 3 or higher	CAP 3, or higher, protocol
5	CAP 3 or higher SMS	(for future use)
6	Failed to determine	Unspecified error

Configuring the node – Branch on Protocol

This node requires no configuration data. You may change the **Node name**, if required.

Branch on Service Key

The Branch on Service Key (BoSK) feature node compares an ACS IDP service key with a fixed value configured in the feature node. The feature node routes calls to different branches depending on the feature node configuration and whether or not a match is found.

You configure the BoSK feature node by allocating a service key number or range of numbers to each exit. The service key number can have up to 10 digits and must be less than or equal to 2147483647.

To increase the number of available exits for which you can specify service key numbers and ranges, edit the feature node structure.

Node exits – Branch on Service Key

This feature node can have between three and ten exits. You can configure the number of exits within this range as required, using the **Edit Node Exits** option on the shortcut menu. See [Editing Feature Node Exits](#).

Exits 1 and 2 are set by the system and may not be changed by the user.

Exit	Cause	Description
1	No match found	No match was found for the service key extracted from the Initial Detection Point.

Exit	Cause	Description
2	Error	The service key rules are incorrectly configured or an internal error has occurred.
3 to 10	Exit 3	These exits are followed depending on the rules attached to them.

Configuring the node – Branch on Service Key

Follow these steps to edit the feature node configuration.

1. Edit the number of feature node exits to create one or more additional exits. See Editing node exits for details.

Note: The new number of exits is represented on the feature node icon, but NOT in the exit list in the feature node configuration window.

2. Open the Configure Branch on Service Key window.

The Service Key Branching tree displays, listing all the configurable exit branches. This will be the total number of feature node exits, minus the two pre-configured exits. You configure the feature node by specifying the branching rules for each exit, where a rule is either a range of service keys or a single value.

For example, the following diagram shows the service key rules configured for two exit branches.

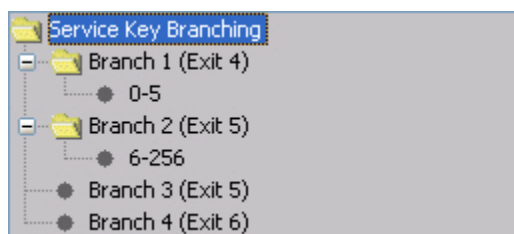

3. Add the rules to each branch by performing the following steps:
 - a. Right-click on the branch, and select **Add** from the pop-up menu. The Add Rules dialog displays.
 - b. Specify the service key values for the rule. To specify:
 - A single value, enter the value in the left hand field only, or the same number in both fields. A service key number can have up to 10 digits and must be less than or equal to 2147483647.
 - A range of numbers, enter values in both fields. The 'from' value must be lower than the 'to' value.
 - Click **Okay**. The rule is added to the list of rules for the selected branch.

If a rule conflicts with an existing rule or the rule is invalid, an Invalid Rule dialog box appears informing you about the error.

Note: You can add multiple rules to a branch, but you must specify at least one rule for each branch.

4. To edit a previously configured rule, perform the following steps:

- a. Right-click on the rule you want to change and select **Edit** from the pop-up menu.
The Edit Rules dialog appears, displaying the previously configured rule values.
 - b. In the text fields enter the new rule values. The numbers for the rule must not overlap any other rule range.
 - c. Click **Okay**.
5. To delete a previously configured rule, right-click on the rule and select **Delete** from the pop-up menu.
 6. Click **Save** to save the feature node configuration.

Note: You must configure at least one rule for each branch before you will be able to save the feature node configuration.

Note: You can configure additional exits for, or remove exits from the feature node, at any time. If you remove an exit then the next time you open the Configure Branch on Service Key window, a warning message displays:

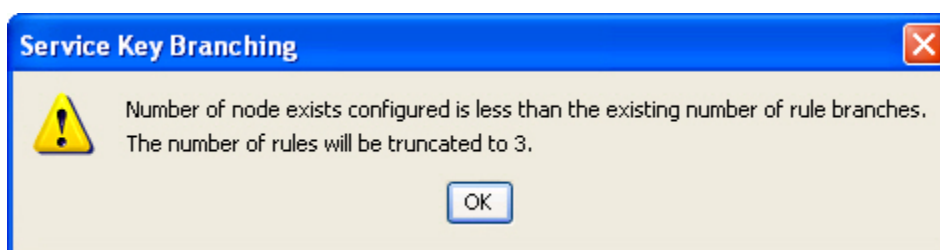

Calculation

The Calculation feature node allows basic calculations on two input values. The input values can be retrieved either from profile fields, or from a profile field and a fixed value. The result of the calculation is then stored to another profile field.

You use the Calculation feature node to perform the following operations:

- Addition: Adding two source numbers ($2+2=4$)
- Subtraction: Subtracting the second source number from the first ($5-2=3$)
- Multiplication: Multiplying two source numbers together ($2\times 2=4$)
- Division: Dividing the second source number into the first ($10\div 2=5$)
- Modulus: Finding the remainder when one number is divided into another ($10 \bmod 6=4$)

Node exits – Calculation

This node has one entry and three exits. The number of exits cannot be changed.

Exit	Name	Cause
1	Success	All calculation results have been stored successfully.

Exit	Name	Cause
2	Error	The unrounded result is too large for the type of target profile tag, or an error occurs (other than divide by zero).
3	Divide by zero	The calculation divides a number by zero.

Configuring the node – Calculation

Follow these steps to configure the node.

1. In the **First Number** section, specify the input value for your mathematical calculation by performing the following steps:
 - a. From the **Profile Value Data Type** list, select the type of value for your mathematical calculation. Depending on your selection, different options for **Profile Value Location** will be available to you.
 - b. From the **Profile Value Location** list, select the location of the value for your mathematical calculation.
 - c. From the **Profile Value Field** list, select the field that contains the value for your mathematical calculation.
2. In the **Operation** section, select the mathematical operation you wish to perform (**Multiply, Divide, Add, Subtract, or Modulus**).
3. In the **Second Number** section, specify the input value needed to complete your mathematical calculation by performing the following steps:
 - a. From the **Profile Value Data Type** list, select the type of value of the second number needed to complete your mathematical calculation.
 - b. If your profile value data type is a fixed value: In the **Profile Value Fixed Value** section, enter the number by which you wish to add, subtract, multiply, or divide. Otherwise, leave **Profile Value Fixed Value** blank.
4. In the **Rounding** section, select the option for the type of rounding you prefer (**Truncate, Ceiling, Median Up, Bankers, or Floor**).
5. In the **Destination** section, specify the profile field in which to store the calculation result by performing the following steps:
 - a. From the **Destination Profile Data Type** list, select the type of value of the profile field.
 - b. From the **Destination Profile Location** list, select the profile, database, or storage associated with your destination profile field.
 - c. From the **Destination Profile Field** list, select the profile field in which to store the calculation result.
6. Click **Save**.

Call Filtering

Use the Call Filtering feature node to check the number in the selected call-digits buffer to determine whether it matches a number in the allowed or barred list stored in the configured profile location.

Node exits – Call Filtering

This feature node has one entry and three exits. The number of exits cannot be changed.

Exit	Cause	Description
1	Barred	The call is barred, so it is routed down branch 1. This may then be followed by the required functionality, such as a Play Announcement or Disconnect feature node.
2	Allowed	The call is allowed, so it is routed down branch 2. This may then be followed by the required functionality, such as a Termination Unchanged feature node.
3	Data Not Found	No data is found to identify the number as allowed or barred. The call is routed down branch 3. It may then be followed by the required functionality, such as a Play Announcement or Disconnect feature node.

Configuring the node – Call Filtering

To edit the Call Filtering feature node:

1. From the lists in the Compare With Which Buffer area, select the buffer that contains the number to check in the allowed or barred numbers list. You specify the number list to use in the location fields.
2. From the **Location Of List Type** lists, select the profile field that sets whether the list type is allowed or barred.
3. From the **Location Of List Data** lists, select the prefix tree profile field that contains the list of allowed or barred numbers.
4. From the **Location Of Ignore Flag** lists, select the profile field that sets whether the list should be used or ignored. When the value in the profile field is set to true, the list is ignored and all numbers are allowed.
5. Click **Save**.

Call Forwarded Branching

This node branches in either of two directions, depending on whether or not ACS has been advised that a terminating call has been forwarded.

ACS may receive advice about call-forwarding from a Service Switching Point (SSP) that complies with the CAMEL Application Part (CAP) specification. To use the Call Forwarded Branching node, you need to be familiar with the CAP specification. The specification is contained in the following document.

3GPP TS 29.078 v3.7.0

3rd Generation Partnership Project;

Technical Specification Group Core Network;

Customised Applications for Mobile network Enhanced Logic

(CAMEL) Phase 3

CAMEL Application Part (CAP) specification

(Release 1999)

Note: This node can only be used with terminating calls passed to ACS by an SSP that complies with the CAP specification.

Node exits – Call Forwarded Branching

The Call Forwarded Branching node has one entry and two exits. The number of exits is fixed and cannot be changed.

Exit	Label	Cause
1	Call Forwarded	ACS has been advised that a terminating call has been forwarded.
2	Call Not Forwarded	ACS has not been advised that a terminating call has been forwarded.

Note: ACS is advised that a terminating call has been forwarded when an EventReportBCSM is received from the SSP. EventReportBCSM indicates to ACS's tBusy and tNoAnswer detection points that a "call forwarded" has been received.

Configuring the node – Call Forwarded Branching

This node requires no configuration data. You may change the **Node name**, if required.

Example of the use of the Call Forwarded Branching node

For a terminating call, you may want to play an announcement if the call has been call-forwarded and simply terminate the call if it has not been call-forwarded.

To implement this scenario, you could set up the control plan shown below.

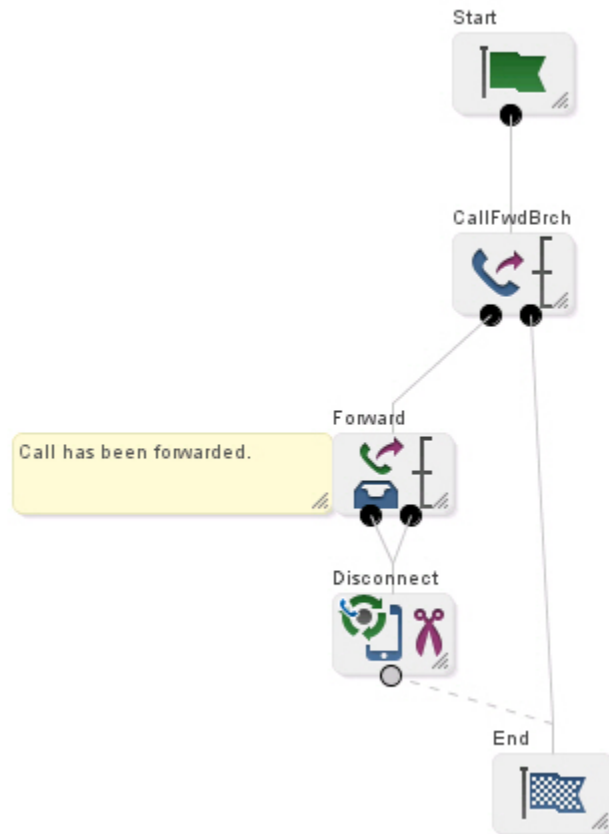

Call Initiation

The Call Initiation feature node enables a call attempt to be initiated from within the control plan. The feature node initiates a call attempt (ICA) to an IN switch to create a call that can be processed by ACS as if it had been a standard dialed call.

When the response (answered, noAnswer, busy, or Route Selection Failure) to the call is received, the feature node performs both the following actions:

- Process the current control plan as normal by taking the appropriate exit
- Transfer the new dialog (on which the ICA was sent) back into ACS as an IDP. The new call is processed in the normal way, executing a new control plan based on the standard service loading rules.

If the customer has a restricted termination range policy, the available termination ranges will be displayed in the top left hand corner of the configuration screen.

Notes:

- The IDP is constructed from information supplied in the Configure Call Initiation screen, the standard control plan number buffers and the call information from the initiating call.
- The available network switches are defined in **acs.conf** and made available to this feature node (Switch Name list) through the **acs.jnlp** or **sms.jnlp** files (ssfs parameter). See *ACS Technical Guide*, topic *Customizing the screens* for details.

- The destination for the ICA is configurable within the feature node. The SLEE interface for the ICA network is configurable in **acs.conf**. See *ACS Technical Guide* for details.
- This feature node may not be available, depending on the license agreement with Oracle.

Node exits – Call Initiation

This node has one entry and six exits. The number of exits cannot be changed.

Exit	Cause	Description
1	Success	The response the ICA received was 'Answer'.
2	Busy	The response the ICA received was 'Busy'.
3	No Answer	The response the ICA received was 'No Answer'.
4	Route Select Failure	The response the ICA received was 'Route Select Failure'.
5	Transient Failure	Either the node cannot find the network entity for the specified name, or it cannot find the service interface.
6	Permanent Failure	No response was received for the ICA.

Specifying values in profile selection fields

For each combo box combination on this screen, there are two methods of entering a value:

1. Use the drop down lists in the **Data Type**, **Location** and **Field** boxes, as in this example, to select the relevant values:

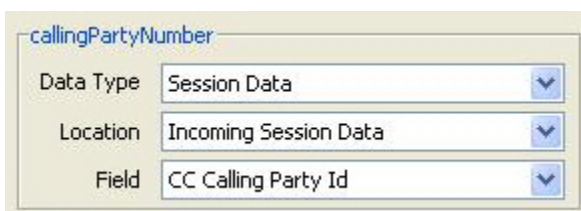

The screenshot shows a configuration window titled 'callingPartyNumber'. It contains three dropdown menus:

- Data Type:** Session Data
- Location:** Incoming Session Data
- Field:** CC Calling Party Id

2. Select Fixed Value in the **Data Type** box.

Result: The fields will change, as in this example, and you can type the required value in the **Fixed Value** field.

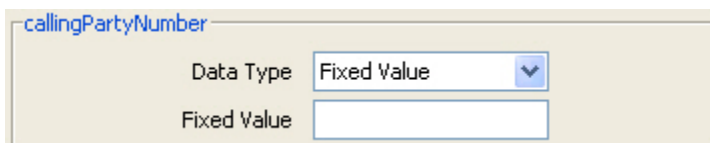

The screenshot shows the same configuration window, but the **Data Type** dropdown is now set to 'Fixed Value'. Below it, there is a text input field labeled 'Fixed Value'.

Configuring the node – Call Initiation

Follow these steps to edit the node configuration.

1. In the **Switch** area, select the **Name** of the network entity for the ICA destination from the drop down list .
2. (Optional) In the **Calling Party** frame, specify the value for the Calling Party ICA. Specify either an ACS termination number or an ACS buffer.
3. (Optional) In the **Prefix Calling Party** field, type a prefix for the calling party. This could be used, for example, so that the switch will not be re-triggered on the terminating leg.
4. (Required) In the **Party to call** frame, specify the value for the Called Party ICA. Specify either an ACS termination number or an ACS buffer.
5. In the **No Answer Timeout** field, type the number of seconds the switch should wait for the called party to accept the connection before assuming there was no answer. The No Answer Timeout value must be greater than zero.

Note: The wait time is automatically increased by a configurable amount defined in **acs.conf**. See *ACS Technical Guide* for details.

6. (Optional) In the **Controller** area, enter the **Service Key** for the IDP.
7. For each IDP, specify the values for the following optional fields:
 - callingPartyNumber
 - calledPartyNumber
 - redirectingPartyID
 - locationNumber
 - additionalCallingPartyNumber

8. Click **Save**.

Note: The list of data types is fixed at installation time for each feature node or screen.

Further reference:

- For information about profile blocks (data type, location, and field) and how to use them, see Profile Blocks and Tags.
- The primary tag lists are configured in the **SMS > Services > ACS Service > Configuration > Profile Tag Details** and **Profile Tag Mapping** tabs (see *ACS User's Guide, Profile Tag Details* for more information).

Call Progression

The Call Progression node allows you to configure the following parameters in the outgoing connect message:

- Suppress Switch Announcements
- Set OCSI Applicable

Node exits – Call Progression

This node has one entry and two exits. The number of exits cannot be changed.

Exit	Cause	Description
1	Success	The node parameters have been set.
2	Failure	The node parameters have not been set.

Configuring the node – Call Progression

Follow these steps to edit the node configuration.

1. Select the **Suppress Ann** check box to suppress switch announcements in the outgoing Connect message.
2. Select the **OCSIApplicable** check box to set the OCSIApplicable parameter in the outgoing Connect message.
3. Click **Save**.

Calling Party

This node routes calls based on the telephone number from which the call is made. This allows callers whose phone numbers have specified prefixes to be routed to different exits. Calls are routed to the exit that is mapped to the best match between the calling party number and the prefixes that are in the node data.

Example: If the prefixes entered into the node data are 04, 09, 04477 and 044, a caller from 044773384 will be routed down the branch associated with 04477, as this is the best match found for the calling party number.

For calls where there is no match found in the prefix list, the call is routed down the default exit.

Shortcut keys – Calling Party

The shortcut keys to add a Calling Party node are **Alt+C**.

Node exits – Calling Party

This node has one entry and may have two through 20 exits. You can configure the number of exits within this range as required, using the **Edit Node Exits** option on the shortcut menu. See [Editing Feature Node Exits](#).

Configuring the node – Calling Party

Follow these steps to configure the node.

1. Edit the node exits to add up to another eighteen exits as required. See [Editing node exits](#) for details.
2. Click **Add Prefix**.

Result: A highlighted entry appears in the display grid. This creates the new Prefix entry, and is edited in the following steps.

3. Type the prefix in the entry field to the left of the **Branch** box.
Calls made from numbers with this prefix are routed to the exit specified in this step.
4. Use the **Branch** box to select the exit these calls should be routed to.
5. Click **Change**.
Result: The Prefix appears in the display grid, with the exit displayed in brackets.
6. Repeat Steps 1 – 4 for as many prefix additions as required.
7. Set the default branch for all calls which do not match a specified prefix.
8. Click **Save**.
Note: **Save** is not available until all the required information has been selected or entered.

Calling Party Category

This node routes a call based on the category of phone from which the call originates. A category number identifies calls within the system, indicating the type of telephone from which the call is made (for example, pay phones, hotels or prisons).

This node is used by System Administrators only, for advanced editing. It will only work if the Telco's system is set up to provide the IDP calling party category information. This configuration must be configured on the switch at system level.

Shortcut keys – Calling Party Category

The shortcut keys to add a Calling Party Category node are **Alt+Shift+C**.

Node exits – Calling Party Category

This node has one entry and may have two through seven exits. You can configure the number of exits within this range as required, using the **Edit Node Exits** option on the shortcut menu. See [Editing Feature Node Exits](#).

Configuring the node – Calling Party Category

Follow these steps to edit the Calling Party Category node.

1. Edit the node exits to add up to another five exits as required. See [Editing node exits](#) for details.
2. Select the default branch.
Where the system is not configured to process calling party category data, the system will use the default branch for any calls using a Control Plan containing this node.
3. Click **Add Entry**.
Result: A highlighted entry appears in the display grid. This creates the new entry, and is edited in the following steps.
4. Use the Calling Party Type spin box to select the category number of the required type of phone.

Any value from 0 – 255 may be used to indicate any given category of phone. These values are network-specific, so they may be set to reflect the needs of the market. The table below details the standard values used for ISUP.

Result: Calls from phones of the selected calling party type will route down the selected branch.

Example: If values are selected from the ITU/ETSI CS1 standards, category 4 represents calls from the Russian language operator, and category 15 represents calls from payphones.

If the incoming call is from an undefined category, or if the system is not configured to process calling party category data, the call will be routed down the default branch.

5. Use the Branch spin box to select the exit.

This is the exit to which calls made from phones of this category are routed.

6. Click **Change**.

Result: The Category appears in the display grid, with the exit displayed in brackets.

7. Repeat Steps 1 – 4 for as many category additions as required.

8. Click **Save**.

Note: **Save** is not available until all the required information has been selected or entered.

ISUP: Enumerated Values for Calling Party Category

The table below details the standard values.

Integer value	Station type
-1	Unknown (not provided)
0	Unknown
1	Operator, language French
2	Operator, language English
3	Operator, language German
4	Operator, language Russian
5	Operator, language Spanish
6 - 8	Available to administration for selecting a particular language by mutual agreement
9	Reserved
10	Ordinary Calling subscriber
11	Calling subscriber with priority
12	Data call (voice band data)
13	Test call
14	Spare
15	Payphone
16 - 223	Spare
224 - 254	Reserved for national use
255	Spare

The following table shows values for the IS-41 NP(MSID) type.

Integer value	Station type
0	Mobile Identification Number
1	International Mobile Station Identity

For more information about the Calling Party Category, see *ITU-T standard Q763*.

Change CDR

The **Change CDR** node allows control plan designers to alter and add EDR tags to ACS EDRs during call flow. The EDR tag and value can be defined as whatever the designer requires within the rules listed in the Configuring the node procedure.

Note: The Change CDR node alters the EDR at the point in the control plan where it is placed, future events may further alter the EDR, either through external events (such as, the end of a call) or through other Change CDR nodes.

System-generated EDR tags

This is a list of the system-generated tags. These may be used in the Change CDR node, but their values will not be changed, a new tag of the same name will be added to the end of the EDR instead.

CID, OA, OTI, CUST, SN, TN, CGN, CLI, SK, TCS, TCE, LPN, LAC, CS, CPC, CC, CPNI, PCNA, TPNI, PTNA, CGNA, TGNA, TFN, LGID, CPN, CAET, CCET, CA, RELC, OCPI, CPNN, CGNN, CPPI, NOAT, CBAT, FATS, CCTS, HTS, AIDL, EXT*n*

Node exits – Change CDR

This node has one entry and two exits. The number of exits cannot be changed.

Exit	Cause	Description
1	Success	The EDR has been successfully updated with the details specified for the CDR tag and new CDR value.
2	Error	This branch is taken only in the event that node configuration is incorrect. Technical limitations limit the validation done on the node configuration at compile time, and therefore must be done at run time. The following situations will cause the Error branch to be taken: <ul style="list-style-type: none"> The CDRTag field is left empty The CDRValue field is left empty

Configuring the node – Change CDR

Follow these steps to edit the node configuration.

1. Select the **ForceAppend** check box to force the specified EDR tag to be appended to the EDR. If the tag already exists in the EDR, it will not be altered and the EDR will end up with the same tag in multiple places. The tag values in this case will not necessarily be the same.

If this box is not selected and the EDR already includes the tag configured in the node, then the tag in the EDR is modified to have the value defined in the node. If the tag does not exist in the EDR, then the tag/value pair is added to the EDR. This means the tag defined in the node is always included in the EDR..

2. The value in the **CDRTag** field must be between 1 - 50 characters long.

It defines the EDR tag to modify or add to the EDR. Any character may be used in this field, however the following rules apply:

- Use only uppercase A-Z characters.
- Do not use the characters | and =

Warning: The use of any of the system generated tags causes the original to remain unchanged and a second tag added to the end of the EDR, as if **ForceAppend** had been selected.

3. Select the **Tag Value** source, Options are:

- **Fixed Value** - from **CDRValue** field when this option selected.
- **Profile Value** - from profile location when this option selected.

4. If **Fixed Value** selected, enter the **CDRValue** field, this must be between 1 - 50 characters long.

It specifies the EDR value for the defined EDR tag. You may use any character in this field, except the characters | and =.

Note: If the profile value is selected, this field is grayed out.

5. If **Profile Value** selected, select the location from the **Data Type**, **Location** and **Field** drop down lists.

Note: If the fixed value is selected, these fields are grayed out.

6. Click **Save**.

Change Ordered Prefix Tree Entry

The Change Ordered Prefix Tree Entry node changes the contents of an ordered prefix tree.

This table describes the valid actions.

Action	Description
Add a new entry	This will add the contents of an ACS number buffer to the end of an ordered prefix tree. Note: If the prefix tree is missing a profile field will be created as a prefix tree with the new entry in it.

Action	Description
Change an existing entry	The feature node will replace the specified entry in the tree with the contents of an ACS number buffer.
Delete an existing entry	The specified entry will be removed from the tree.

Note: All of these operations will maintain the ordering of the tree entries (see Ordered prefix trees).

Node exits – Change Ordered Prefix Tree Entry

This node has one entry and two exits. The number of exits cannot be changed.

Exit	Cause	Description
1	Success	The change was successful.
2	Error	The change failed, due to one of: <ul style="list-style-type: none"> Specified entry not present in the prefix tree (change or delete action) Entry profile field not set (change or delete action) General node processing error (including add action failure)

Configuring the node – Change Ordered Prefix Tree Entry

Follow these steps to edit the node configuration.

1. Select the **Operation Type** option:

- Add Entry
- Update Entry
- Remove Entry

Result: The field availability changes as listed:

For Add Entry:

- Ordered Prefix Tree fields
- Number Source fields

For Update Entry:

- Ordered Prefix Tree fields
- Entry to be Updated/Removed fields
- Number Source fields

For Remove Entry

- Ordered Prefix Tree fields
- Entry to be Updated/Removed fields

2. In the Ordered Prefix Tree area, using the drop down lists, select the Prefix Tree.
3. For Update or Remove options, in the Entry to be Updated/Removed area, using the drop down lists, select the required Prefix Tree entry.
4. For Add or Update options, in the Number Source area, using the drop down lists, select the entry value to use.
5. Click **Save**.

Note: The list of data types is fixed at installation time for each feature node or screen.

Further reference:

- For information about profile blocks (data type, location, and field) and how to use them, see Profile Blocks and Tags.

The primary tag lists are configured in the **SMS > Services > ACS Service > Configuration > Profile Tag Details** and **Profile Tag Mapping** tabs (see *ACS User's Guide, Profile Tag Details* for more information).

Check Limitations

The Check Limitations node compares the contents of a number profile block against the limitations for a specified limited type. See About Prefix Tree Feature Nodes for information on limitations.

Node exits – Check Limitations

This node has one entry and five exits. The number of exits cannot be changed.

Exits 2 through 4 are all types of "Error".

Exit	Cause	Description
1	Number Allowed	The number meets all criteria for acceptance.
2	Number Barred	The entered number was either included in the barred list, or excluded from the allowed list, depending on the limitation prefix tree type.
3	Number Too Short	The entered number was not long enough for the given profile field.
4	Number Too Long	The entered number was too long for the given profile field.
5	Error	General Error.

Configuring the node – Check Limitations

Follow these steps to edit the node configuration.

1. From the **Source Primary Tag** drop down list, select the limitation to use.

Note: The available limitation types for this feature node are:

- Limited Ordered Prefix Tree

- Limited Number String
2. From the drop down lists in the **Number Source** area, select the **Source Data Type**, **Location** and **Field** containing the number to compare against the selected limitation type.
 3. Click **Save**.

Note: The list of data types is fixed at installation time for each feature node or screen.

Further reference:

- For information about profile blocks (data type, location, and field) and how to use them, see Profile Blocks and Tags.

The primary tag lists are configured in the **SMS > Services > ACS Service > Configuration > Profile Tag Details** and **Profile Tag Mapping** tabs (see *ACS User's Guide, Profile Tag Details* for more information).

Check Prefix Tree Capacity

The Check Prefix Tree Capacity node enables you to:

- Check how many entries there are in a prefix tree
- Optionally, for a limited ordered prefix tree, play the configured capacity type value (if played, the value is stored in the profile field configured in the node)

The capacity type value which can be played is one of the following:

- The number of entries available (only for limited ordered)
- The number of entries used (all types)
- The maximum number of entries for the tree (only for limited ordered)

If the prefix tree profile field is missing from the profile, the node assumes it is a tree with zero entries.

Node exits – Check Prefix Tree Capacity

This node has one entry and four exits. The number of exits cannot be changed.

Exit	Cause	Description
1	Free Entries	The prefix tree is not full.
2	Full	The prefix tree is full.
3	Abandon	The user hung up during the announcement.
4	Error	General error handling

Configuring the node – Check Prefix Tree Capacity

Follow these steps to edit the node configuration.

1. Select the **Play Announcement** check box to play the capacity result.

Result: The Play Capacity **Announcement Set** and **Announcement Entry** fields become available and the **Save** button becomes unavailable.

2. Select the Prefix Tree Type.

Result: If you selected:

- **Normal**, the Source fields in the Source Prefix Tree area and the Target fields in the Capacity Storage area become available. Go to step 4.
- **Limited Order**, in addition, the Capacity Type options and the rest of the fields in the Source Prefix Tree area become available. Go to step 3.

3. Select the Capacity Type option to use for capacity calculations:

- **Entries count** - the number of entries available,
- **Entries left** - the number of entries used, or
- **Capacity** - the maximum number of entries for the tree.

4. In the Source Prefix Tree area select the source limited ordered prefix tree to query using the **Source** drop down lists.

5. If you selected Limited Order:

- From the **Limit** drop down lists, select where the limit (value of the maximum capacity of prefix trees) is stored.
- From the **Alternate Limit** drop down lists, select an alternate location if the limit is empty (optional fields).

6. In the Capacity Storage area, using the drop down lists, select the capacity store target.

7. In the Play Capacity area, select the announcement to play for the selected capacity type.

Result: The **Save** button becomes available.8. Click **Save**.**Note:** The list of data types is fixed at installation time for each feature node or screen.**Further reference:**

- For information about profile blocks (data type, location, and field) and how to use them, see Profile Blocks and Tags.
- The primary tag lists are configured in the **SMS > Services > ACS Service > Configuration > Profile Tag Details** and **Profile Tag Mapping** tabs (see *ACS User's Guide, Profile Tag Details* for more information).

Collect Date to Tag

Collects and saves a date and/or time to a profile field. Input is either another profile or subscriber.

Node exits – Collect Date to Tag

This node has one entry and three exits. The number of exits cannot be changed.

Exit	Cause	Description
1	Success	The date and /or time was successfully saved in the target location.

Exit	Cause	Description
2	Error	Any of: <ul style="list-style-type: none"> Maximum number of retries has been reached without getting any valid date and/or time. Equipment failure during interaction with Subscriber
3	Abandoned	Any of: <ul style="list-style-type: none"> The subscriber hung up before completing the date/time request. The subscriber pressed the star key to cancel the selection of the date or time.

Response defaults – Collect Date to Tag

When collecting date and /or time from a subscriber, there are defaults used if the complete date or time are not entered.

The defaults for dates are:

- The month value must be entered by the subscriber.
- Missing year is substituted by the current sysdate year value.
- Missing day is substituted by "01".
- When time only collected, date is defaulted to "01/01/1970"

The defaults for times are:

- The hour value must be entered by the subscriber.
- Missing minutes are substituted by "00".
- Missing seconds are substituted by "00".
- When date only collected, time is defaulted to "00240000".

Configuring the node – Collect Date to Tag

To configure User Interaction:

1. Select **User Interaction** for the source profile tag.
2. Select what data is to be requested from the subscriber. The options are:
 - **Collect Date Only**
 - **Collect Time Only**
 - **Collect Date + Time**

Result: The relevant date/time fields are available or grayed out.

3. Select **Maximum number of retries** from the scroll box.

Notes:

- Each announcement also has a number of allowed retries, collectively these may be greater than the Maximum number of retries.
 - If there is a timeout, or an invalid date or time selected by the user, the Retry prompt is played to invite the user to provide another date or time.
 - After the announcement **Repetition** or **Maximum number of retries** failures, the feature node branches to Error.
 - When the **Collect Date + Time** option has been selected and the date is valid before running out of allowed retries, then the number of retries for the time selections are set to the Maximum number of retries value.
4. For the option:
 - **Collect Date Only:** Follow the procedure for [Configuring the date only interaction](#).
 - **Collect Time Only:** Follow the procedure for [Configuring the time only interaction](#).
 - **Collect Date + Time:**
 - a. Follow the procedure for [Configuring the date only interaction](#).
 - b. Follow the procedure for [Configuring the time only interaction](#).
 5. Follow the steps for **Target Selection**.
 6. Click **Save**.

To configure Profile Tag:

1. Select **ProfileTag** for the source profile tag..
2. Select the **Source Profile Tag** from the **Data Type**, **Location** and **Field** drop down lists.
3. Select the date and time format from the **Source Tag Mask** drop down list.
4. Follow the steps for **Target Selection**.
5. Click **Save**.

Note: The list of data types is fixed at installation time for each feature node or screen.

Further reference:

- For information about profile blocks (data type, location, and field) and how to use them, see Profile Blocks and Tags.
- The primary tag lists are configured in the **SMS > Services > ACS Service > Configuration > Profile Tag Details** and **Profile Tag Mapping** tabs (see *ACS User's Guide, Profile Tag Details* for more information).

Configuring the date only interaction (Collect Date to Tag)

Follow these steps to configure the date only interaction.

1. Select the date entry announcement to play from the **Collect Date Main Configuration** drop down lists.
2. Select the maximum number of times to repeat the announcement from the Collect Date Main Configuration **Repetition** scroll box.
3. Select the maximum duration (in seconds)to wait for user interaction from the Collect Date Main Configuration **Duration** scroll box.
4. Select the retry announcement to play from the **Collect Date Retry Configuration** drop down lists.

5. Select the maximum number of times to repeat the announcement from the Collect Date Retry Configuration **Repetition** scroll box.
6. Select the maximum duration (in seconds)to wait for user interaction from the Collect Date Retry Configuration **Duration** scroll box.
7. Select the confirmation announcement to play from the **Collect Date Confirmation Configuration** drop down lists.
8. Select the maximum number of times to repeat the announcement from the Collect Date Confirmation Configuration **Repetition** scroll box.
9. Select the maximum duration (in seconds) to wait for user interaction from the Collect Date Confirmation Configuration **Duration** scroll box.
10. Select the **Date Format** from the drop down list.

Configuring the time only interaction (Collect Date to Tag)

Follow these steps to configure the time only interaction.

1. Select the time entry announcement to play from the **Collect Time Main Configuration** drop down lists.
2. Select the maximum number of times to repeat the announcement from the Collect Time Main Configuration **Repetition** scroll box.
3. Select the maximum duration (in seconds)to wait for user interaction from the Collect Time Main Configuration **Duration** scroll box.
4. Select the retry announcement to play from the **Collect Time Retry Configuration** drop down lists.
5. Select the maximum number of times to repeat the announcement from the Collect Time Retry Configuration **Repetition** scroll box.
6. Select the maximum duration (in seconds)to wait for user interaction from the Collect Time Retry Configuration **Duration** scroll box.
7. Select the confirmation announcement to play from the **Collect Time Confirmation Configuration** drop down lists.
8. Select the maximum number of times to repeat the announcement from the Collect Time Confirmation Configuration **Repetition** scroll box.
9. Select the maximum duration (in seconds) to wait for user interaction from the Collect Time Confirmation Configuration **Duration** scroll box.
10. Select the **Time Format** from the drop down list.
11. Select the **Timezone type** from the drop down list. Options are:
 - SCP Local Time
 - GMT
 - Explicit Unix TZ
 - TZ of Service Number
 - TZ of Logical CLI
 - TZ of Network CLI
12. If you selected the type - `Explicit Unix TZ`, select the **Unix Timezone** from the drop down list.

Configuring the date and time data target (Collect Date to Tag)

To select the target for storing the date and time data, select in the **Target Selection** frame, the target **Data Type**, **Location** and **Field** drop down lists.

Note: This may require scrolling to the bottom of the screen.

Note: The list of data types is fixed at installation time for each feature node or screen.

Further reference:

- For information about profile blocks (data type, location, and field) and how to use them, see Profile Blocks and Tags.
- The primary tag lists are configured in the **SMS > Services > ACS Service > Configuration > Profile Tag Details** and **Profile Tag Mapping** tabs (see *ACS User's Guide, Profile Tag Details* for more information).

Collect Digits to Buffer

This node prompts the user to enter digits which it then stores in the nominated buffer or profile location. The digits may be retrieved later and used in the Control Plan. Any buffer may be selected; however some buffers may be used by subsequent nodes that are expecting a different value.

Node exits – Collect Digits to Buffer

This node has one entry and three exits. The number of exits cannot be changed.

Exit	Cause	Description
1	Success	The correct number of digits was collected successfully.
2	Not Updated	The correct number of digits was not collected after the specified number of retries.
3	Abandoned	The caller abandoned the call.

Configuring the node – Collect Digits to Buffer

Follow these steps to edit the feature node.

1. The **Type of Digits to Collect** field is only relevant if you are going to select **CC Pending Termination Number** from the **Buffer Field** list. See Step 2.

If relevant, select a value for this field; otherwise ignore it.

2. From the lists in the **Buffer** frame, select the location to use to store the collected digits.

Notes:

- If you want to copy the type of digits data to Pending TN Type, select the Pending Termination Number buffer.

-

3. From the **Main Announcement** frame, select:

- The announcement set that contains the main announcement you want to play to the caller from the **Announcement Set** list.
 - The announcement to play from the **Announcement Entry** list.
4. Set the **Repetition** field to the number of times to repeat the main announcement while the system waits for the caller to take an action. If set to zero, the announcement will be repeated for the length of the duration set.
 5. Set the **Duration** field to the length of time in seconds that the announcement is to be played. If set to zero, the announcement will be played for its full length.
 6. The retry announcement contains the announcement you want to play to the caller if the number of digits collected is not within the range specified.

In the **Retry Announcement** frame, select the:

- **Announcement Set** that contains the retry announcement.
- **Announcement Entry** for the retry announcement you want to play.

Then set:

- **Repetition** to the number of times to repeat the retry announcement.
 - **Duration** to the length of time, in seconds, that the retry announcement is to be played.
7. In the **Number of Retries** field, set the number of times that the feature node will attempt to collect data from the caller, before routing the call to the Not Updated branch. This value may be between 0 and 10.
 8. In the **Minimum Number of digits** field, set the minimum number of digits that must be collected. The value set must be between 1 and 32.

The minimum number of digits must be less than, or equal to, the maximum number of digits.
 9. In the **Maximum Number of digits** field, set the maximum number of digits that must be collected. The value set must be between 1 and 32.

The maximum number of digits must be greater than, or equal to, the minimum number of digits.
 10. (Optional) To include a prefix before the digits collected value, enter the prefix in the **Digit Prefix** field.

The prefix may be up to 32 valid characters. Valid characters include 0-9, A-F.
 11. From the **Cancel Character** options, select the character that the caller can use to cancel the digit collection.

The switch on the answering device is used by default.
 12. From the **End Character** options, select the character that the caller can use to indicate the end of the digit collection.

The switch on the answering device is used by default.
 13. (Optional) To check that the collected digits are within the TN ranges for this client, select the **Verify Against TN Ranges?** check box.

This will check the termination number range rules set up for this customer (through the New or the Edit Customer screen in ACS) and verify according to the rules set. For more information, see the discussion on *Adding customers in ACS User's Guide*.

14. Click **Save**.

Note: The **Save** button becomes available when you have entered all the required information.

Result: The feature node data will be saved.

Note: The announcement set and announcement entry lists are populated with data that is specified using the **Announcements** tab of the ACS Configuration screen.

For more information about configuring announcement sets and announcement entries, see the **Announcements** tab of the ACS Configuration screen.

Collect Digits to Pending TN

This node prompts the caller to enter digits which it then stores in a buffer (the Pending TN Buffer). The digits may be retrieved later and used in the control plan. The nodes that read from this buffer are:

- [Terminate to Pending TN](#)
- [Attempt Terminate to Pending TN](#)

Node exits – Collect Digits to Pending TN

This node has one entry and three exits. The number of exits cannot be changed.

Exit	Cause	Description
1	Success	The correct number of digits was collected successfully.
2	Not Updated	The correct number of digits was not collected after the specified number of retries.
3	Abandoned	The caller abandoned the call.

Configuring the node – Collect Digits to Pending TN

Follow these steps to edit the feature node.

1. Select the **Type of Digits to Collect** from the drop-down list. The type may be:
 - Off Net
 - On Net
 - Speed Dial
 - Service Number
 - CLI
2. From the **Main Announcement** frame, select the **Announcement Set** that contains the main announcement you want to play to the caller.

Result: The **Announcement Entry** drop-down box will become available.
3. From the **Announcement Entry** drop-down list, select the main announcement you want to play to the caller.

4. Set the **Repetition** field to the number of times to repeat the main announcement while the system waits for the caller to take an action. If set to zero, the announcement will be repeated for the length of the duration set.
5. Set the **Duration** field to the length of time in seconds that the announcement is to be played. If set to zero, the announcement will be played for its full length.
6. The retry announcement contains the announcement you want to play to the caller if the number of digits collected is not within the range specified.

In the **Retry Announcement** frame, select one of the following as described in steps 2 - 5:

- **Announcement Set** which contains the retry announcement
 - **Announcement Entry** for the retry announcement you want to play
 - Set the **Repetition** to the number of times to repeat the retry announcement
 - Set the **Duration** to the length of time, in seconds, that the retry announcement is to be played.
7. In the **Number of Retries** field, set the number of times that the node will retry collecting data from the caller (after an initial failure), before routing the call to the Not Updated branch. This value may be between 0 and 10.
 8. In the **Minimum Number of digits** field, set the minimum number of digits that must be collected. This box accepts values between 1 and 32.

The minimum number of digits must be less than, or equal to, the maximum number of digits.

9. In the **Maximum Number of digits** field, set the maximum number of digits that must be collected. This box accepts values between 1 and 32. The maximum number of digits must be greater than, or equal to, the minimum number of digits.
10. If a prefix is to be included before the digits collected, enter this in the **Digit Prefix** field.

The prefix may be up to 32 valid characters. Valid characters include 0-9, A-F.

11. From the **Cancel Character** options, select the character which the caller can use to cancel the digit collection.

The default option will use the switch on the answering device.

Notes:

- If the caller uses this digit and the maximum number of retries has not been met, it will return the caller to the retry prompt and add one to the retry count.
 - If the caller uses this digit and the maximum number of retries has been met, it will take the Not Updated branch.
12. From the **End Character** options, select the character which the caller can use to indicate the end of the digit collection.

The default option will use the switch on the answering device.

13. If you want to check that the collected digits are within the TN ranges for this client, tick the Verify Against TN Ranges? check box.

This will check the Termination Number Range Rules set up for this customer (via the New/Edit Customer screen in ACS) and verify according to the setting. For more information, refer to Adding customers in the ACS Customer screen.

14. Click **Save**.

Note: **Save** is not available until all the required information has been selected or entered.

Result: The node data will be saved.

Note: The announcement set and announcement entry lists are populated with data that is specified using the **Announcements** tab of the ACS Configuration screen.

For more information about configuring announcement sets and announcement entries, see the **Announcements** tab of the ACS Configuration screen.

Collect Digits to Sub-tag

This node will prompt the user to enter digits, and will save the digits to a sub-tag. This sub-tag will be a part of a profile block (for example, the speed dial block contains the sub-tag list of speed dial numbers). See Sub-tags for a definition.

The node can be used to add digits to a sub-tag in a profile, or to access a previously configured sub-tag in a profile. Consequently, this node is usually used immediately before a profile node.

Refer to the *Copy node*, Use Stored Sub-Tag description for an example of using this node, in conjunction with the Copy node, to change a speed dial number.

Node exits – Collect Digits to Sub-tag

This node has one entry and three exits. The number of exits cannot be changed.

Exit	Cause	Description
1	Success	The digits were entered and collected successfully.
2	Not Updated	The digits could not be collected.
3	Abandoned	The caller abandoned the call.

Configuring the node – Collect Digits to Sub-tag

Follow these steps to edit the Collect Digits to Sub-Tag node.

- From the Main Announcement area, select the **Announcement Set** that contains the main announcement you want to play to the caller. The main announcement will be played to prompt for digits to enter into a sub-tag.
Result: The **Announcement Entry** drop-down box will become available.
- From the **Announcement Entry** drop-down list, select the main announcement you want to play to the caller.
- Set the **Repetition** field to the number of times to repeat the main announcement while the system waits for the caller to take an action. If set to zero, the announcement will be repeated for the length of the duration set.
- Set the **Duration** field to the length of time in seconds that the announcement is to be played. If set to zero, the announcement will be played for its full length.
- The retry announcement contains the announcement you want to play to the caller if the sub-tag value is not within the range specified in step 7.

In the Retry Announcement area, select one of the following as described in steps 1 - 4:

- **Announcement Set** which contains the retry announcement
 - **Announcement Entry** for the retry announcement you want to play, and set the
 - **Repetition** to the number of times to repeat the retry announcement
 - **Duration** to the length of time, in seconds, that the retry announcement is to be played.
6. In the **Number of Retries** field, set the number of times that the node will attempt to collect data from the caller, before routing the call to the Not Updated branch. This value may be between 0 and 10.
 7. In the **Minimum Sub Tag Value** and **Maximum Sub Tag Value** fields, set the minimum and maximum sub-tag value to be collected. This is the range of values that the user can set, for example, speed dial numbers between 10 and 20.
 8. Click **Save**.

Note: **Save** is not available until all the required information has been selected or entered.

Note: The announcement set and announcement entry lists are populated with data that is specified using the **Announcements** tab of the ACS Configuration screen.

For more information about configuring announcement sets and announcement entries, see the [Announcements](#) tab of the ACS Configuration screen.

Compare Profile Data

The Compare Profile Data node allows you to compare the value of two profile fields and then branch on the outcome.

The compare is initially done at the field length level and then at the content level if the two fields are the same length.

Node exits – Compare Profile Data

This node has one entry and five exits. The number of exits cannot be changed.

Exit	Cause	Description
1	A < B	Profile field value A is less than profile field B.
2	A = B	Profile field value A is equal to profile field B.
3	A > B	Profile field value A is greater than profile field B.
4	Missing Field	Either profile field A or profile field B is missing from their respective profiles.

Exit	Cause	Description
5	Error	Any of: <ul style="list-style-type: none"> Invalid field type length Failed to retrieve profile fields General Error Unrecognized field type

Content comparison rules – Compare Profile Data

This table describes how the field contents are compared when the two field lengths are equal.

Profile Field Type	Comparison
BOOLEAN	Integer comparison where false = 0, and true = 1.
BYTE	Integer comparison.
INTEGER	Integer comparison.
DATE	Integer comparison, where the dates are represented as a positive integer (seconds since the Epoch).
STRING, NSTRING, LNSTRING	Lexicographical comparison between the two equal length strings (finding the order of two words as they would appear in a dictionary).
PREFIX, OPREFIX, LOPREFIX	Perform byte by byte comparison of the two compiled prefix trees. Branches based on the difference between the two bytes in the two prefix trees that differ.
PATTERNS, UINTEGER, UINTEGER64	Perform a memory compare between the two fields.

Configuring the node – Compare Profile Data

Follow these steps to edit the node configuration.

1. Select the profile field type for the comparison from the **Type** drop down list.

Note: Not all the list items are valid for comparison. See the Content comparison rules table.

2. Using the drop down lists in the Profile Field A area, select the first profile field to compare.
3. Using the drop down lists in the Profile Field B area, select the other profile field to compare.
4. Click **Save**.

Note: The list of data types is fixed at installation time for each feature node or screen.

Further reference:

- For information about profile blocks (data type, location, and field) and how to use them, see Profile Blocks and Tags.

The primary tag lists are configured in the **SMS > Services > ACS Service > Configuration > Profile Tag Details** and **Profile Tag Mapping** tabs (see *ACS User's Guide, Profile Tag Details* for more information).

Control Plan Notes

Allows you to place notes on the CPE canvas. The note box can be expanded or contracted by clicking and dragging the resizing handle in the bottom right hand corner of the feature node.

Note: There is no feature node icon for this, just a yellow box for entering notes.

Control plan notes are simply notes you can place anywhere on the canvas to add understanding to the control plan, including behind feature node icons to add comments to a group of feature nodes. They add no functionality to the control plan.

Once a note has been placed on the canvas, it may be moved around, duplicated, or deleted as required. Control plan notes will 'stick' where they are placed when the control plan is saved and reloaded.

Node exits – Control Plan Notes

This node has no entries or exits, as it is not connected to other nodes within a control plan.

Editing Control Plan Notes

Follow these steps to add a note to a control plan.

1. Drag the node on to the canvas and drop into place.
The Control Plan Notes feature node icon appears in the canvas.
2. Double click the Control Plan Notes feature node icon.
The Edit Comments window displays.
3. Click inside the editable area and type the text that is to appear in the control plan note.

Note: All text appears in the note exactly as it is entered. To ensure that text does not appear in a long line, break it up with manual line breaks.

4. Click **Ok**.
The text appears in the note box.

Copy

The Copy feature node allows you to copy data (for example - digits) from one profile field to another. You can always copy a profile field to another profile field of the same type. In addition, you can use the Copy feature node to convert between the following profile field types:

- Boolean
- Byte
- Short

- Integer
- Unsigned Integer
- Unsigned 64-bit Integer
- String
- Numeric String
- Limited Numeric String
- Bounded Integer
- Price (from Integer or String)

The Copy feature node first converts the source field to a character string (except when it is already a string or a numeric string field) and then converts the character string to the target type, according to a set of predefined Profile Field Conversion Rules.

If the source profile field type is OPREFIX or LOPREFIX, then the Copy feature node copies the source field content directly into a corresponding prefix tree without any conversion.

Profile Field Conversion Rules – Copy

This table lists the types of conversions and the corresponding conversion rules used by the Copy feature node to convert profile field data to and from character strings.

Type of Conversion	Conversion Rule
Boolean to character string	Interprets the stored bytes as a signed four byte integer that is represented in base 10, and: <ul style="list-style-type: none"> • Converts false to zero (0). • Converts true to a non zero integer (usually either one (1), or 16777216).
Character string to boolean	Converts the following values to true: <ul style="list-style-type: none"> • Non-zero integers. • "true", "t", "yes", "y", and "on". Converts all other values, including an empty string, and zero (0) to false.
Byte to character string	Converts bytes (assumed to be unsigned) to a value in the range of "0" to "255".
Short to character string	Converts shorts (assumed to be unsigned) to a value in the range of "0" to "65535".
Integer to character string	Converts integers (represented in base 10) to a value in the range of "-9223372036854775808" to "9223372036854775807". <p>Note: Integers are either four bytes or eight bytes long.</p>
Unsigned 64-bit integer to character string	Converts unsigned integers (represented in base 10) to a value in the range of "0" to "18446744073709551615".

Type of Conversion	Conversion Rule
Character string to one of: <ul style="list-style-type: none"> • Unsigned Integer • Unsigned 64-bit integer • Integer • Short • Byte 	Converts the string to the required number type. If the character string starts with "0x", then the Copy feature node discards the "0x" and interprets the string as a base 16 number. Otherwise the Copy feature node interprets the string as a base 10 number.
Unsigned integer to character string	Converts unsigned integers (represented in base 10) to a value in the range of "0" to "4294967295".
String, limited numeric string, or numeric string to character string. Character string to string, limited numeric string, or numeric string.	No conversion needed. The Copy feature node copies these types of profile fields to another profile field of the same type.
Bounded integer to character string	The Copy feature node cannot copy a bounded integer to a character string.
Character string to bounded integer	Converts the character string to a four byte integer and puts it in bytes 9, 10, 11 and 12 of the bounded integer. Note: Bytes one to four hold the lower bound, and bytes five to eight hold the upper bound. To successfully copy an integer to a bounded integer, the source integer must be between the two bounds.
Integer <ul style="list-style-type: none"> • INTEGER • UINTEGER • UINTEGER64 to Price	A Price profile tag contains a string with the strict format <i>DDDDDDCC</i> , where <i>DDDDDD</i> are the big units (for example, Euros) with zero padding and <i>CC</i> are the small units (for example, Cents) also zero padded. Conversion from an integer value will assume the value is expressed in small units with the lowest two digits providing the <i>CC</i> part. The conversion (and copy) will fail if the integer value is bigger than 99999999. Example: An integer value 95642 will be converted to "00095642" which equates to 956.42 (Euros).

Type of Conversion	Conversion Rule
String <ul style="list-style-type: none"> • STRING • NSTRING • LNSTRING to Price	<p>A Price profile tag contains a string with the strict format <i>DDDDDDCC</i>, where <i>DDDDDD</i> are the big units (for example, Euros) with zero padding and <i>CC</i> are the small units (for example, Cents) also zero padded.</p> <p>Conversion from a string value will accept two forms of input. A string containing a decimal point will be assumed to contain a value already in cost form.</p> <p>A string conversion will fail if the input value is too large (the max is either "999999.99" or "99999999").</p> <p>Behaviors:</p> <ul style="list-style-type: none"> • A string containing "8.71" will be converted to "00000871". • Any decimal places more than 2 will be stripped so "19.563" will be converted to "00001956". • A string containing no decimal point will be assumed to contain a value expressed in small units (like the integer values). So a string containing "11223" will be converted to "00011223" which equates to 112.23.

Node exits – Copy

This node has one entry and two exits. The number of exits cannot be changed.

Exit	Cause	Description
1	Success Branch	Data successfully saved to the profile.
2	Not Updated Branch	Data could not be saved.

Include Pending TN Type (Copy)

The **Include PendingTN Type** check box appears when the **Source Field** selection is `CC Pending Termination Number`, as shown in this example of part of the screen.

The screenshot shows a configuration window with two main sections: "Source Profile" and "Target Profile".

Source Profile:

- Source Data Type: Session Data
- Source Location: Outgoing Session Data
- Source Field: CC Pending Termination Number

Target Profile:

- Target Data Type: Session Data
- Target Location: Incoming Session Data
- Target Field: CC Call Duration Seconds

At the bottom, there is a checkbox labeled "Include PendingTN Type" which is currently unchecked.

Treat Target as Prefix (Copy)

The **Use Source as Prefix** check box appears when the **Source Field** and **Target Field** selections are of type string or number string, as shown in this example of part of the screen.

The screenshot shows the "Configure Copy" dialog box. The "Node name" is "Copy".

Source Profile:

- Source Data Type: Database
- Source Location: CCS Global Profile
- Source Field: CCS CWTR Name

Target Profile:

- Target Data Type: Session Data
- Target Location: Incoming Session Data
- Target Field: CC Called Location Number

The "Use Source as Prefix" checkbox is checked.

Below the checkbox, there is a note: "This node copies the data from one profile location to another, with a limited number of conversions allowed. There are special rules for some types, explained in the help."

Exit Branches:

- 1 Success Branch
- 2 Not Updated Branch

Buttons at the bottom: Comments, Save, Cancel.

Use Stored Sub-Tag (Copy)

The **Use Stored Sub-Tag** check box appears when the **Target Field** selection contains sub-tags (for example, the Speed Dial Block contains the sub-tag list of speed dial numbers. For more information, see Sub-tags), as shown in this example of part of the screen.

The screenshot shows a configuration window for a 'Copy' node. It is divided into two main sections: 'Source Profile' and 'Target Profile'.
Source Profile:
 - Source Data Type: Session Data (dropdown)
 - Source Location: Outgoing Session Data (dropdown)
 - Source Field: CC Pending Termination Number (dropdown)
Target Profile:
 - Target Data Type: Database (dropdown)
 - Target Location: CLI Subscriber Profile (dropdown)
 - Target Field: Speed Dial Block (dropdown)
 Below the profiles, there are three checkboxes and one dropdown:
 - Use Stored Sub-Tag
 - Include PendingTN Type
 - Target Sub-Tag Storage Format: Default (dropdown)

In this example, earlier in the control plan, the sub-tag (e.g. the speed dial number, let's say 50) has been specified using the [Collect Digits to Sub-tag](#) node. The telephone number, e.g. 08001234567, to associate with it has then been stored in the CC Pending TN buffer using the [Collect Digits to Pending TN](#) node. Using the Copy node, that number is copied into the Speed Dial block, so that the speed dial number 50 is set to call 08001234567.

Configuring the node – Copy

Follow these steps to configure the Copy node.

1. From the drop down lists in the **Source Profile** area, select the source stored data location.

Notes: If you set a customer-specific profile, the profile set in this field must belong to the customer who will be running the Control Plan.

If the Control Plan is owned by the Boss user:

- the profile must be set to Control Plan, or
 - a customer id must be specified at an earlier point in the Control Plan.
2. From the drop down lists in the **Target Profile** area, select the target that the data is to be copied to.
 3. If the **Include Pending TN Type** check box is displayed, then either:
 - tick: the node will save the Pending TN to the profile with the Pending TN Type prefixed.
 - Clear: the node will save just the Pending TN to the profile.
 4. If the **Use Source as Prefix** check box is displayed, then either:
 - tick: the node will prefix the target value with the source value.
 - Clear: the node will copy the source value to the target value.
 5. If the **Use Stored Sub-Tag** check box is displayed, select the required target field format from the **Target sub-tag Storage Format** drop down list. The node will save the sub-tag value with the required format in the target field.

6. Click **Save**.

Note: **Save** is not available until all the required information has been selected or entered.

Note: The list of data types is fixed at installation time for each feature node or screen.

Further reference:

- For information about profile blocks (data type, location, and field) and how to use them, see Profile Blocks and Tags.

The primary tag lists are configured in the **SMS > Services > ACS Service > Configuration > Profile Tag Details** and **Profile Tag Mapping** tabs (see *ACS User's Guide, Profile Tag Details* for more information).

For information about using the Call Context Profile, refer to ACS Buffers.

Copy Hunting List

This node prompts the user for a hunting list and copies the hunting list contents to the pending TN buffers. The hunting list can be one of:

- Identified by name
- The hunting list selected by the hunting planner

Only the first ten numbers in the list are used. The first number in the list is copied to the pending TN and the next nine numbers are copied to the additional pending TNs. Any further numbers are discarded.

Note: To use this node either VPN or FMC must be activated on your system. If you are using this node with VPN then the hunting lists and hunting planner must be formatted according to the format used by the VPN product and must be located within the VPN_PT_HUNTING_CONFIG profile tag. See *VPN Technical Guide* for more details.

The node also gives the user the option to override the no answer timer with one of:

- A fixed value held in a user defined profile field
- The highest timer found within the hunting list

Node exits – Copy Hunting List

This node has one entry and four exits. The number of exits cannot be changed.

Exit	Cause	Description
1	Success	The hunting list numbers have been successfully copied.
2	Success Trunct	The hunting list contains more than ten numbers. Only the first ten numbers have been copied.
3	Failure No Planner	The node has been configured to copy the list selected by the hunting planner but no hunting planner was defined.

Exit	Cause	Description
4	Failure No List	The specified list name does not match an existing hunting list.

Configuring the node – Copy Hunting List

Follow these steps to configure the node.

- In the Hunting list panel set the hunting list to be copied, to copy:
 - the hunting list chosen by the hunting planner, select the **Use planner list** option
 - a specified list, select the **Use list below** option and type the hunting list name in the **List name** box.
- If required, set the override for the No answer timeout. To use:
 - the current No Answer Timeout value, ensure **Leave unchanged** is selected
 - the highest timer within the hunting list, select the **Use max from list** option, or
 - a value from a profile tag, select the **Read from profile** option and set the Data Type, Location and Field holding the timer using the drop down lists.

Note: If you selected Read from profile and the node cannot find the specified profile field, then the No Answer Timeout will not be overridden.

- Click **Save**.

Note: The list of data types is fixed at installation time for each feature node or screen.

Further reference:

- For information about profile blocks (data type, location, and field) and how to use them, see Profile Blocks and Tags.

The primary tag lists are configured in the **SMS > Services > ACS Service > Configuration > Profile Tag Details** and **Profile Tag Mapping** tabs (see *ACS User's Guide, Profile Tag Details* for more information).

Create Prefix Tree

The Create Prefix Tree node creates a prefix tree from a delimited input string. Each entry in the input string is checked against the limitation profile tag field specified in the node. This checks whether the entry is one of:

- Allowed
- Barred
- Too long
- Too short

Delimiters – Create Prefix Tree

This table lists the delimiters allowed between entries in the input string.

Delimiter	Description
" "	Space
","	Comma
":"	Colon
" "	Pipe

Note: Delimiter characters may be combined, for example, so that spaces and commas can be used between entries.

Node exits – Create Prefix Tree

This node has one entry and three exits. The number of exits cannot be changed.

Exit	Cause	Description
1	Success	The node has successfully inserted all the entries from the source string into the selected prefix tree.
2	Entries Limited	The limitations set in the node prevented one or more source entries from being inserted into the selected prefix tree.
3	Error	Indicates none of the source entries were inserted into the selected prefix tree or an error/failure occurred.

Configuring the node – Create Prefix Tree

Follow these steps to configure the node.

1. From the drop down lists in the Source String area, select the profile tag field containing the string you want to use to create the prefix tree.
2. From the drop down lists in the Destination Profile area, select the profile tag field where the prefix tree will be stored.
3. To limit the allowable entries in the source string, tick the **Use Limitations** check box. Then, from the **Limitation Primary Tag** drop down list, select the profile tag field to use.

Note: The Product Type profile will be used if available, otherwise the Service Provider profile will be used.

4. Click **Save**.

Note: The list of data types is fixed at installation time for each feature node or screen.

Further reference:

- For information about profile blocks (data type, location, and field) and how to use them, see Profile Blocks and Tags.

The primary tag lists are configured in the **SMS > Services > ACS Service > Configuration > Profile Tag Details** and **Profile Tag Mapping** tabs (see *ACS User's Guide, Profile Tag Details* for more information).

Day of Week

The Day of Week node allows branching based on the day of the week on which the call is placed. This branching decision is made according to the data that is entered into the node through the Configure Day of Week Node edit screen.

To configure this node, the user adds a day of week range and maps that range to a specified exit. Calls made on any day of the week within the range are routed down that exit, to be processed according to the nodes that follow.

Shortcut keys – Day of Week

The shortcut keys to add a Day of Week node are **Alt+W**.

Node exits – Day of Week

The Day of Week node has one entry and may have 2 through 7 exits. Each exit is mapped to a day of week range, and must be connected to an appropriate node. You can configure the number of exits within this range as required, using the **Edit Node Exits** option on the shortcut menu. See [Editing Feature Node Exits](#).

Configuring the node – Day of Week

Follow these steps to configure the day of week node.

1. Edit the node exits to add up to another five exits as required to accommodate the dates you are planning to configure. See [Editing node exits](#) for details.
2. From the **Timezone Type** field, select the timezone to use.

If you select `Explicit Unix TZ`, you must select a specific region from the **Unix Timezone** field.

Note: The GMT+ and GMT- time zone names adhere to POSIX Unix conventions, which use positive (+) signs for West of Greenwich and negative (-) signs for East of Greenwich. For example, GMT+4 corresponds to 4 hours behind GMT.

For more time zone information, see [Time Zones](#).

3. Select the **Default** branch in the box on the left of the screen. Any calls made on a day not specified in an allocated range route down the default branch.
4. Map the required day of week ranges to the appropriate exits, as detailed below.
5. Once all the data is correct, click **Save**.

The **Save** button will not be available if a range has not been accepted, or if the ranges overlap.

Adding a branch/range mapping – Day of Week

Follow these steps to map a day of week range to an exit, using the Configure Day of Week screen.

1. Click **Add Range**.
To the left of the **Branch** field, the drop-down lists will be populated.
2. Select the day required in each list, to show the first and last day in the range. A range of:
 - Wed – Wed affects only calls made on Wednesday of each week.
 - Mon – Thur affects calls made on any day from Monday to Thursday.
3. Note that the range may not overlap any existing range. The ranges specified do not need to include all possibilities. Any calls made on a day not specified in an allocated range routes down the default branch.
4. Select the branch that is to be mapped to the specified range. Calls made within that range are routed down the exit selected in the branch list.
It is possible to have several ranges routing down the same branch or to have branches that no calls will ever take.
5. Click **Change**.
Result: The branch/range mapping will appear in the display field.
To delete a mapping, select the entry and click **Delete Range**.

Day of Year

This node allows control plan branches to be taken based on the current day of the year.

Dates may be specified as individual days or as named holidays, as set in the **Holidays** tab on the ACS Configuration screen. Multiple dates and ranges of dates can be specified for each branch from the node.

To configure this node, the user adds a day of year range and maps that range to a specified exit. Calls made on any day of the year within the range are routed down that exit, to be processed according to the nodes that follow.

For more information about configuring holiday sets, see *ACS User's Guide*.

Shortcut keys – Day of Year

The shortcut keys to add a Day of Year node are **Alt+Y**.

Node exits – Day of Year

The Day of Year node has one entry and may have 2 through 20 exits. Although this node accepts up to 20 exits, it is recommended that this number is restricted to a maximum of 10, due to the width restraints of the node. The default number of exits is 2.

There are three types of exit:

- A specific date or date range (which can be mapped to any free branch)
- A default branch (if the current date is not specified in any of the dates or date ranges, this branch will be followed)

- Any holiday in set (if it matches any of the dates in the chosen set that have not been specifically assigned a branch, this branch will be followed)

You cannot map two dates or date ranges to the same branch. Ensure you do not specify the same day twice (either in a holiday set or on a specified branch), as your control plan data will not compile successfully.

If you do not want to use the Any Holidays branch, set it to the same exit as the default.

You can configure the number of exits within this range as required, using the **Edit Node Exits** option on the shortcut menu. See [Editing Feature Node Exits](#).

Adding a branch/range mapping – Day of Year

Dates may be entered in this node in two forms, as one of the following:

- Holiday entries as entered in a specified holiday set
- Explicit date ranges

If a date is included as a holiday set, but is not specifically assigned a branch, the call is routed down the Any Holiday exit.

For calls where there is no match found to any specified date, the call is routed down the default exit.

Configuring the node – Day of Year

Follow these steps to configure the day of year node.

1. Edit the node exits to add up to another eighteen exits as required to accommodate the dates you are planning to configure. See [Editing node exits](#) for details.
2. From the **Timezone Type** box, select the timezone you want to use.

If you select the Explicit Unix TZ option, you must choose a specific region from the **Unix Timezone** box.

For more Time zone information, see [Time Zones](#).

3. Specify the exit for dates which match a date within the specified Holiday Set, but do not match a date entry with a specific branch assigned to it.
4. Enter the holiday details by either:
 - specifying each date or date range explicitly, or
 - mapping the entries from a holiday set to the appropriate branches.
5. More information about entering dates is provided on the next two pages.
6. Select the **Default** branch in the box on the left of the screen. Any calls made on a day not specified in an allocated range route down the default branch.
7. Once all the data is correct, click **Save**.

Note: The **Save** button will not be available if a range has not been accepted, or if the ranges overlap.

Adding holiday set entries – Day of Year

Follow these steps to add holiday set entries, using the Configure Day of Year Node screen.

1. Select the holiday set required from the drop-down box.
2. If the selected holiday set has:
 - More than one entry in it, you can add them all by clicking **Add Whole Set**.
 - Only one entry or if you only want to add the first entry from the set, click **Add Entry**.
3. **Result:** The chosen entries will be added to the display list.
4. In the list box below the display area, select the holiday entry that is required.
5. In the **Branch** field, select the branch the specified days should route to.
6. Click **Change**.
Result: The selected default entry in the display area will be changed to the holiday entry and branch selected.
7. Repeat steps 3 and 4 until all the holiday entries have been mapped to different branches. (They must be mapped to different branches or the control plan will not compile.)
8. Click **Save**.

Adding explicit date ranges – Day of Year

Follow these steps to add explicit date ranges, using the Configure Day of Year Node screen.

1. Click **Add Entry**.
Result: A default entry will be added to the display list, as a selected entry.
2. Select the (Explicit Date Range) option in the Holiday Entry selection box.
Result: The Start and End Date fields will become available.
3. Select the date range required.
Note: The date ranges are inclusive. For example, a date range of January 1 to January 12 will route calls made on 1, 2, 3, 4, 5, 6, 7, 8, 9, 10, 11 and 12 January down the selected branch.
To specify a single date, set both the Start and End Date fields to the same day.
4. Select the branch to be taken by calls within that range.
5. Click **Change Entry**.
Result: The selected default entry in the display area will be changed to the explicit date range and branch selected.
6. Select a holiday data set. This information will not be used, but is required for the Control Plan data to compile correctly.
7. Click **Save**.

Delete Profile Field

The Delete Profile Field node allows you to delete the specified profile field from the profile (that is, the field as well as the contents are removed from the profile).

Node exits – Delete Profile Field

This node has one entry and two exits. The number of exits cannot be changed.

Exit	Cause	Description
1	Success	The delete was successful.
3	Error	The delete failed.

Configuring the node – Delete Profile Field

Follow these steps to edit the node configuration.

1. In the Profile Field area, using the drop down lists, select the profile field to delete.
2. Click **Save**.

Note: The list of data types is fixed at installation time for each feature node or screen.

Further reference:

- For information about profile blocks (data type, location, and field) and how to use them, see Profile Blocks and Tags.

The primary tag lists are configured in the **SMS > Services > ACS Service > Configuration > Profile Tag Details** and **Profile Tag Mapping** tabs (see *ACS User's Guide, Profile Tag Details* for more information).

Dialled Number

The Dialled Number node allows branching, based on the service number (SN) that was dialed by the person making the call. This allows several service numbers to use the same control plan and be routed down different branches, based on the service number that the caller used.

Node exits – Dialled Number

This node has one entry and may have 2 through 20 exits. You can configure the number of exits within this range as required, using the **Edit Node Exits** option on the shortcut menu. See [Editing Feature Node Exits](#).

Configuring the node – Dialled Number

Follow these steps to add a prefix to the node data, using the Configure Dialled Number screen.

1. Edit the node exits to add up to another eighteen exits as required to accommodate the numbers you are planning to configure. See Editing node exits for details.

2. Click **Add Prefix**.

Result: You see an undefined prefix displayed in the list box to the left of the button.

3. Enter the prefix into the field to the left of the **Branch** field, as shown below.

To determine the routing, prefixes (or the entire number) must be entered into the node data. The routing will be based on the best match between the dialed number and the prefixes that are in the node data. The dialed number list takes up to 1500 characters in total, which limits the number of entries in the list. It is recommended that a maximum of 50 entries be made in the list.

Example: If 0800447732 is dialed and the prefixes entered into the node data are 0800, 0900, 0800447 and 080044, the call will be routed down the branch associated with 0800447 because this is the best match found for the number dialed.

4. In the **Branch** field, select the branch down which calls whose dialed number best matches this prefix are to route. When the entry is correct, click **Change**.
5. Repeat steps 1-4 until you have specified the dialed number ranges required.
6. From the **Default** box, select the branch that dialed numbers that do not match any prefix entered into the node will route down.
7. Click **Save**.

Disconnect Call

This node will disconnect a call. The disconnect call will use the cause value 31 by default. This may be changed using the node editing screen.

Shortcut keys – Disconnect Call

The shortcut keys to add a Disconnect Call node are **Alt+R**.

Node exits – Disconnect Call

This node has one entry and one exit. The number of exits cannot be changed.

Configuring the node – Disconnect Call

To edit the Disconnect Call node, enter the value that is to be sent to the switch in the ReleaseCall operation. The value entered determines the tone or message played to the caller on disconnection of the call.

The cause value defaults to 31. Other values are listed in ITU-T recommendation Q850.

Some examples are:

Value	Cause of Disconnection
16	Normal call clearing
17	User busy
19	No answer from user
31	Normal unspecified

Dynamic Switch

The switching node allows calls to be routed to a specified exit. The switching node is simply a switch. It can point to one exit at any time and does not make any decision-based routing. All calls that reach that node are directed to the exit to which the switch points.

It is possible to enable the switch to be changed by the customer over the phone. This is achieved in conjunction with profile nodes.

A control plan may contain as many Dynamic Switch nodes as required.

Node exits – Dynamic Switch

This node has one entry and 2 through 20 exits. Although this node accepts up to 20 exits, it is recommended that this number is restricted to a maximum of 10. You can configure the number of exits within this range as required, using the **Edit Node Exits** option on the shortcut menu. See [Editing Feature Node Exits](#).

Only one exit at a time may be used, and all calls will be routed to the active exit.

Configuring the node – Dynamic Switch

Follow these steps to change the exit to which the switch points.

1. Edit the node exits to add up to another eighteen exits as required to accommodate the branches you are planning to configure.. See [Editing node exits](#) for details.
2. Use the arrows to change the exit number displayed.
Result: As the exit number is changed, the diagram to the right will graphically demonstrate the exit to which the switch is set.
3. Click **Save**.

End

This node signifies the end of the control plan branch.

A control plan may contain as many End nodes as required. The end node must be the last node in each branch of the control plan. There may not be any other node attached after the end node.

Note: If the control plan is going to be used by any sub control plan nodes, there is a maximum of 20 End nodes allowed in the control plan.

Shortcut keys – End

The shortcut keys to add an End node are **Alt+E**.

Node exits – End

This node has one entry and no exit. It is possible to attach several branches of the control plan to the entry of a single End node.

Configuring the node – End

This node requires no configuration data. You may change the **Node name**, if required.

Event Branching

This node will enable alternative control plan branches to be taken, based on the value of a particular event count. A comparison of the current value of a particular counter may be made against a constant value or another event count.

To configure this node, two statistics counters are specified, or a statistics counter and a constant value. The two counters (or the counter and the constant) are compared according to a specified comparison operation. For example, a constant value of 6 may be specified, with a comparison operation of “greater than”. In this case, calls will be routed down the “Comparison is True” branch whenever the first statistics counter registers a value greater than 6. All other calls are routed down the “Comparison is False”.

A control plan may contain as many Event Branching nodes as required.

Node exits – Event Branching

This node has one entry and two exits. The number of exits cannot be changed.

Exit	Cause	Description
1	True	The result of the comparison is true for the factors set in the node screen.
2	False	The result of the comparison is false for the factors set in the node screen.

Configuring the node – Event Branching

Follow these steps to configure the Event Branching node.

1. From the **Counter** list, select the counter that is to be monitored by the node.
2. Counters are configured through the **Event Counters** tab on the ACS Resources screen. For more information, see *ACS User's Guide*
3. From the **Operation** list, select the type of comparison that is to be made.

4. From the **Counter or Constant** list, select a statistics counter or (Compare with Constant Value). If comparing with a constant value, enter the value in the field above the list field.
5. Click **Save**.

Event Counting

This node increments a specified counter by a specified amount, each time a call is routed through the node.

The Event Counting Node must be given a statistics counter in which to save the statistics, and an amount by which to increment each time the node has a call routed through it. This is set in the Configure Event Counting screen shown below. The Configure Event Counting screen is available from the **Edit Node Data** option on the shortcut menu.

A control plan may contain as many Event Counting nodes as required.

Node exits – Event Counting

This node has one entry and one exit. The number of exits cannot be changed.

Configuring the node – Event Counting

Follow these steps to configure the Event Counting node.

1. Select the event counter from the drop-down list to which this Event Counting node is counting. Event counters are set up in the **Event Counters** tab on the ACS Resources screen.
2. In the **Increment** field, enter the number that the counter will increment each time a call is routed through the node.
The increment value must be between -99999 and 999999.
3. Click **Save**.

Event Setting

This node will reset a event counter to a specified number each time a call is routed through this node.

The Event Setting node must have a statistics counter that is to be reset specified and the amount that the statistics counter is to be reset to. These things are set in the Configure Event Setting screen.

A control plan may contain as many Event Setting nodes as required.

Node exits – Event Setting

This node has one entry and one exit. The number of exits cannot be changed.

Configuring the node – Event Setting

Follow these steps to configure the Event Setting Node.

1. Select the event counter that is to be reset from the drop-down list.
Event counters are set up in the [Event Counters](#) tab on the ACS Resources screen.
2. Enter the number to which the statistics counter is to be reset. A Statistics Counter may be reset to any value between -99999 and 999999.
3. Click **Save**.

Geographical Routing

This node allows a control plan to branch based on the geographic location of the calling party. This node may be used to offer different service to calls from certain locations. For example, routing to a local office.

A control plan may contain as many Geographic Routing nodes as required.

Shortcut keys – Geographical Routing

The shortcut keys to add a Geographical Routing node are **Alt+Shift+G**.

Node exits – Geographical Routing

This node has one entry and may have two through 20 exits. Although this node accepts up to 20 exits, it is recommended that this number is restricted to a maximum of 10. You can configure the number of exits within this range as required, using the **Edit Node Exits** option on the shortcut menu. See [Editing Feature Node Exits](#).

Geographic routing

A geography set is made up of multiple nested geography entries. Each entry is mapped to a unique prefix, and may also be connected to a (or several) region. A region is a group of geography entries. The entries contained in a single region may come from different branches and different nested levels, or may contain whole branches.

Routing may be based on either region or geography entry prefix. A geography entry may only appear once on a branch. That is, it may not appear on two branches.

The routing will be based on the best match between the calling party number (or other selected buffer) and the number prefix that has been set for the region in the **Geography** tab of the configuration screens.

Nested subtrees

If an entire nested subtree within a geography set is allocated to a branch then the root of the subtree should be allocated to the branch.

Example: If the number prefix entered for a region used in this node was 0447 and the number prefix for another region used in this node was 04477, a caller from 044773384 will be routed down the branch associated with 04477 because this is the best match found for the calling party number.

Allocating individual prefixes vs allocating folders

It can be visually clearer to allocate every individual prefix to a branch in the **All Geo Areas** frame but this is not necessary. When allocating a folder to a branch all prefixes (and sub-folder prefixes) will route down that branch even though the **Branch Geo Area** (right side) does not list each prefix. However if any prefixes or sub-folders in the root folder are allocated to another branch then calls to those prefixes will route down the new branch instead. You will notice that the prefixes or sub-folders will not be highlighted in the **All Geo Areas** (left side) of the root folder when allocated to other branches.

Example:

The geography set has a folder called Eastern Province which contains 3 prefixes, 2 of which are in a sub-folder called Northern District.

If the Eastern Province folder is allocated to a branch then all matched prefixes will go down that branch (even though the **Branch Geo Areas** frame will only display the Eastern Province folder name).

If the sub-folder, Northern District, is now allocated to another branch then all calls that best match the prefixes in this sub-folder will go down the new branch.

While the third prefix, Southern District (Prefix 12), will still go down the branch allocated to the root folder Eastern Province.



The Northern District folder will not be highlighted in the **All Geo Areas** frame indicating it is allocated on another branch instead.

Default branch

For calls where there is no match found for the allocated prefixes in the **Branch Geo Areas** frame, the call will be routed down the default exit branch, as specified by the **Default Branch** field.

Add a geographic entry or Region to an exit branch – Geographical Routing

Follow these steps to add a geographic entry or region to an exit branch.

1. Select the location of the number data from the **Source Data Type, Location and Field** drop down lists.
2. Select the required geography set from the list. The list will display all the Geography sets that the customer has access to. To the left of the screen is the full tree structure of the geography set. Branches of the tree may be condensed and expanded by:
 - Using the left and right arrow keys
 - Clicking on the  and 
3. Enter the branch number to which the geographic entry or region is to be routed in the **Number** field.

Example:

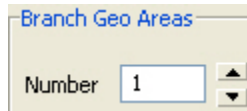

4. Select the entry that is to be routed to that branch from the geography tree at the left.



Notes:

- You can select the root branch by pressing **Alt+S**, and navigate around the tree using the arrow keys. You can also select any of the first nine entries by pressing **Ctrl** and the corresponding number key.
 - To route based on geography regions select the **74 Regions** tab.
 - When routing to exit branches using regions the entries that belong to the region will be assigned to the exit branch.
 - It is important to ensure that an entry is only routed to one exit branch.
5. Either press **Ctrl+B** or click **Move to Branch >>**. The entry will be added to the tree structure for the specified branch. If a condensed branch of the geography tree is added to the branch sub-tree, the entry selected and all levels below that will be added to the branch sub-tree. To add geography entries to another branch, select a new branch and use **Move to Branch >>** or **<< Replace in Set** to add and remove geography tree entries.
 6. Add entries and regions to all branch exits as required.
 7. Select the **Default Branch**.
 8. When you have finished all editing, click **Save**.

Note: **Save** is not available until changes have been made.

Remove geography entries from a branch subtree – Geographical Routing

Follow these steps to remove Geography Entries from a Branch sub-tree.

1. Select the geography set that is required from the list. The list will display all the geography sets that the customer has access to. To the left of the screen is the full tree structure of the geography set. Branches of the tree may be condensed by:
 - Using the left and right arrow keys
 - Clicking on the  and expanded by clicking on the .
2. Select the branch to which a geography tree branch is currently routed by entering a number into the **Branch** field.
3. From the **Branch Geo Areas** frame, select the entry that is to be removed.

Note: You can select the root branch by pressing **Alt+B**, and navigate around the tree using the arrow keys. You can also select any of the first nine entries by pressing **Ctrl** and the corresponding number key.

4. Either press **Ctrl+S** or click **<< Replace in Set**.

Result: The geography entry is replaced in the full geography set tree. This entry may now be added to another branch sub-tree if required.

5. When finished all editing, click **Save**.

Note: Save is not available until changes have been made.

Finding a number in the geographic tree – Geographical Routing

Follow these steps to find where a specific telephone number or prefix is in the geography tree.

1. In the Configure Geographical Routing screen, press **Ctrl+R** to place your cursor into the field next to the **Find** button.
2. Type the number or prefix you want to search for and press **Ctrl+F** to activate the **Find** button.

Result: The **All Geo Areas** tree will expand and highlight the best match for your query.

Example control plan – Geographical Routing

Here is an example control plan containing a Geographical Routing feature node.

This control plan will route calls to different service centers based on where the call originates from (for example, routes to the nearest Pizza shop).

This control plan is triggered when the caller dials a certain termination number (for example 0800 PIZZA).

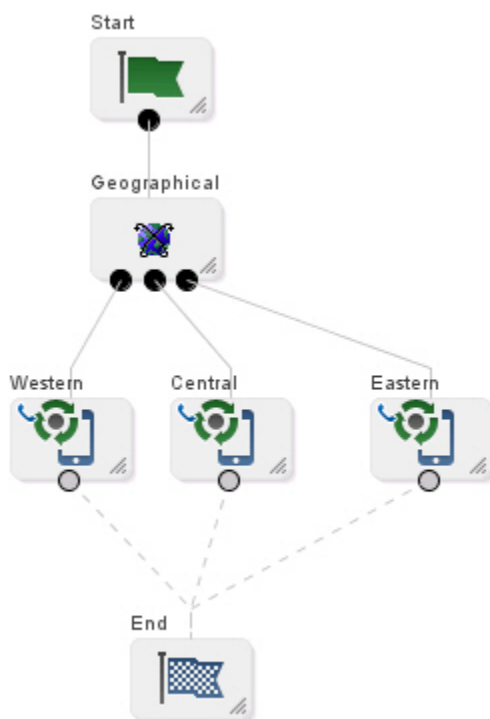

Get Hunting List

Reads hunting list from subscriber's profile, and copies hunting list contents to the additional pending TN buffers.

Node exits – Get Hunting List

This node has one entry and two exits. The number of exits cannot be changed.

Exit	Cause	Description
1	Unsupported	Any outcome other than success, for instance: <ul style="list-style-type: none"> List could not be found Software error
2	Success	The hunting list numbers were retrieved and passed to the ACS Context.

Configuring the node – Get Hunting List

Follow these steps to configure the node.

- In the Hunting list area set the hunting list to use from the Hunting List Data Type, Location and Field drop down lists.
- Set the Timeout. To use:
 - a value from a profile tag, select the **Read from profile** option and set the Data Type, Location and Field holding the timer using the drop down lists, or
 - a node configured value, select the **Use default value** option and enter the value in the Default Timeout field.

Note: If you selected Read from profile and the node cannot find the specified profile field, then the No Answer Timeout will not be overridden.

-
-
-
- Click **Save**.

Note: The drop down lists display Limited Order Prefix Tree profiles.

For more information on profile blocks and tags, see *ACS User's Guide*.

Get Hunting Number

The Get Hunting Number node is used to search a list of termination numbers and timeout pairs within any available profiles.

On each iteration the node sets the PendingTN and timeout using the next number on the list until no numbers remain.

Notes:

- There are no data provisioning screens in ACS for this node. Provisioning the data required by this node requires a custom product like VPN.
- The information for the node is stored in a profile, with the node searching all the profiles it has, in turn, until it finds the hunting information.

Node exits – Get Hunting Number

This node has one entry and three exits. The number of exits cannot be changed.

Exit	Cause	Description
1	Next Number	A number is found
2	No More Numbers	No numbers remain
3	Failure	General failure

Configuring the node – Get Hunting Number

This node requires no configuration data. You may change the **Node name**, if required.

Example – Get Hunting Number

As an example, assuming that the following hunting configuration data has been placed in a profile block:

0x030020 Hunting Config

SubTags (2):

0x000001 356 Hunting Lists (tag 1):

Hunting List ID 1 (name = 'Hunting List 1'):

Rank 1 termination number:

Digits: 04111222

On network ID: 5

Timeout: 10

Rank 2 termination number:

Digits: 1234

Off network number

Timeout: 20

Hunting List ID 2 (name = 'Hunting list 2'):

Rank 1 termination number:

Digits: 04333444

On network ID: 5

Timeout: 30

Rank 2 termination number:

Digits: 4321

Off network number

Timeout: 40
0x000002 380 Hunting Planner (tag 2):
Time Data 0:
Location pattern: ^7777
CLI pattern: ^77777
Time of Day
Start Time: 04:15
End Time: 08:17
Hunting List ID: 1
Time Data 1:
Location pattern: ^6666
CLI pattern: ^76666
Day of Week and Time of Day
Start Time: Sunday 05:00
End Time: Monday 06:00
Hunting List ID: 2
Time Data 2:
Location pattern: ^5555
CLI pattern: ^75555
Day of Year and Time of Day
Start Time: 28 December 01:12
End Time: 29 December 02:15
Hunting List ID: 1
Default Hunting List ID: 1

When the node is used for the first time in a call, it works out which hunting list to use from the hunting planner information, based on time of day, and other factors. The hunting list is an ordered list of termination numbers to try, and a no answer timeout. So, the first list in the example above says try private number 04111222 on network 5 for 10 seconds. The second list says try public number 1234 for 20 seconds.

Each time the get hunting number node is executed, it puts a new number from the list in the pending termination number buffer and the corresponding timeout value in the no answer timer variable in call context. If the end of the list is reached, the get hunting number node exits down branch 2.

The idea is that there is a loop back from the no answer branch of an attempt terminate to pending TN node to a Get Hunting Number node.

Junction

Use the Junction feature node to collect all incoming feature node connections into a single exit point.

The usefulness is being able to position this feature node in a strategic position to move connecting lines clear of other feature nodes, thus making it easier to see what the control plan is doing.

Node exits – Junction

This feature node has one entry and one exit. The number of exits cannot be changed.

Exit	Cause	Description
Branch 1	NA	Connects all the incoming feature nodes to the destination feature node.

Configuring the node – Junction

This node requires no configuration data. You may change the **Node name**, if required.

Load Profile

This node will load the specified profile.

This allows you to read the profile in the database and makes it available to be updated by other nodes that can write back to the profile.

Node exits – Load Profile

This node has one entry and three exits. The number of exits cannot be changed.

Exit	Cause	Description
1	Success Branch	The profile was loaded successfully.
2	Not Loaded Branch	The profile was not loaded.
3	Abandoned Branch	The caller abandoned the call.

Configuring the node – Load Profile

Follow these steps to configure the Load Profile node.

- From the Main Announcement area, select the **Announcement Set** that contains the main announcement you want to play to the caller.
Result: The **Announcement Entry** drop-down box will become available.
- From the **Announcement Entry** drop-down list, select the main announcement you want to play to the caller.

Note: The announcement set and announcement entry lists are populated with data that is specified using the **Announcements** tab of the ACS Configuration screen.

For more information about configuring announcement sets and announcement entries, see [Announcements](#).

3. Set the **Repetition** field to the number of times to repeat the main announcement while the system waits for the caller to take an action. If set to zero, the announcement will be repeated for the length of the duration set.
4. Set the **Duration** field to the length of time in seconds that the announcement is to be played. If set to zero, the announcement will be played for its full length.
5. The retry announcement contains the announcement you want to play to the caller if the number of digits collected is not within the range specified.

In the Retry Announcement area, select one of the following as described in steps 1 - 4:

- **Announcement Set** which contains the retry announcement
 - **Announcement Entry** for the retry announcement you want to play, and set the
 - **Repetition** to the number of times to repeat the retry announcement
 - **Duration** to the length of time, in seconds, that the retry announcement is to be played.
6. In the **Number of Retries** field, set the number of times that the node will attempt to collect data from the caller, before routing the call to the Not Updated branch. This value may be between 0 and 10.
 7. Using the drop down lists in the **Load From Data Type** and **Load From Location** fields, select the Profile block from which information is to be loaded onto the node.

Note: This lists only the profiles that can be updated. For more information about profile blocks, see Profile Blocks and Tags.

8. Click **Save**.

Note: **Save** is not available until all the required information has been selected or entered.

Note: The list of data types is fixed at installation time for each feature node or screen.

Further reference:

- For information about profile blocks (data type, location, and field) and how to use them, see Profile Blocks and Tags.

The primary tag lists are configured in the **SMS > Services > ACS Service > Configuration > Profile Tag Details** and **Profile Tag Mapping** tabs (see *ACS User's Guide, Profile Tag Details* for more information).

Example use of Load Profile node

Here is an example of using the Load Profile node to load the customer profile, in order to access the dial-up self management options.

For detailed information on the ACS Management control plan, see the chapter - Dial-up Control Plan Management in ACS.

1. A customer is set up with an 0800 number and the self management screens.
2. The customer phones a number attached to the ACS management control plan.

Here is an example of a Configure Load Profile screen in ACS Management control plan that prompts the caller for a Customer Profile. See the ACS Management Control Plan example in *ACS User's Guide* to see the entire control plan.

In this example, the caller is prompted to enter their management ID.

Loop Limit

The Loop Limit feature node allows ACS to traverse an instance of the node up to a specified number of times during the control plan processing.

This node can be used in the control plan to create loops composed of other nodes not using telephony.

Node exits – Loop Limit

This node has one entry and two exits. The number of exits cannot be changed.

Exit	Cause	Description
1	Below Limit	The traverse limit has not been reached.
2	Limit Reached	This node cannot be traversed any more for this instance of the control plan.

Configuring the node – Loop Limit

Follow these steps to configure the node.

1. In the **Value** field type the number of iterations for the loop. The value must be between 1 and 1000.
2. Click **Save**.

Modify

The Modify feature node allows you to add, change or remove digits from the start or end (or both) of a number.

Node exits – Modify

This node has one entry and two exits. The number of exits cannot be changed.

Exit	Cause	Description
1	Modified	The number was modified.
2	Error	Error

Configuring the node – Modify

Follow these steps to edit the node.

1. In the Modify area, using the drop down lists, select the field to modify.
Note: ACS normalisation will have already been applied to this number.
2. Type the number of digits that are to be stripped from the front of the number.
Example: If a value of 2 is entered, 2 digits are removed from the start of the number.
3. Type the number of digits that are to be stripped from the end of the number.
4. Type the characters to prepend to the start of the number.
5. Type the characters to append to the end of the number.
6. Click **Save**.

Note: The list of data types is fixed at installation time for each feature node or screen.

Further reference:

- For information about profile blocks (data type, location, and field) and how to use them, see Profile Blocks and Tags.

The primary tag lists are configured in the **SMS > Services > ACS Service > Configuration > Profile Tag Details** and **Profile Tag Mapping** tabs (see *ACS User's Guide, Profile Tag Details* for more information).

NP Destination Selection

The NP Destination Selection node determines the owner of the called number (that is, is the number ported or non ported?). Based on the porting status and whether the number is owned by the operator (internal) or owned by another operator (external), it can be configured how the call number is modified.

Optionally, the NP Least Cost Routing node can be used after the NP Destination Selection node to select the most appropriate route towards the operator that owns the number based on rules configured in nodes within the control plan. If the control plan has been triggered by receiving a MAP message, then the NP MTA node must follow

the NP DS node (or NP LCR node if used). However it is possible to have non telephony in between.

Node exits – NP Destination Selection

This node has one entry and 11 exits. The number of exits cannot be changed.

Exit	Cause	Description
1	DN Number Violation	The Destination Number is not valid.
2	No Destination Found	There is no matching Routing Destination for the called party number.
3	Internal Not Ported F	The node has successfully selected an internal destination on your network where the Routing Number (for a fixed destination call) matches an operator entry in NP_DN_RANGES or a PQYZ entry (depending on the runtime configuration).
4	External Not Ported F	The node has successfully selected an external destination (one that belongs to another operator) where the Routing Number (for a fixed destination call) matches an operator entry in NP_DN_RANGES or a PQYZ entry (depending on the runtime configuration).
5	Internal Ported In F	The Routing Number (for a fixed destination call) has been ported in to your network from another operator and has an associated subscriber match within the NP_DN_RANGES table.
6	External Ported Out F	The Routing Number (for a fixed destination call) has an associated subscriber match within the NP_DN_RANGES table and has been ported out from your network to another operator.
7	Internal Not Ported M	The node has successfully selected an internal destination on your network where the Routing Number (for a mobile destination call) matches an operator entry in NP_DN_RANGES or a PQYZ entry (depending on the runtime configuration).

Exit	Cause	Description
8	External Not Ported M	The node has successfully selected an external destination (one that belongs to another operator) where the Routing Number (for a mobile destination call) matches an operator entry in NP_DN_RANGES or a PQYZ entry (depending on the runtime configuration).
9	Internal Ported In M	The Routing Number (for a mobile destination call) has been ported in to your network from another operator and has an associated subscriber match within the NP_DN_RANGES table.
10	External Ported Out M	The Routing Number (for a mobile destination call) has an associated subscriber match within the NP_DN_RANGES table and has been ported out from your network to another operator.
11	Processing Error	An internal error has occurred.

Configuration fields – NP Destination Selection

This table describes the function of each field.

Field	Description
TN unmodified (Internal or External)	Do not change the pending Termination Number.
Prepend TN with RN (Internal or External)	Prefix the pending Termination Number with the Additional Routing Number. If this is not available use the Routing Number.
Replace TN with RN (Internal or External)	Replace the pending Termination Number with the Additional Routing Number. If this is not available use the Routing Number.
Append URI	Include the URI associated with the Called Party Number in an Extension field that will be sent in the INAP CONNECT operation to the client interface.

Configuring the node – NP Destination Selection

Follow these steps to configure the node.

1. Select the required **Internal** option.
2. Select the required **External** option.
3. Select the **Append URI** check box if required.
4. Click **Save**.

NP Home Routing

The NP Home Routing node is used to determine the routing destination for a call within the network.

The node looks up the called number in the subscriber list. If the called number is:

- A regular subscriber, then the node retrieves the destination from the DN range that matches the called number. Least cost routing can then be used to select an appropriate carrier for the call.
- A special number, then no routing destination is set and the Special Number node exit is used

Otherwise the No Destination exit is used.

Node exits – NP Home Routing

This node has one entry and four exits. The number of exits cannot be changed.

Exit	Cause	Description
1	Home Dest Selected	The node has successfully matched the called number to a home routing number.
2	Special Number	The node has successfully matched the called number to a special number.
3	No Destination	The called number is not your subscriber. The destination could not be found.
4	Error	An internal error has occurred.

Configuring the node – NP Home Routing

This node requires no configuration data. You may change the node name, if required.

NP Least Cost Routing

The NP Least Cost Routing node is used to determine which carrier to use during call processing based on least cost rules.

The routing destination set by the Destination Selection node or the Home Routing node determines which list of carriers to try from the rule set. An attempt is made to connect the call to the carriers in sequence until one of:

- The call is successfully connected
- No more carriers are available

Prior to each connection attempt, the pending calling and called numbers of the call will be modified in accordance with the preferred number format of the carrier, their country code, optional override NOA and called party prefix.

Note: Standard ACS feature nodes, such as the Time of Day, or Day of Week routing nodes may be used to select different rule sets for different scenarios.

Node exits – NP Least Cost Routing

This node has one entry and four exits. The number of exits cannot be changed.

Exit	Cause	Description
1	Route not found	The node could not find the route specified for the carrier.
2	Carrier Available	The call has been successfully connected to the selected carrier.
3	No More Carriers	Attempts to connect to each carrier in the Rule Set were unsuccessful.
4	Error	An internal error has occurred

Configuration fields – NP Least Cost Routing

This table describes the function of the field on this screen.

Field	Description
Rule Set	Defines the list of rules available for least cost routing that determine which carrier and routing destination will be used.

Configuring the node – NP Least Cost Routing

Follow these steps to configure the node.

1. Select the **Rule Set** from the drop down list of carriers to use for least cost routing.
2. Click **Save**.

NP Map Trigger

The NP Map Trigger node is used to determine the appropriate response to the Map message that triggered the IN service.

For example, in an MNP environment the MAP message can be one of:

- Acknowledged with the MAP response message
- Acknowledged with the MAP error message (TCAP_ERROR message being returned)
- Aborted at the TCAP level (TCAP_U_ABORT message being returned)
- Relayed at the SCCP level to the appropriate HLR for processing

Node exits – NP Map Trigger

This node has one entry and two exits. The number of exits cannot be changed.

Exit	Cause	Description
1	Config Applied	SCI successfully configured.
2	Processing Error	Unable to apply configuration.

Configuration fields – NP Map Trigger

This table describes the function of each field.

Note: The DRA is the `destinationRoutingAddress` field in the INAP CONNECT and is derived from the pendingTN buffer.

Field	Description
Map with DRA	Sends MAP response and puts the Destination Routing Address (DRA) in the configured MAP field (NOA value for configured MAP field).
Map Error	Sends MAP Error where the error cause is set to the MAP Error field value.
TCAP Abort	Sends TCAP_ABORT - U_ABORT with the cause value set to the TCAP Error field value. (Cause value mapped to appropriate alarm by MAP trigger application).
SCCP Relay 1	Updates the SCCP called Global Title (GT) with the DRA, performs GT Translation on the DRA, and sets Routing Information = route on PC (NOA value for the SCCP called GT NOA).
SCCP Relay 2	Updates the SCCP called GT with the DRA, does not perform GT Translation on the DRA, and Routing Information = route on GT (NOA value for the SCCP called GT NOA).
SCCP Relay 3	No change to SCCP called GT digits, performs GT Translation on the DRA, and Routing Information = route on Point Code (NOA value for the SCCP called GT NOA).
NOA	Sets the Nature of Address value for one of these options: <ul style="list-style-type: none"> • Map with DRA • SCCP Relay 1 • SCCP Relay 2 • SCCP Relay 3 Valid values are in the range 0-127, and 255.
TCAP Error	Sets the TCAP Error cause value for the TCAP Abort option.
Map Error	Sets the Map Error value for the Map Error option.

Configuring the node – NP Map Trigger

Follow these steps to configure the node.

1. Select the required option.
2. If you selected one of the following options, then in the **NOA** field, set the NOA:

- Map with DRA
 - SCCP with GTT
 - SCCP no GTT, or
 - SCCP with GT digits
3. If you selected the MAP Error option then select the map error message to use from the **Map Error** drop down list.
 4. If you selected the TCAP Abort option then in the **TCAP Error** field, type the cause value.
 5. Click **Save**.

Number Lookup and Translation

This node takes a number that is either entered by the user or is held as a data item, and translates it to another number.

The new number is stored in a field in a specified location for later use, for example, as a pending termination number.

Node exits – Number Lookup and Translation

This node has one entry and four exits. The number of exits cannot be changed.

Exit	Cause	Description
1	Success	The number has been successfully translated.
2	Not Translated	The number has not been translated.
3	Abandoned	The caller has abandoned the call.
4	Not Updated	The number could not be updated.

Configuring the node – Number Lookup and Translation

Follow these steps to configure the node.

1. In the **Read number translation list from** field, select the location in which the number translations are stored. The Control Plan designer must verify that this field contains the correct selection.

Note: If this number translation has been established by using the **ACS > Resource > Number Translations** screen, the information will always be in Customer Profile, Sub-field 1.

2. In the **Sub-field** field, enter the sub-tag that selects a group of number translations. This field entry does not have a default value. See Sub-tags for a definition of sub-tags.

The list that is stored under the sub-field is a prefix tree data structure, which allows the input number to be quickly looked up and verified.

Example:

- Sub-field 1 could be Marketing translations between account codes and phone numbers.
 - Sub-field 2 could be Sales Department quick dial numbers.
3. Select the method of obtaining the number:
 - Retrieve stored number
Result: The **Retrieve number from location** and **Retrieve number from field** fields are activated. Go to Step 4.
 - Prompt and collect number
Result: The Announcement areas are activated. Go to Step 6.
 4. If you selected the Retrieve stored number option, in the **Retrieve number from location** and **Retrieve number from field** drop down lists, select the location of the data to retrieve.
 5. Go to Step 12.
 6. If you selected the Prompt and collect number option, from the Main Announcement area, select the **Announcement Set** that contains the main announcement you want to play to the caller.
Result: The **Announcement Entry** drop-down box will become available.
 7. From the **Announcement Entry** drop-down list, select the main announcement you want to play to the caller.
Note: All announcements are established in the **ACS > Configuration > Announcements** screens.
 8. Set the **Repetition** field to the number of times to repeat the main announcement while the system waits for the caller to take an action. If set to zero, the announcement will be repeated for the length of the duration set.
 9. Set the **Duration** field to the length of time in seconds that the announcement is to be played. If set to zero, the announcement will be played for its full length.
 10. The retry announcement contains the announcement you want to play to the caller if the digits they enter are not recognised.
In the Retry Announcement area, select one of the following as described in steps 5 - 9:
 - **Announcement Set** which contains the retry announcement
 - **Announcement Entry** for the retry announcement you want to play, and set the
 - **Repetition** to the number of times to repeat the retry announcement
 - **Duration** to the length of time, in seconds, that the retry announcement is to be played.
 11. In the **Number of Retries** field, set the number of times that the node will attempt to collect data from the caller, before routing the call to the Not Translated branch. This value may be between 0 and 10.
 12. From the **Store translated number to Location** and **Store translated number to Field** drop down lists, select where to store the translated number.
 13. Click **Save**.

Note: **Save** is not available until all the required information has been selected or entered.

Note: The announcement set and announcement entry lists are populated with data that is specified using the **Announcements** tab of the ACS Configuration screen.

For more information about configuring announcement sets and announcement entries, see the **Announcements** tab of the ACS Configuration screen.

Example – Number Lookup and Translation

The following have been set up in the **ACS > Resource > Number Translation** screens (list of Sub-field 1 numbers):

Input Number	Termination Number
08004567	041234567
08009876	063456789

The number to translate is compared to the Input Number list.

When a match is found, the matching termination number is stored in the configured location.

Number Matching

The Number Matching node finds numbers that match:

- One or more search patterns
- A profile block and field

Node exits – Number Matching

This node has one entry and three exits. The number of exits cannot be changed.

Exit	Cause	Description
1	Number Found	The selected number matches a search pattern.
2	Number Not Found	The selected number does not match a search pattern.
3	Number is Undefined	One of: <ul style="list-style-type: none"> • The buffer to compare is empty • There is no number list found at the profile and field combination provided

Search patterns – Number Matching

The Number Matching feature node allows you to enter one or more search patterns in the **Static Pattern List** field.

The search patterns are entered using regular expressions. Some characters have special meaning when used in a regular expression; other characters stand for themselves. Under ACS, telephone number matching is customized for patterns of

telephone numbers. The "number" character set is represented by digits zero through nine, asterisk, pound sign (hash mark), and the letters A through F.

The control plan compiler notifies you if the pattern entered is invalid.

Special characters

Here are the definitions of special characters used in search patterns.

Special Character	Definition
c	For the purposes of this feature node, the character c refers to the "number" character set as defined above.
?	Any single character in the pattern.
(r)	The regular expression r. For example, (r)x(y)z is the combination of regular expressions rxyzy. This is typically used to group number sequences as distinct units.
r%	Zero or more successive occurrences of the regular expression r. The longest left-most match is chosen.
rx	The occurrence of regular expression r, followed by the occurrence of regular expression x.
r<m:n>	Any number of m through n successive occurrences of the regular expression r. The regular expression r<m> matches exactly m occurrences; r<m:> matches at least m occurrences. The occurrence counting angle brackets allows only numbers and a colon within the brackets. The angle brackets and colon have no meaning outside of this context.
[s]	Any character in the set s, where s is a sequence of characters and/or a range of characters, for example [0-9]. When used in square brackets, the dash denotes a range, for example [cc]. Note: The dash has no special meaning if it occurs immediately after the open bracket, or before the closing bracket: for example, ([-c] or [c-]).
[^s]	Any character not in the set s, where s is defined as in the previous entry. The circumflex has the meaning "complement of", where it immediately follows the open bracket for example, [^s]. A circumflex is not part of a telephone number, so a match will never be found for a pattern where the circumflex does not immediately follow the open bracket.

Examples:

Here are some examples of search patterns.

Search Pattern	Definition
123	Match digit sequence '123' exactly

Search Pattern	Definition
123%	Match digit sequence '12' followed by none or more '3' digits {matches 12, 123, 1233, 12333}
123<1:>	Match digit sequence '12' followed by one or more '3' digits {matches 123, 1233, 12333, ..}
(123)%	Match none or more entire sequences of '123' {matches nothing, 123, 123123, 123123123, ...}
(123)<1:2>	Match on at least one and no more than two sequences '123' {matches ONLY 123 and 123123}
021?<6:7>	Match on prepaid (at least 6 of any digits) & subscriber (most 7 digits)
025?<6:>	Match on at least 6 of any digit, no upper limit of digits
02[15]?<6:>	Match on a number that starts with 02, is directly followed by a single digit 1 or 5, and followed by at least 6 occurrences of any digit
123?%	Match on a number where 123 is followed by anything or nothing
??123???	Match on any 8-digit number where the 3rd to 5th digits are 123
?%123	Match on any number ending in 123, including 123

Configuring the node – Number Matching

Follow these steps to configure the node.

1. In the **Number to Match** frame, using the drop down lists, specify the number to match.
2. Select the pattern list location. If you select:
 - **Node dialog**, the **Static Pattern List** field is active.
 - **Profile**, specify the data type, location, and field.
3. If you selected **Node dialog**, fill in the **Number Match Pattern List** field. See [Search patterns – Number Matching](#) for a list of example patterns.

Warning: Do not leave this field empty. If you leave this field empty, exit 2 will be taken, as there is nothing to match against.

If you selected **Profile**, select from the drop-down lists:

- **Pattern List Data Type**

Note: Only String data types are accepted. To be able to find a profile with an Integer data type, you must add a Copy node to your control plan just before the Number Matching Node. Configure the Copy node to temporarily change the profile data type from Number to String.
 - **Pattern List Location**
 - **Pattern List Field** containing the pattern to match against
4. Click **Save**.

Note: If any control plan containing Number Matching nodes were exported prior to the profile block functionality being introduced and you import them again, you will need to re-save to allow the control plan to recompile.

Note: The list of data types is fixed at installation time for each feature node or screen.

Further reference:

- For information about profile blocks (data type, location, and field) and how to use them, see Profile Blocks and Tags.
- The primary tag lists are configured in the **SMS > Services > ACS Service > Configuration > Profile Tag Details** and **Profile Tag Mapping** tabs (see *ACS User's Guide, Profile Tag Details* for more information).

Example – Number Matching

This example is based on the configuration screen shown for this node:

- The number to match against is held in the Calling Logical Number field in the call context.
- The search pattern looks for the digits 123, starting in position 3, in an eight digit number.

The exit taken is shown in this table for the various Calling Logical Number examples:

CLN	Exit taken	Why
NA	3 - Number is Undefined	No number found at configured location - Logical Calling Number buffer is empty.
04123678	1 - Number Found	123 found, starting at position 3, in an eight digit number.
0412367	2 - Number Not Found	Not an eight digit number - only 7 digits.
12345678	2 - Number Not Found	123 not at position 3 - occurs at position 2.
0212345678	2 - Number Not Found	Not an eight digit number - 9 digits.

Number Normalisation

The Number Normalisation node normalizes the number currently held in the selected buffer, following the rules defined in **acs.conf**.

Note: Any changes made to **acs.conf** will necessitate a SLEE restart for the changes to be registered with this node.

Node exits – Number Normalisation

This node has one entry and two exits. The number of exits cannot be changed.

Exit	Cause	Description
1	Success	The caller has successfully exited the node.

Exit	Cause	Description
2	Error	Invalid value found in selected buffer. Error exit branch is followed whenever the value held in buffer is NULL/empty or has more than 32 characters.

Configuring the node – Number Normalisation

Follow these steps to edit the node configuration.

See the *ACS technical Guide*, topic *acsChassis Normalisation Parameters (SCP)* for information on number normalisation.

1. Using the drop down lists in the Number Buffer area, specify the buffer containing the number to normalise.
2. Type the **Source NOA** value.
3. Click **Save**.

Note: The list of data types is fixed at installation time for each feature node or screen.

Further reference:

- For information about profile blocks (data type, location, and field) and how to use them, see *Profile Blocks and Tags*.

The primary tag lists are configured in the **SMS > Services > ACS Service > Configuration > Profile Tag Details** and **Profile Tag Mapping** tabs (see *ACS User's Guide, Profile Tag Details* for more information).

PIN Authorisation

This node checks that there is a PIN in the PIN buffer. If there is none there, it prompts the user to enter their PIN and places the received digits in the PIN buffer. It then checks that the PIN is correct. If it is not, then it prompts for PIN entry (maximum of ten times). It then collects the PIN accesses in the station profile (if there is none, it uses the network profile default). A check is made that the attempted action is permitted.

Note: A PIN can be set for a service number or CLI number in ACS. See *Service Number* and *CLI New Numbers* fields, accessed from the *ACS Numbers* screen, for details.

Node exits – PIN Authorisation

This node has one entry and three exits. The number of exits cannot be changed.

Exit	Cause	Description
1	Success	The valid PIN is entered.
2	Not Allowed	The entered PIN is not recognized.

Exit	Cause	Description
3	Abandoned	An error has occurred and the PIN has not been collected.

Configuring the node – PIN Authorisation

Follow these steps to edit the PIN Authorisation node.

- From the Main Announcement area, select the **Announcement Set** that contains the main announcement you want to play.
Result: The **Announcement Entry** drop-down box will become available.
- From the **Announcement Entry** drop-down list, select the main announcement you want to play to the caller to request a PIN.
- Set the **Repetition** field to the number of times to repeat the main announcement while the system waits for the caller to take an action. If set to zero, the announcement will be repeated for the length of the duration set.
- Set the **Duration** field to the length of time in seconds that the announcement is to be played. If set to zero, the announcement will be played for its full length.
- The retry announcement contains the announcement you want to play to the caller if an incorrect PIN is entered.

In the Retry Announcement area, select one of the following as described in steps 1 - 4:

- **Announcement Set** which contains the retry announcement
 - **Announcement Entry** for the retry announcement you want to play, and set the
 - **Repetition** to the number of times to repeat the retry announcement
 - **Duration** to the length of time, in seconds, that the retry announcement is to be played.
- In the **Number of Retries** field, set the number of times that the node will attempt to collect the correct PIN from the caller, before routing the call to the Not Allowed branch. This value may be between 0 and 10.
 - Tick the Access Rights Required check boxes that you wish to give right of access to the information that the node requires. These relate directly to the application in which the PIN was stored.
 - Select the profile blocks in which the information that the node requires is located. A profile block must be selected for each of the PIN, the Access Rights, and the default Access.

Note: For information about profile blocks, see Profile Blocks and Tags.

- Click **Save**.

Note: **Save** is not available until all the required information has been selected or entered.

Note: The announcement set and announcement entry lists are populated with data that is specified using the **Announcements** tab of the ACS Configuration screen.

For more information about configuring announcement sets and announcement entries, see the **Announcements** tab of the ACS Configuration screen.

Play Announcement

This node will play a specified recorded announcement to the caller.

Shortcut keys – Play Announcement

The shortcut keys to add a Play Announcement node are **Alt+P**.

Node exits – Play Announcement

This feature node has one entry and two exits. The number of exits cannot be changed.

Exit	Cause	Description
1	Completed	The announcement completed playing to the caller without any problems, the caller interrupting (by pressing keys on their telephone or speaking in a voice recognition system), or hanging up.
2	Abandoned	The playing of the announcement was abandoned for some reason. This could be that the caller hung up before the announcement had completed playing, or the announcement could not be played correctly as there was some sort of error.
3	Error	Continue session control after announcement failures and aborts.

Configuring the node – Play Announcement

Follow these steps to edit the Play Announcement node.

1. In the **Main Announcement** frame, select the **Announcement Set** which contains the main announcement to play to the caller.
Result: The **Announcement Entry** field becomes available.
2. From the **Announcement Entry** drop-down list, select the main announcement to play to the caller.
3. Set the **Repetition** field to the number of times to repeat the main announcement while the system waits for the caller to take an action. If set to zero, the announcement is played for the duration set.
4. Set the **Duration** field to the length of time, in seconds, that the announcement is to be played. When set to zero, the announcement will be played for its full length.
5. Click **Save**.

Note: The announcement set and announcement entry lists are populated with data that is specified using the **Announcements** tab of the ACS Configuration screen.

For more information about configuring announcement sets and announcement entries, see the **Announcements** tab of the ACS Configuration screen.

Play Ordered Prefix Tree Entry

The Play Ordered Prefix Tree Entry node plays a single selected entry from an ordered prefix tree to the caller.

If the entry number profile field is not present, the first prefix tree entry (entry number zero) is used in the announcement.

Selection keys – Play Ordered Prefix Tree Entry

Selection keys (digits 0 to 9) to cater for “Forward”, “Backward”, “Select”, and “Exit” operations can be optionally configured to enable scrolling through a prefix tree.

When configured, the announcement is played as a prompt and collect operation. If an incorrect digit is collected, the Invalid Key error branch is taken.

When not configured, the announcement is played as a variable announcement with two parts in the following order:

1. Entry Number
2. Prefix Tree Entry

Node exits – Play Ordered Prefix Tree Entry

This node has one entry and nine exits. The number of exits cannot be changed.

Exits 1 through 5 are optional and therefore available only when configured.

Exit	Cause	Description
1	Next	The caller entered the “Next” key (digit 0 to 9). Note: Checks (listed under exit 6 below) are made before branching which could result in exit 6 being taken instead, see exit 6 below.
2	Previous	The caller entered the “Previous” key (digit 0 to 9).
3	Exit	The caller entered the “Exit” key (digit 0 to 9).
4	Selected	The caller entered the “Select” key (digit 0 to 9).
5	Timed Out	The user did not enter a digit within the configured menu timeout period.

Exit	Cause	Description
6	Last Played	One of the following occurred. <ul style="list-style-type: none"> The last entry was played in the tree. The next entry in the tree is outside the maximum number of entries (and Check Limitations was set). The entry number was not valid for this tree (in which case the last entry (or last applicable entry in the case of limitations being applied) will have been played). The prefix tree is not present in the profile. The prefix tree has no entries.
7	Invalid Key	The caller entered an invalid key.
8	Abandoned	The caller hung up during the announcement.
9	Error	General Error Handling.

Configuration fields – Play Ordered Prefix Tree Entry

This table describes the function of each field.

Field	Description
Check Limitations	When selected, restricts the maximum number of entries that may be played to the maximum number of entries for the source prefix tree.
Announcement Set	List of all the announcement sets (configured in the ACS Configuration screen in ACS).
Announcement Entry	List of all the announcements belonging to the selected announcement set.
Source Data Type	The source data type for the prefix tree.
Source Location	The profile block containing the prefix tree location.
Source Field	The prefix tree location field within the profile block. The available field types listed are: <ul style="list-style-type: none"> Limited Ordered Prefix Tree Ordered Prefix Tree
Entry Data Type	The data type of the prefix tree entry number to play.
Entry Location	Profile block that contains the prefix tree entry number to play.
Entry Field	Profile field containing the entry number to play.

Field	Description
Forward	Sets the key for "Next" operation. This is optional, and if not set, no next option will be available to the caller. Single 0 to 9 digit not configured else where.
Backward	Sets the key for "Previous" operation. This is optional, and if not set, no previous option will be available to the caller. Single 0 to 9 digit not configured else where.
Exit	Sets the key for "Exit" operation. This is optional, and if not set, no exit option will be available to the caller. Single 0 to 9 digit not configured else where.
Select	Sets the key for "Selected" operation. This is optional, and if not set, no selected option will be available to the caller. Single 0 to 9 digit not configured else where.
Menu Timeout	Seconds to wait for a key entry (when selection keys are configured) before branching "Timed out". Range is 0 to 99 seconds. Note: The lower this value is the more likely a timeout is going to occur (that is, 0 would result in 100% certain timeout).

Configuring the node – Play Ordered Prefix Tree Entry

Follow these steps to edit the node configuration.

1. Tick the **Check limitations** check box to restrict the maximum number of entries to play to the source prefix tree maximum number of entries.
Non-selection will allow all the available entries to be played.
2. In the Play Entry area, using the drop down boxes, select the **Announcement Set** and **Announcement Entry** for the prefix tree entry announcement to play.
3. In the source Prefix Tree area, using the drop down boxes, select the prefix tree.
4. In the Entry Number to be Played area, using the drop down boxes, select the prefix tree number to play.
5. In the **Forward** field, enter the unique digit (0 to 9) the caller must enter to use the forward function. This is optional.
6. In the **Backward** field, enter the unique digit (0 to 9) the caller must enter to use the backward function. This is optional.
7. In the **Exit** field, enter the unique digit (0 to 9) the caller must enter to use the exit function. This is optional.
8. In the **Select** field, enter the unique digit (0 to 9) the caller must enter to use the select function. This is optional.
9. In the **Menu Timeout** field, optionally enter a number of seconds (0 to 99). This is the amount of time to wait for a response from the caller before taking the Timed out exit.

Note: The lower this value is, the more likely a timeout is going to occur. 0 results in 100% certain timeout.

10. Click **Save**.

Note: In steps 5 to 8, the digit must be unique for this configuration. Any conflicts will be reported and must be resolved before saving.

Note: The list of data types is fixed at installation time for each feature node or screen.

Further reference:

- For information about profile blocks (data type, location, and field) and how to use them, see Profile Blocks and Tags.

The primary tag lists are configured in the **SMS > Services > ACS Service > Configuration > Profile Tag Details** and **Profile Tag Mapping** tabs (see *ACS User's Guide, Profile Tag Details* for more information).

Play Variable Part Announcement

The Play Variable Part Announcement feature node announces to the user up to five variables that were loaded from the profile block.

The feature node must have an announcement selected with variable parts. This announcement will be played and the variable parts specified will be played in the announcement.

You can configure variable part announcements to comply with the 3GPP CAMEL specification: *3GPP TS 29.078*, by setting the `TypeOfIVR` parameter to CAMEL in the `srf` (Special Resource Function) configuration in the `acs.conf` configuration file. When set, the Play Variable Part Announcement feature node plays dates sent over the network with a size of four octets in announcements. By default, the feature node plays dates sent over the network with a size of three octets. For more information about `srf` configuration, see the discussion on `acsChassis srf` configuration in *ACS Technical Guide*.

Node exits – Play Variable Part Announcement

This feature node has one entry and two exits. The number of exits cannot be changed.

Note: These exit descriptions are specific to the responses received from an Oracle VWSbilling engine. For specific information about how responses from other billing engines map to these exits, see the technical guide for the interface for billing engine being used.

Exit	Cause	Description
1	Completed	The announcement completed playing to the caller without any problems, the caller interrupting (by pressing keys on their telephone or speaking in a voice recognition system), or hanging up.

Exit	Cause	Description
2	Abandoned	The playing of the announcement was abandoned for some reason. This could be that the caller hung up before the announcement had completed playing, or the announcement could not be played correctly as there was some sort of error.
3	Error	Continue session control after announcement failures and aborts.

Configuring the node – Play Variable Part Announcement

Follow these steps to edit the Play Variable Part Announcement node.

1. From the **Main Announcement** frame, select the **Announcement Set** which contains the main announcement you want to play to the caller.

Result: The **Announcement Entry** list becomes available.

Select the main announcement you want to play to the caller from the **Announcement Entry** drop down list.

2. For each of the variable parts:
 - In the **Data Type** field, select the profile data type.
 - In the **Location** field, select the location where the field is stored.
 - In the **Field** field, select the field to be played.
 - Select the **Denormalisation** check box, if you wish the number in this field to be denormalized. See *ACS Technical Guide, Play Variable Part Announcement Configuration* topic, for this node's denormalization rules.
3. Click **Save**.

Note: **Save** is not available until all the required information has been selected or entered.

Note: The announcement set and announcement entry lists are populated with data that is specified using the **Announcements** tab of the ACS Configuration screen.

For more information about configuring announcement sets and announcement entries, see the **Announcements** tab of the ACS Configuration screen.

Note: The list of data types is fixed at installation time for each feature node or screen.

Further reference:

- For information about profile blocks (data type, location, and field) and how to use them, see *Profile Blocks and Tags*.
- The primary tag lists are configured in the **SMS > Services > ACS Service > Configuration > Profile Tag Details** and **Profile Tag Mapping** tabs (see *ACS User's Guide, Profile Tag Details* for more information).

Prefix Branching

The Prefix Branching node allows you to compare the contents of an ACS number buffer against the specified profile field, and will branch according to whether the profile field content is a prefix of the ACS number buffer value.

Node exits – Prefix Branching

This node has one entry and two exits. The number of exits cannot be changed.

Exit	Cause	Description
1	Matched	The specified profile field's value was a prefix of the number buffer's value.
2	Not Matched	The specified profile field's value was not a prefix of the number buffer's value.

Editing the node – Prefix Branching

Follow these steps to edit the node configuration.

1. Using the drop down lists in the Number String area, select the source prefix tree.
2. Using the drop down lists in the Number Source area, select the ACS number buffer containing the number to compare with the prefix tree.
3. Click **Save**.

Note: The list of data types is fixed at installation time for each feature node or screen.

Further reference:

- For information about profile blocks (data type, location, and field) and how to use them, see Profile Blocks and Tags.

The primary tag lists are configured in the **SMS > Services > ACS Service > Configuration > Profile Tag Details** and **Profile Tag Mapping** tabs (see *ACS User's Guide, Profile Tag Details* for more information).

Prefix Tree Branching

The Prefix Tree Branching node allows you to compare the contents of an ACS number buffer against the specified prefix tree, and will branch according to whether the tree contains a prefix of the number.

If a match is found, the value associated with the matched entry (often the order of a limited prefix tree) will be stored in the specified profile field.

Node exits – Prefix Tree Branching

This node has one entry and three exits. The number of exits cannot be changed.

Exit	Cause	Description
1	Matched	A prefix of the number was found in the tree.
2	Not Matched	A prefix of the number was not found in the tree.
3	Fully Matched	The number was found in the tree (full match, not a prefix)

Configuring the node – Prefix Tree Branching

Follow these steps to edit the node configuration.

1. In the Prefix Tree area, using the drop down boxes, select from the list of prefix trees.
2. In the Number Source area, using the drop down boxes, select the source for the number to match.
3. If you want to temporarily store a matched number in a specified field so that the node doesn't change the prefix tree:
 - a. Tick the **Enabled** check box in the Use Selected Entry area.
 - b. Then use the drop-down lists in the Selected Entry area to specify where to store the number.
4. Click **Save**.

Note: The list of data types is fixed at installation time for each feature node or screen.

Further reference:

- For information about profile blocks (data type, location, and field) and how to use them, see Profile Blocks and Tags.

The primary tag lists are configured in the **SMS > Services > ACS Service > Configuration > Profile Tag Details** and **Profile Tag Mapping** tabs (see *ACS User's Guide, Profile Tag Details* for more information).

Prefix Tree Entry Extraction

The Prefix Tree Entry Extraction feature node enables one or more entries in a profile prefix tree to be extracted and stored in other profile fields.

Looping – Prefix Tree Entry Extraction

If there is more than one entry in the prefix tree that requires processing then the Prefix Tree Entry Extraction node should be set up in a loop in the control plan. If no external data will be supplied to the Prefix Tree Entry Extraction node, then the following additional nodes will be required in the control plan:

- Set feature node
- Loop Limit feature node
- Profile Counting feature node

Loop process – Prefix Tree Entry Extraction

This process describes how a loop can be used to process multiple entries from the prefix tree specified in the Prefix Tree Entry Extraction (PTEE) node in the control plan.

1. The Set node is used to initialize the first entry position for the PTEE node. This means it must be placed in the control plan before the PTEE node.
2. The PTEE node will extract the initial entry and follow the More Entries path (if more entries exist).
3. Following any required processing, the Loop Limit node will be checked to ensure the maximum number of iterations has not been reached and its counter will be incremented.
4. The Profile Counting node must be placed after the Loop Limit node in the control plan. It will increment the entry position to be used by the PTEE node.
5. The PTEE node will extract the entry indicated by the Profile Counting node and if more entries exist it will exit through the More Entries path.
6. This processing will continue until there are no more entries in the prefix tree or the loop limit is reached. The loop will then be exited following any required processing.

Node exits – Prefix Tree Entry Extraction

This node has one entry and four exits. The number of exits cannot be changed.

Exit	Cause	Description
1	More Entries	There are some more entries to extract.
2	No More Entries	The entry position is pointing to the last entry indicating that there are no more entries to extract.
3	Invalid Position	The entry position is either 0 or greater than the limit.
4	Error	The specified profile does not exist.

Configuration fields – Prefix Tree Entry Extraction

This table describes the function of each field.

Field	Description
Source Data Type	The data type of the source profile block.
Source Location	The profile block containing the prefix tree.
Source Field	The prefix tree field within the profile block. The available field types listed are: <ul style="list-style-type: none"> • Limited Ordered Prefix Tree • Ordered Prefix Tree

Field	Description
Entry Data Type	The data type of the entry profile block.
Entry Location	The profile block that contains the prefix tree entry number to extract.
Entry Field	The profile field containing the entry number to extract. This will be an integer field.
Destination Data Type	The data type of the profile to use to store the extracted data.
Destination Location	The profile block location for the extracted data.
Destination Field	The profile field where the extracted data will be stored. This will be an integer field.

Configuring the node – Prefix Tree Entry Extraction

Follow these steps to configure the node.

1. From the Source Prefix Tree area, using the drop down boxes, select the prefix tree.
2. From the Entry Position to be Extracted area, using the drop down boxes, select the prefix tree number to extract.
3. From the Destination Profile Field area, using the drop down boxes, select the destination profile field for the extracted data.
4. Click **Save**.

For more information about profile blocks (data type, location, and field) and how to use them, see *Profile Blocks and Fields*.

For more information about profile field configuration, see the discussion on profile tag configuration in *NCC Advanced Control Services User's Guide*.

Presence Branching

This node sends a request via ACS to a third party presence server to query a selected location for the presence and availability of a specified subscriber or presence entity. It then branches accordingly.

Note: The node relies on a protocol specific presence querying chassis action to process the request. The library used is delivered separately by another package, such as *scaScp*.

Following are the standard set of locations and availabilities, delivered at installation, that may be queried.

Standard Locations:

- Home
- Office
- PlaceOther

Standard Availabilities:

- Available
- Away

- Busy
- N/A

Node exits – Presence Branching

This node has one entry and up to eight exits depending on which availabilities the user configures for the selected query location.

Exits 1 through 4 are determined by the system and cannot be changed.

Exit	Cause	Description
1	No presence entity	The specified presence entity could not be found.
2	No presence domain	The presence domain profile tag does not exist and no default presence domain has been configured.
3	No match	The availability retrieved by the presence server does not match any of the configured availabilities.
4	Error	The presence server has reported an error.
5	Available	At the configured location the presence entity is: <ul style="list-style-type: none"> • Available
6	Away	<ul style="list-style-type: none"> • Away
7	Busy	<ul style="list-style-type: none"> • Busy
8	N/A	<ul style="list-style-type: none"> • Not available

Note: Exits 5 through 8 will be in the order configured, and therefore not necessarily in the order shown here.

Configuring the node – Presence Branching

Follow these steps to edit the node configuration.

1. From the drop down lists in the Presence Entity panel, select the Data Type, Location and Field where the presence entity name or number is held.

Note: The selected Field must be of type STRING.
2. If required, set the Domain Name field to the name of the domain to append to the presence entity name or number.

Note: The domain will not be appended to the presence entity if it is already present in the Field selected in the Presence Entity panel.
3. From the drop down lists in the Presence Domain panel, select the Data Type, Location and Field that identifies the presence query chassis action protocol. The selected Field must be of type INTEGER.

Note: Currently only the SIP protocol is supported.
4. Set the action to be taken if the presence domain cannot be found. Select:

- Error - to report an error, or
 - Use default below - to use the default presence domain. Select the default presence domain from the drop down list.
5. Set the Location to query for the presence entity.
 6. Set the Availabilities to query for the selected location.
 - To add an availability to the location query, select it in the drop down list and click **Add branch**.
 - To remove an availability from the location query, select it in the drop down list and click **Remove branch**.
 7. **Note:** Each time you add or remove an availability, an exit is either added or removed from the node.
 8. Click **Save**.

Profile Branching

The Profile Branching feature node checks the value of a specified profile field against a set value.

Node exits – Profile Branching

This node has one entry and three exits. The number of exits cannot be changed.

Note: These exit descriptions are specific to the responses received from an Oracle VWS billing engine. For specific information about how responses from other billing engines map to these exits, see the technical guide for the interface for billing engine being used.

Exit	Cause	Description
1	True	The result of the comparison is true for the factors set in the node screen.
2	False	The result of the comparison is false for the factors set in the node screen.
3	Data Not Found	Data required by the node has not been found. No comparison has been made.

Configuring the node – Profile Branching

Follow these steps to configure the Profile Branching node.

1. In the **Source Data Type** field, select the data type of the source profile block.
2. In the **Source Location** field, select the profile block in which relevant information is stored.
3. In the **Source Field** field, select the profile tag that identifies the information required by the node.
4. Select either to compare the **Value**, or the **Length** of the source.
5. From the **Comparison Operator** list, select the type of comparison that is to be made.

This field describes the relationship between the value in the specified profile field and the value set as the Constant.

Example: In the screen shown above, the value in the specified profile field is required to be greater than 0. Therefore, the Comparison Operator is set to “Greater than” and the Comparison Constant is set to “0”.

6. Type the **Comparison Constant** that is required.

Result: The specified Profile field will be compared with the set constant value.

7. Click **Save**.

Note: The **Save** button becomes available when the Primary Tag field is populated with a value other than 0.

Profile Counting

The Profile Counting node resets the configured integer profile field by one of:

- Setting the profile field content with this nodes configured value
- Incrementing the profile field content by this nodes configured value

Node exits – Profile Counting

This node has one entry and two exits. The number of exits cannot be changed.

Exit	Cause	Description
1	Success	The profile counting field was updated successfully.
2	Error	General Error.

Configuring the node – Profile Counting

Follow these steps to edit the node configuration.

1. In the Profile Counter Field area, using the drop down boxes, select the target profile counter field.
2. Type the number to set to or increment the profile counter by in the **Value** field.
3. To set the profile counter to the value, tick the **Set Absolute** check box.
To increment the profile counter by the value, clear the **Set Absolute** check box.
4. Click **Save**.

Note: The list of data types is fixed at installation time for each feature node or screen.

Further reference:

- For information about profile blocks (data type, location, and field) and how to use them, see Profile Blocks and Tags.

The primary tag lists are configured in the **SMS > Services > ACS Service > Configuration > Profile Tag Details** and **Profile Tag Mapping** tabs (see *ACS User's Guide, Profile Tag Details* for more information).

Profile Date Compare

The Profile Date Compare node compares the selected Profile Date with the current system date, and branches according to the following rules:

- the stored date is in the past (stored date is less than current date),
- the stored date is in the future (stored date is greater than current date),
- the stored date is today's date (stored date equals current date).

Node exits – Profile Date Compare

This node has one entry and five exits. The number of exits cannot be changed.

Exit	Cause	Description
1	Failure	There was an internal error.
2	Not Found	The selected Profile Date could not be found.
3	Past	The selected Profile Date is earlier than the current system date.
4	Today	The selected Profile Date is the same as the current system date.
5	Future	The selected Profile Date is later than the current system date.

Configuring the node – Profile Date Compare

Follow these steps to edit the Profile Date Compare node.

1. From the drop down lists in the Location of Date area, select the profile **Data Type**, **Location** and **Field** that holds the stored Profile Date you want to be compared against the current system date.
2. Click **Save**.

Note: The list of data types is fixed at installation time for each feature node or screen.

Further reference:

- For information about profile blocks (data type, location, and field) and how to use them, see Profile Blocks and Tags.

The primary tag lists are configured in the **SMS > Services > ACS Service > Configuration > Profile Tag Details** and **Profile Tag Mapping** tabs (see *ACS User's Guide, Profile Tag Details* for more information).

Profile Date Store

The Profile Date Store feature node stores a date extension number depending on the type of extension selected. The extended date is stored within the requested profile, for future use.

The stored date is either:

- The current system date plus the date extension (not specified = current system date).
- The date retrieved from the store location plus the date extension.
- The best date of either the first two options.

Note: Only whole days may be stored.

Node exits – Profile Date Store

The Profile Date Store feature node has one entry and two exits. The number of exits cannot be changed.

Exit	Cause	Description
1	Failure	The date could not be stored for one or more of the following reasons: <ul style="list-style-type: none"> • The date was invalid • The profile date was missing from the selected Profile when a date was expected • There was an general error
2	Success	The date has been stored to the selected profile date for the selected profile.

Configuring the node – Profile Date Store

Follow these steps to edit the Profile Date Store feature node.

1. From the drop down lists in the Store Date To area, select the **Data Type**, **Location** and **Field** where you want to retrieve and/or store the Profile Date.

Note: The available profile data is the same for all service providers on the system.
2. In the Units area select whether to add **Days**, **Months** or **Years** to the stored date.
3. In the Number to add area, configure the number of units of the selected type to add to the stored date. Do one of the following:
 - In the **Time to add** field enter the number of units to add.
 - Tick the **Use Profile** check box and select the profile **Data Type**, **Location** and **Field** where the number you want to add is stored.

The feature node checks the extended date to ensure that it is not greater than the maximum Unix time defined for the system.

Note: If you do not specify a value here, then a value of zero is assumed.

4. If you chose **Months** in the Units area, then in the End month algorithm area select the required option for adjusting end of month dates.
 - **Adjust up** – Adding a month to the end of the current month sets the date to the last day in the following month. Also sets the date to the last day in the

following month if the current date is the day before the last day in the month and the following month has fewer days.

- **Adjust down** – Adding a month to the end of the current month sets the date to the last day in the following month for months which have the same or fewer days than the current month. Where the following month has more days than the current month, it sets the date to the same day number in the month.
 - **Add # days in month** – Adds the number of days in the current month to the selected Extend From date.
5. For further clarification, see [Adding months example](#).
 6. Select the type of extension required from the Extend From options.
 - **Today** – To add the specified number of units to the current system time.
 - **Profile** – To add the specified number of units to the date currently stored.
 - **Later of the two** – To store the later date out of the Today and Profile options.
 7. In the Timezone area select the required time zone from the drop down lists.
 8. Click **Save**.

Note: The list of data types is fixed at installation time for each feature node or screen.

Further reference:

- For information about profile blocks (data type, location, and field) and how to use them, see Profile Blocks and Tags.

The primary tag lists are configured in the **SMS > Services > ACS Service > Configuration > Profile Tag Details** and **Profile Tag Mapping** tabs (see *ACS User's Guide, Profile Tag Details* for more information).

Adding months example – Profile Date Store

This table shows some example month end adjustment results after adding one month to the current date.

Current Date	Adjust up	Adjust down	Add # days in month
30 January	28 February	28 February	2 March
30 April	31 May	30 May	30 May

Proportional Distribution

This node allows calls to be routed to different exits, based on the proportion of calls that are received. The user may configure the proportions of calls to be routed to each exit.

For example, you may wish 20% of calls to be routed to one exit, and 80% of calls to be routed to a second exit. This could be achieved by entering 20:80 in the node edit screen, or by entering 1:4.

Shortcut keys – Proportional Distribution

The shortcut keys to add a Proportional Distribution node are **Alt+D**.

Node exits – Proportional Distribution

This node has one entry and may have 2 through 20 exits. You can configure the number of exits within this range as required, using the **Edit Node Exits** option on the shortcut menu. See [Editing Feature Node Exits](#).

Configuring the node – Proportional Distribution

Follow these steps to configure the node.

1. Ensure that you have enough exits specified to accommodate the proportions you are planning to configure.
2. Using the spin box for each exit, change the number displayed to show the proportion of calls that are routed down that exit.

Note: The proportion is calculated per total across all exits. To configure the node on a percentage basis, the total must equal 100. If there are two exits, configured with the digits 1 and 4, 1 out of 5 calls will route down exit 1 and the remaining 4 calls will route down exit 2.

3. When all proportions are as required, click **Save**.

Selection Dependent Routing

Use the Selection Dependent Routing feature node to play an announcement to the caller and to route the call according to their response. In addition, you can configure a fast timeout period that enables callers to exit directly from the feature node after timing out. For example, you can use this feature to connect calls directly to the operator after timing out.

This feature node routes calls based on a single digit, letter, or character entered on the caller's telephone keypad. You map valid digits, letters, or characters to the feature node exits in the feature node configuration window. Valid digits, letters, and characters are:

- Numbers ranging from 0 (zero) to 9
- Letters ranging from A to F
- Special characters * and #

You configure the fast timeout period (in seconds) by mapping the letter "T" to the required feature node exit and entering a value for the fast timeout period in the Configure Selection Dependent Routing configuration window. When you configure this option, the caller is not prompted for a number after timing out. For details, see [Setting the Fast Timeout Period – Selection Dependent Routing](#).

Shortcut keys – Selection Dependent Routing

The shortcut keys to add a Selection Dependent Routing node are **Alt+M**.

Node exits – Selection Dependent Routing

This node has one entry and may have 2 through 20 exits. You can configure the number of exits within this range as required, using the **Edit Node Exits** option on the shortcut menu. See [Editing Feature Node Exits](#).

There are two cases in which a caller will be sent to a branch other than the branch corresponding to a digit selected by the caller. These are:

Exit	Cause	Description
1	Not Collected	The branch that the call will be sent to after the Timeout Announcement is played to them the number of times set in the Max Iterations field.
2	Hang Up	The branch that the call is to be routed down, when the caller hangs up or there is a network error.

Configuring the node – Selection Dependent Routing

Follow these steps to configure the Selection Dependent Routing node.

1. From the Main Announcement area, select the **Main Announcement Set** that contains the main announcement to play to the caller.

Note: It is not necessary to have all the announcements that are to be played by this node in the same announcement set.

Result: The **Main Announcement Entry** drop-down box will become available.

2. From the **Main Announcement Entry** drop-down list, select the main announcement to play to the caller.
3. Set the **Repetition** field to the number of times to repeat the main announcement while the system waits for the caller to take an action. If set to zero, the announcement will be repeated for the length of the duration set.
4. The timeout announcement contains the announcement you want to play to the caller when the caller has waited too long before entering a digit.

In the **Timeout Announcement** frame, select the following, as described in steps 2 - 5:

- **Timeout Announcement Set** which contains the timeout announcement
 - **Timeout Announcement Entry** for the announcement to play
 - **Repetition** to the number of times to repeat the announcement
 - **Duration** to the length of time, in seconds, that the announcement is to be played.
5. The invalid digit announcement contains the announcement you want to play to the caller when the caller has entered a disallowed digit.

In the **Invalid Digit Announcement** frame, select the following, as described in steps 2 - 5:

- **Invalid Digit Announcement Set** which contains the announcement

- **Invalid Digit Announcement Entry** for the announcement to play
 - **Repetition** to the number of times to repeat the retry announcement
 - **Duration** to the length of time, in seconds, that the retry announcement is to be played.
6. In the **Number of Retries** field, set the number of times that the node will attempt to collect a number from the caller, before routing the call to the Not Collected branch. This value may be between 0 and 10.
 7. In the standard range entry field in the lower half of the screen, map the digits that a caller may enter to an exit branch.
To add a digit:
 - Click **Add Digit**
Result: A new default entry appears.
 - In the **Digit** drop-down box, select the required digit.
 - In the **Branch** drop-down box, select the exit to which calls receiving the entry of that digit are to be routed.
 - Click **Change**.
 8. Repeat for the required number of mappings.
 9. Click **Save**.

Note: **Save** is not available until all the required information has been selected or entered.

Note: The announcement set and announcement entry lists are populated with data that is specified using the **Announcements** tab of the ACS Configuration screen.

For more information about configuring announcement sets and announcement entries, see the **Announcements** tab of the ACS Configuration screen.

Setting the Fast Timeout Period – Selection Dependent Routing

To configure the Selection Dependent Routing feature node to exit directly after timing out:

1. Open the configuration window for the Selection Dependent Routing feature node.
2. Specify the branch that you want to use for the fast timeout exit by changing the current configuration for a branch to T or by adding T to a branch.

To change the current configuration for a branch to T.

- a. Select the digit and branch combination you want to change from the list in the digit table.
- b. Select T from the **Digit** list and click **Change**.

To add T to a branch.

- a. Use the **Branch** arrow keys to select the branch you want.
- b. Select T from the **Digit** list and click **Add**.

The **Fast Timeout Period** field is enabled and set to the preconfigured default value of 10.

Note: If set, the value for the `SDRfastTimeoutDefault` parameter in the `sms.jnlp` file overrides the fast timeout period default value. For more information on configuring ACS `sms.jnlp` parameters, see *Advanced Control Services Technical Guide*.

3. (Optional) Change the timeout period by performing the following steps:
 - a. In the digit table, select T.
 - b. In the **Fast Timeout Period** field, enter the timeout value in seconds and click **Change**.
4. Click **Save**.
The feature node configuration is saved.

Send Notification

This node constructs message text from the given notification template and then sends the message using one of the available transport mechanisms.

Node exits – Send Notification

This node has one entry and eleven exits. The number of exits cannot be changed.

Exit	Cause	Description
1	Success	The notification was constructed and sent.
2	Delivery Failure	The notification was constructed, but encountered a problem when attempting to send.
3	No Language	No language was selected in the node configuration.
4	No Template	No template could be found to construct the message.
5	Missing Information	The template expected more information than could be found.
6	Subscriber Opt-out	The subscriber has opted out of receiving any notifications. This option is set in ACS Configuration > Notifications tab > Add/Edit Notification Type panel.
7	Node Failure	Internal node error. Message not sent.
8	Timeout	Did not get the expected response within the Timeout number of seconds.
9	Temporary Error	The returned cause code maps to a temporary error.
10	Permanent Error	The returned cause code maps to a permanent error.
11	Abort	The returned cause code maps to an abort error.

Note: The temporary, permanent and abort errors are all configured in the Messaging Manager Action and Error Codes screens. From the main SMS screen, see **Services > Messaging Manager > Action and Error Codes** and the **Error Type** column.

Configuring the node – Send Notification

Follow these steps to configure the node.

1. In the **Template** section, do one of:
 - Provide the location of the template by selecting a profile location from the **Data Type, Location** and **Field** lists
 - Select the template to use from the **Fixed** lists
 - Select the location where notification template name for a specific Application type can be found from the **Data Type, Location** and **Field** lists
2. In the **Language** section, do one of:
 - Select **Automatically determined** to have the system determine the language
 - Select the location where the language can be found from the **Data Type, Location** and **Field** lists
 - Select the language to use from the **Fixed** list
3. If a response is expected, to avoid missing the response, select the **Wait for Response** check box and then enter the number of seconds to wait for the response in the **Timeout** field in the **Options** section.

Tip: If the check box is deselected, then the node will exit the Success exit immediately.
4. Click **Save**.

Send Short Message

Warning: This feature node has now been deprecated and should no longer be used. This feature node will still function in existing control plans. For new control plans please use the **Send Notification** feature node.

This feature node sends a short message to the caller when triggered by a nominated application.

Node exits – Send Short Message

This node has one entry and two exits. The number of exits cannot be changed.

Exit	Cause	Description
1	Success	The short message was successfully sent.
2	Failure	The message could not be sent.

Configuring the node – Send Short Message

Follow these steps to configure the Send Short Message node.

1. From the **Application** drop down list, select application that will trigger the short message to be sent.
2. From the **Message** drop down list, select the message that will be sent.
Note: Messages are created and maintained through the **ACS > Configuration > Notification** tab.
3. From the **Language** drop down list, select the language the message will be sent in.
Note: Available languages are maintained through the **ACS > Tools > Language** tab.
4. Click **Save**.

Notes:

- The calling number is normalized before it is sent to the notificationIF.
- This node sends a SLEE notification event to the notificationIF.
- The notificationIF will then forward the message to either Messaging Manager or the SMSC interface depending on configuration.
- See *SMSC Technical Guide* for details on how to install and configure the notificationIF.

Service Handover

The Service Handover feature node allows the call to be passed to another service that runs a control plan as if it were a new call.

Node exits – Service Handover

This node has one entry and two exits. The number of exits cannot be changed. Since this node passes the call to another control plan, a Success exit is not required.

Exit	Cause	Description
1	Data Not Found	The control plan selected for handover is not found.
2	Chain Count Exceeded	The chain count limit has been exceeded, and the call may not be passed to another control plan. Note: The chain count limit is set in the acsChassis section of the acs.conf - refer to <i>ACS Technical Guide</i> .

Configuring the node – Service Handover

Follow these steps to configure the Service Handover node.

1. In the **Handover to** list, select a service. Calls passing through this node will be transferred to this service.
2. Click **Save**.

Set

This node stores the entered digits in a data field. They may be later collected from this profile and used in the control plan.

A percentage character will have a special meaning during the node processing. If a '%' is entered in the digits field on the node edit screen it will be replaced by the current value of the buffer and the buffer will be updated with that final result. Only the first occurrence of the '%' char will be treated this way. Any other occurrences of the percentage character will be ignored.

Node exits – Set

This node has one entry and two exits. The number of exits cannot be changed.

Exit	Cause	Description
1	Success	Value has been set in target profile.
2	Error	Error occurred.

Configuring the node – Set

Follow these steps to configure the Set node.

1. In the **Value** field type the number (in digits) to save in the selected target profile field.
2. In the Target Profile area, using the drop down boxes, select the target profile.
3. Click **Save**.

Note: The list of data types is fixed at installation time for each feature node or screen.

Further reference:

- For information about profile blocks (data type, location, and field) and how to use them, see Profile Blocks and Tags.

The primary tag lists are configured in the **SMS > Services > ACS Service > Configuration > Profile Tag Details** and **Profile Tag Mapping** tabs (see *ACS User's Guide, Profile Tag Details* for more information).

Set Carrier Code

This node sets the identity of the carrier for the call. The carrier code is a string of digits that are prefixed onto the Destination Routing Address (DRA) of the connect sent by following Termination feature nodes.

The carrier code can be set in any of the available profile blocks (for example, the Service Number Profile).

Note: This node has no effect if the CarrierCodeDisposal parameter in **acs.conf** is set to 1. For more information, see *ACS Technical Guide*.

Node exits – Set Carrier Code

This node has one entry and two exits. The number of exits cannot be changed.

Exit	Cause	Description
1	CC Set Branch	Used when the data is found and the carrier code is set.
2	CC Not Set Branch	Used when profile-based data is not found. Is also used if the length of the number string in the profile field specified for the carrier code is greater than the allowable length of the carrier code.

Configuring the node – Set Carrier Code

Follow these steps to configure the Set Carrier Code node.

1. Select the option of:
 - using the carrier number entered into this screen, or
 - reading the carrier number from a profile block.

The fields relating to the non-selected option are disabled and cannot be edited.

2. Where the following option is selected:

- **Use This Carrier Number**

Type the carrier code in the **Use This Carrier Number** field.

Carrier codes may include any hexadecimal character (0-9, a-f, A-F, and # and *). You can enter up to 20 characters.

Note: If this option is selected and the text field is empty, then the carrier code field will be cleared when this node is triggered. Use to clear a carrier code set by an earlier Set Carrier Code node.

- **Read from Profile Block**

Select the profile field to read the carrier code from using the **Read From Data Type**, **Read from Location** and **Read From Field** drop down lists.

Note: If the length of the number string in the profile field specified for the carrier code is greater than the allowable length of the carrier code, an alarm is raised and the “CC Not Set Branch” is taken.

3. Click **Save**.

Note: **Save** is not available until all the required information has been selected or entered.

Note: If you import a previously exported control plan which contains Set Carrier Code nodes prior to the profile block functionality being introduced, then you will need to re-save in order to allow the control plan to recompile.

Note: The list of data types is fixed at installation time for each feature node or screen.

Further reference:

- For information about profile blocks (data type, location, and field) and how to use them, see Profile Blocks and Tags.

The primary tag lists are configured in the **SMS > Services > ACS Service > Configuration > Profile Tag Details** and **Profile Tag Mapping** tabs (see *ACS User's Guide, Profile Tag Details* for more information).

Set Cut and Paste

The number entered in the node configuration dialog is sent in all following INAP Connect operations as the value of the `cutAndPaste` parameter.

For details about the effect of `cutAndPaste`, see *ETS 300 374-1*.

Node exits – Set Cut and Paste

This node has one entry and one exit. The number of exits cannot be changed.

Exit	Cause	Description
1	Cut and Paste Set	The cut and paste has been set.

Configuring the node – Set Cut and Paste

Follow these steps to configure the Set Cut and Paste node.

- In the **Cut Value** field, enter the value to set the `cutAndPaste` parameter to in INAP Connect operations sent to the switch from here on.

Note: If you set Cut Value to 23 or more, ACS will stop setting the `cutAndPaste` parameter in INAP Connect operations.

- Click **Save**.

Set Indicator

The Set Indicator node allows you to set the value one of the indicators of a specified number sent in the CONNECT message:

- Number incomplete
- Screening
- Presentation restricted

Node exits – Set Indicator

This node has one entry and two exits. The number of exits cannot be changed.

Exit	Cause	Description
1	Success	Value successfully set.
2	Error	Value not set due to error

Configuring the node – Set Indicator

Follow these steps to configure the node.

1. From the **Select Indicator** options, select the indicator to set:
 - Presentation Restricted
 - Screening
 - Number Incomplete.
2. From **Select Number** drop down list, select the phone number to apply the indicator to.
 - CallingPartyNumber
 - AdditionalCallingPartyNumber
 - OriginalCalledPartyID
 - RedirectingPartyID
 - LocationNumber
 - LocationInformationLocationNumber
3. **Note:** This list contains all the valid phone number options.
4. From the **Set Indicator** options, select the value to apply to the selected phone number indicator.
Refer to the interpretation of values table below.
5. Click **Save**.

Interpretation of values – Set Indicator

This table describes the meaning of each value, depending on the indicator selected.

Value	Presentation Restricted	Screening	Number Incomplete
0	The presentation is allowed	User provided, but not verified	Complete
1	The presentation is restricted	User provided, verified and passed	Incomplete
2	The address is not available	User provided, verify failed	NA
3	Spare	Network provided	NA

Set Pending TN from Profile

The Set Pending TN from Profile feature node takes a number from the profile and places it in the pending termination number buffer.

This node can also be used to set the NoAnswer timeout.

Node exits – Set Pending TN from Profile

This node has one entry and two exits. The number of exits cannot be changed.

Exit	Cause	Description
1	Success	The number has been placed in the Pending TN buffer.
2	Data Not Found	The number has not been placed in the Pending TN buffer.

Configuring the node – Set Pending TN from Profile

Follow these steps to configure the Set Pending TN from Profile node.

- Using the drop down lists in the Location of TN **Data Type**, **Location** and **Field** boxes, select where the number is to be read from.

Notes:

- If you set a customer-specific profile, the profile set in this field must belong to the customer who will be running the control plan.
 - If the control plan is owned by the Boss user then the profile must be set to control plan, or a customer ID must be specified at an earlier point in the control plan.
- Using the drop down lists in the Location of Timeout **Data Type**, **Location** and **Field** fields, select where the timeout period is to be read from.
 - Click **Save**.

Note: **Save** is not available until all the required information has been selected or entered.

Note: The list of data types is fixed at installation time for each feature node or screen.

Further reference:

- For information about profile blocks (data type, location, and field) and how to use them, see Profile Blocks and Tags.
- The primary tag lists are configured in the **SMS > Services > ACS Service > Configuration > Profile Tag Details** and **Profile Tag Mapping** tabs (see *ACS User's Guide, Profile Tag Details* for more information).

Set Presence

This node sends a request through ACS to a third party presence server to set the availability at a selected location of a specified subscriber or presence entity.

Before sending the request, the node prompts the user to select the following:

- The number and domain name for the presence entity to set
- An availability and location

- The implementation of the presence setting chassis action to invoke. Currently only SIP is supported.

The presence entity number can be specified using fields which may contain (for example) the:

- Called number
- Calling party number
- Subscriber phone number
- Subscriber name

Notes:

The node relies on a protocol specific presence setting chassis action to process the request. The library for the presence setting chassis action is delivered separately by another package, such as scaScp.

Only one availability per location may be set for a presence entity. Each time you specify a new availability for a particular location, the previous one is overwritten.

Following are the standard set of locations and availabilities that are delivered at installation and that may be set for a presence entity.

Standard Locations

- Home
- Office
- PlaceOther

Standard Availabilities

- Available
- Away
- Busy
- N/A

Node exits – Set Presence

This node has one entry and four exits. The number of exits cannot be changed.

Exit	Cause	Description
1	No presence entity	The specified presence entity could not be found.
2	No presence domain	The presence domain does not exist and no default presence domain has been configured.
3	Error	The presence server has reported an error.
4	Success	The presence entity was successfully set to the configured location and availability.

Configuring the node – Set Presence

Follow these steps to edit the node configuration.

1. From the drop down lists in the Presence Entity panel, select the **Data Type**, **Location** and **Field** where the presence entity name or number is held.
2. If required, set the Domain Name field to the name of the domain to append to the presence entity name or number.

Note: The domain will not be appended to the presence entity if it is already present in the **Field** selected in the Presence Entity panel.
3. From the drop down lists in the Presence domain panel, select the **Data Type**, **Location** and **Field** where the presence setting chassis action information is held.

Note: Currently only SIP presence setting is supported.
4. Set the action to be taken if the presence domain cannot be found. Select:
 - Error – to report an error, or
 - Use default below – to use the default presence domain. Select the default presence domain from the drop down list.
5. Set the **Location** for the presence entity.
6. Select the **Availability** that will be set by the node for the selected location.
7. Click **Save**.

Set Tariff Code

This feature node sets the billing information that is sent to the switch. This may be a Furnish Charging Information (FCI) request or a Send Charging Information (SCI) request.

Note: The SCI operation may contain a tariff code.

It is used in conjunction with the optional **Tariff Codes** tab of the ACS Resources screen. Where the **Tariff Code** tab has not been purchased as part of ACS, this node is not available for use within a control plan. For more information about configuring tariffs, see *ACS User's Guide*.

Node exits – Set Tariff Code

This node has one entry and two exits. The number of exits cannot be changed.

Exit	Cause	Description
1	Tariff Set	A failure has occurred and a text message has not been sent.
2	Tariff Not Set	A text message has been successfully sent.

Configuring the node – Set Tariff Code

Follow these steps to set the tariff code.

1. Use the drop-down list to select the type tariff applied to the current call. The tariff code names available in the list are set on the **Tariff Codes** tab of the ACS Resources screen.
2. Click **Save**.

Note: **Save** is not available until all the required information has been selected or entered.

Sleep

The Sleep node allows time for background tasks to complete before proceeding to the next step in the control plan.

The value used should be large enough for the background task to finish, but short enough to avoid holding up the Control Plan unnecessarily.

Node exits – Sleep

This node has one entry and two exits. The number of exits cannot be changed.

Exit	Cause	Description
1	Success	The control plan slept for the configured amount of time.
2	Error	In theory, should never be able to take this branch.

Configuring the node – Sleep

Follow these steps to configure the node.

1. Enter the Sleep Time **Value** in milliseconds the node is to wait before branching down the Success branch.

Note: There is a maximum sleep time allowed of 600000ms (ten minutes)

2. Click **Save**.

Start

The start node must be the first node in the control plan. All feature nodes in the control plan must be available on a branch starting from the Start node.

Shortcut keys – Start

The shortcut keys to add a Start node are **Alt+S**.

Note: If there is already a Start node in the Control Plan, pressing this key combination will select the Start node.

Node exits – Start

This node has no entry and one exit. The number of exits is fixed and cannot be changed.

Configuring the node – Start

The Start node does not need to have any control plan data attached to it when operating in standard mode, although the user must accept the default settings by opening the node edit screen and clicking **Save**.

Follow these steps to configure the Start node.

1. In the Standard Mode of operation, the control plan may not contain loops. For some advanced control plans, loops may be required. To allow loops in the control plan, select the **Loops Allowed** check box.

Note: The control plan compiler will permit loops within the control plan, as long as those loops contain at least one feature node that performs a telephony action. For example, an attempt termination node or node that plays an announcement.

2. Click **Save**.

Statistic

The Statistic node either resets or increments a specified statistical counter, which may be a specific named statistic or a profile location.

Node exits – Statistic

This node has one entry and three exits. The number of exits cannot be changed.

Exit	Cause	Description
1	Success	Statistic was successfully incremented or reset.
2	Profile Update Fail	Storing the statistic value failed.
3	Failure	Failure to read the configured profile tag.

Configuring the node – Statistic

Follow these steps to configure the Statistic Increment node.

1. Select the **Statistic Action**, either:
 - **Reset** - reset the statistic value to zero.
 - **Increment** - increments the statistic by one.
2. Select the **Statistic Name** to action location, either:
 - From a profile field - check the **Derive From Profile** check box.
 - A named statistic - uncheck the Derive From Profile check box.

3. Select the **Statistic Name** to action, either:
 - From a profile field - select location from the **Data Type, Location** and **Field** drop down lists.
 - Named statistic - select from the **Application Id** and **Statistic ID** drop down lists.

Note: This list is populated from entries made in the Statistic Management screens. Refer to the *SMS User's Guide* for more information.
4. Optionally set the **Statistic Storage** location. Check the **Store** check box and then selection the storage location from the **Data Type, Location** and **Field** drop down lists.
5. Click **Save**.

Statistic Increment

This node allows you to use statistics that you wish to track for a specific application or statistic within an application.

Node exits – Statistic Increment

This node has one entry and two exits. The number of exits cannot be changed.

Exit	Cause	Description
1	Success	Statistic was successfully incremented.
2	Node Error	General case for an un-handled state in this node.

Configuring the node – Statistic Increment

Follow these steps to configure the Statistic Increment node.

1. (Required) Select the Application ID using the **Application ID** field drop down list.
2. (Required) Select the Statistic ID using the **Statistic ID** field drop down list.

Note: This list is populated from entries made in the Statistic Management screens. See *SMS User's Guide* for more information.

You can produce reports on the statistic from the Service Management System Operator Functions, Report Functions menu option. See *SMS User's Guide* for more information.

Sub Control Plan

The Load Sub Control Plan node executes a successfully compiled control plan.

When this control plan is compiled, this node is effectively replaced by the other plan to create a single run time control plan. In the CPE this plan shows the Load Sub Control Plan node with the relevant exits that apply for the other plan.

Node exits – Sub Control Plan

This node has one entry and a varying number of exits that are set as a result of the sub control plan. A user cannot change the number of exits.

Configuring the node – Sub Control Plan

Follow these steps to edit the node configuration.

1. (Optional) In the **Search By** field enter the control plan name prefix to use to filter the list of available control plans. You can enter the following wildcards in the search string:
 - % (percent) to match any string of any length
 - _ (underscore) to match a single character

Tip: You can limit the number of control plans found by entering a value in **Max Rows**.

2. From the **Control Plans** list, select the control plan to load into the main control plan as a sub-control plan.
3. (Optional) To view the selected control plan, click **View**.

The selected control plan opens in a new Control Plan Editor window. The control plan structure will be read-only, but you will be able to edit the control plan data, and save it to a new version of the control plan, if required.

- To save any changes to the control plan data, select **Save** from the **File** menu. In the Save Data/Structure dialog box, enter a new name in the **Control Plan Data** field, and click **Save**.
 - To close the control plan, click the close window button in the top right corner of the Control Plan Editor window.
4. Click **Save**.

Table Lookup

The Table Lookup feature node maps a specified prefix or CLI to a geographical routing code, such as a postal code or an exchange code, by looking up the code in a selected table lookup dataset. The feature node stores the resulting code in a profile field. The exit taken from the feature node depends on whether or not a match is found for the prefix or CLI.

About table lookup datasets

A table lookup dataset contains a group of related codes, for example, for a specific geographic area or suburb.

A table lookup dataset can be public or private. A private table lookup dataset belongs to a specific customer. It is only available to that customer and the parent customers linked to that customer in the customer hierarchy. A public table lookup dataset is available to all customers.

Node exits – Table Lookup

This node has one entry and three exits. The number of exits cannot be changed.

Exit	Name	Cause
1	Matched	A prefix has been mapped to a code.
2	No Match	No matching prefix was found in the dataset
3	Error	An internal error has occurred.

Configuring the node – Table Lookup

To configure the Table Lookup feature node:

1. Open the configuration window for the Table Lookup feature node.
2. In the **Lookup Input source** area select the location of the prefix or CLI that you want the feature node to look up from the **Source Data Type**, **Source Location** and **Source Field** lists.
3. In the **Lookup Result target** area select the location to store the resulting code from the **Target Data Type**, **Target Location** and **Target Field** lists.
4. From the **Dataset** list, select the dataset that corresponds to the type of code you want. You can select a publicly owned dataset or a dataset that belongs to the customer. For more information about table lookup datasets, see [About table lookup datasets](#).
5. Click **Save**.

TCAP Handover

The TCAP Handover node calls a chassisAction to construct an IDP on the existing SLEE dialog. It then calls the TCAP interface to hand over the SLEE dialog to an external network entity.

The available network entities are defined in **acs.conf** and made available to this node (SCP Name list) through the **acs.jnlp** or **sms.jnlp** files (scfs parameter). These will typically be SLCs, see *ACS Technical Guide*, topic *Customizing the screens* for details.

The following IDP parameters can be configured in the node to use a specific ACS termination number or buffer:

- Calling Party Number
- Called Party Number
- Redirecting Party ID
- Location Number
- Additional Calling Party Number

The available buffers are listed in the Buffer list.

Note: All other fields in the constructed IDP are taken from the calling information for the original call.

Node exits – TCAP Handover

This node has one entry and three exits. The number of exits cannot be changed.

Exit	Cause	Description
1	Success	The node successfully passed the TCAP dialog to another entity.
2	Bad Destination	The hand over destination defined for the specified network entity could not be found.
3	Failure	The hand over was unsuccessful.

Specifying values in profile selection fields – TCAP Handover

For each combo box combination on this screen, there are two methods of entering a value:

1. Use the drop down lists in the **Data Type**, **Location** and **Field** boxes, as in this example, to select the relevant values:

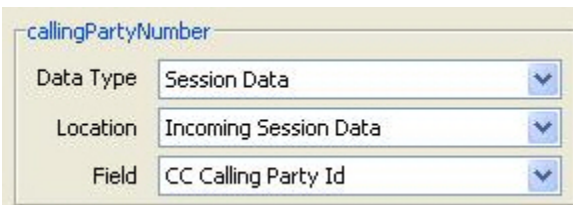

The screenshot shows a configuration window for 'callingPartyNumber'. It contains three dropdown menus: 'Data Type' is set to 'Session Data', 'Location' is set to 'Incoming Session Data', and 'Field' is set to 'CC Calling Party Id'.

2. Select Fixed Value in the **Data Type** box.

Result: The fields will change, as in this example, and you can type the required value in the **Fixed Value** field.

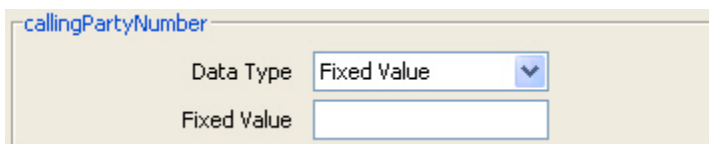

The screenshot shows the same configuration window for 'callingPartyNumber'. The 'Data Type' dropdown is now set to 'Fixed Value', and a text input field labeled 'Fixed Value' is visible below it.

Configuring the node – TCAP Handover

Follow these steps to edit the TCAP Handover feature node.

1. Select the **SCP Name** of the network entity for the handover destination.
2. In the IDP Parameters area, for each IDP parameter, specify the value.

You can specify the following optional IDP parameters:

- callingPartyNumber
- calledPartyNumber
- redirectingPartyID
- locationNumber
- additionalCallingPartyNumber

3. When a TCAP handover is performed it is often desirable to preserve fields from original incoming IDP into fields in outgoing IDP. By default, the original IDP parameter values are preserved - the **Preserve Attributes** check box is selected.

To disable the original IDP parameter values preservation, deselect the check box .

4. Click **Save**.

For more information on profile blocks and tags, see *ACS User's Guide*.

Terminate to Pending TN

The Terminate to Pending TN node terminates unconditionally to the number assigned to the PendingTN variable. For information about the PendingTN variable, see Pending termination number variables.

This node is sometimes called Unconditional Terminate to Pending TN.

Shortcut key – Terminate to Pending TN

The shortcut key to add a Terminate to Pending TN node is **Alt+Shift+U**.

Node exits – Terminate to Pending TN

This node has one entry and one exit. The number of exits cannot be changed.

Configuring the node – Terminate to Pending TN

Follow these steps to configure the Terminate to Pending TN node.

1. From the **National/International Prefix Location Fixed Value** drop down list, select the profile to read least cost routing configuration from. The list displays a list of all profiles which can be read from.

For more information about profile blocks, see Profile Blocks and Tags.

If you do not want to use [Least Cost Routing](#) on this destination number, select **None Selected**.

2. Click **Save**.

Terminate Unchanged

The number that was dialed is used to connect the call.

Node exits – Terminate Unchanged

This node has one entry and one exit. The number of exits is fixed and cannot be changed.

Exit	Cause	Description
1	Unconditional termination	Terminate call, taking no other actions.

Configuring the node – Terminate Unchanged

This node requires no configuration data. You may change the **Node name**, if required.

Test Pending TN Type

The Test Pending TN Type node branches in one of six ways depending on the value assigned to the PendingTNType variable.

The PendingTNType variable classifies an associated termination number as any one of:

- A number of an unknown type
- A number that accesses the PSTN directly (sometimes called an Off-Net number)
- A number that passes through a private network on its way to the PSTN (sometimes called an On-Net number)
- A speed-dial number
- A service number
- A calling line identification (CLI)

For more information about the PendingTNType variable, see Pending termination number variables.

Node exits – Test Pending TN Type

This node has one entry and six exits. The number of exits cannot be changed.

Exit	Cause	Description
1	Unknown	Number type is unknown.
2	Public Network	Number type is public network.
3	Private Network	Number type is private network.
4	Speed Dial	Number type is speed dial.
5	Service Number	Number type is service number.
6	CLI	Number type is CLI.

Configuring the node – Test Pending TN Type

This node requires no configuration data. You may change the **Node name**, if required.

Time of Day

The Time of Day node allows branching based on the time of day that the call is placed. The branching decision is made according to the data that is entered into the node.

Shortcut keys – Time of Day

The shortcuts key to add a Time of Day node are **Alt+T**.

Node exits – Time of Day

This node has one entry and may have 2 through 20 exits. You can configure the number of exits within this range as required, using the **Edit Node Exits** option on the shortcut menu. See [Editing Feature Node Exits](#).

Configuring the node – Time of Day

Follow these steps to add a time range to the node data.

1. From the **Timezone Type** drop down list, select the timezone to use.
If you select `Explicit Unix TZ`, you need to select a specific region from the **Unix Timezone** drop down list.
For more time zone information, see [Time Zones](#).
2. From the **Default** field, select the branch calls that do not match a time of day range should be routed to.
3. Click **Add Range** and make the changes necessary to the time range given, then choose the branch down which calls made in this time range are to route.
4. Enter the time range in the boxes to the left of the **Branch** field and click **Change**.
5. To add another range, repeat steps 3 and 4.
6. Click **Save**.

Transmission Type Branching

The Transmission Type Branching node allows you to route the call to different branches depending on the incoming calling party transmission type.

Node exits – Transmission Type Branching

This node has one entry and seven exits. The number of exits cannot be changed.

Exit	Cause	Description
1	Speech	NA
2	Unrest. Digital	Unrestricted Digital
3	Restricted Digital	NA
4	3.1kHz audio	NA
5	Unret. Dg. Tones	Unrestricted Digital Tones

Exit	Cause	Description
6	Video	NA
7	No Bearer Cap	NA

Configuring the node – Transmission Type Branching

This node requires no configuration data. You may change the **Node name**, if required.

Unconditional Termination

The Unconditional Termination node directs the call to be terminated to a specified termination number (TN).

Termination numbers are specified as ranges of numbers in the ACS Configuration screens. The numbers shown in the Configure Unconditional Termination screen are the ranges of termination numbers that have been specified for the logged in ACS Customer. If the customer for whom the control plan is being created is a managed customer, termination numbers that have not been specified for the customer may be used in the node. For more information about setting up ranges of numbers, see *ACS User's Guide*.

Note: The Unconditional Termination feature node can be set to automatically display the TN as the feature node name by setting the `useTNForNodeName` parameter in the `acs.jnlp` file. If this parameter is set, then you may not manually edit the feature node name. For more information, see *Advanced Control Services Technical Guide*.

Shortcut keys – Unconditional Termination

The shortcut keys to add an Unconditional Termination node are **Alt+U**.

Node exits – Unconditional Termination

This node has one entry and one exit. The number of exits cannot be changed.

Exit	Cause	Description
1	Unconditional termination	Terminates to the configured termination number.

Configuring the node – Unconditional Termination

Follow these steps to configure the node.

1. To specify a termination number for the node, select the range in which the number lies from the ranges shown.

Result: The prefix digits will be entered into the **Termination Number** field.

2. Use the **Termination Number** field to complete the number.

The Xs in the range signify the minimum number of digits that are required and the Ys signify the maximum number of digits in the range.

3. Click **Save** to commit that termination number to the node.

The Save button will become available when a number that is within the selected range is displayed in the **Termination Number** field.