

Oracle® Communications

EAGLE Database Administration - IP7 User's Guide



Release 47.1

F88435-01

October 2023

The Oracle logo, consisting of a solid red square with the word "ORACLE" in white, uppercase, sans-serif font centered within it.

ORACLE®

F88435-01

Copyright © 1993, 2023, Oracle and/or its affiliates.

This software and related documentation are provided under a license agreement containing restrictions on use and disclosure and are protected by intellectual property laws. Except as expressly permitted in your license agreement or allowed by law, you may not use, copy, reproduce, translate, broadcast, modify, license, transmit, distribute, exhibit, perform, publish, or display any part, in any form, or by any means. Reverse engineering, disassembly, or decompilation of this software, unless required by law for interoperability, is prohibited.

The information contained herein is subject to change without notice and is not warranted to be error-free. If you find any errors, please report them to us in writing.

If this is software, software documentation, data (as defined in the Federal Acquisition Regulation), or related documentation that is delivered to the U.S. Government or anyone licensing it on behalf of the U.S. Government, then the following notice is applicable:

U.S. GOVERNMENT END USERS: Oracle programs (including any operating system, integrated software, any programs embedded, installed, or activated on delivered hardware, and modifications of such programs) and Oracle computer documentation or other Oracle data delivered to or accessed by U.S. Government end users are "commercial computer software," "commercial computer software documentation," or "limited rights data" pursuant to the applicable Federal Acquisition Regulation and agency-specific supplemental regulations. As such, the use, reproduction, duplication, release, display, disclosure, modification, preparation of derivative works, and/or adaptation of i) Oracle programs (including any operating system, integrated software, any programs embedded, installed, or activated on delivered hardware, and modifications of such programs), ii) Oracle computer documentation and/or iii) other Oracle data, is subject to the rights and limitations specified in the license contained in the applicable contract. The terms governing the U.S. Government's use of Oracle cloud services are defined by the applicable contract for such services. No other rights are granted to the U.S. Government.

This software or hardware is developed for general use in a variety of information management applications. It is not developed or intended for use in any inherently dangerous applications, including applications that may create a risk of personal injury. If you use this software or hardware in dangerous applications, then you shall be responsible to take all appropriate fail-safe, backup, redundancy, and other measures to ensure its safe use. Oracle Corporation and its affiliates disclaim any liability for any damages caused by use of this software or hardware in dangerous applications.

Oracle®, Java, and MySQL are registered trademarks of Oracle and/or its affiliates. Other names may be trademarks of their respective owners.

Intel and Intel Inside are trademarks or registered trademarks of Intel Corporation. All SPARC trademarks are used under license and are trademarks or registered trademarks of SPARC International, Inc. AMD, Epyc, and the AMD logo are trademarks or registered trademarks of Advanced Micro Devices. UNIX is a registered trademark of The Open Group.

This software or hardware and documentation may provide access to or information about content, products, and services from third parties. Oracle Corporation and its affiliates are not responsible for and expressly disclaim all warranties of any kind with respect to third-party content, products, and services unless otherwise set forth in an applicable agreement between you and Oracle. Oracle Corporation and its affiliates will not be responsible for any loss, costs, or damages incurred due to your access to or use of third-party content, products, or services, except as set forth in an applicable agreement between you and Oracle.

Contents

1 Introduction

1.1	Overview	1-1
1.2	Scope and Audience	1-1
1.3	References	1-1
1.4	Maintenance and Administration Subsystem	1-2
1.5	EAGLE Database Partitions	1-3

2 IP7 Secure Gateway Overview

2.1	Introduction	2-1
2.2	Hardware, Applications, and Functions	2-1
2.3	IP Connections	2-2
2.4	Point-to-Point Connectivity (IPLIM or IPLIMI Application)	2-13
2.5	Point-to-Multipoint Connectivity (SS7IPGW and IPGWI)	2-14
2.6	SNMP Agent Implementation	2-19
2.7	Mixed Networks Using the ANSI/ITUMTP Gateway Feature	2-22
2.8	IETF Adapter Layer Support	2-26
2.8.1	Overview	2-26
2.9	IP Signaling Gateway (IPSG)	2-36

3 IETF M2PA Configuration Procedures

3.1	Adding IETF IPLIMx Components	3-1
3.2	Adding an IPLIMx Card	3-2
3.3	Adding an IPLIMx Signaling Link	3-10
3.4	Configuring an IP Link	3-32
3.5	Adding an IP Host	3-61
3.6	Configuring an IP Card	3-65
3.7	Adding an IP Route	3-77
3.8	Adding an M2PA Association	3-86
3.9	Activating the Large MSU Support for IP Signaling Feature	3-101
3.10	Removing IETF M2PA Components	3-112
3.11	Removing an IPLIMx Card	3-112

3.12	Removing an IPLIMx Signaling Link	3-115
3.13	Removing an IP Host Assigned to an IPLIMx Card	3-126
3.14	Removing an IP Route	3-132
3.15	Removing an M2PA Association	3-135
3.16	Changing IETF M2PA Components	3-139
3.17	Changing the Attributes of an M2PA Association	3-140
3.18	Changing the Buffer Size of a M2PA Association	3-155
3.19	Changing the Host Values of a M2PA Association	3-166
3.20	Changing the Link Value of a M2PA Association to another Link Value on the Same IPLIMx Card	3-185
3.21	Configuring SCTP Retransmission Control for a M2PA Association	3-195
3.22	Changing a M2PA Timer Set	3-204
3.23	Changing the SCTP Checksum Algorithm Option for M2PA Associations	3-213
3.24	Turning Off the Large MSU Support for IP Signaling Feature	3-232

4 IETF M3UA and SUA Configuration Procedures

4.1	Adding IETF M3UA and SUA Components	4-1
4.2	Adding an IPGWx Card	4-3
4.3	Configuring an IPGWx Linkset	4-12
4.4	Adding a Mate IPGWx Linkset to another IPGWx Linkset	4-44
4.5	Adding an IPGWx Signaling Link	4-59
4.6	Configuring an IP Link	4-79
4.7	Adding an IP Host	4-109
4.8	Configuring an IP Card	4-113
4.9	Adding an IP Route	4-125
4.10	Adding an M3UA or SUA Association	4-134
4.11	Adding a New Association to a New Application Server	4-147
4.12	Adding an Existing Association to a New Application Server	4-156
4.13	Adding a New Association to an Existing Application Server	4-167
4.14	Adding an Existing Association to an Existing Application Server	4-182
4.15	Adding a Routing Key Containing an Application Server	4-194
4.16	Adding a Network Appearance	4-216
4.17	Activating the Large MSU Support for IP Signaling Feature	4-223
4.18	Removing IETF M3UA and SUA Components	4-237
4.19	Removing an IPGWx Card	4-237
4.20	Removing an IPGWx Signaling Link	4-241
4.21	Removing a Mate IPGWx Linkset from another IPGWx Linkset	4-249
4.22	Removing an IP Host Assigned to an IPGWx Card	4-262
4.23	Removing an IP Route	4-268
4.24	Removing a M3UA or SUA Association	4-271
4.25	Removing an Association from an Application Server	4-275

4.26	Removing a Routing Key Containing an Application Server	4-282
4.27	Removing a Network Appearance	4-293
4.28	Changing IETF M3UA and SUA Components	4-296
4.29	Changing IP Options	4-296
4.30	Changing the Attributes of a M3UA or SUA Association	4-300
4.31	Changing the Buffer Size of a M3UA or SUA Association	4-325
4.32	Changing the Host Values of a M3UA or SUA Association	4-336
4.33	Configuring SCTP Retransmission Control for a M3UA or SUA Association	4-353
4.34	Changing an Application Server	4-363
4.35	Changing the CIC Values in an Existing Routing Key Containing an Application Server	4-371
4.36	Changing the Routing Context Value in an Existing Routing Key	4-380
4.37	Changing the SCTP Checksum Algorithm Option for M3UA and SUA Associations	4-389
4.38	Changing a UA Parameter Set	4-411
4.39	Turning Off the Large MSU Support for IP Signaling Feature	4-424

5 End Office Support

5.1	Overview	5-1
5.2	End Office Support Configuration	5-10
5.3	Adding an End Node Internal Point Code	5-11
5.4	Removing an End Node Internal Point Code	5-15

6 IPSPG M2PA and M3UA Configuration Procedures

6.1	Adding IPSPG Components	6-1
6.2	Adding an IPSPG Card	6-3
6.3	Adding an IPSPG M2PA Linkset	6-10
6.4	Adding an IPSPG M3UA Linkset	6-32
6.5	Configuring an IP Link	6-55
6.6	Adding an IP Host	6-85
6.7	Configuring an IP Card	6-89
6.8	Adding an IP Route	6-101
6.9	Adding an IPSPG M2PA Association	6-110
6.10	Adding an IPSPG M3UA Association	6-124
6.11	Adding an IPSPG M2PA Signaling Link	6-133
6.12	Adding an IPSPG M3UA Signaling Link	6-156
6.13	Adding a Network Appearance	6-191
6.14	Activating the Large MSU Support for IP Signaling Feature	6-200
6.15	Removing IPSPG Components	6-213
6.16	Removing an IPSPG Card	6-213
6.17	Removing an IPSPG Linkset	6-218

6.18	Removing an IP Host Assigned to an IPSP Card	6-238
6.19	Removing an IP Route	6-245
6.20	Removing an IPSP Association	6-249
6.21	Removing an IPSP M2PA Signaling Link	6-256
6.22	Removing an IPSP M3UA Signaling Link	6-266
6.23	Removing a Network Appearance	6-277
6.24	Changing IPSP Components	6-280
6.25	Changing an IPLIMx Card to an IPSP Card	6-280
6.26	Configuring IP Options	6-297
6.27	Configuring IPSP M3UA Linkset Options	6-301
6.28	Changing an IPSP M2PA Linkset	6-307
6.29	Changing an IPSP M3UA Linkset	6-331
6.30	Changing the Attributes of an IPSP Association	6-366
6.31	Changing the Buffer Size of an IPSP Association	6-391
6.32	Changing the Host Values of an IPSP Association	6-409
6.33	Configuring an IPSP Association for SCTP Retransmission Control	6-435
6.34	Changing the SCTP Checksum Algorithm Option for IPSP M2PA Associations	6-446
6.35	Changing the SCTP Checksum Algorithm Option for IPSP M3UA Associations	6-467
6.36	Changing an M2PA Timer Set	6-487
6.37	Changing a UA Parameter Set	6-496
6.38	Turning Off the Large MSU Support for IP Signaling Feature	6-509

A Reference Information

A.1	Maximum Card Capacity for Different Card Types	A-1
A.2	Requirements for EAGLEs Containing more than 1200 Signaling Links	A-1
A.3	Determining the Number of High-Speed and Low-Speed Signaling Links	A-2
A.4	Enabling the Large System # Links Controlled Feature	A-3

My Oracle Support (MOS)

[My Oracle Support \(MOS\)](#) is your initial point of contact for any of the following requirements:

- **Product Support:**

The generic product related information and resolution of product related queries.

- **Critical Situations**

A critical situation is defined as a problem with the installed equipment that severely affects service, traffic, or maintenance capabilities, and requires immediate corrective action. Critical situations affect service and/or system operation resulting in one or several of these situations:

- A total system failure that results in loss of all transaction processing capability
- Significant reduction in system capacity or traffic handling capability
- Loss of the system's ability to perform automatic system reconfiguration
- Inability to restart a processor or the system
- Corruption of system databases that requires service affecting corrective actions
- Loss of access for maintenance or recovery operations
- Loss of the system ability to provide any required critical or major trouble notification

Any other problem severely affecting service, capacity/traffic, billing, and maintenance capabilities may be defined as critical by prior discussion and agreement with Oracle.

- **Training Need**

Oracle University offers training for service providers and enterprises.

My Oracle Support (<https://support.oracle.com>) is your initial point of contact for all product support and training needs. A representative at Customer Access Support can assist you with My Oracle Support registration.

Call the Customer Access Support main number at 1-800-223-1711 (toll-free in the US), or call the Oracle Support hotline for your local country from the list at <http://www.oracle.com/us/support/contact/index.html>. When calling, make the selections in the sequence shown below on the Support telephone menu:

- For Technical issues such as creating a new Service Request (SR), select **1**.
- For Non-technical issues such as registration or assistance with My Oracle Support, select **2**.
- For Hardware, Networking and Solaris Operating System Support, select **3**.

You are connected to a live agent who can assist you with My Oracle Support registration and opening a support ticket.

My Oracle Support is available 24 hours a day, 7 days a week, 365 days a year.

Acronyms

The following table provides information about the acronyms and the terminology used in the document:

Table Acronyms

Acronym	Description
APC	Adjacent Point Code
DPC	Destination Point Code
GPL	Generic Program Load
ICMP	Internet Control Message Protocol
IMT	Interprocessor Message Transport
IPSG	IP Signaling Gateway
LIM	Link Interface Module
MAS	Maintenance and Administration Subsystem
MASP	Maintenance and Administration Subsystem Processor
MIB	Management Information Base
MSU	Message Signaling Unit
MTP	Message Transfer Part
NI	Network Identifier
NMS	Network Management System
SIF	Signaling Information Field
SIO	Service Information Octet
SLIC	Service and Link Interface Card
SLS	Signaling Link Selector
SNMP	Simple Network Management Protocol
SSN	SS7 Subsystem Number
TCP	ransport Control Protocol
TPC	True Point Code

What's New in This Guide

This section introduces the documentation updates for Release 47.1 in Oracle Communications EAGLE Database Administration - IP7 User's Guide.

Release 47.1 -F88435-01, October 2023

There are no updates to this document in this release.

1

Introduction

Chapter 1, Introduction, contains general information about the database and the organization of this manual.

1.1 Overview

The *Database Administration – IP7 User's Guide* describes the procedures used to configure the EAGLE and its database to implement the IP7 Secure Gateway functionality.



Note:

For the complete list of cards supported by EAGLE Release 47.0, see Hardware Reference Guide.

Throughout this manual, these terms are used to refer to either the original card or the EPM-B version or other replacement version of the card unless one of the card types is specifically required.

- E5-ENET - the original E5-ENET or the E5-ENET-B card
- E5-E1T1 - the original E5-E1T1 or the E5-E1T1-B card
- E5-ATM - the original E5-ATM or the E5-ATM-B card
- E5-IPSM - the original E5-IPSM or the E5-ENET-B card that is running the IPSHC GPL
- E5-SM4G - the original E5-SM4G or the E5-SM8G-B card (not an EPM-B card)
- MCPM - the original MCPM or the E5-MCPM-B card

1.2 Scope and Audience

This guide is intended for database administration personnel or translations personnel responsible for configuring the EAGLE and its database to implement the IP⁷ Secure Gateway functionality.

1.3 References

For more information, refer to the following documents:

1. *Installation Guide*
2. *Commands User's Guide*
3. *Unsolicited Alarm and Information Messages Reference*
4. *Database Administration - SS7 User's Guide*

1.4 Maintenance and Administration Subsystem

The Maintenance and Administration Subsystem (MAS) is the central management point for the EAGLE. The MAS provides user interface, maintenance communication, peripheral services, alarm processing, system disk interface, and measurements. Management and redundancy are provided by use of two separate subsystem processors.

The MAS resides on two separate sets of Maintenance and Administration Subsystem Processor (MASP) cards and a Maintenance Disk and Alarm card (collectively referred to as control cards). The control cards are located in slots 1113 through 1118 of the EAGLE control shelf. The control cards must be E5-based cards.

E5-based Control Cards

The E5-based set of EAGLE control cards consists of the following cards:

- Two Maintenance and Administration Subsystem Processor cards (E5-MASP) cards. Each dual-slot E5-MASP card is made up of the following two modules:
 - Maintenance Communication Application Processor (E5-MCAP) card
 - Terminal Disk Module (E5-TDM) card
- One Maintenance Disk and Alarm card (E5-MDAL card)

Maintenance Communication Application Processor (E5-MCAP) Card

The E5-MCAP card contains the Communications Processor and Applications Processor and provides connections to the IMT bus. The card controls the maintenance and database administration activity and performs both application and communication processing. E5-MCAP cards are located in slots 1113 and 1115 of the control shelf.

Each E5-MCAP card contains two USB ports. One latched USB port is used with removable flash media (“thumb drives”), and one flush-mounted USB port is used with a plug-in flash drive. The removable media drive in the latched USB port is used to install and back up customer data. The flush-mounted USB port is used for upgrade and could be used for disaster recovery.

Terminal Disk Module (E5-TDM) Card

The E5-TDM card provides the Terminal Processor for the 16 I/O ports, and interfaces to the Maintenance Disk and Alarm (E5-MDAL) card and fixed disk storage. The E5-TDM card also distributes Composite Clocks and High Speed Source clocks throughout the EAGLE, and distributes Shelf ID to the EAGLE. Each E5-TDM card contains one fixed SATA drive that is used to store primary and backup system databases, measurements, and Generic Program Loads (GPLs). E5-TDM cards are located in slots 1114 and 1116 of the control shelf.

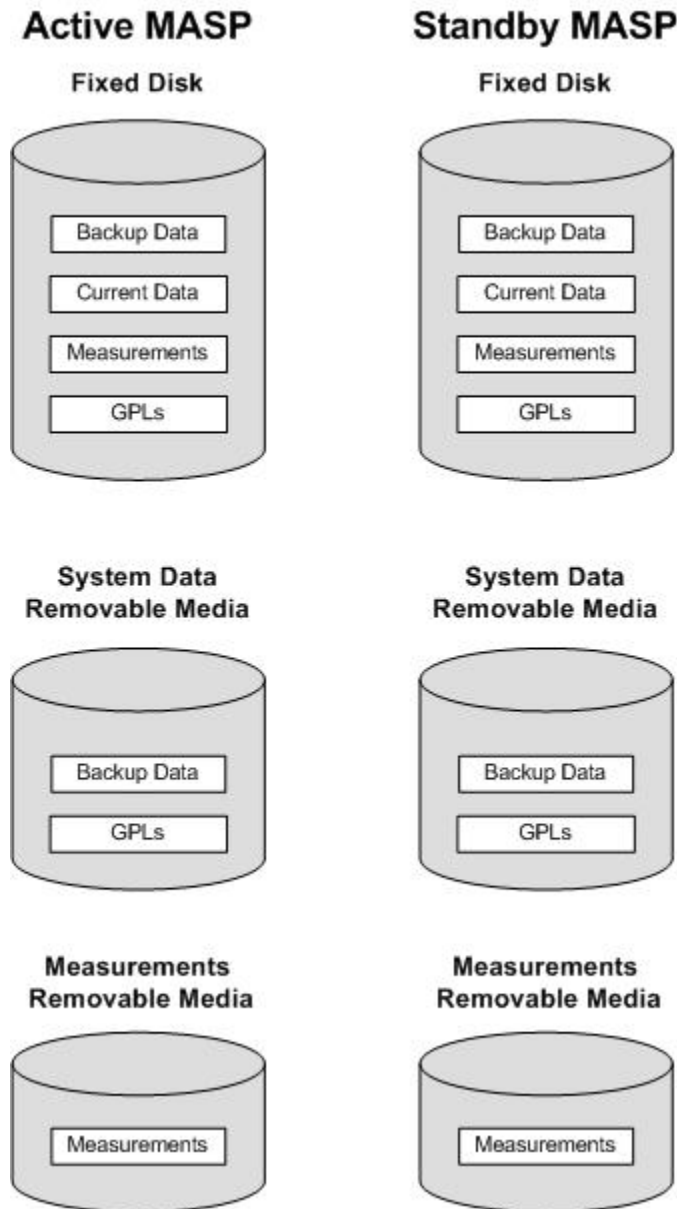
Maintenance Disk and Alarm (E5-MDAL) Card

The E5-MDAL card processes alarm requests and provides fan control. There is only one E5-MDAL card in a control card set. Critical, major, and minor system alarms are provided for up to 6 individual frames. In addition to the 3 system alarms, the E5-MDAL card provides the system audible alarm. The E5-MDAL card provides control of fans on a per-frame basis, and allows for each fan relay to be set individually. The E5-MDAL card is located in slots 1117 and 1118 of the control shelf.

1.5 EAGLE Database Partitions

The data that the EAGLE uses to perform its functions are stored in two separate areas: the fixed disk drives, and the removable media. The following sections describe these areas and data that is stored on them. These areas and their partitions are shown in [Figure 1-1](#).

Figure 1-1 EAGLE Database Partitions (E5-Based Control Cards)



Fixed Disk Drive

There are two fixed disk drives on the EAGLE. The fixed disk drives contain the “primary” set of data and programs for the EAGLE. The two fixed disk drives are located on the terminal disk modules (E5-TDMs). Both disks have the same files. The data stored on the fixed disks

is partially replicated on the various cards in the EAGLE. Changes made during database administration sessions are sent to the appropriate cards.

The data on the fixed disks can be viewed as four partitions.

- Current partition
- Backup partition
- Measurements partition
- Generic program loads (GPLs) partition

The data which can be administered by users is stored in two partitions on the fixed disk, a current database partition which has the tables which are changed by on-line administration, and a backup database partition which is a user-controlled copy of the current partition.

All of the on-line data administration commands affect the data in the current partition. The purpose of the backup partition is to provide the users with a means of rapidly restoring the database to a known good state if there has been a problem while changing the current partition.

A full set of GPLs is stored on the fixed disk, in the GPL partition. There is an approved GPL and a trial GPL for each type of GPL in this set and a utility GPL, which has only an approved version. Copies of these GPLs are downloaded to the EAGLE cards. The GPL provides each card with its functionality. For example, the `ss7ansi` GPL provides MTP functionality for link interface modules (LIMs).

Measurement tables are organized as a single partition on the fixed disk. These tables are used as holding areas for the measurement counts.

Removable Media

The removable media is used with the E5-MCAP card portion of the E5-MASP in card locations 1113 and 1115.

The removable media is used for two purposes.

- To hold an off-line backup copy of the administered data and system GPLs
- To hold a copy of the measurement tables

Because of the size of the data stored on the fixed disk drives on the E5-TDMs, a single removable media cannot store all of the data in the database, GPL and measurements partitions.

To use a removable media to hold the system data, it must be formatted for system data. To use a removable media to hold measurements data, it must be formatted for measurements data. The EAGLE provides the user the ability to format a removable media for either of these purposes. A removable media can be formatted on the EAGLE by using the `format-disk` command. More information on the `format-disk` command can be found in *Commands User's Guide*. More information on the removable media drives can be found in *Hardware Guide*.

Additional and preformatted removable media are available from the [My Oracle Support \(MOS\)](#).

2

IP7 Secure Gateway Overview

Chapter 2, IP7 Secure Gateway Overview, describes the basics of the IP7 Secure Gateway functionality.

2.1 Introduction

The **IP⁷** Secure Gateway functionality in the **EAGLE** provides connectivity between **SS7** and **IP** networks, enabling messages to pass between the **SS7** network domain and the **IP** network domain, as follows:

- When an **EAGLE** receives an **SS7** formatted message over an **SS7** link, the **IP⁷** Secure Gateway functionality dynamically converts this message into **IP** format and routes the re-formatted message over an associated **IP** link to a destination residing within an **IP** network.

The **IP⁷** Secure Gateway functionality use associations to access the **IP** domain. Associations identify **IP** sessions.

- Conversely, when the **EAGLE** receives an **IP** formatted message over an **IP** link, the **IP⁷** Secure Gateway functionality dynamically converts this message into **SS7** format and routes the re-formatted message over an associated **SS7** link to a destination residing within the **SS7** signaling network.

Address resolution is not performed in the **IP** to **SS7** direction. It is the responsibility of the sending application to ensure that the appropriate **SS7** point code information resides in the **IP** message to allow a valid **SS7** message to be constructed for routing to the **SS7** network.

2.2 Hardware, Applications, and Functions

The **IP⁷** Secure Gateway functionality is provided by applications that run on **IP** cards or **E5-ENET** cards. **IP** cards provide interfaces between the **IMT** bus and two 10/100 Base-T **IEEE 802.3/DIX** Ethernet interfaces. The **IP** cards, similar to any other **Link Interface Module (LIM)**, use the Interprocessor Message Transport (**IMT**) bus to communicate with the other cards in the **EAGLE**. Like other **LIMs**, the primary job of an **IP** card is to send and receive **SS7** data on a network (in this case, an **IP** network), and to route that data to other cards in the **EAGLE** as appropriate.

The **IP** card can run on the following applications:

- `iplim` or `iplimi` - Both applications support **STP** connectivity via **MTP-over-IP** functionality point-to-point connectivity (for more information, see [Point-to-Point Connectivity \(IPLIM or IPLIMI Application\)](#)).

The `iplim` and `iplimi` applications support these types of connections:

- **M2PA/SCTP/IP** (A, B, C, D, and E links)
- **SCP**
- **SEP**

- **SCP/SEP**

This type of connection is essentially the same as that of a traditional **SS7** point-to-point link, except that the traditional **MTP2** and 56Kb/s technology is replaced by **IP** and Ethernet technology.

The `iplim` application supports point-to-point connectivity for **ANSI** networks. The `iplimi` application supports point-to-point connectivity for **ITU** networks. With the optional **ANSI/ITU MTP Gateway** feature and proper configuration, the **EAGLE** could convert between any of the **ANSI**, **ITU-N**, and **ITU-I** networks, switch traffic between these networks, and perform network management for each of these networks (for more information, see [Mixed Networks Using the ANSI/ITUMTP Gateway Feature](#)).

The **EAGLE** can support up to 100 cards running the `iplim` and `iplimi` applications.

- `ss7ipgw` and `ipgwi` - These applications support the following types of point-to-multipoint connectivity for networks:
 - **SCP** connectivity via **SCCP/TCAP-over-IP** functionality (for more information, see [Connecting to SCPs with SCCP/TCAP Messages Sent Over the IP Network](#))
 - **SEP** connectivity via **ISUP**, **Q.BICC**, and **TUP-over-IP** functionality (for more information, see [Connecting SEPs Using ISUP, Q.BICC, and TUP Messages Over the IP Network](#))
 - **SCP/SEP** connectivity via non-**ISUP**, non-**SCCP**, non-**Q.BICC**, and non-**TUP-over-IP** functionality (for more information, see [Connecting SCPs and SEPs Using Non-ISUP, Non-SCCP, Non-Q.BICC, and Non-TUP Messages Over the IP Network](#))

The `ss7ipgw` application supports point-to-multipoint connectivity for **ANSI** networks. The `ipgwi` application supports point-to-multipoint connectivity for **ITU** networks.

The **EAGLE** can support a maximum of 125 cards running the `ss7ipgw` and `ipgwi` applications.

In addition to running an `iplim`, `iplimi`, `ss7ipgw`, or `ipgwi` application, each **IP** card supports the following functions:

- A **Simple Network Management Protocol (SNMP)** agent. For more information, see [SNMP Agent Implementation](#).
- **Message Transfer Part (MTP)** status. This function is available only on **IP** cards that support the `ss7ipgw` or `ipgwi` application. For more information, see [Support for MTP Status Functions](#).

2.3 IP Connections

IP connections involve the following assignments:

- Transport protocol – The SCTP transport protocol is specified by the `ent-assoc` and `chg-assoc` commands.
- Adapter protocol – The M3UA, M2PA, or SUA adapter protocol is specified by the `adapter` parameter of the `ent-assoc` and `chg-assoc` commands.

- One or two near-end (local) hosts – The local host is specified by the `lhost` parameter of the `ent-assoc` and `chg-assoc` commands. A second local host can be specified for an association using the `alhost` parameter of the `ent-assoc` and `chg-assoc` commands, allowing the near-end host of the association to be multi-homed. Specifying only one local host for an association allows the association to be uni-homed.
- Far-end (remote) host – The remote host is specified by the `rhost` parameter of the `ent-assoc` and `chg-assoc` commands.
- Near-end (local) transport protocol port – The local transport protocol port is specified by the `lport` parameter of the `ent-assoc` and `chg-assoc` commands.
- Far-end (remote) transport protocol port – The remote transport protocol port is specified by the `rport` parameter of the `ent-assoc` and `chg-assoc` commands.
- SS7 signaling link – specified by the `loc` and `link` parameters of the `ent-slk` command.

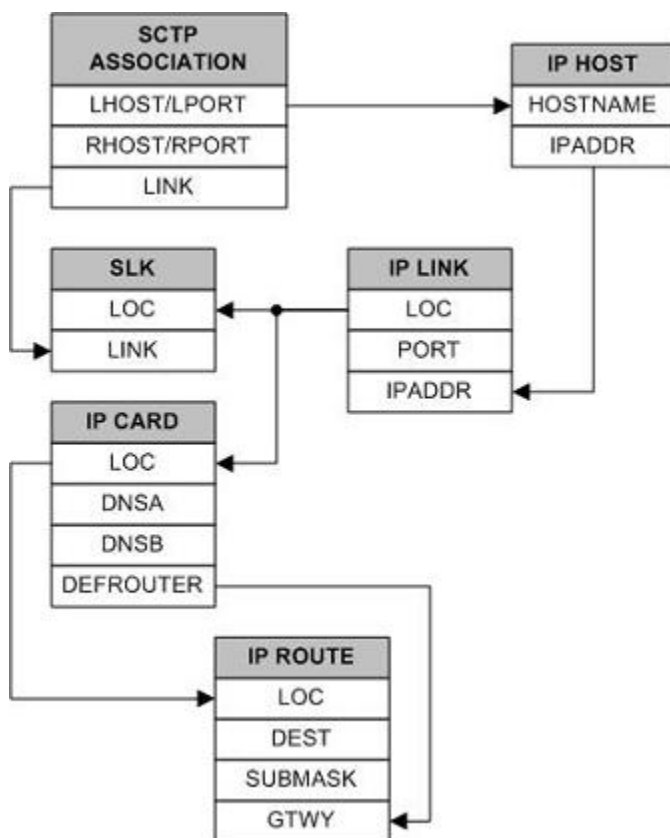
The local host is mapped to a particular Ethernet interface on the IP card by linking the local host name of the IP connection to an IP address with the `ent-ip-host` command. The IP address is also assigned to an IP card and to an Ethernet interface on that IP card using the `chg-ip-lnk` command. A signaling link on that card is assigned to the IP connection using the `link` parameter of the `ent-assoc` and `chg-assoc` commands and referencing the signaling link on the IP card.

An SCTP association can establish a connection between one local host and one remote host (a uni-homed association) or between multiple local hosts and a remote host (a multi-homed association). It is possible that the remote host may be multi-homed, but the **EAGLE** allows only one remote host to be specified for a multi-homed association. If an IP node has multiple IP address associated with it, then an SCTP association originating from this node may take advantage of this added connectivity by establishing an SCTP multi-homed association.

For more information on multi-homed associations, see the [Multi-Homed SCTP Associations](#) section and the [Routing](#) section.

[Figure 2-1](#) shows the components of an SCTP association and how these components interact with each other.

Figure 2-1 SCTP Association Database Relationships



There is no direct correlation between signaling link ports and Ethernet interfaces. A card can be using Ethernet interface A and signaling link B to transmit data to the remote host. Another scenario could have the card using Ethernet interface B and signaling link A to transmit data to the remote host.

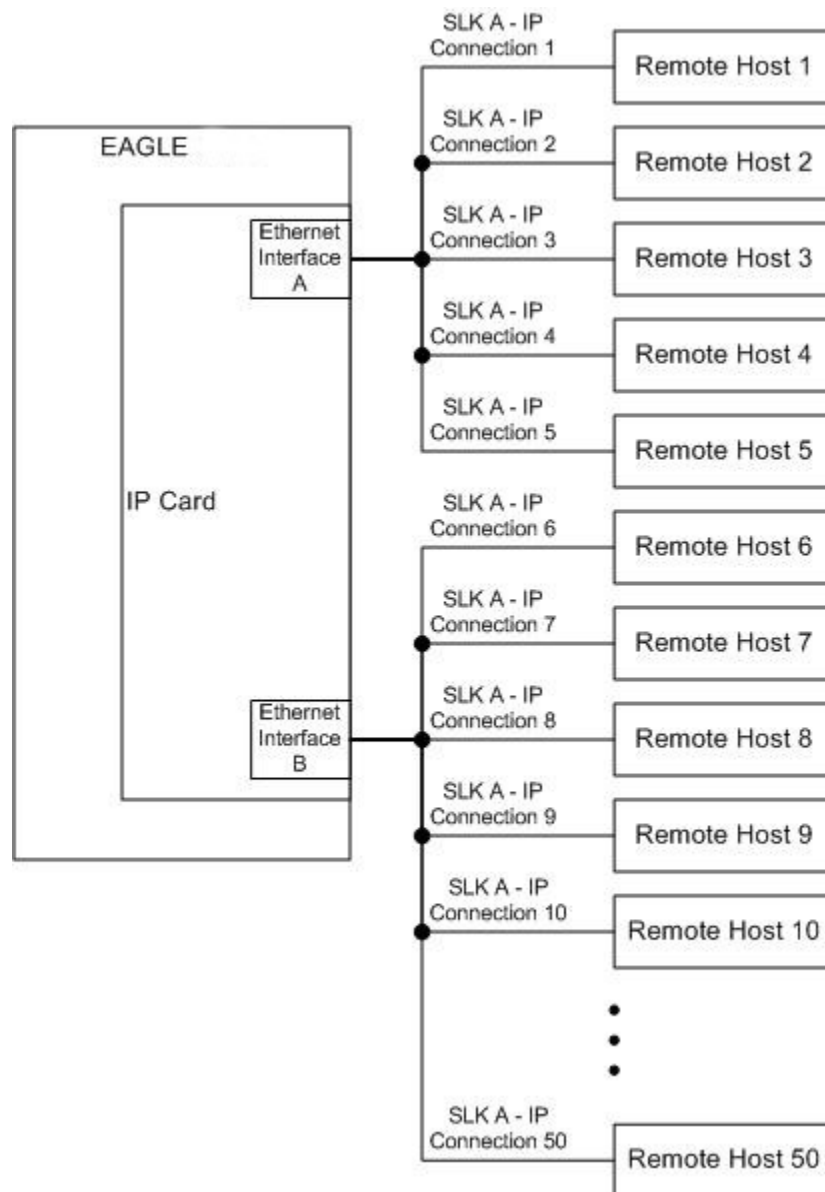
The numbers of signaling link ports and Ethernet interfaces on IP cards varies depending on the card type and application running on the card, as shown in Table 2-1. The sections that follow Table 2-1 describe the IP connections supported by each IP card type. The IP connections described in these sections are uni-homed SCTP associations.

Table 2-1 Ethernet Interface and Signaling Link Combinations

Card	Application	Ethernet Interface	Signaling Link
E5-ENET	IPLIMx	A and B	A - A7, B - B7
	IPGWx	A and B	A

IP Connection on an E5-ENET Card Running the IPGWx Application

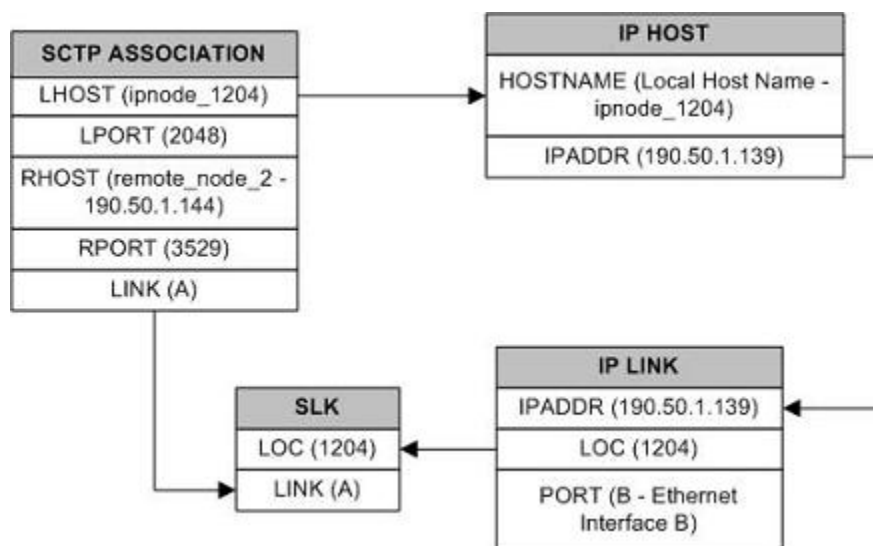
Figure 2-2 IP Connections using an E5-ENET Card running the IPGWx Applications



The assignment of the transport protocol port number is made through the local host port (`lport`) and remote host port (`rport`) parameters of the `ent-assoc` or `chg-assoc` commands (for an SCTP association).

Figure 2-3 shows typical IP connection data for a uni-homed SCTP association and how these components interact with each other.

Figure 2-3 Typical SCTP Association Configuration

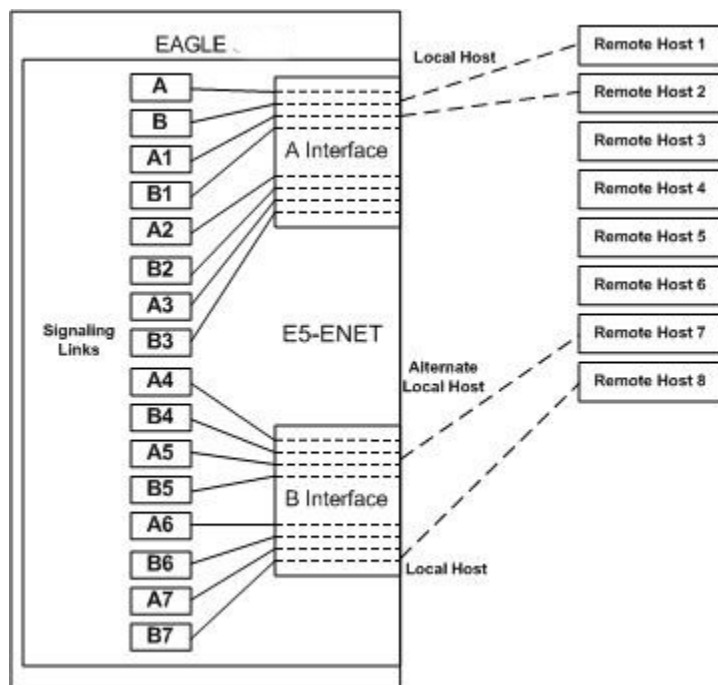


The IP connection defined by the SCTP association is from local host ipnode-1204 (190.50.1.139), SCTP port 2048, to remote host remote-node-2 (190.50.1.144), SCTP port 3529, using Ethernet interface B on IP card 1204, and signaling link A on IP card 1204.

IP Connection on an E5-ENET Card Running the IPLIMx Application

E5-ENET cards running the IPLIMx applications can have 16 signaling links (A, B, A1, B1, A2, B2, A3, B3, A4, B4, A5, B5, A6, B6, A7 or B7) and 2 Ethernet interfaces (A or B) resulting in a maximum of 16 IP connections, one for each signaling link. Each link can use either Ethernet interface A or B. The local host and alternate host assigned to a signaling link must use different Ethernet interfaces; they cannot be assigned to the same Ethernet interface. [Figure 2-4](#) shows some ways the 16 signaling links and the 2 Ethernet interfaces can be used to establish IP connections.

Figure 2-4 IP Connections using E5-ENET Cards running the IPLIMx Applications



Multi-Homed SCTP Associations

If the IP cards are **EDCMs** or E5-ENET cards, SCTP associations can have two local hosts, and are referred to as multi-homed associations. A multi-homed association uses both Ethernet interfaces on the IP card. Each Ethernet interface is assigned to a local host. Each local host is assigned to a different local network. One of the local hosts is configured with the `lhost` parameter of the `ent-assoc` or `chg-assoc` commands. The second local host, or alternate local host, is configured with the `alhost` parameter of the `ent-assoc` or `chg-assoc` commands. One of the local hosts references one of the Ethernet interfaces on the IP card and the other local host references the other Ethernet interface on the IP card. The multi-homed SCTP association allows the E5-ENET card to communicate with another node over two networks. Traffic is passed to and from the remote node on either local interface on the card.

An SCTP association can be uni-homed also. A uni-homed association uses only one Ethernet interface (A or B), which is assigned to only one local host. This local host is configured with the `lhost` parameter of the `ent-assoc` or `chg-assoc` commands. For a uni-homed association, the `alhost` parameter is not be specified with the `ent-assoc` or `chg-assoc` commands. A uni-homed association allows the IP card to communicate to another node on one network only. Traffic is passed to and from the remote node on the local interface on the card defined by the `lhost` parameter.

The remote node can be either uni-homed or multi-homed, and is not dependent on whether or not the local node (containing the local hosts) is uni-homed or multi-homed. For example, Node A can be uni-homed and can be connected to a multi-homed Node B, or a multi-homed Node A can be connected to a uni-homed Node B. [Table 2-2](#) illustrates the possible combinations.

Table 2-2 Uni-Homed and Multi-Homed Node Combinations

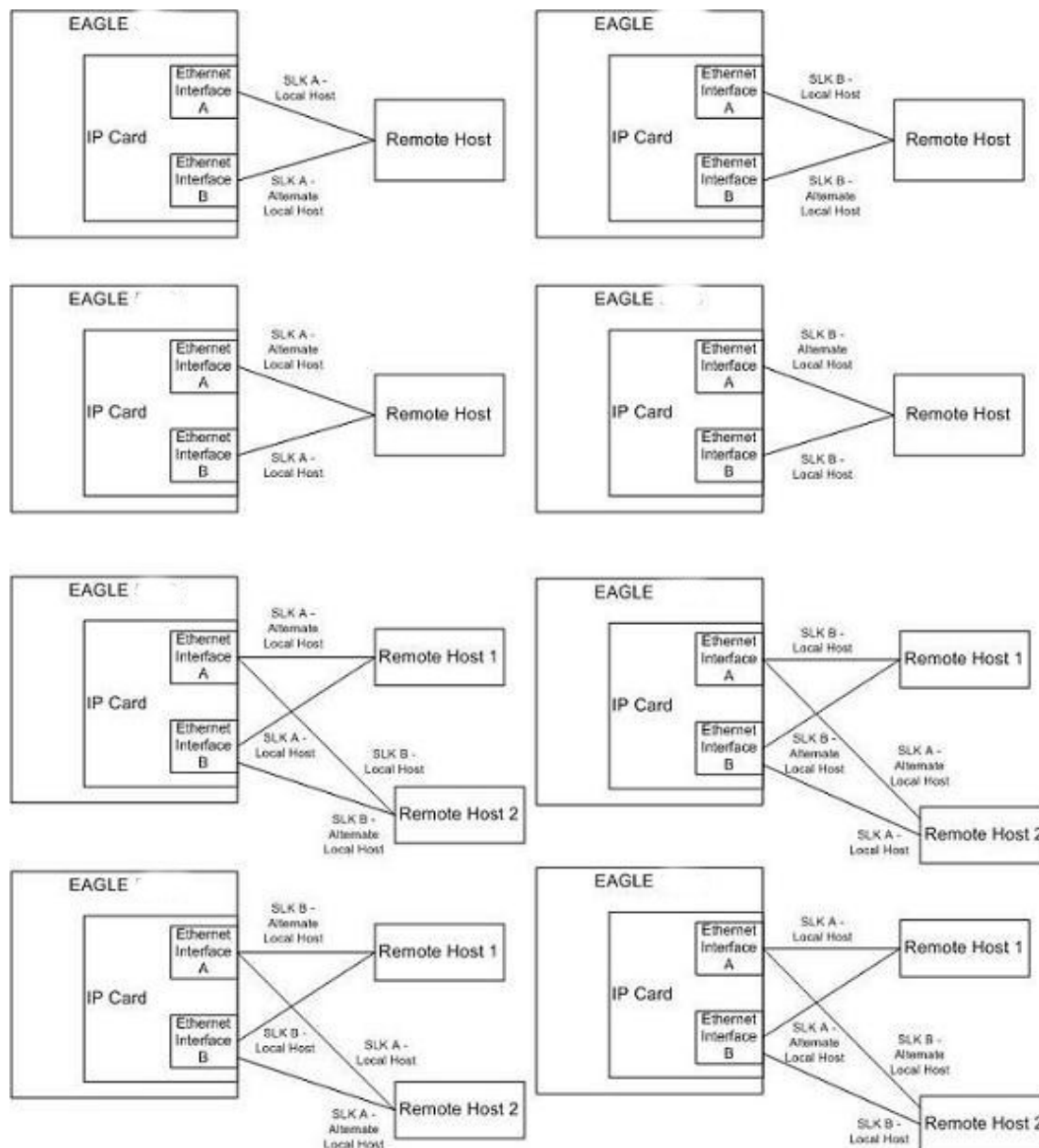
Node A	Node B
Uni-homed	Uni-homed
Uni-homed	Multi-homed
Multi-homed	Uni-homed
Multi-homed	Multi-homed

Multi-Homed Associations on EDCMs or E5-ENET Cards Running the IPLIMx Application

A multi-homed association on an IPLIMx card uses both Ethernet interfaces to reach the remote host, but only one signaling link. An association, either uni-homed or multi-homed, can be assigned to only one signaling link. That signaling link can be either signaling link A or B. The local and alternate local hosts are assigned to each Ethernet interface on the IP card. The IPLIMx cards are limited to one IP connection per signaling link. Since the IPLIMx cards can have eight signaling links on the card, eight multi-homed associations can be assigned to an IPLIMx card.

[Figure 2-5](#) shows the ways a multi-homed IP connection can be established on an IPLIMx card. The remote hosts can be multi-homed, but only one remote host can be specified for each multi-homed association in the **EAGLE**, so only one remote host is shown in [Figure 2-5](#).

Figure 2-5 Multi-Homed Associations on E5-ENET Cards running the IPLIMx Applications



Multi-Homed Associations on E5-ENET Cards Running the IPGWx Applications

A multi-homed association on an IPGWx card uses both Ethernet interfaces to reach the remote host, but only one signaling link, signaling link A on the IPGWx card. The local and alternate local hosts are assigned to each Ethernet interface on the IP card. The IPGWx cards can have up to 50 connections for each IPGWx card. The IPGWx card can contain both uni-homed and multi-homed IP connections, as long as the total number of connections does not exceed 50.

Figure 2-6 shows the way a multi-homed IP connection can be established on an IPGWx card. The remote hosts can be multi-homed, but only one remote host can be specified for each multi-homed association in the **EAGLE**, so only one remote host is shown in Figure 2-6.

Figure 2-6 Multi-Homed Associations on E5-ENET Cards running the IPGWx Applications

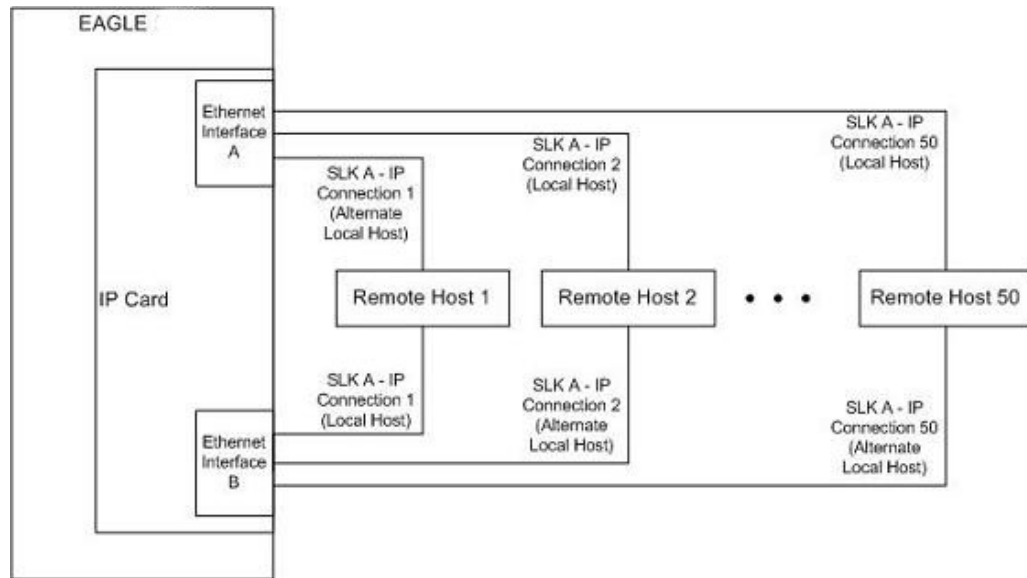
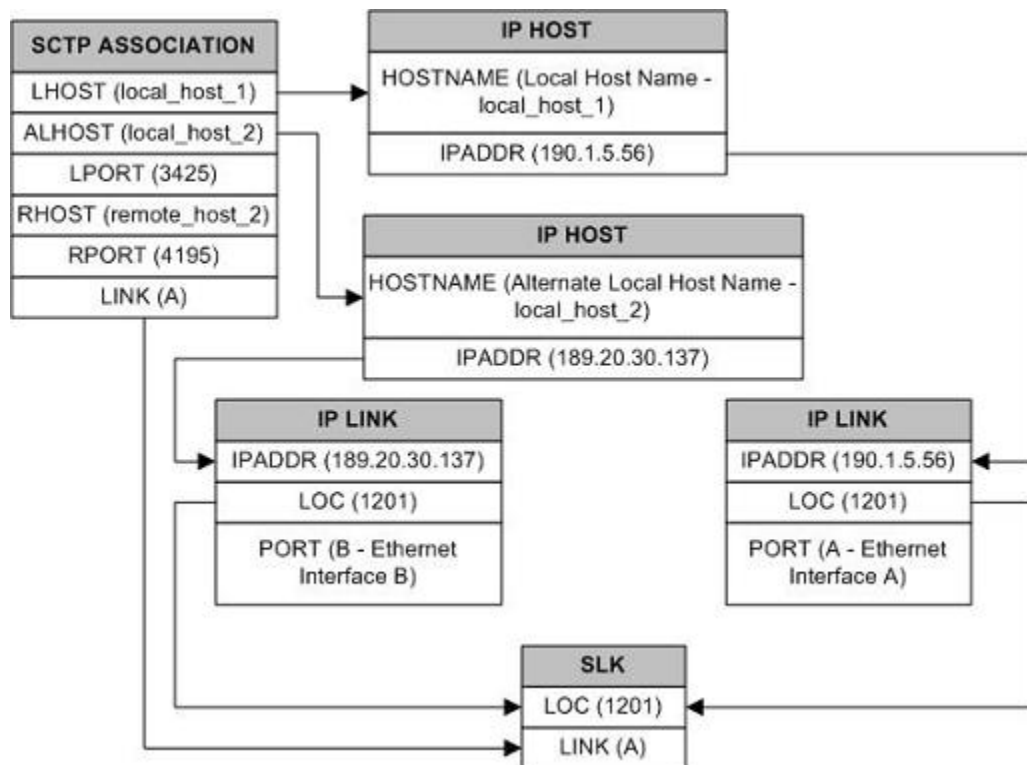


Figure 2-7 shows the components of the multi-homed SCTP association and how these components interact with each other.

Figure 2-7 Multi-Homed Association Database Relationships



Using the data shown in [Figure 2-7](#), the IP connection is defined as a multi-homed association, connecting to a remote host using local hosts 190.1.5.56 and 189.20.30.137 over SCTP port 3425, using signaling link B on card 1201.

Routing

The IP7 Secure Gateway functionality in the EAGLE support two transport protocols –TCP and SCTP. Although both transport protocols are connection oriented, they differ greatly with respect to operation in a multi-homed host environment. The TCP protocol provides for a point-to-point transport connection. The SCTP protocol implements connections with either point to point, point to multi-point, or multi-point to multi-point connectivity capabilities.

An SCTP IETF connection (association) is defined as a four-tuple as follows:

- local host list – one or more of the local host's IP interface addresses
- local SCTP port
- remote host list – one or more of the remote host's IP interface addresses
- remote SCTP port

Based on this definition for an SCTP IETF connection, and the fact that the IPGWx and IPLIMx applications may utilize both Ethernet interfaces (a multi-homed host), an SCTP IETF association can take advantage of multi-homing and be a multi-homed SCTP endpoint. As a multi-homed endpoint, an SCTP IETF connection remains active and usable as long as at least one of the Ethernet interfaces can be reached by the remote host. Multiple paths through multiple interfaces to the remote host provides a more reliable connection. The SCTP IETF protocol is designed to make such a network outage transparent to the application.

In previous releases, an SCTP IETF endpoint could only operate as a uni-homed host using only the Ethernet A interface. In this mode, any SCTP transmission received on or transmitted out of the Ethernet B interface are silently discarded. By using the Ethernet B interface, the SCTP protocol running on the IP card can provide SCTP multi-homing endpoint support – that is, when an SCTP IETF association is formed, it may list both the Ethernet A and B IP addresses for the respective interfaces. As a multi-homed association endpoint, SCTP data would be allowed to flow on either of the Ethernet interfaces and thus provide more robust network connectivity.

In order to provide more flexible network connectivity, an association can be configured as follows with respect to the Ethernet interfaces:

- Ethernet A interface only (uni-homed)
- Ethernet B interface only (uni-homed)
- Ethernet A and B interface (multi-homed)

The interface mode is specified by the `lhost` and `alhost` parameters of the `ent-assoc` or `chg-assoc` commands.

In previous releases, the `lhost` parameter of the `ent-assoc` or `chg-assoc` commands is used to define the local IP address of the SCTP IETF association endpoint. The IP address would have to be an IP address associated with an Ethernet A interface. With this release, the IP address may be associated with either the Ethernet A or B interfaces. If it is an Ethernet A interface IP address, and the `alhost` parameter is not specified, then the association operates as a uni-homed SCTP endpoint on Ethernet interface A. If it is an Ethernet B interface IP address, and the `alhost` parameter is not specified, then the association operates as a uni-homed SCTP endpoint on Ethernet interface B. An association is configured as an SCTP multi-homed endpoint by specifying both the `lhost` and `alhost` parameter values with values corresponding to the Ethernet interface IP address for the IP

card. The `lhost` and `alhost` parameter values represent the IP addresses specified by the `chg-ip-lnk` command for the specific IP card. Traffic cannot be passed between the Ethernet interfaces on the IP card containing a multi-homed SCTP association. The IP card cannot act as an IP router between the networks defined by the local host and alternate local hosts of a multi-homed association.

A host that is not on the local network, the network identified by the local host's IP address, can be reached only through a gateway router. A gateway router is a device with more than one physical network connection, and can be connected to multiple networks. Unlike a multi-homed host, a gateway router is permitted to route IP messages between the physical Ethernet interfaces on the IP card. The network portion of the gateway router's IP address must be the same as the network portion of the IP address of one of the IP addresses of the Ethernet interfaces on the IP card. The gateway router is configured using the `defrouter` of the `chg-ip-card` command, or using the `ent-ip-rte` command.

Static entries are added to the IP Routing table using the `ent-ip-rte` command. Static routes are usually assigned to give control over which routers are used, allowing different routers to be selected based upon the destination IP address. There are two types of static routes:

- host static IP routes
- network or subnetwork static IP routes

The default route entry is a special static route. If there is not a specific host or network address in the IP Routing table that matches the destination IP address of an outbound datagram, then the datagram is sent to the default router (gateway) specified by the default route.

An IP route is configured using the `ent-ip-rte` command with the location of the IP card, the IP address of the gateway router (the `gtwy` parameter), and the IP address and subnet mask of the destination (that is, host or network). The IP address of the gateway router must be a locally attached IP address (that is, the gateway IP address must share the network portion of one of the two Ethernet interfaces).

When an IP packet is to be transmitted the IP routing table must be interrogated to determine where to send the IP datagram. If the destination IP address is local to the node (that is, directly reachable by an Ethernet interface), then the IP datagram is transmitted directly to the node with that associated IP address. If the destination IP address is determined to not be local to the node, then it must be routed (that is, sent to a gateway to reach its destination).

IP routing requires accessing the IP routing table to select a route. The destination IP address of the outbound datagram is used to search the IP routing table for the most specific route match. The order for selection is:

1. Host route
2. Subnetwork route
3. Network route
4. Aggregated route
5. Default route

Based on this selection order if an IP route is found then the outbound IP datagram will be transmitted to the gateway specified by the route. If no IP route is found (where no

default route is specified), then the transmission of the datagram fails due to destination unreachable.

The capability to enter static IP routes provides for flexibility and control with respect to controlling network traffic. An IP card can contain up to 64 IP routes. The EAGLE can contain up to 1024 IP routes.

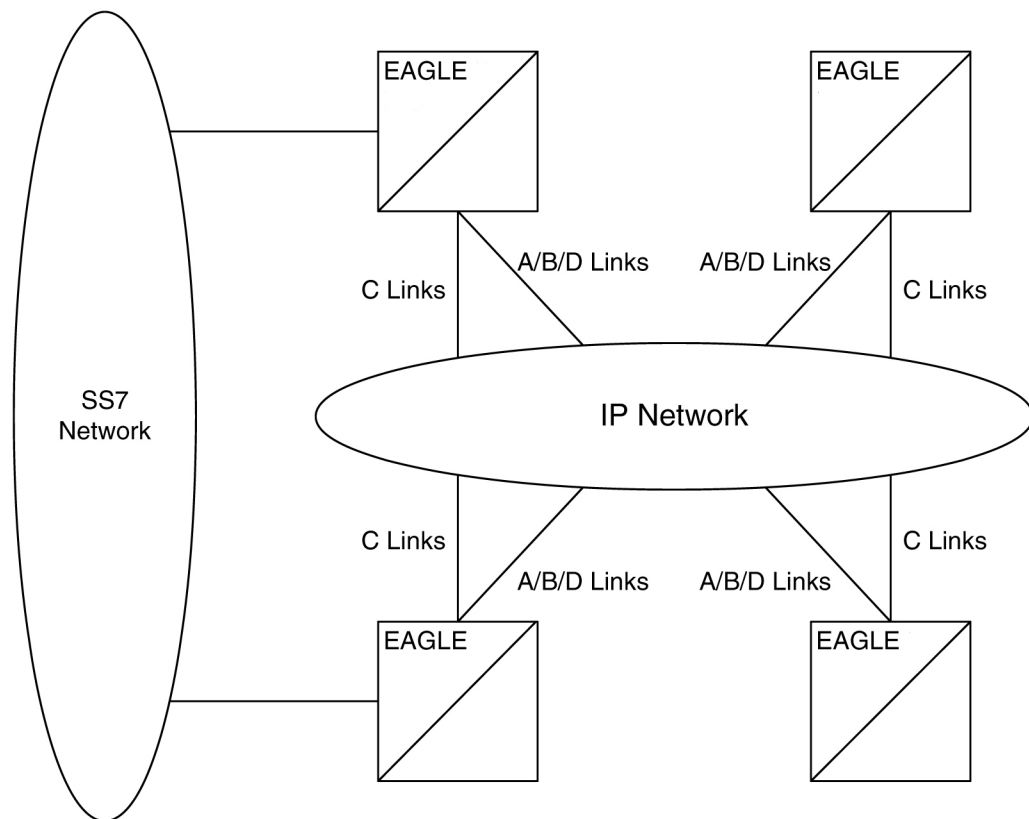
2.4 Point-to-Point Connectivity (IPLIM or IPLIMI Application)

The following sections describe the types of point-to-point connectivity provided, and how routing is accomplished, by the `iplim` or `iplimi` application:

Connecting STPs Over the IP Network

This functionality allows the use of an **IP** network in place of point-to-point **SS7** links to carry **SS7MSUs**. [Figure 2-8](#) shows a diagram of this type of network. For example, the C links between the mated pair of **STPs** or A/B/D links between **STPs** can be replaced by an **IP** network. The **IP⁷** Secure Gateway functionality is deployed on both ends of the link (point-to-point connection). The **EAGLE** converts the **SS7MSUs** to **IP** packets on one end of the link, and **IP** packets to **SS7MSUs** on the other end of the link. The **IPLIMx** applications support **M2PA/SCTP/IP** associations over A, B, C, D, and E links.

Figure 2-8 EAGLE Network (STP Connectivity via MTP-over-IP)



2.5 Point-to-Multipoint Connectivity (SS7IPGW and IPGWI)

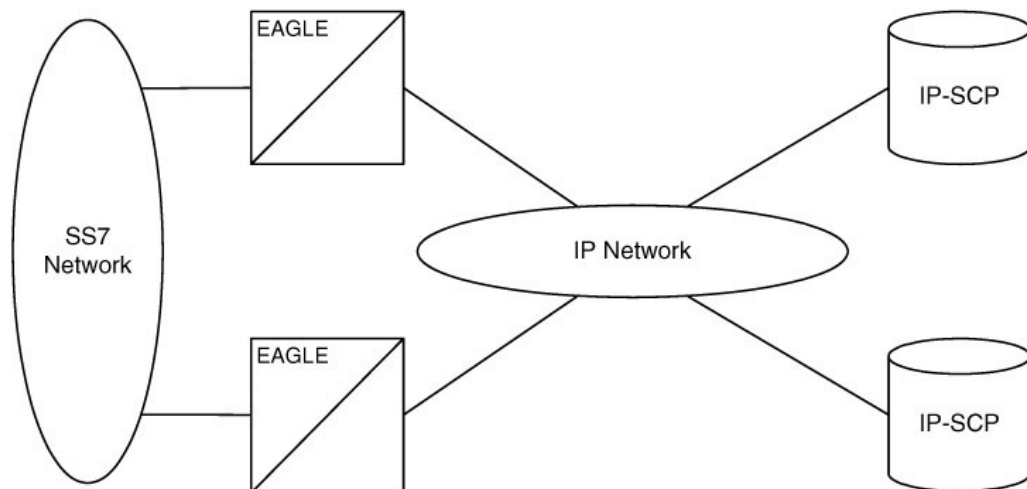
The following sections describe the types of point-to-multipoint connectivity, how routing is accomplished, and the **MTP** status functions provided by the `ss7ipgw` and `ipgwi` applications:

- Connecting to SCPs with SCCP/TCAP Messages Sent Over the IP Network
- Connecting SEPs Using ISUP, Q.BICC, and TUP Messages Over the IP Network
- Connecting SCPs and SEPs Using Non-ISUP, Non-SCCP, Non-Q.BICC, and Non-TUP Messages Over the IP Network
- Understanding Routing for SS7IPGW and IPGWI Applications
- Support for MTP Status Functions

Connecting to SCPs with SCCP/TCAP Messages Sent Over the IP Network

This functionality allows **SS7** nodes to exchange **SCCP/TCAP** queries and responses with an **SCP** residing on an **IP** network. Figure 2-9 shows a diagram of this type of network.

Figure 2-9 IP Network (SCP Connectivity via TCAP-over-IP)



The **EAGLE** manages the virtual point codes and subsystem numbers for the **IP-SCP**. From the **SS7** network perspective, the **TCAP** queries are routed using these virtual point codes/**SSNs**. The **EAGLE** maps the virtual point code/**SSN** to one or more **TCP** sessions (point-to-multipoint connection), converts the **SS7MSUs** to **IP** packets by embedding the **SCCP/TCAP** data inside **IP** packets, and routes them over an **IP** network. The **EAGLE** also manages application subsystem status from an **IP** network's perspective and an **SS7** network's perspective.

The following sequence of events illustrates this functionality:

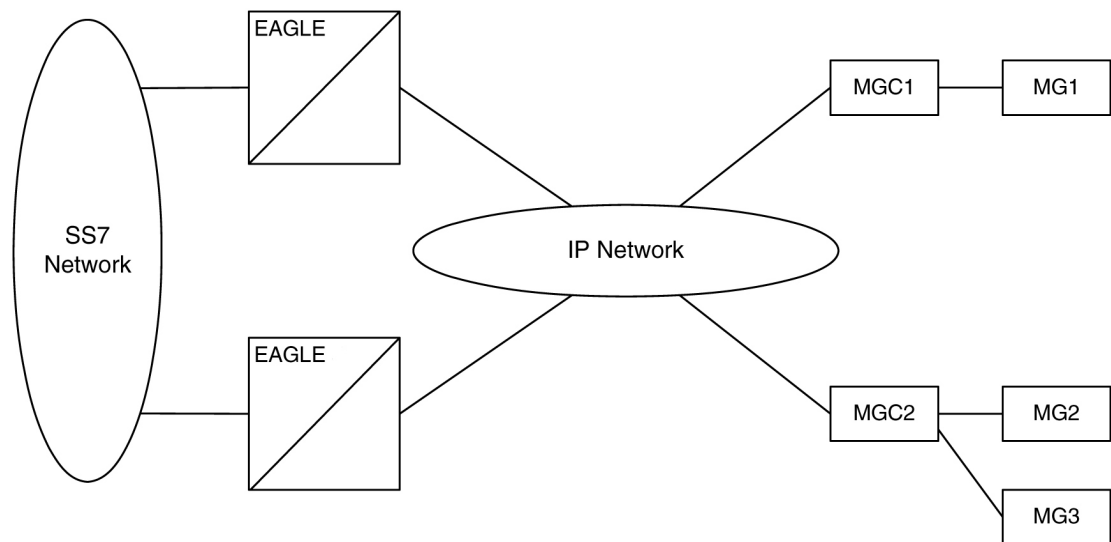
1. Traditional **SS7** devices route **MSUs** (such as **TCAP** Queries) to the **EAGLE**.
2. The **EAGLE** performs a global title translation and forwards the translated **MSU** to the correct **IP** device based on **Point Code** and **SCCP** Subsystem information in the **MSU**.

3. The **TCAP** query is processed at the **IP-SCP**, and the **IP-SCP** sends a **TCAP** reply back to the **EAGLE**.
4. The **EAGLE** forwards the **TCAP** reply back to the sender of the original query.

Connecting SEPs Using ISUP, Q.BICC, and TUP Messages Over the IP Network

This point-to-multipoint functionality allows **SS7** nodes to exchange **ISUP**, **Q.BICC**, and **TUP** protocol messages with one or more signaling end points (class 4 switches, class 5 switches, VoIP gateways, Media Gateway Controllers, or Remote Access Servers) residing on an **IP** network. [Figure 2-10](#) shows an example of this type of network.

Figure 2-10 IP Network (SEP connectivity via ISUP, Q.BICC, and TUP-over-IP)



The **EAGLE** maps the originating point code, destination point code, and circuit identification code to an **IP** connection. The **SEP** is provided the originating and destination point codes in the **MTP** level 3 routing label as part of the passed protocol.

Connecting SCPs and SEPs Using Non-ISUP, Non-SCCP, Non-Q.BICC, and Non-TUP Messages Over the IP Network

This point-to-multipoint functionality allows **SS7** nodes to exchange non-**ISUP**, non-**SCCP**, non-**Q.BICC**, and non-**TUP** protocol messages with one or more **IP**-based devices residing on an **IP** network. The network example is similar to the **SCP** connectivity via **SCCP/TCAP-over-IP** functionality example shown in [Figure 2-9](#). The **EAGLE** maps the destination point code, and service indicator (non-**ISUP**, non-**SCCP**, non-**Q.BICC**, non-**TUP**) to an **IP** connection.

Understanding Routing for SS7IPGW and IPGWI Applications

The `ss7ipgw` and `ipgwi` applications can use a single point code, called a virtual point code. This code is assigned to a set of **IP** devices that it connects to. The **EAGLE** distinguishes between the devices within the set by using application routing keys and application servers.

Application routing associates **SS7** routing keys with application servers. **SS7** routing keys define a filter based on **SS7** message data. Application servers define the connection between the **IP** local host/local transport protocol port and **IP** remote host/remote transport protocol port.

An application server is a logical entity serving a specific routing key. The application server contains a set of one or more unique application server processes, of which one or more is normally actively processing traffic. An application server process is a process instance of an application server and contains an **SCTP** association. For more information on application servers, application server processes, and **SCTP** associations, see the [IETF Adapter Layer Support](#) section.

If the routing key filter matches the **SS7** message presented for routing to the **IP** network, the **SS7** message is sent to the associated application server.

Only one application server can be associated with each **SS7** routing key. One application server can have up to 16 associations. **SS7** messages delivered to the **IP** network using a routing key are distributed over the available application server based on the **SLS** (signaling link selector) value in the **SS7** message.

Routing keys can be fully or partially specified, or specified by default.

Full Routing Keys

For this routing application, all applicable fields in the **Message Signaling Unit (MSU)** must match the contents of the full routing key. [Table 2-3](#) defines which **SS7** message parameters are used to search for a match for full routing keys for each of the functions supported by the `ss7ipgw` and `ipgwi` applications (**IPGWx** functionality).

Table 2-3 SS7 Full Routing Keys per IPGWx Functionality

IPGWx Functionality (ANSI and ITU)	SS7 Routing Keys
SCP connectivity via TCAP-over-IP	Destination Point Code Service Indicator (=3) Subsystem Number
SEP connectivity via ISUP-over-IP	Destination Point Code Service Indicator (=5) Originating Point Code CIC Range Start CIC Range End
SEP connectivity via Q.BICC-over-IP	Destination Point Code Service Indicator (=13) Originating Point Code CIC Range Start CIC Range End
SEP connectivity via TUP-over-IP (ITU only)	Destination Point Code Service Indicator (=4) Originating Point Code CIC Range Start CIC Range End
SCP/SEP connectivity via non- ISUP , non- SCCP , non- Q.BICC , non- TUP-over-IP	Destination Point Code Service Indicator (any value other than 3, 4*, 5, and 13)

* The service indicator value of 4 can be used in this instance if the **DPC** is an **ANSI** point code.

Partial Routing Keys

Partially specified routing keys are explicitly, but not completely defined. These routing keys ignore some of the contents of the **MSU**. The parts of the **MSU** that are ignored are specific. For example, for the 'ignore *cic*' partial-key type, the destination point code (*dpc*), service indicator (*si*), and originating point code (*opc*) must be configured, but the circuit identification code (*cic*) field does not have to be configured. The other types of **SS7** partial routing keys are as follows:

- *dpc*, *si*, and *opc* specified (ignore *cic* for **CIC**-based messages)
- *dpc* and *si* specified (ignore *ssn* for **SCCP** messages)
- *dpc* and *si* specified (ignore *opc* and *cic* for **CIC**-based messages)
- *dpc* specified (ignore all but the *dpc* field)
- *si* specified (ignore all but the *si* field)

Default Routing Keys

Default routing keys do not need any part of the **MSU** specified. This routing key can be used to carry any **SS7MSU**, regardless of the type of **MSU** or the fields that make up the **MSU**.

Routing Key Tables

Each **IP** card has a **Routing Key** table that maps **SS7** routing keys to **IP** connections, as illustrated by the example in [Table 2-4](#). **MSUs** that match the parameters in a given row are sent over one of the **IP** connections shown for that row (up to 16 **IP** connections can be defined for a single routing key). Multiple **IP** connections for a given row allow load sharing. In addition, multiple routing keys can be used to send traffic to a single **IP** connection.

Each **IP** card's **Routing Key** table can contain up to 2500 entries. Entries in the **Routing Key** table are defined by the `ent-appl-rtkey` command entered through the **OAM**, saved on disk, and reloaded to each **IP** card upon reset. The routing key entries can be full, partial, or default routing keys. The entries in one **IP** card's **Routing Key** table are identical to the entries in the other **IP** card's table. The entries can be changed by the `chg-appl-rtkey` command or removed by the `dlt-appl-rtkey` command.

[Table 2-4](#) shows a sample **Routing Key** table that has one entry for an **SSCP/TCAP-over-IP** connection; one entry each for an **ISUP**, **Q.BICC**, and **TUP-over-IP** connection; and a non-**SSCP/non-ISUP/ non-Q.BICC/non-TUP** connection.

Table 2-4 Example SS7 Routing Key Table

SS7 DPC Routing Key Parameter	SS7 SI Routing Key Parameter	SS7 SSN Routing Key Parameter	SS7 OPC Routing Key Parameter	CIC START Routing Key Parameter	CIC END Routing Key Parameter	Name of IP Connections that carry traffic for that Routing Key
DPC-SI-SSN routing key for SSCP/TCAP-over-IP connectivity						
5-5-5	03	6	-	-	-	kchr11201 kchr21201 kchr11203 kchr21203
ISUP-CIC routing key for ISUP-over-IP connectivity						

Table 2-4 (Cont.) Example SS7 Routing Key Table

SS7 DPC Routing Key Parameter	SS7 SI Routing Key Parameter	SS7 SSN Routing Key Parameter	SS7 OPC Routing Key Parameter	CIC START Routing Key Parameter	CIC END Routing Key Parameter	Name of IP Connections that carry traffic for that Routing Key
5-5-6	05	-	4-4-4	1	100	dnmsc11201 dnmsc21201 dnmsc11203 dnmsc21203
Q. BICC-CIC routing key for Q. BICC-over-IP connectivity						
4363	13	-	5834	48486	48486	lpmsg11204 lpmsg21204 lpmsg31204
TUP- CIC routing key for TUP-over-IP connectivity						
1-44-2	04	-	2-5-1	3948	3948	lpmsg11205 lpmsg21205 lpmsg31205
DPC-SI routing key for non- SCCP /non- ISUP /non-Q. BICC /non- TUP connectivity						
5-5-7	02					sfhlr11204

Routing Key Lookup Hierarchy

To facilitate the delivery of Message Signaling Units (**MSUs**) that do not match full routing key entries in the **Routing Key** table, each **MSU** is processed and delivered according to a specific routing key lookup hierarchy. The hierarchy guarantees that the **MSU** is delivered to the best possible location based on the **MSU**'s closest match in the **Routing Key** table, and also prevents **MSUs** without full routing key matches from being discarded. [Table 2-5](#) defines the routing key lookup hierarchy.

Table 2-5 Routing Key Lookup Hierarchy

Type of MSU	Lookup Order per MSU Type	Segment of MSU that Must Match Routing Key	Routing Key Type
CIC	1	dpc + si + opc + cic	Full
	2	dpc + si + opc (ignore cic)	Partial
	3	dpc + si (ignore opc & cic)	Partial
	4	dpc (ignore si, opc & cic)	Partial
	5	si (ignore dpc, opc & cic)	Partial
	6	None	Default
SCCP	1	dpc + si + ssn	Full
	2	dpc + si (ignore ssn)	Partial
	3	dpc (ignore si & ssn)	Partial

Table 2-5 (Cont.) Routing Key Lookup Hierarchy

Type of MSU	Lookup Order per MSU Type	Segment of MSU that Must Match Routing Key	Routing Key Type
OtherSI	4	si (ignore dpc & ssn)	Partial
	5	None	Default
	1	dpc + si	Full
	2	dpc (ignore si)	Partial
	2	si (ignore dpc)	Partial
	3	None	Default

When an **MSU** has an **si** value of 5, 13, or 4 (**ITU** only), it is a **CIC** message. Messages with an **si** value of 3 are **SCCP** messages. All other **MSUs** are considered **OtherSI** messages. The **EAGLE** first tries to match each **MSU** with a full routing key and second with one of the partial keys as numbered in ascending order in the table. Third, if no segment of the routing key matches either full or partial routing keys, the **EAGLE** assigns the **MSU** a default routing key.

Support for MTP Status Functions

This feature, available only on **IP** cards that support the `ss7ipgw` and `ipgwi` applications, allows the **Message Transfer Part (MTP)** status of point codes in the **SS7** networks to be made available to **IP**-connected media gateway controllers (**MGCs**) and **IP-SCPs**. This feature is similar to the **MTP3** network management procedures used in an **SS7** network.

This feature enables an **IP** device to:

- Divert traffic from a secure gateway that is not able to access a point code that the mated secure gateway can access
- Audit point code status
- Build up routing tables before sending traffic
- Be warned about network congestion
- Abate congestion (`ss7ipgw` application only)
- Obtain **SS7** User Part Unavailability status

2.6 SNMP Agent Implementation

This feature implements a **Simple Network Management Protocol (SNMP)** agent on each **IP** card that runs the `ss7ipgw`, `ipgwi`, `iplim`, or `iplimi` applications. **SNMP** is an industry-wide standard protocol used for network management. **SNMP** agents interact with network management applications called Network Management Systems (**NMSs**).

Supported Managed Object Groups

The **SNMP** agent maintains data variables that represent aspects of the **IP** card. These variables are called managed objects and are stored in a management information base (**MIB**). The **SNMP** protocol arranges managed objects into groups. [Table 2-6](#) shows the groups that are supported.

Table 2-6 SNMP Object Groups

Group Name	Description	Contents
<i>system</i>	Text description of agent in printable ASCII characters	System description, object identifier, length of time since reinitialization of agent, other administrative details
<i>interfaces</i>	Information about hardware interfaces on the IP card	Table that contains for each interface, speed, physical address, current operational status, and packet statistics
<i>ip</i>	Information about host and router use of the IP	Scalar objects that provide IP -related datagram statistics, and 3 tables: address table, IP -to-physical address translation table, and IP -forwarding table
<i>icmp</i>	Intranetwork control messages, representing various ICMP operations within the IP card	26 scalar objects that maintain statistics for various Internet Control Message Protocol (ICMP) messages
<i>tcp</i>	Information about TCP operation and connections	14 scalar objects that record TCP parameters and statistics, such as the number of TCP connections supported and the total number of TCP segments transmitted, and a table that contains information about individual TCP connections
<i>udp</i>	Information about UDP operation	4 scalar objects that maintain UDP -related datagram statistics, and a table that contains address and port information
<i>snmp</i>	Details about SNMP objects	30 scalar objects, including SNMP message statistics, number of MIB objects retrieved, and number of SNMP traps sent

Supported SNMP Messages

The **SNMP** agent interacts with up to two **NMSs** by:

- Responding to *Get* and *GetNext* commands sent from an **NMS** for monitoring the **IP** card.
- Responding to *Set* commands sent from an **NMS** for maintaining the **IP** card and changing managed objects as specified.
- Sending *Trap* messages to asynchronously notify an **NMS** of conditions such as a link going up or down. *Traps* provide a way to alert the **NMS** in a more timely fashion than waiting for a *Get* or *GetNext* from the **NMS**. Two hostnames, **DCMSNMPTRAPHOST1** and **DCMSNMPTRAPHOST2**, are utilized to specify the **SNMPNMS** to which traps are sent. In this release, only the following traps are supported:
 - *coldStart*, sent one time only when the **IP** stack initialization occurs on the **IP** card as part of boot processing
 - *linkUp*, sent when one of the ports on the **IP** card initially comes up or recovers from a previous failure
 - *linkDown*, sent when one of the ports on the **IP** card fails

When a trap occurs at the **IP** card agent, the agent sends the trap to each of the **SNMP** specific host names that can be resolved to an **IP** address. Resolution is based on configuration data in the `chg-ip-card` command (or default data) which specifies **DNS** search order and **DNS** information.

Deviations from SNMP Protocol

[Table 2-7](#) shows how the **EAGLE** deviates from the standard **SNMP** protocol definition.

Table 2-7 Deviations from SNMP Protocols

Group	Variable Name	Usage	Deviation
<i>system</i>	<i>sysContact</i>	Text identification of contact information for agent	Cannot be set by <i>Set</i> command; may be set only by <code>chg-sg-opts</code> command.
	<i>sysLocation</i>	Physical location of agent	Cannot be set by <i>Set</i> command; internally set using configuration data already available; set to <code><CLLI>-<slot of IP card></code>
	<i>sysName</i>	Administratively assigned name for agent	Cannot be set by <i>Set</i> command; internally set using configuration data already available; set to <code><CLLI>-<slot of IP card></code>
<i>interface</i>	<i>ifAdminStatus</i>	Desired state of the interface	Cannot be set by <i>Set</i> command (to ensure that an NMS does not disrupt SS7 traffic by placing an IP interface in a nonoperable state)
<i>ip</i>	<i>ipForwarding</i>	IP route-specific values	Cannot be set by <i>Set</i> command
	<i>ipDefaultTTL</i>		
	<i>ipRoute Dest</i>		
	<i>ipRouteIfIndex</i>		
	<i>ipRouteMetric1-5</i>		
	<i>ipRouteNextHop</i>		
	<i>ipRouteType</i>		
	<i>iprouteAge</i>		
	<i>ipRouteMask</i>		
	<i>ipNetToMediaIfIndex</i>		
<i>ipNetToMediaPhysAddress</i>			
<i>ipNetToMediaNetAddress</i>			
<i>ipNetToMediaType</i>			
<i>tcp</i>	<i>tcpConnState</i>	State of a TCP connection	Cannot be set by <i>Set</i> command
<i>snmp</i>	<i>snmpEnableAuthenTraps</i>	Indicate whether agent is permitted to generate authentication failure traps	Cannot be set by <i>Set</i> command

2.7 Mixed Networks Using the ANSI/ITUMTP Gateway Feature

The optional **ANSI/ITUMTP** Gateway feature, now also available for **IP** networks, and the addition of the `iplimi` and `ipgwi` applications enables the **EAGLE** to act as an interface between nodes that support **ANSI**, **ITU-I**, and **ITU-N** protocols. For more information on the **ANSI/ITUMTP** Gateway feature, contact your Oracle Sales Representative.

[Figure 2-11](#) shows an example of a complex network that includes all these types of nodes. [Table 2-8](#) provides more detail about the nodes, network types, and point codes used in this example.

The following **SS7** protocol constraints determine how the network must be configured:

- A linkset is a group of links that terminate into the same adjacent point code. All links in the linkset can transport compatible **MSU** formats. The network type of the linkset is the same as the network type of the adjacent point code assigned to the linkset.
- When nodes in different networks need to communicate, each node must have either a true point code or an alias point code for each of the network types. For example, if Node 1 (in an **ANSI** network) needs to communicate to Node 7 (in an **ITU-N** network), Node 1 must have an **ANSI** true point code and an **ITU-N** alias point code, while Node 7 must have an **ITU-N** true point code and an **ANSI** alias point code.
- The systems are usually deployed as mated pairs. The links connecting the **EAGLE** to its mate are C links. Each **EAGLE** must have a C linkset for each network type that the **EAGLE** connects to. Therefore, in [Figure 2-11](#), Nodes 5 and 6 are connected with three linksets, one each for **ANSI** traffic, **ITU-I** traffic, and **ITU-N** traffic.
- To perform routing, the **EAGLE** must convert the routing labels in **MSUs**. To perform this conversion, every destination point code (**DPC**), originating point code (**OPC**), and concerned point code must be defined in the Routing table. Even if the **EAGLE** does not route **MSUs** to these nodes, they must be provisioned in the Routing table to provision the alias point codes required in the conversion process.

Figure 2-11 Complex Network with ANSI, ITU-I, and ITU-N Nodes

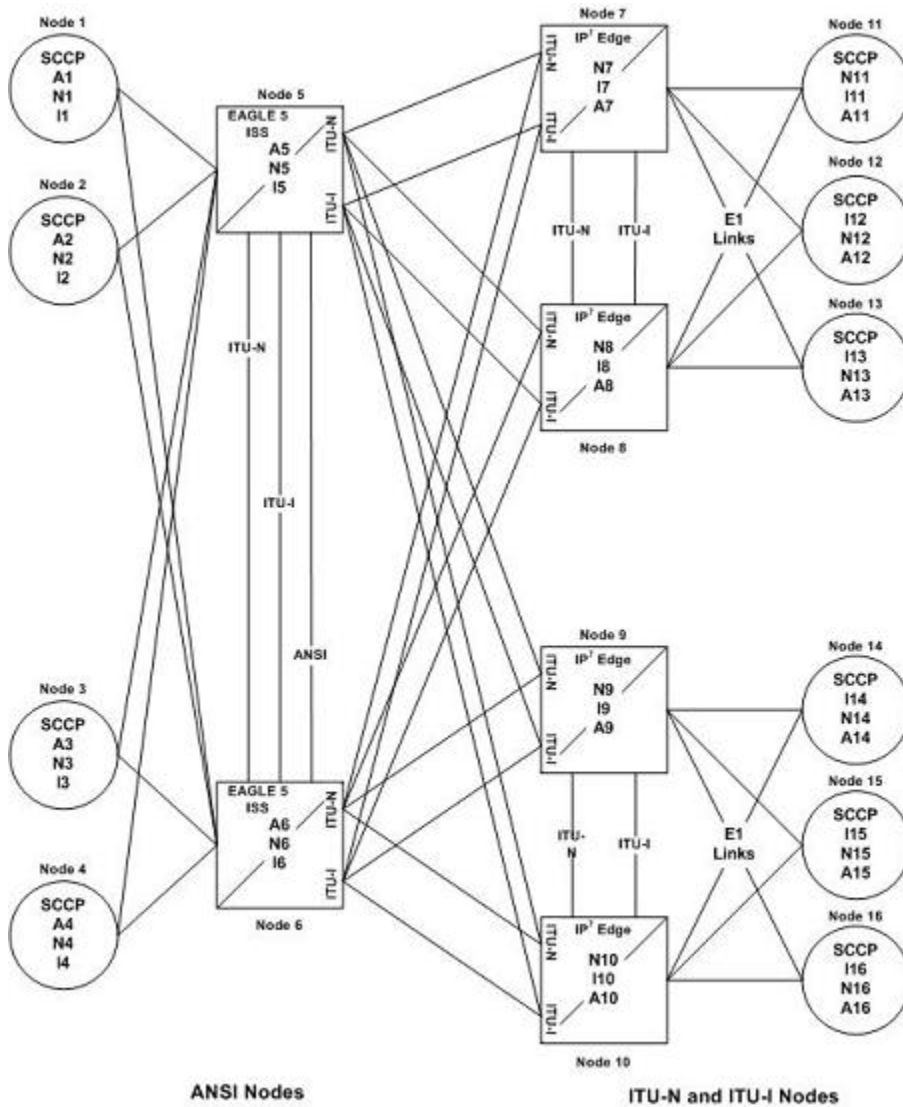


Table 2-8 Nodes and Point Codes in Complex Network Example

Node	Node Type	Network Types Supported	True Point Codes ¹	Alias Point Codes ²
1	SSP	ANSI	A1	N1, I1
2	SSP	ANSI	A2	I2
3	SSP	ANSI	A3	N3, I3
4	SSP	ANSI	A4	N4
5	STP (with IP ⁷ Secure Gateway functionality)	ANSI, ITU-N, ITU-I	A5, N5, I5	
6	STP (with IP ⁷ Secure Gateway functionality)	ANSI, ITU-N, ITU-I	A6, N6, I6	

Table 2-8 (Cont.) Nodes and Point Codes in Complex Network Example

Node	Node Type	Network Types Supported	True Point Codes ¹	Alias Point Codes ²
7	STP (with IP ⁷ Secure Gateway functionality)	ITU-N, ITU-I	N7, I7	A7
8	STP (with IP ⁷ Secure Gateway functionality)	ITU-N, ITU-I	N8, I8	A8
9	STP (with IP ⁷ Secure Gateway functionality)	ITU-N, ITU-I	N9, I9	A9
10	STP (with IP ⁷ Secure Gateway functionality)	ITU-N, ITU-I	N10, I10	A10
11	SSP	ITU-N	N11	I11, A11
12	SSP	ITU-I	I12	N12, A12
13	SSP	ITU-I	I13	N13, A13
14	SSP	ITU-N	N14	I14, A14
15	SSP	ITU-I	I15	N15, A15
16	SSP	ITU-I	I16	N16, A16

Notes: 1. A true point code (**TPC**) defines a destination in the EAGLE's destination point code table. **A TPC is a unique identifier of a node in a network.** An STP (with IP⁷ Secure Gateway functionality) must have a TPC for each network type that the EAGLE connects to. An SSP connects to only one type of network, so it has only one TPC.

2. An alias point code is used to allow nodes in other networks to send traffic to and from a EAGLE when that EAGLE does not have a TPC for the same network type.

The configured links and point codes in the complex network shown in [Figure 2-11](#) allows most nodes to communicate with other nodes. However, note that Node 2 cannot communicate with Node 13 or Node 16, or with any node in the ITU-N network because Node 2 does not have an ITU-N alias point code.

Routing and Conversion Within a Single Network Type

The following steps demonstrate how an **EAGLE** routes and converts when an **ITU-N** node sends an **MSU** to another **ITU-N** node. For example, assume that Node 11 in [Figure 2-11](#) sends an **MSU** to Node 14. The **MSU** is routed from Node 11 to Node 7 to Node 5 to Node 9 to Node 14. The following steps describe the actions performed at Node 5 (an **STP** with IP⁷ Secure Gateway functionality):

1. An **ITU-N** formatted **MSU** (which has a network identifier=01b and a 14-bit destination point code/originating point code) is received on an `iplimi` card (for this example at location 1103).
2. **MSU** discrimination is performed with the following substeps:
 - a. Compare the received network identifier (**NI**) to the list of valid **NIs**. (Each configured linkset for a receiving link has a defined list of valid **NIs**.) If the comparison fails, the **MSU** is discarded and an **STP** measurement is logged. In this example, the received **NI** (01b) is valid for an `iplimi` card.
 - b. Extract the **NI** and destination point code (**DPC**) from the received **MSU**.
 - c. Determine whether the destination of the received **MSU** is this **STP**. If not (as is the case in this example), the **MSU** is passed to the **STP**'s routing function.

3. The routing function selects which outgoing link to use by searching a routing table for an entry for the **DPC** (N14 in this example). The routing table identifies another `iplimi` card (for this example at location 1107) to be used for the outgoing link.
4. Determine whether **MSU** conversion is required (required when the source network type is not the same as the destination network type). In this example, both Node 11 and Node 14 are **ITU-N** nodes, so conversion is not required.
5. Forward the **MSU** across the Interprocessor Message Transport (**IMT**) bus from location 1103 to location 1107, where the **MSU** is transmitted out the link towards Node 14.

Routing and Conversion Between Different Network Types

The routing and conversion steps performed by a **EAGLE** when an **ITU-N** node sends an **MSU** to an **ITU-I** node are the same as the steps shown in the [Routing and Conversion Within a Single Network Type](#) section, except for the conversion step.

For example, assume that Node 11 in [Figure 2-11](#) sends an **MSU** to Node 16. The **MSU** is routed from Node 11 to Node 7 to Node 5 to Node 9 to Node 16. The following steps describe the actions performed at Node 5 (an **EAGLE** with IP⁷ Secure Gateway functionality):

1. Perform step 1 through step 3 as shown in the [Routing and Conversion Within a Single Network Type](#) section. In this example, assume that the routing function determines that the outgoing link is configured on the **IP** card at location 1203.
2. Determine whether **MSU** conversion is required (required when the source network type is not the same as the destination network type). In this example, Node 11 is an **ITU-N** node and Node 16 is an **ITU-I** node, so conversion is required. Conversion consists of two phases: **Message Transfer Part (MTP)** conversion and user part conversion.
3. Perform **MTP** conversion (also known as routing label conversion). The following parts of the **MSU** can be affected by **MTP** conversion:
 - Length indicator — for **ITU-N** to **ITU-I** conversion, the length of the **MSU** does not change
 - **Service Information Octet (SIO)**, Priority — for conversion to **ITU**, the priority is set to 0. For conversion to **ANSI**, the priority is set to a default of 0, which can later be changed based on user part conversion.
 - **Service Information Octet (SIO)**, Network Indicator — the **NI** bits are set to the **NI** value for the destination node. In this example, **NI** is set to 00b.
 - Routing Label, **Destination Point Code (DPC)** — the **DPC** is replaced with the destination's true point code. In this example, N16 is replaced by I16.
 - Routing Label, **Originating Point Code (OPC)** — the **OPC** is replaced with the appropriate network type's alias point code for the originating node. In this example, N11 is replaced with I11.
 - Routing Label, **Signaling Link Selector (SLS)** — no **SLS** conversion is required between **ITU-I** and **ITU-N** nodes. However, if one of the nodes were an **ANSI** node, conversion would be required between a 5-bit or 8-bit **SLS** for **ANSI** nodes and a 4-bit **SLS** for **ITU** nodes.
4. Perform user part conversion, if necessary. Currently, only **SCCP** traffic and only network management messages have the **Message Transfer Part (MTP)** converted. All other user parts have their data passed through unchanged.
5. Forward the **MSU** across the Interprocessor Message Transport (**IMT**) bus from location 1103 to location 1203, where the **MSU** is transmitted out the link towards Node 16.

2.8 IETF Adapter Layer Support

2.8.1 Overview

The current implementation of the **IETF** adapter layers in the **EAGLE** uses three adapter layers: **SUA**, **M3UA**, and **M2PA**. These adapter layers are assigned to **SCTP** associations which define the connection to the far end. An **SCTP** association is defined in the **EAGLE** by the local host name, the local **SCTP** port, the remote host name, and the remote **SCTP** port.

The three adapter layers used in the **EAGLE** are supported depending on the type of **IP** card being used for the **IP** connection. The **SUA** and **M3UA** adapter layers can be used only on **IPGWx** cards (cards running either the **SS7IPGW** or **IPGWI** applications). The **M2PA** adapter layer can be used only on **IPLIMx** cards (cards running either the **IPLIM** or **IPLIMI** applications).

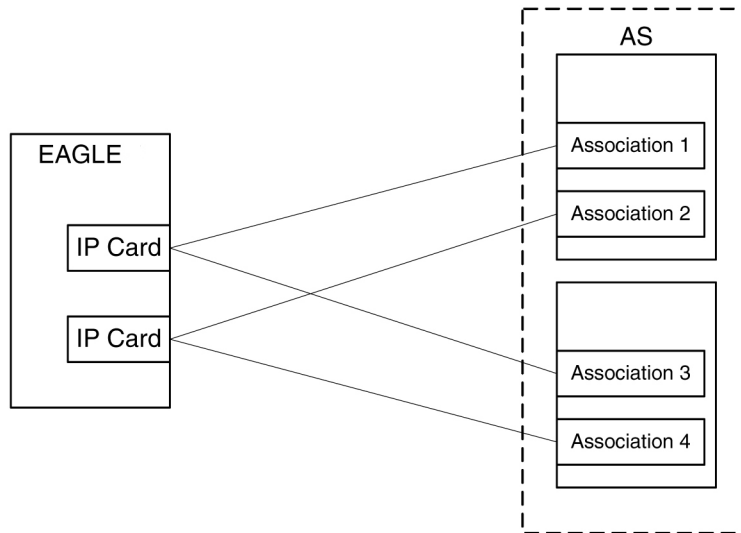
SCTP associations on **IPGWx** cards use routing keys to distinguish between the **IP** devices being connected to. **SCTP** associations cannot be assigned directly to routing keys. To get an **SCTP** association ultimately assigned to a routing key, the **IETF** adapter layers use the concept of the application server (**AS**). The **SCTP** association is assigned to an application server. One or more associations are normally actively processing traffic. A group of associations (up to 16) can be assigned to an application server. An application server, a logical entity serving a specific routing key, is assigned to a routing key. This results in assigning the **SCTP** association, up to a maximum of 16, to a routing key.

The **IETFSUA** and **M3UA** adapter layers are supported on **IPGWx** cards. These adapter layers support the full implementation of the **AS** and routing key for the **EAGLE**. **SCTP** associations assigned to **IPGWx** cards can be assigned to application servers and routing keys.

The **IETFM2PA** adapter layer is supported on **IPLIMx** cards. The **M2PA** adapter layer does not support application servers, therefore **SCTP** associations assigned to **M2PA** links on **IPLIMx** cards cannot be assigned to application servers.

[Figure 2-12](#) shows a typical configuration with four connections (**SCTP** associations) out of the **EAGLE** using **IPGWx** cards. Each association is connected to a process on the far end.

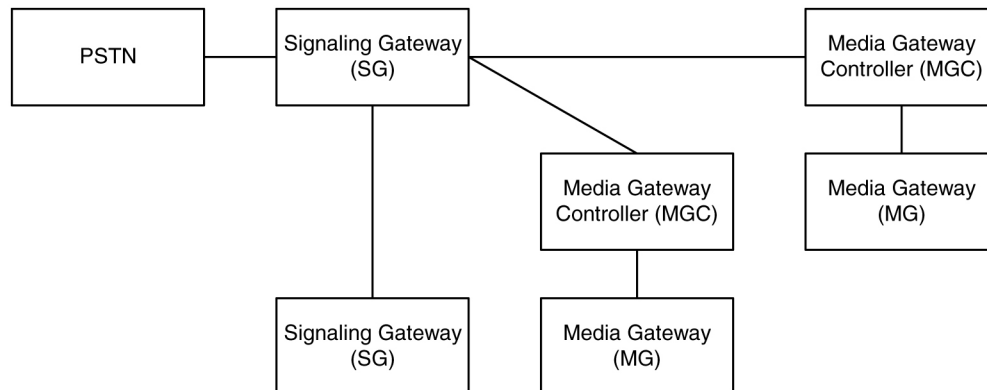
Figure 2-12 AS/Association Relationship



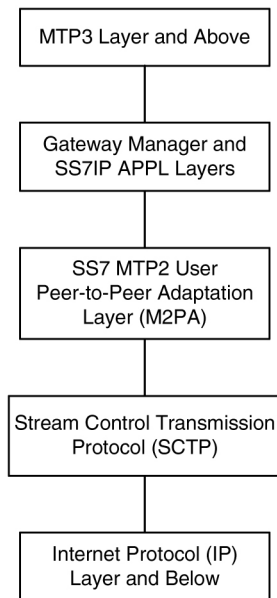
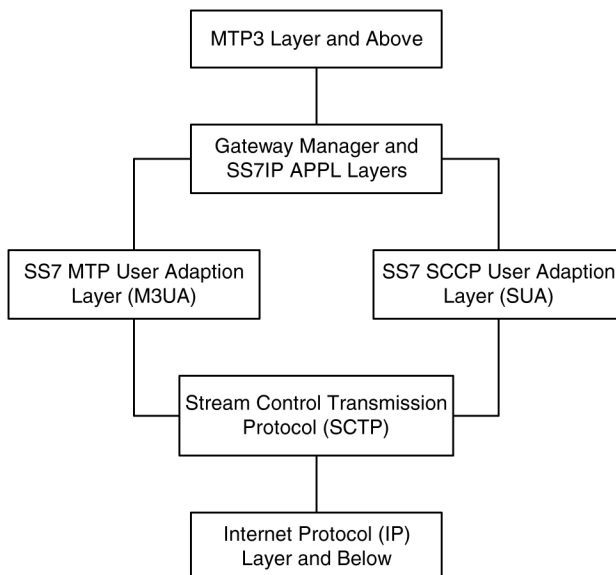
Feature Components

The **EAGLE** with **IP⁷** Secure Gateway functionality is used as a signaling gateway between the **PSTN** and **IP** networks as shown in [Figure 2-13](#). This figure shows that signaling gateways interface with media gateway controllers (**MGCs**) and **MGCs** interface with media gateways (**MGs**).

Figure 2-13 SG/MGC/MG Network Diagram



To provide a signaling gateway solution that will be able to communicate with a larger number of **IP** devices, the **EAGLE** needs to be able to communicate with multiple **MGCs** which are using **SCTP** as the transport layer and **M3UA**, **M2PA**, or **SUA** as an adapter layer. On an **IPLIMx** card, the **M2PA** adapter layer can be used with **SCTP** as shown in [Figure 2-14](#). On an **IPGWx** card, the **M3UA** and **SUA** adapter layers can be used with **SCTP** as shown in [Figure 2-15](#).

Figure 2-14 IPLIMx Protocol Stack with SCTP as the Transport Layer**Figure 2-15 IPGWx Protocol Stack with SCTP as the Transport Layer**

SUA Layer

The **SUA** layer, only supported on **IP** cards running either the **SS7IPGW** or **IPGWI** applications (**IPGWx** cards), was designed to fit the need for the delivery of **SCCP**-user messages (**MAP** & **CAP** over **TCAP**, **RANAP**, etc.) and new third generation network protocol messages over **IP** between two signaling endpoints. Consideration is given for the transport from an **SS7** signaling gateway to an **IP** signaling node (such as an **IP**-resident database). This protocol can also support transport of **SCCP**-user messages between two endpoints wholly contained within an **IP** network. The layer is expected to meet the following criteria:

- Support for transfer of **SS7SCCP**-User Part messages (for example, **TCAP**, **RANAP**, etc.)
- Support for **SCCP** connectionless service.
- Support for the seamless operation of **SCCP**-User protocol peers
- Support for the management of **SCTP** transport associations between a signaling gateway and one or more **IP**-based signaling nodes).
- Support for distributed **IP**-based signaling nodes.
- Support for the asynchronous reporting of status changes to management

Depending upon the **SCCP**-users supported, the **SUA** layer supports the four possible **SCCP** protocol classes transparently. The **SCCP** protocol classes are defined as follows:

- Protocol class 0 provides unordered transfer of **SCCP**-user messages in a connectionless manner.
- Protocol class 1 allows the **SCCP**-user to select the in-sequence delivery of **SCCP**-user messages in a connectionless manner.
- Protocol class 2 allows the bi-directional transfer of **SCCP**-user messages by setting up a temporary or permanent signaling connection.
- Protocol class 3 allows the features of protocol class 2 with the inclusion of flow control. Detection of message loss or mis-sequencing is included.

Protocol classes 0 and 1 make up the **SCCP** connectionless service. Protocol classes 2 and 3 make up the **SCCP** connection-oriented service.

The **SUA** layer supports the following **SCCP** network management functions:

- Coord Request
- Coord Indication
- Coord Response
- Coord Confirm
- State Request
- State Indication
- Pcstate Indication

The **SUA** layer provides interworking with **SCCP** management functions at the signaling gateway for seamless inter-operation between the **SCN** network and the **IP** network. This means:

- An indication to the **SCCP**-user at an application server process that a remote **SS7** endpoint/peer is unreachable.
- An indication to the **SCCP**-user at an application server process that a remote **SS7** endpoint/peer is reachable.
- Congestion indication to **SCCP**-user at an application server process.
- The initiation of an audit of remote **SS7** endpoints at the signaling gateway.

M3UA Layer

The **M3UA** layer, supported on only **IPGWx** cards, was designed to fit the need for signaling protocol delivery from an **SS7** signaling gateway to a media gateway controller (**MGC**) or **IP**-resident database. The layer is expected to meet the following criteria:

- Support for the transfer of all **SS7MTP3**-User Part messages (for example, **ISUP**, **SCCP**, **TUP**, etc.)
- Support for the seamless operation of **MTP3**-User protocol peers
- Support for the management of **SCTP** transport associations and traffic between a signaling gateway and one or more **MGCs** or **IP**-resident databases
- Support for **MGC** or **IP**-resident database process fail-over and load-sharing
- Support for the asynchronous reporting of status changes to management

The **M3UA** layer at an application server provides a set of primitives at its upper layer to the **MTP3**-Users that is the equivalent of those provided by the **MTP** Level 3 to its local users at an **SS7 SEP**. In this way, the **ISUP** or **SCCP** layer at an application server process is unaware that the expected **MTP3** services are offered remotely from an **MTP3** Layer at a signaling gateway, and not by a local **MTP3** layer. The **MTP3** layer at a signaling gateway may also be unaware that its local users are actually remote user parts over the **M3UA** layer. The **M3UA** layer extends access to the **MTP3** layer services to a remote **IP**-based application. The **M3UA** layer does not provide the **MTP3** services.

The **M3UA** layer provides the transport of **MTP-TRANSFER** primitives across an established **SCTP** association between a signaling gateway and an application server process and between **IPSPs**. The **MTP-TRANSFER** primitives are encoded as **MTP3**-User messages with attached **MTP3** Routing Labels as described in the message format sections of the **SCCP** and **ISUP** recommendations. In this way, the **SCCP** and **ISUP** messages received from the **SS7** network are not re-encoded into a different format for transport to or from the server processes. All the required **MTP3** Routing Label information (**OPC**, **DPC**, and **SIO**) is available at the application server process and the **IPSP** as is expected by the **MTP3**-User protocol layer.

At the signaling gateway, the **M3UA** layer also provides inter-working with **MTP3** management functions to support seamless operation of the signaling applications in the **SS7** and **IP** domains. This includes:

- Providing an indication to **MTP3**-Users at an application server process that a remote destination in the **SS7** network is not reachable.
- Providing an indication to **MTP3**-Users at an application server process that a remote destination in the **SS7** network is now reachable.
- Providing an indication to **MTP3**-Users at an application server process that messages to a remote **MTP3**-User peer in the **SS7** network are experiencing **SS7** congestion
- Providing an indication to **MTP3**-Users at an application server process that a remote **MTP3**-User peer is unavailable.

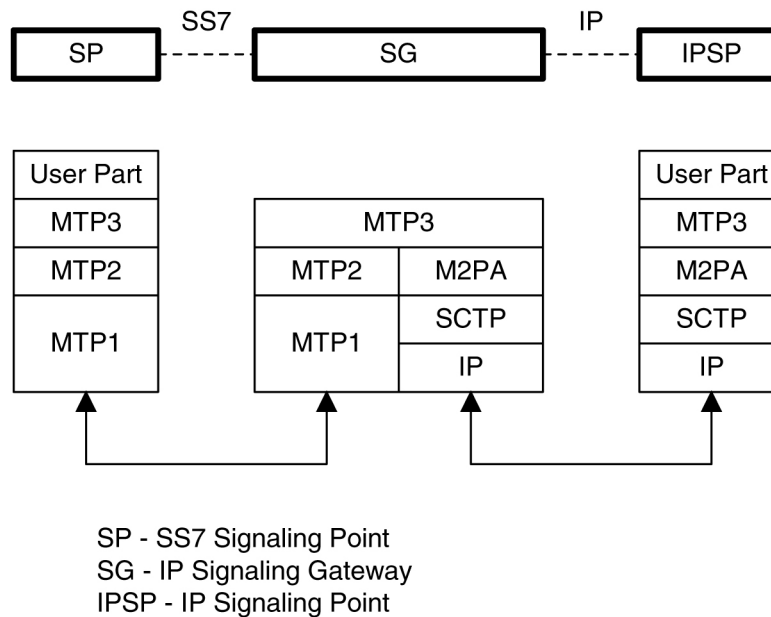
The **M3UA** layer at the signaling gateway maintains the availability of all configured remote application server processes, in order to manage the **SCTP** Associations and the traffic between the signaling gateway and application server processes. As well, the Active/Inactive state of remote application server processes is also maintained - Active application server processes are those currently receiving traffic from the signaling gateway.

M2PA Layer

The **M2PA** layer, supported only on **IPLIMx** cards, is a peer-to-peer protocol and provides mappings for all **SS7** messages. In a peer-to-peer mode, either side of the **IP** connection may initiate the connection.

The **M2PA** layer lies below **MTP3** in the protocol stack. [Figure 2-16](#) shows the protocol layers in three interconnected nodes involving the **M2PA** layer.

Figure 2-16 M2PA in the IP⁷ Signaling Gateway



The **M2PA** layer receives the primitives sent from **MTP3** to its lower layer. The **M2PA** layer processes these primitives or maps them to appropriate primitives at the **M2PA/SCTP** interface. Likewise, the **M2PA** layer sends primitives to **MTP3** like those used in the **MTP3/MTP2** interface.

The **M2PA** layer provides **MTP2** functionality that is not provided by **SCTP**. This includes:

- Reporting of link status changes to **MTP3**
- Processor outage procedure
- **Link** alignment procedure

The **M2PA** layer allows **MTP3** to perform all of its Message Handling and Network Management functions with **IPSPs** as with other **SS7** nodes.

The **M2PA** layer also supports full retrieval because it assigns sequence numbers to all protocol messages and provides for acknowledgements from the **M2PA** peer. This means that an **M2PA** signaling link is able to execute the Change-Over and Change-Back procedures. The **M2PA** layer makes use of the **SS7** Extended **Changeover (XCO)** and **SS7** Extended **Changeover** Acknowledgement (**XCA**) messages in order to communicate 24-bit sequence numbers with the peer.

SCTP

SCTP is a protocol designed to operate on top of a non-reliable protocol such as **IP**, while providing a reliable data delivery to the **SCTP** user. The **SCTP** protocol is designed to be a discrete protocol.

Although **SCTP** is similar in some respects to the Transport Control Protocol (**TCP**), it differs in several key areas. The two protocols are similar in that they both provide reliable data

delivery over a non-reliable network protocol (**IP**). The **SCTP** protocol is a more robust and higher performance protocol than **TCP**.

Broader Definition of Connection Four-Tuple

The **TCP** protocol defines a connection via a four-tuple – a specific local **IP** address, local transport protocol port, a specific remote host **IP** address and remote transport protocol port. The **TCP** connection is point-to-point and once the session is established the four-tuple can not change. **SCTP** uses a similar four-tuple concept, but provides for the local and remote **IP** address values to be a list of **IP** addresses. **SCTP** allows a multi-homed host, with multiple network interfaces and more than one way to reach the far-end host, the capability to make use of this additional network connectivity to support the transport of data via the **SCTP** protocol. Redundancy through the support of multi-homing session end-points is a major **SCTP** advantage.

Multiple Streams

TCP is a point-to-point byte stream oriented transport protocol. In such a protocol if a single byte is corrupted or lost, then all data that follows must be queued and delayed from delivery to the application until the missing data is retransmitted and received to make the stream valid. With the **TCP** protocol, all data being transmitted is affected because there is only one path from end-to-end. The **SCTP** protocol addresses this limitation by providing the capability to specify more than one transport path between the two end-points. In **SCTP**, the four-tuple – with the multi-homing feature – defines what the **SCTP** protocol calls an *association*.

The association is composed of one or more uni-directional transport paths called *streams*. The number of inbound and outbound streams is independent of one another and is determined at session initiation time (for example, an association may be composed of three outbound and one inbound stream). In this scheme, a data retransmission only affects a single stream. If an association is defined with multiple streams and a packet is lost on a specific stream, data transmission on the other streams, which form this association, is not blocked. However, this feature is only beneficial if the upper layer application uses it.

In the **EAGLE**, a maximum of 2 inbound and 2 outbound streams can be defined for an association. Stream 0 in each direction is designated for **Link** Status messages. Stream 1 is designated for User Data messages. Separating the **Link** Status and User Data messages onto separate streams allows the adapter layer to prioritize the messages in a manner similar to **MTP2**. If the peer chooses to configure the association to have only one stream, then the signaling gateway will be able to use only stream 0 for both **Link** Status messages and User Data messages.

Datagram Stream

While **TCP** is implemented as a byte-oriented stream protocol, **SCTP** is based on a datagram-oriented protocol stream. By choosing the datagram as the smallest unit of transport, the **SCTP** protocol removes the need for the upper layer application to encode the length of a message as part of the message. An **SCTP** send results in the data being sent as a unit – a datagram – and received at the receiving node as a datagram.

Selective Acknowledgements

TCP acknowledgements are specified as the last consecutive byte in the byte stream that has been received. If a byte is dropped, the **TCP** protocol on the receiving side cannot pass inbound data to the user until the sender retransmits the lost byte; the

stream is blocked. **SCTP** uses a feature known as *selective acknowledgement* in which each data chunk is identified by a chunk number – the Transmission Sequence Number (**TSN**) in **SCTP** terminology – and is explicitly acknowledged at a data chunk granularity. This means that if a data chunk is dropped, only that one data chunk needs to be retransmitted. In **SCTP**, a dropped data chunk only effects one stream, since ordered transmission of data is only enforced at the stream and not the association level.

Un-order Delivery Capability

The **SCTP** protocol provides a mechanism for un-ordered datagram delivery. This feature means that a datagram can be transmitted and received independent of datagram sequencing and thus not delayed while awaiting a retransmission. **TCP** does not provide an equivalent feature of this type.

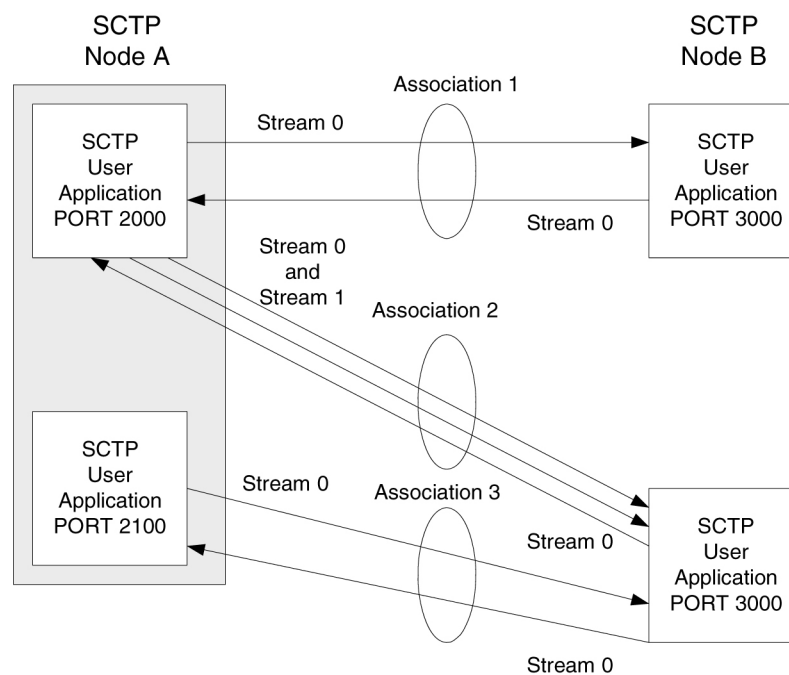
Enhanced Security

The **TCP** protocol has a known and easily exploitable vulnerability to denial of service attacks (for example, **SYN** attacks). This weakness is due to the three-way handshake used by the **TCP** session-establishment protocol. The **TCP** session establishment method causes **EAGLE** resources to be committed prior to actually establishing the session. **SCTP** uses a four-way handshake where resources are not committed by the host being contacted until the contacting host confirms that it is actually making a contact request to prevent such attacks.

SCTP Connectivity Concepts

The basic connectivity provided by the **SCTP** protocol is illustrated by [Figure 2-17](#):

Figure 2-17 SCTP Connectivity



Key elements of the **SCTP** connection include:

- **SCTP** Instance

- **SCTP** Endpoint
- **SCTPAssociation**
- **SCTP** Stream

An **SCTP** instance is defined by the local **SCTP** port number. Each local **SCTP** port number requires its own **SCTP** instance. An **SCTP** instance as an entity defines the various **SCTP** characteristics that will apply to “all” **SCTP** associations that are created as part of the **SCTP** instance. These include timeout values, maximum receive windows, and so forth.

In [Figure 2-17](#) there are three hosts: **SCTP** node A, node B and node C. Node A has two **SCTP** instances: local **SCTP** port 2000 and 2100. Both node B and node C have a single **SCTP** instance, local **SCTP** port 3000 and 3000 respectively. The fact that both node B and C are using port 3000 does not tie them together in any way.

An **SCTP** endpoint is defined as the logical sender/receiver of **SCTP** packets. On a multi-homed host, an **SCTP** endpoint is represented to its peers as a combination of a set of eligible destination transport addresses to which **SCTP** packets can be sent and a set of eligible source transport addresses from which **SCTP** packets can be received. All transport addresses used by an **SCTP** endpoint must use the same port number, but can use multiple **IP** addresses. A transport address used by an **SCTP** endpoint must not be used by another **SCTP** endpoint. In other words, a transport address is unique to an **SCTP** endpoint.

The concept of **SCTP** instance clarifies this definition. In [Figure 2-17](#), **IP** addresses are not shown, but to illustrate this definition, assume the following:

- Node A is multi-homed having two network interface cards with **IP** addresses 192.168.110.10 and 192.168.55.10
- Node B has a single network interface card with **IP** address of 192.168.110.20
- Node C is multi-homed having two network interface cards with **IP** addresses 192.168.110.30 and 192.168.55.30

Based on these **IP** addresses from above and the defined port numbers for [Figure 2-17](#), there are four **SCTP** endpoints ([Table 2-9](#)).

Table 2-9 Sample SCTP Endpoints

Node	Local IP Address	Local SCTP Port
Node-1	192.168.110.10	2000
	192.168.55.10	
Node-1	192.168.110.10	2100
	192.168.55.10	
Node-2	192.168.110.20	3000
Node-3	192.168.110.30	3000
	192.168.55.30	

An **SCTP** association is defined as a protocol relationship between **SCTP** endpoints, composed of the two **SCTP** endpoints and protocol state information including verification tags and the currently active set of Transmission Sequence Numbers (**TSNs**), etc. An association can be uniquely identified by the transport addresses used by the endpoints in the association. Two **SCTP** endpoints must not have more than one **SCTP** association between them at any given time.

Based on this definition, given the endpoints listed above and [Figure 2-17](#), there are three defined **SCTP** associations.

Table 2-10 Sample SCTP Associations

Association	Local IP Address	Local SCTP Port	Remote IP Address	Remote SCTP Port
Association-1	192.168.110.10	2000	192.168.110.20	3000
	192.168.55.10			
Association-2	192.168.110.10	2000	192.168.110.30	3000
	192.168.55.10			
Association-3	192.168.110.10	2100	192.168.110.30	3000
	192.168.55.10			

An **SCTP** stream is defined as a uni-directional logical channel established from one to another associated **SCTP** endpoint, within which all user messages are delivered in sequence except for those submitted to the unordered delivery service.



Note:

The relationship between stream numbers in opposite directions is strictly a matter of how the applications use them. It is the responsibility of the **SCTP** user to create and manage these correlations if they are so desired.

Based on this definition and [Figure 2-17](#), there are a total of seven streams for the three associations.

Table 2-11 Sample SCTP Associations

Association	Stream Number	Local IP Address	Local SCTP Port	Remote IP Address	Remote SCTP Port
Association-1	Stream 0 Out	192.168.110.10	2000	192.168.110.20	3000
		192.168.55.10			
Association-1	Stream 0 In	192.168.110.10	2000	192.168.110.20	3000
		192.168.55.10			
Association-2	Stream 0 Out	192.168.110.10	2000	192.168.110.30	3000
		192.168.55.10			
Association-2	Stream 1 Out	192.168.110.10	2000	192.168.110.30	3000
		192.168.55.10			
Association-2	Stream 0 In	192.168.110.10	2000	192.168.110.30	3000
		192.168.55.10			
Association-3	Stream 0 Out	192.168.110.10	2100	192.168.110.30	3000
		192.168.55.10			
Association-3	Stream 0 In	192.168.110.10	2100	192.168.110.30	3000
		192.168.55.10			

2.9 IP Signaling Gateway (IPSG)

The IP Signaling Gateway (IPSG) feature provides a signaling gateway (**SG**) application as an alternative to the IPLIM and IPGW applications. However, the IPLIM and IPGW applications continue to be supported.

The IPSG feature can run the M2PA and M3UA protocols simultaneously on the same card. They can also have GTT-enabled capabilities support with SLIC running the 64-bit IPSG GPL. The feature also supports ANSI, ITU-N or ITUN-24, and ITU-I simultaneously on one card and one association.

The IPSG feature runs on the E5-ENET-B and SLIC cards with the IPSG application. An E5-ENET-B or SLIC card running the IPSG application is referred to as an IPSG card.

For the M3UA protocol, the IPSG feature equates a linkset with an application server (**AS**) and equates a signaling link with an application-server/application server process instance (**AS-ASP**).

Note:

The following M3UA application server (AS) procedures are not currently supported by the IP Signaling Gateway (IPSG):

- AS Pending procedure with non-zero T(recovery) timer
- AS Override traffic mode

The connection to the remote host is provided by IPSG M3UA and IPSG M2PA signaling links. An IPSG M3UA signaling link is a signaling link that is assigned to an IPSG linkset whose `ADAPTER` value is `m3ua`. An IPSG M2PA signaling link is a signaling link that is assigned to an IPSG linkset whose `ADAPTER` value is `m2pa`. A maximum of 128 IPSG M2PA or IPSG M3UA signaling links are supported per IPSG card running on SLIC hardware.

The IPSG M2PA signaling link can run the ANSI or ITU protocol, but not both simultaneously. ANSI and ITU can run on the same IPSG card on separate IPSG M2PA signaling links. ANSI and ITU can run on the same IPSG M3UA signaling link.

A series of three IS-NR link count thresholds are used to control the transition of the IPSG-M3UA links between Allowed, Restricted, and Prohibited states.

M2PA links on IPLIMx and IPSG cards can exist in the same linkset. M3UA links on IPSG and IPGWx cards cannot exist in the same linkset. M2PA and M3UA links cannot exist within the same linkset.

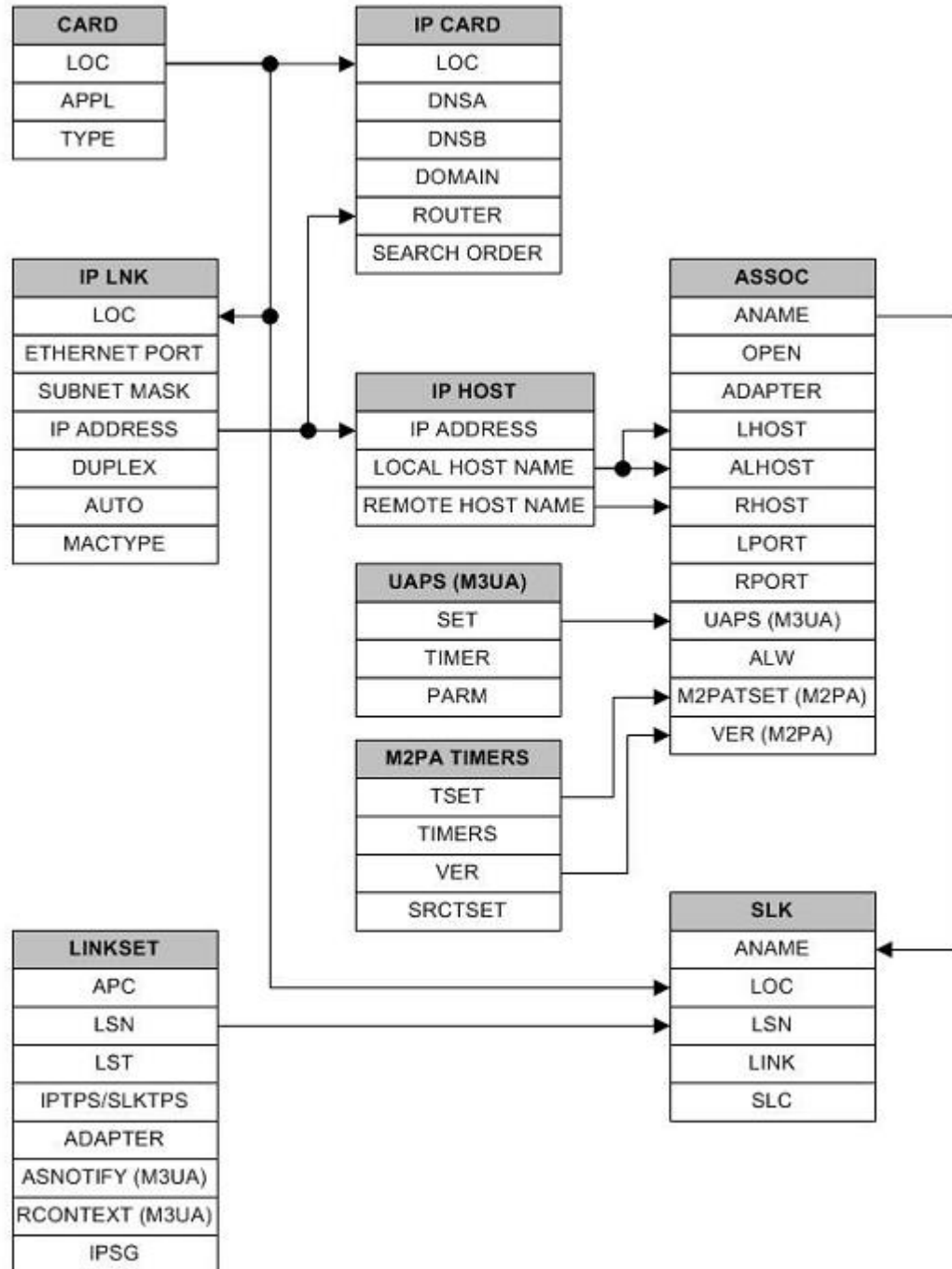
Each IPSG card running on SLIC hardware can host up to 128 SCTP associations. A maximum of 16 M3UA links or 1 M2PA link can be assigned to an association. M3UA and M2PA cannot be mixed on the same association.

The SCTP ADLER-32 or CRC-32 checksum algorithm can be selected for an individual IPLIM, IPGW, or IPSG card.

The adjacent point code (**APC**) of the IPSG-M3UA linkset is the point code assigned to an AS.

Provisioning for the IP Signaling Gateway feature uses the card, linkset, signaling link, IP card, IP link, IP host, and association database entities. The relationship between these entities is shown in [Figure 2-18](#). The provisioning for the IP Signaling Gateway feature is shown in [IPSG M2PA and M3UA Configuration Procedures](#).

Figure 2-18 IP Signaling Gateway Database Relationships



3

IETF M2PA Configuration Procedures

Chapter 3, IETF M2PA Configuration Procedures, describes the procedures necessary to configure the components necessary to establish IP connections using M2PA associations on IPLIMx signaling links.

3.1 Adding IETF IPLIMx Components

This section describes how to configure the components necessary to establish **IP** connections using **M2PA** associations on **IPLIMx** signaling links. **IPLIMx** signaling links are signaling links assigned to cards running either the **IPLIM** or **IPLIMI** applications. The **IPLIM** application supports point-to-point connectivity for **ANSI** networks. The **IPLIMI** application supports point-to-point connectivity for **ITU** networks.

The configuration of these **IP** connections consists of these items.

1. Configure the **IPLIMx** card with the [Adding an IPLIMx Card](#) procedure.
2. Configure the required destination point codes - see Chapter 2, "Configuring Destination Tables," in *Database Administration - SS7 User's Guide*.
3. Configure the required **IPLIMx** linksets - see Chapter 3, "**SS7** Configuration," in *Database Administration - SS7 User's Guide*.
4. Configure the **IPLIMx** signaling links with the [Adding an IPLIMx Signaling Link](#) procedure. The `ipliml2=m2pa` parameter of the `ent-slk` command must be specified for these signaling links. If the addition of these signaling links will exceed the current number of signaling links the **EAGLE** is allowed to have, the [Enabling the Large System # Links Controlled Feature](#) procedure will have to be performed to increase the quantity of signaling links.
5. Configure the required routes - see Chapter 3, "SS7 Configuration," in the *Database Administration - SS7 User's Guide*.
6. **IP** addresses must be assigned to the **IPLIMx** card configured in step 1 by performing the [Configuring an IP Link](#) procedure. There are other **IP** link parameters that are assigned to the **IPLIMx** card when the **IPLIMx** card is configured. Default values are assigned to these parameters when the **IPLIMx** card is configured. These values can be displayed by the `rtrv-ip-lnk` command. These values can be changed by performing the [Configuring an IP Link](#) procedure.
7. Local **IP** hosts, assigned to the **IP** addresses assigned to step 6, must be configured in the database by performing the [Adding an IP Host](#) procedure. Verify the hosts with the `rtrv-ip-host` command. This establishes a relationship between the **IP** card related information and the connection related information.
8. When the **IP** cards are added to the database in step 1, there are **IP** parameters that control the **IP** stack that are assigned default values. These parameter values can be displayed by the `rtrv-ip-card` command. These values can be changed by performing the [Configuring an IP Card](#) procedure.

9. Static IP routes provide more flexibility in selecting the path to the remote destination and reduces the dependence on default routers. Static IP routes are provisioned by performing the [Adding an IP Route](#) procedure.
10. Associations specify a connection between a local host/TCP port and a remote host/TCP port. Three types of associations can be provisioned: **M2PA**, **M3UA**, and **SUA**. Associations that are assigned to **IPLIMx** signaling links must be **M2PA** associations. The `ipliml2=m2pa` parameter must be assigned to the signaling link that is assigned to an **M2PA** association. The **M2PA** association is configured by performing the [Adding an M2PA Association](#) procedure. **M3UA** and **SUA** associations are provisioned with the [Adding an M3UA or SUA Association](#) procedure. Associations can be assigned to IPSPG signaling links also. These associations are configured by performing the [Adding an IPSPG M2PA Association](#) or [Adding an IPSPG M3UA Association](#) procedures. A number of fields in the association cannot be configured with the [Adding an M2PA Association](#) procedure and are set to default values. The values of these fields can be displayed using the `rtrv-assoc` command after the [Adding an M2PA Association](#) procedure is performed. These values can be changed by performing the [Adding an M2PA Association](#) procedure. An **IPLIMx** card can have one association for each signaling link assigned to the card.
11. There are two versions of **M2PA** associations, **RFC** and Draft 6, that can be configured in the database. When an **M2PA** association is added to the database with [Adding an M2PA Association](#) procedure, the association is configured as an **RFC M2PA** association. The **RFC** version of **M2PA** timer set 1 is also assigned to the association when the **M2PA** association is added to the database.

There are two different versions, **RFC** and Draft 6, of **M2PA** timer sets that can be assigned to **M2PA** associations. Each version of the **M2PA** timer sets contains 20 timer sets. The values of these timer sets can be changed with the [Changing a M2PA Timer Set](#) procedure.

The version of the **M2PA** association and the **M2PA** timer set assigned to the association can be changed with [Adding an M2PA Association](#) procedure. The **M2PA** version of the association determines the version of the **M2PA** timer set that is assigned to the association. For example, if **M2PA** timer set 3 is assigned to the **M2PA** association, and the association is an **RFC M2PA** association, the **RFC** version of **M2PA** timer set 3 is used with the association. If **M2PA** timer set 7 is assigned to the **M2PA** association, and the association is a Draft 6 **M2PA** association, the Draft 6 version of **M2PA** timer set 7 is used with the association.
12. The EAGLE processes messages with a service information field (**SIF**) that is 272 bytes or smaller. The Large MSU Support for IP Signaling feature allows the EAGLE to process messages with a service indicator value of 6 to 15 and with a **SIF** that is larger than 272 bytes. Perform the [Activating the Large MSU Support for IP Signaling Feature](#) procedure to enable and turn on the Large MSU Support for IP Signaling feature.

3.2 Adding an IPLIMx Card

This procedure is used to add an **IPLIMx** card to the database using the `ent-card` command. An **IPLIMx** card runs either the **IPLIM** or **IPLIMI** applications. A maximum of 100 **IPLIMx** cards can be provisioned in the database. [Table 3-1](#) shows the cards that can be provisioned in this procedure.

Table 3-1 IPLIMx Card Types

Card Type	Part Number
E5-ENET	870-2212-xx
E5-ENET-B	870-2971-xx

The EAGLE can support a combination of E5-ENET and E5-ENET-B cards.

The `ent-card` command uses these parameters.

`:loc` – The location of the card being added to the database.

`:type` – The type of card being added to the database. For this procedure, the value of this parameter is `dcm`.

`:appl` – The application software that is assigned to the card. For this procedure, the value of this parameter is `iplim` for **ANSI IP** network connections or `iplimi` for **ITU IP** network connections.

`:force` – If the global title translation feature is on, the `force=yes` parameter allows the **LIM** to be added to the database even if the current **SCCP** transactions-per-second threshold is unable to support the additional **SCCP** transaction-per-second capacity created by adding the **IP** card. This parameter is obsolete and is no longer used.

Card Slot Selection

The **E5-ENET** card can be inserted into any card slot, except for card slots that must remain empty to accommodate dual-slot cards, slots 09 and 10 in each shelf, and slots 1113 through 1118.

To provision a E5-ENET card, the shelf containing the E5-ENET card must have HIPR2 cards installed in slots 9 and 10 in that shelf. If HIPR2 cards are not installed in the shelf that the E5-ENET card will occupy, the E5-ENET card will be auto-inhibited when the E5-ENET card is inserted into the shelf. Enter the `rept-stat-gpl:gpl=hipr2` command to verify whether or not **HIPR2** cards are installed in the same shelf as the E5-ENET card being provisioned in this procedure.

Before adding an IPLIMx card, the Eagle STP must have a fan unit, and the fan feature must be turned on. Also, the MFC STP option must be on.

1. Display the cards in the database using the `rtrv-card` command.

This is an example of the possible output. Cards should be distributed throughout the EAGLE for proper power distribution. Refer to *Installation Guide* for the shelf power distribution.

```
rlghncxa03w 09-05-05 08:12:53 GMT 41.0.0
CARD  TYPE      APPL      LSET NAME      LINK SLC LSET NAME      LINK SLC
1101  DSM          VSCCP
1102  TSM          GLS
1113  GSPM        EOAM
1114  TDM-A
1115  GSPM        EOAM
1116  TDM-B
1117  MDAL
1201  LIMDS0      SS7ANSI  sp2             A      0      sp1             B      0
```

```

1203 LIMDSO SS7ANSI sp3 A 0
1204 LIMDSO SS7ANSI sp3 A 1
1206 LIMDSO SS7ANSI nsp3 A 1 nsp4
B 1
1301 LIMDSO SS7ANSI sp6 A 1 sp7
B 0
1302 LIMDSO SS7ANSI sp7 A 1 sp5
B 1
1303 DCM IPLIM ipnode1 A 0 ipnode3
B 1
1305 DCM IPLIM ipnode4 A 0
2101 ENET IPG
2103 ENET IPG
2105 ENET IPG
2107 ENET IPG
2201 DCM IPLIM
2203 DCM IPLIM
2207 DCM IPLIM
2211 DCM SS7IPGW
2213 DCM SS7IPGW
2215 DCM IPGWI
2217 DCM IPGWI
2301 DCM SS7IPGW
2303 DCM SS7IPGW
2305 DCM IPGWI
2307 DCM IPGWI
2311 DCM IPLIMI
2313 DCM IPLIMI

```

Continue the procedure by performing one of these steps.

- If the required unprovisioned card slots (see the section [Card Slot Selection](#)) are shown in the `rtrv-card` output, continue the procedure with [4](#).
 - If the required unprovisioned card slots are not shown in the `rtrv-card` output, [2](#) must be performed.
2. Display the shelves in the database by entering the `rtrv-shlf` command. This is an example of the possible output.

```

rlghncxa03w 08-03-05 08:12:53 GMT 38.0.0
SHELF DISPLAY
FRAME SHELF TYPE
1 1 CONTROL
1 2 EXTENSION
1 3 EXTENSION
2 1 EXTENSION
2 2 EXTENSION
2 3 EXTENSION

```

If all the shelves are provisioned in the database, then the remainder of this procedure cannot be performed. There are no available card slots for the new **IPLIMx** card.

If all the shelves have not been provisioned in the database, continue the procedure with [3](#).

3. Add the required shelf using the `ent-shlf` command with the location of the shelf and the `type=ext` parameter. The shelf location values are 1200, 1300, 2100, 2200, 2300, 3100, 3200, 3300, 4100, 4200, 4300, 5100, 5200, 5300, and 6100. For this example, enter this command.

```
ent-shlf:loc=3100:type=ext
```

When this command has successfully completed, this message should appear.

```
rlghncxa03w 07-05-01 09:12:36 GMT EAGLE5 37.0.0
ENT-SHLF: MASP A - COMPLTD
```

4. Verify that the card to be entered has been physically installed into the proper location (see the section [Card Slot Selection](#)).

Caution:

If the versions of the flash GPLs on the **IPSG** card do not match the flash GPL versions in the database when the **IPSG** card is inserted into the card slot, **UAM 0002** is generated indicating that these **GPL** versions do not match. If **UAM 0002** has been generated, perform the alarm clearing procedure for **UAM 0002** in *Maintenance Guide* before proceeding with this procedure.

Note:

If the card being added in this procedure is not an **E5-ENET** card, continue the procedure with [10](#).

5. Verify that **HIPR2** cards are installed in card locations 9 and 10 in the shelf containing the **E5-ENET** card being added in this procedure. Enter this command.

```
rept-stat-gpl:gpl=hipr2
```

This is an example of the possible output.

```
rlghncxa03w 09-07-05 08:12:53 GMT 41.1.0
GPL          CARD      RUNNING          APPROVED          TRIAL
HIPR2        1109      132-002-000     132-002-000     132-003-000
HIPR2        1110      132-002-000     132-002-000     132-003-000
HIPR2        1209      132-002-000     132-002-000     132-003-000
HIPR2        1210      132-002-000     132-002-000     132-003-000
HIPR2        1309      132-002-000     132-002-000     132-003-000
HIPR2        1310      132-002-000     132-002-000     132-003-000
HIPR2        2109      132-002-000     132-002-000     132-003-000
HIPR2        2110      132-002-000     132-002-000     132-003-000
HIPR2        2209      132-002-000     132-002-000     132-003-000
HIPR2        2210      132-002-000     132-002-000     132-003-000
HIPR2        2309      132-002-000     132-002-000     132-003-000
HIPR2        2310      132-002-000     132-002-000     132-003-000
Command Completed
```

If **HIPR2** cards are installed in the shelf containing the **E5-ENET** card, continue the procedure with [10](#).

If HIPR or HIPR2 cards are not installed on the shelf containing the E5-ENET card, go to *Installation Guide* and install the HIPR2 cards. Once the HIPR2 cards have been installed, continue the procedure with [10](#).

6. Enter the `rtrv-stpopts` command to verify whether or not the MFC option is on.

This is an example of the possible output.

```
rlghncxa03w 11-10-17 16:02:05 GMT EAGLE5 44.0.0
STP OPTIONS
-----
MFC                               off
```

The `rtrv-stpopts` command output contains other fields that are not used by this procedure. To see all fields displayed by the `rtrv-stpopts` command, see the `rtrv-stpopts` command description in *Commands User's Guide*.

If the **MFC** option is off, perform the Configuring the MFC Option procedure in *Database Administration - System Management User's Guide* to turn on the MFC option.

If the MFC option is on or the MFC Option procedure in *Database Administration - System Management User's Guide* was performed in this step, continue the procedure with [7](#).

The Fan feature must be purchased before you turn this feature on with the `chg-feat` command. If you are not sure if you have purchased the Fan feature, contact your Sales Representative or Account Representative.

7. Enter the `rtrv-feat` command to verify that the Fan feature is on.

If the Fan feature is on, shown in either the `rtrv-feat` output in this step or in [7](#), continue this procedure with [9](#).

If [7](#) was not performed, the `FAN` field should be set to `on`.

The `rtrv-feat` command output contains other fields that are not used by this procedure. To see all fields displayed by the `rtrv-feat` command, see the `rtrv-feat` command description in *Commands User's Guide*.

If the Fan feature is off, continue the procedure with [8](#).

8. Turn the Fan feature on by entering this command.

```
chg-feat:fan=on
```

 **Note:**

Once the Fan feature is turned on with the `chg-feat` command, it cannot be turned off.

When the `chg-feat` has successfully completed, this message appears.

```
rlghncxa03w 11-10-28 11:43:04 GMT EAGLE5 44.0.0
CHG-FEAT: MASP A - COMPLTD
```

- The shelf containing the E5-ENET-B card that is being added in this procedure must have fans installed. Verify whether or not fans are installed on the shelf.

If the fans are installed, continue the procedure with [10](#).

If the fans are not installed on the shelf containing the E5-ENET-B card, go to *Installation Guide* and install the fans. After the fans have been installed and tested, continue the procedure with [10](#).

- Add the card using the `ent-card` command. For this example, enter these commands.

```
ent-card:loc=1311:type=dcm:appl=iplim
ent-card:loc=1313:type=dcm:appl=iplimi
```

When each of these commands have successfully completed, this message should appear.

```
rlghncxa03w 06-10-12 09:12:36 GMT EAGLE5 36.0.0
ENT-CARD: MASP A - COMPLTD
```

- Verify the changes using the `rtrv-card` command with the card location specified in [10](#). For this example, enter these commands.

```
rtrv-card:loc=1311
```

This is an example of the possible output.

```
rlghncxa03w 06-10-28 09:12:36 GMT EAGLE5 36.0.0
CARD   TYPE      APPL      LSET NAME      LINK SLC LSET NAME      LINK SLC
1311   DCM        IPLIM
```

```
rtrv-card:loc=1313
```

This is an example of the possible output.

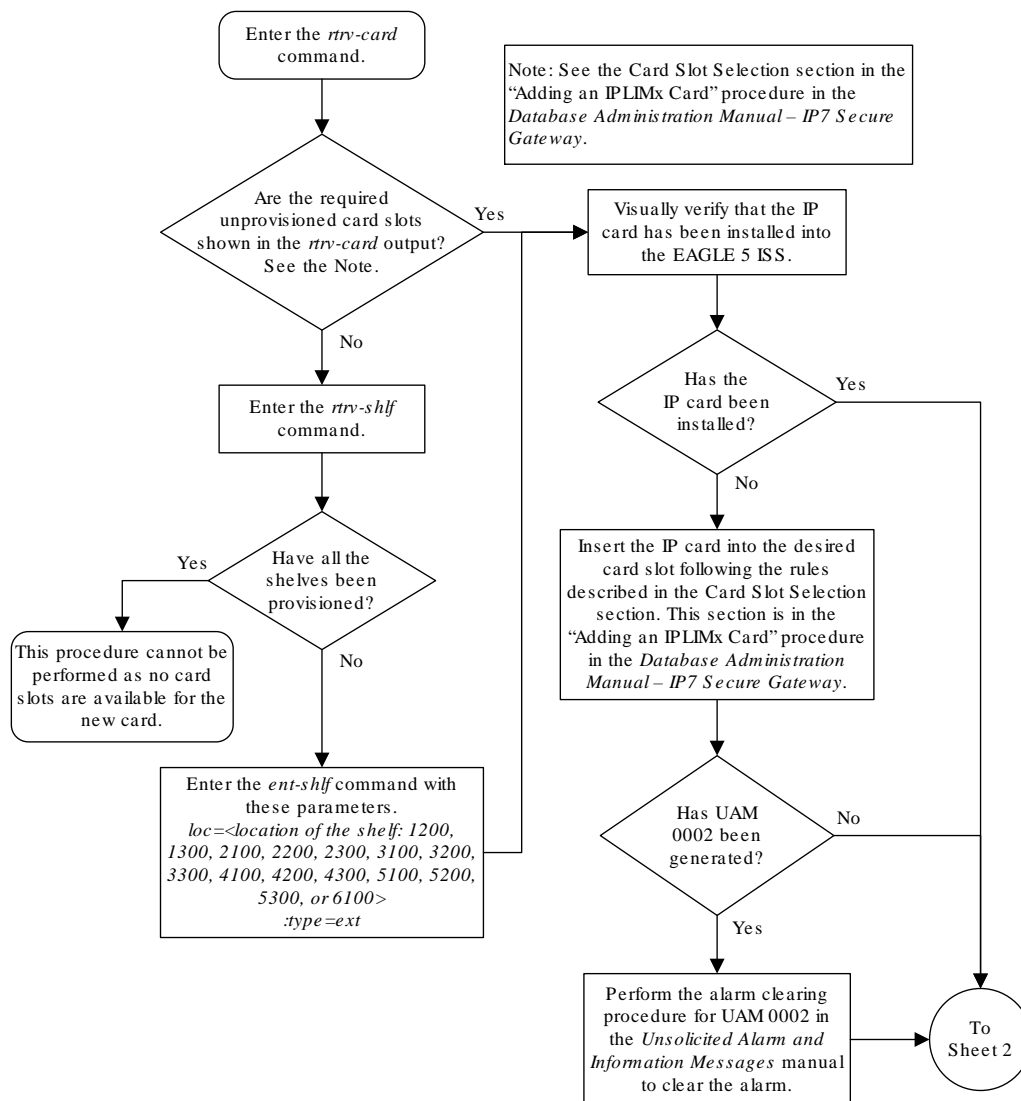
```
rlghncxa03w 06-10-28 09:12:36 GMT EAGLE5 36.0.0
CARD   TYPE      APPL      LSET NAME      LINK SLC LSET NAME      LINK SLC
1313   DCM        IPLIMI
```

- Back up the new changes using the `chg-db:action=backup:dest=fixed` command. These messages should appear, the active **Maintenance and Administration Subsystem Processor (MASP)** appears first.

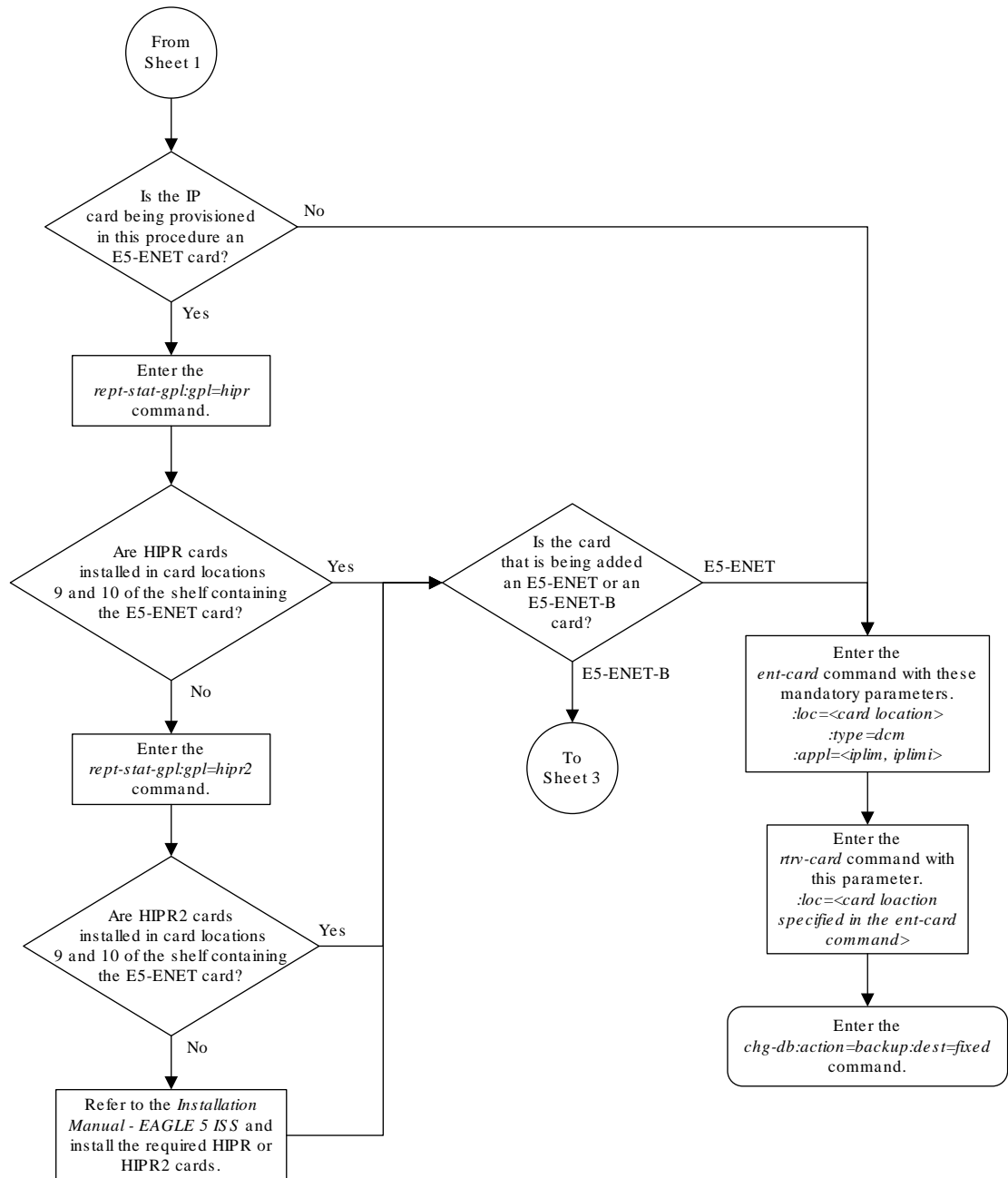
```
BACKUP (FIXED) : MASP A - Backup starts on active MASP.
BACKUP (FIXED) : MASP A - Backup on active MASP to fixed disk complete.
```

BACKUP (FIXED) : MASP A - Backup starts on standby MASP.
 BACKUP (FIXED) : MASP A - Backup on standby MASP to fixed disk complete.

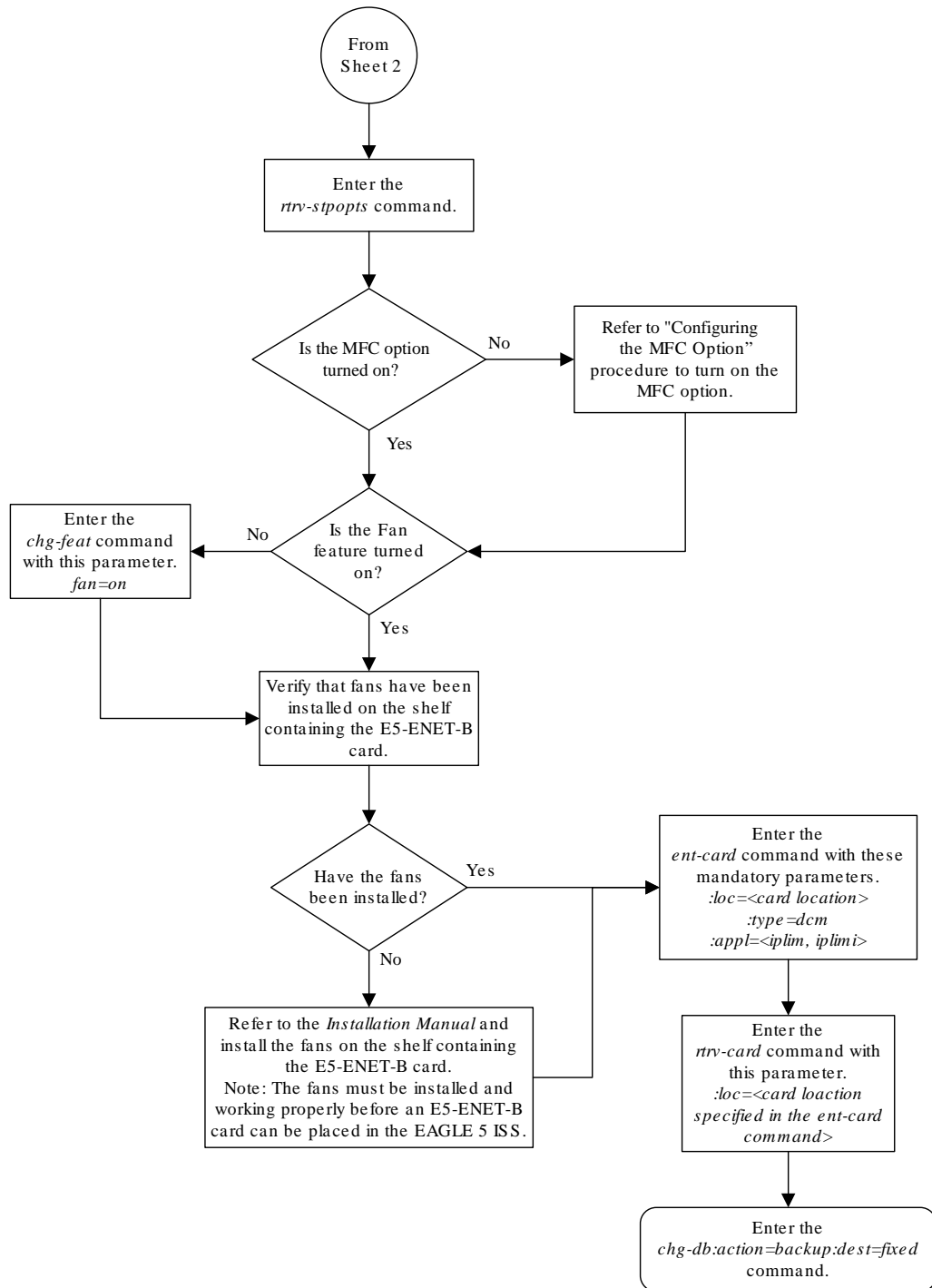
Figure 3-1 Adding an IPLIMx Card



Sheet 1 of 3



Sheet 2 of 3



Sheet 3 of 3

3.3 Adding an IPLIMx Signaling Link

This procedure is used to add an **IPLIMx** signaling link to the database using the `ent-slk` command. The `ent-slk` command uses these parameters.

`:loc` – The card location of the **IP** card that the **IP** signaling link will be assigned to. The cards specified by this parameter are **IP** cards running the **IPLIM** or **IPLIMI** applications.

`:link` – The signaling link on the card specified in the `loc` parameter.

`:lsn` – The name of the linkset that will contain the signaling link.

`:slc` – The signaling link code. The **SLC** must be unique within the linkset. It must be the same at both the **EAGLE** location and the distant node.

`:ipliml2` – The L2 protocol stack to be assigned to the **IP** signaling link, **M2PA** (the default value).

The `ent-slk` command contains other optional parameters that are not used to configure an IPGWx signaling link. These parameters are discussed in more detail in *Commands User's Guide* or in these sections.

- These procedures in this manual:
 - [Adding an IPGWx Signaling Link](#)
 - [Adding an IPSP M3UA Signaling Link](#)
 - [Adding an IPSP M2PA Signaling Link](#)
- These procedures in *Database Administration - SS7 User's Guide*
 - Adding an SS7 Signaling Link
 - Adding an E1 Signaling Link
 - Adding a T1 Signaling Link
 - Adding an ATM High-Speed Signaling Link

These items must be configured in the database before an **IP** signaling link can be added:

- Shelf – perform the "Adding a Shelf" procedure in *Database Administration - System Management User's Guide*
- Card – perform the [Adding an IPLIMx Card](#) procedure
- Destination **Point Code** – perform the "Adding a **Destination Point Code**" procedure in *Database Administration - SS7 User's Guide*.
- Linkset – An IPLIMx signaling link can be assigned to any linkset that does not contain IPGWx signaling links. Perform one of these procedures to add the linkset.
 - "Adding an SS7 Linkset" in *Database Administration - SS7 User's Guide*
 - [Adding an IPSP M2PA Linkset](#)
 - [Adding an IPSP M3UA Linkset](#)

Adding the IPLIMx signaling link to an IPLIMx card that does not contain any IPLIMx signaling links cannot exceed the maximum total provisioned system TPS shown in the `rtrv-tps` output. An IPLIMx card that contains IPLIMx signaling links uses 4000 TPS. If the IPLIMx signaling link is being added to an IPLIMx card that contains other signaling links, no additional TPS is used and the maximum total provisioned system TPS shown in the `rtrv-tps` output will not be exceeded.

If adding the IPLIMx signaling link will exceed the maximum total provisioned system TPS, and the maximum total provisioned system TPS is 500,000, perform the "Activating the HIPR2 High Rate Mode" feature in *Database Administration - System Management User's Guide* to enable and turn on the HIPR2 High Rate Mode feature. When the HIPR2 High Rate

Mode feature is enabled and turned on, the maximum total provisioned system TPS is increased to 1,000,000 (1M). If the maximum total provisioned system TPS is 1M, or the maximum total provisioned system TPS is 500,000 and will not be increased, and adding the IPLIMx signaling link will exceed the maximum total provisioned system TPS, the IPLIMx signaling link cannot be added unless the amount of available TPS is reduced enough to allow the IPLIMx signaling link to be added. The available TPS can be reduced by performing one or more of these actions.

- The IP TPS values of some IPGWx linksets have to be changed.
- The MAXSLKTPS values of some IPSG linksets (and the RSVDSLKTPS values if necessary) have to be changed.
- Some ATM high-speed signaling links have to be removed.
- An IPLIMx card that contains signaling links has to be removed.

Verify that the link has been physically installed (all cable connections have been made).

To configure the EAGLE to perform circular routing detection test on the signaling links, “Configuring Circular Route Detection” procedure in the *Database Administration - SS7 User’s Guide*.

**Note:**

Circular route detection is not supported in **ITU** networks.

To provision a EAGLE with more than 1200 signaling links, the EAGLE must have certain levels of hardware installed. See the [Requirements for EAGLEs Containing more than 1200 Signaling Links](#) section for more information on these hardware requirements.

The EAGLE can contain a mixture of low-speed, E1, T1, ATM high-speed, and IP signaling links. The [Determining the Number of High-Speed and Low-Speed Signaling Links](#) section describes how to determine the quantities of the different types of signaling links the EAGLE can have.

Canceling the REPT-STAT-SLK, RTRV-LS, and RTRV-SLK Commands

Because the `rept-stat-slk`, `rtrv-ls`, and `rtrv-slk` commands used in this procedure can output information for a long period of time, the `rept-stat-slk`, `rtrv-ls`, and `rtrv-slk` commands can be canceled and the output to the terminal stopped. There are three ways that the `rept-stat-slk`, `rtrv-ls`, and `rtrv-slk` commands can be canceled.

- Press the F9 function key on the keyboard at the terminal where the `rept-stat-slk`, `rtrv-ls`, or `rtrv-slk` commands were entered.
- Enter the `canc-cmd` without the `trm` parameter at the terminal where the `rept-stat-slk`, `rtrv-ls`, or `rtrv-slk` commands were entered.
- Enter the `canc-cmd:trm=<xx>`, where `<xx>` is the terminal where the `rept-stat-slk`, `rtrv-ls`, or `rtrv-slk` commands were entered, from another terminal other than the terminal where the `rept-stat-slk`, `rtrv-ls`, or `rtrv-slk` commands was entered. To enter the `canc-cmd:trm=<xx>` command, the terminal must allow Security Administration commands to be entered from it and

the user must be allowed to enter Security Administration commands. The terminal's permissions can be verified with the `rtrv-secu-trm` command. The user's permissions can be verified with the `rtrv-user` or `rtrv-secu-user` commands.

For more information about the `canc-cmd` command, go to *Commands User's Guide*.

1. Display the maximum number of signaling links the EAGLE can have and the number of signaling links that are currently provisioned by entering the `rtrv-tbl-capacity` command.

This is an example of the possible output.

```
rlghncxa03w 09-07-19 21:16:37 GMT EAGLE5 41.1.0
SLK      table is (          4 of      1200)   1% full
```

 **Note:**

The `rtrv-tbl-capacity` command output contains other fields that are not used by this procedure. If you wish to see all the fields displayed by the `rtrv-tbl-capacity` command, refer to the `rtrv-tbl-capacity` command description in *Commands User's Guide*.

If the addition of the new signaling link will not exceed the maximum number of signaling links the EAGLE can have, continue the procedure with 2.

If the addition of the new signaling link will exceed the maximum number of signaling links the EAGLE can have, and the maximum number of signaling links is less than 2800, perform the [Enabling the Large System # Links Controlled Feature](#) procedure to enable the desired quantity of signaling links. After the new quantity of signaling links has been enabled, continue the procedure with 2.

If the addition of the new signaling link will exceed the maximum number of signaling links the EAGLE can have (in this example, the maximum number of signaling links is 1200), and the maximum number of signaling links is 2800, this procedure cannot be performed. The EAGLE cannot contain more than 2800 signaling links.

2. Display the total provisioned system TPS by entering the `rtrv-tps` command. This is an example of the possible output.

```
rlghncxa03w 10-07-10 16:20:46 GMT EAGLE 42.0.0

CARD      NUM      NUM      RSVD      MAX
TYPE     CARDS   LINKS    TPS       TPS
-----  -
IPGW      17      16      48000     80000
IPSG       3       7       4200      8000
IPLIM     2       4       8000      8000
ATM       2       2       3668     3668

Total provisioned System TPS (99668 of 500000) 20%
```

Command Completed.

3. Display the cards in the database using the `rtrv-card` command.

This is an example of the possible output.

```
rlghncxa03w 13-06-28 09:12:36 GMT EAGLE5 45.0.0
CARD   TYPE      APPL      LSET NAME   LINK SLC LSET NAME   LINK SLC
1101   DCM        SS7IPGW   ipgwx1      A    0
1102   DCM        SS7IPGW   ipgwx1      A    1
1103   DCM        SS7IPGW   ipgwx1      A    2
1104   DCM        SS7IPGW   ipgwx1      A    3
1105   DCM        SS7IPGW   ipgwx1      A    4
1106   DCM        SS7IPGW   ipgwx1      A    5
1107   DCM        SS7IPGW   ipgwx1      A    6
1108   DCM        SS7IPGW   ipgwx1      A    7
1111   DCM        SS7IPGW   ipgwx2      A    0
1112   DCM        SS7IPGW   ipgwx2      A    1
1113   E5MCAP     OAMHC
1114   E5TDM-A
1115   E5MCAP     OAMHC
1116   E5TDM-B
1117   E5MDAL
1201   DCM        SS7IPGW   ipgwx2      A    2
1202   DCM        SS7IPGW   ipgwx2      A    3
1203   DCM        SS7IPGW   ipgwx2      A    4
1204   DCM        SS7IPGW   ipgwx2      A    5
1205   DCM        SS7IPGW   ipgwx2      A    6
1206   DCM        SS7IPGW   ipgwx2      A    7
1207   DSM        VSCCP
1208   TSM        GLS
1301   DCM        IPLIM     lsniplim   A    0   lsniplim   A1   1
          lsniplim   B1   2
1302   LIMATM     ATMANSI
1303   ENET       IPG       ipsglsn    A    0   ipsglsn    A1   1
          ipsglsn    B1   2   ipsglsn    A2   3
          ipsglsn    A3   4   ipsglsn2   B3   0
1304   LIMATM     ATMANSI
1305   LIMATM     ATMANSI   lsnds0     A    1
1306   LIME1ATM   ATMITU    lsnituatm  A    0
1307   ENET       IPG       ipsglsn    A    5
1311   DCM        IPLIM
1312   LIMDS0     SS7ANSI   lsnds0     A    0
1317   DCM        IPLIMI    lsniplimi  A    0
1318   LIMATM     ATMANSI
```

If the required card is not in the database, perform the [Adding an IPLIMx Card](#) procedure and add the IPLIMx card to the database.

 **Note:**

If the linkset that the signaling link will be added to contains the `multgc=yes` parameter, the application assigned to the card must be IPLIMI.

An IPLIMx card that contains signaling links uses 4000 TPS. If the card that the new IPLIMx signaling link will be assigned to has other signaling links assigned to it (shown in the `LSET NAME, LINK, and SLC` columns in the `rtrv-card` output), continue the procedure with 8.

If the [Adding an IPLIMx Card](#) procedure was performed in this step, or if the new signaling link will be assigned to an existing IPLIMx card that contains no signaling links, continue the procedure by performing one of these actions.

- If adding the new IPLIMx signaling link will not exceed the maximum total provisioned system TPS, shown in 2 , continue the procedure with 8.
- If adding the new IPLIMx signaling link will exceed the maximum total provisioned system TPS, and the maximum total provisioned system TPS is 500,000 shown, perform the "Activating the HIPR2 High Rate Mode Feature" procedure in *Database Administration - System Management User's Guide* to enable and turn on the HIPR2 High Rate Mode feature. When the HIPR2 High Rate Mode feature is enabled and turned on, the maximum total provisioned system TPS is increased to 1M. After the HIPR2 High Rate Mode feature has been enabled and turned on, continue the procedure with 8.
- If the maximum total provisioned system TPS is 1M, or the maximum total provisioned system TPS is 500,000 and will not be increased, and adding the IPLIMx signaling link will exceed the maximum total provisioned system TPS, the IPLIMx signaling link cannot be added unless the amount of available TPS is reduced enough to allow the IPLIMx signaling link to be added. The available TPS can be increased by performing one or more of these actions.
 - The IP TPS values of some IPGWx linksets have to be changed. To perform this action, continue the procedure with 6.
 - The MAXSLKTPS values of some IPSPG linksets (and the RSVDSLKTPS values if necessary) have to be changed. To perform this action, continue the procedure with 6.
 - Some ATM high-speed signaling links have to be removed. To perform this action, continue the procedure with 4.
 - An IPLIMx card that contains signaling links has to be removed. To perform this action, continue the procedure with 5.

4. Display the ATM high-speed signaling links by entering this command.

```
rtrv-slk:type=saal
```

This is an example of the possible output.

```
rlghncxa03w 10-07-19 21:16:37 GMT EAGLE5 42.0.0
```

LOC	LINK	LSN	SLC	TYPE	LP SET	ATM BPS	TSEL	VCI	VPI	LL
1303	A	lsnds0	1	LIMATM	1	1.544M	LINE	5	0	0

```

                                LP           ATM
E1ATM
LOC LINK LSN          SLC TYPE      SET BPS      TSEL      VCI      VPI
CRC4 SI SN
1306 A   lsnituatm    0   LIME1ATM 21   2.048M LINE      5        0
ON      3   0

```

SLK table is (30 of 1200) 2% full.

If ATM high-speed signaling links are shown in the `rtrv-slk` output, perform the "Removing an SS7 Signaling Link" procedure in *Database Administration - SS7 User's Guide* to remove some of the ATM high-speed signaling links.

If ATM high-speed signaling links are not displayed in the `rtrv-slk` output, perform one or more of these actions to increase the available TPS.

 **Note:**

If one or more of these actions are not performed to increase the available TPS and the available TPS will not allow the IPLIMx signaling link to be added, the IPLIMx signaling link cannot be added and the remainder of this procedure cannot be performed.

- The IP TPS values of some IPGWx linksets have to be changed. To perform this action, continue the procedure with 6.
- The MAXSLKTPS values of some IPGS linksets (and the RSVDSLKTPS values if necessary) have to be changed. To perform this action, continue the procedure with 6.
- An IPLIMx card that contains signaling links has to be removed. To perform this action, continue the procedure with 5.

If you do not wish to perform other actions to increase the available TPS and the available TPS will allow the IPLIMx signaling link to be added, continue the procedure with 8.

5. Display the signaling links that are assigned to IPLIMx cards by entering this command.

```
rtrv-slk:type=iplim
```

This is an example of the possible output.

```
rlghncxa03w 10-07-19 21:16:37 GMT EAGLE5 42.0.0
```

```

LOC LINK LSN          SLC TYPE      ANAME          SLKTPS
1301 A   lsniplim      0   IPLIM      M2PA
1301 A1  lsniplim      1   IPLIM      M2PA
1301 B1  lsniplim      2   IPLIM      M2PA
1317 A   lsniplimi     0   IPLIMI     M2PA

```

SLK table is (30 of 1200) 2% full.

If IPLIMx cards containing signaling links are shown in the `rtrv-slks` output, perform the [Removing an IPLIMx Card](#) procedure to remove an IPLIMx card and its associated signaling links.

If IPLIMx cards containing signaling links are not displayed in the `rtrv-slks` output, perform one or more of these actions to increase the available TPS.

 **Note:**

If one or more of these actions are not performed to increase the available TPS and the available TPS will not allow the IPLIMx signaling link to be added, the IPLIMx signaling link cannot be added and the remainder of this procedure cannot be performed.

- The IP TPS values of some IPGWx linksets have to be changed. To perform this action, continue the procedure with [6](#).
- The MAXSLKTPS values of some IPSG linksets (and the RSVDSLKTPS values if necessary) have to be changed. To perform this action, continue the procedure with [6](#).
- Some ATM high-speed signaling links have to be removed. To perform this action, continue the procedure with [4](#).

If you do not wish to perform other actions to increase the available TPS and the available TPS will allow the IPLIMx signaling link to be added, continue the procedure with [8](#).

6. Display the IPGWx and IPSG linksets by entering this command.

```
rept-stat-iptps
```

This is an example of the possible output.

```
rlghncxa03w 10-07-19 21:16:37 GMT EAGLE5 42.0.0
IP TPS USAGE REPORT
```

	THRESH	CONFIG/ RSVD	CONFIG/ MAX		TPS	PEAK	PEAKTIMESTAMP

LSN							
ipgwx1	100%	----	32000	TX:	3700	4000	10-07-19 09:49:19
				RCV:	3650	4000	10-07-19 09:49:19
ipgwx2	100%	----	16000	TX:	4800	5000	10-07-19 09:49:09
				RCV:	4850	5000	10-07-19 09:49:09
ipgwx3	100%	----	32000	TX:	427	550	10-07-19 09:49:19
				RCV:	312	450	10-07-19 09:49:19
ipsglsn	100%	600	24000	TX:	4800	5000	10-07-19 09:49:19
				RCV:	4800	5000	10-07-19
09:49:19							
ipsglsn2	100%	600	4000	TX:	427	550	10-07-19 09:49:19
				RCV:	312	450	10-07-19
09:49:19							

Command Completed.

If linksets are displayed in the `rept-stat-iptps` output, continue the procedure with 7.

If linksets are not displayed in the `rept-stat-iptps` output, perform one or more of these actions to increase the available TPS.

 **Note:**

If one or more of these actions are not performed to increase the available TPS and the available TPS will not allow the IPLIMx signaling link to be added, the IPLIMx signaling link cannot be added and the remainder of this procedure cannot be performed.

- An IPLIMx card that contains signaling links has to be removed. To perform this action, continue the procedure with 5.
- Some ATM high-speed signaling links have to be removed. To perform this action, continue the procedure with 4.

If you do not wish to perform other actions to increase the available TPS and the available TPS will allow the IPLIMx signaling link to be added, continue the procedure with 8.

7. Display the attributes of the linksets shown in 6 by entering the `rtrv-ls` command with the name of the linkset shown in 6.

For this example enter these commands.

```
rtrv-ls:lsn=ipgwx1
```

This is an example of the possible output.

```
rlghncxa03w 10-07-19 21:16:37 GMT EAGLE5 42.0.0

LSN          APCA   (SS7)  SCRN SET SET BEI LST LNKS ACT MES DIS
SLSCI NIS
ipgwx1      001-001-002  none 1  1  no  A  8  off off off
no         off

          SPCA          CLLI          TFATCABMLQ MTPRSE ASL8
-----
          4          ---          no

RANDSLS
off

IPSG  IPGWAPC  GTTMODE          CGGTMOD
no    yes    CdPA          no

MATELSN  IPTPS  LSUSEALM  SLKUSEALM
-----  -----  -----  -----
          32000  100%    80%
```



```

LOC LINK SLC TYPE
1101 A 0 SS7IPGW
1102 A 1 SS7IPGW
1103 A 2 SS7IPGW
1104 A 3 SS7IPGW
1105 A 4 SS7IPGW
1106 A 5 SS7IPGW
1107 A 6 SS7IPGW
1108 A 7 SS7IPGW

```

Link set table is (8 of 1024) 1% full.

```
rtrv-ls:lsn=ipgwx2
```

This is an example of the possible output.

```
rlghncxa03w 10-07-19 21:16:37 GMT EAGLE5 42.0.0
```

```

LSN          APCA  (SS7)  SCRN SET SET BEI LST LNKS ACT MES DIS SLSCI
NIS
ipgwx2      001-001-003  none 1 1 no A 8 off off off no
off

```

```

          SPCA          CLLI          TFATCABMLQ MTPRSE ASL8
-----
          4          ---          no

```

```
RANDSLS
off
```

```

IPSG IPGWAPC GTTMODE          CGGTMOD
no   yes     CdPA          no

```

```

MATELSN IPTPS LSUSEALM SLKUSEALM
----- 16000 100%    80%

```

```

LOC LINK SLC TYPE
1111 A 0 SS7IPGW
1112 A 1 SS7IPGW
1201 A 2 SS7IPGW
1202 A 3 SS7IPGW
1203 A 4 SS7IPGW
1204 A 5 SS7IPGW
1205 A 6 SS7IPGW
1206 A 7 SS7IPGW

```

Link set table is (8 of 1024) 1% full.

```
rtrv-ls:lsn=ipgwx3
```

This is an example of the possible output.

```
rlghncxa03w 10-07-19 21:16:37 GMT EAGLE5 42.0.0

LSN          APCA   (SS7)  SCRN SET SET BEI LST LNKS ACT MES DIS
SLSCI NIS
ipgwx3       001-001-004  none 1  1  no  A  0  off off off
no          off

          SPCA          CLLI          TFATCABMLQ MTPRSE ASL8
-----
          1          ---          no

RANDSLS
off

IPSG  IPGWAPC  GTTMODE          CGGTMOD
no    yes     CdPA          no

MATELSN  IPTPS  LSUSEALM  SLKUSEALM
-----  32000  100%     80%
```

Link set table is (8 of 1024) 1% full.

```
rtrv-ls:lsn=ipsglsn
```

This is an example of the possible output.

```
rlghncxa03w 10-07-19 21:16:37 GMT EAGLE5 42.0.0

LSN          APCA   (SS7)  SCRN SET SET BEI LST LNKS ACT MES DIS
SLSCI NIS
ipsglsn      003-003-003  none 1  1  no  A  6  off off off
no          off

          SPCA          CLLI          TFATCABMLQ MTPRSE ASL8
-----
          3          ---          no

RANDSLS
off

IPSG  IPGWAPC  GTTMODE          CGGTMOD
yes   no      CdPA          no

ADAPTER  RSVDSLKTPS  MAXSLKTPS
m2pa     600      4000

TPSALM  LSUSEALM  SLKUSEALM
rsvdslktps 100%     100%

LOC  LINK SLC TYPE  ANAME
```

```

1303 A    0    IP SG    ipsgm2pa1
1303 A1   1    IP SG    ipsgm2pa2
1303 B1   2    IP SG    ipsgm2pa3
1303 A2   3    IP SG    ipsgm2pa4
1303 A3   4    IP SG    ipsgm2pa5
1307 A    5    IP SG    m2pa2

```

Link set table is (8 of 1024) 1% full.

```
rtrv-ls:lsn=ipsglsn2
```

This is an example of the possible output.

```
rlghncxa03w 10-07-19 21:16:37 GMT EAGLE5 42.0.0
```

```

LSN          APCA   (SS7)   SCR N SET SET BEI LST LNKS ACT MES DIS SLSCI
NIS
ipsglsn2     005-005-005 none 1  1  no  A  1  off off off no
off

          SPCA          CLLI          TFATCABMLQ MTPRSE ASL8
-----
          1          ---          no

RANDSLS
off

IPSG IPGWAPC GTTMODE          CGGTMOD
yes  no      CdPA          no

ADAPTER  RSVDSLKTPS  MAXSLKTPS
m2pa     600        4000

TPSALM   LSUSEALM    SLKUSEALM
rsvdslktps 100%      100%

LOC  LINK  SLC  TYPE  ANAME
1303 B3  0    IP SG    ipsgm2pa6

```

Link set table is (8 of 1024) 1% full.

Perform one or both of these actions as necessary.

- Perform the [Configuring an IPGWx Linkset](#) procedure to change the IPTPS value for any linksets shown in the rtrv-ls output whose IPGWAPC value is yes.
- Perform the [Changing an IP SG M2PA Linkset](#) procedure (for linkset whose IP SG value is yes and ADAPTER value is M2PA) or the [Changing an IP SG M3UA Linkset](#) procedure (for linkset whose IP SG value is yes and ADAPTER value is M3UA) to change the MAXSLKTPS value (and RSVDSLKTPS value if necessary) for any linksets shown in the rtrv-ls output.

Perform one or both of these actions to increase the available TPS if needed.

- An IPLIMx card that contains signaling links has to be removed. To perform this action, continue the procedure with 5.
- Some ATM high-speed signaling links have to be removed. To perform this action, continue the procedure with 4.

If you do not wish to perform other actions to increase the available TPS and the available TPS will allow the IPLIMx signaling link to be added, continue the procedure with 8.

8. Display the current signaling link configuration using the `rtrv-slkl` command.

This is an example of the possible output.

```

rlghncxa03w 10-07-19 21:16:37 GMT EAGLE5 42.0.0
                                     L2T          PCR PCR
LOC LINK LSN          SLC TYPE   SET  BPS    ECM  N1  N2
1312 A   lsnds0       0  LIMDS0   1   56000  BASIC  ----  -----

                                     LP          ATM
LOC LINK LSN          SLC TYPE   SET  BPS    TSEL  VCI  VPI  LL
1305 A   lsnds0       1  LIMATM   1   1.544M LINE   5    0    0

                                     LP          ATM
E1ATM
LOC LINK LSN          SLC TYPE   SET  BPS    TSEL  VCI  VPI
CRC4 SI SN
1306 A   lsnituatm    0  LIME1ATM 21   2.048M LINE   5    0
ON   3  0

LOC LINK LSN          SLC TYPE   ANAME          SLKTPS
1303 A   ipsglsn      0  IPSEG         ipsgm2pa1      600
1303 A1  ipsglsn      1  IPSEG         ipsgm2pa2      600
1303 B1  ipsglsn      2  IPSEG         ipsgm2pa3      600
1303 A2  ipsglsn      3  IPSEG         ipsgm2pa4      600
1303 A3  ipsglsn      4  IPSEG         ipsgm2pa5      600
1303 B3  ipsglsn2     0  IPSEG         ipsgm2pa6     1000
1307 A   ipsglsn      5  IPSEG         m2pa2          600

LOC LINK LSN          SLC TYPE   IPLIML2
1301 A   lsniplim     0  IPLIM        M2PA
1301 A1  lsniplim     1  IPLIM        M2PA
1301 B1  lsniplim     2  IPLIM        M2PA
1317 A   lsniplimi    0  IPLIMI       M2PA

LOC LINK LSN          SLC TYPE
1201 A   ipgwx2       2  SS7IPGW
1202 A   ipgwx2       3  SS7IPGW
1203 A   ipgwx2       4  SS7IPGW
1204 A   ipgwx2       5  SS7IPGW
1205 A   ipgwx2       6  SS7IPGW
1206 A   ipgwx2       7  SS7IPGW
1101 A   ipgwx1       0  SS7IPGW
1102 A   ipgwx1       1  SS7IPGW

```

```

1103 A    ipgwx1    2    SS7IPGW
1104 A    ipgwx1    3    SS7IPGW
1105 A    ipgwx1    4    SS7IPGW
1106 A    ipgwx1    5    SS7IPGW
1107 A    ipgwx1    6    SS7IPGW
1108 A    ipgwx1    7    SS7IPGW
1111 A    ipgwx2    0    SS7IPGW
1112 A    ipgwx2    1    SS7IPGW

```

SLK table is (30 of 1200) 2% full.

9. Display the current linkset configuration using the `rtrv-ls` command.

This is an example of the possible output.

```
rlghncxa03w 10-07-10 11:43:04 GMT EAGLE5 42.0.0
```

```

                L3T SLT                GWS GWS GWS
LSN            APCA  (SS7)  SCRN SET SET BEI LST LNKS ACT MES DIS SLSCI
NIS
ipgwx1         001-001-002  none 1  1  no  A  8   off off off no
off
ipgwx2         001-001-003  none 1  1  no  A  8   off off off no
off
ipgwx3         001-001-004  none 1  1  no  A  0   off off off no
off
lsniplim      002-002-002  none 1  1  no  A  3   off off off no
off
ipsglsn       003-003-003  none 1  1  no  A  6   off off off no
off
ipsglsn2      005-005-005  none 1  1  no  A  1   off off off no
off
lsnds0        009-009-009  none 1  1  no  A  2   off off off no
off

```

```

                L3T SLT                GWS GWS GWS
LSN            APCI  (SS7)  SCRN SET SET BEI LST LNKS ACT MES DIS SLSCI
NIS
lsnituatm     1-002-3      none 1  2  no  A  1   off off off no
off
atmitul       3-111-3      none 1  1  no  A  0   off off off no
off

```

```

                L3T SLT                GWS GWS GWS
LSN            APCN  (SS7)  SCRN SET SET BEI LST LNKS ACT MES DIS SLSCI
NIS
lsipgw        2968          none 1  2  no  A  1   off off off no
off

```

Link set table is (10 of 1024) 1% full.

If the desired linkset is not in the database, perform one of these procedures to add the linkset to the database.

- “Adding an SS7 Linkset” in *Database Administration - SS7 User's Guide*
- [Adding an IPSP M2PA Linkset](#)
- [Adding an IPSP M3UA Linkset](#)

After the new linkset has been added, continue the procedure with [11](#).

If the signaling link will be assigned to the linkset shown in this step, continue the procedure with [10](#).

10. Display the linkset that the signaling link is being assigned to using the `rtrv-ls` command, specifying the name of the linkset that the signaling link is being assigned to.

For this example, enter this command.

```
rtrv-ls:lsn=lsipgw
```

This is an example of the possible output.

```
rlghncxa03w 10-07-17 11:43:04 GMT EAGLE5 42.0.0

LSN          APCN  (SS7)  L3T SLT          GWS GWS GWS
SLSCI NIS
lsipgw       2968          none 1  2  no  A  1  off off off
no          off

          SPCN          CLLI          TFATCABMLQ MTPRSE ASL8
-----
          1          ---      ---

SLSOCSBIT SLSRSB RANDSL S MULTGC ITUTFR
none      1      off    no    off

IPSP IPGWAPC GTTMODE          CGGTMOD
no    no    CdPA          no

LOC  LINK SLC TYPE          IPLIML2
1317 A  0  IPLIMI  M2PA

SAPCI
1-10-1

SAPCN
1234-aa
1235-bb
1200-zz
```

Link set table is (10 of 1024) 1% full.

The signaling link cannot be assigned to a linkset whose `IPGWAPC` value is `yes`. If the `IPGWAPC` value for the linkset is `yes`, repeat the procedure from [9](#) and choose another linkset.

If the `IPGWAPC` value for the linkset is `no`, continue the procedure with [11](#).

11. Add the signaling link to the database using the `ent-slk` command.

Table 3-2 shows the parameters and values that can be specified with the `ent-slk` command.

Table 3-2 M2PA IPLIMx Signaling Link Parameter Combinations

M2PA IPLIMx Signaling Link
Mandatory Parameters
:loc = location of the IP card with one of these applications: IPLIM or IPLIMI; and the DCM card type. (See Note 1)
:link = <see Note 2>
:lsn = linkset name (See Note 3)
:slc = 0 - 15 (See Note 4)
Optional Parameter
:ipliml2 = m2pa, default value = m2pa
Notes:
1. If the <code>multgc=yes</code> parameter is assigned to the linkset, the card's application must be IPLIMI .
2. The range of link parameter values is dependent on the type of IPLIMx card that is being provisioned.
Single-Slot EDCM - Link Parameter Values A - A3, B - B3
E5-ENET - Link Parameter Values A - A7, B - B7
3. If the card's application is IPLIMI , the linkset adjacent point code must be ITU . If the card's application is IPLIM , the linkset adjacent point code must be ANSI . The domain of the linkset adjacent point code must be SS7 .
4. Signaling links provisioned in this procedure can be in a linkset that contains non- IPLIMx signaling links.

For this example, enter these commands.

```
ent-slk:loc=2204:link=b:lsn=lsnlp2:slc=0:ipliml2=m2pa
ent-slk:loc=2205:link=a:lsn=lsnlp1:slc=1:ipliml2=m2pa
ent-slk:loc=2213:link=a:lsn=lsnlp5:slc=1:ipliml2=m2pa
```

When each of these commands have successfully completed, this message should appear.

```
rlghncxa03w 06-10-07 08:29:03 GMT EAGLE5 36.0.0
ENT-SLK: MASP A - COMPLTD
```

 **Note:**

If adding the new signaling link will result in more than 700 signaling links in the database and the OAMHCMEAS value in the `rtrv-measopts` output is `son`, the scheduled UI measurement reports will be disabled.

- Verify the changes using the `rtrv-slk` command with the card location and link parameter values specified in 11. For this example, enter these commands.

```
rtrv-slk:loc=2204:link=b
```

This is an example of the possible output.

```
rlghncxa03w 06-10-19 21:16:37 GMT EAGLE5 36.0.0
LOC LINK LSN          SLC TYPE    IPLIML2
2204 B   lsnlp2       0  IPLIM     M2PA
```

```
rtrv-slk:loc=2205:link=a
```

This is an example of the possible output.

```
rlghncxa03w 06-10-19 21:16:37 GMT EAGLE5 36.0.0
LOC LINK LSN          SLC TYPE    IPLIML2
2205 A   lsnlp1       1  IPLIM     M2PA
```

```
rtrv-slk:loc=2213:link=a
```

This is an example of the possible output.

```
rlghncxa03w 06-10-19 21:16:37 GMT EAGLE5 36.0.0
LOC LINK LSN          SLC TYPE    IPLIML2
2213 A   lsnlp5       0  IPLIM     M2PA
```

Continue the procedure by performing one of these steps.

- If a new signaling link is the first signaling link on the IPLIMx card, continue the procedure with [13](#).
 - If all the signaling links that were added in this procedure were added to IPLIMx cards that contained other signaling links, continue the procedure with [14](#).
- 13.** Place the IPLIMx card containing the first signaling link on that card into service with the `rst-card` command, specifying the location of the card. For this example, enter these commands.

```
rst-card:loc=2204
```

```
rst-card:loc=2205
```

```
rst-card:loc=2213
```

When each of these commands have successfully completed, this message should appear.

```
rlghncxa03w 06-10-23 13:05:05 GMT EAGLE5 36.0.0
Card has been allowed.
```

- 14.** Activate all signaling links on the cards using the `act-slk` command, specifying the card location and `link` parameter value of each signaling link. For this example, enter these commands.

```
act-slk:loc=2204:link=b
```

```
act-slk:loc=2205:link=a
```



```
act-slk:loc=2213:link=a
```

When each of these commands have successfully completed, this message should appear.

```
rlghncxa03w 06-10-07 08:31:24 GMT EAGLE5 36.0.0
Activate Link message sent to card
```

15. Check the status of the signaling links added in 11 using the `rept-stat-slk` command with the card location and link parameter values specified in 11. The state of each signaling link should be in service normal (**IS-NR**) after the link has completed alignment (shown in the **PST** field). For this example, enter these commands.

```
rept-stat-slk:loc=2204:link=b
```

This is an example of the possible output.

```
rlghncxa03w 07-05-23 13:06:25 GMT EAGLE5 37.0.0
SLK      LSN      CLLI      PST      SST      AST
2204,B   lsnlp2   -----  IS-NR    Avail    ----
  ALARM STATUS      =
  UNAVAIL REASON    =
```

```
rept-stat-slk:loc=2205:link=a
```

This is an example of the possible output.

```
rlghncxa03w 07-05-23 13:06:25 GMT EAGLE5 37.0.0
SLK      LSN      CLLI      PST      SST      AST
2205,A   lsnlp1   -----  IS-NR    Avail    ----
  ALARM STATUS      =
  UNAVAIL REASON    =
```

```
rept-stat-slk:loc=2213:link=a
```

This is an example of the possible output.

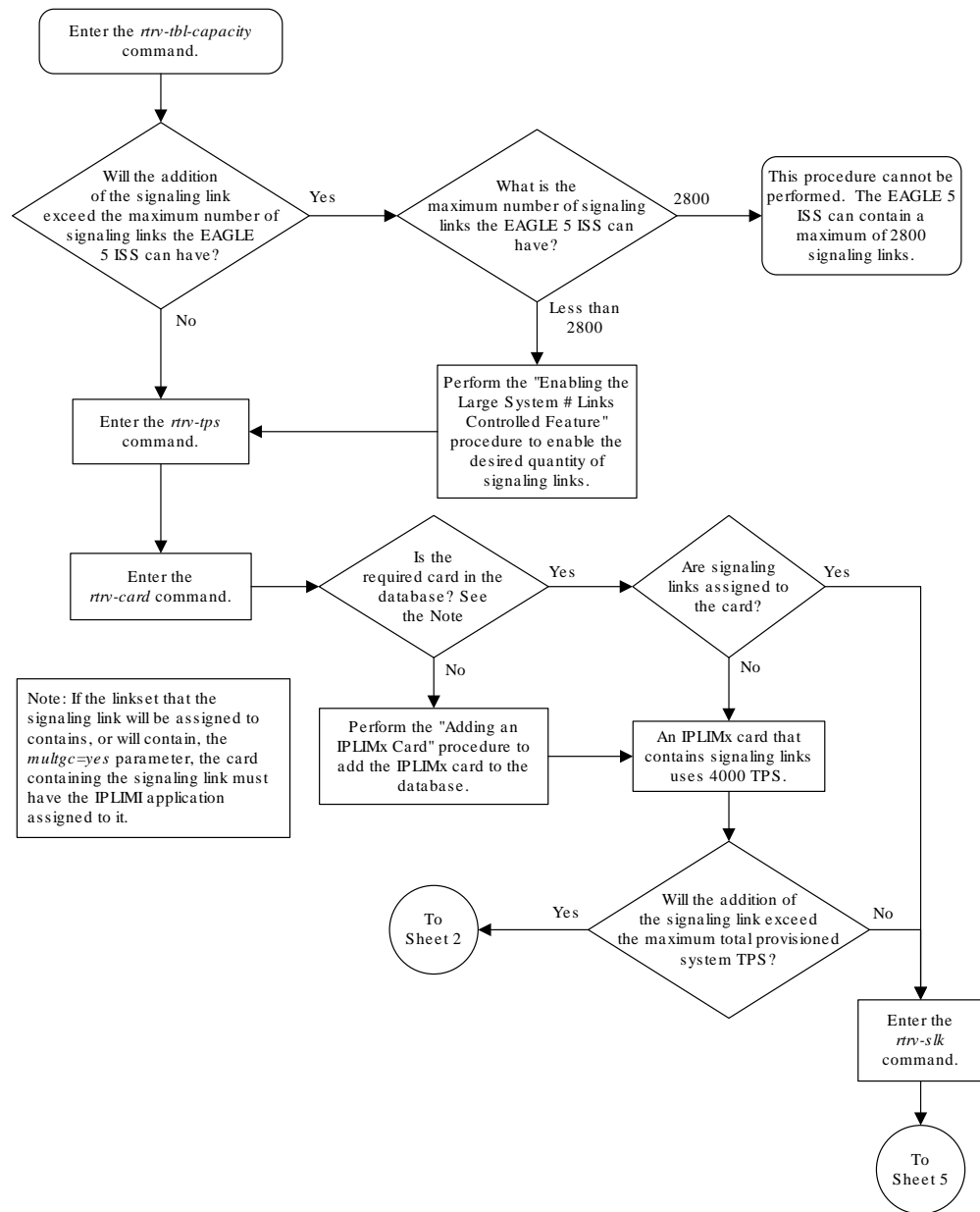
```
rlghncxa03w 07-05-23 13:06:25 GMT EAGLE5 37.0.0
SLK      LSN      CLLI      PST      SST      AST
2213,A   lsnlp5   -----  IS-NR    Avail    ----
  ALARM STATUS      =
  UNAVAIL REASON    =
```

16. Back up the new changes using the `chg-db:action=backup:dest=fixed` command. These messages should appear, the active **Maintenance and Administration Subsystem Processor (MASP)** appears first.

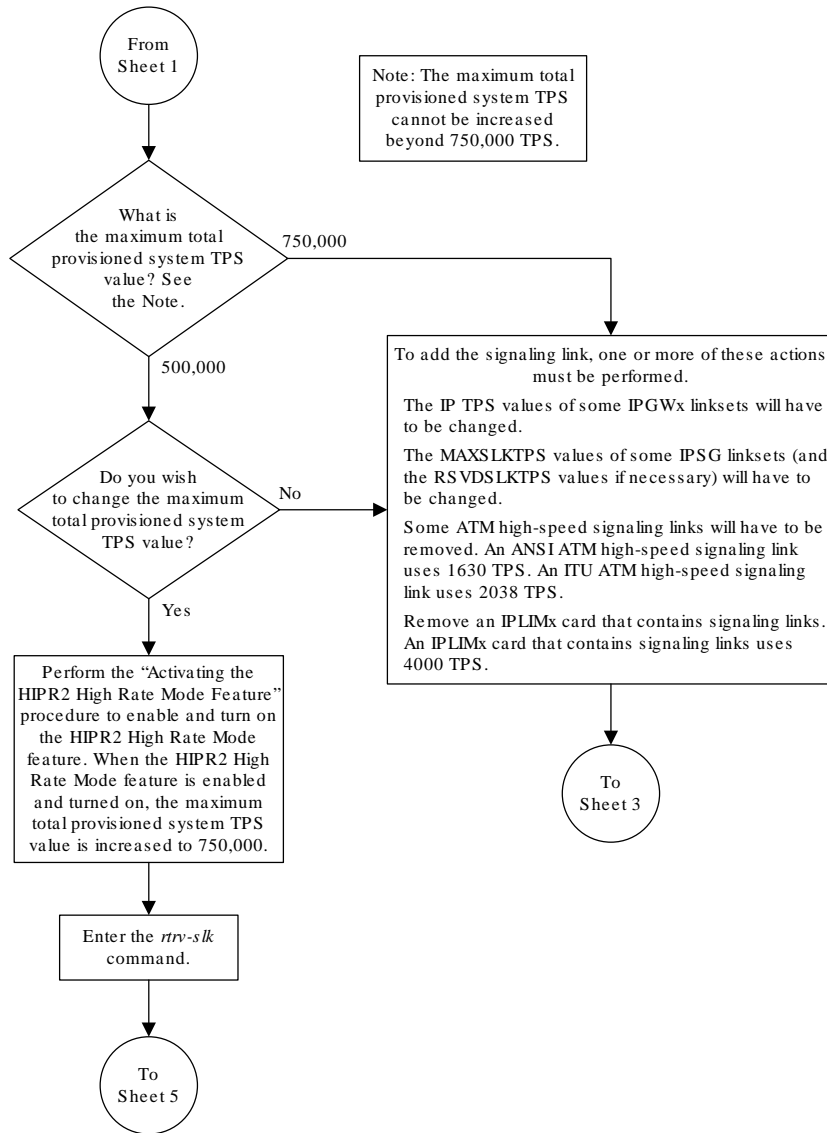
```
BACKUP (FIXED) : MASP A - Backup starts on active MASP.
BACKUP (FIXED) : MASP A - Backup on active MASP to fixed disk complete.
```

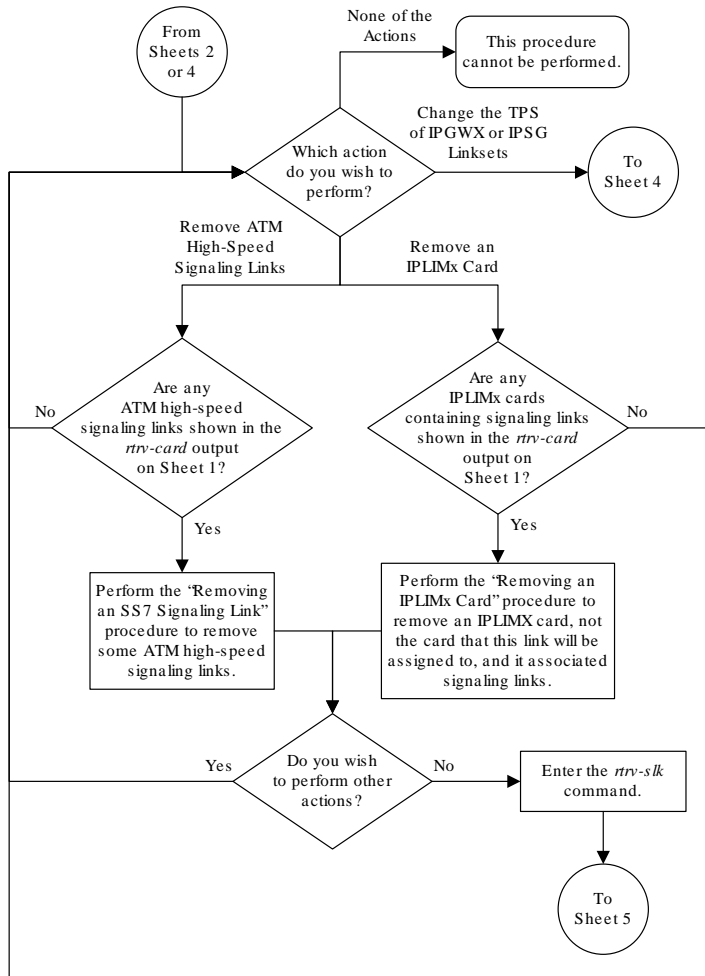
BACKUP (FIXED) : MASP A - Backup starts on standby MASP.
 BACKUP (FIXED) : MASP A - Backup on standby MASP to fixed disk complete.

Figure 3-2 Adding an IPLIMx Signaling Link

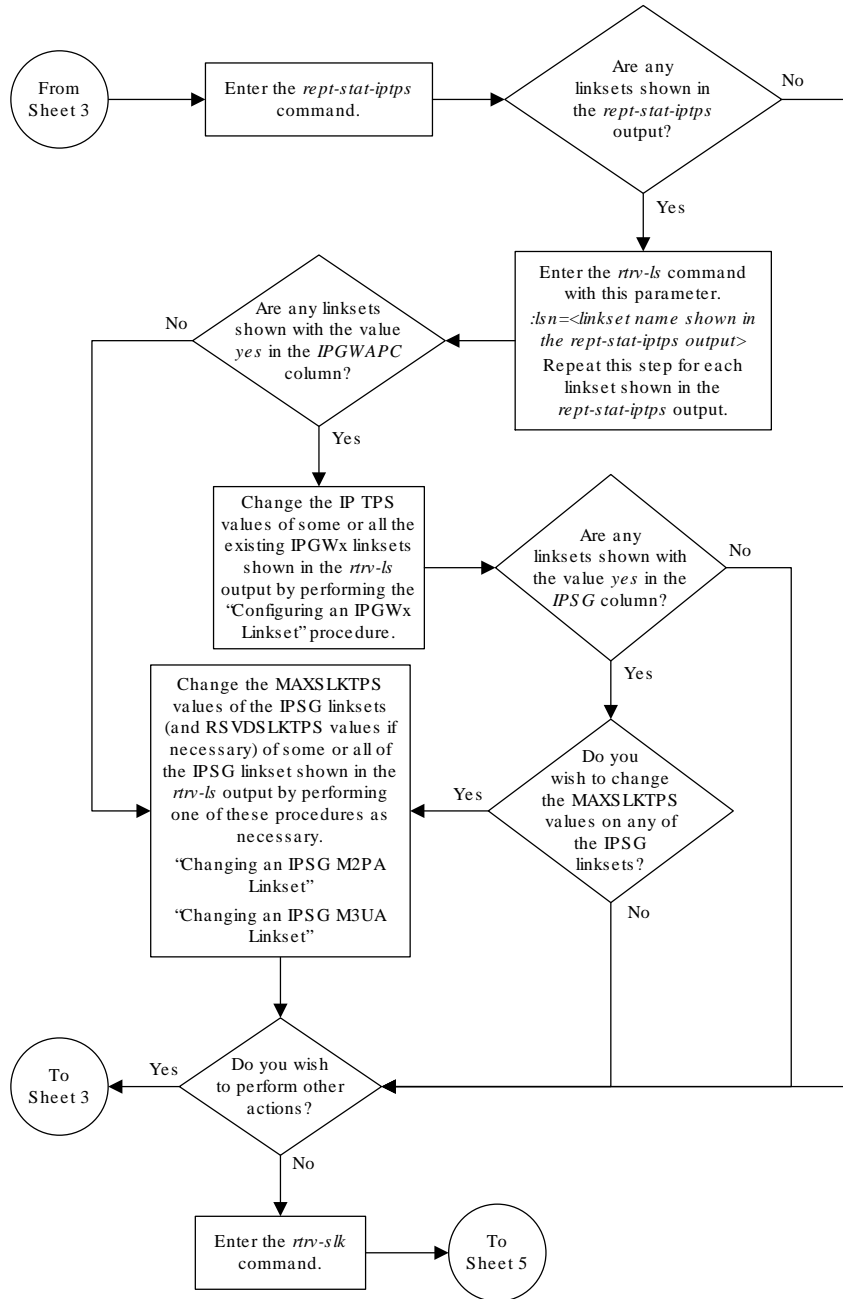


Sheet 1 of 5

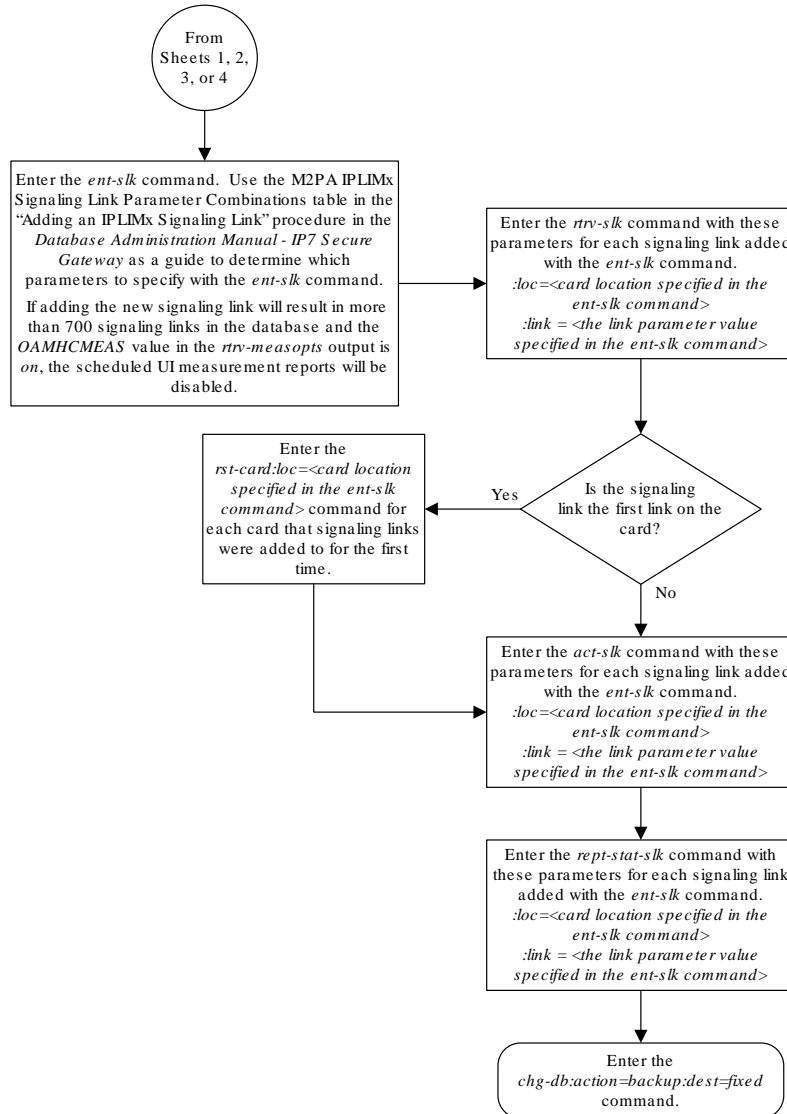




Sheet 3 of 5



Sheet 4 of 5



Sheet 5 of 5

3.4 Configuring an IP Link

This procedure is used to configure the link parameters for **IP** cards using the `chg-ip-lnk` command. These link parameters are used to configure the Ethernet hardware.

The `chg-ip-lnk` command uses the following parameters.

`:loc` – The card location of the **IP** card.

`:port` – The Ethernet interface on the **IP** card, A or B.

`:ipaddr` – **IP** address assigned to the Ethernet interface on the **IP** card. This is an **IP** address expressed in standard “dot notation.” **IP** addresses consist of the system’s network number and the machine’s unique host number.

`:submask` – The subnet mask of the **IP** interface. A subnet mask is an **IP** address with a restricted range of values. The bits in the mask must be a string of one’s followed by a string of zero’s. There must be at least two one’s in the mask, and the mask cannot be all one’s. See [Table 3-3](#) to assign the correct parameter values.

`:auto` – Tells hardware whether to automatically detect the `duplex` and `speed`.

`:duplex` – This is the mode of operation of the interface.

`:speed` – This is the bandwidth in megabits per second of the interface.

`:mactype` – This is the Media Access Control Type of the interface.

`:mcast` – The multicast control flag. This parameter enables or disables multicast support for the interface.

The EAGLE can contain a maximum of 2048 IP links.

A zero `ipaddr` parameter value (0.0.0.0) indicates the **IP** card Ethernet interface to **IP** link association is disabled. The host to the original **IP** address must be removed before the `ipaddr=0.0.0.0` can be specified.

If the `defrouter` parameter of the `chg-ip-card` command contains an **IP** address for the card specified in this procedure, the network portion of one of the **IP** addresses assigned to the card in this procedure must match the network portion of the **IP** address specified by the `defrouter` parameter of the `chg-ip-card` command.

The network portion of the **IP** address is based on the class of the **IP** address (shown in [Table 3-3](#)). If the **IP** address is a Class A **IP** address, the first field is the network portion of the **IP** address. If the **IP** address is a Class B **IP** address, the first two fields are the network portion of the **IP** address. If the **IP** address is a Class C **IP** address, the first three fields are the network portion of the **IP** address. For example, if the **IP** address is 193.5.207.150, a Class C **IP** address, the network portion of the **IP** address is 193.5.207.

If the `auto=yes` parameter is specified, then the `duplex` and `speed` parameters are not allowed.

The `loc` parameter value must be shown in the `rtrv-ip-card` output.

The **IP** card must be placed out of service.

If either the `ipaddr` or `submask` parameters are specified, then both parameters must be specified. If the `ipaddr` parameter value is zero (0.0.0.0), the `submask` parameter is not required.

The **IP** address and subnet mask values cannot be changed to an address representing a different network if:

- If the network interface specified by the `loc` and `port` parameters has a default router, `dnrsa`, or `dsnb` parameter values assigned to it, as shown in the `rtrv-ip-card` output.
- Any **IP** routes, shown in the `rtrv-ip-rte` output, reference the **IP** address for the network interface specified by the `loc` and `port` parameters.

The **IP** link cannot be changed if open associations reference the **IP** link being changed.

The network portion of the **IP** addresses assigned to the **IP** links on an **IP** card must be unique. For example, if **IP** links are assigned to **IP** card 1103, the network portion of the **IP** address for Ethernet interface A (`port=a`) must be different from the **IP** address for Ethernet interface B (`port=b`).

The `submask` parameter value is based upon the `ipaddr` setting. See [Table 3-3](#) for the valid input values for the `submask` and `ipaddr` parameter combinations.

Table 3-3 Valid Subnet Mask Parameter Values

Network Class	IP Network Address Range	Valid Subnet Mask Values
A	1.0.0.0 to 127.0.0.0	255.0.0.0 (the default value for a class A IP address)
		255.192.0.0
		255.224.0.0
		255.240.0.0
		255.248.0.0
		255.252.0.0
		255.254.0.0
A+B	128.0.0.0 to 191.255.0.0	255.255.128.1
		255.255.0.0 (the default value for a class B IP address)
		255.255.192.0
		255.255.224.0
		255.255.240.0
		255.255.248.0
		255.255.252.0
A+B+C	192.0.0.0 to 223.255.255.0	255.255.254.0
		255.255.255.128
		255.255.255.0 (the default value for a class C IP address)
		255.255.255.192
		255.255.255.224
		255.255.255.240
		255.255.255.248
255.255.255.252		

If a Class B **IP** address is specified for the `ipaddr` parameter of the `chg-ip-lnk` command, the subnet address that results from the `ipaddr` and `submask` parameter values cannot be the same as the subnet address that results from the `pvn` and `pvnmask`, `fcna` and `fcnamask`, or `fcnb` and `fcnbmask` parameter values of the `chg-netopts` command. The `pvn` and `pvnmask`, `fcna` and `fcnamask`, or `fcnb` and `fcnbmask` parameter values can be verified by entering the `rtrv-netopts` command. Choose `ipaddr` and `submask` parameter values for the **IP** link whose resulting subnet address is not be the same as the subnet address resulting from the `pvn` and `pvnmask`, `fcna` and `fcnamask`, or `fcnb` and `fcnbmask` parameter values of the `chg-netopts` command.

The IP address for the IP link cannot be shown as the IPADDR value in the `rtrv-ip-lnk`, `rtrv-ftp-serv`, or `rtrv-seas-config` outputs, or the BPIPADDR value in the `rtrv-ip-card` output.

Canceling the RTRV-ASSOC Command

Because the `rtrv-assoc` command used in this procedure can output information for a long period of time, the `rtrv-assoc` command can be canceled and the output to the terminal stopped. There are three ways that the `rtrv-assoc` command can be canceled.

- Press the F9 function key on the keyboard at the terminal where the `rtrv-assoc` command was entered.
- Enter the `canc-cmd` without the `trm` parameter at the terminal where the `rtrv-assoc` command was entered.
- Enter the `canc-cmd:trm=<xx>`, where `<xx>` is the terminal where the `rtrv-assoc` command was entered, from another terminal other than the terminal where the `rtrv-assoc` command was entered. To enter the `canc-cmd:trm=<xx>` command, the terminal must allow Security Administration commands to be entered from it and the user must be allowed to enter Security Administration commands. The terminal's permissions can be verified with the `rtrv-secu-trm` command. The user's permissions can be verified with the `rtrv-user` or `rtrv-secu-user` commands.

For more information about the `canc-cmd` command, go to *Commands User's Guide*.

1. Display the current link parameters associated with the IP card in the database by entering the `rtrv-ip-lnk` command.

The following is an example of the possible output.

```
rlghncxa03w 08-12-28 21:14:37 GMT EAGLE5 40.0.0
LOC  PORT  IPADDR          SUBMASK          DUPLEX  SPEED  MACTYPE  AUTO
MCAST
1201  A    192.1.1.10      255.255.255.128  HALF    10     802.3    NO   NO
1201  B    -----        -----        HALF    10     DIX      NO   NO
1203  A    192.1.1.12      255.255.255.0   ----    ---    DIX      YES  NO
1203  B    -----        -----        HALF    10     DIX      NO   NO
1205  A    192.1.1.14      255.255.255.0   FULL    100    DIX      NO   NO
1205  B    -----        -----        HALF    10     DIX      NO   NO
2101  A    192.1.1.20      255.255.255.0   FULL    100    DIX      NO   NO
2101  B    -----        -----        HALF    10     DIX      NO   NO
2103  A    192.1.1.22      255.255.255.0   FULL    100    DIX      NO   NO
2103  B    -----        -----        HALF    10     DIX      NO   NO
2105  A    192.1.1.24      255.255.255.0   FULL    100    DIX      NO   NO
2105  B    -----        -----        HALF    10     DIX      NO   NO
2205  A    192.1.1.30      255.255.255.0   FULL    100    DIX      NO   NO
2205  B    -----        -----        HALF    10     DIX      NO   NO
2207  A    192.1.1.32      255.255.255.0   FULL    100    DIX      NO   NO
2207  B    -----        -----        HALF    10     DIX      NO   NO
2213  A    192.1.1.50      255.255.255.0   FULL    100    DIX      NO   NO
2213  B    -----        -----        HALF    10     DIX      NO   NO
2301  A    192.1.1.52      255.255.255.0   FULL    100    DIX      NO   NO
2301  B    -----        -----        HALF    10     DIX      NO   NO
```

IP-LNK table is (20 of 2048) full.

 **Note:**

If the `ipaddr=0.0.0.0` is not being specified in this procedure, continue the procedure with [3](#).

2. If **IP** address information is being added or changed (not deleted) in the link parameters, verify that the **IP** address is present in the **IP** host table by using the `rtrv-ip-host:display=all` command.

The following is an example of the possible output.

```
rlghncxa03w 13-06-28 21:15:37 GMT EAGLE5 45.0.0
```

```
LOCAL IPADDR    LOCAL HOST
192.1.1.10     IPNODE1-1201
192.1.1.12     IPNODE1-1203
192.1.1.14     IPNODE1-1205
192.1.1.20     IPNODE2-1201
192.1.1.22     IPNODE2-1203
192.1.1.24     IPNODE2-1205
192.1.1.30     KC-HLR1
192.1.1.32     KC-HLR2
192.1.1.50     DN-MSC1
192.1.1.52     DN-MSC2

REMOTE IPADDR   REMOTE HOST
150.1.1.5      NCDEPTECONOMIC_DEVELOPMENT.
SOUTHEASTERN_COORIDOR_ASHVL. GOV
```

```
IP Host table is (11 of 4096) 0.26% full
```

If the current **IP** address of the **IP** link is shown in the `rtrv-ip-host` output, remove the host assigned to the **IP** address by performing the [Removing an IP Host Assigned to an IPLIMx Card](#) procedure.

3. To change **IP** link parameters, the signaling link to the **IP** card and the **IP** card have to be inhibited.

Display the signaling link associated with the card shown in [1](#) using the `rtrv-slk` command specifying the card location.

For this example, enter this command.

```
rtrv-slk:loc=1201
```

This is an example of the possible output.

```
rlghncxa03w 06-10-19 21:17:04 GMT EAGLE5 36.0.0
LOC  LINK LSN          SLC TYPE   IPLIML2
1201 A   nc001             0  IPLIM    M2PA
```

4. Retrieve the status of the signaling link assigned to the **IP** card to be changed using the `rept-stat-slk` command.

For example, enter this command.

```
rept-stat-slk:loc=1201:link=a
```

The output lists the signaling link assigned to this card:

```
rlghncxa03w 06-10-28 21:16:37 GMT EAGLE5 36.0.0
SLK      LSN      CLLI      PST      SST      AST
1201,A   nc001     -----  IS-NR
Command Completed.
```

If the signaling link is in service-normal (**IS-NR**), continue the procedure with [5](#) to deactivate the signaling link. If the signaling link is out-of-service-maintenance disabled (**OOS-MT-DSBLD**), continue the procedure with [7](#) to verify the **IP** card status.

- Deactivate the signaling link assigned to the **IP** card using the `dact-slk` command.

For example, enter this command.

```
dact-slk:loc=1201:link=a
```

Caution:

This command impacts network performance and should only be used during periods of low traffic.

After this command has successfully completed, this message appears.

```
rlghncxa03w 06-10-12 09:12:36 GMT EAGLE5 36.0.0
Deactivate Link message sent to card.
```

- Verify the new link status using the `rept-stat-slk` command.

For example, enter this command.

```
rept-stat-slk:loc=1201:link=a
```

The output displays the link status as **OOS-MT-DSBLD** and gives off a minor alarm:

```
rlghncxa03w 06-10-27 17:00:36 GMT EAGLE5 36.0.0
SLK      LSN      CLLI      PST      SST      AST
1201,A   nc001     -----  OOS-MT-DSBLD AVAIL   ---
ALARM STATUS = * 0236 REPT-LKS:not aligned
UNAVAIL REASON = NA
Command Completed.
```

- Verify the status of the **IP** card to be inhibited using the `rept-stat-card` command.

For example, enter this command.

```
rept-stat-card:loc=1201
```

This is an example of the possible output.

```
rlghncxa03w 06-10-27 17:00:36 GMT EAGLE5 36.0.0
CARD  VERSION      TYPE   GPL      PST      SST      AST
1201  114-000-000    DCM    IPLIM    IS-NR    Active   -----
ALARM STATUS      = No Alarms.
BPDCM GPL         = 002-102-000
IMT BUS A         = Conn
IMT BUS B         = Conn
SIGNALING LINK STATUS
SLK   PST          LS      CLLI
A     IS-NR        nc001   -----
```

Command Completed.

If the **IP** card to be inhibited is in service-normal (**IS-NR**), continue the procedure with **8** to inhibit the card. If the **IP** card is out-of-service-maintenance disabled (**OOS-MT-DSBLD**), continue the procedure with **10** to change the **IP** link parameters.

8. Inhibit the **IP** card using the `inh-card` command.

For example, enter this command.

```
inh-card:loc=1201
```

This message should appear.

```
rlghncxa03w 06-10-28 21:18:37 GMT EAGLE5 36.0.0
Card has been inhibited.
```

9. Display the status of the **IP** card to verify that it is out-of-service maintenance-disabled (**OOS-MT-DSBLD**).

Enter this command.

```
rept-stat-card:loc=1201
```

This is an example of the possible output.

```
rlghncxa03w 06-10-27 17:00:36 GMT EAGLE5 36.0.0
CARD  VERSION      TYPE   GPL      PST      SST      AST
1201  114-000-000    DCM    IPLIM    IS-NR    Active   -----
ALARM STATUS      = No Alarms.
BPDCM GPL         = 002-102-000
IMT BUS A         = Conn
IMT BUS B         = Conn
SIGNALING LINK STATUS
SLK   PST          LS      CLLI
A     IS-NR        nc001   -----
```

Command Completed.

10. Display the attributes of the **IP** card assigned to the **IP** link being changed by entering the `rtrv-ip-card` command and specifying the card location of the **IP** link.

 **Note:**

If the `ipaddr` or `submask` parameter values are not being changed, continue the procedure with [13](#).

For this example, enter this command.

```
rtrv-ip-card:loc=1201
```

This is an example of the possible output.

```
rlghncxa03w 08-08-28 21:17:37 GMT EAGLE5 39.0.0
  LOC 1201
    SRCHORDR  LOCAL
    DNSA      150.1.1.1
    DNSB      -----
    DEFROUTER -----
    DOMAIN    -----
    SCTPCSUM  crc32c
    BPIPADDR  -----
    BPSUBMASK -----
```

If the `rtrv-ip-card` output shows an **IP** address for the default router (`DEFROUTER`) whose network portion matches the network portion of the **IP** address being changed, go to the [Configuring an IP Card](#) procedure and change the **IP** address of the default router to 0.0.0.0.

11. Display any **IP** routes referencing the **IP** link being changed by entering the `rtrv-ip-rte` command and specifying the card location of the **IP** link.

For this example, enter this command.

```
rtrv-ip-rte:loc=1201
```

This is an example of the possible output.

```
rlghncxa03w 06-10-28 21:17:37 GMT EAGLE5 36.0.0
LOC  DEST          SUBMASK          GTWY
1201 128.252.10.5    255.255.255.255 140.188.13.33
1201 128.252.0.0     255.255.0.0     140.188.13.34
1201 150.10.1.1      255.255.255.255 140.190.15.3
```

```
IP Route table is (5 of 2048) 0.24% full
```

If the `rtrv-ip-rte` output shows that the card has **IP** routes assigned to it, go to the [Removing an IP Route](#) procedure and remove the **IP** routes from the database.

12. The subnet address that results from the `ipaddr` and `submask` parameter values of the `chg-ip-lnk` command cannot be the same as the subnet address that results from the

`pvn` and `pvnmask`, `fcna` and `fcnamask`, or `fcnb` and `fcnbmask` parameter values of the `chg-netopts` command.

 **Note:**

If a Class A or CIP address (see [Table 3-3](#)) will be specified for the `ipaddr` parameter in [14](#), continue the procedure with [13](#).

Display the `pvn`, `pvnmask`, `fcna`, `fcnamask`, `fcnb`, and `fcnbmask` parameter values of the `chg-netopts` command by entering the `rtrv-netopts` command.

If error message E3967 Cmd Rej: E5IS must be on is displayed after the `rtrv-netopts` command is executed, the `pvn`, `pvnmask`, `fcna`, `fcnamask`, `fcnb`, and `fcnbmask` parameters are not configured. Continue the procedure with [13](#).

This is an example of the possible output if the **E5IS** feature is on.

```
rlghncxa03w 09-02-28 21:17:37 GMT EAGLE5 40.1.0
NETWORK OPTIONS
-----
PVN          = 128.20.30.40
PVNMASK      = 255.255.192.0
FCNA        = 170.120.50.0
FCNAMASK    = 255.255.240.0
FCNB        = 170.121.50.0
FCNBMASK    = 255.255.254.0
```

Choose `ipaddr` and `submask` parameter values for the **IP** link whose resulting subnet address is not be the same as the subnet address resulting from the `pvn` and `pvnmask`, `fcna` and `fcnamask`, or `fcnb` and `fcnbmask` parameter values of the `chg-netopts` command. Continue the procedure with [13](#).

13. Display the associations referencing the local host name that is associated with the **IP** link being changed by entering the `rtrv-assoc` command and specifying the local host name shown in the `rtrv-ip-host` output in [2](#).

For this example, enter this command.

```
rtrv-assoc:lhost="ipnode-1201"
```

This is an example of the possible output.

```
rlghncxa03w 06-10-28 09:12:36 GMT EAGLE5 36.0.0
CARD IPLNK
ANAME          LOC  PORT  LINK ADAPTER  LPORT  RPORT  OPEN  ALW
swbel32       1201 A    A    M2PA      1030  2345  YES  YES
```

```
IP Appl Sock/Assoc table is (3 of 4000) 1% full
Assoc Buffer Space Used (16 KB of 3200 KB) on LOC = 1201
```

If no associations are displayed in this step, continue the procedure with [14](#).

If the `rtrv-assoc` output shows that the `open` parameter for any associations is `yes`, perform one of these procedures to change the value of the `open` parameter the associations to `no`.

- [Changing the Attributes of an M2PA Association](#)
- [Changing the Attributes of a M3UA or SUA Association](#)

14. Change the link parameters associated with the **IP** card in the database using the `chg-ip-lnk` command.

For this example, enter this command.

```
chg-ip-
lnk:loc=1201:port=a:ipaddr=192.1.1.10:submask=255.255.255.0 :auto
=yes:mactype=dix
```

When this command has successfully completed, the following message should appear.

```
rlghncxa03w 06-10-28 21:18:37 GMT EAGLE5 36.0.0
CHG-IP-LNK: MASP A - COMPLTD
```

15. Verify the new link parameters associated with the **IP** card that was changed in 14 by entering the `rtrv-ip-lnk` command with the card location specified in 14.

For this example, enter this command.

The following is an example of the possible output.

```
rlghncxa03w 07-05-28 21:14:37 GMT EAGLE5 37.0.0
LOC  PORT  IPADDR          SUBMASK          DUPLEX  SPEED  MACTYPE  AUTO
MCAST
1201  A      192.1.1.10      255.255.255.128  HALF    10     DIX      YES  NO
1201  B      -----          -----          HALF    10     DIX      NO   NO
```

16. Allow the **IP** card that was inhibited in 8 by using by using the `alw-card` command.

 **Note:**

If 8 was not performed, continue the procedure with 18.

For example, enter this command.

```
alw-card:loc=1201
```

This message should appear.

```
rlghncxa03w 06-10-28 21:20:37 GMT EAGLE5 36.0.0
Card has been allowed.
```

17. Verify the in-service normal (**IS-NR**) status of the **IP** card using the `rept-stat-card` command.

For example, enter this command.

```
rept-stat-card:loc=1201
```

This is an example of the possible output.

```
rlghncxa03w 06-10-27 17:00:36 GMT EAGLE5 36.0.0
CARD VERSION      TYPE   GPL      PST      SST      AST
1201 114-000-000  DCM    IPLIM    IS-NR     Active   -----
  ALARM STATUS      = No Alarms.
  BPDCM GPL         = 002-102-000
  IMT BUS A        = Conn
  IMT BUS B        = Conn
  SIGNALING LINK STATUS
    SLK   PST           LS      CLLI
    A     IS-NR         nc001   -----
```

Command Completed.

18. Activate the signaling link from 5 using the `act-slk` command.

 **Note:**

If 5 was not performed, continue the procedure with 20.

For example, enter this command.

```
act-slk:loc=1201:link=a
```

The link changes its state from **OOS-MT-DSBLD** (out-of-service maintenance-disabled) to **IS-NR** (in-service normal).

The output confirms the activation.

```
rlghncxa03w 06-10-07 11:11:28 GMT EAGLE5 36.0.0
Activate Link message sent to card
```

19. Verify the in-service normal (**IS-NR**) status of the signaling link using the `rept-stat-slk` command.

For example, enter this command.

```
rept-stat-slk:loc=1201:link=a
```

This message should appear.

```
rlghncxa03w 06-10-28 21:16:37 GMT EAGLE5 36.0.0
SLK   LSN      CLLI      PST      SST      AST
1201,A  nc001     -----  IS-NR     Active   -----
Command Completed.
```

20. Perform the [Configuring an IP Card](#) procedure and change the **IP** address of the default router to a non-zero value, where the network portion of the default router **IP** address matches the network portion of the **IP** link's new **IP** address.

 **Note:**

If the `ipaddr` or `submask` values were not changed, continue the procedure with [22](#).

 **Note:**

If the IP address of the default router was not changed to 0.0.0.0 in [10](#), continue the procedure with [21](#).

21. Perform the [Adding an IP Route](#) procedure and add the IP routes back into the database.

 **Note:**

If IP routes were not removed in [11](#), continue the procedure with [22](#).

22. Perform one of these procedures as necessary and change the value of the `open` parameter of the association to `yes`.

 **Note:**

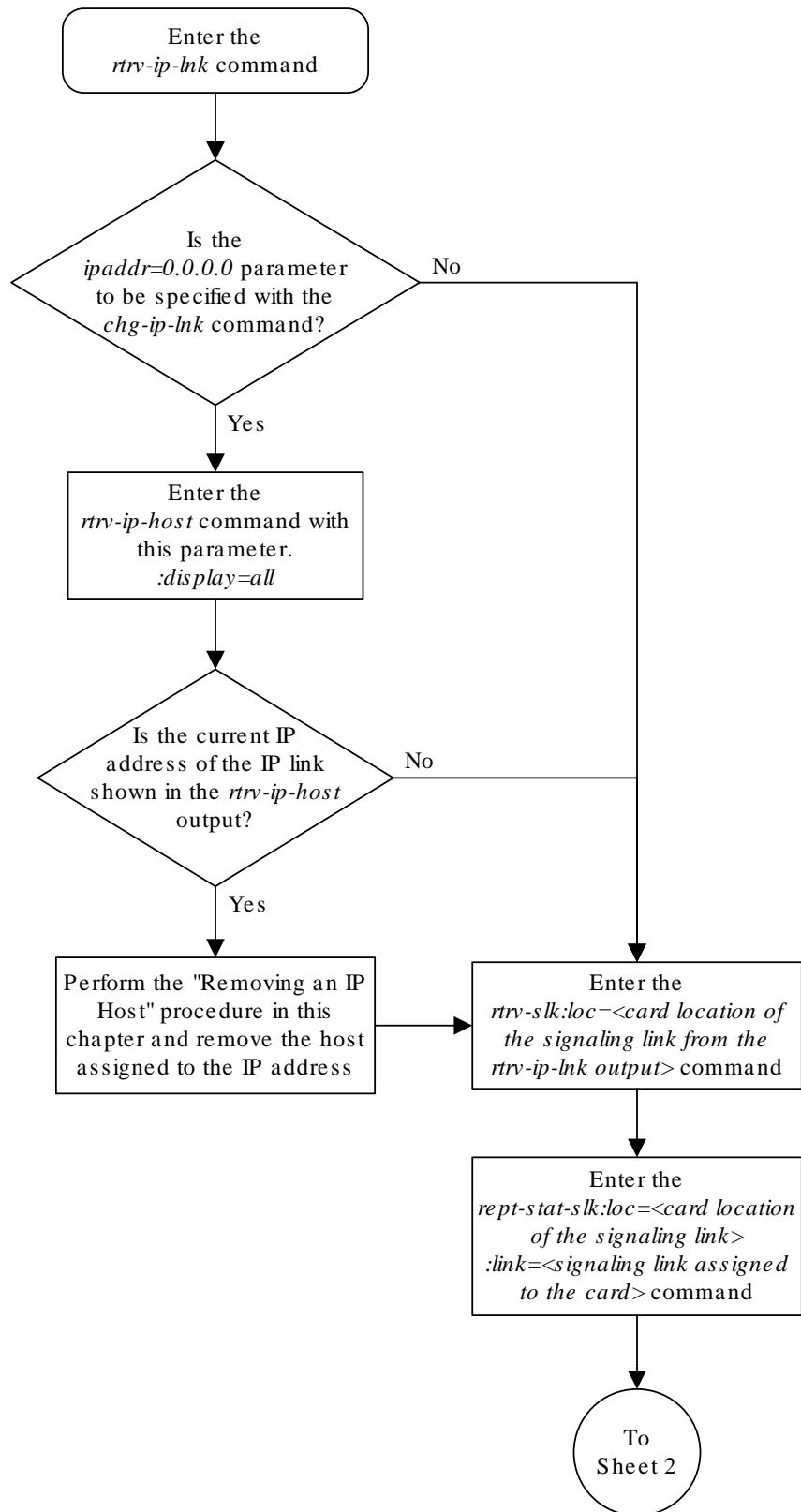
If the `open` parameter value for an association was not changed in [13](#), continue the procedure with [23](#).

- [Changing the Attributes of an M2PA Association](#)
 - [Changing the Attributes of a M3UA or SUA Association](#)
23. Back up the new changes using the `chg-db:action=backup:dest=fixed` command.

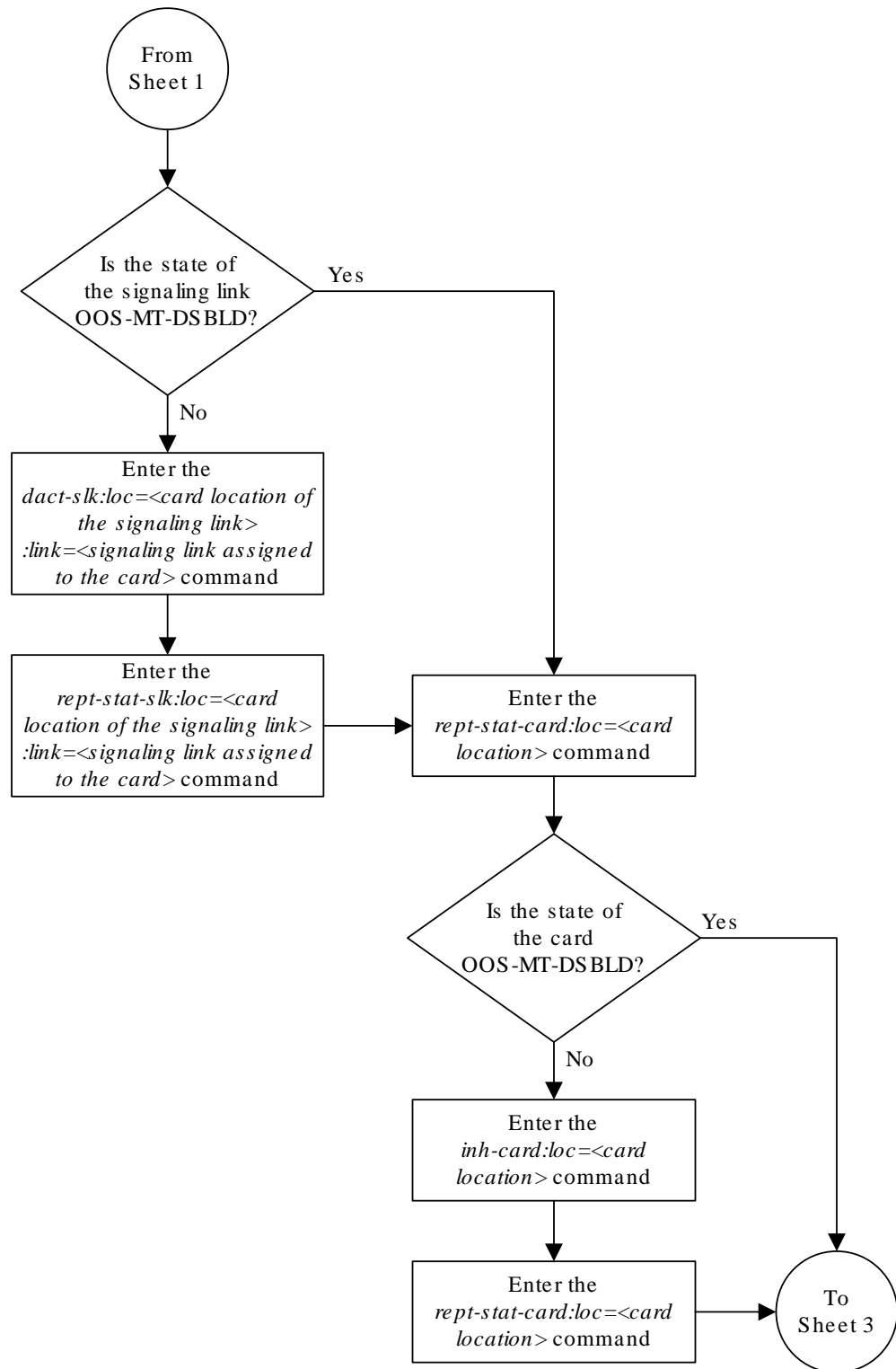
These messages should appear, the active **Maintenance and Administration Subsystem Processor (MASP)** appears first.

```
BACKUP (FIXED) : MASP A - Backup starts on active MASP.  
BACKUP (FIXED) : MASP A - Backup on active MASP to fixed disk complete.  
BACKUP (FIXED) : MASP A - Backup starts on standby MASP.  
BACKUP (FIXED) : MASP A - Backup on standby MASP to fixed disk complete.
```

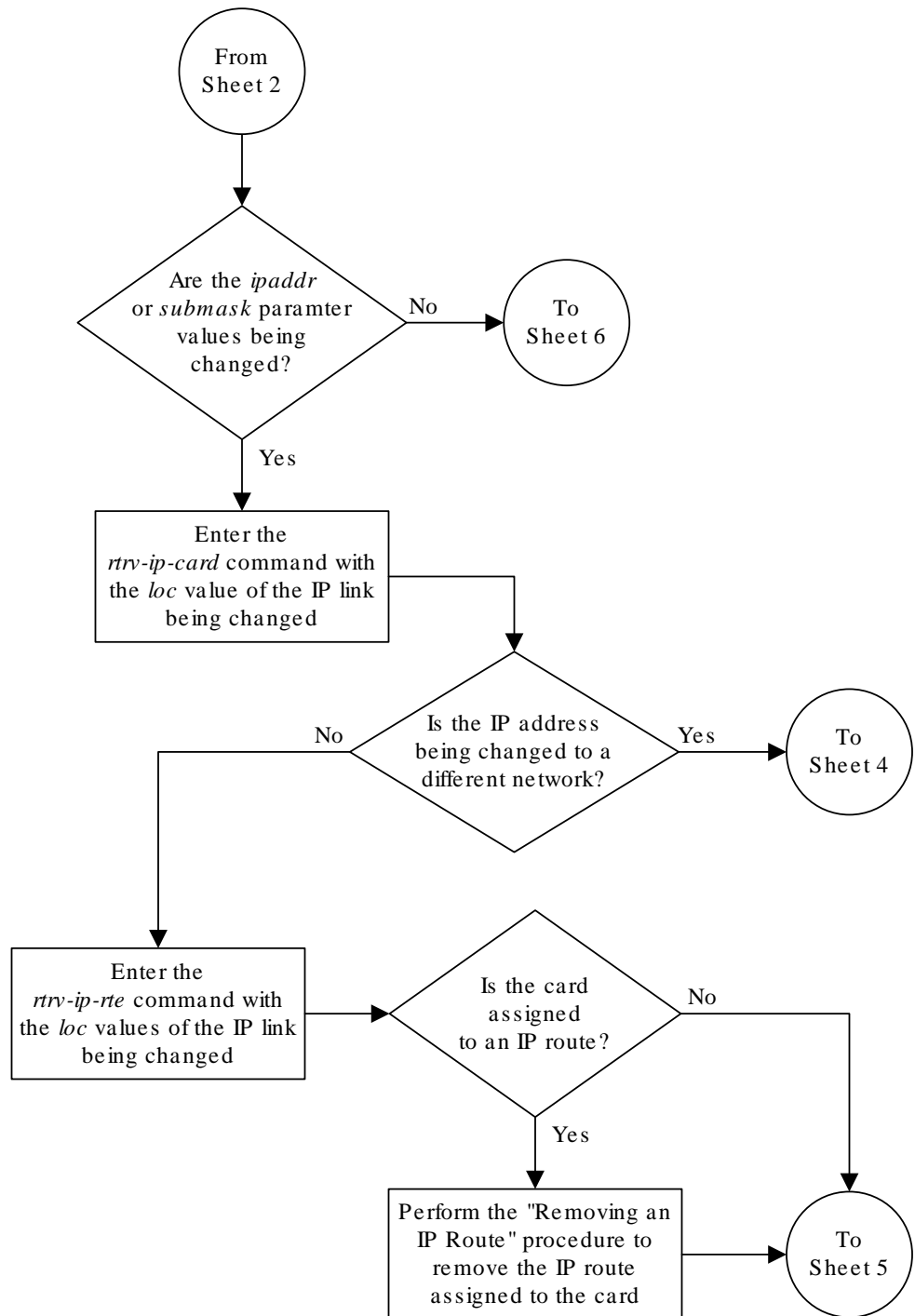
Figure 3-3 Configuring an IP Link



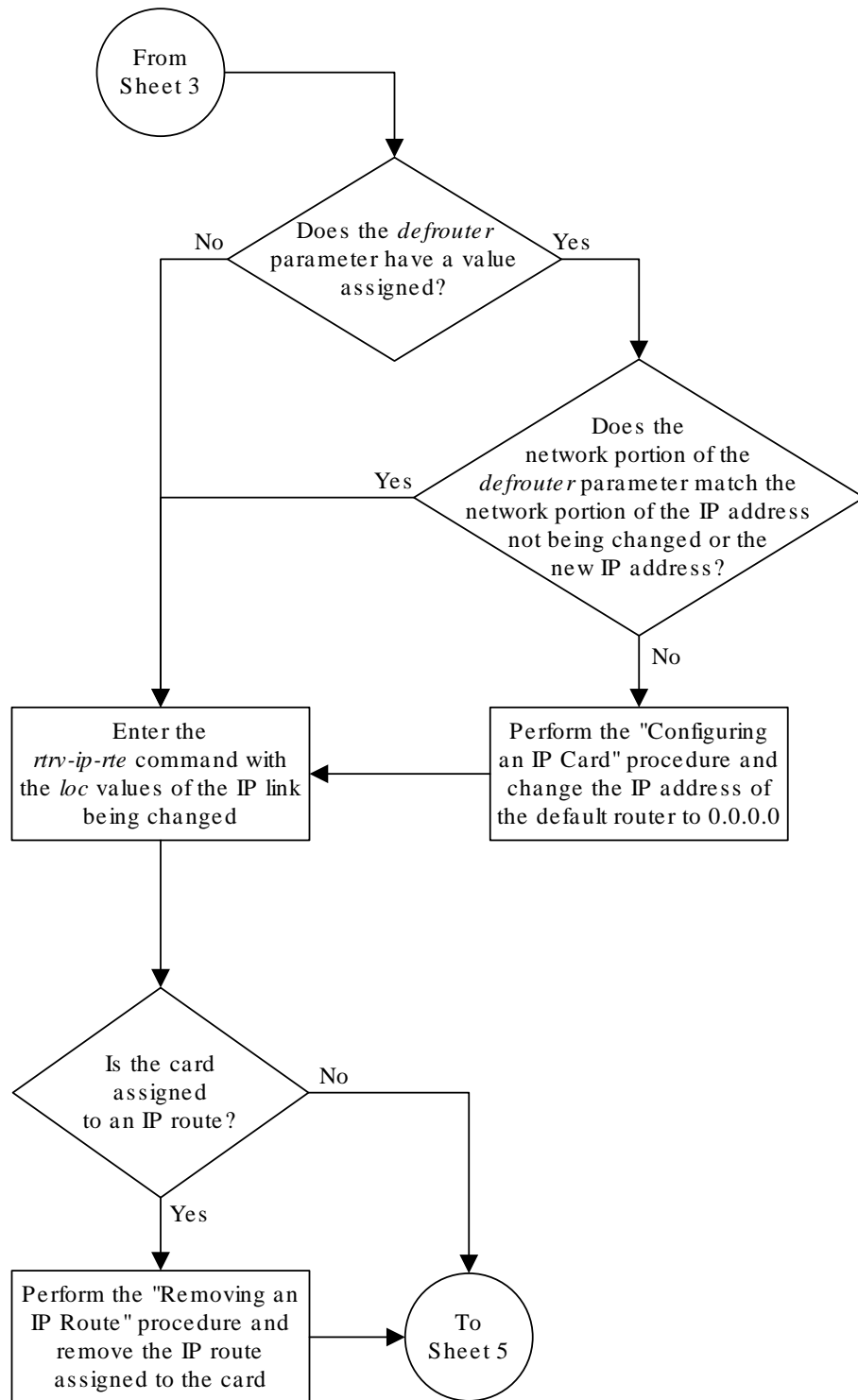
Sheet 1 of 9



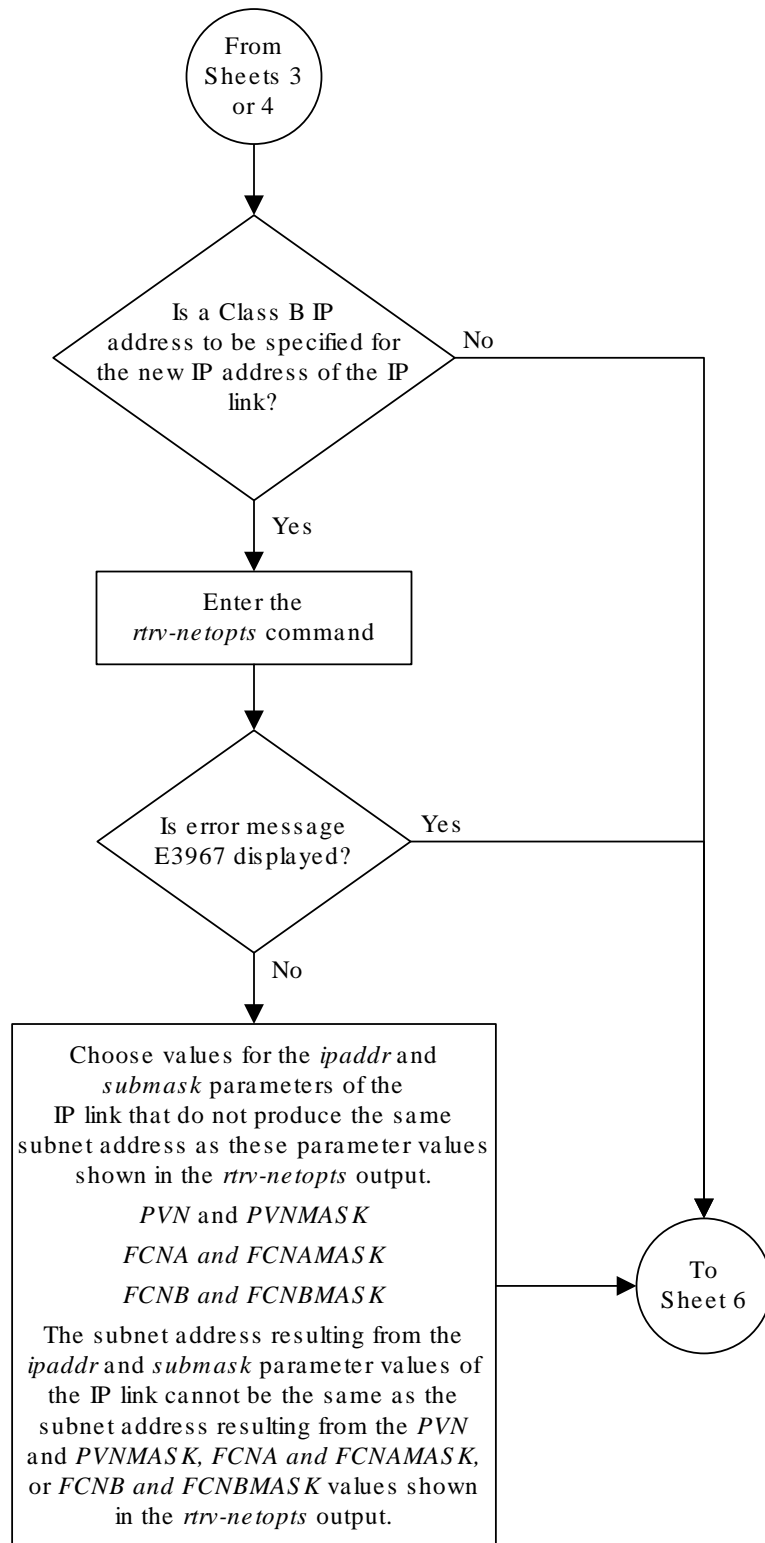
Sheet 2 of 9



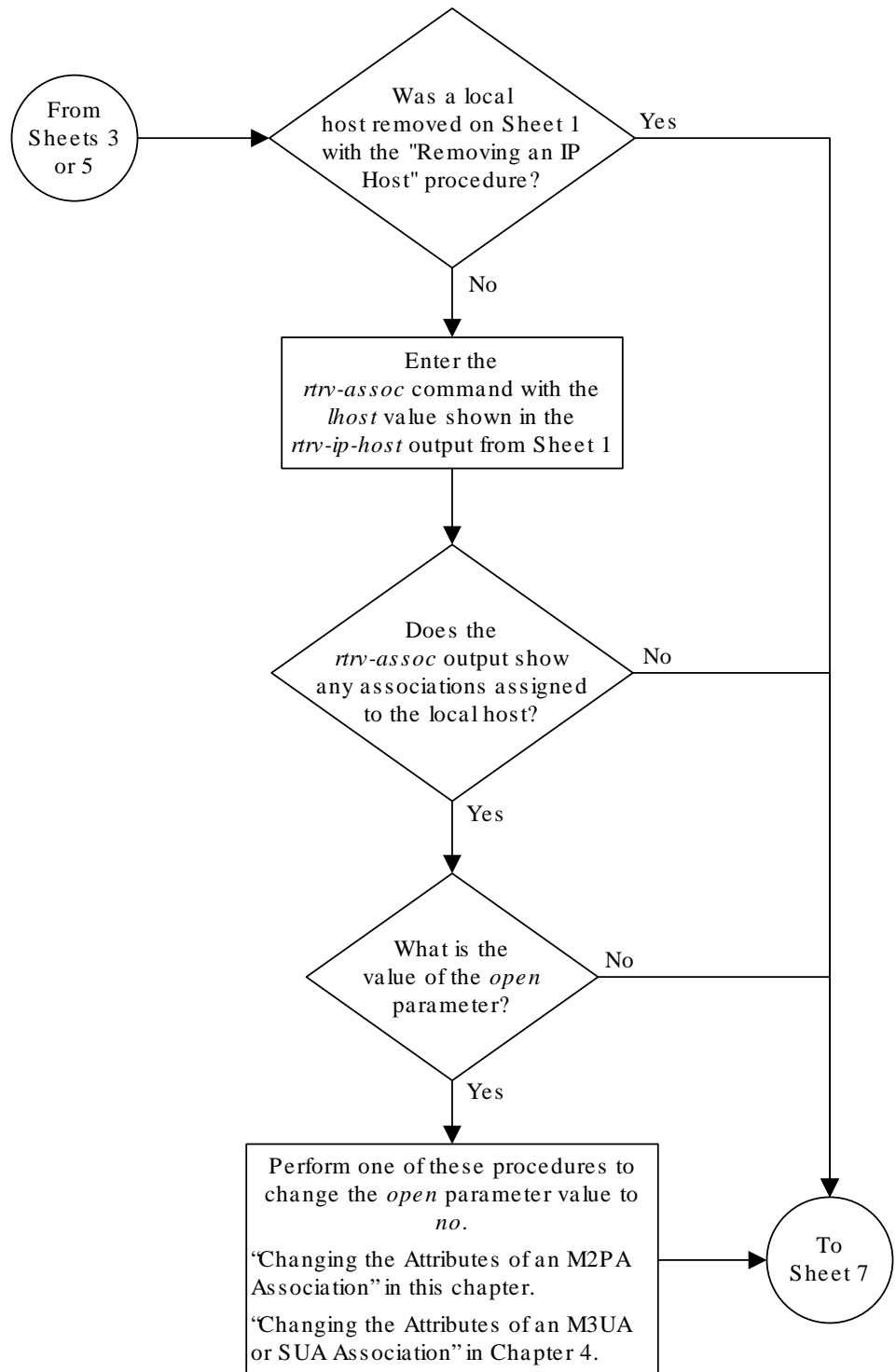
Sheet 3 of 9



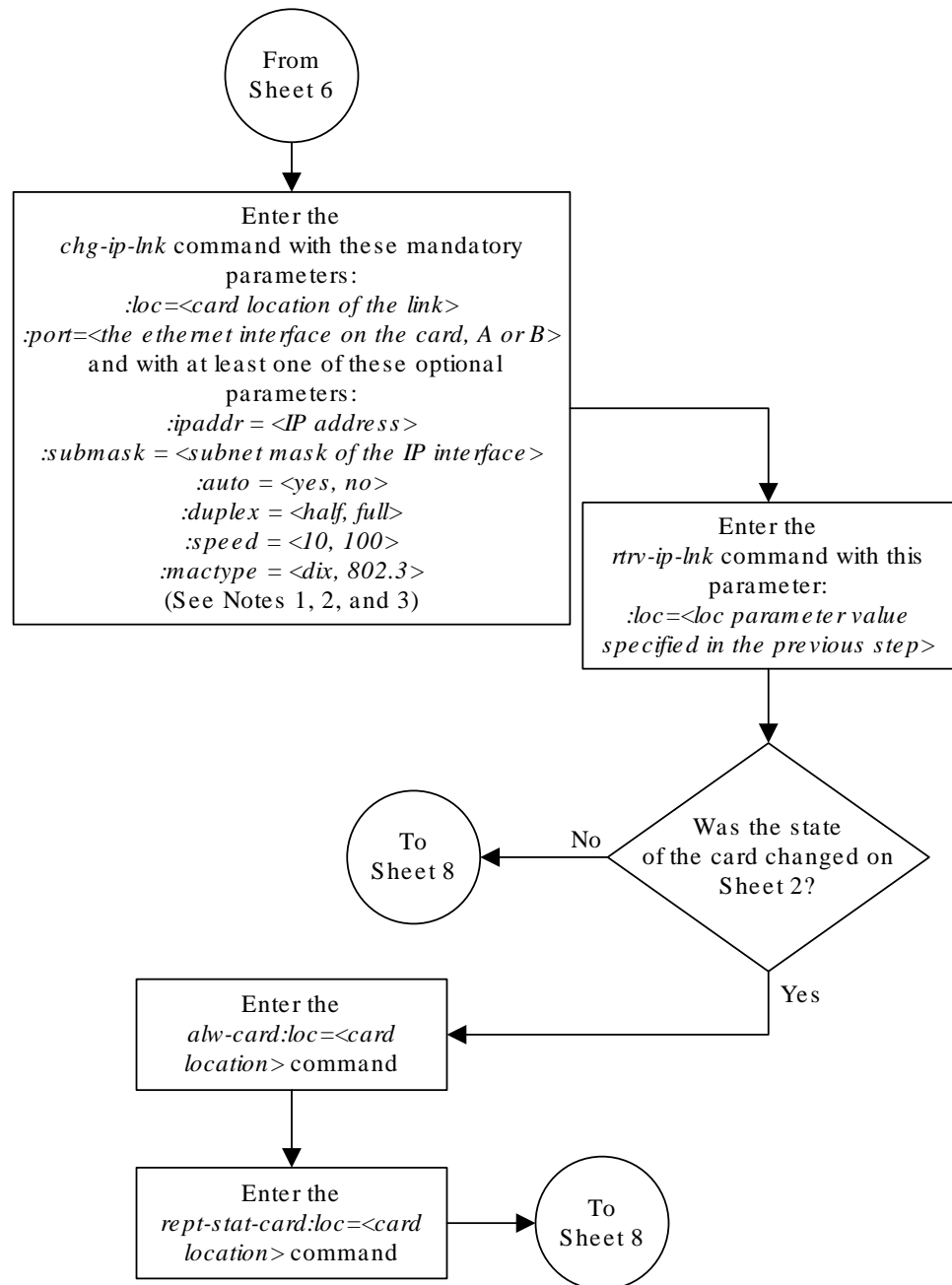
Sheet 4 of 9



Sheet 5 of 9



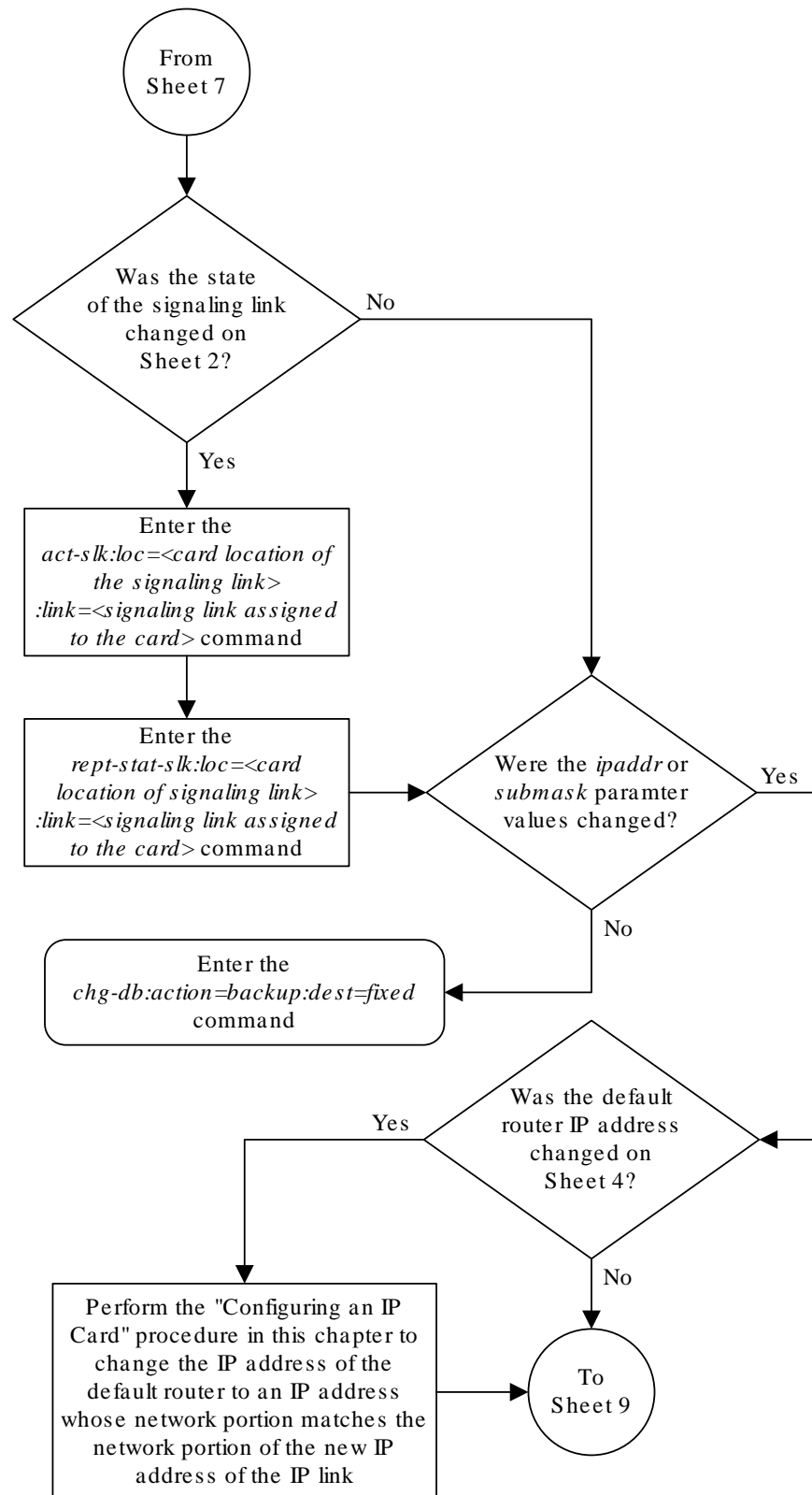
Sheet 6 of 9



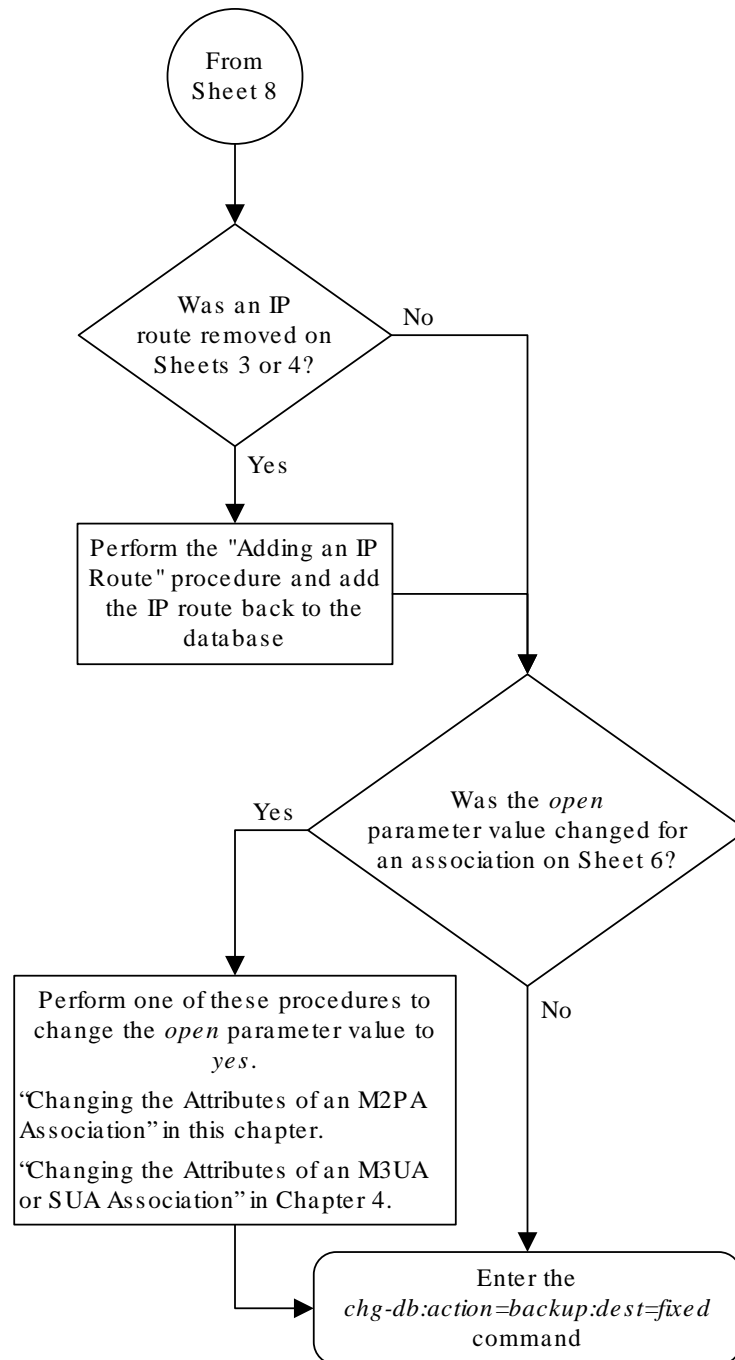
Notes:

1. If either the *ipaddr* or *submask* parameters are specified, then both parameters must be specified, unless the *ipaddr=0.0.0.0* parameter is specified, then the *submask* parameter is not required.
2. The *ipaddr=0.0.0.0* parameter disables the IP link.
3. If the *auto=yes* parameter is specified, then the *duplex* and *speed* parameters cannot be specified.

Sheet 7 of 9



Sheet 8 of 9



3.5 Adding an IP Host

This procedure associates hostnames with **IP** addresses using the `ent-ip-host` command.

The `ent-ip-host` command uses the following parameters.

`:host` – The host name to be associated with the **IP** address. This parameter identifies the logical name assigned to the device with the **IP** address indicated. The host name can contain up to 60 characters (using only these characters: a-z, A-Z, 0-9, -, .) and is not case sensitive. The host name must begin with a letter. Host names containing a dash (-) must be enclosed in double quotes.

`:ipaddr` – The **IP** address to be associated with the hostname. The node's **IP** address. This is an **IP** address expressed in standard "dot notation." **IP** addresses consist of the system's network number and the machine's unique host number.

`:type` – Specifies if the host resides on the **IP** card on the **EAGLE 5** (`type=local`, the default value), or if the host resides on equipment that is not in the **EAGLE 5** (`type=remote`). This parameter is optional.

The **EAGLE 5** can contain a maximum of 4096 IP hosts.

The **IP** address for a local host must be shown in the `rtrv-ip-lnk` output.

The **IP** address for a remote host must not be shown in the `rtrv-ip-lnk` output.

1. Display the current **IP** host information in the database by entering the `rtrv-ip-host:display=all` command.

The following is an example of the possible output.

```
rlghncxa03w 13-06-28 21:17:37 GMT EAGLE5 45.0.0
LOCAL IPADDR    LOCAL HOST
192.1.1.10      IPNODE1-1201
192.1.1.12      IPNODE1-1203
192.1.1.14      IPNODE1-1205
192.1.1.20      IPNODE2-1201
192.1.1.22      IPNODE2-1203
192.1.1.24      IPNODE2-1205
192.1.1.32      KC-HLR2
192.1.1.50      DN-MS1
192.1.1.52      DN-MS2

REMOTE IPADDR    REMOTE HOST
150.1.1.5        NCDEPTECONOMIC_DEVELOPMENT. SOUTHEASTERN_COORIDOR_ASHVL.
GOV
```

```
IP Host table is (10 of 4096) .24% full
```

2. Verify that the **IP** address assigned to the **IP** links by entering the `rtrv-ip-lnk` command.

The following is an example of the possible output.

```

rlghncxa03w 08-12-28 21:14:37 GMT EAGLE5 40.0.0
LOC  PORT IPADDR          SUBMASK          DUPLEX  SPEED  MACTYPE
AUTO MCAST
1201  A    192.1.1.10        255.255.255.128  HALF    10     802.3
NO   NO
1201  B    -----          -----          HALF    10     DIX
NO   NO
1203  A    192.1.1.12        255.255.255.0   ----    ---    DIX
YES  NO
1203  B    -----          -----          HALF    10     DIX
NO   NO
1205  A    192.1.1.14        255.255.255.0   FULL    100    DIX
NO   NO
1205  B    -----          -----          HALF    10     DIX
NO   NO
2101  A    192.1.1.20        255.255.255.0   FULL    100    DIX
NO   NO
2101  B    -----          -----          HALF    10     DIX
NO   NO
2103  A    192.1.1.22        255.255.255.0   FULL    100    DIX
NO   NO
2103  B    -----          -----          HALF    10     DIX
NO   NO
2105  A    192.1.1.24        255.255.255.0   FULL    100    DIX
NO   NO
2105  B    -----          -----          HALF    10     DIX
NO   NO
2207  A    192.1.1.32        255.255.255.0   FULL    100    DIX
NO   NO
2207  B    -----          -----          HALF    10     DIX
NO   NO
2213  A    192.1.1.50        255.255.255.0   FULL    100    DIX
NO   NO
2213  B    -----          -----          HALF    10     DIX
NO   NO
2301  A    192.1.1.52        255.255.255.0   FULL    100    DIX
NO   NO
2301  B    -----          -----          HALF    10     DIX
NO   NO

```

```
IP-LNK table is (20 of 2048) 1% full.
```

If a local host is being configured in this procedure, the **IP** address assigned to the local host must be shown in the `rtrv-ip-lnk` output. If the **IP** address is not shown in the `rtrv-ip-lnk` output, add the **IP** address by performing the [Configuring an IP Link](#) procedure.

If a remote host is being configured in this procedure, the **IP** address assigned to the remote host cannot be shown in the `rtrv-ip-lnk` output.

3. Add **IP** host information to the database by entering the `ent-ip-host` command.

If a local host is being configured, enter the `ent-ip-host` command with the IP address from 2, and the `type=local` parameter or without the `type` parameter. If the `type` parameter is not specified with the `ent-ip-host` command, the `type` parameter value defaults to `local`.

If a remote host is being configured, enter the `ent-ip-host` command with the IP address that is not shown in 2, and the `type=remote` parameter.

For example, enter this command.

```
ent-ip-host:host="kc-hlr1":ipaddr=192.1.1.30
```

When this command has successfully completed, the following message should appear.

```
rlghncxa03w 06-10-28 21:18:37 GMT EAGLE5 36.0.0  
ENT-IP-HOST: MASP A - COMPLTD
```

4. Verify the new IP host information in the database by entering the `rtrv-ip-host` command with the `host` parameter value specified in 3.

For this example, enter this command.

```
rtrv-ip-host:host="kc-hlr1"
```

The following is an example of the possible output.

```
rlghncxa03w 13-06-28 21:19:37 GMT EAGLE5 45.0.0  
LOCAL IPADDR      LOCAL HOST  
192.1.1.30        KC-HLR1
```

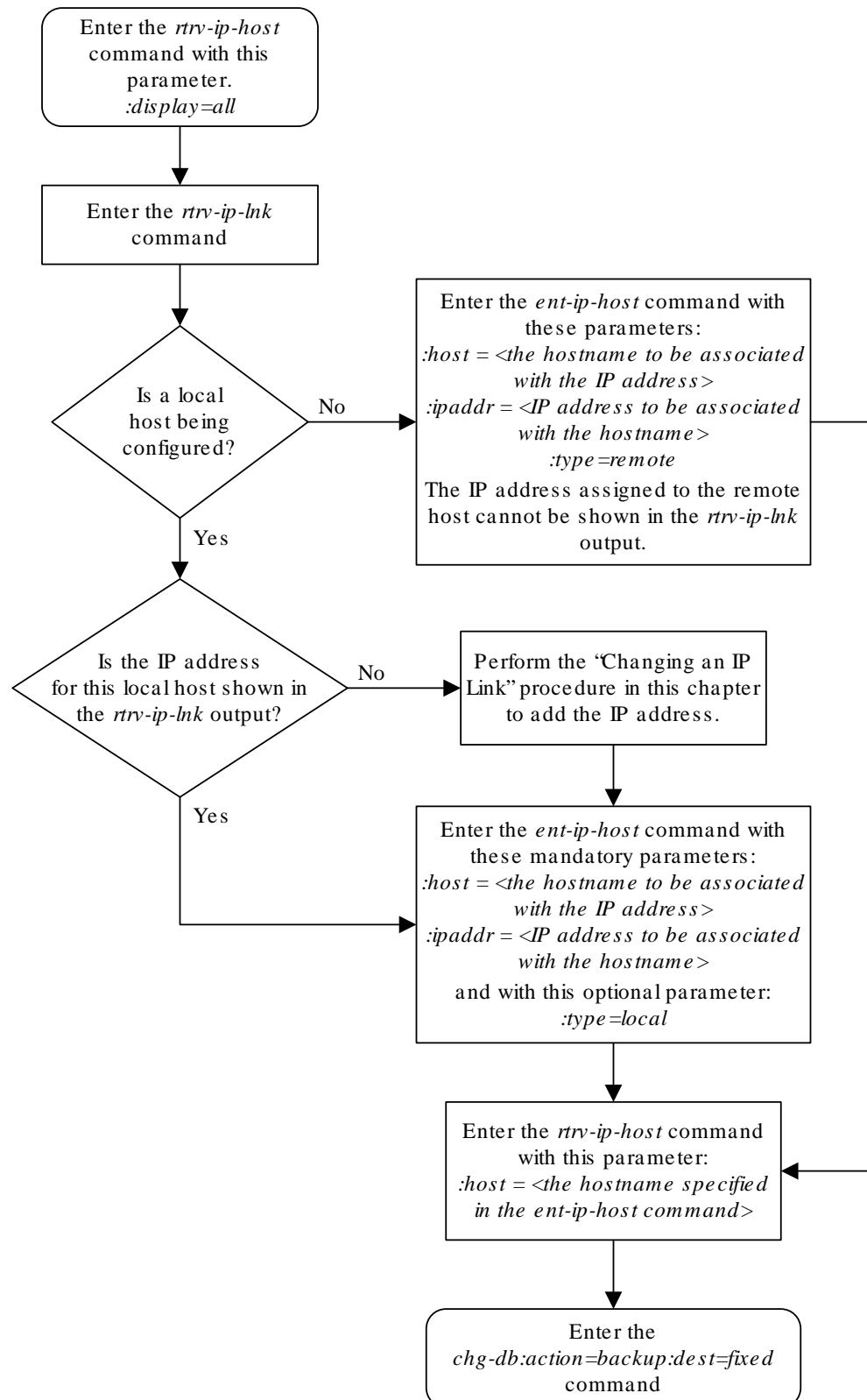
```
IP Host table is (11 of 4096) .26% full
```

5. Back up the new changes using the `chg-db:action=backup:dest=fixed` command.

These messages should appear, the active **Maintenance and Administration Subsystem Processor (MASP)** appears first.

```
BACKUP (FIXED) : MASP A - Backup starts on active MASP.  
BACKUP (FIXED) : MASP A - Backup on active MASP to fixed disk complete.  
BACKUP (FIXED) : MASP A - Backup starts on standby MASP.  
BACKUP (FIXED) : MASP A - Backup on standby MASP to fixed disk complete.
```

Figure 3-4 Adding an IP Host



3.6 Configuring an IP Card

This procedure is used to change the **IP** stack parameters associated with an **IP** card in the database using the `chg-ip-card` command.

The `chg-ip-card` command uses the following parameters.

`:loc` – The card location of the **IP** card

`:srchordr` – Host Table Search Order

`:dnlsa` – **Domain** name server A's **IP** address. This is an **IP** address expressed in standard "dot notation." **IP** addresses consist of the system's network number and the machine's unique host number.

`:dnspb` – **Domain** name server B's **IP** address. This is an **IP** address expressed in standard "dot notation." **IP** addresses consist of the system's network number and the machine's unique host number.

`:domain` – The domain name is used to construct a fully-qualified **DNS** name consisting of 120 characters or less. For example, a domain name can be `tekelec.com`, the hostname is `john.doe`. The fully-qualified **DNS** name would be `john.doe@tekelec.com`.

`:defrouter` – Default router **IP** address. This is an **IP** address expressed in standard "dot notation." **IP** addresses consist of the system's network number and the machine's unique host number.

`:rstdomain` – Reset **Domain** name. The parameter is used to reset the domain to a **NULL** value.

`:sctpcsum` – The SCTP checksum algorithm that will be applied to the traffic on the IP card, either `adler32` or `crc32c`. The `sctpcsum` parameter can be specified only if the `SCTPCSUM` value in the `rtrv-sg-opts` output is `percard`.

The `chg-ip-card` command contains other parameters that cannot be used in this procedure. Refer to *Commands User's Guide* for more information about these parameters.

The **IP** card must be placed out of service.

The `rstdomain` parameter cannot be specified if the `domain` parameter is specified.

There is only one default router (`defrouter` parameter) for each **IP** card. The default router is used as the primary route unless a static **IP** routes is defined for the destination **IP** address. Static **IP** routes are assigned using the `ent-ip-rte` command in the [Adding an IP Route](#) procedure.

The network portion of the **IP** address of the default router must match the network portion of one of the **IP** addresses assigned to the card.

The network portion of the **IP** address is based on the class of the **IP** address (shown in [Table 3-3](#)). If the **IP** address is a Class A **IP** address, the first field is the network portion of the **IP** address. If the **IP** address is a Class B **IP** address, the first two fields are the network portion of the **IP** address. If the **IP** address is a Class C **IP** address, the first three fields are the network portion of the **IP** address. For example, if the **IP** address is 193.5.207.150, a Class C **IP** address, the network portion of the **IP** address is 193.5.207.

The default router can be associated with only one **IP** address assigned to the card if the defrouter parameter is specified. For example, the `dnrsa` value for card 1101 is 150.1.1.10. The `dnrsb` value for card 1101 is 160.25.37.1. A default router is provisioned with the **IP** address 150.1.1.4. The default router is associated with the Ethernet A **IP** address (the `dnrsa` parameter value), but not the Ethernet B **IP** address (the `dnrsb` parameter value).

If the default router is associated with one of the **IP** card's **IP** addresses, a second gateway router can be assigned to the other **IP** address on the **IP** card by provisioning a static **IP** route for the **IP** card using the `ent-ip-rte` command in the [Adding an IP Route](#) procedure. Static **IP** routes can provide gateway routers associated with the other **IP** address on the **IP** card. To provision the gateway router (the `gtwy` parameter of the `ent-ip-rte` command) for the other **IP** address assigned to the **IP** card, the network portion of the gateway router's **IP** address must match the network portion of the other **IP** address assigned to the **IP** card.

Specifying the **IP** address 0.0.0.0 for the `dnrsa` or `dnrsb` parameters, removes the **IP** address for Ethernet A (`dnrsa`) or Ethernet B (`dnrsb`).

When an **IP** card is entered into the database with the `ent-card` command, the **IP** stack parameters associated with this card are initially set with these default values:

- `:srchordr` – **SRVR**
- `:dnrsa` – No **DNSA** **IP** address is specified
- `:dnrsb` – No **DNSB** **IP** address is specified
- `:domain` – No domain name is specified
- `:defrouter` – No default router **IP** address is specified
- `:rstdomain` – No
- `:sctpcsum` – **CRC32C**

The value of any optional parameter not specified with the `chg-ip-card` command is not changed.

1. Display the current **IP** parameters associated with card in the database by entering the `rtrv-ip-card` command.

The following is an example of the possible output.

```
rlghncxa03w 08-06-28 21:17:37 GMT EAGLE5 39.0.0
  LOC 1201
    SRCHORDR  SRVR
    DNSA      150.1.1.1
    DNSB      -----
    DEFROUTER -----
    DOMAIN    -----
    SCTPCSUM  crc32c
    BPIPADDR  -----
    BPSUBMASK -----
  LOC 1203
    SRCHORDR  LOCAL
    DNSA      192.1.1.40
    DNSB      -----
```



```

DEFROUTER -----
DOMAIN      NC. TEKELEC. COM
SCTPCSUM    crc32c
BPIPADDR    -----
BPSUBMASK   -----
LOC 1205
SRCHORDR    SRVRONLY
DNSA        192.1.1.40
DNSB        -----
DEFROUTER   -----
DOMAIN      NC. TEKELEC. COM
SCTPCSUM    crc32c
BPIPADDR    -----
BPSUBMASK   -----

```

To change the parameters of an **IP** card, the signaling link to the card and the card have to be inhibited.

2. Display the signaling link associated with the card shown in 1 using the `rtrv-slk` command specifying the card location.

For this example, enter this command.

```
rtrv-slk:loc=1201
```

This is an example of the possible output.

```

rlghncxa03w 06-10-28 21:17:37 GMT EAGLE5 36.0.0
LOC  LINK LSN          SLC TYPE  IPLIML2
1201 A   nc001          0  IPLIM  M2PA

```

3. Retrieve the status of the signaling link shown in 2 using the `rept-stat-slk` command specifying the card location and signaling link.

For example, enter this command.

```
rept-stat-slk:loc=1201:link=a
```

The output lists the signaling link assigned to this card:

```

rlghncxa03w 06-10-28 21:16:37 GMT EAGLE5 36.0.0
SLK      LSN      CLLI      PST      SST      AST
1201,A   nc001      -----  IS-NR
          Avail      ----
Command Completed.

```

If the signaling link is in service-normal (**IS-NR**), continue the procedure with 4 to deactivate the signaling link. If the signaling link is out-of-service-maintenance disabled (**OOS-MT-DSBLD**), continue the procedure with 6 to verify the card status.

4. Deactivate the signaling link assigned to the **IP** card using the `rept-stat-slk` command.

For example, enter this command.

```
dact-slk:loc=1201:link=a
```

▲ Caution:

This command impacts network performance and should only be used during periods of low traffic.

After this command has successfully completed, this message appears.

```
rlghncxa03w 06-10-12 09:12:36 GMT EAGLE5 36.0.0
Deactivate Link message sent to card.
```

5. Verify the new link status using the `rept-stat-slk` command.

For example, enter this command.

```
rept-stat-slk:loc=1201:link=a
```

The output displays the link status as **OOS-MT-DSBLD** and gives off a minor alarm:

```
rlghncxa03w 06-10-27 17:00:36 GMT EAGLE5 36.0.0
SLK      LSN      CLLI      PST      SST      AST
1201,A   nc001     -----  OOS-MT-DSBLD  AVAIL    ---
ALARM STATUS = * 0236 REPT-LKS:not aligned
UNAVAIL REASON = NA
Command Completed.
```

6. Verify the status of the **IP** card to be inhibited using the `rept-stat-card` command.

For example, enter this command.

```
rept-stat-card:loc=1201
```

This is an example of the possible output.

```
rlghncxa03w 06-10-27 17:00:36 GMT EAGLE5 36.0.0
CARD  VERSION  TYPE  GPL      PST      SST      AST
1201  114-000-000  DCM   IPLIM   IS-NR    Active   -----
ALARM STATUS      = No Alarms.
BPDCM GPL         = 002-102-000
IMT BUS A         = Conn
IMT BUS B         = Conn
SIGNALING LINK STATUS
      SLK  PST      LS      CLLI
      A   IS-NR    nc001   -----

Command Completed.
```

If the **IP** card to be inhibited is in service-normal (**IS-NR**), continue the procedure with [7](#) to inhibit the card. If the **IP** card is out-of-service-maintenance disabled (**OOS-MT-DSBLD**), continue the procedure with [9](#).

7. Inhibit the **IP** card using the `inh-card` command.

For example, enter this command.

```
inh-card:loc=1201
```

This message should appear.

```
rlghncxa03w 06-10-28 21:18:37 GMT EAGLE5 36.0.0
Card has been inhibited.
```

8. Display the status of the **IP** card to verify that it is out-of-service maintenance-disabled (**OOS-MT-DSBLD**).

Enter this command.

```
rept-stat-card:loc=1201
```

This is an example of the possible output.

```
rlghncxa03w 06-10-27 17:00:36 GMT EAGLE5 36.0.0
CARD VERSION      TYPE   GPL      PST      SST      AST
1201 114-000-000 DCM    IPLIM    IS-NR    Active   -----
  ALARM STATUS      = No Alarms.
  BPDCM GPL         = 002-102-000
  IMT BUS A         = Conn
  IMT BUS B         = Conn
  SIGNALING LINK STATUS
    SLK  PST      LS      CLLI
    A    IS-NR    nc001   -----
```

Command Completed.

If the `defrouter` parameter will be specified in [11](#), continue the procedure with [11](#).

If the `defrouter` parameter will not be specified in [11](#), continue the procedure by performing one of these steps.

- If the `sctpcsum` parameter value for the card will not be changed, continue the procedure with [11](#).
 - If the `sctpcsum` parameter value for the card will be changed, continue the procedure with [10](#).
9. Verify that the **IP** address of either Ethernet A or B (the address whose network portion matches the network portion of the `defrouter` parameter value to be used in [11](#)) is in the **IP** link table by entering the `rtrv-ip-lnk` command with the card location specified in this procedure.

For this example, enter this command.

```
rtrv-ip-lnk:loc=1201
```

The following is an example of the possible output.

```
rlghncxa03w 06-10-28 21:17:37 GMT EAGLE5 36.0.0
LOC  PORT IPADDR      SUBMASK      DUPLEX  SPEED MACTYPE AUTO
MCAST
```

```

1201 A 192.1.1.10 255.255.255.0 ---- --- DIX
YES NO
1201 B -----
YES NO

```

If the network portion of the **IP** address specified by the `defrouter` value does not match the network portions of either **IP** address displayed in this step, perform one of these actions:

- Choose another value for the `defrouter` parameter, making sure that the network portion of the new **IP** address matches the network portion of one of the **IP** addresses displayed in this step.
- Perform the [Configuring an IP Link](#) procedure and change one of the **IP** addresses shown in this step so that the network portion of the new **IP** address changed in the [Configuring an IP Link](#) procedure matches the network portion of the **IP** address value for the `defrouter` parameter.

After this step has been completed, continue the procedure by performing one of these steps.

- If the `sctpchecksum` parameter value for the card will not be changed, continue the procedure with [11](#).
- If the `sctpchecksum` parameter value for the card will be changed, continue the procedure with [10](#).

- 10.** To change the `sctpchecksum` parameter value for the IP card, the `sctpchecksum` parameter value in the `rtrv-sg-opts` output must be `percard`. Verify the `sctpchecksum` parameter value by entering the `rtrv-sg-opts` command.

The following is an example of the possible output.

```

rlghncxa03w 08-04-13 09:19:43 GMT EAGLE5 38.0.0
SRKQ: 1500
SNMPCONT: tekelec
GETCOMM: public
SETCOMM: private
TRAPCOMM: public
SCTPCSUM: adler32
IPGWABATE: NO
UAMEASUSEDFTAS: NO

```

If the `sctpchecksum` parameter value in the `rtrv-sg-opts` output is `percard`, continue the procedure with [11](#).

If the `sctpchecksum` parameter value in the `rtrv-sg-opts` output is `adler 32` or `crc32c`, perform the [Changing the SCTP Checksum Algorithm Option for M2PA Associations](#) procedure to change the `sctpchecksum` parameter value to `percard`. After the [Changing the SCTP Checksum Algorithm Option for M2PA Associations](#) procedure has been performed, continue the procedure with [11](#).

- 11.** Change the **IP** stack parameters associated with an **IP** card in the database using the `chg-ip-card` command.

For this example, enter this command.

```
chg-ip-
card:loc=1201:srchordr=local:dnsa=192.1.1.40:domain=nc.tekelec.co
m :sctpcsum=adler32
```

When this command has successfully completed, the following message should appear.

```
rlghncxa03w 06-10-28 21:20:37 GMT EAGLE5 36.0.0
CHG-IP-CARD: MASP A - COMPLTD
```

- Verify the new **IP** parameters associated with the **IP** card that was changed in [11](#) by entering the `rtrv-ip-card` command with the card location specified in [11](#).

For this example, enter this command.

```
rtrv-ip-card:loc=1201
```

The following is an example of the possible output.

```
rlghncxa03w 08-06-28 21:17:37 GMT EAGLE5 39.0.0
LOC 1201
SRCHORDR LOCAL
DNSA      192.1.1.40
DNSB      -----
DEFROUTER -----
DOMAIN    NC. TEKELEC. COM
SCTPCSUM  adler32
BPIPADDR  -----
BPSUBMASK -----
```

 **Note:**

If [7](#) was not performed, continue the procedure with [15](#).

- Allow the **IP** card that was inhibited in [7](#) by using the `alw-card` command.

For example, enter this command.

```
alw-card:loc=1201
```

This message should appear.

```
rlghncxa03w 06-10-28 21:22:37 GMT EAGLE5 36.0.0
Card has been allowed.
```

- Verify the in-service normal (**IS-NR**) status of the **IP** card using the `rept-stat-card` command.

For example, enter this command.

```
rept-stat-card:loc=1201
```

This is an example of the possible output.

```
rlghncxa03w 06-10-27 17:00:36 GMT EAGLE5 36.0.0
CARD VERSION      TYPE    GPL      PST      SST      AST
1201 114-000-000  DCM    IPLIM    IS-NR    Active   -----
  ALARM STATUS    = No Alarms.
  BPDCM GPL      = 002-102-000
  IMT BUS A      = Conn
  IMT BUS B      = Conn
  SIGNALING LINK STATUS
    SLK  PST      LS      CLLI
    A    IS-NR    nc001   -----
```

Command Completed.

15. Activate the signaling link from 4 using the `act-slk` command.

 **Note:**

If 4 was not performed, continue the procedure with 17.

For example, enter this command.

```
act-slk:loc=1201:link=a
```

The link changes its state from **OOS-MT-DSBLD** (out-of-service maintenance-disabled) to **IS-NR** (in-service normal).

The output confirms the activation.

```
rlghncxa03w 06-10-07 11:11:28 GMT EAGLE5 36.0.0
Activate Link message sent to card
```

16. Verify the in-service normal (**IS-NR**) status of the signaling link using the `rept-stat-slk` command.

For example, enter this command.

```
rept-stat-slk:loc=1201:link=a
```

This message should appear.

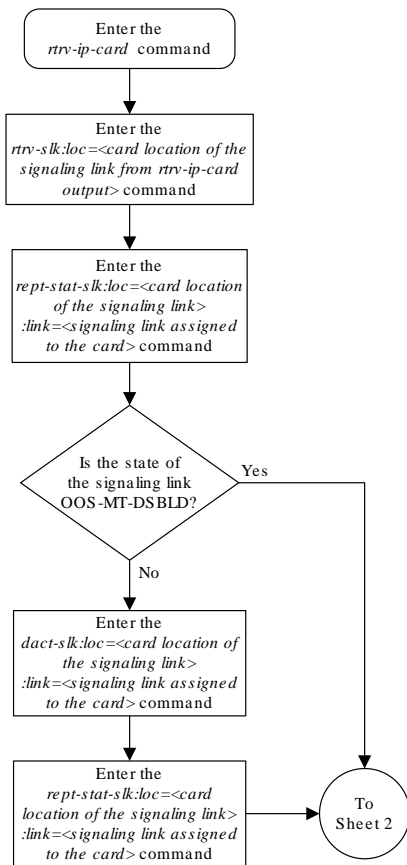
```
rlghncxa03w 06-10-28 21:16:37 GMT EAGLE5 36.0.0
SLK  LSN      CLLI      PST      SST      AST
1201,A  nc001    -----  IS-NR
      Avail   ----
Command Completed.
```

17. Back up the new changes using the `chg-db:action=backup:dest=fixed` command.

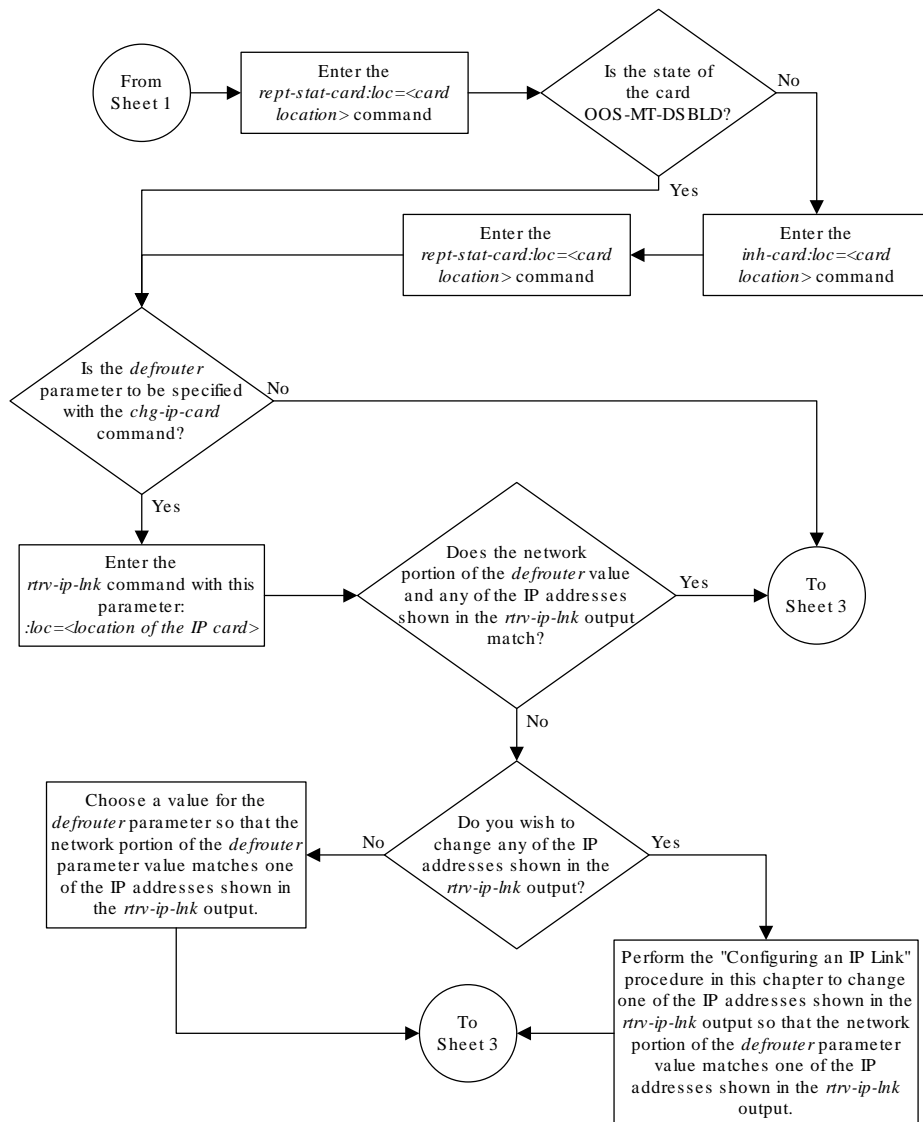
These messages should appear, the active **Maintenance and Administration Subsystem Processor (MASP)** appears first.

```
BACKUP (FIXED) : MASP A - Backup starts on active MASP.  
BACKUP (FIXED) : MASP A - Backup on active MASP to fixed disk complete.  
BACKUP (FIXED) : MASP A - Backup starts on standby MASP.  
BACKUP (FIXED) : MASP A - Backup on standby MASP to fixed disk complete.
```

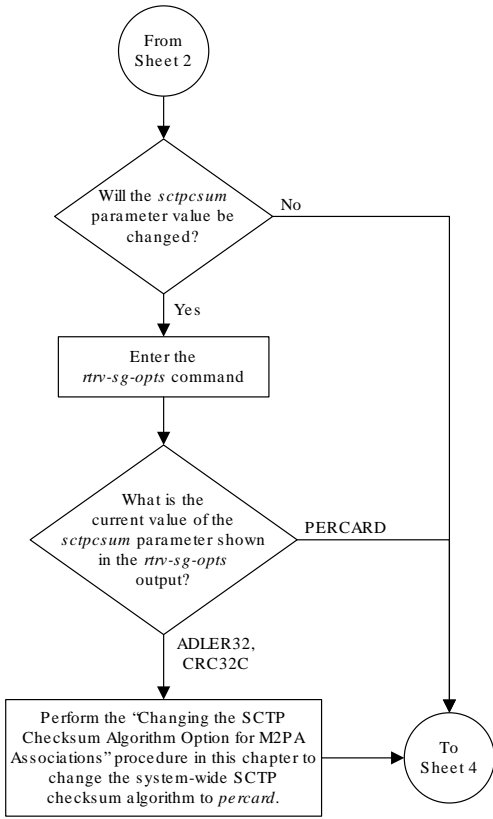
Figure 3-5 Configuring an IP Card

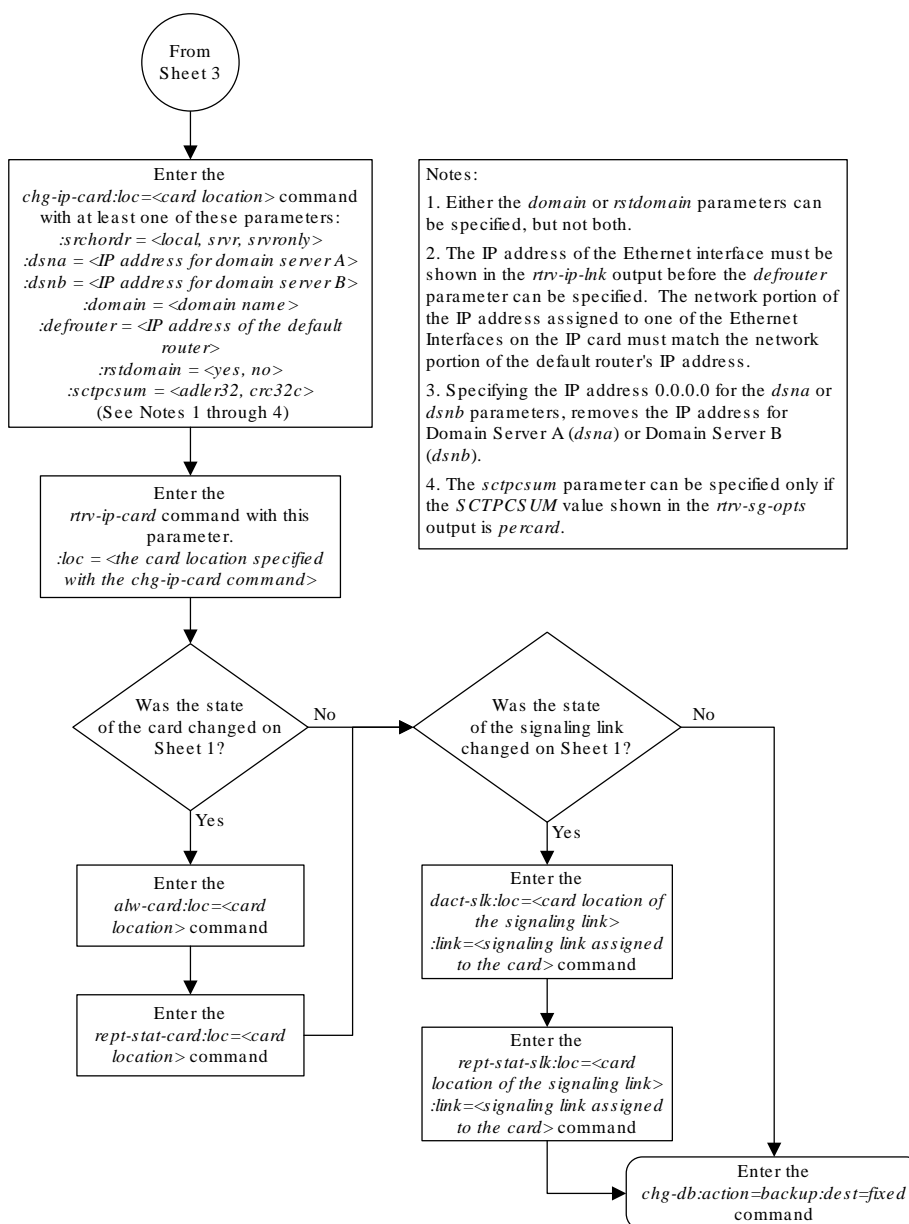


Sheet 1 of 4



Sheet 2 of 4





Sheet 4 of 4

3.7 Adding an IP Route

This procedure is used to add an **IP** route to the database using the `ent-ip-rte` command.

The `ent-ip-rte` command uses these parameters.

`:loc` – The location of the **IP** card that the **IP** route will be assigned to.

: `dest` – The **IP** address of the remote host or network.

: `submask` – The subnet mask of the destination **IP** address.

: `gtwy` – The **IP** address of the gateway or router that will send the **IP** data to its final destination.

There can be a maximum of 64 **IP** routes assigned to an **IP** card.

The **EAGLE** can contain a maximum of 1024 **IP** routes.

Ethernet Interfaces A and B on the **IP** card specified by the `loc` parameter can be used.

The network portion of the **IP** address value of the `gtwy` parameter must be the same as the network portion of the **IP** addresses shown for either the A or B interfaces in the `rtrv-ip-card` output.

The value of the `dest` and `gtwy` parameters cannot be 127.x.x.x (the loopback address), 0.0.0.0, or the **IP** addresses of the A or B interfaces on the **IP** card, and cannot be assigned to another **IP** card.

If the `dest` parameter value represents a host **IP** address, the value for the `submask` parameter must be 255.255.255.255. Otherwise, the `submask` parameter value identifies the network/host **ID** portions that must be entered when the `dest` parameter value represents a network address.

The submask is applied to the **IP** address which is being routed to see if it yields a route match. For example, if **IP** address 192.1.1.2 is being routed and the **IP** routing table contains these entries.

Table 3-4 Sample IP Routing Table

IP address	Submask	Gateway
191.1.0.0	255.255.0.0	192.168.110.250
192.0.0.0	255.0.0.0	192.168.110.251

IP routing occurs as follows:

1. The subnet mask of route 1 (255.255.0.0) is applied to the **IP** address being routed (192.1.1.2) with the resulting **IP** address of 192.1.0.0. **IP** address 192.1.0.0 does not match **IP** address 191.1.0.0 in the **IP** routing table, so the next route is chosen.
2. The subnet mask of route 2 (255.0.0.0) is applied to the **IP** address being routed (192.1.1.2) with the resulting **IP** address of 192.0.0.0 which matches the second route in the **IP** routing table, so this route is selected for routing this datagram.

See [Table 3-5](#) for the valid input values for the `submask` and `dest` parameter combinations.

Table 3-5 Valid Subnet Mask Parameter Values

Network Class	IP Network Address Range	Valid Subnet Mask Values
A	1.0.0.0 to 127.0.0.0	255.0.0.0 (the default value for a class A IP address)
		255.192.0.0
		255.224.0.0
		255.240.0.0
		255.248.0.0
		255.252.0.0
		255.254.0.0
		255.255.128.1
A+B	128.1.0.0 to 191.255.0.0	255.255.0.0 (the default value for a class B IP address)
		255.255.192.0
		255.255.224.0
		255.255.240.0
		255.255.248.0
		255.255.252.0
		255.255.254.0
A+B+C	192.0.0.0 to 223.255.255.0	255.255.255.0 (the default value for a class C IP address)
		255.255.255.192
		255.255.255.224
		255.255.255.240
		255.255.255.248
		255.255.255.252

If a Class B IP address is specified for the `dest` parameter of the `ent-ip-rte` command, the subnet address that results from the `dest` and `submask` parameter values cannot be the same as the subnet address that results from the `pvn` and `pvnmask`, `fcna` and `fcnamask`, or `fcnb` and `fcnbmask` parameter values of the `chg-netopts` command. The `pvn` and `pvnmask`, `fcna` and `fcnamask`, or `fcnb` and `fcnbmask` parameter values can be verified by entering the `rtrv-netopts` command. Choose `dest` and `submask` parameter values for the IP route whose resulting subnet address is not be the same as the subnet address resulting from the `pvn` and `pvnmask`, `fcna` and `fcnamask`, or `fcnb` and `fcnbmask` parameter values of the `chg-netopts` command.

1. Display the IP routes in the database with the `rtrv-ip-rte` command.

This is an example of the possible output.

```
rlghncxa03w 06-10-28 09:12:36 GMT EAGLE5 36.0.0
LOC  DEST          SUBMASK          GTWY
1301 128.252.10.5     255.255.255.255 140.188.13.33
1301 128.252.0.0      255.255.0.0      140.188.13.34
1301 150.10.1.1       255.255.255.255 140.190.15.3
1303 192.168.10.1     255.255.255.255 150.190.15.23
```

```
1303 192.168.0.0      255.255.255.0    150.190.15.24
```

```
IP Route table is (5 of 2048) 0.24% full
```

2. Display the IP cards in the database with the `rtrv-ip-card` command.

This is an example of the possible output.

```
rlghncxa03w 08-08-28 21:17:37 GMT EAGLE5 39.0.0
  LOC 1212
    SRCHORDR  LOCAL
    DNSA      150.1.1.1
    DNSB      -----
    DEFROUTER 150.1.1.100
    DOMAIN    NC. TEKELEC. COM
    SCTPCSUM  crc32c
    BPIPADDR  -----
    BPSUBMASK -----
  LOC 1301
    SRCHORDR  SRVROONLY
    DNSA      140.188.13.10
    DNSB      140.190.15.28
    DEFROUTER -----
    DOMAIN    NC. TEKELEC. COM
    SCTPCSUM  crc32c
    BPIPADDR  -----
    BPSUBMASK -----
  LOC 1303
    SRCHORDR  LOCAL
    DNSA      150.190.15.1
    DNSB      -----
    DEFROUTER 150.190.15.25
    DOMAIN    NC. TEKELEC. COM
    SCTPCSUM  crc32c
    BPIPADDR  -----
    BPSUBMASK -----
```

If the required IP card is not shown in the `rtrv-ip-card` output, perform the [Adding an IPLIMx Card](#) procedure to add the card to the database.

Perform the [Configuring an IP Card](#) procedure and make sure that the network portion of the IP addresses assigned for the A or B interfaces of the IP card is the same as the network portion of the IP address that will be assigned to the `gtwy` parameter of the IP route

 **Note:**

If a Class A or CIP address (see [Table 3-5](#)) will be specified for the `dest` parameter in 4, continue the procedure with 4.

3. The subnet address that results from the `dest` and `submask` parameter values of the `ent-ip-rte` command cannot be the same as the subnet address that

results from the `pvn` and `pvnmask`, `fcna` and `fcnamask`, or `fcnb` and `fcnbmask` parameter values of the `chg-netopts` command.

Display the `pvn`, `pvnmask`, `fcna`, `fcnamask`, `fcnb`, and `fcnbmask` parameter values of the `chg-netopts` command by entering the `rtrv-netopts` command.

If error message `E3967 Cmd Rej: E5IS must be on` is displayed after the `rtrv-netopts` command is executed, the `pvn`, `pvnmask`, `fcna`, `fcnamask`, `fcnb`, and `fcnbmask` parameters are not configured. Continue the procedure with 4.

This is an example of the possible output if the **E5IS** feature is on.

```
rlghncxa03w 09-02-28 21:17:37 GMT EAGLE5 40.1.0
NETWORK OPTIONS
-----
PVN          = 128.20.30.40
PVNMASK     = 255.255.192.0
FCNA        = 170.120.50.0
FCNAMASK    = 255.255.240.0
FCNB        = 170.121.50.0
FCNBMASK    = 255.255.254.0
```

Choose `dest` and `submask` parameter values for the **IP** route whose resulting subnet address is not be the same as the subnet address resulting from the `pvn` and `pvnmask`, `fcna` and `fcnamask`, or `fcnb` and `fcnbmask` parameter values of the `chg-netopts` command. Continue the procedure with 4.

4. Add the **IP** route to the database using the `ent-ip-rte` command.

For this example, enter this command.

```
ent-ip-
rte:loc=1212:dest=132.10.175.20:submask=255.255.255.255 :gtwy=150
.1.1.50
```

When this command has successfully completed, this message should appear.

```
rlghncxa03w 06-10-12 09:12:36 GMT EAGLE5 36.0.0
ENT-IP-RTE: MASP A - COMPLTD
```

5. Verify the changes using the `rtrv-ip-rte` command with the card location specified with the `ent-ip-rte` command in 4.

For this example, enter these commands.

```
rtrv-ip-rte:loc=1212
```

This is an example of the possible output.

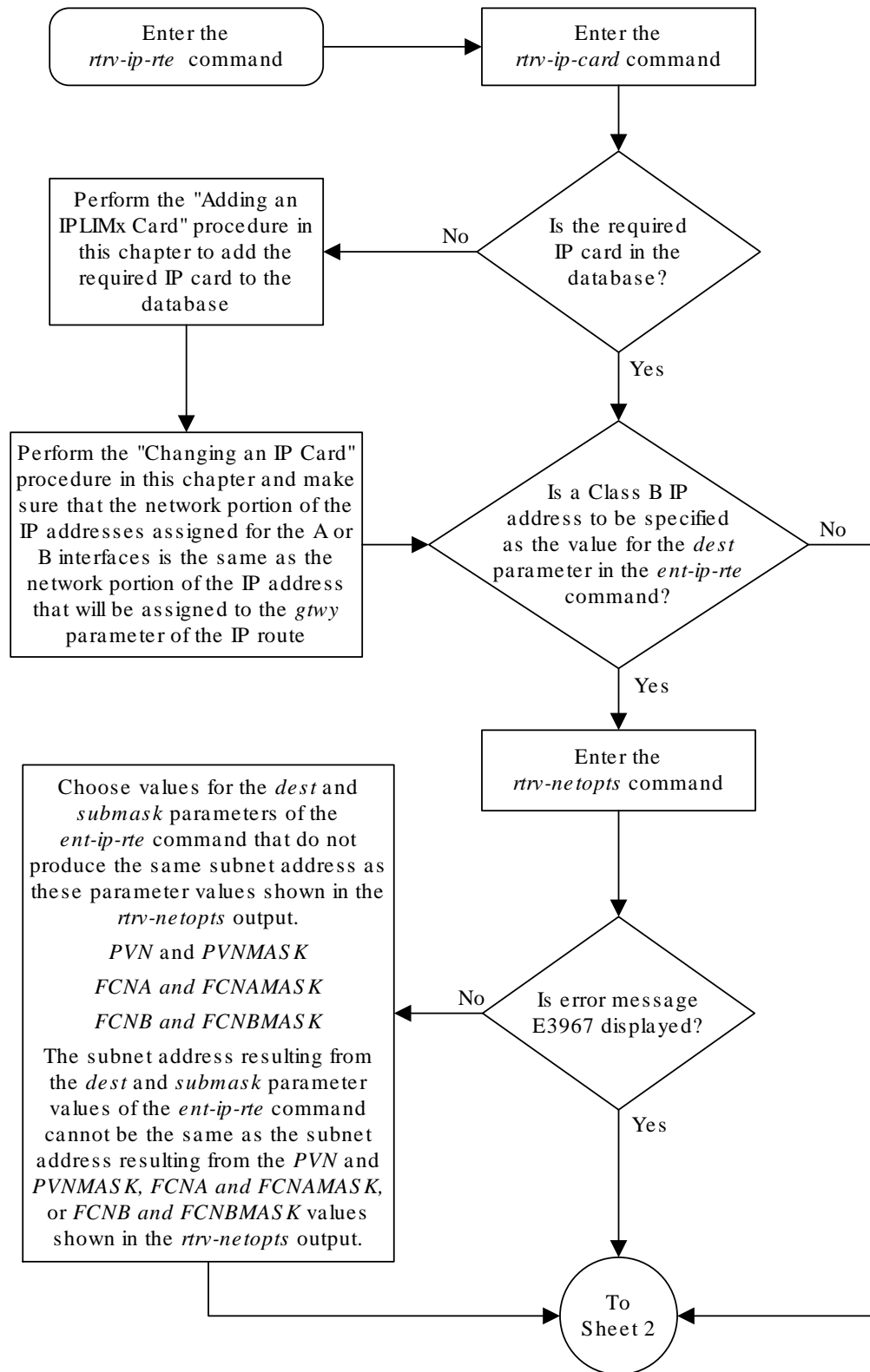
```
rlghncxa03w 06-10-28 09:12:36 GMT EAGLE5 36.0.0
LOC  DEST          SUBMASK          GTWY
1212 132.10.175.20   255.255.255.255 150.1.1.50
IP Route table is (6 of 2048) 0.29% full
```

6. Back up the new changes using the `chg-db:action=backup:dest=fixed` command.

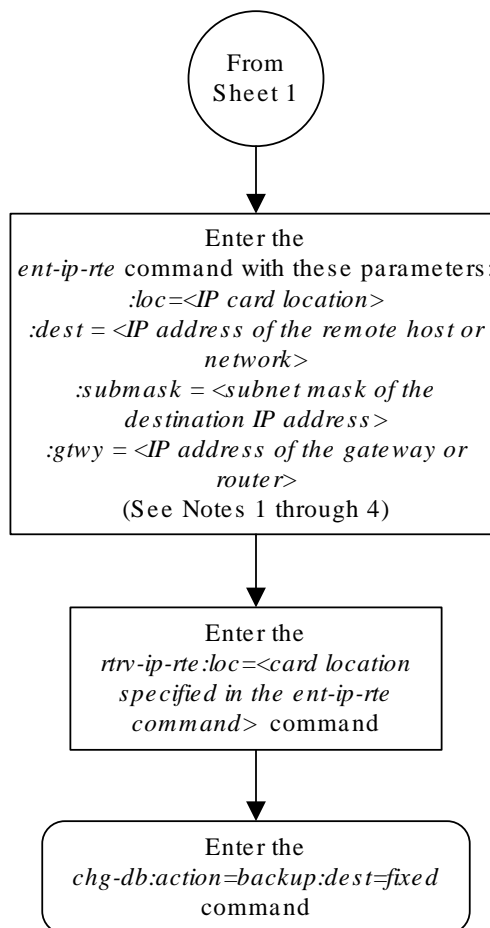
These messages should appear, the active **Maintenance and Administration Subsystem Processor (MASP)** appears first.

```
BACKUP (FIXED) : MASP A - Backup starts on active MASP.  
BACKUP (FIXED) : MASP A - Backup on active MASP to fixed disk  
complete.  
BACKUP (FIXED) : MASP A - Backup starts on standby MASP.  
BACKUP (FIXED) : MASP A - Backup on standby MASP to fixed disk  
complete.
```


Figure 3-6 Adding an IP Route



Sheet 1 of 2



Notes:

1. The network portion of the IP address value of the *gtwy* parameter must be the same as the network portion of the IP addresses shown for either the A or B interfaces in the *rtrv-ip-card* output.
2. The value of the *dest* and *gtwy* parameters cannot be 127.x.x.x (the loopback address), 0.0.0.0, or the IP addresses of the A or B interfaces on the IP card, and cannot be assigned to another IP card.
3. There can be a maximum of 64 IP routes assigned to an IP card.
4. The EAGLE 5 ISS can contain a maximum of 1024 IP routes.

3.8 Adding an M2PA Association

This procedure is used to configure **M2PA** associations using the `ent-assoc` command. The combination of a local host, local **SCTP** port, remote host and remote **SCTP** port defines an association. **M2PA** associations are assigned to cards running either the **IPLIM** or **IPLIMI** applications (**IPLIMx** cards).

The `ent-assoc` command uses these parameters:

`:aname` – The name assigned to the association. Valid association names can contain up to 15 alphanumeric characters where the first character is a letter and the remaining characters are alphanumeric characters. The `aname` parameter value is not case-sensitive.

`:lhost` – Local Hostname. The logical name assigned to the local host device.

`:lport` – The **SCTP** port number for the local host.

`:rhost` – Remote Hostname. The logical name assigned to the remote host device.

`:rport` – The **SCTP** port number for the remote host.

`:link` – The signaling link on the **IP** card. If a signaling link is not specified for a association when it is entered, the association defaults to signaling link A. If the card is an **E5-ENET** or **E5-ENET-B** card, the values for the `link` parameter can be `a`, `a1`, `a2`, `a3`, `a4`, `a5`, `a6`, `a7`, `b`, `b1`, `b2`, `b3`, `b4`, `b5`, `b6`, or `b7`.

 **Note:**

The `port` parameter can be used in place of the `link` parameter to specify the signaling link on the card.

`:adapter` – The adapter layer for this association, `m2pa`. The `adapter` parameter is optional. The default value for the `adapter` parameter is `m2pa`.

`:alhost` – The alternate local host name.

`:m2patset` – The **M2PA** timer set assigned to the association. The `m2patset` parameter can be specified only with the `adapter=m2pa` parameter. If the `adapter=m2pa` parameter is specified, and the `m2patset` parameter is not specified with the `ent-assoc` command, the default value for the `m2patset` parameter (1 - **M2PA** timer set 1) is assigned to the association.

Associations contain fields whose values are not assigned using the `ent-assoc` command. When an association is added to the database, these fields receive their default values. If a different value is desired, the `chg-assoc` command must be used. To change these values perform the [Changing the Attributes of an M2PA Association](#) procedure.

These fields and their default values are shown in [Table 3-6](#).

Table 3-6 M2PA Association Fields and Default Values

open=no	rmax=800	cwmin=3000	alw=no	uaps=10
istrms=2	rmode=lin	rtimes=10	ostrms=2	rmin=120
ver=rfc	bufsize=200	rtxthr=0	rhostval=rela xed	

An M2PA association that is assigned to an IPLIMx signaling link can contain a UA parameter set value (the `uaps` parameter). The `uaps` parameter cannot be specified with the `ent-
assoc` command. The default value for the `uaps` parameter is 10. While the `uaps` parameter value can be changed with the `chg-
assoc` command, the `uaps` parameter value has no impact on the traffic carried by an M2PA association that is assigned to an IPLIMx signaling link. The `uaps` parameter value impacts M3UA or SUA associations that are assigned to IPGWx signaling links and M2PA and M3UA associations that are assigned to IPSG cards. The `uaps` parameter value is shown in the `UAPS` field in the `rtrv-
assoc` output for an M2PA associations that is assigned to an IPLIMx signaling link.

An M2PA association can contain an alternate remote host. The alternate remote host is provisioned with the `rhost` and `rhostype=alternate` parameters of the `chg-
assoc` command. A primary remote host can be provisioned in this procedure by specifying the `rhost` parameter with the `ent-
assoc` command. To provision an alternate remote host for an M2PA association, perform [Changing the Attributes of an M2PA Association](#).

The size of the buffers on the on the E5-ENET and E5-ENET-B cards are shown in the following list.

- E5-ENET Card and E5-ENET-B - 3200 KB

The size of the buffers assigned to each association that is assigned to the **IP** card cannot exceed the maximum buffer size for the **IP** card. When a new association is added, the default buffer size for the association is assigned to the association. If adding the new association causes the total buffer size for all the associations on the **IP** card to exceed the maximum buffer size for that **IP** card, the `ent-
assoc` command will be rejected. If the you wish to add the association and the maximum buffer size for the **IP** card will be exceeded, the buffer size of the other associations assigned to the **IP** card must be decreased by performing the [Changing the Buffer Size of a M2PA Association](#) procedure. The available size of the buffers on the **IP** card can be verified by entering this command.

```
rtrv-  
assoc:lhost=<local host name assigned to the association being  
changed>
```

The `alhost` parameter can also be used with the `rtrv-
assoc` command to display the available size of the buffers on the **IP** card.

The `aname` parameter can be used with the `rtrv-
assoc` command to display the available size of the buffers on the **IP** card and the size of the buffer assigned to the association.

The value of the `lhost`, `rhost`, or `alhost` parameters is a text string of up to 60 characters, with the first character being a letter. The command line on the terminal can contain up to 150 characters. If the host names are too long to fit on the `ent-
assoc` command line, perform the `chg-
assoc` command with the parameters and values necessary to complete the entry of the M2PA association.

The **EAGLE** can contain a maximum of 4000 connections (association to application server assignments).

IPLIMx cards can contain one association for each signaling link on the card. The **E5-ENET** card can contain a maximum of 16 signaling links, resulting in a maximum of 16 associations for this card.

The B Ethernet interface of the **IP** card can be used on the **E5-ENET** card.

If the association is to be activated in this procedure, with the `chg-assoc` command, the association must contain values for the `lhost`, `lport`, `rhost`, `rport` parameters.

The `iplim12` parameter value of the signaling link assigned to the association must be `m2pa`. The `adapter` parameter value of the association must be `m2pa`.

The signaling link being assigned to the association must be out of service. This state is shown in the `rept-stat-slk` output with the entries `OOS-MT` in the `PST` field and `Unavail` in the `SST` field.

If the association is being opened in this procedure with the `chg-assoc` command and the `open=yes` parameter, the signaling link assigned to the association must be in the database and the `iplim12` parameter value of the signaling link assigned to the association must be `m2pa`.

Uni-homed endpoints are associations configured with the `lhost` parameter only. The `lhost` parameter value represents an **IP** address that corresponds to either the A or B network interface of the **IP** card. Multi-homed endpoints are associations configured with both the `lhost` and `alhost` parameters. The `lhost` parameter value represents an **IP** address corresponding to one of the network interfaces (A or B) of the **IP** card while the `alhost` parameter value represents an **IP** address corresponding to the other network interface of the same **IP** card.

An alternate remote host can be configured for multi-homed associations using the `rhost` and `rhosttype` parameters of the `chg-assoc` command. The `rhost` parameter value with the `rhosttype=primary` parameter represents an IP address that corresponds to one of the network interfaces at the remote end while the `rhost` parameter value with the `rhosttype=alternate` parameter represents an IP address that corresponds to the other network interface at the remote end.

Canceling the `RTRV-ASSOC` Command

Because the `rtrv-assoc` command used in this procedure can output information for a long period of time, the `rtrv-assoc` command can be canceled and the output to the terminal stopped. There are three ways that the `rtrv-assoc` command can be canceled.

- Press the `F9` function key on the keyboard at the terminal where the `rtrv-assoc` command was entered.
- Enter the `canc-cmd` without the `trm` parameter at the terminal where the `rtrv-assoc` command was entered.
- Enter the `canc-cmd:trm=<xx>`, where `<xx>` is the terminal where the `rtrv-assoc` command was entered, from another terminal other than the terminal where the `rtrv-assoc` command was entered. To enter the `canc-cmd:trm=<xx>` command, the terminal must allow Security Administration commands to be entered from it and the user must be allowed to enter Security Administration commands. The terminal's permissions can be verified with the `rtrv-secu-trm`

command. The user's permissions can be verified with the `rtrv-user` or `rtrv-secu-user` commands.

For more information about the `canc-cmd` command, go to *Commands User's Guide*.

1. Display the associations in the database using the `rtrv-assoc` command. This is an example of possible output.

```
rlghncxa03w 08-04-28 09:12:36 GMT EAGLE5 38.0.0
                CARD IPLNK
ANAME          LOC  PORT  LINK ADAPTER LPORT RPORT OPEN ALW
swbel132      1201 A    A    M3UA  1030  2345 YES  YES
a2            1305 A    A    SUA   1030  2345 YES  YES
a3            1307 A    A    SUA   1030  2346 YES  YES
assoc3        1203 A    A1   M2PA  2048  1030 NO   NO
```

Perform one of these actions.

- If the desired IP link (shown by the entries in the `CARD LOC` and `IPLINK PORT` columns for an association whose `ADAPTER` value is `M2PA`) is shown in the `rtrv-assoc` output, continue the procedure with [2](#).
 - If the desired IP link is not shown in the `rtrv-assoc` output, continue the procedure with [3](#).
2. Display the signaling links assigned to the card that the new M2PA association will be assigned to by entering the `rtrv-slk` command with the card location displayed in [1](#). For this example, enter this command.

```
rtrv-slk:loc=1203
```

The following is an example of the possible output.

```
rlghncxa03w 08-04-06 10:07:25 GMT EAGLE5 38.0.0

LOC  LINK LSN          SLC TYPE      IPLIML2
1203 A   e5e6a      0  IPLIM      M2PA
1203 A1 m2pa1      0  IPLIM      M2PA
```

If the value in the `TYPE` column is either `IPLIM` or `IPLIMI`, continue the procedure with [6](#).

If the value in the `TYPE` column is `IPSG`, the links and host assigned to this card cannot be used in this procedure. If you wish to use this card to configure an M2PA association, perform the [Adding an IPSG M2PA Association](#) procedure.

If you do not wish to use this card to configure an M2PA association, perform one of these actions.

- Choose another card from the `rtrv-assoc` output in [1](#) and repeat this step.
 - Continue the procedure with [3](#) to choose another `IPLIMx` card and IP link for the new M2PA association.
3. Display the IP links in the database by entering the `rtrv-ip-lnk` command. The following is an example of the possible output.

```
rlghncxa03w 08-12-28 21:14:37 GMT EAGLE5 40.0.0
```

LOC	PORT	IPADDR	SUBMASK	DUPLEX	SPEED	MACTYPE
AUTO	MCAST					
1201	A	192.1.1.10	255.255.255.128	HALF	10	802.3
NO	NO					
1201	B	-----	-----	HALF	10	DIX
NO	NO					
1203	A	192.1.1.12	255.255.255.0	----	---	DIX
YES	NO					
1203	B	-----	-----	HALF	10	DIX
NO	NO					
1205	A	192.1.1.14	255.255.255.0	FULL	100	DIX
NO	NO					
1205	B	-----	-----	HALF	10	DIX
NO	NO					
2101	A	192.1.1.20	255.255.255.0	FULL	100	DIX
NO	NO					
2101	B	-----	-----	HALF	10	DIX
NO	NO					
2103	A	192.1.1.22	255.255.255.0	FULL	100	DIX
NO	NO					
2103	B	-----	-----	HALF	10	DIX
NO	NO					
2105	A	192.1.1.24	255.255.255.0	FULL	100	DIX
NO	NO					
2105	B	-----	-----	HALF	10	DIX
NO	NO					
2205	A	192.1.1.30	255.255.255.0	FULL	100	DIX
NO	NO					
2205	B	-----	-----	HALF	10	DIX
NO	NO					
2207	A	192.1.1.32	255.255.255.0	FULL	100	DIX
NO	NO					
2207	B	-----	-----	HALF	10	DIX
NO	NO					
2213	A	192.1.1.50	255.255.255.0	FULL	100	DIX
NO	NO					
2213	B	-----	-----	HALF	10	DIX
NO	NO					
2301	A	192.1.1.52	255.255.255.0	FULL	100	DIX
NO	NO					
2301	B	-----	-----	HALF	10	DIX
NO	NO					

IP-LNK table is (20 of 2048) 1% full.

If the required IP link is not in the database, add the IP link using the [Configuring an IP Link](#) procedure.

4. Verify that the local host name to be assigned to the association is in the database by using the `rtrv-ip-host:display=all` command. The following is an example of the possible output.

```
rlghncxa03w 13-06-28 21:15:37 GMT EAGLE5 45.0.0
```



```

LOCAL IPADDR      LOCAL HOST
192.1.1.10        IPNODE1-1201
192.1.1.12        IPNODE1-1203
192.1.1.14        IPNODE1-1205
192.1.1.20        IPNODE2-1201
192.1.1.22        IPNODE2-1203
192.1.1.24        IPNODE2-1205
192.1.1.30        KC-HLR1
192.1.1.32        KC-HLR2
192.1.1.50        DN-MS1
192.1.1.52        DN-MS2

REMOTE IPADDR     REMOTE HOST
150.1.1.5         NCDEPTECONOMIC_DEVELOPMENT. SOUTHEASTERN_COORIDOR_ASHVL.
GOV

```

```
IP Host table is (11 of 4096) .26% full
```

The **IP** address of the **IP** link should be assigned to the local host name that will be assigned to the association.

The `ipliml2` parameter value of the signaling link must be `m2pa`.

The values of the `lhost` and `alhost` parameters must be in the `LOCAL HOST` column in the `rtrv-ip-host` output.

If the required hostname is not in the database, add the **IP** host name using the [Adding an IP Host](#) procedure.

5. Display the signaling links assigned to the card that the new M2PA association will be assigned to by entering the `rtrv-slk` command with the card location displayed in [3](#) or the card location of the IP link that was configured by performing the [Configuring an IP Link](#) procedure in [3](#). For this example, enter this command.

```
rtrv-slk:loc=1203
```

The following is an example of the possible output.

```
rlghncxa03w 08-04-06 10:07:25 GMT EAGLE5 38.0.0
```

LOC	LINK	LSN	SLC	TYPE	IPLIML2
1203	A	e5e6a	0	IPLIM	M2PA
1203	A1	m2pa1	0	IPLIM	M2PA

If the signaling link that you wish to assign to the association is shown in the `rtrv-slk` output, continue the procedure with [6](#).

If the signaling link that you wish to assign to the association is not shown in the `rtrv-slk` output, add the signaling link to the database with the `ipliml2=m2pa` parameter, and without activating the signaling link, by performing the [Adding an IPLIMx Signaling Link](#) procedure. After the signaling link has been added, continue the procedure with [9](#).

6. Display the status of the signaling link shown in [5](#) using the `rept-stat-slk` command specifying the card location and signaling link. For example, enter this command.

```
rept-stat-slk:loc=1203:link=a
```

This is an example of the possible output.

```
rlghncxa03w 08-04-28 21:16:37 GMT EAGLE5 38.0.0
SLK      LSN      CLLI      PST      SST      AST
1203,A   e5e6a     -----  IS-NR    Avail    ----
Command Completed.
```

If the primary state (**PST**) of the signaling link is `OOS-MT` and the secondary state (**SST**) is `Unavail`, continue the procedure with [9](#).

If the primary state (**PST**) of the signaling link not is `OOS-MT` and the secondary state (**SST**) is not `Unavail`, continue the procedure with [7](#).

- Deactivate the signaling link from [6](#) using the `dact-slk` command. For example, enter this command.

```
dact-slk:loc=1203:link=a
```

When this command has successfully completed, the following message should appear.

```
rlghncxa03w 08-04-07 11:11:28 GMT EAGLE5 38.0.0
Deactivate Link message sent to card
```

- Verify the status of the signaling link using the `rept-stat-slk` command. For example, enter this command.

```
rept-stat-slk:loc=1203:link=a
```

This is an example of the possible output.

```
rlghncxa03w 08-04-28 21:16:37 GMT EAGLE5 38.0.0
SLK      LSN      CLLI      PST      SST      AST
1203,A   e5e6a     -----  OOS-MT   Unavail  ----
Command Completed.
```

- Verify the values of the **M2PA** timer set you wish to assign to the association by entering the `rtrv-m2pa-tset` command with the `ver=rfc` parameter.

When an **M2PA** association is provisioned in this procedure, the **RFC M2PA** version is assigned to the **M2PA** association by default.

The **M2PA** version of the association determines the version of the **M2PA** timer set that is assigned to the association. For example, if **M2PA** timer set 3 is assigned to the **M2PA** association, and the association is an **RFCM2PA** association, the **RFC** version of **M2PA** timer set 3 is used with the association. If **M2PA** timer set 7 is assigned to the **M2PA** association, and the association is a Draft 6 **M2PA** association, the Draft 6 version of **M2PA** timer set 7 is used with the association.

If you wish to assign the Draft 6 **M2PA** version to this association and use the Draft 6 **M2PA** timer sets, perform the [Changing the Attributes of an M2PA Association](#) procedure after this procedure is completed to change the **M2PA** version of this association.

 **Note:**

If the `m2patset` parameter will not be specified with the `ent-assoc` command, the M2PA timer set 1 will be assigned to the association.

To display the **M2PA** Draft 6 timer values, enter this command.

```
rtrv-m2pa-tset:ver=d6
```

This is an example of the possible output.

```
rlghncxa03w 08-04-28 21:16:37 GMT EAGLE5 38.0.0
```

M2PA Draft 6 Timers (in msec, T16 in microsec)

TSET	T1	T2	T3	T4N	T4E	T5	T6	T7	T16	T17	T18
1	6000	-----	5000	20000	500	5000	4000	1000	100000	150	500
2	7500	-----	1500	2000	500	9000	1250	300	150000	175	600
3	100000	-----	2000	3000	500	4000	1500	500	170000	200	800
4	200000	-----	20000	4000	500	6000	2000	700	480000	225	900
5	250000	-----	30000	30000	500	100	2250	400	400000	400	8000
6	50000	-----	50000	60000	500	500	4500	800	300000	300	7000
7	10000	-----	10000	10000	500	1000	3000	1200	200000	250	1000
8	80000	-----	1500	15000	500	8000	2750	1100	350000	350	5000
9	27500	-----	3850	4859	450	5700	3750	1150	250	375	8750
10	90000	-----	2500	50000	500	7500	5000	1750	440000	450	3000
11	20000	-----	4500	5500	500	6500	5500	1600	250000	475	4500
12	30000	-----	7500	7000	500	750	4250	1800	275000	275	3500
13	40000	-----	35000	9000	500	1250	3500	1900	500	325	9000
14	70000	-----	45000	11000	500	1500	1750	900	1000	125	6000
15	9000	-----	25000	40000	500	2500	3250	600	5000	425	5500
16	75000	-----	15000	25000	500	4500	1600	1400	6000	240	9500
17	350000	-----	60000	70000	600	10000	6000	2000	500000	500	10000
18	150000	-----	55000	35000	500	3500	5750	1500	125000	440	750
19	175000	-----	12500	45000	500	1100	2600	1300	7000	340	850
20	1000	-----	1000	1000	400	80	1000	200	100	100	100

To display the **M2PARFC** values, enter this command.

```
rtrv-m2pa-tset:ver=rfc
```

This is an example of the possible output.

```
rlghncxa03w 08-04-28 21:16:37 GMT EAGLE5 38.0.0
```

M2PA RFC Timers (in msec, T16 in microsec)

TSET	T1	T2	T3	T4N	T4E	T5	T6	T7	T16	T17	T18
1	6000	75000	5000	20000	500	5000	4000	1000	100000	150	500
2	7500	8000	1500	2000	500	9000	1250	300	150000	175	600
3	100000	10000	2000	3000	500	4000	1500	500	170000	200	800
4	200000	6000	20000	4000	500	6000	2000	700	480000	225	900
5	250000	140000	30000	30000	500	100	2250	400	400000	400	8000

```

6    50000 100000 50000 60000 500 500 4500 800 300000 300
7000
7    300000 20000 2000 10000 500 1000 3000 1200 200000 250
1000
8    80000 130000 1500 15000 500 8000 2750 1100 350000 350
5000
9    27500 120000 3850 4859 450 5700 3750 1150 250 375
8750
10   90000 9000 2500 50000 500 7500 5000 1750 440000 450
3000
11   20000 60000 4500 5500 500 6500 5500 1600 250000 475
4500
12   30000 50000 7500 7000 500 750 4250 1800 275000 275
3500
13   40000 90000 35000 9000 500 1250 3500 1900 500 325
9000
14   70000 45000 45000 11000 500 1500 1750 900 1000 125
6000
15   9000 30000 25000 40000 500 2500 3250 600 5000 425
5500
16   75000 15000 15000 25000 500 4500 1600 1400 6000 240
9500
17   350000 150000 60000 70000 600 10000 6000 2000 500000 500
10000
18   150000 20000 55000 35000 500 3500 5750 1500 125000 440 750
19   175000 12500 12500 45000 500 1100 2600 1300 7000 340 850
20   1000 5000 1000 1000 400 80 1000 200 100 100 100

```

If the `ver` parameter is not specified when entering the `rtrv-m2pa-tset` command, both the Draft 6 and RFC values are displayed. This is an example of the possible output.

```
rlghncxa03w 08-04-28 21:16:37 GMT EAGLE5 38.0.0
```

```

M2PA Draft 6 Timers (in msec, T16 in microsec)
TSET T1    T2    T3    T4N  T4E  T5    T6    T7    T16  T17  T18
1    6000  ----- 5000 20000 500 5000 4000 1000 100000 150 500
2    7500  ----- 1500 2000 500 9000 1250 300 150000 175 600
3    100000 ----- 2000 3000 500 4000 1500 500 170000 200 800
4    200000 ----- 20000 4000 500 6000 2000 700 480000 225 900
5    250000 ----- 30000 30000 500 100 2250 400 400000 400
8000
6    50000  ----- 50000 60000 500 500 4500 800 300000 300
7000
7    10000  ----- 10000 10000 500 1000 3000 1200 200000 250
1000
8    80000  ----- 1500 15000 500 8000 2750 1100 350000 350
5000
9    27500  ----- 3850 4859 450 5700 3750 1150 250 375
8750
10   90000  ----- 2500 50000 500 7500 5000 1750 440000 450
3000
11   20000  ----- 4500 5500 500 6500 5500 1600 250000 475

```

```

4500
12 30000 ----- 7500 7000 500 750 4250 1800 275000 275 3500
13 40000 ----- 35000 9000 500 1250 3500 1900 500 325 9000
14 70000 ----- 45000 11000 500 1500 1750 900 1000 125 6000
15 9000 ----- 25000 40000 500 2500 3250 600 5000 425 5500
16 75000 ----- 15000 25000 500 4500 1600 1400 6000 240 9500
17 350000 ----- 60000 70000 600 10000 6000 2000 500000 500 10000
18 150000 ----- 55000 35000 500 3500 5750 1500 125000 440 750
19 175000 ----- 12500 45000 500 1100 2600 1300 7000 340 850
20 1000 ----- 1000 1000 400 80 1000 200 100 100 100

```

M2PA RFC Timers (in msec, T16 in microsec)

TSET	T1	T2	T3	T4N	T4E	T5	T6	T7	T16	T17	T18
1	6000	75000	5000	20000	500	5000	4000	1000	100000	150	500
2	7500	8000	1500	2000	500	9000	1250	300	150000	175	600
3	100000	10000	2000	3000	500	4000	1500	500	170000	200	800
4	200000	6000	20000	4000	500	6000	2000	700	480000	225	900
5	250000	140000	30000	30000	500	100	2250	400	400000	400	8000
6	50000	100000	50000	60000	500	500	4500	800	300000	300	7000
7	300000	20000	2000	10000	500	1000	3000	1200	200000	250	1000
8	80000	130000	1500	15000	500	8000	2750	1100	350000	350	5000
9	27500	120000	3850	4859	450	5700	3750	1150	250	375	8750
10	90000	9000	2500	50000	500	7500	5000	1750	440000	450	3000
11	20000	60000	4500	5500	500	6500	5500	1600	250000	475	4500
12	30000	50000	7500	7000	500	750	4250	1800	275000	275	3500
13	40000	90000	35000	9000	500	1250	3500	1900	500	325	9000
14	70000	45000	45000	11000	500	1500	1750	900	1000	125	6000
15	9000	30000	25000	40000	500	2500	3250	600	5000	425	5500
16	75000	15000	15000	25000	500	4500	1600	1400	6000	240	9500
17	350000	150000	60000	70000	600	10000	6000	2000	500000	500	10000
18	150000	20000	55000	35000	500	3500	5750	1500	125000	440	750
19	175000	12500	12500	45000	500	1100	2600	1300	7000	340	850
20	1000	5000	1000	1000	400	80	1000	200	100	100	100

If the **M2PA** timer set you wish to assign to the association does not contain the desired values, go to the [Changing a M2PA Timer Set](#) procedure and changed the desired timer values.

 **Caution:**

Changing an **M2PA** timer set may affect the performance of any associations using the timer set being changed.

10. Verify the available buffer size for the **IP** card that will contain the association being added in this procedure by entering the `rtrv-assoc` command with the local host name assigned to the association being added. For this example, enter this command.

```
rtrv-assoc:lhost="IPNODE2-1203"
```

This is an example of the possible output.

```
rlghncxa03w 08-04-28 09:12:36 GMT EAGLE5 38.0.0
```

ANAME	CARD		IPLNK		LPORT	RPORT	OPEN	ALW
	LOC	PORT	LINK	ADAPTER				
assoc2	1203	A	A1	M2PA	2048	1030	NO	NO

IP Appl Sock/Assoc table is (8 of 4000) 1% full
 Assoc Buffer Space Used (200 KB of 1600 KB) on LOC = 1203

If adding the new association causes the total buffer size for all the associations on the **IP** card to exceed the maximum buffer size for that **IP** card, the `ent-assoc` command will be rejected.

The default buffer value for an **IPLIMx** association is 200.

If the you wish to add the association and the maximum buffer size for the **IP** card will be exceeded, the buffer size of the other associations assigned to the **IP** card must be decreased by performing the [Changing the Buffer Size of a M2PA Association](#) procedure.

11. Add the associations using the `ent-assoc` command. For this example, enter this command.

```
ent-
assoc:aname=assoc2:lhost=gw107.nc.tekelec.com:lport=2000:
rhost=gw100.nc.tekelec.com:rport=1030:adapter=m2pa:link=a
```

These are the rules that apply to adding M2PA associations that are assigned to IPLIMx signaling links.

- The B Ethernet interface can be used with E5-ENET cards.
- The EAGLE can contain a maximum of 4000 connections (association – application server assignments plus sockets).
- The `adapter` parameter value for the association must be `m2pa`. The value of the `ipliml2` parameter of the signaling link being assigned to this association must be `m2pa`. The default value for the `adapter` parameter is `m2pa`.
- IPLIMx cards can have only one connection for each signaling link assigned to the card. If the card is an E5-ENET card, the card may contain a maximum of 16 connections.
- The value of the `lhost`, `rhost`, or `alhost` parameters is a text string of up to 60 characters, with the first character being a letter. The command line on the terminal can contain up to 150 characters. If the host names are too long to fit on the `ent-assoc` command line, perform the `chg-assoc` command with the parameters and values necessary to complete the entry of the M2PA association.
- If the new association is to be activated in this procedure with the `chg-assoc` command, the association must contain values for the `lhost`, `rhost`, `lport`, and `rport` parameters.
- If the `lhost` and `alhost` parameters are specified, the `lhost` parameter value represents the IP address corresponding to one of the network interfaces (A or B) on the IP card while the `alhost` parameter value represents the IP address corresponding to the other network interface of the same IP card.
- The `m2patset` parameter can be specified only with the `adapter=m2pa` parameter.

- The `m2patset` parameter value defaults to M2PA timer set 1 (`m2patset=1`) if the `m2patset` parameter is not specified.
- The `port` parameter can be used in place of the `link` parameter to specify the signaling link assigned to the association.
- When the `adapter=m2pa` parameter is specified, the RFC M2PA version is assigned to the M2PA association by default. If you wish to assign the Draft 6 M2PA version to this association, perform the [Changing the Attributes of an M2PA Association](#) procedure after this procedure is completed to change the M2PA version of this association.

When each of these commands have successfully completed, this message should appear.

```
rlghncxa03w 08-04-28 09:12:36 GMT EAGLE5 38.0.0
ENT-ASSOC: MASP A - COMPLTD
```

 **Note:**

If the association added in this step is not being activated in this procedure, continue the procedure with [13](#).

- 12.** Activate the association added in [11](#) by entering the `chg-assoc` command with the association name specified in [11](#) and the `open=yes` and `alw=yes` parameters. For example, enter this command.

```
chg-assoc:aname=assoc2:open=yes:alw=yes
```

When this command have successfully completed, this message should appear.

```
rlghncxa03w 08-04-28 21:15:37 GMT EAGLE5 38.0.0
CHG-ASSOC: MASP A - COMPLTD
```

- 13.** Verify the changes using the `rtrv-assoc` command specifying the association name specified in [11](#) and [12](#). For this example, enter this command.

```
rtrv-assoc:aname=assoc2
```

This is an example of possible output.

```
rlghncxa03w 10-07-28 09:12:36 GMT EAGLE5 42.0.0
ANAME assoc2
  LOC      1203          IPLNK PORT  A          LINK  A
  ADAPTER  M2PA          VER          M2PA RFC
  LHOST    gw105.nc.tekelec.com
  ALHOST   ---
  RHOST    gw100.nc.tekelec.com
  ARHOST   ---
  LPORT    1030          RPORT        1030
  ISTRMS   2            OSTRMS       2          BUFSIZE  200
  RMODE    LIN          RMIN         120        RMAX      800
  RTIMES   10          CWMIN        3000       UAPS      10
```

```

OPEN      NO          ALW      NO          RTXTHR  0
RHOSTVAL  RELAXED     M2PATSET 1

```

```

IP Appl Sock table is (5 of 4000) 1% full
Assoc Buffer Space Used (400 KB of 1600 KB) on LOC = 1203

```

14. Activate the signaling link assigned to the association using the `act-slk` command.

For example, enter this command.

```
act-slk:loc=1203:link=a
```

When this command has successfully completed, the following message should appear.

```

rlghncxa03w 08-04-07 11:11:28 GMT EAGLE5 38.0.0
Activate Link message sent to card

```

15. Verify the status of the signaling link using the `rept-stat-slk` command. For example, enter this command.

```
rept-stat-slk:loc=1203:link=a
```

This is an example of the possible output.

```

rlghncxa03w 08-04-28 21:16:37 GMT EAGLE5 38.0.0
SLK      LSN      CLLI      PST      SST      AST
1203,A  e5e6a      -----  IS-NR    Avail    ----
Command Completed.

```

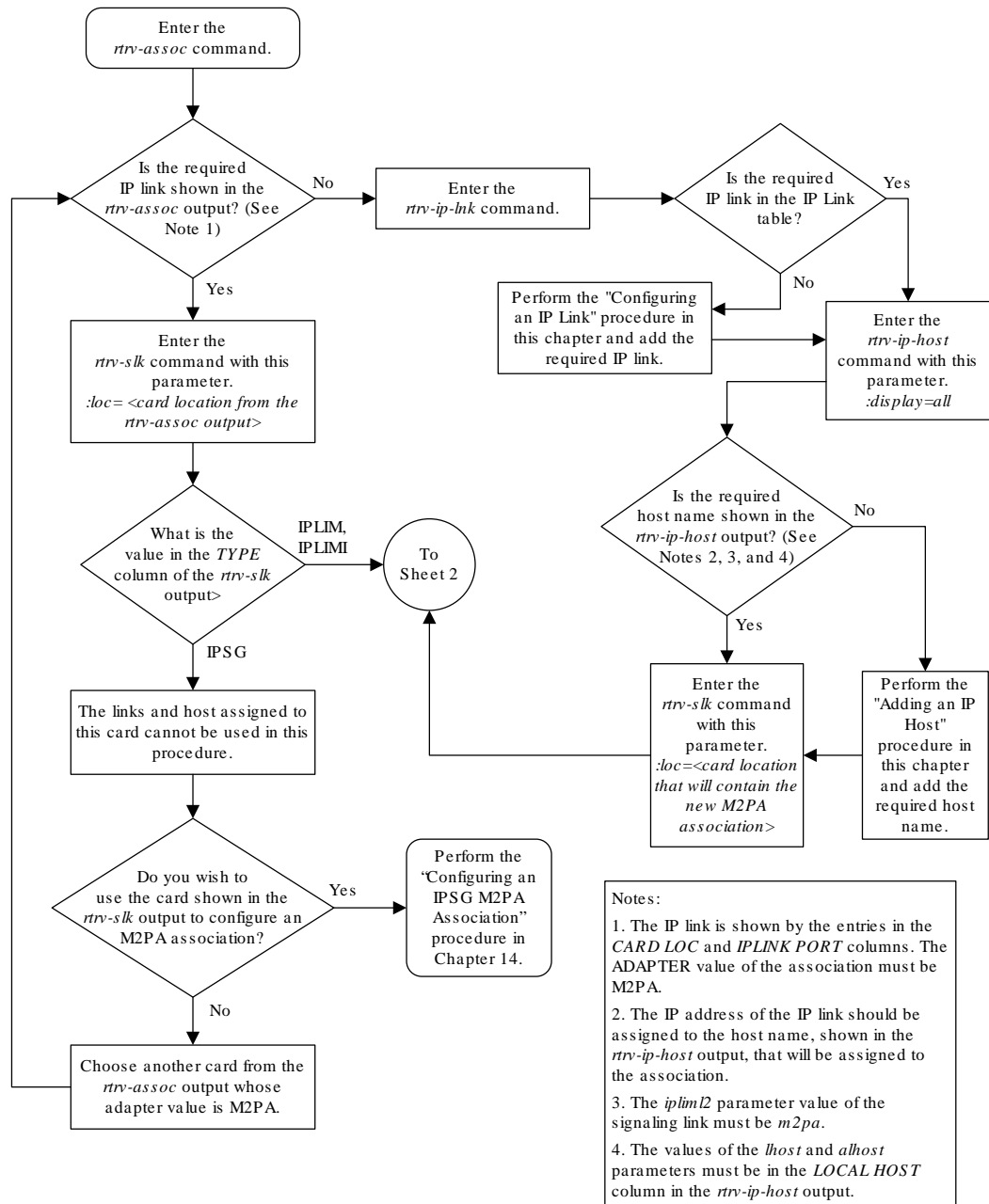
16. Back up the new changes, using the `chg-db:action=backup:dest=fixed` command. These messages should appear; the active **Maintenance and Administration Subsystem Processor (MASP)** appears first.

```

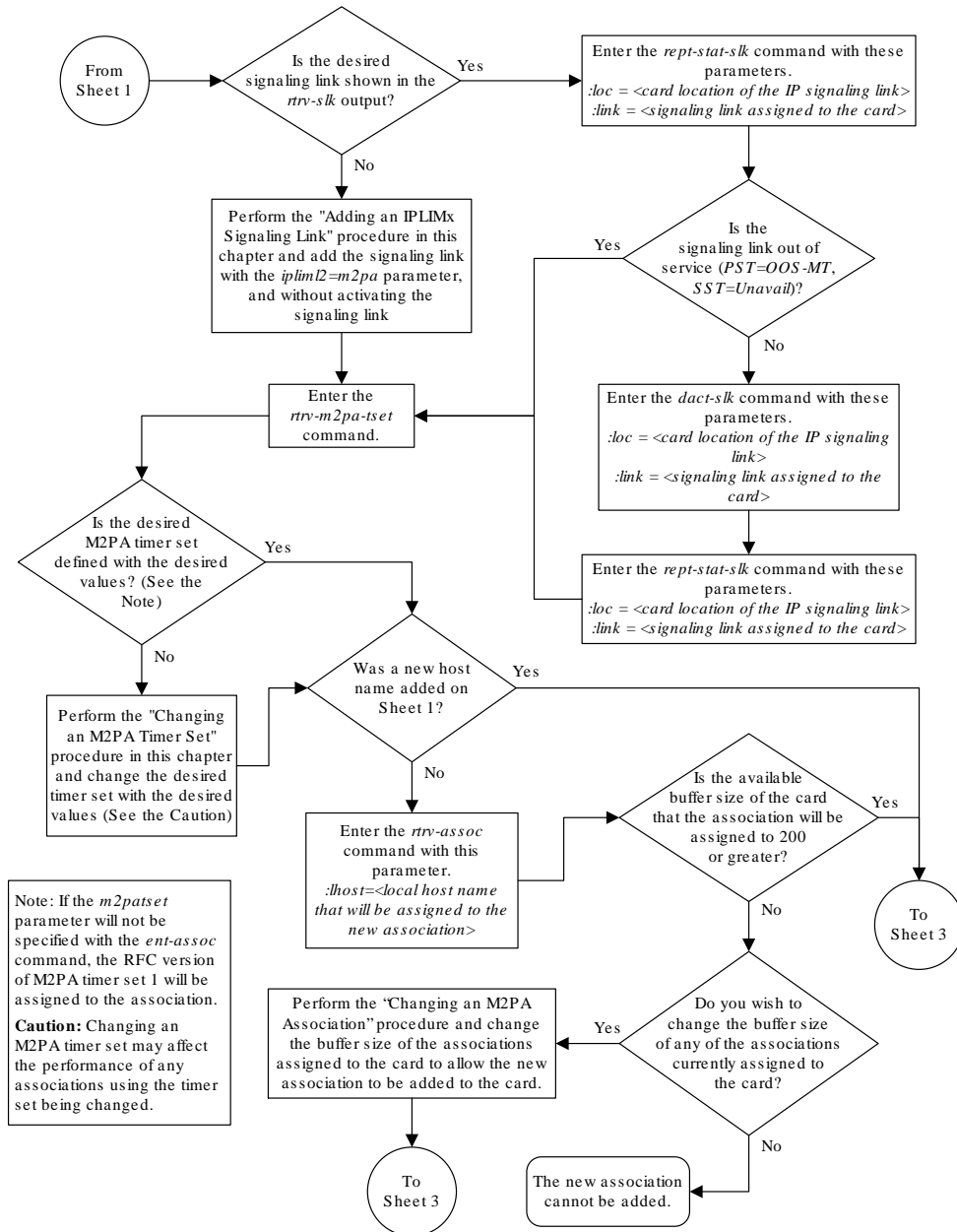
BACKUP (FIXED) : MASP A - Backup starts on active MASP.
BACKUP (FIXED) : MASP A - Backup on active MASP to fixed disk
complete.
BACKUP (FIXED) : MASP A - Backup starts on standby MASP.
BACKUP (FIXED) : MASP A - Backup on standby MASP to fixed disk
complete.

```

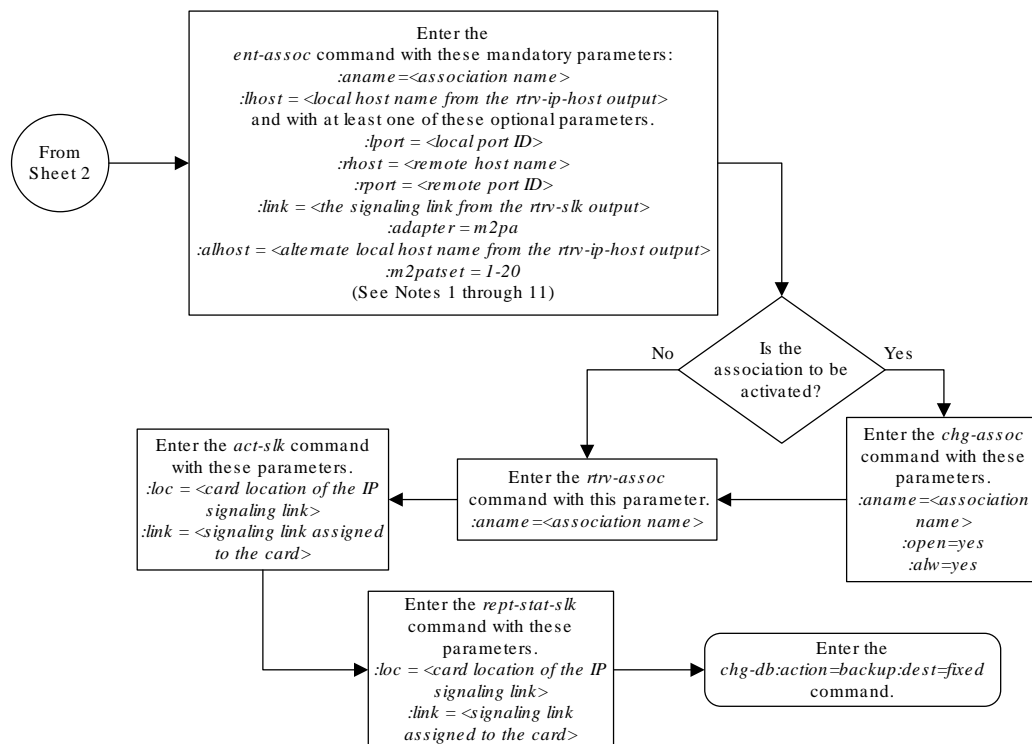

Figure 3-7 Adding an M2PA Association



Sheet 1 of 3



Sheet 2 of 3



Notes:

1. The B Ethernet interface can be used with single-slot EDCMs or E5-ENET cards.
2. The EAGLE 5 ISS can contain a maximum of 4000 connections (association – application server assignments plus sockets).
3. The *adapter* parameter value for the association must be *m2pa*. The value of the *ipiml2* parameter of the signaling link being assigned to this association must be *m2pa*. The default value for the adapter parameter is *m2pa*.
4. IPLIMx cards can have only one connection for each signaling link assigned to the card. If the card is a single-slot EDCM, the card may contain a maximum of eight connections. If the card is an E5-ENET card, the card may contain a maximum of 16 connections.
5. The value of the *lhost*, *rhost*, or *alhost* parameters is a text string of up to 60 characters, with the first character being a letter. The command line on the terminal can contain up to 150 characters. If the host names are too long to fit on the *ent-assoc* command line, perform the *chg-assoc* command with the parameters and values necessary to complete the entry of the M2PA association.
6. If the new association is to be activated in this procedure with the *chg-assoc* command, the association must contain values for the *lhost*, *rhost*, *lport*, and *rport* parameters.
7. If the *lhost* and *alhost* are specified, the *lhost* parameter value represents the IP address corresponding to one of the network interfaces (A or B) on the IP card while the *alhost* parameter value represents the IP address corresponding to the other network interface of the same IP card.
8. The *m2patset* parameter can be specified only with the *adapter=m2pa* parameter.
9. The *m2patset* parameter value defaults to M2PA timer set 1 (*m2patset=1*) if the *m2patset* parameter is not specified.
10. The *port* parameter can be used in place of the *link* parameter to specify the signaling link assigned to the association.
11. When the *adapter=m2pa* parameter is specified, the RFC M2PA version is assigned to the M2PA association by default. If you wish to assign the Draft 6 M2PA version to this association, perform the "Changing the Attributes of an M2PA Association" procedure in this chapter after this procedure is completed to change the M2PA version of this association.

Sheet 3 of 3

3.9 Activating the Large MSU Support for IP Signaling Feature

This procedure is used to enable and turn on the Large MSU Support for IP Signaling feature using the feature's part number and a feature access key.

The feature access key for the Large MSU Support for IP Signaling feature is based on the feature's part number and the serial number of the EAGLE, making the feature access key site-specific.

The `enable-ctrl-feat` command enables the controlled feature by inputting the controlled feature's access key and the controlled feature's part number with these parameters:

 **Note:**

As of Release 46.3, the `fak` parameter is no longer required. This parameter is only used for backward compatibility.

`: fak` – The feature access key provided by Oracle. The feature access key contains 13 alphanumeric characters and is not case sensitive.

`: partnum` – The Oracle-issued part number of the Large MSU Support for IP Signaling feature, 893018401.

The `enable-ctrl-feat` command requires that the database contain a valid serial number for the EAGLE, and that this serial number is locked. This can be verified with the `rtrv-serial-num` command. The EAGLE is shipped with a serial number in the database, but the serial number is not locked. The serial number can be changed, if necessary, and locked once the EAGLE is on-site, by using the `ent-serial-num` command. The `ent-serial-num` command uses these parameters.

`: serial` – The serial number assigned to the EAGLE. The serial number is not case sensitive.

`: lock` – Specifies whether or not the serial number is locked. This parameter has only one value, `yes`, which locks the serial number. Once the serial number is locked, it cannot be changed.

 **Note:**

To enter and lock the EAGLE's serial number, the `ent-serial-num` command must be entered twice, once to add the correct serial number to the database with the `serial` parameter, then again with the `serial` and the `lock=yes` parameters to lock the serial number. You should verify that the serial number in the database is correct before locking the serial number. The serial number can be found on a label affixed to the control shelf (shelf 1100).

This feature cannot be temporarily enabled (with the temporary feature access key).

Once this feature has been enabled, the feature must be turned on with the `chg-ctrl-feat` command. The `chg-ctrl-feat` command uses these parameters:

`: partnum` – The Oracle-issued part number of the Large MSU Support for IP Signaling feature, 893018401.

`: status=on` – used to turn the Large MSU Support for IP Signaling feature on.

Once the Large MSU Support for IP Signaling feature has been turned on, it can be turned off. For more information about turning the Large MSU Support for IP Signaling feature off, go to the [Turning Off the Large MSU Support for IP Signaling Feature](#) procedure.

The status of the features in the EAGLE is shown with the `rtrv-ctrl-feat` command.

The Large MSU Support for IP Signaling feature allows the EAGLE to process messages with a service indicator value of 6 to 15 and with a service information field (SIF) that is larger than 272 bytes. The large messages are processed only on E5-ENET cards. There are certain software components that if enabled or provisioned, that will not process large messages even if the Large MSU Support for IP Signaling feature is enabled and turned on. UIMs are displayed when most of these circumstances occur. These UIMs are:

- UIM 1333 – Displayed when a large message is received on an M3UA association and the Large MSU Support for IP Signaling feature is not enabled or is enabled and turned off. The large message is discarded.
- UIM 1350 – Displayed when a M2PA IP connection receives message with an SIF greater than 272 bytes and the Large MSU Support for IP Signaling feature is not enabled or is enabled and turned off. The large message is discarded.
- UIM 1352 – Displayed when a message with an SIF greater than 272 bytes is received; the Large MSU Support for IP Signaling feature is enabled and turned on; there are routes available for the destination point code; but the selected outbound card does not support large messages.
- UIM 1353 – Displayed when a large message passes a gateway screening screenset that redirects messages for the Database Transport Access (DTA) feature. Large messages are not redirected for the DTA feature.

For more information on these UIMs, refer to the *Unsolicited Alarm and Information Messages Reference*.



Note:

For STC style monitoring, large messages are not monitored by the EAGLE 5 Integrated Monitoring Support feature and are not sent to the IMF. A UIM is not generated. If Fast Copy is allowed, however, Fast Copy can copy large MSUs to IMF.

1. Display the status of the controlled features by entering the `rtrv-ctrl-feat` command.

The following is an example of the possible output.

```
rlghncxa03w 08-04-28 21:15:37 GMT EAGLE5 38.0.0
The following features have been permanently enabled:

Feature Name           Partnum   Status   Quantity
Command Class Management 893005801 on       ----
LNP Short Message Service 893006601 on       ----
Intermed GTT Load Sharing 893006901 on       ----
XGTT Table Expansion     893006101 on       400000
XMAP Table Expansion     893007710 off      ----
Large System # Links     893005910 on       2000
Routesets               893006401 on       6000
```

```
HC-MIM SLK Capacity      893012707  on      64
```

The following features have been temporarily enabled:

Feature Name	Partnum	Status	Quantity	Trial
Period Left				
Zero entries found.				

The following features have expired temporary keys:

Feature Name	Partnum
Zero entries found.	

If the Large MSU Support for IP Signaling feature is enabled and turned on, no further action is necessary. This procedure does not need to be performed.

If the Large MSU Support for IP Signaling feature is enabled and but not turned on, continue this procedure with step 7.

If the Large MSU Support for IP Signaling feature is not enabled, continue this procedure with step 2.

 **Note:**

If the `rtrv-ctrl-feat` output in step 1 shows any controlled features, continue this procedure with step 6. If the `rtrv-ctrl-feat` output shows only the HC-MIM SLK Capacity feature with a quantity of 64, step 2 through step 5 must be performed.

2. Display the serial number in the database with the `rtrv-serial-num` command.

This is an example of the possible output.

```
rlghncxa03w 06-10-28 21:15:37 GMT EAGLE5 36.0.0
System serial number = nt00001231
```

System serial number is not locked.

```
rlghncxa03w 06-10-28 21:15:37 GMT EAGLE5 36.0.0
Command Completed
```

 **Note:**

If the serial number is correct and locked, continue the procedure with [6](#). If the serial number is correct but not locked, continue the procedure with [5](#). If the serial number is not correct, but is locked, this feature cannot be enabled and the remainder of this procedure cannot be performed. Contact the Customer Care Center to get an incorrect and locked serial number changed. Refer to [My Oracle Support \(MOS\)](#) for the contact information. The serial number can be found on a label affixed to the control shelf (shelf 1100).

3. Enter the correct serial number into the database using the `ent-serial-num` command with the `serial` parameter.

For this example, enter this command.

```
ent-serial-num:serial=<EAGLE's correct serial number>
```

When this command has successfully completed, the following message should appear.

```
rlghncxa03w 06-10-28 21:15:37 GMT EAGLE5 36.0.0  
ENT-SERIAL-NUM: MASP A - COMPLTD
```

4. Verify that the serial number entered into step 3 was entered correctly using the `rtrv-serial-num` command.

This is an example of the possible output.

```
rlghncxa03w 06-10-28 21:15:37 GMT EAGLE5 36.0.0  
System serial number = nt00001231
```

```
System serial number is not locked.
```

```
rlghncxa03w 06-10-28 21:15:37 GMT EAGLE5 36.0.0  
Command Completed
```

If the serial number was not entered correctly, repeat step 3 and step 4 and re-enter the correct serial number.

5. Lock the serial number in the database by entering the `ent-serial-num` command with the serial number shown in step 2, if the serial number shown in step 2 is correct, or with the serial number shown in step 4, if the serial number was changed in step 3, and with the `lock=yes` parameter.

For this example, enter this command.

```
ent-serial-num:serial=<EAGLE's serial number>:lock=yes
```

When this command has successfully completed, the following message should appear.

```
rlghncxa03w 06-10-28 21:15:37 GMT EAGLE5 36.0.0  
ENT-SERIAL-NUM: MASP A - COMPLTD
```

6. Enable the Large MSU Support for IP Signaling feature with the `enable-ctrl-feat` command specifying the part number for the Large MSU Support for IP Signaling feature and the feature access key. Enter this command.

```
enable-ctrl-feat:partnum=893018401:fak=<Large MSU Support for IP  
Signaling feature access key>
```

 **Note:**

A temporary feature access key cannot be specified to enable this feature.

 **Note:**

The values for the feature access key (the `fak` parameter) are provided by Oracle. If you do not have the feature access key for the feature you wish to enable, contact your Sales Representative or Account Representative.

When the `enable-ctrl-feat` command has successfully completed, this message should appear.

```
rlghncxa03w 06-10-28 21:15:37 GMT EAGLE5 36.0.0
ENABLE-CTRL-FEAT: MASP B - COMPLTD
```

7. Turn the Large MSU Support for IP Signaling feature on with the `chg-ctrl-feat` command specifying the part number for the Large MSU Support for IP Signaling feature and the `status=on` parameter. Enter this command.

```
chg-ctrl-feat:partnum=893018401:status=on
```

When the `chg-ctrl-feat` command has successfully completed, this message should appear.

```
rlghncxa03w 07-05-28 21:15:37 GMT EAGLE5 37.0.0
CHG-CTRL-FEAT: MASP B - COMPLTD
```

8. Verify the changes by entering the `rtrv-ctrl-feat` command with the Large MSU Support for IP Signaling feature part number. Enter this command.

```
rtrv-ctrl-feat:partnum=893018401
```

The following is an example of the possible output.

```
rlghncxa03w 10-04-28 21:15:37 GMT EAGLE5 42.0.0
The following features have been permanently enabled:
```

Feature Name	Partnum	Status	Quantity
Large MSU for IP Sig	893018401	on	----

The following features have been temporarily enabled:

Feature Name	Partnum	Status	Quantity	Trial
Period Left				
Zero entries found.				

The following features have expired temporary keys:

Feature Name	Partnum
Zero entries found.	

9. Back up the new changes using the `chg-db:action=backup:dest=fixed` command. These messages should appear, the active Maintenance and Administration Subsystem Processor (MASP) appears first.

```
BACKUP (FIXED) : MASP A - Backup starts on active MASP.  
BACKUP (FIXED) : MASP A - Backup on active MASP to fixed disk complete.  
BACKUP (FIXED) : MASP A - Backup starts on standby MASP.  
BACKUP (FIXED) : MASP A - Backup on standby MASP to fixed disk complete.
```

Figure 3-8 Activate the Large MSU Support for IP Signaling Feature - Sheet 1 of 4

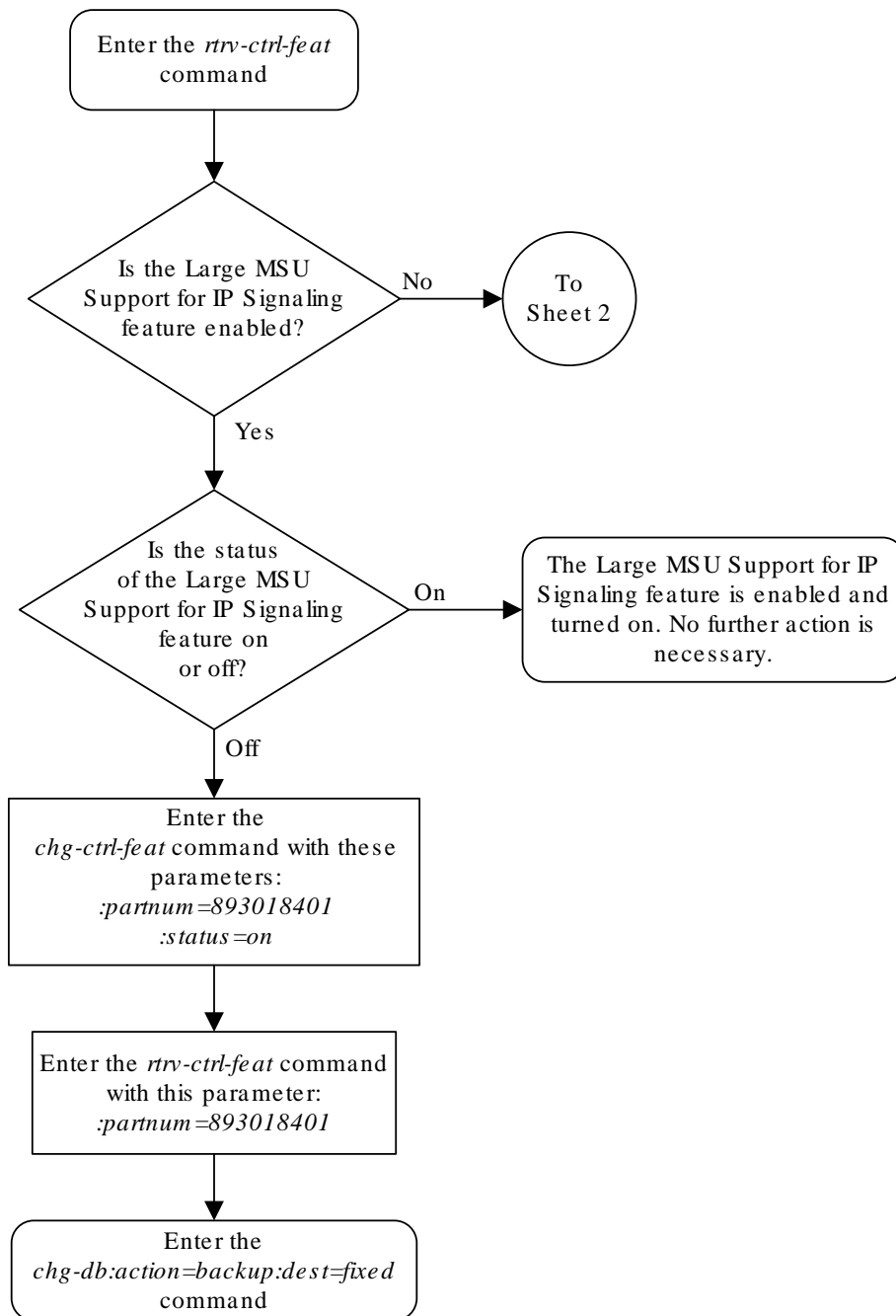
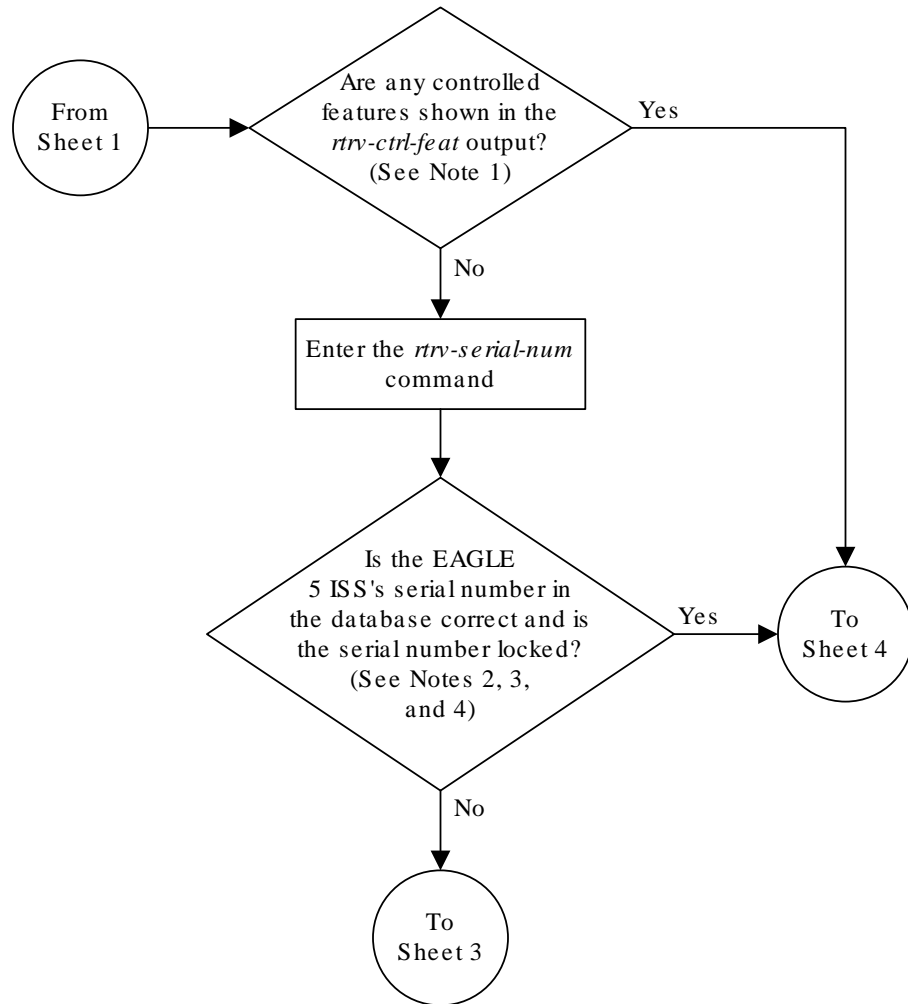


Figure 3-9 Activate the Large MSU Support for IP Signaling Feature - Sheet 2 of 4



Notes:

1. If the *rtrv-ctrl-feat* output shows only the HC-MIM SLK Capacity feature with a quantity of 64, the answer to this question is no and the Eagle 5 ISS's serial number must be verified. This is the default entry for the *rtrv-ctrl-feat* output. This entry is shown whether or not the Eagle 5 ISS's serial number is in the database.
2. If the serial number is locked, it cannot be changed.
3. If the serial number is not locked, the controlled feature cannot be enabled.
4. The serial number can be found on a label affixed to the control shelf (shelf 1100).

Figure 3-10 Activate the Large MSU Support for IP Signaling Feature - Sheet 3 of 4

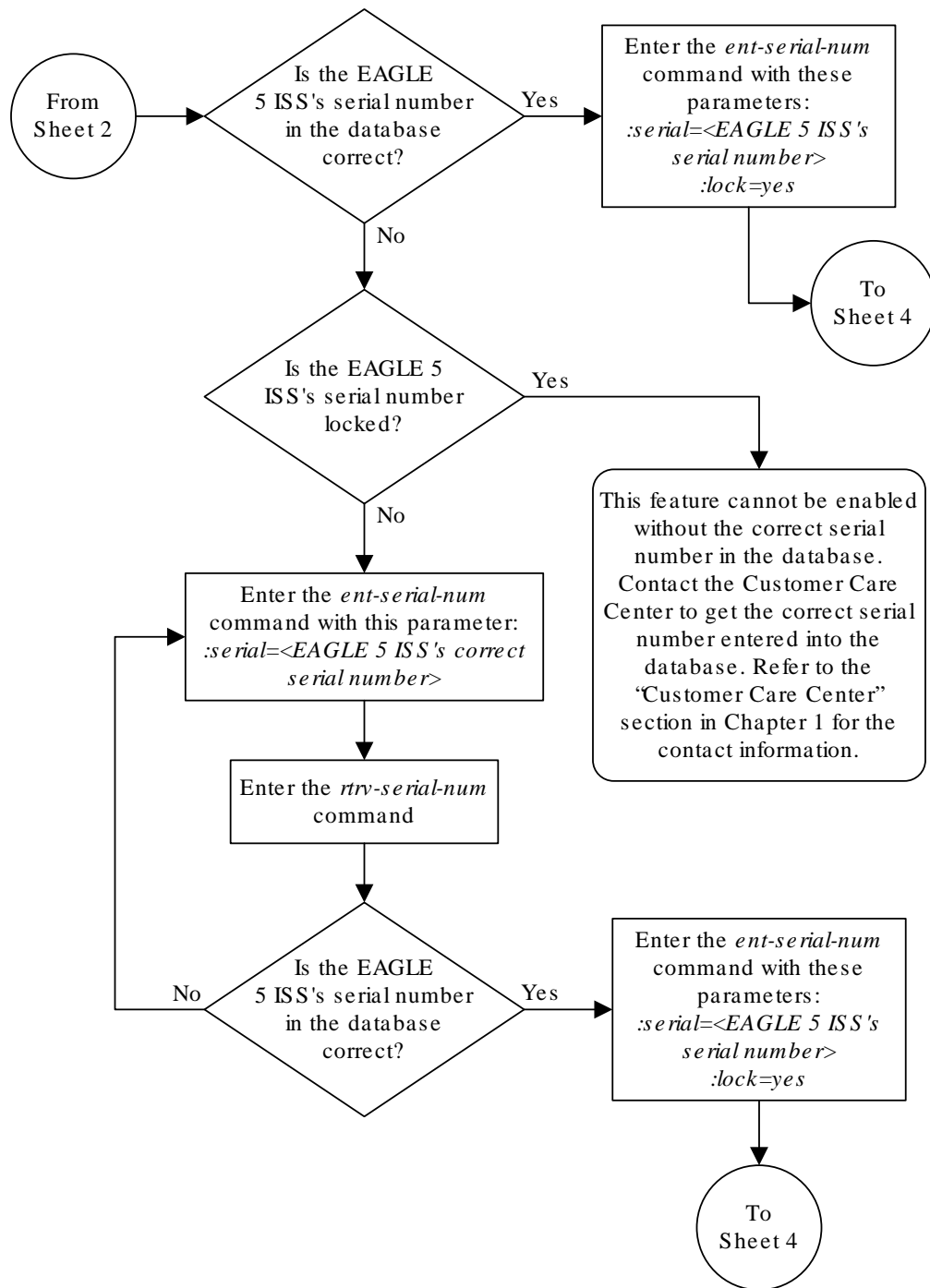
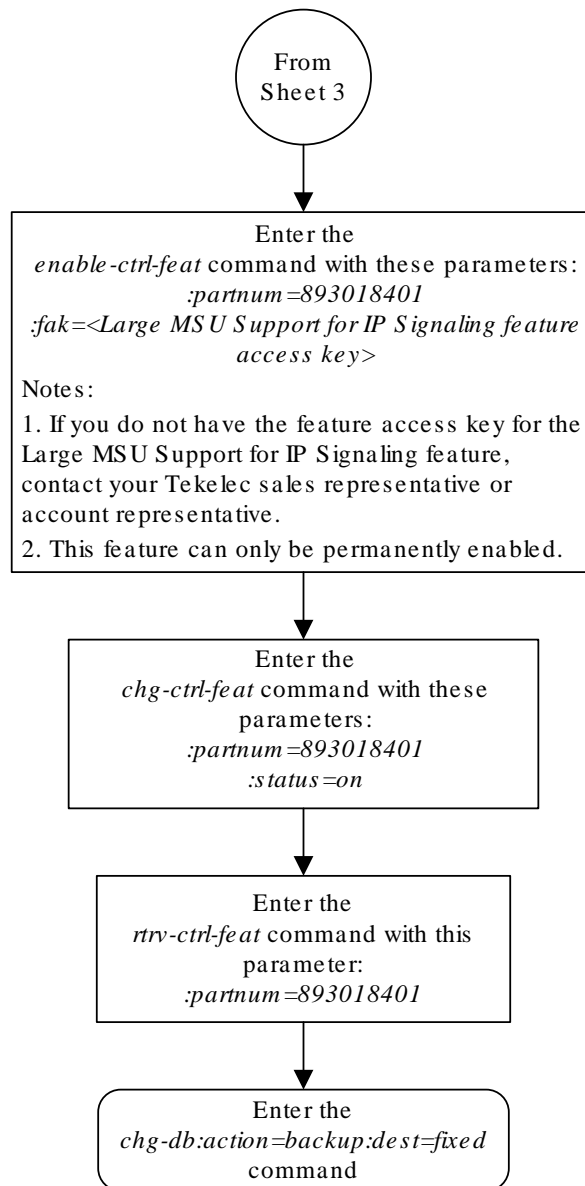


Figure 3-11 Activate the Large MSU Support for IP Signaling Feature - Sheet 4 of 4



3.10 Removing IETF M2PA Components

This section describes how to remove the following components from the database.

- An **IPLIMx** Card – Perform the [Removing an IPLIMx Card](#) procedure
- An **IPLIMx** Signaling Link – Perform the [Removing an IPLIMx Signaling Link](#) procedure
- An **IP** Host – Perform the [Removing an IP Host Assigned to an IPLIMx Card](#) procedure
- An **IP** Route – Perform the [Removing an IP Route](#) procedure
- An **M2PA** Association – Perform the [Removing an M2PA Association](#) procedure

3.11 Removing an IPLIMx Card

Use this procedure to remove an **IPLIMx** card, a card running the `iplim` or `iplimi` applications from the database using the `dlt-card` command.

The card cannot be removed if it does not exist in the database. Prior to removing the card from the database, the signaling links assigned to the card must be removed.

▲ Caution:

If the **IPGWx** card is the last **IP** card in service, removing this card from the database will cause traffic to be lost.

1. Display the cards in the database using the `rtrv-card` command.

This is an example of the possible output.

```
rlghncxa03w 13-06-15 16:34:56 GMT EAGLE5 45.0.0
CARD   TYPE      APPL      LSET NAME      LINK SLC LSET NAME
LINK SLC
1101   DSM        VSCCP
1102   TSM        GLS
1113   E5MCAP     OAMHC
1114   E5TDM-A
1115   E5MCAP     OAMHC
1116   E5TDM-B
1117   E5MDAL
1201   LIMDS0     SS7ANSI    lsn1           A    0    lsn2
B      1
1203   LIMDS0     SS7ANSI    lsn2           A    0    lsn1
B      1
1204   LIMATM     ATMANSI    atmgwy         A    0
1205   DCM        IPLIM      ipnode1        A    0    ipnode3
B      1
1207   DCM        IPLIM      ipnode2        A    0
1303   DCM        IPLIM      ipnode1        A    0    ipnode3
```

```
B      1
1305   DCM      IPLIM   ipnode4   A      0
```

Select a card whose application is either `IPLIM` or `IPLIMI`.

Perform the [Removing an IPLIMx Signaling Link](#) procedure in this chapter to remove all the signaling links assigned to the card, shown in the `LINK` column of the `rtrv-card` output.

The card location is shown in the `CARD` field of the `rtrv-card` command output. No entries in the `LSET NAME`, `LINK`, and `SLC` columns mean that no signaling link is assigned to the card.

2. Remove the card from the database using the `dlt-card` command.

The `dlt-card` command has only one parameter, `loc`, which is the location of the card. For this example, enter these commands.

```
dlt-card:loc=1205
```

```
dlt-card:loc=1207
```

When these commands have successfully completed, this message appears.

```
rlghncxa03w 06-10-12 09:12:36 GMT EAGLE5 36.0.0
DLT-CARD: MASP A - COMPLTD
```

3. Verify the changes using the `rtrv-card` command and specifying the card that was removed in 2.

For this example, enter these commands.

```
rtrv-card:loc=1205
```

```
rtrv-card:loc=1207
```

When these commands have successfully completed, this message appears.

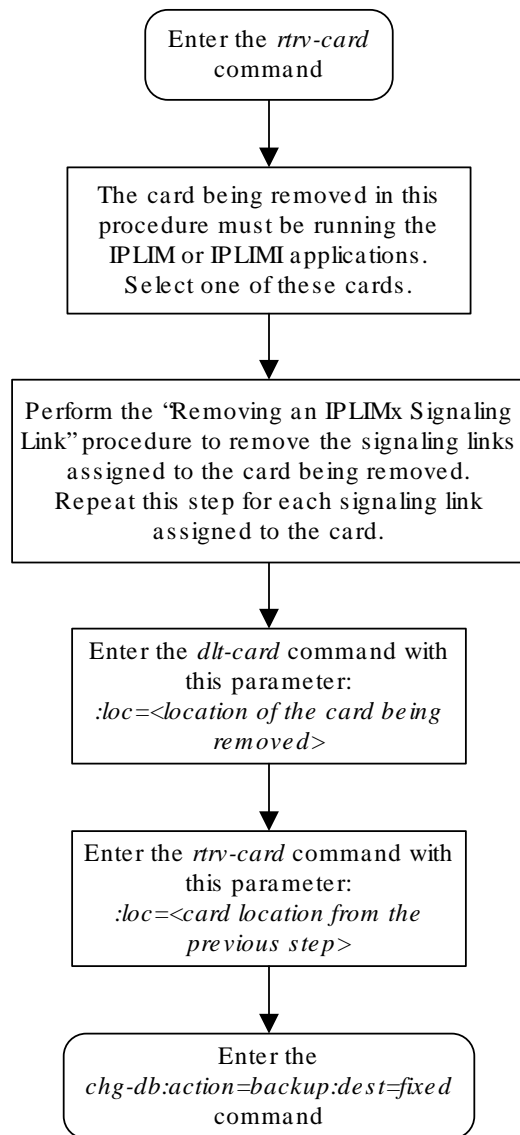
```
E2144 Cmd Rej: Location invalid for hardware configuration
```

4. Back up the new changes using the `chg-db:action=backup:dest=fixed` command.

These messages appear, the active **Maintenance and Administration Subsystem Processor (MASP)** appears first.

```
BACKUP (FIXED) : MASP A - Backup starts on active MASP.
BACKUP (FIXED) : MASP A - Backup on active MASP to fixed disk complete.
BACKUP (FIXED) : MASP A - Backup starts on standby MASP.
BACKUP (FIXED) : MASP A - Backup on standby MASP to fixed disk complete.
```

Figure 3-12 Removing an IPLIMx Card



3.12 Removing an IPLIMx Signaling Link

This procedure is used to remove an **IPLIMx** signaling link from the database using the `dlt-slk` command. The `dlt-slk` command uses these parameters.

`:loc` – The card location of the **IPLIMx** card that the **IP** signaling link is assigned to.

`:link` – The signaling link on the card specified in the `loc` parameter.

`:force` – This parameter must be used to remove the last link in a linkset without having to remove all of the routes that referenced the linkset.

The `tfatcabmlq` parameter (**TFA/TCA Broadcast Minimum Link Quantity**), assigned to linksets, shows the minimum number of links in the given linkset (or in the combined link set in which it resides) that must be available for traffic. When the number of signaling links in the specified linkset is equal to or greater than the value of the `tfatcabmlq` parameter, the status of the routes that use the specified linkset is set to allowed and can carry traffic. Otherwise, these routes are restricted. The value of the `tfatcabmlq` parameter cannot exceed the total number of signaling links contained in the linkset.

If the linkset type of the linkset that contains the signaling link that is being removed is either A, B, D, E, or PRX, the signaling link can be removed regardless of the `tfatcabmlq` parameter value of the linkset and regardless of the `LSRESTRICT` option value. When a signaling link in one of these types of linksets is removed, the `tfatcabmlq` parameter value of the linkset is decreased automatically.

If the linkset type of the linkset that contains the signaling link that is being removed is C, the signaling link can be removed only:

- If the `LSRESTRICT` option is off. The `LSRESTRICT` option value is shown in the `rtrv-ss7opts` output.
- If the `LSRESTRICT` option is on and the number of signaling links assigned to the linkset will be equal to or greater than the value of the `tfatcabmlq` parameter value of the linkset after the signaling link is removed.
The `tfatcabmlq` parameter value of the linkset is shown in the `TFATCABMLQ` column of the `rtrv-ls:lsn=<linkset name>` output. The `tfatcabmlq` parameter value can be a fixed value (1 to 16) or 0. If the `tfatcabmlq` parameter value of the linkset is a fixed value, the number of signaling links that are in the linkset after the signaling link is removed must be equal to or greater than the `tfatcabmlq` parameter value of the linkset.

If the `tfatcabmlq` parameter value is 0, the signaling link can be removed. When the `tfatcabmlq` parameter value is 0, the value displayed in the `TFATCABMLQ` column of the `rtrv-ls` output is 1/2 of the number of signaling links contained in the linkset. If the number of signaling links in the linkset is an odd number, the `tfatcabmlq` parameter value is rounded up to the next whole number. As the signaling links are removed, the `tfatcabmlq` parameter value of the linkset is decreased automatically.

Canceling the `RTRV-SLK` Command

Because the `rtrv-slk` command used in this procedure can output information for a long period of time, the `rtrv-slk` command can be canceled and the output to the terminal stopped. There are three ways that the `rtrv-slk` command can be canceled.

- Press the F9 function key on the keyboard at the terminal where the `rtrv-slk` command was entered.
- Enter the `canc-cmd` without the `trm` parameter at the terminal where the `rtrv-slk` command was entered.
- Enter the `canc-cmd:trm=<xx>`, where `<xx>` is the terminal where the `rtrv-slk` command was entered, from another terminal other than the terminal where the `rtrv-slk` command was entered. To enter the `canc-cmd:trm=<xx>` command, the terminal must allow Security Administration commands to be entered from it and the user must be allowed to enter Security Administration commands. The terminal's permissions can be verified with the `rtrv-secu-trm` command. The user's permissions can be verified with the `rtrv-user` or `rtrv-secu-user` commands.

For more information about the `canc-cmd` command, go to *Commands User's Guide*.

1. Display the current link configuration using the `rtrv-slk` command.

This is an example of the possible output.

```
rlghncxa03w 09-07-19 21:16:37 GMT EAGLE5 41.1.0
```

LOC	LINK	LSN	SLC	TYPE	L2T SET	BPS	ECM	PCR N1	PCR N2
1201	A	ls01	0	LIMDS0	1	56000	BASIC	----	-----
1201	B	lsa1	0	LIMDS0	1	56000	BASIC	----	-----
1203	A	ls03	0	LIMDS0	3	56000	BASIC	----	-----
1203	B	lsa2	0	LIMDS0	1	56000	BASIC	----	-----
1204	B	ls01	1	LIMDS0	1	56000	BASIC	----	-----
1207	A	lsn1207a	0	LIMDS0	1	56000	BASIC	----	-----
1207	B	lsn1207b	0	LIMDS0	1	56000	BASIC	----	-----
1208	B	ls03	1	LIMDS0	3	56000	BASIC	----	-----
1213	B	ls05	0	LIMDS0	5	56000	BASIC	----	-----
1215	A	ls05	1	LIMDS0	5	56000	BASIC	----	-----
1311	A	ls01	2	LIMDS0	1	56000	BASIC	----	-----
1311	A1	ls05	2	LIMDS0	5	56000	BASIC	----	-----
1311	B	ls03	2	LIMDS0	3	56000	BASIC	----	-----
1311	B1	ls07	1	LIMDS0	7	56000	BASIC	----	-----
1313	A	ls07	0	LIMDS0	7	56000	BASIC	----	-----

LOC	LINK	LSN	SLC	TYPE	LP SET	BPS	ATM TSEL	VCI
1302	A	atmansio	0	LIMATM	3	1544000	EXTERNAL	35
15	0							
1305	A	atmansil	0	LIMATM	4	1544000	INTERNAL	100
20	2							
1318	A	atmansio	1	LIMATM	9	1544000	LINE	150
25	4							

ATM LOC	LINK	LSN	SLC	TYPE	LP SET	BPS	ATM TSEL	VCI	VPI
2101	A	atmitu1	0	LIME1ATM	5	2.048M	LINE	150	2

```
ON 1 20
2105 A atmitu1 1 LIME1ATM 5 2.048M LINE 35 15 ON 2
15
```

```
LOC LINK LSN SLC TYPE IPLIML2
2202 A lsnlp1 0 IPLIM M2PA
2205 A lsnip1 0 IPLIM M2PA
2204 B lsnlp2 0 IPLIM M2PA
2213 A lsnip5 0 IPLIMI M2PA
2215 A lsnlp2 1 IPLIM M2PA
```

```
LOC LINK LSN SLC TYPE
2207 A lsnlp3 0 SS7IPGW
2211 A lsnlp4 0 IPGWI
```

SLK table is (27 of 1200) 2% full

2. Display the linkset that contains the signaling link that is being removed by entering the `rtrv-ls` command with the name of the linkset shown in the `LSN` column of the `rtrv-slkslk` output.

For this example, enter these commands.

```
rtrv-ls:lsn=lsnip1
```

This is an example of the possible output.

```
rlghncxa03w 10-07-17 11:43:04 GMT EAGLE5 42.0.0
```

```

                L3T SLT                GWS GWS GWS
LSN            APCA  (SS7)  SCRN SET SET BEI LST LNKS ACT MES DIS SLSCI
NIS
lsnip1        002-009-003  scr2 1  1  no  a  1  on  off on  no
off
```

```

                SPCA            CLLI            TFATCABMLQ MTPRSE ASL8
-----
1                no            no
```

```
RANDSLS
off
```

```
ISLSRSB RLS8
1        no
```

```
IPSG IPGWAPC GTTMODE            CGGTMOD
no   no      CdPA                no
```

```
LOC LINK SLC TYPE IPLIML2
2205 A 0 IPLIM M2PA
```

Link set table is (20 of 1024) 2% full

```
rtrv-ls:lsn=lsnlp2
```

This is an example of the possible output.

```
rlghncxa03w 10-07-17 11:43:04 GMT EAGLE5 42.0.0

          L3T SLT          GWS GWS GWS
LSN      APCA  (SS7)  SCRN SET SET BEI LST LNKS ACT MES DIS
SLSCI NIS
lsnlp2   002-009-003  scr2 1  1  no  a  2   on  off on
no      off

          SPCA          CLLI          TFATCABMLQ MTPRSE ASL8
-----
RANDSLS
off

ISLSRSB RSL8
1       no

IPSG  IPGWAPC  GTTMODE          CGGTMOD
no    no      CdPA              no

LOC  LINK  SLC  TYPE    IPLIML2
2204 B    0   IPLIM    M2PA
2215 A    1   IPLIM    M2PA
```

Link set table is (20 of 1024) 2% full

If the linkset type of the linkset is A, B, D, E, or PRX, continue the procedure with [5](#).

If the linkset type of the linkset is C, continue the procedure with [3](#).

3. Display the LSRESTRICT option value by entering the `rtrv-ss7opts` command.

This is an example of the possible output.

```
rlghncxa03w 10-07-30 15:09:00 GMT 42.0.0

SS7 OPTIONS
-----
LSRESTRICT    on
```

 **Note:**

The `rtrv-feat` command output contains other fields that are not used by this procedure. If you wish to see all the fields displayed by the `rtrv-feat` command, refer to the `rtrv-feat` command description in *Commands User's Guide*.

The signaling link cannot be removed, if the `LSRESTRICT` option is `on` and the number of signaling links assigned to the linkset will be less than the value of the `tfatcabmlq` parameter value of the linkset if the signaling link is removed.

If the `LSRESTRICT` option is `on` and the number of signaling links assigned to the linkset will be equal to or greater than the value of the `tfatcabmlq` parameter value of the linkset if the signaling link is removed, continue the procedure with 5.

If the `LSRESTRICT` option is `on` and the number of signaling links assigned to the linkset will be less than the value of the `tfatcabmlq` parameter value of the linkset if the signaling link is removed, the signaling link cannot be removed unless the `tfatcabmlq` parameter value of the linkset is changed to 0. Continue the procedure with 4.

If the `LSRESTRICT` value is `off`, continue the procedure with 5.

4. Change the `tfatcabmlq` parameter value of the linkset to 0 by entering the `chg-ls` command with the name of the linkset that contains the signaling link that is being removed and the `tfatcabmlq` parameters. For this example, enter this command.

```
chg-ls:lsn=ls17:tfatcabmlq=0
```

When this command has successfully completed, this message should appear.

```
rlghncxa03w 10-07-07 08:41:12 GMT EAGLE5 42.0.0
```

```
Link set table is (20 of 1024) 2% full.
```

```
CHG-LS: MASP A - COMPLTD
```

5. Display the IP link associated with the card that the signaling link being removed the database is assigned to.

Enter the `rtrv-ip-lnk` command with the card location of the signaling link being removed shown in 1. For this example, enter these commands.

```
rtrv-ip-lnk:loc=2205
```

The following is an example of the possible output.

```
rlghncxa03w 06-10-28 21:14:37 GMT EAGLE5 36.0.0
LOC  PORT IPADDR          SUBMASK          DUPLEX  SPEED  MACTYPE  AUTO
MCAST
2205  A    192.3.1.10           255.255.255.128  HALF    10     802.3    NO    NO
2205  B    -----              -----          HALF    10     DIX      NO    NO
```

```
rtrv-ip-lnk:loc=2204
```

The following is an example of the possible output.

```
rlghncxa03w 06-10-28 21:14:37 GMT EAGLE5 36.0.0
LOC  PORT IPADDR          SUBMASK          DUPLEX  SPEED  MACTYPE  AUTO
MCAST
2204  A    192.1.1.10           255.255.255.128  HALF    10     802.3    NO    NO
2204  B    -----              -----          HALF    10     DIX      NO    NO
```

6. Display the **IP** host information associated with the **IP** link by entering the `rtrv-ip-host` command with the **IP** address shown in 5.

For this example, enter these commands.

```
rtrv-ip-host:ipaddr=192.001.001.010
```

The following is an example of the possible output.

```
rlghncxa03w 08-12-28 21:17:37 GMT EAGLE5 40.0.0
```

```
LOCAL IPADDR      LOCAL HOST
192.1.1.10        IPNODE1_2204
```

```
IP Host table is (11 of 4096) .26% full
```

```
rtrv-ip-host:ipaddr=192.003.001.010
```

The following is an example of the possible output.

```
rlghncxa03w 08-12-28 21:17:37 GMT EAGLE5 40.0.0
```

```
LOCAL IPADDR      LOCAL HOST
192.3.1.10        IPNODE1_2205
```

```
IP Host table is (11 of 4096) .26% full
```

7. Display the association associated with the local host name shown in 6 by entering the `rtrv-assoc` command.

For this example, enter this command.

```
rtrv-assoc:lhost=ipnode1_2204
```

This is an example of possible output.

```
rlghncxa03w 06-10-28 09:12:36 GMT EAGLE5 36.0.0
```

```
                CARD IPLNK
ANAME           LOC  PORT  LINK ADAPTER LPORT RPORT OPEN ALW
assoc1          2204 A    A    M2PA      1030 1030 YES  YES
```

```
IP Appl Sock/Assoc table is (4 of 4000) 1% full
```

```
Assoc Buffer Space Used (16 KB of 3200 KB) on LOC = 2204
```

```
rtrv-assoc:lhost=ipnode1_2205
```

This is an example of possible output.

```
rlghncxa03w 06-10-28 09:12:36 GMT EAGLE5 36.0.0
```

```
IP Appl Sock/Assoc table is (4 of 4000) 1% full
```

 **Note:**

If there are no associations assigned to the specified local host name, the `rtv-assoc` output shows no association information as shown above.

8. Change the value of the `open` and `alw` parameters to `no` by specifying the `chg-assoc` command with the `open=no` and `alw=no` parameters, as necessary.

 **Note:**

If there is no association shown in 7, or the `open` and `alw` parameter values of the association shown in 7 are `no`, continue the procedure with 9.

For this example, enter this command.

```
chg-assoc:aname=assoc1:open=no:alw=no
```

When this command has successfully completed, this message should appear.

```
rlghncxa03w 06-10-28 09:12:36 GMT EAGLE5 36.0.0
CHG-ASSOC: MASP A - COMPLTD;
```

9. Deactivate the link to be removed using the `dact-slk` command, using the output from 1 to obtain the card location and `link` parameter value of the signaling link to be removed.

For this example, enter these commands.

```
dact-slk:loc=2205:link=a
```

```
dact-slk:loc=2204:link=a
```

When each of these command has successfully completed, this message should appear.

```
rlghncxa03w 06-10-07 08:41:12 GMT EAGLE5 36.0.0
Deactivate Link message sent to card
```

10. Verify that the link is out of service - maintenance disabled (**OOS-MT-DSBLD**) using the `rept-stat-slk` command with the card location and `link` parameter values specified in 9.

For this example, enter these commands.

```
rept-stat-slk:loc=2205:link=a
```

This is an example of the possible output.

```
rlghncxa03w 06-10-23 13:06:25 GMT EAGLE5 36.0.0
SLK      LSN      CLLI      PST      SST      AST
2205,A   ls05      ls05c1li  OOS-MT_DSBLD Unavail  ----
  ALARM STATUS      = *   0235 REPT-LNK-MGTINH: local inhibited
  UNAVAIL REASON    = LI
```

```
rept-stat-slk:loc=2204:link=a
```

This is an example of the possible output.

```
rlghncxa03w 06-10-23 13:06:25 GMT EAGLE5 36.0.0
SLK      LSN      CLLI      PST      SST      AST
2204,A   ls04      ls04clli  OOS-MT   Unavail  ----
  ALARM STATUS      = *   0235 REPT-LNK-MGTINH: local inhibited
  UNAVAIL REASON    = LI
```

11. If the signaling link to be removed is the last signaling link on a card, the card must be inhibited before the signaling link is removed.

 **Note:**

If the signaling link being removed is not the last signaling link on the card, continue the procedure with [13](#).

Before entering the `dlt-slk` command, enter the `rmv-card` command and specify the location of the card to be inhibited. The card location is shown in the output of `rept-stat-slk` command executed in [10](#).

In the example used for this procedure, the signaling link is the last signaling link on the card and must be inhibited. Enter these commands.

```
rmv-card:loc=2205
```

```
rmv-card:loc=2204
```

When each of these command has successfully completed, this message should appear.

```
rlghncxa03w 06-10-07 08:41:12 GMT EAGLE5 36.0.0
Card has been inhibited.
```

12. Verify that the card has been inhibited by entering the `rept-stat-card` command with the card location specified in [11](#). For this example, enter these commands.

```
rept-stat-card:loc=2205
```

This is an example of the possible output.

```
rlghncxa03w 07-05-27 16:43:42 GMT EAGLE5 37.0.0
CARD  VERSION      TYPE      GPL      PST      SST
AST
2205  114-001-000  DCM      IPLIM    OOS-MT-DSBLD  Isolated
-----
  ALARM STATUS      = ** 0013 Card is isolated from the system
  BPDCM GPL         = 002-102-000
  IMT BUS A        = Disc
  IMT BUS B        = Disc
  SIGNALING LINK STATUS
      SLK      PST      LS      CLLI      E5IS
```



```

A      OOS-MT      lsnlp1      -----      INACTIVE

Command Completed.

```

```
rept-stat-card:loc=2204
```

This is an example of the possible output.

```

rlghncxa03w 07-05-27 16:43:42 GMT EAGLE5 37.0.0
CARD  VERSION      TYPE      GPL      PST      SST      AST
2204  114-001-000    DCM      IPLIM    OOS-MT-DSBLD  Isolated  -----
ALARM STATUS      = ** 0013 Card is isolated from the system
BPDCM GPL         = 002-102-000
IMT BUS A         = Disc
IMT BUS B         = Disc
SIGNALING LINK STATUS
SLK   PST          LS          CLLI        E5IS
A     OOS-MT      lsnlp2      -----      INACTIVE

```

Command Completed.

13. Remove the signaling link from the **EAGLE** using the `dlt-slk` command.

If there is only one signaling link in the linkset, the `force=yes` parameter must be specified to remove the signaling link.

In the example used in this procedure, the signaling link is the last signaling link in the linkset. Enter these commands.

```
dlt-slk:loc=2205:link=a:force=yes
```

```
dlt-slk:loc=2204:link=a:force=yes
```

When this command has successfully completed, this message should appear.

```

rlghncxa03w 06-10-07 08:41:17 GMT EAGLE5 36.0.0
DLT-SLK: MASP A - COMPLTD

```

 **Note:**

If removing the signaling link will result in 700 or less signaling links in the database and the `OAMHCMEAS` value in the `rtrv-measopts` output is on, the scheduled UI measurement reports will be enabled.

14. Verify the changes using the `rtrv-slk` command with the card location and link values specified in 13. For this example, enter these commands.

```
rtrv-slk:loc=2205:link=a
```

```
rtrv-slk:loc=2204:link=a
```

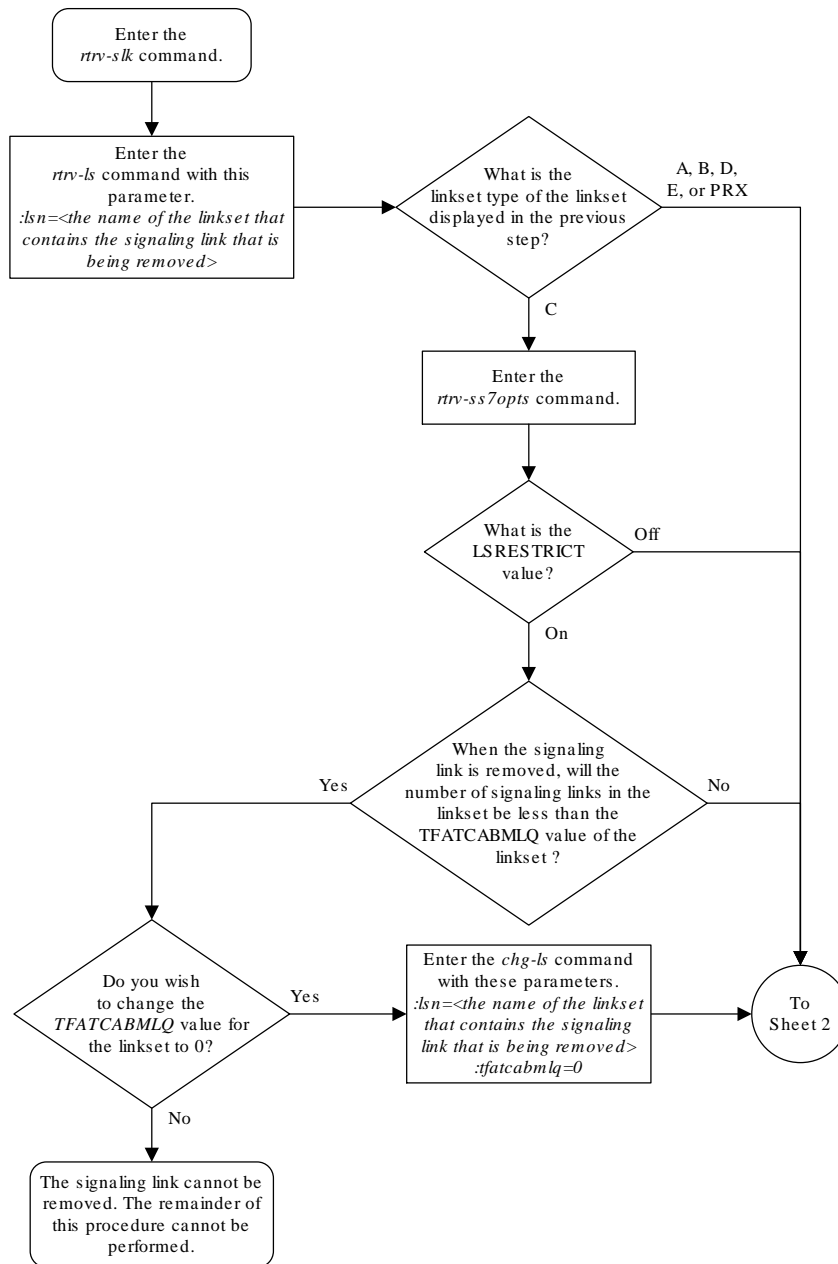
When the `rtrv-slk` command has completed, the specified signaling link is not shown in the `rtrv-slk` output, as shown in this example.

```
rlghncxa03w 09-09-18 13:43:31 GMT EAGLE5 41.1.0  
E2373 Cmd Rej: Link is unequipped in the database
```

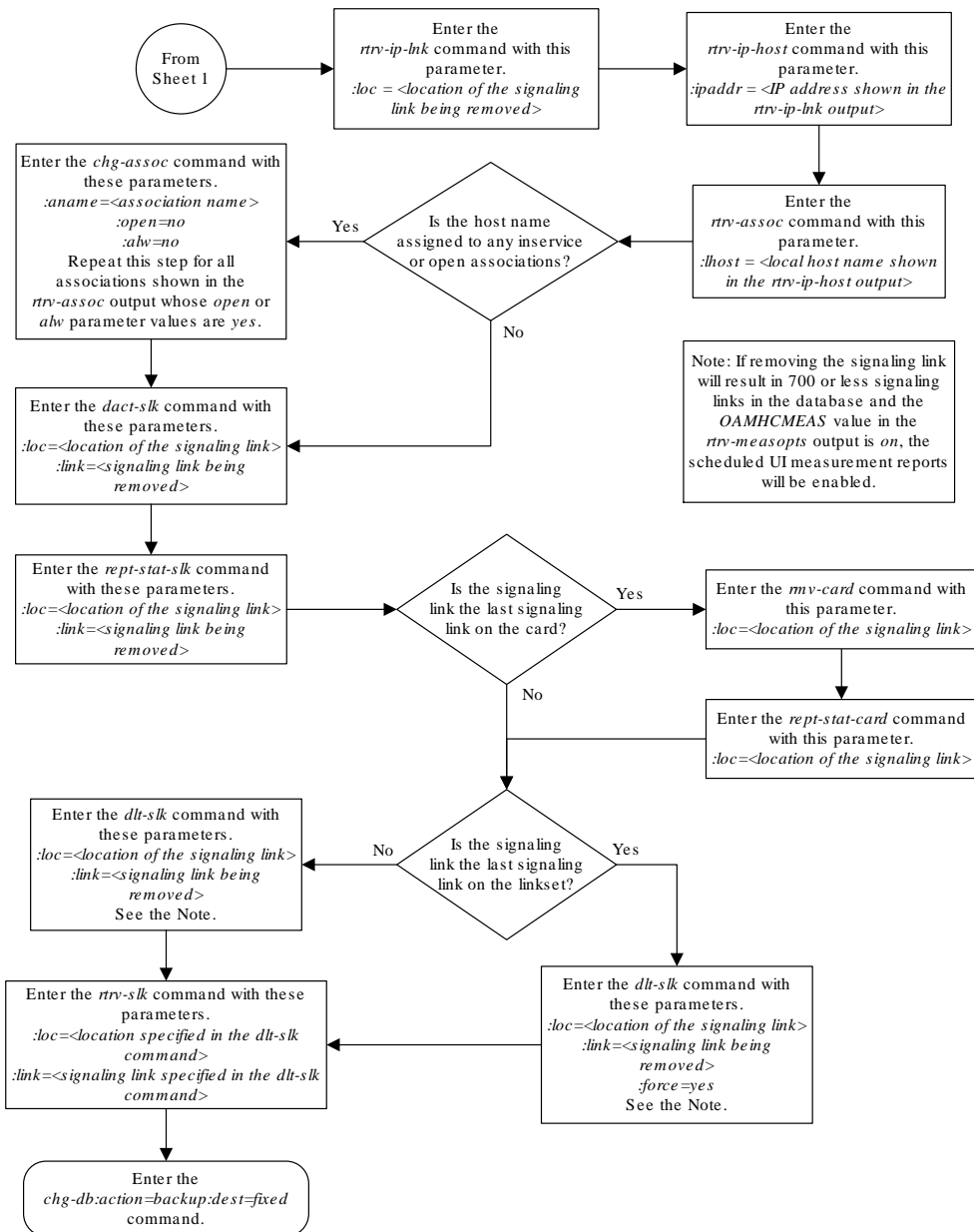
15. Back up the new changes using the `chg-db:action=backup:dest=fixed` command. These messages should appear, the active **Maintenance and Administration Subsystem Processor (MASP)** appears first.

```
BACKUP (FIXED) : MASP A - Backup starts on active MASP.  
BACKUP (FIXED) : MASP A - Backup on active MASP to fixed disk  
complete.  
BACKUP (FIXED) : MASP A - Backup starts on standby MASP.  
BACKUP (FIXED) : MASP A - Backup on standby MASP to fixed disk  
complete.
```

Figure 3-13 Removing an IPLIMx Signaling Link



Sheet 1 of 2



Sheet 2 of 2

3.13 Removing an IP Host Assigned to an IPLIMx Card

This procedure removes an IP host that is assigned to an IPLIMx card using the `dlt-ip-host` command.

The `dlt-ip-host` command uses the following parameter.

`:host`— Hostname. The hostname to be removed. This parameter identifies the logical name assigned to a device with an **IP** address.

No associations can reference the host name being removed in this procedure.

The associations referencing the host name can be removed by performing the [Removing an M2PA Association](#) procedure or the host name in these associations can be changed by performing the [Changing the Host Values of a M2PA Association](#) procedure. The host name assigned to associations is displayed in the `rtrv-assoc` outputs.

1. Display the current **IP** host information in the database by entering the `rtrv-ip-host:display=all` command.

The following is an example of the possible output.

```
rlghncxa03w 08-12-28 21:17:37 GMT EAGLE5 40.0.0

LOCAL IPADDR      LOCAL HOST
192.1.1.10        IPNODE1-1201
192.1.1.12        IPNODE1-1203
192.1.1.14        IPNODE1-1205
192.1.1.20        IPNODE2-1201
192.1.1.22        IPNODE2-1203
192.1.1.24        IPNODE2-1205
192.1.1.30        KC-HLR1
192.1.1.32        KC-HLR2
192.1.1.50        DN-MS1
192.1.1.52        DN-MS2
192.3.3.33        GW100. NC. TEKELEC. COM

REMOTE IPADDR     REMOTE HOST
150.1.1.5         NCDEPTECONOMIC_DEVELOPMENT. SOUTHEASTERN_COORIDOR_ASHVL.
GOV

IP Host table is (12 of 4096) .29% full
```

If the IP host that is being removed is a remote host, continue the procedure with [5](#).

If the IP host that is being removed is a local host, continue the procedure with [2](#).

2. Display the current link parameters associated with the **IP** card in the database by entering the `rtrv-ip-lnk` command. The following is an example of the possible output.

```
rlghncxa03w 08-12-28 21:14:37 GMT EAGLE5 40.0.0
LOC  PORT  IPADDR          SUBMASK          DUPLEX  SPEED  MACTYPE  AUTO
MCAST
1303  A     192.1.1.10     255.255.255.128  HALF    10     802.3    NO   NO
1303  B     -----        -----          HALF    10     DIX      NO   NO
1305  A     192.1.1.12     255.255.255.0   ----    ---    DIX      YES  NO
1305  B     -----        -----          HALF    10     DIX      NO   NO
1313  A     192.1.1.14     255.255.255.0   FULL    100    DIX      NO   NO
1313  B     -----        -----          HALF    10     DIX      NO   NO
2101  A     192.1.1.20     255.255.255.0   FULL    100    DIX      NO   NO
2101  B     -----        -----          HALF    10     DIX      NO   NO
2103  A     192.1.1.22     255.255.255.0   FULL    100    DIX      NO   NO
2103  B     -----        -----          HALF    10     DIX      NO   NO
```

```

2105 A 192.1.1.24 255.255.255.0 FULL 100 DIX
NO NO
2105 B ----- ----- HALF 10 DIX
NO NO
2205 A 192.1.1.30 255.255.255.0 FULL 100 DIX
NO NO
2205 B ----- ----- HALF 10 DIX
NO NO
2207 A 192.1.1.32 255.255.255.0 FULL 100 DIX
NO NO
2207 B ----- ----- HALF 10 DIX
NO NO
2213 A 192.1.1.50 255.255.255.0 FULL 100 DIX
NO NO
2213 B ----- ----- HALF 10 DIX
NO NO
2301 A 192.1.1.52 255.255.255.0 FULL 100 DIX
NO NO
2301 B ----- ----- HALF 10 DIX
NO NO
2305 A 192.3.3.33 255.255.255.0 FULL 100 DIX
NO NO
2305 B ----- ----- HALF 10 DIX
NO NO

```

IP-LNK table is (22 of 2048) 1% full.

3. Display the cards in the database using the `rtrv-card` command. This is an example of the possible output.

```

rlghncxa03w 09-05-28 09:12:36 GMT EAGLE5 41.0.0
CARD TYPE APPL LSET NAME LINK SLC LSET NAME
LINK SLC
1101 DSM VSCCP
1102 TSM GLS
1113 E5MCAP EOAM
1114 E5TDM-A
1115 E5MCAP EOAM
1116 E5TDM-B
1117 E5MDAL
1201 LIMDS0 SS7ANSI sp2 A 0 sp1
B 0
1203 LIMDS0 SS7ANSI sp3 A 0
1204 LIMDS0 SS7ANSI sp3 A 1
1206 LIMDS0 SS7ANSI nsp3 A 1 nsp4
B 1
1301 LIMDS0 SS7ANSI sp6 A 1 sp7
B 0
1302 LIMDS0 SS7ANSI sp7 A 1 sp5
B 1
1303 DCM IPLIM ipnode1 A 0 ipnode3
B 1
1305 DCM IPLIM ipnode4 A 0
1313 DCM SS7IPGW ipgtwy1 A 0
2101 DCM SS7IPGW ipgtwy2 A 0

```

2103	DCM	SS7IPGW	ipgtwy3	A	0				
2105	DCM	IPLIM	ipnode1	A1	1	ipnode5	B	2	
2205	DCM	IPLIM	ipnode3	A2	0	ipnode6	B1	2	
2207	DCM	IPLIM	ipnode5	A	0	ipnode4	B3	1	
2213	DCM	IPLIM	ipnode5	A3	1	ipnode3	B2	2	
2301	DCM	IPLIM	ipnode6	A	0	ipnode1	B	2	
2305	DCM	IPLIM	ipnode6	A1	1	ipnode1	B1	3	

Select an **IP** host whose **IP address** is assigned to a card running the **IPLIM** or **IPLIMI** application.

4. Display the associations referencing the host name being removed in this procedure by entering the `rtrv-assoc` command with the local host name.

For this example, enter this command.

```
rtrv-assoc:lhost=gw100.nc.tekelec.com
```

The following is an example of the possible output.

```
rlghncxa03w 06-10-28 21:14:37 GMT EAGLE5 36.0.0
                CARD IPLNK
ANAME           LOC  PORT  LINK ADAPTER LPORT RPORT OPEN ALW
a2              2305 A    A    M2PA    7205  7001  NO  NO
```

```
IP Appl Sock/Assoc table is (4 of 4000) 1% full
Assoc Buffer Space Used (200 KB of 1600 KB) on LOC = 2305
```

If no associations referencing the host name being removed in this procedure are shown in this step, continue the procedure with [5](#).

Any associations referencing the host name must either be removed or the host name assigned to the association must be changed.

To remove the associations, perform the [Removing an M2PA Association](#) procedure.

Continue the procedure with [5](#) after the associations have been removed.

To change the host name assigned to the associations, perform the [Changing the Host Values of a M2PA Association](#) procedure.

Continue the procedure with [5](#) after the host name assigned to the associations have been changed.

5. Delete **IP** host information from the database by entering the `dlt-ip-host` command.

For example, enter this command.

```
dlt-ip-host:host=gw100.nc.tekelec.com
```

When this command has successfully completed, the following message should appear.

```
rlghncxa03w 06-10-28 21:19:37 GMT EAGLE5 36.0.0
DLT-IP-HOST: MASP A - COMPLTD
```

6. Verify the changes by entering the `rtrv-ip-host` command with the host name specified in [5](#).

For this example, enter this command.

```
rtrv-ip-host:host=gw100.nc.tekelec.com
```

The following is an example of the possible output.

```
rlghncxa03w 09-07-28 21:20:37 GMT EAGLE5 41.1.0
```

```
No matching entries found.
```

```
IP Host table is (10 of 4096) .24% full
```

7. Back up the new changes using the `chg-db:action=backup:dest=fixed` command.

These messages should appear, the active **Maintenance and Administration Subsystem Processor (MASP)** appears first.

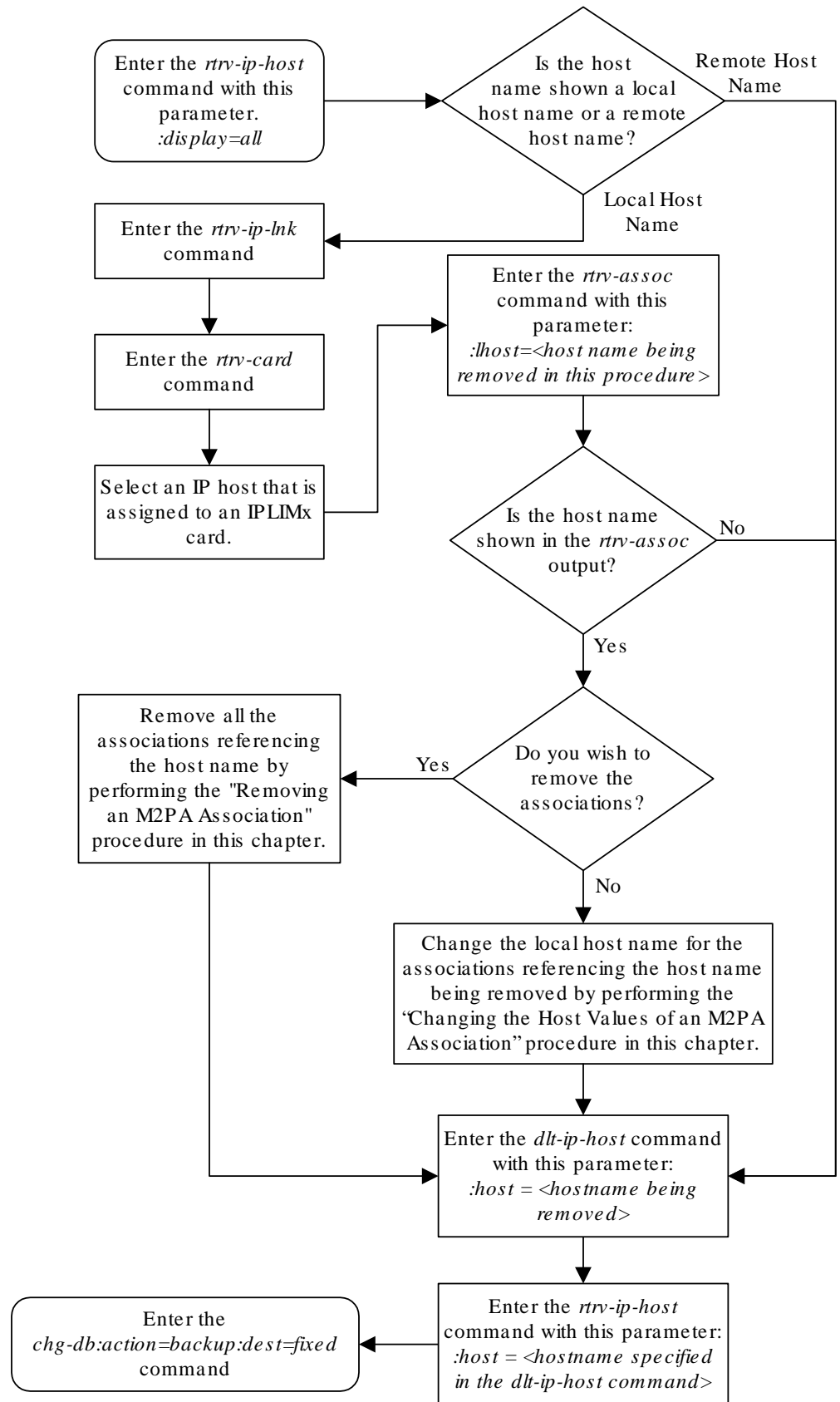
```
BACKUP (FIXED) : MASP A - Backup starts on active MASP.
```

```
BACKUP (FIXED) : MASP A - Backup on active MASP to fixed disk  
complete.
```

```
BACKUP (FIXED) : MASP A - Backup starts on standby MASP.
```

```
BACKUP (FIXED) : MASP A - Backup on standby MASP to fixed disk  
complete.
```


Figure 3-14 Removing an IP Host Assigned to an IPLIMx Card



3.14 Removing an IP Route

This procedure is used to remove an **IP** route from the database using the `dlt-ip-rte` command.

The `dlt-ip-rte` command uses these parameters.

`:loc` – The location of the **IP** card containing the **IP** route being removed.

`:dest` – The **IP** address of the remote host or network assigned to the **IP** route being removed.

`:force` – To remove the **IP** route, the **IP** card that the route is assigned to must be out of service, or the `force=yes` parameter must be specified with the `dlt-ip-rte` command. The `force=yes` parameter allows the **IP** route to be removed if the **IP** card is in service.

▲ Caution:

Removing an **IP** route while the **IP** card is still in service can result in losing the ability to route outbound **IP** traffic on the **IP** card. This can cause both **TCP** and **SCTP** sessions on the **IP** card to be lost.

1. Display the **IP** routes in the database with the `rtrv-ip-rte` command.

This is an example of the possible output.

```
rlghncxa03w 06-10-28 09:12:36 GMT EAGLE5 36.0.0
LOC  DEST          SUBMASK          GTWY
1212 132.10.175.20    255.255.0.0      150.1.1.50
1301 128.252.10.5     255.255.255.255 140.188.13.33
1301 128.252.0.0      255.255.0.0      140.188.13.34
1301 150.10.1.1       255.255.255.255 140.190.15.3
1303 192.168.10.1     255.255.255.255 150.190.15.23
1303 192.168.0.0      255.255.255.0    150.190.15.24
```

IP Route table is (6 of 2048) 0.29% full

2. Verify the state of the **IP** card containing the **IP** route being removed by entering the `rept-stat-card` command and specifying the card location of the **IP** card.

The **IP** card should be in the out-of-service maintenance-disabled (**OOS-MT-DSBLD**) in order to remove the **IP** route. If the **IP** card's state is out-of-service maintenance-disabled, the entry **OOS-MT-DSBLD** is shown in the **PST** column of the `rept-stat-card` output. For this example, enter this command.

```
rept-stat-card:loc=1301
```

This is an example of the possible output.

```
rlghncxa03w 06-10-27 17:00:36 GMT EAGLE5 36.0.0
CARD  VERSION      TYPE      GPL      PST      SST      AST
```

```

1301 114-000-000 DCM      IPLIM      IS-NR      Active      -----
ALARM STATUS      = No Alarms.
BPDCM GPL         = 002-102-000
IMT BUS A         = Conn
IMT BUS B         = Conn
SIGNALING LINK STATUS
  SLK   PST              LS           CLLI
  A     IS-NR            nc001      -----

```

Command Completed.

 **Note:**

If the output of 2 shows that the **IP** card's state is not **OOS-MT-DSBLD**, and you do not wish to change the state of the **IP** card, continue the procedure with 4.

3. Change the **IP** card's state to **OOS-MT-DSBLD** using the `inh-card` command and specifying the card location of the **IP** card.

For this example, enter these commands.

```
inh-card:loc=1301
```

When this command has successfully completed, this message appears.

```
rlghncxa03w 06-10-12 09:12:36 GMT EAGLE5 36.0.0
Card has been inhibited.
```

4. Remove the **IP** route from the database using the `dlt-ip-rte` command.

If the state of the **IP** card is not **OOS-MT-DSBLD**, the `force=yes` parameter must be specified with the `dlt-ip-rte` command. For this example, enter this command.

```
dlt-ip-rte:loc=1301:dest=128.252.0.0
```

 **Caution:**

Removing an **IP** route while the **IP** card is still in service can result in losing the ability to route outbound **IP** traffic on the **IP** card. This can cause both **TCP** and **SCTP** sessions on the **IP** card to be lost.

When this command has successfully completed, this message should appear.

```
rlghncxa03w 06-10-12 09:12:36 GMT EAGLE5 36.0.0
DLT-IP-RTE: MASP A - COMPLTD
```

5. Verify the changes using the `rtrv-ip-rte` command.

This is an example of the possible output.

```
rlghncxa03w 06-10-28 09:12:36 GMT EAGLE5 36.0.0
LOC  DEST          SUBMASK          GTWY
1212 132.10.175.20    255.255.0.0      150.1.1.50
1301 128.252.10.5     255.255.255.255  140.188.13.33
1301 150.10.1.1       255.255.255.255  140.190.15.3
1303 192.168.10.1     255.255.255.255  150.190.15.23
1303 192.168.0.0      255.255.0.0      150.190.15.24
```

```
IP Route table is (5 of 2048) 0.24% full
```

6. Place the **IP** card back into service by using the `alw-card` command.

 **Note:**

If the **IP** card containing the **IP** route that was removed from the database does not contain other **IP** routes, continue the procedure with [7](#).

For example, enter this command.

```
alw-card:loc=1301
```

This message should appear.

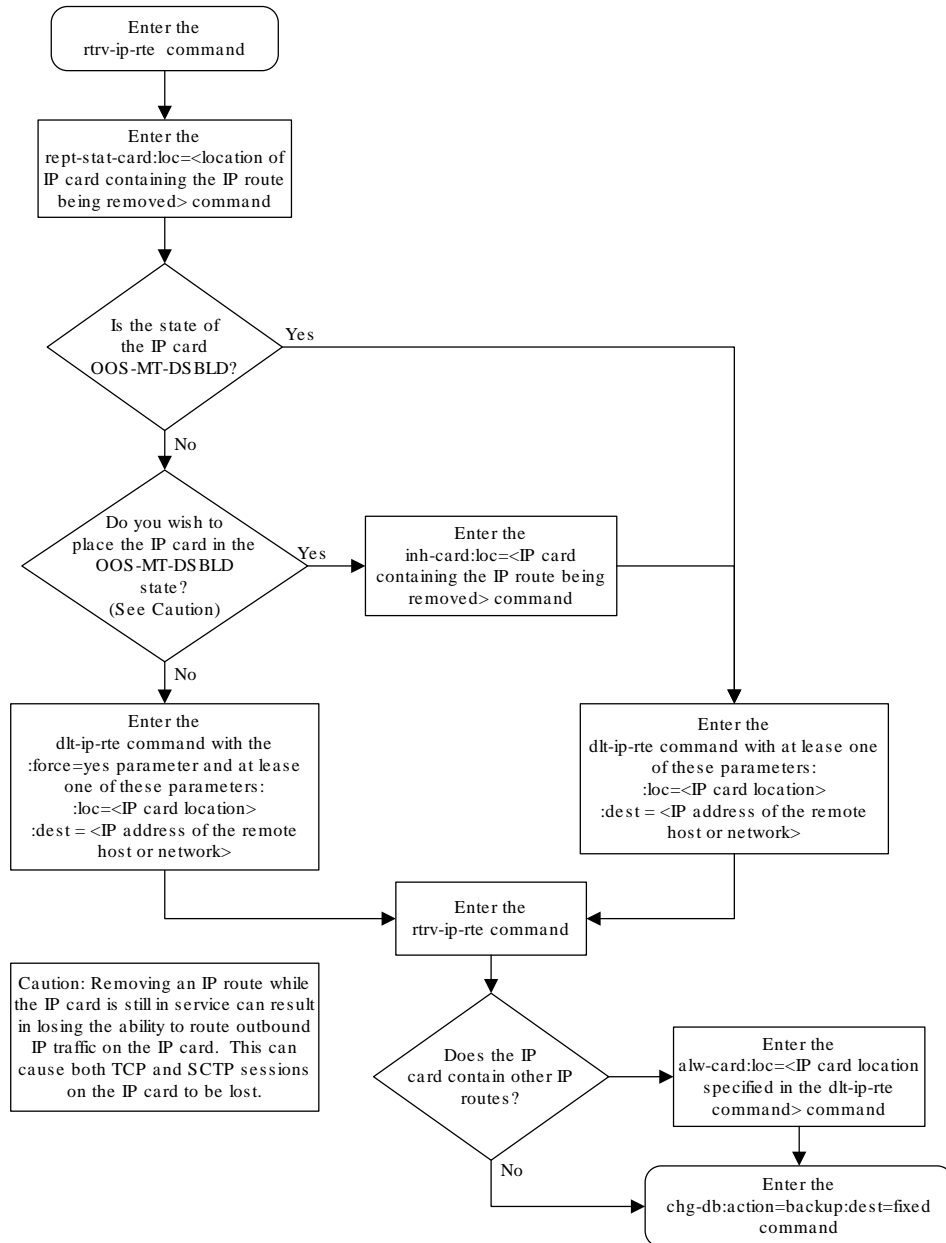
```
rlghncxa03w 06-10-28 21:22:37 GMT EAGLE5 36.0.0
Card has been allowed.
```

7. Back up the new changes using the `chg-db:action=backup:dest=fixed` command.

These messages should appear, the active **Maintenance and Administration Subsystem Processor (MASP)** appears first.

```
BACKUP (FIXED) : MASP A - Backup starts on active MASP.
BACKUP (FIXED) : MASP A - Backup on active MASP to fixed disk
complete.
BACKUP (FIXED) : MASP A - Backup starts on standby MASP.
BACKUP (FIXED) : MASP A - Backup on standby MASP to fixed disk
complete.
```

Figure 3-15 Removing an IP Route



3.15 Removing an M2PA Association

This procedure is used to remove an association from the database using the `dlt-assoc` command.

The `dlt-assoc` command uses one parameter, `aname`, the name of the association being removed from the database. The association being removed must be in the database.

The `open` parameter must be set to `no` before the association can be removed. Use the `chg-assoc` command to change the value of the `open` parameter.

The `adapter` value assigned to the association being removed in this procedure must be `m2pa`. The application assigned to the card that is hosting the M2PA association must be either `IPLIM` or `IPLIMI`. Perform the [Removing an IPSP Association](#) procedure to remove an M2PA association assigned to an IPSP card.

Canceling the `RTRV-ASSOC` Command

Because the `rtrv-assoc` command used in this procedure can output information for a long period of time, the `rtrv-assoc` command can be canceled and the output to the terminal stopped. There are three ways that the `rtrv-assoc` command can be canceled.

- Press the `F9` function key on the keyboard at the terminal where the `rtrv-assoc` command was entered.
- Enter the `canc-cmd` without the `trm` parameter at the terminal where the `rtrv-assoc` command was entered.
- Enter the `canc-cmd:trm=<xx>`, where `<xx>` is the terminal where the `rtrv-assoc` command was entered, from another terminal other than the terminal where the `rtrv-assoc` command was entered. To enter the `canc-cmd:trm=<xx>` command, the terminal must allow Security Administration commands to be entered from it and the user must be allowed to enter Security Administration commands. The terminal's permissions can be verified with the `rtrv-secu-trm` command. The user's permissions can be verified with the `rtrv-user` or `rtrv-secu-user` commands.

For more information about the `canc-cmd` command, go to *Commands User's Guide*.

1. Display the associations in the database using the `rtrv-assoc` command.

This is an example of possible output.

```
rlghncxa03w 06-10-28 09:12:36 GMT EAGLE5 36.0.0
```

ANAME	CARD		LINK	ADAPTER	LPORT	RPORT	OPEN	ALW
	LOC	PORT						
swbel32	1201	A	A	M3UA	1030	2345	YES	YES
a2	1305	A	A	SUA	1030	2345	YES	YES
a3	1307	A	A	SUA	1030	2346	YES	YES
assoc1	1203	A	A1	M2PA	2048	1030	NO	NO

2. Enter the `rtrv-card` command with the location of the card that is hosting the M2PA association that will be removed in this procedure. For this example, enter this command.

```
rtrv-card:loc=1203
```

This is an example of possible output.

```
rlghncxa03w 08-03-06 15:17:20 EST EAGLE5 38.0.0
CARD   TYPE      APPL      LSET NAME   LINK SLC LSET NAME   LINK SLC
1203   DCM          IPLIM     lsn1        A1    0
```

If the application assigned to the card is IPLIM or IPLIMI, shown in the `APPL` column, continue the procedure with [3](#).

If the application assigned to the card is IPSPG, perform the [Removing an IPSPG Association](#) procedure.

3. Change the value of the `open` parameter to `no` by specifying the `chg-assoc` command with the `open=no` parameter.

 **Note:**

If the value of the `open` parameter for the association being removed from the database (shown in [1](#)) is `no`, continue this procedure with [4](#).

For this example, enter this command.

```
chg-assoc:aname=assoc1:open=no
```

When this command has successfully completed, this message should appear.

```
rlghncxa03w 06-10-28 09:12:36 GMT EAGLE5 36.0.0
CHG-ASSOC: MASP A - COMPLTD;
```

4. Remove the association from the database using the `dlt-assoc` command.

For this example, enter this command.

```
dlt-assoc:aname=assoc1
```

When this command has successfully completed, this message should appear.

```
rlghncxa03w 06-10-28 09:12:36 GMT EAGLE5 36.0.0
DLT-ASSOC: MASP A - COMPLTD
```

5. Verify the changes using the `rtrv-assoc` command with the name of the association specified in [4](#).

For this example, enter this command.

```
rtrv-assoc:aname=assoc1
```

This is an example of possible output.

```
rlghncxa03w 06-10-28 09:12:36 GMT EAGLE5 36.0.0

No matching entries found
```

IP Appl Sock table is (3 of 4000) 1% full

6. Back up the new changes, using the `chg-db:action=backup:dest=fixed` command. These messages should appear; the active **Maintenance and Administration Subsystem Processor (MASP)** appears first.

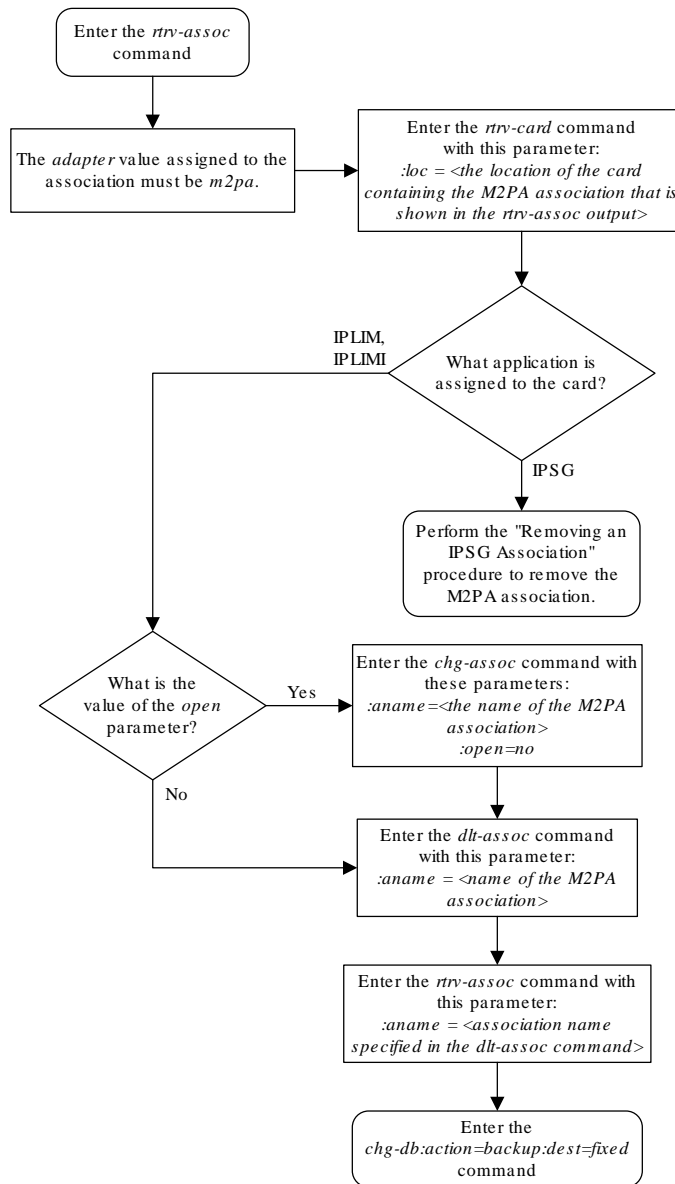
BACKUP (FIXED) : MASP A - Backup starts on active MASP.

BACKUP (FIXED) : MASP A - Backup on active MASP to fixed disk complete.

BACKUP (FIXED) : MASP A - Backup starts on standby MASP.

BACKUP (FIXED) : MASP A - Backup on standby MASP to fixed disk complete.

Figure 3-16 Removing an M2PA Association



3.16 Changing IETF M2PA Components

This section describes how to change the attributes of the following components in the database.

- An **M2PA** Association – Perform these procedures.

- [Changing the Attributes of an M2PA Association](#)
- [Changing the Buffer Size of a M2PA Association](#)
- [Changing the Host Values of a M2PA Association](#)
- [Changing the Link Value of a M2PA Association to another Link Value on the Same IPLIMx Card](#)
- The **SCTP** retransmission parameters – Perform the [Changing the SCTP Checksum Algorithm Option for M2PA Associations](#) procedure.
- A **M2PA** timer set – Perform the [Changing a M2PA Timer Set](#) procedure.
- The **SCTP** Checksum Algorithm – Perform the [Changing the SCTP Checksum Algorithm Option for M2PA Associations](#) procedure.
- Turn off the Large MSU Support for **IP** Signaling feature – Perform the [Turning Off the Large MSU Support for IP Signaling Feature](#) procedure.

3.17 Changing the Attributes of an M2PA Association

This procedure is used to change the values of the attributes of an M2PA association, assigned to cards that are running the IPLIM or IPLIMI applications, using the `chg-assoc` command and the following parameters.

Table 3-7 Change M2PA Association Parameters

aname	lport	rhost	rport	open	alw
rmode	rmin	rmax	rtimes	cwmin	istrms
ostrms	m2patset	ver	rtxthr	rhosttype	rhostval

An M2PA association that is assigned to an IPLIMx signaling link can contain a UA parameter set value (the `uaps` parameter). While the `uaps` parameter value can be changed with the `chg-assoc` command, the `uaps` parameter value has no impact on the traffic carried by an M2PA association that is assigned to an IPLIMx signaling link. The `uaps` parameter value impacts M3UA or SUA associations that are assigned to IPGWx signaling links and M2PA and M3UA associations that are assigned to IPSG cards. The `uaps` parameter value is shown in the `UAPS` field in the `rtrv-assoc` output for an M2PA associations that is assigned to an IPLIMx signaling link.

If you wish to change the attributes of M2PA associations assigned to cards that are running the IPSG application, perform [Changing the Attributes of an IPSG Association](#).

The `chg-assoc` command contains other parameters that are not used in this procedure. To change these parameters, perform these procedures.

- `lhost` and `alhost` - [Changing the Host Values of a M2PA Association](#)
- `link` - [Changing the Link Value of a M2PA Association to another Link Value on the Same IPLIMx Card](#)
- `bufsize` - [Changing the Buffer Size of a M2PA Association](#)

`:aname` – The name assigned to the association, shown in the `rtrv-assoc` output.

`:lport` – The **SCTP** port number for the local host.

`:rhost` – The host name for the remote host, `rhost` can be any string of characters starting with a letter and comprising these characters [‘a’..‘z’, ‘A’..‘Z’, ‘0’..‘9’, ‘-’, ‘.‘]. Hostnames are not case-sensitive and can contain up to 60 characters. The default value of this optional parameter is empty (null string).

`:rport` – The **SCTP** port number for the remote host.

`:open` – The connection state for this association. Valid values are `yes` or `no`. When the `open=yes` parameter is specified, the connection manager opens the association if the association is operational. When the `open=no` parameter is specified, the connection manager will not open the association.

`:alw` – The connection state for this association. Valid values are `yes` or `no`. When the `alw=yes` parameter is specified, the connection manager allows the association to carry **SS7** traffic. When the `alw=no` parameter is specified, the connection manager prohibits the association from carrying **SS7** traffic.

`:rmode` – The retransmission policy used when packet loss is detected. The values are `rfc` or `lin`.

- `rfc` – Standard **RFC 2960** algorithm in the retransmission delay doubles after each retransmission. The **RFC 2960** standard for congestion control is also used.
- `lin` – Oracle's linear retransmission policy where each retransmission timeout value is the same as the initial transmission timeout and only the slow start algorithm is used for congestion control.

`:rmin` – The minimum value of the calculated retransmission timeout in milliseconds, from 10 - 1000.

`:rmax` – The maximum value of the calculated retransmission timeout in milliseconds, from 10 - 1000.

`:rtimes` – The number of times a data retransmission will occur before closing the association from 3 - 12.

`:cwmin` – The minimum size in bytes of the association's congestion window and the initial size in bytes of the congestion window, from 1500 - 409600. The `cwmin` parameter value must be less than or equal to the size of the buffer used by the association, shown by the `bufsize` parameter value. If the buffer size for the association needs to be changed, perform [Changing the Buffer Size of a M2PA Association](#).

The `rmode`, `rmin`, `rmax`, `rtimes`, and `cwmin` parameters are used to configure the **SCTP** retransmission controls for an association, in addition to other commands. Perform [Configuring SCTP Retransmission Control for a M2PA Association](#) to configure the **SCTP** retransmission controls for an association.

`:istrms` – The number of inbound streams (1 or 2) advertised by the **SCTP** layer for the association.

`:ostrms` – The number of outbound streams (1 or 2) advertised by the **SCTP** layer for the association.

`:m2patset` – The **M2PA** timer set assigned to the association. The `m2patset` parameter can be specified only with the `adapter=m2pa` parameter, or if the association already has the `adapter=m2pa` parameter assigned and the `adapter` parameter value is not being changed. If the `adapter` parameter value is being changed to `m2pa`, and the `m2patset` parameter is not specified, the default value for the `m2patset` parameter (1 - **M2PA** timer set

1) is assigned to the association. If the `adapter` parameter value for the association is `m2pa`, is not being changed, and the `m2patset` parameter is not specified with the `chg-assoc` command, the `m2patset` parameter value is not changed.

`:ver` – The **M2PA** version assigned to the **M2PA** association, either the **RFC** version (`ver=rfc`), or the Draft 6 version (`ver=d6`). The `ver` parameter can be specified only if, when this procedure is completed, the `adapter` parameter value is `m2pa`. If the `adapter` parameter value is being changed to `m2pa`, and the `ver` parameter is not specified, the default **M2PA** version of **RFC** is assigned to the association. To change the `ver` parameter value, the `open` parameter value for the association must be `no`.

`:rtxthr` –The retransmission threshold for the association. The `RTXTHR` parameter value indicates the number of packet re-transmissions that can occur on the association (per monitoring time period of 2 seconds). Alarm "IP Connection Excess Retransmits" (UAM 536) will be raised if the number of packets re-transmitted is greater than the configured `RTXTHR` parameter value, during 5 such consecutive monitoring periods. Once alarm is raised, it may require up to 12 consecutive monitoring periods with the number of re-transmissions < `RTXTHR` to clear the alarm. The design allows the alarm to come on at low error rates, and not come for occasional errors.

The value of this parameter is 0 to 65,535. The value of this parameter is shown in the `RTXTHR` field of the `rtrv-assoc:aname=<association name>` output. The `rtxthr` parameter value can be changed if the `open` parameter value is either "yes" or "no". It is possible to configure the `RTXTHR` so that UAM 536 alarms if the error rate on association is above the recommended maximum packet loss of 0.025%. If the error rate is more than 0.025%, investigate to determine if this can be improved in the network.

`:rhosttype` – The type of remote host assigned to the association, `primary` or `alternate`. The primary remote host is shown in the `RHOST` field of the `rtrv-assoc:aname=<association name>` output. The alternate remote host is shown in the `ARHOST` field of the `rtrv-assoc:aname=<association name>` output.

An alternate remote host can be configured for multi-homed associations using the `rhost` and `rhosttype` parameters of the `chg-assoc` command. The `rhost` parameter value with the `rhosttype=primary` parameter represents an IP address that corresponds to one of the network interfaces at the remote end while the `rhost` parameter value with the `rhosttype=alternate` parameter represents an IP address that corresponds to the other network interface at the remote end.

`:rhostval` – The validation mode used for the association when an SCTP INIT/INIT-ACK message is received. The value of this parameter is shown in the `RHOSTVAL` field of the `rtrv-assoc:aname=<association name>` output. This parameter has two values.

- `relaxed` - accept the message if the IP address for the primary or alternate remote host matches the IP address, source IP address, or the host name in the message.
- `match` - accept the message if the message contains the primary remote host value and the alternate remote host value (if the alternate remote host is provisioned). If the alternate remote host is not provisioned, then accept the message if the message contains the primary remote host value. Reject the message if it contains any IP address other than that of the primary or alternate remote host.

Refer to the `chg-assoc` command description in *Commands User's Guide* for more information about this parameter.

If the value of the `open` parameter is `yes`, only the value of the `alw`, and `rtxthr` parameters can be changed. To change the values of other parameters, the value of the `open` parameter must be `no`.

To set the `open` parameter value to `yes`, the association specified by the `aname` parameter must contain values for the `lhost`, `lport`, `rhost`, and `rport` parameters. The `lhost` parameter value must have a signaling link assigned to it.

At least one optional parameter is required.

The command input is limited to 150 characters, including the hostnames.

The value of the `rmin` parameter must be less than or equal to the `rmax` parameter value.

The `ipliml2` parameter value of the signaling link assigned to the association must be `m2pa`. The `adapter` parameter value of the association must match the `ipliml2` parameter value.

The signaling link being assigned to the association must be out of service. This state is shown in the `rept-stat-slk` output with the entries `OOS-MT` in the `PST` field and `Unavail` in the `SST` field.

If the association is being opened in this procedure with the `chg-assoc` command and the `open=yes` parameter, the signaling link assigned to the association must be in the database and the `ipliml2` parameter value of the signaling link assigned to the association must be `m2pa`.

Canceling the `RTRV-ASSOC` Command

Because the `rtrv-assoc` command used in this procedure can output information for a long period of time, the `rtrv-assoc` command can be canceled and the output to the terminal stopped. There are three ways that the `rtrv-assoc` command can be canceled.

- Press the `F9` function key on the keyboard at the terminal where the `rtrv-assoc` command was entered.
- Enter the `canc-cmd` without the `trm` parameter at the terminal where the `rtrv-assoc` command was entered.
- Enter the `canc-cmd:trm=<xx>`, where `<xx>` is the terminal where the `rtrv-assoc` command was entered, from another terminal other than the terminal where the `rtrv-assoc` command was entered. To enter the `canc-cmd:trm=<xx>` command, the terminal must allow Security Administration commands to be entered from it and the user must be allowed to enter Security Administration commands. The terminal's permissions can be verified with the `rtrv-secu-trm` command. The user's permissions can be verified with the `rtrv-user` or `rtrv-secu-user` commands.

For more information about the `canc-cmd` command, go to *Commands User's Guide*.

1. Display the associations in the database using the `rtrv-assoc` command.

This is an example of possible output.

```
rlghncxa03w 06-10-28 09:12:36 GMT EAGLE5 36.0.0
```

ANAME	CARD		IPLNK		LPORT	RPORT	OPEN	ALW
	LOC	PORT	LINK	ADAPTER				
swbel32	1201	A	A	M3UA	1030	2345	YES	YES
a2	1305	A	A	SUA	1030	2345	YES	YES
a3	1307	A	A	SUA	1030	2346	YES	YES
assoc1	1201	A	A	M3UA	2000	1030	YES	YES
assoc2	1205	A	A	M2PA	2048	2048	YES	YES
assoc3	1205	A	B2	M2PA	3000	3000	YES	YES
assoc5	1205	A	A3	M2PA	1500	3000	YES	YES

2. Enter the `rtrv-card` command with the location of the card that is hosting the M2PA association that will be changed in this procedure. For this example, enter this command.

```
rtrv-card:loc=1205
```

This is an example of possible output.

```
rlghncxa03w 08-04-06 15:17:20 EST EAGLE5 38.0.0
CARD  TYPE      APPL      LSET NAME    LINK SLC LSET NAME    LINK SLC
1205  DCM          IPLIM      e5e6a        A    0    e5e6a        B2    1
                                e5e6a        A3    2
```

If the application assigned to the card is IPLIM or IPLIMI, shown in the `APPL` column, and the values of any of these parameters are being changed: `lport`, `rhost`, `rport`, `rmode`, `rmin`, `rmax`, `rtimes`, `cwmin`, `istrms`, `ostrms`, `ver`, or `m2patset`, continue the procedure by performing one of these steps.

- If the `open` parameter value for the association is `yes`, continue the procedure with 3.
- If the `open` parameter value for the association is `no`, continue the procedure with 4.

If the application assigned to the card is IPLIM or IPLIMI, shown in the `APPL` column, and only the values of the `alw`, `open`, `rtxthr` parameters are being changed, continue the procedure by performing one of these steps.

- If only the values of the `alw` parameter is being changed, or the `open` parameter value is being changed to `no`, continue the procedure with 9.
- If the value of the `rtxthr` parameter is being changed, continue the procedure with 4.
- If the value of the `open` parameter value is being changed to `yes`, a signaling link must be assigned to the card shown in this step. If a signaling links is assigned to the card, entries are shown in the `LSET NAME` and `LINK` columns of the `rtrv-card` output. If a signaling link is assigned to the card, perform one of these actions.
 - If only the `alw` parameter is being specified with the `open=yes` parameter, continue the procedure with 9.
 - If the value of the `rtxthr` parameter is being changed, continue the procedure with 4.
- If the value of the `open` parameter value is being changed to `yes` and a signaling link is not assigned to the card, perform [Adding an IPLIMx Signaling](#)

[Link](#) to assign an IPLIMx signaling link to the card. After the signaling link has been added, perform one of these actions.

- If only the `alw` parameter is being specified with the `open=yes` parameter, continue the procedure with [9](#).
- If the value of the `rtxtthr` parameter is being changed, continue the procedure with [4](#).

If the application assigned to the card is IPSPG, perform [Changing the Attributes of an IPSPG Association](#).

3. Change the value of the `open` parameter to `no` by specifying the `chg-assoc` command with the `open=no` parameter.

For this example, enter this command.

```
chg-assoc:aname=assoc2:open=no
```

When this command has successfully completed, this message should appear.

```
rlghncxa03w 06-10-28 09:12:36 GMT EAGLE5 36.0.0
CHG-ASSOC: MASP A - COMPLTD;
```

4. Display the association being changed by entering the `rtrv-assoc` command with the `aname` parameter specified in [3](#) or selected in [1](#).

For this example, enter this command.

```
rtrv-assoc:aname=assoc2
```

This is an example of the possible output.

```
rlghncxa03w 10-07-28 21:14:37 GMT EAGLE5 42.0.0
ANAME assoc2
      LOC      1205          IPLNK PORT  A          LINK  A
ADAPTER M2PA          VER          M2PA RFC
LHOST    IPNODE2-1205
ALHOST   ---
RHOST    remothost1
ARHOST   ---
LPORT    2048          RPORT      2048
ISTRMS   2          OSTRMS     2          BUFSIZE  400
RMODE    LIN          RMIN       120          RMAX     800
RTIMES   10          CWMIN      3000        UAPS     10
OPEN     NO          ALW        YES          RTXTHR   2000
RHOSTVAL RELAXED      M2PATSET   1
```

```
IP Appl Sock/Assoc table is (8 of 4000) 1% full
Assoc Buffer Space Used (1600 KB of 1600 KB) on LOC = 1205
```

Continue the procedure by performing one of these actions.

- If the `cwmin` and `m2patset` parameters will not be specified in this procedure, continue the procedure with [7](#).
- If the `cwmin` parameter will be specified in this procedure, continue the procedure with [5](#).

- If the `m2patset` parameter will be specified in this procedure, but the `cwmin` parameter will not be specified in this procedure, continue the procedure with 6.
5. To change the `cwmin` value, the new `cwmin` parameter value must be less than or equal to the `bufsize` parameter value.

The `cwmin` parameter is the number of bytes specified for the association's congestion window. The `bufsize` is the number of kilobytes specified for the size of the association's buffer. To determine whether or not the `cwmin` value is less than or equal to the `bufsize` value, perform one of these actions.

- Multiply the `bufsize` value by 1024.
- Divide the `cwmin` value by 1024.

Continue the procedure by performing one of these actions.

- If the new `cwmin` value is less than or equal to the `bufsize` value, and the `m2patset` parameter will be specified in this procedure, continue the procedure with 6.
 - If the new `cwmin` value is less than or equal to the `bufsize` value, and the `m2patset` parameter will not be specified in this procedure, continue the procedure with 7.
 - If the new `cwmin` value is not less than or equal to the `bufsize` value, either choose another value for the `cwmin` parameter that is less than or equal to the `bufsize` value, or perform to change the `bufsize` value so that the `bufsize` value is greater than or equal to the `cwmin` value. After the new `cwmin` value has been chosen or the `bufsize` value has been changed, continue the procedure by performing one of these actions.
 - If the `m2patset` parameter will be specified in this procedure, continue the procedure with 6.
 - If the `m2patset` parameter will not be specified in this procedure, continue the procedure with 7.
6. Verify the values of the **M2PA** timer set you wish to assign to the association by entering the `rtrv-m2pa-tset` command with the **M2PA** version (either `ver=rfc` to display the **RFCM2PA** timer values or `ver=d6` to display the Draft 6 **M2PA** timer values) of the timer set you wish to assign to the association.

If the `ver` parameter is not specified with the `rtrv-m2pa-tset` command, both the **RFC** and Draft 6 timer values are displayed.

To display the **M2PA** Draft 6 timer values, enter this command.

```
rtrv-m2pa-tset:ver=d6
```

This is an example of the possible output.

```
rlghncxa03w 06-10-28 21:16:37 GMT EAGLE5 36.0.0
```

```
M2PA Draft 6 Timers (in msec, T16 in microsec)
```

TSET	T1	T2	T3	T4N	T4E	T5	T6	T7	T16	T17	T18
1	6000	-----	5000	20000	500	5000	4000	1000	100000	150	500
2	7500	-----	1500	2000	500	9000	1250	300	150000	175	600


```

3  100000  ----- 2000  3000  500  4000  1500  500  170000 200  800
4  200000  ----- 20000 4000  500  6000  2000  700  480000 225  900
5  250000  ----- 30000 30000 500  100  2250  400  400000 400  8000
6  50000   ----- 50000 60000 500  500  4500  800  300000 300  7000
7  10000   ----- 10000 10000 500  1000  3000  1200  200000 250  1000
8  80000   ----- 1500  15000 500  8000  2750  1100  350000 350  5000
9  27500   ----- 3850  4859  450  5700  3750  1150  250  375  8750
10 90000   ----- 2500  50000 500  7500  5000  1750  440000 450  3000
11 20000   ----- 4500  5500  500  6500  5500  1600  250000 475  4500
12 30000   ----- 7500  7000  500  750  4250  1800  275000 275  3500
13 40000   ----- 35000 9000  500  1250  3500  1900  500  325  9000
14 70000   ----- 45000 11000 500  1500  1750  900  1000  125  6000
15 9000     ----- 25000 40000 500  2500  3250  600  5000  425  5500
16 75000   ----- 15000 25000 500  4500  1600  1400  6000  240  9500
17 350000  ----- 60000 70000 600  10000 6000  2000  500000 500  10000
18 150000  ----- 55000 35000 500  3500  5750  1500  125000 440  750
19 175000  ----- 12500 45000 500  1100  2600  1300  7000  340  850
20 1000    ----- 1000  1000  400  80  1000  200  100  100  100

```

To display the **M2PARFC** values, enter this command.

```
rtrv-m2pa-tset:ver=rfc
```

This is an example of the possible output.

```
rlghncxa03w 06-10-28 21:16:37 GMT EAGLE5 36.0.0
```

M2PA RFC Timers (in msec, T16 in microsec)

```

TSET T1      T2      T3      T4N  T4E  T5      T6      T7      T16     T17  T18
1     6000   75000  5000  20000 500  5000  4000 1000  100000 150  500
2     7500   8000   1500  2000  500  9000  1250 300  150000 175  600
3     100000 10000  2000  3000  500  4000  1500 500  170000 200  800
4     200000 6000   20000 4000  500  6000  2000 700  480000 225  900
5     250000 140000 30000 30000 500  100  2250  400  400000 400  8000
6     50000  100000 50000 60000 500  500  4500  800  300000 300  7000
7     300000 20000  2000  10000 500  1000  3000  1200  200000 250  1000
8     80000  130000 1500  15000 500  8000  2750 1100  350000 350  5000
9     27500  120000 3850  4859  450  5700  3750 1150  250  375  8750
10    90000  9000   2500  50000 500  7500  5000 1750  440000 450  3000
11    20000  60000  4500  5500  500  6500  5500 1600  250000 475  4500
12    30000  50000  7500  7000  500  750  4250 1800  275000 275  3500
13    40000  90000  35000 9000  500  1250  3500 1900  500  325  9000
14    70000  45000  45000 11000 500  1500  1750 900  1000  125  6000
15    9000   30000  25000 40000 500  2500  3250 600  5000  425  5500
16    75000  15000  15000 25000 500  4500  1600 1400  6000  240  9500
17    350000 150000 60000 70000 600  10000 6000 2000  500000 500  10000
18    150000 20000  55000 35000 500  3500  5750 1500  125000 440  750
19    175000 12500  12500 45000 500  1100  2600 1300  7000  340  850
20    1000   5000   1000  1000  400  80  1000  200  100  100  100

```

If the `ver` parameter is not specified when entering the `rtrv-m2pa-tset` command, both the Draft 6 and RFC values are displayed. This is an example of the possible output.

```
rlghncxa03w 06-10-28 21:16:37 GMT EAGLE5 36.0.0
```

```
M2PA Draft 6 Timers (in msec, T16 in microsec)
```

TSET	T1	T2	T3	T4N	T4E	T5	T6	T7	T16	T17	T18
1	6000	-----	5000	20000	500	5000	4000	1000	100000	150	500
2	7500	-----	1500	2000	500	9000	1250	300	150000	175	600
3	100000	-----	2000	3000	500	4000	1500	500	170000	200	800
4	200000	-----	20000	4000	500	6000	2000	700	480000	225	900
5	250000	-----	30000	30000	500	100	2250	400	400000	400	
8000											
6	50000	-----	50000	60000	500	500	4500	800	300000	300	
7000											
7	10000	-----	10000	10000	500	1000	3000	1200	200000	250	
1000											
8	80000	-----	1500	15000	500	8000	2750	1100	350000	350	
5000											
9	27500	-----	3850	4859	450	5700	3750	1150	250	375	
8750											
10	90000	-----	2500	50000	500	7500	5000	1750	440000	450	
3000											
11	20000	-----	4500	5500	500	6500	5500	1600	250000	475	
4500											
12	30000	-----	7500	7000	500	750	4250	1800	275000	275	
3500											
13	40000	-----	35000	9000	500	1250	3500	1900	500	325	
9000											
14	70000	-----	45000	11000	500	1500	1750	900	1000	125	
6000											
15	9000	-----	25000	40000	500	2500	3250	600	5000	425	
5500											
16	75000	-----	15000	25000	500	4500	1600	1400	6000	240	
9500											
17	350000	-----	60000	70000	600	10000	6000	2000	500000	500	
10000											
18	150000	-----	55000	35000	500	3500	5750	1500	125000	440	750
19	175000	-----	12500	45000	500	1100	2600	1300	7000	340	850
20	1000	-----	1000	1000	400	80	1000	200	100	100	100

```
M2PA RFC Timers (in msec, T16 in microsec)
```

TSET	T1	T2	T3	T4N	T4E	T5	T6	T7	T16	T17	T18
1	6000	75000	5000	20000	500	5000	4000	1000	100000	150	500
2	7500	8000	1500	2000	500	9000	1250	300	150000	175	600
3	100000	10000	2000	3000	500	4000	1500	500	170000	200	800
4	200000	6000	20000	4000	500	6000	2000	700	480000	225	900
5	250000	140000	30000	30000	500	100	2250	400	400000	400	
8000											
6	50000	100000	50000	60000	500	500	4500	800	300000	300	
7000											

7	300000	20000	2000	10000	500	1000	3000	1200	200000	250	1000
8	80000	130000	1500	15000	500	8000	2750	1100	350000	350	5000
9	27500	120000	3850	4859	450	5700	3750	1150	250	375	8750
10	90000	9000	2500	50000	500	7500	5000	1750	440000	450	3000
11	20000	60000	4500	5500	500	6500	5500	1600	250000	475	4500
12	30000	50000	7500	7000	500	750	4250	1800	275000	275	3500
13	40000	90000	35000	9000	500	1250	3500	1900	500	325	9000
14	70000	45000	45000	11000	500	1500	1750	900	1000	125	6000
15	9000	30000	25000	40000	500	2500	3250	600	5000	425	5500
16	75000	15000	15000	25000	500	4500	1600	1400	6000	240	9500
17	350000	150000	60000	70000	600	10000	6000	2000	500000	500	10000
18	150000	20000	55000	35000	500	3500	5750	1500	125000	440	750
19	175000	12500	12500	45000	500	1100	2600	1300	7000	340	850
20	1000	5000	1000	1000	400	80	1000	200	100	100	100

If the **M2PA** timer set you wish to assign to the association does not contain the desired values, perform [Changing a M2PA Timer Set](#) to change the desired timer values.

Caution:

Changing an **M2PA** timer set may affect the performance of any associations using the timer set being changed.

- The remote hosts assigned to the association can be changed by specifying the `rhost` and `rhosttype` parameters with the `chg-assoc` command.

If the primary and alternate remote hosts are not being changed in this procedure, or if only the primary remote host is being changed, continue the procedure with [9](#).

To change the alternate remote host value for the association, the association must have a primary remote host assigned to it. If the association has a primary remote host, continue the procedure with [9](#). If the association does not have a primary remote host, continue the procedure with [8](#).

- Assign a primary remote host to the association by entering the `chg-assoc` command with the name of the association and the primary remote host name.

For this example, enter this command.

```
chg-assoc:aname=assoc2:rhost="gw200.nc-Oracle.com"
```

The `rhosttype=primary` parameter can be specified with the `chg-assoc` command, but is not necessary.

When this command has successfully completed, this message should appear.

```
rlghncxa03w 09-05-28 09:12:36 GMT EAGLE5 41.0.0
CHG-ASSOC: MASP A - COMPLTD;
```

- Change the association using the `chg-assoc` command.

For this example, enter this command.

```
chg-assoc:aname=assoc2:rhost="gw200.nc-
Oracle.com":rport=3000 :rtxthr=10000:rhostval=match
```

If an alternate remote host is being specified for the association, for this example enter this command.

```
chg-assoc:aname=assoc2:rhost="gw210.nc-  
Oracle.com":rhosttype=alternate:rport=3000 :rtxthr=10000:rho  
stval=match
```

If only the `alw`, `open`, or `rtxthr` parameter values are being changed in this step, for this example, enter this command.

```
chg-assoc:aname=assoc2:alw=no:open=yes:rtxthr=10000
```

These are the rules that apply to changing the attributes of M2PA associations that are assigned to IPLIMx signaling links.

- If any optional parameters are not specified with the `chg-assoc` command, those values are not changed.
- The value of the `rhost` parameter is a text string of up to 60 characters, with the first character being a letter. The command input is limited to 150 characters, including the hostname.
- If the value of the `open` parameter is `yes`, only the values of the `alw` and `rtxthr` parameters can be changed. To change the values of the other parameters, the value of the `open` parameter must be `no`.
- The value of the `rmin` parameter must be less than or equal to the `rmax` parameter value.
- The M2PA version of the association determines the version of the M2PA timer set that is assigned to the association. For example, if M2PA timer set 3 is assigned to the M2PA association, and the association is an RFC M2PA association, the RFC version of M2PA timer set 3 is used with the association. If M2PA timer set 7 is assigned to the M2PA association, and the association is a Draft 6 M2PA association, the Draft 6 version of M2PA timer set 7 is used with the association.

When this command has successfully completed, this message should appear.

```
rlghncxa03w 06-10-28 09:12:36 GMT EAGLE5 36.0.0  
CHG-ASSOC: MASP A - COMPLTD;
```

If the value of the `open` parameter was not changed in [3](#), continue the procedure with [Oracle](#).

10. Change the value of the `open` parameter to `yes` by specifying the `chg-assoc` command with the `open=yes` parameter.

For this example, enter this command.

```
chg-assoc:aname=assoc2:open=yes
```

When this command has successfully completed, this message should appear.

```
rlghncxa03w 06-10-28 09:12:36 GMT EAGLE5 36.0.0  
CHG-ASSOC: MASP A - COMPLTD;
```

11. Verify the changes using the `rtrv-assoc` command specifying the association name specified in 9 and 10.

For this example, enter this command.

```
rtrv-assoc:aname=assoc2
```

This is an example of possible output.

```
rlghncxa03w 10-07-28 21:14:37 GMT EAGLE5 42.0.0
  ANAME assoc2
    LOC      1205          IPLNK PORT  A          LINK  A
  ADAPTER  M2PA          VER          M2PA RFC
  LHOST    IPNODE2-1205
  ALHOST    ---
  RHOST    gw200.nc-Oracle.com
  ARHOST    gw210.nc-Oracle.com
  LPORT    2048          RPORT      3000
  ISTRMS   2            OSTRMS     2          BUFSIZE  400
  RMODE    LIN          RMIN       120        RMAX     800
  RTIMES   10          CWMIN      3000      UAPS     10
  OPEN     YES          ALW        NO         RTXTHR  10000
  RHOSTVAL MATCH      M2PATSET   1
```

```
IP Appl Sock/Assoc table is (8 of 4000) 1% full
Assoc Buffer Space Used (1600 KB of 1600 KB) on LOC = 1205
```

12. Back up the new changes, using the `chg-db:action=backup:dest=fixed` command.

These messages should appear; the active **Maintenance and Administration Subsystem Processor (MASP)** appears first.

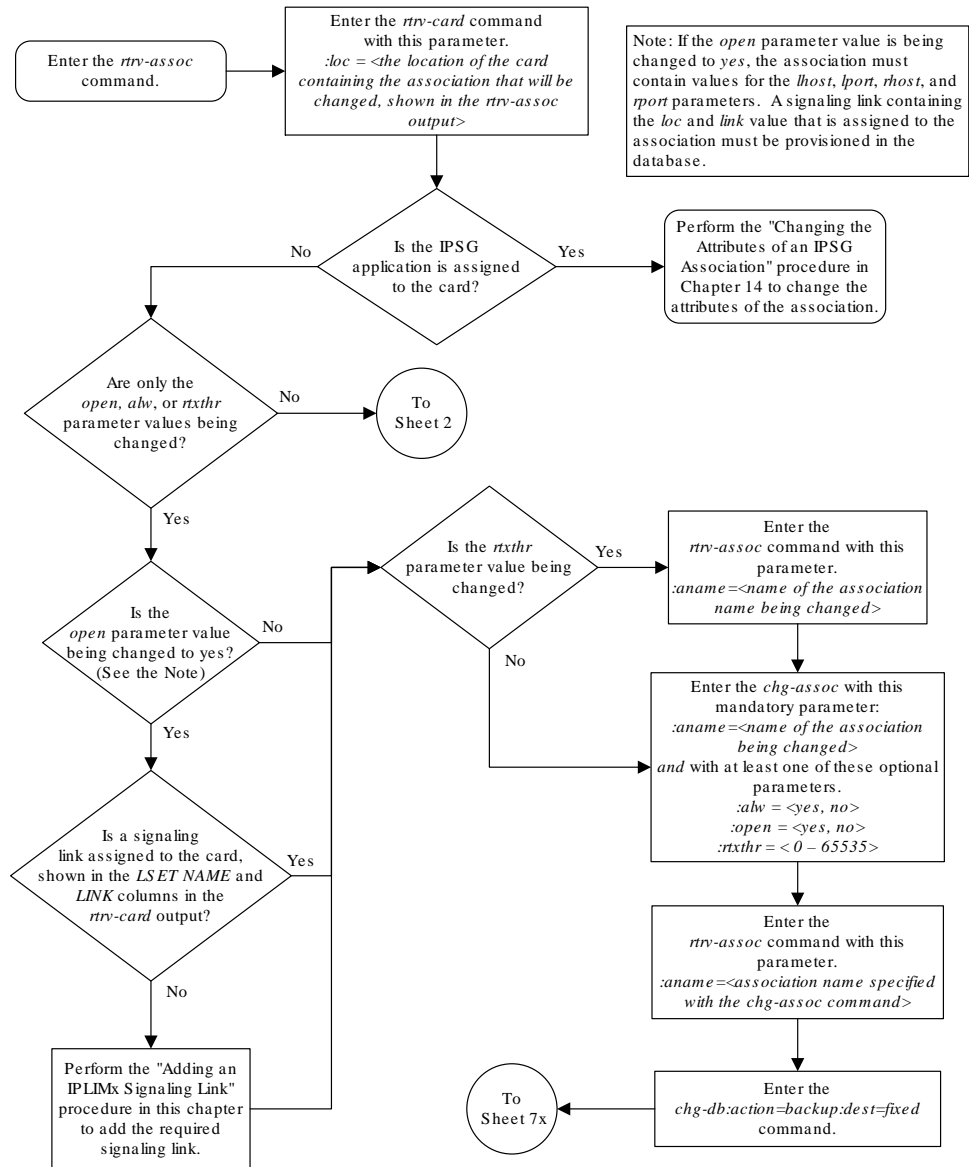
```
BACKUP (FIXED) : MASP A - Backup starts on active MASP.
BACKUP (FIXED) : MASP A - Backup on active MASP to fixed disk complete.
BACKUP (FIXED) : MASP A - Backup starts on standby MASP.
BACKUP (FIXED) : MASP A - Backup on standby MASP to fixed disk complete.
```

If you wish to change the `lhost`, `alhost`, `bufsize`, or `link` values of the M2PA association, perform one of these procedures.

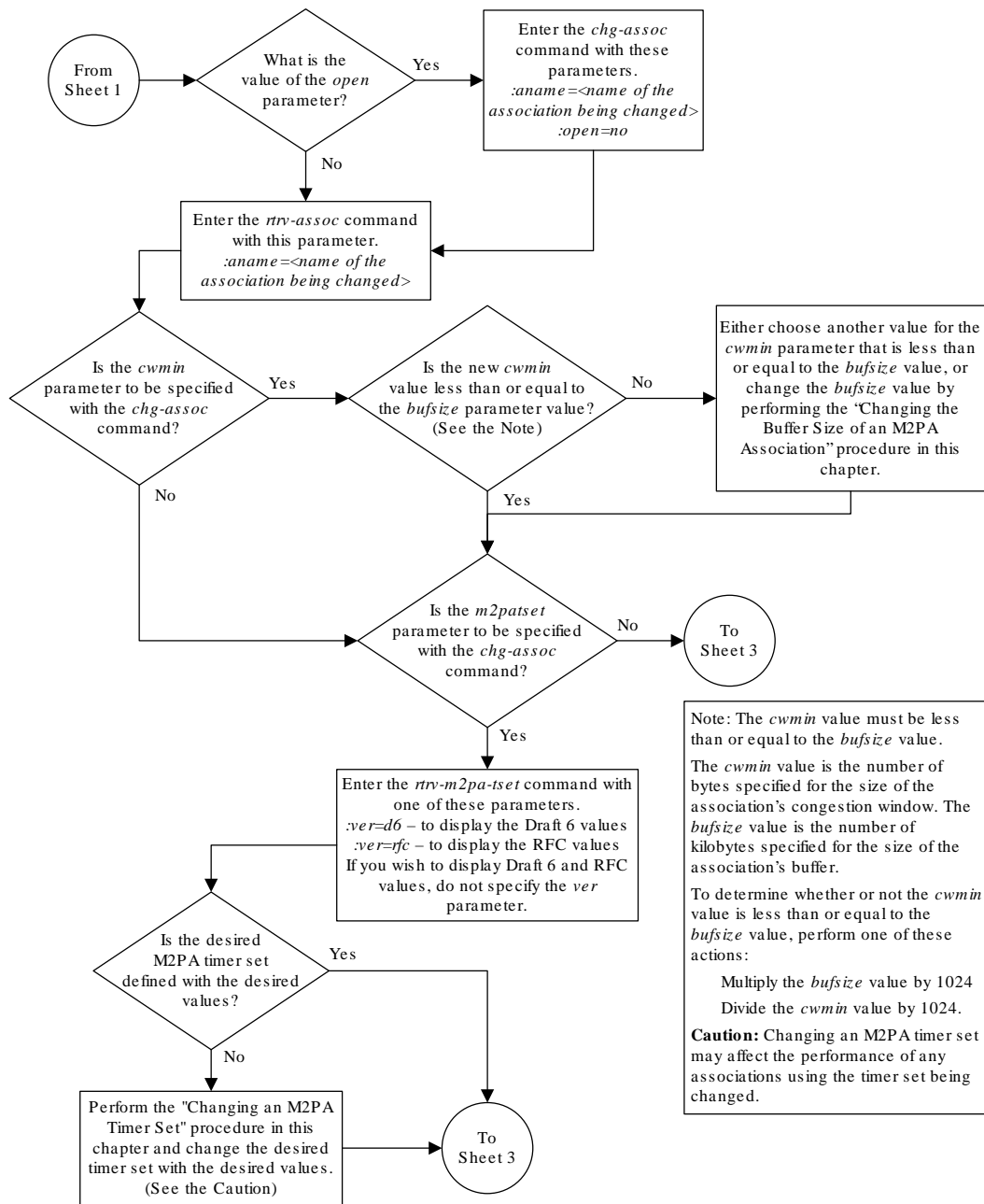
- `lhost` and `alhost` - [Changing the Host Values of a M2PA Association](#)
- `bufsize` - [Changing the Buffer Size of a M2PA Association](#)
- `link` - [Changing the Link Value of a M2PA Association to another Link Value on the Same IPLIMx Card](#)

If you do not wish to change the `lhost`, `alhost`, `bufsize`, or `link` values of the M2PA association, this procedure is finished.

Figure 3-17 Changing the Attributes of an M2PA Association



Sheet 1 of 4



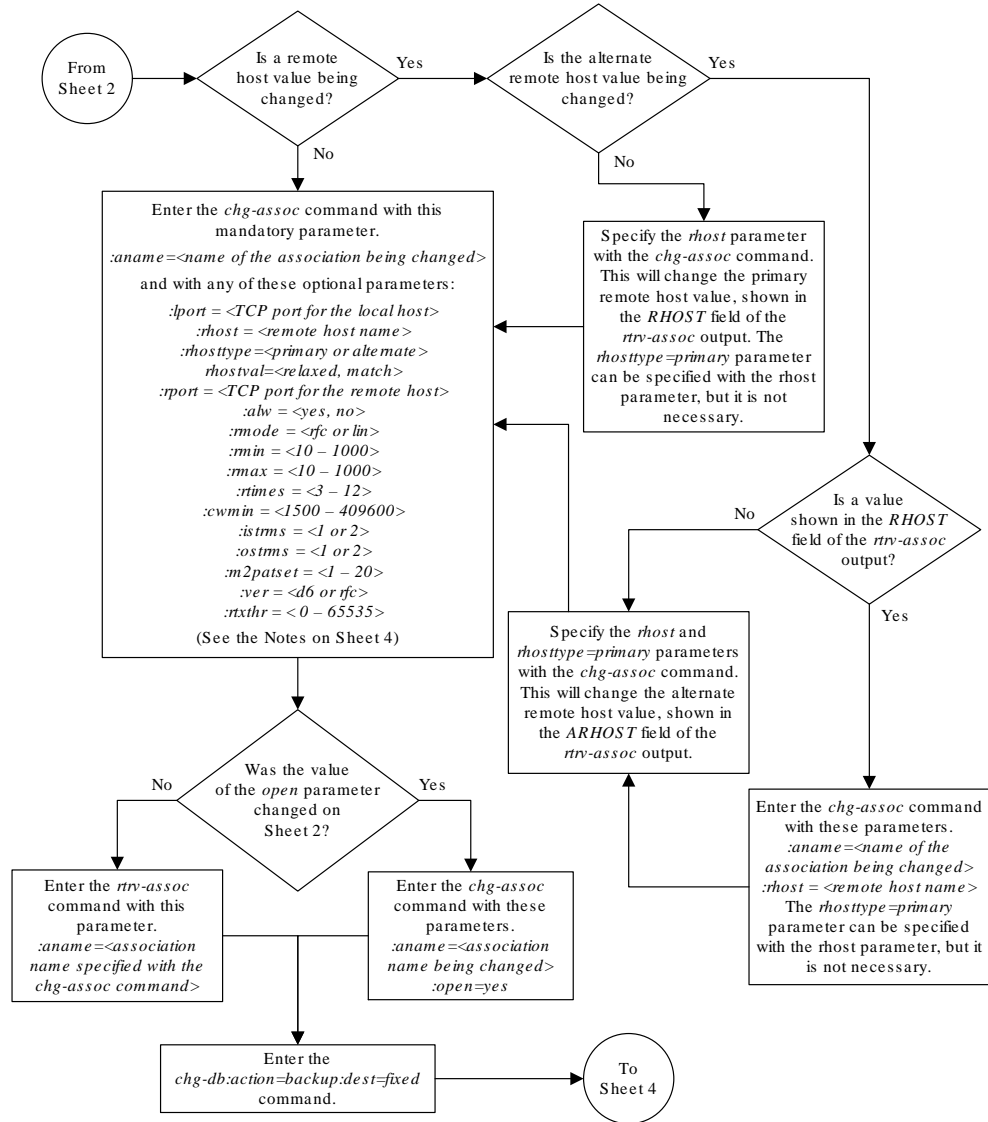
Note: The *cwmIn* value must be less than or equal to the *bufSize* value.

The *cwmIn* value is the number of bytes specified for the size of the association's congestion window. The *bufSize* value is the number of kilobytes specified for the size of the association's buffer.

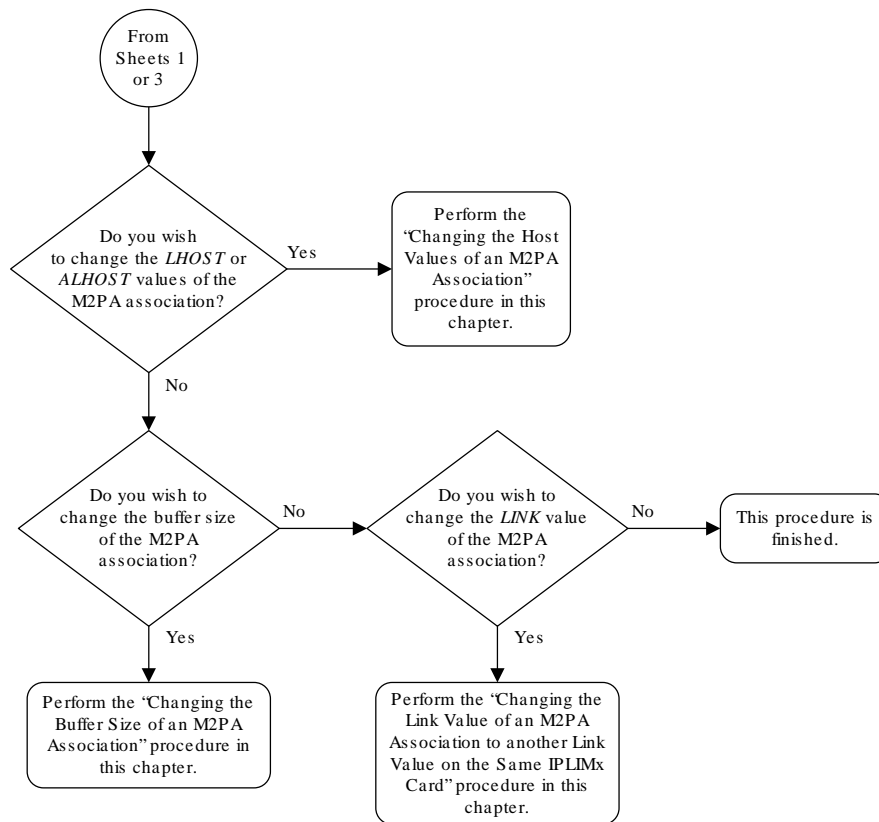
To determine whether or not the *cwmIn* value is less than or equal to the *bufSize* value, perform one of these actions:

- Multiply the *bufSize* value by 1024
- Divide the *cwmIn* value by 1024.

Caution: Changing an M2PA timer set may affect the performance of any associations using the timer set being changed.



Sheet 3 of 4



Notes:

1. If any optional parameters are not specified with the *chg-assoc* command, those values are not changed.
2. The value of the *hst* parameter is a text string of up to 60 characters, with the first character being a letter. The command input is limited to 150 characters, including the hostname.
3. If the value of the *open* parameter is *yes*, only the values of the *abw* and *rxthr* parameters can be changed. To change the values of the other parameters, the value of the *open* parameter must be *no*.
4. The value of the *min* parameter must be less than or equal to the *max* parameter value.
5. The M2PA version of the association determines the version of the M2PA timer set that is assigned to the association. For example, if M2PA timer set 3 is assigned to the M2PA association, and the association is an RFC M2PA association, the RFC version of M2PA timer set 3 is used with the association. If M2PA timer set 7 is assigned to the M2PA association, and the association is a Draft 6 M2PA association, the Draft 6 version of M2PA timer set 7 is used with the association.

Sheet 4 of 4

3.18 Changing the Buffer Size of a M2PA Association

This procedure is used to change the buffer size of a **M2PA** association, assigned to cards that are running the IPLIM or IPLIMI applications, using the *chg-assoc* command. If you wish to change the buffer size of M2PA associations assigned to cards that are running the IPSPG application, perform the [Changing the Buffer Size of an IPSPG Association](#) procedure.

These parameters of the `chg-assoc` command are used in this procedure:

`:aname` – The name assigned to the association, shown in the `rtrv-assoc` output.

`:open` – The connection state for this association. Valid values are `yes` or `no`. When the `open=yes` parameter is specified, the connection manager opens the association if the association is operational. When the `open=no` parameter is specified, the connection manager will not open the association.

`:bufsize` – The size, in kilobytes, of the buffer used by the association. The values for this parameter are 8 kilobytes to 400 kilobytes. The maximum size of the buffers on the E5-ENET cards are shown in the following list.

- E5-ENET Card - 3200 KB

The size of the buffers assigned to each association that is assigned to the **IP** card cannot exceed the maximum buffer size for that card. If the `bufsize` parameter value causes the total buffer size for all the associations on the **IP** card to exceed the maximum buffer size for that **IP** card, the `chg-assoc` command will be rejected. The available size of the buffers on the **IP** card can be verified by entering this command.

```
rtrv-assoc:lhost=<local host name assigned to the association  
being changed>
```

The `alhost` parameter can also be used with the `rtrv-assoc` command to display the available size of the buffers on the **IP** card.

The `aname` parameter can be used with the `rtrv-assoc` command to display the available size of the buffers on the **IP** card and the size of the buffer assigned to the association.

If you wish to increase the buffer size for this association to a value that is greater than available buffer size for the card, the buffer size of the other associations assigned to the card must be decreased.

The `chg-assoc` command contains other parameters that are not used this procedure. To change these parameters, perform these procedures.

- `lhost` and `alhost` - [Changing the Host Values of a M2PA Association](#)
- `link` - [Changing the Link Value of a M2PA Association to another Link Value on the Same IPLIMx Card](#)
- Other attributes of the M2PA Association - [Changing the Attributes of an M2PA Association](#)

Canceling the RTRV-ASSOC Command

Because the `rtrv-assoc` command used in this procedure can output information for a long period of time, the `rtrv-assoc` command can be canceled and the output to the terminal stopped. There are three ways that the `rtrv-assoc` command can be canceled.

- Press the `F9` function key on the keyboard at the terminal where the `rtrv-assoc` command was entered.
- Enter the `canc-cmd` without the `trm` parameter at the terminal where the `rtrv-assoc` command was entered.
- Enter the `canc-cmd:trm=<xx>`, where `<xx>` is the terminal where the `rtrv-assoc` command was entered, from another terminal other than the terminal where

the `rtrv-assoc` command was entered. To enter the `canc-cmd:trm=<xx>` command, the terminal must allow Security Administration commands to be entered from it and the user must be allowed to enter Security Administration commands. The terminal's permissions can be verified with the `rtrv-secu-trm` command. The user's permissions can be verified with the `rtrv-user` or `rtrv-secu-user` commands.

For more information about the `canc-cmd` command, go to *Commands User's Guide*.

1. Display the associations in the database using the `rtrv-assoc` command.

This is an example of possible output.

```
rlghncxa03w 06-10-28 09:12:36 GMT EAGLE5 36.0.0

          CARD IPLNK
ANAME     LOC  PORT  LINK ADAPTER LPORT RPORT OPEN ALW
swbel32   1201 A    A    M3UA  1030  2345 YES  YES
a2        1305 A    A    SUA   1030  2345 YES  YES
a3        1307 A    A    SUA   1030  2346 YES  YES
assoc1    1201 A    A    M3UA  2000  1030 YES  YES
assoc2    1205 A    A    M2PA  2048  2048 YES  YES
assoc3    1205 A    B2   M2PA  3000  3000 YES  YES
assoc5    1205 A    A3   M2PA  1500  3000 YES  YES
```

2. Enter the `rtrv-card` command with the location of the card that is hosting the M2PA association that will be changed in this procedure. For this example, enter this command.

```
rtrv-card:loc=1205
```

This is an example of possible output.

```
rlghncxa03w 08-04-06 15:17:20 EST EAGLE5 38.0.0
CARD  TYPE      APPL      LSET NAME    LINK SLC LSET NAME    LINK SLC
1205  DCM        IPLIM     e5e6a       A    0    e5e6a       B2    1
                   e5e6a       A3    2
```

If the application assigned to the card is IPLIM or IPLIMI, shown in the APPL column, continue the procedure by performing one of these steps.

- If the `open` parameter value for the association being changed is `yes`, continue the procedure with [3](#).
- If the `open` parameter value for the association being changed is `no`, continue the procedure with [4](#).

If the application assigned to the card is IPSPG, perform the [Changing the Buffer Size of an IPSPG Association](#) procedure.

3. Change the value of the `open` parameter to `no` by specifying the `chg-assoc` command with the `open=no` parameter.

For this example, enter this command.

```
chg-assoc:aname=assoc2:open=no
```

When this command has successfully completed, this message should appear.

```
rlghncxa03w 06-10-28 09:12:36 GMT EAGLE5 36.0.0
CHG-ASSOC: MASP A - COMPLTD;
```

4. Display the association being changed by entering the `rtrv-assoc` command with the `aname` parameter specified in 3 or the name of the association assigned to the card displayed in 1.

For this example, enter this command.

```
rtrv-assoc:aname=assoc2
```

This is an example of the possible output.

```
rlghncxa03w 10-07-28 21:14:37 GMT EAGLE5 42.0.0
ANAME assoc2
      LOC      1205          IPLNK PORT  A          LINK  A
ADAPTER M2PA          VER          M2PA RFC
LHOST  IPNODE2-1205
ALHOST ---
RHOST  remotehost1
ARHOST ---
LPORT  2048          RPORT      2048
ISTRMS 2          OSTRMS     2          BUFSIZE 400
RMODE  LIN          RMIN       120          RMAX    800
RTIMES 10         CWMIN     3000         UAPS    10
OPEN    NO          ALW        YES          RTXTHR 2000
RHOSTVAL RELAXED    M2PATSET  1
```

```
IP Appl Sock/Assoc table is (8 of 4000) 1% full
Assoc Buffer Space Used (1600 KB of 1600 KB) on LOC = 1205
```

5. If the `bufsize` parameter value causes the total buffer size for all the associations on the **IP** card to exceed the maximum buffer size for that **IP** card, the `chg-assoc` command will be rejected.

If you wish to increase the buffer size for this association to a value that is greater than available buffer size for the card, the buffer size of the other associations assigned to the card must be decreased. Perform this step and 6, 7, and 8.

If the buffers on the other associations assigned to the card do not need to be changed, continue the procedure with 9.

Display the associations assigned to the **IP** card (and its corresponding local host) by entering the `rtrv-assoc` command with the local host name assigned to the association being changed. For this example, enter this command.

```
rtrv-assoc:lhost=IPNODE2-1205
```

This is an example of the possible output.

```
rlghncxa03w 06-10-28 21:14:37 GMT EAGLE5 36.0.0
      CARD IPLNK
ANAME      LOC  PORT  LINK ADAPTER LPORT RPORT OPEN ALW
```

```

assoc2      1205 A    A    M2PA    2048 2048 YES YES
assoc3      1205 A    B2   M2PA    3000 3000 YES YES
assoc5      1205 A    A3   M2PA    1500 3000 YES YES
    
```

IP Appl Sock/Assoc table is (8 of 4000) 1% full
 Assoc Buffer Space Used (1600 KB of 1600 KB) on LOC = 1205

- Display each association shown in 5 by entering the `rtrv-assoc` command with the name of each association shown in 5.

For this example, enter these commands.

```
rtrv-assoc:aname=assoc2
```

This is an example of the possible output.

```

rlghncxa03w 10-07-28 21:14:37 GMT EAGLE5 42.0.0
ANAME assoc2
  LOC      1205          IPLNK PORT  A          LINK  A
  ADAPTER  M2PA          VER          M2PA RFC
  LHOST    IPNODE2-1205
  ALHOST    ---
  RHOST    remotehost1
  ARHOST    ---
  LPORT    2048          RPORT      2048
  ISTRMS   2            OSTRMS     2          BUFSIZE  400
  RMODE    LIN          RMIN       120        RMAX     800
  RTIMES   10          CWMIN      3000       UAPS     10
  OPEN     NO           ALW        YES        RTXTHR  2000
  RHOSTVAL RELAXED     M2PATSET   1
    
```

IP Appl Sock/Assoc table is (8 of 4000) 1% full
 Assoc Buffer Space Used (1600 KB of 1600 KB) on LOC = 1205

```
rtrv-assoc:aname=assoc3
```

This is an example of the possible output.

```

rlghncxa03w 10-07-28 21:14:37 GMT EAGLE5 42.0.0
ANAME assoc2
  LOC      1205          IPLNK PORT  A          LINK  B2
  ADAPTER  M2PA          VER          M2PA RFC
  LHOST    IPNODE2-1205
  ALHOST    ---
  RHOST    remotehost3
  ARHOST    ---
  LPORT    3000          RPORT      3000
  ISTRMS   2            OSTRMS     2          BUFSIZE  400
  RMODE    LIN          RMIN       120        RMAX     800
  RTIMES   10          CWMIN      3000       UAPS     10
  OPEN     YES          ALW        YES        RTXTHR  2000
  RHOSTVAL RELAXED     M2PATSET   1
    
```

```
IP Appl Sock/Assoc table is (8 of 4000) 1% full
Assoc Buffer Space Used (1600 KB of 1600 KB) on LOC = 1205
```

```
rtrv-assoc:aname=assoc5
```

This is an example of the possible output.

```
rlghncxa03w 10-07-28 21:14:37 GMT EAGLE5 42.0.0
ANAME assoc2
  LOC      1205          IPLNK PORT  A          LINK  A3
  ADAPTER  M2PA          VER          M2PA RFC
  LHOST    IPNODE2-1205
  ALHOST    ---
  RHOST    remotehost3
  ARHOST    ---
  LPORT    1500          RPORT      3000
  ISTRMS   2            OSTRMS     2          BUFSIZE  400
  RMODE    LIN          RMIN       120        RMAX     800
  RTIMES   10          CWMIN      3000      UAPS     10
  OPEN     YES          ALW        YES        RTXTHR  2000
  RHOSTVAL RELAXED     M2PATSET   1
```

```
IP Appl Sock/Assoc table is (8 of 4000) 1% full
Assoc Buffer Space Used (1600 KB of 1600 KB) on LOC = 1205
```

- To change the `bufsize` value for the associations shown in 6, the new `bufsize` parameter value must be greater than or equal to the `cwmin` parameter value.

The `cwmin` parameter is the number of bytes specified for the association's congestion window. The `bufsize` is the number of kilobytes specified for the size of the association's buffer. To determine whether or not the `cwmin` value is less than or equal to the `bufsize` value, perform one of these actions.

- Multiply the `bufsize` value by 1024.
- Divide the `cwmin` value by 1024.

Continue the procedure by performing one of these actions.

- If the new `bufsize` value is greater than or equal to the `cwmin` value, continue the procedure with 8.
 - If the new `bufsize` value is not greater than or equal to the `cwmin` value, either choose another value for the `bufsize` parameter that is greater than or equal to the `cwmin` value, or perform the [Changing the Attributes of an M2PA Association](#) procedure to change the `bufsize` value so that the `bufsize` value is greater than or equal to the `cwmin` value. After the new `bufsize` value has been chosen or the `cwmin` value has been changed, continue the procedure with 8.
- Change the size of the buffers for one or more of the associations displayed in 6 to allow the buffer of the association displayed in 4 to be changed.

Enter the `chg-assoc` command with the `bufsize` parameter. For this example, enter this command.

```
chg-assoc:aname=assoc3:bufsize=400
```

When this command has successfully completed, this message should appear.

```
rlghncxa03w 06-10-28 09:12:36 GMT EAGLE5 36.0.0  
CHG-ASSOC: MASP A - COMPLTD;
```

9. To change the `bufsize` value for the association shown in 4, the new `bufsize` parameter value must be greater than or equal to the `cwmin` parameter value.

The `cwmin` parameter is the number of bytes specified for the association's congestion window. The `bufsize` is the number of kilobytes specified for the size of the association's buffer. To determine whether or not the `cwmin` value is less than or equal to the `bufsize` value, perform one of these actions.

- Multiply the `bufsize` value by 1024.
- Divide the `cwmin` value by 1024.

Continue the procedure by performing one of these actions.

- If the new `bufsize` value is greater than or equal to the `cwmin` value, continue the procedure with 10.
- If the new `bufsize` value is not greater than or equal to the `cwmin` value, either choose another value for the `bufsize` parameter that is greater than or equal to the `cwmin` value, or perform the [Changing the Attributes of an M2PA Association](#) procedure to change the `bufsize` value so that the `bufsize` value is greater than or equal to the `cwmin` value. After the new `bufsize` value has been chosen or the `cwmin` value has been changed, continue the procedure with 10.

10. Change the association using the `chg-assoc` command.

For this example, enter this command.

```
chg-assoc:aname=assoc2:bufsize=500
```

When this command has successfully completed, this message should appear.

```
rlghncxa03w 06-10-28 09:12:36 GMT EAGLE5 36.0.0  
CHG-ASSOC: MASP A - COMPLTD;
```

If the value of the `open` parameter was not changed in 3, continue the procedure with 12.

If the value of the `open` parameter was changed in 3, continue the procedure with 11.

11. Change the value of the `open` parameter to `yes` by specifying the `chg-assoc` command with the `open=yes` parameter.

For this example, enter this command.

```
chg-assoc:aname=assoc2:open=yes
```

When this command has successfully completed, this message should appear.

```
rlghncxa03w 06-10-28 09:12:36 GMT EAGLE5 36.0.0  
CHG-ASSOC: MASP A - COMPLTD;
```

12. Verify the changes using the `rtrv-assoc` command specifying the association name specified in 10 and 11.

For this example, enter this command.

```
rtrv-assoc:aname=assoc2
```

This is an example of possible output.

```
rlghncxa03w 10-07-28 21:14:37 GMT EAGLE5 42.0.0
ANAME assoc2
      LOC      1205          IPLNK PORT  A          LINK  A
ADAPTER M2PA          VER          M2PA RFC
LHOST  IPNODE2-1205
ALHOST ---
RHOST  remotehost1
ARHOST ---
LPORT  2048          RPORT      2048
ISTRMS 2          OSTRMS     2          BUFSIZE 500
RMODE  LIN          RMIN       120         RMAX     800
RTIMES 10         CWMIN      3000        UAPS     10
OPEN   YES          ALW        YES         RTXTHR  2000
RHOSTVAL RELAXED    M2PATSET   1
```

```
IP Appl Sock/Assoc table is (8 of 4000) 1% full
Assoc Buffer Space Used (1600 KB of 1600 KB) on LOC = 1205
```

13. Back up the new changes, using the `chg-db:action=backup:dest=fixed` command.

These messages should appear; the active **Maintenance and Administration Subsystem Processor (MASP)** appears first.

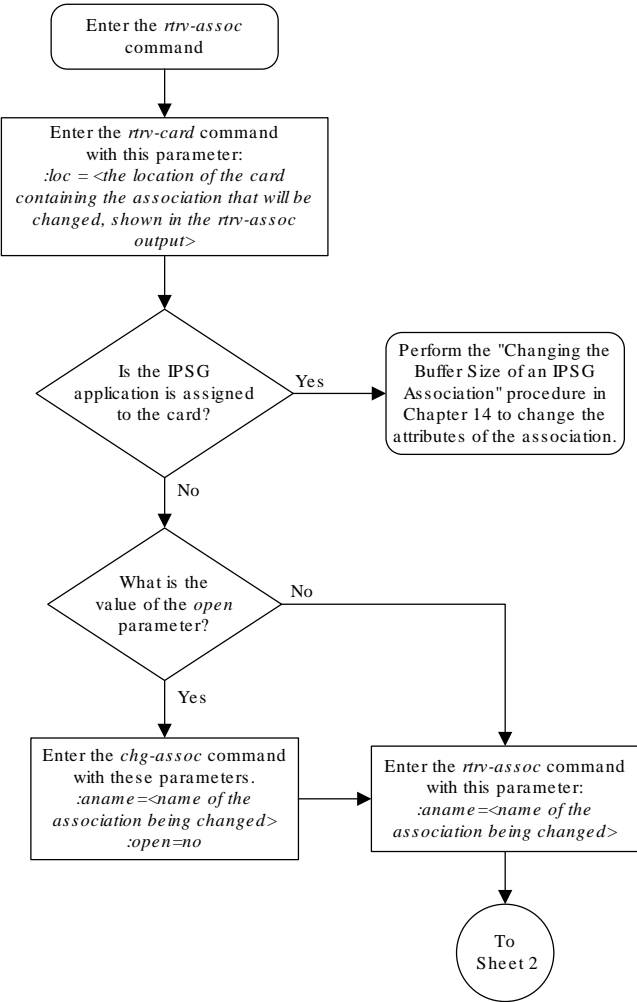
```
BACKUP (FIXED) : MASP A - Backup starts on active MASP.
BACKUP (FIXED) : MASP A - Backup on active MASP to fixed disk
complete.
BACKUP (FIXED) : MASP A - Backup starts on standby MASP.
BACKUP (FIXED) : MASP A - Backup on standby MASP to fixed disk
complete.
```

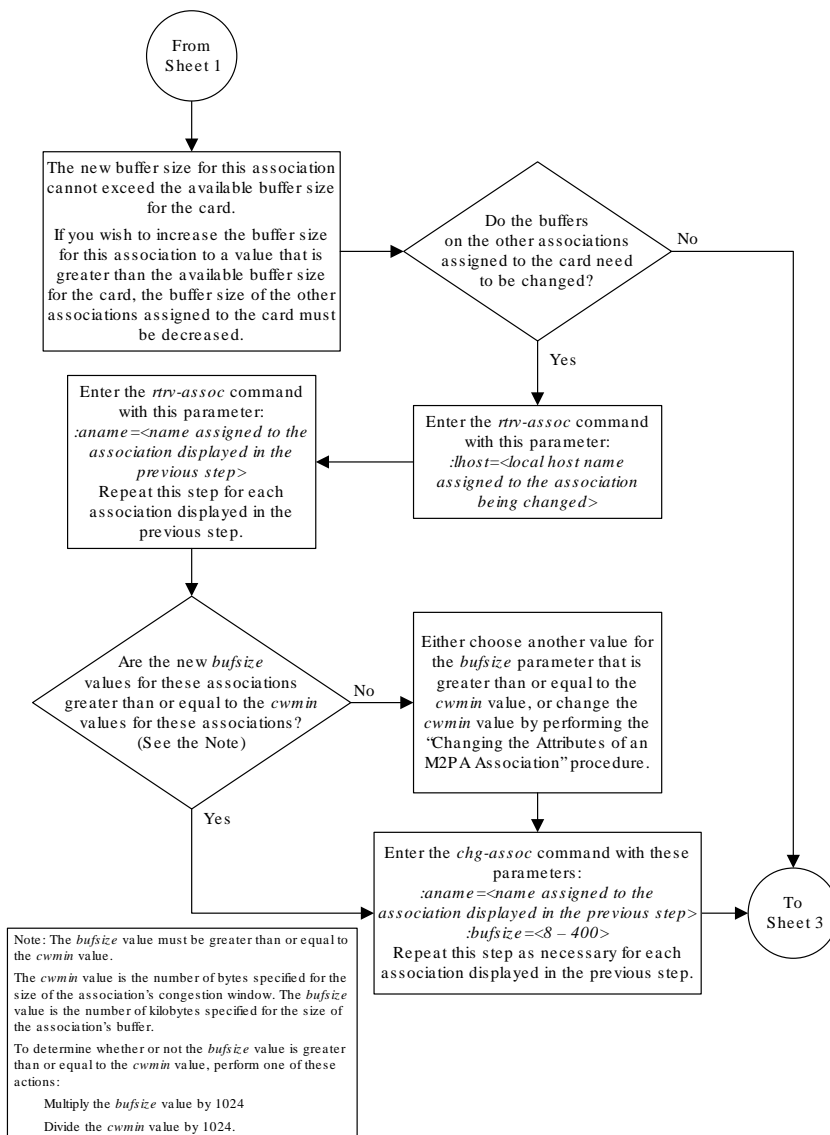
If you wish to change the other attributes of the M2PA association, perform one of these procedures.

- `lhost` and `alhost` - [Changing the Host Values of a M2PA Association](#)
- `link` - [Changing the Link Value of a M2PA Association to another Link Value on the Same IPLIMx Card](#)
- Other attributes of the M2PA Association - [Changing the Attributes of an M2PA Association](#)

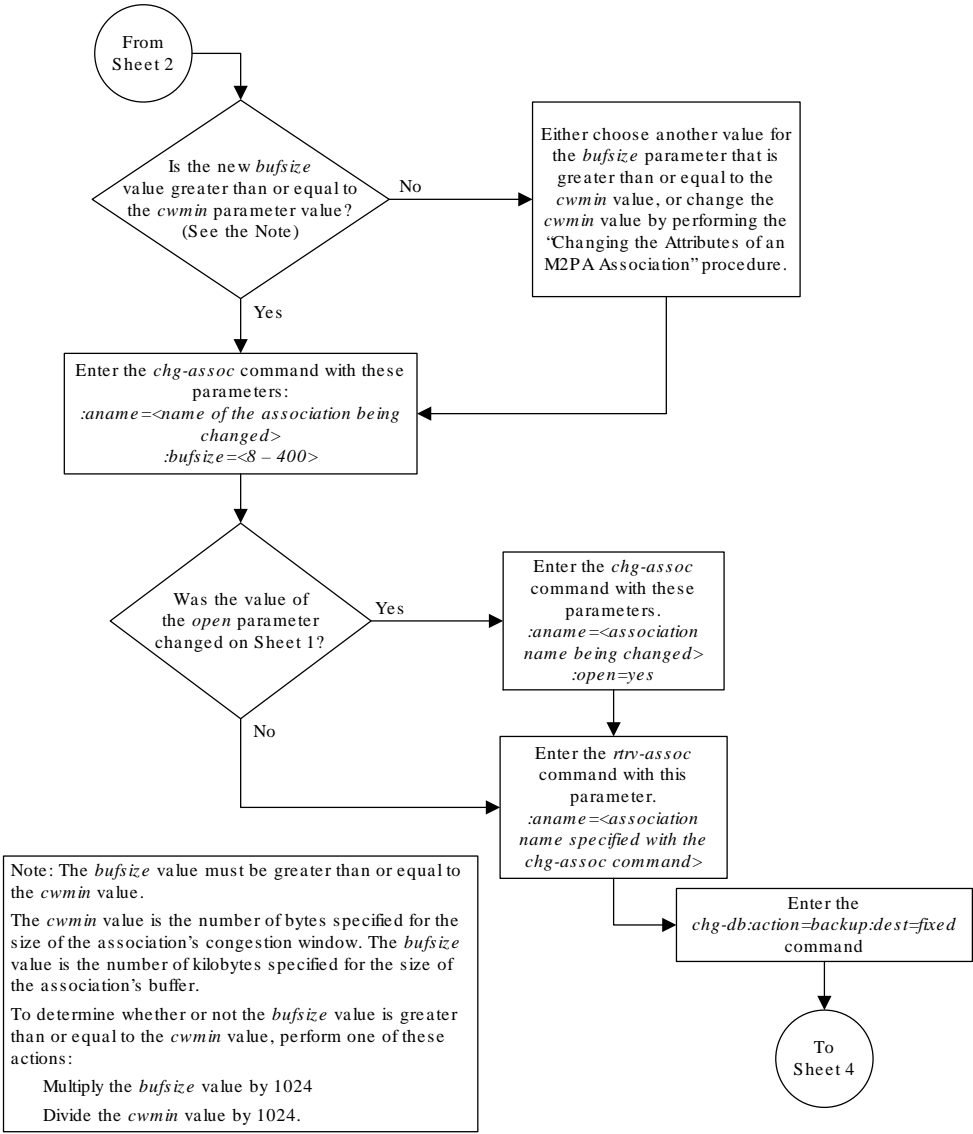
If you do not wish to change the other attributes of the M2PA association, this procedure is finished.

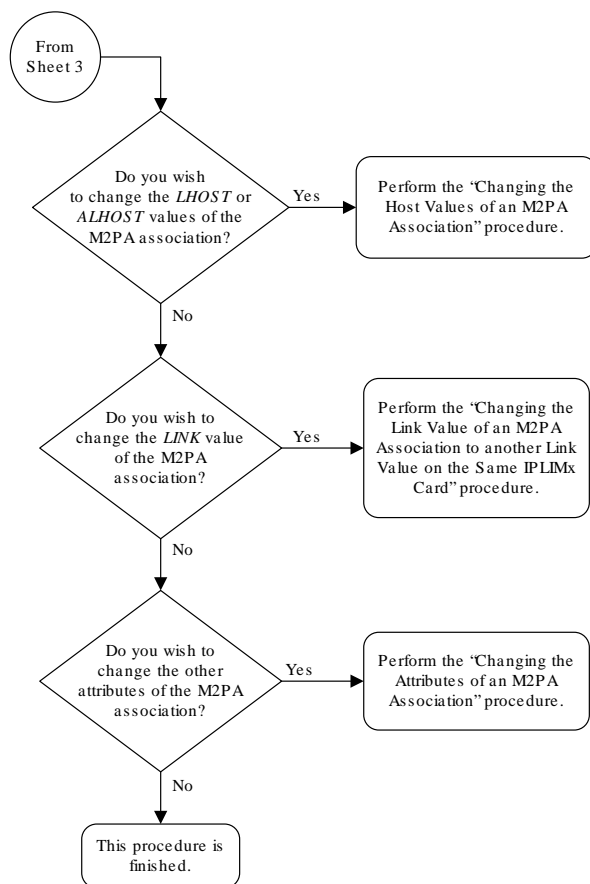
Figure 3-18 Changing the Buffer Size of a M2PA Association





Sheet 2 of 4





Sheet 4 of 4

3.19 Changing the Host Values of a M2PA Association

This procedure is used to change the host values of a **M2PA** association, assigned to cards that are running the IPLIM or IPLIMI applications, using the `chg-assoc` command. If you wish to change the attributes of M2PA associations assigned to cards that are running the IPSP application, perform the [Changing the Host Values of an IPSP Association](#) procedure.

These parameters of the `chg-assoc` command are used in this procedure:

`:aname` – The name assigned to the association, shown in the `rtrv-assoc` output.

`:lhost` – The host name for the local host, shown in the `rtrv-ip-host` output.

`:lport` – The **SCTP** port number for the local host.

`:rhost` – The host name for the remote host, `rhost` can be any string of characters starting with a letter and comprising these characters [‘a’..‘z’, ‘A’..‘Z’, ‘0’..‘9’, ‘-’, ‘.‘]. Hostnames are not case-sensitive and can contain up to 60 characters. The default value of this optional parameter is empty (null string).

`:rport` – The **SCTP** port number for the remote host.

`:alhost` – The alternate local host name, shown in the `rtrv-ip-host` output.

`:link` – The signaling link on the **IPLIMx** card. If the card is a **E5-ENET** card, the values for the `link` parameter can be `a`, `a1`, `a2`, `a3`, `a4`, `a5`, `a6`, `a7`, `b`, `b1`, `b2`, `b3`, `b4`, `b5`, `b6`, or `b7`.



Note:

The `port` parameter can be used in place of the `link` parameter to specify the signaling link on the card.

`:adapter` – The adapter layer for this association, `m2pa`.

`:open` – The connection state for this association. Valid values are `yes` or `no`. When the `open=yes` parameter is specified, the connection manager opens the association if the association is operational. When the `open=no` parameter is specified, the connection manager will not open the association.

`:m2patset` – The **M2PA** timer set assigned to the association. The `m2patset` parameter can be specified only with the `adapter=m2pa` parameter, or if the association already has the `adapter=m2pa` parameter assigned and the `adapter` parameter value is not being changed. If the `adapter` parameter value is being changed to `m2pa`, and the `m2patset` parameter is not specified, the default value for the `m2patset` parameter (1 - **M2PA** timer set 1) is assigned to the association. If the `adapter` parameter value for the association is `m2pa`, is not being changed, and the `m2patset` parameter is not specified with the `chg-assoc` command, the `m2patset` parameter value is not changed.

`:ver` – The **M2PA** version assigned to the **M2PA** association, either the **RFC** version (`ver=rfc`), or the Draft 6 version (`ver=d6`). The `ver` parameter can be specified only if, when this procedure is completed, the `adapter` parameter value is `m2pa`. If the `adapter` parameter value is being changed to `m2pa`, and the `ver` parameter is not specified, the default **M2PA** version of **RFC** is assigned to the association. To change the `ver` parameter value, the `open` parameter value for the association must be `no`.

The `chg-assoc` command contains other parameters that are not used this procedure. To change these parameters, perform these procedures.

- `bufsize` - [Changing the Buffer Size of a M2PA Association](#)
- Other attributes of the M2PA Association - [Changing the Attributes of an M2PA Association](#)

At least one optional parameter is required.

The command input is limited to 150 characters, including the hostnames.

The **EAGLE** can contain a maximum of 4000 connections (association to application server assignments).

IPLIMx cards can have one association for each signaling link on the card. The **E5-ENET** card can contain a maximum of 16 signaling links, resulting in a maximum of 16 associations for this card.

The B Ethernet interface of the **IP** card can be used on **E5-ENET** cards.

The `iplim12` parameter value of the signaling link assigned to the association must be `m2pa`. The `adapter` parameter value of the association must match the `iplim12` parameter value.

The signaling link being assigned to the association must be out of service. This state is shown in the `rept-stat-slk` output with the entries `OOS-MT` in the `PST` field and `Unavail` in the `SST` field.

Uni-homed endpoints are associations configured with the `lhost` parameter only. The `lhost` parameter value represents an **IP** address that corresponds to either the A or B network interface of the **IP** card. Multi-homed endpoints are associations configured with both the `lhost` and `alhost` parameters. The `lhost` parameter value represents an **IP** address corresponding to one of the network interfaces (A or B) of the **IP** card while the `alhost` parameter value represents an **IP** address corresponding to the other network interface of the same **IP** card.

The `alhost=none` parameter removes the alternate local host from the specified association, which also removes the multi-homed endpoint capability.

Canceling the **RTRV-ASSOC** and **RTRV-AS** Commands

Because the `rtrv-assoc` and `rtrv-as` commands used in this procedure can output information for a long period of time, the `rtrv-assoc` and `rtrv-as` commands can be canceled and the output to the terminal stopped. There are three ways that the `rtrv-assoc` and `rtrv-as` commands can be canceled.

- Press the **F9** function key on the keyboard at the terminal where the `rtrv-assoc` or `rtrv-as` commands were entered.
- Enter the `canc-cmd` without the `trm` parameter at the terminal where the `rtrv-assoc` or `rtrv-as` commands were entered.
- Enter the `canc-cmd:trm=<xx>`, where `<xx>` is the terminal where the `rtrv-assoc` or `rtrv-as` commands were entered, from another terminal other than the terminal where the `rtrv-assoc` or `rtrv-as` commands were entered. To enter the `canc-cmd:trm=<xx>` command, the terminal must allow Security Administration commands to be entered from it and the user must be allowed to enter Security Administration commands. The terminal's permissions can be verified with the `rtrv-secu-trm` command. The user's permissions can be verified with the `rtrv-user` or `rtrv-secu-user` commands.

For more information about the `canc-cmd` command, go to *Commands User's Guide*.

1. Display the associations in the database using the `rtrv-assoc` command.

This is an example of possible output.

```
rlghncxa03w 08-04-28 09:12:36 GMT EAGLE5 38.0.0
```

ANAME	CARD		IPLNK		LINK ADAPTER	LPORT	RPORT	OPEN	ALW
	LOC	PORT	LINK	ADAPTER					
swbel32	1201	A	A	M3UA	1030	2345	YES	YES	
a2	1305	A	A	SUA	1030	2345	YES	YES	
a3	1307	A	A	SUA	1030	2346	YES	YES	
assoc1	1201	A	A	M3UA	2000	1030	YES	YES	
assoc2	2105	A	A	M2PA	2048	2048	YES	YES	
assoc3	2105	A	B2	M2PA	3000	3000	YES	YES	
assoc5	2105	A	A3	M2PA	1500	3000	YES	YES	

2. Enter the `rtrv-card` command with the location of the card that is hosting the M2PA association that will be changed in this procedure. For this example, enter this command.

```
rtrv-card:loc=2105
```

This is an example of possible output.

```
rlghncxa03w 08-04-06 15:17:20 EST EAGLE5 38.0.0
```

CARD	TYPE	APPL	LSET	NAME	LINK	SLC	LSET	NAME	LINK	SLC
2105	DCM	IPLIM	e5e6a		A	0	e5e6a		B2	1
			e5e6a		A3	2				

If the application assigned to the card is IPLIM or IPLIMI, shown in the APPL column, continue the procedure by performing one of these steps.

- If the `open` parameter value for the association being changed is `yes`, continue the procedure with [3](#).
- If the `open` parameter value for the association being changed is `no`, continue the procedure with [4](#).

If the application assigned to the card is IPSG, perform the [Changing the Host Values of an IPSG Association](#) procedure.

3. Change the value of the `open` parameter to `no` by specifying the `chg-assoc` command with the `open=no` parameter.

For this example, enter this command.

```
chg-assoc:aname=assoc2:open=no
```

When this command has successfully completed, this message should appear.

```
rlghncxa03w 08-04-28 09:12:36 GMT EAGLE5 38.0.0
```

```
CHG-ASSOC: MASP A - COMPLTD;
```

4. Display the association being changed by entering the `rtrv-assoc` command with the `aname` parameter specified in [3](#).

For this example, enter this command.

```
rtrv-assoc:aname=assoc2
```

This is an example of the possible output.

```
rlghncxa03w 10-07-28 21:14:37 GMT EAGLE5 42.0.0
  ANAME assoc2
    LOC      2105          IPLNK PORT  A,B          LINK  A
    ADAPTER  M2PA          VER          M2PA RFC
    LHOST    IPNODE2-1205
    ALHOST   M2PA1
    RHOST    remotehost1
    ARHOST   ---
    LPORT    2048          RPORT      2048
    ISTRMS   2            OSTRMS     2            BUFSIZE  400
    RMODE    LIN          RMIN       120          RMAX     800
    RTIMES   10          CWMIN      3000        UAPS     10
    OPEN     NO           ALW        YES          RTXTHR   2000
    RHOSTVAL RELAXED     M2PATSET   1
```

```
IP Appl Sock/Assoc table is (8 of 4000) 1% full
Assoc Buffer Space Used (1600 KB of 1600 KB) on LOC = 2105
```

If the association shown in this step is not an M2PA association, continue the procedure with [5](#).

If the association shown in this step is an M2PA association, perform one of these actions.

- If the association does not have an ALHOST value, continue the procedure with [5](#).
 - If the association does have an ALHOST value, and the ALHOST value will be removed along with changing the LHOST value of the association, continue the procedure with [5](#).
 - If the association does have an ALHOST value, and the only action that will be performed in this procedure is to remove the ALHOST value from the association, continue the procedure with [Oracle](#).
5. Verify that the local host name to be assigned to the association is in the database by entering the `rtrv-ip-host:display=all` command.

The following is an example of the possible output.

```
rlghncxa03w 08-12-28 21:15:37 GMT EAGLE5 40.0.0

LOCAL IPADDR   LOCAL HOST
192.1.1.10     IPNODE1-1201
192.1.1.12     GW105. NC. Oracle. COM
192.1.1.14     IPNODE1-1205
192.1.1.20     IPNODE2-1201
192.1.1.22     IPNODE2-1203
192.1.1.24     IPNODE2-1205
192.1.1.30     KC-HLR1
192.1.1.32     KC-HLR2
192.1.1.50     DN-MS1
192.1.1.52     DN-MS2
```



```

192.1.1.54      M2PA1

REMOTE IPADDR  REMOTE HOST
150.1.1.5      NCDEPTECONOMIC_DEVELOPMENT. SOUTHEASTERN_COORIDOR_ASHVL.
GOV

IP Host table is (12 of 4096) .29% full

```

6. Display the IP links in the database by entering the `rtrv-ip-lnk` command.

The following is an example of the possible output.

```

rlghncxa03w 08-12-28 21:14:37 GMT EAGLE5 40.0.0
LOC  PORT  IPADDR          SUBMASK          DUPLEX  SPEED  MACTYPE  AUTO
MCAST
1303  A    192.1.1.10      255.255.255.128  HALF    10     802.3    NO   NO
1303  B    -----         -----         HALF    10     DIX      NO   NO
1305  A    192.1.1.12      255.255.255.0   ----    ---    DIX      YES  NO
1305  B    -----         -----         HALF    10     DIX      NO   NO
1313  A    192.1.1.14      255.255.255.0   FULL    100    DIX      NO   NO
1313  B    -----         -----         HALF    10     DIX      NO   NO
2101  A    192.1.1.20      255.255.255.0   FULL    100    DIX      NO   NO
2101  B    -----         -----         HALF    10     DIX      NO   NO
2103  A    192.1.1.22      255.255.255.0   FULL    100    DIX      NO   NO
2103  B    -----         -----         HALF    10     DIX      NO   NO
2105  A    192.1.1.24      255.255.255.0   FULL    100    DIX      NO   NO
2105  B    192.1.1.54      255.255.255.0   FULL    100    DIX      NO   NO
2205  A    192.1.1.30      255.255.255.0   FULL    100    DIX      NO   NO
2205  B    -----         -----         HALF    10     DIX      NO   NO
2207  A    192.1.1.32      255.255.255.0   FULL    100    DIX      NO   NO
2207  B    -----         -----         HALF    10     DIX      NO   NO
2213  A    192.1.1.50      255.255.255.0   FULL    100    DIX      NO   NO
2213  B    -----         -----         HALF    10     DIX      NO   NO
2301  A    192.1.1.52      255.255.255.0   FULL    100    DIX      NO   NO
2301  B    -----         -----         HALF    10     DIX      NO   NO

IP-LNK  table is (20 of 2048) 1% full.

```

If the required IP link, one that contains the desired IP address, is not shown in the `rtrv-ip-lnk` output, add the IP link using the [Configuring an IP Link](#) procedure. After the IP link has been added, assign the IP address of the IP link to the IP host name using the [Adding an IP Host](#) procedure. Then continue the procedure with [11](#).

If the required IP link is shown in the `rtrv-ip-lnk` output, but the IP host is not shown in the `rtrv-ip-host` output in [5](#), assign the IP address of the IP link to the IP host name using the [Adding an IP Host](#) procedure. Then continue the procedure with [11](#).

If the required IP host was shown in [5](#), the required IP link is shown in the `rtrv-ip-lnk` output in this step. Perform [7](#) to verify the application running on the card whose IP address is assigned to the IP host.

 **Note:**

The `rtrv-ip-host` output must contain a host name for the association's `slhost` parameter and a host name for the association's `salhost` parameter, if the `alhost` parameter will be specified for the association. The IP address of the IP link should be assigned to the host name, shown in the `rtrv-ip-host` output, that will be used as the association's `slhost` parameter value. If the `alhost` parameter will be specified for the association, the IP address of the IP link must be assigned to the host name that will be used as the `alhost` parameter value. The IP links associated with the association's `slhost` and `alhost` values must be assigned to the same card.

7. Display the application running on the **IP** card shown in 6 whose **IP** address is assigned to the **IP** host using the `rept-stat-card` command specifying the location of the IP card.

For this example, enter this command.

```
rept-stat-card:loc=1205
```

This is an example of the possible output.

```
rlghncxa03w 08-04-27 17:00:36 GMT EAGLE5 38.0.0
CARD VERSION      TYPE   GPL      PST      SST      AST
1205 114-000-000  DCM   IPLIM   IS-NR   Active   -----
  ALARM STATUS      = No Alarms.
  BPDCM GPL         = 002-102-000
  IMT BUS A         = Conn
  IMT BUS B         = Conn
  SIGNALING LINK STATUS
    SLK  PST          LS          CLLI
    A    IS-NR       e5e6a      -----
    A3   IS-NR       e5e6a      -----
    B2   IS-NR       e5e6a      -----
```

Command Completed.

8. Display the signaling link associated with the association being changed using the `rtrv-slk` command and specifying the card location shown in 7, and the new `link` parameter value of the association for the `link` parameter value. The card location should reference the local host assigned to the association. The `rtrv-ip-lnk` output shows the card location associated with the **IP** address that is associated with the local host in 7. If the `rtrv-ip-lnk` command was not executed in 6, execute it now to get the card location and the **IP** address. To display the signaling link for this example, enter this command.

 **Note:**

If the `link` parameter value is not being changed, continue the procedure with 9.

```
rtrv-slk:loc=1205:link=a
```

The following is an example of the possible output.

```
rlghncxa03w 08-04-19 21:17:04 GMT EAGLE5 38.0.0
LOC  LINK LSN          SLC TYPE  IPLIML2
1205 A    e5e6a          0  IPLIM   M2PA
```

If the required signaling link is not in the database, add the signaling link using the [Adding an IPLIMx Signaling Link](#) procedure without activating the signaling link. If the application of the card containing the signaling link is **IPLIM** or **IPLIMI**, the `ipliml2=m2pa` parameter must be specified for the signaling link and the `adapter=m2pa` parameter value must be specified for the association.

9. Display the application servers referencing the association being changed using the `rtrv-as` command with the name of the association being changed in this procedure.

 **Note:**

If the `adapter` parameter value is not being changed from M3UA or SUA to M2PA, continue the procedure with [10](#).

For this example, enter this command.

```
rtrv-as:aname=assoc2
```

This is an example of possible output.

```
rlghncxa03w 08-04-28 21:14:37 GMT EAGLE5 38.0.0
AS Name      Mode      Tr ms   Association Names
as1          LOADSHARE 2000    assoc2

as4          LOADSHARE 2000    assoc2

as6          LOADSHARE 2000    assoc2

AS Table is (6 of 250) 1% full
```

If the association is not assigned to any application servers, continue the procedure with [10](#)

If the association is assigned to any application servers, go to the [Removing an Association from an Application Server](#) procedure and remove the association from the application servers. After the association has been removed from the application servers, continue the procedure with [10](#)

10. Display the application running on the **IP** card shown in [6](#) using the `rept-stat-card` command specifying the location of the IP card.

 **Note:**

If the `rept-stat-card` command was performed in [7](#), continue the procedure with [11](#).

For this example, enter this command.

```
rept-stat-card:loc=2105
```

This is an example of the possible output.

```
rlghncxa03w 08-04-27 17:00:36 GMT EAGLE5 38.0.0
CARD VERSION      TYPE      GPL      PST      SST      AST
2105 114-000-000  DCM      IPLIM    IS-NR    Active   -----
ALARM STATUS      = No Alarms.
BPDCM GPL         = 002-102-000
IMT BUS A         = Conn
IMT BUS B         = Conn
SIGNALING LINK STATUS
SLK  PST          LS          CLLI
A    IS-NR        e5e6a      -----
A3   IS-NR        e5e6a      -----
B2   IS-NR        e5e6a      -----
```

Command Completed.

11. Display the signaling link that will be assigned to the association by entering the `rtrv-slk` command and specifying the card location and signaling link.

 **Note:**

If a new signaling link was added in [8](#), continue the procedure with [Oracle](#).

For this example, enter this command.

```
rtrv-slk:loc=1203:link=a
```

This is an example of the possible output.

```
rlghncxa03w 08-04-19 21:17:04 GMT EAGLE5 38.0.0
LOC  LINK LSN          SLC TYPE  IPLIML2
1203 A    e5e6a          1  IPLIM    M2PA
```

When the IP card's application is either **IPLIM** or **IPLIMI**, the `ipliml2` parameter value for the signaling link assigned to the association must be `m2pa`. If the `ipliml2` parameter is not `m2pa`, remove the signaling link using the [Removing an IPLIMx Signaling Link](#) procedure. Add the signaling link back into the database with the `ipliml2=m2pa` parameter, and without activating the signaling link, using the [Adding an IPLIMx Signaling Link](#) procedure.

- Display the status of the signaling link shown in 11 using the `rept-stat-slk` command specifying the card location and signaling link.

 **Note:**

If the [Adding an IPLIMx Signaling Link](#) procedure was not performed in 11, continue the procedure with [Oracle](#).

For example, enter this command.

```
rept-stat-slk:loc=1203:link=a
```

This is an example of the possible output.

```
rlghncxa03w 08-04-28 21:16:37 GMT EAGLE5 38.0.0
SLK      LSN      CLLI      PST      SST      AST
1203,A   e5e6a      -----  IS-NR    Avail    ----
Command Completed.
```

 **Note:**

If the primary state (**PST**) of the signaling link is `OOS-MT` and the secondary state (**SST**) is `Unavail`, continue the procedure with [Oracle](#).

- Deactivate the signaling link from 12 using the `dact-slk` command.

For example, enter this command.

```
dact-slk:loc=1203:link=a
```

When this command has successfully completed, the following message should appear.

```
rlghncxa03w 08-04-07 11:11:28 GMT EAGLE5 38.0.0
Deactivate Link message sent to card
```

- Verify the status of the signaling link using the `rept-stat-slk` command.

For example, enter this command.

```
rept-stat-slk:loc=1203:link=a
```

This is an example of the possible output.

```
rlghncxa03w 08-04-28 21:16:37 GMT EAGLE5 38.0.0
SLK      LSN      CLLI      PST      SST      AST
1203,A   e5e6a      -----  OOS-MT   Unavail  ----
Command Completed.
```

- Change the association using the `chg-assoc` command.

For this example, enter this command.

```
chg-
assoc:aname=assoc2:lhost=m2pa2:alhost=m2pa3:rhost="gw200.nc-
Oracle.com"
```

These are the rules that apply to changing the host value of M2PA associations that are assigned to IPLIMx signaling links.

- If any optional parameters are not specified with the `chg-assoc` command, those values are not changed.
- The B Ethernet interface can be used with E5-ENET cards.
- The EAGLE can contain a maximum of 4000 connections.
- IPLIMx cards can have only one connection for each signaling link assigned to the card. If the card is an E5-ENET card, the card may contain a maximum of 16 connections.
- The value of the `lhost` and `rhost` parameters is a text string of up to 60 characters, with the first character being a letter. The command input is limited to 150 characters, including the hostnames.
- The `adapter` parameter value for the association must be `m2pa` and the `ipliml2=m2pa` parameter must be assigned to the signaling link on the `iplim` or `iplimi` card.
- Specifying the `lhost` parameter only creates a uni-homed endpoint. The network portion of the endpoint's IP address must be the same as the network portion of the IP address assigned to either the A or B network interface of the IP card.
- Specifying the `lhost` and `alhost` parameters creates a multi-homed endpoint. The network portion of the IP address associated with the `lhost` parameter must be the same as the network portion of the IP address assigned to one of the network interfaces (A or B) of the IP card, and the network portion of the IP address associated with the `alhost` parameter must be the same as the network portion of the IP address assigned to the other network interface on the IP card.
- The `alhost=none` parameter removes the alternate local host from the specified association, which also removes the multi-homed endpoint capability.
- If the `mp2atset` parameter is not specified with the `chg-assoc` command, and the `adapter` parameter value is being changed to `m2pa`, the `m2patset` parameter value defaults to M2PA timer set 1 (`m2patset=1`).
- The `port` parameter can be used in place of the `link` parameter to specify the signaling link assigned to the association.
- The M2PA version of the association determines the version of the M2PA timer set that is assigned to the association. For example, if M2PA timer set 3 is assigned to the M2PA association, and the association is an RFC M2PA association, the RFC version of M2PA timer set 3 is used with the association. If M2PA timer set 7 is assigned to the M2PA association, and the association is a Draft 6 M2PA association, the Draft 6 version of M2PA timer set 7 is used with the association.
- If the `adapter` parameter value of the association is changed to `m2pa` in this procedure and the `ver` parameter is not specified, the version of the association will be RFC. To make this association a M2PA Draft 6 association, the `ver=d6` parameter must be specified for this association.

When this command has successfully completed, this message should appear.

```
rlghncxa03w 08-04-28 09:12:36 GMT EAGLE5 38.0.0
CHG-ASSOC: MASP A - COMPLTD;
```

 **Note:**

If the value of the `open` parameter was not changed in [3](#), continue the procedure with [Oracle](#).

- 16.** Change the value of the `open` parameter to `yes` by specifying the `chg-assoc` command with the `open=yes` parameter.

For this example, enter this command.

```
chg-assoc:aname=assoc2:open=yes
```

When this command has successfully completed, this message should appear.

```
rlghncxa03w 08-04-28 09:12:36 GMT EAGLE5 38.0.0
CHG-ASSOC: MASP A - COMPLTD;
```

- 17.** Verify the changes using the `rtrv-assoc` command specifying the association name specified in [Oracle](#) and [16](#).

For this example, enter this command.

```
rtrv-assoc:aname=assoc2
```

This is an example of possible output.

```
rlghncxa03w 10-07-28 21:14:37 GMT EAGLE5 42.0.0
ANAME assoc2
  LOC      1203          IPLNK PORT  A,B          LINK  A
  ADAPTER  M2PA         VER        M2PA RFC
  LHOST    M2PA2
  ALHOST   M2PA3
  RHOST    gw200.nc-tekelec.com
  ARHOST   ---
  LPORT    2048          RPORT      3000
  ISTRMS   2            OSTRMS     2            BUFSIZE  500
  RMODE    LIN          RMIN       120          RMAX     800
  RTIMES   10           CWMIN      3000        UAPS     10
  OPEN     YES          ALW        YES          RTXTHR   10000
  RHOSTVAL RELAXED     M2PATSET   1
```

```
IP Appl Sock/Assoc table is (8 of 4000) 1% full
Assoc Buffer Space Used (1300 KB of 1600 KB) on LOC = 1203
```

- 18.** Activate the signaling link assigned to the association using the `act-slk` command.

For example, enter this command.

```
act-slk:loc=1203:link=a
```

When this command has successfully completed, the following message should appear.

```
rlghncxa03w 08-04-07 11:11:28 GMT EAGLE5 38.0.0  
Activate Link message sent to card
```

19. Verify the status of the signaling link using the `rept-stat-slk` command.

For example, enter this command.

```
rept-stat-slk:loc=1203:link=a
```

This is an example of the possible output.

```
rlghncxa03w 08-04-28 21:16:37 GMT EAGLE5 38.0.0  
SLK      LSN      CLLI      PST      SST      AST  
1203,A   e5e6a     -----  IS-NR     Avail    ----  
Command Completed.
```

20. Back up the new changes, using the `chg-db:action=backup:dest=fixed` command.

These messages should appear; the active **Maintenance and Administration Subsystem Processor (MASP)** appears first.

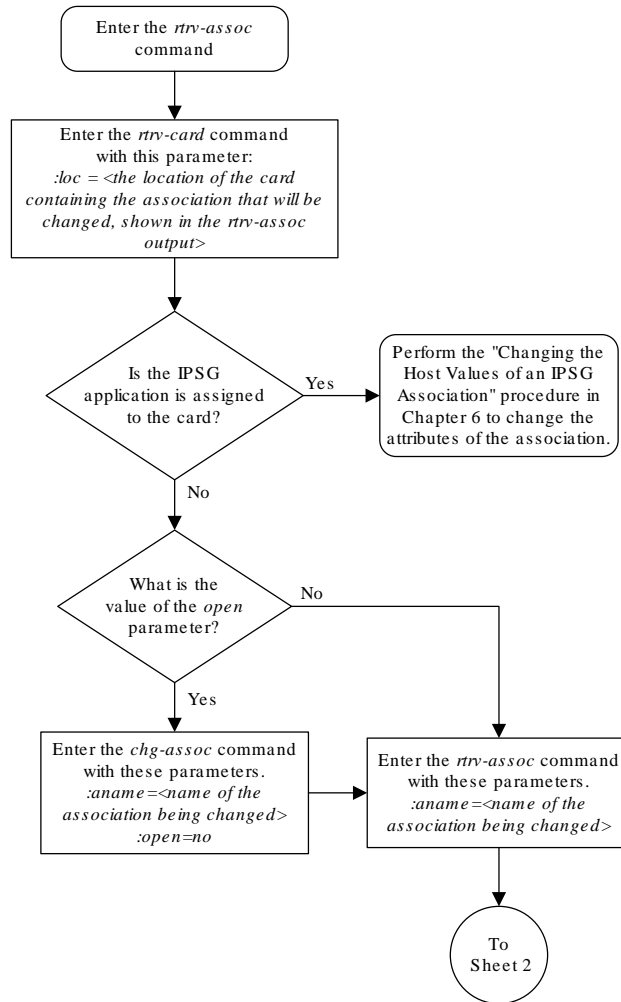
```
BACKUP (FIXED) : MASP A - Backup starts on active MASP.  
BACKUP (FIXED) : MASP A - Backup on active MASP to fixed disk  
complete.  
BACKUP (FIXED) : MASP A - Backup starts on standby MASP.  
BACKUP (FIXED) : MASP A - Backup on standby MASP to fixed disk  
complete.
```

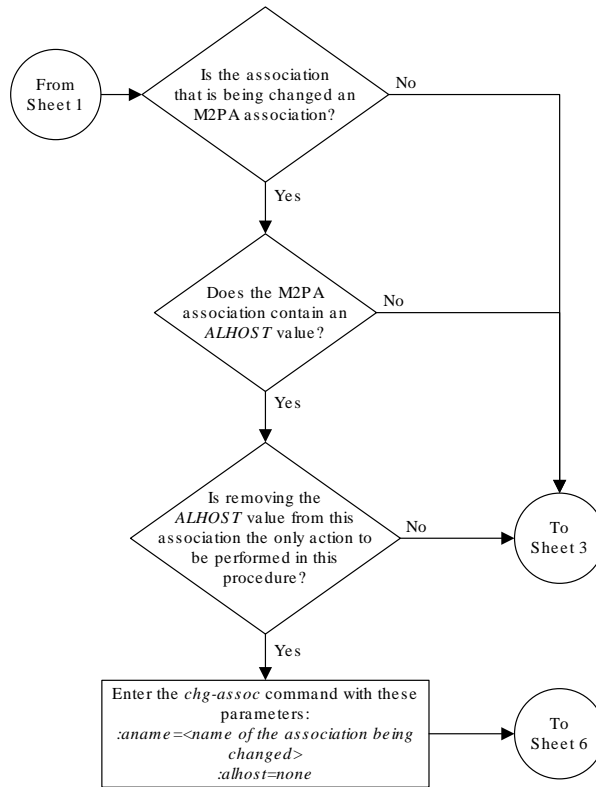
If you wish to change the other attributes of the M2PA association, perform one of these procedures.

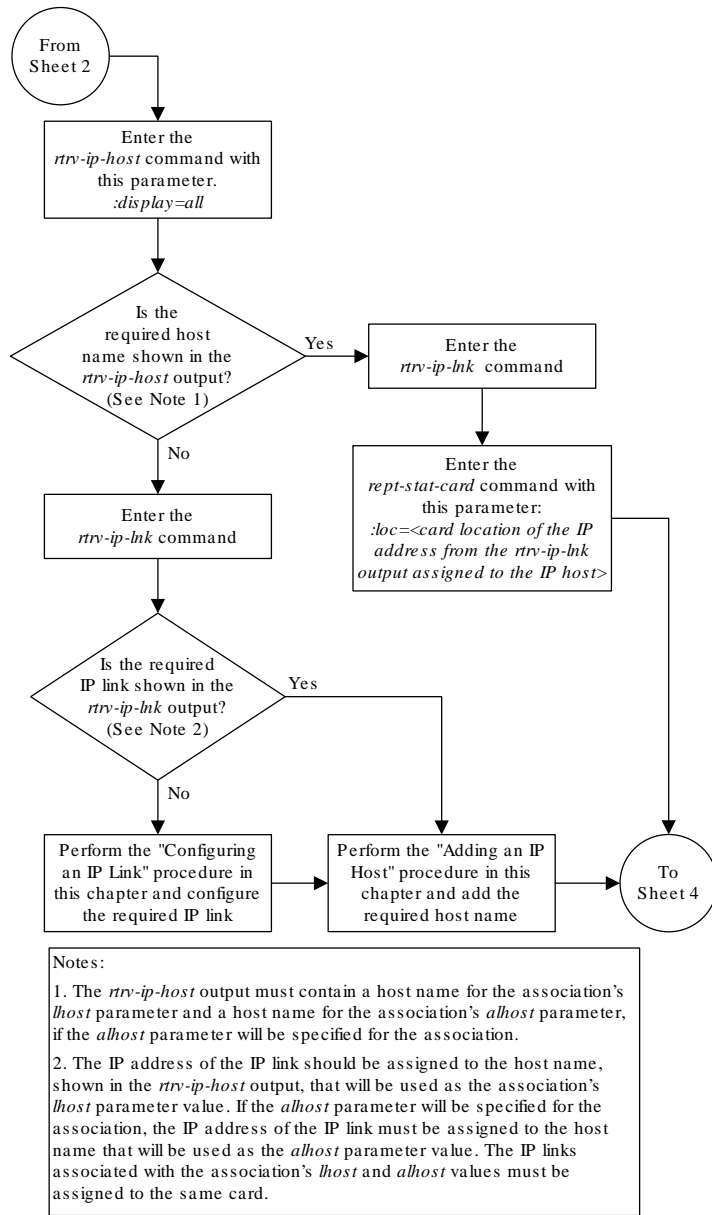
- `bufsize` - [Changing the Buffer Size of a M2PA Association](#)
- Other attributes of the M2PA Association - [Changing the Attributes of an M2PA Association](#)

If you do not wish to change the other attributes of the M2PA association, this procedure is finished.

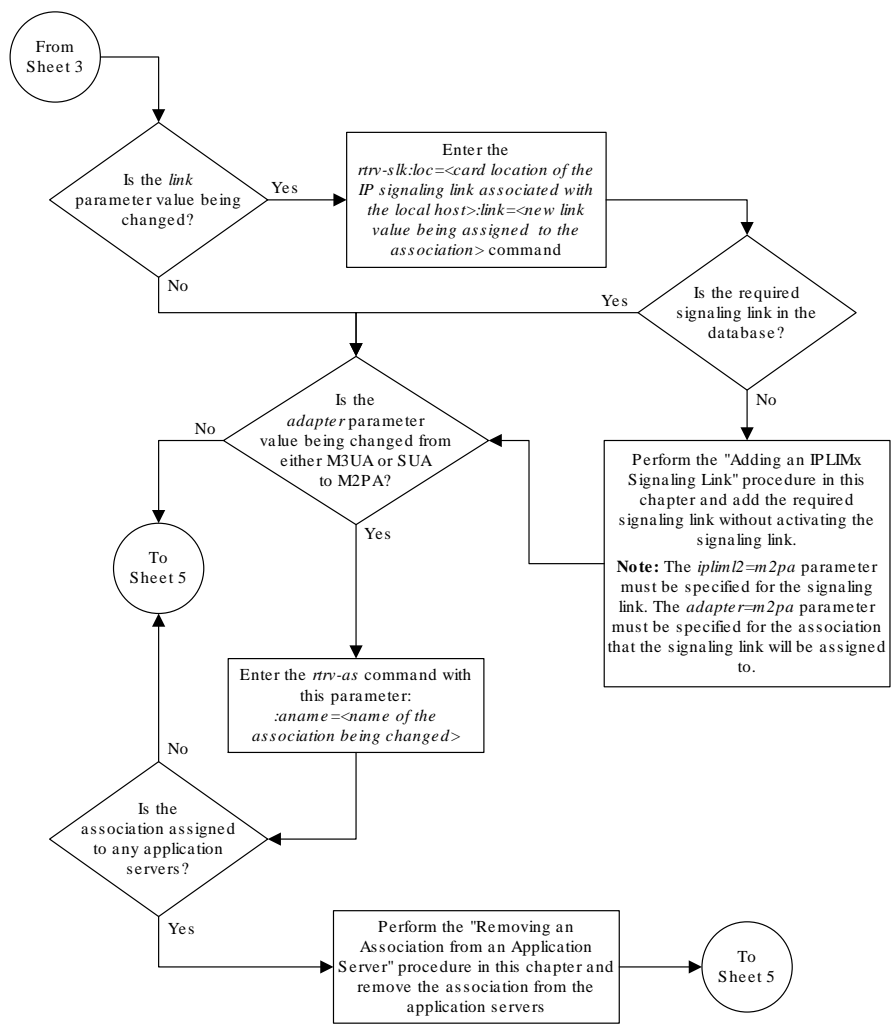
Figure 3-19 Changing the Host Values of a M2PA Association

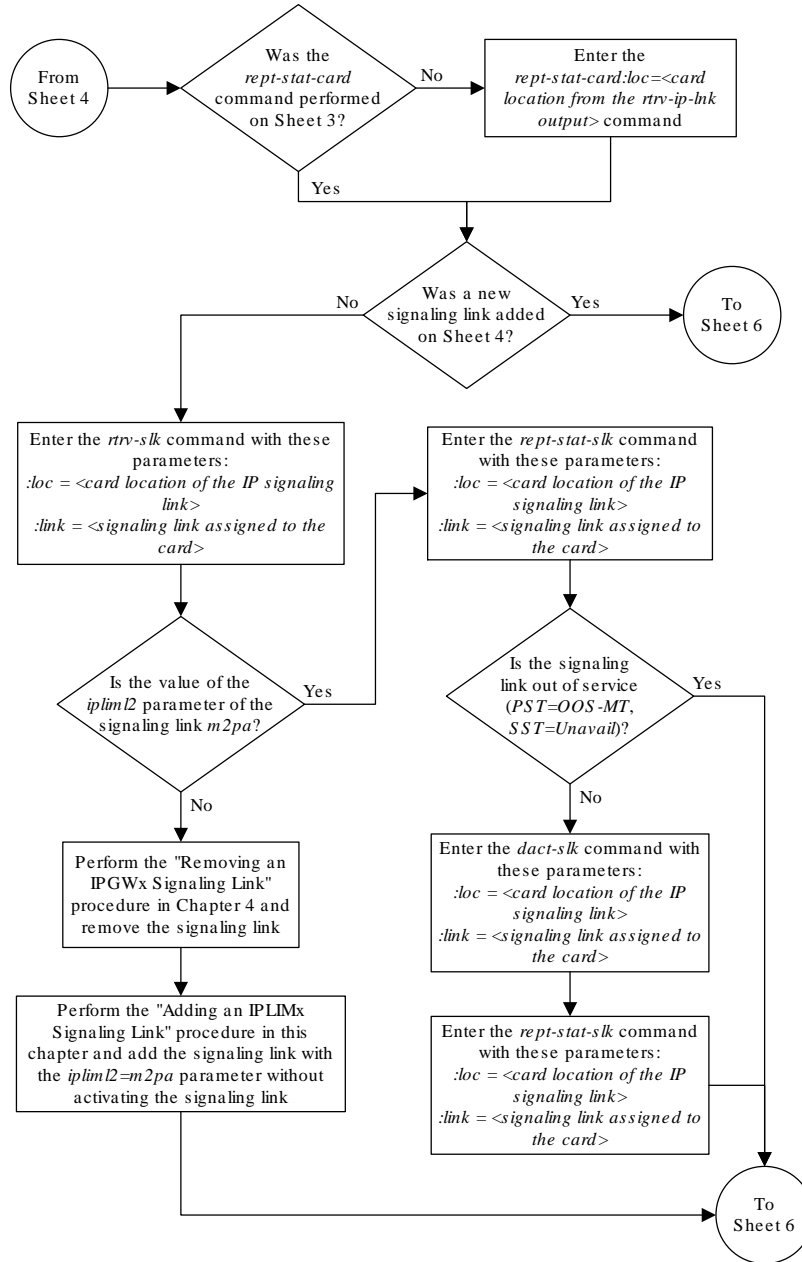




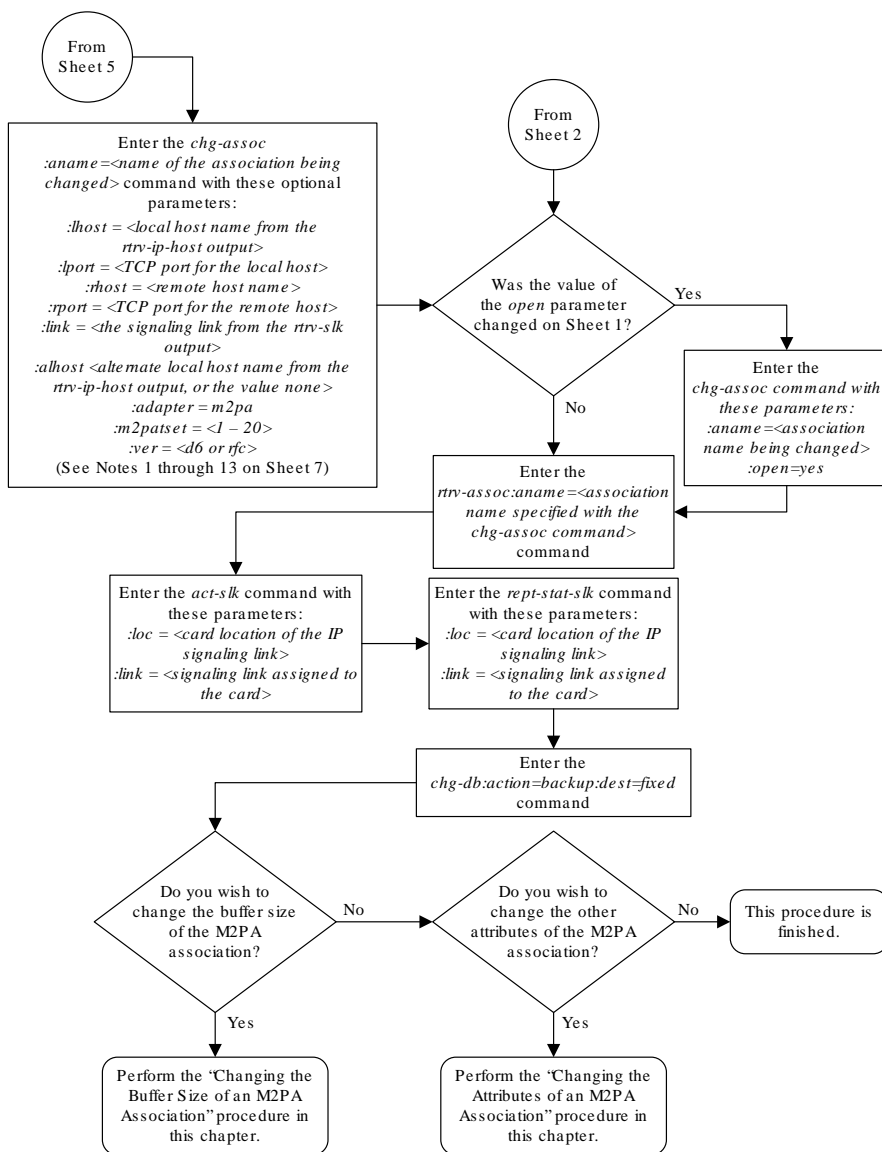


Sheet 3 of 7





Sheet 5 of 7



Sheet 6 of 7

Notes:

1. If any optional parameters are not specified with the *chg-assoc* command, those values are not changed.
2. The B Ethernet interface can be used with single-slot EDCMs or E5-ENET cards.
3. The EAGLE 5 ISS can contain a maximum of 4000 connections.
4. IPLIMx cards can have only one connection for each signaling link assigned to the card. If the card is a single-slot EDCM, the card may contain a maximum of eight connections. If the card is an E5-ENET card, the card may contain a maximum of 16 connections.
5. The value of the *hst* and *rhst* parameters is a text string of up to 60 characters, with the first character being a letter. The command input is limited to 150 characters, including the hostnames.
6. The *adapter* parameter value for the association must be *m2pa* and the *ipliml2=m2pa* parameter must be assigned to the signaling link on the *iplim* or *iplimi* card.
7. Specifying the *hst* parameter only creates a uni-homed endpoint. The network portion of the endpoint's IP address must be the same as the network portion of the IP address assigned to either the A or B network interface of the IP card.
8. Specifying the *hst* and *alhost* parameters creates a multi-homed endpoint. The network portion of the IP address associated with the *hst* parameter must be the same as the network portion of the IP address assigned to one of the network interfaces (A or B) of the IP card, and the network portion of the IP address associated with the *alhost* parameter must be the same as the network portion of the IP address assigned to the other network interface on the IP card.
9. The *alhost=none* parameter removes the alternate local host from the specified association, which also removes the multi-homed endpoint capability.
10. If the *mp2atset* parameter is not specified with the *chg-assoc* command, and the *adapter* parameter value is being changed to *m2pa*, the *m2patset* parameter value defaults to M2PA timer set 1 (*m2patset=1*).
11. The *port* parameter can be used in place of the *link* parameter to specify the signaling link assigned to the association.
12. The M2PA version of the association determines the version of the M2PA timer set that is assigned to the association. For example, if M2PA timer set 3 is assigned to the M2PA association, and the association is an RFC M2PA association, the RFC version of M2PA timer set 3 is used with the association. If M2PA timer set 7 is assigned to the M2PA association, and the association is a Draft 6 M2PA association, the Draft 6 version of M2PA timer set 7 is used with the association.
13. If the *adapter* parameter value of the association is changed to *m2pa* in this procedure and the *ver* parameter is not specified, the version of the association will be RFC. To make this association a M2PA Draft 6 association, the *ver=d6* parameter must be specified for this association.

Sheet 7 of 7

3.20 Changing the Link Value of a M2PA Association to another Link Value on the Same IPLIMx Card

This procedure is used to change the `link` value of an **M2PA** association, assigned to cards that are running the IPLIM or IPLIMI applications (IPLIMx cards), to another `link` value that

is assigned to the same IPLIMx card that is hosting the M2PA association. The `chg-assoc` command is used to change the `link` value for the association. If you wish to change the attributes of M2PA associations assigned to cards that are running the IPSP application, perform the [Changing the Attributes of an IPSP Association](#) procedure.

These parameters of the `chg-assoc` command are used in this procedure:

`:aname` – The name assigned to the association, shown in the `rtrv-assoc` output.

`:link` – The signaling link on the **IPLIMx** card. If the card is a single-slot **EDCM**, the values for the `link` parameter can be `a`, `a1`, `a2`, `a3`, `b`, `b1`, `b2`, or `b3`.

If the card is a **E5-ENET** card, the values for the `link` parameter can be `a`, `a1`, `a2`, `a3`, `a4`, `a5`, `a6`, **`a7`**, `b`, `b1`, `b2`, `b3`, `b4`, `b5`, `b6`, or `b7`.

Note:

The `port` parameter can be used in place of the `link` parameter to specify the signaling link on the card.

`:open` – The connection state for this association. Valid values are `yes` or `no`. When the `open=yes` parameter is specified, the connection manager opens the association if the association is operational. When the `open=no` parameter is specified, the connection manager will not open the association.

IPLIMx cards can have one association for each signaling link on the card. The single-slot **EDCM** can contain a maximum of eight signaling links, resulting in a maximum of eight associations for this card. The **E5-ENET** card can contain a maximum of 16 signaling links, resulting in a maximum of 16 associations for this card.

The signaling link being assigned to the association must be out of service. This state is shown in the `rept-stat-slk` output with the entries `OOS-MT` in the `PST` field and `Unavail` in the `SST` field.

If you wish to change the `lhost`, `alhost`, `bufsize`, or `link` values of the M2PA association, perform one of these procedures.

- `lhost` and `alhost` - [Changing the Host Values of a M2PA Association](#)
- `bufsize` - [Changing the Buffer Size of a M2PA Association](#)
- Other attributes of the M2PA Association - [Changing the Attributes of an M2PA Association](#)

If you do not wish to change the `lhost`, `alhost`, `bufsize`, or `link` values of the M2PA association, this procedure is finished.

Canceling the `RTRV-ASSOC` Command

Because the `rtrv-assoc` command used in this procedure can output information for a long period of time, the `rtrv-assoc` command can be canceled and the output to the terminal stopped. There are three ways that the `rtrv-assoc` command can be canceled.

- Press the `F9` function key on the keyboard at the terminal where the `rtrv-assoc` command was entered.

- Enter the `canc-cmd` without the `trm` parameter at the terminal where the `rtrv-assoc` command was entered.
- Enter the `canc-cmd:trm=<xx>`, where `<xx>` is the terminal where the `rtrv-assoc` command was entered, from another terminal other than the terminal where the `rtrv-assoc` command was entered. To enter the `canc-cmd:trm=<xx>` command, the terminal must allow Security Administration commands to be entered from it and the user must be allowed to enter Security Administration commands. The terminal's permissions can be verified with the `rtrv-secu-trm` command. The user's permissions can be verified with the `rtrv-user` or `rtrv-secu-user` commands.

For more information about the `canc-cmd` command, go to *Commands User's Guide*.

1. Display the associations in the database using the `rtrv-assoc` command.

This is an example of possible output.

```
rlghncxa03w 06-10-28 09:12:36 GMT EAGLE5 36.0.0
```

ANAME	CARD		IPLNK	LINK ADAPTER	LPORT	RPORT	OPEN	ALW
	LOC	PORT						
swbel132	1201	A	A	M3UA	1030	2345	YES	YES
a2	1305	A	A	SUA	1030	2345	YES	YES
a3	1307	A	A	SUA	1030	2346	YES	YES
assoc1	1201	A	A	M3UA	2000	1030	YES	YES
assoc2	1205	A	A	M2PA	2048	2048	YES	YES
assoc3	1205	A	B2	M2PA	3000	3000	YES	YES

2. Enter the `rtrv-card` command with the location of the card that is hosting the M2PA association that will be changed in this procedure. For this example, enter this command.

```
rtrv-card:loc=1205
```

This is an example of possible output.

```
rlghncxa03w 08-04-06 15:17:20 EST EAGLE5 38.0.0
```

CARD	TYPE	APPL	LSET NAME	LINK	SLC	LSET NAME	LINK	SLC
1205	DCM	IPLIM	e5e6a	A	0	e5e6a	B2	1
			e5e6a	A3	2			

If the application assigned to the card is IPLIM or IPLIMI, shown in the `APPL` column, continue the procedure by performing one of these steps.

- If the `open` parameter value for the association being changed is `yes`, continue the procedure with [3](#).
- If the `open` parameter value for the association being changed is `no`, continue the procedure with [4](#).

If the application assigned to the card is IPSPG, perform the [Changing the Attributes of an IPSPG Association](#) procedure.

3. Change the value of the `open` parameter to `no` by specifying the `chg-assoc` command with the `open=no` parameter.

For this example, enter this command.

```
chg-assoc:aname=assoc2:open=no
```

When this command has successfully completed, this message should appear.

```
rlghncxa03w 06-10-28 09:12:36 GMT EAGLE5 36.0.0
CHG-ASSOC: MASP A - COMPLTD;
```

4. Perform one of these actions.

- If the new link value is not shown in the `rtrv-card` output in 2, perform the [Adding an IPLIMx Signaling Link](#) procedure to provision the signaling link with the card location specified in 2 and the new link value. After the new signaling link has been provisioned, continue the procedure with 8.
- If the new link value is shown in the `rtrv-card` output in 2 and in the `rtrv-assoc` output in 1, this link value cannot be used. Perform the [Adding an IPLIMx Signaling Link](#) procedure to provision the signaling link with the card location specified in 2 and the new link value. After the new signaling link has been provisioned, continue the procedure with 8.
- If the new link value is shown in the `rtrv-card` output in 2 but not in the `rtrv-assoc` output in 1, continue the procedure with 5.

5. Display the status of the signaling link that will be the new link value for the association shown in 2 (using the values in the `LOC` and `LINK` columns in the `rtrv-card` output) by entering the `rept-stat-slk` command specifying the card location and signaling link.

For example, enter this command.

```
rept-stat-slk:loc=1205:link=a3
```

This is an example of the possible output.

```
rlghncxa03w 06-10-28 21:16:37 GMT EAGLE5 36.0.0
SLK      LSN      CLLI      PST      SST      AST
1205,A3  e5e6a      -----  IS-NR    Avail    ----
Command Completed.
```

If the primary state (**PST**) of the signaling link not is `OOS-MT` and the secondary state (**SST**) is `Unavail`, continue the procedure with 6.

If the primary state (**PST**) of the signaling link is `OOS-MT` and the secondary state (**SST**) is `Unavail`, continue the procedure with 8.

6. Deactivate the signaling link shown in 5 using the `dact-slk` command.

For example, enter this command.

```
dact-slk:loc=1205:link=a3
```

When this command has successfully completed, the following message should appear.

```
rlghncxa03w 06-10-07 11:11:28 GMT EAGLE5 36.0.0
Deactivate Link message sent to card
```

7. Verify the status of the signaling link using the `rept-stat-slk` command.

For example, enter this command.

```
rept-stat-slk:loc=1205:link=a3
```

This is an example of the possible output.

```
rlghncxa03w 06-10-28 21:16:37 GMT EAGLE5 36.0.0
SLK      LSN      CLLI      PST      SST      AST
1205,A3  e5e6a      -----  OOS-MT   Unavail   ----
Command Completed.
```

8. Change the association using the `chg-assoc` command.

For this example, enter this command.

```
chg-assoc:aname=assoc2:link=a3
```

When this command has successfully completed, this message should appear.

```
rlghncxa03w 06-10-28 09:12:36 GMT EAGLE5 36.0.0
CHG-ASSOC: MASP A - COMPLTD;
```

If the value of the `open` parameter was not changed in 3, continue the procedure with 10.

If the value of the `open` parameter was changed in 3, continue the procedure with 9.

9. Change the value of the `open` parameter to `yes` by specifying the `chg-assoc` command with the `open=yes` parameter.

For this example, enter this command.

```
chg-assoc:aname=assoc2:open=yes
```

When this command has successfully completed, this message should appear.

```
rlghncxa03w 06-10-28 09:12:36 GMT EAGLE5 36.0.0
CHG-ASSOC: MASP A - COMPLTD;
```

10. Verify the changes using the `rtrv-assoc` command specifying the association name specified in 8 and 9.

For this example, enter this command.

```
rtrv-assoc:aname=assoc2
```

This is an example of possible output.

```
rlghncxa03w 10-07-28 21:14:37 GMT EAGLE5 42.0.0
ANAME assoc2
      LOC      1205      IPLNK PORT  A      LINK  A
ADAPTER M2PA      VER      M2PA RFC
LHOST   IPNODE2-1205
ALHOST  ---
RHOST   gw200.nc-tekelec.com
```

```

ARHOST    ---
LPORT     2048          RPORT     3000
ISTRMS    2           OSTRMS    2           BUFSIZE   500
RMODE     LIN         RMIN      120          RMAX      800
RTIMES    10         CWMIN     3000        UAPS      10
OPEN      YES        ALW       NO           RTXTHR    10000
RHOSTVAL  MATCH      M2PATSET  1

```

```

IP Appl Sock/Assoc table is (8 of 4000) 1% full
Assoc Buffer Space Used (1300 KB of 1600 KB) on LOC = 1205

```

If the state of the signaling link was changed in 6, continue the procedure with 11.

If the state of the signaling link was not changed in 6, continue the procedure with 13.

11. Activate the signaling link assigned to the association using the `act-slk` command.

For example, enter this command.

```
act-slk:loc=1205:link=a3
```

When this command has successfully completed, the following message should appear.

```

rlghncxa03w 06-10-07 11:11:28 GMT EAGLE5 36.0.0
Activate Link message sent to card

```

12. Verify the status of the signaling link using the `rept-stat-slk` command.

For example, enter this command.

```
rept-stat-slk:loc=1205:link=a3
```

This is an example of the possible output.

```

rlghncxa03w 06-10-28 21:16:37 GMT EAGLE5 36.0.0
SLK      LSN      CLLI      PST      SST      AST
1205,A3  e5e6a    -----  IS-NR    Avail    ----
Command Completed.

```

13. Back up the new changes, using the `chg-db:action=backup:dest=fixed` command.

These messages should appear; the active **Maintenance and Administration Subsystem Processor (MASP)** appears first.

```

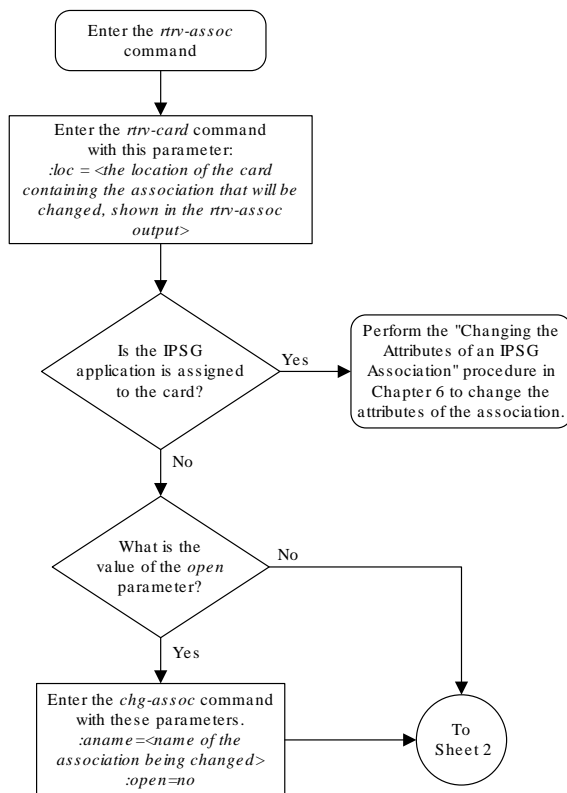
BACKUP (FIXED) : MASP A - Backup starts on active MASP.
BACKUP (FIXED) : MASP A - Backup on active MASP to fixed disk
complete.
BACKUP (FIXED) : MASP A - Backup starts on standby MASP.
BACKUP (FIXED) : MASP A - Backup on standby MASP to fixed disk
complete.

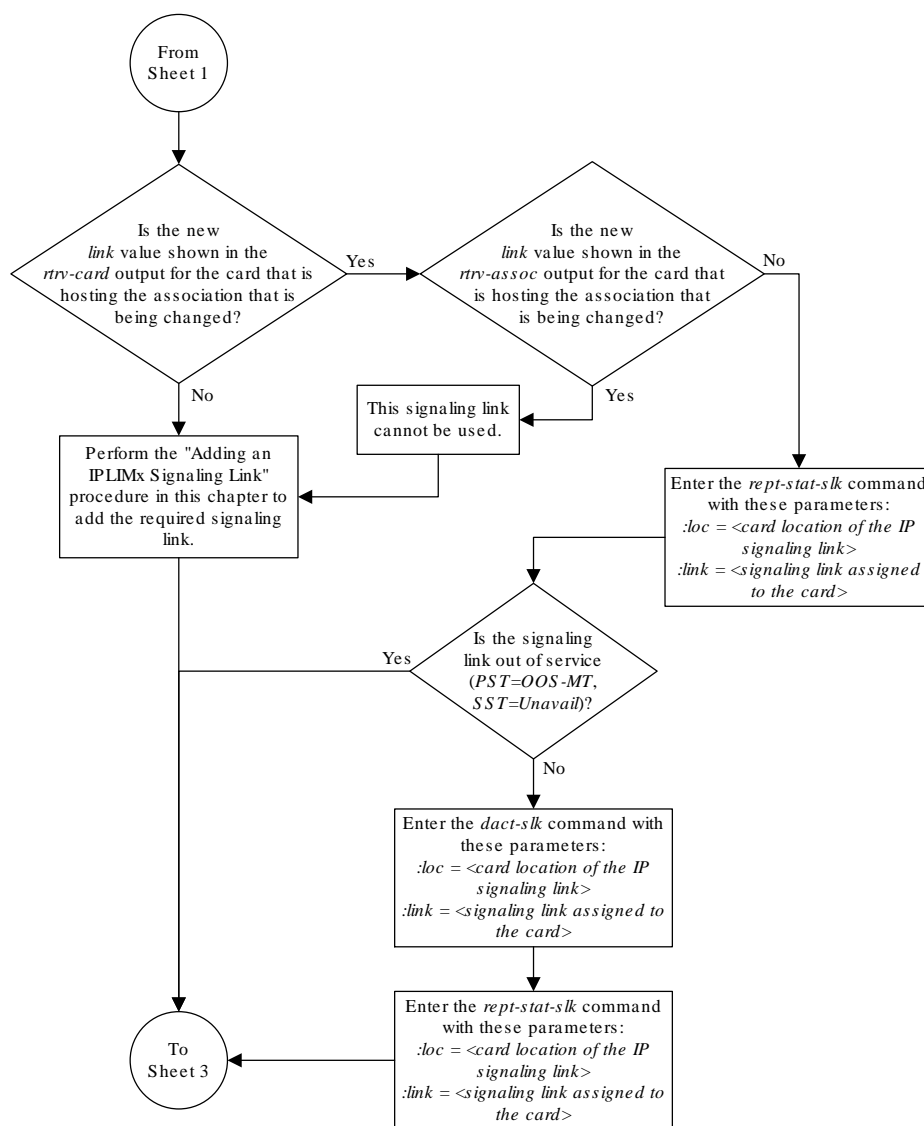
```

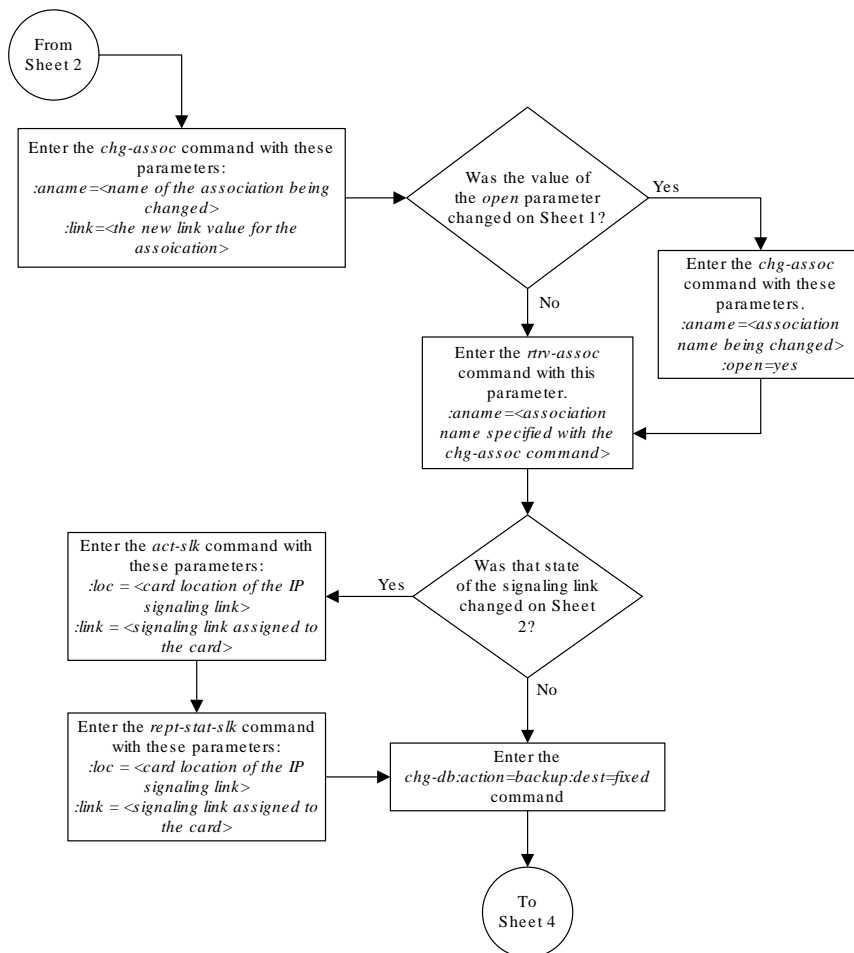
If you wish to change the other attributes of the M2PA association, perform one of these procedures.

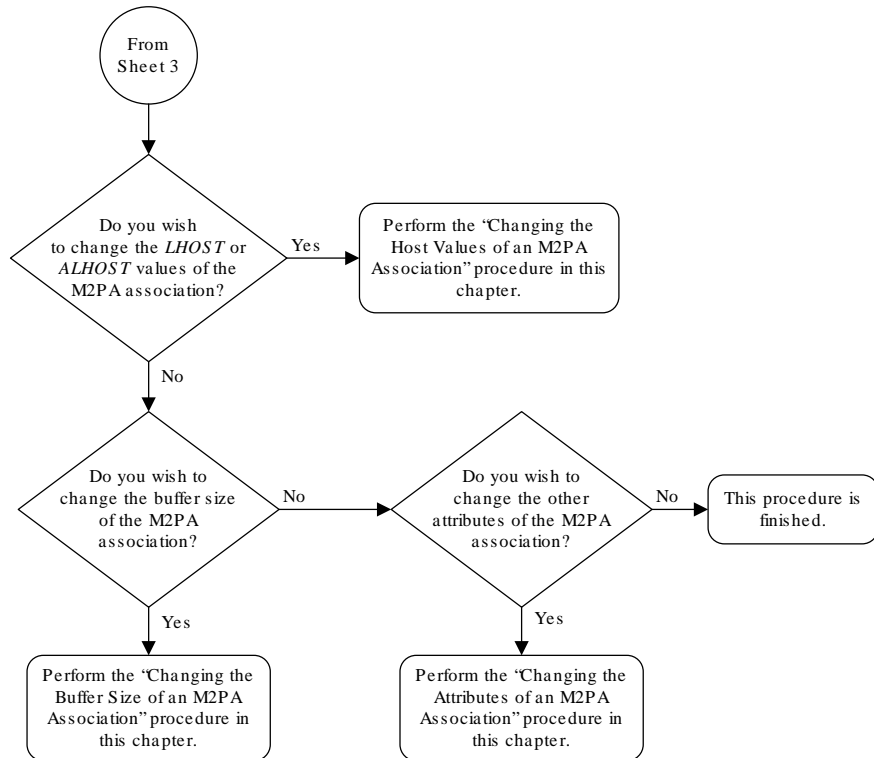
- `lhost` and `alhost` - [Changing the Host Values of a M2PA Association](#)
- `bufsize` - [Changing the Buffer Size of a M2PA Association](#)
- Other attributes of the M2PA Association - [Changing the Attributes of an M2PA Association](#)

If you do not wish to change the other attributes of the M2PA association, this procedure is finished.

Figure 3-20 Changing the Link Value of a M2PA Association to another Link Value on the Same IPLIMx Card







Sheet 4 of 4

3.21 Configuring SCTP Retransmission Control for a M2PA Association

This procedure is used to gather the information required to configure the retransmission parameters for M2PA associations assigned to cards running either the IPLIM or IPLIMI

applications. Perform the [Configuring an IPSG Association for SCTP Retransmission Control](#) procedure to configure the retransmission parameters for M2PA associations assigned to IPSG cards. If any assistance is needed to configure the retransmission parameters for associations, contact [My Oracle Support \(MOS\)](#).

The retransmission parameters are configured using the `rmode`, `rmin`, `rmax`, `rtimes`, and `cwmin` parameters of the `chg-assoc` command.

`:rmode` – The retransmission mode used when packet loss is detected. The values are `rfc` or `lin`.

- `rfc` – Standard **RFC 2960** algorithm in the retransmission delay doubles after each retransmission. The **RFC 2960** standard for congestion control is also used.
- `lin` – Oracle's linear retransmission mode where each retransmission timeout value is the same as the initial transmission timeout and only the slow start algorithm is used for congestion control.

`:rmin` – The minimum value of the calculated retransmission timeout in milliseconds.

`:rmax` – The maximum value of the calculated retransmission timeout in milliseconds.

 **Note:**

The `rmin` and `rmax` parameter values form a range of retransmission values. The value of the `rmin` parameter must be less than or equal to the `rmax` parameter value.

`:rtimes` – The number of times a data retransmission occurs before closing the association.

`:cwmin` – The minimum size in bytes of the association's congestion window and the initial size in bytes of the congestion window.

The [Changing the Attributes of an M2PA Association](#) procedure is used to change the values of these parameters. In addition to using the [Changing the Attributes of an M2PA Association](#) procedure, these pass commands are also used in this procedure.

- `ping` – tests for the presence of hosts on the network.
- `assocrtt` – displays the **SCTP** round trip times for a specified association. Minimum, maximum, and average times are kept for each open association. The Retransmission Mode (**RFC** or **LIN**) and the configured Minimum and Maximum Retransmission Timeout limits are also displayed.
- `sctp` – provides a summary list of all **SCTP** instances.
- `sctp -a <association name>` – displays the measurements and information for a specific association.

 **Note:**

The values for the minimum and maximum retransmission times in the output from this command are shown in microseconds.

For more information on the `pass` commands, see *Commands User's Guide*.

The `chg-assoc` command contains other optional parameters that can be used to configure an association. These parameters are not shown here because they are not necessary for configuring the **SCTP** retransmission parameters. These parameters are explained in more detail in the [Changing the Attributes of an M2PA Association](#) procedure, or in the `chg-assoc` command description in *Commands User's Guide*.

Canceling the `RTRV-ASSOC` Command

Because the `rtrv-assoc` command used in this procedure can output information for a long period of time, the `rtrv-assoc` command can be canceled and the output to the terminal stopped. There are three ways that the `rtrv-assoc` command can be canceled.

- Press the `F9` function key on the keyboard at the terminal where the `rtrv-assoc` command was entered.
- Enter the `canc-cmd` without the `trm` parameter at the terminal where the `rtrv-assoc` command was entered.
- Enter the `canc-cmd:trm=<xx>`, where `<xx>` is the terminal where the `rtrv-assoc` command was entered, from another terminal other than the terminal where the `rtrv-assoc` command was entered. To enter the `canc-cmd:trm=<xx>` command, the terminal must allow Security Administration commands to be entered from it and the user must be allowed to enter Security Administration commands. The terminal's permissions can be verified with the `rtrv-secu-trm` command. The user's permissions can be verified with the `rtrv-user` or `rtrv-secu-user` commands.

For more information about the `canc-cmd` command, go to *Commands User's Guide*.

1. Display the associations in the database using the `rtrv-assoc` command.

This is an example of possible output.

```
rlghncxa03w 06-10-28 09:12:36 GMT EAGLE5 36.0.0

          CARD IPLNK
ANAME      LOC  PORT  LINK ADAPTER  LPORT  RPORT  OPEN  ALW
swbel32    1201 A     A    M3UA   1030  2345  YES   YES
a2         1305 A     A     SUA   1030  2345  YES   YES
a3         1307 A     A     SUA   1030  2346  YES   YES
assoc1     1201 A     A    M2PA   2000  1030  YES   YES
```

2. Enter the `rtrv-card` command with the location of the card that is hosting the M2PA association that will be changed in this procedure. For this example, enter this command.

```
rtrv-card:loc=1201
```

This is an example of possible output.

```
rlghncxa03w 08-03-06 15:17:20 EST EAGLE5 38.0.0
CARD  TYPE      APPL      LSET NAME  LINK SLC  LSET NAME  LINK SLC
1201  DCM          IPLIM     lsn1      A      0
```

If the application assigned to the card is `IPLIM` or `IPLIMI`, shown in the `APPL` column, continue the procedure with [3](#).

If the application assigned to the card is IPSG, perform the [Configuring an IPSG Association for SCTP Retransmission Control](#) procedure.

3. Display the association that will be changed by entering the `rtrv-assoc` command with the name of the association. For this example, enter this command.

```
rtrv-assoc:aname=assoc1
```

This is an example of the possible output.

```
rlghncxa03w 10-07-28 21:14:37 GMT EAGLE5 42.0.0
  ANAME assoc1
      LOC      1201          IPLNK PORT  A          LINK  A
  ADAPTER  M2PA          VER          M2PA RFC
  LHOST    IPNODE2-1205
  ALHOST   ---
  RHOST    gw100.nc-tekelec.com
  ARHOST   ---
  LPORT    2000          RPORT      1030
  ISTRMS   2            OSTRMS     2          BUFSIZE  400
  RMODE    LIN          RMIN       120        RMAX     800
  RTIMES   10          CWMIN      3000      UAPS     10
  OPEN     YES          ALW        NO         RTXTHR   2000
  RHOSTVAL MATCH      M2PATSET   1
```

```
IP Appl Sock/Assoc table is (8 of 4000) 1% full
Assoc Buffer Space Used (1600 KB of 1600 KB) on LOC = 1201
```

4. Enter the `ping pass` command specifying the card location of the local host, shown in [3](#), and the name of the remote host assigned to the association being changed, shown in [3](#).

This command is entered several times to obtain the average round trip time. For this example, enter this command.

```
pass:loc=1201:cmd="ping gw100.nc.tekelec.com"
```

The following is an example of the possible output

```
rlghncxa03w 06-10-28 21:15:37 GMT EAGLE5 36.0.0
PASS: Command sent to card

rlghncxa03w 06-10-28 21:15:37 GMT EAGLE5 36.0.0
PING command in progress

rlghncxa03w 06-10-28 21:15:37 GMT EAGLE5 36.0.0
PING GW100. NC. TEKELEC. COM (192.1.1.30): 56 data bytes
64 bytes from tekral.nc.tekelec.com (192.1.1.30): icmp_seq=0.
time=5. ms
64 bytes from tekral.nc.tekelec.com (192.1.1.30): icmp_seq=1.
time=9. ms
64 bytes from tekral.nc.tekelec.com (192.1.1.30): icmp_seq=2.
time=14. ms
----tekral PING Statistics----
3 packets transmitted, 3 packets received, 0% packet loss
round-trip (ms)  min/avg/max = 5/9/14
```

PING command complete

If the **SCTP** retransmission parameters do not need to be changed, do not perform 5 through 8. This procedure is finished.

5. Perform the [Changing the Attributes of an M2PA Association](#) procedure to change the retransmission parameters of the association based on the results of pinging the remote host.
6. Enter the `assocrtt` pass command to display the round trip time data collected after an association is established when an **SCTP** INIT message is sent and an acknowledgment is received.

The `assocrtt` command is entered with the card location from 4 (the card location assigned to the association being changed), and the name of the association being changed. This association must contain the host name used in 4. For this example, enter this command.

```
pass:loc=1201:cmd="assocrtt assoc1"
```

The following is an example of the possible output

```
rlghncxa03w 06-10-28 21:15:37 GMT EAGLE5 36.0.0
PASS: Command sent to card

rlghncxa03w 06-10-28 21:15:37 GMT EAGLE5 36.0.0

ASSOCRTT: Association round-trip time report (in milliseconds)

Retransmission Configuration
  Retransmission Mode           : LIN
  Minimum RTO: 120
  Maximum RTO: 800

Traffic Round-Trip Times

  Minimum round-trip time       : 5
  Maximum round-trip time       : 120
  Weighted Average round-trip time : 10
  Last recorded round-trip time  : 10

Measured Congested Traffic Round-Trip Times

  Minimum round-trip time       : 0
  Maximum round-trip time       : 0
  Weighted Average round-trip time : 0
  Last recorded round-trip time  : 0
;
rlghncxa03w 06-10-28 21:15:37 GMT EAGLE5 36.0.0
ASSOCRTT command complete
```

7. Enter the `sctp -a <association name> pass` command to determine if retransmissions have occurred.

The association name is the association name specified in 6. Specify the card location used in 6. For this example, enter this command.

```
pass:loc=1201:cmd="sctp -a assoc1"
```

The following is an example of the possible output

```
rlghncxa03w 10-12-28 21:15:37 GMT EAGLE5 43.0.0

Aname          Local          Local Remote          Remote
                IP Address     Port  Address         Port
Assoc1         192.168.110.12 2222  192.168.112.4   5555
                192.168.112.12

                Configuration                               State
                Retransmission Mode = LIN                 State = OPEN
Min. Retransmission Timeout = 10000                    ULP association id = 18
Max. Retransmission Timeout = 800000                  Number of nets = 2
Max. Number of Retries = 10                           Inbound Streams = 1
Min. Congestion Window = 3000                         Outbound Streams = 2
                Inbound Streams = 2
                Outbound Streams = 2
                Checksum Algorithm = crc32c
                Send/Rcv Buffer Size = 204800

                                Nets Data

                IP Address 192.168.112.4          State Reachable
                Port      7777                          Primary YES
                MTU       1500                          cwnd  16384
                ssthresh  16384                          RTO   120

                IP Address 192.168.113.5          State Reachable
                Port      7777                          Primary NO
                MTU       1500                          cwnd  16384
                ssthresh  16384                          RTO   120

                Last Net Sent To = 192.168.112.4
                Last Net Rcvd From = 192.168.112.4
                Over All Eror Count = 0
                Peers Rwnd = 13880
                My Rwnd = 16384
                Max Window = 16384
                Initial Seq Number = 24130
                Next Sending Seq Number = 124686
                Last Acked Seq Number = 124669
                Maximum Outbound Char Count = 16384
                Current Outbound Char Count = 2112
                Number Unsent Char Count = 0
                Outbound Data Chunk Count = 16
                Number Unsent = 0
                Number To Retransmit = 0

                ip datagrams rcvd = 155402
                ip datagrams with data chunks rcvd = 120844
```

```

data chunks rcvd = 367908
data chunks read = 367900
dup tsns rcvd = 8
sacks rcvd = 38734
gap ack blocks rcvd = 3
heartbeat requests rcvd = 135
heartbeat acks rcvd = 52
heartbeat requests sent = 52
ip datagrams sent = 129254
ip datagrams with data chunks sent = 73084
data chunks sent = 396330
retransmit data chunks sent = 135
sacks sent = 64872
send failed = 0
retransmit timer count = 0
consecutive retransmit timeouts = 0
RTT between RMIN and RMAX inclusive = 6
RTT greater than RMAX = 0
fast retransmit count = 135
recv timer count = 0
heartbeat timer count = 244
none left tosend = 0
none left rwnd gate = 5
none left cwnd gate = 8

```

;

```
rlghncxa03w 10-12-28 21:15:37 GMT EAGLE5 43.0.0
```

```
SCTP command complete
```

```
rlghncxa03w 06-10-28 21:15:37 GMT EAGLE5 36.0.0
```

Aname	Local	Local	Remote	Remote
	IP Address	Port	Address	Port
Assoc1	192.168.110.12	2222	192.168.112.4	5555
	192.168.112.12			

Configuration	State
Retransmission Mode = LIN	State = OPEN
Min. Retransmission Timeout = 10	ULP association id = 18
Max. Retransmission Timeout = 800	Number of nets = 2
Max. Number of Retries = 10	Inbound Streams = 1
Min. Congestion Window = 3000	Outbound Streams = 2
Inbound Streams = 2	
Outbound Streams = 2	

Nets Data

IP Address	192.168.112.4	State	Reachable
Port	7777	Primary	YES
MTU	1500	cwnd	16384
ssthresh	16384	RTO	120

IP Address	192.168.113.5	State	Reachable
Port	7777	Primary	NO
MTU	1500	cwnd	16384
ssthresh	16384	RTO	120

```

Last Net Sent To = 192.168.112.4
Last Net Rcvd From = 192.168.112.4
Over All Eror Count = 0
    Peers Rwnd = 13880
    My Rwnd = 16384
    Max Window = 16384
    Initial Seq Number = 24130
    Next Sending Seq Number = 124686
    Last Acked Seq Number = 124669
Maximum Outbound Char Count = 16384
Current Outbound Char Count = 2112
Number Unsent Char Count = 0
Outbound Data Chunk Count = 16
    Number Unsent = 0
    Number To Retransmit = 0

    ip datagrams rcvd = 155402
ip datagrams with data chunks rcvd = 120844
    data chunks rcvd = 367908
    data chunks read = 367900
    dup tsns rcvd = 8
    sacks rcvd = 38734
    gap ack blocks rcvd = 3
    heartbeat requests rcvd = 135
    heartbeat acks rcvd = 52
    heartbeat requests sent = 52
    ip datagrams sent = 129254
ip datagrams with data chunks sent = 73084
    data chunks sent = 396330
retransmit data chunks sent = 135
    sacks sent = 64872
    send failed = 0
    retransmit timer count = 0
    consecutive retransmit timeouts = 0
RTT between RMIN and RMAX inclusive = 6
    RTT greater than RMAX = 0
    fast retransmit count = 135
    rcv timer count = 0
    heartbeat timer count = 244
    none left tosend = 0
    none left rwnd gate = 5
    none left cwnd gate = 8

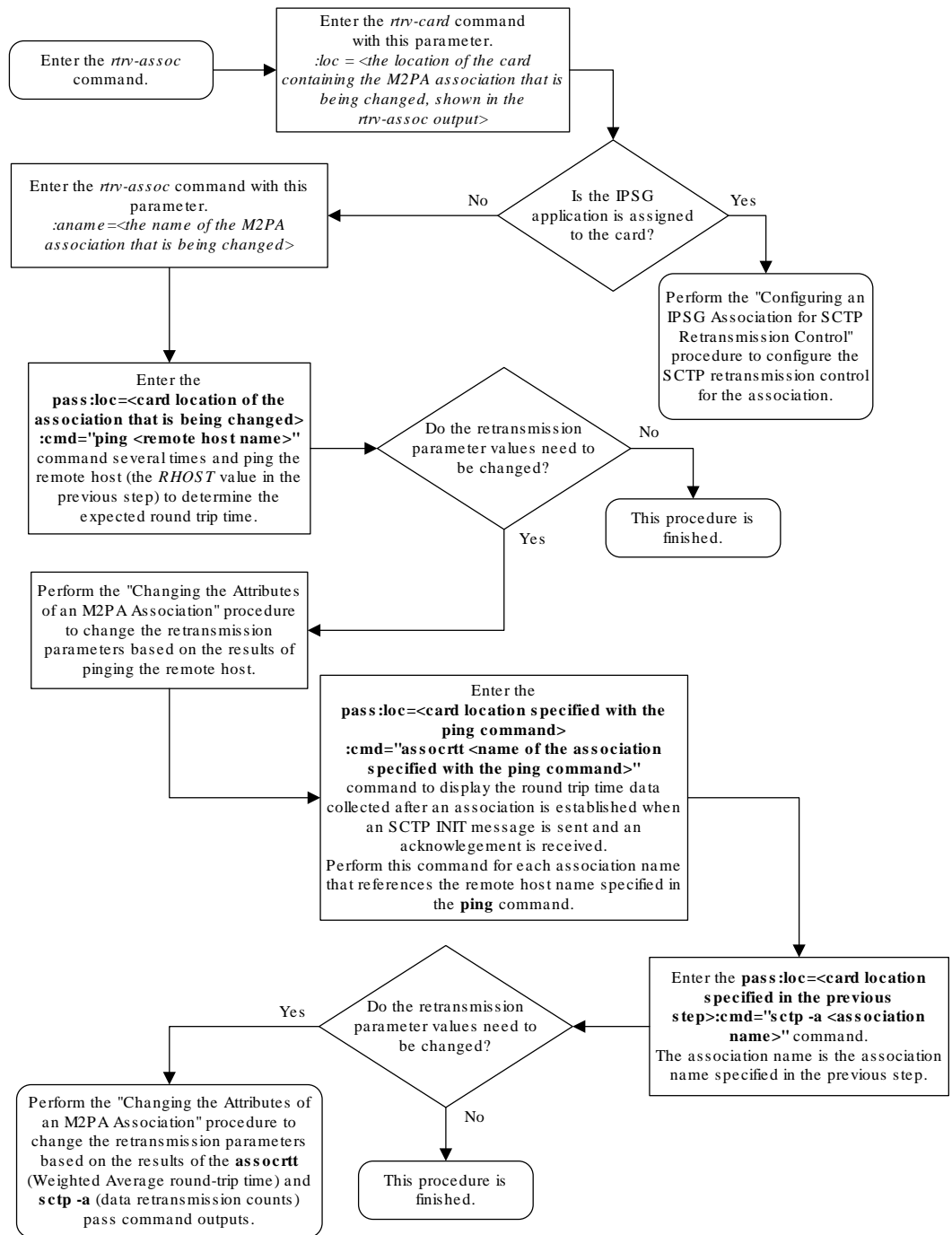
```

SCTP command complete

8. Perform the [Changing the Attributes of an M2PA Association](#) procedure to change the retransmission parameters of the association based on the results of the outputs of 6 and 7.

The `Weighted Average round-trip time` shown in the `assocrtt pass` command output in 6, and the `data retransmission counts` shown in the `sctp -a pass` command output in 7 are used as a guide to determine the appropriate values for the `rmode`, `rmin`, `rmax`, and `rtimes` parameters. If the retransmission parameters do not have to be adjusted, do not perform this step. This procedure is finished.

Figure 3-21 Configuring the SCTP Retransmission Control for a M2PA Association



3.22 Changing a M2PA Timer Set

This procedure is used to change the values of the **M2PA** timers in a **M2PA** timer set using the `chg-m2pa-tset` command. The **M2PA** timers are used to control the behavior of the signaling link assigned to an **M2PA** association (an association containing the **M2PA** adapter layer - `adapter=m2pa`) during signaling link alignment and proving, and during times of transmit congestion.

The **EAGLE** contains 20 **M2PA** timer sets. One of these timer sets is assigned to an **M2PA** association using the `m2patset` parameter of either the `ent-assoc` or `chg-assoc` command. If the `m2patset` parameter is not specified with the `ent-assoc` command, or with the `chg-assoc` command if the adapter layer for that association is being changed to **M2PA**, timer set 1 is automatically assigned to the association.

Caution:

Changing an **M2PA** timer set may affect the performance of any associations using the timer set being changed.

The `chg-m2pa-tset` command uses these parameters.

`:tset` – The **M2PA** timer set being changed, 1 - 20.

`:srctset` – The timer values in an existing **M2PA** timer set can be copied to another **M2PA** timer set, specified by the `tset` parameter. The `srctset` parameter specifies the timer set that is to be copied. If the `srctset` parameter is specified, no other timer values can be specified, The `srctset` parameter value cannot be the timer set specified by the `tset` parameter.

`:ver` – The **M2PA** version, either Draft 6 (`ver=d6`) or **RFC** (`ver=rfc`).

Note:

The definitions of timers **T1** and **T3** for the Draft 6 version are different from the **RFC** version. The **T2** timer applies only to the **RFC** version. The definitions of timers **T4N**, **T4E**, **T5**, **T6**, **T7**, **T16**, **T17** and **T18** for are the same for the Draft 6 version and the **RFC** version.

The timer parameter descriptions and values are shown in [Table 3-8](#).

Table 3-8 M2PA Timers

Timer	Draft 6 Timer Name	RFC Timer Name	Definition	Value (in msec)	DRAFT 6 System Default Value (in msec)	RFC System Default Value (in msec)
:t1	N/A	Ready Timer	The amount of time after proving the M2PA adapter layer waits to receive a Link Status Ready message from the peer.	1000 - 350000	N/A	300000
:t1	Alignment Timer	N/A	The amount of time the M2PA adapter layer waits to receive a Link Status Alignment message from the peer.	1000 - 350000	10000	N/A
:t2 *	N/A	Not Aligned Timer	The the amount of time the M2PA adapter layer waits to receive a Link Status Alignment/ Link Status Proving message after sending a Link Status Alignment message. Timer T2 is not used in M2PA Draft 6 timer sets.	5000 - 150000	N/A	20000
	N/A	Alignment Timer	The amount of time the M2PA adapter layer waits to receive a Link Status Alignment message from the peer.	1000 - 60000	N/A	2000
:t3	Ready Timer	N/A	The amount of time after proving the M2PA adapter layer waits to receive a Link Status Ready message from the peer.	1000 - 60000	10000	N/A
:t4n	Proving Timer (Normal)		The amount of time the M2PA adapter layer generates Link Status Proving messages during normal proving.	1000 - 70000	10000	30000
:t4e	Proving Timer (Emergency)		The amount of time the M2PA adapter layer generates Link Status Proving messages during emergency proving.	400 - 5000	500	500
:t5	Busy Rate Timer		The amount of time between sending Link Status Busy messages while the link is in-service.	80 - 10000	1000	100
:t6	Remote Congestion Timer		The amount of time that a congested link will remain in service.	1000 - 6000	3000	3000

Table 3-8 (Cont.) M2PA Timers

Timer	Draft 6 Timer Name	RFC Timer Name	Definition	Value (in msec)	DRAFT 6 System Default Value (in msec)	RFC System Default Value (in msec)
:t7	Excess Delay in Acknowledgement Timer		The maximum amount of time that may pass between when a user data message is transmitted and an acknowledgement for that message is received from the peer. If this timer expires, the link is taken out of service.	200 - 2000	1200	1200
:t16	Proving Rate Timer		The amount of time between sending Link Status Proving messages while the T4N or T4E timer is running.	100 - 500000 **	200000 **	200000 **
:t17	Ready Rate Timer		The amount of time between sending Link Status Ready messages while the T3 timer is running.	100 - 500	250	250
:t18	Processor Outage Rate Timer		The amount of time between sending Link Status Processor Outage messages while the link is in-service.	100 - 10000	1000	1000

msecs - milliseconds

* The T2 Timer can be specified only for the **M2PA RFC** version.

** The value of the T16 Timer is in microseconds.

The value of any timer parameter not specified with the `chg-m2pa-tset` command is not changed.

1. Display the **M2PA** timer sets in the database by entering the `rtrv-m2pa-tset` command with the version of the **M2PA** timer sets you wish to change with the `ver` parameter.

To display the **M2PA** Draft 6 timer values, enter this command.

```
rtrv-m2pa-tset:ver=d6
```

```
rlghncxa03w 06-10-28 21:16:37 GMT EAGLE5 36.0.0
```

```
M2PA Draft 6 Timers (in msec, T16 in microsec)
```

```
TSET T1    T2    T3    T4N  T4E  T5    T6    T7    T16  T17  T18
1    6000  ----- 5000 20000 500  5000  3000 1000 200000 250
1000
2    10000 ----- 10000 10000 500  1000  3000 1200 200000 250
1000
3    10000 ----- 10000 10000 500  1000  3000 1200 200000 250
1000
4    10000 ----- 10000 10000 500  1000  3000 1200 200000 250
```

```

1000
5  10000  ----- 10000 10000 500  1000  3000 1200  200000 250  1000
6  10000  ----- 10000 10000 500  1000  3000 1200  200000 250  1000
7  10000  ----- 10000 10000 500  1000  3000 1200  200000 250  1000
8  10000  ----- 10000 10000 500  1000  3000 1200  200000 250  1000
9  27500  ----- 3850  4859  450  5700  3750 1150  250    375  8750
10 10000  ----- 10000 10000 500  1000  3000 1200  200000 250  1000
11 10000  ----- 10000 10000 500  1000  3000 1200  200000 250  1000
12 10000  ----- 10000 10000 500  1000  3000 1200  200000 250  1000
13 10000  ----- 10000 10000 500  1000  3000 1200  200000 250  1000
14 10000  ----- 10000 10000 500  1000  3000 1200  200000 250  1000
15 10000  ----- 10000 10000 500  1000  3000 1200  200000 250  1000
16 10000  ----- 10000 10000 500  1000  3000 1200  200000 250  1000
17 10000  ----- 10000 10000 500  1000  3000 1200  200000 250  1000
18 10000  ----- 10000 10000 500  1000  3000 1200  200000 250  1000
19 10000  ----- 10000 10000 500  1000  3000 1200  200000 250  1000
20 10000  ----- 10000 10000 500  1000  3000 1200  200000 250  1000

```

To display the **M2PARFC** timer values, enter this command.

```
rtrv-m2pa-tset:ver=rfc
```

```
rlghncxa03w 06-10-28 21:16:37 GMT EAGLE5 36.0.0
```

M2PA RFC Timers (in msec, T16 in microsec)

TSET	T1	T2	T3	T4N	T4E	T5	T6	T7	T16	T17	T18
1	6000	20000	5000	20000	500	5000	3000	1000	200000	250	1000
1	300000	20000	2000	30000	500	100	3000	1200	200000	250	1000
2	300000	20000	2000	30000	500	100	3000	1200	200000	250	1000
3	300000	20000	2000	30000	500	100	3000	1200	200000	250	1000
4	300000	20000	2000	30000	500	100	3000	1200	200000	250	1000
5	300000	20000	2000	30000	500	100	3000	1200	200000	250	1000
6	300000	20000	2000	30000	500	100	3000	1200	200000	250	1000
7	300000	20000	2000	30000	500	100	3000	1200	200000	250	1000
8	300000	20000	2000	30000	500	100	3000	1200	200000	250	1000
9	27500	10000	3850	4859	450	5700	3750	1150	250	375	8750
10	300000	20000	2000	30000	500	100	3000	1200	200000	250	1000
11	300000	20000	2000	30000	500	100	3000	1200	200000	250	1000
12	300000	20000	2000	30000	500	100	3000	1200	200000	250	1000
13	300000	20000	2000	30000	500	100	3000	1200	200000	250	1000
14	300000	20000	2000	30000	500	100	3000	1200	200000	250	1000
15	300000	20000	2000	30000	500	100	3000	1200	200000	250	1000
16	300000	20000	2000	30000	500	100	3000	1200	200000	250	1000
17	300000	20000	2000	30000	500	100	3000	1200	200000	250	1000
18	300000	20000	2000	30000	500	100	3000	1200	200000	250	1000
19	300000	20000	2000	30000	500	100	3000	1200	200000	250	1000
20	300000	20000	2000	30000	500	100	3000	1200	200000	250	1000

If the `ver` parameter is not specified when entering the `rtrv-m2pa-tset` command, both the Draft 6 and RFC values are displayed. This is an example of the possible output.

```
rlghncxa03w 06-10-28 21:16:37 GMT EAGLE5 36.0.0
```

```
M2PA Draft 6 Timers (in msec, T16 in microsec)
```

TSET	T1	T2	T3	T4N	T4E	T5	T6	T7	T16	T17	T18
1	6000	-----	5000	20000	500	5000	3000	1000	200000	250	
	1000										
2	10000	-----	10000	10000	500	1000	3000	1200	200000	250	
	1000										
3	10000	-----	10000	10000	500	1000	3000	1200	200000	250	
	1000										
4	10000	-----	10000	10000	500	1000	3000	1200	200000	250	
	1000										
5	10000	-----	10000	10000	500	1000	3000	1200	200000	250	
	1000										
6	10000	-----	10000	10000	500	1000	3000	1200	200000	250	
	1000										
7	10000	-----	10000	10000	500	1000	3000	1200	200000	250	
	1000										
8	10000	-----	10000	10000	500	1000	3000	1200	200000	250	
	1000										
9	27500	-----	3850	4859	450	5700	3750	1150	250	375	
	8750										
10	10000	-----	10000	10000	500	1000	3000	1200	200000	250	
	1000										
11	10000	-----	10000	10000	500	1000	3000	1200	200000	250	
	1000										
12	10000	-----	10000	10000	500	1000	3000	1200	200000	250	
	1000										
13	10000	-----	10000	10000	500	1000	3000	1200	200000	250	
	1000										
14	10000	-----	10000	10000	500	1000	3000	1200	200000	250	
	1000										
15	10000	-----	10000	10000	500	1000	3000	1200	200000	250	
	1000										
16	10000	-----	10000	10000	500	1000	3000	1200	200000	250	
	1000										
17	10000	-----	10000	10000	500	1000	3000	1200	200000	250	
	1000										
18	10000	-----	10000	10000	500	1000	3000	1200	200000	250	
	1000										
19	10000	-----	10000	10000	500	1000	3000	1200	200000	250	
	1000										
20	10000	-----	10000	10000	500	1000	3000	1200	200000	250	
	1000										

```
M2PA RFC Timers (in msec, T16 in microsec)
```

TSET	T1	T2	T3	T4N	T4E	T5	T6	T7	T16	T17	T18
1	6000	20000	5000	20000	500	5000	3000	1000	200000	250	

1000												
2	300000	20000	2000	30000	500	100	3000	1200	200000	250	1000	
3	300000	20000	2000	30000	500	100	3000	1200	200000	250	1000	
4	300000	20000	2000	30000	500	100	3000	1200	200000	250	1000	
5	300000	20000	2000	30000	500	100	3000	1200	200000	250	1000	
6	300000	20000	2000	30000	500	100	3000	1200	200000	250	1000	
7	300000	20000	2000	30000	500	100	3000	1200	200000	250	1000	
8	300000	20000	2000	30000	500	100	3000	1200	200000	250	1000	
9	27500	10000	3850	4859	450	5700	3750	1150	250	375	8750	
10	300000	20000	2000	30000	500	100	3000	1200	200000	250	1000	
11	300000	20000	2000	30000	500	100	3000	1200	200000	250	1000	
12	300000	20000	2000	30000	500	100	3000	1200	200000	250	1000	
13	300000	20000	2000	30000	500	100	3000	1200	200000	250	1000	
14	300000	20000	2000	30000	500	100	3000	1200	200000	250	1000	
15	300000	20000	2000	30000	500	100	3000	1200	200000	250	1000	
16	300000	20000	2000	30000	500	100	3000	1200	200000	250	1000	
17	300000	20000	2000	30000	500	100	3000	1200	200000	250	1000	
18	300000	20000	2000	30000	500	100	3000	1200	200000	250	1000	
19	300000	20000	2000	30000	500	100	3000	1200	200000	250	1000	
20	300000	20000	2000	30000	500	100	3000	1200	200000	250	1000	

2. Change the desired timer set with the `chg-m2pa-tset` command. To change a specific timer set, enter the `chg-m2pa-tset` command with the `tset` and `ver` parameters and the timer parameters you wish to change. For this example, to change the values of the RFC version of timer set 1, enter this command.

```
chg-m2pa-
tset:tset=1:t1=27500:t2=10000:t3=3850:t4e=450:t4n=45000:t5=5700 :
t6=3750:t7=1150:t16=250000:t17=375:t18=8750:ver=rfc
```

To change the values of the Draft 6 version of timer set 1, enter this command.

```
chg-m2pa-
tset:tset=1:t1=27500:t3=3850:t4e=450:t4n=45000:t5=5700 :t6=3750:t
7=1150:t16=250000:t17=375:t18=8750:ver=d6
```

 **Note:**

The values for the M2PA timers are shown in [Table 3-8](#).

To copy an M2PA timer set to another timer set, enter the `chg-m2pa-tset` command with the `tset`, `ver`, and `srctset` parameters. For this example, to copy the RFC version of timer set 9 to timer set 1, enter this command.

```
chg-m2pa-tset:tset=1:srctset=9:ver=rfc
```

To copy the Draft 6 version of timer set 9 to timer set 1, enter this command.

```
chg-m2pa-tset:tset=1:srctset=9:ver=d6
```

 **Note:**

The `ver` parameter is optional and does not have to be specified to change the **M2PARFC** timer values. The default value for the `ver` parameter is `rfc`. If you wish to change the **M2PA Draft 6** timer values, the `ver=d6` parameter must be specified with the `chg-m2pa-tset` command.

When the `chg-m2pa-tset` command has successfully completed, the following message should appear.

```
rlghncxa03w 06-10-28 21:16:37 GMT EAGLE5 36.0.0
CHG-M2PA-TSET: MASP A - COMPLTD
```

3. Verify the changes by entering the `rtrv-m2pa-tset` command specifying the timer set and version parameter values specified in 2. For this example, enter one of these commands.

```
rtrv-m2pa-tset:tset=1:ver=rfc
```

```
rlghncxa03w 06-10-28 21:16:37 GMT EAGLE5 36.0.0
```

```
M2PA RFC Timers (in msec, T16 in microsec)
```

TSET	T1	T2	T3	T4N	T4E	T5	T6	T7	T16	T17	T18
1	27500	10000	3850	45000	450	5700	3750	1150	250000	375	8750

```
rtrv-m2pa-tset:tset=1:ver=d6
```

```
rlghncxa03w 06-10-28 21:16:37 GMT EAGLE5 36.0.0
```

```
M2PA Draft 6 Timers (in msec, T16 in microsec)
```

TSET	T1	T2	T3	T4N	T4E	T5	T6	T7	T16	T17	T18
1	27500	-----	3850	45000	450	5700	3750	1150	250000	375	8750

```
rtrv-m2pa-tset:tset=9:ver=rfc
```

```
rlghncxa03w 06-10-28 21:16:37 GMT EAGLE5 36.0.0
```

```
M2PA RFC Timers (in msec, T16 in microsec)
```

TSET	T1	T2	T3	T4N	T4E	T5	T6	T7	T16	T17	T18
1	27500	10000	3850	45000	450	5700	3750	1150	250000	375	8750


```
9      27500  10000  3850  45000  450  5700  3750  1150  250000  375  8750
```

```
rtrv-m2pa-tset:tset=9:ver=d6
```

```
rlghncxa03w 06-10-28 21:16:37 GMT EAGLE5 36.0.0
```

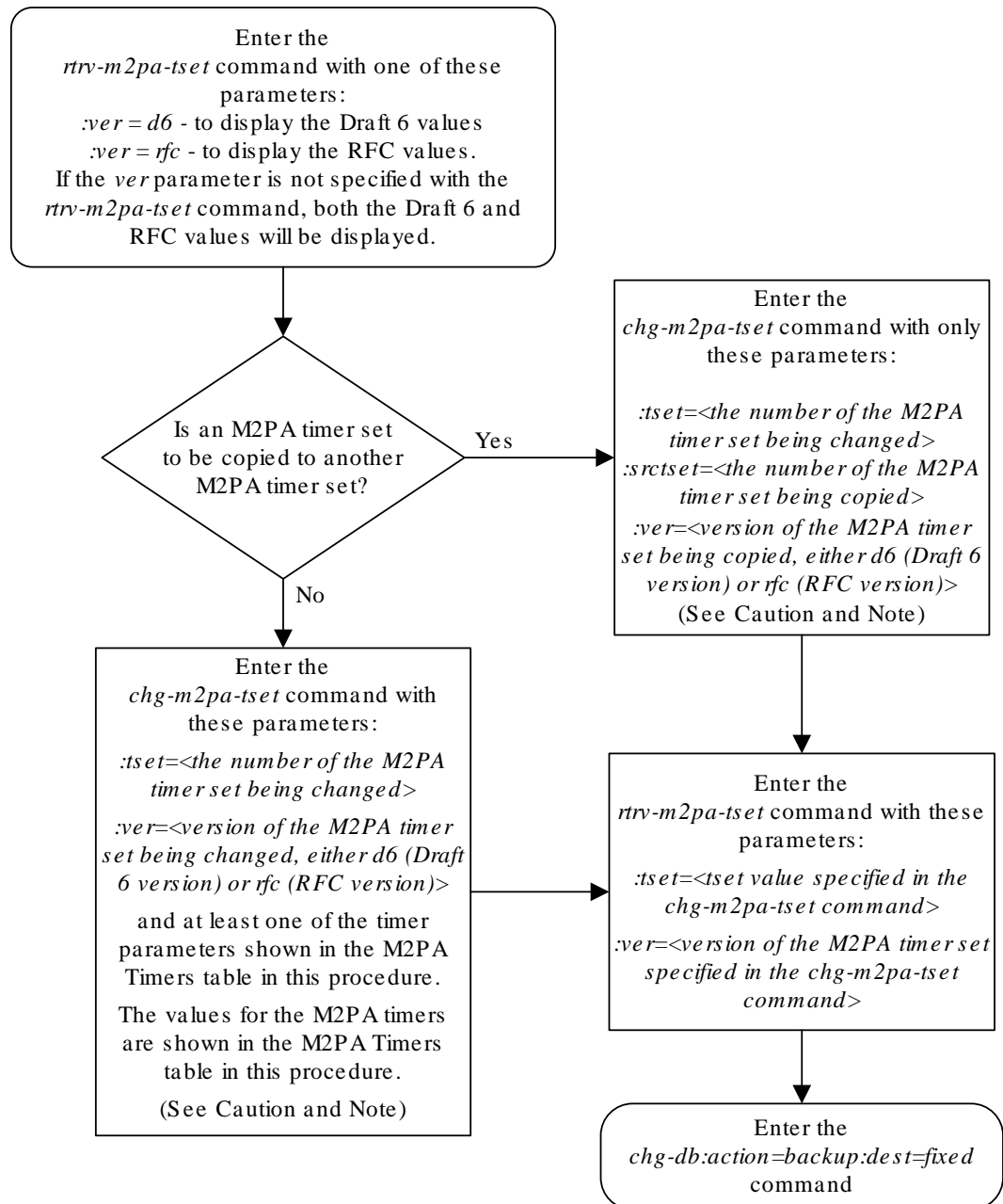
```
M2PA Draft 6 Timers (in msec, T16 in microsec)
```

```
TSET T1      T2      T3      T4N   T4E   T5      T6   T7      T16      T17  T18
9     27500  ----- 3850   45000 450   5700  3750 1150  250000  375  8750
```

4. Back up the new changes, using the `chg-db:action=backup:dest=fixed` command. These messages should appear; the active **Maintenance and Administration Subsystem Processor (MASP)** appears first.

```
BACKUP (FIXED) : MASP A - Backup starts on active MASP.
BACKUP (FIXED) : MASP A - Backup on active MASP to fixed disk complete.
BACKUP (FIXED) : MASP A - Backup starts on standby MASP.
BACKUP (FIXED) : MASP A - Backup on standby MASP to fixed disk complete.
```

Figure 3-22 Changing an M2PA Timer Set



Notes:

1. Either the timer parameters or the *srctset* parameter must be specified with the *chg-m2pa-tset* command. Both the timer parameters and the *srctset* parameter cannot be specified with the *chg-m2pa-tset* command.
2. If the *ver* parameter is not specified with the *chg-m2pa-tset* command, the RFC values will be changed. To change the Draft 6 values, the *ver=d6* parameter must be specified with the *chg-m2pa-tset* command.

Caution: Changing an M2PA timer set may affect the performance of any associations using the timer set being changed.

3.23 Changing the SCTP Checksum Algorithm Option for M2PA Associations

Use this procedure to change the **SCTP** checksum algorithm, either Adler-32 or CRC-32c, applied to traffic on **SCTP** associations. The `setpcsum` parameter of the `chg-sg-opts` command is used to change this option. The Adler-32 and CRC-32c checksum algorithms specified in this procedure applies to all the associations that are assigned to all the IP cards running the IPLIM or IPLIMI applications. This option is a system-wide option. To apply this option to associations assigned to cards running the SS7IPGW, IPGWI, or IPSP applications, perform these procedures.

- [Changing the SCTP Checksum Algorithm Option for IPSP M2PA Associations](#)
- [Changing the SCTP Checksum Algorithm Option for IPSP M3UA Associations](#)
- [Changing the SCTP Checksum Algorithm Option for M3UA and SUA Associations](#)

The `setpcsum` parameter contains another value, `percard`, that allows either the Adler-32 or CRC-32c SCTP checksum algorithm to be specified for the all the associations assigned to a specific card. With this option specified, the Adler-32 checksum algorithm can be specified for the associations on one card and the CRC-32c checksum algorithm can be specified for the associations on another card. Setting the `setpcsum` parameter to `percard` changes the SCTP checksum algorithm for the associations assigned to a card to the SCTP checksum algorithm value for that card. The checksum algorithm for individual cards is provisioned by performing the [Configuring an IP Card](#) procedure.

Once the **SCTP** checksum option has been changed, the associations on each **IP** card need to be reset by changing the `open` parameter value for each association to `no`, then back to `yes`. This ensures that the associations on the **IP** card are using the new **SCTP** checksum algorithm.

Canceling the `RTRV-ASSOC` Command

Because the `rtrv-assoc` command used in this procedure can output information for a long period of time, the `rtrv-assoc` command can be canceled and the output to the terminal stopped. There are three ways that the `rtrv-assoc` command can be canceled.

- Press the `F9` function key on the keyboard at the terminal where the `rtrv-assoc` command was entered.
- Enter the `canc-cmd` without the `trm` parameter at the terminal where the `rtrv-assoc` command was entered.
- Enter the `canc-cmd:trm=<xx>`, where `<xx>` is the terminal where the `rtrv-assoc` command was entered, from another terminal other than the terminal where the `rtrv-assoc` command was entered. To enter the `canc-cmd:trm=<xx>` command, the terminal must allow Security Administration commands to be entered from it and the user must be allowed to enter Security Administration commands. The terminal's permissions can be verified with the `rtrv-secu-trm` command. The user's permissions can be verified with the `rtrv-user` or `rtrv-secu-user` commands.

For more information about the `canc-cmd` command, go to *Commands User's Guide*.

1. Display the current **IP** options in the database by entering the `rtrv-sg-opts` command. The following is an example of the possible output.

```
rlghncxa03w 06-10-28 21:16:37 GMT EAGLE5 36.0.0
SCTPCSUM:      adler32
```

The `rtrv-sg-opts` command output contains other fields that are not used by this procedure. If you wish to see all the fields displayed by the `rtrv-sg-opts` command, see the `rtrv-sg-opts` command description in *Commands User's Guide*.

2. Display the cards in the **EAGLE** by entering the `rtrv-card` command. This is an example of the possible output.

```
rlghncxa03w 13-05-28 09:12:36 GMT EAGLE5 45.0.0
CARD   TYPE      APPL      LSET NAME      LINK SLC LSET NAME
LINK SLC
1101   DSM         VSCCP
1102   TSM         GLS
1113   E5MCAP     EOAM
1114   E5TDM-A
1115   E5MCAP     EOAM
1116   E5TDM-B
1117   E5MDAL
1201   LIMDS0     SS7ANSI   sp2            A    0    sp1
B    0
1203   LIMDS0     SS7ANSI   sp3            A    0
1204   LIMDS0     SS7ANSI   sp3            A    1
1206   LIMDS0     SS7ANSI   nsp3           A    1    nsp4
B    1
1301   LIMDS0     SS7ANSI   sp6            A    1    sp7
B    0
1302   LIMDS0     SS7ANSI   sp7            A    1    sp5
B    1
1303   DCM        IPLIM     ipnode1       A    0    ipnode3
B    1
1305   DCM        IPLIM     ipnode4       A    0
1313   DCM        SS7IPGW   ipgtwy1       A    0
2101   DCM        SS7IPGW   ipgtwy2       A    0
2103   DCM        SS7IPGW   ipgtwy3       A    0
2105   DCM        IPLIM     ipnode1       A1   1    ipnode5
B    2
2205   DCM        IPLIM     ipnode3       A2   0    ipnode6
B1   2
2207   DCM        IPLIM     ipnode5       A    0    ipnode4
B3   1
2213   DCM        IPLIM     ipnode5       A3   1    ipnode3
B2   2
2301   DCM        IPLIM     ipnode6       A    0    ipnode1
B    2
2305   DCM        IPLIM     ipnode6       A1   1    ipnode1
B1   3
```

Record the card location, shown in the `LOC` column, and signaling link, shown in the `LINK` column, information for all cards running the **IPLIM** or **IPLIMI** applications.

3. Change the **SCTP** checksum option in the database using the `chg-sg-opts` command. For this example, enter this command.

```
chg-sg-opts:sctpcsum=crc32c
```

When this command has successfully completed, the following message should appear.

```
rlghncxa03w 06-10-28 21:19:37 GMT EAGLE5 36.0.0  
CHG-SG-OPTS: MASP A - COMPLTD
```

Continue the procedure by performing one of these actions.

- If the `sctpcsum` parameter value was changed to either `adler32` or `crc32c`, continue the procedure with 4.
 - If the `sctpcsum` parameter value was changed to `percard`, perform the [Configuring an IP Card](#) procedure to assign an `sctpcsum` parameter value to all the cards running the **IPLIM** or **IPLIMI** applications. After the [Configuring an IP Card](#) procedure has been performed, continue the procedure with 5.
4. Verify that the **SCTP** checksum algorithm was changed using the `rtrv-sg-opts` command. The **SCTP** checksum algorithm option value is shown in the `SCTPCSUM` parameter. The following is an example of the possible output.

```
rlghncxa03w 06-10-28 21:16:37 GMT EAGLE5 36.0.0  
SCTPCSUM:      crc32c
```

The `rtrv-sg-opts` command output contains other fields that are not used by this procedure. If you wish to see all the fields displayed by the `rtrv-sg-opts` command, see the `rtrv-sg-opts` command description in *Commands User's Guide*.

5. Select one of the **IP** cards shown in the `rtrv-card` output in 2 running the **IPLIM** or **IPLIMI** applications. Place the signaling links on this card out of service using the `dact-slk` command. For this example, enter these commands.

```
dact-slk:loc=1308:link=a1  
dact-slk:loc=1308:link=b  
dact-slk:loc=1308:link=b2
```

When these commands have successfully completed, this message appears.

```
rlghncxa03w 06-10-12 09:12:36 GMT EAGLE5 36.0.0  
Deactivate Link message sent to card
```

6. Display the **IP** addresses of the **IP** links in the database by entering the `rtrv-ip-lnk` command. The following is an example of the possible output.

```
rlghncxa03w 08-12-28 21:17:37 GMT EAGLE5 40.0.0  
LOC  PORT IPADDR      SUBMASK      DUPLEX  SPEED MACTYPE AUTO  
MCAST
```

```

1202 A 192.1.1.10 255.255.255.0 HALF 10 DIX
NO NO
1202 B -----
NO NO
1205 A 192.1.1.12 255.255.255.0 HALF 10 DIX
NO NO
1205 B -----
NO NO
1207 A 192.1.1.14 255.255.255.0 HALF 10 DIX
NO NO
1207 B -----
NO NO
1303 A 192.1.1.20 255.255.255.0 HALF 10 DIX
NO NO
1303 B -----
NO NO
1305 A 192.1.1.22 255.255.255.0 HALF 10 DIX
NO NO
1305 B -----
NO NO
1308 A 192.1.1.24 255.255.255.0 HALF 10 DIX
NO NO
1308 B -----
NO NO
1315 A 192.1.1.50 255.255.255.0 HALF 10 DIX
NO NO
1315 B -----
NO NO
1317 A 192.1.1.52 255.255.255.0 HALF 10 DIX
NO NO
1317 B -----
NO NO

```

IP-LNK table is (16 of 2048) 1% full.

7. Display the current IP host information in the database by entering the `rtrv-ip-host:display=all` command. The following is an example of the possible output.

```
rlghncxa03w 08-12-28 21:17:37 GMT EAGLE5 40.0.0
```

```

LOCAL IPADDR LOCAL HOST
192.1.1.10 IPNODE1-1201
192.1.1.12 IPNODE1-1203
192.1.1.14 IPNODE1-1205
192.1.1.20 IPNODE2-1201
192.1.1.22 IPNODE2-1203
192.1.1.24 IPNODE2-1205
192.1.1.32 KC-HLR2
192.1.1.50 DN-MS1
192.1.1.52 DN-MS2

REMOTE IPADDR REMOTE HOST
150.1.1.5 NCDEPTECONOMIC_DEVELOPMENT.

```

```
SOUTHEASTERN_COORIDOR_ASHVL. GOV
```

```
IP Host table is (10 of 4096) .24% full
```

8. Display the associations assigned to the **IP** card specified in 5, using the `rtrv-assoc` command with the local host name of the associations assigned to the **IP** card. To find the local host name of the association, the card location of the **IP** card is assigned to an **IP** address in the **IP** link table (`rtrv-ip-lnk` output). The **IP** address is assigned to a hostname in the **IP** host table (`rtrv-ip-host` output).

For this example, the local host name of associations assigned to the **IP** card 1308 (the card specified in 5) is **IPNODE2-1205**. Enter this command.

```
rtrv-assoc:lhost=ipnode2-1205
```

The following is an example of the possible output.

```
rlghncxa03w 06-10-28 09:12:36 GMT EAGLE5 36.0.0
                CARD IPLNK
ANAME           LOC  PORT  LINK ADAPTER  LPORT  RPORT  OPEN  ALW
assoc2          1308 A    A1   M2PA    2187   1025   YES   YES
assoc4          1308 A    B    M2PA    3290   1025   YES   YES
assoc5          1308 A    B2   M2PA    1057   1025   YES   YES
```

```
IP Appl Sock/Assoc table is (9 of 4000) 1% full
Assoc Buffer Space Used (600 KB of 3200 KB) on LOC = 1308
```

9. Change the value of the `open` parameter of the associations shown in 8 to `no` by specifying the `chg-assoc` command with the `open=no` parameter. For this example, enter this command.

```
chg-assoc:aname=assoc2:open=no
```

```
chg-assoc:aname=assoc4:open=no
```

```
chg-assoc:aname=assoc5:open=no
```

When this command has successfully completed, this message should appear.

```
rlghncxa03w 06-10-28 09:12:36 GMT EAGLE5 36.0.0
CHG-ASSOC: MASP A - COMPLTD;
```

10. Change the value of the `open` parameter of the associations changed in 9 to `yes` by specifying the `chg-assoc` command with the `open=yes` parameter. For this example, enter this command.

```
chg-assoc:aname=assoc2:open=yes
```

```
chg-assoc:aname=assoc4:open=yes
```

```
chg-assoc:aname=assoc5:open=yes
```

When this command has successfully completed, this message should appear.

```
rlghncxa03w 06-10-28 09:12:36 GMT EAGLE5 36.0.0
CHG-ASSOC: MASP A - COMPLTD;
```

11. Verify the checksum algorithm that is assigned to the associations shown in 10 by entering the `sctp -a pass` command with the card location of the IP card specified in 5 and the name of the associations specified in 10. For this example, enter this command.

```
pass:loc=1308:cmd="sctp -a assoc2 "
```

The following is an example of the possible output.

```
rlghncxa03w 10-12-28 21:16:37 GMT EAGLE5 43.0.0
Aname          Local          Local  Primary
Remote
                IP Address      Port    Address      Port
assoc2         192.1.1.24     2187   192.168.112.4 1025
                192.1.1.24
```

```
Configuration                               State
Retransmission Mode = LIN                   State = OPEN
Min. Retransmission Timeout = 10000         ULP association id = 18
Max. Retransmission Timeout = 800000       Number of nets = 2
Max. Number of Retries = 10                 Inbound Streams = 1
Min. Congestion Window = 3000              Outbound Streams = 2
Inbound Streams = 2
Outbound Streams = 2
Checksum Algorithm = crc32c
Send/Rcv Buffer Size = 204800
```

Nets Data

```
IP Address 192.168.112.4   State Reachable
Port       1025                    Primary YES
MTU        1500                    cwnd  16384
ssthresh   16384                   RTO   120

IP Address 192.168.112.5   State Reachable
Port       7777                    Primary NO
MTU        1500                    cwnd  16384
ssthresh   16384                   RTO   120
```

```
Last Net Sent To = 192.168.112.4
Last Net Rcvd From = 192.168.112.4
Over All Error Count = 0
Peers Rwnd = 13880
My Rwnd = 16384
Max Window = 16384
Initial Seq Number = 24130
Next Sending Seq Number = 124686
Last Acked Seq Number = 124669
Maximum Outbound Char Count = 16384
Current Outbound Char Count = 2112
Number Unsent Char Count = 0
Outbound Data Chunk Count = 16
Number Unsent = 0
Number To Retransmit = 0
```



```

        ip datagrams rcvd = 155402
ip datagrams with data chunks rcvd = 120844
        data chunks rcvd = 367908
        data chunks read = 367900
        dup tsns rcvd = 8
        sacks rcvd = 38734
        gap ack blocks rcvd = 3
        heartbeat requests rcvd = 135
        heartbeat acks rcvd = 52
        heartbeat requests sent = 52
        ip datagrams sent = 129254
ip datagrams with data chunks sent = 73084
        data chunks sent = 396330
        retransmit data chunks sent = 135
        sacks sent = 64872
        send failed = 0
        retransmit timer count = 0
        consecutive retransmit timeouts = 0
RTT between RMIN and RMAX inclusive = 6
        RTT greater than RMAX = 0
        fast retransmit count = 135
        rcv timer count = 0
        heartbeat timer count = 244
        none left tosend = 0
        none left rwnd gate = 5
        none left cwnd gate = 8

```

;

```
rlghncxa03w 10-12-28 21:16:37 GMT EAGLE5 43.0.0
```

```
SCTP command complete
```

```
rlghncxa03w 08-04-28 21:16:37 GMT EAGLE5 38.0.0
```

Aname	Local	Local	Primary	Remote
	IP Address	Port	Address	Port
assoc2	192.1.1.24	2187	192.168.112.4	1025
	192.1.1.24			

Configuration	State
Retransmission Mode = LIN	State = OPEN
Min. Retransmission Timeout = 10	ULP association id = 18
Max. Retransmission Timeout = 800	Number of nets = 2
Max. Number of Retries = 10	Inbound Streams = 1
Min. Congestion Window = 3000	Outbound Streams = 2
Inbound Streams = 2	
Outbound Streams = 2	
Checksum Algorithm = crc32c	

```
Nets Data
```

IP Address	192.168.112.4	State	Reachable
Port	1025	Primary	YES
MTU	1500	cwnd	16384
ssthresh	16384	RTO	120
IP Address	192.168.112.5	State	Reachable
Port	7777	Primary	NO
MTU	1500	cwnd	16384
ssthresh	16384	RTO	120

```

Last Net Sent To = 192.168.112.4
Last Net Rcvd From = 192.168.112.4
Over All Error Count = 0
  Peers Rwnd = 13880
  My Rwnd = 16384
  Max Window = 16384
  Initial Seq Number = 24130
  Next Sending Seq Number = 124686
  Last Acked Seq Number = 124669
Maximum Outbound Char Count = 16384
Current Outbound Char Count = 2112
Number Unsent Char Count = 0
Outbound Data Chunk Count = 16
  Number Unsent = 0
  Number To Retransmit = 0

```

```

ip datagrams rcvd = 155402
ip datagrams with data chunks rcvd = 120844
  data chunks rcvd = 367908
  data chunks read = 367900
  dup tsns rcvd = 8
  sacks rcvd = 38734
  gap ack blocks rcvd = 3
  heartbeat requests rcvd = 135
  heartbeat acks rcvd = 52
  heartbeat requests sent = 52
  ip datagrams sent = 129254
ip datagrams with data chunks sent = 73084
  data chunks sent = 396330
  retransmit data chunks sent = 135
  sacks sent = 64872
  send failed = 0
  retransmit timer count = 0
  consecutive retransmit timeouts = 0
RTT between RMIN and RMAX inclusive = 6
  RTT greater than RMAX = 0
  fast retransmit count = 135
  rcv timer count = 0
  heartbeat timer count = 244
  none left tosend = 0
  none left rwnd gate = 5
  none left cwnd gate = 8

```

```

;

rlghncxa03w 08-04-28 21:16:37 GMT EAGLE5 38.0.0

SCTP command complete

```

```
pass:loc=1308:cmd="sctp -a assoc4 "
```

The following is an example of the possible output.

```

rlghncxa03w 10-12-28 21:16:37 GMT EAGLE5 43.0.0
Aname          Local          Local  Primary      Remote
               IP Address     Port   Address      Port
assoc4         192.1.1.24    3290   192.168.112.4 1025
               192.1.1.24

Configuration                                State
Retransmission Mode = LIN                    State = OPEN
Min. Retransmission Timeout = 10000          ULP association id = 18
Max. Retransmission Timeout = 800000        Number of nets = 2
Max. Number of Retries = 10                 Inbound Streams = 1
Min. Congestion Window = 3000              Outbound Streams = 2
      Inbound Streams = 2
      Outbound Streams = 2
Checksum Algorithm = crc32c
Send/Rcv Buffer Size = 204800

Nets Data

IP Address    192.168.112.4    State    Reachable
Port          1025             Primary  YES
MTU           1500            cwnd    16384
ssthresh     16384           RTO     120

IP Address    192.168.112.5    State    Reachable
Port          7777            Primary  NO
MTU           1500            cwnd    16384
ssthresh     16384           RTO     120

Last Net Sent To = 192.168.112.4
Last Net Rcvd From = 192.168.112.4
Over All Eror Count = 0
      Peers Rwnd = 13880
      My Rwnd = 16384
      Max Window = 16384
      Initial Seq Number = 24130
      Next Sending Seq Number = 124686
      Last Acked Seq Number = 124669
Maximum Outbound Char Count = 16384
Current Outbound Char Count = 2112
      Number Unsent Char Count = 0
Outbound Data Chunk Count = 16
      Number Unsent = 0
      Number To Retransmit = 0

```

```

        ip datagrams rcvd = 155402
ip datagrams with data chunks rcvd = 120844
        data chunks rcvd = 367908
        data chunks read = 367900
            dup tsns rcvd = 8
            sacks rcvd = 38734
        gap ack blocks rcvd = 3
        heartbeat requests rcvd = 135
        heartbeat acks rcvd = 52
        heartbeat requests sent = 52
        ip datagrams sent = 129254
ip datagrams with data chunks sent = 73084
        data chunks sent = 396330
        retransmit data chunks sent = 135
            sacks sent = 64872
            send failed = 0
        retransmit timer count = 0
        consecutive retransmit timeouts = 0
RTT between RMIN and RMAX inclusive = 6
        RTT greater than RMAX = 0
        fast retransmit count = 135
            rcv timer count = 0
        heartbeat timer count = 244
            none left tosend = 0
            none left rwnd gate = 5
            none left cwnd gate = 8

```

```
;
```

```
rlghncxa03w 10-12-28 21:16:37 GMT EAGLE5 43.0.0
```

```
SCTP command complete
```

```
rlghncxa03w 08-04-28 21:16:37 GMT EAGLE5 38.0.0
```

Aname	Local	Local	Primary	
Remote				
	IP Address	Port	Address	Port
assoc4	192.1.1.24	3290	192.168.112.4	1025
	192.1.1.24			

Configuration	State
Retransmission Mode = LIN	State = OPEN
Min. Retransmission Timeout = 10	ULP association id = 18
Max. Retransmission Timeout = 800	Number of nets = 2
Max. Number of Retries = 10	Inbound Streams = 1
Min. Congestion Window = 3000	Outbound Streams = 2
Inbound Streams = 2	
Outbound Streams = 2	
Checksum Algorithm = crc32c	

Nets Data

IP Address	192.168.112.4	State	Reachable
Port	1025	Primary	YES
MTU	1500	cwnd	16384
ssthresh	16384	RTO	120
IP Address	192.168.112.5	State	Reachable
Port	7777	Primary	NO
MTU	1500	cwnd	16384
ssthresh	16384	RTO	120

Last Net Sent To = 192.168.112.4

Last Net Rcvd From = 192.168.112.4

Over All Eror Count = 0

Peers Rwnd = 13880

My Rwnd = 16384

Max Window = 16384

Initial Seq Number = 24130

Next Sending Seq Number = 124686

Last Acked Seq Number = 124669

Maximum Outbound Char Count = 16384

Current Outbound Char Count = 2112

Number Unsent Char Count = 0

Outbound Data Chunk Count = 16

Number Unsent = 0

Number To Retransmit = 0

ip datagrams rcvd = 155402

ip datagrams with data chunks rcvd = 120844

data chunks rcvd = 367908

data chunks read = 367900

dup tsns rcvd = 8

sacks rcvd = 38734

gap ack blocks rcvd = 3

heartbeat requests rcvd = 135

heartbeat acks rcvd = 52

heartbeat requests sent = 52

ip datagrams sent = 129254

ip datagrams with data chunks sent = 73084

data chunks sent = 396330

retransmit data chunks sent = 135

sacks sent = 64872

send failed = 0

retransmit timer count = 0

consecutive retransmit timeouts = 0

RTT between RMIN and RMAX inclusive = 6

RTT greater than RMAX = 0

fast retransmit count = 135

recv timer count = 0

heartbeat timer count = 244

none left tosend = 0

none left rwnd gate = 5

none left cwnd gate = 8

```

;

rlghncxa03w 08-04-28 21:16:37 GMT EAGLE5 38.0.0

SCTP command complete

```

```
pass:loc=1308:cmd="sctp -a assoc5 "
```

The following is an example of the possible output.

```

rlghncxa03w 10-12-28 21:16:37 GMT EAGLE5 43.0.0
Aname          Local          Local  Primary
Remote
                IP Address      Port    Address      Port
assoc5         192.1.1.24     1057   192.168.112.4 1025
                192.1.1.24

```

```

                Configuration                      State
Retransmission Mode = LIN                        State = OPEN
Min. Retransmission Timeout = 10000             ULP association id = 18
Max. Retransmission Timeout = 800000           Number of nets = 2
Max. Number of Retries = 10                     Inbound Streams = 1
Min. Congestion Window = 3000                   Outbound Streams = 2
Inbound Streams = 2
Outbound Streams = 2
Checksum Algorithm = crc32c
Send/Rcv Buffer Size = 204800

```

Nets Data

```

IP Address      192.168.112.4      State    Reachable
Port            1025                  Primary  YES
MTU             1500                  cwnd    16384
ssthresh        16384                 RTO     120

IP Address      192.168.112.5      State    Reachable
Port            7777                  Primary  NO
MTU             1500                  cwnd    16384
ssthresh        16384                 RTO     120

```

```

Last Net Sent To = 192.168.112.4
Last Net Rcvd From = 192.168.112.4
Over All Eror Count = 0
Peers Rwnd = 13880
My Rwnd = 16384
Max Window = 16384
Initial Seq Number = 24130
Next Sending Seq Number = 124686
Last Acked Seq Number = 124669
Maximum Outbound Char Count = 16384
Current Outbound Char Count = 2112
Number Unsent Char Count = 0

```

```

Outbound Data Chunk Count = 16
      Number Unsent = 0
      Number To Retransmit = 0

      ip datagrams rcvd = 155402
ip datagrams with data chunks rcvd = 120844
      data chunks rcvd = 367908
      data chunks read = 367900
      dup tsns rcvd = 8
      sacks rcvd = 38734
      gap ack blocks rcvd = 3
      heartbeat requests rcvd = 135
      heartbeat acks rcvd = 52
      heartbeat requests sent = 52
      ip datagrams sent = 129254
ip datagrams with data chunks sent = 73084
      data chunks sent = 396330
      retransmit data chunks sent = 135
      sacks sent = 64872
      send failed = 0
      retransmit timer count = 0
      consecutive retransmit timeouts = 0
RTT between RMIN and RMAX inclusive = 6
      RTT greater than RMAX = 0
      fast retransmit count = 135
      rcv timer count = 0
      heartbeat timer count = 244
      none left tosend = 0
      none left rwnd gate = 5
      none left cwnd gate = 8

;

rlghncxa03w 10-12-28 21:16:37 GMT EAGLE5 43.0.0

SCTP command complete

rlghncxa03w 08-04-28 21:16:37 GMT EAGLE5 38.0.0
Aname          Local          Local Primary      Remote
                IP Address      Port   Address      Port
assoc5         192.1.1.24     1057   192.168.112.4 1025
                192.1.1.24

Configuration                                     State
Retransmission Mode = LIN                          State = OPEN
Min. Retransmission Timeout = 10                    ULP association id = 18
Max. Retransmission Timeout = 800                   Number of nets = 2
Max. Number of Retries = 10                          Inbound Streams = 1
Min. Congestion Window = 3000                       Outbound Streams = 2
Inbound Streams = 2
Outbound Streams = 2
Checksum Algorithm = crc32c

```

Nets Data

IP Address	192.168.112.4	State	Reachable
Port	1025	Primary	YES
MTU	1500	cwnd	16384
ssthresh	16384	RTO	120
IP Address	192.168.112.5	State	Reachable
Port	7777	Primary	NO
MTU	1500	cwnd	16384
ssthresh	16384	RTO	120

Last Net Sent To = 192.168.112.4

Last Net Rcvd From = 192.168.112.4

Over All Error Count = 0

Peers Rwnd = 13880

My Rwnd = 16384

Max Window = 16384

Initial Seq Number = 24130

Next Sending Seq Number = 124686

Last Acked Seq Number = 124669

Maximum Outbound Char Count = 16384

Current Outbound Char Count = 2112

Number Unsent Char Count = 0

Outbound Data Chunk Count = 16

Number Unsent = 0

Number To Retransmit = 0

ip datagrams rcvd = 155402

ip datagrams with data chunks rcvd = 120844

data chunks rcvd = 367908

data chunks read = 367900

dup tsns rcvd = 8

sacks rcvd = 38734

gap ack blocks rcvd = 3

heartbeat requests rcvd = 135

heartbeat acks rcvd = 52

heartbeat requests sent = 52

ip datagrams sent = 129254

ip datagrams with data chunks sent = 73084

data chunks sent = 396330

retransmit data chunks sent = 135

sacks sent = 64872

send failed = 0

retransmit timer count = 0

consecutive retransmit timeouts = 0

RTT between RMIN and RMAX inclusive = 6

RTT greater than RMAX = 0

fast retransmit count = 135

recv timer count = 0

heartbeat timer count = 244

none left tosend = 0


```

none left rwnd gate = 5
none left cwnd gate = 8

;

rlghncxa03w 08-04-28 21:16:37 GMT EAGLE5 38.0.0

SCTP command complete

```

If the checksum algorithm shown in any of the associations displayed in this step do not match the checksum algorithm specified in 3, contact the Customer Care Center. Refer to [My Oracle Support \(MOS\)](#) for the contact information.

If the checksum algorithm shown in all of the associations displayed in this step match the checksum algorithm specified in 3, continue the procedure with 12.

12. Put the signaling links that were placed out of service in 5 back into service using the `act-slk` command. For example, enter this command.

```

act-slk:loc=1308:link=a1
act-slk:loc=1308:link=b
act-slk:loc=1308:link=b2

```

When these commands have successfully completed, this message appears.

```

rlghncxa03w 06-10-07 11:11:28 GMT EAGLE5 36.0.0
Activate Link message sent to card

```

13. Verify the in-service normal (**IS-NR**) status of the signaling link by using the `rept-stat-slk` command and specifying the card location and link values specified in 12.

For example, enter these commands.

```
rept-stat-slk:loc=1308:link=a1
```

This message should appear.

```

rlghncxa03w 06-10-28 21:16:37 GMT EAGLE5 36.0.0
SLK      LSN      CLLI      PST      SST      AST
1308,A1  ipnode1  -----  IS-NR    Avail    ----
Command Completed.

```

```
rept-stat-slk:loc=1308:link=b
```

This message should appear.

```

rlghncxa03w 06-10-28 21:16:37 GMT EAGLE5 36.0.0
SLK      LSN      CLLI      PST      SST      AST
1308,B   ipnode3  -----  IS-NR    Avail    ----
Command Completed.

```

```
rept-stat-slk:loc=1308:link=b2
```

This message should appear.

```
rlghncxa03w 06-10-28 21:16:37 GMT EAGLE5 36.0.0
SLK      LSN      CLLI      PST      SST      AST
1308,B2  ipnode4  -----  IS-NR    Avail    ----
Command Completed.
```

14. Enter the `netstat -p sctp pass` command with the card location of the IP card to determine if any errors have occurred. For this example, enter this command.

```
pass:loc=1308:cmd="netstat -p sctp"
```

The following is an example of the possible output.

```
rlghncxa03w 08-04-28 21:16:37 GMT EAGLE5 38.0.0
ip packets sent..... 1474882
  ip packets sent with data chunk..... 306354
  control chunks (excluding retransmissions)..... 1172759
  ordered data chunks (excluding retransmissions).. 1534350
  unordered data chunks (excluding retransmissions) 0
  user messages fragmented due to MTU..... 0
  retransmit data chunks sent..... 4
  sacks sent..... 496302
  send failed..... 0
ip packets received..... 1816035
  ip packets received with data chunk..... 989957
  control chunks (excluding duplicates)..... 833141
  ordered data chunks (excluding duplicates)..... 989968
  unordered data chunks (excluding duplicates).... 0
  user messages reassembled..... 0
  data chunks read..... 988601
  duplicate tsns received..... 0
  sacks received..... 153763
  gap ack blocks received..... 0
  out of the blue..... 4
  with invalid checksum..... 0
connections established..... 2954
  by upper layer..... 0
  by remote endpoint..... 2958
connections terminated..... 4
  ungracefully..... 2952
  gracefully..... 0
associations dropped due to retransmits..... 0
consecutive retransmit timeouts..... 4
retransmit timer count..... 6
fast retransmit count..... 0
heartbeat requests received..... 330275
heartbeat acks received..... 340239
heartbeat requests sent..... 340258
associations supported..... 50
milliseconds cookie life at 4-way start-up handshake. 5000
retransmission attempts allowed at start-up phase.... 8
```

;

```
rlghncxa03w 08-04-28 21:16:37 GMT EAGLE5 38.0.0
```

```
NETSTAT command complete
```

If errors are shown in the pass command output, contact the Customer Care Center. Refer to [My Oracle Support \(MOS\)](#) for the contact information.

15. Repeat 5 through 14 to update the other **IP** cards in the **EAGLE** running the **IPLIM** and **IPLIMI** applications with the new **SCTP** checksum algorithm.

If the `rtrv-card` output in 2 shows cards running the **SS7IPGW**, **IPGWI**, or **IPSG** applications, continue the procedure with 17.

16. Back up the database by entering the `chg-db:action=backup:dest=fixed` command. These messages should appear, the active **Maintenance and Administration Subsystem Processor (MASP)** appears first.

```
BACKUP (FIXED) : MASP A - Backup starts on active MASP.  
BACKUP (FIXED) : MASP A - Backup on active MASP to fixed disk complete.  
BACKUP (FIXED) : MASP A - Backup starts on standby MASP.  
BACKUP (FIXED) : MASP A - Backup on standby MASP to fixed disk complete.
```

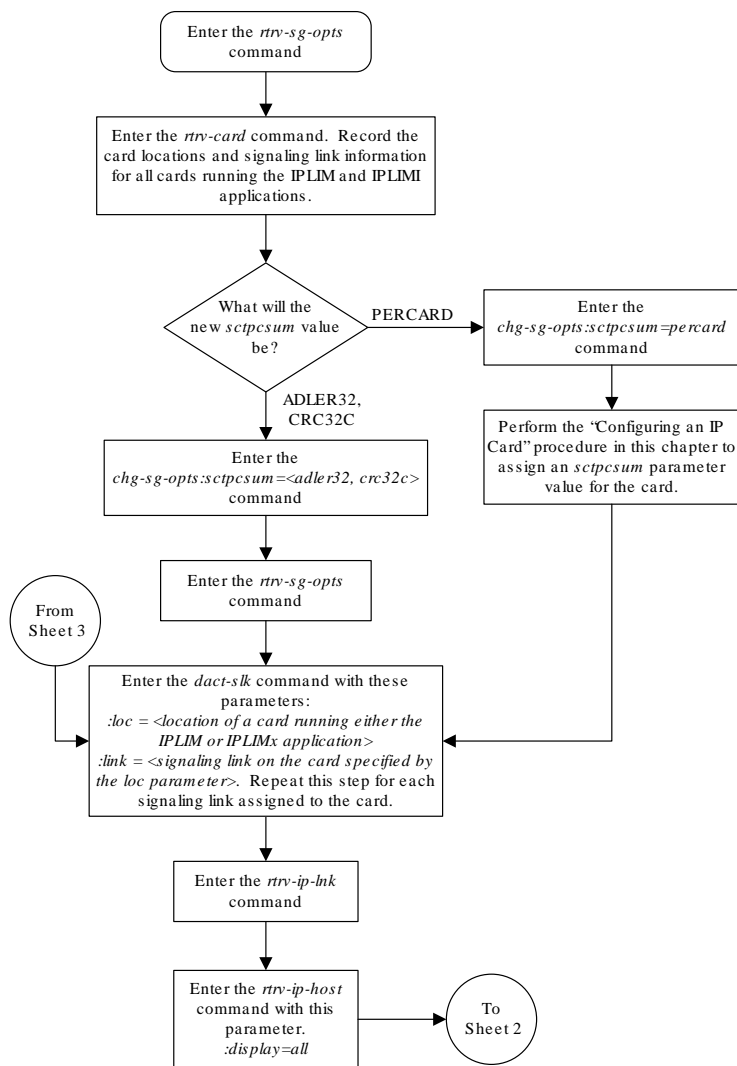
17. If the `rtrv-card` output in 2 shows cards running the **SS7IPGW** or **IPGWI** applications, perform the [Changing the SCTP Checksum Algorithm Option for M3UA and SUA Associations](#) procedure.

If the `rtrv-card` output in 2 shows cards running the **IPSG** application, perform these procedures.

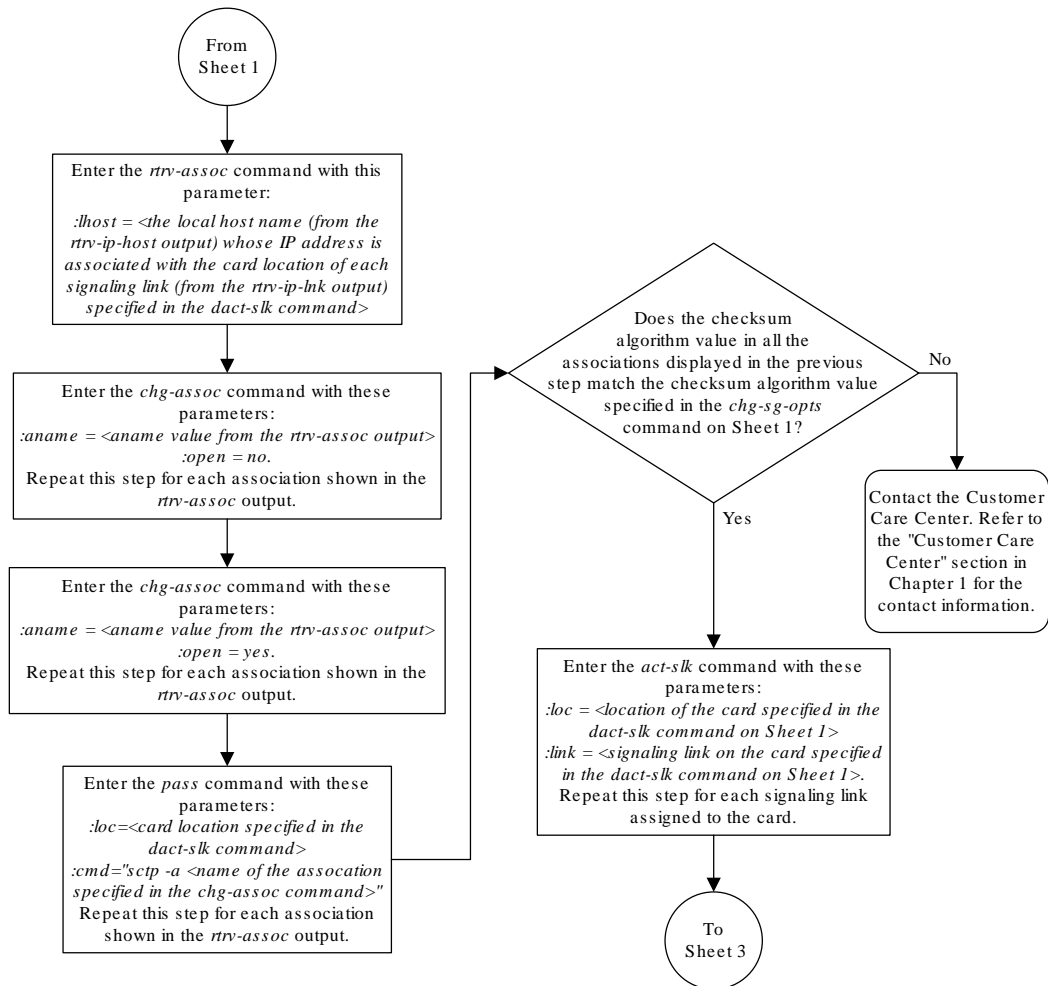
- [Changing the SCTP Checksum Algorithm Option for IPSG M3UA Associations](#)
- [Changing the SCTP Checksum Algorithm Option for IPSG M2PA Associations](#)

If the `rtrv-card` output in 2 shows that there are no cards running the **SS7IPGW**, **IPGWI**, or **IPSG** applications, this procedure is finished.

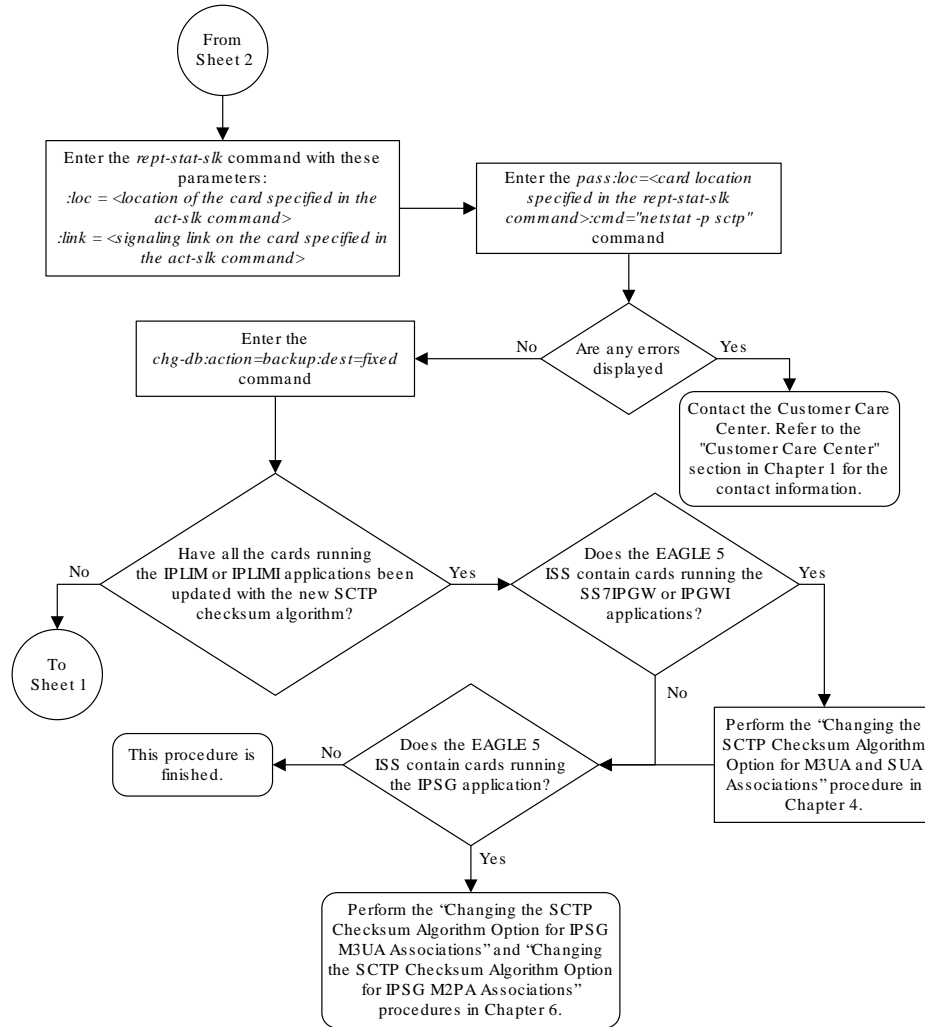
Figure 3-23 Changing the SCTP Checksum Algorithm Option for M2PA Associations



Sheet 1 of 3



Sheet 2 of 3



Sheet 3 of 3

3.24 Turning Off the Large MSU Support for IP Signaling Feature

This procedure is used to turn off the Large **MSU** Support for **IP** Signaling feature, using the `chg-ctrl-feat` command.

The `chg-ctrl-feat` command uses these parameters:

`:partnum` – The part number of the Large MSU Support for IP Signaling feature, 893018401.

`:status=off` – used to turn off the Large MSU Support for IP Signaling feature.

The status of the Large MSU Support for IP Signaling feature must be on and is shown with the `rtrv-ctrl-feat` command.

▲ Caution:

If the Large MSU Support for IP Signaling feature is turned off, the EAGLE will not process messages with a signaling information field (**SIF**) that is larger than 272 bytes.

1. Display the status of the Large MSU Support for IP Signaling feature by entering the `rtrv-ctrl-feat:partnum=893018401` command. The following is an example of the possible output.

```
rlghncxa03w 10-04-28 21:15:37 GMT EAGLE5 42.0.0
```

The following features have been permanently enabled:

Feature Name	Partnum	Status	Quantity
Large MSU for IP Sig	893018401	on	----

The following features have been temporarily enabled:

Feature Name	Partnum	Status	Quantity	Trial Period Left
Zero entries found.				

The following features have expired temporary keys:

Feature Name	Partnum
Zero entries found.	

If the status of the Large MSU Support for IP Signaling feature is off, or if the Large MSU Support for IP Signaling feature is not enabled, this procedure cannot be performed.

2. Turn off the Large MSU Support for IP Signaling feature by entering the `chg-ctrl-feat` command with the `status=off` parameter. For example, enter this command.

```
chg-ctrl-feat:partnum=893018401:status=off
```

When this command has successfully completed, the following message should appear.

```
rlghncxa03w 06-10-28 21:15:37 GMT EAGLE5 36.0.0
```

```
CHG-CTRL-FEAT: MASP B - COMPLTD
```

3. Verify that the Large MSU Support for IP Signaling feature has been turned off by using the `rtrv-ctrl-feat:partnum=893018401` command. The following is an example of the possible output.

```
rlghncxa03w 10-04-28 21:15:37 GMT EAGLE5 42.0.0
The following features have been permanently enabled:
```

Feature Name	Partnum	Status	Quantity
Large MSU for IP Sig	893018401	off	----

The following features have been temporarily enabled:

Feature Name	Partnum	Status	Quantity	Trial Period Left
Zero entries found.				

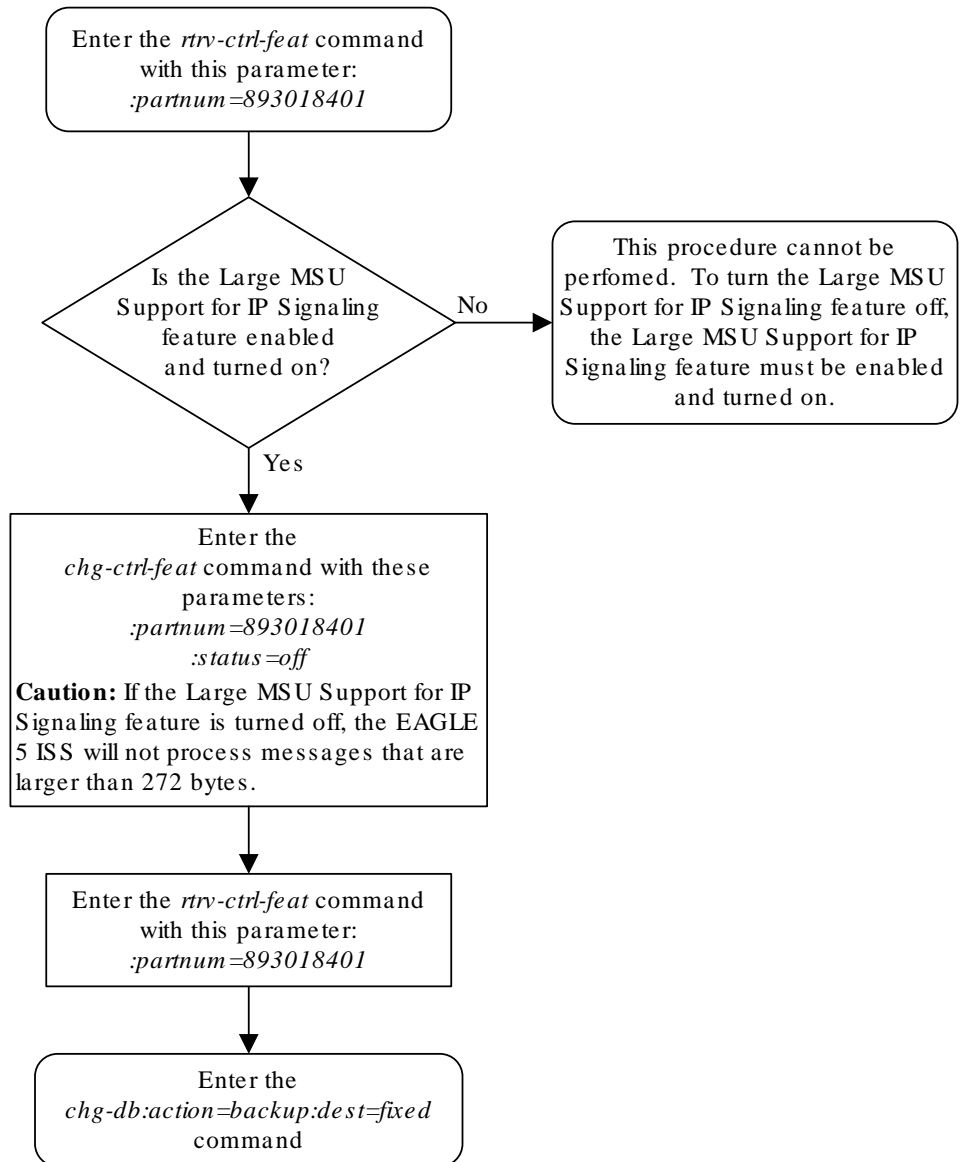
The following features have expired temporary keys:

Feature Name	Partnum
Zero entries found.	

4. Back up the new changes using the `chg-db:action=backup:dest=fixed` command. These messages should appear, the active **Maintenance and Administration Subsystem Processor (MASP)** appears first.

```
BACKUP (FIXED) : MASP A - Backup starts on active MASP.
BACKUP (FIXED) : MASP A - Backup on active MASP to fixed disk
complete.
BACKUP (FIXED) : MASP A - Backup starts on standby MASP.
BACKUP (FIXED) : MASP A - Backup on standby MASP to fixed disk
complete.
```


Figure 3-24 Turning Off the Large MSU Support for IP Signaling Feature



4

IETF M3UA and SUA Configuration Procedures

Chapter 4, IETF M3UA and SUA Configuration Procedures, describes the procedures necessary to configure the components necessary to establish IP connections using M3UA or SUA associations on IPGWx signaling links.

4.1 Adding IETF M3UA and SUA Components

This section describes how to configure the components necessary to establish IP connections using M3UA or SUA associations on IPGWx signaling links. IPGWx signaling links are signaling links assigned to cards running either the SS7IPGW or IPGWI applications. The SS7IPGW application supports point-to-multipoint connectivity for ANSI networks. The IPGWI application supports point-to-multipoint connectivity for ITU networks.

The configuration of these IP connections consists of these items.

1. Configure the IPGWx card with the [Adding an IPGWx Card](#) procedure. Turn the ISUP-over-IP (ipisup) feature with the `chg-feat` command.

Note:

Before turning on the ISUP-over-IP feature (ipisup) feature, make sure you have purchased these features. If you are not sure whether you have purchased the ISUP-over-IP feature, contact your Oracle Sales Representative or Account Representative. Once a feature has been turned on with the `chg-feat` command, the feature cannot be turned off.

2. Configure the required destination point codes - see Chapter 2, "Configuring Destination Tables," in *Database Administration - SS7 User's Guide*.
3. Configure the required IPGWx linksets with the [Configuring an IPGWx Linkset](#) procedure. If you wish to add a mate IPGWx linkset to another IPGWx linkset, perform the [Adding a Mate IPGWx Linkset to another IPGWx Linkset](#) procedure.
4. Configure the IPGWx signaling links with the [Adding an IPGWx Signaling Link](#) procedure. If the addition of these signaling links will exceed the current number of signaling links the EAGLE is allowed to have, the [Enabling the Large System # Links Controlled Feature](#) procedure will have to be performed to increase the quantity of signaling links.
5. Configure the required routes - see Chapter 3, "SS7 Configuration," in *Database Administration - SS7 User's Guide*.
6. IP addresses must be assigned to the IPGWx card configured in step 1 by performing the [Configuring an IP Link](#) procedure. There are other IP link parameters that are assigned to the IPGWx card when the IPGWx card is configured. Default values are assigned to these parameters when the IPGWx card is configured. These values can be displayed by the `rtrv-ip-lnk` command. These values can be changed by performing the [Configuring an IP Link](#) procedure.

7. Local **IP** hosts, assigned to the **IP** addresses assigned to step 6, must be configured in the database by performing the [Adding an IP Host](#) procedure. Verify the hosts with the `rtrv-ip-host` command. This establishes a relationship between the **IP** card related information and the connection related information.
8. When the **IP** cards are added to the database in step 1, there are **IP** parameters that control the **IP** stack that are assigned default values. These parameter values can be displayed by the `rtrv-ip-card` command. These values can be changed by performing the [Configuring an IP Card](#) procedure.
9. Static **IP** routes provide more flexibility in selecting the path to the remote destination and reduces the dependence on default routers. Static **IP** routes are provisioned by performing the [Adding an IP Route](#) procedure.
10. Associations specify a connection between a local host/**TCP** port and a remote host/**TCP** port. Three types of associations can be provisioned: **M2PA**, **M3UA**, and **SUA**. Associations that are assigned to IPGWx signaling links must be either **M3UA** or **SUA** associations. The **M3UA** and **SUA** associations are configured by performing the [Adding an M3UA or SUA Association](#) procedure. **M2PA** associations that are assigned to IPLIMx signaling links are provisioned with the [Adding an M2PA Association](#) procedure in [IETF M2PA Configuration Procedures](#). Associations can be assigned to IPSG signaling links also. These associations are configured by performing the [Adding an IPSG M2PA Association](#) or [Adding an IPSG M3UA Association](#) procedures. A number of fields in the association cannot be configured with the [Adding an M3UA or SUA Association](#) procedure and are set to default values. The values of these fields can be displayed using the `rtrv-assoc` command after the [Adding an M3UA or SUA Association](#) procedure is performed. These values can be changed by performing these procedures: [Changing the Attributes of a M3UA or SUA Association](#), [Changing the Buffer Size of a M3UA or SUA Association](#). Only one signaling link can be assigned to an IPGWx card. A maximum of 50 IP connections can be assigned to an IPGWx card.
11. When an **M3UA** or **SUA** association is added to the database, **UA** parameter set 10 is assigned to the association. There are 10 **UA** parameter sets that can be assigned to an association, but the **UA** parameter set assignment can be changed, using the [Changing the Attributes of a M3UA or SUA Association](#) procedure. The values assigned to each **UA** parameter set can be changed, except for **UA** parameter set 10, using the [Changing a UA Parameter Set](#) procedure.
12. The application server contains a set of one to 16 associations, of which one or more is normally actively processing traffic. Application servers are configured by performing one of these procedures:
 - [Adding a New Association to a New Application Server](#)
 - [Adding an Existing Association to a New Application Server](#)
 - [Adding a New Association to an Existing Application Server](#)
 - [Adding an Existing Association to an Existing Application Server](#)If the associations assigned to application server are **M3UA** associations, and the `open` parameter value for these associations is `yes`, then the same **UA** parameter set must be assigned to all of the associations in the application server.
13. Routing keys specify **MSU** filters for the **IP** connection. Configure the routing keys with the [Adding a Routing Key Containing an Application Server](#) procedure.

14. An internal point code can be provisioned to provide routing to an IP end office node. Configure the internal point codes by performing the [Adding an End Node Internal Point Code](#) procedure.
15. The network appearance field identifies the **SS7** network context for the message, for the purpose of logically separating the signaling traffic between the **SGP** (signaling gateway process) and the application server over a common **SCTP** (stream control transmission protocol) association. This field is contained in the **DATA**, **DUNA**, **DAVA**, **DRST**, **DAUD**, **SCON**, and **DUPU** messages. Network appearances are configured by performing the [Adding a Network Appearance](#) procedure.
16. The EAGLE processes messages with a service information field (**SIF**) that is 272 bytes or smaller. The Large MSU Support for IP Signaling feature allows the EAGLE to process messages with a service indicator value of 6 to 15 and with a SIF that is larger than 272 bytes. Perform the [Activating the Large MSU Support for IP Signaling Feature](#) procedure to enable and turn on the Large MSU Support for IP Signaling feature.

4.2 Adding an IPGWx Card

This procedure is used to add an IPGWx card to the database using the `ent-card` command. An IPGWx card is a card that is running either the SS7IPGW or IPGWI applications. [Table 4-1](#) shows the cards that can be provisioned in this procedure.

Table 4-1 IPGWx Card Types

Card Type	Part Number
E5-ENET	870-2212-xx
E5-ENET-B	870-2971-xx

The EAGLE can support a combination of E5-ENET and E5-ENET-B cards.

The `ent-card` command uses these parameters.

`:loc` – The location of the card being added to the database.

`:type` – The type of card being added to the database. For this procedure, the value of this parameter is `dcm`.

`:appl` – The application software that is assigned to the card. For this procedure, the value of this parameter is `ss7ipgw` for ANSI IP network connections or `ipgwi` for ITU IP network connections.

`:force` – If the global title translation feature is on, the `force=yes` parameter allows the LIM to be added to the database even if the current SCCP transactions-per-second threshold is unable to support the additional SCCP transaction-per-second capacity created by adding the IP card. This parameter is obsolete and is no longer used.

If you have purchased the ISUP-over-IP (`ipisup`) feature, verify that the ISUP-over-IP feature is turned on (`ipisup=on`) using the `rtrv-feat` command. If the appropriate feature is off, turn it on with the `chg-feat` command. For more information on the ISUP-over-IP feature, refer to section [Point-to-Multipoint Connectivity \(SS7IPGW and IPGWI\)](#).

 **Note:**

Before turning on the ISUP-over-IP feature (`ipisup`), make sure you have purchased this feature. If you are not sure whether you have purchased the ISUP-over-IP feature, contact your Oracle Sales Representative or Account Representative. Once a feature has been turned on with the `chg-feat` command, the feature cannot be turned off.

Card Slot Selection

The E5-ENET card can be inserted into any card slot, except for card slots that must remain empty to accommodate dual-slot cards, slots 09 and 10 in each shelf, and slots 1113 through 1118.

To provision a E5-ENET card, the shelf containing the E5-ENET card must have HIPR2 cards installed in slots 9 and 10 in that shelf. If HIPR2 cards are not installed in the shelf that the E5-ENET card will occupy, the E5-ENET card will be auto-inhibited when the E5-ENET card is inserted into the shelf. Enter the `rept-stat-gpl:gpl=hipr2` command to verify whether or not HIPR2 cards are installed in the same shelf as the E5-ENET card being provisioned in this procedure.

1. Display the cards in the database using the `rtrv-card` command.

This is an example of the possible output. Cards should be distributed throughout the EAGLE for proper power distribution. Refer to *Installation Guide* for the shelf power distribution.

```
rlghncxa03w 09-03-05 08:12:53 GMT 41.0.0
CARD   TYPE      APPL      LSET NAME      LINK SLC LSET NAME
LINK SLC
1101   DSM        VSCCP
1102   TSM        GLS
1113   GSPM      EOAM
1114   TDM-A
1115   GSPM      EOAM
1116   TDM-B
1117   MDAL
1201   LIMDS0    SS7ANSI   sp2            A    0    sp1
B    0
1203   LIMDS0    SS7ANSI   sp3            A    0
1204   LIMDS0    SS7ANSI   sp3            A    1
1206   LIMDS0    SS7ANSI   nsp3           A    1    nsp4
B    1
1301   LIMDS0    SS7ANSI   sp6            A    1    sp7
B    0
1302   LIMDS0    SS7ANSI   sp7            A    1    sp5
B    1
1303   DCM       IPLIM     ipnode1        A    0    ipnode3
B    1
1305   DCM       IPLIM     ipnode4        A    0
2101   ENET      IPG
2103   ENET      IPG
2105   ENET      IPG
2107   ENET      IPG
```

```

2201 DCM IPLIM
2203 DCM IPLIM
2207 DCM IPLIM
2211 DCM SS7IPGW
2213 DCM SS7IPGW
2215 DCM IPGWI
2217 DCM IPGWI
2301 DCM SS7IPGW
2303 DCM SS7IPGW
2305 DCM IPGWI
2307 DCM IPGWI
2311 DCM IPLIMI
2313 DCM IPLIMI

```

If the required unprovisioned card slots (see the [Card Slot Selection](#) section) are shown in the `rtrv-card` output, continue the procedure with [4](#).

If the required unprovisioned card slots are not shown in the `rtrv-card` output, [2](#) must be performed.

2. Display the shelves in the database by entering the `rtrv-shlf` command. This is an example of the possible output.

```

rlghncxa03w 08-03-05 08:12:53 GMT 38.0.0
SHELF DISPLAY
FRAME SHELF TYPE
1 1 CONTROL
1 2 EXTENSION
1 3 EXTENSION
2 1 EXTENSION
2 2 EXTENSION
2 3 EXTENSION

```

If all the shelves are provisioned in the database, this procedure cannot be performed. There are no available card slots for the new IPGWx card.

If all the shelves have not been provisioned in the database, continue the procedure with [3](#).

3. Add the required shelf using the `ent-shlf` command with the location of the shelf and the `type=ext` parameter. The shelf location values are 1200, 1300, 2100, 2200, 2300, 3100, 3200, 3300, 4100, 4200, 4300, 5100, 5200, 5300, and 6100. For this example, enter this command.

```
ent-shlf:loc=3100:type=ext
```

When this command has successfully completed, this message should appear.

```

rlghncxa03w 07-05-01 09:12:36 GMT EAGLE5 37.0.0
ENT-SHLF: MASP A - COMPLTD

```

4. Verify that the card to be entered has been physically installed into the proper location (see the [Card Slot Selection](#) section). If the card has not been installed, insert the card into the desired card location following the rules described in the [Card Slot Selection](#) section.

 **Caution:**

If the versions of the flash GPLs on the IP card do not match the flash GPL versions in the database when the IP card is inserted into the card slot, UAM 0002 is generated indicating that these GPL versions do not match. If UAM 0002 has been generated, perform the alarm clearing procedure for UAM 0002 in *Unsolicted Alarm and Information Messages* before proceeding with this procedure.

If the ISUP-over-IP feature will be used, continue the procedure with 5.

If the ISUP-over-IP feature will not be used, continue the procedure with one of these actions.

- If the card being added in this procedure is not an E5-ENET card, continue the procedure with 12.
- If the card being added in this procedure is an E5-ENET card, continue the procedure with 7.

5. Verify the ISUP-over-IP feature is on by entering the `rtrv-feat` command.

If the ISUP-over-IP feature is on, the `ipisup` field is set to `on`.

 **Note:**

The `rtrv-feat` command output contains other fields that are not used by this procedure. If you wish to see all the fields displayed by the `rtrv-feat` command, see the `rtrv-feat` command description in the *Commands User's Guide*.

If the ISUP-over-IP feature is on, continue the procedure with one of these actions.

- If the card being added in this procedure is not an E5-ENET card, continue the procedure with 12.
- If the card being added in this procedure is an E5-ENET card, continue the procedure with 7.

If the ISUP-over-IP feature is not on, continue the procedure with 6.

6. Turn the ISUP-over-IP feature on by entering this command.

To enable the ISUP-over-IP feature, enter this command.

```
chg-feat:ipisup=on
```

 **Note:**

Once the ISUP-over-IP feature is turned on with the `chg-feat` command, it cannot be turned off.

 **Note:**

The ISUP-over-IP feature must be purchased before turning them on. If you are not sure whether you have purchased the ISUP-over-IP feature, contact your Sales Representative or Account Representative.

When this command has successfully completed, this message should appear.

```
rlghncxa03w 06-10-12 09:12:36 GMT EAGLE5 36.0.0
CHG-FEAT: MASP A - COMPLTD
```

After the ISUP-over-IP feature is turned on, continue the procedure with one of these actions.

- If the card being added in this procedure is not an E5-ENET card, continue the procedure with [12](#).
 - If the card being added in this procedure is an E5-ENET card, continue the procedure with [7](#).
7. Verify that HIPR2 cards are installed in card locations 9 and 10 in the shelf containing the E5-ENET card being added in this procedure. Enter this command.

```
rept-stat-gpl:gpl=hipr2
```

This is an example of the possible output.

```
rlghncxa03w 09-07-05 08:12:53 GMT 41.1.0
GPL          CARD      RUNNING          APPROVED        TRIAL
HIPR2       1109      132-002-000     132-002-000     132-003-000
HIPR2       1110      132-002-000     132-002-000     132-003-000
HIPR2       1209      132-002-000     132-002-000     132-003-000
HIPR2       1210      132-002-000     132-002-000     132-003-000
HIPR2       1309      132-002-000     132-002-000     132-003-000
HIPR2       1310      132-002-000     132-002-000     132-003-000
HIPR2       2109      132-002-000     132-002-000     132-003-000
HIPR2       2110      132-002-000     132-002-000     132-003-000
HIPR2       2209      132-002-000     132-002-000     132-003-000
HIPR2       2210      132-002-000     132-002-000     132-003-000
HIPR2       2309      132-002-000     132-002-000     132-003-000
HIPR2       2310      132-002-000     132-002-000     132-003-000
Command Completed
```

If HIPR2 cards are installed in the shelf containing the E5-ENET card, continue the procedure with [12](#).

If HIPR2 cards are not installed on the shelf containing the E5-ENET card, go to *Installation Guide* and install the HIPR2 cards. Once the HIPR2 cards have been installed, continue the procedure with [12](#).

8. Enter the `rtrv-stpopts` command to verify whether or not the MFC option is on.

This is an example of the possible output.

```
rlghncxa03w 11-10-17 16:02:05 GMT EAGLE5 44.0.0
STP OPTIONS
```



```
-----
MFC                               off
```

The `rtrv-stpopts` command output contains other fields that are not used by this procedure. To see all fields displayed by the `rtrv-stpopts` command, see the `rtrv-stpopts` command description in the *Commands User's Guide*.

If the MFC option is off, perform the Configuring the MFC Option procedure in *Database Administration - System Management User's Guide* to turn on the MFC option.

If the MFC option is on or the Configuring the MFC Option procedure in *Database Administration - System Management User's Guide* was performed in this step, continue the procedure with [9](#).

9. The Fan feature must be turned on. If the `rtrv-feat` command in [5](#) was not performed, enter the `rtrv-feat` command to verify that the Fan feature is on.

If the Fan feature is on, shown in either the `rtrv-feat` output in this step or in [6](#) if [13](#) was performed, the `FAN` field should be set to `on`.

The `rtrv-feat` command output contains other fields that are not used by this procedure. To see all fields displayed by the `rtrv-feat` command, see the `rtrv-feat` command description in *Commands User's Guide*.

If the Fan feature is on, continue the procedure with [11](#).

If the Fan feature is off, continue the procedure with [10](#).

10. Turn the Fan feature on by entering this command.

```
chg-feat:fan=on
```

 **Note:**

Once the Fan feature is turned on with the `chg-feat` command, it cannot be turned off.

When the `chg-feat` has successfully completed, this message appears.

```
rlghncxa03w 11-10-28 11:43:04 GMT EAGLE5 44.0.0
CHG-FEAT: MASP A - COMPLTD
```

11. The shelf containing the E5-ENET-B card that is being added in this procedure must have fans installed. Verify whether or not fans are installed on the shelf.

If the fans are installed, continue the procedure with [12](#).

If the fans are not installed on the shelf containing the E5-ENET-B card, go to *Installation User's Guide* and install the fans. After the fans have been installed and tested, continue the procedure with [12](#).

12. Add the card using the `ent-card` command.

For this example, enter these commands.

```
ent-card:loc=1315:type=dcm:appl=ss7ipgw
ent-card:loc=1317:type=dcm:appl=ipgwi
```

When each of these commands have successfully completed, this message should appear.

```
rlghncxa03w 06-10-12 09:12:36 GMT EAGLE5 36.0.0
ENT-CARD: MASP A - COMPLTD
```

13. Verify the changes using the `rtrv-card` command with the card location specified in [12](#).

For this example, enter these commands.

```
rtrv-card:loc=1315
```

This is an example of the possible output.

```
rlghncxa03w 06-10-28 09:12:36 GMT EAGLE5 36.0.0
CARD   TYPE      APPL      LSET NAME      LINK SLC LSET NAME      LINK SLC
1315   DCM          SS7IPGW
```

```
rtrv-card:loc=1317
```

This is an example of the possible output.

```
rlghncxa03w 06-10-28 09:12:36 GMT EAGLE5 36.0.0
CARD   TYPE      APPL      LSET NAME      LINK SLC LSET NAME      LINK SLC
1317   DCM          IPGWI
```

14. Back up the new changes using the `chg-db:action=backup:dest=fixed` command.

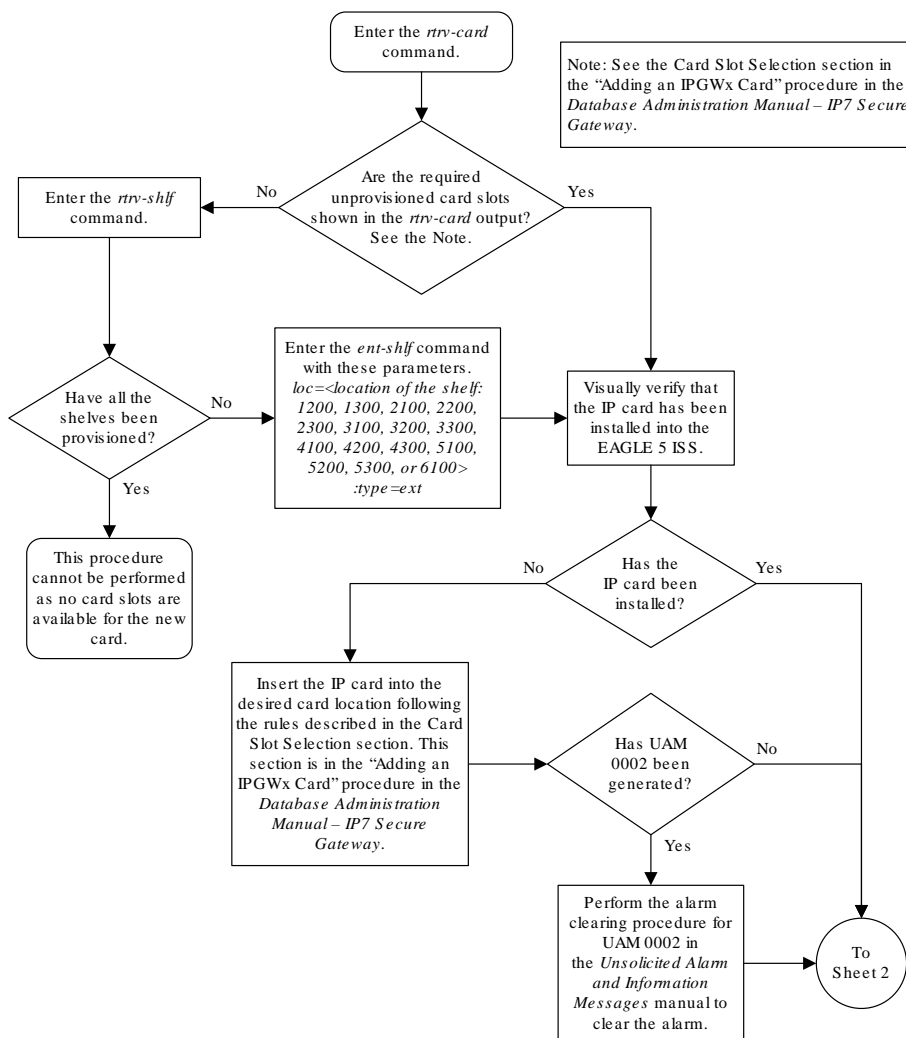
These messages should appear, the active Maintenance and Administration Subsystem Processor (MASP) appears first.

```
BACKUP (FIXED) : MASP A - Backup starts on active MASP.
BACKUP (FIXED) : MASP A - Backup on active MASP to fixed disk complete.
BACKUP (FIXED) : MASP A - Backup starts on standby MASP.
BACKUP (FIXED) : MASP A - Backup on standby MASP to fixed disk complete.
```

15. If you wish to change the quantity of static routing keys in the database, perform the [Changing IP Options](#) procedure.

Otherwise, this procedure is finished.

Figure 4-1 Add an IPGWx Card - Sheet 1 of 3



Note:

Before executing this procedure, make sure you have purchased the ISUP-over-IP feature. If you are not sure whether you have purchased the ISUP-over-IP feature, contact your Sales Representative or Account Representative.

Figure 4-2 Add an IPGWx Card - Sheet 2 of 3

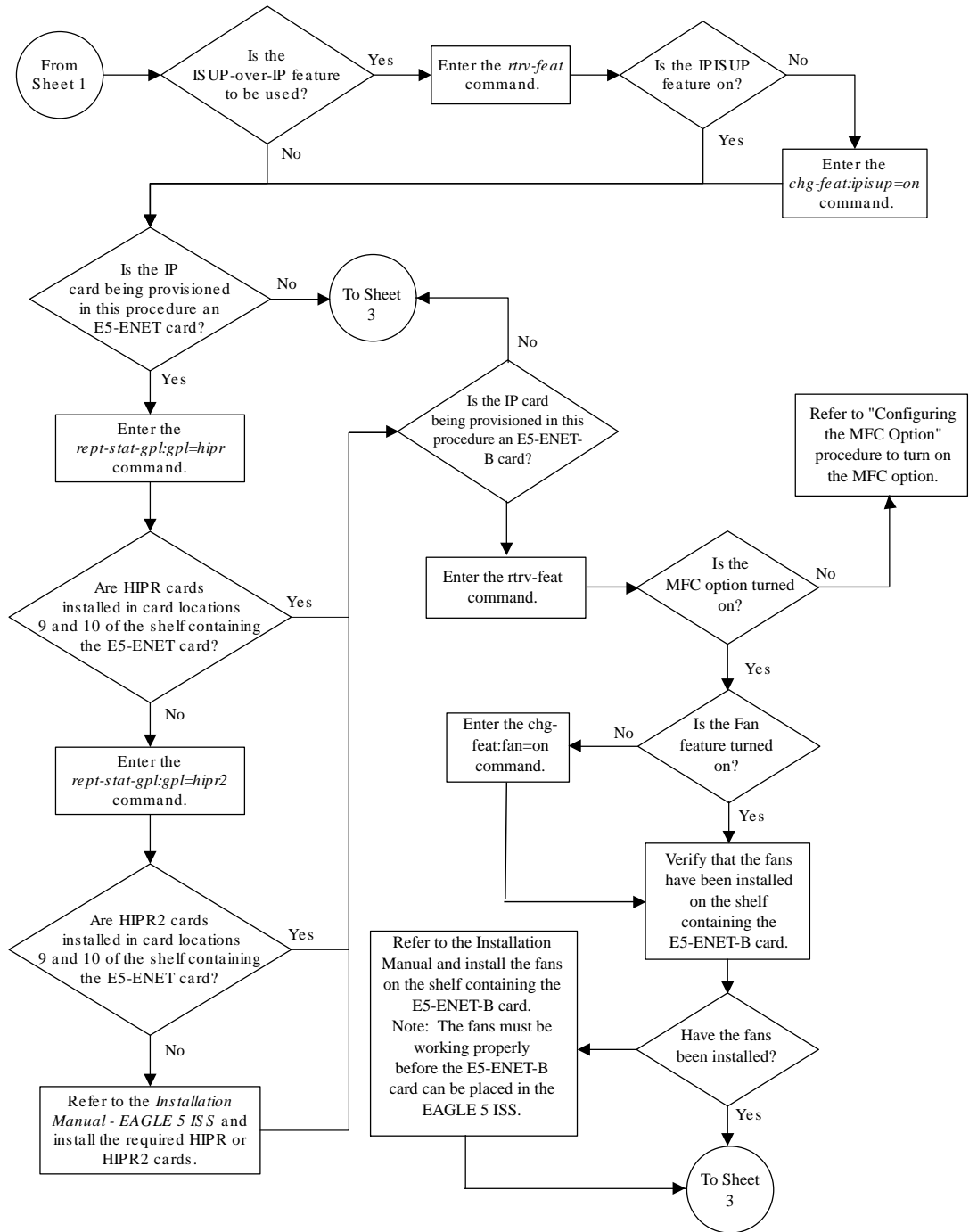
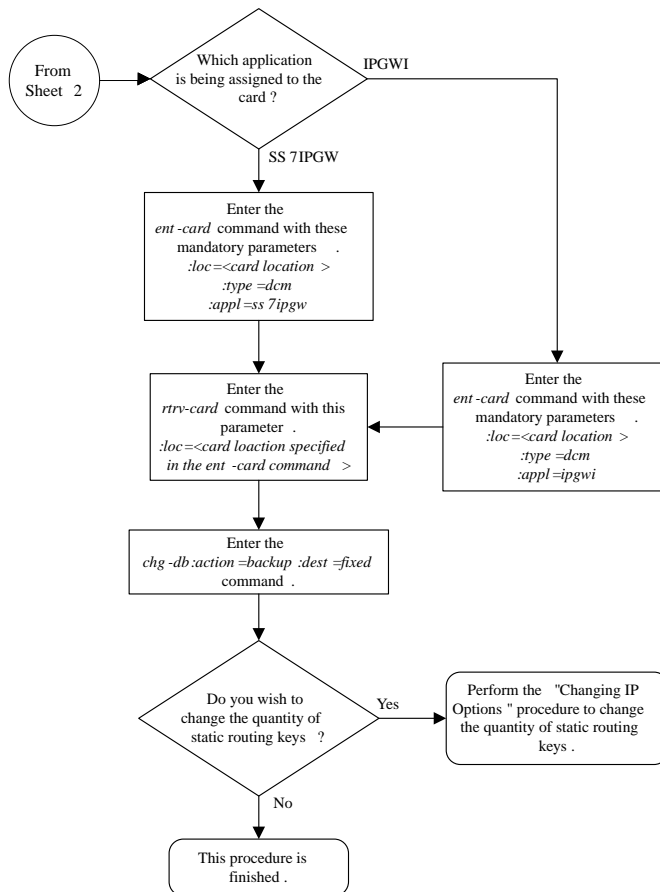


Figure 4-3 Add an IPGWx Card - Sheet 3 of 3



4.3 Configuring an IPGWx Linkset

This procedure is used to configure **IPGWx** linksets in the **EAGLE** using the `ent-ls` or `chg-ls` commands with these parameters. An **IPGWx** linkset is a linkset that contains signaling links running either the **SS7IPGW** or **IPGWI** applications.

 **Note:**

This procedure is not used to configure a mate **IPGWx** linkset, with the `matelsn` and `action` parameters. To configure a mate **IPGWx** linkset, perform procedure.

`:lsn` – The name of the linkset. The linkset name can contain up to 10 characters, with the first character being a letter. However, the **SEAS** interface supports only eight characters. If this linkset is displayed on the **SEAS** interface and the linkset name contains more than eight characters, only the first eight characters in the linkset name are shown. If this linkset name contains more than eight characters, and is specified with the linkset commands on the **SEAS** interface, only the first eight characters can be specified.

`:apc/apca/apci/apcn/apcn24` – Adjacent point code – the point code identifying the node that is next to the **EAGLE**. The adjacent point code can be one of the following types of point codes:

`:apc/apca` – **ANSI** point code, **ANSI** private point code

`:apci` – **ITU-I** point code, **ITU-I** spare point code, **ITU-I** private point code, **ITU-I** private spare point code.

`:apcn` – 14-bit **ITU-N** point code, 14-bit **ITU-N** spare point code, 14-bit **ITU-N** private point code, 14-bit **ITU-N** private spare point code.

`:apcn24` – 24-bit **ITU-N** point code, 24-bit **ITU-N** private point code.

 **Note:**

See the “**Point Code Formats**” section in *Database Administration - SS7 User's Guide* for a definition of the point code types that are used on the **EAGLE** and for a definition of the different formats that can be used for **ITU** national point codes.

 **Note:**

The `apc/apca/apci/apcn/apcn24` parameter must be specified with the `ent-ls` command. Specifying this parameter with the `chg-ls` command is required only if the adjacent point code of the linkset is being changed.

`:lst` – The linkset type of the specified linkset - The `lst` parameter must be specified with the `ent-ls` command. Specifying this parameter with the `chg-ls` command is required only if the linkset type of the linkset is being changed.

`:ipgwapc` – **IP Gateway Adjacent Point Code** indicator. Specify the `ipgwapc=yes` parameter to provide **SS7** linkset definition compatibility for gateway connections to **IP-SCPs**. This parameter can be specified only for, and must be specified for, linksets containing signaling links assigned to either the **SS7IPGW** or **IPGWI** applications. The default is `ipgwapc=no`.

 **Note:**

The `ipgwapc` parameter can be specified only with the `ent-ls` command.

To provision **ISUP-CIC** routing keys, the `ipgwapc=yes` parameter and the **IP Gateway ISUP** routing feature must be turned on. Verify this with the `rtrv-feat` command. If the **IP Gateway ISUP** routing feature is turned on, the `ipisup` field should be set to `on`. If the **IP Gateway ISUP** routing feature is not turned on, enter the `chg-feat:ipisup=on` command.

 **Note:**

Once the **IP Gateway ISUP** routing feature is turned on with the `chg-feat` command, it cannot be turned off.

 **Note:**

The **IP Gateway ISUP** routing feature must be purchased before you turn the feature on with the `chg-feat` command. If you are not sure if you have purchased the **IP Gateway ISUP** routing feature, contact your Oracle Sales Representative or Account Representative.

`:iptps` – The quantity of IP TPS (transactions per second) that is assigned to the **IPGWx** linkset, from 100 to 32,000. The total amount of the IP TPS for all **IPGWx** linksets cannot exceed the total provisioned system TPS value in the `rtrv-tps` output..

`:lsusealm` – The linkset's IPTPS alarm threshold, from 10 to 100 percent of the linkset's IPTPS. When this threshold is reached, a major alarm (**UAM 0115**) is generated. When the linkset's IPTPS falls below this threshold, **UAM 0115** is automatically cleared and **UAM 0118** is generated.

`:slkusealm` – The signaling link IPTPS alarm threshold, from 10 to 100 percent of the signaling link's fair share of the linkset's IPTPS or from 10 to 100 percent of the **IPGWx** card's capacity (4000 TPS). This threshold is reached when the signaling link's actual usage exceeds the percentage of the signaling link's fair share of the linkset's IPTPS or the percentage of the **IPGWx** card's capacity.

A signaling link's fair share of linkset's IPTPS is the linkset's IPTPS divided by the number of in-service links in the linkset. For example, if the linkset IPTPS is 4000 and there are 4 signaling links in the linkset, all in-service, then the signaling link's fair-share would be 1000 IPTPS ($4000/4=1000$). [Table 4-2](#) shows this calculation for a linkset with 1, 2, 3 and 4 in-service signaling links.

Table 4-2 Signaling Link Fair Share Example

Number of In-Service Signaling Links	Linkset IPTPS	Signaling Link Fair Share of the Linkset IPTPS
4	4000	1000
3	4000	1333
2	4000	2000
1	4000	4000

When this threshold is exceeded, a minor alarm (**UAM 0116**) is generated. When the amount of traffic on the signaling link falls below this threshold, **UAM 0116** is automatically cleared and **UAM 0119** is generated.

The signaling link IPTPS alarm shows that the linkset IPTPS is set too low for the linkset or that the **IPGWx** card's capacity has been exceeded. Setting the signaling link IPTPS alarm threshold lower than the linkset IPTPS alarm threshold can give the user an earlier indication that the linkset IPTPS is inadequate or that traffic is not balanced across the links in the linkset.

`:multgpc` – specifies whether multiple group codes (for 14-bit **ITU-N** point codes) are supported for the linkset. When this parameter value is `yes`, secondary adjacent point codes whose group codes are different from the adjacent point code of the linkset can be assigned to the linkset. If the parameter value is `no`, the group code of the secondary adjacent point code must be the same as the group code of the linkset's adjacent point code. For more information on secondary adjacent point codes, go to the “Configuring an **ITU** Linkset with a Secondary **Adjacent Point Code (SAPC)**” procedure in the *Database Administration - SS7 User's Guide*.

This parameter only applies to linksets whose adjacent point codes are either **ITU** international point codes or **ITU** national point codes. All the signaling links in this linkset must be assigned to cards running the **IPGWI** application. For more information on assigning signaling links to cards running the **IPGWI** application, go to the [Adding an IPGWx Signaling Link](#) procedure.

The **ITU** duplicate point code feature must be on before this parameter can be specified. Verify this with the `rtvr-feat` command. If the **ITU** duplicate point code feature is turned on, the `ituduppc` field should be set to `on`. If the **ITU** duplicate point code feature is not turned on, enter the `chg-feat:ituduppc=on` command.

 **Note:**

Once the **ITU** duplicate point code feature is turned on with the `chg-feat` command, it cannot be turned off.

The **ITU** duplicate point code feature must be purchased before you turn the feature on with the `chg-feat` command. If you are not sure if you have purchased the **ITU** duplicate point code feature, contact your Oracle Sales Representative or Account Representative.

Adding the IPGWx linkset cannot exceed the maximum total provisioned system TPS shown in the `rtvr-tps` output. An IPGWx linkset uses 4000 TPS.

If adding the IPGWx linkset will exceed the maximum total provisioned system TPS, and the maximum total provisioned system TPS is 500,000, perform the "Activating the HIPR2 High Rate Mode" feature in *Database Administration - System Management User's Guide* to enable and turn on the HIPR2 High Rate Mode feature. When the HIPR2 High Rate Mode feature is enabled and turned on, the maximum total provisioned system TPS is increased to 1,000,000 (1M). If the maximum total provisioned system TPS is 1M, or the maximum total provisioned system TPS is 500,000 and will not be increased, and adding the IPGWx linkset will exceed the maximum total provisioned system TPS, the IPGWx linkset cannot be added unless the amount of available TPS is reduced enough to allow the IPGWx linkset to be added. The available TPS can be reduced by performing one or more of these actions.

- The IP TPS values of some IPGWx linksets have to be changed.
- The MAXSLKTPS values of some IPGW linksets (and the RSVDSLKTPS values if necessary) have to be changed.
- Some ATM high-speed signaling links have to be removed.
- An IPLIMx card that contains signaling links has to be removed.

The adjacent point code (**APC**) for the linkset must be defined in the database, must be in the SS7 domain and cannot match the point code or capability point code of the EAGLE. The domain of the point code is shown in the `DMN` field in the output of the `rtrv-dstn` command. The point code of the EAGLE is shown in the `PCA`, `PCN`, `PCN24`, or `PCI` fields and the capability point code of the **EAGLE** are shown in the `CPCA`, `CPCN`, `CPCN24`, or `CPCI` fields in the output of the `rtrv-sid` command. An **ANSI** adjacent point code must be a full point code and cannot be a cluster point code or a network routing point code. The adjacent point code of the linkset cannot be a proxy point code, cannot have a proxy point code assigned to it, and cannot be assigned to another linkset.

If the **APC** is not in the destination point code table, go to the "Adding a **Destination Point Code**" procedure in *Database Administration - SS7 User's Guide* and add the **APC** to the destination point code table.

For **IPGWx** linksets, more than one device may be attached to the **LAN** and have **IP** connections to the **IP** card running either the **SS7IPGW** or **IPGWI** application. Thus each **IPGWx** linkset is adjacent to all devices on the **LAN** (or adjacent to no device on the **LAN**, depending on your point of view). To provide a scheme allowing this point-to-multipoint connection and maintain consistent **SS7** linkset definition rules, a virtual **APC** is required. This virtual **APC** is a real **SS7** point code that is not used anywhere else in the **SS7** network. Virtual **APCs** assigned to **SS7IPGW** linksets are **ANSI** point codes. Virtual **APCs** assigned to **IPGWI** linksets are either **ITU-I** or **ITU-N** point codes (either 14-bit or 24-bit **ITU-N** point codes). Virtual point codes can be reused on more than one switch. For example, a mated set of switches, each with two related links, could share two virtual point codes instead of requiring four. **DPCs** and linksets related to the virtual **APC** must be defined with the `ipgwapc` parameter set to `yes`.

For provisioning of **ISUP-CIC** routing keys, the `ipgwapc=yes` parameter and the **IP** Gateway **ISUP** routing feature must be turned on. Verify this with the `rtrv-feat` command. If the **IP** Gateway **ISUP** routing feature is turned on, the `ipisup` field should be set to `on`. If the **IP** Gateway **ISUP** routing feature is not turned on, enter the `chg-feat:ipisup=on` command.

 **Note:**

Once the IP Gateway **ISUP** routing feature is turned on with the `chg-feat` command, it cannot be turned off.

The IP Gateway **ISUP** routing feature must be purchased before you turn the feature on with the `chg-feat` command. If you are not sure if you have purchased the IP Gateway **ISUP** routing feature, contact your Oracle Sales Representative or Account Representative.

Other Optional Parameters

There are other optional parameters that can be used to configure an IPGWx linkset. These parameters are not required for configuring an IPGWx linkset. These parameters are discussed in more detail in *Commands User's Guide* or in these sections.

- These procedures in this manual:
 - [Adding a Mate IPGWx Linkset to another IPGWx Linkset](#)
 - [Removing a Mate IPGWx Linkset from another IPGWx Linkset](#)
 - [Adding an IPSG M2PA Linkset](#)
 - [Adding an IPSG M3UA Linkset](#)
 - [Changing an IPSG M2PA Linkset](#)
 - [Changing an IPSG M3UA Linkset](#)
- These procedures in *Database Administration - SS7 User's Guide*
 - Adding an SS7 Linkset
 - Changing an SS7 Linkset
 - Configuring an ITU Linkset with a Secondary Adjacent Point Code (SAPC)
- The "Configuring a Linkset for the GSM MAP Screening Feature" procedure in *Database Administration - Features User's Guide*.

 **Note:**

The `mtprse`, `spc/spca/spci/spcn/spcn24`, and `ppc/ppca/ppci/ppcn/ppcn24` parameters cannot be specified for an **IPGWx** linkset.

Canceling the `RTRV-LS` and `RTRV-DSTN` Commands

Because the `rtrv-ls` and `rtrv-dstn` commands used in this procedure can output information for a long period of time, the `rtrv-ls` and `rtrv-dstn` commands can be canceled and the output to the terminal stopped. There are three ways that the `rtrv-ls` and `rtrv-dstn` commands can be canceled.

- Press the F9 function key on the keyboard at the terminal where the `rtrv-ls` or `rtrv-dstn` commands were entered.
- Enter the `canc-cmd` without the `trm` parameter at the terminal where the `rtrv-ls` or `rtrv-dstn` commands were entered.

- Enter the `canc-cmd:trm=<xx>`, where `<xx>` is the terminal where the `rtrv-ls` or `rtrv-dstn` commands were entered, from another terminal other than the terminal where the `rtrv-ls` or `rtrv-dstn` commands were entered. To enter the `canc-cmd:trm=<xx>` command, the terminal must allow Security Administration commands to be entered from it and the user must be allowed to enter Security Administration commands. The terminal's permissions can be verified with the `rtrv-secu-trm` command. The user's permissions can be verified with the `rtrv-user` or `rtrv-secu-user` commands.

For more information about the `canc-cmd` command, go to *Commands User's Guide*.

1. Display the total provisioned system TPS by entering the `rtrv-tps` command.

This is an example of the possible output.

```
rlghncxa03w 10-07-10 16:20:46 GMT EAGLE 42.0.0
```

CARD TYPE	NUM CARDS	NUM LINKS	RSVD TPS	MAX TPS
IPGW	17	16	48000	80000
IPSG	3	7	4200	8000
IPLIM	2	4	8000	8000
ATM	2	2	3668	3668

```
Total provisioned System TPS (99668 of 500000) 20%
```

```
Command Completed.
```

An IPGWx linkset uses 4000 TPS. If configuring the linkset will not exceed the maximum total provisioned system TPS, continue the procedure with 7.

If configuring the IPGWx linkset will exceed the maximum total provisioned system TPS, continue the procedure by performing one of these actions.

- If the maximum total provisioned system TPS is 500,000 and you wish to change and the maximum total provisioned system TPS to 1M, perform the "Activating the HIPR2 High Rate Mode" feature in *Database Administration - System Management User's Guide* to enable and turn on the HIPR2 High Rate Mode feature. When the HIPR2 High Rate Mode feature is enabled and turned on, the maximum total provisioned system TPS is increased to 1M. After the HIPR2 High Rate Mode feature has been enabled and turned on, continue the procedure with 7.
- If the maximum total provisioned system TPS is 1M, or the maximum total provisioned system TPS is 500,000 and will not be increased, and adding the IPGWx linkset will exceed the maximum total provisioned system TPS, the IPGWx linkset cannot be added unless the amount of available TPS is reduced enough to allow the IPGWx linkset to be added. The available TPS can be increased by performing one or more of these actions.
 - The IP TPS values of some IPGWx linksets have to be changed. To perform this action, continue the procedure with 4.
 - The MAXSLKTPS values of some IPSG linksets (and the RSVDSLKTPS values if necessary) have to be changed. To perform this action, continue the procedure with 4.

- Some ATM high-speed signaling links have to be removed. To perform this action, continue the procedure with 2.
- An IPLIMx card that contains signaling links has to be removed. To perform this action, continue the procedure with 3.

2. Display the ATM high-speed signaling links by entering this command.

```
rtrv-slk:type=saal
```

This is an example of the possible output.

```
rlghncxa03w 10-07-19 21:16:37 GMT EAGLE5 42.0.0
```

LOC	LINK	LSN	SLC	TYPE	LP	ATM	VCI	VPI	LL	
					SET	BPS	TSEL			
1303	A	lsnds0	1	LIMATM	1	1.544M	LINE	5	0	0

LOC	LINK	LSN	SLC	TYPE	LP	ATM	VCI	VPI	CRC4	SI
					SET	BPS	TSEL			
1306	A	lsnituatm	0	LIME1ATM	21	2.048M	LINE	5	0	ON 3 0

```
SLK table is (30 of 1200) 2% full.
```

If ATM high-speed signaling links are shown in the `rtrv-slk` output, perform the "Removing an SS7 Signaling Link" procedure in *Database Administration - SS7 User's Guide* to remove some of the ATM high-speed signaling links.

If ATM high-speed signaling links are not displayed in the `rtrv-slk` output, perform one or more of these actions to increase the available TPS.

 **Note:**

If one or more of these actions are not performed to increase the available TPS and the available TPS will not allow the IPGWx linkset to be added, the IPGWx linkset cannot be added and the remainder of this procedure cannot be performed.

- The IP TPS values of some IPGWx linksets have to be changed. To perform this action, continue the procedure with 4.
- The MAXSLKTPS values of some IPGWx linksets (and the RSVDSLKTPS values if necessary) have to be changed. To perform this action, continue the procedure with 4.
- An IPLIMx card that contains signaling links has to be removed. To perform this action, continue the procedure with 3.

If you do not wish to perform other actions to increase the available TPS and the available TPS will allow the IPGWx linkset to be added, continue the procedure with 7.

3. Display the signaling links that are assigned to IPLIMx cards by entering this command.

```
rtrv-slk:type=iplim
```

This is an example of the possible output.

```
rlghncxa03w 10-07-19 21:16:37 GMT EAGLE5 42.0.0

LOC LINK LSN          SLC TYPE   ANAME          SLKTPS
1301 A   lsniplim  0   IPLIM   M2PA
1301 A1  lsniplim  1   IPLIM   M2PA
1301 B1  lsniplim  2   IPLIM   M2PA
1317 A   lsniplimi 0   IPLIMI  M2PA
```

SLK table is (30 of 1200) 2% full.

If IPLIMx cards containing signaling links are shown in the `rtrv-slk` output, perform the [Removing an IPLIMx Card](#) procedure to remove an IPLIMx card and its associated signaling links.

If IPLIMx cards containing signaling links are not displayed in the `rtrv-slk` output, perform one or more of these actions to increase the available TPS.

 **Note:**

If one or more of these actions are not performed to increase the available TPS and the available TPS will not allow the IPGWx linkset to be added, the IPGWx linkset cannot be added and the remainder of this procedure cannot be performed.

- The IP TPS values of some IPGWx linksets have to be changed. To perform this action, continue the procedure with [4](#).
- The MAXSLKTPS values of some IPSP linksets (and the RSVDSLKTPS values if necessary) have to be changed. To perform this action, continue the procedure with [4](#).
- Some ATM high-speed signaling links have to be removed. To perform this action, continue the procedure with [2](#).

If you do not wish to perform other actions to increase the available TPS and the available TPS will allow the IPGWx linkset to be added, continue the procedure with [7](#).

4. Display the IPGWx and IPSP linksets by entering this command.

```
rept-stat-iptps
```

This is an example of the possible output.

```
rlghncxa03w 10-07-19 21:16:37 GMT EAGLE5 42.0.0
IP TPS USAGE REPORT

          THRESH  CONFIG/  CONFIG/          TPS   PEAK
PEAKTIMESTAMP          RSVD      MAX
-----
```

```

LSN
ipgwx1105      70%      ----      10000  TX:   3700   4000  10-07-19 09:49:19
                                     RCV:   3650   4000  10-07-19 09:49:19
ipgwx1         100%      ----      32000  TX:   3700   4000  10-07-19 09:49:19
                                     RCV:   3650   4000  10-07-19 09:49:19
ipgwx2         100%      ----      16000  TX:   4800   5000  10-07-19 09:49:09
                                     RCV:   4850   5000  10-07-19 09:49:09
ipgwx3         100%      ----      32000  TX:    427    550  10-07-19 09:49:19
                                     RCV:    312    450  10-07-19 09:49:19
ipsglsn        100%        600     24000  TX:   4800   5000  10-07-19 09:49:19
                                     RCV:   4800   5000  10-07-19
09:49:19
ipsglsn2       100%        600      4000  TX:    427    550  10-07-19 09:49:19
                                     RCV:    312    450  10-07-19
09:49:19
-----

```

Command Completed.

If linksets are displayed in the `rept-stat-iptps` output, continue the procedure with 5.

If linksets are not displayed in the `rept-stat-iptps` output, perform one or more of these actions to increase the available TPS.

 **Note:**

If one or more of these actions are not performed to increase the available TPS and the available TPS will not allow the IPGWx linkset to be added, the IPGWx linkset cannot be added and the remainder of this procedure cannot be performed.

- An IPLIMx card that contains signaling links has to be removed. To perform this action, continue the procedure with 3.
- Some ATM high-speed signaling links have to be removed. To perform this action, continue the procedure with 2.

If you do not wish to perform other actions to increase the available TPS and the available TPS will allow the IPGWx linkset to be added, continue the procedure with 7.

5. Display the attributes of the linksets shown in 4 by entering the `rtrv-ls` command with the name of the linkset shown in 4. If an existing IPGWx linkset is being changed in 20, that linkset does not need to be displayed in this step.

For this example enter these commands.

```
rtrv-ls:lsn=ipgwx1
```

This is an example of the possible output.

```

rlghncxa03w 10-07-19 21:16:37 GMT EAGLE5 42.0.0

                                     L3T SLT                                     GWS GWS GWS
LSN          APCA   (SS7)  SCRN SET SET BEI LST LNKS ACT MES DIS SLSCI
NIS

```

```

ipgwx1      001-001-002  none 1  1  no  A  8  off off off
no         off

          SPCA          CLLI          TFATCABMLQ  MTPRSE  ASL8
-----
          4          ---          no

RANDSLS
off

IPSG  IPGWAPC  GTTMODE          CGGTMOD
no    yes     CdPA          no

MATELSN  IPTPS  LSUSEALM  SLKUSEALM
-----  32000  100%     80%

LOC  LINK  SLC  TYPE
1101 A    0   SS7IPGW
1102 A    1   SS7IPGW
1103 A    2   SS7IPGW
1104 A    3   SS7IPGW
1105 A    4   SS7IPGW
1106 A    5   SS7IPGW
1107 A    6   SS7IPGW
1108 A    7   SS7IPGW

```

Link set table is (11 of 1024) 1% full.

rtrv-ls:lsn=ipgwx2

This is an example of the possible output.

rlghncxa03w 10-07-19 21:16:37 GMT EAGLE5 42.0.0

```

          L3T  SLT          GWS  GWS  GWS
LSN      APCA  (SS7)  SCRN  SET  SET  BEI  LST  LNKS  ACT  MES  DIS
SLSCI  NIS
ipgwx2  001-001-003  none 1  1  no  A  8  off off off
no     off

          SPCA          CLLI          TFATCABMLQ  MTPRSE  ASL8
-----
          4          ---          no

RANDSLS
off

IPSG  IPGWAPC  GTTMODE          CGGTMOD
no    yes     CdPA          no

MATELSN  IPTPS  LSUSEALM  SLKUSEALM
-----  16000  100%     80%

LOC  LINK  SLC  TYPE
1111 A    0   SS7IPGW

```

```

1112 A    1    SS7IPGW
1201 A    2    SS7IPGW
1202 A    3    SS7IPGW
1203 A    4    SS7IPGW
1204 A    5    SS7IPGW
1205 A    6    SS7IPGW
1206 A    7    SS7IPGW

```

Link set table is (11 of 1024) 1% full.

```
rtrv-ls:lsn=ipgwx3
```

This is an example of the possible output.

```
rlghncxa03w 10-07-19 21:16:37 GMT EAGLE5 42.0.0
```

```

                L3T SLT                GWS GWS GWS
LSN            APCA  (SS7)  SCRN SET SET BEI LST LNKS ACT MES DIS SLSCI
NIS
ipgwx3        001-001-004  none 1   1   no  A   0   off off off no
off

                SPCA                CLLI                TFATCABMLQ MTPRSE ASL8
-----
                1                ---      no

RANDSLS
off

IPSG  IPGWAPC  GTTMODE                CGGTMOD
no    yes      CdPA                    no

MATELSN  IPTPS  LSUSEALM  SLKUSEALM
-----  32000  100%     80%

```

Link set table is (11 of 1024) 1% full.

```
rtrv-ls:lsn=ipsglsn
```

This is an example of the possible output.

```
rlghncxa03w 10-07-19 21:16:37 GMT EAGLE5 42.0.0
```

```

                L3T SLT                GWS GWS GWS
LSN            APCA  (SS7)  SCRN SET SET BEI LST LNKS ACT MES DIS SLSCI
NIS
ipsglsn        003-003-003  none 1   1   no  A   6   off off off no
off

                SPCA                CLLI                TFATCABMLQ MTPRSE ASL8
-----
                3                ---      no

```



```

RANDSLS
off

IPSG  IPGWAPC  GTTMODE          CGGTMOD
yes   no      CdPA              no

ADAPTER  RSVDSLKTPS  MAXSLKTPS
m2pa     600         4000

TPSALM   LSUSEALM    SLKUSEALM
rsvdslktps 100%      100%

LOC  LINK  SLC  TYPE  ANAME
1303 A   0   IPSG  ipsgm2pa1
1303 A1  1   IPSG  ipsgm2pa2
1303 B1  2   IPSG  ipsgm2pa3
1303 A2  3   IPSG  ipsgm2pa4
1303 A3  4   IPSG  ipsgm2pa5
1307 A   5   IPSG  m2pa2

```

Link set table is (11 of 1024) 1% full.

```
rtrv-ls:lsn=ipsglsn2
```

This is an example of the possible output.

```
rlghncxa03w 10-07-19 21:16:37 GMT EAGLE5 42.0.0
```

```

LSN          APCA  (SS7)  L3T SLT          GWS GWS GWS
SLSCI NIS    SCRN SET SET BEI LST LNKS ACT MES DIS
ipsglsn2    005-005-005  none 1  1  no  A  1  off off off
no         off

          SPCA          CLLI          TFATCABMLQ MTPRSE ASL8
-----
          1          ---          no

```

```

RANDSLS
off

IPSG  IPGWAPC  GTTMODE          CGGTMOD
yes   no      CdPA              no

ADAPTER  RSVDSLKTPS  MAXSLKTPS
m2pa     600         4000

TPSALM   LSUSEALM    SLKUSEALM
rsvdslktps 100%      100%

LOC  LINK  SLC  TYPE  ANAME
1303 B3  0   IPSG  ipsgm2pa6

```

Link set table is (11 of 1024) 1% full.

Perform one or both of these actions as necessary.

- To change the IPTPS value for any linksets shown in the `rtrv-ls` output whose IPGWAPC value is `yes`, continue the procedure with 6.
- To change the MAXSLKTPS value (and RSVDSLKTPS value if necessary) for any linksets shown in the `rtrv-ls` output, perform the [Changing an IPSP M2PA Linkset](#) procedure (for linkset whose IPSP value is `yes` and ADAPTER value is M2PA) or the [Changing an IPSP M3UA Linkset](#) procedure (for linkset whose IPSP value is `yes` and ADAPTER value is M3UA).

Perform one or both of these actions to increase the available TPS if needed.

- An IPLIMx card that contains signaling links has to be removed. To perform this action, continue the procedure with 3.
- Some ATM high-speed signaling links have to be removed. To perform this action, continue the procedure with 2.

If you do not wish to perform other actions to increase the available TPS and the available TPS will allow the IPGWx linkset to be added, continue the procedure with 7.

6. Reduce the IPTPS values of some or all the **IPGWx** linksets by entering the `chg-ls` command with the name of each linkset being changed, shown in 5, and the new IPTPS value. For this example, enter these commands.

```
chg-ls:lsn=ipgwx1:iptps=28000
```

```
chg-ls:lsn=ipgwx3:iptps=28000
```

When the `chg-ls` command has successfully completed, this message should appear.

```
rlghncxa03w 10-07-17 16:23:21 GMT EAGLE5 42.0.0  
Link set table is ( 11 of 1024) 1% full  
CHG-LS: MASP A - COMPLTD
```

If no IPSP linksets are shown in 5, continue the procedure with 7.

If IPSP linksets are shown in 5, continue the procedure with one of these steps.

- To change the MAXSLKTPS value (and RSVDSLKTPS value if necessary) for any linksets shown in the `rtrv-ls` output, perform the [Changing an IPSP M2PA Linkset](#) procedure (for linkset whose IPSP value is `yes` and ADAPTER value is M2PA) or the [Changing an IPSP M3UA Linkset](#) procedure (for linkset whose IPSP value is `yes` and ADAPTER value is M3UA).
- If you do not wish to change any IPSP linksets, continue the procedure by performing these actions as required.
 - To remove some IPLIMx cards that contains signaling links, continue the procedure with 3.
 - To remove some ATM high-speed signaling links, continue the procedure with 2.
 - If you do not wish to perform other actions to increase the available TPS and the available TPS will allow the IPGWx linkset to be added, continue the procedure with 7.

7. Display the current linksets in the database using the `rtrv-ls` command.

This is an example of the possible output.

```
rlghncxa03w 10-07-10 11:43:04 GMT EAGLE5 42.0.0

LSN          APCA  (SS7)  L3T SLT          GWS GWS GWS
SLSCI NIS    SCRNI SET SET BEI LST LNKS ACT MES DIS
ipgw1       001-001-002  none 1  1  no  A  8  off off off
no off
ipgw2       001-001-003  none 1  1  no  A  8  off off off
no off
ipgw3       001-001-004  none 1  1  no  A  0  off off off
no off
lsniplim    002-002-002  none 1  1  no  A  3  off off off
no off
ipsglsn     003-003-003  none 1  1  no  A  6  off off off
no off
ipsglsn2    005-005-005  none 1  1  no  A  1  off off off
no off
lsgw1105    009-002-003  none 1  1  no  A  1  off off off
no off
lsnds0      009-009-009  none 1  1  no  A  2  off off off
no off

LSN          APCI  (SS7)  L3T SLT          GWS GWS GWS
SLSCI NIS    SCRNI SET SET BEI LST LNKS ACT MES DIS
lsnituatm   1-002-3      none 1  2  no  A  1  off off off
no off
atmitul     3-111-3      none 1  1  no  A  0  off off off
no off

LSN          APCN  (SS7)  L3T SLT          GWS GWS GWS
SLSCI NIS    SCRNI SET SET BEI LST LNKS ACT MES DIS
lsipgw      2968         none 1  2  no  A  1  off off off
no off

Link set table is (11 of 1024) 1% full.
```

Continue the procedure by performing one of these steps.

- If the `multgc=yes` parameter is not being specified for the linkset, continue the procedure by performing one of these steps.
 - If a new linkset is being added, continue the procedure with [12](#).
 - If an existing linkset is being changed and the APC of the linkset is being changed, continue the procedure with [12](#).
 - If an existing linkset is being changed and the APC of the linkset is not being changed, continue the procedure with [20](#).

- If the `multgc=yes` parameter will be specified for the linkset and a new linkset is being added, continue the procedure by performing one of these steps. The `multgc=yes` parameter can be specified only for IPGWx linksets that contain signaling links that are assigned to cards that are running the IPGWI application.
 - If linksets containing ITU-N adjacent point codes with group codes are shown in the `rtrv-ls` output, continue the procedure with [12](#).
 - If linksets containing ITU-N adjacent point codes with group codes are not shown in the `rtrv-ls` output, continue the procedure with [8](#).
 - If the `multgc` parameter value for an existing linkset will be changed, continue the procedure by performing one of these steps.
 - If the `multgc` parameter value is being changed to `no`, continue the procedure with [10](#).
 - If the `multgc` parameter value is being changed to `yes`, continue the procedure with [8](#). The `multgc=yes` parameter can be specified only for IPGWx linksets that contain signaling links that are assigned to cards that are running the IPGWI application.
8. To specify the `multgc=yes` parameter with the `ent-ls` or `chg-ls` commands, the ITU Duplicate Point Code feature must be on. For the ITU Duplicate Point Code feature to be on, the Multiple Point Code feature must be on. Enter the `rtrv-feat` command to verify that either of these features are on.

The entry `MPC = on` in the `rtrv-feat` command output shows that the **Multiple Point Code** feature is on. The entry `ITUDUPPC = on` in the `rtrv-feat` command output shows that the **ITU Duplicate Point Code** feature is on.

 **Note:**

The `rtrv-feat` command output contains other fields that are not used by this procedure. If you wish to see all the fields displayed by the `rtrv-feat` command, see the `rtrv-feat` command description in *Commands User's Guide*.

Continue the procedure by performing one of these steps.

- If the ITU Duplicate Point Code feature is on (`ITUDUPPC = on`), continue the procedure with [10](#).
 - If the ITU Duplicate Point Code feature is off (`ITUDUPPC = off`), continue the procedure with [Oracle](#).
9. Turn the ITU Duplicate Point Code feature on, and the **Multiple Point Code** feature if necessary, by entering one of these commands.

To turn the ITU Duplicate Point Code feature on only.

```
chg-feat:ituduppc=on
```

To turn both the ITU Duplicate Point Code and Multiple Point Code features on.

```
chg-feat:mpc=on:ituduppc=on
```

 **Note:**

Once the ITU Duplicate Point Code and Multiple Point Code features are turned on with the `chg-feat` command, they cannot be turned off. The ITU Duplicate Point Code and Multiple Point Code features must be purchased before you turn either of these features on with the `chg-feat` command. If you are not sure if you have purchased these features, contact your Oracle Sales Representative or Account Representative.

When this command has successfully completed, this message should appear.

```
rlghncxa03w 06-10-10 11:43:04 GMT EAGLE5 37.5.0
CHG-FEAT: MASP A - COMPLTD
```

Continue the procedure by performing one of these steps.

- If a new linkset is being added, continue the procedure with [12](#).
 - If an existing linkset is being changed and the APC of the linkset is being changed, continue the procedure with [12](#).
 - If an existing linkset is being changed and the APC of the linkset is not being changed, continue the procedure with [20](#).
- 10.** If the `multgc` parameter value is changed to `no`, the linkset can contain only one secondary adjacent point code. An **ITU** international linkset can contain only one 14-bit **ITU** national secondary adjacent point code. If the **ITU** international linkset contains more than one 14-bit **ITU** national secondary adjacent point code, all but one of these 14-bit **ITU** national secondary adjacent point codes must be removed from the linkset. An **ITU** national linkset can contain only one **ITU** international secondary adjacent point code. All 14-bit **ITU-N** secondary adjacent point codes must be removed from the linkset. All routes to these secondary adjacent point codes must be removed from the database before the secondary adjacent point codes can be removed.

Display the routes using the secondary adjacent point code being removed from the linkset with the `rtrv-rte` command, specifying the secondary adjacent point code being removed as the value of the `dpc` parameter.

For this example, enter these commands.

```
rtrv-rte:dpcn=11213-de
```

This is an example of the possible output.

```
rlghncxa03w 06-10-07 11:43:04 GMT EAGLE5 37.5.0
DPCN          ALIASA          ALIASI  LSN          RC      APC
11213-de      -----  -----  lsn3         10     11213-de
                                     RTX:No  CLI=-----
```

```
rtrv-rte:dpcn=12114-fr
```

This is an example of the possible output.

```
rlghncxa03w 06-10-07 11:43:04 GMT EAGLE5 37.5.0
DPCN          ALIASA          ALIASI  LSN          RC          APC
12114-fr      -----
RTX:No  CLLI=-----
```

```
rtrv-rte:dpcn=12115-uk
```

This is an example of the possible output.

```
rlghncxa03w 06-10-07 11:43:04 GMT EAGLE5 37.5.0
DPCN          ALIASA          ALIASI  LSN          RC          APC
12115-uk      -----
RTX:No  CLLI=-----
```

If the secondary adjacent point code is assigned to a route, that route must be removed from the database. Perform the “Removing a **Route**” procedure in the *Database Administration - SS7 User's Guide* to remove the route from the database.

11. Remove the secondary adjacent point codes specified in 10 from the linkset with the `chg-ls` command with the `sapcn` and the `action=delete` parameters. For this example, enter these commands.

```
chg-ls:lsn=lsn3:sapcn=11213-de:action=delete
chg-ls:lsn=lsn3:sapcn=12114-fr:action=delete
chg-ls:lsn=lsn3:sapcn=12115-uk:action=delete
```

When the `chg-ls` command has successfully completed, this message should appear.

```
rlghncxa03w 06-10-17 16:23:21 GMT EAGLE5 37.5.0
Link set table is ( 13 of 255)  5% full
CHG-LS: MASP A - COMPLTD
```

Continue the procedure by performing one of these steps.

- If a new linkset is being added, continue the procedure with 12.
 - If an existing linkset is being changed and the APC of the linkset is being changed, continue the procedure with 12.
 - If an existing linkset is being changed and the APC of the linkset is not being changed, continue the procedure with 20.
12. Display the point code and capability point code of the **EAGLE** by using the `rtrv-sid` command.

This is an example of the possible output.

```
rlghncxa03w 06-10-10 11:43:04 GMT EAGLE5 37.5.0
PCA          PCI          PCN          CLLI          PCTYPE
001-001-001  1-200-6      13482       rlghncxa03w  OTHER
```

```

CPCA
002-002-002      002-002-003      002-002-004      002-002-005
002-002-006      002-002-007      002-002-008      002-002-009
004-002-001      004-003-003      144-212-003

CPCA (LNP)
005-005-002      005-005-004      005-005-005

CPCI
1-001-1          1-001-2          1-001-3          1-001-4

CPCN
02091            02092            02094            02097
02191            02192            11177

```

13. Display the destination point codes in the database by entering the `rtrv-dstn` command. This is an example of the possible output.

```

rlghncxa03w 10-12-10 11:43:04 GMT EAGLE5 43.0.0
Extended Processing Time may be Required

```

```

      DPCA      CLLI      BEI ELEI  ALIASI
ALIASN/N24  DMN
001-207-000  ----- no  --- -----
-----
SS7
001-001-001  ----- no  --- -----
-----
SS7
001-001-002  ----- no  --- -----
-----
SS7
001-005-000  ----- no  --- -----
-----
SS7
001-007-000  ----- no  --- -----
-----
SS7
008-012-003  ----- no  --- -----
-----
SS7
003-002-004  ----- no  --- -----
-----
SS7
009-002-003  ----- no  --- -----
-----
SS7
010-020-005  ----- no  --- -----
-----
SS7

      DPCI      CLLI      BEI ELEI  ALIASA
ALIASN/N24  DMN
1-207-0      ----- no  --- -----
-----
SS7
0-015-0      ----- no  --- -----
-----
SS7
0-017-0      ----- no  --- -----
-----
SS7
1-011-1      ----- no  --- -----
-----
SS7
1-011-2      ----- no  --- -----

```

```
----- SS7
```

```
Destination table is (14 of 2000) 1% full
Alias table is (0 of 12000) 0% full
```

If the new adjacent point code is not shown in the `rtrv-dstn` output, perform the "Adding a Destination Point Code" procedure in *Database Administration - SS7 User's Guide* to add the required point code. This point code cannot be a proxy point code (the `prx=yes` value assigned to the point code) and a proxy point code (a point code value is shown in the `PPC` column) cannot be assigned to the point code. After the point code has been added, continue the procedure by performing one of these steps.

- If a new linkset is being added, continue the procedure by performing one of these steps.
 - If you do not wish to use the IP Gateway **ISUP** routing feature, continue the procedure with [19](#).
 - If you wish to use the IP Gateway ISUP routing feature, continue the procedure with [17](#).
- If an existing linkset is being changed, continue the procedure with [20](#).

If the new adjacent point code is shown in the `rtrv-dstn` output, continue the procedure with [14](#).

14. Display the adjacent point code of the new linkset in the destination point code table by using the `rtrv-dstn` command and specifying the point code. For this example, enter this command.

```
rtrv-dstn:dpca=010-020-005
```

This is an example of the possible output.

```
rlghncxa03w 10-12-10 11:43:04 GMT EAGLE5 43.0.0
```

DPCA	CLLI	BEI	ELEI	ALIASI	ALIASN/N24	DMN	
010-020-005	-----	no	---	-----	-----	SS7	
SPCA	NCAI	RCAUSE	NPRST	SPLITIAM	HMSMSC	HMSCP	SCCPMSGCNV
-----	----	none	off	none	no	no	none

```
Destination table is (14 of 2000) 1% full
Alias table is (0 of 12000) 0% full
```

This point code cannot be a proxy point code (the `prx=yes` value assigned to the point code) and a proxy point code (a point code value is shown in the `PPC` column) cannot be assigned to the point code. If a proxy point code is shown in this step, or if the point code is a proxy point code, choose another point code and repeat this procedure from [12](#).

15. The **APC** of the linkset cannot be the **DPC** of any exception route. Verify that the adjacent point code of the linkset is not the **DPC** of any exception route by entering the `rtrv-rtx` command with the `dpc/dpca/dpci/dpcn/dpcn24` parameter. The `dpc/dpca/dpci/dpcn/dpcn24` parameter value is the adjacent point code value that will be specified for the linkset.

For this example, enter this command.

```
rtrv-rtx:dPCA=010-020-005
```

This is an example of the possible output.

```
rlghncxa03w 06-10-10 11:43:04 GMT EAGLE5 37.5.0
      DPCA          RTX-CRITERIA          LSN          RC          APC
      010-020-005  OPCA
      007-008-009          ls1305          20
001-005-000
      008-008-008          ls1307          40
001-007-000

DESTINATION ENTRIES ALLOCATED:  2000
      FULL DPC(s) :                13
      EXCEPTION DPC(s) :            5
      NETWORK DPC(s) :                0
      CLUSTER DPC(s) :                1
      TOTAL DPC(s) :                19
      CAPACITY (% FULL) :            1%
ALIASES ALLOCATED:                12000
      ALIASES USED:                  0
      CAPACITY (% FULL) :            0%
X-LIST ENTRIES ALLOCATED:         500
```

If the adjacent point code of the linkset is not the **DPC** of a route exception table entry, no entries are displayed in the `rtrv-rtx` output, but a summary of the point code quantities is displayed, as shown in the following output example.

```
rlghncxa03w 06-10-10 11:43:04 GMT EAGLE5 37.5.0

      DESTINATION ENTRIES ALLOCATED:  2000
      FULL DPC(s) :                15
      EXCEPTION DPC(s) :            5
      NETWORK DPC(s) :                0
      CLUSTER DPC(s) :                1
      TOTAL DPC(s) :                21
      CAPACITY (% FULL) :            1%
ALIASES ALLOCATED:                12000
      ALIASES USED:                  0
      CAPACITY (% FULL) :            0%
X-LIST ENTRIES ALLOCATED:         500
```

If the point code specified in this step is shown in the `DPCA/DPCI/DPCN/ DPCN24` columns in this step, the point code value cannot be used as an adjacent point code unless one of two actions are taken:

- Choose another adjacent point code value and repeat [12](#) through [15](#).
- Remove all the entries displayed in this step by performing the “Removing a **Route** Exception Entry” procedure in *Database Administration - SS7 User's Guide*.

16. Display any entires in the route table whose **DPC** value is also the adjacent point code of the new linkset being added in this procedure, or the new adjacent point code of the existing linkset being changed in this procedure. Enter the `rtrv-rte` command with the `dpc/dpca/dpci/dpcn/dpcn24` parameter. The `dpc/dpca/dpci/dpcn/dpcn24` parameter value is the adjacent point code value that will be specified for the linkset. For this example, enter this command.

```
rtrv-rte:dpca=010-020-005
```

This is an example of the possible output.

```
rlghncxa03w 06-10-10 11:43:04 GMT EAGLE5 37.5.0
```

DPCA	ALIASI	ALIASN/N24	LSN	RC	APCA
010-020-005	-----	-----	lsn1	1	003-003-003
			lsn2	2	003-003-004
			RTX:No	CLLI=-----	

If the adjacent point code of the linkset is not the **DPC** of a route, the point code entry is displayed in the `rtrv-rte` output, but the **LSN**, **RC**, and **APC** columns contain dashes, as shown in the following output example.

```
rlghncxa03w 06-10-10 11:43:04 GMT EAGLE5 37.5.0
```

DPCA	ALIASI	ALIASN/N24	LSN	RC	APCA
002-002-002	-----	-----	-----	--	-----
				RTX:No	CLLI=-----

If the point code specified in this step is shown in the `DPCA/DPCI/DPCN/ DPCN24` columns in this step, the point code value cannot be used as an adjacent point code unless one of two actions are taken:

- Choose another adjacent point code value and repeat 12 through 16.
- Remove all the entries displayed in this step by performing the “Removing a Route” procedure in *Database Administration - SS7 User's Guide*.

After this step has been performed, continue the procedure by performing one of these steps.

- If a new linkset is being added, continue the procedure by performing one of these steps.
 - If you do not wish to use the **IP Gateway ISUP** routing feature, continue the procedure with 19.
 - If you wish to use the **IP Gateway ISUP** routing feature, continue the procedure with 17.
 - If an existing linkset is being changed, continue the procedure with 20.
17. Verify that the **IP Gateway ISUP** routing feature is on by entering the `rtrv-feat` command. The entry `IPISUP = on` in the `rtrv-feat` command output shows that the **IP Gateway ISUP** routing feature is on.

 **Note:**

The `rtv-feat` command output contains other fields that are not used by this procedure. If you wish to see all the fields displayed by the `rtv-feat` command, see the `rtv-feat` command description in *Commands User's Guide*.

- If the IP Gateway ISUP routing feature is on, continue the procedure with [19](#).
- If the IP Gateway ISUP routing feature, continue the procedure with [18](#).

18. Turn the **IP Gateway ISUP** routing feature on by entering this command.

 **Note:**

If the **IP Gateway ISUP** routing feature is on (`IPISUP = on`), continue the procedure with [19](#).

```
chg-feat:ipisup=on
```

 **Note:**

Once the **IP Gateway ISUP** routing feature is turned on with the `chg-feat` command, it cannot be turned off. The **IP Gateway ISUP** routing feature must be purchased before you turn the feature on with the `chg-feat` command. If you are not sure if you have purchased the **IP Gateway ISUP** routing feature, contact your Oracle Sales Representative or Account Representative.

When this command has successfully completed, this message should appear.

```
rlghncxa03w 06-10-10 11:43:04 GMT EAGLE5 37.5.0
CHG-FEAT: MASP A - COMPLTD
```

19. Add the new linkset to the database using the `ent-ls` command. The new linkset must meet these conditions.

The name of this linkset, the `lsn` parameter value, cannot be used by another linkset – the linkset configuration is shown in the output of [7](#).

The **APC** of the new linkset must be in the destination point code table, but cannot be either the **EAGLE**'s point code or the **EAGLE**'s capability point code – shown in the outputs of [12](#), [13](#), and [14](#). The adjacent point code can be one of the following types of point codes:

`:apc/apca` – **ANSI** point code, **ANSI** private point code

`:apci` – **ITU-I** point code, **ITU-I** spare point code, **ITU-I** private point code, **ITU-I** private spare point code.

:apcn – 14-bit ITU-N point code, 14-bit ITU-N spare point code, 14-bit ITU-N private point code, 14-bit ITU-N private spare point code.

:apcn24 – 24-bit ITU-N point code, 24-bit ITU-N private point code.

These parameters and values must also be specified for the IPGWx linkset:

- ipgwapc=yes
- lst=<a,b,c,d,e>
- iptps=<100-32000>

 **Note:**

The `iptps` parameter value must be divisible by 10. The sum of all the linkset IP TPS values, including the value for this linkset, cannot exceed the maximum total provisioned system TPS value shown in the `rtrv-tps` output in [1](#), or the increased value if the "Activating the HIPR2 High Rate Mode Feature" procedure was performed.

- The optional parameters `lsusealm` (the linkset's IP TPS alarm threshold) and `slkusealm` (the signaling link IP TPS alarm threshold) can be specified with the `ent-ls` command. The default value for the `lsusealm` parameter is 100%, and the default value for the `slkusealm` parameters is 80%.
- The `multgc=yes` parameter can be specified only for IPGWx linksets that will contain signaling links that are assigned to cards that are running the IPGWI application.

 **Note:**

There are other optional parameters that can be specified with the `ent-ls` command, but are not required for an IPGWx linkset. See the [Other Optional Parameters](#) section for the procedures that discuss these parameters and their usage.

For this example, enter this command.

```
ent-
ls:lsn=lsqw1107:apca=010-020-005:lst=a:ipgwapc=yes:iptps=4000 :ls
usealm=70:slkusealm=70
```

When this command has successfully completed, this message should appear.

```
rlghncxa03w 06-10-17 16:23:21 GMT EAGLE5 37.5.0
Link set table is ( 14 of 1024) 1% full
ENT-LS: MASP A - COMPLTD
```

Continue the procedure with [21](#).

20. Change the existing linkset by entering the `chg-ls` command.

The name of the linkset that is being changed, specified with the `lsn` parameter, must be specified. The name of the linkset is shown in the `rept-stat-iptps` output in 4.

One of these optional parameters must be specified.

- The new adjacent point code of the linkset, specified with the `apc/apca/apci/apcn/apcn24`, if the current adjacent point code of the linkset is being changed.
- `iptps=<100-32000>`

 **Note:**

The `iptps` parameter value must be divisible by 10. The sum of all the linkset IP TPS values, including the value for this linkset, cannot exceed the maximum total provisioned system TPS value shown in the `rtrv-tps` output in 1, or the increased value if the "Activating the HIPR2 High Rate Mode Feature" procedure was performed. .

- The optional parameters `lsusealm` (the linkset's **IP TPS** alarm threshold) and `slkusealm` (the signaling link **IPTPS** alarm threshold) can be specified with the `chg-ls` command.
- The `multgc=yes` parameter can be specified only for **IPGWx** linksets that contain signaling links that are assigned to cards that are running the **IPGWI** application.

 **Note:**

There are other optional parameters that can be specified with the `ent-ls` command, but are not required for an IPGWx linkset. See the [Other Optional Parameters](#) section for the procedures that discuss these parameters and their usage.

For this example, enter this command.

```
chg-ls:lsn=lsgw1105:iptps=14000:lsusealm=70:slkusealm=70
```

When this command has successfully completed, this message should appear.

```
rlghncxa03w 06-10-17 16:23:21 GMT EAGLE5 37.5.0
Link set table is ( 14 of 1024) 1% full
CHG-LS: MASP A - COMPLTD
```

21. Verify the changes using the `rtrv-ls` command specifying the linkset name specified in either 19 or 20 with the `lsn` parameter. For this example, enter these commands.

```
rtrv-ls:lsn=lsgw1105
```

This is an example of the possible output.

```
rlghncxa03w 08-04-17 11:43:04 GMT EAGLE5 38.0.0

LSN          APCA   (SS7)  SCRN   L3T SLT          GWS GWS GWS
NIS          LSGW1105 009-002-003 none  1   1   no  A   1   off off off no
off

          CLLI          TFATCABMLQ MTPRSE ASL8
          ----- 1          no    no

          IPGWAPC MATELSN      IPTPS LSUSEALM SLKUSEALM GTTMODE
          yes      ----- 14000 70      % 70      % CdPA

          LOC LINK SLC TYPE
          1105 A   0   SS7IPGW
```

Link set table is (14 of 1024) 1% full

```
rtrv-ls:lsn=lsgw1107
```

This is an example of the possible output.

```
rlghncxa03w 08-04-17 11:43:04 GMT EAGLE5 38.0.0

LSN          APCA   (SS7)  SCRN   L3T SLT          GWS GWS GWS
NIS          LSGW1107 010-020-005 none  1   1   no  A   0   off off off no
off

          CLLI          TFATCABMLQ MTPRSE ASL8
          ----- 1          no    no

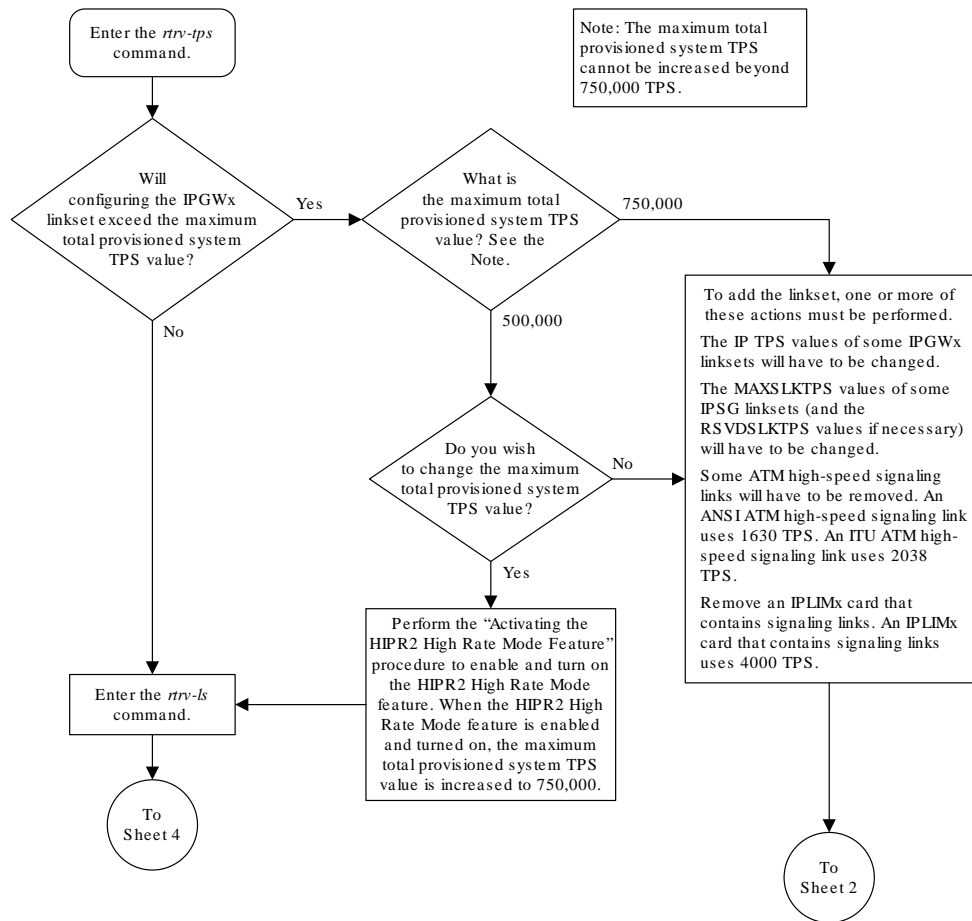
          IPGWAPC MATELSN      IPTPS LSUSEALM SLKUSEALM GTTMODE
          yes      ----- 4000 70      % 70      % CdPA
```

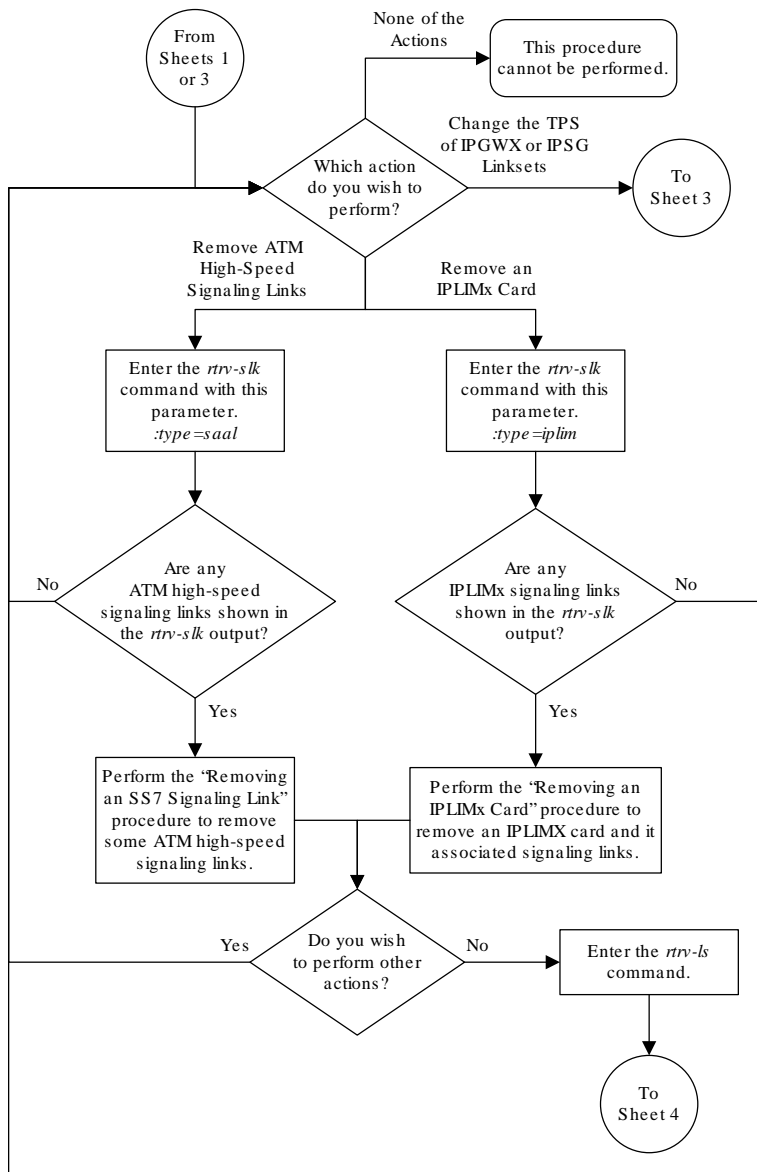
Link set table is (14 of 1024) 1% full

22. Back up the new changes using the `chg-db:action=backup:dest=fixed` command. These messages should appear, the active **Maintenance and Administration Subsystem Processor (MASP)** appears first.

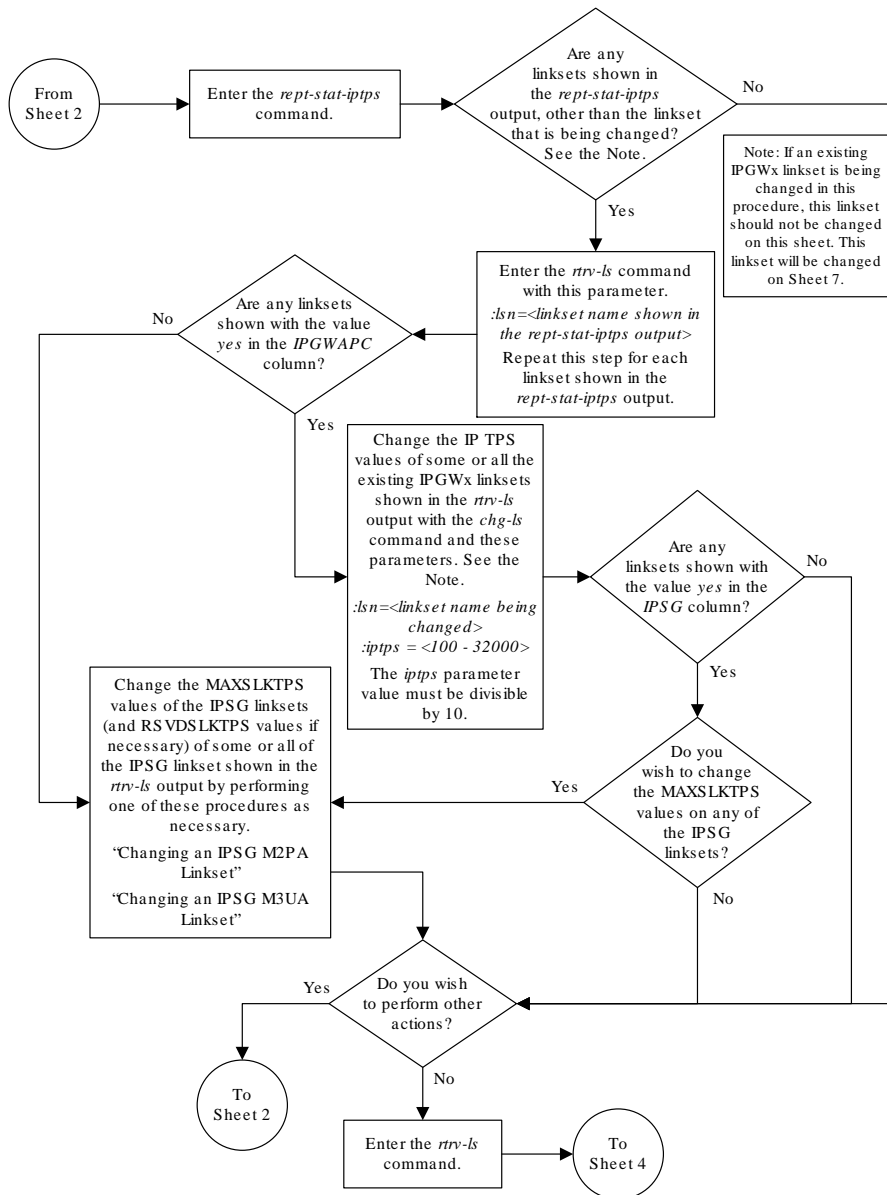
```
BACKUP (FIXED) : MASP A - Backup starts on active MASP.
BACKUP (FIXED) : MASP A - Backup on active MASP to fixed disk complete.
BACKUP (FIXED) : MASP A - Backup starts on standby MASP.
BACKUP (FIXED) : MASP A - Backup on standby MASP to fixed disk complete.
```

Figure 4-4 Configuring an IPGWx Linkset

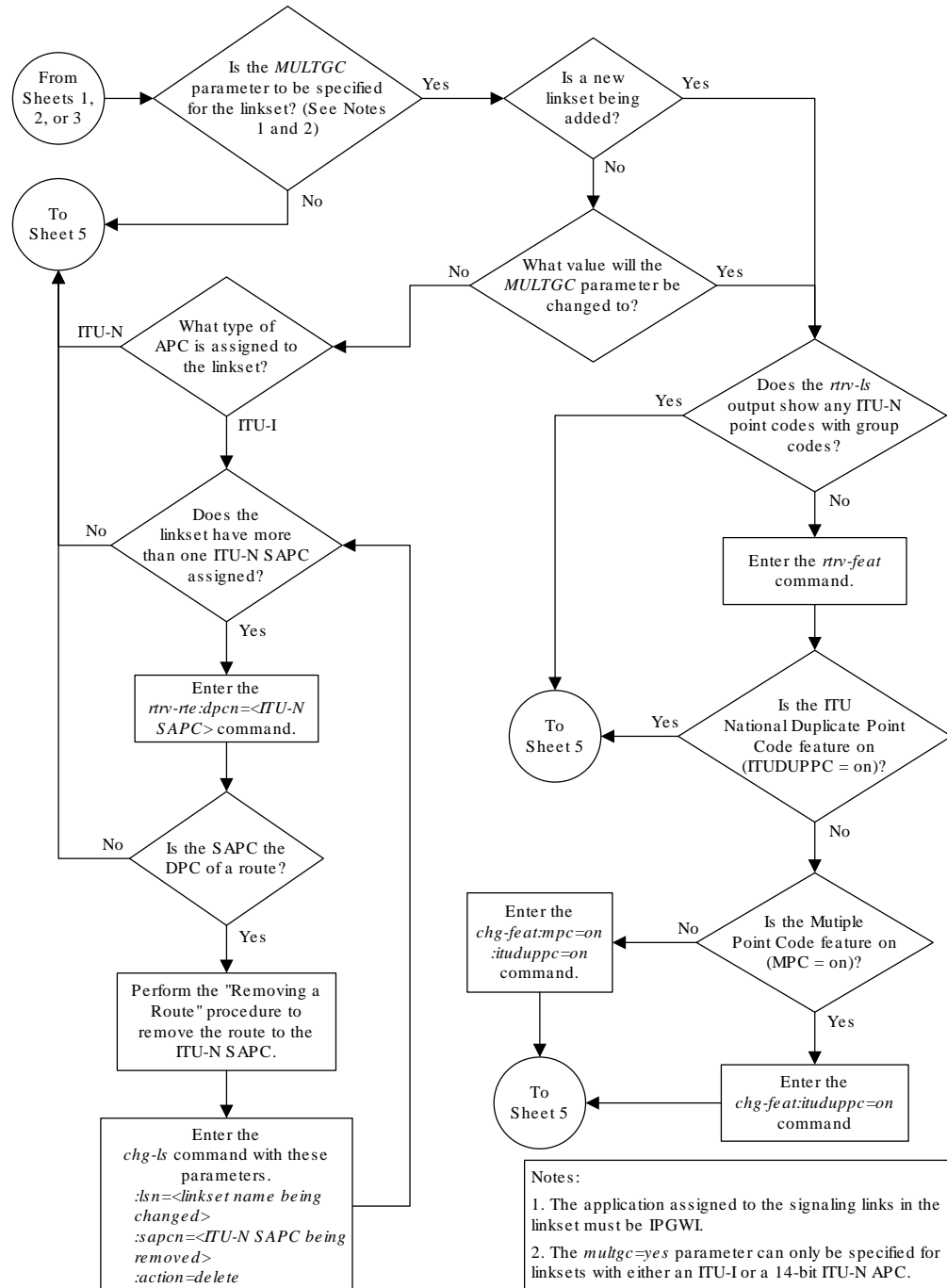




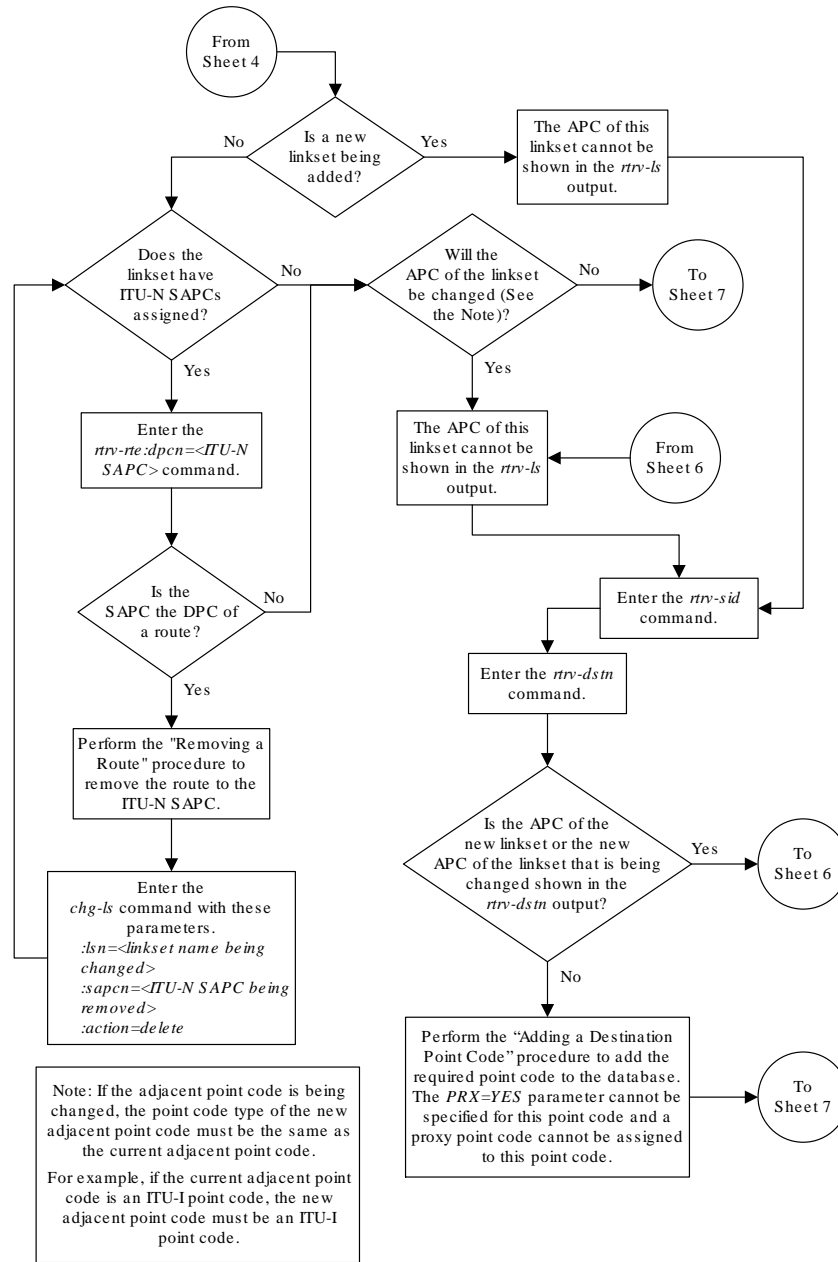
Sheet 2 of 7



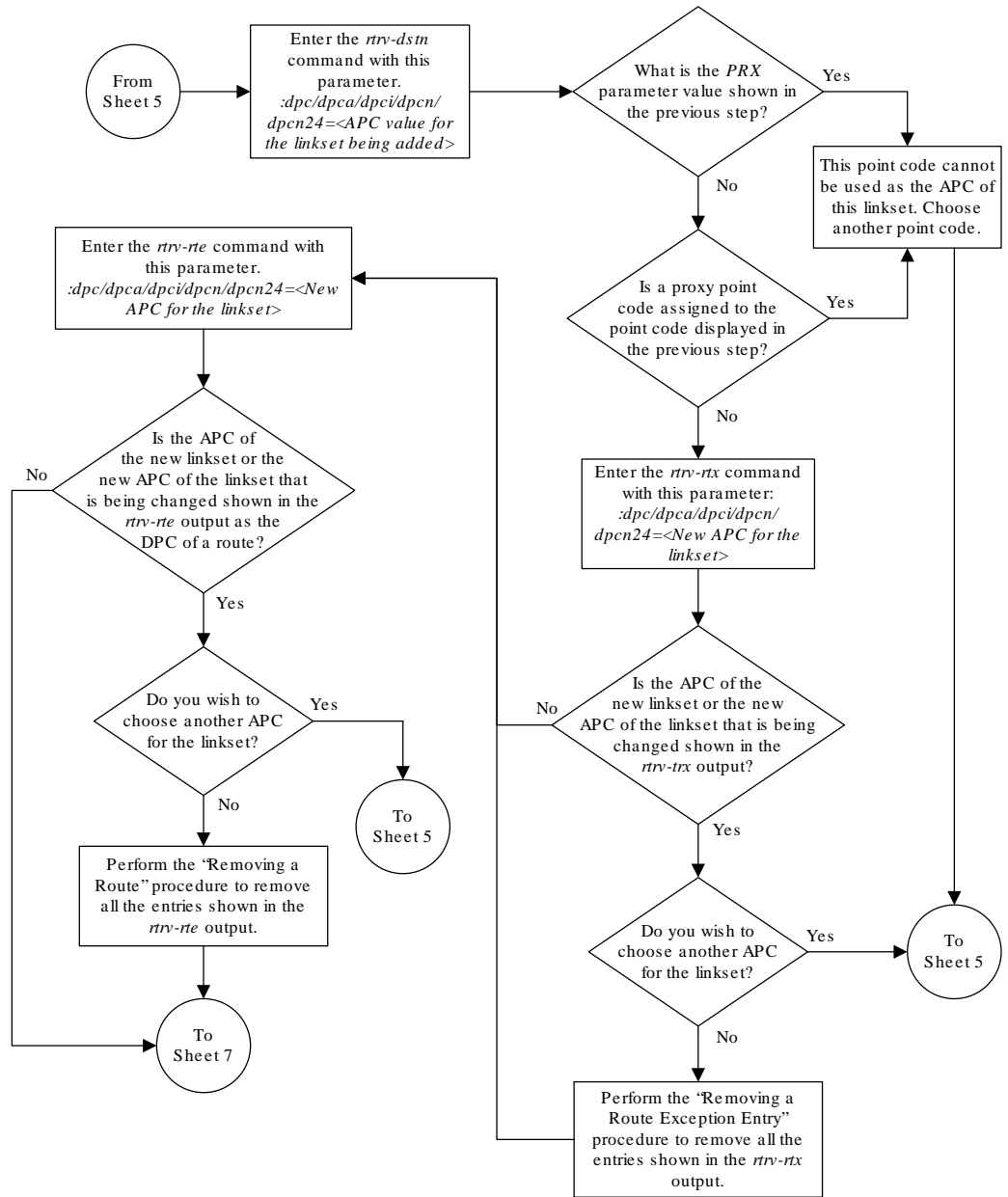
Sheet 3 of 7



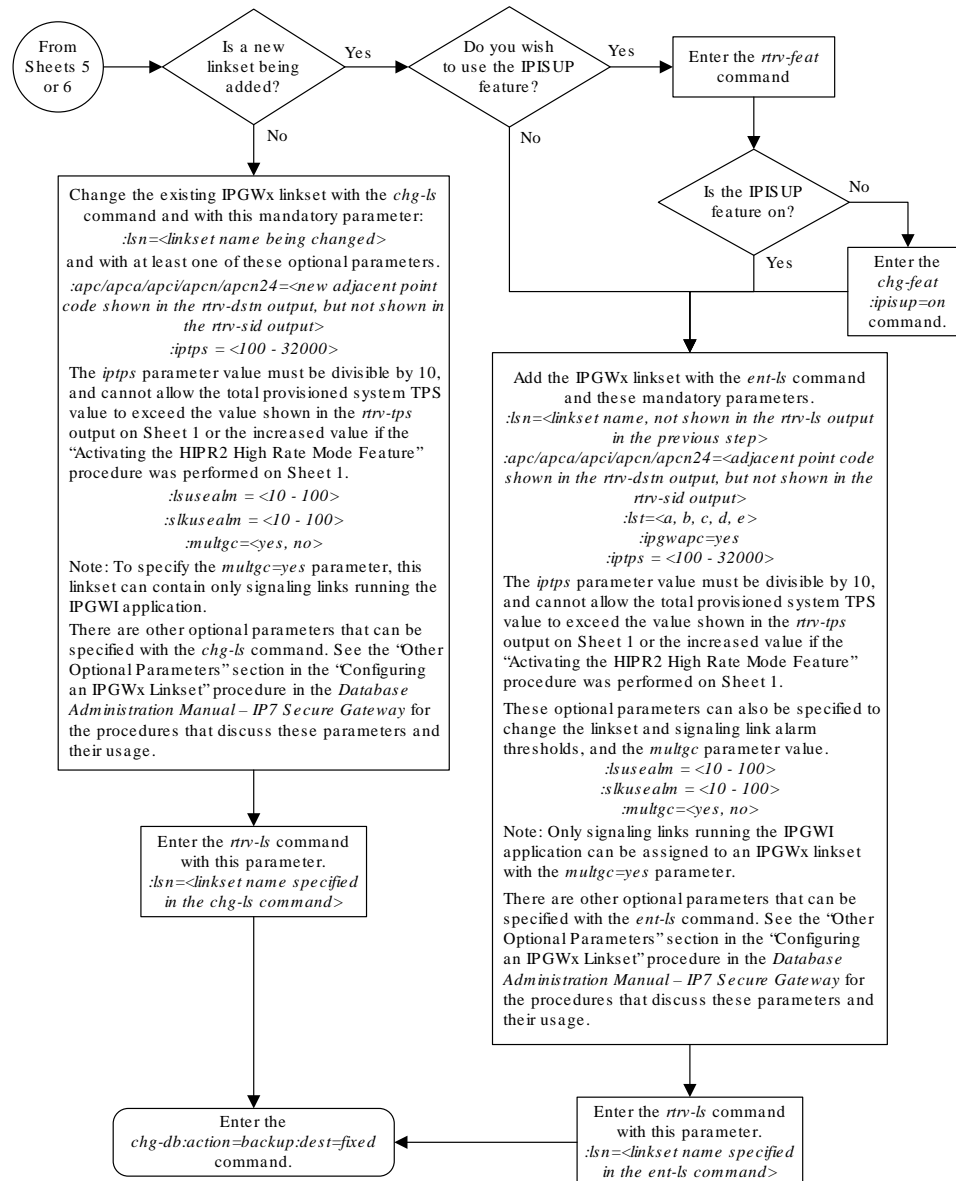
Sheet 4 of 7



Sheet 5 of 7



Sheet 6 of 7



Sheet 7 of 7

4.4 Adding a Mate IPGWx Linkset to another IPGWx Linkset

This procedure is used to add a mate IPGWx linkset to an existing IPGWx linkset `chg-ls` command with these parameters.

`:lsn` – The name of the IPGWx linkset that will contain the mate IPGWx linkset that is being added shown in the `rept-stat-iptps` or `rtrv-ls` command outputs. is being added.

`:matelsn` – The name of the mate IPGWx linkset that is being added.

`:action=add` – adds the mate IPGWx linkset to the IPGWx linkset specified by the `lsn` parameter.

An IPGWx linkset is a linkset that contains signaling links assigned to IPGWx cards. **IPGWx** cards are cards running either the **SS7IPGW** or **IPGWI** applications.

The **EAGLE** allows an **IPGWx** linkset to contain up to 8 **IPGWx** signaling links, and as a result, 8 **IPGWx** cards. This increases the amount of traffic that can be delivered to a single **IP** node compared to the two-card combined **IPGWx** linkset deployments used in previous releases. An **IPGWx** linkset containing up to 8 **IPGWx** signaling links is the preferred method of configuring **IPGWx** linksets (see the [Configuring an IPGWx Linkset](#) procedure). This method is required if more than two **IPGWx** signaling links are to be used in the linkset.

To provide backward compatibility with pre-existing two-card combined **IPGWx** linkset deployments, the **EAGLE** also provides for a mate **IPGWx** linkset. A mate **IPGWx** linkset consists of one **IPGWx** linkset assigned to another **IPGWx** linkset using the `matelsn` parameter of the `chg-ls` command. To assign a mate **IPGWx** linkset to another **IPGWx** linkset, both linksets can contain no more than one signaling link. While mate **IPGWx** linksets can be configured using this procedure, the preferred method of configuring two-card **IPGWx** deployments is to configure a two-link non-mated linkset using the [Configuring an IPGWx Linkset](#) procedure.

Each linkset in the mated pair must either contain no mate linksets, or can reference the other linkset in the mated pair. For example, to assign linkset `LSN2` to **IPGWx** linkset `LSN1` as a mate linkset, linkset `LSN1` cannot contain any mate linksets. Linkset `LSN2` can have linkset `LSN1` as a mate, otherwise linkset `LSN2` cannot have any mate linksets assigned to it.

The mate linkset name is displayed in the `rtrv-ls:lsn=<linkset name>` command output. If either linkset contains more than one signaling link, all but one of the signaling links must be removed from these linksets or other linksets must be chosen. Perform the [Removing an IPGWx Signaling Link](#) procedure to remove any signaling links from the linkset. If new linksets must be configured for this procedure, perform the [Configuring an IPGWx Linkset](#) procedure.

Before a mate **IPGWx** linkset can be added to an **IPGWx** linkset, the card containing the **IPGWx** signaling link assigned to the linkset being changed, and the signaling link assigned to that card must be placed out of service.

The network type of the adjacent point code of the mate **IPGWx** linkset must be the same type as the linkset the mate is assigned to. For example, if a mate **IPGWx** linkset is assigned to an **IPGWx** linkset with an **ITU-I** adjacent point code, the mate **IPGWx** linkset must have an **ITU-I** adjacent point code.

Other Optional Parameters

There are other optional parameters that can be used to configure a linkset. These parameters are not required for configuring an IPGWx linkset. These parameters are discussed in more detail in *Commands User's Guide* or in these sections.

- These procedures in this manual:
 - [Configuring an IPGWx Linkset](#)
 - [Removing a Mate IPGWx Linkset from another IPGWx Linkset](#)
 - [Adding an IPSP M3UA Linkset](#)
 - [Adding an IPSP M2PA Linkset](#)
 - [Changing an IPSP M3UA Linkset](#)

- [Changing an IPSPG M2PA Linkset](#)
 - These procedures in *Database Administration - SS7 User's Guide*
 - Adding an SS7 Linkset
 - Changing an SS7 Linkset
 - Configuring an ITU Linkset with a Secondary Adjacent Point Code (SAPC)
 - The "Configuring a Linkset for the GSM MAP Screening Feature" procedure in *Database Administration - Features User's Guide*.
1. Display the system-wide **IP** TPS usage report, and the **IPGWx** linksets, by entering the `rept-stat-iptps` command. This is an example of the possible output.

```
rlghncxa03w 10-07-19 21:16:37 GMT EAGLE5 42.0.0
IP TPS USAGE REPORT
```

PEAKTIMESTAMP	THRESH	CONFIG/ RSVD	CONFIG/ MAX		TPS	PEAK	

LSN							
lsgw1101	80%	----	6000	TX:	5100	5500	05-02-10
11:40:04							
				RCV:	5100	5500	05-02-10
11:40:04							
lsgw1103	80%	----	6000	TX:	5200	5500	05-02-10
11:40:04							
				RCV:	5200	5500	05-02-10
11:40:04							
lsgw1105	80%	----	14000	TX:	7300	7450	05-02-10
11:40:04							
				RCV:	7300	7450	05-02-10
11:40:04							
lsgw1107	70%	----	4000	TX:	3200	3500	05-02-10
11:40:04							
				RCV:	3200	3500	05-02-10
11:40:04							

Command Completed.

If linksets are displayed in this step, continue the procedure [2](#).
 If no linksets are displayed in this step, perform the [Configuring an IPGWx Linkset](#) to create two IPGWx linksets. After the IPGWx linksets have been created, continue the procedure with [14](#).

2. Display the linkset that is being changed by entering the `rtrv-ls` command with a linkset name shown in the `rept-stat-iptps` output in [1](#). For this example, enter this command.

```
rtrv-ls:lsn=lsgw1103
```

This is an example of the possible output.

```
rlghncxa03w 08-04-17 11:43:04 GMT EAGLE5 38.0.0
```

```

                L3T SLT                GWS GWS GWS
LSN            APCA  (SS7)  SCRN  SET SET BEI LST LNKS ACT MES DIS SLSCI
NIS
lsgw1103      003-002-004  none  1   1   no  A   1   off off off no
off

```

```

                CLLI            TFATCABMLQ MTPRSE ASL8
----- 1                no    no

```

```

IPGWAPC MATELSN      IPTPS LSUSEALM SLKUSEALM GTTMODE
yes      ----- 10000 70      % 70      % CdPA

```

```

LOC LINK SLC TYPE
1103 A   0   SS7IPGW

```

```
Link set table is ( 14 of 1024) 1% full
```

To assign a mate IPGWx linkset to this linkset, this linkset cannot contain more than one signaling link.

If this linkset does not contain more than one signaling link, and the linkset that will be the mate IPGWx linkset is shown in the `rept-stat-iptps` output in [1](#), continue the procedure with [3](#).

If this linkset does not contain more than one signaling link, and the linkset that will be the mate IPGWx linkset is not shown in the `rept-stat-iptps` output in [1](#), continue the procedure with [5](#).

If this linkset contains more than one signaling link, and you wish to add the mate IPGWx linkset to this linkset, perform the [Removing an IPGWx Signaling Link](#) procedure to remove all but one of the signaling links in the linkset. After the signaling links have been removed, perform one of these actions.

- If the linkset that will be the mate IPGWx linkset is shown in the `rept-stat-iptps` output in [1](#), continue the procedure with [3](#).
- If the linkset that will be the mate IPGWx linkset is not shown in the `rept-stat-iptps` output in [1](#), perform the [Configuring an IPGWx Linkset](#) procedure to add the linkset that will be the mate IPGWx linkset. After the linkset has been added, continue the procedure with [5](#).

If this linkset contains more than one signaling link, and you do not wish to add the mate IPGWx linkset to this linkset, perform one of these actions.

- If wish to use another linkset shown in the `rept-stat-iptps` output in [1](#), repeat this step with a linkset shown in the `rept-stat-iptps` output in [1](#).
- Perform the [Configuring an IPGWx Linkset](#) procedure to add the new IPGWx linkset that the mate IPGWx linkset will be assigned to. After the linkset has been added, if the linkset that will be the mate IPGWx linkset is shown in the `rept-stat-iptps` output in [1](#), continue the procedure with [3](#). If the linkset that will be the mate IPGWx

linkset is not shown in the `rept-stat-iptps` output in 1, perform the [Configuring an IPGWx Linkset](#) procedure to add the new IPGWx linkset that will be the mate IPGWx linkset. After the mate IPGWx linkset has been added, continue the procedure with 14

3. Display the mate linkset from the **IPGWx** linksets shown in the `rept-stat-iptps` output in 1.

For this example, enter this command.

```
rtrv-ls:lsn=lsgw1107
```

This is an example of the possible output.

```
rlghncxa03w 08-04-17 11:43:04 GMT EAGLE5 38.0.0

LSN          APCA  (SS7)  SCRN  L3T  SLT          GWS  GWS  GWS
SLSCI NIS
lsgw1107     003-002-004  none  1    1    no  A    1    off off off
no          off

          CLLI          TFATCABMLQ  MTPRSE  ASL8
          -----  1          no      no

          IPGWAPC  MATELSN      IPTPS  LSUSEALM  SLKUSEALM  GTTMODE
          yes      -----  10000  70      % 70      % CdPA

          LOC  LINK  SLC  TYPE
          1107  A    0    SS7IPGW

Link set table is ( 14 of 1024) 1% full
```

4. To use the linkset shown in 3 as a mate, the network type of the adjacent point code of the linkset shown in 3 must be the same as the network type of the linkset shown in 2. The linkset shown in 3 must not have more than one signaling link assigned to it.

If the linkset contains more than one signaling link, all but one of these signaling links must be removed from the linkset. Perform the [Removing an IPGWx Signaling Link](#) procedure to remove these signaling links.

If you do not wish to change this linkset, or if the network type of the adjacent point codes of both linksets are not the same, either choose another linkset from the `rept-stat-iptps` output in 1, and repeat 3, and 4 if necessary, or perform the [Configuring an IPGWx Linkset](#) procedure and add a new linkset. Continue the procedure with 5.

If the network types of the adjacent point codes of both linksets are the same, and the mate linkset contains no more than one signaling link, do not perform the actions in this step. Continue the procedure with 5.

5. Display the status of the card containing the signaling link assigned to the linkset being changed by entering the `rept-stat-card` command with the card location shown in the `LOC` field in the `rtrv-ls` output in 2. For this example, enter this command.

 **Note:**

If the linkset that the mate linkset is being added to has no signaling links (see the `rtv-ls` output in 2), continue the procedure with 14.

```
rept-stat-card:loc=1103
```

This is an example of the possible output.

```
rlghncxa03w 08-04-27 17:00:36 GMT EAGLE5 38.0.0
CARD  VERSION      TYPE   GPL      PST      SST      AST
1103  114-000-000    DCM    SS7IPGW  IS-NR    Active   -----
ALARM STATUS      = No Alarms.
BPDCM GPL         = 002-102-000
IMT BUS A         = Conn
IMT BUS B         = Conn
SIGNALING LINK STATUS
SLK   PST          LS      CLLI
A     IS-NR        lsgw1103  -----
Command Completed.
```

6. Display the status of the signaling link assigned to the card shown in 5 by entering the `rept-stat-slk` command with the card location used in 5 and the `link=a` parameter. For this example, enter this command.

 **Note:**

If the status of the card shown in `PST` field in the `rept-stat-card` output in 5 is `OOS-MT-DSBLD`, continue the procedure with 14.

```
rept-stat-slk:loc=1103:link=a
```

This is an example of the possible output.

```
rlghncxa03w 08-04-27 17:00:36 GMT EAGLE5 38.0.0
SLK   LSN          CLLI      PST      SST      AST
1103,A  lsgw1103    -----  IS-NR    Avail   -----
ALARM STATUS      = No Alarms.
UNAVAIL REASON    = NA
Command Completed.
```

If the status of the signaling link is out-of-service maintenance disabled (OOS-MT-DSBLD), continue the procedure with 14.

If the status of the signaling link is not out-of-service maintenance disabled (OOS-MT-DSBLD), any in-service IP connections on the signaling link must be placed out of service. Continue the procedure by performing one of these steps.

- The recommended method is to have the far end node place these IP connections out of service. Have the far-end node for the signaling link shown in this step place the

M3UA or **SUA** associations in either the **ASP-INACTIVE** or **ASP-DOWN** state. After the IP connections have been placed out of service, continue the procedure with 12.

- If you do not wish to have the far end node place these **IP** connections out of service, continue the procedure with 7.
7. Display the **IP** link associated with the card that the signaling link shown in 6 is assigned to by entering the `rtrv-ip-lnk` command with the card location shown in 6. For this example, enter this command.

```
rtrv-ip-lnk:loc=1103
```

The following is an example of the possible output.

```
rlghncxa03w 08-04-28 21:14:37 GMT EAGLE5 38.0.0
LOC   PORT IPADDR          SUBMASK          DUPLEX   SPEED  MACTYPE
AUTO MCAST
1103  A    192.1.1.10      255.255.255.128 HALF     10    802.3
NO    NO
1103  B    -----        -----        HALF     10    DIX
NO    NO
```

8. Display the **IP** host information associated with the **IP** link by entering the `rtrv-ip-host` command with the **IP** address shown in 7. For this example, enter this command.

```
rtrv-ip-host:ipaddr=192.001.001.010
```

The following is an example of the possible output.

```
rlghncxa03w 08-12-28 21:17:37 GMT EAGLE5 40.0.0

LOCAL IPADDR   LOCAL HOST
192.1.1.10    IPNODE1_1103

IP Host table is (11 of 4096) .26% full
```

9. Display the association associated with the local host name shown in 8 by entering the `rtrv-assoc` command.

For this example, enter this command.

```
rtrv-assoc:lhost=ipnode1_1103
```

The following is an example of the possible output.

```
rlghncxa03w 08-04-28 09:12:36 GMT EAGLE5 38.0.0
CARD IPLNK
ANAME          LOC PORT  LINK ADAPTER LPORT RPORT OPEN ALW
assoc2        1103 A    A    M3UA      1030 1030 YES YES

IP Appl Sock/Assoc table is (4 of 4000) 1% full
Assoc Buffer Space Used (16 KB of 3200 KB) on LOC = 1103
```

10. Change the `alw` parameter values in the association shown in 9 using the `chg-assoc` command with the `alw=no` parameters, as necessary.

 **Note:**

If the `open` and `alw` parameter values of the association shown in 9 are `no`, continue the procedure with 11.

```
chg-assoc:aname=assoc2:alw=no
```

 **Caution:**

This command impacts network performance and should only be used during periods of low traffic.

When this command has successfully completed, this message should appear.

```
rlghncxa03w 08-04-28 09:12:36 GMT EAGLE5 38.0.0  
CHG-ASSOC: MASP A - COMPLTD
```

Repeat this step for all associations shown in 9.

11. Change the `open` parameter values in the association shown in 9 using the `chg-assoc` command with the `open=no` parameters, as necessary.

```
chg-assoc:aname=assoc2:open=no
```

When this command has successfully completed, this message should appear.

```
rlghncxa03w 08-04-28 09:12:36 GMT EAGLE5 38.0.0  
CHG-ASSOC: MASP A - COMPLTD
```

Repeat this step for all associations shown in 9.

12. Deactivate the signaling link assigned to the IP card using the `dact-slk` command. For example, enter this command.

```
dact-slk:loc=1103:link=a
```

 **Caution:**

This command impacts network performance and should only be used during periods of low traffic.

After this command has successfully completed, this message appears.

```
rlghncxa03w 08-04-12 09:12:36 GMT EAGLE5 38.0.0  
Deactivate Link message sent to card.
```

13. Inhibit the IP card using the `inh-card` command. For example, enter this command.

```
inh-card:loc=1103
```

This message should appear.

```
rlghncxa03w 08-04-28 21:18:37 GMT EAGLE5 38.0.0
Card has been inhibited.
```

14. Change the linkset shown in 2 by entering the `chg-ls` command with the `matelsn` and `action=add` parameters.

For this example, enter this command.

```
chg-ls:lsn=lsgw1103:matelsn=lsgw1107:action=add
```

When the `chg-ls` command has successfully completed, this message should appear.

```
rlghncxa03w 08-04-17 16:23:21 GMT EAGLE5 38.0.0
Link set table is ( 14 of 1024) 1% full
CHG-LS: MASP A - COMPLTD
```

15. Verify the changes using the `rtrv-ls` command specifying the linkset name specified in 14 with the `lsn` parameter. For this example, enter this command.

```
rtrv-ls:lsn=lsgw1103
```

This is an example of the possible output.

```
rlghncxa03w 08-04-17 11:43:04 GMT EAGLE5 38.0.0

LSN          APCA  (SS7)  SCRN  L3T  SLT          GWS  GWS  GWS
SLSCI NIS
lsgw1103     003-002-004  none  1    1    no  A    1    off off off
no          off

          CLLI          TFATCABMLQ  MTPRSE  ASL8
-----  1          no      no

IPGWAPC  MATELSN  IPTPS  LSUSEALM  SLKUSEALM  GTTMODE
yes      lsgw1107  10000  70      % 70      % CdPA

LOC  LINK  SLC  TYPE
1103 A    0    SS7IPGW
```

```
Link set table is ( 14 of 1024) 1% full
```

If the linkset shown in this step does not have a signaling link assigned to it, or if the `dact-slk` command in 12 was not performed, continue the procedure with 20.

16. Allow the IP card that was inhibited in 13 using the `alw-card` command. For example, enter this command.

```
alw-card:loc=1103
```

This message should appear.

```
rlghncxa03w 08-04-28 21:21:37 GMT EAGLE5 38.0.0  
Card has been allowed.
```

17. Activate the signaling link from 12 using the `act-slk` command. For example, enter this command.

```
act-slk:loc=1103:link=a
```

The output confirms the activation.

```
rlghncxa03w 08-04-07 11:11:28 GMT EAGLE5 38.0.0  
Activate Link message sent to card
```

If 10 and 11 were not performed, continue the procedure with 19.

18. Change the `open` and `alw` parameter values for all the associations changed in 10 or 11 using the `chg-assoc` command with the `open=yes` and `alw=yes` parameters.

```
chg-assoc:aname=assoc1:open=yes:alw=yes
```

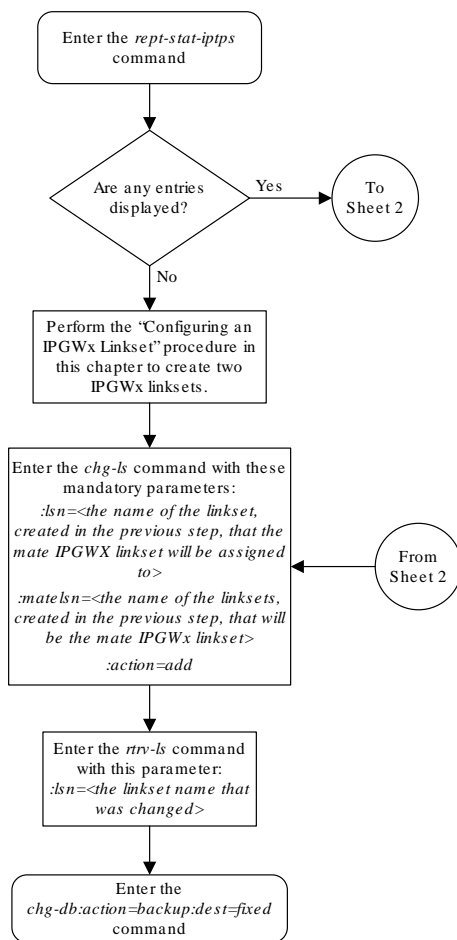
When this command has successfully completed, this message should appear.

```
rlghncxa03w 08-04-28 09:12:36 GMT EAGLE5 38.0.0  
CHG-ASSOC: MASP A - COMPLTD
```

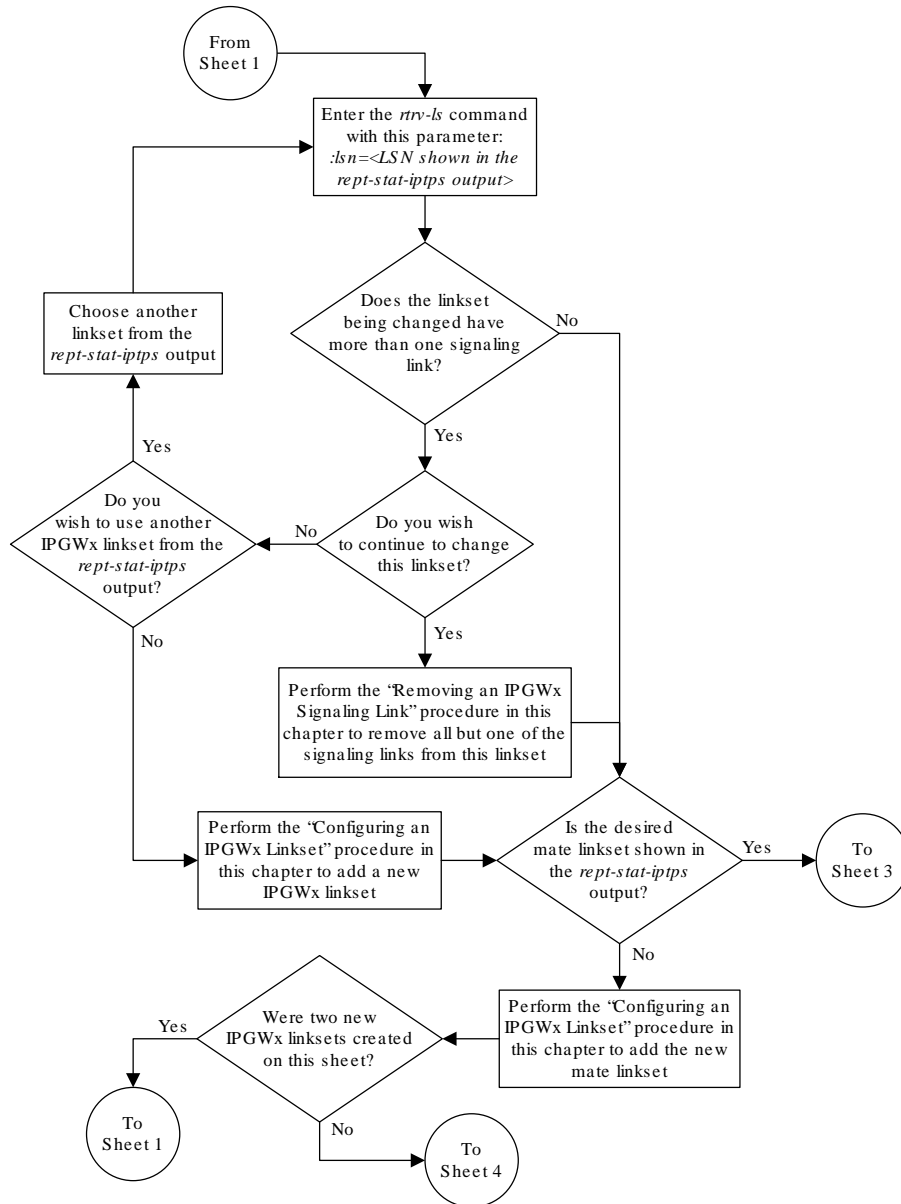
19. Have the far-end node for the signaling link shown in 15 place the IP connections on the signaling link into service by placing the M3UAor **SUA** associations in the ASP-ACTIVE state.
20. Back up the new changes using the `chg-db:action=backup:dest=fixed` command. These messages should appear, the active Maintenance and Administration Subsystem Processor (MASP) appears first.

```
.  
  
BACKUP (FIXED) : MASP A - Backup starts on active MASP.  
BACKUP (FIXED) : MASP A - Backup on active MASP to fixed disk complete.  
BACKUP (FIXED) : MASP A - Backup starts on standby MASP.  
BACKUP (FIXED) : MASP A - Backup on standby MASP to fixed disk complete.
```

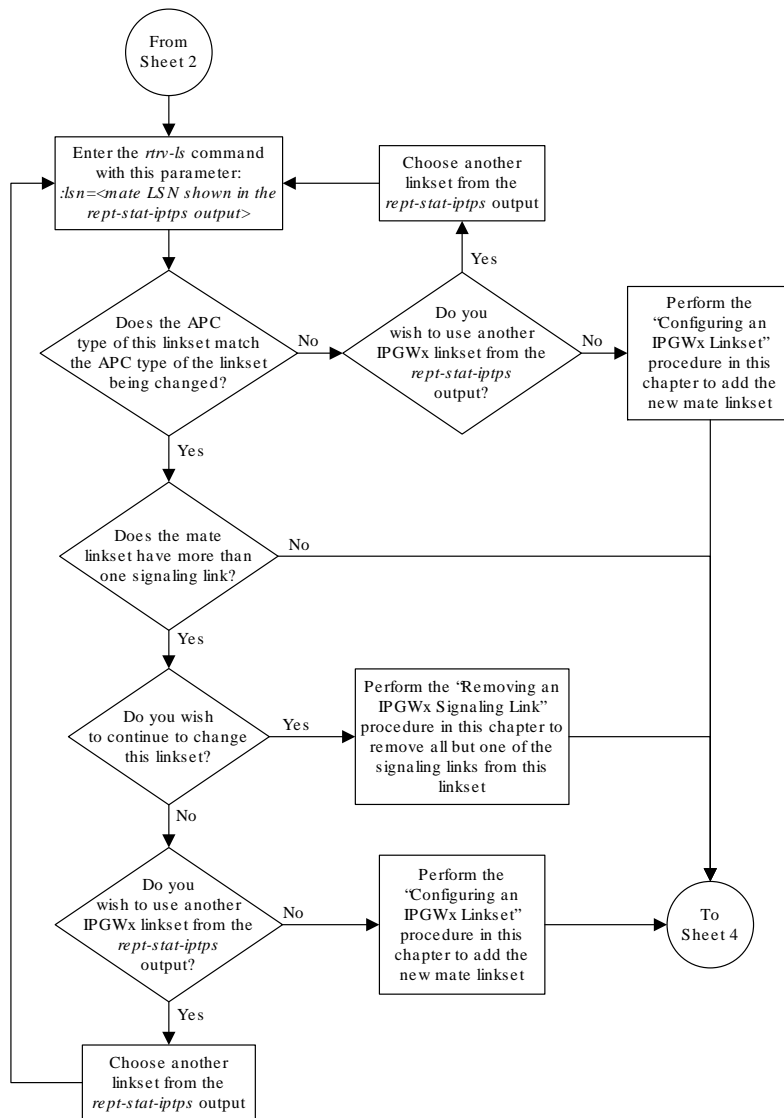
Figure 4-5 Adding a Mate IPGWx Linkset to another IPGWx Linkset

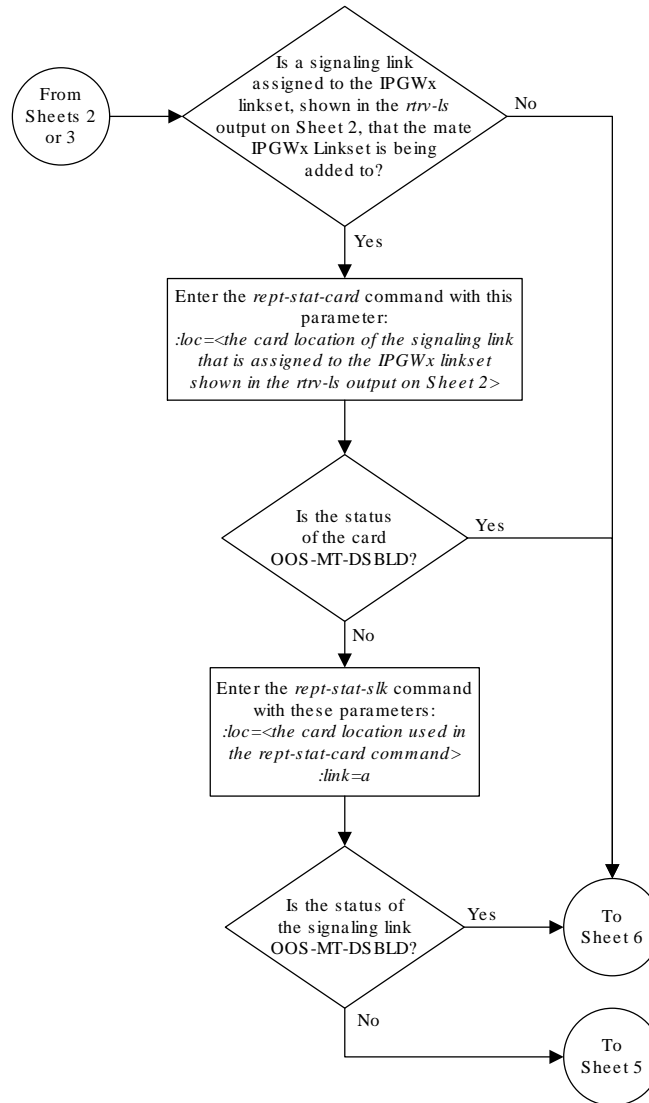


Sheet 1 of 6

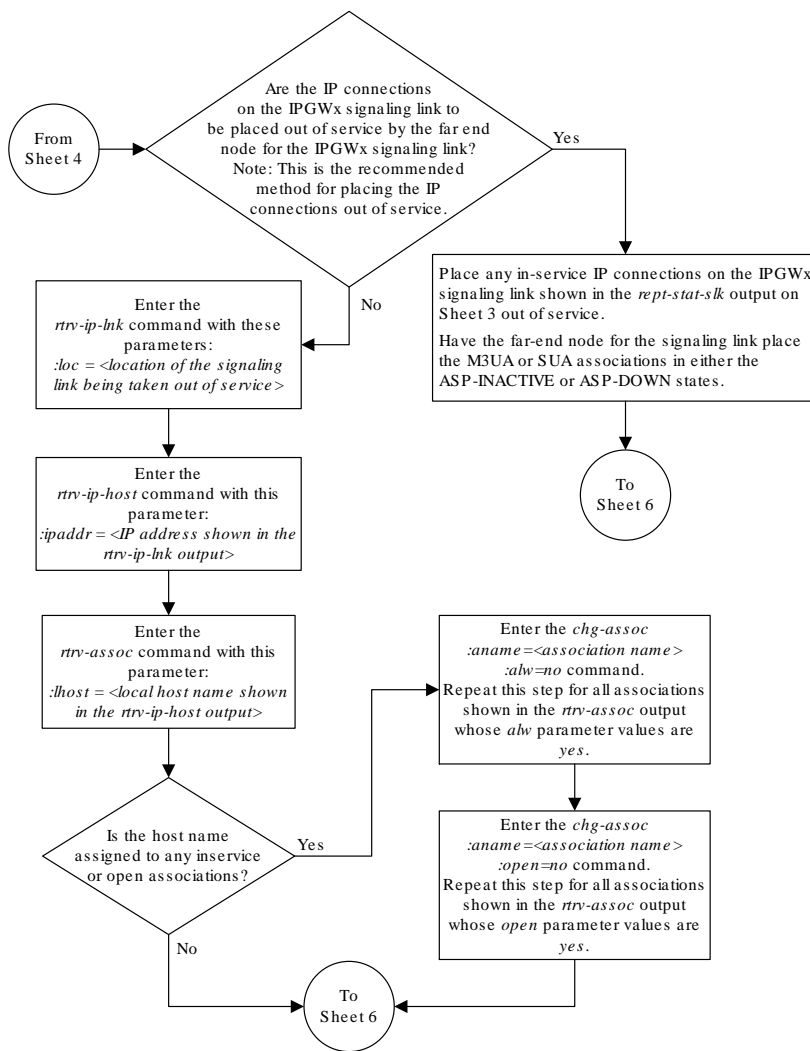


Sheet 2 of 6

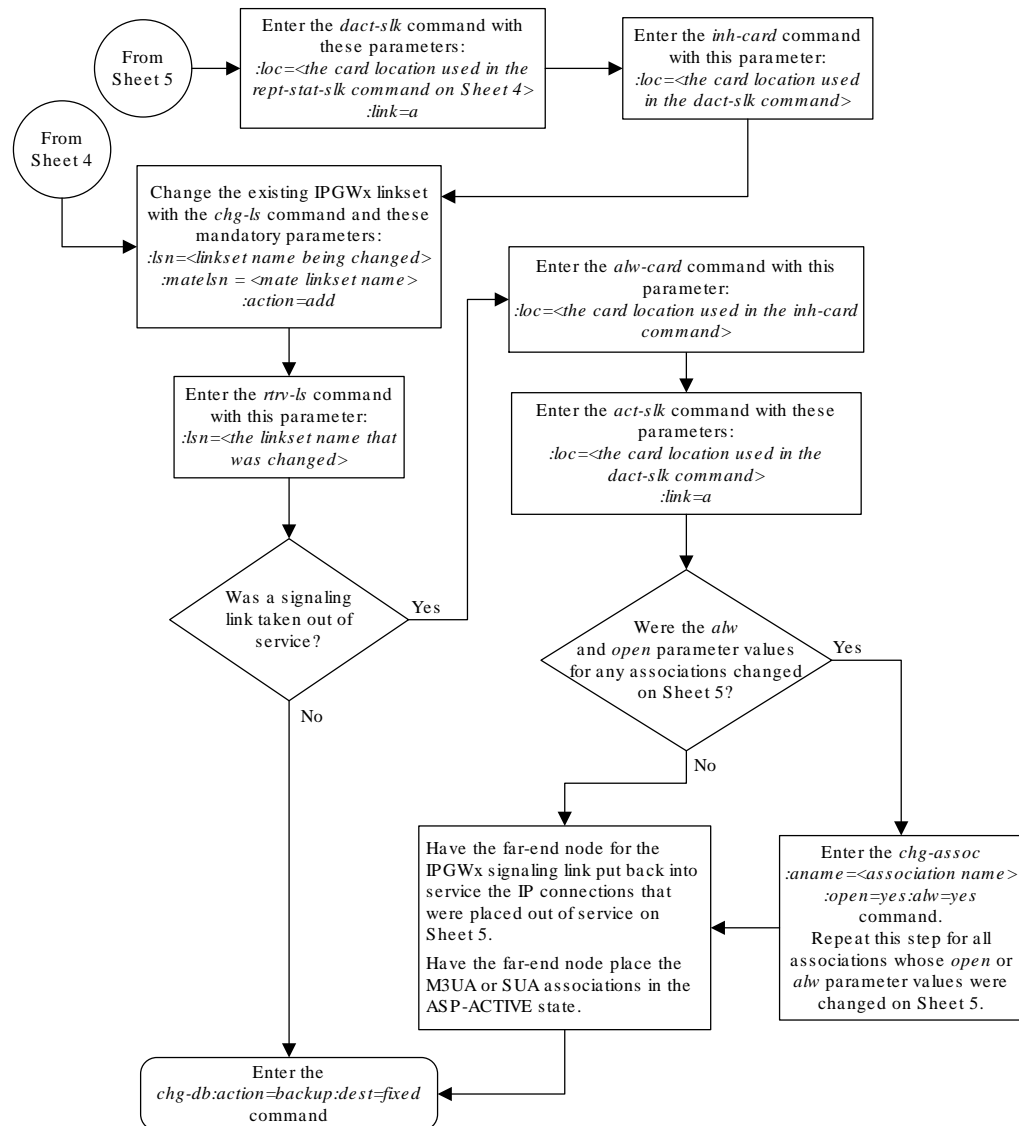




Sheet 4 of 6



Sheet 5 of 6



Sheet 6 of 6

4.5 Adding an IPGWx Signaling Link

This procedure is used to add an **IPGWx** signaling link to the database using the `ent-slk` command with these parameters:

:loc – The card location of the **IP** card that the **IP** signaling link will be assigned to. The cards specified by this parameter are **IP** cards running the **SS7IPGW** or **IPGWI** applications.

:link – The signaling link on the card specified in the loc parameter.

:lsn – The name of the linkset that will contain the signaling link.

:slc – The signaling link code. The **SLC** must be unique within the linkset. It must be the same at both the **EAGLE** location and the distant node.

The `ent-slk` command contains other optional parameters that are not used to configure an IPGWx signaling link. These parameters are discussed in more detail in *Commands User's Guide* or in these sections.

- These procedures in this manual:
 - [Adding an IPLIMx Signaling Link](#)
 - [Adding an IPSP M3UA Signaling Link](#)
 - [Adding an IPSP M2PA Linkset](#)
- These procedures in *Database Administration - SS7 User's Guide*
 - Adding an SS7 Signaling Link
 - Adding an E1 Signaling Link
 - Adding a T1 Signaling Link
 - Adding an ATM High-Speed Signaling Link

These items must be configured in the database before an **IP** signaling link can be added:

- Shelf – see "Adding a Shelf" in the *Database Administration - System Management User's Guide*.
- Card – see [Adding an IPGWx Card](#)
- Destination **Point Code** – see "Adding a **Destination Point Code**" in the *Database Administration - SS7 User's Guide*.
- Linkset – see [Configuring an IPGWx Linkset](#).

Verify that the link has been physically installed (all cable connections have been made).

To configure the **EAGLE** to perform circular routing detection test on the signaling links, "Configuring Circular **Route** Detection" procedure in *Database Administration - SS7 User's Guide*.

**Note:**

Circular route detection is not supported in **ITU** networks.

To provision a **EAGLE** with more than 1200 signaling links, the **EAGLE** must have certain levels of hardware installed. See the [Requirements for EAGLEs Containing more than 1200 Signaling Links](#) section for more information on these hardware requirements.

The **EAGLE** can contain a mixture of low-speed, **E1**, **T1**, **ATM** high-speed, and **IP** signaling links. The [Determining the Number of High-Speed and Low-Speed Signaling Links](#) section describes how to determine the quantities of the different types of signaling links the **EAGLE** can have.

Canceling the **REPT-STAT-SLK**, **RTRV-LS**, and **RTRV-SLK** Commands

Because the `rept-stat-slk`, `rtrv-ls`, and `rtrv-slk` commands used in this procedure can output information for a long period of time, the `rept-stat-slk`, `rtrv-ls`, and `rtrv-slk` commands can be canceled and the output to the terminal stopped. There are three ways that the `rept-stat-slk`, `rtrv-ls`, and `rtrv-slk` commands can be canceled.

- Press the **F9** function key on the keyboard at the terminal where the `rept-stat-slk`, `rtrv-ls`, or `rtrv-slk` commands were entered.
- Enter the `canc-cmd` without the `trm` parameter at the terminal where the `rept-stat-slk`, `rtrv-ls`, or `rtrv-slk` commands were entered.
- Enter the `canc-cmd:trm=<xx>`, where `<xx>` is the terminal where the `rept-stat-slk`, `rtrv-ls`, or `rtrv-slk` commands were entered, from another terminal other than the terminal where the `rept-stat-slk`, `rtrv-ls`, or `rtrv-slk` commands was entered. To enter the `canc-cmd:trm=<xx>` command, the terminal must allow Security Administration commands to be entered from it and the user must be allowed to enter Security Administration commands. The terminal's permissions can be verified with the `rtrv-secu-trm` command. The user's permissions can be verified with the `rtrv-user` or `rtrv-secu-user` commands.

For more information about the `canc-cmd` command, go to *Commands User's Guide*.

1. Display the maximum number of signaling links the **EAGLE** can have and the number of signaling links that are currently provisioned by entering the `rtrv-tbl-capacity` command.

This is an example of the possible output.

```
rlghncxa03w 09-07-19 21:16:37 GMT EAGLE5 41.1.0  
  
SLK      table is (          7 of      1200)   1% full
```

Note:

The `rtrv-tbl-capacity` command output contains other fields that are not used by this procedure. If you wish to see all the fields displayed by the `rtrv-tbl-capacity` command, refer to the `rtrv-tbl-capacity` command description in *Commands User's Guide*.

If the addition of the new signaling link will not exceed the maximum number of signaling links the **EAGLE** can have, continue the procedure with [2](#).

If the addition of the new signaling link will exceed the maximum number of signaling links the **EAGLE** can have, and the maximum number of signaling links is less than 2800, perform the [Enabling the Large System # Links Controlled Feature](#) procedure to enable the desired quantity of signaling links. After the new quantity of signaling links has been enabled, continue the procedure with [2](#).

If the addition of the new signaling link will exceed the maximum number of signaling links the EAGLE can have (in this example, the maximum number of signaling links is 1200), and the maximum number of signaling links is 2800, this procedure cannot be performed. The EAGLE cannot contain more than 2800 signaling links.

2. Display the current signaling link configuration using the `rtrv-slk` command.

```
rlghncxa03w 09-07-19 21:16:37 GMT EAGLE5 41.1.0
                                L2T                PCR  PCR
LOC  LINK LSN          SLC TYPE   SET  BPS    ECM  N1  N2
1201 B   lsa1          0  LIMDS0   1   56000  BASIC ---  -----
1203 B   lsa2          0  LIMDS0   1   56000  BASIC ---  -----
1207 A   lsn1207a     0  LIMDS0   1   56000  BASIC ---  -----
1207 B   lsn1207b     0  LIMDS0   1   56000  BASIC ---  -----
```

SLK table is (4 of 1200) 1% full.

3. Display the current linkset configuration using the `rtrv-ls` command.

This is an example of the possible output.

```
rlghncxa03w 08-04-10 11:43:04 GMT EAGLE5 38.0.0

                                L3T SLT                GWS GWS GWS
LSN          APCA  (SS7)  SCRNR  SET SET BEI LST LNKS ACT MES DIS
SLSCI NIS
ele2         001-207-000  none  1  1  no  B  6  off off off
no  off
ls1305      000-005-000  none  1  1  no  A  1  off off off
no  off
ls1307      000-007-000  none  1  1  no  A  1  off off off
no  off
elm1s1      001-001-001  none  1  1  no  A  7  off off off
no  off
elm1s2      001-001-002  none  1  1  no  A  7  off off off
no  off
```

```
                                L3T SLT                GWS GWS GWS
LSN          APCI  (SS7)  SCRNR  SET SET BEI LST LNKS ACT MES DIS
SLSCI NIS
ele2i       1-207-0      none  1  1  no  B  4  off off off
---  on
ls1315      0-015-0      none  1  1  no  A  1  off off off
---  off
ls1317      0-017-0      none  1  1  no  A  1  off off off
---  on
elm2s1      1-011-1      none  1  1  no  A  7  off off off
---  off
elm2s2      1-011-2      none  1  1  no  A  7  off off off
---  off
```

Link set table is (10 of 1024) 1% full.

If the required linkset is not in the database, perform the [Configuring an IPGWx Linkset](#) to add the linkset to the database.

If you plan to use a linkset shown in this step, continue the procedure with [4](#).

If a new linkset is being added in this step, continue the procedure with [5](#).

4. Display the linkset that the signaling link is being assigned to using the `rtrv-ls` command, specifying the name of the linkset that the signaling link is being assigned to.

For this example, enter this command.

```
rtrv-ls:lsn=lsnipgw
```

This is an example of the possible output.

```
rlghncxa03w 08-04-17 11:43:04 GMT EAGLE5 38.0.0

LSN          APCI  (SS7)  SCRN  L3T  SLT          GWS  GWS  GWS
NIS          2968          none  1    1    no  A    1    off off off ---
lsipgw
off

          CLLI          TFATCABMLQ  MTPRSE  ASL8  SLRSRB  MULTGC  ITUTFR
          -----  1          no      ---  1          yes      off

          IPGWAPC  MATELSN  IPTPS  LSUSEALM  SLKUSEALM  GTTMODE
          yes      -----  10000  70      % 70      % CdPA

          LOC  LINK  SLC  TYPE
          1317  A    0    IPGWI

          SAPCI
          1-10-1

          SAPCN
          1234-aa
          1235-bb
          1200-zz
```

Link set table is (13 of 1024) 1% full.

Linksets containing IPGWx signaling links can contain only IPGWx signaling links.

5. Display the cards in the database using the `rtrv-card` command.

This is an example of the possible output.

```
rlghncxa03w 09-10-28 09:12:36 GMT EAGLE5 41.0.0
CARD  TYPE      APPL      LSET NAME      LINK SLC  LSET NAME      LINK SLC
1102  TSM         GLS
1113  GSPM        EOAM
1114  TDM-A
1115  GSPM        EOAM
1116  TDM-B
```


1117	MDAL						
1201	LIMDS0	SS7ANSI	lsa1	B	0		
1202	LIMDS0	SS7ANSI					
1203	LIMDS0	SS7ANSI	lsa2	B	0		
1204	LIMDS0	SS7ANSI					
1205	LIMDS0	SS7ANSI	lsa3	A	0		
1206	LIMDS0	SS7ANSI					
1207	LIMDS0	SS7ANSI	lsn1207a	A	0	lsn1207b	
B	0						
1208	LIMDS0	SS7ANSI					
1212	LIMDS0	SS7ANSI					
1213	LIMDS0	SS7ANSI					
1214	LIMDS0	SS7ANSI	lsn1214a	A	0	lsa3	
B	1						
1215	LIMDS0	SS7ANSI					
1301	LIMDS0	ATMANSI					
1302	LIMATM	ATMANSI					
1304	LIMDS0	SS7ANSI					
1305	LIMATM	ATMANSI					
1308	LIMDS0	SS7ANSI					
1311	LIMDS0	SS7ANSI					
1313	LIMDS0	SS7ANSI					
1318	LIMATM	ATMANSI					

If the required card is not in the database, perform the [Adding an IPGWx Card](#) procedure and add the **IP** card to the database.

 **Note:**

If the linkset that the signaling link will be added to contains the `multtgc=yes` parameter, the application assigned to the card must be **IPGWI**.

 **Note:**

If the **IPGWx** linkset contains any **IPGWx** signaling links, continue the procedure with [7](#).

6. If you wish to assign an **IPGWx** signaling link to a linkset that contains no signaling links, but the `IPGWAPC` value is no, perform the “Removing a Linkset Containing **SS7** Signaling Links” procedure in the *Database Administration - **SS7** User's Guide* and remove the linkset, then perform the [Configuring an IPGWx Linkset](#) procedure and re-enter the new linkset with the `ipgwapc=yes` parameter. Continue the procedure with [10](#).
7. If the desired linkset, shown in the `rtrv-ls` output in [4](#), has a mate **IPGWx** linkset assigned, or is the mate to another **IPGWx** linkset, the desired linkset can contain only one signaling link.

If the desired linkset does not have a mate **IPGWx** linkset assigned, or is not the mate of another **IPGWx** linkset, the desired linkset can contain up to 8 **IPGWx** signaling links. No other signaling link types can be in an **IPGWx** linkset.

If you wish to assign more than one **IPGWx** signaling link to an **IPGWx** linkset that has a mate linkset assigned, the mate to this linkset must be removed. Perform the [Removing a Mate IPGWx Linkset from another IPGWx Linkset](#) procedure and remove the mate linkset from the linkset you wish to assign the **IPGWx** signaling link to. If you do not wish to use this linkset, perform the [Configuring an IPGWx Linkset](#) procedure and add a new **IPGWx** linkset.

If the desired **IPGWx** linkset does not have a mate assigned, continue the procedure with [9](#).

If the desired linkset has a mate linkset assigned, and contains an **IPGWx** signaling link, perform the [Configuring an IPGWx Linkset](#) procedure and add a new **IPGWx** linkset. Continue the procedure with [10](#).

8. If you wish to assign more than one **IPGWx** signaling link to an **IPGWx** linkset that is a mate to another **IPGWx** linkset, this linkset must be removed from the other linkset as a mate.

To verify if the linkset you wish to use is the mate of another **IPGWx** linkset, enter the `rept-stat-iptps` command to display the names of all the **IPGWx** linksets. This is an example of the possible output.

```
rlghncxa03w 10-07-19 21:16:37 GMT EAGLE5 42.0.0
IP TPS USAGE REPORT
```

	THRESH	CONFIG/ RSVD	CONFIG/ MAX		TPS	PEAK	PEAKTIMESTAMP

LSN							
lsgw1101	80%	----	6000	TX:	5100	5500	05-02-10
11:40:04							
				RCV:	5100	5500	05-02-10
11:40:04							
lsgw1103	80%	----	6000	TX:	5200	5500	05-02-10
11:40:04							
				RCV:	5200	5500	05-02-10
11:40:04							
lsgw1105	80%	----	14000	TX:	7300	7450	05-02-10
11:40:04							
				RCV:	7300	7450	05-02-10
11:40:04							
lsgw1107	70%	----	4000	TX:	3200	3500	05-02-10
11:40:04							
				RCV:	3200	3500	05-02-10
11:40:04							

Command Completed.

9. Enter the `rtrv-ls:lsn=<IPGWx linkset name from the rept-stat-iptps output>` to verify if the desired linkset is the mate of another **IPGWx** linkset.

For this example, enter this command.

```
rtrv-ls:lsn=lsgw1103
```

This is an example of the possible output.

```
rlghncxa03w 08-04-17 11:43:04 GMT EAGLE5 38.0.0

LSN          APCA   (SS7)  SCRN  L3T SLT          GWS GWS GWS
SLSCI NIS
lsgw1103     003-002-004  none  1   1   no  A   1   off off off
no          off

          CLLI          TFATCABMLQ MTPRSE  ASL8
          -----  1           no     no

IPGWAPC MATELSN      IPTPS  LSUSEALM  SLKUSEALM  GTTMODE
yes      lsgw1107  10000  70       % 70       % CdPA

LOC  LINK  SLC  TYPE
1103 A    0   SS7IPGW
```

Link set table is (14 of 1024) 1% full

If the name of the linkset you wish to use is not shown in the `MATELSN` field of the `rtrv-ls` output, repeat this step until all the **IPGWx** linksets have been displayed, or until a linkset has been found that has the linkset you wish to use assigned as a mate. If the linkset you wish to use is not the mate of another **IPGWx** linkset, continue the procedure with [10](#).

If the name of the linkset you wish to use is shown in the `MATELSN` field of the `rtrv-ls` output, perform the [Removing a Mate IPGWx Linkset from another IPGWx Linkset](#) procedure to remove this linkset from the other linkset as a mate. Then continue the procedure with [10](#).

If the desired linkset is the mate of another **IPGWx** linkset, and you do not wish to use this linkset, perform the [Configuring an IPGWx Linkset](#) procedure and add a new **IPGWx** linkset. Then continue the procedure with [10](#).

10. Add the signaling link to the database using the `ent-slk` command [Table 4-3](#) shows the parameters and values that can be specified with the `ent-slk` command.

Table 4-3 IPGWx Signaling Link Parameter Combinations

IPGWx Signaling Link
:loc = location of the IP card with one of these applications: SS7IPGW or IPGWI; and the DCM card type. (See Note 6)
:link = A
:lsn = linkset name (See Notes 1, 2, 3, 4, and 5)
:slc = 0 - 15 (See Notes 4 and 5)

Table 4-3 (Cont.) IPGWx Signaling Link Parameter Combinations

IPGWx Signaling Link
<p>Notes:</p> <ol style="list-style-type: none"> 1. If the <code>multgc=yes</code> parameter is assigned to the linkset, the card's application must be IPGWI. 2. The <code>ipgwapc=yes</code> parameter must be assigned to the linkset. 3. If the card's application is IPGWI, the linkset adjacent point code must be ITU. If the card's application is SS7IPGW, the linkset adjacent point code must be ANSI. The domain of the linkset adjacent point code must be SS7. 4. A linkset can contain only one signaling link assigned to the SS7IPGW or IPGWI applications if the linkset contains a mate IPGWx linkset, or is the mate of an IPGWx linkset. 5. If the linkset does not have a mate IPGWx linkset assigned to it, or is not the mate of an IPGWx linkset, the linkset can contain up to 8 signaling links assigned to the SS7IPGW or IPGWI applications.

For this example, enter these commands.

```
ent-slk:loc=2207:link=a:lsn=lsnlp3:slc=0
```

```
ent-slk:loc=2211:link=a:lsn=lsnlp4:slc=0
```

When each of these commands have successfully completed, this message should appear.

```
rlghncxa03w 06-10-07 08:29:03 GMT EAGLE5 36.0.0
ENT-SLK: MASP A - COMPLTD
```

 **Note:**

If adding the new signaling link will result in more than 700 signaling links in the database and the `OAMHCMEAS` value in the `rtrv-measopts` output is `son`, the scheduled UI measurement reports will be disabled.

11. Verify the changes using the `rtrv-slk` command with the card location and `link` parameter values specified in 10.

```
rtrv-slk:loc=2207:link=a
```

This is an example of the possible output.

```
rlghncxa03w 07-05-19 21:17:04 GMT EAGLE5 37.0.0
LOC LINK LSN          SLC TYPE
2207 A   lsnlp3      0  SS7IPGW
```

```
rtrv-slk:loc=2211:link=a
```

This is an example of the possible output.

```
rlghncxa03w 07-05-19 21:17:04 GMT EAGLE5 37.0.0
```

```
LOC LINK LSN          SLC TYPE
2211 A   lsnlp4      0  IPGWI
```

12. If any cards contain the first signaling link on a card, those cards must be brought into service with the `rst-card` command, specifying the location of the card.

For this example, enter these commands.

```
rst-card:loc=2207
rst-card:loc=2211
```

When each of these commands have successfully completed, this message should appear.

```
rlghncxa03w 06-10-23 13:05:05 GMT EAGLE5 36.0.0
Card has been allowed.
```

13. Activate all signaling links on the cards using the `act-slk` command, specifying the card location and `link` parameter value of each signaling link.

For this example, enter these commands.

```
act-slk:loc=2207:link=a
act-slk:loc=2211:link=a
```

When each of these commands have successfully completed, this message should appear.

```
rlghncxa03w 06-10-07 08:31:24 GMT EAGLE5 36.0.0
Activate Link message sent to card
```

14. Check the status of the signaling links added in 10 using the `rept-stat-slk` command with the card location and `link` parameter values specified in 10. The state of each signaling link should be in service normal (**IS-NR**) after the link has completed alignment (shown in the `PST` field). For this example, enter these commands.

```
rept-stat-slk:loc=2207:link=a
```

This is an example of the possible output.

```
rlghncxa03w 07-05-23 13:06:25 GMT EAGLE5 37.0.0
SLK      LSN      CLLI      PST      SST      AST
2207,A   lsnlp3   -----  IS-NR    Avail    ----
  ALARM STATUS      =
  UNAVAIL REASON    =
```

```
rept-stat-slk:loc=2211:link=a
```

This is an example of the possible output.

```
rlghncxa03w 07-05-23 13:06:25 GMT EAGLE5 37.0.0
SLK      LSN      CLLI      PST      SST      AST
2211,A   lsnlp4   -----  IS-NR    Avail    ----
```

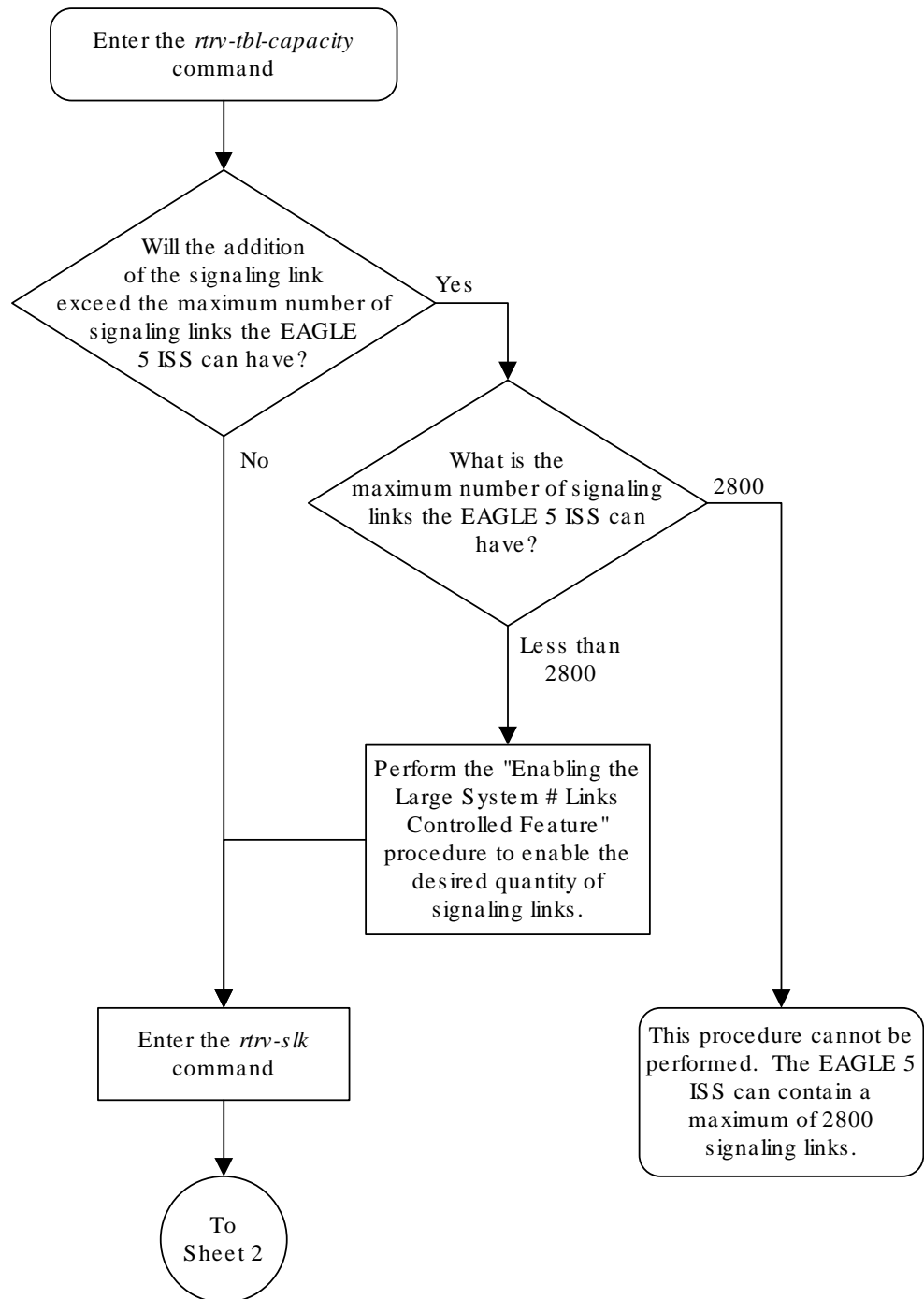
```
ALARM STATUS      =  
UNAVAIL REASON    =
```

15. Back up the new changes using the `chg-db:action=backup:dest=fixed` command.

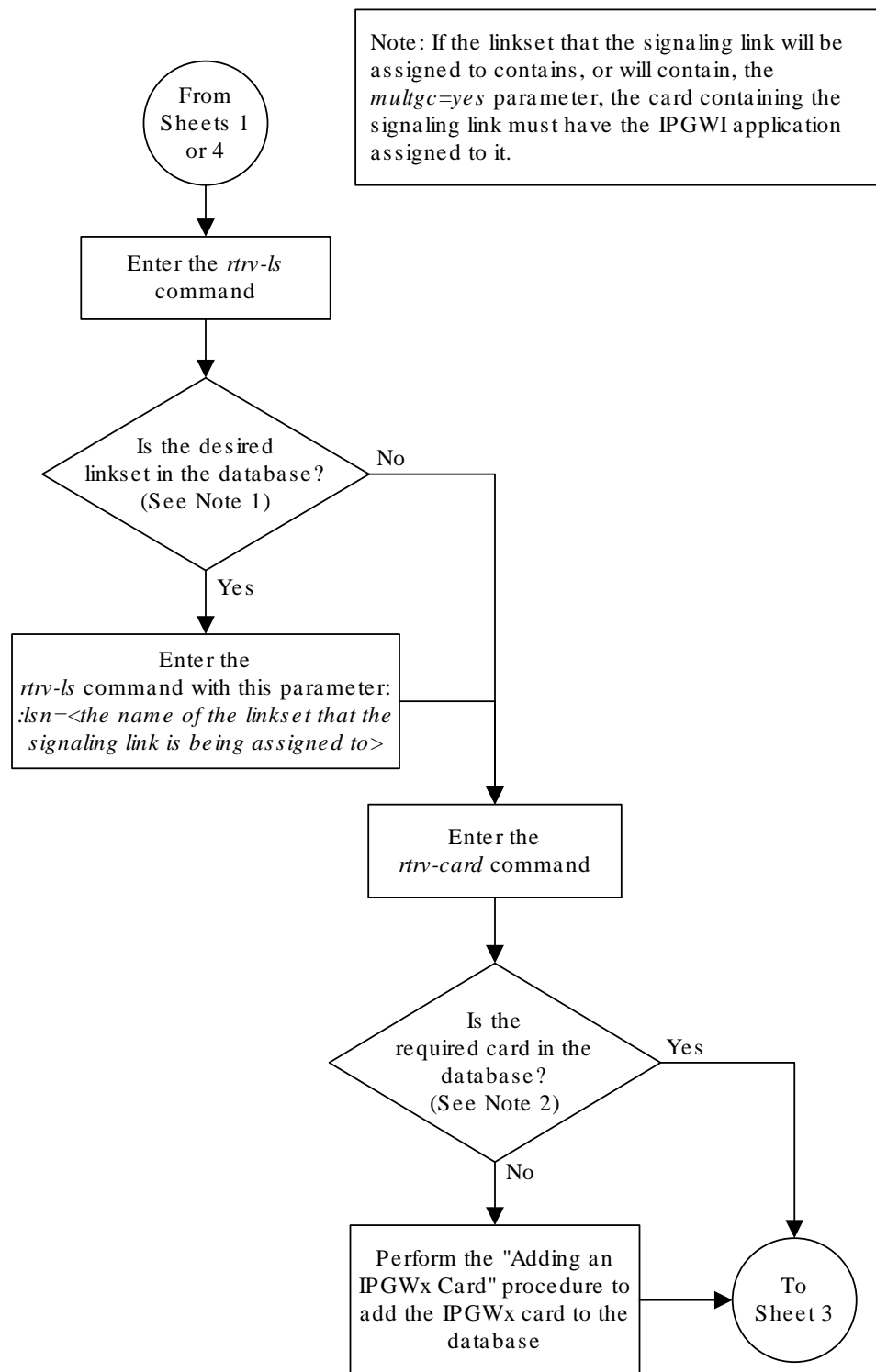
These messages should appear, the active **Maintenance and Administration Subsystem Processor (MASP)** appears first.

```
BACKUP (FIXED) : MASP A - Backup starts on active MASP.  
BACKUP (FIXED) : MASP A - Backup on active MASP to fixed disk complete.  
BACKUP (FIXED) : MASP A - Backup starts on standby MASP.  
BACKUP (FIXED) : MASP A - Backup on standby MASP to fixed disk complete.
```

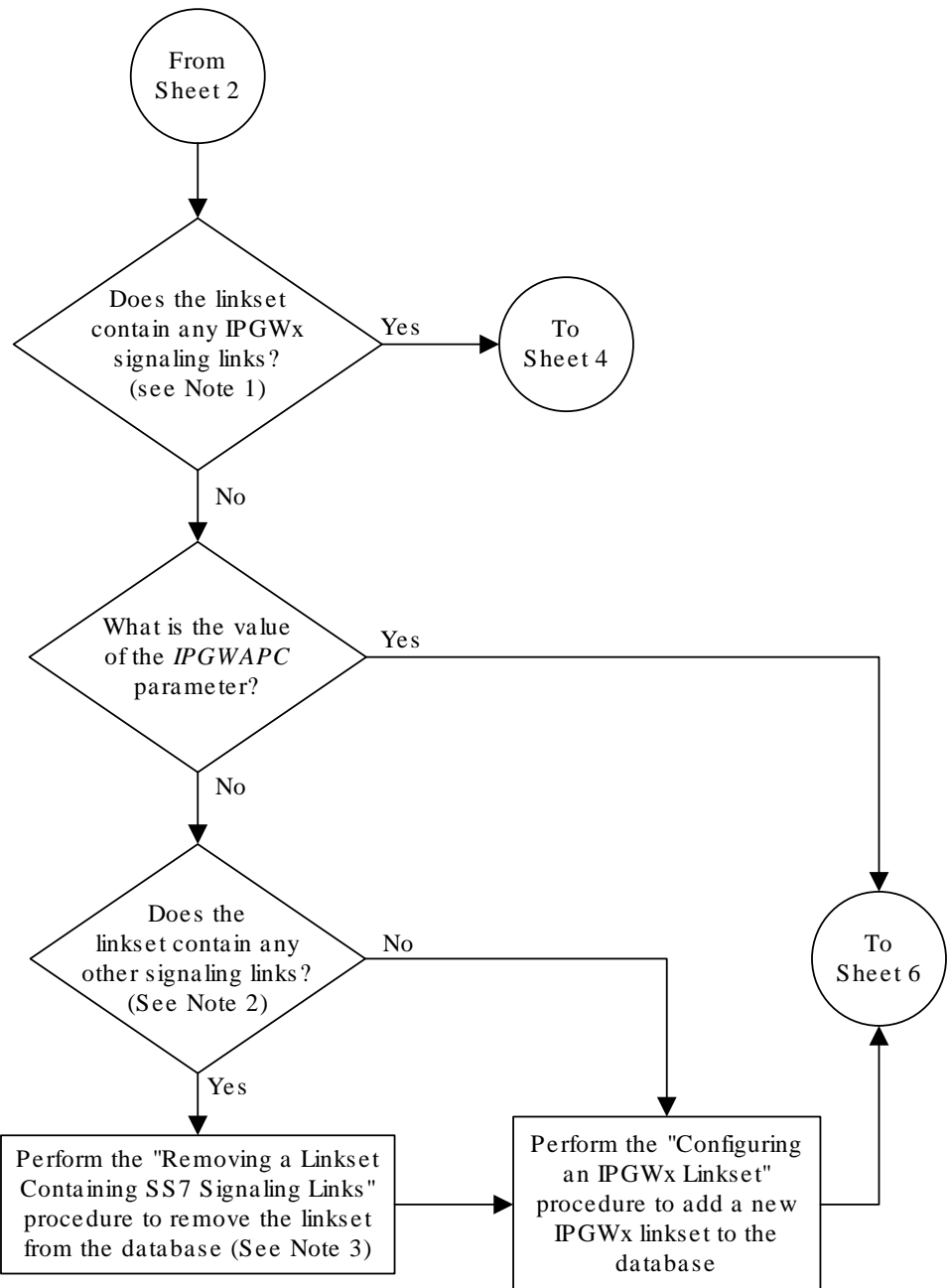
Figure 4-6 Adding an IPGWx Signaling Link



Sheet 1 of 6



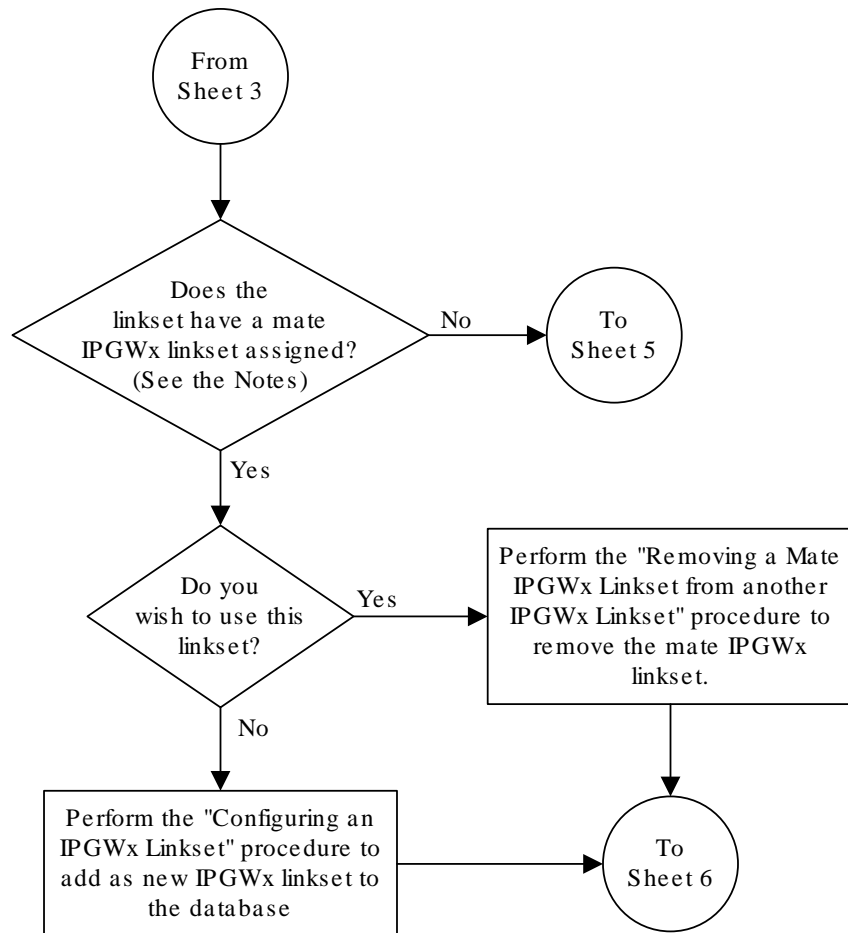
Sheet 2 of 6



Notes:

1. An IPGWx signaling link is a signaling link assigned to a card running either the SS7IPGW or IPGWI applications.
2. An IPGWx linkset can contain only IPGWx signaling links.
3. The *IPGWAPC=yes* parameter, required for an IPGWx linkset, can be specified only with the *ent-ls* command. To use this parameter for an existing linkset that has the *IPGWAPC=no* parameter, the linkset must be removed, then re-entered with the *IPGWAPC=YES* parameter.

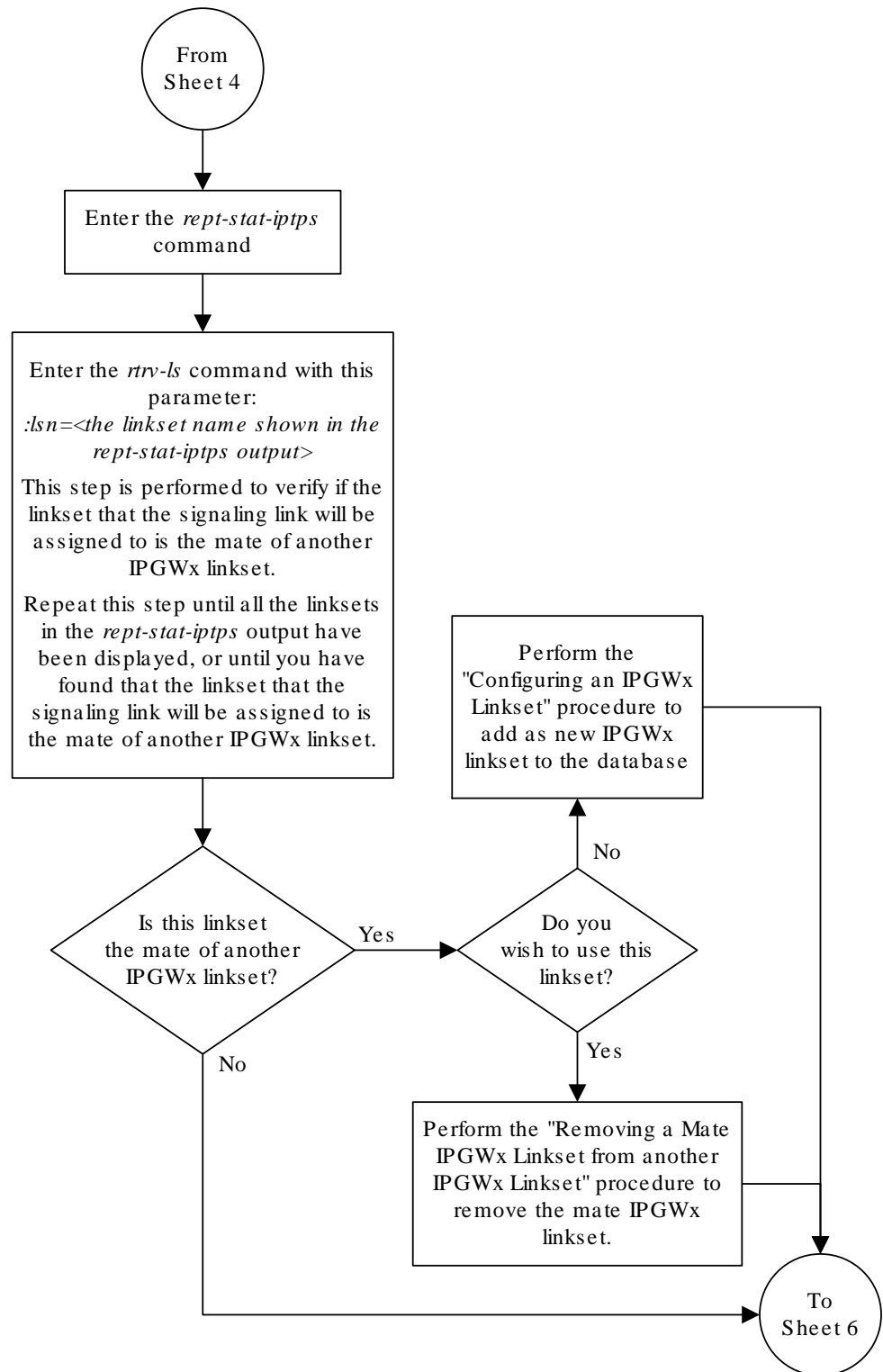
Sheet 3 of 6



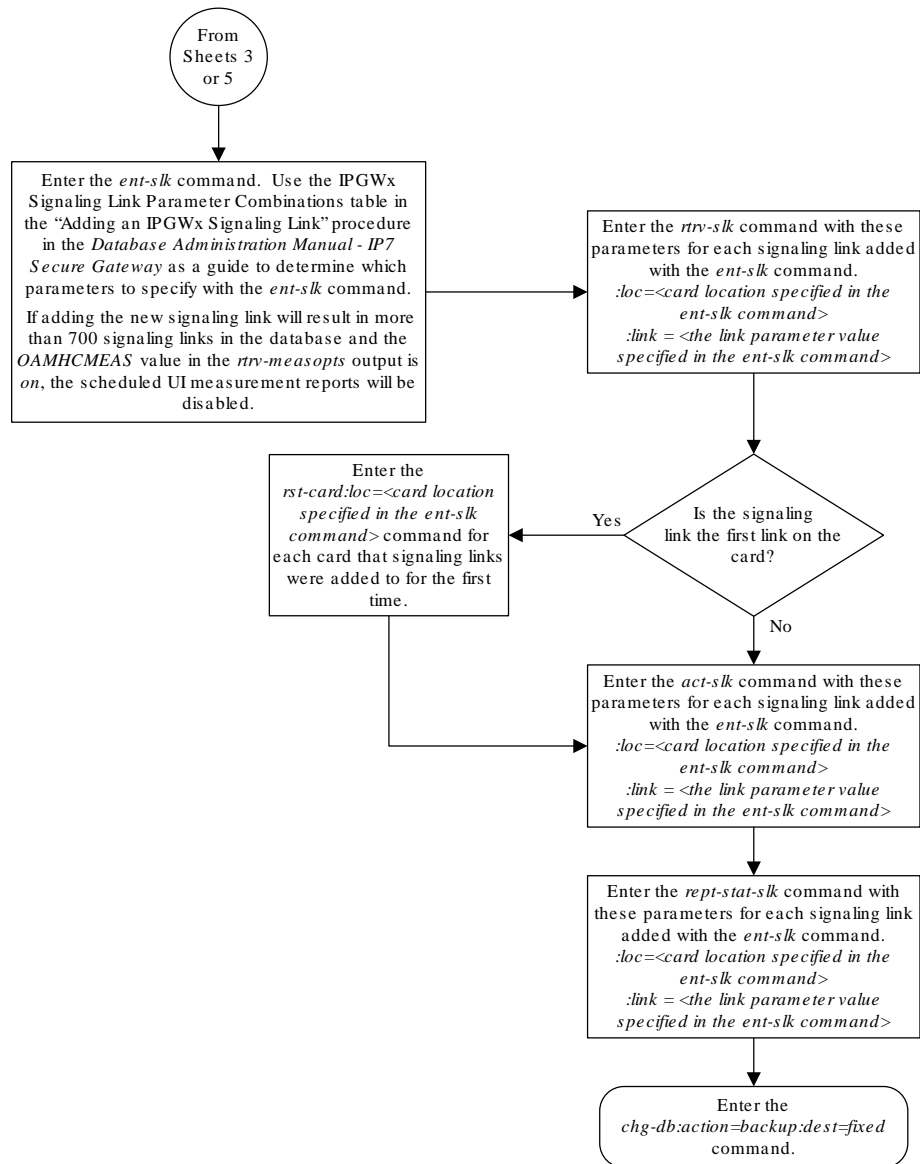
Notes:

1. An IPGWx linkset can contain only one IPGWx signaling link if the IPGWx linkset has a mate IPGWx linkset assigned to it, or is the mate to an IPGWx linkset.
2. If the IPGWx linkset is not the mate to another IPGWx linkset, or does not have a mate IPGWx linkset assigned, the IPGWx linkset can contain up to 8 IPGWx signaling links.

Sheet 4 of 6



Sheet 5 of 6



Sheet 6 of 6

4.6 Configuring an IP Link

This procedure is used to configure the link parameters for IP cards using the `chg-ip-lnk` command. These link parameters are used to configure the Ethernet hardware.

The `chg-ip-lnk` command uses the following parameters.

`:loc` – The card location of the **IP** card.

`:port` – The Ethernet interface on the **IP** card, A or B.

`:ipaddr` – **IP** address assigned to the Ethernet interface on the **IP** card. This is an **IP** address expressed in standard “dot notation.” **IP** addresses consist of the system’s network number and the machine’s unique host number.

`:submask` – The subnet mask of the **IP** interface. A subnet mask is an **IP** address with a restricted range of values. The bits in the mask must be a string of one’s followed by a string of zero’s. There must be at least two one’s in the mask, and the mask cannot be all one’s. See [Table 4-4](#) to assign the correct parameter values.

`:auto` – Tells hardware whether to automatically detect the `duplex` and `speed`.

`:duplex` – This is the mode of operation of the interface.

`:speed` – This is the bandwidth in megabits per second of the interface.

`:mactype` – This is the Media Access Control Type of the interface.

`:mcast` – The multicast control flag. This parameter enables or disables multicast support for the interface.

The EAGLE can contain a maximum of 2048 IP links.

A zero `ipaddr` parameter value (0.0.0.0) indicates the **IP** card Ethernet interface to **IP** link association is disabled. The host to the original **IP** address must be removed before the `ipaddr=0.0.0.0` can be specified.

If the `defrouter` parameter of the `chg-ip-card` command contains an **IP** address for the card specified in this procedure, the network portion of one of the **IP** addresses assigned to the card in this procedure must match the network portion of the **IP** address specified by the `defrouter` parameter of the `chg-ip-card` command.

The network portion of the **IP** address is based on the class of the **IP** address (shown in [Table 4-4](#)). If the **IP** address is a Class A **IP** address, the first field is the network portion of the **IP** address. If the **IP** address is a Class B **IP** address, the first two fields are the network portion of the **IP** address. If the **IP** address is a Class C **IP** address, the first three fields are the network portion of the **IP** address. For example, if the **IP** address is 193.5.207.150, a Class C **IP** address, the network portion of the **IP** address is 193.5.207.

If the `auto=yes` parameter is specified, then the `duplex` and `speed` parameters are not allowed.

The `loc` parameter value must be shown in the `rtrv-ip-card` output.

The **IP** card must be placed out of service.

If either the `ipaddr` or `submask` parameters are specified, then both parameters must be specified. If the `ipaddr` parameter value is zero (0.0.0.0), the `submask` parameter is not required.

The **IP** address and subnet mask values cannot be changed to an address representing a different network if:

- If the network interface specified by the `loc` and `port` parameters has a default router, `dnrsa`, or `dsnb` parameter values assigned to it, as shown in the `rtrv-ip-card` output.
- Any IP routes, shown in the `rtrv-ip-rte` output, reference the IP address for the network interface specified by the `loc` and `port` parameters.

The IP link cannot be changed if open associations reference the IP link being changed.

The network portion of the IP addresses assigned to the IP links on an IP card must be unique. For example, if IP links are assigned to IP card 1103, the network portion of the IP address for Ethernet interface A (`port=a`) must be different from the IP address for Ethernet interface B (`port=b`).

The `submask` parameter value is based upon the `ipaddr` setting. See [Table 4-4](#) for the valid input values for the `submask` and `ipaddr` parameter combinations.

Table 4-4 Valid Subnet Mask Parameter Values

Network Class	IP Network Address Range	Valid Subnet Mask Values
A	1.0.0.0 to 127.0.0.0	255.0.0.0 (the default value for a class A IP address)
		255.192.0.0
		255.224.0.0
		255.240.0.0
		255.248.0.0
		255.252.0.0
		255.254.0.0
		255.255.128.1
A+B	128.0.0.0 to 191.255.0.0	255.255.0.0 (the default value for a class B IP address)
		255.255.192.0
		255.255.224.0
		255.255.240.0
		255.255.248.0
		255.255.252.0
		255.255.254.0
		255.255.255.128
A+B+C	192.0.0.0 to 223.255.255.0	255.255.255.0 (the default value for a class C IP address)
		255.255.255.192
		255.255.255.224
		255.255.255.240
		255.255.255.248
		255.255.255.252

If a Class B IP address is specified for the `ipaddr` parameter of the `chg-ip-lnk` command, the subnet address that results from the `ipaddr` and `submask` parameter values cannot be the same as the subnet address that results from the `pvn` and `pvnmask`, `fcna` and `fcnamask`, or `fcnb` and `fcnbmask` parameter values of the `chg-netopts` command. The `pvn` and `pvnmask`, `fcna` and `fcnamask`, or `fcnb` and `fcnbmask` parameter values can be verified by entering the `rtrv-netopts` command. Choose `ipaddr` and `submask`

parameter values for the **IP** link whose resulting subnet address is not be the same as the subnet address resulting from the `pvn` and `pvnmask`, `fcna` and `fcnamask`, or `fcnb` and `fcnbmask` parameter values of the `chg-netopts` command.

Canceling the `RTRV-ASSOC` Command

Because the `rtrv-assoc` command used in this procedure can output information for a long period of time, the `rtrv-assoc` command can be canceled and the output to the terminal stopped. There are three ways that the `rtrv-assoc` command can be canceled.

- Press the `F9` function key on the keyboard at the terminal where the `rtrv-assoc` command was entered.
- Enter the `canc-cmd` without the `trm` parameter at the terminal where the `rtrv-assoc` command was entered.
- Enter the `canc-cmd:trm=<xx>`, where `<xx>` is the terminal where the `rtrv-assoc` command was entered, from another terminal other than the terminal where the `rtrv-assoc` command was entered. To enter the `canc-cmd:trm=<xx>` command, the terminal must allow Security Administration commands to be entered from it and the user must be allowed to enter Security Administration commands. The terminal's permissions can be verified with the `rtrv-secu-trm` command. The user's permissions can be verified with the `rtrv-user` or `rtrv-secu-user` commands.

For more information about the `canc-cmd` command, go to *Commands User's Guide*.

1. Display the current link parameters associated with the **IP** card in the database by entering the `rtrv-ip-lnk` command.

The following is an example of the possible output.

```
rlghncxa03w 08-12-28 21:14:37 GMT EAGLE5 40.0.0
LOC  PORT IPADDR          SUBMASK          DUPLEX  SPEED  MACTYPE
AUTO MCAST
1201  A    192.1.1.10         255.255.255.128 HALF    10    802.3
NO   NO
1201  B    -----            -----            HALF    10    DIX
NO   NO
1203  A    192.1.1.12         255.255.255.0   ----    ---    DIX
YES  NO
1203  B    -----            -----            HALF    10    DIX
NO   NO
1205  A    192.1.1.14         255.255.255.0   FULL    100   DIX
NO   NO
1205  B    -----            -----            HALF    10    DIX
NO   NO
2101  A    192.1.1.20         255.255.255.0   FULL    100   DIX
NO   NO
2101  B    -----            -----            HALF    10    DIX
NO   NO
2103  A    192.1.1.22         255.255.255.0   FULL    100   DIX
NO   NO
2103  B    -----            -----            HALF    10    DIX
NO   NO
```

```

2105 A 192.1.1.24      255.255.255.0  FULL  100  DIX  NO  NO
2105 B -----            -----            HALF  10   DIX  NO  NO
2205 A 192.1.1.30      255.255.255.0  FULL  100  DIX  NO  NO
2205 B -----            -----            HALF  10   DIX  NO  NO
2207 A 192.1.1.32      255.255.255.0  FULL  100  DIX  NO  NO
2207 B -----            -----            HALF  10   DIX  NO  NO
2213 A 192.1.1.50      255.255.255.0  FULL  100  DIX  NO  NO
2213 B -----            -----            HALF  10   DIX  NO  NO
2301 A 192.1.1.52      255.255.255.0  FULL  100  DIX  NO  NO
2301 B -----            -----            HALF  10   DIX  NO  NO

```

IP-LNK table is (20 of 2048) 1% full.

 **Note:**

If the `ipaddr=0.0.0.0` is not being specified in this procedure, continue the procedure with [3](#).

2. If **IP** address information is being added or changed (not deleted) in the link parameters, verify that the **IP** address is present in the **IP** host table by using the `rtrv-ip-host:display=all` command.

The following is an example of the possible output.

```
rlghncxa03w 13-06-28 21:15:37 GMT EAGLE5 45.0.0
```

```

LOCAL IPADDR    LOCAL HOST
192.1.1.10      IPNODE1-1201
192.1.1.12      IPNODE1-1203
192.1.1.14      IPNODE1-1205
192.1.1.20      IPNODE2-1201
192.1.1.22      IPNODE2-1203
192.1.1.24      IPNODE2-1205
192.1.1.30      KC-HLR1
192.1.1.32      KC-HLR2
192.1.1.50      DN-MSC1
192.1.1.52      DN-MSC2

REMOTE IPADDR   REMOTE HOST
150.1.1.5       NCDEPTECONOMIC_DEVELOPMENT. SOUTHEASTERN_COORIDOR_ASHVL.
GOV

```

IP Host table is (11 of 4096) 0.26% full

If the current **IP** address of the **IP** link is shown in the `rtrv-ip-host` output, remove the host assigned to the **IP** address by performing the [Removing an IP Host Assigned to an IPGWx Card](#) procedure.

3. To change **IP** link parameters, the signaling link to the **IP** card and the **IP** card have to be inhibited.

Display the signaling link associated with the card shown in [1](#) using the `rtrv-slk` command specifying the card location.

For this example, enter this command.

```
rtrv-slk:loc=1201
```

This is an example of the possible output.

```
rlghncxa03w 06-10-19 21:17:04 GMT EAGLE5 36.0.0
LOC  LINK LSN          SLC TYPE
1201 A   nc001          0  SS7IPGW
```

- Retrieve the status of the signaling link assigned to the **IP** card to be changed using the `rept-stat-slk` command.

For example, enter this command.

```
rept-stat-slk:loc=1201:link=a
```

The output lists the signaling link assigned to this card:

```
rlghncxa03w 06-10-28 21:16:37 GMT EAGLE5 36.0.0
SLK      LSN      CLLI      PST      SST      AST
1201,A   nc001      -----  IS-NR
Command Completed.
```

If the signaling link is in service-normal (**IS-NR**), continue the procedure with [5](#) to deactivate the signaling link. If the signaling link is out-of-service-maintenance disabled (**OOS-MT-DSBLD**), continue the procedure with [7](#) to verify the **IP** card status.

- Deactivate the signaling link assigned to the **IP** card using the `dact-slk` command.

For example, enter this command.

```
dact-slk:loc=1201:link=a
```

Caution:

This command impacts network performance and should only be used during periods of low traffic.

After this command has successfully completed, this message appears.

```
rlghncxa03w 06-10-12 09:12:36 GMT EAGLE5 36.0.0
Deactivate Link message sent to card.
```

- Verify the new link status using the `rept-stat-slk` command.

For example, enter this command.

```
rept-stat-slk:loc=1201:link=a
```

The output displays the link status as **OOS-MT-DSBLD** and gives off a minor alarm:

```
rlghncxa03w 06-10-27 17:00:36 GMT EAGLE5 36.0.0
SLK      LSN      CLLI      PST      SST      AST
1201,A   nc001      ----- OOS-MT-DSBLD AVAIL   ---
ALARM STATUS = * 0236 REPT-LKS:not aligned
UNAVAIL REASON = NA
Command Completed.
```

- Verify the status of the **IP** card to be inhibited using the `rept-stat-card` command.

For example, enter this command.

```
rept-stat-card:loc=1201
```

This is an example of the possible output.

```
rlghncxa03w 06-10-27 17:00:36 GMT EAGLE5 36.0.0
CARD VERSION      TYPE  GPL      PST      SST      AST
1201 114-000-000 DCM   SS7IPGW IS-NR      Active   -----
  ALARM STATUS      = No Alarms.
  BPDCM GPL          = 002-102-000
  IMT BUS A         = Conn
  IMT BUS B         = Conn
  SIGNALING LINK STATUS
    SLK  PST          LS      CLLI
    A    IS-NR       nc001   -----
```

Command Completed.

If the **IP** card to be inhibited is in service-normal (**IS-NR**), continue the procedure with **8** to inhibit the card. If the **IP** card is out-of-service-maintenance disabled (**OOS-MT-DSBLD**), continue the procedure with **10** to change the **IP** link parameters.

- Inhibit the **IP** card using the `inh-card` command.

For example, enter this command.

```
inh-card:loc=1201
```

This message should appear.

```
rlghncxa03w 06-10-28 21:18:37 GMT EAGLE5 36.0.0
Card has been inhibited.
```

- Display the status of the **IP** card to verify that it is out-of-service maintenance-disabled (**OOS-MT-DSBLD**).

Enter this command.

```
rept-stat-card:loc=1201
```

This is an example of the possible output.

```
rlghncxa03w 06-10-27 17:00:36 GMT EAGLE5 36.0.0
```

```

CARD  VERSION      TYPE   GPL      PST      SST      AST
1201  114-000-000   DCM    SS7IPGW  IS-NR    Active   -----
ALARM STATUS      = No Alarms.
BPDCM GPL         = 002-102-000
IMT BUS A         = Conn
IMT BUS B         = Conn
SIGNALING LINK STATUS
      SLK   PST              LS      CLLI
      A    IS-NR            nc001   -----

```

Command Completed.

10. Display the attributes of the **IP** card assigned to the **IP** link being changed by entering the `rtrv-ip-card` command and specifying the card location of the **IP** link.

 **Note:**

If the `ipaddr` or `submask` parameter values are not being changed, continue the procedure with [13](#).

For this example, enter this command.

```
rtrv-ip-card:loc=1201
```

This is an example of the possible output.

```

rlghncxa03w 08-06-28 21:17:37 GMT EAGLE5 39.0.0
LOC 1201
SRCHORDR LOCAL
DNSA      150.1.1.1
DNSB      -----
DEFROUTER -----
DOMAIN    -----
SCTPCSUM  crc32c
BPIPADDR  -----
BPSUBMASK -----

```

If the `rtrv-ip-card` output shows an **IP** address for the default router (`DEFROUTER`) whose network portion matches the network portion of the **IP** address being changed, go to the [Configuring an IP Card](#) procedure and change the **IP** address of the default router to `0.0.0.0`.

11. Display any **IP** routes referencing the **IP** link being changed by entering the `rtrv-ip-rte` command and specifying the card location of the **IP** link.

For this example, enter this command.

```
rtrv-ip-rte:loc=1201
```

This is an example of the possible output.

```
rlghncxa03w 06-10-28 21:17:37 GMT EAGLE5 36.0.0
LOC   DEST          SUBMASK          GTWY
1201  128.252.10.5   255.255.255.255 140.188.13.33
1201  128.252.0.0    255.255.0.0     140.188.13.34
1201  150.10.1.1     255.255.255.255 140.190.15.3

IP Route table is (5 of 2048) 0.24% full
```

If the `rtrv-ip-rte` output shows that the card has **IP** routes assigned to it, go to the [Removing an IP Route](#) procedure and remove the **IP** routes from the database.

- The subnet address that results from the `ipaddr` and `submask` parameter values of the `chg-ip-lnk` command cannot be the same as the subnet address that results from the `pvn` and `pvnmask`, `fcna` and `fcnamask`, or `fcnb` and `fcnbmask` parameter values of the `chg-netopts` command.

 **Note:**

If a Class A or CIP address (see [Table 4-4](#)) will be specified for the `ipaddr` parameter in [14](#), continue the procedure with [13](#).

Display the `pvn`, `pvnmask`, `fcna`, `fcnamask`, `fcnb`, and `fcnbmask` parameter values of the `chg-netopts` command by entering the `rtrv-netopts` command.

If error message E3967 Cmd Rej: E5IS must be on is displayed after the `rtrv-netopts` command is executed, the `pvn`, `pvnmask`, `fcna`, `fcnamask`, `fcnb`, and `fcnbmask` parameters are not configured. Continue the procedure with [13](#).

This is an example of the possible output if the **E5IS** feature is on.

```
rlghncxa03w 09-02-28 21:17:37 GMT EAGLE5 40.1.0
NETWORK OPTIONS
-----
PVN      = 128.20.30.40
PVMASK   = 255.255.192.0
FCNA     = 170.120.50.0
FCNAMASK = 255.255.240.0
FCNB     = 170.121.50.0
FCNBMASK = 255.255.254.0
```

Choose `ipaddr` and `submask` parameter values for the **IP** link whose resulting subnet address is not be the same as the subnet address resulting from the `pvn` and `pvnmask`, `fcna` and `fcnamask`, or `fcnb` and `fcnbmask` parameter values of the `chg-netopts` command. Continue the procedure with [13](#).

- Display the associations referencing the local host name that is associated with the **IP** link being changed by entering the `rtrv-assoc` command and specifying the local host name shown in the `rtrv-ip-host` output in [2](#).

For this example, enter this command.

```
rtrv-assoc:lhost="ipnode-1201"
```

This is an example of the possible output.

```
rlghncxa03w 06-10-28 09:12:36 GMT EAGLE5 36.0.0
                CARD IPLNK
ANAME          LOC  PORT  LINK ADAPTER LPORT RPORT OPEN ALW
swbel32        1201 A    A    M3UA    1030  2345  YES  YES

IP Appl Sock/Assoc table is (3 of 4000) 1% full
Assoc Buffer Space Used (16 KB of 3200 KB) on LOC = 1201
```

If no associations are displayed in this step, continue the procedure with [14](#).

If the `rtrv-assoc` output shows that the `open` parameter for any associations is `yes`, perform one of these procedures to change the value of the `open` parameter the associations to `no`.

- [Changing the Attributes of an M2PA Association](#)
- [Changing the Attributes of a M3UA or SUA Association](#)

- 14.** Change the link parameters associated with the **IP** card in the database using the `chg-ip-lnk` command.

For this example, enter this command.

```
chg-ip-
lnk:loc=1201:port=a:ipaddr=192.1.1.10:submask=255.255.255.0
:auto=yes:mactype=dix
```

When this command has successfully completed, the following message should appear.

```
rlghncxa03w 06-10-28 21:18:37 GMT EAGLE5 36.0.0
CHG-IP-LNK: MASP A - COMPLTD
```

- 15.** Verify the new link parameters associated with the **IP** card that was changed in [14](#) by entering the `rtrv-ip-lnk` command with the card location specified in [14](#).

For this example, enter this command.

The following is an example of the possible output.

```
rlghncxa03w 07-05-28 21:14:37 GMT EAGLE5 37.0.0
LOC  PORT IPADDR          SUBMASK          DUPLEX  SPEED  MACTYPE
AUTO MCAST
1201 A    192.1.1.10          255.255.255.128  HALF    10     DIX
YES  NO
1201 B    -----             -----          HALF    10     DIX
NO   NO
```

- 16.** Allow the **IP** card that was inhibited in [8](#) by using by using the `alw-card` command.

 **Note:**

If [8](#) was not performed, continue the procedure with [18](#).

For example, enter this command.

```
alw-card:loc=1201
```

This message should appear.

```
rlghncxa03w 06-10-28 21:20:37 GMT EAGLE5 36.0.0
Card has been allowed.
```

- 17.** Verify the in-service normal (**IS-NR**) status of the **IP** card using the `rept-stat-card` command.

For example, enter this command.

```
rept-stat-card:loc=1201
```

This is an example of the possible output.

```
rlghncxa03w 06-10-27 17:00:36 GMT EAGLE5 36.0.0
CARD  VERSION      TYPE   GPL      PST      SST      AST
1201  114-000-000  DCM    SS7IPGW  IS-NR    Active   -----
ALARM STATUS      = No Alarms.
BPDCM GPL         = 002-102-000
IMT BUS A        = Conn
IMT BUS B        = Conn
SIGNALING LINK STATUS
  SLK   PST          LS      CLLI
  A     IS-NR        nc001   -----
```

Command Completed.

- 18.** Activate the signaling link from [5](#) using the `act-slk` command.

 **Note:**

If [5](#) was not performed, continue the procedure with [20](#).

For example, enter this command.

```
act-slk:loc=1201:link=a
```

The link changes its state from **OOS-MT-DSBLD** (out-of-service maintenance-disabled) to **IS-NR** (in-service normal).

The output confirms the activation.

```
rlghncxa03w 06-10-07 11:11:28 GMT EAGLE5 36.0.0
Activate Link message sent to card
```

19. Verify the in-service normal (**IS-NR**) status of the signaling link using the `rept-stat-slk` command.

For example, enter this command.

```
rept-stat-slk:loc=1201:link=a
```

This message should appear.

```
rlghncxa03w 06-10-28 21:16:37 GMT EAGLE5 36.0.0
SLK      LSN      CLLI      PST      SST      AST
1201,A   nc001      -----  IS-NR
Command Completed.
```

20. Perform the [Configuring an IP Card](#) procedure and change the **IP** address of the default router to a non-zero value, where the network portion of the default router **IP** address matches the network portion of the **IP** link's new **IP** address.

 **Note:**

If the `ipaddr` or `submask` values were not changed, continue the procedure with [22](#).

 **Note:**

If the **IP** address of the default router was not changed to 0.0.0.0 in [10](#), continue the procedure with [21](#).

21. Perform the [Adding an IP Route](#) procedure and add the **IP** routes back into the database.

 **Note:**

If **IP** routes were not removed in [11](#), continue the procedure with [22](#).

22. Perform one of these procedures as necessary and change the value of the `open` parameter of the association to `yes`.

 **Note:**

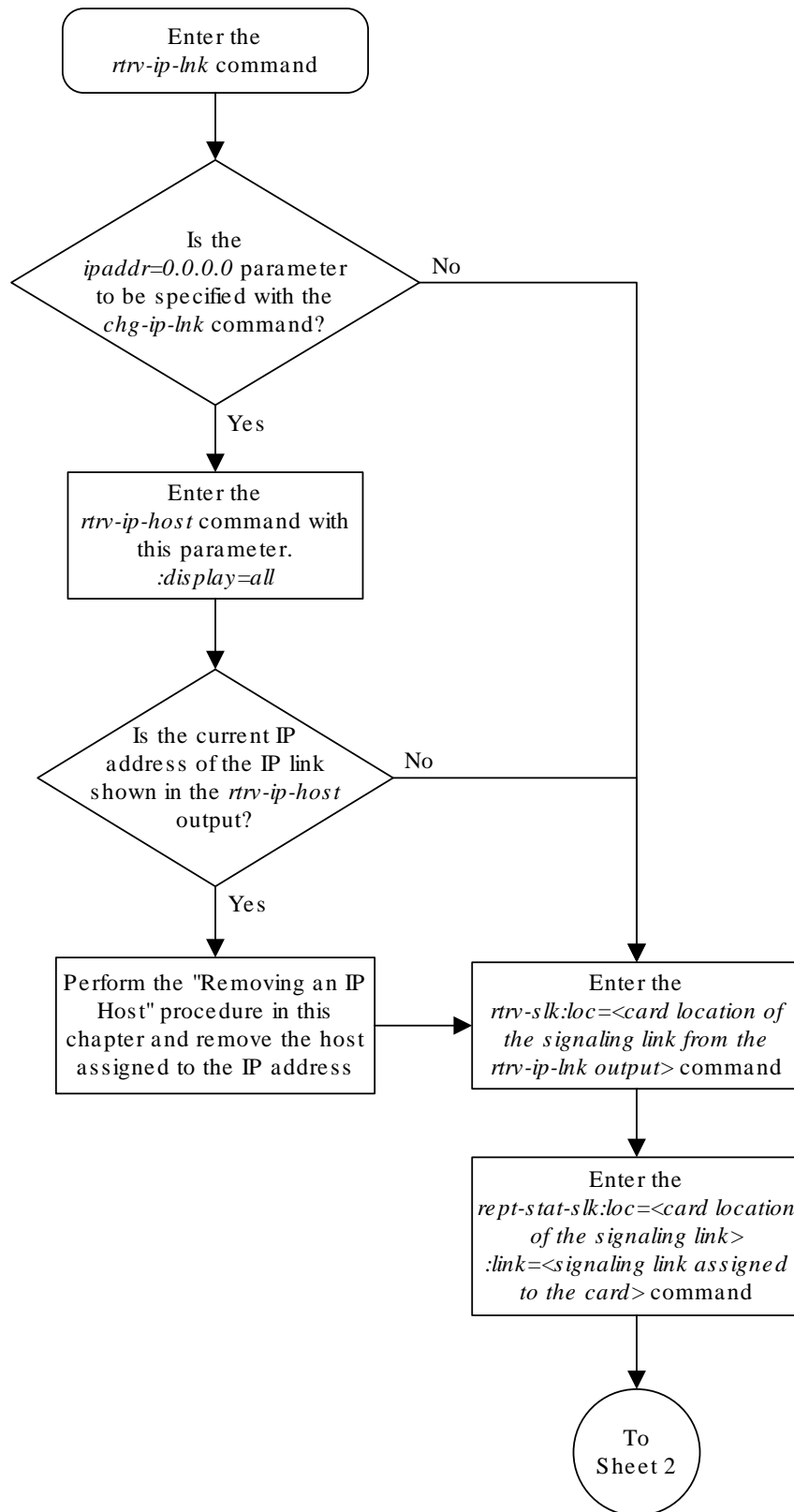
If the `open` parameter value for an association was not changed in [13](#), continue the procedure with [23](#).

- [Changing the Attributes of an M2PA Association](#)
 - [Changing the Attributes of a M3UA or SUA Association](#)
23. Back up the new changes using the `chg-db:action=backup:dest=fixed` command.

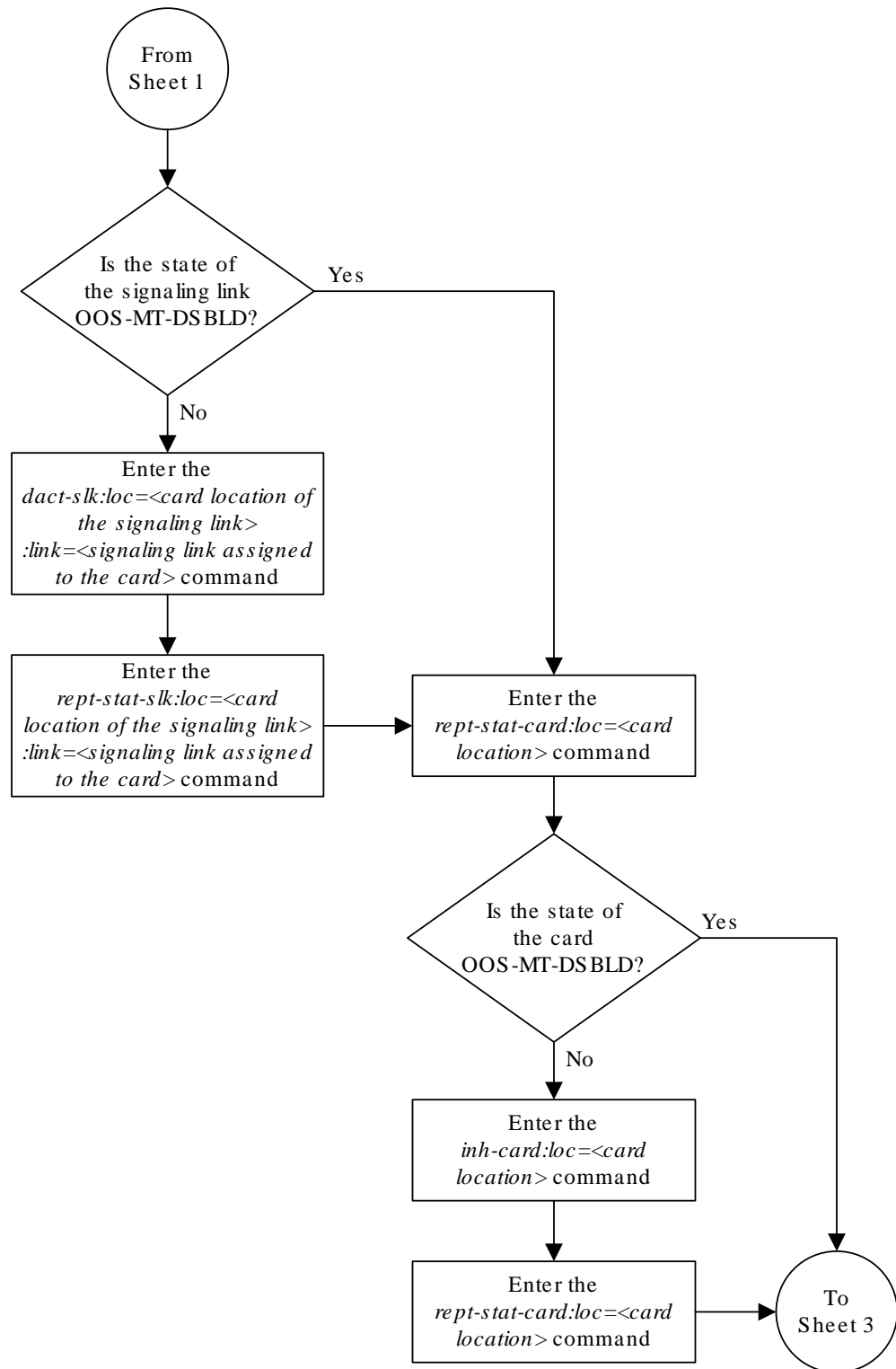
These messages should appear, the active **Maintenance and Administration Subsystem Processor (MASP)** appears first.

```
BACKUP (FIXED) : MASP A - Backup starts on active MASP.  
BACKUP (FIXED) : MASP A - Backup on active MASP to fixed disk complete.  
BACKUP (FIXED) : MASP A - Backup starts on standby MASP.  
BACKUP (FIXED) : MASP A - Backup on standby MASP to fixed disk complete.
```

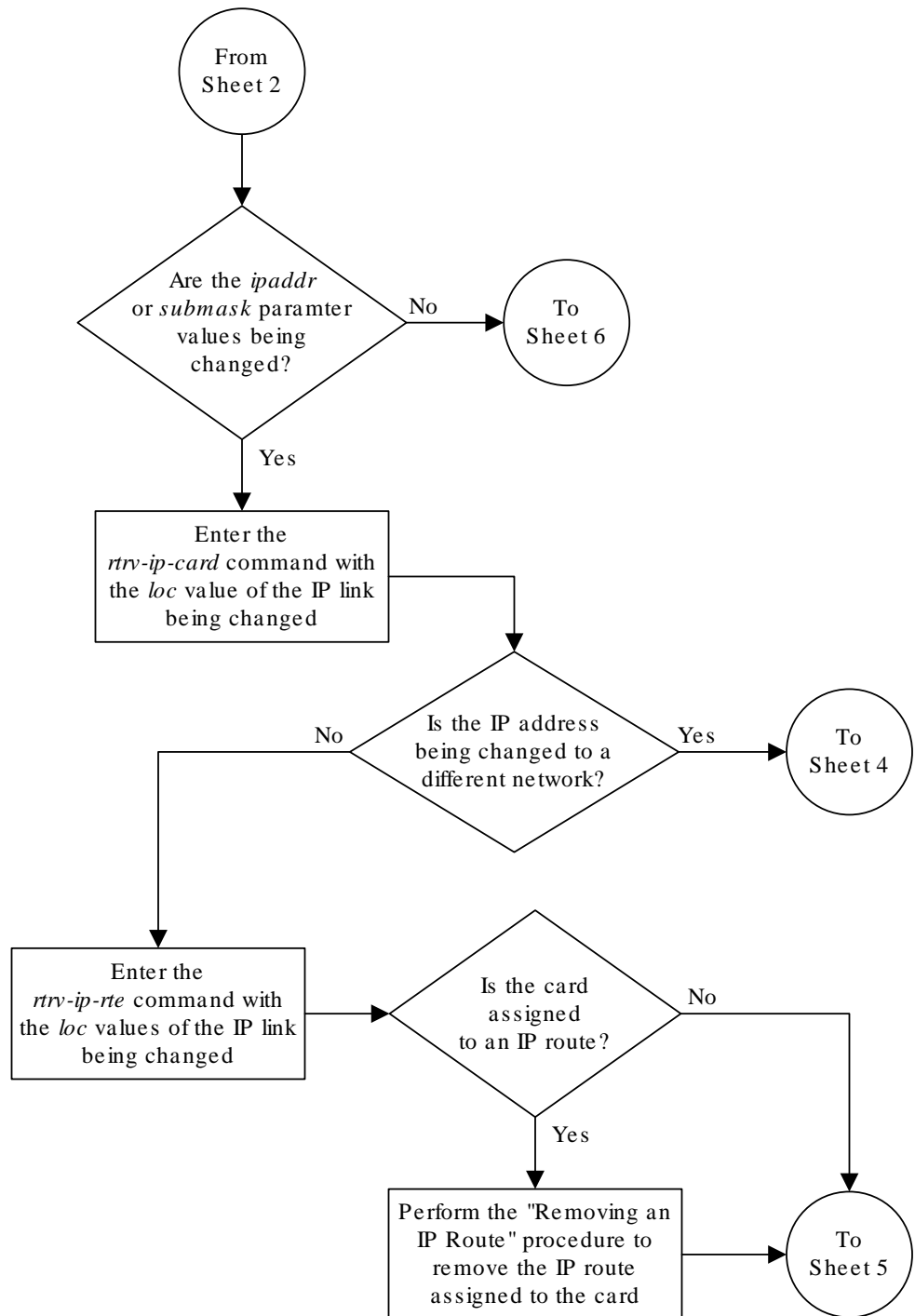
Figure 4-7 Configuring an IP Link



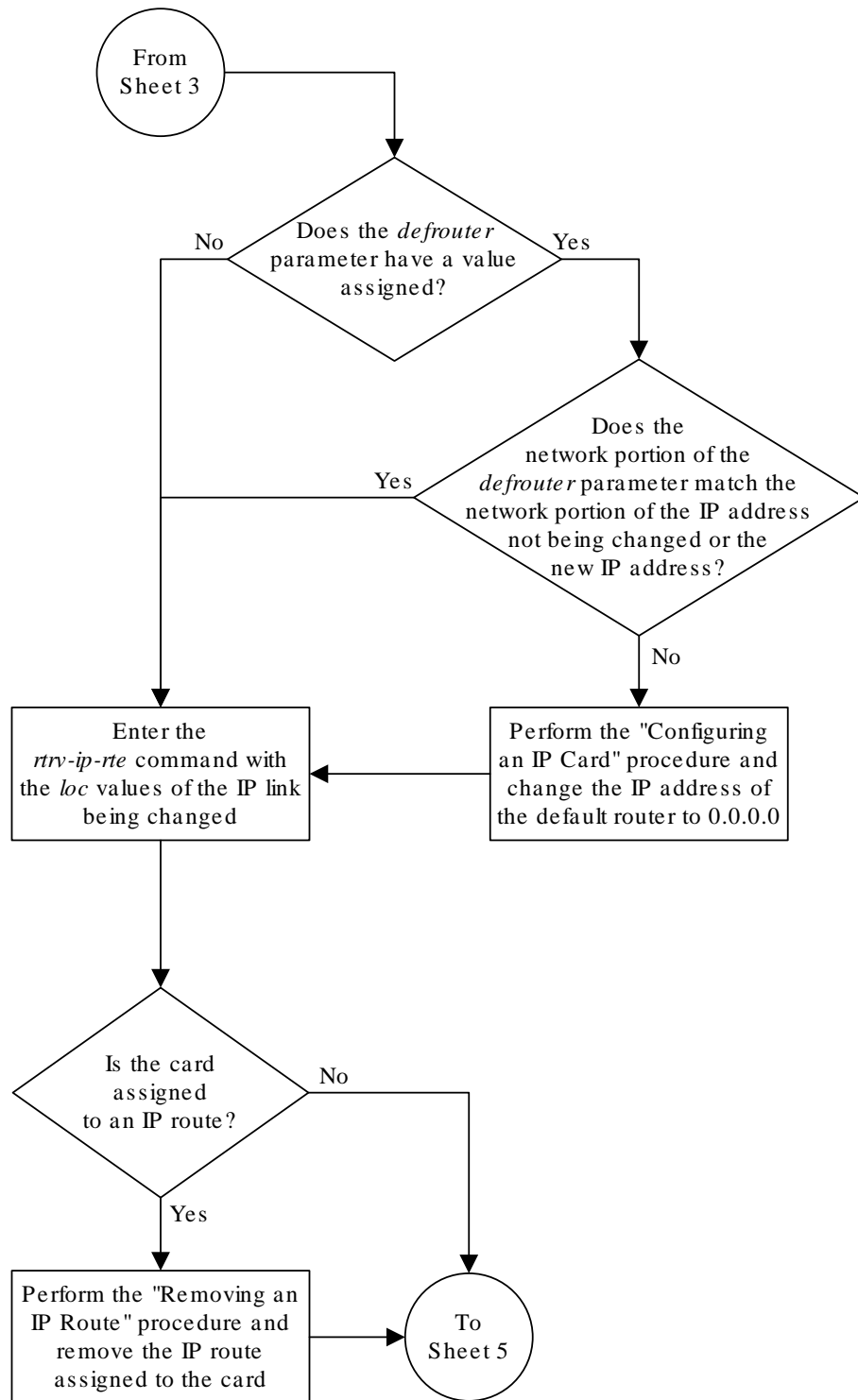
Sheet 1 of 9



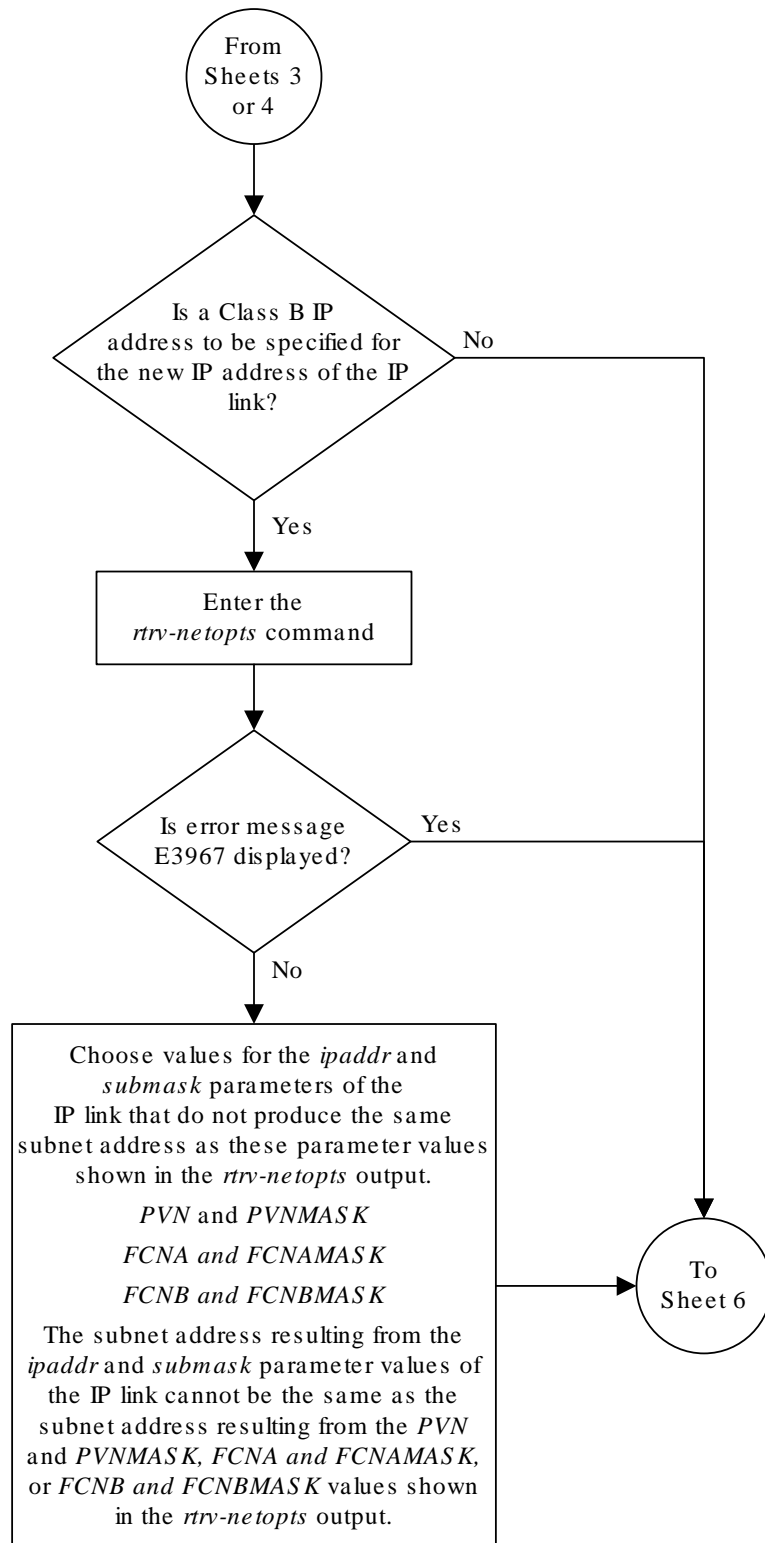
Sheet 2 of 9



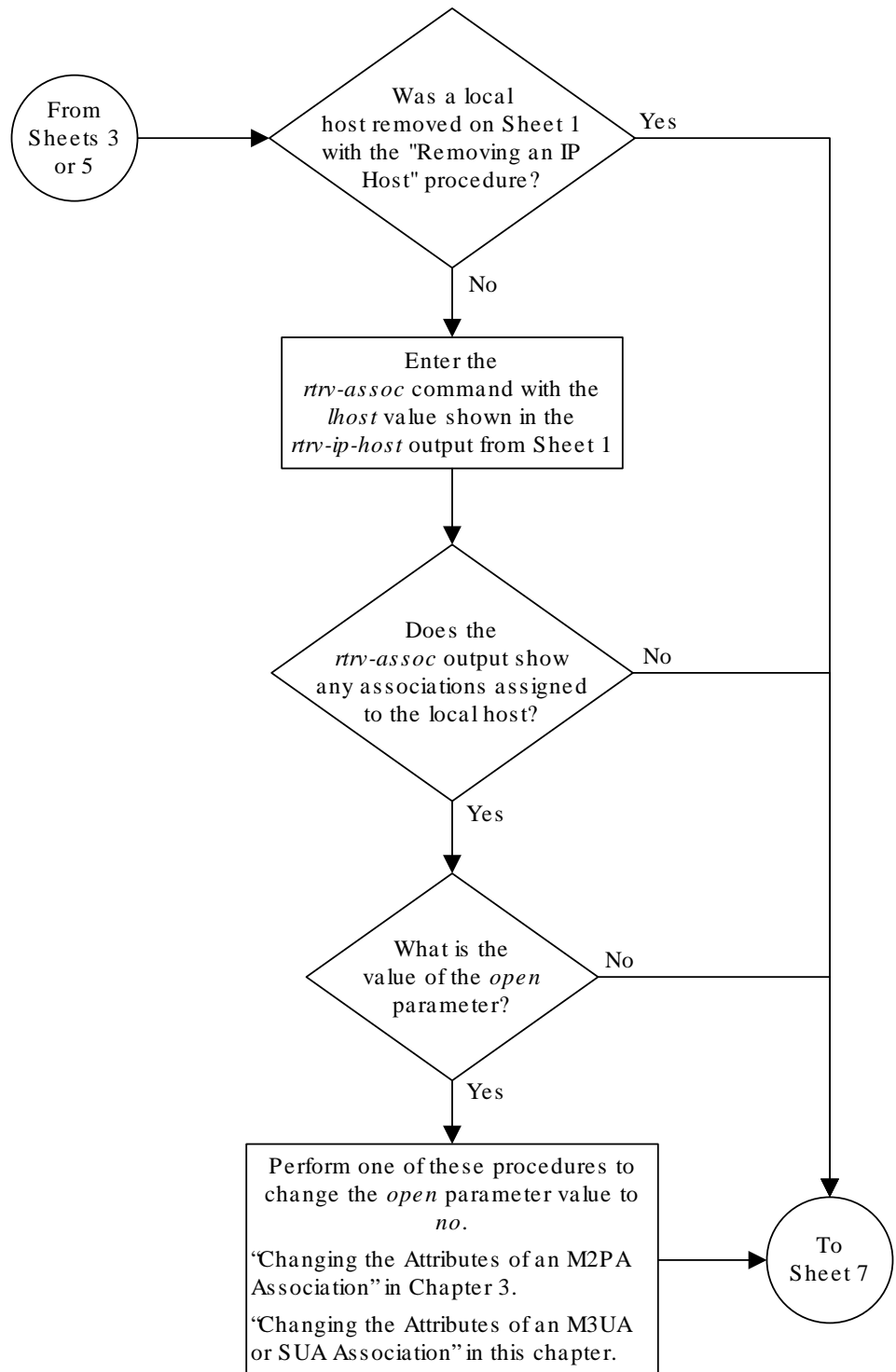
Sheet 3 of 9



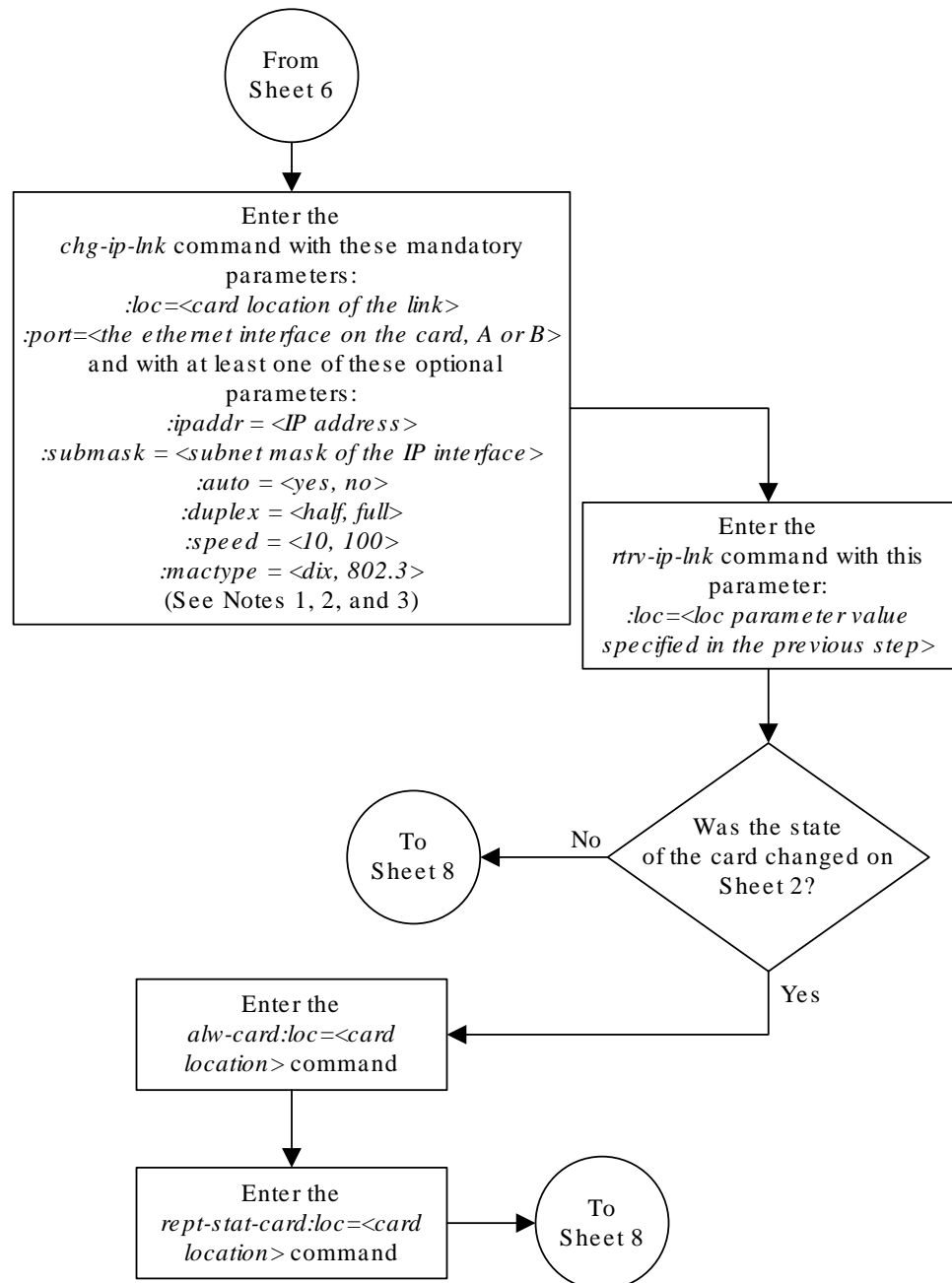
Sheet 4 of 9



Sheet 5 of 9



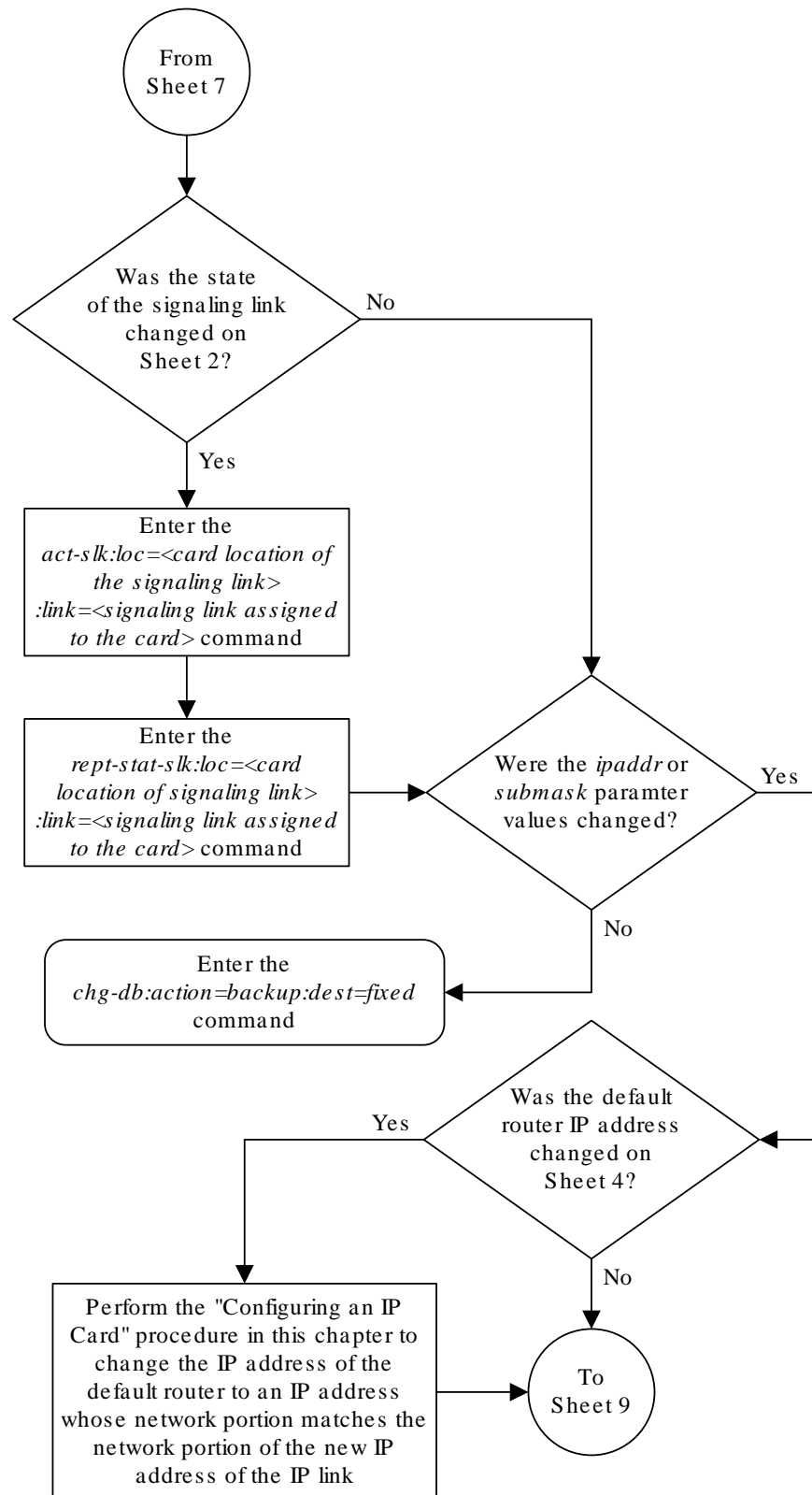
Sheet 6 of 9



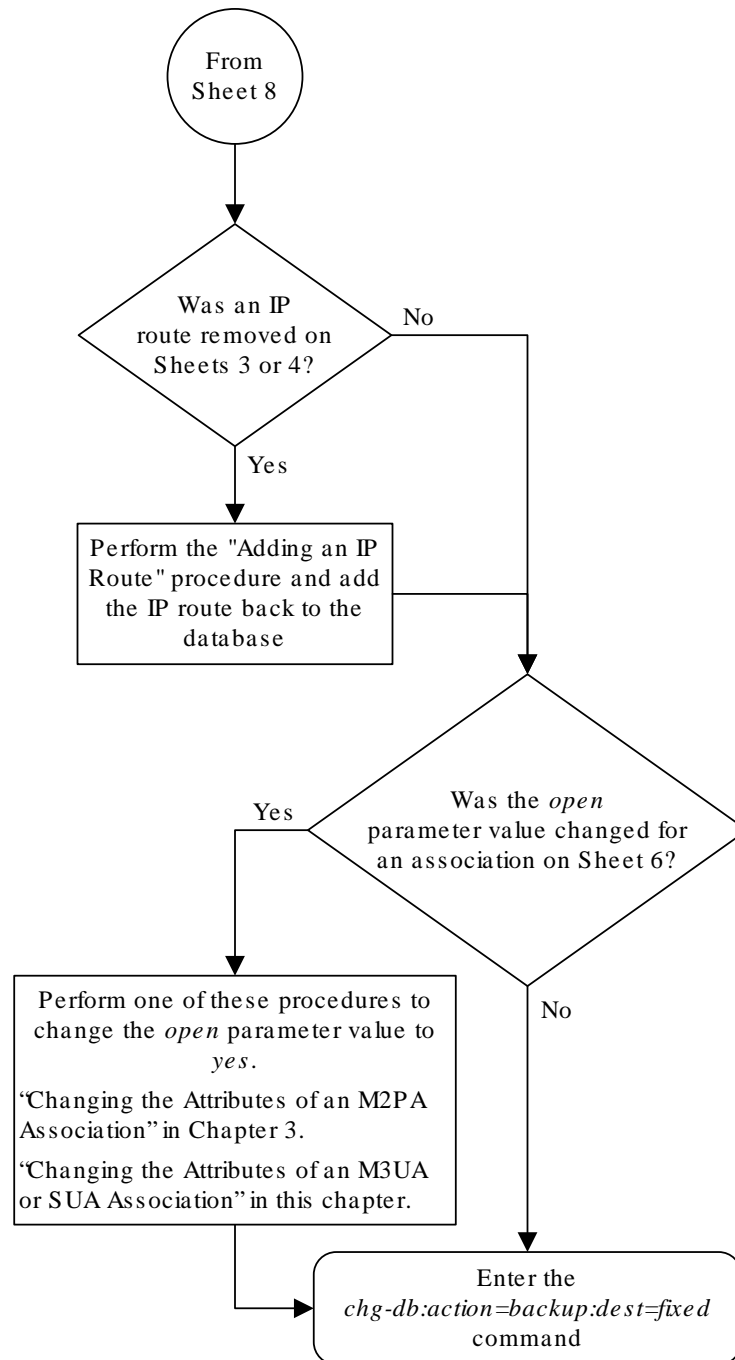
Notes:

1. If either the *ipaddr* or *submask* parameters are specified, then both parameters must be specified, unless the *ipaddr=0.0.0.0* parameter is specified, then the *submask* parameter is not required.
2. The *ipaddr=0.0.0.0* parameter disables the IP link.
3. If the *auto=yes* parameter is specified, then the *duplex* and *speed* parameters cannot be specified.

Sheet 7 of 9



Sheet 8 of 9



4.7 Adding an IP Host

This procedure associates hostnames with **IP** addresses using the `ent-ip-host` command.

The `ent-ip-host` command uses the following parameters.

`:host` – The host name to be associated with the **IP** address. This parameter identifies the logical name assigned to the device with the **IP** address indicated. The host name can contain up to 60 characters (using only these characters: a-z, A-Z, 0-9, -, .) and is not case sensitive. The host name must begin with a letter. Host names containing a dash (-) must be enclosed in double quotes.

`:ipaddr` – The **IP** address to be associated with the hostname. The node's **IP** address. This is an **IP** address expressed in standard "dot notation." **IP** addresses consist of the system's network number and the machine's unique host number.

`:type` – Specifies if the host resides on the **IP** card on the **EAGLE 5** (`type=local`, the default value), or if the host resides on equipment that is not in the **EAGLE 5** (`type=remote`). This parameter is optional.

The **EAGLE 5** can contain a maximum of 4096 IP hosts.

The **IP** address for a local host must be shown in the `rtrv-ip-lnk` output.

The **IP** address for a remote host must not be shown in the `rtrv-ip-lnk` output.

1. Display the current **IP** host information in the database by entering the `rtrv-ip-host:display=all` command.

The following is an example of the possible output.

```
rlghncxa03w 13-06-28 21:17:37 GMT EAGLE5 45.0.0
LOCAL IPADDR    LOCAL HOST
192.1.1.10      IPNODE1-1201
192.1.1.12      IPNODE1-1203
192.1.1.14      IPNODE1-1205
192.1.1.20      IPNODE2-1201
192.1.1.22      IPNODE2-1203
192.1.1.24      IPNODE2-1205
192.1.1.32      KC-HLR2
192.1.1.50      DN-MS1
192.1.1.52      DN-MS2

REMOTE IPADDR   REMOTE HOST
150.1.1.5       NCDEPTECONOMIC_DEVELOPMENT. SOUTHEASTERN_COORIDOR_ASHVL.
GOV
```

```
IP Host table is (10 of 4096) .24% full
```

2. Verify that the **IP** address assigned to the **IP** links by entering the `rtrv-ip-lnk` command.

The following is an example of the possible output.

```

rlghncxa03w 08-12-28 21:14:37 GMT EAGLE5 40.0.0
LOC  PORT IPADDR          SUBMASK          DUPLEX  SPEED  MACTYPE
AUTO MCAST
1201  A    192.1.1.10        255.255.255.128  HALF    10     802.3
NO   NO
1201  B    -----          -----          HALF    10     DIX
NO   NO
1203  A    192.1.1.12        255.255.255.0   ----    ---    DIX
YES  NO
1203  B    -----          -----          HALF    10     DIX
NO   NO
1205  A    192.1.1.14        255.255.255.0   FULL    100    DIX
NO   NO
1205  B    -----          -----          HALF    10     DIX
NO   NO
2101  A    192.1.1.20        255.255.255.0   FULL    100    DIX
NO   NO
2101  B    -----          -----          HALF    10     DIX
NO   NO
2103  A    192.1.1.22        255.255.255.0   FULL    100    DIX
NO   NO
2103  B    -----          -----          HALF    10     DIX
NO   NO
2105  A    192.1.1.24        255.255.255.0   FULL    100    DIX
NO   NO
2105  B    -----          -----          HALF    10     DIX
NO   NO
2207  A    192.1.1.32        255.255.255.0   FULL    100    DIX
NO   NO
2207  B    -----          -----          HALF    10     DIX
NO   NO
2213  A    192.1.1.50        255.255.255.0   FULL    100    DIX
NO   NO
2213  B    -----          -----          HALF    10     DIX
NO   NO
2301  A    192.1.1.52        255.255.255.0   FULL    100    DIX
NO   NO
2301  B    -----          -----          HALF    10     DIX
NO   NO

```

IP-LNK table is (20 of 2048) 1% full.

If a local host is being configured in this procedure, the **IP** address assigned to the local host must be shown in the `rtrv-ip-lnk` output. If the **IP** address is not shown in the `rtrv-ip-lnk` output, add the **IP** address by performing the [Configuring an IP Link](#) procedure.

If a remote host is being configured in this procedure, the **IP** address assigned to the remote host cannot be shown in the `rtrv-ip-lnk` output.

3. Add **IP** host information to the database by entering the `ent-ip-host` command.

If a local host is being configured, enter the `ent-ip-host` command with the IP address from 2, and the `type=local` parameter or without the `type` parameter. If the `type` parameter is not specified with the `ent-ip-host` command, the `type` parameter value defaults to `local`.

If a remote host is being configured, enter the `ent-ip-host` command with the IP address that is not shown in 2, and the `type=remote` parameter.

For example, enter this command.

```
ent-ip-host:host="kc-hlr1":ipaddr=192.1.1.30
```

When this command has successfully completed, the following message should appear.

```
rlghncxa03w 06-10-28 21:18:37 GMT EAGLE5 36.0.0  
ENT-IP-HOST: MASP A - COMPLTD
```

4. Verify the new IP host information in the database by entering the `rtrv-ip-host` command with the `host` parameter value specified in 3.

For this example, enter this command.

```
rtrv-ip-host:host="kc-hlr1"
```

The following is an example of the possible output.

```
rlghncxa03w 13-06-28 21:19:37 GMT EAGLE5 45.0.0  
LOCAL IPADDR    LOCAL HOST  
192.1.1.30      KC-HLR1
```

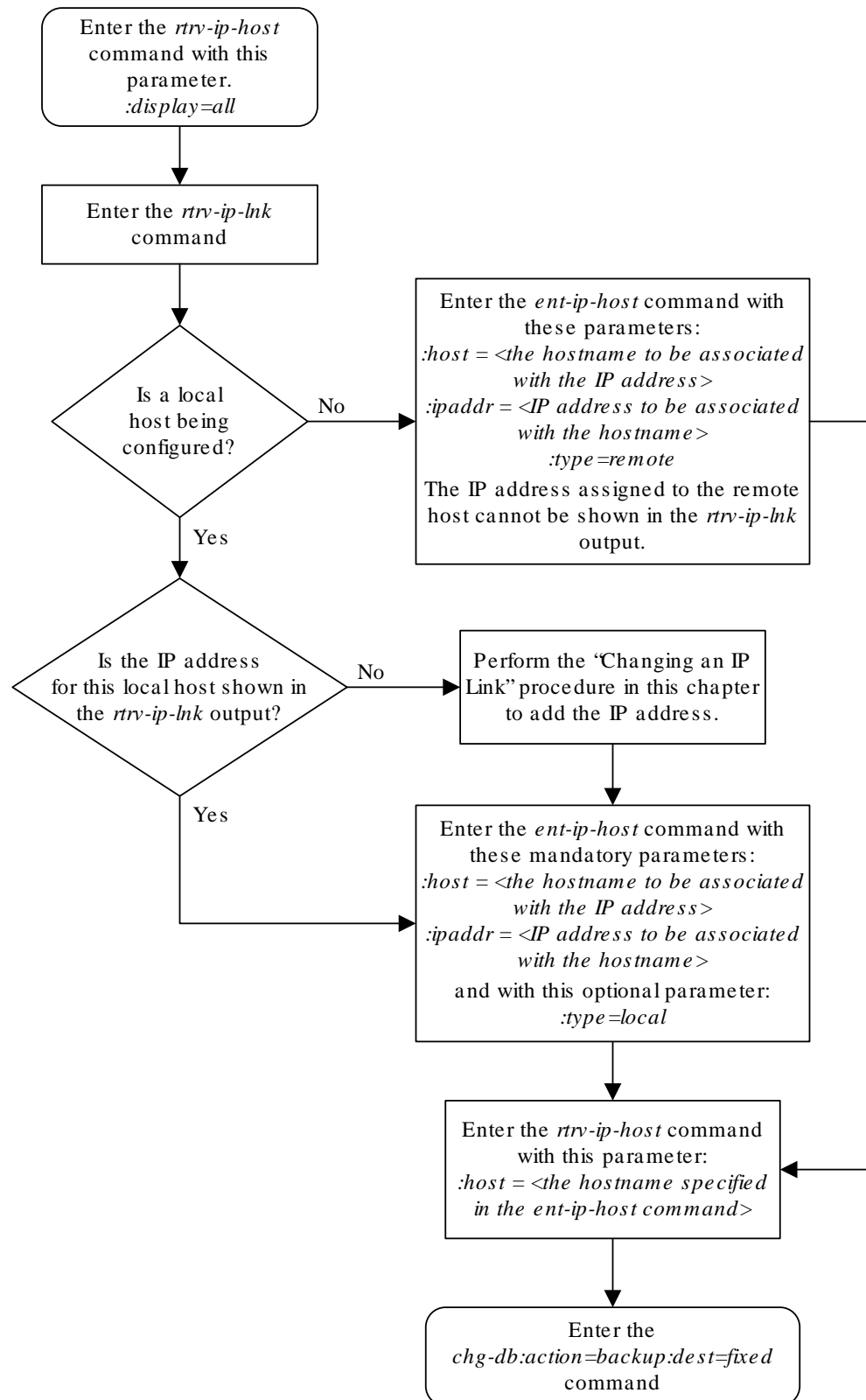
```
IP Host table is (11 of 4096) .26% full
```

5. Back up the new changes using the `chg-db:action=backup:dest=fixed` command.

These messages should appear, the active **Maintenance and Administration Subsystem Processor (MASP)** appears first.

```
BACKUP (FIXED) : MASP A - Backup starts on active MASP.  
BACKUP (FIXED) : MASP A - Backup on active MASP to fixed disk complete.  
BACKUP (FIXED) : MASP A - Backup starts on standby MASP.  
BACKUP (FIXED) : MASP A - Backup on standby MASP to fixed disk complete.
```


Figure 4-8 Adding an IP Host



4.8 Configuring an IP Card

This procedure is used to change the **IP** stack parameters associated with an **IP** card in the database using the `chg-ip-card` command.

The `chg-ip-card` command uses the following parameters.

`:loc` – The card location of the **IP** card

`:srchordr` – Host Table Search Order

`:dnسا` – **Domain** name server A's **IP** address. This is an **IP** address expressed in standard "dot notation." **IP** addresses consist of the system's network number and the machine's unique host number.

`:dnسب` – **Domain** name server B's **IP** address. This is an **IP** address expressed in standard "dot notation." **IP** addresses consist of the system's network number and the machine's unique host number.

`:domain` – The domain name is used to construct a fully-qualified **DNS** name consisting of 120 characters or less. For example, a domain name can be `tekelec.com`, the hostname is `john.doe`. The fully-qualified **DNS** name would be `john.doe@tekelec.com`.

`:defrouter` – Default router **IP** address. This is an **IP** address expressed in standard "dot notation." **IP** addresses consist of the system's network number and the machine's unique host number.

`:rstdomain` – Reset **Domain** name. The parameter is used to reset the domain to a **NULL** value.

`:sctpcsum` – The SCTP checksum algorithm that will be applied to the traffic on the IP card, either `adler32` or `crc32c`. The `sctpcsum` parameter can be specified only if the `SCTPCSUM` value in the `rtrv-sg-opts` output is `percard`.

The `chg-ip-card` command contains other parameters that cannot be used in this procedure. Refer to *Commands User's Guide* for more information about these parameters.

The **IP** card must be placed out of service.

The `rstdomain` parameter cannot be specified if the `domain` parameter is specified.

There is only one default router (`defrouter` parameter) for each **IP** card. The default router is used as the primary route unless a static **IP** routes is defined for the destination **IP** address. Static **IP** routes are assigned using the `ent-ip-rte` command in the [Adding an IP Route](#) procedure.

The network portion of the **IP** address of the default router must match the network portion of one of the **IP** addresses assigned to the card.

The network portion of the **IP** address is based on the class of the **IP** address (shown in [Table 4-4](#)). If the **IP** address is a Class A **IP** address, the first field is the network portion of the **IP** address. If the **IP** address is a Class B **IP** address, the first two fields are the network portion of the **IP** address. If the **IP** address is a Class C **IP** address, the first three fields are the network portion of the **IP** address. For example, if the **IP** address is 193.5.207.150, a Class C **IP** address, the network portion of the **IP** address is 193.5.207.

The default router can be associated with only one **IP** address assigned to the card if the defrouter parameter is specified. For example, the `dnrsa` value for card 1101 is 150.1.1.10. The `dnrsb` value for card 1101 is 160.25.37.1. A default router is provisioned with the **IP** address 150.1.1.4. The default router is associated with the Ethernet A **IP** address (the `dnrsa` parameter value), but not the Ethernet B **IP** address (the `dnrsb` parameter value).

If the default router is associated with one of the **IP** card's **IP** addresses, a second gateway router can be assigned to the other **IP** address on the **IP** card by provisioning a static **IP** route for the **IP** card using the `ent-ip-rte` command in the [Adding an IP Route](#) procedure. Static **IP** routes can provide gateway routers associated with the other **IP** address on the **IP** card. To provision the gateway router (the `gtwy` parameter of the `ent-ip-rte` command) for the other **IP** address assigned to the **IP** card, the network portion of the gateway router's **IP** address must match the network portion of the other **IP** address assigned to the **IP** card.

Specifying the **IP** address 0.0.0.0 for the `dnrsa` or `dnrsb` parameters, removes the **IP** address for Ethernet A (`dnrsa`) or Ethernet B (`dnrsb`).

When an **IP** card is entered into the database with the `ent-card` command, the **IP** stack parameters associated with this card are initially set with these default values:

- `:srchordr` – **SRVR**
- `:dnrsa` – No **DNSA** **IP** address is specified
- `:dnrsb` – No **DNSB** **IP** address is specified
- `:domain` – No domain name is specified
- `:defrouter` – No default router **IP** address is specified
- `:rstdomain` – No
- `:sctpcsum` – **crc32c**

The value of any optional parameter not specified with the `chg-ip-card` command is not changed.

1. Display the current **IP** parameters associated with card in the database by entering the `rtrv-ip-card` command.

The following is an example of the possible output.

```
rlghncxa03w 08-06-28 21:17:37 GMT EAGLE5 39.0.0
  LOC 1201
    SRCHORDR  SRVR
    DNSA      150.1.1.1
    DNSB      -----
    DEFROUTER -----
    DOMAIN    -----
    SCTPCSUM  crc32c
    BPIPADDR  -----
    BPSUBMASK -----
  LOC 1203
    SRCHORDR  LOCAL
    DNSA      192.1.1.40
    DNSB      -----
```

```

DEFROUTER -----
DOMAIN      NC. TEKELEC. COM
SCTPCSUM    crc32c
BPIPADDR    -----
BPSUBMASK   -----
LOC 1205
SRCHORDR    SRVROONLY
DNSA        192.1.1.40
DNSB        -----
DEFROUTER   -----
DOMAIN      NC. TEKELEC. COM
SCTPCSUM    crc32c
BPIPADDR    -----
BPSUBMASK   -----

```

To change the parameters of an **IP** card, the signaling link to the card and the card have to be inhibited.

2. Display the signaling link associated with the card shown in 1 using the `rtrv-slk` command specifying the card location.

For this example, enter this command.

```
rtrv-slk:loc=1201
```

This is an example of the possible output.

```

rlghncxa03w 06-10-28 21:17:37 GMT EAGLE5 36.0.0
LOC  LINK LSN          SLC TYPE
1201 A   nc001          0  SS7IPGW

```

3. Retrieve the status of the signaling link shown in 2 using the `rept-stat-slk` command specifying the card location and signaling link.

For example, enter this command.

```
rept-stat-slk:loc=1201:link=a
```

The output lists the signaling link assigned to this card:

```

rlghncxa03w 06-10-28 21:16:37 GMT EAGLE5 36.0.0
SLK  LSN      CLLI      PST      SST      AST
1201,A  nc001      -----  IS-NR
      Avail    ----
Command Completed.

```

If the signaling link is in service-normal (**IS-NR**), go to 4 to deactivate the signaling link. If the signaling link is out-of-service-maintenance disabled (**OOS-MT-DSBLD**), continue the procedure with 6 to verify the card status.

4. Deactivate the signaling link assigned to the **IP** card using the `rept-stat-slk` command.

For example, enter this command.

```
dact-slk:loc=1201:link=a
```

▲ Caution:

This command impacts network performance and should only be used during periods of low traffic.

After this command has successfully completed, this message appears.

```
rlghncxa03w 06-10-12 09:12:36 GMT EAGLE5 36.0.0
Deactivate Link message sent to card.
```

5. Verify the new link status using the `rept-stat-slk` command.

For example, enter this command.

```
rept-stat-slk:loc=1201:link=a
```

The output displays the link status as **OOS-MT-DSBLD** and gives off a minor alarm:

```
rlghncxa03w 06-10-27 17:00:36 GMT EAGLE5 36.0.0
SLK      LSN      CLLI      PST      SST      AST
1201,A   nc001      ----- OOS-MT-DSBLD AVAIL   ---
ALARM STATUS = * 0236 REPT-LKS:not aligned
UNAVAIL REASON = NA
Command Completed.
```

6. Verify the status of the **IP** card to be inhibited using the `rept-stat-card` command.

For example, enter this command.

```
rept-stat-card:loc=1201
```

This is an example of the possible output.

```
rlghncxa03w 06-10-27 17:00:36 GMT EAGLE5 36.0.0
CARD VERSION      TYPE      GPL      PST      SST      AST
1201 114-000-000   DCM      SS7IPGW  IS-NR      Active   -----
ALARM STATUS      = No Alarms.
BPDCM GPL         = 002-102-000
IMT BUS A         = Conn
IMT BUS B         = Conn
SIGNALING LINK STATUS
      SLK      PST      LS      CLLI
      A      IS-NR      nc001      -----
Command Completed.
```

If the **IP** card to be inhibited is in service-normal (**IS-NR**), go to [7](#) to inhibit the card. If the **IP** card is out-of-service-maintenance disabled (**OOS-MT-DSBLD**), continue the procedure with [9](#).

7. Inhibit the **IP** card using the `inh-card` command.

For example, enter this command.

```
inh-card:loc=1201
```

This message should appear.

```
rlghncxa03w 06-10-28 21:18:37 GMT EAGLE5 36.0.0
Card has been inhibited.
```

8. Display the status of the **IP** card to verify that it is out-of-service maintenance-disabled (**OOS-MT-DSBLD**).

Enter this command.

```
rept-stat-card:loc=1201
```

This is an example of the possible output.

```
rlghncxa03w 06-10-27 17:00:36 GMT EAGLE5 36.0.0
CARD VERSION      TYPE  GPL      PST      SST      AST
1201 114-000-000  DCM   SS7IPGW IS-NR     Active   -----
  ALARM STATUS      = No Alarms.
  BPDCM GPL         = 002-102-000
  IMT BUS A         = Conn
  IMT BUS B         = Conn
  SIGNALING LINK STATUS
    SLK  PST      LS      CLLI
    A    IS-NR   nc001   -----
```

Command Completed.

If the `defrouter` parameter will be specified in [11](#), continue the procedure with [11](#).

If the `defrouter` parameter will not be specified in [11](#), continue the procedure by performing one of these steps.

- If the `sctpcsum` parameter value for the card will not be changed, continue the procedure with [11](#).
 - If the `sctpcsum` parameter value for the card will be changed, continue the procedure with [10](#).
9. Verify that the **IP** address of either Ethernet A or B (the address whose network portion matches the network portion of the `defrouter` parameter value to be used in [11](#)) is in the **IP** link table by entering the `rtrv-ip-lnk` command with the card location specified in this procedure.

For this example, enter this command.

```
rtrv-ip-lnk:loc=1201
```

The following is an example of the possible output.

```
rlghncxa03w 06-10-28 21:17:37 GMT EAGLE5 36.0.0
LOC  PORT IPADDR      SUBMASK      DUPLEX  SPEED MACTYPE AUTO
MCAST
```

```

1201 A 192.1.1.10 255.255.255.0 ---- --- DIX
YES NO
1201 B -----
YES NO

```

If the network portion of the **IP** address specified by the `defrouter` value does not match the network portions of either **IP** address displayed in this step, perform one of these actions:

- Choose another value for the `defrouter` parameter, making sure that the network portion of the new **IP** address matches the network portion of one of the **IP** addresses displayed in this step.
- Perform the [Configuring an IP Link](#) procedure and change one of the **IP** addresses shown in this step so that the network portion of the new **IP** address changed in the [Configuring an IP Link](#) procedure matches the network portion of the **IP** address value for the `defrouter` parameter.

After this step has been completed, continue the procedure by performing one of these steps.

- If the `sctpchecksum` parameter value for the card will not be changed, continue the procedure with [11](#).
 - If the `sctpchecksum` parameter value for the card will be changed, continue the procedure with [10](#).
- 10.** To change the `sctpchecksum` parameter value for the IP card, the `sctpchecksum` parameter value in the `rtrv-sg-opts` output must be `percard`. Verify the `sctpchecksum` parameter value by entering the `rtrv-sg-opts` command.

The following is an example of the possible output.

```

rlghncxa03w 08-04-13 09:19:43 GMT EAGLE5 38.0.0
SRKQ: 1500
SNMPCONT: tekelec
GETCOMM: public
SETCOMM: private
TRAPCOMM: public
SCTPCSUM: adler32
IPGWABATE: NO
UAMEASUSEDFTAS: NO

```

If the `sctpchecksum` parameter value in the `rtrv-sg-opts` output is `percard`, continue the procedure with [11](#).

If the `sctpchecksum` parameter value in the `rtrv-sg-opts` output is `adler 32` or `crc32c`, perform the [Changing the SCTP Checksum Algorithm Option for M3UA and SUA Associations](#) procedure to change the `sctpchecksum` parameter value to `percard`. After the [Changing the SCTP Checksum Algorithm Option for M3UA and SUA Associations](#) procedure has been performed, continue the procedure with [11](#).

- 11.** Change the **IP** stack parameters associated with an **IP** card in the database using the `chg-ip-card` command.

For this example, enter this command.

```
chg-ip-
card:loc=1201:srchordr=local:dnsa=192.1.1.40:domain=nc.tekelec.co
m :sctpcsum=adler32
```

When this command has successfully completed, the following message should appear.

```
rlghncxa03w 06-10-28 21:20:37 GMT EAGLE5 36.0.0
CHG-IP-CARD: MASP A - COMPLTD
```

12. Verify the new **IP** parameters associated with the **IP** card that was changed in [11](#) by entering the `rtrv-ip-card` command. with the card location specified in [11](#)

For this example, enter this command.

```
rtrv-ip-card:loc=1201
```

The following is an example of the possible output.

```
rlghncxa03w 08-06-28 21:17:37 GMT EAGLE5 39.0.0
LOC 1201
SRCHORDR LOCAL
DNSA      192.1.1.40
DNSB      -----
DEFROUTER -----
DOMAIN    NC. TEKELEC. COM
SCTPCSUM  adler32
BPIPADDR  -----
BPSUBMASK -----
```

 **Note:**

If [7](#) was not performed, continue the procedure with [15](#).

13. Allow the **IP** card that was inhibited in [7](#) by using the `alw-card` command.

For example, enter this command.

```
alw-card:loc=1201
```

This message should appear.

```
rlghncxa03w 06-10-28 21:22:37 GMT EAGLE5 36.0.0
Card has been allowed.
```

14. Verify the in-service normal (**IS-NR**) status of the **IP** card using the `rept-stat-card` command.

For example, enter this command.

```
rept-stat-card:loc=1201
```


This is an example of the possible output.

```
rlghncxa03w 06-10-27 17:00:36 GMT EAGLE5 36.0.0
CARD VERSION      TYPE      GPL      PST      SST      AST
1201 114-000-000  DCM      SS7IPGW  IS-NR    Active   -----
  ALARM STATUS    = No Alarms.
  BPDCM GPL      = 002-102-000
  IMT BUS A      = Conn
  IMT BUS B      = Conn
  SIGNALING LINK STATUS
    SLK  PST      LS      CLLI
    A    IS-NR    nc001   -----
```

Command Completed.

15. Activate the signaling link from 4 using the `act-slk` command.

 **Note:**

If 4 was not performed, continue the procedure with 17.

For example, enter this command.

```
act-slk:loc=1201:link=a
```

The link changes its state from **OOS-MT-DSBLD** (out-of-service maintenance-disabled) to **IS-NR** (in-service normal).

The output confirms the activation.

```
rlghncxa03w 06-10-07 11:11:28 GMT EAGLE5 36.0.0
Activate Link message sent to card
```

16. Verify the in-service normal (**IS-NR**) status of the signaling link using the `rept-stat-slk` command.

For example, enter this command.

```
rept-stat-slk:loc=1201:link=a
```

This message should appear.

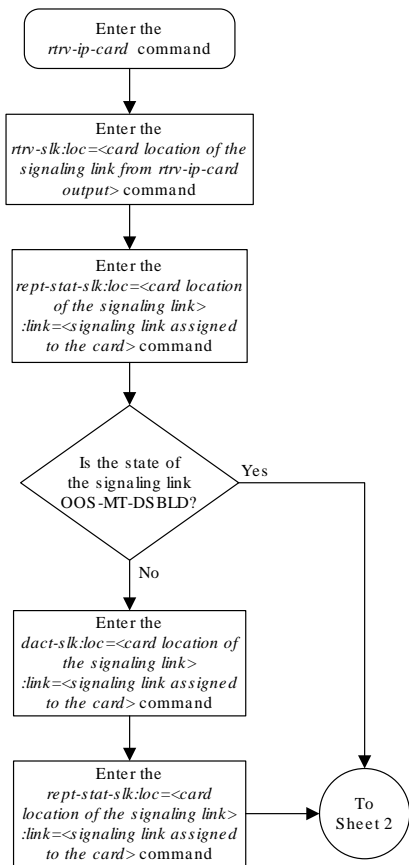
```
rlghncxa03w 06-10-28 21:16:37 GMT EAGLE5 36.0.0
SLK  LSN      CLLI      PST      SST      AST
1201,A  nc001    -----  IS-NR
      Avail   ----
Command Completed.
```

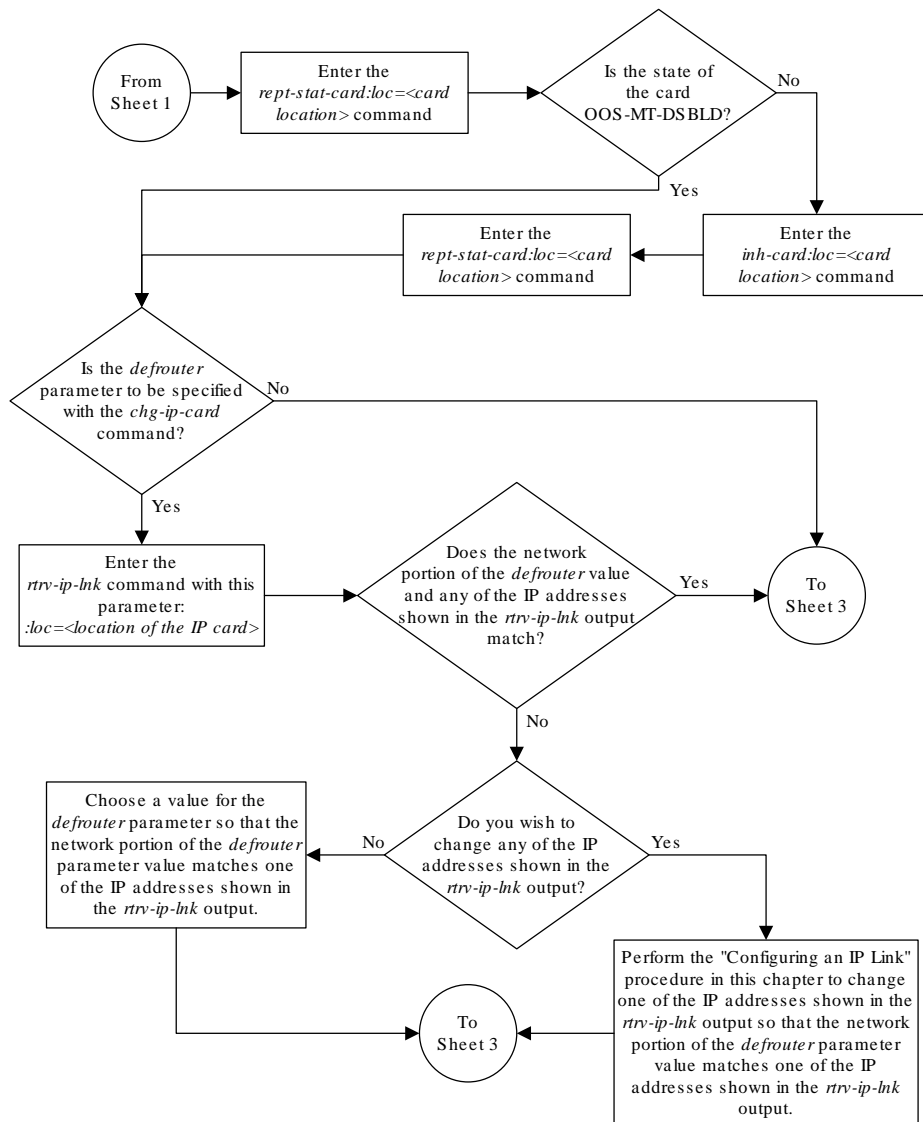
17. Back up the new changes using the `chg-db:action=backup:dest=fixed` command.

These messages should appear, the active **Maintenance and Administration Subsystem Processor (MASP)** appears first.

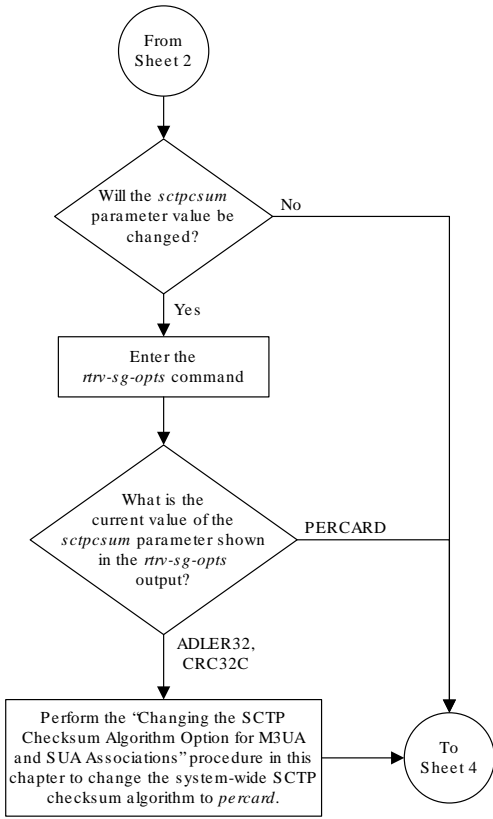
```
BACKUP (FIXED) : MASP A - Backup starts on active MASP.  
BACKUP (FIXED) : MASP A - Backup on active MASP to fixed disk complete.  
BACKUP (FIXED) : MASP A - Backup starts on standby MASP.  
BACKUP (FIXED) : MASP A - Backup on standby MASP to fixed disk complete.
```

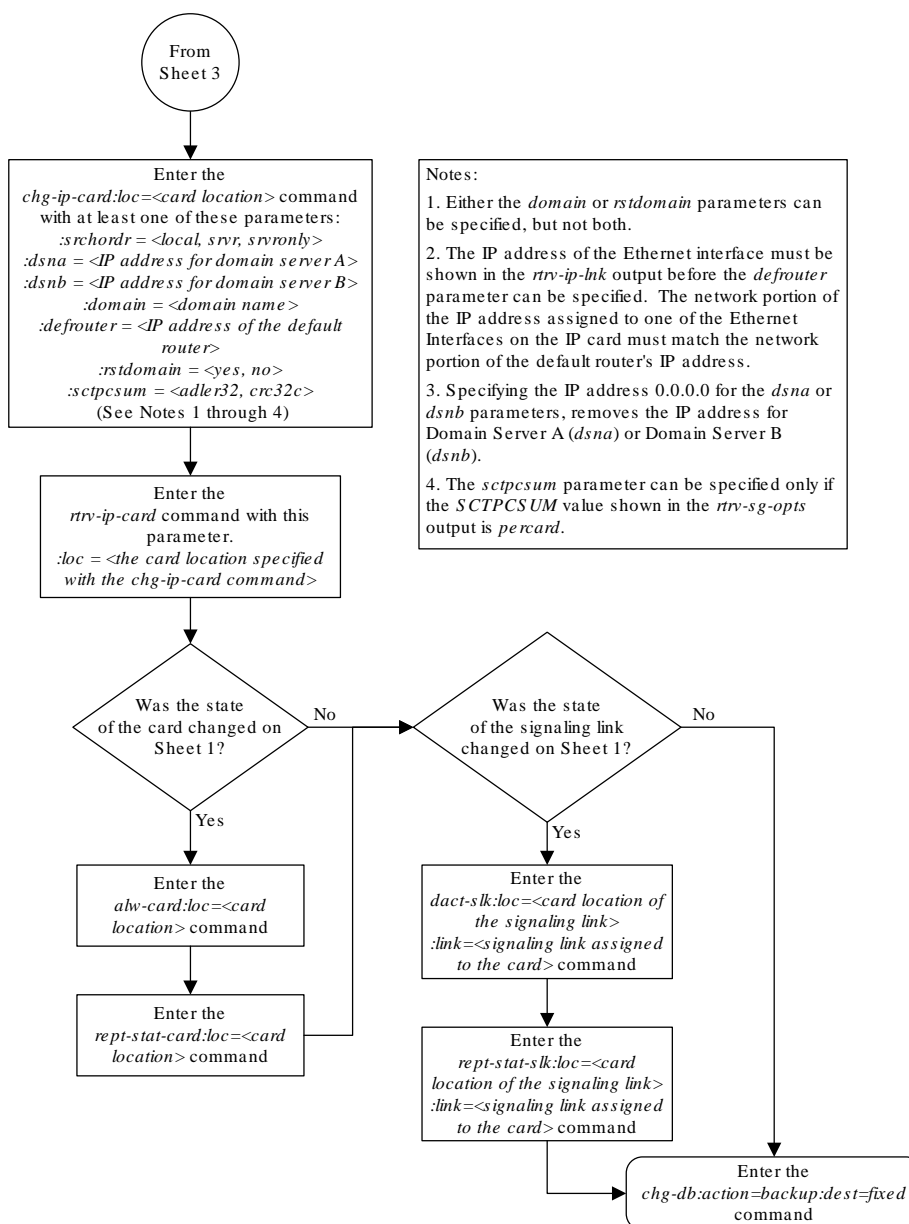
Figure 4-9 Configuring an IP Card





Sheet 2 of 4





Sheet 4 of 4

4.9 Adding an IP Route

This procedure is used to add an **IP** route to the database using the `ent-ip-rte` command.

The `ent-ip-rte` command uses these parameters.

`:loc` – The location of the **IP** card that the **IP** route will be assigned to.

: `dest` – The **IP** address of the remote host or network.

: `submask` – The subnet mask of the destination **IP** address.

: `gtwy` – The **IP** address of the gateway or router that will send the **IP** data to its final destination.

There can be a maximum of 64 **IP** routes assigned to an **IP** card.

The **EAGLE** can contain a maximum of 2048 **IP** routes.

Ethernet Interfaces A and B on the **IP** card specified by the `loc` parameter can be used.

The network portion of the **IP** address value of the `gtwy` parameter must be the same as the network portion of the **IP** addresses shown for either the A or B interfaces in the `rtrv-ip-card` output.

The value of the `dest` and `gtwy` parameters cannot be 127.x.x.x (the loopback address), 0.0.0.0, or the **IP** addresses of the A or B interfaces on the **IP** card, and cannot be assigned to another **IP** card.

If the `dest` parameter value represents a host **IP** address, the value for the `submask` parameter must be 255.255.255.255. Otherwise, the `submask` parameter value identifies the network/host **ID** portions that must be entered when the `dest` parameter value represents a network address.

The submask is applied to the **IP** address which is being routed to see if it yields a route match. For example, if **IP** address 192.1.1.2 is being routed and the **IP** routing table contains these entries.

Table 4-5 Sample IP Routing Table

IP address	Submask	Gateway
191.1.0.0	255.255.0.0	192.168.110.250
192.0.0.0	255.0.0.0	192.168.110.251

IP routing occurs as follows:

1. The subnet mask of route 1 (255.255.0.0) is applied to the **IP** address being routed (192.1.1.2) with the resulting **IP** address of 192.1.0.0. **IP** address 192.1.0.0 does not match **IP** address 191.1.0.0 in the **IP** routing table, so the next route is chosen.
2. The subnet mask of route 2 (255.0.0.0) is applied to the **IP** address being routed (192.1.1.2) with the resulting **IP** address of 192.0.0.0 which matches the second route in the **IP** routing table, so this route is selected for routing this datagram.

See [Table 4-6](#) for the valid input values for the `submask` and `dest` parameter combinations.

Table 4-6 Valid Subnet Mask Parameter Values

Network Class	IP Network Address Range	Valid Subnet Mask Values
A	1.0.0.0 to 127.0.0.0	255.0.0.0 (the default value for a class A IP address)
		255.192.0.0
		255.224.0.0
		255.240.0.0
		255.248.0.0
		255.252.0.0
		255.254.0.0
		255.255.128.1
A+B	128.1.0.0 to 191.255.0.0	255.255.0.0 (the default value for a class B IP address)
		255.255.192.0
		255.255.224.0
		255.255.240.0
		255.255.248.0
		255.255.252.0
		255.255.254.0
A+B+C	192.0.0.0 to 223.255.255.0	255.255.255.0 (the default value for a class C IP address)
		255.255.255.192
		255.255.255.224
		255.255.255.240
		255.255.255.248
		255.255.255.252

If a Class B IP address is specified for the `dest` parameter of the `ent-ip-rte` command, the subnet address that results from the `dest` and `submask` parameter values cannot be the same as the subnet address that results from the `pvn` and `pvnmask`, `fcna` and `fcnamask`, or `fcnb` and `fcnbmask` parameter values of the `chg-netopts` command. The `pvn` and `pvnmask`, `fcna` and `fcnamask`, or `fcnb` and `fcnbmask` parameter values can be verified by entering the `rtrv-netopts` command. Choose `dest` and `submask` parameter values for the IP route whose resulting subnet address is not be the same as the subnet address resulting from the `pvn` and `pvnmask` parameter values of the `chg-netopts` command.

1. Display the IP routes in the database with the `rtrv-ip-rte` command.

This is an example of the possible output.

```
rlghncxa03w 06-10-28 09:12:36 GMT EAGLE5 36.0.0
LOC  DEST          SUBMASK          GTWY
1301 128.252.10.5    255.255.255.255 140.188.13.33
1301 128.252.0.0     255.255.0.0     140.188.13.34
1301 150.10.1.1      255.255.255.255 140.190.15.3
1303 192.168.10.1    255.255.255.255 150.190.15.23
1303 192.168.0.0     255.255.255.0   150.190.15.24
```


IP Route table is (5 of 2048) 0.24% full

2. Display the IP cards in the database with the `rtrv-ip-card` command.

This is an example of the possible output.

```
rlghncxa03w 08-08-28 21:17:37 GMT EAGLE5 39.0.0
  LOC 1212
    SRCHORDR LOCAL
    DNSA      150.1.1.1
    DNSB      -----
    DEFROUTER 150.1.1.100
    DOMAIN    NC. TEKELEC. COM
    SCTPCSUM  crc32c
    BPIPADDR  -----
    BPSUBMASK -----
  LOC 1301
    SRCHORDR SRVROONLY
    DNSA      140.188.13.10
    DNSB      140.190.15.28
    DEFROUTER -----
    DOMAIN    NC. TEKELEC. COM
    SCTPCSUM  crc32c
    BPIPADDR  -----
    BPSUBMASK -----
  LOC 1303
    SRCHORDR LOCAL
    DNSA      150.190.15.1
    DNSB      -----
    DEFROUTER 150.190.15.25
    DOMAIN    NC. TEKELEC. COM
    SCTPCSUM  crc32c
    BPIPADDR  -----
    BPSUBMASK -----
```

If the required IP card is not shown in the `rtrv-ip-card` output, perform the [Adding an IPGWx Card](#) to add the card to the database.

Perform the [Configuring an IP Card](#) and make sure that the network portion of the IP addresses assigned for the A or B interfaces of the IP card is the same as the network portion of the IP address that will be assigned to the `gtwy` parameter of the IP route

 **Note:**

If a Class A or CIP address (see [Table 4-6](#)) will be specified for the `dest` parameter in 4, continue the procedure with 4.

3. The subnet address that results from the `dest` and `submask` parameter values of the `ent-ip-rte` command cannot be the same as the subnet address that results from the `pvn` and `pvnmask`, `fcna` and `fcnamask`, or `fcnb` and `fcnbmask` parameter values of the `chg-netopts` command.

Display the `pvn`, `pvnmask`, `fcna`, `fcnamask`, `fcnb`, and `fcnbmask` parameter values of the `chg-netopts` command by entering the `rtrv-netopts` command.

If error message `E3967 Cmd Rej: E5IS must be on` is displayed after the `rtrv-netopts` command is executed, the `pvn`, `pvnmask`, `fcna`, `fcnamask`, `fcnb`, and `fcnbmask` parameters are not configured. Continue the procedure with 4.

This is an example of the possible output if the **E5IS** feature is on.

```
rlghncxa03w 09-02-28 21:17:37 GMT EAGLE5 40.1.0
NETWORK OPTIONS
-----
PVN          = 128.20.30.40
PVNMASK      = 255.255.192.0
FCNA        = 170.120.50.0
FCNAMASK    = 255.255.240.0
FCNB        = 170.121.50.0
FCNBMASK    = 255.255.254.0
```

Choose `dest` and `submask` parameter values for the **IP** route whose resulting subnet address is not be the same as the subnet address resulting from the `pvn` and `pvnmask`, `fcna` and `fcnamask`, or `fcnb` and `fcnbmask` parameter values of the `chg-netopts` command. Continue the procedure with 4.

4. Add the **IP** route to the database using the `ent-ip-rte` command.

For this example, enter this command.

```
ent-ip-
rte:loc=1212:dest=132.10.175.20:submask=255.255.255.255 :gtwy=150
.1.1.50
```

When this command has successfully completed, this message should appear.

```
rlghncxa03w 06-10-12 09:12:36 GMT EAGLE5 36.0.0
ENT-IP-RTE: MASP A - COMPLTD
```

5. Verify the changes using the `rtrv-ip-rte` command with the card location specified with the `ent-ip-rte` command in 4.

For this example, enter these commands.

```
rtrv-ip-rte:loc=1212
```

This is an example of the possible output.

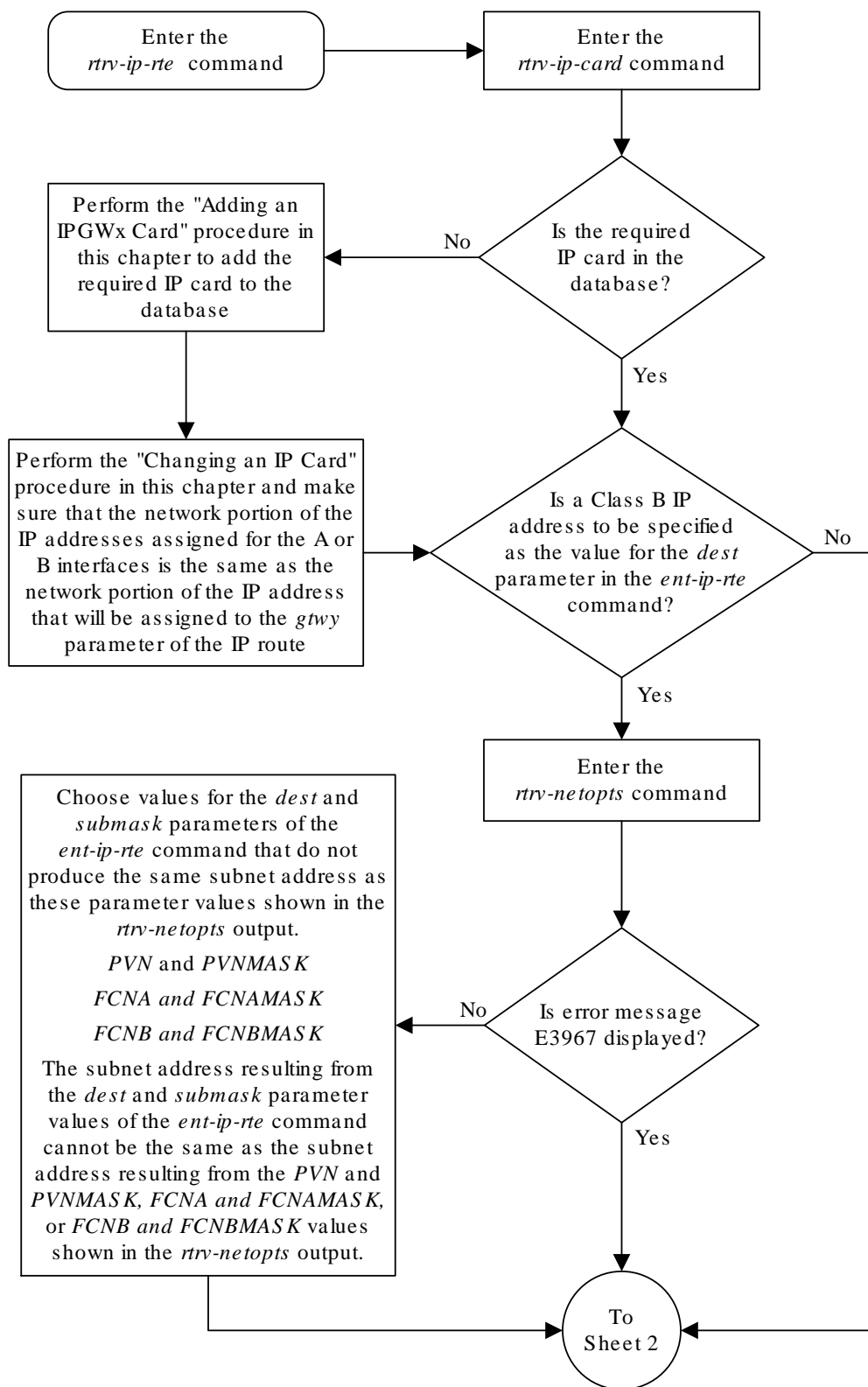
```
rlghncxa03w 06-10-28 09:12:36 GMT EAGLE5 36.0.0
LOC  DEST          SUBMASK          GTWY
1212 132.10.175.20  255.255.255.255  150.1.1.50
IP Route table is (6 of 2048) 0.29% full
```

6. Back up the new changes using the `chg-db:action=backup:dest=fixed` command.

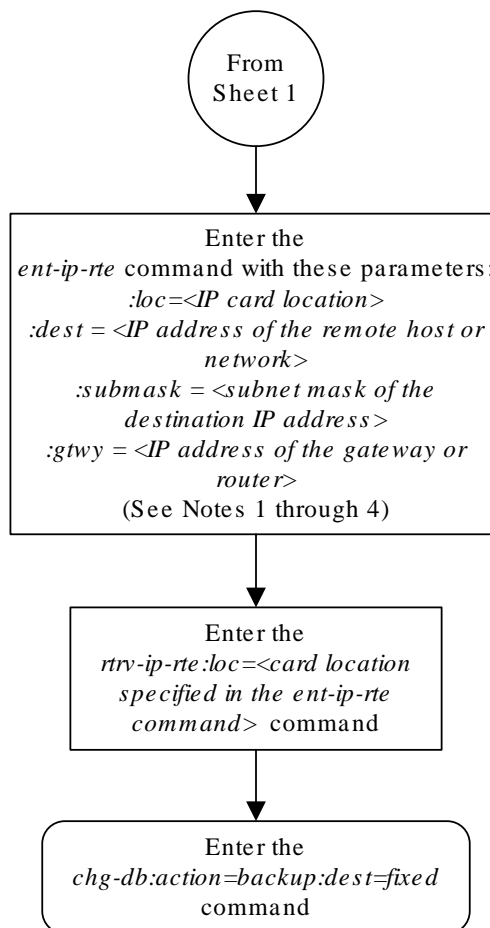
These messages should appear, the active **Maintenance and Administration Subsystem Processor (MASP)** appears first.

```
BACKUP (FIXED) : MASP A - Backup starts on active MASP.  
BACKUP (FIXED) : MASP A - Backup on active MASP to fixed disk  
complete.  
BACKUP (FIXED) : MASP A - Backup starts on standby MASP.  
BACKUP (FIXED) : MASP A - Backup on standby MASP to fixed disk  
complete.
```

Figure 4-10 Adding an IP Route



Sheet 1 of 2



Notes:

1. The network portion of the IP address value of the *gtwy* parameter must be the same as the network portion of the IP addresses shown for either the A or B interfaces in the *rtrv-ip-card* output.
2. The value of the *dest* and *gtwy* parameters cannot be the 127.x.x.x (the loopback address), 0.0.0.0, or the IP addresses of the A or B interfaces on the IP card, and cannot be assigned to another IP card.
3. There can be a maximum of 64 IP routes assigned to an IP card.
4. The EAGLE 5 ISS can contain a maximum of 1024 IP routes.

4.10 Adding an M3UA or SUA Association

This procedure is used to configure **M3UA** or **SUA** associations using the `ent-assoc` command. The combination of a local host, local **SCTP** port, remote host and remote **SCTP** port defines an association. M3UA and SUA associations are assigned to cards running either the **SS7IPGW** or **IPGWI** applications (**IPGWx** cards).

The `ent-assoc` command uses these parameters:

`:aname` – The name assigned to the association. Valid association names can contain up to 15 alphanumeric characters where the first character is a letter and the remaining characters are alphanumeric characters. The `aname` parameter value is not case-sensitive.

`:lhost` – Local Hostname. The logical name assigned to the local host device.

`:lport` – The **SCTP** port number for the local host.

`:rhost` – Remote Hostname. The logical name assigned to the remote host device.

`:rport` – The **SCTP** port number for the remote host.

`:link` – The signaling link on the **IP** card. The value for the link parameter for **M3UA** or **SUA** associations is A.



Note:

The `port` parameter can be used in place of the `link` parameter to specify the signaling link on the card.

`:adapter` – The adapter layer for this association, either `m3ua` or `sua`. The `adapter` parameter is optional. The default value for the `adapter` parameter is `m3ua`.

`:alhost` – The alternate local host name.

The `adapter=m2pa` and `m2patset` parameters can be used only when configuring **M2PA** associations. Perform the [Adding an M2PA Association](#) or [Adding an IPSP M2PA Association](#) procedures to configure **M2PA** associations.

Associations contain fields whose values are not assigned using the `ent-assoc` command. When an association is added to the database, these fields receive their default values. If a different value is desired, the `chg-assoc` command must be used. To change these values perform the [Changing the Attributes of a M3UA or SUA Association](#) procedure.

These fields and their default values are shown in [Table 4-7](#).

Table 4-7 M3UA and SUA Association Fields and Default Values

<code>open=no</code>	<code>rmax=800</code>	<code>cwmin=3000</code>	<code>alw=no</code>	<code>uaps=10</code>
<code>istrms=2</code>	<code>rmode=lin</code>	<code>rtimes=10</code>	<code>ostrms=2</code>	<code>rmin=120</code>

Table 4-7 (Cont.) M3UA and SUA Association Fields and Default Values

bufsize=16	rtxthr=0	rhostval=re laxed
------------	----------	----------------------

An M3UA or SUA association can contain an alternate remote host. The alternate remote host is provisioned with the `rhost` and `rhostype=alternate` parameters of the `chg-assoc` command. A primary remote host can be provisioned on this procedure by specifying the `rhost` parameter with the `ent-assoc` command. To provision an alternate remote host for an M3UA or SUA association, perform [Changing the Attributes of a M3UA or SUA Association](#).

The size of the buffers on the **E5-ENET** card is shown in the following list.

- E5-ENET Card - 3200 KB

The size of the buffers assigned to each association that is assigned to the **IP** card cannot exceed the maximum buffer size for the **IP** card. When a new association is added, the default buffer size for the association is assigned to the association. If adding the new association causes the total buffer size for all the associations on the **IP** card to exceed the maximum buffer size for that **IP** card, the `ent-assoc` command will be rejected. If you wish to add the association and the maximum buffer size for the **IP** card will be exceeded, the buffer size of the other associations assigned to the **IP** card must be decreased by performing the [Changing the Buffer Size of a M3UA or SUA Association](#) procedure. The available size of the buffers on the **IP** card can be verified by entering this command.

```
rtrv-assoc:lhost=<local host name assigned to the association being changed>
```

The `alhost` parameter can also be used with the `rtrv-assoc` command to display the available size of the buffers on the **IP** card.

The `aname` parameter can be used with the `rtrv-assoc` command to display the available size of the buffers on the **IP** card and the size of the buffer assigned to the association.

The value of the `lhost`, `rhost`, or `alhost` parameters is a text string of up to 60 characters, with the first character being a letter. The command line on the terminal can contain up to 150 characters. If the host names are too long to fit on the `ent-assoc` command line, perform the `chg-assoc` command with the parameters and values necessary to complete the entry of the M3UA or SUA association.

The **EAGLE** can contain a maximum of 4000 connections (association to application server assignments).

The B Ethernet interface of the **IP** card can be used on the **E5-ENET** card.

If the association is to be activated in this procedure, with the `chg-assoc` command, the association must contain values for the `lhost`, `lport`, `rhost`, and `rport` parameters.

The signaling link being assigned to the association must be in service. This state is shown in the `rept-stat-slk` output with the entries **IS-NR** in the **PST** field and **Avail** in the **SST** field.

Uni-homed endpoints are associations configured with the `lhost` parameter only. The `lhost` parameter value represents an **IP** address that corresponds to either the A or B network interface of the **IP** card. Multi-homed endpoints are associations configured with both the `lhost` and `alhost` parameters. The `lhost` parameter value represents an **IP** address

corresponding to one of the network interfaces (A or B) of the **IP** card while the `alhost` parameter value represents an **IP** address corresponding to the other network interface of the same **IP** card.

An alternate remote host can be configured for multi-homed associations using the `rhost` and `rhosttype` parameters of the `chg-assoc` command. The `rhost` parameter value with the `rhosttype=primary` parameter represents an IP address that corresponds to one of the network interfaces at the remote end while the `rhost` parameter value with the `rhosttype=alternate` parameter represents an IP address that corresponds to the other network interface at the remote end.

Canceling the `RTRV-ASSOC` Command

Because the `rtrv-assoc` command used in this procedure can output information for a long period of time, the `rtrv-assoc` command can be canceled and the output to the terminal stopped. There are three ways that the `rtrv-assoc` command can be canceled.

- Press the `F9` function key on the keyboard at the terminal where the `rtrv-assoc` command was entered.
- Enter the `canc-cmd` without the `trm` parameter at the terminal where the `rtrv-assoc` command was entered.
- Enter the `canc-cmd:trm=<xx>`, where `<xx>` is the terminal where the `rtrv-assoc` command was entered, from another terminal other than the terminal where the `rtrv-assoc` command was entered. To enter the `canc-cmd:trm=<xx>` command, the terminal must allow Security Administration commands to be entered from it and the user must be allowed to enter Security Administration commands. The terminal's permissions can be verified with the `rtrv-secu-trm` command. The user's permissions can be verified with the `rtrv-user` or `rtrv-secu-user` commands.

For more information about the `canc-cmd` command, go to *Commands User's Guide*.

1. Display the associations in the database using the `rtrv-assoc` command. This is an example of possible output.

```
rlghncxa03w 06-10-28 09:12:36 GMT EAGLE5 36.0.0
CARD IPLNK
ANAME      LOC  PORT  LINK ADAPTER LPORT RPORT OPEN ALW
swbel32    1201 A    A    M3UA  1030  2345 YES  YES
a2         1305 A    A    SUA   1030  2345 YES  YES
a3         1307 A    A    SUA   1030  2346 YES  YES
assoc3     1203 A    A1   M2PA  2048  1030 NO   NO
```

Perform one of these actions.

- If SUA associations are assigned to the desired IP link (shown by the entries in the `CARD LOC` and `IPLNK PORT` columns for an association whose `ADAPTER` value is `SUA` in the `rtrv-assoc` output), continue the procedure with [5](#).
- If M3UA associations are assigned to the desired IP link (shown by the entries in the `CARD LOC` and `IPLNK PORT` columns for an association whose

ADAPTER value is M3UA in the `rtrv-assoc` output), continue the procedure with 2.

- If the desired IP link is not shown in the `rtrv-assoc` output, continue the procedure with 3.
2. Display the signaling links assigned to the card that the new M3UA association will be assigned to by entering the `rtrv-slk` command with the card location displayed in 1. For this example, enter this command.

```
rtrv-slk:loc=1201
```

The following is an example of the possible output.

```
rlghncxa03w 08-04-06 10:07:25 GMT EAGLE5 38.0.0
```

```
LOC LINK LSN          SLC TYPE
1201 A   lsn1          0   SS7IPGW
```

If the value in the `TYPE` column is either `SS7IPGW` or `IPGWI`, continue the procedure with 5.

If the value in the `TYPE` column is `IPSG`, the links and host assigned to this card cannot be used in this procedure. If you wish to use this card to configure an M3UA association, perform the [Adding an IPSG M3UA Association](#) procedure.

If you do not wish to use this card to configure an M3UA association, perform one of these actions.

- Choose another card from the `rtrv-assoc` output in 1 and repeat this step.
 - Continue the procedure with 3 to choose another IPGWx card and IP link for the new association.
3. Display the IP links in the database by entering the `rtrv-ip-lnk` command. The following is an example of the possible output.

```
rlghncxa03w 08-12-28 21:14:37 GMT EAGLE5 40.0.0
LOC  PORT IPADDR          SUBMASK          DUPLEX  SPEED MACTYPE AUTO
MCAST
1201 A   192.1.1.10        255.255.255.128 HALF      10    802.3  NO  NO
1201 B   -----          -----          HALF      10    DIX    NO  NO
1203 A   192.1.1.12        255.255.255.0   ----     ---    DIX    YES NO
1203 B   -----          -----          HALF      10    DIX    NO  NO
1205 A   192.1.1.14        255.255.255.0   FULL     100    DIX    NO  NO
1205 B   -----          -----          HALF      10    DIX    NO  NO
2101 A   192.1.1.20        255.255.255.0   FULL     100    DIX    NO  NO
2101 B   -----          -----          HALF      10    DIX    NO  NO
2103 A   192.1.1.22        255.255.255.0   FULL     100    DIX    NO  NO
2103 B   -----          -----          HALF      10    DIX    NO  NO
2105 A   192.1.1.24        255.255.255.0   FULL     100    DIX    NO  NO
2105 B   -----          -----          HALF      10    DIX    NO  NO
2205 A   192.1.1.30        255.255.255.0   FULL     100    DIX    NO  NO
2205 B   -----          -----          HALF      10    DIX    NO  NO
2207 A   192.1.1.32        255.255.255.0   FULL     100    DIX    NO  NO
2207 B   -----          -----          HALF      10    DIX    NO  NO
2213 A   192.1.1.50        255.255.255.0   FULL     100    DIX    NO  NO
2213 B   -----          -----          HALF      10    DIX    NO  NO
```

```

2301 A 192.1.1.52 255.255.255.0 FULL 100 DIX
NO NO
2301 B ----- HALF 10 DIX
NO NO

```

IP-LNK table is (20 of 2048) 1% full.

If the required **IP** link is not in the database, add the **IP** link using the [Configuring an IP Link](#) procedure.

4. Verify that the local host name to be assigned to the association is in the database by using the `rtrv-ip-host:display=all` command. The following is an example of the possible output.

```
rlghncxa03w 13-06-28 21:15:37 GMT EAGLE5 45.0.0
```

```

LOCAL IPADDR LOCAL HOST
192.1.1.10 IPNODE1-1201
192.1.1.12 IPNODE1-1203
192.1.1.14 IPNODE1-1205
192.1.1.20 IPNODE2-1201
192.1.1.22 IPNODE2-1203
192.1.1.24 IPNODE2-1205
192.1.1.30 KC-HLR1
192.1.1.32 KC-HLR2
192.1.1.50 DN-MSC1
192.1.1.52 DN-MSC2

REMOTE IPADDR REMOTE HOST
150.1.1.5 NCDEPTECONOMIC_DEVELOPMENT.
SOUTHEASTERN_COORIDOR_ASHVL. GOV

```

IP Host table is (11 of 4096) .26% full

The **IP** address of the **IP** link should be assigned to the local host name that will be assigned to the association.

The values of the `lhost` and `alhost` parameters must be in the `LOCAL HOST` column in the `rtrv-ip-host` output.

If the required hostname is not in the database, add the **IP** host name using the [Adding an IP Host](#) procedure.

5. Verify the available buffer size for the **IP** card that will contain the association being added in this procedure by entering the `rtrv-assoc` command with the local host name assigned to the association being added. For this example, enter this command.

 **Note:**

If a new **IP** host was added in 4, continue the procedure with 6.

```
rtrv-assoc:lhost="IPNODE2-1305"
```

This is an example of the possible output.

```
rlghncxa03w 06-10-28 09:12:36 GMT EAGLE5 36.0.0
                CARD IPLNK
ANAME          LOC  PORT  LINK ADAPTER LPORT RPORT OPEN ALW
a2             1305 A    A    SUA      1030  2345  YES  YES

IP Appl Sock/Assoc table is (8 of 4000) 1% full
Assoc Buffer Space Used (16 KB of 800 KB) on LOC = 1305
```

If adding the new association causes the total buffer size for all the associations on the **IP** card to exceed the maximum buffer size for that **IP** card, the `ent-assoc` command will be rejected.

The default buffer value for an **M3UA** or **SUA** association is 16.

If the you wish to add the association and the maximum buffer size for the **IP** card will be exceeded, the buffer size of the other associations assigned to the **IP** card must be decreased by performing the [Changing the Buffer Size of a M3UA or SUA Association](#) procedure.

6. Add the associations using the `ent-assoc` command. For this example, enter these commands.

```
ent-assoc:aname=assoc1:lhost=gw105.nc.tekelec.com:lport=1030:
rhost=gw100.nc.tekelec.com:rport=1030:adapter=m3ua:link=a
```

These are the rules that apply to adding M3UA or SUA associations that are assigned to IPGWx signaling links.

- The B Ethernet interface can be used with E5-ENET cards.
- Each local host on an IPGWx card can contain a maximum of 50 connections (association – application server assignments).
- The EAGLE can contain a maximum of 4000 connections (association – application server assignments).
- The value of the `lhost`, `rhost`, or `alhost` parameters is a text string of up to 60 characters, with the first character being a letter. The command line on the terminal can contain up to 150 characters. If the host names are too long to fit on the `ent-assoc` command line, perform the `chg-assoc` command with the parameters and values necessary to complete the entry of the M3UA or SUA association.
- If the new association is to be activated in this procedure with the `chg-assoc` command, the association must contain values for the `lhost`, `rhost`, `lport`, and `rport` parameters.
- If the `lhost` and `alhost` are specified, the `lhost` parameter value represents the IP address corresponding to one of the network interfaces (A or B) on the IP card while the `alhost` parameter value represents the IP address corresponding to the other network interface of the same IP card.
- The default value for the `adapter` parameter is `m3ua`.
- The `port` parameter can be used in place of the `link` parameter to specify the signaling link assigned to the association.

When each of these commands have successfully completed, this message should appear.

```
rlghncxa03w 06-10-28 09:12:36 GMT EAGLE5 36.0.0
ENT-ASSOC: MASP A - COMPLTD
```

 **Note:**

If the association added in step 6 is not being activated in this procedure, skip step 7 and go to step 8.

7. Activate the association added in 6 by entering the `chg-assoc` command with the association name specified in 6 and the `open=yes` and `alw=yes` parameters. For example, enter this command.

```
chg-assoc:aname=assoc1:open=yes:alw=yes
```

When this command has successfully completed, this message should appear.

```
rlghncxa03w 06-10-28 21:15:37 GMT EAGLE5 36.0.0
CHG-ASSOC: MASP A - COMPLTD
```

8. Verify the changes using the `rtrv-assoc` command specifying the association name specified in 6 and 7. For this example, enter these commands.

```
rtrv-assoc:aname=assoc1
```

This is an example of possible output.

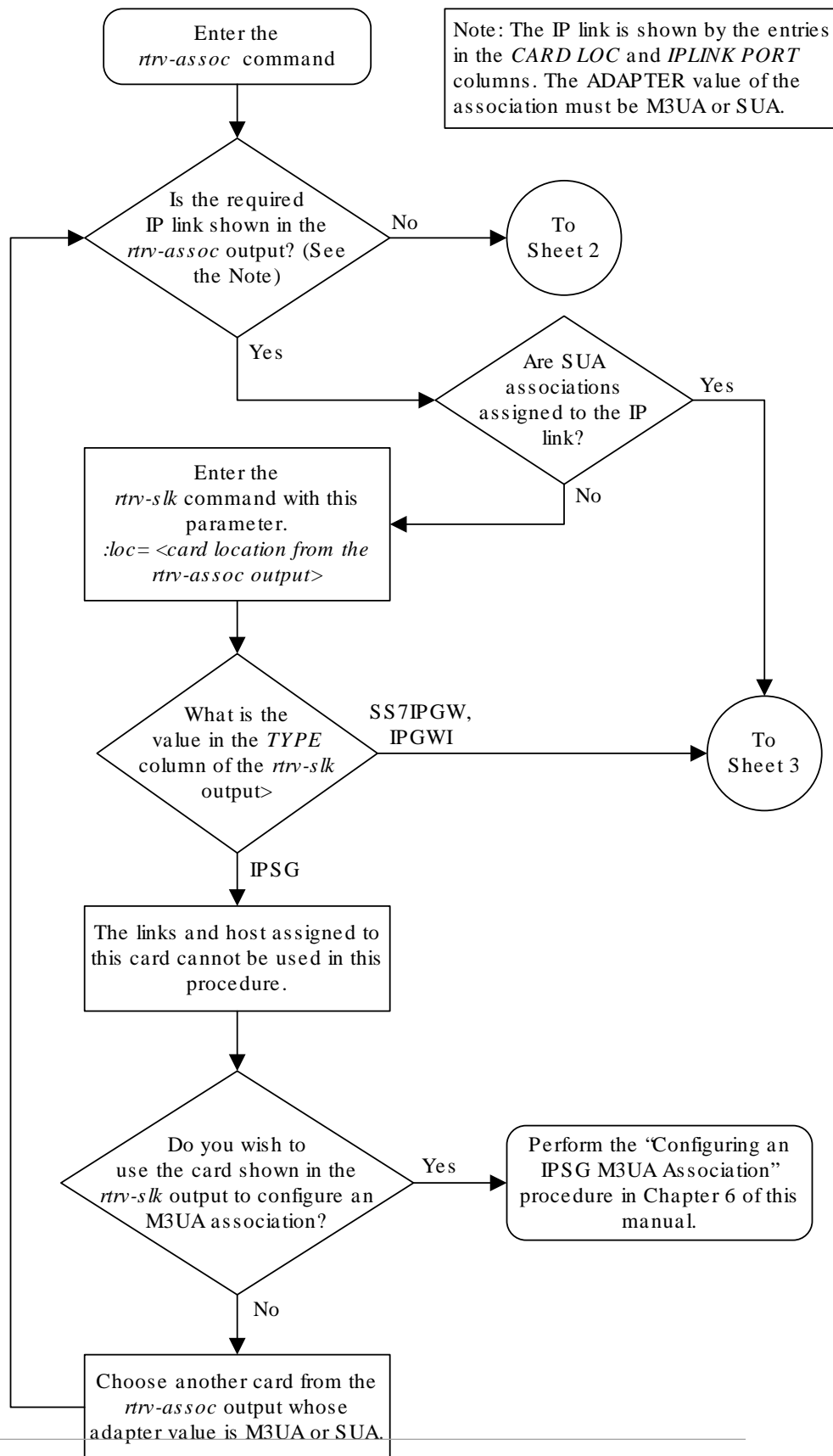
```
rlghncxa03w 09-05-28 09:12:36 GMT EAGLE5 41.0.0
ANAME assoc1
  LOC      1305          IPLNK PORT  A          LINK  A
  ADAPTER  M3UA          VER          M3UA RFC
  LHOST    gw105.nc.tekelec.com
  ALHOST    ---
  RHOST    gw100.nc.tekelec.com
  ARHOST    ---
  LPORT    1030          RPORT      1030
  ISTRMS   2            OSTRMS     2          BUFSIZE  16
  RMODE    LIN          RMIN       120        RMAX     800
  RTIMES   10          CWMIN      3000       UAPS     10
  OPEN     YES          ALW        YES         RTXTHR   0
  RHOSTVAL RELAXED
```

```
IP Appl Sock table is (5 of 4000) 1% full
Assoc Buffer Space Used (16 KB of 800 KB) on LOC = 1305
```

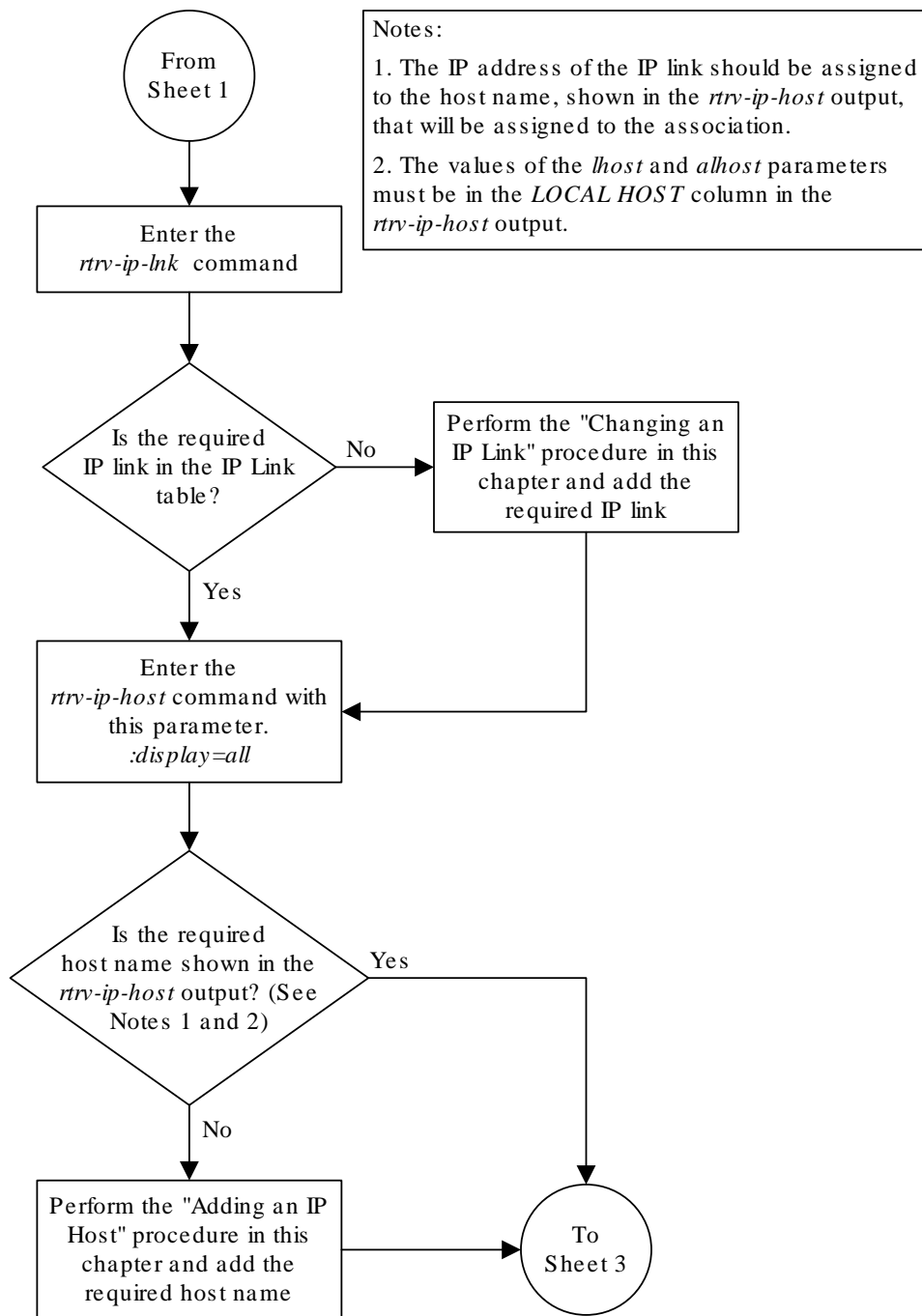
9. Back up the new changes, using the `chg-db:action=backup:dest=fixed` command. These messages should appear; the active **Maintenance and Administration Subsystem Processor (MASP)** appears first.

```
BACKUP (FIXED) : MASP A - Backup starts on active MASP.  
BACKUP (FIXED) : MASP A - Backup on active MASP to fixed disk complete.  
BACKUP (FIXED) : MASP A - Backup starts on standby MASP.  
BACKUP (FIXED) : MASP A - Backup on standby MASP to fixed disk complete.
```

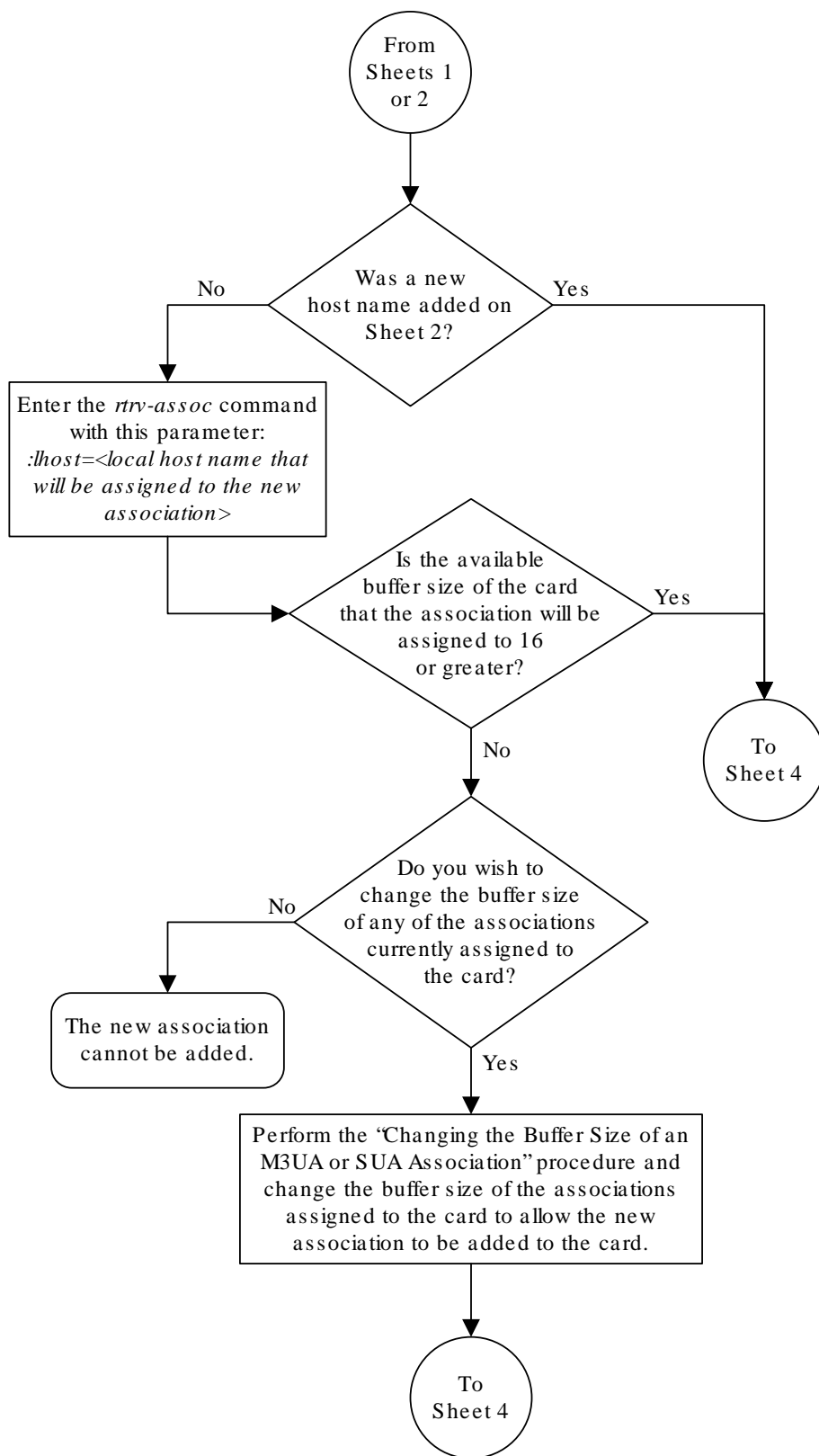
Figure 4-11 Adding an IPGWx M3UA or SUA Association



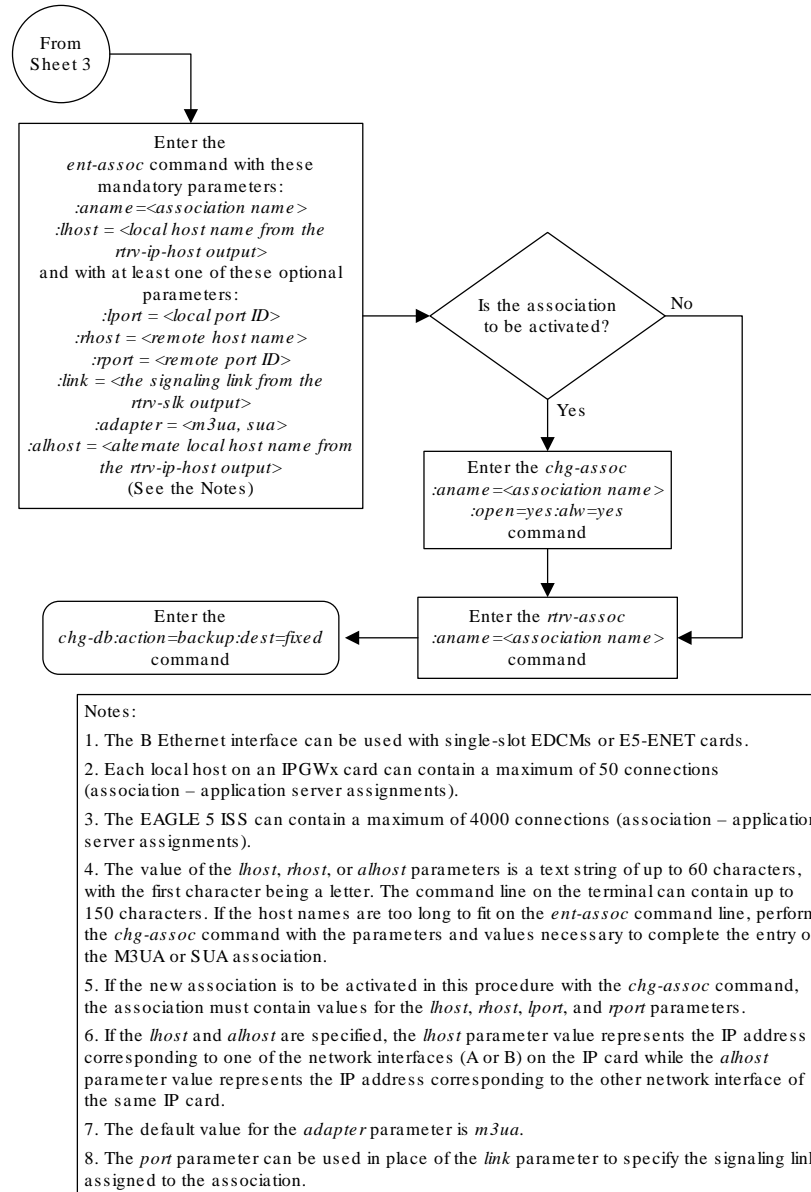
Sheet 1 of 4



Sheet 2 of 4



Sheet 3 of 4



Sheet 4 of 4

4.11 Adding a New Association to a New Application Server

This procedure is used create a new application server and assign a new association to the application server using the `ent-as` command.

The `ent-as` command uses these parameters:

`:asname` – The name of the new application server. The name of the application server can contain up to 15 alphanumeric characters, with the first character being an alphabetic character. Application server names are not case sensitive.

`:aname` – The name of the association being assigned to the application server.

The maximum number **SCTP** association to application server assignments that can be hosted by an **IPGWx** card (referenced by the `lhost` parameter of the association) is 50. For example, the IPGWx card currently contains 38 SCTP association to application server assignments. The **SCTP** association to application server assignments could be one **SCTP** association assigned to 38 application servers, two **SCTP** associations assigned to 19 application servers, or any combination of **SCTP** associations assigned to application servers that add up to 38. The **SCTP** association to application server assignments can be verified with the `rtrv-
assoc:lhost=<local host name>` and `rtrv-as:aname=<association name>` commands.

Table 4-8 Examples of IPGWx Card Provisioning Limits

Number of Associations hosted by the IPGWx card	Number of Application Servers each Association is Assigned to *	Total Association - Application Server Assignments maintained by the IPGWx card
1	50	50
50	1	50
25	1	50
25	2	50
0	0	50
38	1	38
19	2	38

* The **EAGLE** can contain a maximum of 250 application servers.

The `open` parameter of the association must be set to `no` before the association can be assigned to the application server. This can be verified with the `rtrv-
assoc` command.

M2PA associations (`adapter=m2pa`) cannot be assigned to application servers. Only **M3UA** (`adapter=m3ua`) and **SUA** (`adapter=sua`) associations can be assigned to application servers. This can be verified in the `ADAPTER` field in the `rtrv-
assoc` output.

The application server recovery timer (the `tr` parameter of the `chg-
as` command) for the application server is set by default to 10 milliseconds when an application server is added. The traffic mode (the `mode` parameter of the `chg-
as` command) for the application server is set by default to `LOADSHARE` when an application server is added. Perform the [Changing an Application Server](#) procedure to change these parameter values.

Canceling the `RTRV-AS` and `RTRV-ASSOC` Commands

Because the `rtrv-as` and `rtrv-assoc` commands used in this procedure can output information for a long period of time, the `rtrv-as` and `rtrv-assoc` commands can be canceled and the output to the terminal stopped. There are three ways that the `rtrv-as` and `rtrv-assoc` commands can be canceled.

- Press the F9 function key on the keyboard at the terminal where the `rtrv-as` or `rtrv-assoc` commands were entered.
- Enter the `canc-cmd` without the `trm` parameter at the terminal where the `rtrv-as` or `rtrv-assoc` commands were entered.
- Enter the `canc-cmd:trm=<xx>`, where `<xx>` is the terminal where the `rtrv-as` or `rtrv-assoc` commands were entered, from another terminal other than the terminal where the `rtrv-as` or `rtrv-assoc` commands were entered. To enter the `canc-cmd:trm=<xx>` command, the terminal must allow Security Administration commands to be entered from it and the user must be allowed to enter Security Administration commands. The terminal's permissions can be verified with the `rtrv-secu-trm` command. The user's permissions can be verified with the `rtrv-user` or `rtrv-secu-user` commands.

For more information about the `canc-cmd` command, go to *Commands User's Guide*.

1. Display the application servers in the database using the `rtrv-as` command. This is an example of possible output.

```
rlghncxa03w 06-10-28 09:12:36 GMT EAGLE5 36.0.0

AS Name           Mode           Tr ms   Association Names
as1                LOADSHARE     10      a2
                  a3
                  assoc1

as2                OVERRIDE      10      assoc7
as3                OVERRIDE      10      swbel32

AS table is (3 of 250) 1% full.
```

2. Display the associations in the database using the `rtrv-assoc` command. This is an example of possible output.

```
rlghncxa03w 06-10-28 09:12:36 GMT EAGLE5 36.0.0

CARD IPLNK
ANAME           LOC  PORT  LINK ADAPTER  LPORT  RPORT  OPEN  ALW
swbel32         1201 A    A    M3UA      1030   2345   YES   YES
a2              1305 A    A    SUA       2000   2345   YES   YES
a3              1307 A    A    SUA       3000   3000   YES   YES
assoc1          1305 A    A    SUA       4000   1030   YES   YES
assoc7          1311 A    A    SUA       2500   2000   YES   YES
```

3. Display the **IP** host names in the database by using the `rtrv-ip-host:display=all` command. The following is an example of the possible output.

```
rlghncxa03w 13-06-28 21:15:37 GMT EAGLE5 45.0.0
```

```
LOCAL IPADDR      LOCAL HOST
192.1.1.10       IPNODE1-1201
192.1.1.12       GW105. NC. TEKELEC. COM
192.1.1.14       IPNODE1-1205
192.1.1.20       IPNODE2-1201
192.1.1.22       IPNODE2-1203
192.1.1.24       IPNODE2-1205
192.1.1.30       KC-HLR1
192.1.1.32       KC-HLR2
192.1.1.50       DN-MSC1
192.1.1.52       DN-MSC2
```

```
REMOTE IPADDR    REMOTE HOST
150.1.1.5        NCDEPTECONOMIC_DEVELOPMENT.
SOUTHEASTERN_COORIDOR_ASHVL. GOV
```

```
IP Host table is (11 of 4096) .26% full
```

If the **IP** host name for the new association is not shown in the `LOCAL HOST` column of the `rtrv-ip-host` output, add the **IP** host name by performing the [Adding an IP Host](#) procedure. After the IP host has been added, continue the procedure with [7](#).

If the **IP** host name for the new association is shown in the `LOCAL HOST` column of the `rtrv-ip-host` output, continue the procedure with [4](#).

4. Display the IP links in the database by entering the `rtrv-ip-lnk` command. The following is an example of the possible output.

```
rlghncxa03w 08-12-28 21:14:37 GMT EAGLE5 40.0.0
LOC  PORT IPADDR      SUBMASK          DUPLEX  SPEED  MACTYPE
AUTO MCAST
1201  A   192.1.1.10      255.255.255.128 HALF    10    802.3
NO   NO
1201  B   -----          -----          HALF    10    DIX
NO   NO
1203  A   192.1.1.12      255.255.255.0   ----    ---    DIX
YES  NO
1203  B   -----          -----          HALF    10    DIX
NO   NO
1205  A   192.1.1.14      255.255.255.0   FULL    100   DIX
NO   NO
1205  B   -----          -----          HALF    10    DIX
NO   NO
2101  A   192.1.1.20      255.255.255.0   FULL    100   DIX
NO   NO
```

```

2101 B -----
2103 A 192.1.1.22 255.255.255.0 FULL 100 DIX NO NO
2103 B -----
2105 A 192.1.1.24 255.255.255.0 FULL 100 DIX NO NO
2105 B -----
2205 A 192.1.1.30 255.255.255.0 FULL 100 DIX NO NO
2205 B -----
2207 A 192.1.1.32 255.255.255.0 FULL 100 DIX NO NO
2207 B -----
2213 A 192.1.1.50 255.255.255.0 FULL 100 DIX NO NO
2213 B -----
2301 A 192.1.1.52 255.255.255.0 FULL 100 DIX NO NO
2301 B -----

```

IP-LNK table is (20 of 2048) 1% full.

5. Enter the `rtrv-card` command with the location of the card, from the `rtrv-ip-lnk` output in 4, that will host the association that will be assigned to the application server. For this example, enter this command.

```
rtrv-card:loc=1205
```

This is an example of possible output.

```

rlghncxa03w 08-03-06 15:17:20 EST EAGLE5 38.0.0
CARD TYPE APPL LSET NAME LINK SLC LSET NAME LINK SLC
1205 DCM SS7IPGW lsn1 A 0

```

If the application assigned to the card is SS7IPGW or IPGWI, shown in the `APPL` column, continue the procedure with 6.

If the application assigned to the card is IPSG, the host assigned to this card cannot be used for the association that will be assigned to the application server. Repeat this procedure from 3 and choose another IP host.

6. Display the associations assigned to the local host value that will be assigned to the association being configured in this procedure by entering the `rtrv-assoc` command with the `lhost` parameter. For this example, enter this command.

```
rtrv-assoc:lhost="IPNODE2-1205"
```

This is an example of the possible output.

```

rlghncxa03w 06-10-28 21:14:37 GMT EAGLE5 36.0.0
CARD IPLNK
ANAME LOC PORT LINK ADAPTER LPORT RPORT OPEN ALW
a2 1205 A A SUA 2000 2048 YES YES
a3 1205 A A SUA 3000 3000 YES YES

```

IP Appl Sock/Assoc table is (8 of 4000) 1% full
Assoc Buffer Space Used (32 KB of 3200 KB) on LOC = 1205

7. Display the application servers that the associations shown in 6 are assigned to by entering `rtrv-as` command with the names of the associations shown in 6. For this example, enter these commands.


```
rtrv-as:aname=a2
```

This is an example of the possible output.

```
rlghncxa03w 06-10-28 21:14:37 GMT EAGLE5 36.0.0
AS Name      Mode      Tr ms    Association Names
as1          LOADSHARE 2000     a2
AS Table is (3 of 250) 1% full
```

```
rtrv-as:aname=a3
```

This is an example of the possible output.

```
rlghncxa03w 06-10-28 21:14:37 GMT EAGLE5 36.0.0
AS Name      Mode      Tr ms    Association Names
as2          LOADSHARE 2000     a3
AS Table is (3 of 250) 2% full
```

The maximum number of **SCTP** association to application server assignments that can be hosted by an **IPGWx** card (referenced by the `lhost` parameter of the association) is 50.

If the number of **SCTP** association to application server assignments is less than 50, continue the procedure with [8](#).

If the number of **SCTP** association to application server assignments is 50, the local host value cannot be used in this procedure.

Repeat this procedure from [3](#) and select another local **IP** host from the `rtrv-ip-host` output or perform the [Adding an IP Host](#) procedure to add a new local **IP** host. After the new local **IP** host name as been added, continue the procedure with [8](#).

8. Add the new association by performing the [Adding an M3UA or SUA Association](#) procedure.

The `open` parameter value for this association must be set to `no`.

These are the rules that apply to the association and the application server.

- a. M2PA associations cannot be assigned to an application server.
- b. If the application server is being added in this procedure will be assigned to a routing key containing an `rcontext` parameter value, the `adapter` parameter value for the association assigned to this application server can be either M3UA or SUA.
- c. If the application server is being added in this procedure will be assigned to a routing key that does not contain an `rcontext` parameter value, the `adapter` parameter value for the association assigned to this application server must be M3UA.
- d. SUA associations and their corresponding application server, can be assigned to only these types of routing keys.
 - Full routing key – DPC/SI=3/SSN
 - Partial routing key – DPC/SI=3

- Partial routing key – DPC only
 - Partial routing key – SI=3 only
 - Default routing key.
 - The routing key containing the application server with the SUA associations must have an `rcontext` value assigned to it. If the new application server will not be assigned to one of these types of routing keys, the `adapter` parameter value of the associations assigned to the application server must be M3UA.
- e. 5. The application of the card containing the signaling link assigned to the association is either SS7IPGW or IPGWI.
9. Assign the new association to the new application server and add the new application server to the database using the `ent-as` command. For this example, enter this command

```
ent-as:asname=as4:aname=assoc10
```

When this command has successfully completed, this message should appear.

```
rlghncxa03w 06-10-28 09:12:36 GMT EAGLE5 36.0.0
ENT-AS: MASP A - COMPLTD;
```

10. Verify the changes using the `rtrv-as` command with the application server name and association name specified in 9. For this example, enter this command.

```
rtrv-as:asname=as4:aname=assoc10
```

This is an example of possible output.

```
rlghncxa03w 06-10-28 09:12:36 GMT EAGLE5 36.0.0
AS Name           Mode           Tr ms   Association Names
as4                LOADSHARE     10      assoc10
```

AS table is (4 of 250) 1% full.

 **Note:**

If you do not wish to change the `open` parameter value of the association specified in 9, continue the procedure with 12.

11. Change the value of the `open` parameter to `yes` by specifying the `chg-assoc` command with the `open=yes` parameter. For this example, enter this command.

```
chg-assoc:aname=assoc10:open=yes
```

When this command has successfully completed, this message should appear.

```
rlghncxa03w 06-10-28 09:12:36 GMT EAGLE5 36.0.0
CHG-ASSOC: MASP A - COMPLTD;
```

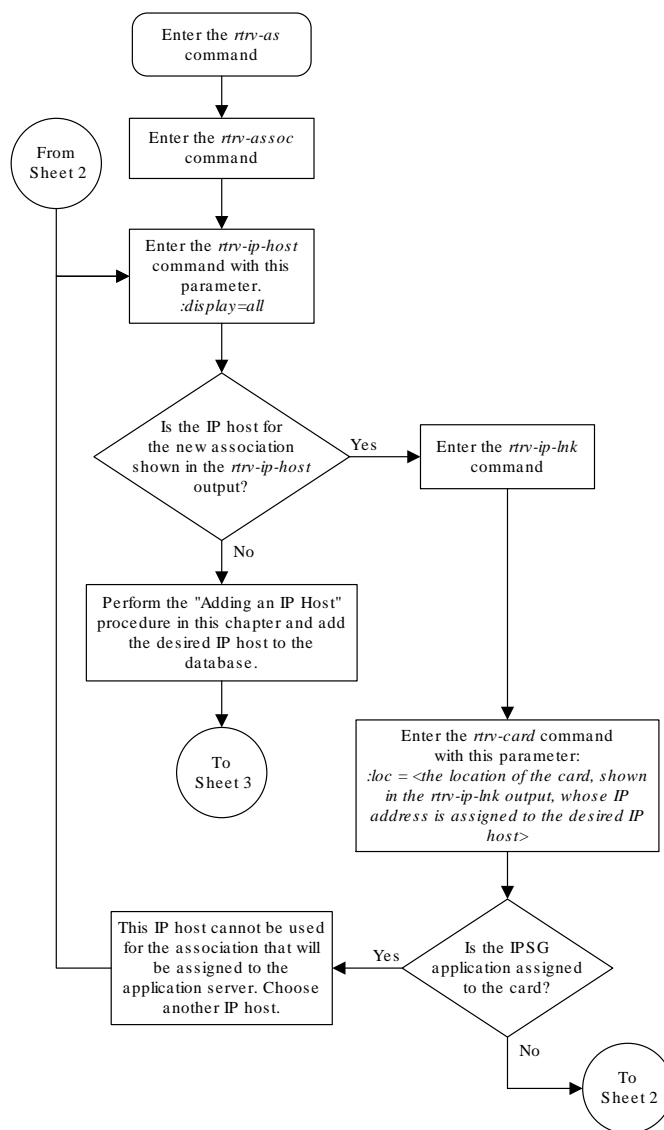
12. Back up the new changes, using the `chg-db:action=backup:dest=fixed` command.

These messages should appear; the active **Maintenance and Administration Subsystem Processor (MASP)** appears first.

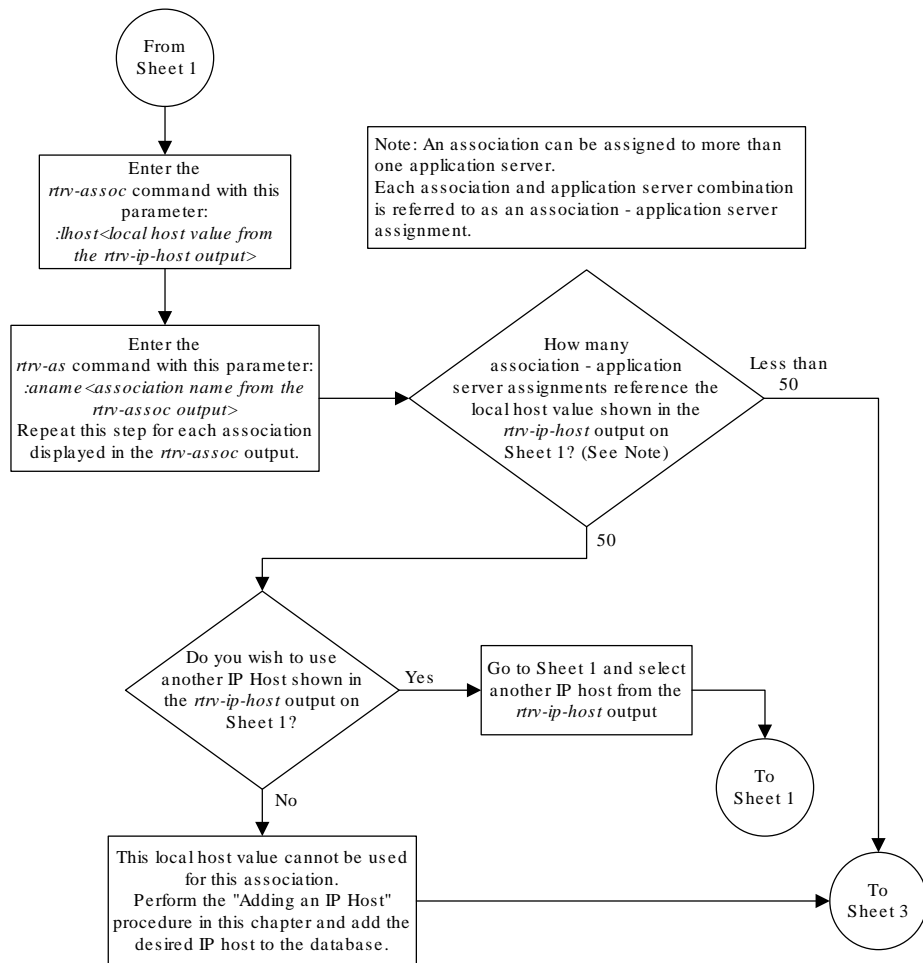
```

BACKUP (FIXED) : MASP A - Backup starts on active MASP.
BACKUP (FIXED) : MASP A - Backup on active MASP to fixed disk
complete.
BACKUP (FIXED) : MASP A - Backup starts on standby MASP.
BACKUP (FIXED) : MASP A - Backup on standby MASP to fixed disk
complete.
    
```

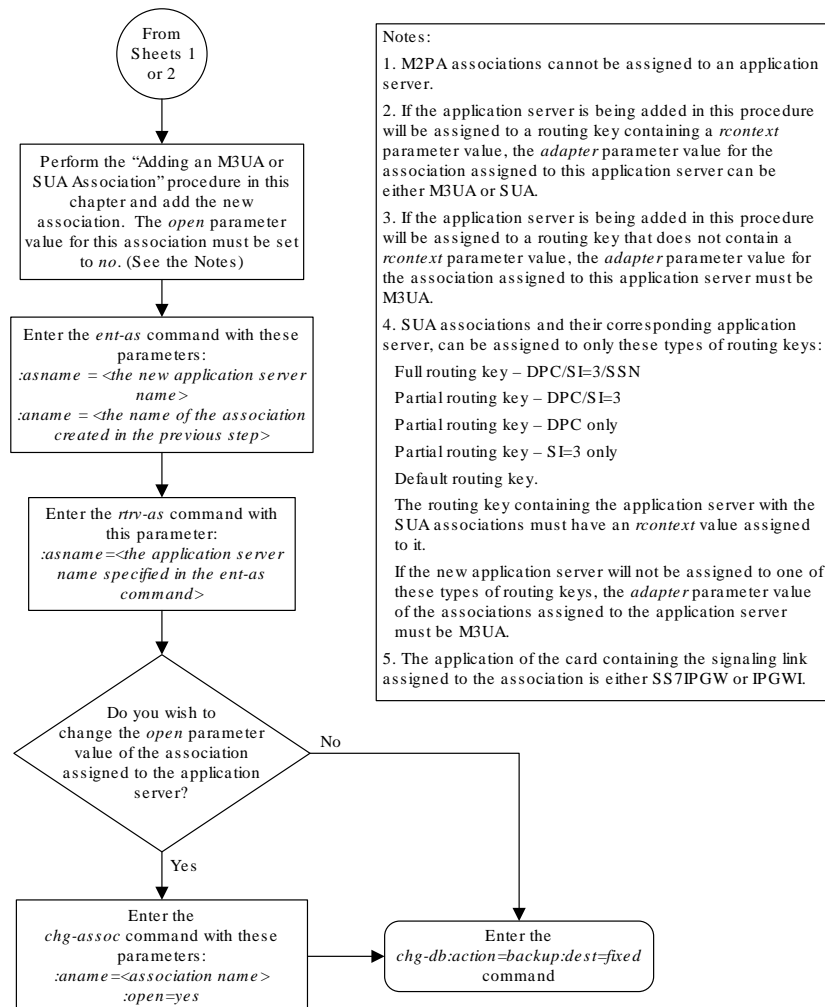
Figure 4-12 Adding a New Association to a New Application Server



Sheet 1 of 3



Sheet 2 of 3



Sheet 3 of 3

4.12 Adding an Existing Association to a New Application Server

This procedure is used create a new application server and assign an existing association to the application server using the `ent-as` command.

The `ent-as` command uses these parameters:

:asname – The name of the new application server. The name of the application server can contain up to 15 alphanumeric characters, with the first character being an alphabetic character. Application server names are not case sensitive.

:aname – The name of the association being assigned to the application server.

The maximum number SCTP association to application server assignments that can be hosted by an IPGWx card (referenced by the lhost parameter of the association) is 50. For example, the IPGWx card currently contains 38 SCTP association to application server assignments. The SCTP association to application server assignments could be one SCTP association assigned to 38 application servers, two SCTP associations assigned to 19 application servers, or any combination of SCTP associations assigned to application servers that add up to 38. The SCTP association to application server assignments can be verified with the rtrv-`assoc:lhost=<local host name>` and rtrv-`as:aname=<association name>` commands.

Table 4-9 Examples of IPGWx Card Provisioning Limits

Number of Associations hosted by the IPGWx card	Number of Application Servers each Association is Assigned to *	Total Association - Application Server Assignments maintained by the IPGWx card
1	50	50
50	1	50
25	1	50
25	2	50
0	0	50
38	1	38
19	2	38

* The EAGLE can contain a maximum of 250 application servers.

The open parameter of the association must be set to no before the association can be assigned to the application server. This can be verified with the rtrv-`assoc` command.

M2PA associations (adapter=m2pa) cannot be assigned to application servers. Only M3UA (adapter=m3ua) and SUA (adapter=sua) associations can be assigned to application servers. This can be verified in the ADAPTER field in the rtrv-`assoc` output.

The application server recovery timer (the tr parameter of the chg-`as` command) for the application server is set by default to 10 milliseconds when an application server is added. The traffic mode (the mode parameter of the chg-`as` command) for the application server is set by default to LOADSHARE when an application server is added. Perform the [Changing an Application Server](#) procedure to change these parameter values.

Canceling the RTRV-AS and RTRV-ASSOC Commands

Because the rtrv-`as` and rtrv-`assoc` commands used in this procedure can output information for a long period of time, the rtrv-`as` and rtrv-`assoc` commands can be canceled and the output to the terminal stopped. There are three ways that the rtrv-`as` and rtrv-`assoc` commands can be canceled.

- Press the F9 function key on the keyboard at the terminal where the rtrv-`as` or rtrv-`assoc` commands were entered.
- Enter the `canc-cmd` without the `trm` parameter at the terminal where the rtrv-`as` or rtrv-`assoc` commands were entered.

- Enter the `canc-cmd:trm=<xx>`, where `<xx>` is the terminal where the `rtrv-as` or `rtrv-assoc` commands were entered, from another terminal other than the terminal where the `rtrv-as` or `rtrv-assoc` commands were entered. To enter the `canc-cmd:trm=<xx>` command, the terminal must allow Security Administration commands to be entered from it and the user must be allowed to enter Security Administration commands. The terminal's permissions can be verified with the `rtrv-secu-trm` command. The user's permissions can be verified with the `rtrv-user` or `rtrv-secu-user` commands.

For more information about the `canc-cmd` command, go to *Commands User's Guide*.

1. Display the application servers in the database using the `rtrv-as` command.

This is an example of possible output.

```
rlghncxa03w 06-10-28 09:12:36 GMT EAGLE5 36.0.0
```

AS Name	Mode	Tr ms	Association Names
as1	LOADSHARE	10	a2 a3 assoc1
as2	OVERRIDE	10	assoc7
as3	OVERRIDE	10	swbel32

AS table is (3 of 250) 1% full.

Note:

If the association being added to the application server is not shown in the `rtrv-as` output in [1](#), continue the procedure with [3](#).

2. Display the associations in the database using the `rtrv-assoc` command and specifying the association name shown in the `rtrv-as` output in [1](#).

For this example, enter this command.

```
rtrv-assoc:aname=assoc1
```

This is an example of possible output.

```
rlghncxa03w 09-05-28 09:12:36 GMT EAGLE5 41.0.0
```

```
ANAME assoc1
  LOC      1305          IPLNK PORT  A          LINK  A
ADAPTER  SUA          VER          SUA RFC
LHOST    gw102.nc.tekelec.com
ALHOST   ---
RHOST    gw100.nc.tekelec.com
ARHOST   ---
LPORT    4000          RPORT      1030
ISTRMS   2            OSTRMS     2          BUFSIZE  16
RMODE    LIN          RMIN       120        RMAX     800
RTIMES   10          CWMIN      3000       UAPS     10
OPEN     YES          ALW        YES        RTXTHR   10000
RHOSTVAL RELAXED
```

```
ASNAMES
as1
```

```
IP Appl Sock table is (6 of 4000) 1% full
Assoc Buffer Space Used (16 KB of 800 KB) on LOC = 1305
```

If the association does not meet the requirements shown in 8, repeat this step with another association shown in 1, or continue the procedure with 3.

If the association does meet the requirements shown in 8, continue the procedure with 5.

3. Display the associations in the database using the `rtrv-assoc` command with the `display=all` parameter.

This is an example of possible output.

```
rlghncxa03w 09-05-28 09:12:36 GMT EAGLE5 41.0.0
```

```
ANAME swbel32
LOC      1201          IPLNK PORT  A          LINK  A
ADAPTER  M3UA             VER        M3UA RFC
LHOST    gw101.nc.tekelec.com
ALHOST    ---
RHOST    gw100.ncd-economic-development.southeastern-corridor-
ash.gov
ARHOST    ---
LPORT    1030           RPORT      2345
ISTRMS   2              OSTRMS     2          BUFSIZE  16
RMODE    LIN         RMIN       120        RMAX     800
RTIMES   10           CWMIN      3000      UAPS     10
OPEN     YES         ALW        YES        RTXTHR  10000
RHOSTVAL RELAXED

ASNAMES
as3
```

```
IP Appl Sock table is (6 of 4000) 1% full
Assoc Buffer Space Used (16 KB of 800 KB) on LOC = 1201
```

```
ANAME a2
LOC      1305          IPLNK PORT  A          LINK  A
ADAPTER  SUA             VER        SUA RFC
LHOST    gw102.nc.tekelec.com
ALHOST    ---
RHOST    gw100.nc.tekelec.com
ARHOST    ---
LPORT    2000           RPORT      2345
ISTRMS   2              OSTRMS     2          BUFSIZE  16
RMODE    LIN         RMIN       120        RMAX     800
RTIMES   10           CWMIN      3000      UAPS     10
OPEN     YES         ALW        YES        RTXTHR  10000
RHOSTVAL RELAXED

ASNAMES
as1
```


IP Appl Sock table is (6 of 4000) 1% full
 Assoc Buffer Space Used (16 KB of 800 KB) on LOC = 1305

```

ANAME a3
  LOC      1307          IPLNK PORT  A          LINK  A
  ADAPTER  SUA          VER          SUA RFC
  LHOST    gw103.nc.tekelec.com
  ALHOST   ---
  RHOST    gw106.nc.tekelec.com
  ARHOST   ---
  LPORT    3000          RPORT      2346
  ISTRMS   2            OSTRMS     2          BUFSIZE  16
  RMODE    LIN          RMIN       120        RMAX     800
  RTIMES   10          CWMIN      3000       UAPS     10
  OPEN     YES          ALW        YES        RTXTHR  10000
  RHOSTVAL RELAXED
  
```

ASNAMES

as1

IP Appl Sock table is (6 of 4000) 1% full
 Assoc Buffer Space Used (16 KB of 800 KB) on LOC = 1307

```

ANAME assoc1
  LOC      1305          IPLNK PORT  A          LINK  A
  ADAPTER  SUA          VER          SUA RFC
  LHOST    gw102.nc.tekelec.com
  ALHOST   ---
  RHOST    gw100.nc.tekelec.com
  ARHOST   ---
  LPORT    4000          RPORT      1030
  ISTRMS   2            OSTRMS     2          BUFSIZE  16
  RMODE    LIN          RMIN       120        RMAX     800
  RTIMES   10          CWMIN      3000       UAPS     10
  OPEN     YES          ALW        YES        RTXTHR  10000
  RHOSTVAL RELAXED
  
```

ASNAMES

as1

IP Appl Sock table is (6 of 4000) 1% full
 Assoc Buffer Space Used (16 KB of 800 KB) on LOC = 1305

```

ANAME assoc7
  LOC      1311          IPLNK PORT  A          LINK  A
  ADAPTER  SUA          VER          SUA RFC
  LHOST    gw105.nc.tekelec.com
  ALHOST   ---
  RHOST    gw100.nc.tekelec.com
  ARHOST   ---
  LPORT    2500          RPORT      2000
  ISTRMS   2            OSTRMS     2          BUFSIZE  16
  RMODE    LIN          RMIN       120        RMAX     800
  
```

```

RTIMES    10          CWMIN      3000      UAPS      10
OPEN      YES         ALW        YES       RTXTHR   10000
RHOSTVAL  RELAXED

```

```

ASNAMES
as2

```

```

IP Appl Sock table is (6 of 4000) 1% full
Assoc Buffer Space Used (16 KB of 800 KB) on LOC = 1311

```

If the desired association is shown in the `rtrv-assoc` output, see 8 for the rules that apply to the association and the new application server, continue the procedure with 4.

If the desired association is not shown in the `rtrv-assoc` output, perform the [Adding a New Association to a New Application Server](#) procedure to add a new association to a new application server.

4. Enter the `rtrv-card` command with the location of the card, from the `rtrv-assoc` output in 3, that contains the association that will be assigned to the application server. For this example, enter this command.

```
rtrv-card:loc=1201
```

This is an example of possible output.

```

rlghncxa03w 08-03-06 15:17:20 EST EAGLE5 38.0.0
CARD  TYPE      APPL      LSET NAME  LINK SLC LSET NAME  LINK SLC
1201  DCM          SS7IPGW  lsn1      A      0

```

If the application assigned to the card is `SS7IPGW` or `IPGWI`, shown in the `APPL` column, continue the procedure with 5.

If the application assigned to the card is `IPSG`, the association assigned to this card cannot be assigned to the application server. Repeat this procedure from 3 and choose another association.

5. Display the associations assigned to the local IP host value specified in 2 or 3 by entering the `rtrv-assoc` command with the `lhost` parameter.

For this example, enter this command.

```
rtrv-assoc:lhost=gw102.nc.tekelec.com
```

This is an example of the possible output.

```

rlghncxa03w 06-10-28 21:14:37 GMT EAGLE5 36.0.0
CARD IPLNK
ANAME      LOC  PORT  LINK ADAPTER  LPORT  RPORT  OPEN  ALW
assoc1    1305 A    A    SUA      4000  1030  YES  YES

```

```

IP Appl Sock/Assoc table is (5 of 4000) 1% full
Assoc Buffer Space Used (16 KB of 3200 KB) on LOC = 1305

```

6. Display the application servers that the associations shown in 5 are assigned to by entering `rtrv-as` command with the names of the associations shown in 5.

For this example, enter this command.

```
rtrv-as:aname=assoc1
```

This is an example of the possible output.

```
rlghncxa03w 06-10-28 21:14:37 GMT EAGLE5 36.0.0
AS Name          Mode          Tr ms    Association Names
asl              LOADSHARE    10       assoc1
AS Table is (3 of 250) 1% full
```

The maximum number of SCTP association to application server assignments that can be hosted by an IPGWx card (referenced by the `lhost` parameter of the association) is 50.

If the number of SCTP association to application server assignments is less than 50, continue the procedure with [7](#).

If the number of SCTP association to application server assignments is 50, the association shown in either [2](#) or [3](#) cannot be used in this procedure. Go back to [1](#) and choose another association to assign to the new application server.

 **Note:**

If the value of the `open` parameter of the association being assigned to the application server in [5](#) is `no`, continue the procedure with [8](#).

- Change the value of the `open` parameter to `no` by specifying the `chg-assoc` command with the `open=no` parameter.

For this example, enter this command.

```
chg-assoc:aname=assoc1:open=no
```

When this command has successfully completed, this message should appear.

```
rlghncxa03w 06-10-28 09:12:36 GMT EAGLE5 36.0.0
CHG-ASSOC: MASP A - COMPLTD;
```

- Add the application server to the database with the name of the association shown in either [2](#) or [3](#) using the `ent-as` command.

These are the rules that apply to the association and the application server.

- M2PA associations cannot be assigned to an application server.
- If the application server is being added in this procedure will be assigned to a routing key containing an `rcontext` parameter value, the `adapter` parameter value for the association assigned to this application server can be either M3UA or SUA.
- If the application server is being added in this procedure will be assigned to a routing key that does not contain an `rcontext` parameter value, the `adapter` parameter value for the association assigned to this application server must be M3UA.
- SUA associations and their corresponding application server, can be assigned to only these types of routing keys.
 - Full routing key – DPC/SI=3/SSN
 - Partial routing key – DPC/SI=3

- Partial routing key – DPC only
- Partial routing key – SI=3 only
- Default routing key.
- The routing key containing the application server with the SUA associations must have an `rcontext` value assigned to it. If the new application server will not be assigned to one of these types of routing keys, the `adapter` parameter value of the associations assigned to the application server must be M3UA.

For this example, enter this command.

```
ent-as:asname=as4:aname=assoc1
```

This is an example of the possible outputs.

```
rlghncxa03w 06-10-28 09:12:36 GMT EAGLE5 36.0.0
ENT-AS: MASP A - COMPLTD;
```

9. Verify the changes using the `rtrv-as` command with the application server name specified in 8.

For this example, enter this command.

```
rtrv-as:asname=as4
```

This is an example of the possible output.

```
rlghncxa03w 06-10-28 09:12:36 GMT EAGLE5 36.0.0

AS Name           Mode           Tr ms   Association Names
as4                LOADSHARE     10      assoc1

AS table is (4 of 250) 1% full.
```

 **Note:**

If you do not wish to change the `open` parameter value of the association specified in 8, continue the procedure with 11.

10. Change the value of the `open` parameter to `yes` by specifying the `chg-assoc` command with the `open=yes` parameter.

For this example, enter this command.

```
chg-assoc:aname=assoc1:open=yes
```

When this command has successfully completed, this message should appear.

```
rlghncxa03w 06-10-28 09:12:36 GMT EAGLE5 36.0.0
CHG-ASSOC: MASP A - COMPLTD;
```

11. Back up the new changes, using the `chg-db:action=backup:dest=fixed` command.

These messages should appear; the active Maintenance and Administration Subsystem Processor (MASP) appears first.

```

    BACKUP (FIXED) : MASP A - Backup starts on active MASP.
    BACKUP (FIXED) : MASP A - Backup on active MASP to fixed disk
    complete.
    BACKUP (FIXED) : MASP A - Backup starts on standby MASP.
    BACKUP (FIXED) : MASP A - Backup on standby MASP to fixed disk
    complete.
    
```

Figure 4-13 Add an Existing Association to a New Application Server - Sheet 1 of 4

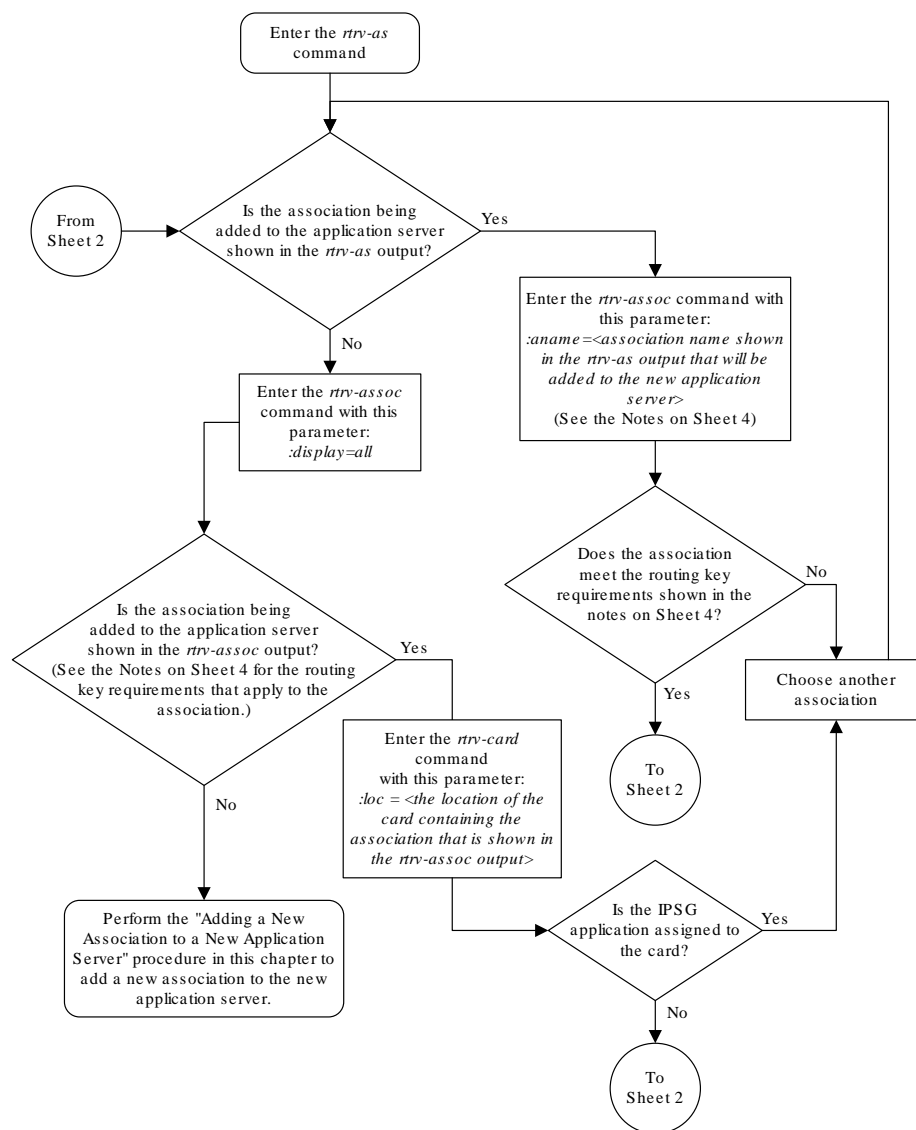


Figure 4-14 Add an Existing Association to a New Application Server - Sheet 2 of 4

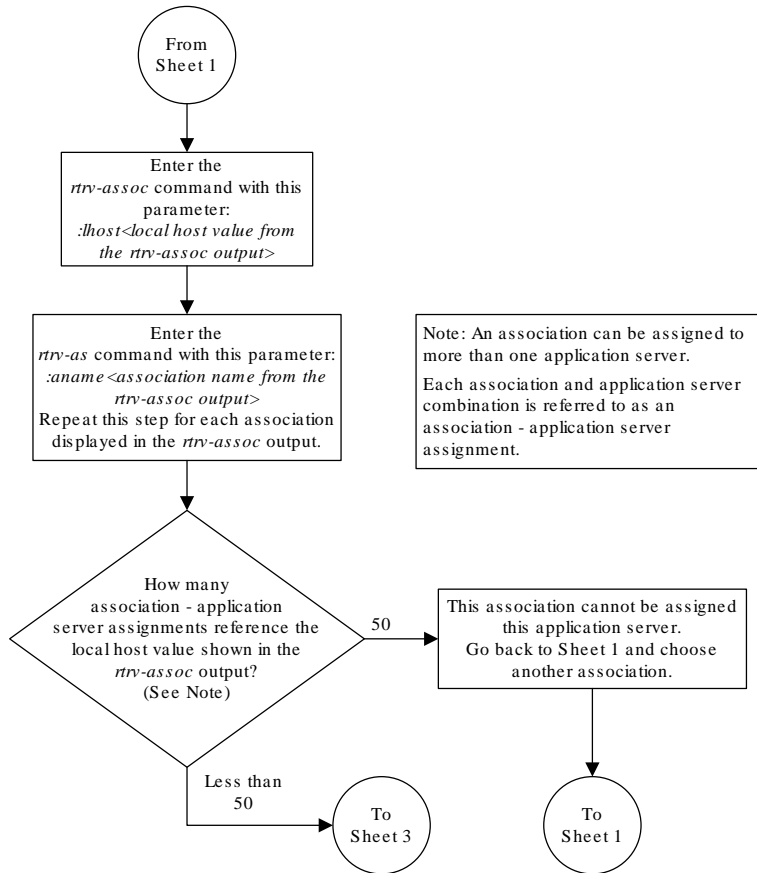


Figure 4-15 Add an Existing Association to a New Application Server - Sheet 3 of 4

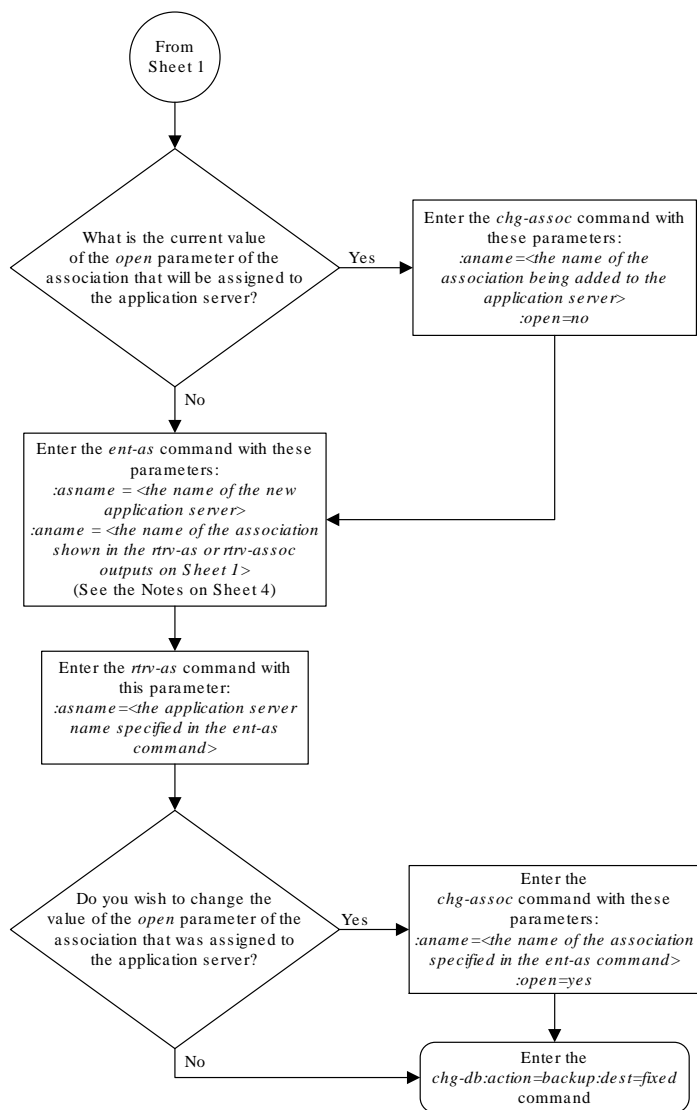


Figure 4-16 Add an Existing Association to a New Application Server - Sheet 4 of 4

Notes:

1. If the application server is being added in this procedure will be assigned to a routing key containing a *rcontext* parameter value, the *adapter* parameter value for the association assigned to this application server can be either M3UA or SUA.
2. If the application server is being added in this procedure will be assigned to a routing key that does not contain a *rcontext* parameter value, the *adapter* parameter value for the association assigned to this application server must be M3UA.
3. SUA associations and their corresponding application server, can be assigned to only these types of routing keys:
 - Full routing key – DPC/SI=3/SSN
 - Partial routing key – DPC/SI=3
 - Partial routing key – DPC only
 - Partial routing key – SI=3 only
 - Default routing key.The routing key containing the application server with the SUA associations must have an *rcontext* value assigned to it.
If the new application server will not be assigned to one of these types of routing keys, the *adapter* parameter value of the associations assigned to the application server must be M3UA.
4. M2PA associations cannot be assigned to application servers.

4.13 Adding a New Association to an Existing Application Server

This procedure is used assign a new association to an existing application server using the `ent-as` command.

The `ent-as` command uses these parameters:

`:asname` – The name of the new application server.

`:aname` – The name of the association being assigned to the application server.

The maximum number **SCTP** association to application server assignments that can be hosted by an **IPGWx** card (referenced by the `lhost` parameter of the association) is 50. For example, the IPGWx card currently contains 38 SCTP association to application server assignments. The **SCTP** association to application server assignments could be one **SCTP** association assigned to 38 application servers, two **SCTP** associations assigned to 19 application servers, or any combination of **SCTP** associations assigned to application servers that add up to 38. The **SCTP** association to application server assignments can be verified with the `rtrv-
assoc:lhost=<local host name>` and `rtrv-as:aname=<association
name>` commands.

Table 4-10 Examples of IPGWx Card Provisioning Limits

Number of Associations hosted by the IPGWx card	Number of Application Servers each Association is Assigned to *	Total Association - Application Server Assignments maintained by the IPGWx card
1	50	50
50	1	50
25	1	50
25	2	50
0	0	50
38	1	38
19	2	38

* The **EAGLE** can contain a maximum of 250 application servers.

A maximum of 16 associations can be assigned to an application server.

The `open` parameter of the association must be set to `no` before the association can be assigned to the application server. This can be verified with the `rtrv-
assoc` command.

M2PA associations (`adapter=m2pa`) cannot be assigned to application servers. Only **M3UA** (`adapter=m3ua`) and **SUA** (`adapter=sua`) associations can be assigned to application servers. This can be verified in the `ADAPTER` field in the `rtrv-
assoc` output.

The application running on the card hosting the association that will be assigned to the application server must be the same as the application running on the cards hosting the other associations assigned to the application server.

Canceling the `RTRV-AS` and `RTRV-ASSOC` Commands

Because the `rtrv-as` and `rtrv-
assoc` commands used in this procedure can output information for a long period of time, the `rtrv-
as` and `rtrv-
assoc` commands can be canceled and the output to the terminal stopped. There are three ways that the `rtrv-
as` and `rtrv-
assoc` commands can be canceled.

- Press the F9 function key on the keyboard at the terminal where the `rtrv-as` or `rtrv-assoc` commands were entered.
- Enter the `canc-cmd` without the `trm` parameter at the terminal where the `rtrv-as` or `rtrv-assoc` commands were entered.
- Enter the `canc-cmd:trm=<xx>`, where `<xx>` is the terminal where the `rtrv-as` or `rtrv-assoc` commands were entered, from another terminal other than the terminal where the `rtrv-as` or `rtrv-assoc` commands were entered. To enter the `canc-cmd:trm=<xx>` command, the terminal must allow Security Administration commands to be entered from it and the user must be allowed to enter Security Administration commands. The terminal's permissions can be verified with the `rtrv-secu-trm` command. The user's permissions can be verified with the `rtrv-user` or `rtrv-secu-user` commands.

For more information about the `canc-cmd` command, go to *Commands User's Guide*.

1. Display the application servers in the database using the `rtrv-as` command.

This is an example of possible output.

```
rlghncxa03w 06-10-28 09:12:36 GMT EAGLE5 36.0.0
AS Name      Mode      Tr ms    Association Names
as1          LOADSHARE 10       assoc1
              assoc2
              assoc3
              assoc5
              assoc6

as2          OVERRIDE 10       assoc7

AS table is (2 of 250) 1% full.
```

2. Display the application server that the new association will be added to by entering the `rtrv-as` command with the name of the application server.

For this example, enter this command.

```
rtrv-as:asname=as2
```

This is an example of possible output.

```
rlghncxa03w 06-10-28 09:12:36 GMT EAGLE5 36.0.0

AS Name      Mode      Tr ms    Association Names
as2          OVERRIDE 10       assoc7

AS table is (2 of 250) 1% full.
```

A maximum of 16 associations can be assigned to an application server. If the application server displayed in this step contains less than 16 associations, continue the procedure with **3**.

If the application server displayed in this step contains 16 associations, either select another application server to use in this procedure and repeat this step, or perform the

[Adding a New Association to a New Application Server](#) procedure to add the new association to a new application server.

3. Display the one of the associations assigned to the application server shown in [2](#) using the `rtrv-assoc` command and specifying the association name shown in the `rtrv-as` output from [2](#). For this example, enter this command.

```
rtrv-assoc:aname=assoc7
```

This is an example of possible output.

```
rlghncxa03w 09-05-28 09:12:36 GMT EAGLE5 41.0.0
ANAME assoc7
      LOC      1203          IPLNK PORT  A          LINK  A
      ADAPTER  SUA          VER          SUA RFC
      LHOST    gw105.nc.tekelec.com
      ALHOST    ---
      RHOST    gw100.nc.tekelec.com
      ARHOST    ---
      LPORT    1030          RPORT      1030
      ISTRMS   2            OSTRMS     2          BUFSIZE  16
      RMODE    LIN          RMIN       120        RMAX     800
      RTIMES   10          CWMIN      3000      UAPS     10
      OPEN     YES          ALW        YES        RTXTHR  10000
      RHOSTVAL RELAXED

      ASNAMES
      as2
```

```
IP Appl Sock table is (7 of 4000) 1% full
Assoc Buffer Space Used (16 KB of 800 KB) on LOC = 1203
```

The `adapter` parameter value of all the associations assigned to an application server must be the same. This step identifies the `adapter` value of the associations assigned to the application server. The application running on the card hosting the new association must be the same as the application on the cards hosting the associations assigned to the application server.

4. Display the signaling link assigned to the card, shown in [3](#) by entering the `rtrv-slk` command with the card location of the signaling link shown in [3](#). For this example, enter this command.

```
rtrv-slk:loc=1203
```

The following is an example of the possible output.

```
rlghncxa03w 06-10-28 21:19:37 GMT EAGLE5 36.0.0
LOC LINK LSN          SLC TYPE
1203 A   lsn5          1  SS7IPGW
```

The application running on the card is shown in the `TYPE` column of the `rtrv-slk` output.

For this example, the new association must be assigned to a card running the SS7IPGW application.

If the local host value shown in 3 will be assigned to the new association, continue the procedure with 8.

If another local host value will be assigned to the new association, perform 5.

5. Display the IP host names in the database by using the `rtrv-ip-host:display=all` command. The following is an example of the possible output.

```
rlghncxa03w 13-06-28 21:15:37 GMT EAGLE5 44.0.0

LOCAL IPADDR      LOCAL HOST
192.1.1.10        IPNODE1-1201
192.1.1.12        GW105. NC. TEKELEC. COM
192.1.1.14        IPNODE1-1205
192.1.1.20        IPNODE2-1201
192.1.1.22        IPNODE2-1203
192.1.1.24        IPNODE2-1205
192.1.1.30        KC-HLR1
192.1.1.32        KC-HLR2
192.1.1.50        DN-MS1
192.1.1.52        DN-MS2

REMOTE IPADDR     REMOTE HOST
150.1.1.5         NCDEPTECONOMIC_DEVELOPMENT. SOUTHEASTERN_COORIDOR_ASHVL.
GOV

IP Host table is (11 of 4096) .26% full
```

If the local IP host name for the new association is not shown in the LOCAL HOST column of the `rtrv-ip-host` output, add the new IP host name by performing the [Adding an IP Host](#) procedure. The new local IP host must be assigned to a card running the application shown in 4.

After the new local IP host has been added, continue the procedure with 9.

If the local IP host name for the new association is shown in the LOCAL HOST column of the `rtrv-ip-host` output, continue the procedure with 8.

6. Display the IP links in the database by entering the `rtrv-ip-lnk` command. The following is an example of the possible output.

```
rlghncxa03w 08-12-28 21:14:37 GMT EAGLE5 40.0.0
LOC  PORT IPADDR      SUBMASK          DUPLEX  SPEED  MACTYPE  AUTO
MCAST
1201  A    192.1.1.10      255.255.255.128  HALF    10     802.3    NO   NO
1201  B    -----          -----          HALF    10     DIX      NO   NO
1203  A    192.1.1.12      255.255.255.0   ----    ---    DIX      YES  NO
1203  B    -----          -----          HALF    10     DIX      NO   NO
1205  A    192.1.1.14      255.255.255.0   FULL    100    DIX      NO   NO
1205  B    -----          -----          HALF    10     DIX      NO   NO
2101  A    192.1.1.20      255.255.255.0   FULL    100    DIX      NO   NO
2101  B    -----          -----          HALF    10     DIX      NO   NO
2103  A    192.1.1.22      255.255.255.0   FULL    100    DIX      NO   NO
2103  B    -----          -----          HALF    10     DIX      NO   NO
```

```

2105 A 192.1.1.24 255.255.255.0 FULL 100 DIX
NO NO
2105 B ----- HALF 10 DIX
NO NO
2205 A 192.1.1.30 255.255.255.0 FULL 100 DIX
NO NO
2205 B ----- HALF 10 DIX
NO NO
2207 A 192.1.1.32 255.255.255.0 FULL 100 DIX
NO NO
2207 B ----- HALF 10 DIX
NO NO
2213 A 192.1.1.50 255.255.255.0 FULL 100 DIX
NO NO
2213 B ----- HALF 10 DIX
NO NO
2301 A 192.1.1.52 255.255.255.0 FULL 100 DIX
NO NO
2301 B ----- HALF 10 DIX
NO NO

```

IP-LNK table is (20 of 2048) 1% full.

7. Display the signaling link assigned to the card, shown in 6, whose IP address is assigned to the local host shown in 5 by entering the `rtrv-slk` command with the card location of the signaling link. For this example, enter this command.

```
rtrv-slk:loc=1205
```

The following is an example of the possible output.

```
rlghncxa03w 06-10-28 21:19:37 GMT EAGLE5 36.0.0
```

```

LOC LINK LSN          SLC TYPE
1205 A  lsn5          1  SS7IPGW

```

The application running on the card is shown in the `TYPE` column of the `rtrv-slk` output.

For this example, the new association must be assigned to a card running the `SS7IPGW` application.

If the card's application shown in this step and in 4 are the same, continue the procedure with 8.

If the card's application shown in this step and in 4 are not the same, either repeat this procedure from 5 with another local IP host, or add the new local IP host name by performing the [Adding an IP Host](#) procedure. The new local IP host must be assigned to a card running the application shown in 4. After the new local IP host has been added, continue the procedure with 9.

8. Display the associations assigned to the local IP host value specified in 3 or 5 by entering the `rtrv-assoc` command with the `lhost` parameter. For this example, enter this command.

```
rtrv-assoc:lhost="IPNODE-1205"
```

This is an example of the possible output.

```
rlghncxa03w 06-10-28 21:14:37 GMT EAGLE5 36.0.0
                CARD IPLNK
ANAME          LOC  PORT  LINK ADAPTER LPORT RPORT OPEN ALW
assoc1        1205 A    A    M3UA    1030  1030  YES  YES
```

```
IP Appl Sock/Assoc table is (7 of 4000) 1% full
Assoc Buffer Space Used (16 KB of 3200 KB) on LOC = 1205
```

9. Display the application servers that the associations shown in 8 are assigned to by entering `rtrv-as` command with the names of the associations shown in 8. For this example, enter this command.

```
rtrv-as:aname=assoc1
```

This is an example of the possible output.

```
rlghncxa03w 06-10-28 21:14:37 GMT EAGLE5 36.0.0
AS Name        Mode        Tr ms   Association Names
as1            LOADSHARE  10     assoc1
AS Table is (2 of 250) 1% full
```

The maximum number of **SCTP** association to application server assignments that can be hosted by an **IPGWx** card (referenced by the `lhost` parameter of the association) is 50.

If the number of **SCTP** association to application server assignments is less than 50, continue the procedure with 10.

If the number of **SCTP** association to application server assignments is 50, either repeat this procedure from 5 with another local **IP** host, or add the new local **IP** host name by performing the [Adding an IP Host](#) procedure. The new local **IP** host must be assigned to a card running the application shown in 4 and 7. After the new local **IP** host has been added, continue the procedure with 10.

10. Add the new association by performing the [Adding an M3UA or SUA Association](#) procedure.

The `open` parameter value for this association must be set to `no`. The adapter value for this association must be the same as the adapter value shown in 3.

These are the rules that apply to the association and the application server.

- M2PA associations cannot be assigned to an application server.
- If the application server is being added in this procedure will be assigned to a routing key containing an `rcontext` parameter value, the `adapter` parameter value for the association assigned to this application server can be either M3UA or SUA.
- If the application server is being added in this procedure will be assigned to a routing key that does not contain an `rcontext` parameter value, the `adapter` parameter value for the association assigned to this application server must be M3UA.
- SUA associations and their corresponding application server, can be assigned to only these types of routing keys.
 - Full routing key – DPC/SI=3/SSN

- Partial routing key – DPC/SI=3
- Partial routing key – DPC only
- Partial routing key – SI=3 only
- Default routing key.
- The routing key containing the application server with the SUA associations must have an `rcontext` value assigned to it. If the new application server will not be assigned to one of these types of routing keys, the `adapter` parameter value of the associations assigned to the application server must be M3UA.
- The application of the card containing the signaling link assigned to the association is either SS7IPGW or IPGWI.

11. Add the association to the application server using the `ent-as` command with the name of the application server specified in 2 and the name of the new association. For this example, enter this command.

```
ent-as:asname=as2:aname=assoc10
```

This is an example of possible output.

```
rlghncxa03w 06-10-28 09:12:36 GMT EAGLE5 36.0.0
ENT-AS: MASP A - COMPLTD;
```

12. Verify the changes using the `rtrv-as` command with the name of the application server specified in 11. For this example, enter this command.

```
rtrv-as:asname=as2
```

This is an example of possible output.

```
rlghncxa03w 06-10-28 09:12:36 GMT EAGLE5 36.0.0
AS Name           Mode           Tr ms   Association Names
as2                OVERRIDE      10      assoc7
                  assoc10
```

```
AS table is (2 of 250) 1% full.
```

 **Note:**

If you do not wish to change the `open` parameter value of the association specified in 11, continue the procedure with 14.

13. Change the value of the `open` parameter to `yes` by specifying the `chg-assoc` command with the `open=yes` parameter. For this example, enter this command.

```
chg-assoc:aname=assoc10:open=yes
```

When this command has successfully completed, this message should appear.

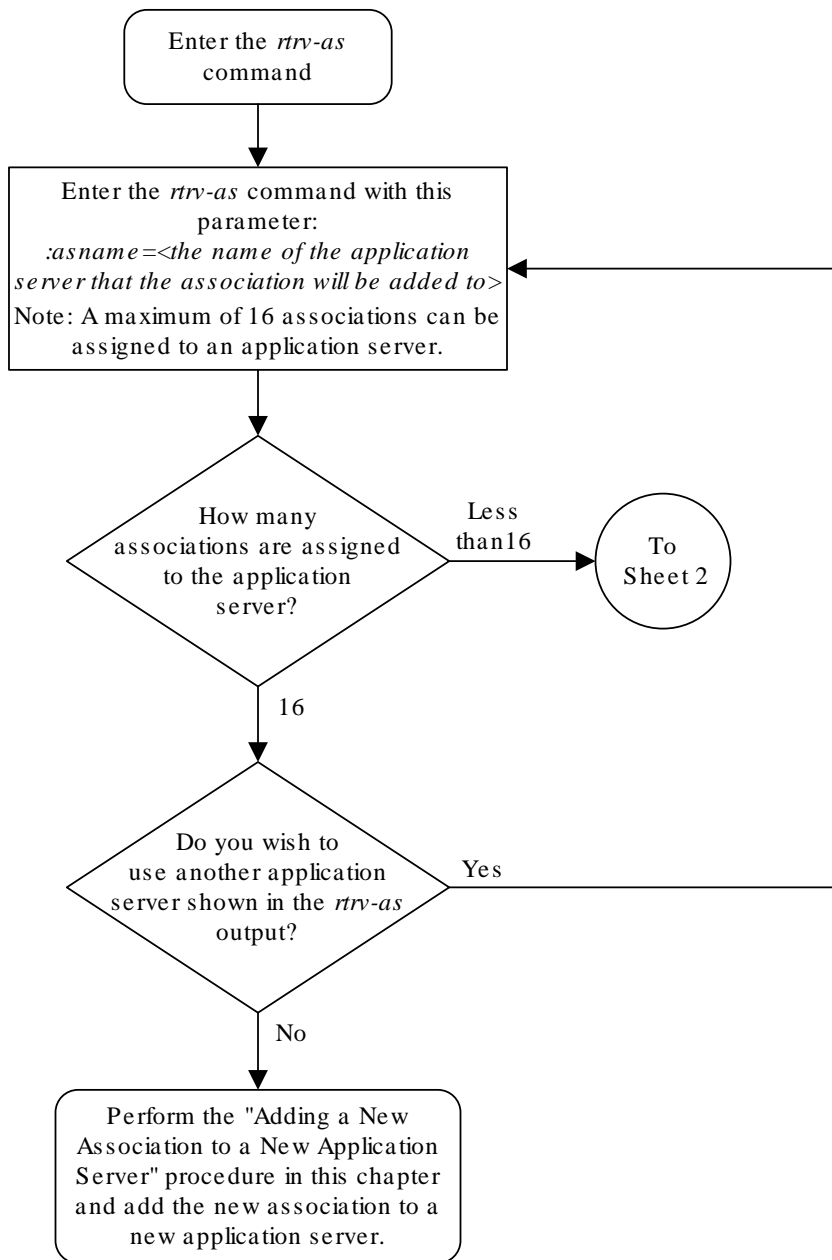
```
rlghncxa03w 06-10-28 09:12:36 GMT EAGLE5 36.0.0  
CHG-ASSOC: MASP A - COMPLTD;
```

14. Back up the new changes, using the `chg-db:action=backup:dest=fixed` command.

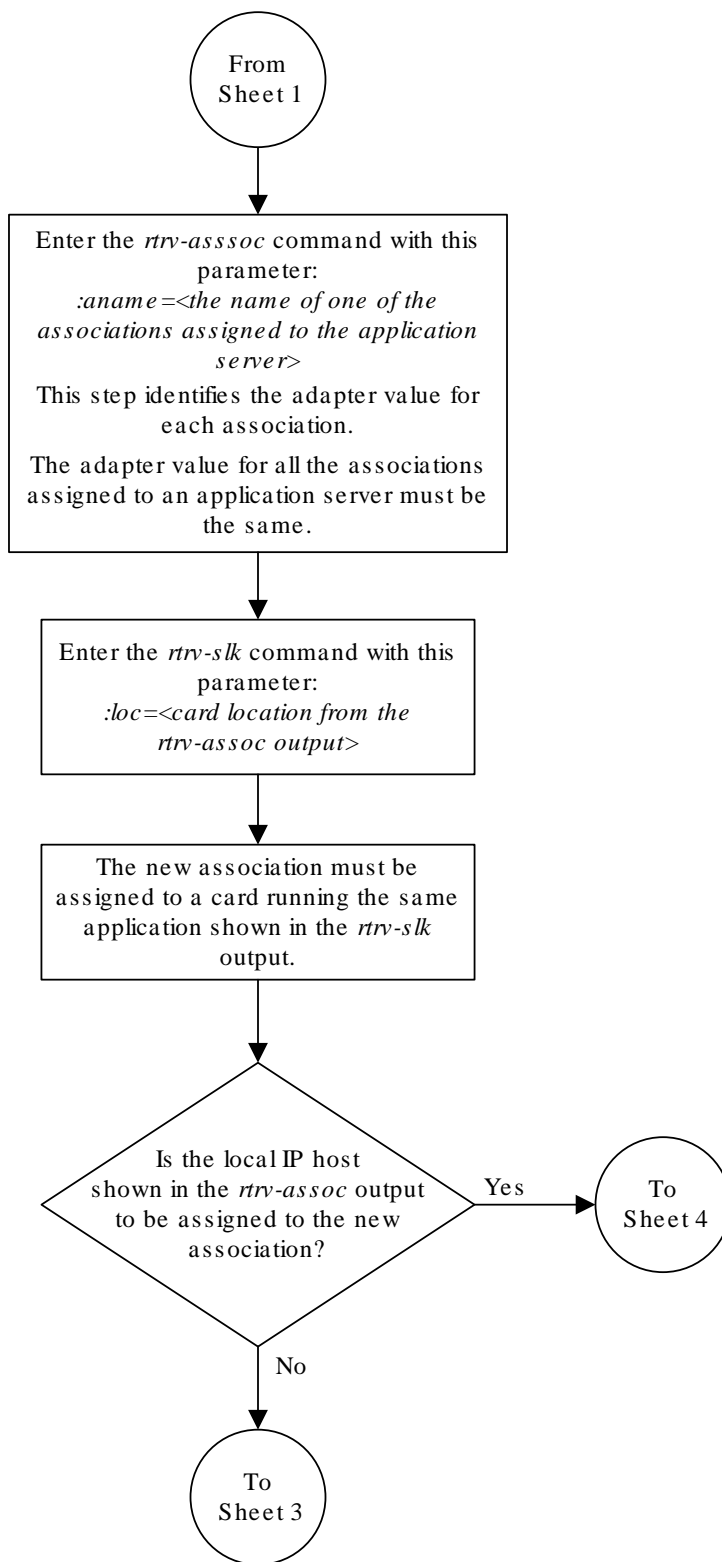
These messages should appear; the active **Maintenance and Administration Subsystem Processor (MASP)** appears first.

```
BACKUP (FIXED) : MASP A - Backup starts on active MASP.  
BACKUP (FIXED) : MASP A - Backup on active MASP to fixed disk complete.  
BACKUP (FIXED) : MASP A - Backup starts on standby MASP.  
BACKUP (FIXED) : MASP A - Backup on standby MASP to fixed disk complete.
```

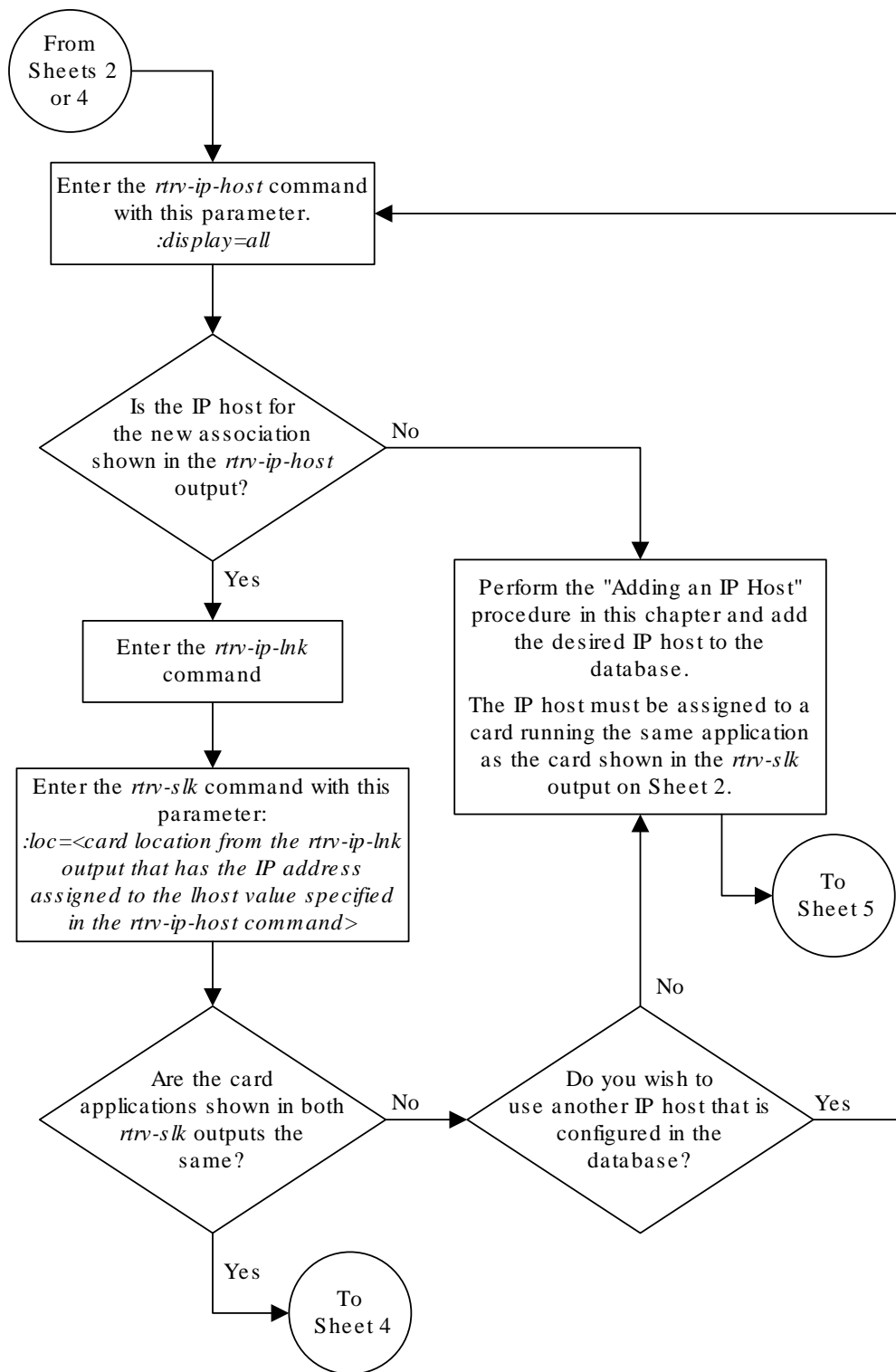

Figure 4-17 Adding a New Association to an Existing Application Server



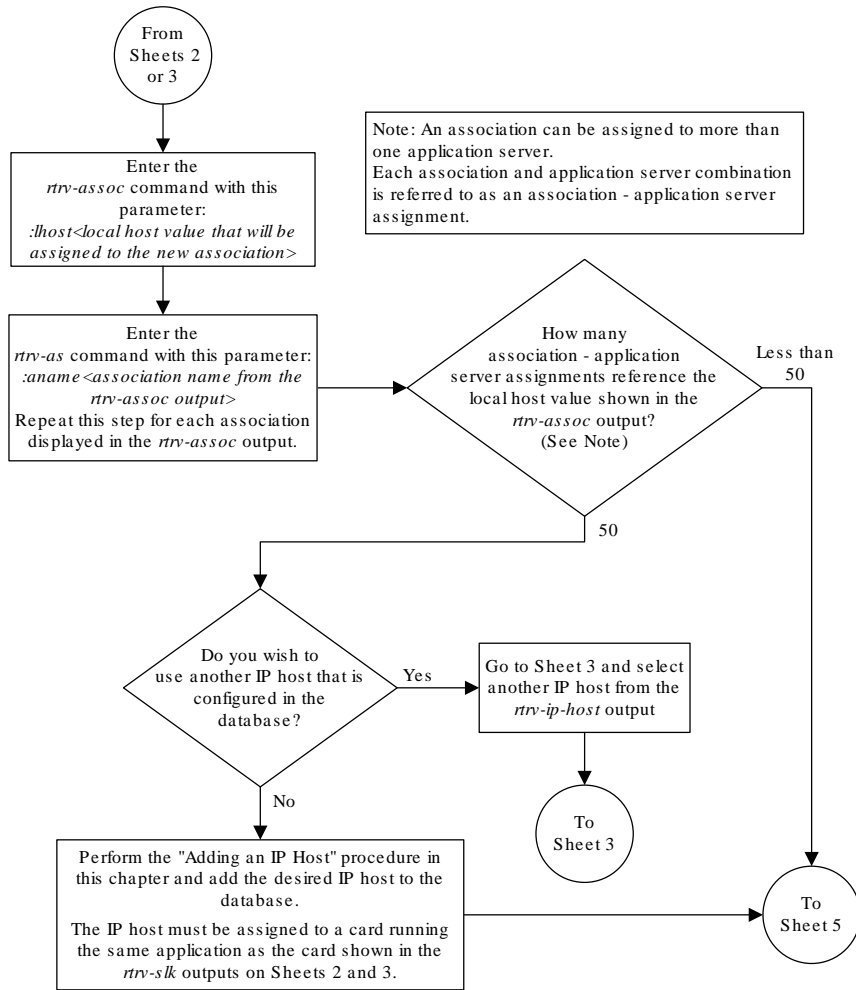
Sheet 1 of 5



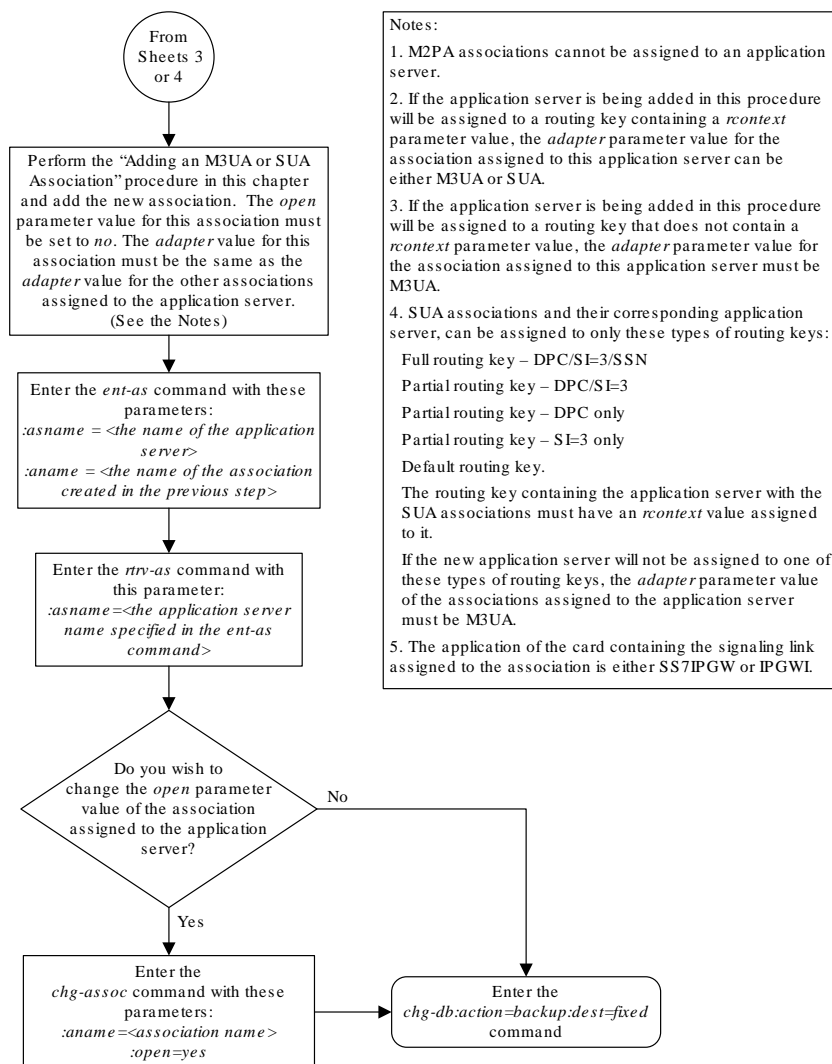
Sheet 2 of 5



Sheet 3 of 5



Sheet 4 of 5



Sheet 5 of 5

4.14 Adding an Existing Association to an Existing Application Server

This procedure is used assign an existing association to an existing application server using the *ent-as* command.

The *ent-as* command uses these parameters:

:asname – The name of the application server.

:aname – The name of the association being assigned to the application server.

The maximum number SCTP association to application server assignments that can be hosted by an IPGWx card (referenced by the `lhost` parameter of the association) is 50. For example, the IPGWx card currently contains 38 SCTP association to application server assignments. The SCTP association to application server assignments could be one SCTP association assigned to 38 application servers, two SCTP associations assigned to 19 application servers, or any combination of SCTP associations assigned to application servers that add up to 38. The SCTP association to application server assignments can be verified with the `rtrv-assoc:lhost=<local host name>` and `rtrv-as:aname=<association name>` commands.

Table 4-11 Examples of IPGWx Card Provisioning Limits

Number of Associations hosted by the IPGWx card	Number of Application Servers each Association is Assigned to *	Total Association - Application Server Assignments maintained by the IPGWx card
1	50	50
50	1	50
25	1	50
25	2	50
0	0	50
38	1	38
19	2	38

* The EAGLE can contain a maximum of 250 application servers.

A maximum of 16 associations can be assigned to an application server.

The `open` parameter of the association must be set to `no` before the association can be assigned to the application server. This can be verified with the `rtrv-assoc` command.

M2PA associations (`adapter=m2pa`) cannot be assigned to application servers. Only M3UA (`adapter=m3ua`) and SUA (`adapter=sua`) associations can be assigned to application servers. This can be verified in the `ADAPTER` field in the `rtrv-assoc` output.

The application running on the card hosting the association that will be assigned to the application server must be the same as the application running on the cards hosting the other associations assigned to the application server.

Canceling the RTRV-AS and RTRV-ASSOC Commands

Because the `rtrv-as` and `rtrv-assoc` commands used in this procedure can output information for a long period of time, the `rtrv-as` and `rtrv-assoc` commands can be canceled and the output to the terminal stopped. There are three ways that the `rtrv-as` and `rtrv-assoc` commands can be canceled.

- Press the F9 function key on the keyboard at the terminal where the `rtrv-as` or `rtrv-assoc` commands were entered.
- Enter the `canc-cmd` without the `trm` parameter at the terminal where the `rtrv-as` or `rtrv-assoc` commands were entered.
- Enter the `canc-cmd:trm=<xx>`, where `<xx>` is the terminal where the `rtrv-as` or `rtrv-assoc` commands were entered, from another terminal other than the terminal where the `rtrv-as` or `rtrv-assoc` commands were entered. To enter the `canc-`

`cmd:trm=<xx>` command, the terminal must allow Security Administration commands to be entered from it and the user must be allowed to enter Security Administration commands. The terminal's permissions can be verified with the `rtrv-secu-trm` command. The user's permissions can be verified with the `rtrv-user` or `rtrv-secu-user` commands.

For more information about the `canc-cmd` command, go to *Commands User's Guide*.

1. Display the application servers in the database using the `rtrv-as` command.

This is an example of possible output.

```
rlghncxa03w 06-10-28 09:12:36 GMT EAGLE5 36.0.0

AS Name          Mode          Tr ms  Association Names
as1              LOADSHARE    10     a2
               a3
               assoc1

as2              OVERRIDE     10     assoc7
as3              OVERRIDE     10     swbel32

AS table is (3 of 250) 1% full.
```

2. Display the application server that the new association will be added to by entering the `rtrv-as` command with the name of the application server.

For this example, enter this command.

```
rtrv-as:asname=as2
```

This is an example of possible output.

```
rlghncxa03w 06-10-28 09:12:36 GMT EAGLE5 36.0.0

AS Name          Mode          Tr ms  Association Names
as2              OVERRIDE     10     assoc7

AS table is (3 of 250) 1% full.
```

A maximum of 16 associations can be assigned to an application server. If the application server displayed in this step contains less than 16 associations, continue the procedure with [3](#).

If the application server displayed in this step contains 16 associations, either select another application server to use in this procedure and repeat this step, or perform the [Adding an Existing Association to a New Application Server](#) procedure to add the association to a new application server.

 **Note:**

If the association being added to the application server is shown in the `rtrv-as` output in [1](#), continue the procedure with [4](#).

3. Display the associations in the database using the `rtrv-assoc` command.

This is an example of possible output.

```
rlghncxa03w 06-10-28 09:12:36 GMT EAGLE5 36.0.0
```

ANAME	CARD		IPLNK		LPOR	RPORT	OPEN	ALW
	LOC	PORT	LINK	ADAPTER				
swbel32	1201	A	A	M3UA	1030	2345	YES	YES
a2	1305	A	A	SUA	2000	2345	YES	YES
a3	1307	A	A	SUA	3000	2346	YES	YES
assoc1	1305	A	A	SUA	4000	1030	YES	YES
assoc7	1305	A	A	SUA	4500	1030	YES	YES

If the association being added to the application server is shown in this step, continue the procedure with 4.

If the association being added to the application server is not shown in this step, perform the [Adding a New Association to an Existing Application Server](#) procedure to add a new association to the application server.

4. Display one of the associations assigned to the application server shown in 2 using the `rtrv-assoc` command and specifying the association name shown in the `rtrv-as` output from 2 or in the `rtrv-assoc` output in 3.

For this example, enter this command.

```
rtrv-assoc:aname=assoc7
```

This is an example of possible output.

```
rlghncxa03w 09-05-28 09:12:36 GMT EAGLE5 41.0.0
```

```
ANAME assoc7
  LOC      1203          IPLNK PORT  A          LINK  A
  ADAPTER  SUA          VER      SUA RFC
  LHOST    gw105.nc.tekelec.com
  ALHOST   ---
  RHOST    gw100.nc.tekelec.com
  ARHOST   ---
  LPOR     4500          RPORT   1030
  ISTRMS   2            OSTRMS  2          BUFSIZE 16
  RMODE    LIN          RMIN    120        RMAX    800
  RTIMES   10          CWMIN   3000       UAPS    10
  OPEN     YES          ALW     YES        RTXTHR 10000
  RHOSTVAL RELAXED

  ASNAMES
  as2
```

```
IP Appl Sock table is (6 of 4000) 1% full
Assoc Buffer Space Used (16 KB of 800 KB) on LOC = 1203
```

The `adapter` parameter value of all the associations assigned to an application server must be the same. This step identifies the `adapter` value of the associations assigned to the application server.

The application running on the card hosting the new association must be the same as the application on the cards hosting the associations assigned to the application server.

5. Display the signaling link assigned to the card, shown in 4 by entering the `rtrv-slk` command with the card location of the signaling link.

For this example, enter this command.

```
rtrv-slk:loc=1205
```

The following is an example of the possible output.

```
rlghncxa03w 06-10-28 21:19:37 GMT EAGLE5 36.0.0
```

```
LOC LINK LSN          SLC TYPE
1205 A   1sn5          1  SS7IPGW
```

The application running on the card is shown in the `TYPE` column of the `rtrv-slk` output.

For this example, the new association must be assigned to a card running the `SS7IPGW` application.

6. Display the association being added to the application server using the `rtrv-assoc` command and specifying the name of the association being added.

For this example, enter this command.

```
rtrv-assoc:aname=assoc1
```

This is an example of possible output.

```
rlghncxa03w 09-05-28 09:12:36 GMT EAGLE5 41.0.0
```

```
ANAME assoc1
      LOC      1203          IPLNK PORT  A          LINK  A
      ADAPTER  SUA          VER          SUA RFC
      LHOST    gw101.nc.tekelec.com
      ALHOST    ---
      RHOST    gw100.nc.tekelec.com
      ARHOST    ---
      LPORT    4000          RPORT      1030
      ISTRMS   2            OSTRMS    2          BUFSIZE  16
      RMODE    LIN          RMIN      120          RMAX     800
      RTIMES   10          CWMIN     3000         UAPS     10
      OPEN     YES          ALW       YES          RTXTHR   10000
      RHOSTVAL RELAXED
```

```
ASNAMES
```

```
as1
```

```
IP Appl Sock table is (6 of 4000) 1% full
```

```
Assoc Buffer Space Used (16 KB of 800 KB) on LOC = 1203
```

If the local host and adapter values shown in this step are the same as the local host and adapter values shown in 4, continue the procedure with 8.

If the adapter value shown in this step is not the same as the adapter value shown in 4, repeat this procedure from 3.

If the local host value shown in this step is not the same as the local host value shown in 4, but the adapter value shown in this step is the same as the adapter values shown in 4, continue the procedure with 7.

7. Display the signaling link assigned to the card, shown in 6 by entering the `rtrv-slk` command with the card location of the signaling link.

For this example, enter this command.

```
rtrv-slk:loc=1201
```

The following is an example of the possible output.

```
rlghncxa03w 06-10-28 21:19:37 GMT EAGLE5 36.0.0
```

LOC	LINK	LSN	SLC	TYPE
1201	A	lsn1	0	SS7IPGW

The application running on the card is shown in the `TYPE` column of the `rtrv-slk` output.

For this example, the association being added to the application server must be assigned to a card running the `SS7IPGW` application.

If the card applications shown in this step and in 5 are the same, continue the procedure with 8.

If the card applications shown in this step and in 5 are not the same, repeat this procedure from 3.

8. Display the associations assigned to the local IP host value specified in by entering the `rtrv-assoc` command with the `lhost` parameter.

For this example, enter this command.

```
rtrv-assoc:lhost=gw101.nc.tekelec.com
```

This is an example of the possible output.

```
rlghncxa03w 06-10-28 21:14:37 GMT EAGLE5 36.0.0
```

ANAME	CARD IPLNK		LINK	ADAPTER	LPORT	RPORT	OPEN	ALW
	LOC	PORT						
assoc1	1203	A	A	SUA	4000	1030	YES	YES

```
IP Appl Sock/Assoc table is (6 of 4000) 1% full
```

```
Assoc Buffer Space Used (16 KB of 3200 KB) on LOC = 1203
```

9. Display the application servers that the associations shown in 8 are assigned to by entering `rtrv-as` command with the names of the associations shown in 8.

For this example, enter this command.

```
rtrv-as:aname=assoc1
```

This is an example of the possible output.

```
rlghncxa03w 06-10-28 21:14:37 GMT EAGLE5 36.0.0
```

AS Name	Mode	Tr ms	Association Names
as1	LOADSHARE	10	assoc1

```
AS Table is (3 of 250) 1% full
```

The maximum number of SCTP association to application server assignments that can be hosted by an IPGWx card (referenced by the `lhost` parameter of the association) is 50.

If the number of SCTP association to application server assignments is less than 50, continue the procedure with [10](#).

If the number of SCTP association to application server assignments is 50, either repeat this procedure from [3](#), or perform the [Adding a New Association to an Existing Application Server](#) procedure to add a new association to this application server.

 **Note:**

If the value of the `open` parameter shown in [6](#) is `no`, continue the procedure with [11](#).

- 10.** Change the value of the `open` parameter to `no` by specifying the `chg-assoc` command with the `open=no` parameter.

For this example, enter this command.

```
chg-assoc:aname=assoc1:open=no
```

When this command has successfully completed, this message should appear.

```
rlghncxa03w 06-10-28 09:12:36 GMT EAGLE5 36.0.0
CHG-ASSOC: MASP A - COMPLTD;
```

- 11.** Add the association to the application server using the `ent-as` command.

For this example, enter this command

```
ent-as:asname=as2:aname=assoc1
```

This is an example of possible output.

```
rlghncxa03w 06-10-28 09:12:36 GMT EAGLE5 36.0.0
ENT-AS: MASP A - COMPLTD;
```

- 12.** Verify the changes using the `rtrv-as` command with the application server name specified in [11](#).

For this example, enter this command.

```
rtrv-as:asname=as2
```

This is an example of possible output.

```
rlghncxa03w 06-10-28 09:12:36 GMT EAGLE5 36.0.0

AS Name           Mode           Tr ms   Association Names
as2                OVERRIDE      10      assoc1
                  assoc7
AS table is (3 of 250) 1% full.
```

 **Note:**

If you do not wish to change the `open` parameter value of the association specified in [11](#), continue the procedure with [14](#).

13. Change the value of the `open` parameter to `yes` by specifying the `chg-assoc` command with the `open=yes` parameter.

For this example, enter this command.

```
chg-assoc:aname=assoc1:open=yes
```

When this command has successfully completed, this message should appear.

```
rlghncxa03w 06-10-28 09:12:36 GMT EAGLE5 36.0.0  
CHG-ASSOC: MASP A - COMPLTD;
```

14. Back up the new changes, using the `chg-db:action=backup:dest=fixed` command.

These messages should appear; the active Maintenance and Administration Subsystem Processor (MASP) appears first.

```
BACKUP (FIXED) : MASP A - Backup starts on active MASP.  
BACKUP (FIXED) : MASP A - Backup on active MASP to fixed disk complete.  
BACKUP (FIXED) : MASP A - Backup starts on standby MASP.  
BACKUP (FIXED) : MASP A - Backup on standby MASP to fixed disk complete.
```

Figure 4-18 Add an Existing Application to an Existing Application Server - Sheet 1 of 5

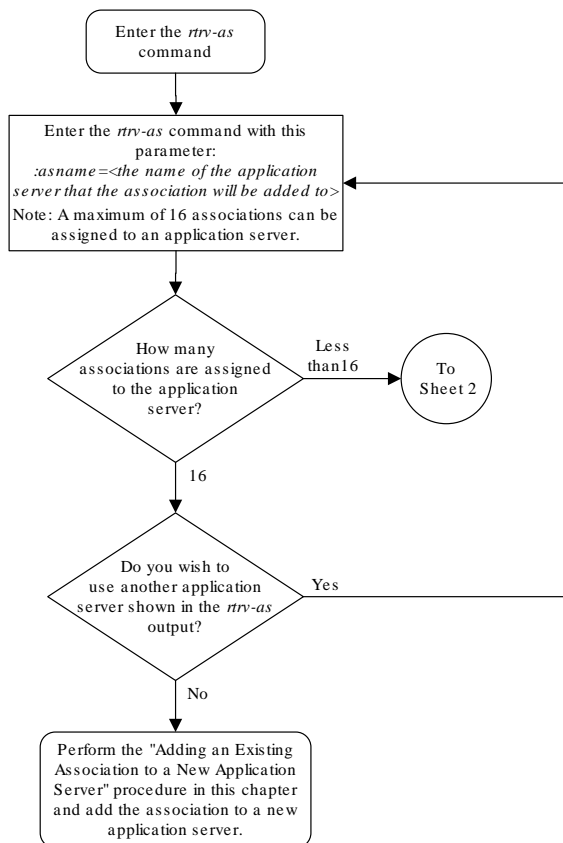


Figure 4-19 Add an Existing Application to an Existing Application Server - Sheet 2 of 5

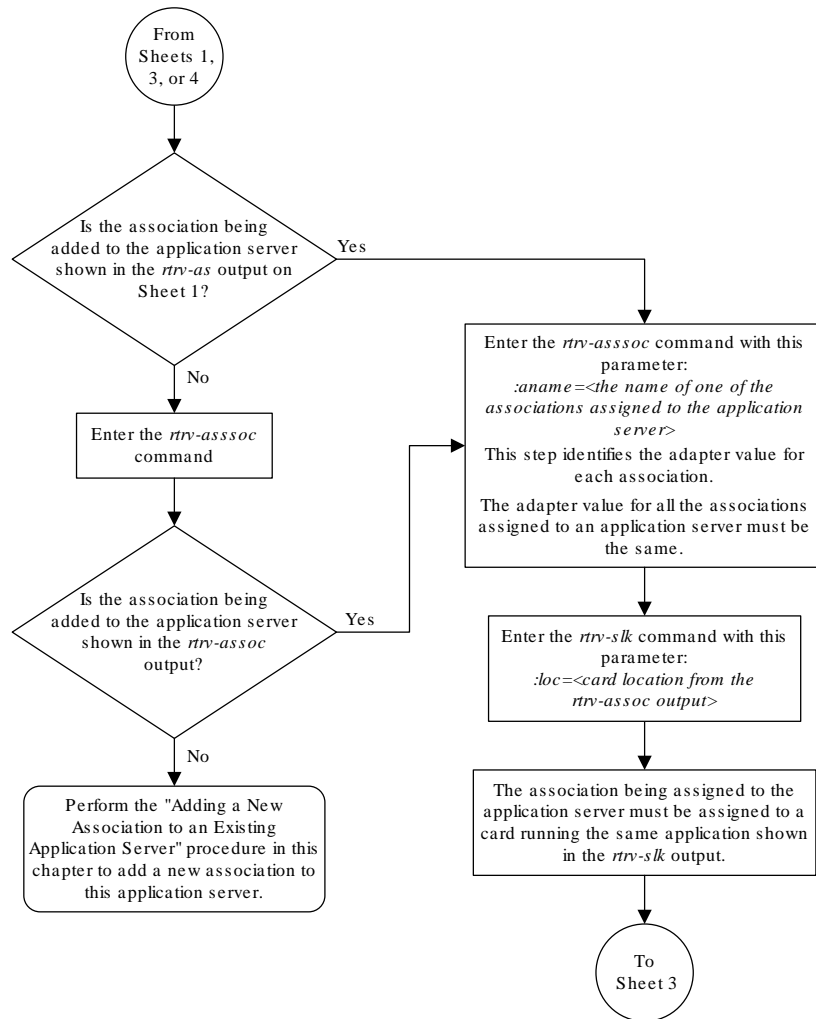


Figure 4-20 Add an Existing Application to an Existing Application Server - Sheet 3 of 5

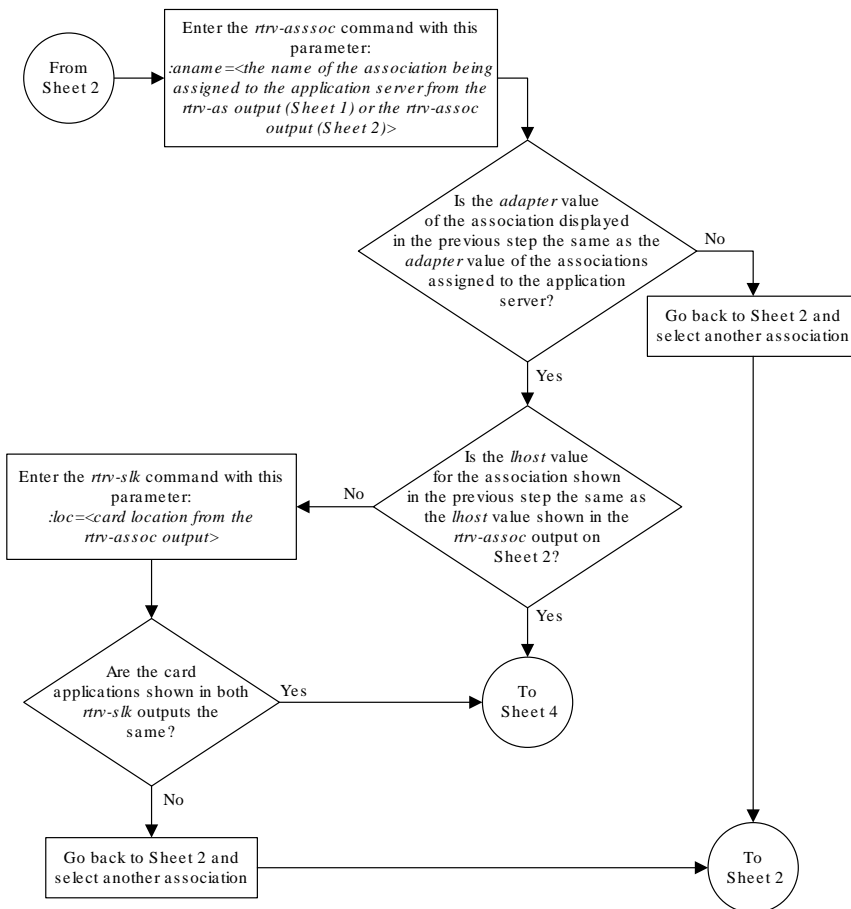


Figure 4-21 Add an Existing Application to an Existing Application Server - Sheet 4 of 5

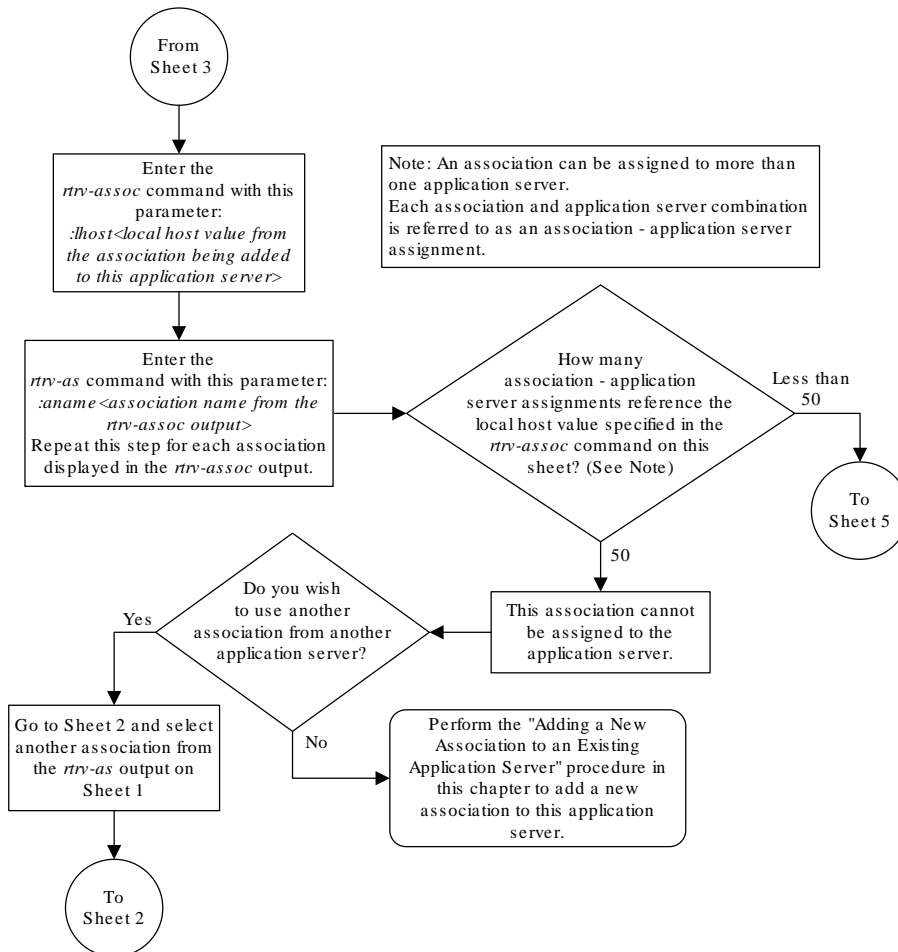
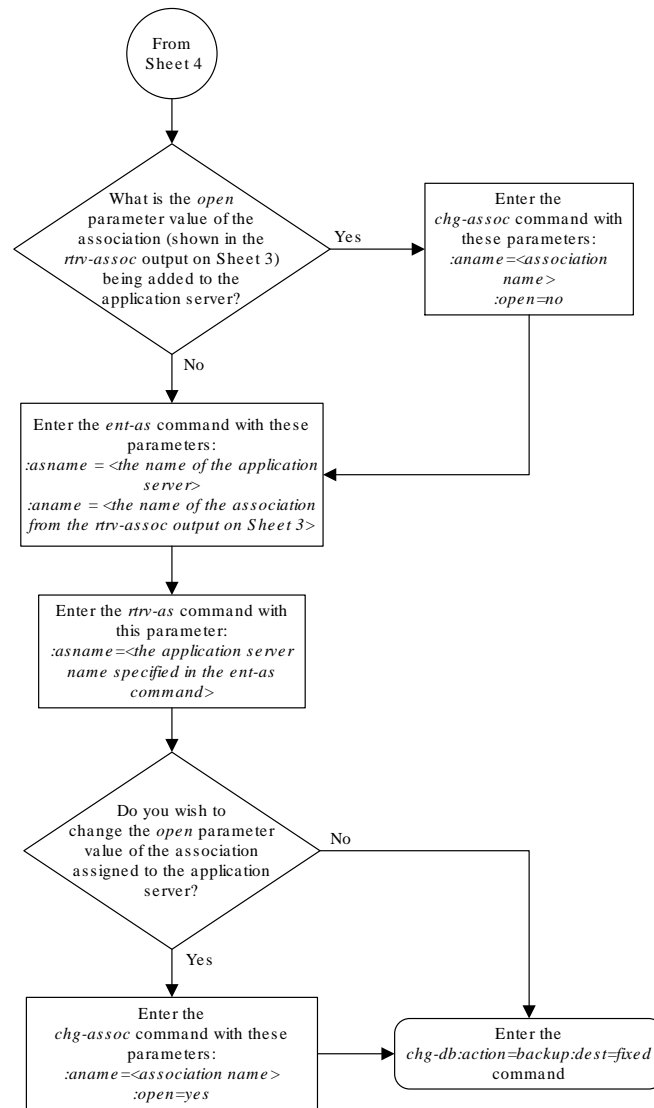


Figure 4-22 Add an Existing Application to an Existing Application Server - Sheet 5 of 5



4.15 Adding a Routing Key Containing an Application Server

This procedure is used to add a routing key containing an application server to the database using the `ent-appl-rtkey` command.

A routing key defines a filter that checks the specified values in an incoming **SS7 MSU** to determine which, if any, association receives the **MSU**. For more information about static routing keys, see [Understanding Routing for SS7IPGW and IPGWI Applications](#).

The `ent-appl-rtkey` command uses these parameters.

`:dpc/dpca/dpci/dpcn/dpcn24` – The destination point code value that is used to filter incoming **MSUs**. This parameter must not specify a cluster route. The destination point code of the routing key cannot be the **APC** of an **IPGWx** linkset or the **SAPC** assigned to an **IPGWx** linkset.

`:opc/opca/opci/opcn/opcn24` – The originating point code value that is used to filter incoming **MSUs**. This parameter must not specify a cluster route. This parameter is valid only when the `si` parameter value is set to 4, 5, or 13. This parameter is required if `si=4, 5, or 13` and `type=full`.

 **Note:**

See the “**Point Code Formats**” section in *Database Administration - SS7 User's Guide* for a definition of the point code types that are used on the **EAGLE** and for a definition of the different formats that can be used for **ITU** national point codes.

`:si` – The service indicator value that is used to filter incoming **MSUs**. The range of values for the service indicator parameter (`si`) can be a numerical value from 0 to 15, or for selected service indicator values, a text string can be used instead of numbers. [Table 4-12](#) shows the text strings that can be used in place of numbers for the service indicator values.

Table 4-12 Service Indicator Text String Values

Service Indicator Value	Text String
0	snm
1	regtest
2	spltst
3	sccp
4	tup
5	isup
13	qbicc

`:ssn` – The subsystem value that is used to filter incoming **MSUs**. The `ssn` parameter is only valid when the `si` parameter value is set to 3 or `sccp`.

`:cics` – The starting circuit identification code that is used to filter incoming **MSUs**. When specified with `cice`, `cics` identifies the start of the range of circuit identification codes. The `cics` parameter is valid only when the `si` parameter value is set to 4, 5, or 13. The `cics` is required if `si=4, 5, or 13` and `type=full`.

`:cice` – The ending circuit identification code that is used to filter incoming **MSUs**. When specified with `cics`, `cice` identifies the end of the range of circuit identification codes. The `cice` parameter is valid only when the `si` parameter value is set to 4, 5, or 13. The `cice` is required if `si=4, 5, or 13` and `type=full`.

`:type` – The routing key type – Identifies the type of routing key that is being entered and used to route message signaling units (**MSUs**). One of three values, `full/partial/`

default, can be specified for the type parameter (see [Table 4-13](#)). If type is not explicitly specified, type=full is assumed.

:asname – Application server (**AS**) name.

:rcontext – The routing context parameter, which has two functions:

- Provides an index of the application server traffic that the sending application server is configured or registered to receive.
- Identifies the **SS7** network context for the message. The routing context parameter implicitly defines the **SS7** point code format used, the **SS7** network indicator value, and the **SCCP** protocol type/variant/version used.

Application server names are shown in the `rtrv-as` output.

Only one application server can be assigned to a routing key. There is a maximum of 2500 routing keys allowed per **EAGLE**. The application server names in each routing key must be unique.

The number of static routing keys is limited by the `srkq` parameter that was specified on the `chg-sg-opts` command.

Routing keys are associated only with the `ss7ipgw` or `ipgwi` application.

Group codes are required for 14-bit ITU-N point codes (**DPCN/OPCN**) when the Duplicate **Point Code** feature is enabled.

The starting circuit identification code must be less than or equal to the ending circuit identification code.

The **ISUP** routing over **IP** feature must be on in order to enter a routing key with these parameters: `dpc`, `si`, `opc`, `cics`, and `cice`. The `IPISUP` field in the `rtrv-feat` command output shows whether or not this feature is on.

The parameter combinations used by the `ent-appl-rtkey` command are based on the type of routing key and the service indicator value in the routing key. The parameter combinations are shown in [Table 4-13](#).

Table 4-13 Routing Key Parameter Combinations for Adding a Routing Key Containing an Application Server

Full Routing Key - SI = 3 (SCCP)	Partial Routing Key - SI = 3 (SCCP)	Full Routing Key - SI=4 (TUP), 5 (ISUP), 13 (QBICC)	Partial Routing Key - SI=4 (TUP), 5 (ISUP), 13 (QBICC)	Full Routing Key - Other SI Values	Partial Routing Key - Other SI Values	Default Routing Key
dpc (See Notes 1, 2, and 11)	type=partial	dpc (See Notes 1 and 2)	type=partial	dpc (See Notes 1 and 2)	type=partial	type=default
si=3 (See Notes 4 and 11)	dpc (See Notes 1, 2, and 3)	si=4, 5, 13 (See Note 4)	dpc (See Notes 1, 2, and 3)	si=value other than 3, 4, 5, 13 (See Note 4)	dpc (See Notes 1, 2, and 3)	asname (See Note 10)

Table 4-13 (Cont.) Routing Key Parameter Combinations for Adding a Routing Key Containing an Application Server

Full Routing Key - SI = 3 (SCCP)	Partial Routing Key - SI = 3 (SCCP)	Full Routing Key - SI=4 (TUP), 5 (ISUP), 13 (QBICC)	Partial Routing Key - SI=4 (TUP), 5 (ISUP), 13 (QBICC)	Full Routing Key - Other SI Values	Partial Routing Key - Other SI Values	Default Routing Key
ssn (See Note 11)	si=3 (See Notes 3 and 4)	opc (See Notes 1 and 2)	si=4, 5, 13 (See Notes 3, 4, and 10)	type=full	si=value other than 3, 4, 5, 13 (See Notes 3, 4, and 10)	rcontext (See Note 10)
type=full	asname (See Note 10)	cics (See Notes 5, 6, 7, 8, and 9)	opc (See Notes 1, 2, and 3)	asname (See Note 10)	asname (See Note 10)	
asname (See Note 10)	rcontext (See Note 10)	cice (See Notes 5, 6, 7, 8, and 9)	asname (See Note 10)	rcontext (See Note 10)	rcontext (See Note 10)	
rcontext (See Note 10)		type=full	rcontext (See Note 10)			
		asname (See Note 10)				
		rcontext (See Note 10)				

Table 4-13 (Cont.) Routing Key Parameter Combinations for Adding a Routing Key Containing an Application Server

Full Routing Key - SI = 3 (SCCP)	Partial Routing Key - SI = 3 (SCCP)	Full Routing Key - SI=4 (TUP), 5 (ISUP), 13 (QBICC)	Partial Routing Key - SI=4 (TUP), 5 (ISUP), 13 (QBICC)	Full Routing Key - Other SI Values	Partial Routing Key - Other SI Values	Default Routing Key
----------------------------------	-------------------------------------	---	--	------------------------------------	---------------------------------------	---------------------

Notes:

1. The `dpc` and `opc` parameters can be either an **ANSI** point code (`dpca`, `opca`), **ITU-I** point code or **ITU-I** spare point code (`dpci`, `opci`), 14-bit **ITU-N** point code or 14-bit **ITU-N** spare point code (`dpcn`, `opcn`), or 24-bit **ITU-N** point code (`dpcn24`, `opcn24`). If the `dpc` and `opc` parameters are specified, the `dpc` and `opc` must be the same type of point code. For example, if the `dpca` parameter is specified, the **OPC** is specified with the `opca` parameter. If either point code value is a spare point code, the other point code value must be a spare point code on the same type. For example, if the `dpc` value is an **ITU-I** spare point code, the `opc` value must be an **ITU-I** spare point code.
2. If the **ITU National Duplicate Point Code** feature is on, the values for the `dpcn` and `opcn` parameters must have group codes assigned to them. The field `ITUDUPPC` in the `rtrv-feat` command output shows whether or not the **ITU National Duplicate Point Code** feature is on. If group codes are specified for **ITU-N DPC** and **OPC**, the groups codes must be the same.
3. These parameters are optional for partial routing keys, but at least one these parameters must be specified with the `ent-appl-rtkey` command.
4. Text strings can be used in place of some numerical service indicator values. See [Table 4-12](#) for a list of these text strings.
5. When the service indicator parameter value equals 4 and an **ANSI** `dpc` is specified, the `opc`, `cics`, and `cice` parameters cannot be used. If the service indicator parameter value equals 4 and an **ITU** `dpc` is specified, the `opc`, `cics`, and `cice` parameters are required.
6. If the service indicator parameter (`si`) value is 4, the values of the `cics` and `cice` parameters is from 0 to 4095.
7. If the service indicator parameter (`si`) value is 5 and the point code in the routing key is either an **ITU-I**, 14-bit **ITU-N**, or 24-bit **ITU-N** point code, the values of the `cics` and `cice` parameters is from 0 to 4095. If the point code in the routing key is an **ANSI** point code, the values of the `cics` and `cice` parameters is from 0 to 16383.
8. If the service indicator parameter value is 13, the values of the `cics` and `cice` parameters is from 0 to 4294967295.
9. The **CIC** range, defined by the `cics` and `cice` parameters, cannot overlap the **CIC** range in an existing routing key.
10. The following rules apply to using the `rcontext` parameter.
 - The value of the `rcontext` parameter is from 0 to 4294967295.
 - The `rcontext` parameter is required for a routing key containing an **SUA** application server.
 - The `rcontext` parameter is optional for a routing key containing an **M3UA** application server.
 - The `rcontext` parameter value must be unique in the database. Multiple routing keys cannot have the same `rcontext` value assigned.
 - An application server can be assigned to only one routing key containing a routing context value.
 - If the application server being assigned to the new routing key is assigned to other routing keys that do not contain `rcontext` parameter values, the `rcontext` parameter cannot be specified for the new routing key.

Table 4-13 (Cont.) Routing Key Parameter Combinations for Adding a Routing Key Containing an Application Server

Full Routing Key - SI = 3 (SCCP)	Partial Routing Key - SI = 3 (SCCP)	Full Routing Key - SI=4 (TUP), 5 (ISUP), 13 (QBICC)	Partial Routing Key - SI=4 (TUP), 5 (ISUP), 13 (QBICC)	Full Routing Key - Other SI Values	Partial Routing Key - Other SI Values	Default Routing Key
<ul style="list-style-type: none"> An application server can be assigned to multiple routing keys if those routing keys do not contain a routing context value. An application server can be assigned to either a routing key containing a routing context value, or to routing keys that do not contain a routing context value, but the application server cannot be assigned to both types of routing keys. In order for an M3UA or SUA association to be assigned to multiple routing keys with a routing context value, the M3UA or SUA association must be assigned to multiple application servers and then each application server must be assigned to a routing key containing a routing context value. 						
<p>11. To communicate the status changes of remote IP subsystems (defined by the DPC and SSN specified in a full SCCP routing key), the DPC and SSN specified for a full SCCP routing key must be provisioned in the mated application table. Perform one of the mated application procedures in <i>Database Administration - GTT User's Guide</i> to provision a mated application with the DPC and SSN specified for a full SCCP routing key.</p>						

Canceling the RTRV-AS and RTRV-APPL-RTKEY Commands

Because the `rtrv-as` and `rtrv-appl-rtkey` commands used in this procedure can output information for a long period of time, the `rtrv-as` and `rtrv-appl-rtkey` commands can be canceled and the output to the terminal stopped. There are three ways that the `rtrv-as` and `rtrv-appl-rtkey` commands can be canceled.

- Press the F9 function key on the keyboard at the terminal where the `rtrv-as` or `rtrv-appl-rtkey` commands were entered.
- Enter the `canc-cmd` without the `trm` parameter at the terminal where the `rtrv-as` or `rtrv-appl-rtkey` commands were entered.
- Enter the `canc-cmd:trm=<xx>`, where `<xx>` is the terminal where the `rtrv-as` and `rtrv-appl-rtkey` commands were entered, from another terminal other than the terminal where the `rtrv-as` or `rtrv-appl-rtkey` commands were entered. To enter the `canc-cmd:trm=<xx>` command, the terminal must allow Security Administration commands to be entered from it and the user must be allowed to enter Security Administration commands. The terminal's permissions can be verified with the `rtrv-secu-trm` command. The user's permissions can be verified with the `rtrv-user` or `rtrv-secu-user` commands.

For more information about the `canc-cmd` command, go to *Commands User's Guide*.

- Display the current routing key information in the database by entering the `rtrv-appl-rtkey` command.

The following is an example of the possible output.

```
rlghncxa03w 08-04-28 21:15:37 GMT EAGLE5 38.0.0
```



```

RCONTEXT    DPC          SI  ADPTR  ASNAME          TYPE
-----
123-234-123 5   M3UA  as12           FULL
005-005-001 5   M3UA  as9            FULL
005-005-001 5   M3UA  as9            FULL
2500        006-006-001 5   SUA   as10           FULL

RCONTEXT    DPCI         SI  ADPTR  ASNAME          TYPE
-----
2-100-7     6   M3UA  as4            FULL
100         3-137-6     6   SUA   as1            FULL
225        4-035-7     5   SUA   as7            FULL
6-006-6     5   M3UA  as2            FULL
6-006-7     5   M3UA  as8            FULL
6-006-6     5   M3UA  as2            FULL
6-006-6     5   M3UA  as2            FULL
6-006-6     5   M3UA  as2            FULL
6-006-8     3   M3UA  as3            FULL
6-006-8     5   M3UA  as5            FULL
6-024-7     5   M3UA  as4            FULL
6-024-7     5   M3UA  as4            FULL
300        7-008-7     6   SUA   as6            FULL

RCONTEXT    DPC          SI  ADPTR  ASNAME          TYPE
-----
***** **   M3UA  as11           DEFAULT

```

STATIC Route Key table is (17 of 2000) 1% full

STATIC Route Key Socket Association table is (17 of 32000) 1% full

The database can contain only one default routing key. If the `rtrv-appl-rtkey` output contains a default routing key, a default routing key cannot be added in this procedure. Continue the procedure with [2](#) to add either a full or partial routing key with the desired application server.

2. Display the current application server information in the database by entering the `rtrv-as` command.

The following is an example of the possible output.

```
rlghncxa03w 06-10-28 09:12:36 GMT EAGLE5 36.0.0
```

AS Name	Mode	Tr ms	Association Names
as1	LOADSHARE	10	assoc1 assoc2 assoc3 assoc5 assoc6
as2	OVERRIDE	10	assoc7
as3	LOADSHARE	10	assoc8 assoc9
as4	LOADSHARE	10	assoc10 assoc11
as5	LOADSHARE	10	assoc12

```

                                assoc13
as6          LOADSHARE    10    assoc14
                                assoc15
as7          LOADSHARE    10    assoc16
                                assoc17
as8          LOADSHARE    10    assoc18
                                assoc19
as9          LOADSHARE    10    assoc20
                                assoc21
as10         LOADSHARE    10    assoc22
                                assoc23
as12         LOADSHARE    10    assoc24
                                assoc25
AS Table is (11 of 250) 4% full
```

If the required application server is not in the database, perform one of these procedures to add the application server:

- [Adding a New Association to a New Application Server](#)
- [Adding an Existing Association to a New Application Server](#)
- [Adding a New Association to an Existing Application Server](#)
- [Adding an Existing Association to an Existing Application Server.](#)

If the `rcontext` parameter will not be specified for the routing key, make sure that the `adapter` parameter value for the associations assigned to the new application server is `M3UA`.

If the `rcontext` parameter will be specified for the routing key, make sure that the `open` parameter value of the associations is set to `no`. The `adapter` parameter value of these associations can be either `SUA` or `M3UA`.

SUA associations, and their corresponding application server, can be assigned to only these types of routing keys:

- Full routing key – **DPC/SI=3/SSN**
- Partial routing key – **DPC/SI=3**
- Partial routing key – **DPC** only
- Partial routing key – **SI=3** only
- Default routing key.

After the new application server is added to the database, continue the procedure with 4.

3. Display the routing keys containing the application server being used in this procedure by entering the `rtrv-appl-rtkey` command with the application server name and the `display=all` parameter.

For this example, enter these commands.

```
rtrv-appl-rtkey:asname=as4:display=all
```

The following is an example of the possible output.

```
rlghncxa03w 08-04-28 09:12:36 GMT EAGLE5 38.0.0

RCONTEXT  DPCI          SI SSN OPCI          CICS      CICE
-----  -
          6-024-7      5 ---  1-057-4      150       175

          ADPTR  TYPE      ASNAME
          M3UA  FULL      as4

          ANAMES
          assoc11          assoc12

RCONTEXT  DPCI          SI SSN OPCI          CICS
CICE      LOC
-----  -
          2-100-7      6 ---  -----      -----
-----  ----

          ADPTR  TYPE      ASNAME
          M3UA  FULL      as4

          ANAMES
          assoc11          assoc12

STATIC Route Key table is (17 of 2000) 1% full
STATIC Route Key Socket Association table is (17 of 32000) 1% full

rtrv-appl-rtkey:asname=as5:display=all
```

The following is an example of the possible output.

```
rlghncxa03w 08-04-28 09:12:36 GMT EAGLE5 38.0.0

RCONTEXT  DPCI          SI SSN OPCI          CICS      CICE
225       4-035-7      5 ---  3-200-4      200       300

          ADPTR  TYPE      ASNAME
          M3UA  FULL      as5

          ANAMES
          assoc15          assoc16

STATIC Route Key table is (17 of 2000) 1% full
STATIC Route Key Socket Association table is (17 of 32000) 1% full
```

If the application server is not assigned to any routing keys, the `rcontext` parameter can be specified for the new routing key using this application server. Continue the procedure with 4.

An application server can be assigned to only one routing key containing a routing context value. If the application server is assigned to other routing keys, the `rcontext` parameter cannot be specified for the new routing key being added in

this procedure. If you wish to use the `rcontext` parameter for the new routing key, perform one of these procedures to add the application server:

- [Adding a New Association to a New Application Server](#)
- [Adding an Existing Association to a New Application Server](#)
- [Adding a New Association to an Existing Application Server](#)
- [Adding an Existing Association to an Existing Application Server.](#)

After the new application server is added, continue the procedure with 6.

If the application server is assigned to other routing keys, and these routing keys do not contain `rcontext` parameter values, the application server can be assigned to the new routing key in this procedure, but the `rcontext` parameter cannot be specified for the new routing key.

If you do not wish to use the `rcontext` parameter for the new routing key, continue the procedure with 6.

4. Display the associations assigned to the application server displayed in 3, to verify the `open` parameter value of the association, using the `rtrv-assoc` command with the association names shown in 2.

For this example, enter these commands.

```
rtrv-assoc:aname=assoc11
```

This is an example of possible output.

```
rlghncxa03w 06-10-28 09:12:36 GMT EAGLE5 36.0.0
ANAME assoc11
      LOC      1203          IPLNK PORT  A          LINK  A
ADAPTER M3UA          VER          M3UA RFC
LHOST      gw110.nc.tekelec.com
ALHOST      ---
RHOST      gw100.nc.tekelec.com
LPORT      1030          RPORT          1030
ISTRMS     2          OSTRMS     2          BUFSIZE  16
RMODE     LIN          RMIN          120          RMAX     800
RTIMES     10          CWMIN          3000          UAPS     10
OPEN      YES          ALW          YES          RTXTHR   10000

ASNAMES
as4
```

```
IP Appl Sock table is (10 of 4000) 1% full
Assoc Buffer Space Used (16 KB of 800 KB) on LOC = 1203
```

```
rtrv-assoc:aname=assoc12
```

This is an example of possible output.

```
rlghncxa03w 06-10-28 09:12:36 GMT EAGLE5 36.0.0
ANAME assoc12
      LOC      1204          IPLNK PORT  A          LINK  A
ADAPTER M3UA          VER          M3UA RFC
```

```
LHOST    gw200.nc.tekelec.com
ALHOST   ---
RHOST    gw100.nc.tekelec.com
LPORT    2564          RPORT    1030
ISTRMS   2           OSTRMS   2           BUFSIZE  16
RMODE    LIN         RMIN     120          RMAX     800
RTIMES   10         CWMIN    3000        UAPS     10
OPEN     YES         ALW      YES          RTXTHR  10000
```

```
ASNAMES
as4
```

IP Appl Sock table is (10 of 4000) 1% full
Assoc Buffer Space Used (16 KB of 800 KB) on LOC = 1204

```
rtrv-assoc:aname=assoc15
```

This is an example of possible output.

```
rlghncxa03w 06-10-28 09:12:36 GMT EAGLE5 36.0.0
ANAME assoc15
LOC        1207          IPLNK PORT  A           LINK  A
ADAPTER    SUA          VER         SUA RFC
LHOST      gw150.nc.tekelec.com
ALHOST     ---
RHOST      gw100.nc.tekelec.com
LPORT      1500          RPORT      1030
ISTRMS     2           OSTRMS     2           BUFSIZE  16
RMODE      LIN         RMIN       120          RMAX     800
RTIMES     10         CWMIN      3000        UAPS     10
OPEN       YES         ALW        YES          RTXTHR  10000
```

```
ASNAMES
as5
```

IP Appl Sock table is (4 of 4000) 1% full
Assoc Buffer Space Used (16 KB of 800 KB) on LOC = 1207

```
rtrv-assoc:aname=assoc16
```

This is an example of possible output.

```
rlghncxa03w 06-10-28 09:12:36 GMT EAGLE5 36.0.0
ANAME assoc16
LOC        1211          IPLNK PORT  A           LINK  A
ADAPTER    SUA          VER         SUA RFC
LHOST      gw160.nc.tekelec.com
ALHOST     ---
RHOST      gw100.nc.tekelec.com
LPORT      3571          RPORT      1030
ISTRMS     2           OSTRMS     2           BUFSIZE  16
RMODE      LIN         RMIN       120          RMAX     800
RTIMES     10         CWMIN      3000        UAPS     10
```

```

OPEN      YES          ALW      YES      RTXTHR  10000

ASNAMES
as5

```

```

IP Appl Sock table is (4 of 4000) 1% full
Assoc Buffer Space Used (16 KB of 800 KB) on LOC = 1211

```

Repeat this step for each association name displayed in [3](#) to verify the `open` parameter of each association assigned to the application server.

If a new application server was added in [2](#), continue the procedure with [6](#).

If the `rcontext` parameter is not being specified in this procedure, continue the procedure with [6](#).

If the `open` parameter value for all the associations assigned to the application server is `no` (shown in this step), continue the procedure with [6](#).

5. Change the value of the `open` parameter to `no` by specifying the `chg-assoc` command with the `open=no` parameter.

For this example, enter this command.

```

chg-assoc:aname=assoc11:open=no
chg-assoc:aname=assoc12:open=no
chg-assoc:aname=assoc15:open=no
chg-assoc:aname=assoc16:open=no
chg-assoc:aname=assoc20:open=no

```

When each of these commands have successfully completed, this message should appear.

```

rlghncxa03w 06-10-28 09:12:36 GMT EAGLE5 36.0.0
CHG-ASSOC: MASP A - COMPLTD

```

Caution:

The IP connections using the associations specified in this step will not be able to carry any traffic when the `open` parameter is changed to `no`.

Repeat this step for all the associations assigned to the application server that have the `open=yes` parameter value.

If a default routing key with an application server name is being added in this procedure, continue the procedure with [11](#).

If ITU-I or 14-bit ITU-N spare point codes are not being assigned to the routing key, or if ITU-I or 14-bit ITU-N spare point codes are shown in any routing keys shown in the `rtrv-app-rtkey` output in [1](#), continue the procedure with [7](#).

6. Display the status of the ITU National and International **Spare Point Code** Support feature by entering the `rtrv-ctrl-feat` command with the ITU National and International **Spare Point Code** Support feature part number.

Enter this command.

```
rtrv-ctrl-feat:partnum=893013601
```

The following is an example of the possible output.

```
rlghncxa03w 06-10-28 21:15:37 GMT EAGLE5 36.0.0
```

The following features have been permanently enabled:

Feature Name	Partnum	Status	Quantity
Spare Point Code Support	893013601	on	----

The following features have been temporarily enabled:

Feature Name	Partnum	Status	Quantity	Trial Period Left
Zero entries found.				

The following features have expired temporary keys:

Feature Name	Partnum
Zero entries found.	

If the **ITU National and International Spare Point Code Support** feature is not enabled, perform the “Activating the **ITU National and International Spare Point Code Support** feature” procedure in *Database Administration - SS7 User's Guide* and enable and turn on the **ITU National and International Spare Point Code Support** feature.

- The **DPC** of the routing key cannot be the **APC** of an **IPGWx** linkset or an **SAPC** assigned to an **IPGWx** linkset.

Display the names of the **IPGWx** linksets by entering the `rept-stat-iptps` command. This is an example of the possible output.

```
rlghncxa03w 10-07-19 21:16:37 GMT EAGLE5 42.0.0
```

```
IP TPS USAGE REPORT
```

PEAKTIMESTAMP	THRESH	CONFIG/ RSVD	CONFIG/ MAX	TPS	PEAK

LSN					
lsgw1201	80%	----	10000	TX: 7200	7600 05-02-10
11:40:04				RCV: 7200	7600 05-02-10
11:40:04					
lsgw1204	80%	----	10000	TX: 6700	7600 05-02-10
11:40:04				RCV: 6500	7600 05-02-10
11:40:04					
lsgw1207	80%	----	10000	TX: 7300	7450 05-02-10
11:40:04				RCV: 7300	7450 05-02-10
11:40:04					

```

lsgw1211      80%      ----   10000  TX:   7400      7450  05-02-10
11:40:04
                                     RCV:   7400      7450  05-02-10
11:40:04
-----
-

```

Command Completed.

8. Display the **IPGWx** linksets shown in the `rept-stat-iptps` output in 7 using the `rtrv-ls` command and specifying the name of the linkset shown in 7.

For this example, enter these commands.

```
rtrv-ls:lsn=lsgw1201
```

This is an example of the possible output.

```

rlghncxa03w 08-04-28 16:31:35 GMT EAGLE5 38.0.0

LSN          APCA   (SS7)  SCRN  L3T  SLT          GWS  GWS  GWS
NIS          NIS
lsgw1201     240-020-000  scr1  1    1    yes A    1    off off off yes
off

IPGWAPC MATELSN   IPTPS  LSUSEALM  SLKUSEALM  GTTMODE
yes      -----  10000  70      % 70      % CdPA

LOC  LINK  SLC  TYPE      IPLIML2

LOC  LINK  SLC  TYPE
1201 A    0    SS7IPGW

```

Link set table is (14 of 1024) 1% full

```
rtrv-ls:lsn=lsgw1204
```

This is an example of the possible output.

```

rlghncxa03w 08-04-17 11:43:04 GMT EAGLE5 38.0.0

LSN          APCN   (SS7)  SCRN  L3T  SLT          GWS  GWS  GWS
NIS          NIS
lsgw1204     2968          none  1    1    no  A    1    off off off ---
off

CLLI          TFATCABMLQ  MTPRSE  ASL8  SLRSRB  MULTGC  ITUTFR
-----      1          ---    ---    1        no      off

IPGWAPC MATELSN   IPTPS  LSUSEALM  SLKUSEALM  GTTMODE
yes      -----  10000  70      % 70      % CdPA

```



```
LOC LINK SLC TYPE
1204 A 0 IPGWI
```

```
SAPCI
1-010-1
```

Link set table is (14 of 1024) 1% full.

```
rtrv-ls:lsn=lsgw1207
```

This is an example of the possible output.

```
rlghncxa03w 08-04-17 11:43:04 GMT EAGLE5 38.0.0
```

```
LSN          APCI  (SS7)  SCRN  L3T SLT          GWS GWS GWS
SLSCI NIS
lsgw1207     2-154-0      none  1   1   no  A   1   off off off
--- off
```

```
CLLI          TFATCABMLQ  MTPRSE  ASL8  SLRSRB  MULTGC
ITUTFR
----- 1          ---   ---   1          no
off
```

```
IPGWAPC MATELSN  IPTPS  LSUSEALM  SLKUSEALM  GTTMODE
yes      ----- 10000  70      % 70      % CdPA
```

```
LOC LINK SLC TYPE
1207 A 0 IPGWI
```

```
SAPCN
5823
```

Link set table is (14 of 1024) 1% full.

```
rtrv-ls:lsn=lsgw1211
```

This is an example of the possible output.

```
rlghncxa03w 08-04-28 16:31:35 GMT EAGLE5 38.0.0
```

```
LSN          APCA  (SS7)  SCRN  L3T SLT          GWS GWS GWS
SLSCI NIS
lsgw1211     010-130-057  scr1  1   1   yes A   1   off off off
yes off
```

```
IPGWAPC MATELSN  IPTPS  LSUSEALM  SLKUSEALM  GTTMODE
yes      ----- 10000  70      % 70      % CdPA
```

```
LOC LINK SLC TYPE
1211 A 0 SS7IPGW
```

```
Link set table is (14 of 1024) 1% full
```

If the **DPC** of the routing key is shown in the `rtrv-ls` outputs in this step, choose another **DPC** value for the routing key that is not shown in the `rtrv-ls` outputs in this step.

 **Note:**

If the **SI** value of the routing key being added is a value other than 4, 5, or 13, continue the procedure with [11](#).

9. Verify that the **ISUP** Routing over **IP** feature is on, by entering the `rtrv-feat` command.

If the **ISUP** Routing over **IP** feature is on, the `IPISUP` field should be set to `on`. For this example, the **ISUP** Routing over **IP** feature is off.

 **Note:**

The `rtrv-feat` command output contains other fields that are not used by this procedure. If you wish to see all the fields displayed by the `rtrv-feat` command, see the `rtrv-feat` command description in the *Commands Manual*.

If the **ISUP** Routing over **IP** feature is on, continue the procedure with [11](#).

10. Turn the **ISUP** Routing over **IP** feature on by entering this command.

```
chg-feat:ipisup=on
```

 **Note:**

Once the **ISUP** Routing over **IP** feature is turned on with the `chg-feat` command, it cannot be turned off.

The **ISUP** Routing over **IP** feature must be purchased before you turn this feature on with the `chg-feat` command. If you are not sure if you have purchased the **ISUP** Routing over **IP** feature, contact your Oracle Sales Representative or Account Representative.

When the `chg-feat` has successfully completed, this message should appear.

```
rlghncxa03w 06-10-28 11:43:04 GMT EAGLE5 36.0.0  
CHG-FEAT: MASP A - COMPLTD
```

11. Add a routing key entry to the database by entering the `ent-appl-rtkey` command.

The parameters required for the `ent-appl-rtkey` command are determined by the type of routing key being added and the service indicator value in the routing key. See [Table 4-13](#) for the parameter combinations that can be used for the type of routing key being added to the database. For this example, enter these commands.

```
ent-appl-
rtkey:dpci=3-009-3:si=5:opci=4-100-3:cics=100 :cice=500:asna
me=as3:type=full

ent-appl-
rtkey:dpci=1-050-2:si=5:opci=6-077-7:cics=200 :cice=300:asna
me=as20:type=full:rcontext=2000
```

 **Note:**

A routing key cannot be added with the application server `as4`, displayed in [3](#), because application server `as4` is assigned to a routing key containing a routing context value. Only one application server can be assigned to a routing key containing a routing context value.

When each of these commands have successfully completed, the following message should appear.

```
rlghncxa03w 06-10-28 21:15:37 GMT EAGLE5 36.0.0
ENT-APPL-RTKEY: MASP A - COMPLTD
```

- Verify the new routing key information in the database by entering the `rtrv-appl-rtkey` command with the routing key parameters specified in [11](#) (`dpc`, `si`, `opc`, `cics`, `cice`, `ssn`, `asname`, `type`, and `rcontext`, as applicable) with the `display=all` parameter.

For this example, enter these commands.

```
rtrv-appl-
rtkey:dpci=3-009-3:si=5:opci=4-100-3:cics=100 :cice=500:asna
me=as3:type=full:display=all
```

The following is an example of the possible output.

```
rlghncxa03w 08-04-28 21:16:37 GMT EAGLE5 38.0.0
```

RCONTEXT	DPCI	SI	SSN	OPCI	CICS	CICE
-----	3-009-3	5	---	4-100-3	100	500

ADPTR	TYPE	ASNAME
M3UA	FULL	as3

ANAMES
assoc11 assoc12

```
STATIC Route Key table is (19 of 2000) 1% full
STATIC Route Key Socket Association table is (19 of 32000) 1% full
```

```
rtrv-appl-
rtkey:dpci=1-050-2:si=5:opci=6-077-7:cics=200 :cice=300:asna
me=as20:type=full:rcontext=2000:display=all
```

The following is an example of the possible output.

```
rlghncxa03w 08-04-28 21:16:37 GMT EAGLE5 38.0.0

RCONTEXT  DPCI          SI SSN OPCI          CICS      CICE
2000      1-050-2          5 --- 6-077-7          200       300

      ADPTR  TYPE      ASNAME
      SUA   FULL      as20

      ANAMES
      assoc20

STATIC Route Key table is (19 of 2000) 1% full
STATIC Route Key Socket Association table is (19 of 32000) 1% full
```

 **Note:**

If the `open` parameter value of the associations assigned to the routing key added in this procedure was not changed (5 was not performed), continue the procedure with 14.

- Change the value of the `open` parameter of the associations that were changed in 5 to `yes` by specifying the `chg-assoc` command with the `open=yes` parameter.

For this example, enter these commands.

```
chg-assoc:aname=assoc11:open=yes
chg-assoc:aname=assoc12:open=yes
chg-assoc:aname=assoc15:open=yes
chg-assoc:aname=assoc16:open=yes
chg-assoc:aname=assoc20:open=yes
```

When each of these commands have successfully completed, this message should appear.

```
rlghncxa03w 06-10-28 09:12:36 GMT EAGLE5 36.0.0
CHG-ASSOC: MASP A - COMPLTD;
```

Repeat this step for all the associations that were changed in 5.

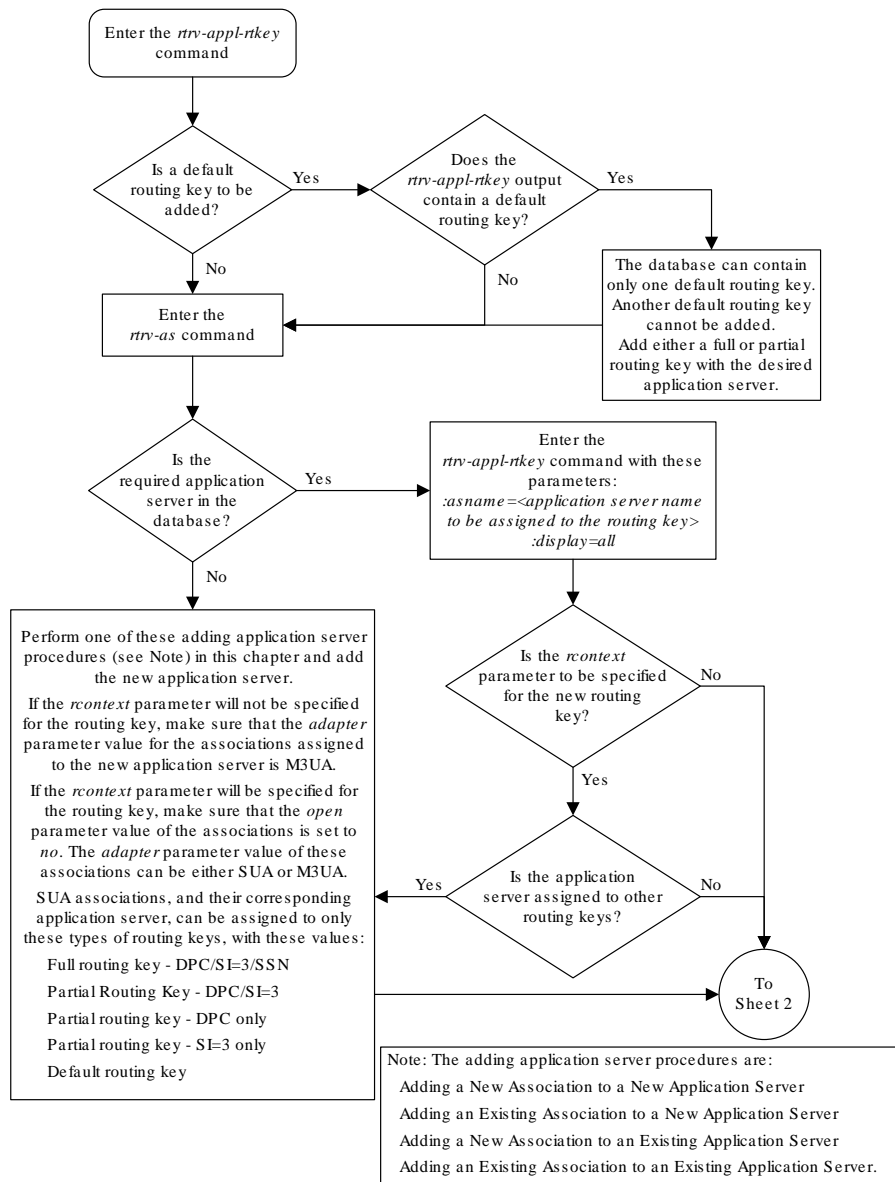
- Back up the new changes using the `chg-db:action=backup:dest=fixed` command.

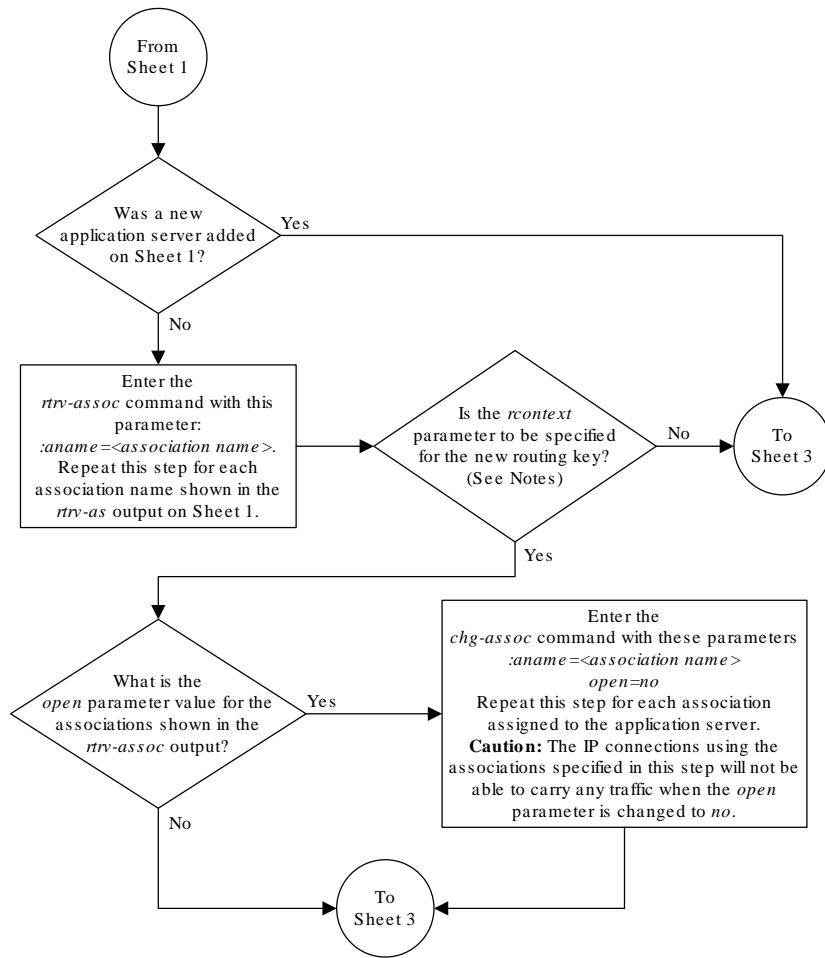
These messages should appear, the active **Maintenance and Administration Subsystem** Processor (**MASP**) appears first.

```
BACKUP (FIXED) : MASP A - Backup starts on active MASP.
BACKUP (FIXED) : MASP A - Backup on active MASP to fixed disk complete.
```

BACKUP (FIXED) : MASP A - Backup starts on standby MASP.
 BACKUP (FIXED) : MASP A - Backup on standby MASP to fixed disk complete.

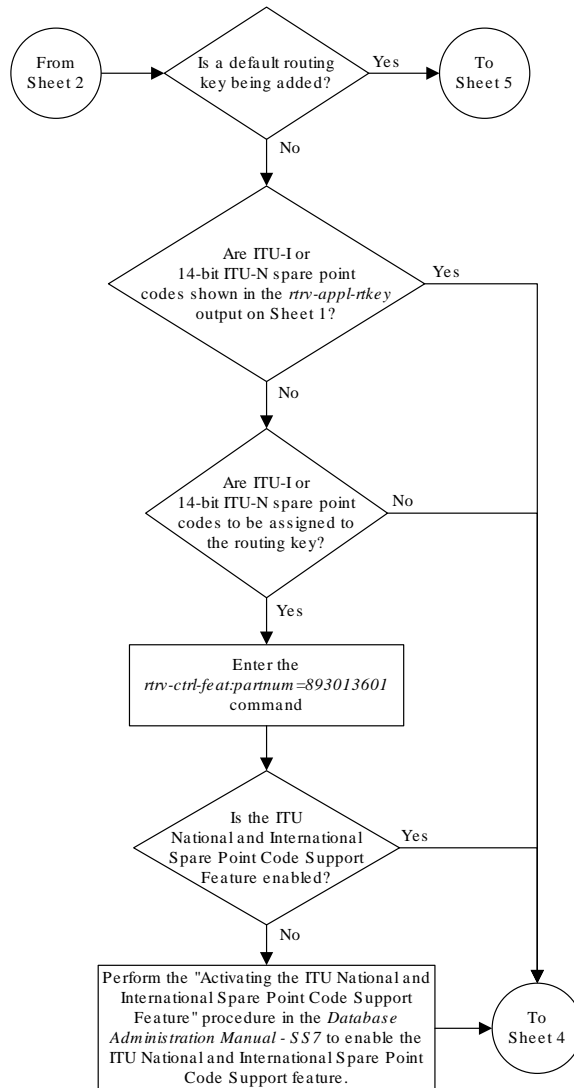
Figure 4-23 Adding a Routing Key Containing an Application Server



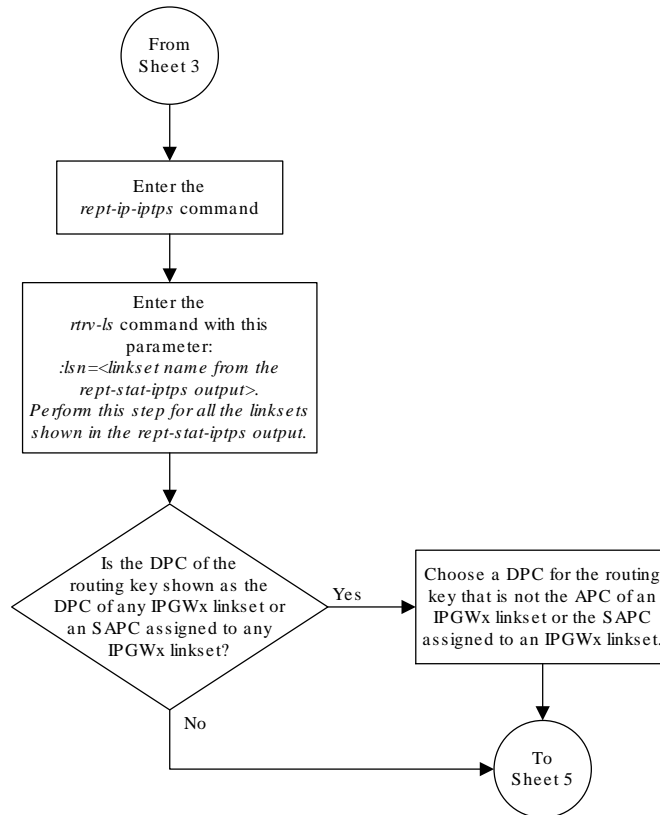


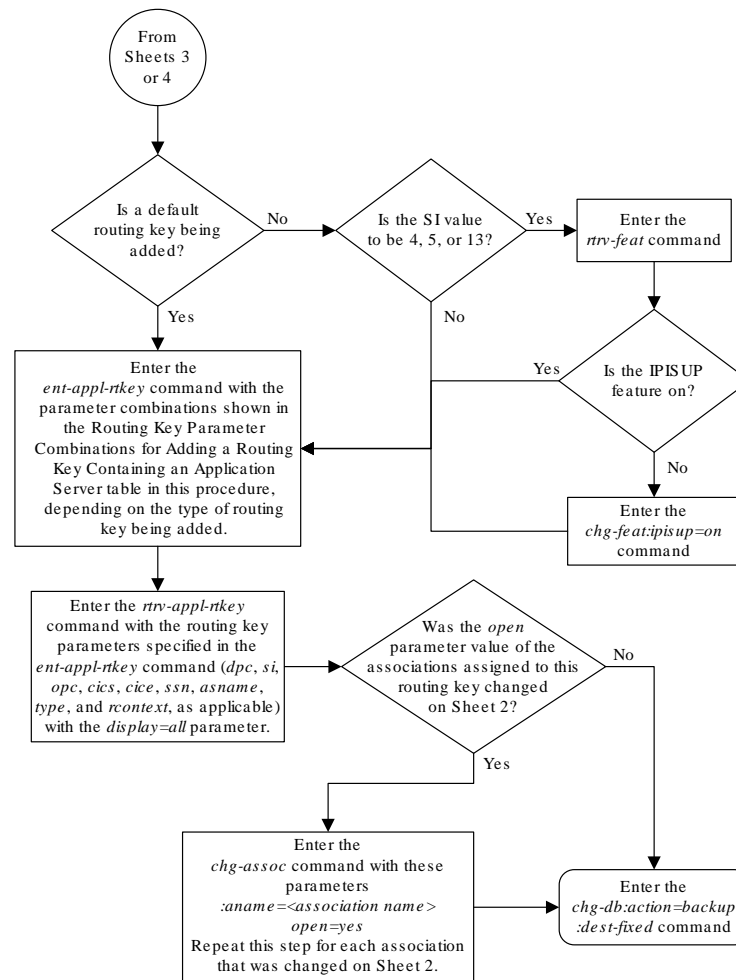
Notes:

1. If the *adapter* parameter value for the application server is SUA, and a new application server is specified for the routing key, the *rcontext* parameter is required.
2. If the *adapter* parameter value for the application server is M3UA, and a new application server is specified for the routing key, the *rcontext* parameter is optional.
3. If the application server is assigned to other routing keys, the *rcontext* parameter cannot be specified for this routing key. An application server can be assigned to only one routing key that contains an *rcontext* parameter value.



Sheet 3 of 5





Sheet 5 of 5

4.16 Adding a Network Appearance

The network appearance field identifies the **SS7** network context for the message, for the purpose of logically separating the signaling traffic between the **SGP** (signaling gateway process) and the **ASP** (application server process) over a common **SCTP** (stream control transmission protocol) association. This field is contained in the **DATA**, **DUNA**, **DAVA**, **DRST**, **DAUD**, **SCON**, and **DUPU** messages.

The network appearance is provisioned in the database using the `ent-na` command with these parameters.

:na – the 32-bit value of the network appearance, from 0 to 4294967295.

:type – the network type of the network appearance, ansi (**ANSI**), itui (**ITU-I**), itun (14-bit **ITU-N**), itun24 (24-bit **ITU-N**), ituis (**ITU-I Spare**), ituns (14-bit **ITU-N Spare**).

:gc – the specific **ITU-N** group code associated with the network appearance.

The gc parameter can be specified only with the type=itun or type=ituns parameters.

The gc parameter must be specified with the type=itun or type=ituns parameters if the **ITU Duplicate Point Code** feature is on. If the **ITU Duplicate Point Code** feature is off, the gc parameter cannot be specified.

The gc parameter value must be shown in the rtrv-spc or rtrv-sid outputs.

The ituis or ituns parameters can be specified only if the **ITU National and International Spare Point Code Support** feature is enabled.

1. Display the network appearances in the database with the rtrv-na command. This is an example of the possible output.

```
rlghncxa03w 06-10-28 09:12:36 GMT EAGLE5 36.0.0
TYPE GC NA
ANSI -- 100
ITUN FR 4000000000
ITUN GE 1000000000
```

 **Note:**

If the gc parameter is not being specified in this procedure, continue the procedure with 4.

2. Display the self-identification of the **EAGLE** using the rtrv-sid command. This is an example of the possible output.

```
rlghncxa03w 06-10-28 09:12:36 GMT EAGLE5 36.0.0
PCA PCI PCN CLLI PCTYPE
001-001-001 1-200-6 13482 rlghncxa03w OTHER

CPCA
002-002-002 002-002-003 002-002-004 002-002-005
002-002-006 002-002-007 002-002-008 002-002-009
004-002-001 004-003-003 144-212-003

CPCA (LNP)
005-005-002 005-005-004 005-005-005

CPCI
1-001-1 1-001-2 1-001-3 1-001-4

CPCN
```

```
02091          02092          02094          02097
02191          02192          11177
```

If the desired group code is shown in the `rtrv-sid` output, continue the procedure with 4.

3. Display the secondary point codes in the database with the `rtrv-spc` command. This is an example of the possible output.

```
rlghncxa03w 06-10-28 09:12:36 GMT EAGLE5 36.0.0
SPC (Secondary Point Codes)
```

```
SPCA
001-010-010
002-010-010
003-010-010
```

```
SPC-I
1-253-5
2-254-6
3-255-7
```

```
SPC-N
10-01-11-1-fr
13-02-12-0-ge
13-02-12-0-uk
```

```
SPC-N24
none
```

```
Secondary Point Code table is (9 of 40) 23% full
```

If the desired group code is not shown in the `rtrv-spc` or `rtrv-sid` outputs, go to the “Adding a **Secondary Point Code**” procedure in *Database Administration - SS7 User's Guide* to turn the **ITU Duplicate Point Code** feature on, and add a secondary point code to the database with the desired group code value.

If the `ituis` or `ituns` parameters will not be specified in this procedure, continue the procedure with 5.

If the `ituis` or `ituns` parameters will be specified in this procedure, and **ITU-I spare** or **14-bit ITU-N spare** network appearances are shown in the `rtrv-na` output in 1, or **ITU-I spare** or **14-bit ITU-N spare** point codes are shown in the `rtrv-sid` output in 2, continue the procedure with 5.

4. Display the status of the **ITU National and International Spare Point Code Support** feature by entering the `rtrv-ctrl-feat` command with the **ITU National and International Spare Point Code Support** feature part number. Enter this command.

```
rtrv-ctrl-feat:partnum=893013601
```

The following is an example of the possible output.

```
rlghncxa03w 06-10-28 21:15:37 GMT EAGLE5 36.0.0
The following features have been permanently enabled:
```

Feature Name	Partnum	Status	Quantity
Spare Point Code Support	893013601	on	----

The following features have been temporarily enabled:

Feature Name	Partnum	Status	Quantity	Trial Period
Left				
Zero entries found.				

The following features have expired temporary keys:

Feature Name	Partnum
Zero entries found.	

If the **ITU National and International Spare Point Code Support** feature is not enabled, perform the “Activating the **ITU National and International Spare Point Code Support** feature” procedure in *Database Administration - SS7 User's Guide* and enable and turn on the **ITU National and International Spare Point Code Support** feature.

5. Add the network appearance to the database with the `ent-na` command.

If the `gc` parameter is specified with the `ent-na` command, the `gc` parameter value must be shown in the `rtrv-sid` output in 2, or assigned to an **ITU-N point code (SPC-N)** shown in the `rtrv-spc` output in 3. For this example, enter these commands.

```
ent-na:na=1000:type=itui
ent-na:na=3:type=itun24
ent-na:na=150000:type=itun:gc=uk
ent-na:na=2000:type=ituis
ent-na:na=5000:type=ituns:gc=sp
```

When each of these commands have successfully completed, this message should appear.

```
rlghncxa03w 06-10-28 09:12:36 GMT EAGLE5 36.0.0
ENT-NA: MASP A - COMPLTD
```

6. Verify the changes using the `rtrv-na` command. This is an example of the possible output.

```
rlghncxa03w 06-10-28 09:12:36 GMT EAGLE5 36.0.0
TYPE  GC      NA
ANSI  --      100
ITUI  --      1000
ITUN  uk      150000
ITUN  fr     4000000000
```

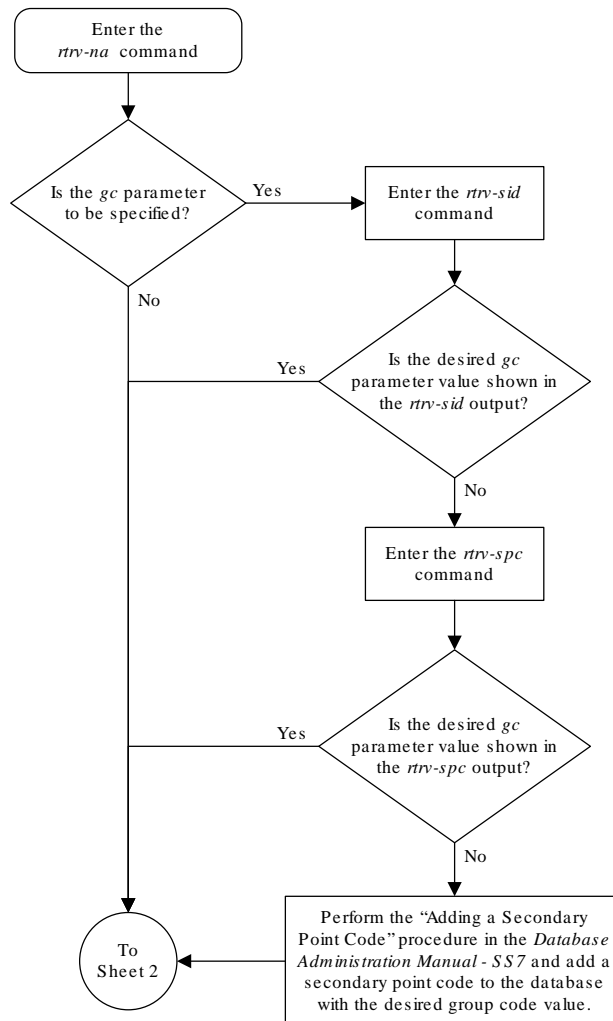
```
ITUN    ge    1000000000
ITUN24  --          3
ITUIS   --      2000
ITUNS   sp      5000
```

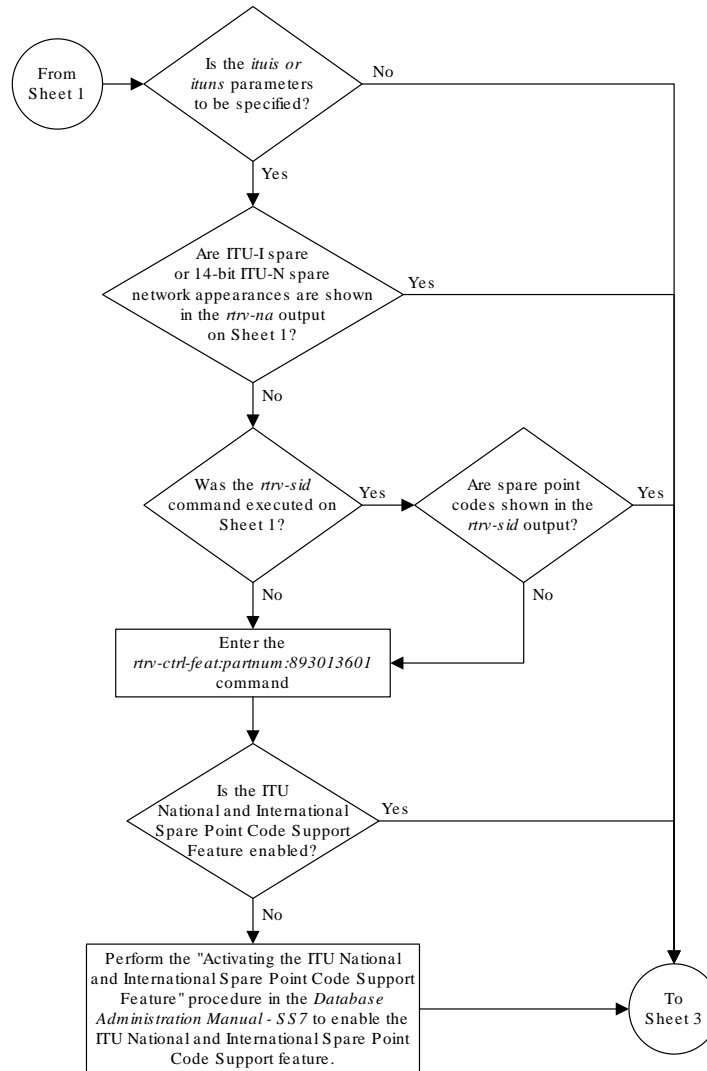
7. Back up the new changes, using the `chg-db:action=backup:dest=fixed` command.

These messages should appear; the active **Maintenance and Administration Subsystem Processor (MASP)** appears first.

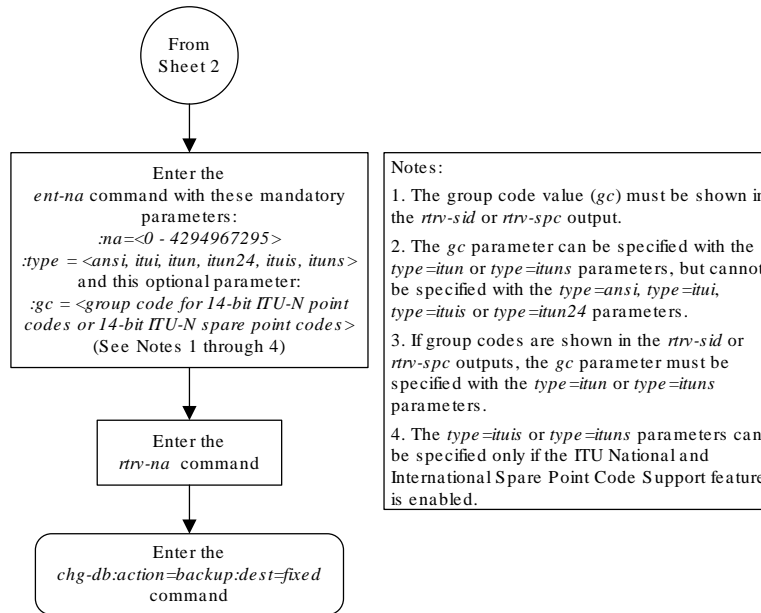
```
BACKUP (FIXED) : MASP A - Backup starts on active MASP.
BACKUP (FIXED) : MASP A - Backup on active MASP to fixed disk
complete.
BACKUP (FIXED) : MASP A - Backup starts on standby MASP.
BACKUP (FIXED) : MASP A - Backup on standby MASP to fixed disk
complete.
```

Figure 4-24 Adding a Network Appearance





Sheet 2 of 3



Sheet 3 of 3

4.17 Activating the Large MSU Support for IP Signaling Feature

This procedure is used to enable and turn on the Large **MSU** Support for **IP** Signaling feature using the feature's part number and a feature access key.

The feature access key for the Large **MSU** Support for **IP** Signaling feature is based on the feature's part number and the serial number of the **EAGLE**, making the feature access key site-specific.

The `enable-ctrl-feat` command enables the controlled feature by inputting the controlled feature's access key and the controlled feature's part number with these parameters:

 **Note:**

As of Release 46.3, the `fak` parameter is no longer required. This parameter is only used for backward compatibility.

`:fak` – The feature access key provided by Oracle. The feature access key contains 13 alphanumeric characters and is not case sensitive.

`:partnum` – The Oracle-issued part number of the Large MSU Support for **IP** Signaling feature, 893018401.

The `enable-ctrl-feat` command requires that the database contain a valid serial number for the **EAGLE**, and that this serial number is locked. This can be verified with the `rtrv-serial-num` command. The **EAGLE** is shipped with a serial number in the database, but the serial number is not locked. The serial number can be changed, if necessary, and locked once the **EAGLE** is on-site, by using the `ent-serial-num` command. The `ent-serial-num` command uses these parameters.

`:serial` – The serial number assigned to the **EAGLE**. The serial number is not case sensitive.

`:lock` – Specifies whether or not the serial number is locked. This parameter has only one value, `yes`, which locks the serial number. Once the serial number is locked, it cannot be changed.

 **Note:**

To enter and lock the **EAGLE**'s serial number, the `ent-serial-num` command must be entered twice, once to add the correct serial number to the database with the `serial` parameter, then again with the `serial` and the `lock=yes` parameters to lock the serial number. You should verify that the serial number in the database is correct before locking the serial number. The serial number can be found on a label affixed to the control shelf (shelf 1100).

This feature cannot be temporarily enabled (with the temporary feature access key).

Once this feature has been enabled, the feature must be turned on with the `chg-ctrl-feat` command. The `chg-ctrl-feat` command uses these parameters:

`:partnum` – The Oracle-issued part number of the Large MSU Support for **IP** Signaling feature, 893018401.

`:status=on` – used to turn the Large MSU Support for **IP** Signaling feature on.

Once the Large MSU Support for IP Signaling feature has been turned on, it can be turned off. For more information about turning the Large MSU Support for IP Signaling feature off, go to the [Turning Off the Large MSU Support for IP Signaling Feature](#) procedure.

The status of the features in the **EAGLE** is shown with the `rtrv-ctrl-feat` command.

The Large MSU Support for IP Signaling feature allows the EAGLE to process messages with a service indicator value of 6 to 15 and with a service information field (**SIF**) that is larger than 272 bytes. The large messages are processed only on E5-ENET cards. There are certain software components that if enabled or provisioned, that will not process large messages even if the Large MSU Support for IP Signaling feature is enabled and turned on. UIMs are displayed when most of these circumstances occur. These UIMs are:

- **UIM 1333** – Displayed when a large message is received on an **M3UA** association and the Large MSU Support for IP Signaling feature is not enabled or is enabled and turned off. The large message is discarded.
- **UIM 1350** – Displayed when a **M2PA** IP connection receives message with an **SIF** greater than 272 bytes and the Large MSU Support for IP Signaling feature is not enabled or is enabled and turned off. The large message is discarded.
- **UIM 1352** – Displayed when a message with an **SIF** greater than 272 bytes is received; the Large MSU Support for IP Signaling feature is enabled and turned on; there are routes available for the destination point code; but the selected outbound card does not support large messages.
- **UIM 1353** – Displayed when a large message passes a gateway screening screenset that redirects messages for the Database Transport Access (**DTA**) feature. Large messages are not redirected for the **DTA** feature.

For more information on these **UIMs**, refer to the *Unsolicited Alarm and Information Messages Reference*.



Note:

Large messages are not monitored by the EAGLE 5 Integrated Monitoring Support feature and are not sent to the **IMF**. A **UIM** is not generated.

1. Display the status of the controlled features by entering the `rtrv-ctrl-feat` command.

The following is an example of the possible output.

```
rlghncxa03w 08-04-28 21:15:37 GMT EAGLE5 38.0.0
The following features have been permanently enabled:
```

Feature Name	Partnum	Status	Quantity
Command Class Management	893005801	on	----
LNP Short Message Service	893006601	on	----
Intermed GTT Load Sharing	893006901	on	----
XGTT Table Expansion	893006101	on	400000
XMAP Table Expansion	893007710	off	----
Large System # Links	893005910	on	2000
Routesets	893006401	on	6000
HC-MIM SLK Capacity	893012707	on	64

The following features have been temporarily enabled:

Feature Name	Partnum	Status	Quantity	Trial
Period Left				
Zero entries found.				

The following features have expired temporary keys:

Feature Name	Partnum
Zero entries found.	

If the Large MSU Support for IP Signaling feature is enabled and turned on, no further action is necessary. This procedure does not need to be performed.

If the Large MSU Support for IP Signaling feature is enabled and but not turned on, continue the procedure with step 7.

If the Large MSU Support for IP Signaling feature is not enabled, continue the procedure with step 2.

 **Note:**

If the `rtrv-ctrl-feat` output in 1 shows any controlled features, continue this procedure with 6. If the `rtrv-ctrl-feat` output shows only the HC-MIM SLK Capacity feature with a quantity of 64, 2 through 5 must be performed.

2. Display the serial number in the database with the `rtrv-serial-num` command.

This is an example of the possible output.

```
rlghncxa03w 06-10-28 21:15:37 GMT EAGLE5 36.0.0
System serial number = nt00001231
```

System serial number is not locked.

```
rlghncxa03w 06-10-28 21:15:37 GMT EAGLE5 36.0.0
Command Completed
```

 **Note:**

If the serial number is correct and locked, continue the procedure with 6. If the serial number is correct but not locked, continue the procedure with step 5. If the serial number is not correct, but is locked, this feature cannot be enabled and the remainder of this procedure cannot be performed. Contact the Customer Care Center to get an incorrect and locked serial number changed. Refer to [My Oracle Support \(MOS\)](#) for the contact information. The serial number can be found on a label affixed to the control shelf (shelf 1100).

3. Enter the correct serial number into the database using the `ent-serial-num` command with the `serial` parameter.

For this example, enter this command.

```
ent-serial-num:serial=<EAGLE's correct serial number>
```

When this command has successfully completed, the following message should appear.

```
rlghncxa03w 06-10-28 21:15:37 GMT EAGLE5 36.0.0  
ENT-SERIAL-NUM: MASP A - COMPLTD
```

4. Verify that the serial number entered into step 3 was entered correctly using the `rtrv-serial-num` command.

This is an example of the possible output.

```
rlghncxa03w 06-10-28 21:15:37 GMT EAGLE5 36.0.0  
System serial number = nt00001231
```

```
System serial number is not locked.
```

```
rlghncxa03w 06-10-28 21:15:37 GMT EAGLE5 36.0.0  
Command Completed
```

If the serial number was not entered correctly, repeat step 3 and step 4 and re-enter the correct serial number.

5. Lock the serial number in the database by entering the `ent-serial-num` command with the serial number shown in step 2, if the serial number shown in step 2 is correct, or with the serial number shown in 4, if the serial number was changed in step 4, and with the `lock=yes` parameter.

For this example, enter this command.

```
ent-serial-num:serial=<EAGLE's serial number>:lock=yes
```

When this command has successfully completed, the following message should appear.

```
rlghncxa03w 06-10-28 21:15:37 GMT EAGLE5 36.0.0  
ENT-SERIAL-NUM: MASP A - COMPLTD
```

6. Enable the Large MSU Support for IP Signaling feature with the `enable-ctrl-feat` command specifying the part number for the Large MSU Support for IP Signaling feature and the feature access key. Enter this command.

```
enable-ctrl-feat:partnum=893018401:fak=<Large MSU Support for IP  
Signaling feature access key>
```

 **Note:**

A temporary feature access key cannot be specified to enable this feature.

 **Note:**

The values for the feature access key (the `fak` parameter) are provided by Oracle. If you do not have the feature access key for the feature you wish to enable, contact your Sales Representative or Account Representative.

When the `enable-ctrl-feat` command has successfully completed, this message should appear.

```
rlghncxa03w 06-10-28 21:15:37 GMT EAGLE5 36.0.0
ENABLE-CTRL-FEAT: MASP B - COMPLTD
```

7. Turn the Large MSU Support for IP Signaling feature on with the `chg-ctrl-feat` command specifying the part number for the Large MSU Support for IP Signaling feature and the `status=on` parameter. Enter this command.

```
chg-ctrl-feat:partnum=893018401:status=on
```

When the `chg-ctrl-feat` command has successfully completed, this message should appear.

```
rlghncxa03w 07-05-28 21:15:37 GMT EAGLE5 37.0.0
CHG-CTRL-FEAT: MASP B - COMPLTD
```

8. Verify the changes by entering the `rtrv-ctrl-feat` command with the Large MSU Support for IP Signaling feature part number. Enter this command.

```
rtrv-ctrl-feat:partnum=893018401
```

The following is an example of the possible output.

```
rlghncxa03w 10-04-28 21:15:37 GMT EAGLE5 42.0.0
The following features have been permanently enabled:
```

Feature Name	Partnum	Status	Quantity
Large MSU for IP Sig	893018401	on	----

The following features have been temporarily enabled:

Feature Name	Partnum	Status	Quantity	Trial
Period Left				
Zero entries found.				

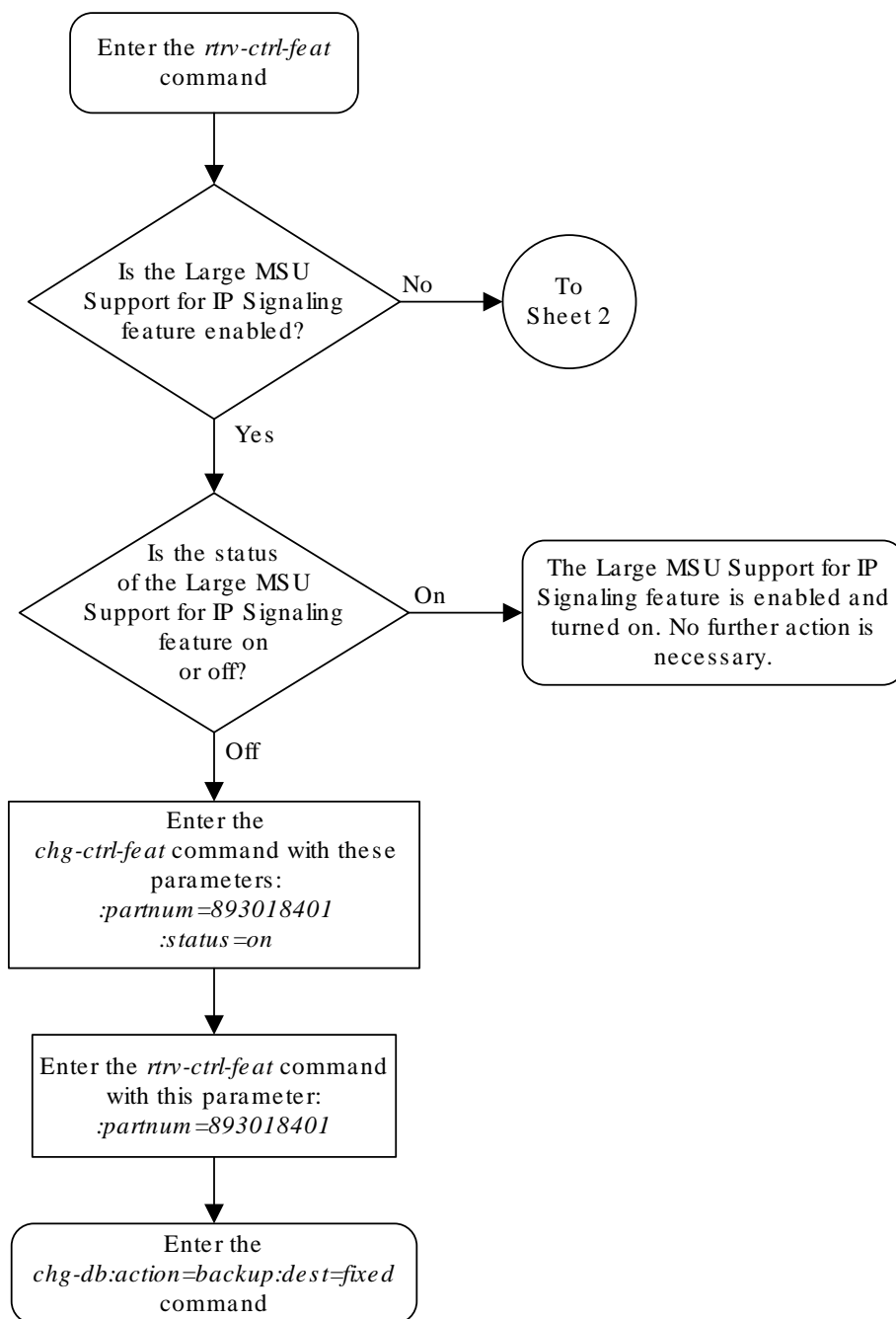
The following features have expired temporary keys:

Feature Name	Partnum
Zero entries found.	

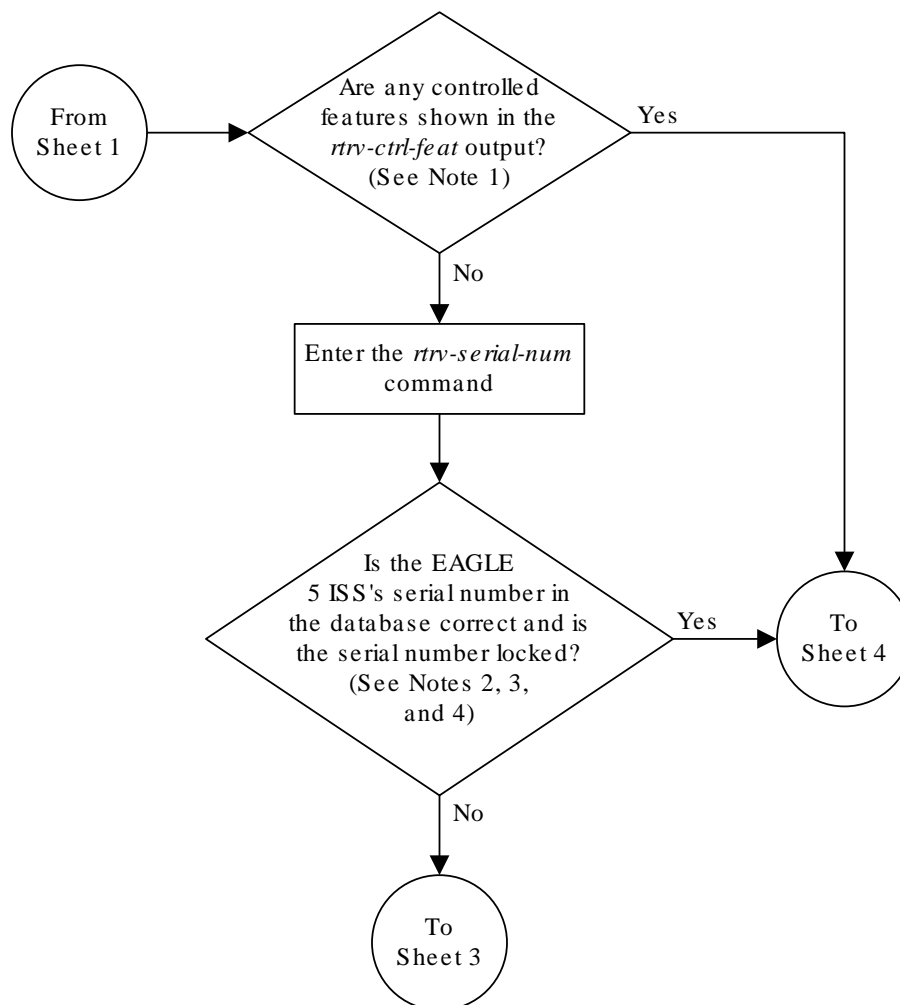
9. Back up the new changes using the `chg-db:action=backup:dest=fixed` command. These messages should appear, the active **Maintenance and Administration Subsystem Processor (MASP)** appears first.

```
BACKUP (FIXED) : MASP A - Backup starts on active MASP.  
BACKUP (FIXED) : MASP A - Backup on active MASP to fixed disk complete.  
BACKUP (FIXED) : MASP A - Backup starts on standby MASP.  
BACKUP (FIXED) : MASP A - Backup on standby MASP to fixed disk complete.
```

Figure 4-25 Activating the Large MSU Support for IP Signaling Feature



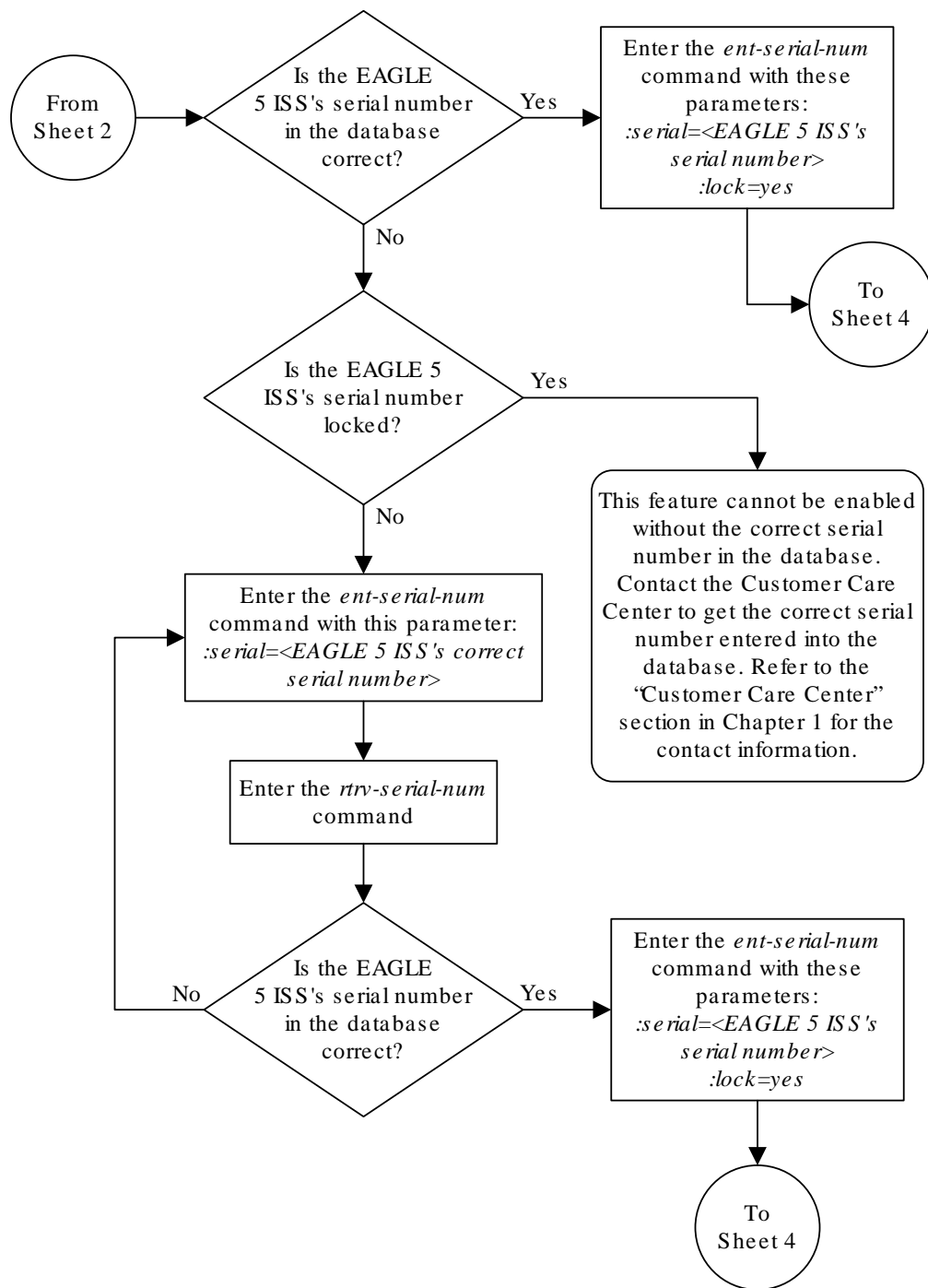
Sheet 1 of 4



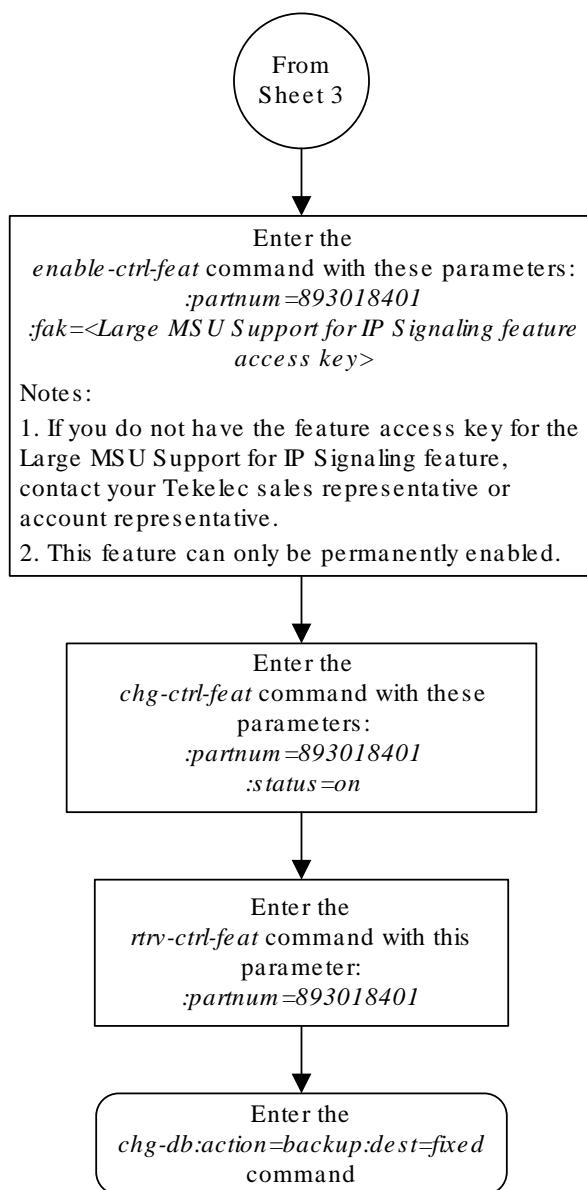
Notes:

1. If the *rrv-ctrl-feat* output shows only the HC-MIM SLK Capacity feature with a quantity of 64, the answer to this question is no and the Eagle 5 ISS's serial number must be verified. This is the default entry for the *rrv-ctrl-feat* output. This entry is shown whether or not the Eagle 5 ISS's serial number is in the database.
2. If the serial number is locked, it cannot be changed.
3. If the serial number is not locked, the controlled feature cannot be enabled.
4. The serial number can be found on a label affixed to the control shelf (shelf 1100).

Sheet 2 of 4



Sheet 3 of 4



4.18 Removing IETF M3UA and SUA Components

This section describes how to remove the following components from the database.

- An **IPGWx** Card – Perform the [Removing an IPGWx Card](#) procedure
- A mate IPGWx linkset from another IPGWx linkset – Perform the [Removing a Mate IPGWx Linkset from another IPGWx Linkset](#) procedure
- An **IPGWx** Signaling Link – Perform the [Removing an IPGWx Signaling Link](#) procedure
- An **IP** Host – Perform the [Removing an IP Host Assigned to an IPGWx Card](#) procedure
- An **IP** Route – Perform the [Removing an IP Route](#) procedure
- An M3UA or SUA Association – Perform the [Removing a M3UA or SUA Association](#) procedure
- An Association from an Application Server – Perform the [Removing an Association from an Application Server](#) procedure
- A Routing Key – Perform the [Removing a Routing Key Containing an Application Server](#) procedure
- A Network Appearance – Perform the [Removing a Network Appearance](#) procedure

4.19 Removing an IPGWx Card

Use this procedure to remove an **IP** card, a card running one of these applications: `ss7ipgw` or `ipgwi`, from the database using the `dlt-card` command.

The card cannot be removed if it does not exist in the database. Prior to removing the card from the database, the signaling links assigned to the card must be removed.

Caution:

If the **IPGWx** card is the last **IP** card in service, removing this card from the database will cause traffic to be lost.

1. Display the cards in the database using the `rtrv-card` command.

This is an example of the possible output.

```
rlghncxa03w 09-10-15 16:34:56 GMT EAGLE5 41.0.0
CARD   TYPE      APPL      LSET NAME      LINK SLC LSET NAME      LINK SLC
1101   DSM       VSCCP
1102   TSM       GLS
1113   GSPM     EOAM
1114   TDM-A
1115   GSPM     EOAM
1116   TDM-B
1117   MDAL
```

```

1201 LIMDSO SS7ANSI lsn1 A 0 lsn2
B 1
1203 LIMDSO SS7ANSI lsn2 A 0 lsn1
B 1
1204 LIMATM ATMANSI atmgyw A 0
1205 DCM IPLIM ipnode1 A 0 ipnode3
B 1
1207 DCM IPLIM ipnode2 A 0
1303 DCM IPLIM ipnode1 A 0 ipnode3
B 1
1305 DCM IPLIM ipnode4 A 0

```

Select a card whose application is either **SS7IPGW** or **IPGWI**.

Perform the [Removing an IPGWx Signaling Link](#) procedure to remove all the signaling links assigned to the card, shown in the `LINK` column of the `rtrv-card` output.

The card location is shown in the `CARD` field of the `rtrv-card` command output. No entries in the `LSET NAME`, `LINK`, and `SLC` columns mean that no signaling link is assigned to the card.

- Remove the card from the database using the `dlt-card` command.

The `dlt-card` command has only one parameter, `loc`, which is the location of the card. For this example, enter these commands.

```

dlt-card:loc=1205
dlt-card:loc=1207

```

When these commands have successfully completed, this message appears.

```

rlghncxa03w 06-10-12 09:12:36 GMT EAGLE5 36.0.0
DLT-CARD: MASP A - COMPLTD

```

- Verify the changes using the `rtrv-card` command and specifying the card that was removed in 2.

For this example, enter these commands.

```

rtrv-card:loc=1205
rtrv-card:loc=1207

```

When these commands have successfully completed, this message appears.

```

E2144 Cmd Rej: Location invalid for hardware configuration

```

- Back up the new changes using the `chg-db:action=backup:dest=fixed` command.

These messages appear, the active **Maintenance and Administration Subsystem Processor (MASP)** appears first.

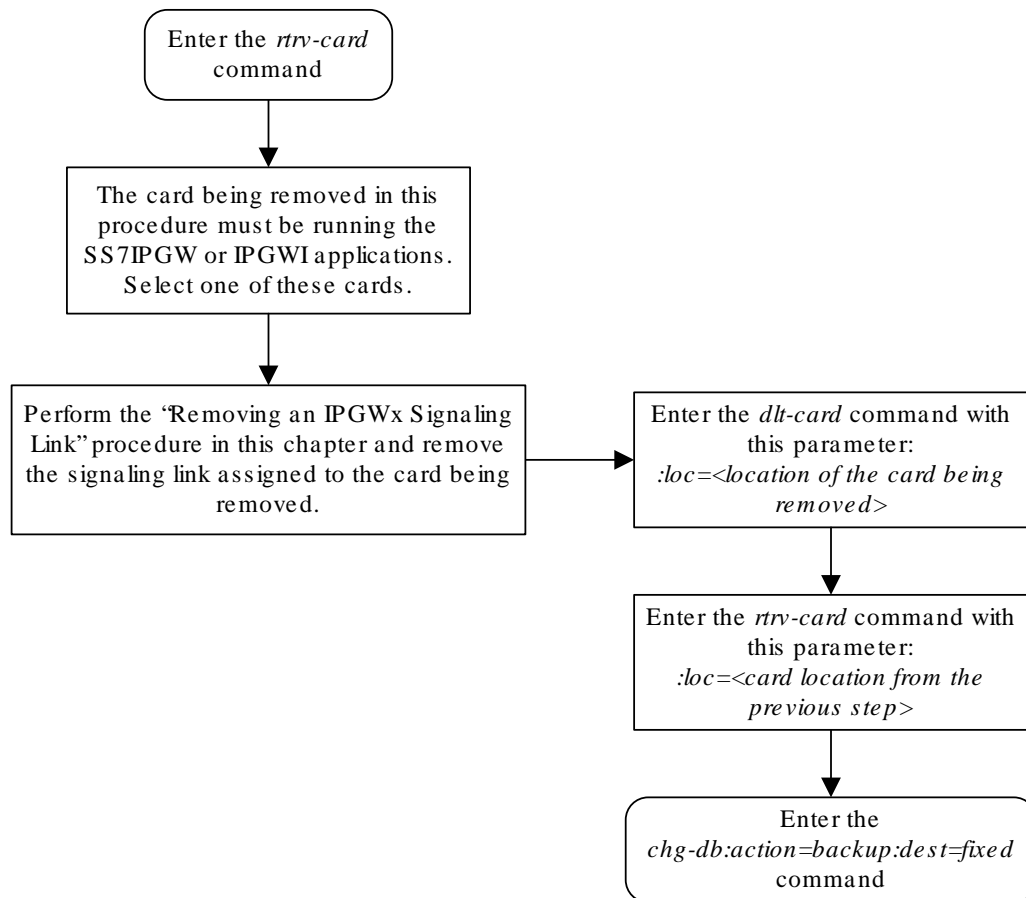
```

BACKUP (FIXED) : MASP A - Backup starts on active MASP.
BACKUP (FIXED) : MASP A - Backup on active MASP to fixed disk
complete.

```

```
BACKUP (FIXED) : MASP A - Backup starts on standby MASP.  
BACKUP (FIXED) : MASP A - Backup on standby MASP to fixed disk complete.
```


Figure 4-26 Removing an IPGWx Card



4.20 Removing an IPGWx Signaling Link

This procedure is used to remove an **IPGWx** signaling link from the database using the `dlt-slk` command. The `dlt-slk` command uses these parameters.

`:loc` – The card location of the **IP** card that the **IP** signaling link is assigned to.

`:link` – The signaling link on the card specified in the `loc` parameter.

`:force` – This parameter must be used to remove the last link in a linkset without having to remove all of the routes that referenced the linkset.

The `tfatcabmlq` parameter (**TFA/TCA Broadcast Minimum Link Quantity**), assigned to linksets, shows the minimum number of links in the given linkset (or in the combined link set in which it resides) that must be available for traffic. When the number of signaling links in the specified linkset is equal to or greater than the value of the `tfatcabmlq` parameter, the status of the routes that use the specified linkset is set to allowed and can carry traffic. Otherwise, these routes are restricted. The value of the `tfatcabmlq` parameter cannot exceed the total number of signaling links contained in the linkset.

If the linkset type of the linkset that contains the signaling link that is being removed is either A, B, D, E, or PRX, the signaling link can be removed regardless of the `tfatcabmlq` parameter value of the linkset and regardless of the `LSRESTRICT` option value. When a signaling link in one of these types of linksets is removed, the `tfatcabmlq` parameter value of the linkset is decreased automatically.

If the linkset type of the linkset that contains the signaling link that is being removed is C, the signaling link can be removed only:

- If the `LSRESTRICT` option is off. The `LSRESTRICT` option value is shown in the `rtrv-ss7opts` output.
- If the `LSRESTRICT` option is on and the number of signaling links assigned to the linkset will be equal to or greater than the value of the `tfatcabmlq` parameter value of the linkset after the signaling link is removed.

The `tfatcabmlq` parameter value of the linkset is shown in the `TFATCABMLQ` column of the `rtrv-ls:lsn=<linkset name>` output. The `tfatcabmlq` parameter value can be a fixed value (1 to 16) or 0. If the `tfatcabmlq` parameter value of the linkset is a fixed value, the number of signaling links that are in the linkset after the signaling link is removed must be equal to or greater than the `tfatcabmlq` parameter value of the linkset.

If the `tfatcabmlq` parameter value is 0, the signaling link can be removed. When the `tfatcabmlq` parameter value is 0, the value displayed in the `TFATCABMLQ` column of the `rtrv-ls` output is 1/2 of the number of signaling links contained in the linkset. If the number of signaling links in the linkset is an odd number, the `tfatcabmlq` parameter value is rounded up to the next whole number. As the signaling links are removed, the `tfatcabmlq` parameter value of the linkset is decreased automatically.

Canceling the `RTRV-SLK` Command

Because the `rtrv-slk` command used in this procedure can output information for a long period of time, the `rtrv-slk` command can be canceled and the output to the terminal stopped. There are three ways that the `rtrv-slk` command can be canceled.

- Press the F9 function key on the keyboard at the terminal where the `rtrv-slk` command was entered.
- Enter the `canc-cmd` without the `trm` parameter at the terminal where the `rtrv-slk` command was entered.
- Enter the `canc-cmd:trm=<xx>`, where `<xx>` is the terminal where the `rtrv-slk` command was entered, from another terminal other than the terminal where the `rtrv-slk` command was entered. To enter the `canc-cmd:trm=<xx>` command, the terminal must allow Security Administration commands to be entered from it and the user must be allowed to enter Security Administration commands. The terminal's permissions can be verified with the `rtrv-secu-trm` command. The user's permissions can be verified with the `rtrv-user` or `rtrv-secu-user` commands.

For more information about the `canc-cmd` command, go to *Commands User's Guide*.

1. Display the current link configuration using the `rtrv-slk` command.

This is an example of the possible output.

```
rlghncxa03w 09-07-19 21:16:37 GMT EAGLE5 41.1.0
```

LOC	LINK	LSN	SLC	TYPE	L2T SET	BPS	ECM	PCR N1	PCR N2
1201	A	ls01	0	LIMDS0	1	56000	BASIC	----	-----
1201	B	lsa1	0	LIMDS0	1	56000	BASIC	----	-----
1203	A	ls03	0	LIMDS0	3	56000	BASIC	----	-----
1203	B	lsa2	0	LIMDS0	1	56000	BASIC	----	-----
1204	B	ls01	1	LIMDS0	1	56000	BASIC	----	-----
1207	A	lsn1207a	0	LIMDS0	1	56000	BASIC	----	-----
1207	B	lsn1207b	0	LIMDS0	1	56000	BASIC	----	-----
1208	B	ls03	1	LIMDS0	3	56000	BASIC	----	-----
1213	B	ls05	0	LIMDS0	5	56000	BASIC	----	-----
1215	A	ls05	1	LIMDS0	5	56000	BASIC	----	-----
1311	A	ls01	2	LIMDS0	1	56000	BASIC	----	-----
1311	A1	ls05	2	LIMDS0	5	56000	BASIC	----	-----
1311	B	ls03	2	LIMDS0	3	56000	BASIC	----	-----
1311	B1	ls07	1	LIMDS0	7	56000	BASIC	----	-----
1313	A	ls07	0	LIMDS0	7	56000	BASIC	----	-----

LOC	LINK	LSN	SLC	TYPE	LP SET	BPS	ATM TSEL	VCI
1302	A	atmansio	0	LIMATM	3	1544000	EXTERNAL	35
15	0							
1305	A	atmansil	0	LIMATM	4	1544000	INTERNAL	100
20	2							
1318	A	atmansio	1	LIMATM	9	1544000	LINE	150
25	4							

ATM LOC	LINK	LSN	SLC	E1ATM TYPE	LP SET	BPS	TSEL	VCI	VPI
2101	A	atmitu1	0	LIME1ATM	5	2.048M	LINE	150	2

```
ON 1 20
2105 A atmitu1 1 LIME1ATM 5 2.048M LINE 35 15 ON 2
15
```

```
LOC LINK LSN SLC TYPE IPLIML2
2202 A lsnlp1 0 IPLIM SAALTALI
2205 A lsnip1 1 IPLIM M2PA
2204 B lsnlp2 0 IPLIM M2PA
2213 A lsnip5 0 IPLIMI M2PA
2215 A lsnlp2 1 IPLIM SAALTALI
```

```
LOC LINK LSN SLC TYPE
2207 A lsnlp3 0 SS7IPGW
2211 A lsnlp4 0 IPGWI
```

SLK table is (27 of 1200) 2% full

2. Display the linkset that contains the signaling link that is being removed by entering the `rtrv-ls` command with the name of the linkset shown in the `LSN` column of the `rtrv-slkslk` output.

For this example, enter these commands.

```
rtrv-ls:lsn=lsnlp3
```

This is an example of the possible output.

```
rlghncxa03w 10-07-17 11:43:04 GMT EAGLE5 42.0.0
```

```

                L3T SLT                GWS GWS GWS
LSN            APCA  (SS7)  SCRN SET SET BEI LST LNKS ACT MES DIS SLSCI
NIS
lsnlp3        002-009-003  scr2 1  1  no  a  1  on  off on  no
off
```

```

                SPCA                CLLI                TFATCABMLQ MTPRSE ASL8
-----
1                no                no
```

```
RANDSLS
off
```

```
IPSG IPGWAPC GTTMODE                CGGTMOD
no   yes    CdPA                no
```

```
MATELSN  IPTPS  LSUSEALM  SLKUSEALM
-----  32000  100%    80%
```

```
LOC LINK SLC TYPE
1201 A 0 SS7IPGW
```

Link set table is (20 of 1024) 2% full

If the linkset type of the linkset is A, B, D, E, or PRX, continue the procedure with [5](#).

If the linkset type of the linkset is C, continue the procedure with [3](#).

3. Display the `LSRESTRICT` option value by entering the `rtrv-ss7opts` command. This is an example of the possible output.

```
rlghncxa03w 10-07-30 15:09:00 GMT 42.0.0

SS7 OPTIONS
-----
LSRESTRICT      on
```

 **Note:**

The `rtrv-feat` command output contains other fields that are not used by this procedure. If you wish to see all the fields displayed by the `rtrv-feat` command, refer to the `rtrv-feat` command description in *Commands User's Guide*.

The signaling link cannot be removed, if the `LSRESTRICT` option is `on` and the number of signaling links assigned to the linkset will be less than the value of the `tfatcabmlq` parameter value of the linkset if the signaling link is removed.

If the `LSRESTRICT` option is `on` and the number of signaling links assigned to the linkset will be equal to or greater than the value of the `tfatcabmlq` parameter value of the linkset if the signaling link is removed, continue the procedure with 5.

If the `LSRESTRICT` option is `on` and the number of signaling links assigned to the linkset will be less than the value of the `tfatcabmlq` parameter value of the linkset if the signaling link is removed, the signaling link cannot be removed unless the `tfatcabmlq` parameter value of the linkset is changed to 0. Continue the procedure with 4.

If the `LSRESTRICT` value is `off`, continue the procedure with 5.

4. Change the `tfatcabmlq` parameter value of the linkset to 0 by entering the `chg-ls` command with the name of the linkset that contains the signaling link that is being removed and the `tfatcabmlq` parameters. For this example, enter this command.

```
chg-ls:lsn=ls17:tfatcabmlq=0
```

When this command has successfully completed, this message should appear.

```
rlghncxa03w 10-07-07 08:41:12 GMT EAGLE5 42.0.0

Link set table is (20 of 1024) 2% full.

CHG-LS: MASP A - COMPLTD
```

5. Any in-service **IP** connections on the signaling link being removed in this procedure must be placed out of service.

Have the far-end node for the signaling link being removed place the **M3UA** or **SUA** associations in either the **ASP-INACTIVE** or **ASP-DOWN** state.

6. Display the **IP** link associated with the card that the signaling link being removed the database is assigned to. Enter the `rtrv-ip-lnk` command with the card location of the signaling link being removed shown in 1. For this example, enter this command.

```
rtrv-ip-lnk:loc=2207
```

The following is an example of the possible output.

```
rlghncxa03w 06-10-28 21:14:37 GMT EAGLE5 36.0.0
LOC  PORT IPADDR          SUBMASK          DUPLEX  SPEED MACTYPE AUTO
MCAST
2207 A    192.1.1.10          255.255.255.128 HALF      10    802.3  NO  NO
2207 B    -----             -----          HALF      10    DIX    NO  NO
```

7. Display the **IP** host information associated with the **IP** link by entering the `rtrv-ip-host` command with the **IP** address shown in 6. For this example, enter these commands.

```
rtrv-ip-host:ipaddr=192.001.001.010
```

The following is an example of the possible output.

```
rlghncxa03w 08-12-28 21:17:37 GMT EAGLE5 40.0.0

LOCAL IPADDR    LOCAL HOST
192.1.1.10      IPNODE1_2207

IP Host table is (11 of 4096) .26% full
```

8. Display the associations associated with the local host name shown in 7 by entering the `rtrv-assoc` command. For this example, enter this command.

```
rtrv-assoc:lhost=ipnode1_2207
```

This is an example of possible output.

```
rlghncxa03w 06-10-28 09:12:36 GMT EAGLE5 36.0.0
CARD IPLNK
ANAME          LOC  PORT  LINK ADAPTER LPORT RPORT OPEN ALW
assoc1         2207 A    A    M3UA    1030 1030 YES  YES
```

```
IP Appl Sock/Assoc table is (4 of 4000) 1% full
Assoc Buffer Space Used (16 KB of 3200 KB) on LOC = 2207
```

9. Change the value of the `open` and `alw` parameters to `no` by specifying the `chg-assoc` command with the `open=no` and `alw=no` parameters, as necessary. For this example, enter this command.

 **Note:**

If there is no association shown in 7, or the `open` and `alw` parameter values of the association shown in 7 are `no`, continue the procedure with 10.

```
chg-assoc:aname=assoc1:open=no:alw=no
```

When this command has successfully completed, this message should appear.

```
rlghncxa03w 06-10-28 09:12:36 GMT EAGLE5 36.0.0
CHG-ASSOC: MASP A - COMPLTD;
```

- Deactivate the link to be removed using the `dact-slk` command, using the output from [1](#) to obtain the card location and `link` parameter value of the signaling link to be removed. For this example, enter these commands.

```
dact-slk:loc=2207:link=a
```

When each of these command has successfully completed, this message should appear.

```
rlghncxa03w 06-10-07 08:41:12 GMT EAGLE5 36.0.0
Deactivate Link message sent to card
```

- Verify that the link is out of service - maintenance disabled (**OOS-MT-DSBLD**) using the `rept-stat-slk` command with the card location and `link` parameter values specified in [10](#). For this example, enter these commands.

```
rept-stat-slk:loc=2207:link=a
```

This is an example of the possible output.

```
rlghncxa03w 06-10-23 13:06:25 GMT EAGLE5 36.0.0
SLK      LSN      CLLI      PST      SST      AST
2207,A  ls04      ls04clli  OOS-MT   Unavail  ----
  ALARM STATUS      = *    0235 REPT-LNK-MGTINH: local inhibited
  UNAVAIL REASON    = LI
```

- Place the card that contains the signaling link shown in [11](#) out of service by entering the `rmv-card` command specifying the card location shown in [11](#). For this example, enter this command.

```
rmv-card:loc=2207
```

When this command has successfully completed, this message should appear.

```
rlghncxa03w 06-10-07 08:41:12 GMT EAGLE5 36.0.0
Card has been inhibited.
```

- Verify that the card has been inhibited by entering the `rept-stat-card` command with the card location specified in [12](#). For this example, enter this command.

```
rept-stat-card:loc=2207
```

This is an example of the possible output.

```
rlghncxa03w 07-05-27 16:43:42 GMT EAGLE5 37.0.0
CARD  VERSION  TYPE  GPL  PST  SST
```

```

AST
2207 114-001-000 DCM          SS7IPGW  OOS-MT-DSBLD  Isolated  -----
ALARM STATUS      = ** 0013 Card is isolated from the system
BPDCM GPL         = 002-102-000
IMT BUS A         = Disc
IMT BUS B         = Disc
SIGNALING LINK STATUS
  SLK  PST          LS          CLLI          E5IS
  A    OOS-MT      lsnlp1      -----      INACTIVE

```

Command Completed.

- Remove the signaling link from the **EAGLE** using the `dlt-slk` command. If there is only one signaling link in the linkset, the `force=yes` parameter must be specified to remove the signaling link.

In the example used in this procedure, the signaling link is the last signaling link in the linkset. Enter this command.

```
dlt-slk:loc=2207:link=a:force=yes
```

When this command has successfully completed, this message should appear.

```

rlghncxa03w 06-10-07 08:41:17 GMT  EAGLE5 36.0.0
DLT-SLK: MASP A - COMPLTD

```

 **Note:**

If removing the signaling link will result in 700 or less signaling links in the database and the `OAMHCMEAS` value in the `rtrv-measopts` output is on, the scheduled UI measurement reports will be enabled.

- Verify the changes using the `rtrv-slk` command, with the card location and link values specified in 14. For this example, enter this command.

```
rtrv-slk:loc=2207:link=a
```

When the `rtrv-slk` command has completed, no entry is displayed showing that the signaling link has been removed.

```

rlghncxa03w 09-09-18 13:43:31 GMT  EAGLE5 41.1.0
E2373 Cmd Rej: Link is unequipped in the database

```

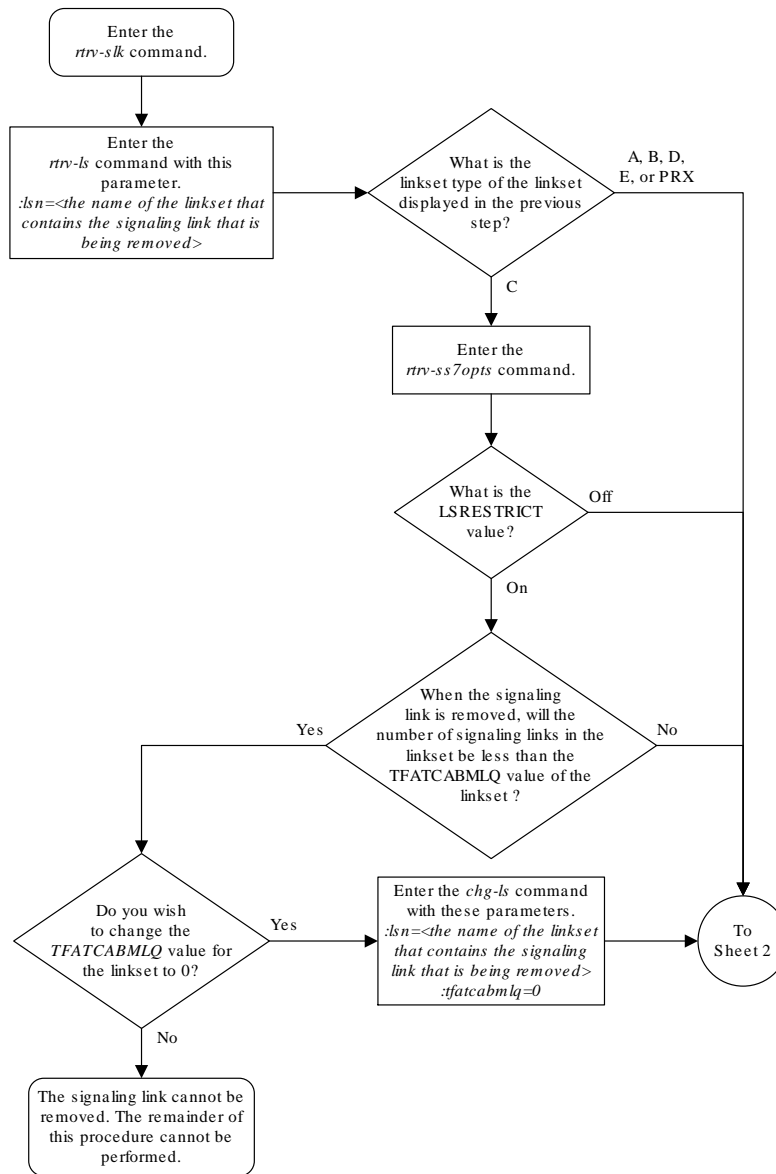
- Back up the new changes using the `chg-db:action=backup:dest=fixed` command. These messages should appear, the active **Maintenance and Administration Subsystem Processor (MASP)** appears first.

```

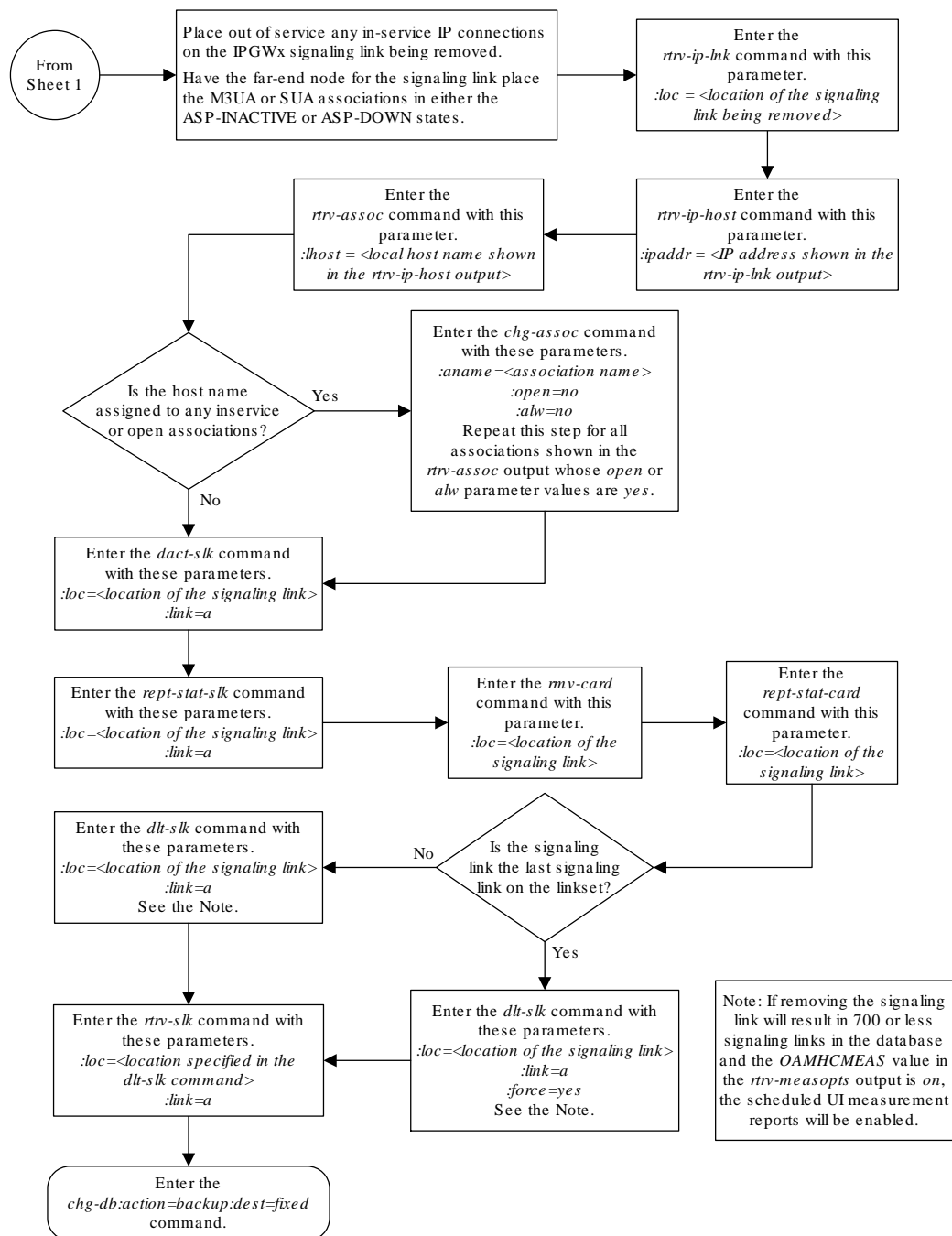
BACKUP (FIXED) : MASP A - Backup starts on active MASP.
BACKUP (FIXED) : MASP A - Backup on active MASP to fixed disk complete.
BACKUP (FIXED) : MASP A - Backup starts on standby MASP.
BACKUP (FIXED) : MASP A - Backup on standby MASP to fixed disk complete.

```


Figure 4-27 Removing an IPGWx Signaling Link



Sheet 1 of 2



Sheet 2 of 2

4.21 Removing a Mate IPGWx Linkset from another IPGWx Linkset

This procedure is used to remove a mate **IPGWx** linkset from an existing **IPGWx** linkset `chg-ls` command with these parameters.

:lsn – The name of the IPGWx linkset that contains the mate IPGWx Linkset that is being removed, shown in the `rept-stat-iptps` or `rtrv-ls` command outputs.

:matelsn – The name of the mate **IPGWx** linkset that is being removed.

:action=delete – removes the mate **IPGWx** linkset from the **IPGWx** linkset specified by the `lsn` parameter.

An **IPGWx** linkset is a linkset that contains signaling links assigned to **IPGWx** cards. **IPGWx** cards are cards running either the **SS7IPGW** or **IPGWI** applications.

The mate linkset name is displayed in the `rtrv-ls:lsn=<linkset name>` command output.

Before a mate **IPGWx** linkset can be removed from an **IPGWx** linkset, the card containing the **IPGWx** signaling link assigned to the mate linkset, and the signaling link assigned to that card must be placed out of service.

Other Optional Parameters

There are other optional parameters that can be used to configure a linkset. These parameters are not required for configuring an IPGWx linkset. These parameters are discussed in more detail in *Commands User's Guide* or in these sections.

- These procedures in this manual:
 - [Configuring an IPGWx Linkset](#)
 - [Adding a Mate IPGWx Linkset to another IPGWx Linkset](#)
 - [Adding an IPSP M3UA Linkset](#)
 - [Adding an IPSP M2PA Linkset](#)
 - [Changing an IPSP M3UA Linkset](#)
 - [Changing an IPSP M2PA Linkset](#)
 - These procedures in the *Database Administration - SS7 User's Guide*
 - Adding an SS7 Linkset
 - Changing an SS7 Linkset
 - Configuring an ITU Linkset with a Secondary Adjacent Point Code (SAPC)
 - The "Configuring a Linkset for the GSM MAP Screening Feature" procedure in *Database Administration - Features User's Guide*.
1. Display the system-wide **IP** TPS usage report, and the **IPGWx** linksets, by entering the `rept-stat-iptps` command. This is an example of the possible output.

```
rlghncxa03w 10-07-19 21:16:37 GMT EAGLE5 42.0.0
IP TPS USAGE REPORT
```

```

          THRESH  CONFIG/  CONFIG/          TPS   PEAK
PEAKTIMESTAMP          RSVD      MAX
-----
-----
LSN
```

```

lsgw1101      80%    ----    6000 TX:   5100    5500 05-02-10
11:40:04
                                     RCV:   5100    5500 05-02-10
11:40:04
lsgw1103      80%    ----    6000 TX:   5200    5500 05-02-10
11:40:04
                                     RCV:   5200    5500 05-02-10
11:40:04
lsgw1105      80%    ----   14000 TX:   7300    7450 05-02-10
11:40:04
                                     RCV:   7300    7450 05-02-10
11:40:04
lsgw1107      70%    ----    4000 TX:   3200    3500 05-02-10
11:40:04
                                     RCV:   3200    3500 05-02-10
11:40:04
-----

```

Command Completed.

If no entries are displayed in the `rept-stat-iptps` output, there are no IPGWx linksets in the database. This procedure cannot be performed.

If entries are displayed in the `rept-stat-iptps` output, continue the procedure with [2](#).

2. Display the attributes of all the linksets shown in the `rept-stat-iptps` output in [1](#) by entering the `rtrv-ls` command with the name of each linkset shown in the `rept-stat-iptps` output in [1](#). For this example, enter these commands.

```
rtrv-ls:lsn=lsgw1101
```

This is an example of the possible output.

```
rlghncxa03w 08-04-17 11:43:04 GMT EAGLE5 38.0.0
```

```

                L3T SLT                GWS GWS GWS
LSN            APCA  (SS7)  SCRN  SET SET BEI LST LNKS ACT MES DIS SLSCI
NIS
lsgw1101      008-012-003  none  1  1  no  A  1  off off off no
off

```

```

CLLI            TFATCABMLQ MTPRSE ASL8
----- 1                no    no

```

```

IPGWAPC MATELSN    IPTPS LSUSEALM SLKUSEALM GTTMODE
yes      ----- 10000 70    % 70    % CdPA

```

```

LOC LINK SLC TYPE
1101 A  0  SS7IPGW

```

Link set table is (14 of 1024) 1% full

```
rtrv-ls:lsn=lsgw1103
```

This is an example of the possible output.

```
rlghncxa03w 08-04-17 11:43:04 GMT EAGLE5 38.0.0

LSN          APCA   (SS7)  SCRN   L3T SLT          GWS GWS GWS
SLSCI NIS
lsgw1103     003-002-004  none  1    1    no  A    1    off off off
no          off

          CLLI          TFATCABMLQ MTPRSE  ASL8
          -----  1          no      no

IPGWAPC MATELSN   IPTPS LSUSEALM SLKUSEALM GTTMODE
yes      lsgw1107  10000 70      % 70      % CdPA

LOC LINK SLC TYPE
1103 A   0   SS7IPGW
```

Link set table is (14 of 1024) 1% full

```
rtrv-ls:lsn=lsgw1105
```

This is an example of the possible output.

```
rlghncxa03w 08-04-17 11:43:04 GMT EAGLE5 38.0.0

LSN          APCA   (SS7)  SCRN   L3T SLT          GWS GWS GWS
SLSCI NIS
lsgw1105     009-002-003  none  1    1    no  A    1    off off off
no          off

          CLLI          TFATCABMLQ MTPRSE  ASL8
          -----  1          no      no

IPGWAPC MATELSN   IPTPS LSUSEALM SLKUSEALM GTTMODE
yes      -----  10000 70      % 70      % CdPA

LOC LINK SLC TYPE
1105 A   0   SS7IPGW
```

Link set table is (14 of 1024) 1% full

```
rtrv-ls:lsn=lsgw1107
```

This is an example of the possible output.

```
rlghncxa03w 08-04-17 11:43:04 GMT EAGLE5 38.0.0

LSN          APCA   (SS7)  SCRN   L3T SLT          GWS GWS GWS
SLSCI NIS
lsgw1107     007-002-004  none  1    1    no  A    1    off off off
no          off

          CLLI          TFATCABMLQ MTPRSE  ASL8
          -----  1          no      no

IPGWAPC MATELSN   IPTPS LSUSEALM SLKUSEALM GTTMODE
yes      -----  10000 70      % 70      % CdPA

LOC LINK SLC TYPE
1107 A   0   SS7IPGW
```

```

SLSCI NIS
lsgw1107      010-020-005  none  1   1   no  A   1   off off off no
off

          CLLI          TFATCABMLQ MTPRSE ASL8
          ----- 1             no     no

IPGWAPC MATELSN      IPTPS LSUSEALM SLKUSEALM GTTMODE
yes      ----- 10000 70      % 70      % CdPA

LOC LINK SLC TYPE
1107 A   0   SS7IPGW

```

Link set table is (14 of 1024) 1% full

If none of the linksets displayed in this step contain a mate IPGWx linkset, shown in the MATELSN column, this procedure cannot be performed.

If any of the linksets displayed in this step contain a mate IPGWx linkset, shown in the MATELSN column, continue this procedure with one of these steps.

- If a signaling link is assigned to the mate linkset, continue the procedure with [3](#).
 - If a signaling link is not assigned to the mate linkset, continue the procedure with [12](#).
- 3.** Display the status of the card containing the signaling link that is assigned to the mate IPGWx linkset that is being removed by entering the `rept-stat-card` command with the card location shown in the `LOC` column for the mate IPGWx linkset shown in [2](#). For this example, enter this command.

```
rept-stat-card:loc=1107
```

This is an example of the possible output.

```

rlghncxa03w 08-04-27 17:00:36 GMT EAGLE5 38.0.0
CARD VERSION      TYPE   GPL      PST          SST      AST
1107 114-000-000  EDCM   SS7IPGW  IS-NR        Active   -----
  ALARM STATUS    = No Alarms.
  BPDCM GPL       = 002-102-000
  IMT BUS A       = Conn
  IMT BUS B       = Conn
  SIGNALING LINK STATUS
    SLK   PST          LS          CLLI
    A     IS-NR        lsgw1107   -----
Command Completed.

```

If the status of the card is out-of-service maintenance disabled (OOS-MT-DSBLD), continue the procedure with [12](#).

If the status of the card is not out-of-service maintenance disabled (OOS-MT-DSBLD), continue the procedure with [4](#).

- 4.** Display the status of the signaling link assigned to the card shown in [3](#) by entering the `rept-stat-slk` command with the card location used in [3](#) and the `link=a` parameter. For this example, enter this command.

```
rept-stat-slk:loc=1107:link=a
```

This is an example of the possible output.

```
rlghncxa03w 08-04-27 17:00:36 GMT EAGLE5 38.0.0
SLK      LSN      CLLI      PST      SST      AST
1107,A   lsgw1107  -----  IS-NR    Avail    -----
  ALARM STATUS      = No Alarms.
  UNAVAIL REASON    = NA
Command Completed.
```

If the status of the signaling link is out-of-service maintenance disabled (OOS-MT-DSBLD), continue the procedure with [12](#).

If the status of the signaling link is not out-of-service maintenance disabled (OOS-MT-DSBLD), any in-service IP connections on the signaling link must be placed out of service. Continue the procedure by performing one of these steps.

- The recommended method is to have the far end node place these **IP**connections out of service. Have the far-end node for the signaling link shown in [4](#) place the **M3UA** or **SUA** associations in either the **ASP-INACTIVE** or **ASP-DOWN** state. After the IP connections have been placed out of service, continue the procedure with [10](#).
 - If you do not wish to have the far end node place these **IP**connections out of service, continue the procedure with [5](#).
5. Display the **IP** link associated with the card that the signaling link shown in [4](#) is assigned to by entering the `rtrv-ip-lnk` command with the card location shown in [4](#). For this example, enter this command.

```
rtrv-ip-lnk:loc=1107
```

The following is an example of the possible output.

```
rlghncxa03w 08-04-28 21:14:37 GMT EAGLE5 38.0.0
LOC  PORT  IPADDR      SUBMASK      DUPLEX  SPEED  MACTYPE
AUTO MCAST
1107 A    192.3.1.10  255.255.255.128  HALF    10     802.3
NO   NO
1107 B    -----    -----    HALF    10     DIX
NO   NO
```

6. Display the **IP** host information associated with the **IP** link by entering the `rtrv-ip-host` command with the **IP** address shown in [5](#). For this example, enter this command.

```
rtrv-ip-host:ipaddr=192.003.001.010
```

The following is an example of the possible output.

```
rlghncxa03w 13-06-28 21:17:37 GMT EAGLE5 45.0.0

LOCAL IPADDR      LOCAL HOST
192.3.1.10        IPNODE1_1107
```

IP Host table is (11 of 4096) .26% full

7. Display the association associated with the local host name shown in 6 by entering the `rtrv-assoc` command.

For this example, enter this command.

```
rtrv-assoc:lhost=ipnode1_1107
```

This is an example of possible output.

```
rlghncxa03w 08-04-28 09:12:36 GMT EAGLE5 38.0.0
                CARD IPLNK
ANAME          LOC  PORT  LINK ADAPTER LPORT RPORT OPEN ALW
assoc1         1107 A    A    M3UA    1030  1030 YES  YES
```

IP Appl Sock/Assoc table is (4 of 4000) 1% full
Assoc Buffer Space Used (16 KB of 3200 KB) on LOC = 1107

8. Change the `alw` parameter values in the association shown in 7 using the `chg-assoc` command with the `alw=no` parameters, as necessary.

 **Note:**

If the `open` and `alw` parameter values of the association shown in 7 are `no`, continue the procedure with 10.

```
chg-assoc:aname=assoc1:alw=no
```

 **Caution:**

This command impacts network performance and should only be used during periods of low traffic.

When this command has successfully completed, this message should appear.

```
rlghncxa03w 08-04-28 09:12:36 GMT EAGLE5 38.0.0
CHG-ASSOC: MASP A - COMPLTD
```

Repeat this step for all associations shown in 7.

9. Change the `open` parameter values in the association shown in 7 using the `chg-assoc` command with the `open=no` parameters, as necessary.

```
chg-assoc:aname=assoc1:open=no
```


When this command has successfully completed, this message should appear.

```
rlghncxa03w 08-04-28 09:12:36 GMT EAGLE5 38.0.0
CHG-ASSOC: MASP A - COMPLTD
```

Repeat this step for all associations shown in 7.

10. Deactivate the signaling link assigned to the **IP** card using the `dact-slk` command. For example, enter this command.

```
dact-slk:loc=1107:link=a (for the removing a mate linkset example)
```

 **Caution:**

This command impacts network performance and should only be used during periods of low traffic.

After this command has successfully completed, this message appears.

```
rlghncxa03w 08-04-12 09:12:36 GMT EAGLE5 38.0.0
Deactivate Link message sent to card.
```

11. Inhibit the **IP** card using the `inh-card` command. For example, enter this command.

```
inh-card:loc=1107 (for the removing a mate linkset example)
```

This message should appear.

```
rlghncxa03w 08-04-28 21:18:37 GMT EAGLE5 38.0.0
Card has been inhibited.
```

12. Change the linkset shown in 2 by entering the `chg-ls` command with the `matelsn` and `action=delete` parameter.

For this example, enter this command.

```
chg-ls:lsn=lsgw1103:matelsn=lsgw1107:action=delete
```

When the `chg-ls` command has successfully completed, this message should appear.

```
rlghncxa03w 08-04-17 16:23:21 GMT EAGLE5 38.0.0
Link set table is ( 14 of 1024) 1% full
CHG-LS: MASP A - COMPLTD
```

13. Verify the changes using the `rtrv-ls` command specifying the linkset name specified in 12 with the `lsn` parameter. For this example, enter this command.

```
rtrv-ls:lsn=lsgw1103
```

This is an example of the possible output.

```
rlghncxa03w 08-04-17 11:43:04 GMT EAGLE5 38.0.0

LSN          APCA   (SS7)  SCRN   L3T SLT          GWS GWS GWS
NIS
lsgw1103     003-002-004  none  1    1    no  A    1    off off off no
off

          CLLI          TFATCABMLQ MTPRSE ASL8
          ----- 1          no    no

IPGWAPC  MATELSN    IPTPS LSUSEALM SLKUSEALM GTTMODE
yes      ----- 10000 70    % 70    % CdPA

LOC  LINK  SLC  TYPE
1103 A    0    SS7IPGW
```

Link set table is (14 of 1024) 1% full

If the linkset shown in this step does not have a signaling link assigned to it, continue the procedure with [18](#).

If the linkset shown in this step has a signaling link assigned to it, continue the procedure with [14](#).

14. Allow the **IP** card that was inhibited in [11](#) using the `alw-card` command. For example, enter this command.

```
alw-card:loc=1107
```

This message should appear.

```
rlghncxa03w 08-04-28 21:21:37 GMT EAGLE5 38.0.0
Card has been allowed.
```

15. Activate the signaling link from [10](#) using the `act-slk` command. For example, enter one of these commands.

```
act-slk:loc=1107:link=a
```

The output confirms the activation.

```
rlghncxa03w 08-04-07 11:11:28 GMT EAGLE5 38.0.0
Activate Link message sent to card
```

16. Change the `open` and `alw` parameter values for all the associations changed in [8](#) or [9](#) using the `chg-assoc` command with the `open=yes` and `alw=yes` parameters.

 **Note:**

If [8](#) and [9](#) were not performed, continue the procedure with [17](#).

```
chg-assoc:aname=assoc1:open=yes:alw=yes
```

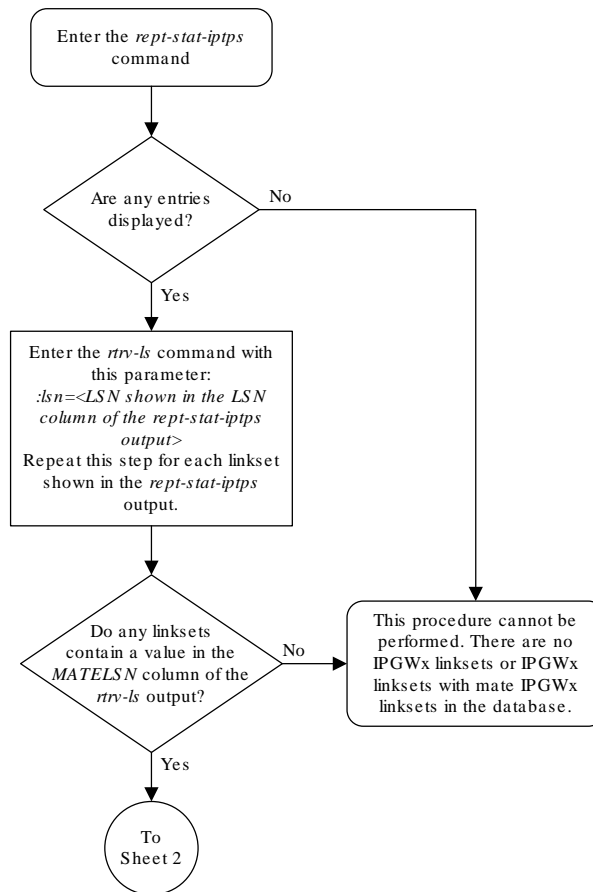
When this command has successfully completed, this message should appear.

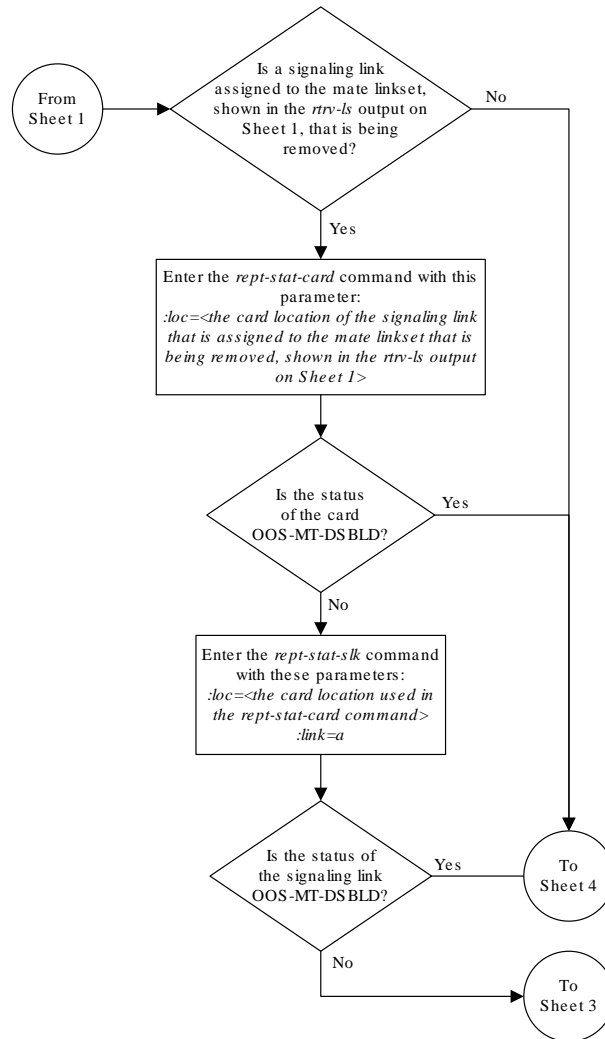
```
rlghncxa03w 08-04-28 09:12:36 GMT EAGLE5 38.0.0  
CHG-ASSOC: MASP A - COMPLTD
```

17. Have the far-end node for the signaling link shown in 13 place the **M3UA** or **SUA** associations in the **ASP-ACTIVE** state to place the **IP** connections on the signaling link into service.
18. Back up the new changes using the `chg-db:action=backup:dest=fixed` command. These messages should appear, the active **Maintenance and Administration Subsystem Processor (MASP)** appears first.

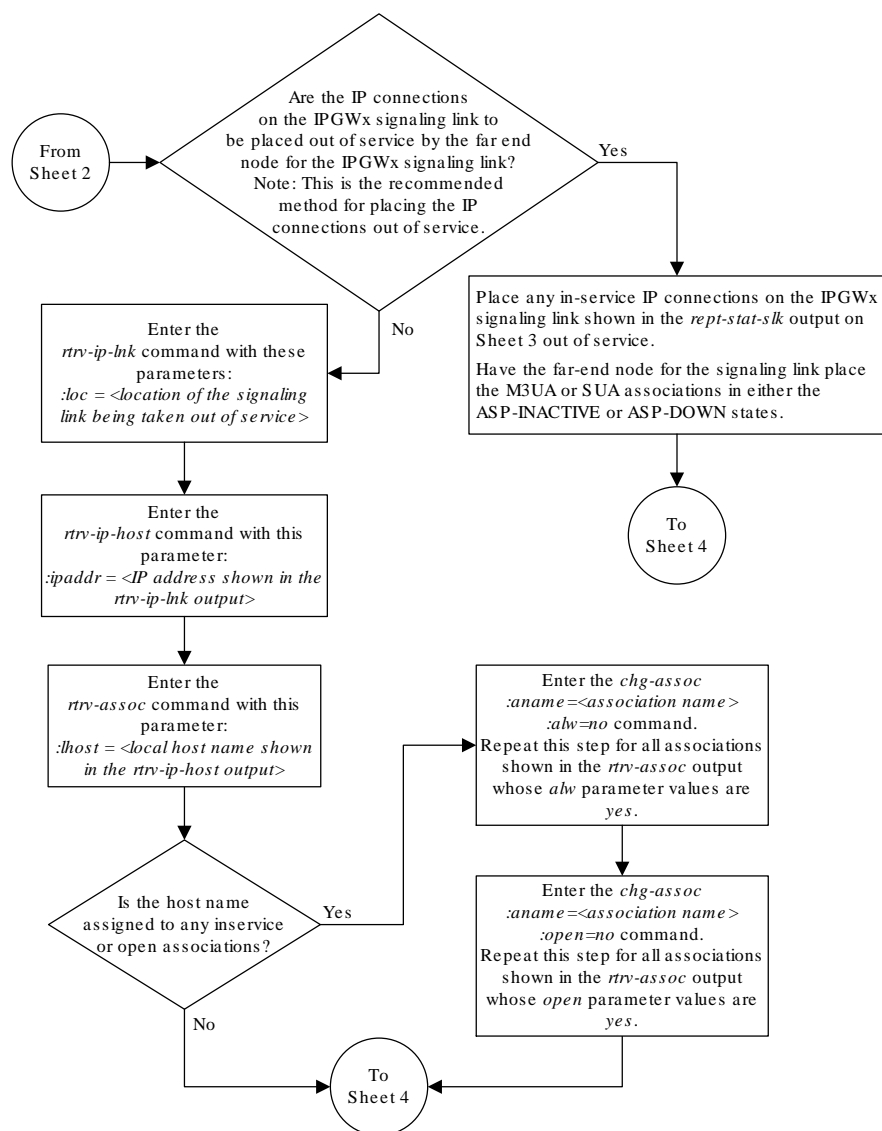
```
.  
  
BACKUP (FIXED) : MASP A - Backup starts on active MASP.  
BACKUP (FIXED) : MASP A - Backup on active MASP to fixed disk  
complete.  
BACKUP (FIXED) : MASP A - Backup starts on standby MASP.  
BACKUP (FIXED) : MASP A - Backup on standby MASP to fixed disk  
complete.
```

Figure 4-28 Removing a Mate IPGWx Linkset from another IPGWx Linkset

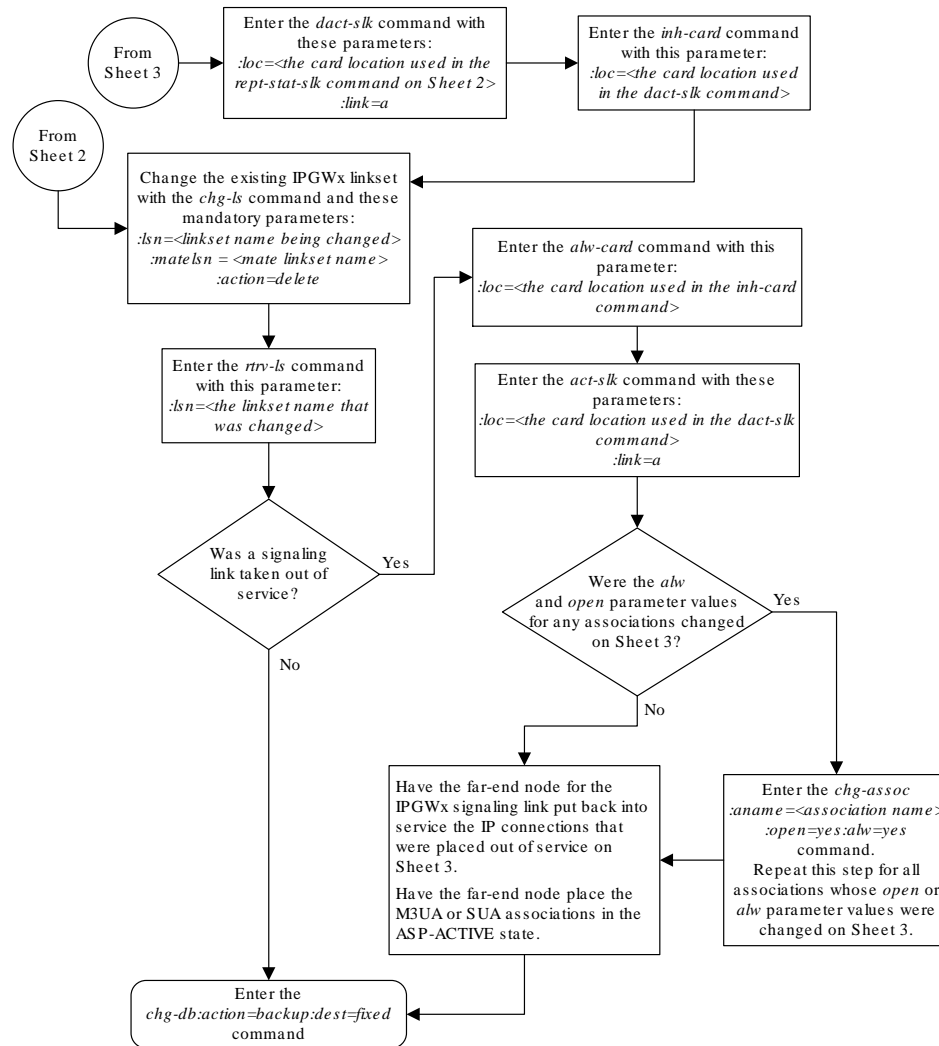




Sheet 2 of 4



Sheet 3 of 4



Sheet 4 of 4

4.22 Removing an IP Host Assigned to an IPGWx Card

This procedure removes an IP host that is assigned to an IPGWx card using the `dlt-ip-host` command.

The `dlt-ip-host` command uses the following parameter.

`:host=` Hostname. The hostname to be removed. This parameter identifies the logical name assigned to a device with an IP address.

No associations can reference the host name being removed in this procedure.

The associations referencing the host name can be removed by performing the [Removing a M3UA or SUA Association](#) procedure or the host name in these associations can be changed by performing the [Changing the Host Values of a M3UA or SUA Association](#) procedure. The host name assigned to associations is displayed in the `rtrv-assoc` outputs.

1. Display the current **IP** host information in the database by entering the `rtrv-ip-host:display=all` command.

The following is an example of the possible output.

```
rlghncxa03w 08-12-28 21:17:37 GMT EAGLE5 40.0.0

LOCAL IPADDR      LOCAL HOST
192.1.1.10        IPNODE1-1201
192.1.1.12        IPNODE1-1203
192.1.1.14        IPNODE1-1205
192.1.1.20        IPNODE2-1201
192.1.1.22        IPNODE2-1203
192.1.1.24        IPNODE2-1205
192.1.1.30        KC-HLR1
192.1.1.32        KC-HLR2
192.1.1.50        DN-MS1
192.1.1.52        DN-MS2
192.3.3.33        GW100. NC. TEKELEC. COM

REMOTE IPADDR     REMOTE HOST
150.1.1.5         NCDEPTECONOMIC_DEVELOPMENT. SOUTHEASTERN_COORIDOR_ASHVL.
GOV

IP Host table is (12 of 4096) 0.29% full
```

If the IP host that is being removed is a remote host, continue the procedure with [5](#).

If the IP host that is being removed is a local host, continue the procedure with [2](#).

2. Display the current link parameters associated with the **IP** card in the database by entering the `rtrv-ip-lnk` command. The following is an example of the possible output.

```
rlghncxa03w 08-12-28 21:14:37 GMT EAGLE5 40.0.0
LOC  PORT  IPADDR          SUBMASK          DUPLEX  SPEED  MACTYPE  AUTO
MCAST
1303  A     192.1.1.10      255.255.255.128  HALF    10     802.3    NO   NO
1303  B     -----         -----         HALF    10     DIX      NO   NO
1305  A     192.1.1.12      255.255.255.0   ----    ---    DIX      YES  NO
1305  B     -----         -----         HALF    10     DIX      NO   NO
1313  A     192.1.1.14      255.255.255.0   FULL    100    DIX      NO   NO
1313  B     -----         -----         HALF    10     DIX      NO   NO
2101  A     192.1.1.20      255.255.255.0   FULL    100    DIX      NO   NO
2101  B     -----         -----         HALF    10     DIX      NO   NO
2103  A     192.1.1.22      255.255.255.0   FULL    100    DIX      NO   NO
2103  B     -----         -----         HALF    10     DIX      NO   NO
```



```

2105 A 192.1.1.24 255.255.255.0 FULL 100 DIX
NO NO
2105 B -----
NO NO
2205 A 192.1.1.30 255.255.255.0 FULL 100 DIX
NO NO
2205 B -----
NO NO
2207 A 192.1.1.32 255.255.255.0 FULL 100 DIX
NO NO
2207 B -----
NO NO
2213 A 192.1.1.50 255.255.255.0 FULL 100 DIX
NO NO
2213 B -----
NO NO
2301 A 192.1.1.52 255.255.255.0 FULL 100 DIX
NO NO
2301 B -----
NO NO
2305 A 192.3.3.33 255.255.255.0 FULL 100 DIX
NO NO
2305 B -----
NO NO

```

IP-LNK table is (22 of 2048) 1% full.

3. Display the cards in the database using the `rtrv-card` command. This is an example of the possible output.

```

rlghncxa03w 09-05-28 09:12:36 GMT EAGLE5 41.0.0
CARD TYPE APPL LSET NAME LINK SLC LSET NAME
LINK SLC
1101 DSM VSCCP
1102 TSM GLS
1113 E5MCAP EOAM
1114 E5TDM-A
1115 E5MCAP EOAM
1116 E5TDM-B
1117 E5MDAL
1201 LIMDS0 SS7ANSI sp2 A 0 sp1
B 0
1203 LIMDS0 SS7ANSI sp3 A 0
1204 LIMDS0 SS7ANSI sp3 A 1
1206 LIMDS0 SS7ANSI nsp3 A 1 nsp4
B 1
1301 LIMDS0 SS7ANSI sp6 A 1 sp7
B 0
1302 LIMDS0 SS7ANSI sp7 A 1 sp5
B 1
1303 DCM IPLIM ipnode1 A 0 ipnode3
B 1
1305 DCM IPLIM ipnode4 A 0
1313 DCM SS7IPGW ipgtwy1 A 0
2101 DCM SS7IPGW ipgtwy2 A 0

```

2103	DCM	SS7IPGW	ipgtwy3	A	0			
2105	DCM	IPLIM	ipnode1	A1	1	ipnode5	B	2
2205	DCM	IPLIM	ipnode3	A2	0	ipnode6	B1	2
2207	DCM	IPLIM	ipnode5	A	0	ipnode4	B3	1
2213	DCM	IPLIM	ipnode5	A3	1	ipnode3	B2	2
2301	DCM	IPLIM	ipnode6	A	0	ipnode1	B	2
2305	DCM	IPLIM	ipnode6	A1	1	ipnode1	B1	3

Select an **IP** host whose **IP address** is assigned to a card running the **SS7IPGW** or **IPGWI** application.

4. Display the associations referencing the host name being removed in this procedure by entering the `rtrv-assoc` command with the local host name.

For this example, enter this command.

```
rtrv-assoc:lhost="IPNODE1-1205"
```

The following is an example of the possible output.

```
rlghncxa03w 06-10-28 21:14:37 GMT EAGLE5 36.0.0
                CARD IPLNK
ANAME          LOC  PORT  LINK ADAPTER LPORT RPORT OPEN ALW
a2             1313 A    A    M3UA    7205  7001 NO  NO
```

```
IP Appl Sock/Assoc table is (4 of 4000) 1% full
Assoc Buffer Space Used (16 KB of 3200 KB) on LOC = 1203
```

If no associations referencing the host name being removed in this procedure are shown in this step, continue the procedure with [5](#).

Any associations referencing the host name must either be removed or the host name assigned to the association must be changed.

To remove the associations, perform the [Removing a M3UA or SUA Association](#) procedure.

Continue the procedure with [5](#) after the associations have been removed.

To change the host name assigned to the associations, perform the [Changing the Host Values of a M3UA or SUA Association](#) procedure.

Continue the procedure with [5](#) after the host name assigned to the associations have been changed.

5. Delete **IP** host information from the database by entering the `dlt-ip-host` command.

For example, enter this command.

```
dlt-ip-host:host="IPNODE1-1205"
```

When this command has successfully completed, the following message should appear.

```
rlghncxa03w 06-10-28 21:19:37 GMT EAGLE5 36.0.0
DLT-IP-HOST: MASP A - COMPLTD
```

6. Verify the changes by entering the `rtrv-ip-host` command with the host name specified in [5](#).

For this example, enter this command.

```
rtrv-ip-host:host="IPNODE1-1205"
```

The following is an example of the possible output.

```
rlghncxa03w 09-07-28 21:20:37 GMT EAGLE5 41.1.0
```

```
No matching entries found.
```

```
IP Host table is (10 of 4096) 0.24% full
```

7. Back up the new changes using the `chg-db:action=backup:dest=fixed` command.

These messages should appear, the active **Maintenance and Administration Subsystem Processor (MASP)** appears first.

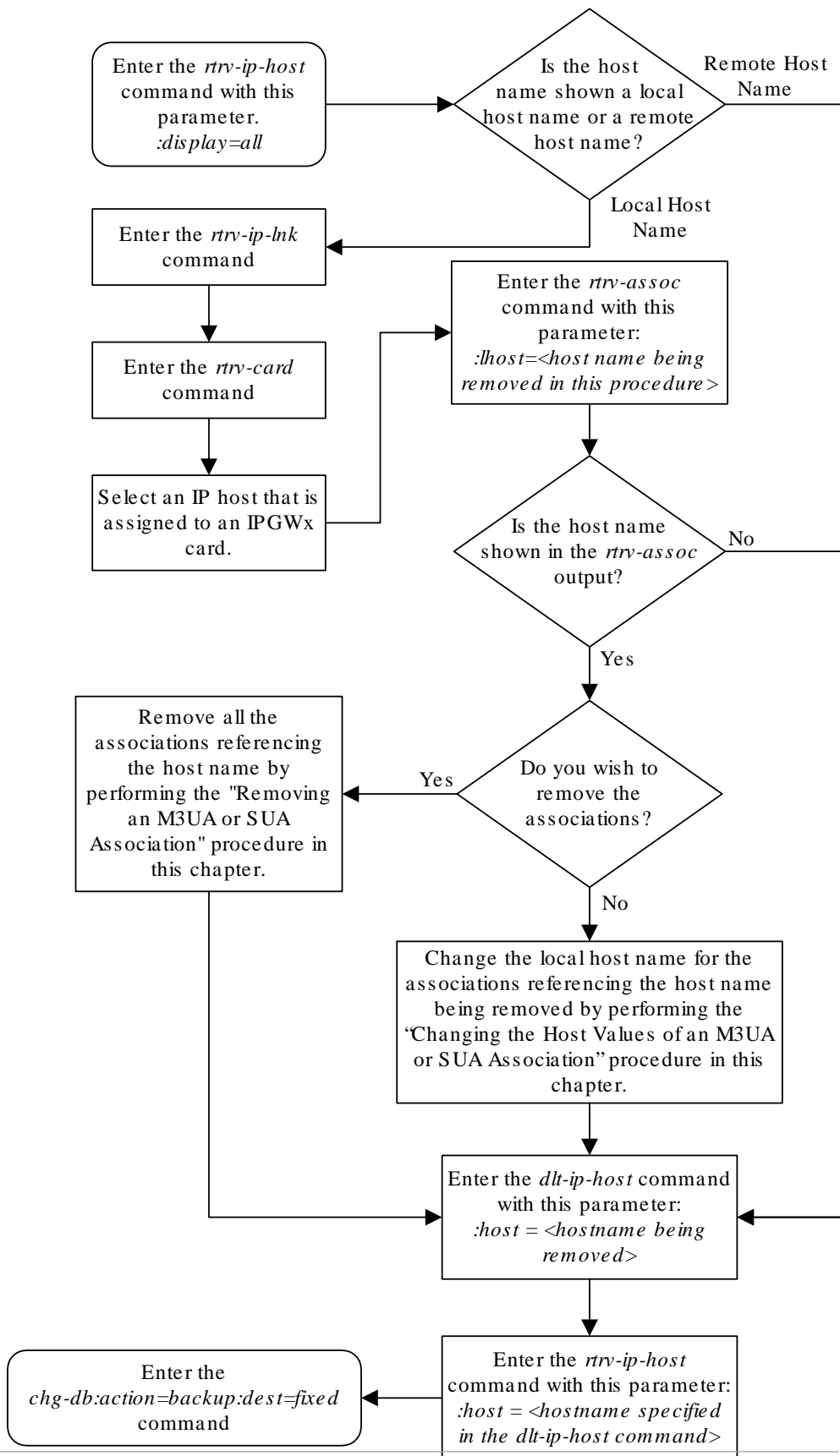
```
BACKUP (FIXED) : MASP A - Backup starts on active MASP.
```

```
BACKUP (FIXED) : MASP A - Backup on active MASP to fixed disk  
complete.
```

```
BACKUP (FIXED) : MASP A - Backup starts on standby MASP.
```

```
BACKUP (FIXED) : MASP A - Backup on standby MASP to fixed disk  
complete.
```

Figure 4-29 Removing an IP Host Assigned to an IPGWx Card



4.23 Removing an IP Route

This procedure is used to remove an **IP** route from the database using the `dlt-ip-rte` command.

The `dlt-ip-rte` command uses these parameters.

`:loc` – The location of the **IP** card containing the **IP** route being removed.

`:dest` – The **IP** address of the remote host or network assigned to the **IP** route being removed.

`:force` – To remove the **IP** route, the **IP** card that the route is assigned to must be out of service, or the `force=yes` parameter must be specified with the `dlt-ip-rte` command. The `force=yes` parameter allows the **IP** route to be removed if the **IP** card is in service.

▲ Caution:

Removing an **IP** route while the **IP** card is still in service can result in losing the ability to route outbound **IP** traffic on the **IP** card. This can cause both **TCP** and **SCTP** sessions on the **IP** card to be lost.

1. Display the **IP** routes in the database with the `rtrv-ip-rte` command.

This is an example of the possible output.

```
rlghncxa03w 06-10-28 09:12:36 GMT EAGLE5 36.0.0
LOC  DEST          SUBMASK          GTWY
1212 132.10.175.20    255.255.0.0      150.1.1.50
1301 128.252.10.5     255.255.255.255  140.188.13.33
1301 128.252.0.0      255.255.0.0      140.188.13.34
1301 150.10.1.1       255.255.255.255  140.190.15.3
1303 192.168.10.1     255.255.255.255  150.190.15.23
1303 192.168.0.0      255.255.255.0    150.190.15.24
```

IP Route table is (6 of 2048) 0.29% full

2. Verify the state of the **IP** card containing the **IP** route being removed by entering the `rept-stat-card` command and specifying the card location of the **IP** card.

The **IP** card should be in the out-of-service maintenance-disabled (**OOS-MT-DSBLD**) in order to remove the **IP** route. If the **IP** card's state is out-of-service maintenance-disabled, the entry `OOS-MT-DSBLD` is shown in the `PST` column of the `rept-stat-card` output. For this example, enter this command.

```
rept-stat-card:loc=1301
```

This is an example of the possible output.

```
rlghncxa03w 06-10-27 17:00:36 GMT EAGLE5 36.0.0
CARD  VERSION      TYPE      GPL      PST      SST      AST
```

```

1301 114-000-000 DCM      SS7IPGW  IS-NR      Active    -----
ALARM STATUS      = No Alarms.
BPDCM GPL         = 002-102-000
IMT BUS A         = Conn
IMT BUS B         = Conn
SIGNALING LINK STATUS
  SLK   PST                LS           CLLI
  A     IS-NR              nc001       -----

```

Command Completed.

 **Note:**

If the output of 2 shows that the **IP** card's state is not **OOS-MT-DSBLD**, and you do not wish to change the state of the **IP** card, continue the procedure with 4.

3. Change the **IP** card's state to **OOS-MT-DSBLD** using the `inh-card` command and specifying the card location of the **IP** card.

For this example, enter these commands.

```
inh-card:loc=1301
```

When this command has successfully completed, this message appears.

```
rlghncxa03w 06-10-12 09:12:36 GMT EAGLE5 36.0.0
Card has been inhibited.
```

4. Remove the **IP** route from the database using the `dlt-ip-rte` command.

If the state of the **IP** card is not **OOS-MT-DSBLD**, the `force=yes` parameter must be specified with the `dlt-ip-rte` command. For this example, enter this command.

```
dlt-ip-rte:loc=1301:dest=128.252.0.0
```

 **Caution:**

Removing an **IP** route while the **IP** card is still in service can result in losing the ability to route outbound **IP** traffic on the **IP** card. This can cause both **TCP** and **SCTP** sessions on the **IP** card to be lost.

When this command has successfully completed, this message should appear.

```
rlghncxa03w 06-10-12 09:12:36 GMT EAGLE5 36.0.0
DLT-IP-RTE: MASP A - COMPLTD
```

5. Verify the changes using the `rtrv-ip-rte` command.

This is an example of the possible output.

```
rlghncxa03w 06-10-28 09:12:36 GMT EAGLE5 36.0.0
LOC  DEST          SUBMASK          GTWY
1212 132.10.175.20    255.255.0.0      150.1.1.50
1301 128.252.10.5     255.255.255.255  140.188.13.33
1301 150.10.1.1       255.255.255.255  140.190.15.3
1303 192.168.10.1     255.255.255.255  150.190.15.23
1303 192.168.0.0      255.255.0.0      150.190.15.24
```

```
IP Route table is (5 of 2048) 0.24% full
```

6. Place the **IP** card back into service by using the `alw-card` command.

 **Note:**

If the **IP** card containing the **IP** route that was removed from the database does not contain other **IP** routes, continue the procedure with [7](#).

For example, enter this command.

```
alw-card:loc=1301
```

This message should appear.

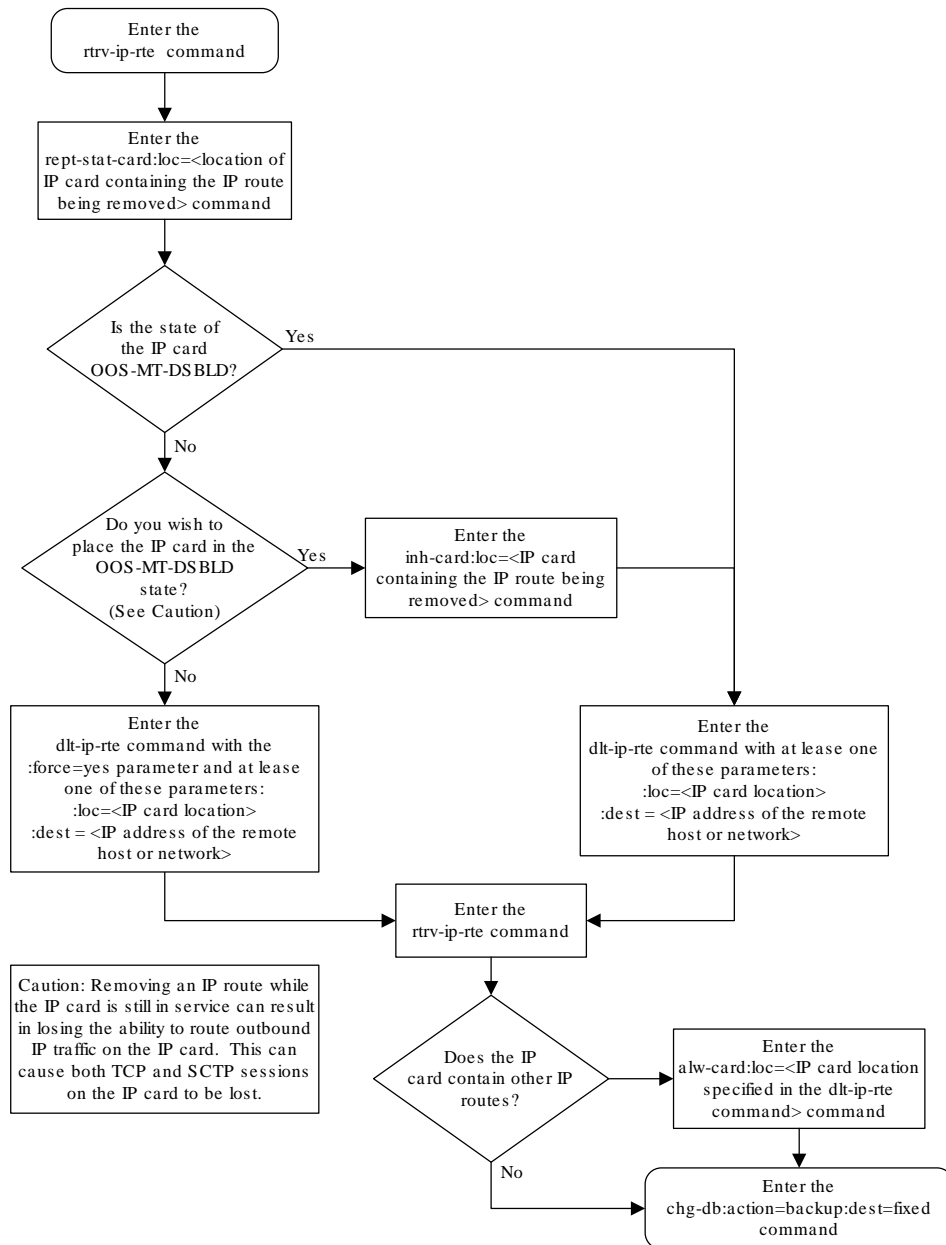
```
rlghncxa03w 06-10-28 21:22:37 GMT EAGLE5 36.0.0
Card has been allowed.
```

7. Back up the new changes using the `chg-db:action=backup:dest=fixed` command.

These messages should appear, the active **Maintenance and Administration Subsystem Processor (MASP)** appears first.

```
BACKUP (FIXED) : MASP A - Backup starts on active MASP.
BACKUP (FIXED) : MASP A - Backup on active MASP to fixed disk
complete.
BACKUP (FIXED) : MASP A - Backup starts on standby MASP.
BACKUP (FIXED) : MASP A - Backup on standby MASP to fixed disk
complete.
```

Figure 4-30 Removing an IP Route



4.24 Removing a M3UA or SUA Association

This procedure is used to remove a SUA association from the database or to remove a M3UA association that is assigned to a card running either the SS7IPGW or IPGW1

applications. Perform the [Removing an IPSG Association](#) procedure to remove a M3UA association that is assigned to a card running the IPSG application.

The `dlt-assoc` command uses one parameter, `aname`, the name of the association being removed from the database. The association being removed must be in the database.

The `open` parameter must be set to `no` before the association can be removed. Use the `chg-assoc` command to change the value of the `open` parameter.

The association being removed from the database cannot be assigned to an application server. This can be verified with the `rtrv-as` command. If the association is assigned to any application servers, go to the [Removing an Association from an Application Server](#) procedure and remove the association from the application servers.

Canceling the RTRV-ASSOC and RTRV-AS Commands

Because the `rtrv-assoc` and `rtrv-as` commands used in this procedure can output information for a long period of time, the `rtrv-assoc` and `rtrv-as` commands can be canceled and the output to the terminal stopped. There are three ways that the `rtrv-assoc` and `rtrv-as` commands can be canceled.

- Press the F9 function key on the keyboard at the terminal where the `rtrv-assoc` or `rtrv-as` commands were entered.
- Enter the `canc-cmd` without the `trm` parameter at the terminal where the `rtrv-assoc` or `rtrv-as` commands were entered.
- Enter the `canc-cmd:trm=<xx>`, where `<xx>` is the terminal where the `rtrv-assoc` or `rtrv-as` commands were entered, from another terminal other than the terminal where the `rtrv-assoc` or `rtrv-as` commands were entered. To enter the `canc-cmd:trm=<xx>` command, the terminal must allow Security Administration commands to be entered from it and the user must be allowed to enter Security Administration commands. The terminal's permissions can be verified with the `rtrv-secu-trm` command. The user's permissions can be verified with the `rtrv-user` or `rtrv-secu-user` commands.

For more information about the `canc-cmd` command, go to *Commands User's Guide*.

1. Display the associations in the database using the `rtrv-assoc` command.

This is an example of possible output.

```
rlghncxa03w 06-10-28 09:12:36 GMT EAGLE5 36.0.0

          CARD IPLNK
ANAME      LOC  PORT  LINK ADAPTER  LPORT  RPORT  OPEN  ALW
swbel32    1201 A    A    M3UA   1030  2345  YES  YES
a2         1305 A    A    SUA    1030  2345  YES  YES
a3         1307 A    A    SUA    1030  2346  YES  YES
assoc1     1203 A    A1   M2PA   2048  1030  NO   NO
```

If the association that is being removed in this procedure is an SUA association, continue the procedure with [3](#).

If the association that is being removed in this procedure is an M3UA association, continue the procedure with [2](#).

2. Enter the `rtrv-card` command with the location of the card that is hosting the M3UA association that will be removed in this procedure. For this example, enter this command.

```
rtrv-card:loc=1201
```

This is an example of possible output.

```
rlghncxa03w 08-03-06 15:17:20 EST EAGLE5 38.0.0
CARD   TYPE      APPL      LSET NAME   LINK SLC LSET NAME   LINK SLC
1201   DCM          SS7IPGW   lsn1        A      0
```

If the application assigned to the card is SS7IPGW or IPGWI, shown in the `APPL` column, continue the procedure with [3](#).

If the application assigned to the card is IPGS, perform the [Removing an IPGS Association](#) procedure.

3. Display the application servers referencing the association being removed from the database using the `rtrv-as` command with the name of the association being removed in this procedure.

For this example, enter this command.

```
rtrv-as:aname=swbel32
```

This is an example of possible output.

```
rlghncxa03w 06-10-28 09:12:36 GMT EAGLE5 36.0.0

AS Name           Mode           Tr ms   Association Names
as1                LOADSHARE     2000    swbel32
as2                OVERRIDE      10      swbel32
AS Table is (2 of 250) 1% full
```

If the association is assigned to any application servers, go to the [Removing an Association from an Application Server](#) procedure and remove the association from the application servers.

4. Change the value of the `open` parameter to `no` by specifying the `chg-assoc` command with the `open=no` parameter.

 **Note:**

If the value of the `open` parameter for the association being removed from the database (shown in [1](#)) is `no`, continue this procedure with [5](#).

For this example, enter this command.

```
chg-assoc:aname=swbel32:open=no
```

When this command has successfully completed, this message should appear.

```
rlghncxa03w 06-10-28 09:12:36 GMT EAGLE5 36.0.0  
CHG-ASSOC: MASP A - COMPLTD;
```

5. Remove the association from the database using the `dlt-assoc` command.

For this example, enter this command.

```
dlt-assoc:aname=swbel32
```

When this command has successfully completed, this message should appear.

```
rlghncxa03w 06-10-28 09:12:36 GMT EAGLE5 36.0.0  
DLT-ASSOC: MASP A - COMPLTD
```

6. Verify the changes using the `rtrv-assoc` command with the name of the association specified in 5.

For this example, enter this command.

```
rtrv-assoc:aname=swbel32
```

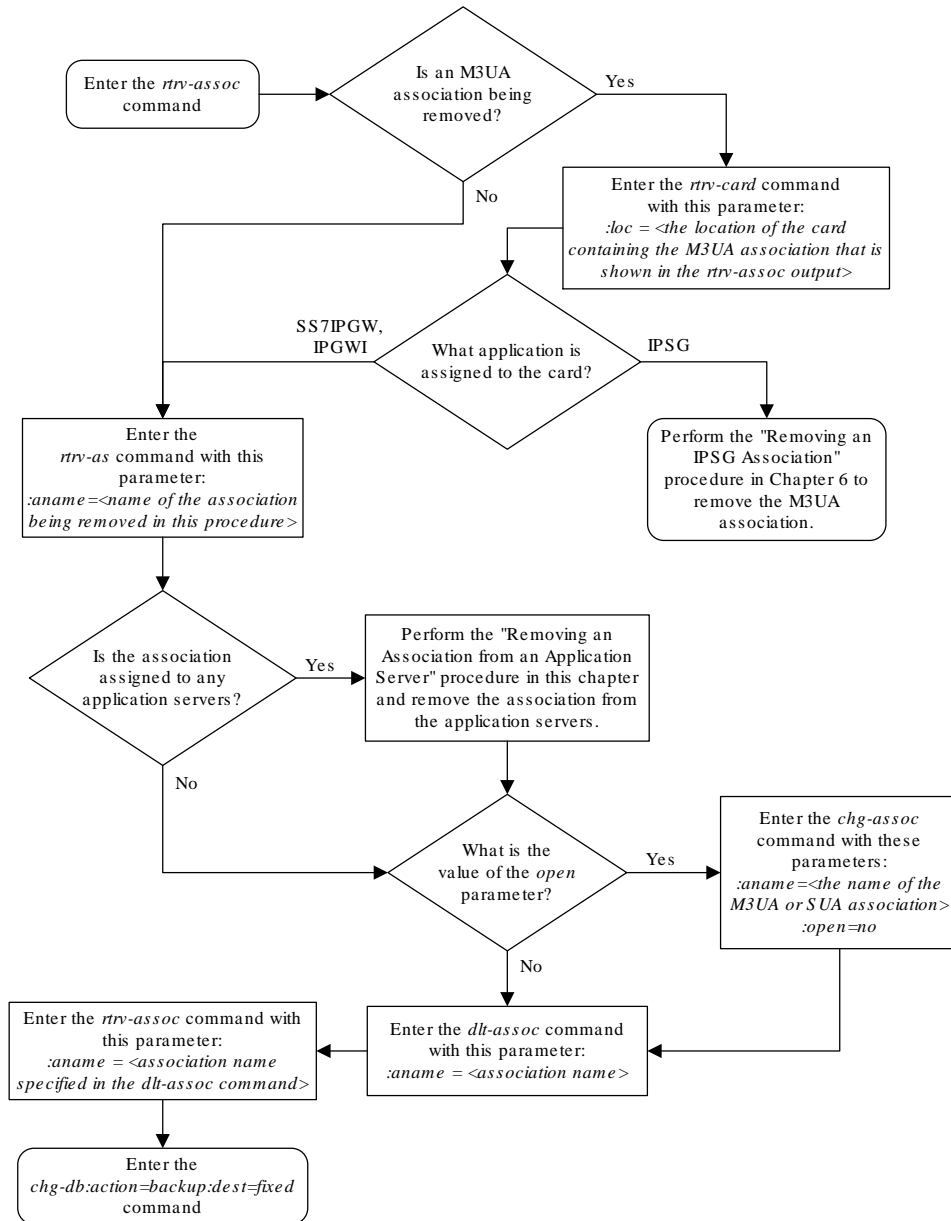
This is an example of possible output.

```
rlghncxa03w 06-10-28 09:12:36 GMT EAGLE5 36.0.0  
  
No matching entries found  
  
IP Appl Sock table is (3 of 4000) 1% full
```

7. Back up the new changes, using the `chg-db:action=backup:dest=fixed` command. These messages should appear; the active **Maintenance and Administration Subsystem Processor (MASP)** appears first.

```
BACKUP (FIXED) : MASP A - Backup starts on active MASP.  
BACKUP (FIXED) : MASP A - Backup on active MASP to fixed disk  
complete.  
BACKUP (FIXED) : MASP A - Backup starts on standby MASP.  
BACKUP (FIXED) : MASP A - Backup on standby MASP to fixed disk  
complete.
```

Figure 4-31 Removing a M3UA or SUA Association



4.25 Removing an Association from an Application Server

This procedure is used to remove an association from an application server using the `dlt-as` command.

The `dlt-as` command uses these parameters:

`:asname` – The application server name containing the association being removed in this procedure.

`:aname` – The name of the association being removed from the application server.

The association name and application server name combination must be in the database.

The `open` parameter value in the association assigned to the application server specified in the `dlt-as` command must be `no`. This can be verified with the `rtrv-assoc` command. Use the `chg-assoc` command to change the value of the `open` parameter.

If the association is the only association assigned to the application server, the application server is removed from the database. The application server cannot be removed from the database if it is assigned to a routing key. This can be verified with the `rtrv-appl-rtkey` command.

Canceling the `RTRV-AS`, `RTRV-ASSOC`, and `RTRV-APPL-RTKEY` Commands

Because the `rtrv-as`, `rtrv-assoc`, and `rtrv-appl-rtkey` commands used in this procedure can output information for a long period of time, the `rtrv-as`, `rtrv-assoc`, and `rtrv-appl-rtkey` commands can be canceled and the output to the terminal stopped. There are three ways that the `rtrv-as`, `rtrv-assoc`, and `rtrv-appl-rtkey` commands can be canceled.

- Press the `F9` function key on the keyboard at the terminal where the `rtrv-as`, `rtrv-assoc`, or `rtrv-appl-rtkey` commands were entered.
- Enter the `canc-cmd` without the `trm` parameter at the terminal where the `rtrv-as`, `rtrv-assoc`, or `rtrv-appl-rtkey` commands were entered.
- Enter the `canc-cmd:trm=<xx>`, where `<xx>` is the terminal where the `rtrv-as`, `rtrv-assoc`, or `rtrv-appl-rtkey` commands were entered, from another terminal other than the terminal where the `rtrv-as`, `rtrv-assoc`, or `rtrv-appl-rtkey` commands were entered. To enter the `canc-cmd:trm=<xx>` command, the terminal must allow Security Administration commands to be entered from it and the user must be allowed to enter Security Administration commands. The terminal's permissions can be verified with the `rtrv-secu-trm` command. The user's permissions can be verified with the `rtrv-user` or `rtrv-secu-user` commands.

For more information about the `canc-cmd` command, go to *Commands Manual User's Guide*.

1. Display the application servers in the database using the `rtrv-as` command.

This is an example of possible output.

```
rlghncxa03w 06-10-28 09:12:36 GMT EAGLE5 36.0.0

AS Name           Mode           Tr ms   Association Names
as1               LOADSHARE     10      assoc1
                  assoc2
                  assoc3
```

```

                                     assoc5
                                     assoc6

as2          OVERRIDE      10      assoc7
as3          LOADSHARE     10      assoc4
  
```

AS table is (3 of 250) 1% full.

2. Display the associations to be removed from the application server using the `rtrv-
assoc` command and specifying the association name shown in the `rtrv-as` output in [1](#).

For this example, enter this command.

```
rtrv-assoc:aname=assoc1
```

This is an example of possible output.

```

rlghncxa03w 09-05-28 09:12:36 GMT EAGLE5 41.0.0
ANAME assoc1
  LOC      1203          IPLNK PORT  A          LINK  A
  ADAPTER  M3UA          VER          M3UA RFC
  LHOST    gw105.nc.tekelec.com
  ALHOST    ---
  RHOST    gw100.nc.tekelec.com
  ARHOST    ---
  LPORT    1030          RPORT      1030
  ISTRMS   2            OSTRMS     2          BUFSIZE  16
  RMODE    LIN          RMIN       120        RMAX     800
  RTIMES   10          CWMIN      3000       UAPS     10
  OPEN     YES          ALW        YES         RTXTHR   10000
  RHOSTVAL RELAXED

  ASNAMES
  as1
  
```

```

IP Appl Sock table is (4 of 4000) 1% full
Assoc Buffer Space Used (16 KB of 800 KB) on LOC = 1203
  
```

3. Change the value of the `open` parameter to `no` by specifying the `chg-
assoc` command with the `open=no` parameter.

 **Note:**

If the value of the `open` parameter shown in [2](#) is `no`, continue the procedure with [4](#).

For this example, enter this command.

```
chg-assoc:aname=assoc1:open=no
```

When this command has successfully completed, this message should appear.

```
rlghncxa03w 06-10-28 09:12:36 GMT EAGLE5 36.0.0
CHG-ASSOC: MASP A - COMPLTD;
```

- If the association is the only association assigned to the application server, the application server is removed from the database.

 **Note:**

If the application server specified in this procedure contains more than one association, continue this procedure with 5.

The application server cannot be removed from the database if it is assigned to a routing key. Verify the routing keys that the application server is assigned to by entering the `rtrv-appl-rtkey` command with the application server name that will be specified in 5 and the `display=all` parameter. For this example, enter this command.

```
rtrv-appl-rtkey:asname=as1:display=all
```

```
rlghncxa03w 06-10-28 09:12:36 GMT EAGLE5 36.0.0
```

```
RCONTEXT  DPCI          SI SSN OPCI          CICS
CICE      LOC
-----  6-024-7      5 ---  1-057-4      150
175      STATIC
```

```
ADPTR  TYPE      ASNAME
M3UA   FULL      as1
```

```
ANAMES
assoc1      assoc2      assoc3      assoc5
assoc6
```

```
RCONTEXT  DPCI          SI SSN OPCI          CICS
CICE      LOC
-----  2-100-7      6 ---  -----      -----
-----  STATIC
```

```
ADPTR  TYPE      ASNAME
M3UA   FULL      as1
```

```
ANAMES
assoc1      assoc2      assoc3      assoc5
assoc6
```

```
STATIC Route Key table is (7 of 2000) 1% full
```

```
STATIC Route Key Socket Association table is (7 of 32000) 1% full
```

If the application server is assigned to any routing keys, remove the routing keys referencing the application server by performing the [Removing a Routing Key Containing an Application Server](#) procedure.

- Remove the association from the application server from the database using the `dlt-as` command.

For this example, enter this command.

```
dlt-as:asname=as1:aname=assoc1
```

 **Note:**

If the association being removed from the application server is the only association assigned to the application server, the application server is removed from the database.

This is an example of possible inputs and outputs:

```
rlghncxa03w 06-10-28 09:12:36 GMT EAGLE5 36.0.0
DLT-AS: MASP A - COMPLTD;
```

- Verify the changes using the `rtrv-as` command with the application server name specified in 5.

For this example, enter this command.

```
rtrv-as:asname=as1
```

This is an example of possible output.

```
rlghncxa03w 06-10-28 09:12:36 GMT EAGLE5 36.0.0

AS Name           Mode           Tr ms   Association Names
as1                LOADSHARE     10      assoc2
                  assoc3
                  assoc5
                  assoc6
```

```
AS table is (3 of 250) 1% full.
```

- Change the value of the `open` parameter to `yes` by specifying the `chg-assoc` command with the `open=yes` parameter.

 **Note:**

If the value of the `open` parameter was not changed in 3, continue this procedure with 8.

For this example, enter this command.

```
chg-assoc:aname=assoc1:open=yes
```


When this command has successfully completed, this message should appear.

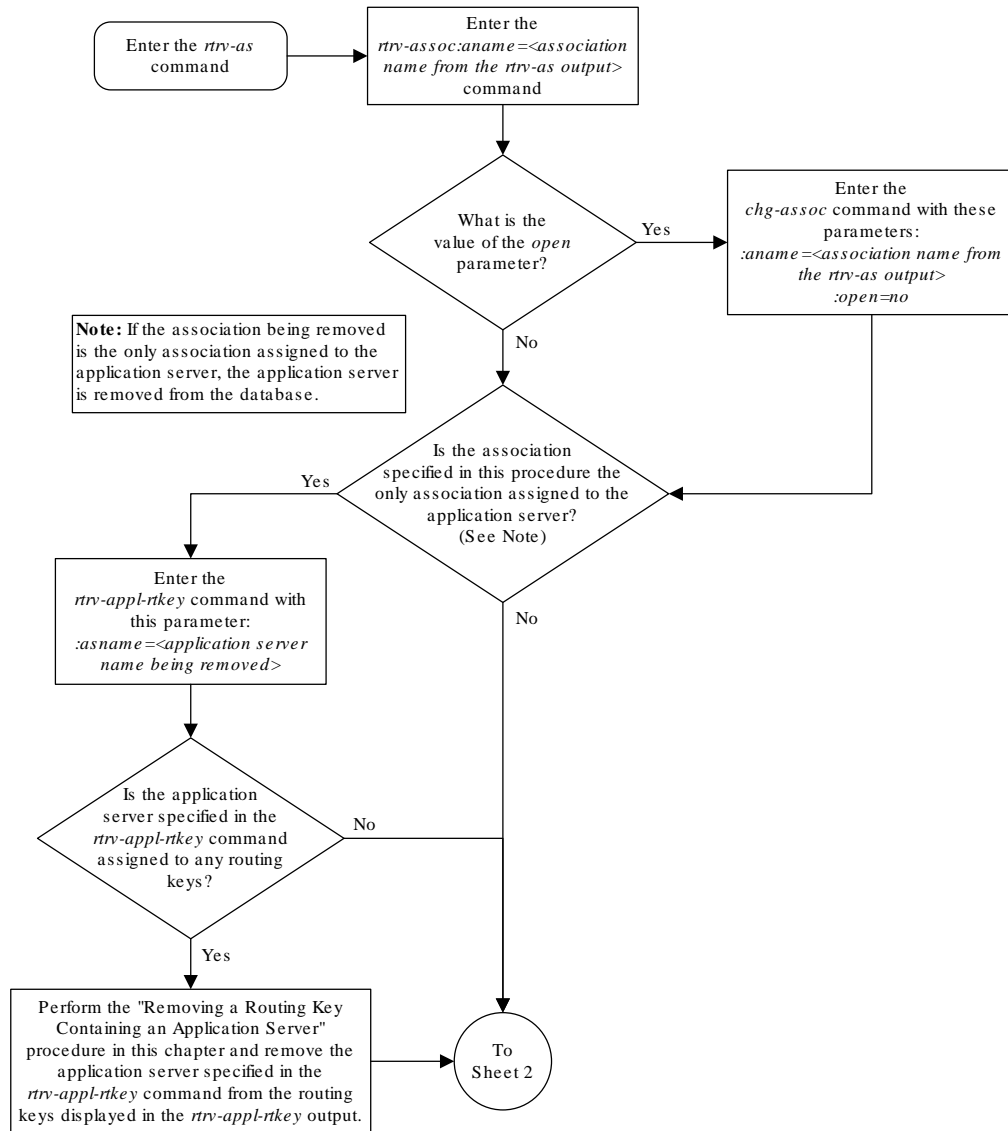
```
rlghncxa03w 06-10-28 09:12:36 GMT EAGLE5 36.0.0  
CHG-ASSOC: MASP A - COMPLTD;
```

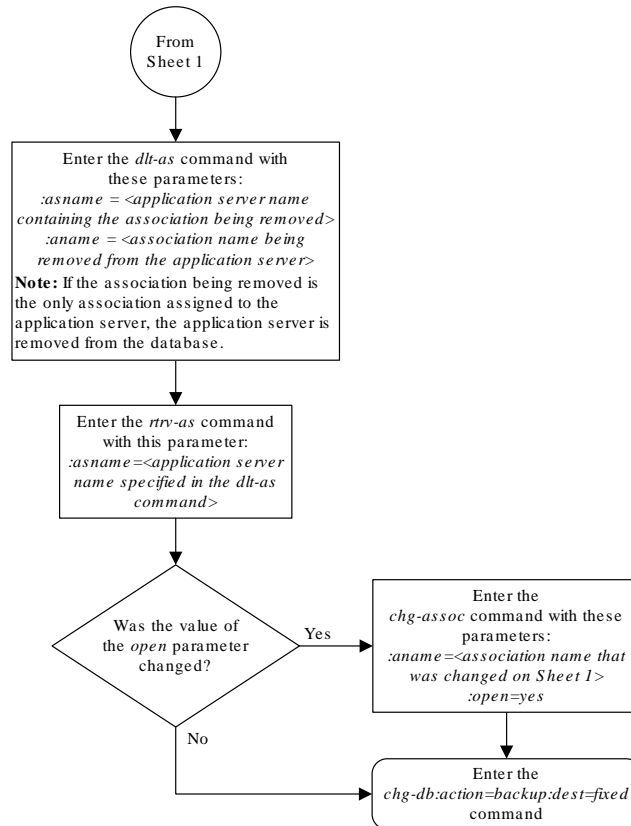
8. Back up the new changes, using the `chg-db:action=backup:dest=fixed` command.

These messages should appear; the active **Maintenance and Administration Subsystem Processor (MASP)** appears first.

```
BACKUP (FIXED) : MASP A - Backup starts on active MASP.  
BACKUP (FIXED) : MASP A - Backup on active MASP to fixed disk  
complete.  
BACKUP (FIXED) : MASP A - Backup starts on standby MASP.  
BACKUP (FIXED) : MASP A - Backup on standby MASP to fixed disk  
complete.
```

Figure 4-32 Removing an Association from an Application Server





Sheet 2 of 2

4.26 Removing a Routing Key Containing an Application Server

This procedure is used to remove a static key from the database using the `dlt-appl-rtkey` command. For more information about static and dynamic routing keys, see [Understanding Routing for SS7IPGW and IPGW Applications](#).

The `dlt-appl-rtkey` command uses these parameters.

:dpc/dpca/dpci/dpcn/dpca24 – The destination point code value that is used to filter incoming **MSUs**.

:opc/opca/opci/opcn/opcn24 - The originating point code value that is used to filter incoming **MSUs**. This parameter must not specify a cluster route. This parameter must not specify a cluster route. This parameter is only valid when the `si` parameter value is set to 4, 5, or 13. This parameter is required if `si=4, 5, or 13` and `type=full`.



Note:

See the “**Point Code Formats**” section in *Database Administration - SS7 User's Guide* for a definition of the point code types that are used on the **EAGLE** and for a definition of the different formats that can be used for **ITU** national point codes.

:si – The service indicator value that is used to filter incoming **MSUs**. The range of values for the service indicator parameter (`si`) can be a numerical value from 0 to 15, or for selected service indicator values, a text string can be used instead of numbers. [Table 4-14](#) shows the text strings that can be used in place of numbers for the service indicator values.

Table 4-14 Service Indicator Text String Values

Service Indicator Value	Text String	Service Indicator Value	Text String
0	snm	4	tup
1	regtest	5	isup
2	spltst	13	qbicc
3	sccp		

:ssn – The subsystem value that is used to filter incoming **MSUs**. The `ssn` parameter is only valid when the `si` parameter value is set to 3 or `sccp`.

:cics - The starting circuit identification code that is used to filter incoming **MSUs**. Specify with `cice` to delete routing keys with the circuit identification code or range of circuit identification codes. The `cics` parameter is only valid when the `si` parameter value is set to 4, 5, or 13. The `cics` is required if `si=4, 5, or 13` and `type=full`.

:cice - The ending circuit identification code that is used to filter incoming **MSUs**. Specify with `cics` to delete routing keys with the circuit identification code or range of circuit identification codes. The `cice` parameter is only valid when the `si` parameter value is set to 4, 5, or 13. The `cics` is required if `si=4, 5, or 13` and `type=full`.

:type - Identifies the type of routing key that is being deleted. One of three values, `type = full/partial/default`. If `type` is not explicitly specified, `type = full` is assumed.

:asname – Application server (**AS**) name.

:rcontext – The routing context parameter value assigned to the routing key.

The parameter combinations used by the `dlt-appl-rtkey` command are based on the type of routing key and the service indicator value in the routing key. The parameter combinations are shown in [Table 4-15](#) .

Table 4-15 Routing Key Parameter Combinations for Removing Routing Keys

Full Routing Key SI=3 (SCCP) (See Notes 1, 3, and 4)	Partial Routing Key SI=3 (SCCP) (See Notes 1, 3, and 4)	Full Routing Key SI=4 (TUP), 5 (ISUP), 13 (QBICC) (See Notes 1, 3, and 4)	Partial Routing Key SI=4 (TUP), 5 (ISUP), 13 (QBICC) (See Notes 1, 3, and 4)	Full Routing Key Other SI Values (See Notes 1, 3, and 4)	Partial Routing Key Other SI Values (See Notes 1, 3, and 4)	Default Routing Key (See Notes 1, 3, and 4)
dpc	type=partial	dpc	type=partial	dpc	type=partial	type=default
si=3 (See Note 1)	dpc (See Note 2)	si=4, 5, 13 (See Note 1)	dpc (See Note 2)	si=value other than 3, 4, 5, 13 (See Note 1)	dpc (See Note 2)	asname
ssn	si=3 (See Notes 1 and 2)	opc	si=4, 5, 13 (See Notes 1 and 2)	type=full	si=value other than 3, 4, 5, 13 (See Notes 1 and 2)	rcontext (See Notes 3 and 4)
type=full	asname	cics	opc (See Note 2)	asname	asname	
asname	rcontext (See Notes 3 and 4)	cice	asname	rcontext (See Notes 3 and 4)	rcontext (See Notes 3 and 4)	
rcontext (See Notes 3 and 4)		type=full	rcontext (See Notes 3 and 4)			
		asname				
		rcontext (See Notes 3 and 4)				

Notes:

1. The values for these parameters must be entered exactly as shown in the `rtrv-appl-rtkey` command output for the routing key being removed. However, text strings can be used in place of some numerical service indicator values. See [Table 4-14](#) for a list of these text strings.
2. These parameters are optional for partial routing keys, but at least one these parameters must be specified with the `dlt-appl-rtkey` command.
3. If the routing key contains a numerical value in the RCONTEXT column in the `rtrv-appl-rtkey` output, the `dlt-appl-rtkey` command can be specified with only the `rcontext` parameter and value instead of the `dpc`, `si`, `ssn`, `opc`, `cics`, `cice`, or `type` parameters and values to remove the routing key.
4. If the routing key contains dashes in the RCONTEXT column in the `rtrv-appl-rtkey` output, the `dpc`, `si`, `ssn`, `opc`, `cics`, `cice`, or `type` parameters and values must be used with the `dlt-appl-rtkey` command to remove the routing key.

Canceling the RTRV-APPL-RTKEY Command

Because the `rtrv-appl-rtkey` command used in this procedure can output information for a long period of time, the `rtrv-appl-rtkey` command can be canceled and the output to the terminal stopped. There are three ways that the `rtrv-appl-rtkey` command can be canceled.

- Press the F9 function key on the keyboard at the terminal where the `rtrv-appl-rtkey` command was entered.
- Enter the `canc-cmd` without the `trm` parameter at the terminal where the `rtrv-appl-rtkey` command was entered.
- Enter the `canc-cmd:trm=<xx>`, where `<xx>` is the terminal where the `rtrv-appl-rtkey` commands were entered, from another terminal other than the terminal where the `rtrv-appl-rtkey` command was entered. To enter the `canc-cmd:trm=<xx>` command, the terminal must allow Security Administration commands to be entered from it and the user must be allowed to enter Security Administration commands. The terminal's permissions can be verified with the `rtrv-secu-trm` command. The user's permissions can be verified with the `rtrv-user` or `rtrv-secu-user` commands.

For more information about the `canc-cmd` command, go to *Commands User's Guide*.

1. Display the current routing key information in the database by entering the `rtrv-appl-rtkey` command.

The following is an example of the possible output.

```
rlghncxa03w 08-04-28 21:15:37 GMT EAGLE5 38.0.0
```

RCONTEXT	DPC	SI	ADPTR	ASNAME	TYPE
-----	123-234-123	5	M3UA	as9	FULL
-----	123-234-123	5	M3UA	as9	FULL
1000	005-005-001	5	SUA	as10	FULL
2000	005-005-001	5	SUA	as10	FULL
-----	006-006-001	5	M3UA	as11	FULL
-----	006-006-001	5	M3UA	as11	FULL

RCONTEXT	DPCI	SI	ADPTR	ASNAME	TYPE
-----	2-100-7	6	M3UA	as4	FULL
100	3-137-6	6	SUA	as1	FULL
225	4-035-7	5	M3UA	as7	FULL
-----	6-006-6	5	M3UA	as2	FULL
-----	6-006-7	5	M3UA	as8	FULL
-----	6-006-6	5	M3UA	as2	FULL
-----	6-006-6	5	M3UA	as2	FULL
-----	6-006-8	3	M3UA	as3	FULL
-----	6-006-8	5	M3UA	as5	FULL
-----	6-024-7	5	M3UA	as4	FULL
-----	6-024-7	5	M3UA	as4	FULL
300	7-008-7	6	SUA	as6	FULL

RCONTEXT	DPC	SI	ADPTR	ASNAME	TYPE
-----	*****	**	M3UA	as123	DEFAULT

```
STATIC Route Key table is (15 of 2000) 1% full
STATIC Route Key Socket Association table is (15 of 32000) 1% full
```

If a routing context value is not assigned to the the routing key being removed in this procedure, continue the procedure with 3.

2. Display the specific routing key information for the routing key being removed from the database by entering the `rtrv-appl-rtkey` command with the `display=all` parameter and the `RCONTEXT` values shown in the `rtrv-appl-rtkey` output in 1 for the routing key being removed.

For this example, enter this command.

```
rtrv-appl-rtkey:rcontext=225
```

This is an example of the possible output.

```
rlghncxa03w 08-04-28 21:16:37 GMT EAGLE5 38.0.0

RCONTEXT   DPCI           SI SSN OPCI           CICS           CICE
225         4-035-7        5 --- 2-007-3        2000           3000

      ADPTR  TYPE      ASNAME
      M3UA   FULL     as7

      ANAMES
      assoc15

STATIC Route Key table is (15 of 2000) 1% full
STATIC Route Key Socket Association table is (15 of 32000) 1% full
```

After this step is performed, continue the procedure with 4.

3. Display the specific routing key information for the routing key being removed from the database by entering the `rtrv-appl-rtkey` command with the `display=all` parameter and the `DPC`, `SI`, and `TYPE` values shown in the `rtrv-appl-rtkey` output in 1 for the routing key being removed. For this example, enter this command.

```
rtrv-appl-rtkey:dpci=6-006-6:si=3:display=all:type=full
```

This is an example of the possible output.

```
rlghncxa03w 08-04-28 09:12:36 GMT EAGLE5 38.0.0

RCONTEXT   DPCI           SI SSN OPCI           CICS           CICE
-----
6-006-6    3 170 -----
-----

      ADPTR  TYPE      ASNAME
      M3UA   FULL     as2

      ANAMES
      assoc1

STATIC Route Key table is (15 of 2000) 1% full
STATIC Route Key Socket Association table is (15 of 32000) 1% full
```

4. Display the associations assigned to the routing key by entering the `rtrv-assoc` parameter with the association name shown in either 2 or 3. For this example, enter these commands.

```
rtrv-assoc:aname=assoc1
```

This is an example of possible output.

```
rlghncxa03w 09-05-28 09:12:36 GMT EAGLE5 41.0.0
ANAME assoc1
  LOC      1203          IPLNK PORT  A          LINK  A
  ADAPTER  M3UA          VER          M3UA RFC
  LHOST    gw105.nc.tekelec.com
  ALHOST   ---
  RHOST    gw100.nc.tekelec.com
  ARHOST   ---
  LPORT    1030          RPORT        1030
  ISTRMS   2            OSTRMS        2          BUFSIZE  16
  RMODE    LIN          RMIN          120        RMAX      800
  RTIMES   10          CWMIN         3000       UAPS      10
  OPEN     YES          ALW           YES         RTXTHR    10000
  RHOSTVAL RELAXED

  ASNAMES
  as2
```

```
IP Appl Sock table is (8 of 4000) 1% full
Assoc Buffer Space Used (16 KB of 800 KB) on LOC = 1203
```

```
rtrv-assoc:aname=assoc15
```

This is an example of possible output.

```
rlghncxa03w 09-05-28 09:12:36 GMT EAGLE5 41.0.0
ANAME assoc15
  LOC      1205          IPLNK PORT  A          LINK  A
  ADAPTER  M3UA          VER          M3UA RFC
  LHOST    gw115.nc.tekelec.com
  ALHOST   ---
  RHOST    gw100.nc.tekelec.com
  ARHOST   ---
  LPORT    2000          RPORT        2000
  ISTRMS   2            OSTRMS        2          BUFSIZE  16
  RMODE    LIN          RMIN          120        RMAX      800
  RTIMES   10          CWMIN         3000       UAPS      10
  OPEN     YES          ALW           YES         RTXTHR    10000
  RHOSTVAL RELAXED

  ASNAMES
  as7
```

```
IP Appl Sock table is (8 of 4000) 1% full
Assoc Buffer Space Used (16 KB of 800 KB) on LOC = 1203
```


Repeat this step for all the associations shown in 2 or 3.

5. Change the `open` parameter value of the association to `no` by using the `chg-assoc` command.

 **Note:**

If the `open` parameter value of all the associations shown in 4 is `no`, continue the procedure with 6.

For example, enter these commands.

```
chg-assoc:aname=assoc1:open=no  
chg-assoc:aname=assoc15:open=no
```

When this command has successfully completed, the following message should appear.

```
rlghncxa03w 06-10-28 21:18:37 GMT EAGLE5 36.0.0  
CHG-ASSOC: MASP A - COMPLTD
```

 **Caution:**

The IP connections using the associations specified in this step will not be able to carry any traffic when the `open` parameter is changed to `no`.

Repeat this step for all the associations shown in 4 that contain the `open=yes` parameter value.

6. Remove the routing key information from the database by entering the `dlt-appl-rtkey` command.

The parameters required for the `dlt-appl-rtkey` command are determined by the type of routing key being added and the service indicator value in the routing key. See Table 4-15 for the parameter combinations that can be used for the type of routing key being added to the database. For example, enter these commands.

```
dlt-appl-rtkey:dpci=6-006-6:si=3:ssn=170:aname=as2  
dlt-appl-rtkey:rcontext=225
```

When each of these commands have successfully completed, the following message should appear.

```
rlghncxa03w 06-10-28 21:16:37 GMT EAGLE5 36.0.0  
DLT-APPL-RTKEY: MASP A - COMPLTD
```

7. Verify the changes by entering the `rtrv-appl-rtkey` command with the routing key parameters specified in 6 (`dpc`, `si`, `opc`, `cics`, `cice`, `ssn`, `aname`, and `type`, and `loc`, as applicable). For this example, enter these commands.

```
rtrv-appl-rtkey:dpci=6-006-6:si=3:ssn=170:aname=as2
```

The following is an example of the possible output.

```
rlghncxa03w 08-04-28 21:15:37 GMT EAGLE5 38.0.0

No matching entries found

STATIC Route Key table is (12 of 2000) 1% full
STATIC Route Key Socket Association table is (6 of 32000) 1% full

rtrv-appl-rtkey:rcontext=225
```

The following is an example of the possible output.

```
rlghncxa03w 08-04-28 21:15:37 GMT EAGLE5 38.0.0

No matching entries found

STATIC Route Key table is (12 of 2000) 1% full
STATIC Route Key Socket Association table is (6 of 32000) 1% full
```

 **Note:**

If [5](#) was not performed, continue the procedure with [9](#).

8. Change the `open` parameter value of the associations that were changed in [5](#) to `yes` by using the `chg-assoc` command.

For example, enter these commands.

```
chg-assoc:aname=assoc1:open=yes
```

```
chg-assoc:aname=assoc15:open=yes
```

When this command has successfully completed, the following message should appear.

```
rlghncxa03w 06-10-28 21:18:37 GMT EAGLE5 36.0.0
CHG-ASSOC: MASP A - COMPLTD
```

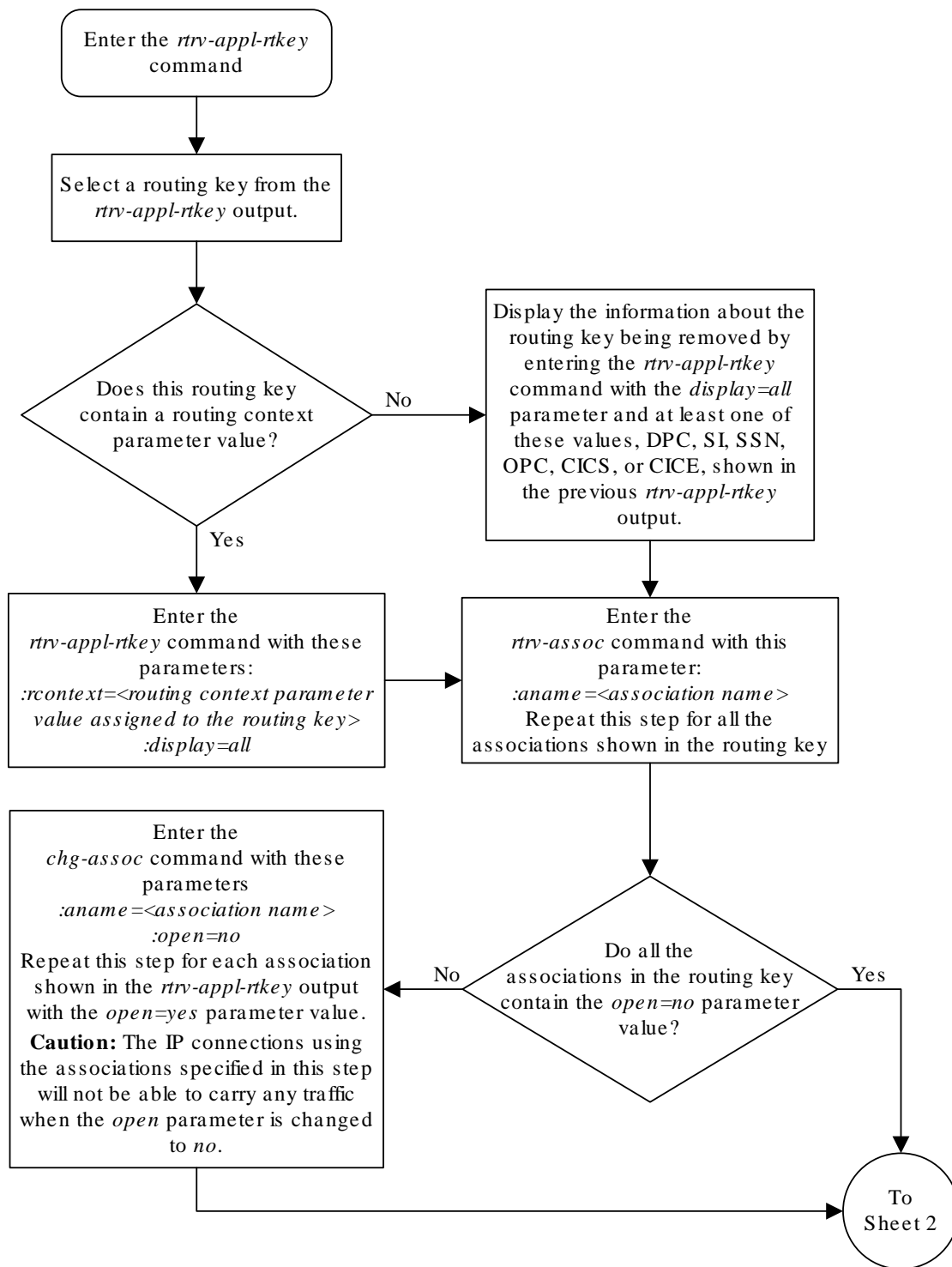
Repeat this step for all the associations that were changed in [9](#).

9. Back up the new changes using the `chg-db:action=backup:dest=fixed` command.

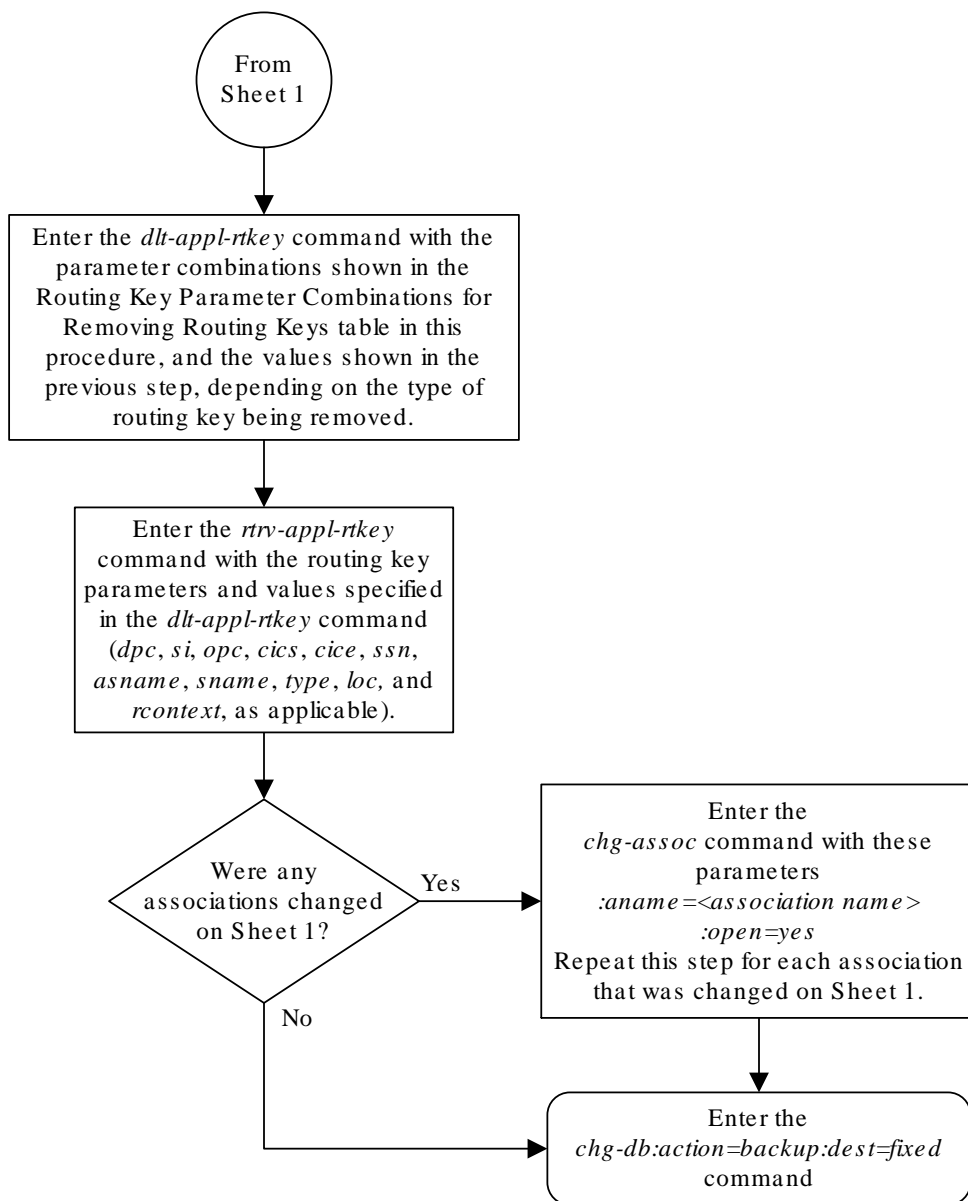
These messages should appear, the active **Maintenance and Administration Subsystem Processor (MASP)** appears first.

```
BACKUP (FIXED) : MASP A - Backup starts on active MASP.
BACKUP (FIXED) : MASP A - Backup on active MASP to fixed disk complete.
BACKUP (FIXED) : MASP A - Backup starts on standby MASP.
BACKUP (FIXED) : MASP A - Backup on standby MASP to fixed disk complete.
```

Figure 4-33 Removing a Routing Key Containing an Application Server



Sheet 1 of 2



Sheet 2 of 2

4.27 Removing a Network Appearance

This procedure removes the network appearance from the database using the `dlt-na` command with these parameters.

`:na` – the 32-bit value of the network appearance, from 0 to 4294967295.

`:type` – the network type of the network appearance, `ansi` (**ANSI**), `itui` (**ITU-I**), `itun` (**14-bit ITU-N**), `itun24` (**24-bit ITU-N**), `ituis` (**ITU-I Spare**), `ituns` (**14-bit ITU-N Spare**).

`:gc` – the specific **ITU-N** group code associated with the network appearance.

Specifying the `gc` parameter removes the specific network appearance containing the `na` and `gc` parameter values.

Specifying the `type=itun` or `type=ituns` parameter without the `gc` parameter removes all 14-bit **ITU-N** or 14-bit **ITU-N** spare network appearances containing the specified `na` parameter value.

1. Display the network appearances in the database with the `rtrv-na` command.

This is an example of the possible output.

```
rlghncxa03w 06-10-28 09:12:36 GMT EAGLE5 36.0.0
TYPE      GC          NA
ANSI      --           100
ITUI      --           1000
ITUN      uk          150000
ITUN      fr          4000000000
ITUN      ge          1000000000
ITUN24    --           3
ITUIS     --           2000
ITUNS     sp           5000
```

2. Remove the network appearance from the database with the `dlt-na` command.

For this example, enter these commands.

```
dlt-na:na=100:type=ansi
```

```
dlt-na:na=4000000000:type=itun:gc=fr
```

When each of these commands have successfully completed, this message should appear.

```
rlghncxa03w 06-10-28 09:12:36 GMT EAGLE5 36.0.0
DLT-NA:  MASP A - COMPLTD
```

3. Verify the changes using the `rtrv-na` command.

This is an example of possible output.

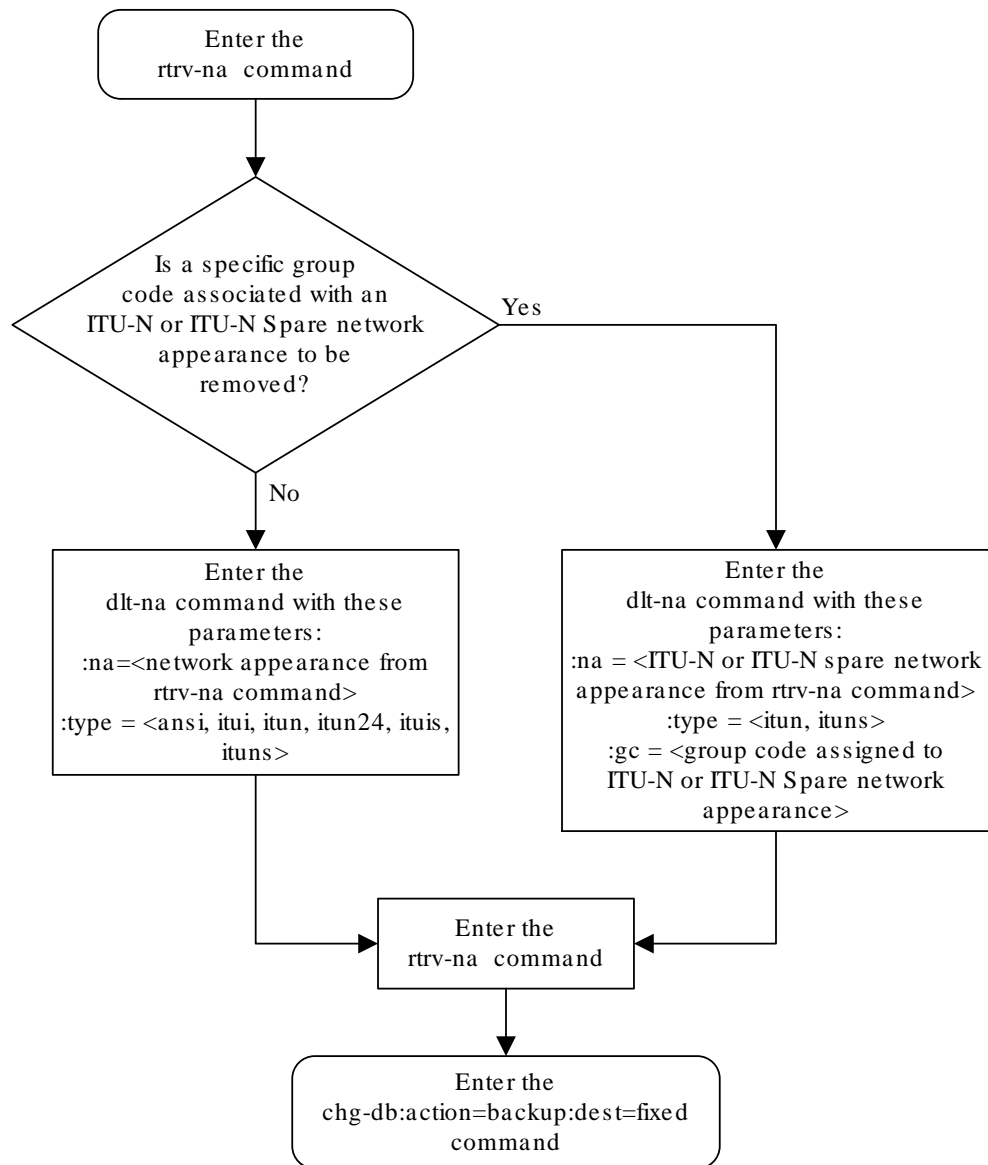
```
rlghncxa03w 06-10-28 09:12:36 GMT EAGLE5 36.0.0
TYPE      GC          NA
ITUI      --          1000
ITUN      uk          150000
ITUN      ge          1000000000
ITUN24    --          3
ITUIS     --          2000
ITUNS     sp          5000
```

4. Back up the new changes, using the `chg-db:action=backup:dest=fixed` command.

These messages should appear; the active **Maintenance and Administration Subsystem Processor (MASP)** appears first.

```
BACKUP (FIXED) : MASP A - Backup starts on active MASP.
BACKUP (FIXED) : MASP A - Backup on active MASP to fixed disk
complete.
BACKUP (FIXED) : MASP A - Backup starts on standby MASP.
BACKUP (FIXED) : MASP A - Backup on standby MASP to fixed disk
complete.
```

Figure 4-34 Removing a Network Appearance



4.28 Changing IETF M3UA and SUA Components

This section describes how to change the attributes of the following components in the database.

- IP Options – Perform the [Changing IP Options](#) procedure.
- An **M3UA** or **SUA** Association – Perform these procedures.
 - [Changing the Attributes of a M3UA or SUA Association](#)
 - [Changing the Buffer Size of a M3UA or SUA Association](#)
 - [Changing the Host Values of a M3UA or SUA Association](#)
- The **SCTP** Retransmission Parameters – Perform the [Changing the SCTP Checksum Algorithm Option for M3UA and SUA Associations](#) procedure.
- An Application Server – Perform the [Changing an Application Server](#) procedure.
- **CIC** Values in a Routing Key – Perform the [Changing the CIC Values in an Existing Routing Key Containing an Application Server](#) procedure.
- Routing Context Values in a Routing Key – Perform the [Changing the Routing Context Value in an Existing Routing Key](#) procedure.
- The **SCTP** Checksum Algorithm – Perform the [Changing the SCTP Checksum Algorithm Option for M3UA and SUA Associations](#) procedure.
- A **UA** Parameter Set – Perform the [Changing a UA Parameter Set](#) procedure.
- Turn off the Large MSU Support for **IP** Signaling feature – Perform the [Turning Off the Large MSU Support for IP Signaling Feature](#) procedure.

4.29 Changing IP Options

Use this procedure to change the **IP** options defined by these parameters: `getcomm`, `setcomm`, `snmpcont`, `srkq`, `trapcomm`, `ipgwabate`, and `uameasusedftas`.

The `chg-sg-opts` command also contains the `sctpchecksum` parameter. Perform the one of these procedures to change the `sctpchecksum` parameter value.

- [Changing the SCTP Checksum Algorithm Option for M3UA and SUA Associations](#)
- [Changing the SCTP Checksum Algorithm Option for M2PA Associations](#)
- [Changing the SCTP Checksum Algorithm Option for IPSG M2PA Associations](#)
- [Changing the SCTP Checksum Algorithm Option for IPSG M3UA Associations](#)

`:getcomm` – The community name used to validate **SNMP** *Get* and *GetNext* requests. This value applies to each **IP** card **SNMP** agent.

`:setcomm` – The community name used to validate **SNMP** *Set* requests. This value applies to each **IP** card **SNMP** agent.

`:snmpcont` – The system contact information for each **IP** card **SNMP** agent, used to define the *sysContact* object in the **SNMP MIB II** System Group.

`:srkq` – The static routing key quantity used to specify the maximum number of static routing key entries in the **Routing Key** table of each `ss7ipgw` and `ipgwi` card.

`:trapcomm` – The community name used when sending **SNMP** traps. This value applies to each **IP** card **SNMP** agent.

`:ipgwabate` – enables (`ipgwabate=yes`) or disables (`ipgwabate=no`) **SS7** congestion abatement procedures for **IPGWx** signaling links (signaling links assigned to cards running the `ss7ipgw` or `ipgwi` applications). The default value for this parameter is `no`.

`:uameasusedftas` - specifies whether UA measurements are pegged against the default application server or against the application server shown by the routing context. The values for this parameter are `yes` and `no`. The system default value for this parameter is `yes`.

- `yes` - UA measurement registers are pegged against the default application server.
- `no` - UA measurements are pegged against the application server shown by the routing context.

The maximum value of the `srkq` parameter is 2500.

The value specified for the `srkq` parameter cannot be less than the current number of provisioned routing keys. The number of routing keys that are currently provisioned is shown in the `rtrv-appl-rtkey` or `rtrv-tbl-capacity` command outputs.

The values of the `snmpcont`, `getcomm`, `setcomm`, and `trapcomm` parameters are a string of up to 32 characters that is not case sensitive. If the character string contains characters other than alphanumeric characters, the character string must be enclosed in single quotes.

1. Display the current **IP** options in the database by entering the `rtrv-sg-opts` command.

The following is an example of the possible output.

```
rlghncxa03w 08-04-28 21:17:37 GMT EAGLE5 38.0.0
SRKQ:          250
SNMPCONT:     john doe 555-123-4567
GETCOMM:      public
SETCOMM:      private
TRAPCOMM:     public
SCTPCSUM:     crc32c
IPGWABATE:    NO
UAMEASUSEDFTAS YES
```

If the `srkq` parameter value will not be changed, continue the procedure with [3](#).

If the `srkq` parameter value will be changed, verify the number of routing keys that are currently provisioned by performing [2](#).

2. Enter the `rtrv-tbl-capacity` command to verify the number of routing keys that are currently provisioned.

The following is an example of the possible output.

```
rlghncxa03w 08-04-28 21:17:37 GMT EAGLE5 38.0.0
RTEKEY table is (          53 of          2500)  2% full
```

 **Note:**

The `rtrv-tbl-capacity` command output contains other fields that are not used by this procedure. If you wish to see all the fields displayed by the `rtrv-tbl-capacity` command, see the `rtrv-tbl-capacity` command description in *Commands User's Guide*.

The number of routing keys that are currently provisioned is shown in the `RTEKEY` row of the `rtrv-tbl-capacity` output. In this example, there are 53 routing keys provisioned in the database. The new `srkq` parameter value cannot be less than 53.

3. Change the **IP** options in the database using the `chg-sg-opts` command.

For this example, enter this command.

```
chg-sg-opts:srkq=200:ipgwabate=yes:uameasusedftas=no
```

When this command has successfully completed, the following message should appear.

```
rlghncxa03w 08-04-28 21:18:37 GMT EAGLE5 38.0.0
CHG-SG-OPTS: MASP A - COMPLTD
```

4. Verify the new **IP** options in the database by entering the `rtrv-sg-opts` command.

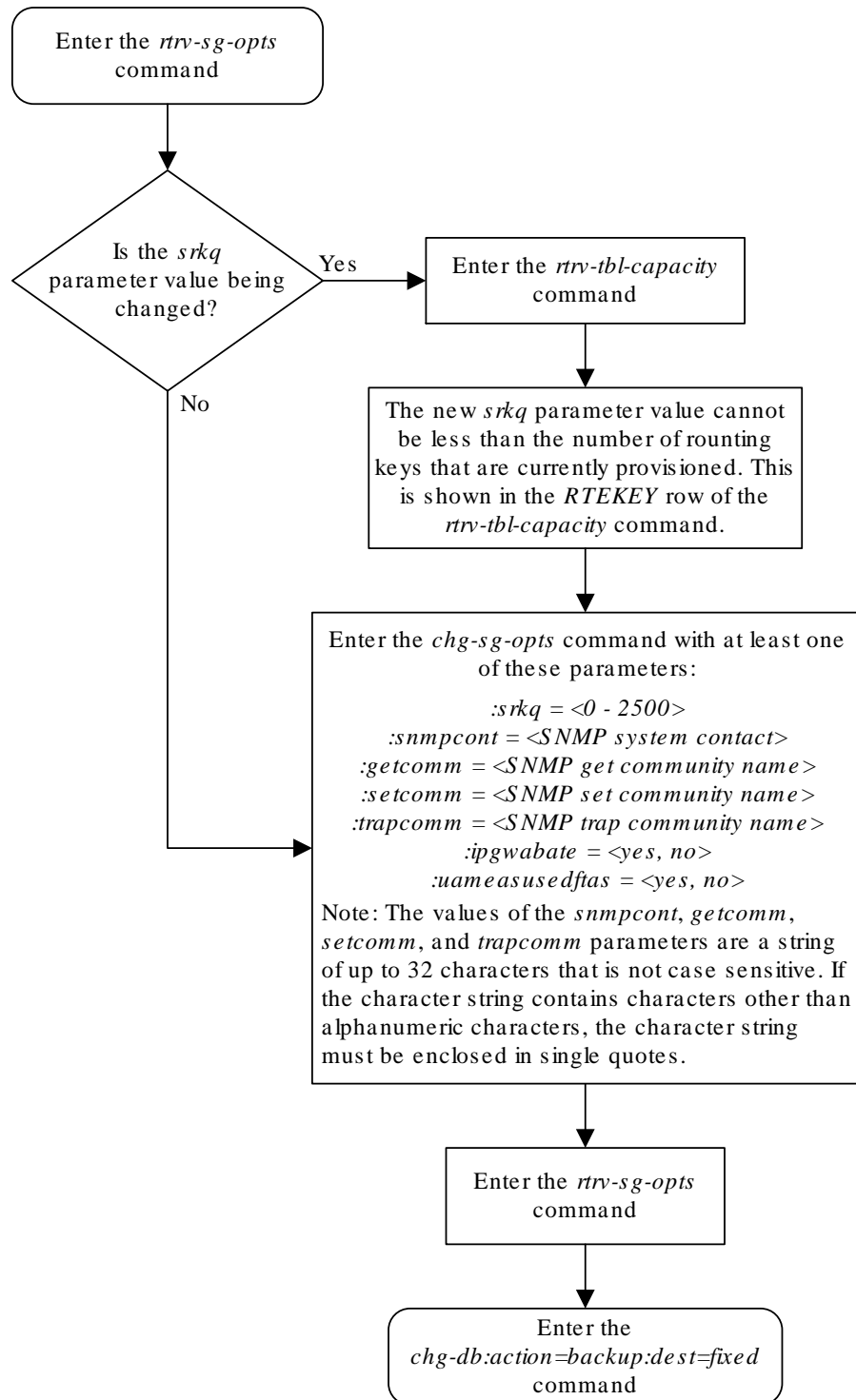
The following is an example of the possible output.

```
rlghncxa03w 08-04-28 21:19:37 GMT EAGLE5 38.0.0
SRKQ:                200
SNMPCONT:            john doe 555-123-4567
GETCOMM:             public
SETCOMM:             private
TRAPCOMM:            public
SCTPCSUM:            crc32c
IPGWABATE:           YES
UAMEASUSEDFTAS      NO
```

5. Back up the new changes using the `chg-db:action=backup:dest=fixed` command. These messages should appear, the active **Maintenance and Administration Subsystem Processor (MASP)** appears first.

```
BACKUP (FIXED) : MASP A - Backup starts on active MASP.
BACKUP (FIXED) : MASP A - Backup on active MASP to fixed disk
complete.
BACKUP (FIXED) : MASP A - Backup starts on standby MASP.
BACKUP (FIXED) : MASP A - Backup on standby MASP to fixed disk
complete.
```

Figure 4-35 Changing IP Options



4.30 Changing the Attributes of a M3UA or SUA Association

This procedure is used to change the values of the attributes of a M3UA or SUA association, assigned to cards that are running the SS7IPGW or IPGWI applications, using the `chg-assoc` command and the following parameters.

Table 4-16 Change M3UA and SUA Association Parameters

aname	lport	rhost	rport	open	alw
rmode	rmin	rmax	rtimes	cwmin	istrms
ostrms	uaps	rtxthr	rhosttype	rhostval	

If you wish to change the attributes of M3UA associations assigned to cards that are running the IPSP application, perform.

The `chg-assoc` command contains other parameters that are not used in this procedure. To change these parameters, perform these procedures.

- `lhost` and `alhost` - [Changing the Host Values of a M3UA or SUA Association](#)
- `bufsize` - [Changing the Buffer Size of a M3UA or SUA Association](#)

`:aname` – The name assigned to the association, shown in the `rtrv-assoc` output.

`:lport` – The **SCTP** port number for the local host.

`:rhost` – The host name for the remote host, `rhost` can be any string of characters starting with a letter and comprising these characters [‘a’..‘z’, ‘A’..‘Z’, ‘0’..‘9’, ‘-’, ‘.‘]. Hostnames are not case-sensitive and can contain up to 60 characters. The default value of this optional parameter is empty (null string).

`:rport` – The **SCTP** port number for the remote host.

`:adapter` – The adapter layer for this association, either `m3ua` or `sua`. The `adapter` parameter is optional. The default value for the `adapter` parameter in this procedure is `m3ua`.

`:open` – The connection state for this association. Valid values are `yes` or `no`. When the `open=yes` parameter is specified, the connection manager opens the association if the association is operational. When the `open=no` parameter is specified, the connection manager will not open the association.

`:alw` – The connection state for this association. Valid values are `yes` or `no`. When the `alw=yes` parameter is specified, the connection manager allows the association to carry **SS7** traffic. When the `alw=no` parameter is specified, the connection manager prohibits the association from carrying **SS7** traffic.

`:rmode` – The retransmission policy used when packet loss is detected. The values are `rfc` or `lin`.

- `rfc` – Standard **RFC 2960** algorithm in the retransmission delay doubles after each retransmission. The **RFC 2960** standard for congestion control is also used.
- `lin` – Oracle’s linear retransmission policy where each retransmission timeout value is the same as the initial transmission timeout and only the slow start algorithm is used for congestion control.

`:rmin` – The minimum value of the calculated retransmission timeout in milliseconds, from 10 - 1000.

`:rmax` – The maximum value of the calculated retransmission timeout in milliseconds, from 10 - 1000.

`:rtimes` – The number of times a data retransmission will occur before closing the association, from 3 - 12.

`:cwmmin` – The minimum size in bytes of the association's congestion window and the initial size in bytes of the congestion window, from 1500 - 409600. The `cwmmin` parameter value must be less than or equal to the size of the buffer used by the association, shown by the `bufsize` parameter value. If the buffer size for the association needs to be changed, perform [Changing the Buffer Size of a M3UA or SUA Association](#).

The `rmode`, `rmin`, `rmax`, `rtimes`, and `cwmmin` parameters are used to configure the **SCTP** retransmission controls for an association, in addition to other commands. Perform [Configuring SCTP Retransmission Control for a M3UA or SUA Association](#) to configure the **SCTP** retransmission controls for an association.

`:istrms` – The number of inbound streams (1 or 2) advertised by the **SCTP** layer for the association.

`:ostrms` – The number of outbound streams (1 or 2) advertised by the **SCTP** layer for the association.

`:uaps` – The **UA** parameter set value being assigned to either an **M3UA** or **SUA** association.

`:rtxthr` – The retransmission threshold for the association. The `rtxthr` parameter value indicates the number of retransmissions that can occur on the association that when exceeded will generate UAM 0537, Ethernet Error Threshold Exceeded. The value of this parameter is 0 to 65,535. The value of this parameter is shown in the `RTXTHR` field of the `rtrv-assoc:aname=<association name>` output. The `rtxthr` parameter value can be changed if the `open` parameter value is either `yes` or `no`.

`:rhosttype` – The type of remote host assigned to the association, `primary` or `alternate`. The primary remote host is shown in the `RHOST` field of the `rtrv-assoc:aname=<association name>` output. The alternate remote host is shown in the `ARHOST` field of the `rtrv-assoc:aname=<association name>` output.

An alternate remote host can be configured for multi-homed associations using the `rhost` and `rhosttype` parameters of the `chg-assoc` command. The `rhost` parameter value with the `rhosttype=primary` parameter represents an IP address that corresponds to one of the network interfaces at the remote end while the `rhost` parameter value with the `rhosttype=alternate` parameter represents an IP address that corresponds to the other network interface at the remote end.

`:rhostval` – The validation mode used for the association when an SCTP INIT/INIT-ACK message is received. The value of this parameter is shown in the `RHOSTVAL` field of the `rtrv-assoc:aname=<association name>` output. This parameter has two values.

- `relaxed` - accept the message if the IP address for the primary or alternate remote host matches the IP address, source IP address, or the host name in the message.
- `match` - accept the message if the message contains the primary remote host value and the alternate remote host value (if the alternate remote host is provisioned). If the alternate remote host is not provisioned, then accept the message if the message

contains the primary remote host value. Reject the message if it contains any IP address other than that of the primary or alternate remote host. Refer to the `chg-assoc` command description in *Commands User's Guide* for more information about this parameter.

If the value of the `open` parameter is `yes`, only the value of the `alw`, and `rtxthr` parameters can be changed. To change the values of other parameters, the value of the `open` parameter must be `no`.

To set the `open` parameter value to `yes`, the association specified by the `aname` parameter must contain values for the `lhost`, `lport`, `rhost`, and `rport` parameters. The `lhost` parameter value must have a signaling link assigned to it.

At least one optional parameter is required.

The command input is limited to 150 characters, including the hostnames.

The `adapter` parameter value cannot be changed if the association is assigned to an application server. This can be verified with the `rtrv-as` command. If the association is assigned to any application servers, perform [Removing an Association from an Application Server](#) to remove the association from the application servers.

The value of the `rmin` parameter must be less than or equal to the `rmax` parameter value.

If the card's application is either **SS7IPGW** or **IPGWI**, the signaling link being assigned to the association must be in service. This state is shown in the `rept-stat-slk` output with the entries `IS-NR` in the `PST` field and `Avail` in the `SST` field.

Canceling the `RTRV-ASSOC` and `RTRV-AS` Commands

Because the `rtrv-assoc` and `rtrv-as` commands used in this procedure can output information for a long period of time, the `rtrv-assoc` and `rtrv-as` commands can be canceled and the output to the terminal stopped. There are three ways that the `rtrv-assoc` and `rtrv-as` commands can be canceled.

- Press the `F9` function key on the keyboard at the terminal where the `rtrv-assoc` or `rtrv-as` commands were entered.
- Enter the `canc-cmd` without the `trm` parameter at the terminal where the `rtrv-assoc` or `rtrv-as` commands were entered.
- Enter the `canc-cmd:trm=<xx>`, where `<xx>` is the terminal where the `rtrv-assoc` or `rtrv-as` commands were entered, from another terminal other than the terminal where the `rtrv-assoc` or `rtrv-as` commands were entered. To enter the `canc-cmd:trm=<xx>` command, the terminal must allow Security Administration commands to be entered from it and the user must be allowed to enter Security Administration commands. The terminal's permissions can be verified with the `rtrv-secu-trm` command. The user's permissions can be verified with the `rtrv-user` or `rtrv-secu-user` commands.

For more information about the `canc-cmd` command, go to *Commands User's Guide*.

1. Display the associations in the database using the `rtrv-assoc` command.

This is an example of possible output.

```
rlghncxa03w 08-04-28 09:12:36 GMT EAGLE5 38.0.0
```

ANAME	CARD		IPLNK		LPOR	RPOR	OPEN	ALW
	LOC	PORT	LINK	ADAPTER				
swbel32	1201	A	A	M3UA	1030	2345	YES	YES
a2	1305	A	A	SUA	1030	2345	YES	YES
a3	1307	A	A	SUA	1030	2346	YES	YES
assoc1	1201	A	A	M3UA	2000	1030	YES	YES
assoc2	1205	A	A	M3UA	2048	2048	YES	YES
assoc3	1205	A	A	M3UA	3000	3000	YES	YES
assoc5	1205	A	A	M3UA	1500	3000	YES	YES

Select an association whose adapter value is M3UA or SUA. If the card shown in the CARD LOC column contains any SUA associations, continue the procedure with 3. If the card contains only M3UA associations, continue the procedure with 2.

- Enter the `rtrv-card` command with the location of the card that is hosting the M3UA association that will be changed in this procedure. For this example, enter this command.

```
rtrv-card:loc=1205
```

This is an example of possible output.

```
rlghncxa03w 08-04-06 15:17:20 EST EAGLE5 38.0.0
CARD  TYPE      APPL      LSET NAME    LINK SLC LSET NAME    LINK SLC
1205  DCM          SS7IPGW  e5e6a        A    0
```

If the application assigned to the card is IPGW, perform [Changing the Attributes of an IPGW Association](#).

If the application assigned to the card is SS7IPGW or IPGWI, continue the procedure with 3.

- Continue the procedure by performing one of these actions.

If the application assigned to the card is SS7IPGW or IPGWI, shown in the APPL column, and the values of any of these parameters are being changed: `lport`, `rhost`, `rport`, `adapter`, `rmode`, `rmin`, `rmax`, `rtimes`, `cwmin`, `istrms`, `ostrms`, or `uaps`, continue the procedure by performing one of these actions.

- If the `open` parameter value for the association is `yes`, continue the procedure with 5.
- If the `open` parameter value for the association is `no`, continue the procedure with 6.

If the application assigned to the card is SS7IPGW or IPGWI, shown in the APPL column, and only the values of the `alw`, `open`, or `rtxthr` parameters are being changed, continue the procedure by performing one of these actions.

- If only the values of the `alw` parameter is being changed, or the `open` parameter value is being changed to `no`, continue the procedure with 12.
- If the value of the `rtxthr` parameter is being changed, continue the procedure with 6.
- If the value of the `open` parameter value is being changed to `yes`, a signaling link must be assigned to the card shown in this step. If 2 was performed, perform one of these actions.

- If a signaling link is assigned to the card, entries area shown in the `LSET NAME` and `LINK` columns of the `rtrv-card` output in 2. If a signaling link is assigned to the card, perform one of these actions.
 - * If only the `alw` parameter is being specified with the `open=yes` parameter, continue the procedure with 12.
 - * If the value of the `rtxthr` parameter is being changed, continue the procedure with 6.
 - If the value of the `open` parameter value is being changed to `yes` and a signaling link is not assigned to the card, perform [Adding an IPGWx Signaling Link](#) to assign an IPGWx signaling link to the card. After the signaling link has been added, perform one of these actions.
 - * If only the `alw` parameter is being specified with the `open=yes` parameter, continue the procedure with 12.
 - * If the value of the `rtxthr` parameter is being changed, continue the procedure with 6.
 - If the value of the `open` parameter value is being changed to `yes`, and 2 was not performed, continue the procedure with 4.
4. Display the signaling link that is assigned to the card containing the association that is being changed by entering the `rtrv-slk` command with the location of the card. For this example, enter this command.

```
rtrv-slk:loc=1205
```

This is an example of possible output.

```
rlghncxa03w 08-04-25 14:02:39 EST 38.0.0
rtrv-slk:loc=1101
Command entered at terminal #4.
```

LOC	LINK	LSN	SLC	TYPE
1205	A	e5e6a	0	SS7IPGW

If a signaling link is shown in this step, perform one of these actions.

- If only the `alw` parameter is being specified with the `open=yes` parameter, continue the procedure with 12.
- If the value of the `rtxthr` parameter is being changed, continue the procedure with 6.

If a signaling link is not shown in this step, perform [Adding an IPGWx Signaling Link](#) to assign an IPGWx signaling link to the card. After the signaling link has been added, perform one of these actions.

- If only the `alw` parameter is being specified with the `open=yes` parameter, continue the procedure with 12.
 - If the value of the `rtxthr` parameter is being changed, continue the procedure with 6.
5. Change the value of the `open` parameter to `no` by specifying the `chg-assoc` command with the `open=no` parameter.

For this example, enter this command.

```
chg-assoc:aname=assoc2:open=no
```

When this command has successfully completed, this message should appear.

```
rlghncxa03w 08-04-28 09:12:36 GMT EAGLE5 38.0.0
CHG-ASSOC: MASP A - COMPLTD;
```

6. Display the association being changed by entering the `rtrv-assoc` command with the `aname` parameter specified in 5 or selected in 1.

For this example, enter this command.

```
rtrv-assoc:aname=assoc2
```

This is an example of the possible output.

```
rlghncxa03w 09-05-28 21:14:37 GMT EAGLE5 41.0.0
ANAME assoc2
  LOC      1205          IPLNK PORT  A          LINK  A
  ADAPTER  M3UA          VER          M3UA RFC
  LHOST    IPNODE2-1205
  ALHOST    ---
  RHOST    remotehost1
  ARHOST    ---
  LPORT    2048          RPORT      2048
  ISTRMS   2            OSTRMS     2          BUFSIZE  200
  RMODE    LIN          RMIN       120        RMAX     800
  RTIMES   10          CWMIN      3000       UAPS     10
  OPEN     No           ALW        YES         RTXTHR   2000
  RHOSTVAL RELAXED

ASNAMES
  as1          as4          as6
```

```
IP Appl Sock/Assoc table is (8 of 4000) 1% full
Assoc Buffer Space Used (800 KB of 800 KB) on LOC = 1205
```

Continue the procedure by performing one of these steps.

- If only the `rtxthr` parameter value is being changed, continue the procedure with [12](#).
 - If the `adapter`, `uaps`, or `cwmin` parameter values are not being changed, continue the procedure with [10](#).
 - If the `adapter` parameter value is being changed, continue the procedure with [7](#).
 - If the `uaps` parameter value is being changed, but the `adapter` parameter value is not being changed, continue the procedure with [8](#).
 - If the `cwmin` parameter value is being changed, but the `adapter` and `uaps` parameter values are not being changed, continue the procedure with [9](#).
7. Display the application servers referencing the association being changed using the `rtrv-as` command with the name of the association being changed in this procedure.

For this example, enter this command.

```
rtrv-as:aname=assoc2
```

This is an example of possible output.

```
rlghncxa03w 08-04-28 21:14:37 GMT EAGLE5 38.0.0
AS Name      Mode      Tr ms     Association Names
as1          LOADSHARE 2000      assoc2
as4          LOADSHARE 2000      assoc2
as6          LOADSHARE 2000      assoc2

AS Table is (6 of 250) 1% full
```

If the association is assigned to any application servers, perform [Removing an Association from an Application Server](#) to remove the association from the application servers.

Continue the procedure by performing one of these steps.

- If the `uaps` or `cwmin` parameter values are not being changed, continue the procedure with [10](#).
 - If the `uaps` parameter value is being changed, continue the procedure with [8](#).
 - If the `cwmin` parameter value is being changed, but the `uaps` parameter value is not being changed, continue the procedure with [9](#).
8. Verify the values of the **UA** parameter set you wish to assign to the association by entering the `rtrv-uaps` command with the desired parameter set.

 **Note:**

If the `uaps` parameter will not be specified with the `chg-assoc` command, and the adapter parameter value is being changed to either `m3ua` or `sua`, the **UA** parameter set 10 will be assigned to the association.

For this example, enter this command.

```
rtrv-uaps:set=3
```

This is an example of possible output.

```
rlghncxa03w 10-07-28 09:12:36 GMT EAGLE5 42.0.0
SET  TIMER      TVALUE  PARM      PVALUE
3    1            10      1          3
3    2           3000    2          0
3    3          10000   3          1
3    4           5000    4          0
3    5            0       5          0
3    6            0       6          0
3    7            0       7          0
3    8            0       8          0
```

3	9	0	9	0
3	10	0	10	0

TIMER 2: False IP Connection Congestion Timer, max time an association can be congested before failing due to false congestion. SS7IPGW and IPGWI applications enforce 0-30000(ms). Not supported on IPSP application.

TVALUE : Valid range = 32-bits

TIMER 3: UA HeartBeat Period Timer T(beat), time (ms) between sending of BEAT msgs by NE. IPSP, SS7IPGW and IPGWI applications enforce 100(ms)-60000(ms).

TVALUE : Valid range = 32-bits

TIMER 4: UA HeartBeat Received Timer T(beat ack), timeout period for response BEAT ACK msgs by NE. IPSP, SS7IPGW and IPGWI applications enforce 100(ms)-10000(ms).

TVALUE : Valid range = 32-bits

PARAM 1: ASP SNM options. Each bit is used as an enabled/disabled flag for a particular ASP SNM option. Not supported on IPSP application.

PVALUE : Valid range = 32-bits

BIT	BIT VALUE
0=Broadcast	0=Disabled , 1=Enabled
1=Response Method	0=Disabled , 1=Enabled
2-5=Reserved	
6=Broadcast Congestion Status Change	0=Disabled , 1=Enabled
7-31=Reserved	

PARAM 2: ASP/AS Notification options. Each bit is used as an enabled/disabled flag for a particular ASP/AS Notification option. Not supported on IPSP application.

PVALUE : Valid range = 32-bits

BIT	BIT VALUE
0=ASP Active Notifications	0=Disabled , 1=Enabled
1=ASP Inactive Notifications	0=Disabled , 1=Enabled
2=ASP AS State Query	0=Disabled , 1=Enabled
3-31=Reserved	

PARAM 3: UA Serviceability Options. Each bit is used as an enabled/disabled flag for a particular UA Serviceability option. Supported on IPSP, SS7IPGW, and IPGWI applications. UA Graceful Shutdown supported on IPSP for M3UA only.

PVALUE : Valid range = 32-bits

BIT	BIT VALUE
0=UA Heartbeats	0=Disabled , 1=Enabled
1=UA Graceful Shutdown	0=Disabled , 1=Enabled
2-31=Reserved	

PARAM 4: SCTP Payload Protocol Indicator byte order option. Bit indicates PPI value is RCV/TX in Big Endian or Little Endian byte format. Supported on IPSP-M2PA associations only.

PVALUE : Valid range = 32-bits

BIT	BIT VALUE
-----	-----------

0=Payload Protocol Indicator 0=Big Endian , 1=Little
 Endian
 1-31=Reserved

If the **UA** parameter set you wish to assign to the association does not contain the desired values, perform [Changing a UA Parameter Set](#) to change the desired parameter set values.

▲ Caution:

Changing a **UA** parameter set may affect the performance of any associations using the parameter set being changed.

Continue the procedure by performing one of these steps.

- If the `cwmin` parameter value is not being changed, continue the procedure with [10](#).
 - If the `cwmin` parameter value is being changed, continue the procedure with [9](#).
- 9.** To change the `cwmin` value, the new `cwmin` parameter value must be less than or equal to the `bufsize` parameter value.

The `cwmin` parameter is the number of bytes specified for the association's congestion window. The `bufsize` is the number of kilobytes specified for the size of the association's buffer. To determine whether or not the `cwmin` value is less than or equal to the `bufsize` value, perform one of these actions.

- Multiply the `bufsize` value by 1024.
- Divide the `cwmin` value by 1024.

Continue the procedure by performing one of these actions.

- If the new `cwmin` value is less than or equal to the `bufsize` value, continue the procedure with [10](#).
 - If the new `cwmin` value is not less than or equal to the `bufsize` value, either choose another value for the `cwmin` parameter that is less than or equal to the `bufsize` value, or perform [Changing the Buffer Size of a M3UA or SUA Association](#) to change the `bufsize` value so that the `bufsize` value is greater than or equal to the `cwmin` value. After the new `cwmin` value has been chosen or the `bufsize` value has been changed, continue the procedure with [10](#).
- 10.** The remote hosts assigned to the association can be changed by specifying the `rhost` and `rhosttype` parameters with the `chg-assoc` command.

If the primary and alternate remote hosts are not being changed in this procedure, or if only the primary remote host is being changed, continue the procedure with [12](#).

To change the alternate remote host value for the association, the association must have a primary remote host assigned to it. If the association has a primary remote host, continue the procedure with [12](#). If the association does not have a primary remote host, continue the procedure with [10](#).

11. Assign a primary remote host to the association by entering the `chg-assoc` command with the name of the association and the primary remote host name.

For this example, enter this command.

```
chg-assoc:aname=assoc2:rhost="gw200.nc-Oracle.com"
```

The `rhosttype=primary` parameter can be specified with the `chg-assoc` command, but is not necessary.

When this command has successfully completed, this message should appear.

```
rlghncxa03w 09-05-28 09:12:36 GMT EAGLE5 41.0.0  
CHG-ASSOC: MASP A - COMPLTD;
```

12. Change the association using the `chg-assoc` command.

For this example, enter this command.

```
chg-assoc:aname=assoc2:rhost="gw200.nc-  
Oracle.com":rport=3000 :rtxthr=10000:rhostval=match
```

If an alternate remote host is being specified for the association, for this example enter this command.

```
chg-assoc:aname=assoc2:rhost="gw210.nc-  
Oracle.com":rhosttype=alternate:rport=3000 :rtxthr=10000:rhostval  
=match
```

If only the `alw`, `open`, or `rtxthr` parameter values are being changed in this step, for this example, enter this command.

```
chg-assoc:aname=assoc2:alw=no:open=yes:rtxthr=10000
```

These are the rules that apply to the `chg-assoc` command.

- a. If any optional parameters are not specified with the `chg-assoc` command, those values are not changed.
- b. The value of the `rmin` parameter must be less than or equal to the `rmax` parameter value.
- c. The value of the `rhost` parameter is a text string of up to 60 characters, with the first character being a letter. The command input is limited to 150 characters, including the hostname.
- d. If the value of the `open` parameter is `yes`, only the values of the `alw` and `rtxthr` parameters can be changed. To change the values of the other parameters, the value of the `open` parameter must be `no`.

When this command has successfully completed, this message should appear.

```
rlghncxa03w 08-04-28 09:12:36 GMT EAGLE5 38.0.0  
CHG-ASSOC: MASP A - COMPLTD;
```

 **Note:**

If the value of the `open` parameter was not changed in [3](#), continue the procedure with [14](#).

13. Change the value of the `open` parameter to `yes` by specifying the `chg-assoc` command with the `open=yes` parameter.

For this example, enter this command.

```
chg-assoc:aname=assoc2:open=yes
```

When this command has successfully completed, this message should appear.

```
rlghncxa03w 08-04-28 09:12:36 GMT EAGLE5 38.0.0
CHG-ASSOC: MASP A - COMPLTD;
```

14. Verify the changes using the `rtrv-assoc` command specifying the association name specified in [12](#) and [13](#).

For this example, enter this command.

```
rtrv-assoc:aname=assoc2
```

This is an example of possible output.

 **Note:**

If the [Removing an Association from an Application Server](#) procedure in [7](#) was not performed, continue the procedure with [16](#).

15. Assign the association changed in [12](#) to all applicable application servers by performing one of these procedures:
 - [Adding an Existing Association to a New Application Server](#)
 - [Adding an Existing Association to an Existing Application Server](#)
16. Back up the new changes, using the `chg-db:action=backup:dest=fixed` command. These messages should appear; the active **Maintenance and Administration Subsystem Processor (MASP)** appears first.

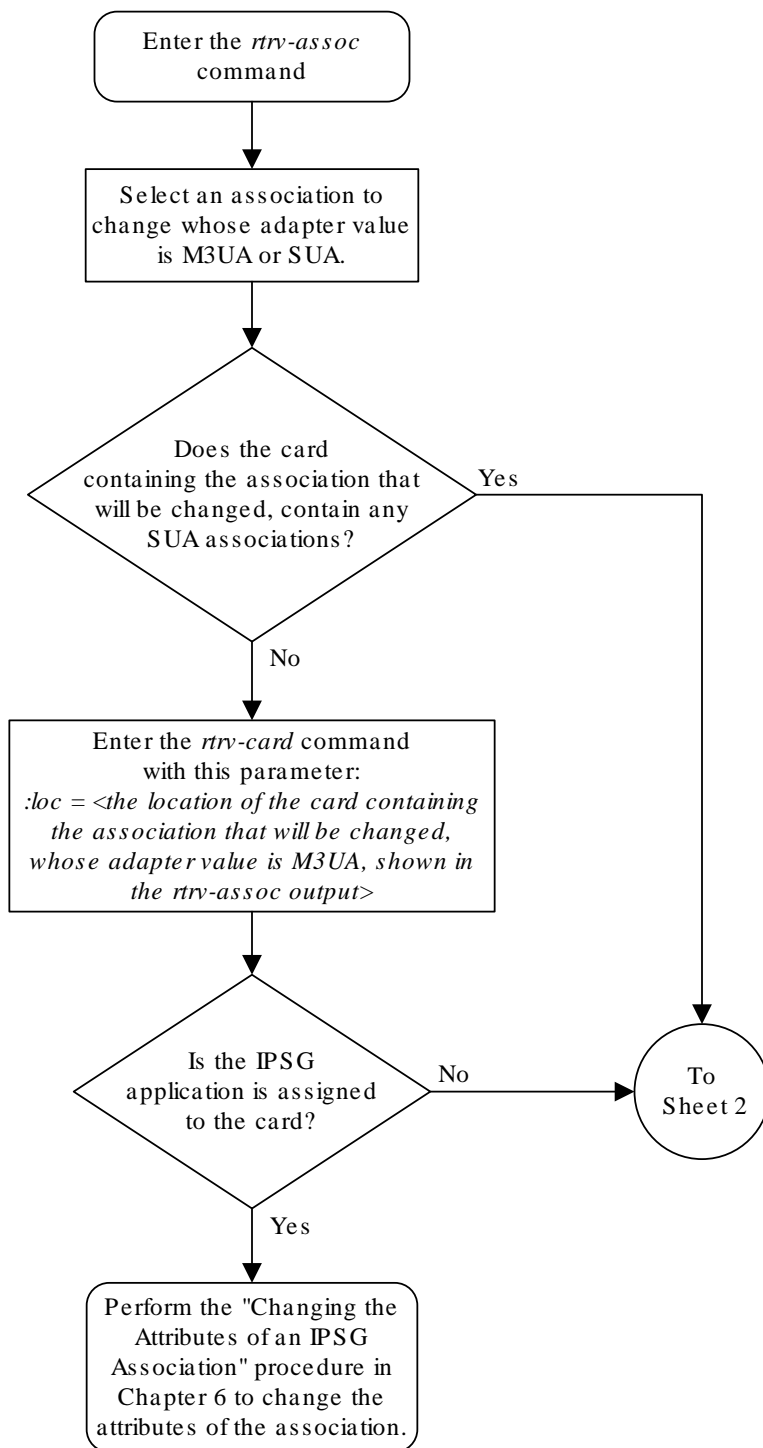
```
BACKUP (FIXED) : MASP A - Backup starts on active MASP.
BACKUP (FIXED) : MASP A - Backup on active MASP to fixed disk
complete.
BACKUP (FIXED) : MASP A - Backup starts on standby MASP.
BACKUP (FIXED) : MASP A - Backup on standby MASP to fixed disk
complete.
```

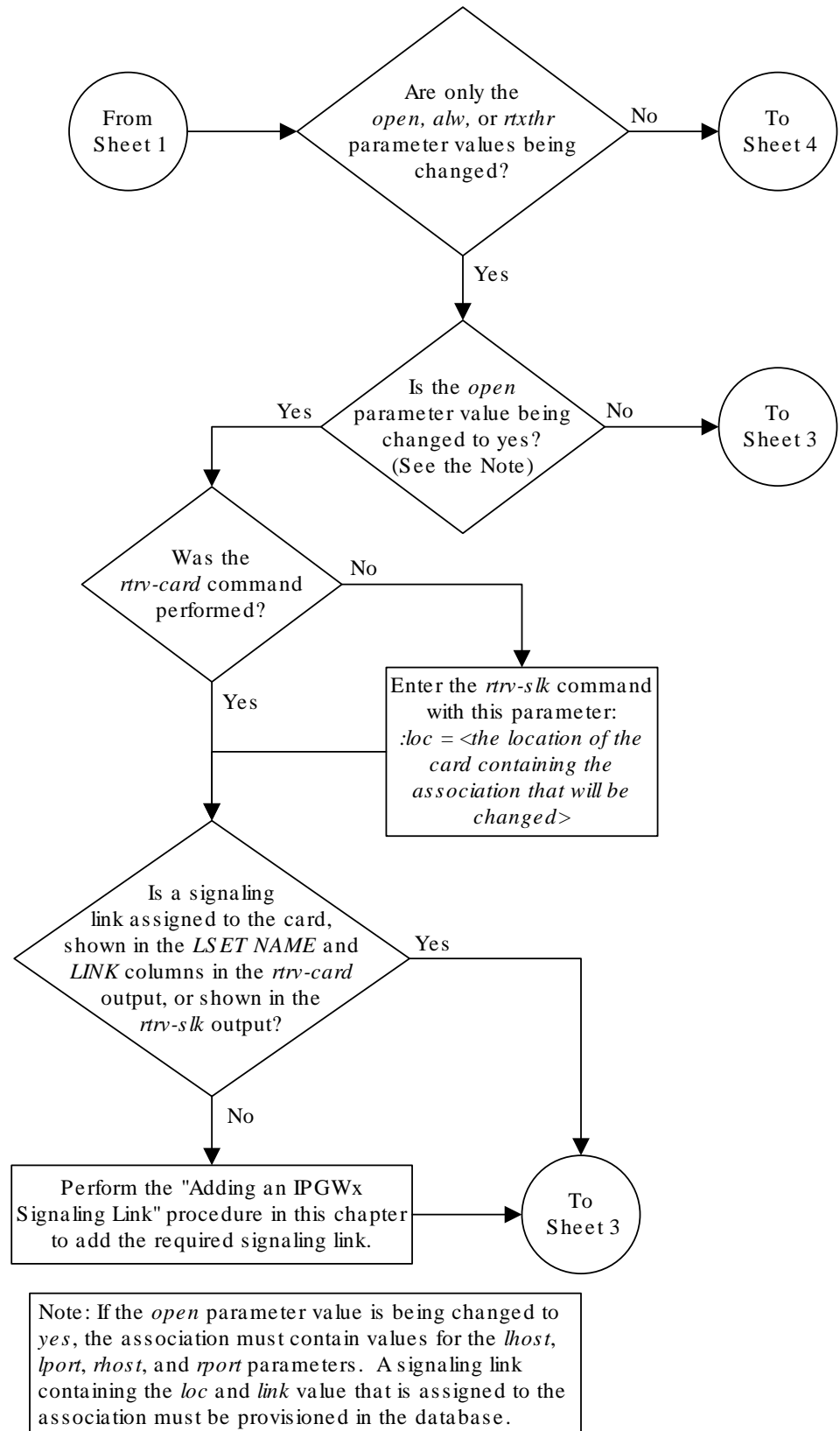
If you wish to change the `lhost`, `alhost`, or `bufsize` values of the M3UA or SUA association, perform one of these procedures.

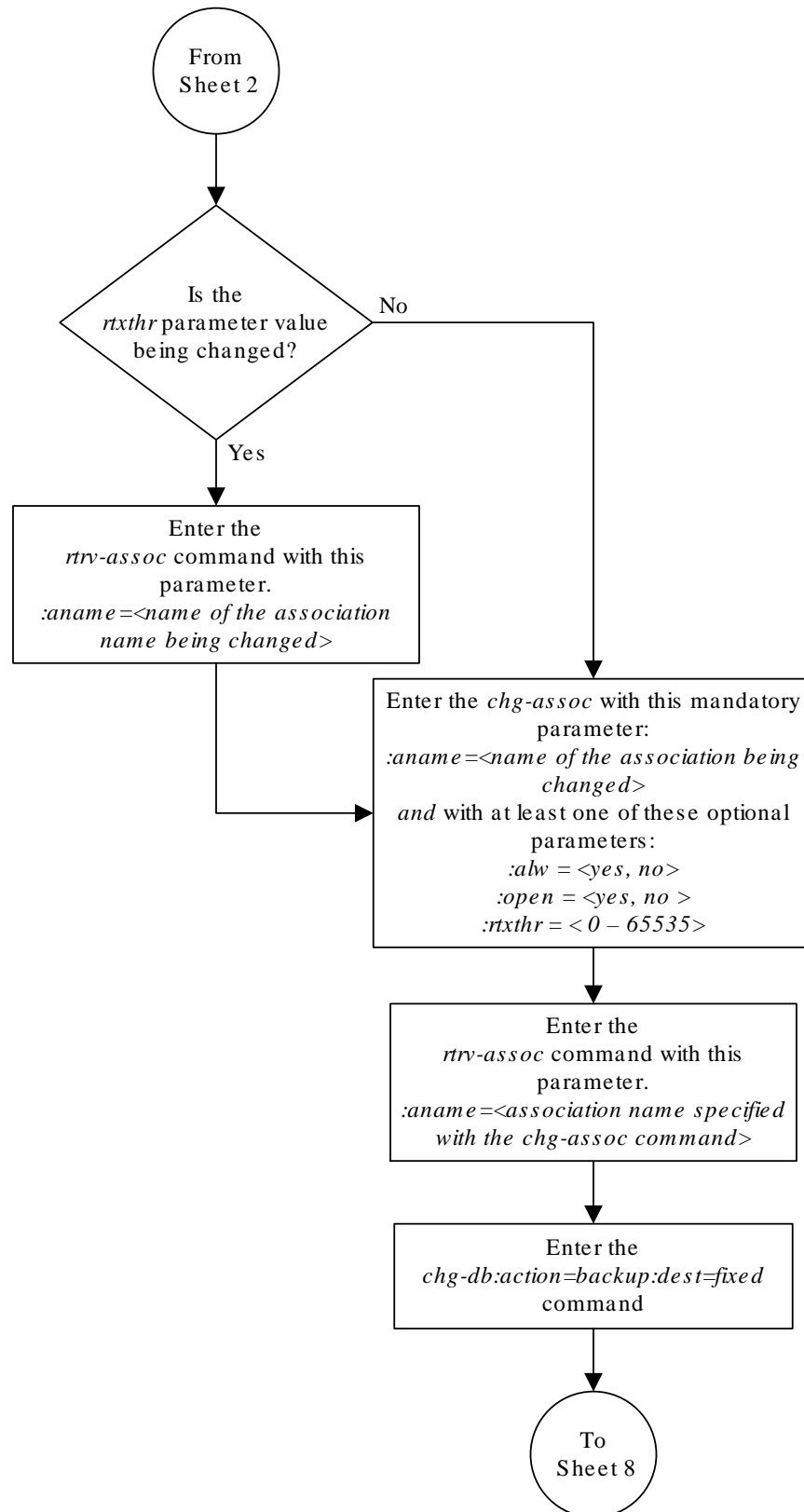
- `lhost` and `alhost` - [Changing the Host Values of a M3UA or SUA Association](#)
- `bufsize` - [Changing the Buffer Size of a M3UA or SUA Association](#)

If you do not wish to change the `lhost`, `alhost`, or `bufsize` values of the M3UA or SUA association, this procedure is finished.

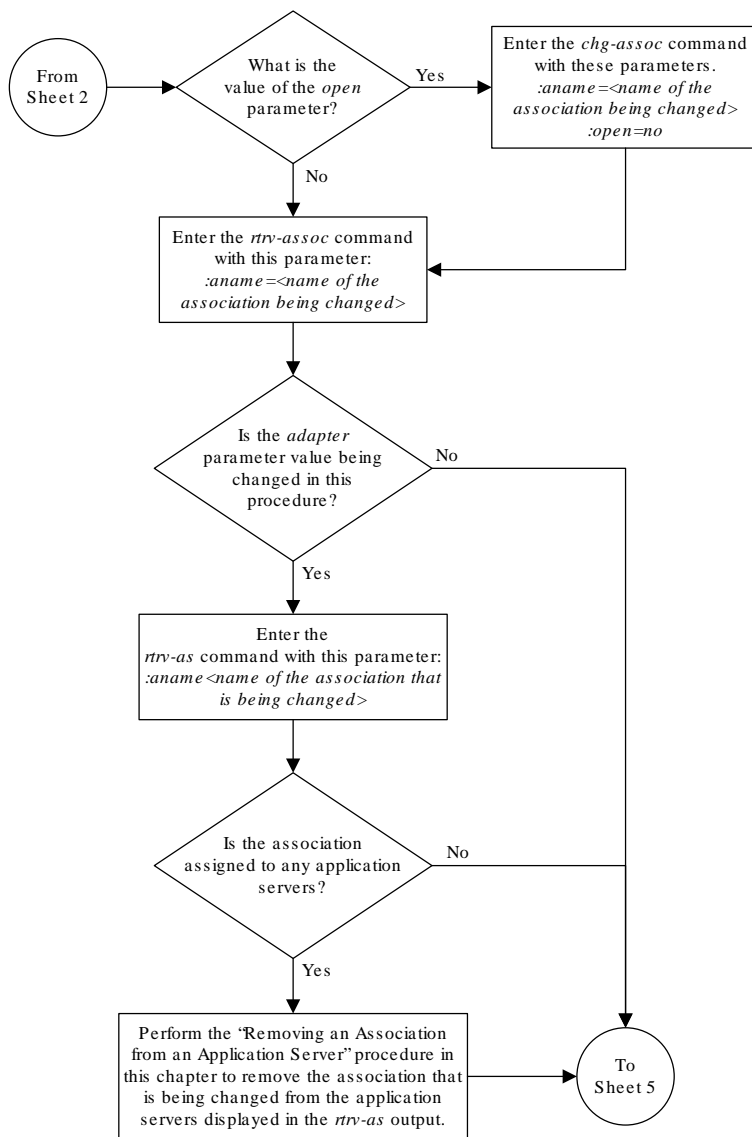
Figure 4-36 Changing the Attributes of a M3UA or SUA Association



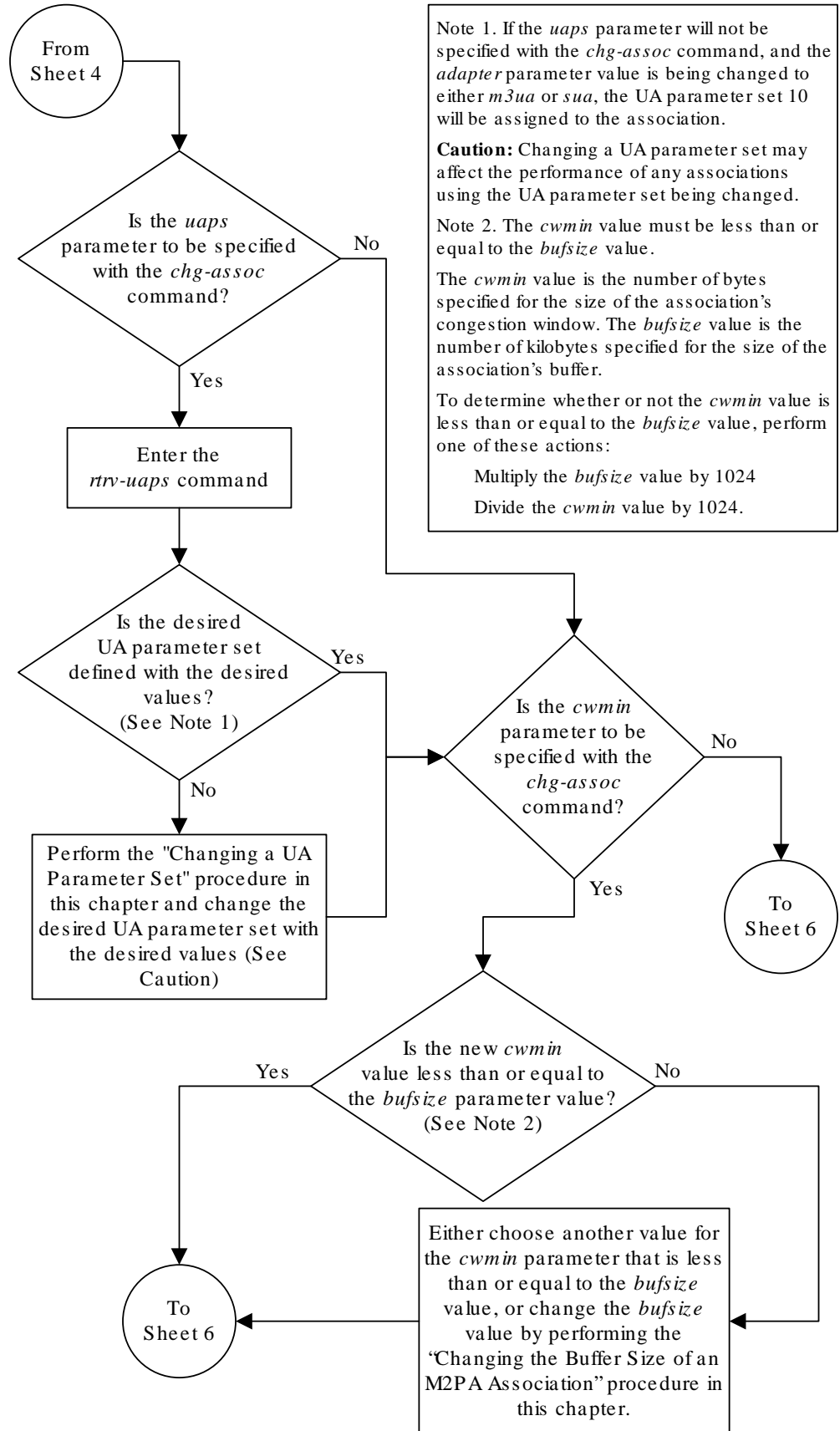


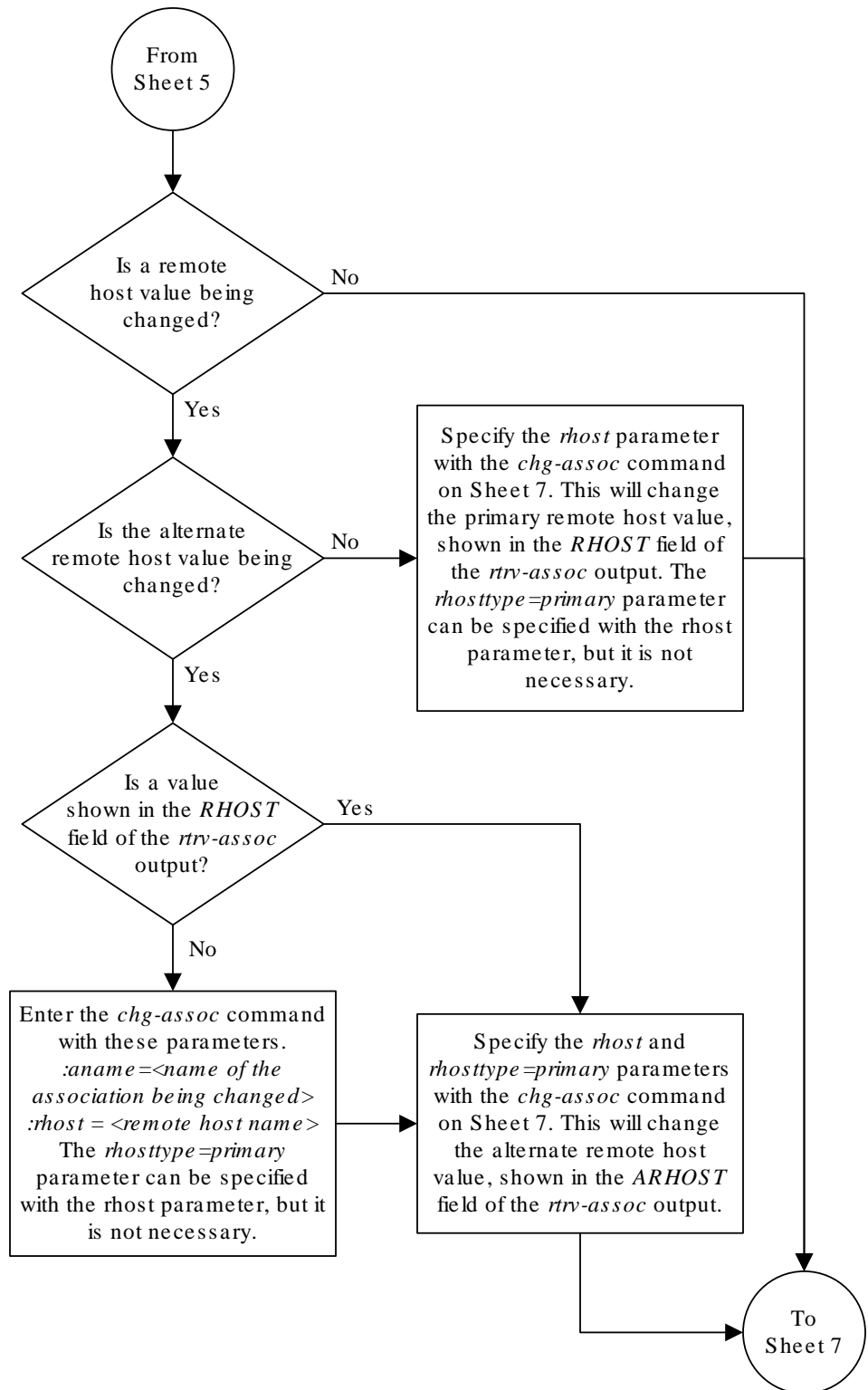


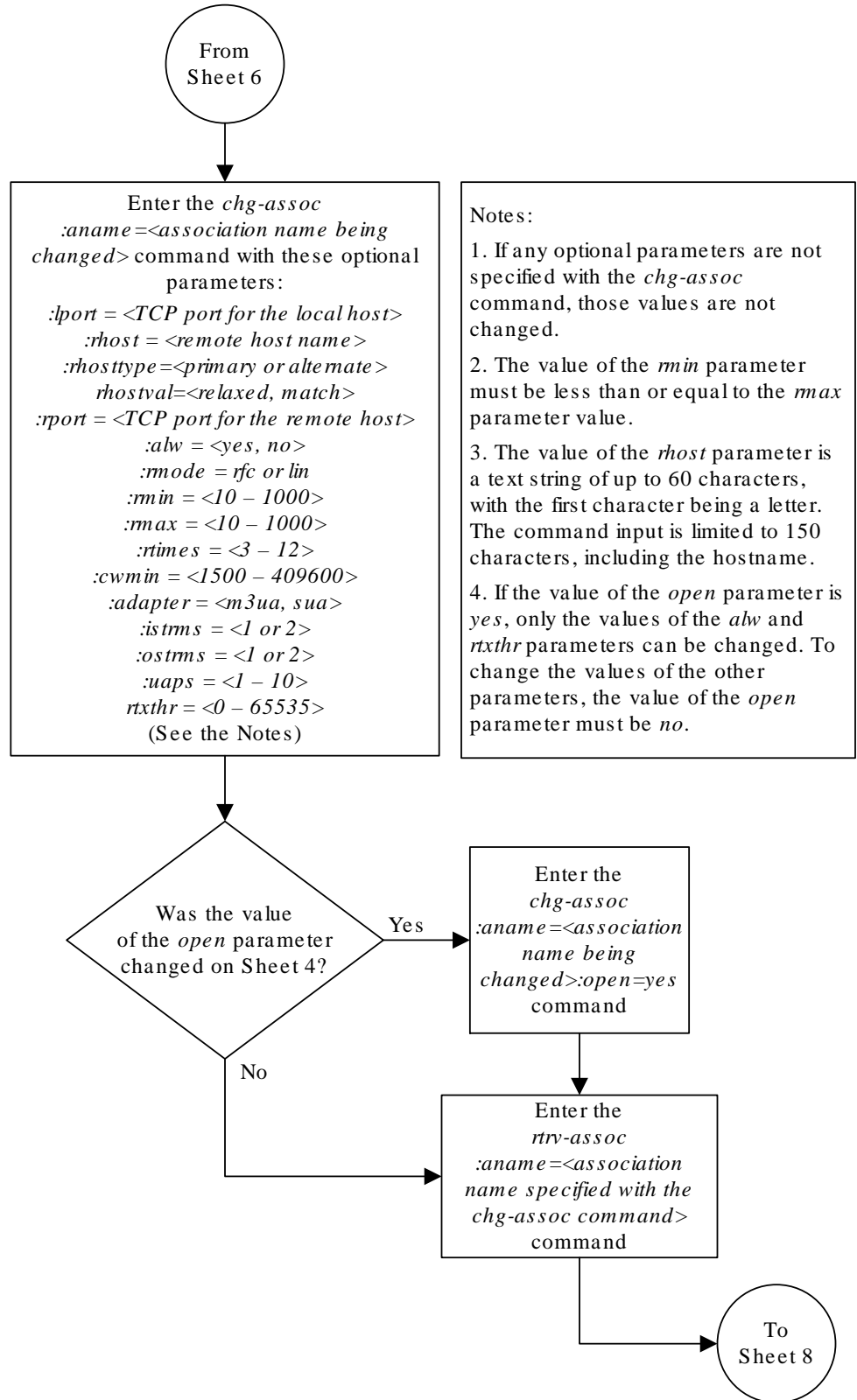
Sheet 3 of 8

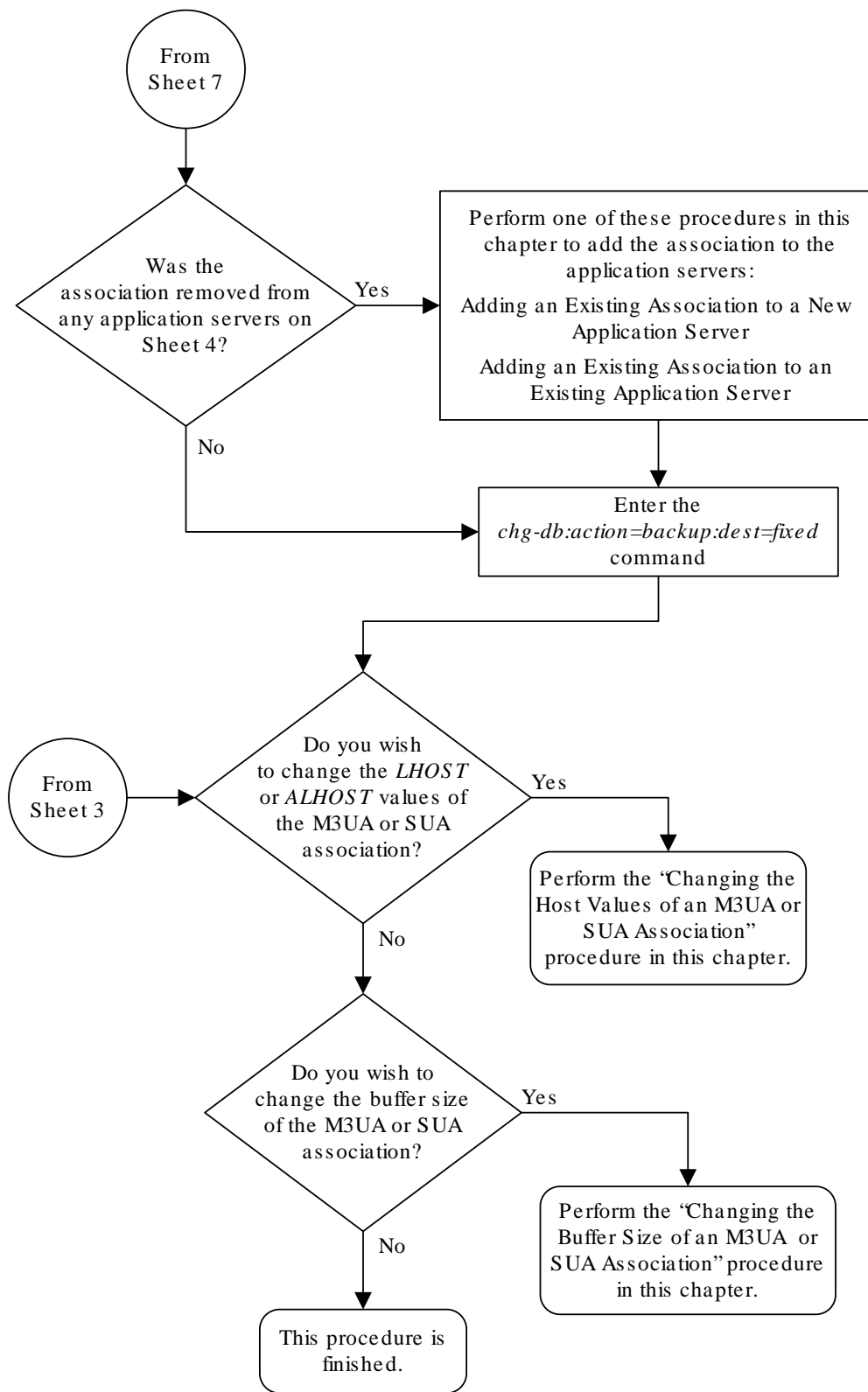


Sheet 4 of 8









4.31 Changing the Buffer Size of a M3UA or SUA Association

This procedure is used to change the buffer size of a **M3UA** or a **SUA** association, assigned to cards that are running the SS7IPGW or IPGWI applications, using the `chg-assoc` command. If you wish to change the attributes of M3UA associations assigned to cards that are running the IPSP application, perform the [Changing the Buffer Size of an IPSP Association](#) procedure.

These parameters of the `chg-assoc` command are used in this procedure:

`:aname` – The name assigned to the association, shown in the `rtrv-assoc` output.

`:open` – The connection state for this association. Valid values are `yes` or `no`. When the `open=yes` parameter is specified, the connection manager opens the association if the association is operational. When the `open=no` parameter is specified, the connection manager will not open the association.

`:bufsize` – The size, in kilobytes, of the buffer used by the association. The values for this parameter are 8 kilobytes to 400 kilobytes. The maximum size of the buffers on the **IP** cards are shown in the following list:

- E5-ENET Card - 3200 KB.

The size of the buffers assigned to each association that is assigned to the **IP** card cannot exceed the maximum buffer size for that card. If the `bufsize` parameter value causes the total buffer size for all the associations on the **IP** card to exceed the maximum buffer size for that **IP** card, the `chg-assoc` command will be rejected. The available size of the buffers on the **IP** card can be verified by entering this command.

```
rtrv-assoc:lhost=<local host name assigned to the association being changed>
```

The `alhost` parameter can also be used with the `rtrv-assoc` command to display the available size of the buffers on the **IP** card.

The `aname` parameter can be used with the `rtrv-assoc` command to display the available size of the buffers on the **IP** card and the size of the buffer assigned to the association.

If you wish to increase the buffer size for this association to a value that is greater than available buffer size for the card, the buffer size of the other associations assigned to the card must be decreased.

The `chg-assoc` command contains other parameters that are not used this procedure. To change these parameters, perform these procedures.

- `lhost` and `alhost` - [Changing the Host Values of a M3UA or SUA Association](#)
- Other attributes of the M3UA or SUA Association - [Changing the Attributes of a M3UA or SUA Association](#)

Canceling the RTRV-ASSOC Command

Because the `rtrv-assoc` command used in this procedure can output information for a long period of time, the `rtrv-assoc` command can be canceled and the output to the terminal stopped. There are three ways that the `rtrv-assoc` command can be canceled.

- Press the F9 function key on the keyboard at the terminal where the `rtrv-assoc` command was entered.
- Enter the `canc-cmd` without the `trm` parameter at the terminal where the `rtrv-assoc` command was entered.
- Enter the `canc-cmd:trm=<xx>`, where `<xx>` is the terminal where the `rtrv-assoc` command was entered, from another terminal other than the terminal where the `rtrv-assoc` command was entered. To enter the `canc-cmd:trm=<xx>` command, the terminal must allow Security Administration commands to be entered from it and the user must be allowed to enter Security Administration commands. The terminal's permissions can be verified with the `rtrv-secu-trm` command. The user's permissions can be verified with the `rtrv-user` or `rtrv-secu-user` commands.

For more information about the `canc-cmd` command, go to *Commands User's Guide*.

1. Display the associations in the database using the `rtrv-assoc` command.

This is an example of possible output.

```
rlghncxa03w 08-04-28 09:12:36 GMT EAGLE5 38.0.0
```

ANAME	CARD		IPLNK	LINK	ADAPTER	LPORT	RPORT	OPEN	ALW
	LOC	PORT							
swbel32	1201	A	A	M3UA	1030	2345	YES	YES	
a2	1305	A	A	SUA	1030	2345	YES	YES	
a3	1307	A	A	SUA	1030	2346	YES	YES	
assoc1	1201	A	A	M3UA	2000	1030	YES	YES	
assoc2	1205	A	A	M3UA	2048	2048	YES	YES	
assoc3	1205	A	A	M3UA	3000	3000	YES	YES	
assoc5	1205	A	A	M3UA	1500	3000	YES	YES	

Select an association whose adapter value is M3UA or SUA. If the card shown in the `CARD LOC` column contains any SUA associations, and the `open` parameter value of the association is `no`, continue the procedure with 4. If the `open` parameter value of the association is `yes`, continue the procedure with 3

If the card contains only M3UA associations, continue the procedure with 2.

2. Enter the `rtrv-card` command with the location of the card that is hosting the M3UA association that will be changed in this procedure. For this example, enter this command.

```
rtrv-card:loc=1205
```

This is an example of possible output.

```
rlghncxa03w 08-04-06 15:17:20 EST EAGLE5 38.0.0
CARD  TYPE      APPL      LSET NAME    LINK SLC LSET NAME    LINK SLC
1205  DCM          SS7IPGW   e5e6a        A    0
```

If the application assigned to the card is `SS7IPGW` or `IPGWI`, shown in the `APPL` column, continue the procedure by performing one of these steps.

- If the `open` parameter value for the association being changed is `yes`, continue the procedure with 3.
- If the `open` parameter value for the association being changed is `no`, continue the procedure with 4.

If the application assigned to the card is IPSPG, perform the [Changing the Buffer Size of an IPSPG Association](#) procedure.

3. Change the value of the `open` parameter to `no` by specifying the `chg-assoc` command with the `open=no` parameter.

For this example, enter this command.

```
chg-assoc:aname=assoc2:open=no
```

When this command has successfully completed, this message should appear.

```
rlghncxa03w 08-04-28 09:12:36 GMT EAGLE5 38.0.0
CHG-ASSOC: MASP A - COMPLTD;
```

4. Display the association being changed by entering the `rtrv-assoc` command with the `aname` parameter specified in 3 or the association selected in 1.

For this example, enter this command.

```
rtrv-assoc:aname=assoc2
```

This is an example of the possible output.

```
rlghncxa03w 09-05-28 21:14:37 GMT EAGLE5 41.0.0
ANAME assoc2
      LOC      1205          IPLNK PORT  A          LINK  A
      ADAPTER  M3UA          VER          M3UA RFC
      LHOST    IPNODE2-1205
      ALHOST    ---
      RHOST    remotehost1
      ARHOST    ---
      LPORT    2048          RPORT      2048
      ISTRMS   2             OSTRMS     2          BUFSIZE  200
      RMODE    LIN          RMIN       120         RMAX     800
      RTIMES   10          CWMIN     3000        UAPS     10
      OPEN     No          ALW        YES          RTXTHR   2000
      RHOSTVAL RELAXED
```

```
ASNAMES
as1          as4          as6
```

```
IP Appl Sock/Assoc table is (8 of 4000) 1% full
Assoc Buffer Space Used (800 KB of 800 KB) on LOC = 1205
```

5. If the `bufsize` parameter value causes the total buffer size for all the associations on the **IP** card to exceed the maximum buffer size for that **IP** card, the `chg-assoc` command will be rejected.

If you wish to increase the buffer size for this association to a value that is greater than available buffer size for the card, the buffer size of the other associations assigned to the card must be decreased. Perform this step and 6, 7, and 8.

If the buffers on the other associations assigned to the card do not need to be changed, continue the procedure with 9.

Display the associations assigned to the **IP** card (and its corresponding local host) by entering the `rtrv-assoc` command with the local host name assigned to the association being changed. For this example, enter this command.

```
rtrv-assoc:lhost="IPNODE2-1205"
```

This is an example of the possible output.

```
rlghncxa03w 08-04-28 21:14:37 GMT EAGLE5 38.0.0
                CARD IPLNK
ANAME          LOC  PORT  LINK ADAPTER LPORT RPORT OPEN ALW
assoc2         1205 A    A    M3UA   2048  2048  YES  YES
assoc3         1205 A    A    M3UA   3000  3000  YES  YES
assoc5         1205 A    A    M3UA   1500  3000  YES  YES
```

```
IP Appl Sock/Assoc table is (8 of 4000) 1% full
Assoc Buffer Space Used (800 KB of 3200 KB) on LOC = 1205
```

6. Display each association shown in 5 by entering the `rtrv-assoc` command with the name of each association shown in 5.

For this example, enter these commands.

```
rtrv-assoc:aname=assoc2
```

This is an example of the possible output.

```
ANAME assoc2
      LOC      1205          IPLNK PORT  A          LINK  A
      ADAPTER  M3UA          VER      M3UA RFC
      LHOST    IPNODE2-1205
      ALHOST   ---
      RHOST    remotehost1
      ARHOST   ---
      LPORT    2048          RPORT      2048
      ISTRMS   2            OSTRMS     2          BUFSIZE  200
      RMODE   LIN           RMIN       120         RMAX     800
      RTIMES   10           CWMIN      3000        UAPS     10
      OPEN     YES          ALW        YES          RTXTHR   2000
      RHOSTVAL RELAXED
```

```
ASNAMES
as1          as4          as6
```

```
IP Appl Sock/Assoc table is (8 of 4000) 1% full
Assoc Buffer Space Used (800 KB of 800 KB) on LOC = 1205
```

```
rtrv-assoc:aname=assoc3
```

This is an example of the possible output.

```

ANAME assoc3
  LOC      1205          IPLNK PORT  A          LINK  A
  ADAPTER  M3UA         VER          M3UA RFC
  LHOST    IPNODE2-1205
  ALHOST    ---
  RHOST    remotehost3
  ARHOST    ---
  LPORT    3000         RPORT      3000
  ISTRMS   2           OSTRMS     2           BUFSIZE  400
  RMODE    LIN         RMIN       120          RMAX     800
  RTIMES   10         CWMIN      3000       UAPS     10
  OPEN     YES        ALW        YES         RTXTHR   10000
  RHOSTVAL RELAXED

ASNAMES
  as2          as3          as5
  
```

IP Appl Sock/Assoc table is (8 of 4000) 1% full
 Assoc Buffer Space Used (800 KB of 800 KB) on LOC = 1205

rtrv-assoc:aname=assoc5

This is an example of the possible output.

```

ANAME assoc5
  LOC      1205          IPLNK PORT  A          LINK  A
  ADAPTER  M3UA         VER          M3UA RFC
  LHOST    IPNODE2-1205
  ALHOST    ---
  RHOST    remotehost3
  ARHOST    ---
  LPORT    1500         RPORT      3000
  ISTRMS   2           OSTRMS     2           BUFSIZE  200
  RMODE    LIN         RMIN       120          RMAX     800
  RTIMES   10         CWMIN      3000       UAPS     10
  OPEN     YES        ALW        YES         RTXTHR   10000
  RHOSTVAL RELAXED

ASNAMES
  as2          as3          as5
  
```

IP Appl Sock/Assoc table is (8 of 4000) 1% full
 Assoc Buffer Space Used (800 KB of 800 KB) on LOC = 1205

- To change the `bufsize` value for the associations shown in 6, the new `bufsize` parameter value must be greater than or equal to the `cwmin` parameter value.

The `cwmin` parameter is the number of bytes specified for the association's congestion window. The `bufsize` is the number of kilobytes specified for the size of the association's buffer. To determine whether or not the `cwmin` value is less than or equal to the `bufsize` value, perform one of these actions.

- Multiply the `bufsize` value by 1024.
- Divide the `cwmin` value by 1024.

Continue the procedure by performing one of these actions.

- If the new `bufsize` value is greater than or equal to the `cwmin` value, continue the procedure with [8](#).
 - If the new `bufsize` value is not greater than or equal to the `cwmin` value, either choose another value for the `bufsize` parameter that is greater than or equal to the `cwmin` value, or perform the [Changing the Attributes of a M3UA or SUA Association](#) procedure to change the `bufsize` value so that the `bufsize` value is greater than or equal to the `cwmin` value. After the new `bufsize` value has been chosen or the `cwmin` value has been changed, continue the procedure with [8](#).
- 8.** Change the size of the buffers for one or more of the associations displayed in [6](#) to allow the buffer of the association displayed in [4](#) to be changed.

Enter the `chg-assoc` command with the `bufsize` parameter. For this example, enter this command.

```
chg-assoc:aname=assoc3:bufsize=200
```

When this command has successfully completed, this message should appear.

```
rlghncxa03w 08-04-28 09:12:36 GMT EAGLE5 38.0.0
CHG-ASSOC: MASP A - COMPLTD;
```

- 9.** To change the `bufsize` value for the association shown in [4](#), the new `bufsize` parameter value must be greater than or equal to the `cwmin` parameter value.

The `cwmin` parameter is the number of bytes specified for the association's congestion window. The `bufsize` is the number of kilobytes specified for the size of the association's buffer. To determine whether or not the `cwmin` value is less than or equal to the `bufsize` value, perform one of these actions.

- Multiply the `bufsize` value by 1024.
- Divide the `cwmin` value by 1024.

Continue the procedure by performing one of these actions.

- If the new `bufsize` value is greater than or equal to the `cwmin` value, continue the procedure with [10](#).
 - If the new `bufsize` value is not greater than or equal to the `cwmin` value, either choose another value for the `bufsize` parameter that is greater than or equal to the `cwmin` value, or perform the [Changing the Attributes of a M3UA or SUA Association](#) procedure to change the `bufsize` value so that the `bufsize` value is greater than or equal to the `cwmin` value. After the new `bufsize` value has been chosen or the `cwmin` value has been changed, continue the procedure with [10](#).
- 10.** Change the association using the `chg-assoc` command.

For this example, enter this command.

```
chg-assoc:aname=assoc2:bufsize=250
```

When this command has successfully completed, this message should appear.

```
rlghncxa03w 08-04-28 09:12:36 GMT EAGLE5 38.0.0
CHG-ASSOC: MASP A - COMPLTD;
```

If the value of the `open` parameter was not changed in 3, continue the procedure with 12.

If the value of the `open` parameter was changed in 3, continue the procedure with 11.

11. Change the value of the `open` parameter to `yes` by specifying the `chg-assoc` command with the `open=yes` parameter.

For this example, enter this command.

```
chg-assoc:aname=assoc2:open=yes
```

When this command has successfully completed, this message should appear.

```
rlghncxa03w 08-04-28 09:12:36 GMT EAGLE5 38.0.0
CHG-ASSOC: MASP A - COMPLTD;
```

12. Verify the changes using the `rtrv-assoc` command specifying the association name specified in 10 and 11.

For this example, enter this command.

```
rtrv-assoc:aname=assoc2
```

This is an example of possible output.

```
rlghncxa03w 09-05-28 09:12:36 GMT EAGLE5 41.0.0
ANAME assoc2
  LOC      1205          IPLNK PORT  A          LINK  A
ADAPTER  M3UA          VER      M3UA RFC
LHOST    IPNODE2-1205
ALHOST   ---
RHOST    gw200.nc-tekelec.com
ARHOST   ---
LPORT    2048          RPORT    3000
ISTRMS   2            OSTRMS   2          BUFSIZE 250
RMODE    LIN          RMIN     120        RMAX     800
RTIMES   10           CWMIN    3000       UAPS     10
OPEN     YES          ALW      YES         RTXTHR  10000
RHOSTVAL RELAXED
```

```
ASNAMES
as1          as4          as6
```

```
IP Appl Sock table is (8 of 4000) 1% full
Assoc Buffer Space Used (650 KB of 800 KB) on LOC = 1205
```

13. Back up the new changes, using the `chg-db:action=backup:dest=fixed` command. These messages should appear; the active **Maintenance and Administration Subsystem Processor (MASP)** appears first.

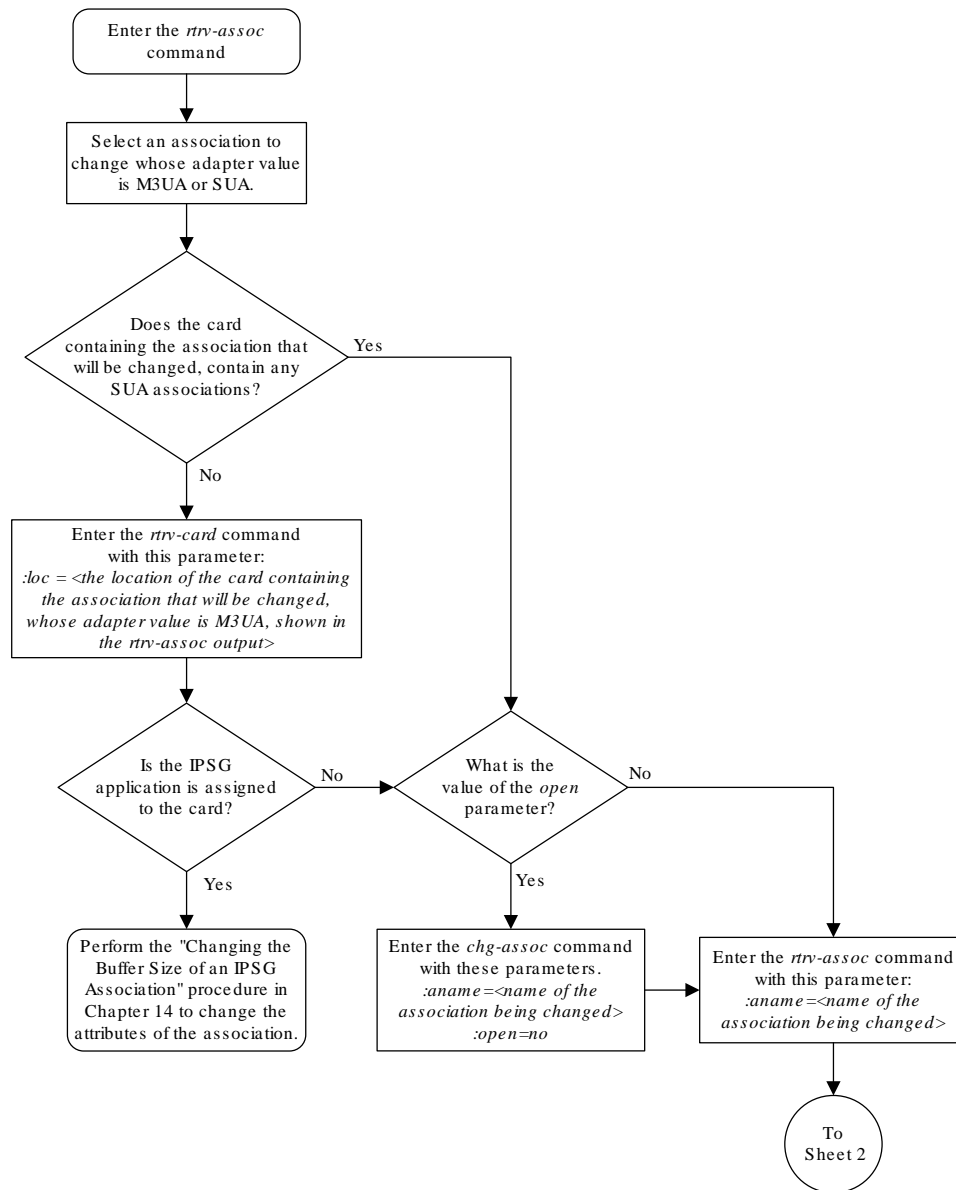
```
BACKUP (FIXED) : MASP A - Backup starts on active MASP.  
BACKUP (FIXED) : MASP A - Backup on active MASP to fixed disk  
complete.  
BACKUP (FIXED) : MASP A - Backup starts on standby MASP.  
BACKUP (FIXED) : MASP A - Backup on standby MASP to fixed disk  
complete.
```

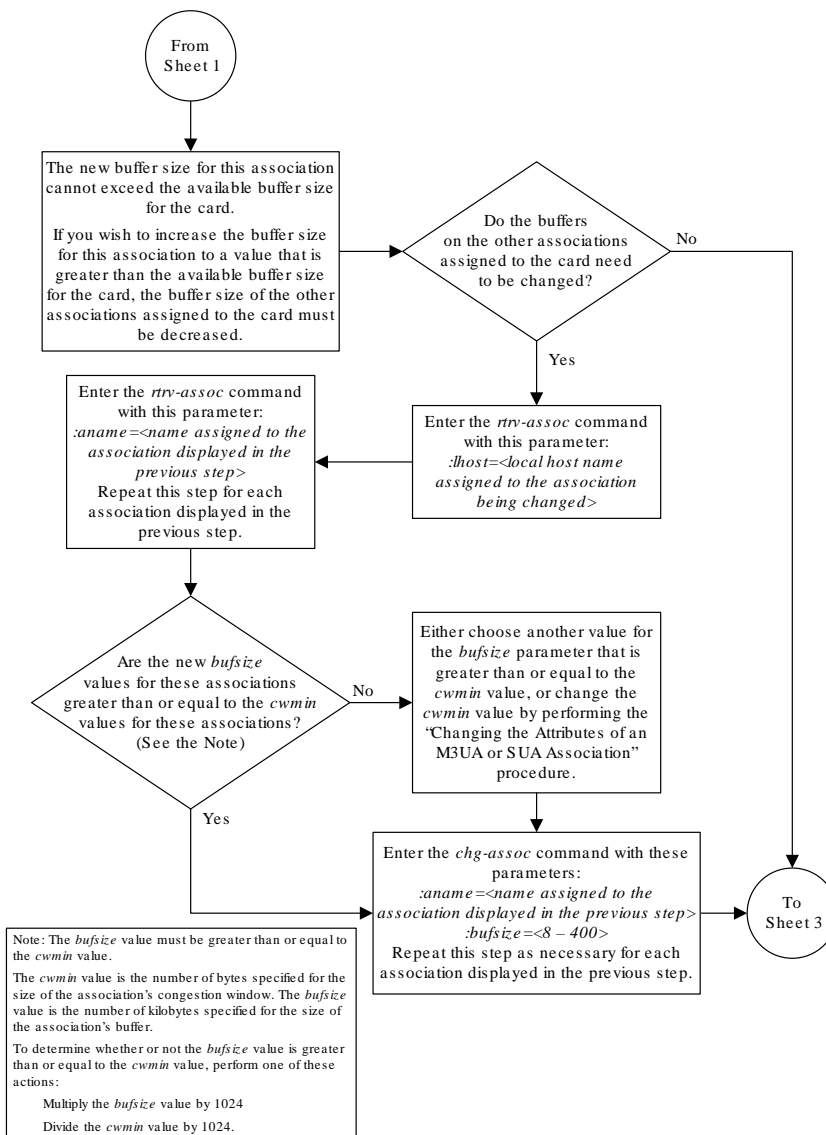
If you wish to change other attributes of the M3UA or SUA association, perform one of these procedures.

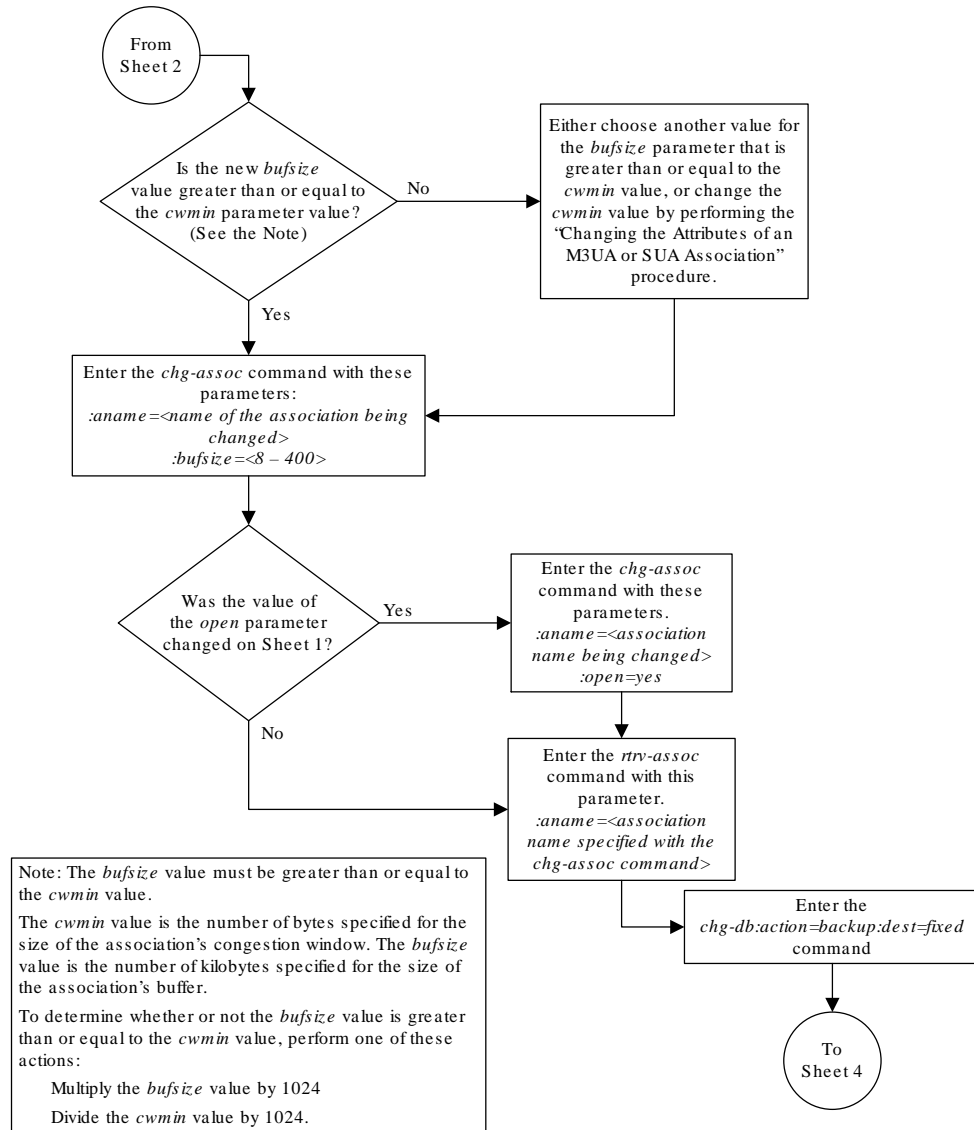
- `lhost` and `alhost` - [Changing the Host Values of a M3UA or SUA Association](#)
- Other attributes of the M3UA or SUA Association - [Changing the Attributes of a M3UA or SUA Association](#)

If you do not wish to change other attributes of the M3UA or SUA association, this procedure is finished.

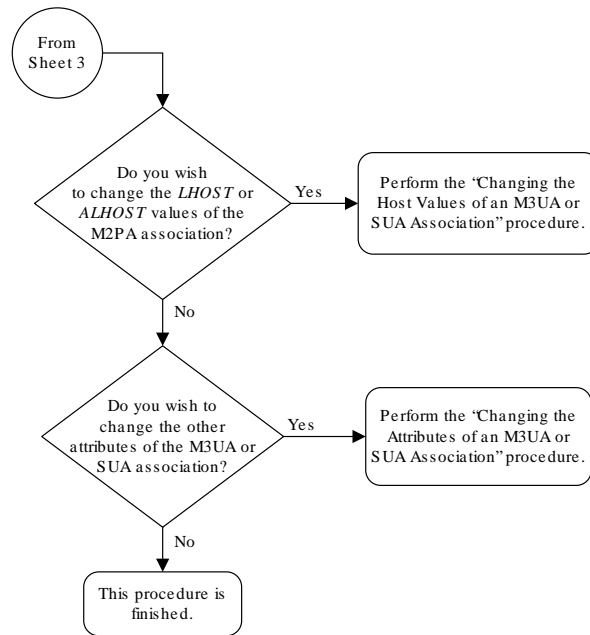
Figure 4-37 Changing the Buffer Size of an M3UA or SUA Association







Sheet 3 of 4



Sheet 4 of 4

4.32 Changing the Host Values of a M3UA or SUA Association

This procedure is used to change the host values of a **M3UA** or **SUA** association, assigned to cards that are running the SS7IPGW or IPGWI applications, using the `chg-assoc` command. If you wish to change the attributes of M3UA associations assigned to cards that are running the IPSG application, perform the [Changing the Host Values of an IPSG Association](#) procedure.

These parameters of the `chg-assoc` command are used in this procedure:

`:aname` – The name assigned to the association, shown in the `rtrv-assoc` output.

`:lhost` – The host name for the local host, shown in the `rtrv-ip-host` output.

`:lport` – The **SCTP** port number for the local host.

`:rhost` – The host name for the remote host, `rhost` can be any string of characters starting with a letter and comprising these characters [‘a’..‘z’, ‘A’..‘Z’, ‘0’..‘9’, ‘-’, ‘.']. Hostnames are not case-sensitive and can contain up to 60 characters. The default value of this optional parameter is empty (null string).

`:rport` – The **SCTP** port number for the remote host.

`:link` – The signaling link on the **IPGWx** card. The value for the `link` parameter for **M3UA** or **SUA** associations is A.

 **Note:**

The `port` parameter can be used in place of the `link` parameter to specify the signaling link on the card.

`:adapter` – The adapter layer for this association, either `m3ua` or `sua`. The `adapter` parameter is optional. The default value for the `adapter` parameter in this procedure is `m3ua`.

`:alhost` – The alternate local host name, shown in the `rtrv-ip-host` output.

`:open` – The connection state for this association. Valid values are `yes` or `no`. When the `open=yes` parameter is specified, the connection manager opens the association if the association is operational. When the `open=no` parameter is specified, the connection manager will not open the association.

`:uaps` – The **UA** parameter set value being assigned to either an **M3UA** or **SUA** association.

At least one optional parameter is required.

The command input is limited to 150 characters, including the hostnames.

The maximum number **SCTP** association to application server assignments that can be hosted by an **IPGWx** card (referenced by the `lhost` parameter of the association) is 50. For example, the **IPGWx** card currently contains 38 **SCTP** association to application server assignments. The **SCTP** association to application server assignments could be one **SCTP** association assigned to 38 application servers, two **SCTP** associations assigned to 19 application servers, or any combination of **SCTP** associations assigned to application servers that add up to 38. The **SCTP** association to application server assignments can be verified with the `rtrv-assoc:lhost=<local host name>` and `rtrv-as:aname=<association name>` commands.

Table 4-17 Examples of IPGWx Card Provisioning Limits

Number of Associations hosted by the IPGWx card	Number of Application Servers each Association is Assigned to *	Total Association - Application Server Assignments maintained by the IPGWx card
1	50	50
50	1	50
25	1	50
25	2	50
0	0	50
38	1	38
19	2	38

* The **EAGLE** can contain a maximum of 250 application servers.

The **EAGLE** can contain a maximum of 4000 connections.

The B Ethernet interface of the **IP** card can be used on the **E5-ENET** cards.

If the card's application is either **SS7IPGW** or **IPGWI**, the signaling link being assigned to the association must be in service. This state is shown in the `rept-stat-slk` output with the entries `IS-NR` in the `PST` field and `Avail` in the `SST` field.

Uni-homed endpoints are associations configured with the `lhost` parameter only. The `lhost` parameter value represents an **IP** address that corresponds to either the A or B network interface of the **IP** card. Multi-homed endpoints are associations configured with both the `lhost` and `alhost` parameters. The `lhost` parameter value represents an **IP** address corresponding to one of the network interfaces (A or B) of the **IP** card while the `alhost` parameter value represents an **IP** address corresponding to the other network interface of the same **IP** card.

The `alhost=none` parameter removes the alternate local host from the specified association, which also removes the multi-homed endpoint capability.

Canceling the **RTRV-ASSOC** and **RTRV-AS** Commands

Because the `rtrv-assoc` and `rtrv-as` commands used in this procedure can output information for a long period of time, the `rtrv-assoc` and `rtrv-as` commands can be canceled and the output to the terminal stopped. There are three ways that the `rtrv-assoc` and `rtrv-as` commands can be canceled.

- Press the **F9** function key on the keyboard at the terminal where the `rtrv-assoc` or `rtrv-as` commands were entered.
- Enter the `canc-cmd` without the `trm` parameter at the terminal where the `rtrv-assoc` or `rtrv-as` commands were entered.
- Enter the `canc-cmd:trm=<xx>`, where `<xx>` is the terminal where the `rtrv-assoc` or `rtrv-as` commands were entered, from another terminal other than the terminal where the `rtrv-assoc` or `rtrv-as` commands were entered. To enter the `canc-cmd:trm=<xx>` command, the terminal must allow Security Administration commands to be entered from it and the user must be allowed to enter Security Administration commands. The terminal's permissions can be

verified with the `rtrv-secu-trm` command. The user's permissions can be verified with the `rtrv-user` or `rtrv-secu-user` commands.

For more information about the `canc-cmd` command, go to *Commands User's Guide*.

1. Display the associations in the database using the `rtrv-assoc` command.

This is an example of possible output.

```
rlghncxa03w 08-04-28 09:12:36 GMT EAGLE5 38.0.0

          CARD IPLNK
ANAME     LOC  PORT  LINK ADAPTER LPORT RPORT OPEN ALW
swbel32   1201 A    A    M3UA   1030  2345  YES  YES
a2        1305 A    A    SUA    1030  2345  YES  YES
a3        1307 A    A    SUA    1030  2346  YES  YES
assoc1    1201 A    A    M3UA   2000  1030  YES  YES
assoc2    1205 A    A    M3UA   2048  2048  YES  YES
assoc3    1205 A    A    M3UA   3000  3000  YES  YES
assoc5    1205 A    A    M3UA   1500  3000  YES  YES
```

Select an association whose adapter value is M3UA or SUA. If the card shown in the `CARD LOC` column contains any SUA associations, continue the procedure by performing one of these steps.

- If the `open` parameter value for the association being changed is `yes`, continue the procedure with 3.
- If the `open` parameter value for the association being changed is `no`, continue the procedure with 4.

If the card contains only M3UA associations, continue the procedure with 2.

2. Enter the `rtrv-card` command with the location of the card that is hosting the M3UA association that will be changed in this procedure. For this example, enter this command.

```
rtrv-card:loc=1205
```

This is an example of possible output.

```
rlghncxa03w 08-04-06 15:17:20 EST EAGLE5 38.0.0
CARD  TYPE      APPL      LSET NAME    LINK SLC LSET NAME    LINK SLC
1205  DCM         SS7IPGW   e5e6a        A    0
```

If the application assigned to the card is IPSPG, perform the [Changing the Host Values of an IPSPG Association](#) procedure.

If the application assigned to the card is SS7IPGW or IPGWI, continue the procedure by performing one of these steps.

- If the `open` parameter value for the association being changed is `yes`, continue the procedure with 3.
- If the `open` parameter value for the association being changed is `no`, continue the procedure with 4.

3. Change the value of the `open` parameter to `no` by specifying the `chg-assoc` command with the `open=no` parameter.

For this example, enter this command.

```
chg-assoc:aname=assoc2:open=no
```

When this command has successfully completed, this message should appear.

```
rlghncxa03w 08-04-28 09:12:36 GMT EAGLE5 38.0.0
CHG-ASSOC: MASP A - COMPLTD;
```

4. Display the association being changed by entering the `rtrv-assoc` command with the `aname` parameter specified in 3 or the association selected in 1.

For this example, enter this command.

```
rtrv-assoc:aname=assoc2
```

This is an example of the possible output.

```
rlghncxa03w 09-05-28 21:14:37 GMT EAGLE5 41.0.0
ANAME assoc2
  LOC      1205          IPLNK PORT  A          LINK  A
  ADAPTER  M3UA          VER          M3UA RFC
  LHOST    IPNODE2-1205
  ALHOST   ---
  RHOST    remotehost1
  ARHOST   ---
  LPORT    2048          RPORT      2048
  ISTRMS   2            OSTRMS     2          BUFSIZE  200
  RMODE    LIN          RMIN       120        RMAX     800
  RTIMES   10          CWMIN      3000      UAPS     10
  OPEN     No           ALW        YES        RTXTHR  2000
  RHOSTVAL RELAXED

ASNAMES
as1          as4          as6
```

```
IP Appl Sock/Assoc table is (8 of 4000) 1% full
Assoc Buffer Space Used (800 KB of 800 KB) on LOC = 1205
```

If the association shown in this step is an M2PA association, continue the procedure with 5.

If the association shown in this step is an M3UA or SUA association, perform one of these actions.

- If the association does not have an `ALHOST` value, continue the procedure with 5.
- If the association does have an `ALHOST` value, and the `ALHOST` value will be removed along with changing the `LHOST` value of the association, continue the procedure with 5.

- If the association does have an `ALHOST` value, and the only action that will be performed in this procedure is to remove the `ALHOST` value from the association, continue the procedure with [Oracle](#).
5. Verify that the local host name to be assigned to the association is in the database by using the `rtrv-ip-host:display=all` command.

The following is an example of the possible output.

```
rlghncxa03w 08-12-28 21:15:37 GMT EAGLE5 40.0.0

LOCAL IPADDR      LOCAL HOST
192.1.1.10        IPNODE1-1201
192.1.1.12        GW105. NC. Oracle. COM
192.1.1.14        IPNODE1-1205
192.1.1.20        IPNODE2-1201
192.1.1.22        IPNODE2-1203
192.1.1.24        IPNODE2-1205
192.1.1.30        KC-HLR1
192.1.1.32        KC-HLR2
192.1.1.50        DN-MS1
192.1.1.52        DN-MS2

REMOTE IPADDR     REMOTE HOST
150.1.1.5         NCDEPTECONOMIC_DEVELOPMENT. SOUTHEASTERN_COORIDOR_ASHVL.
GOV
```

IP Host table is (11 of 4096) .26% full

6. Display the **IP** links in the database by entering the `rtrv-ip-lnk` command.

The following is an example of the possible output.

```
rlghncxa03w 07-05-28 21:14:37 GMT EAGLE5 37.0.0
LOC  PORT  IPADDR          SUBMASK          DUPLEX  SPEED  MACTYPE  AUTO
MCAST
1303 A    192.1.1.10      255.255.255.128 HALF        10    802.3    NO    NO
1303 B    -----          -----          HALF        10    DIX      NO    NO
1305 A    192.1.1.12      255.255.255.0   ----        ---    DIX      YES   NO
1305 B    -----          -----          HALF        10    DIX      NO    NO
1313 A    192.1.1.14      255.255.255.0   FULL        100   DIX      NO    NO
1313 B    -----          -----          HALF        10    DIX      NO    NO
2101 A    192.1.1.20      255.255.255.0   FULL        100   DIX      NO    NO
2101 B    -----          -----          HALF        10    DIX      NO    NO
2103 A    192.1.1.22      255.255.255.0   FULL        100   DIX      NO    NO
2103 B    -----          -----          HALF        10    DIX      NO    NO
2105 A    192.1.1.24      255.255.255.0   FULL        100   DIX      NO    NO
2105 B    -----          -----          HALF        10    DIX      NO    NO
2205 A    192.1.1.30      255.255.255.0   FULL        100   DIX      NO    NO
2205 B    -----          -----          HALF        10    DIX      NO    NO
2207 A    192.1.1.32      255.255.255.0   FULL        100   DIX      NO    NO
2207 B    -----          -----          HALF        10    DIX      NO    NO
2213 A    192.1.1.50      255.255.255.0   FULL        100   DIX      NO    NO
2213 B    -----          -----          HALF        10    DIX      NO    NO
```

```

2301 A 192.1.1.52 255.255.255.0 FULL 100 DIX
NO NO
2301 B ----- HALF 10 DIX
NO NO
2305 A 192.3.3.33 255.255.255.0 FULL 100 DIX
NO NO
2305 B ----- HALF 10 DIX
NO NO

```

```
IP-LNK table is (22 of 2048) 1% full.
```

If the required **IP** link, one that contains the desired **IP** address, is not shown in the `rtrv-ip-lnk` output, add the **IP** link using the [Configuring an IP Link](#) procedure. After the **IP** link has been added, assign the **IP** address of the **IP** link to the **IP** host name using the [Adding an IP Host](#) procedure, then continue the procedure with [11](#).

If the required **IP** link is shown in the `rtrv-ip-lnk` output, but the **IP** host is not shown in the `rtrv-ip-host` output in [5](#), assign the **IP** address of the **IP** link to the **IP** host name using the [Adding an IP Host](#) procedure, then continue the procedure with [11](#).

If the required **IP** host was shown in [5](#), the required **IP** link is shown in the `rtrv-ip-lnk` output in this step. Perform [7](#) to verify the application running on the card whose **IP** address is assigned to the **IP** host.

Note:

The `rtrv-ip-host` output must contain a host name for the association's `slhost` parameter and a host name for the association's `alhost` parameter, if the `alhost` parameter will be specified for the association. The **IP** address of the **IP** link should be assigned to the host name, shown in the `rtrv-ip-host` output, that will be used as the association's `slhost` parameter value. If the `alhost` parameter will be specified for the association, the **IP** address of the **IP** link must be assigned to the host name that will be used as the `alhost` parameter value. The **IP** links associated with the association's `slhost` and `alhost` values must be assigned to the same card.

7. Display the application running on the **IP** card shown in [6](#) whose **IP** address is assigned to the **IP** host using the `rept-stat-card` command specifying the location of the **IP** card.

For this example, enter this command.

```
rept-stat-card:loc=1205
```

This is an example of the possible output.

```

rlghncxa03w 08-04-27 17:00:36 GMT EAGLE5 38.0.0
CARD VERSION      TYPE   GPL      PST      SST      AST
1205 114-000-000  DCM   SS7IPGW IS-NR    Active   -----
  ALARM STATUS    = No Alarms.
  BPCM GPL        = 002-102-000

```

```

IMT BUS A          = Conn
IMT BUS B          = Conn
SIGNALING LINK STATUS
  SLK   PST              LS           CLLI
  A     IS-NR            nc001       -----

```

Command Completed.

8. Display the associations assigned to the local host that will be assigned to the association being configured in this procedure by entering the `rtrv-assoc` command with the `lhost` parameter.

For this example, enter this command.

```
rtrv-assoc:lhost="IPNODE2-1205"
```

This is an example of the possible output.

```

rlghncxa03w 08-04-28 21:14:37 GMT EAGLE5 38.0.0

          CARD IPLNK
ANAME      LOC  PORT  LINK ADAPTER  LPORT  RPORT  OPEN  ALW
assoc2     1205 A    A    M3UA      2048  2048  YES  YES
assoc3     1205 A    A    M3UA      3000  3000  YES  YES
assoc5     1205 A    A    M3UA      1500  3000  YES  YES

```

IP Appl Sock/Assoc table is (8 of 4000) 1% full

Assoc Buffer Space Used (600 KB of 3200 KB) on LOC = 1205

9. Display the application servers that the associations shown in 8 are assigned to by entering `rtrv-as` command with the names of the associations shown in 8.

For this example, enter these commands.

```
rtrv-as:aname=assoc2
```

This is an example of the possible output.

```

rlghncxa03w 08-04-28 21:14:37 GMT EAGLE5 38.0.0
AS Name      Mode      Tr ms   Association Names
as1          LOADSHARE 2000    assoc2

as4          LOADSHARE 2000    assoc2

as6          LOADSHARE 2000    assoc2

```

AS Table is (6 of 250) 1% full

```
rtrv-as:aname=assoc3
```

This is an example of the possible output.

```

rlghncxa03w 08-04-28 21:14:37 GMT EAGLE5 38.0.0
AS Name      Mode      Tr ms   Association Names
as2          LOADSHARE 2000    assoc3

```



```
as3          LOADSHARE    2000    assoc3
as5          LOADSHARE    2000    assoc3
```

AS Table is (6 of 250) 2% full

```
rtrv-as:aname=assoc5
```

This is an example of the possible output.

```
rlghncxa03w 08-04-28 21:14:37 GMT EAGLE5 38.0.0
AS Name      Mode      Tr ms   Association Names
as2          LOADSHARE 2000    assoc5

as3          LOADSHARE 2000    assoc5

as5          LOADSHARE 2000    assoc5
```

AS Table is (6 of 250) 2% full

The maximum number of **SCTP** association to application server assignments that can be hosted by an **IPGWx** card (referenced by the `lhost` parameter of the association) is 50.

If the number of **SCTP** association to application server assignments (shown in this step) is less than 50, continue the procedure by performing one of these steps.

- If the `rept-stat-card` command was not performed in 7, continue the procedure with 10.
- If the `rept-stat-card` command was performed in 7, and the `link` value will not be changed, continue the procedure with [Oracle](#).
- If the `rept-stat-card` command was performed in 7, and the `link` value will be changed, continue the procedure with 11.

If the number of **SCTP** association to application server assignments (shown in this step) is 50, the local host value cannot be used in this procedure. Repeat 5 and 6 and select another **IP** link and **IP**.

10. Display the application running on the **IP** card shown in 6 using the `rept-stat-card` command specifying the location of the IP card.

For this example, enter this command.

```
rept-stat-card:loc=1205
```

This is an example of the possible output.

```
rlghncxa03w 08-04-27 17:00:36 GMT EAGLE5 38.0.0
CARD VERSION      TYPE   GPL      PST          SST      AST
1205 114-000-000  DCM   SS7IPGW  IS-NR       Active   -----
  ALARM STATUS    = No Alarms.
  BPDCM GPL       = 002-102-000
```

```

IMT BUS A          = Conn
IMT BUS B          = Conn
SIGNALING LINK STATUS
  SLK   PST                LS           CLLI
  A     IS-NR              nc001      -----

```

Command Completed.

- If the `link` value will not be changed, continue the procedure with [Oracle](#).
- If the `link` value will be changed, continue the procedure with [11](#).

11. Display the signaling link that will be assigned to the association by entering the `rtrv-slk` command and specifying the card location and signaling link.

For this example, enter this command.

```
rtrv-slk:loc=1203
```

This is an example of the possible output.

```

rlghncxa03w 08-04-19 21:17:04 GMT EAGLE5 38.0.0
LOC  LINK LSN          SLC TYPE
1203 A   e5e6a        1  SS7IPGW

```

If the required IPGWx signaling is shown in this step, continue the procedure with [Oracle](#).

If the required IPGWx signaling is not shown in this step, perform the [Adding an IPGWx Signaling Link](#) to add the required IPGWx signaling link. After the signaling link has been added, continue the procedure with [Oracle](#).

12. Change the association using the `chg-assoc` command.

For this example, enter this command.

```
chg-assoc:aname=assoc2:lhost=m3ua1:alhost=m3ua2:rhost="gw200.nc-Oracle.com"
```

These are the rules that apply to the `chg-assoc` command.

- If any optional parameters are not specified with the `chg-assoc` command, those values are not changed.
- E5-ENET cards can use the B Ethernet interface.
- The number of association – application server assignments on an IPGWx card cannot exceed 50.
- The EAGLE can contain a maximum of 4000 connections.
- The value of the `lhost` and `rhost` parameters is a text string of up to 60 characters, with the first character being a letter. The command input is limited to 150 characters, including the hostnames.
- Specifying the `lhost` parameter only creates a uni-homed endpoint. The network portion of the endpoint's IP address must be the same as the network portion of the IP address assigned to either the A or B network interface of the IP card.
- Specifying the `lhost` and `alhost` parameters creates a multi-homed endpoint. The network portion of the IP address associated with the `lhost` parameter must be the same as the network portion of the IP address assigned to one of the network

interfaces (A or B) of the IP card, and the network portion of the IP address associated with the `alhost` parameter must be the same as the network portion of the IP address assigned to the other network interface on the IP card.

- The `alhost=none` parameter removes the alternate local host from the specified association, which also removes the multi-homed endpoint capability.
- If the `uaps` parameter is not specified with the `chg-assoc` command, and the `adapter` parameter value is being changed to either `m3ua` or `sua`, the `uaps` parameter value defaults to UA parameter set 10 (`uaps=10`).
- The `port` parameter can be used in place of the `link` parameter to specify the signaling link assigned to the association.

When this command has successfully completed, this message should appear.

```
rlghncxa03w 08-04-28 09:12:36 GMT EAGLE5 38.0.0
CHG-ASSOC: MASP A - COMPLTD;
```

 **Note:**

If the value of the `open` parameter was not changed in 3, continue the procedure with [Oracle](#).

13. Change the value of the `open` parameter to `yes` by specifying the `chg-assoc` command with the `open=yes` parameter.

For this example, enter this command.

```
chg-assoc:aname=assoc2:open=yes
```

When this command has successfully completed, this message should appear.

```
rlghncxa03w 08-04-28 09:12:36 GMT EAGLE5 38.0.0
CHG-ASSOC: MASP A - COMPLTD;
```

14. Verify the changes using the `rtrv-assoc` command specifying the association name specified in [Oracle](#) and 13.

For this example, enter this command.

```
rtrv-assoc:aname=assoc2
```

This is an example of possible output.

```
rlghncxa03w 09-05-28 09:12:36 GMT EAGLE5 41.0.0
ANAME assoc2
LOC      1205          IPLNK PORT  A          LINK  A
ADAPTER  M3UA            VER        M3UA RFC
LHOST    m3ua1
ALHOST   m3ua2
RHOST    gw200.nc-tekelec.com
ARHOST   ---
LPORT    2048            RPORT      3000
```

```

ISTRMS 2          OSTRMS 2          BUFSIZE 250
RMODE  LIN       RMIN 120        RMAX 800
RTIMES 10       CWMIN 3000     UAPS 10
OPEN  YES       ALW  YES          RTXTHR 10000
RHOSTVAL RELAXED

```

```

ASNAMES
as1          as4          as6

```

```

IP Appl Sock table is (8 of 4000) 1% full
Assoc Buffer Space Used (650 KB of 800 KB) on LOC = 1205

```

15. Back up the new changes, using the `chg-db:action=backup:dest=fixed` command. These messages should appear; the active **Maintenance and Administration Subsystem Processor (MASP)** appears first.

```

BACKUP (FIXED) : MASP A - Backup starts on active MASP.
BACKUP (FIXED) : MASP A - Backup on active MASP to fixed disk complete.
BACKUP (FIXED) : MASP A - Backup starts on standby MASP.
BACKUP (FIXED) : MASP A - Backup on standby MASP to fixed disk complete.

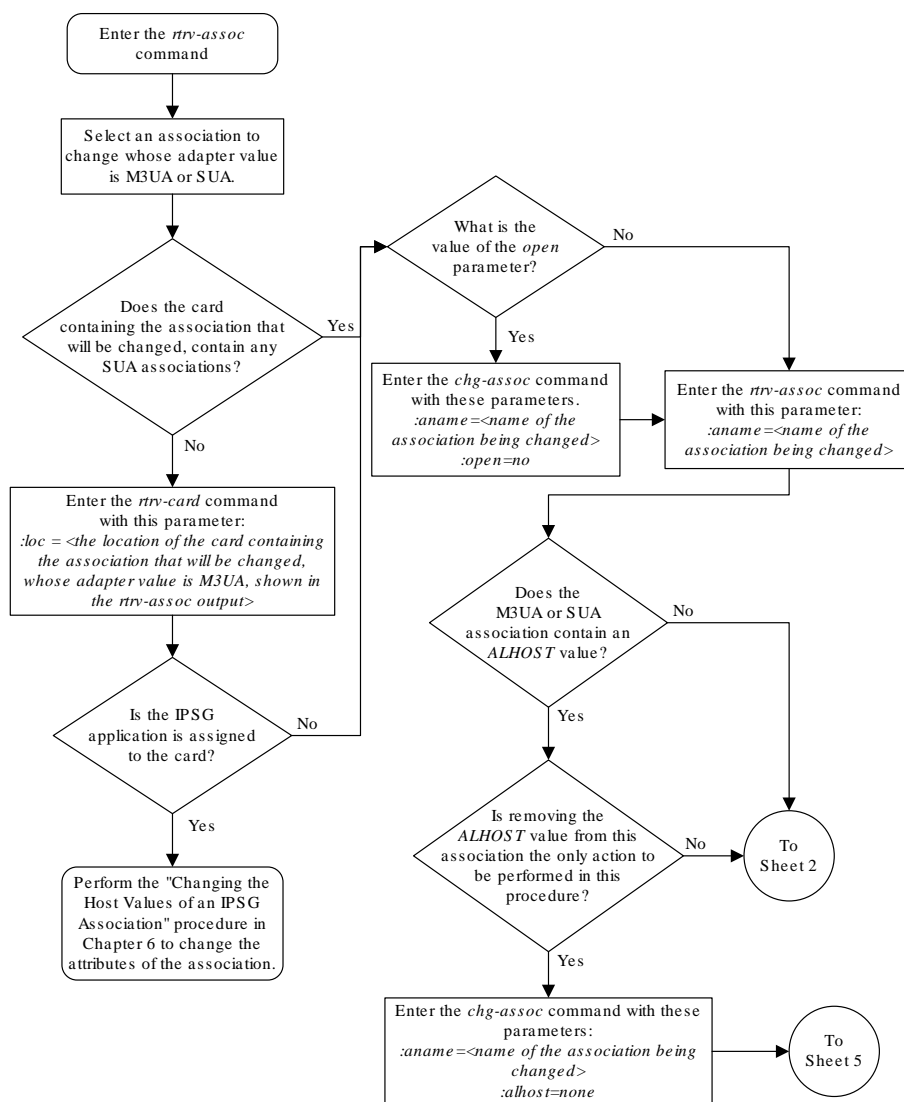
```

If you wish to change other attributes of the M3UA or SUA association, perform one of these procedures.

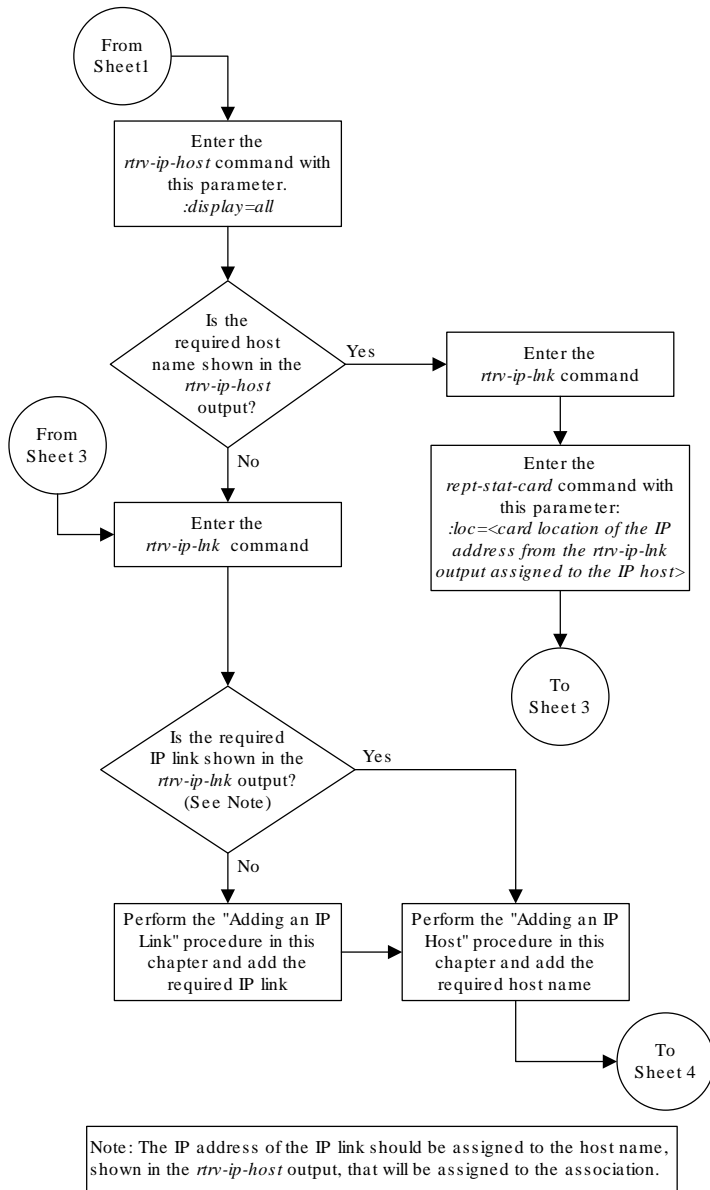
- `bufsize` - [Changing the Buffer Size of a M3UA or SUA Association](#)
- Other attributes of the M3UA or SUA association - [Changing the Attributes of a M3UA or SUA Association](#)

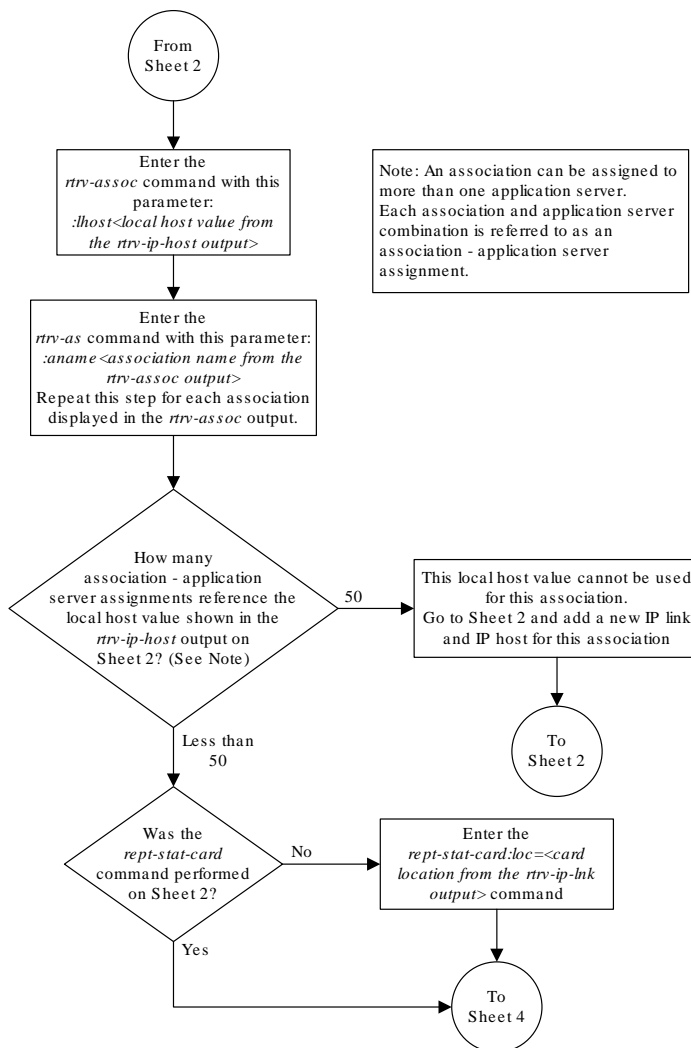
If you do not wish to change the other attributes of the M3UA or SUA association, this procedure is finished.

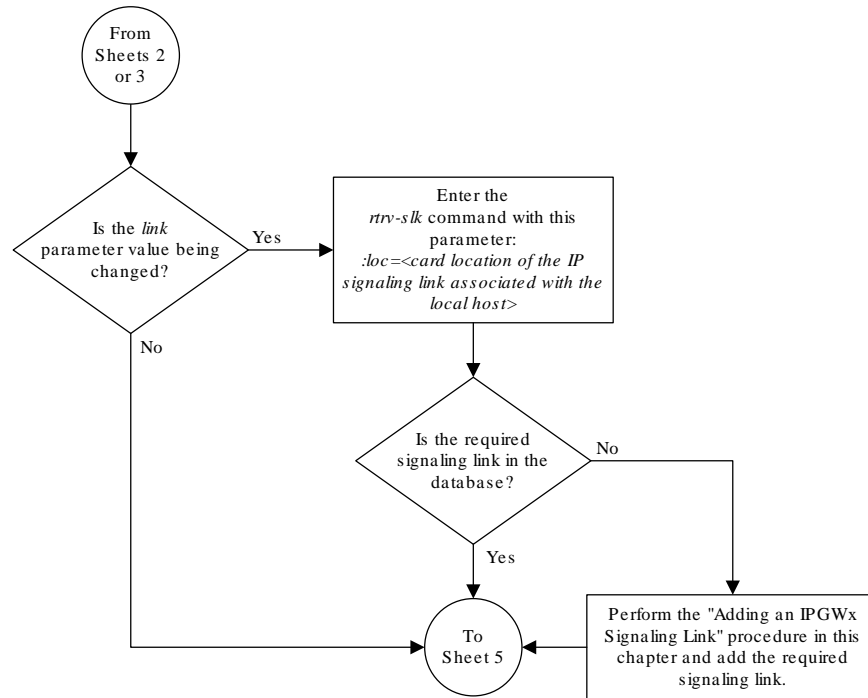
Figure 4-38 Changing the Host Values of a M3UA or SUA Association

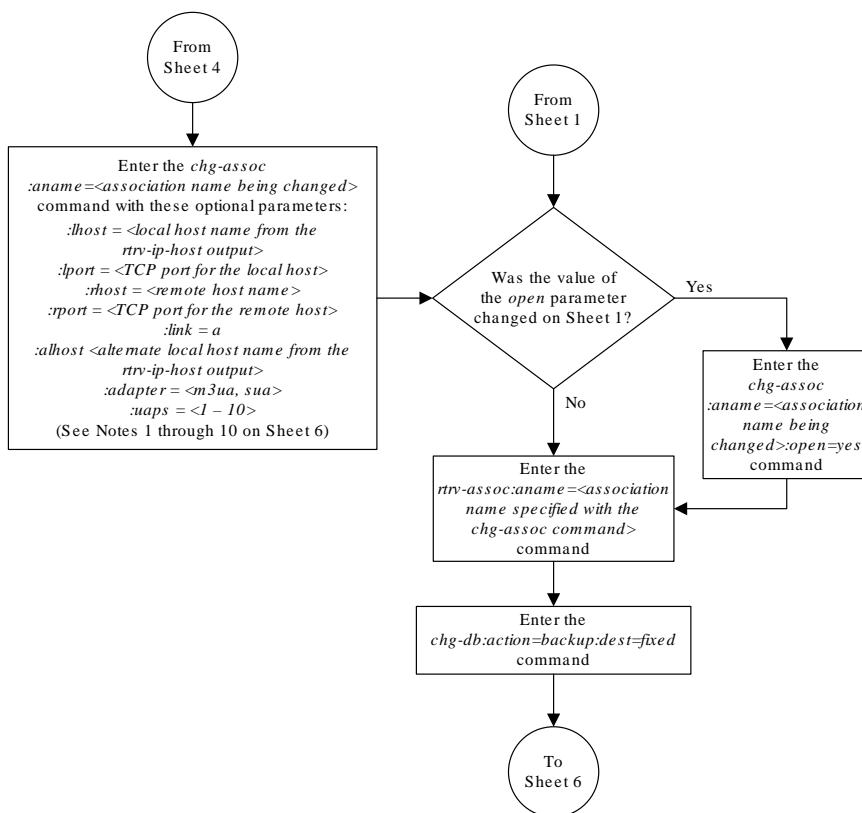


Sheet 1 of 6

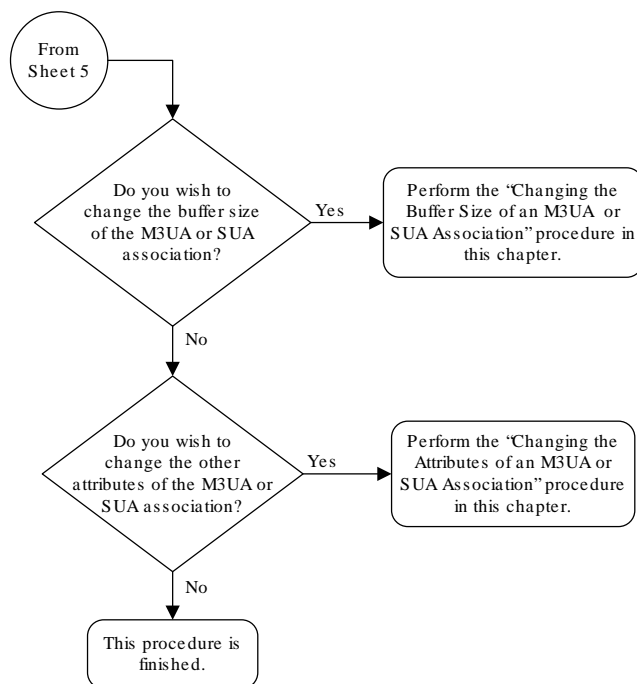








Sheet 5 of 6



Notes:

1. If any optional parameters are not specified with the *chg-assoc* command, those values are not changed.
2. Single-slot EDCMs or E5-ENET cards can use the B Ethernet interface.
3. The number of association – application server assignments on an IPGWx card cannot exceed 50.
4. The EAGLE 5 ISS can contain a maximum of 4000 connections.
5. The value of the *host* and *rhost* parameters is a text string of up to 60 characters, with the first character being a letter. The command input is limited to 150 characters, including the hostnames
6. Specifying the *host* parameter only creates a uni-homed endpoint. The network portion of the endpoint's IP address must be the same as the network portion of the IP address assigned to either the A or B network interface of the IP card.
7. Specifying the *host* and *alhost* parameters creates a multi-homed endpoint. The network portion of the IP address associated with the *host* parameter must be the same as the network portion of the IP address assigned to one of the network interfaces (A or B) of the IP card, and the network portion of the IP address associated with the *alhost* parameter must be the same as the network portion of the IP address assigned to the other network interface on the IP card.
8. The *alhost=none* parameter removes the alternate local host from the specified association, which also removes the multi-homed endpoint capability.
9. If the *uaps* parameter is not specified with the *chg-assoc* command, and the *adapter* parameter value is being changed to either *m3ua* or *sua*, the *uaps* parameter value defaults to UA parameter set 10 (*uaps=10*).
10. The *port* parameter can be used in place of the *link* parameter to specify the signaling link assigned to the association.

Sheet 6 of 6

4.33 Configuring SCTP Retransmission Control for a M3UA or SUA Association

This procedure is used to gather the information required to configure the retransmission parameters for SUA associations and M3UA associations that are assigned to cards running

either the SS7IPGW or IPGWI applications. Perform the [Configuring an IPSG Association for SCTP Retransmission Control](#) procedure to configure the retransmission parameters for M3UA associations assigned to IPSG cards. If any assistance is needed to configure the retransmission parameters for associations, contact the Customer Care Center. Refer to [My Oracle Support \(MOS\)](#) for the contact information.

The retransmission parameters are configured using the `rmode`, `rmin`, `rmax`, `rtimes`, and `cwmin` parameters of the `chg-assoc` command.

`:rmode` – The retransmission mode used when packet loss is detected. The values are `rfc` or `lin`.

- `rfc` – Standard **RFC 2960** algorithm in the retransmission delay doubles after each retransmission. The **RFC 2960** standard for congestion control is also used.
- `lin` – Oracle's linear retransmission mode where each retransmission timeout value is the same as the initial transmission timeout and only the slow start algorithm is used for congestion control.

`:rmin` – The minimum value of the calculated retransmission timeout in milliseconds.

`:rmax` – The maximum value of the calculated retransmission timeout in milliseconds.

Note:

The `rmin` and `rmax` parameter values form a range of retransmission values. The value of the `rmin` parameter must be less than or equal to the `rmax` parameter value.

`:rtimes` – The number of times a data retransmission occurs before closing the association.

`:cwmin` – The minimum size in bytes of the association's congestion window and the initial size in bytes of the congestion window.

For associations assigned to the `ss7ipgw` or `ipgwi` applications, the value of the `cwmin` parameter must be less than or equal to 16384.

The [Changing the Attributes of a M3UA or SUA Association](#) procedure is used to change the values of these parameters. In addition to using the [Changing the Attributes of a M3UA or SUA Association](#) procedure, these pass commands are also used in this procedure.

- `ping` – tests for the presence of hosts on the network.
- `assocrtt` – displays the **SCTP** round trip times for a specified association. Minimum, maximum, and average times are kept for each open association. The Retransmission Mode (**RFC** or **LIN**) and the configured Minimum and Maximum Retransmission Timeout limits are also displayed.
- `sctp` – provides a summary list of all **SCTP** instances.
- `sctp -a <association name>` – displays the measurements and information for a specific association.

 **Note:**

The values for the minimum and maximum retransmission times in the output from this command are shown in microseconds.

For more information on the `pass` commands, see *Commands User's Guide*.

The `chg-assoc` command contains other optional parameters that can be used to configure an association. These parameters are not shown here because they are not necessary for configuring the **SCTP** retransmission parameters. These parameters are explained in more detail in the [Changing the Attributes of a M3UA or SUA Association](#) procedure, or in the `chg-assoc` command description in *Commands User's Guide*.

Canceling the `RTRV-ASSOC` Command

Because the `rtrv-assoc` command used in this procedure can output information for a long period of time, the `rtrv-assoc` command can be canceled and the output to the terminal stopped. There are three ways that the `rtrv-assoc` command can be canceled.

- Press the `F9` function key on the keyboard at the terminal where the `rtrv-assoc` command was entered.
- Enter the `canc-cmd` without the `trm` parameter at the terminal where the `rtrv-assoc` command was entered.
- Enter the `canc-cmd:trm=<xx>`, where `<xx>` is the terminal where the `rtrv-assoc` command was entered, from another terminal other than the terminal where the `rtrv-assoc` command was entered. To enter the `canc-cmd:trm=<xx>` command, the terminal must allow Security Administration commands to be entered from it and the user must be allowed to enter Security Administration commands. The terminal's permissions can be verified with the `rtrv-secu-trm` command. The user's permissions can be verified with the `rtrv-user` or `rtrv-secu-user` commands.

For more information about the `canc-cmd` command, go to *Commands User's Guide*.

1. Display the associations in the database using the `rtrv-assoc` command.

This is an example of possible output.

```
rlghncxa03w 06-10-28 09:12:36 GMT EAGLE5 36.0.0

          CARD IPLNK
ANAME      LOC  PORT  LINK ADAPTER LPORT RPORT OPEN ALW
swbel32    1201 A    A    M3UA  1030  2345 YES  YES
a2         1305 A    A    SUA   1030  2345 YES  YES
a3         1307 A    A    SUA   1030  2346 YES  YES
assoc1     1201 A    A    M3UA  2000  1030 YES  YES
```

If the association that is being removed in this procedure is an SUA association, continue the procedure with **3**.

If the association that is being removed in this procedure is an M3UA association, continue the procedure with **2**.

2. Enter the `rtrv-card` command with the location of the card that is hosting the M3UA association that will be changed in this procedure. For this example, enter this command.

```
rtrv-card:loc=1201
```

This is an example of possible output.

```
rlghncxa03w 08-03-06 15:17:20 EST EAGLE5 38.0.0
CARD  TYPE      APPL      LSET NAME  LINK SLC LSET NAME  LINK SLC
1201  DCM          SS7IPGW  lsn1      A      0
```

If the application assigned to the card is SS7IPGW or IPGWI, shown in the `APPL` column, continue the procedure with [3](#).

If the application assigned to the card is IPSTG, perform the [Configuring an IPSTG Association for SCTP Retransmission Control](#) procedure.

3. Display the association that will be changed by entering the `rtrv-assoc` command with the name of the association. For this example, enter this command.

```
rtrv-assoc:aname=assoc1
```

This is an example of the possible output.

```
rlghncxa03w 09-05-28 21:14:37 GMT EAGLE5 41.0.0
ANAME assoc1
  LOC      1201          IPLNK PORT  A          LINK  A
  ADAPTER  M3UA          VER        M3UA RFC
  LHOST    IPNODE2-1205
  ALHOST    ---
  RHOST    gw100.nc.tekelec.com
  ARHOST    ---
  LPORT    2000          RPORT      1030
  ISTRMS   2            OSTRMS     2          BUFSIZE  200
  RMODE    LIN          RMIN       120        RMAX     800
  RTIMES   10          CWMIN      3000      UAPS     10
  OPEN     YES          ALW        YES        RTXTHR   2000
  RHOSTVAL RELAXED

  ASNAMES
  as1          as4          as6
```

```
IP Appl Sock/Assoc table is (8 of 4000) 1% full
Assoc Buffer Space Used (800 KB of 800 KB) on LOC = 1201
```

4. Enter the `ping pass` command specifying the card location of the local host, shown in [3](#), and the name of the remote host assigned to the association being changed, shown in [3](#).

This command is entered several times to obtain the average round trip time. For this example, enter this command.

```
pass:loc=1201:cmd="ping gw100.nc.tekelec.com"
```

The following is an example of the possible output

```
rlghncxa03w 06-10-28 21:15:37 GMT EAGLE5 36.0.0
PASS: Command sent to card
```

```

rlghncxa03w 06-10-28 21:15:37 GMT EAGLE5 36.0.0
PING command in progress

rlghncxa03w 06-10-28 21:15:37 GMT EAGLE5 36.0.0
PING GW100. NC. TEKELEC. COM (192.1.1.30): 56 data bytes
64 bytes from tekral.nc.tekelec.com (192.1.1.30): icmp_seq=0. time=5. ms
64 bytes from tekral.nc.tekelec.com (192.1.1.30): icmp_seq=1. time=9. ms
64 bytes from tekral.nc.tekelec.com (192.1.1.30): icmp_seq=2. time=14. ms
----tekral PING Statistics----
3 packets transmitted, 3 packets received, 0% packet loss
round-trip (ms)  min/avg/max = 5/9/14

PING command complete

```

If the **SCTP** retransmission parameters are not to be changed, do not perform 5 through 8. This procedure is finished.

5. Perform the [Changing the Attributes of a M3UA or SUA Association](#) procedure to change the retransmission parameters of the association based on the results of pinging the remote host.
6. Enter the `assocrftt` pass command to display the round trip time data collected after an association is established when an **SCTP** INIT message is sent and an acknowledgment is received.

The `assocrftt` command is entered with the card location from 4 (the card location assigned to the association being changed), and the name of the association being changed. This association must contain the local host name used in 4. For this example, enter this command.

```
pass:loc=1201:cmd="assocrftt assoc1"
```

The following is an example of the possible output

```

rlghncxa03w 06-10-28 21:15:37 GMT EAGLE5 36.0.0
PASS: Command sent to card

rlghncxa03w 06-10-28 21:15:37 GMT EAGLE5 36.0.0

ASSOCRFTT: Association round-trip time report (in milliseconds)

Retransmission Configuration
  Retransmission Mode           : LIN
  Minimum RTO: 120
  Maximum RTO: 800

Traffic Round-Trip Times

  Minimum round-trip time       : 5
  Maximum round-trip time       : 120
  Weighted Average round-trip time : 10
  Last recorded round-trip time  : 10

Measured Congested Traffic Round-Trip Times

```

```

Minimum round-trip time      : 0
Maximum round-trip time     : 0
Weighted Average round-trip time : 0
Last recorded round-trip time  : 0
;
rlghncxa03w 06-10-28 21:15:37 GMT EAGLE5 36.0.0
ASSOCRTT command complete

```

7. Enter the `sctp -a <association name> pass` command to determine if retransmissions have occurred.

The association name is the association name specified in 6. Specify the card location used in 6. For this example, enter this command.

```
pass:loc=1201:cmd="sctp -a assoc1"
```

The following is an example of the possible output

```

rlghncxa03w 10-12-28 21:15:37 GMT EAGLE5 43.0.0

Aname          Local          Local Remote          Remote
                IP Address     Port  Address         Port
Assoc1         192.168.110.12 2222  192.168.112.4  5555
                192.168.112.12

Configuration                                State
Retransmission Mode = LIN                    State = OPEN
Min. Retransmission Timeout = 10000          ULP association id = 18
Max. Retransmission Timeout = 800000        Number of nets = 2
Max. Number of Retries = 10                 Inbound Streams = 1
Min. Congestion Window = 3000               Outbound Streams = 2
Inbound Streams = 2
Outbound Streams = 2
Checksum Algorithm = crc32c
Send/Rcv Buffer Size = 204800

Nets Data

IP Address  192.168.112.4    State  Reachable
Port        7777              Primary YES
MTU         1500              cwnd  16384
ssthresh    16384              RTO   120

IP Address  192.168.113.5    State  Reachable
Port        7777              Primary NO
MTU         1500              cwnd  16384
ssthresh    16384              RTO   120

Last Net Sent To = 192.168.112.4
Last Net Rcvd From = 192.168.112.4
Over All Error Count = 0
Peers Rwnd = 13880
My Rwnd = 16384
Max Window = 16384
Initial Seq Number = 24130

```

```

        Next Sending Seq Number = 124686
        Last Acked Seq Number = 124669
    Maximum Outbound Char Count = 16384
    Current Outbound Char Count = 2112
        Number Unsent Char Count = 0
    Outbound Data Chunk Count = 16
        Number Unsent = 0
        Number To Retransmit = 0

        ip datagrams rcvd = 155402
    ip datagrams with data chunks rcvd = 120844
        data chunks rcvd = 367908
        data chunks read = 367900
        dup tsns rcvd = 8
        sacks rcvd = 38734
        gap ack blocks rcvd = 3
    heartbeat requests rcvd = 135
        heartbeat acks rcvd = 52
    heartbeat requests sent = 52
        ip datagrams sent = 129254
    ip datagrams with data chunks sent = 73084
        data chunks sent = 396330
    retransmit data chunks sent = 135
        sacks sent = 64872
        send failed = 0
    retransmit timer count = 0
    consecutive retransmit timeouts = 0
    RTT between RMIN and RMAX inclusive = 6
    RTT greater than RMAX = 0
    fast retransmit count = 135
        rcv timer count = 0
    heartbeat timer count = 244
        none left tosend = 0
        none left rwnd gate = 5
        none left cwnd gate = 8

;
    rlghncxa03w 10-12-28 21:15:37 GMT EAGLE5 43.0.0

    SCTP command complete

    rlghncxa03w 06-10-28 21:15:37 GMT EAGLE5 36.0.0

    Aname          Local          Local Remote          Remote
                   IP Address      Port  Address          Port
    Assoc1         192.168.110.12 2222  192.168.112.4   5555
                   192.168.112.12

        Configuration                               State
    Retransmission Mode = LIN                        State = OPEN
    Min. Retransmission Timeout = 10                 ULP association id = 18
    Max. Retransmission Timeout = 800               Number of nets = 2
    Max. Number of Retries = 10                     Inbound Streams = 1

```



```

Min. Congestion Window = 3000      Outbound Streams = 2
      Inbound Streams = 2
      Outbound Streams = 2

```

Nets Data

IP Address	192.168.112.4	State	Reachable
Port	7777	Primary	YES
MTU	1500	cwnd	16384
ssthresh	16384	RTO	120
IP Address	192.168.113.5	State	Reachable
Port	7777	Primary	NO
MTU	1500	cwnd	16384
ssthresh	16384	RTO	120

```

      Last Net Sent To = 192.168.112.4
      Last Net Rcvd From = 192.168.112.4
      Over All Error Count = 0
          Peers Rwnd = 13880
          My Rwnd = 16384
          Max Window = 16384
          Initial Seq Number = 24130
          Next Sending Seq Number = 124686
          Last Acked Seq Number = 124669
      Maximum Outbound Char Count = 16384
      Current Outbound Char Count = 2112
      Number Unsent Char Count = 0
      Outbound Data Chunk Count = 16
          Number Unsent = 0
          Number To Retransmit = 0

      ip datagrams rcvd = 155402
ip datagrams with data chunks rcvd = 120844
      data chunks rcvd = 367908
      data chunks read = 367900
          dup tsns rcvd = 8
          sacks rcvd = 38734
          gap ack blocks rcvd = 3
      heartbeat requests rcvd = 135
      heartbeat acks rcvd = 52
      heartbeat requests sent = 52
          ip datagrams sent = 129254
ip datagrams with data chunks sent = 73084
      data chunks sent = 396330
      retransmit data chunks sent = 135
          sacks sent = 64872
          send failed = 0
          retransmit timer count = 0
      consecutive retransmit timeouts = 0
      RTT between RMIN and RMAX inclusive = 6
          RTT greater than RMAX = 0
          fast retransmit count = 135
          rcv timer count = 0
          heartbeat timer count = 244

```

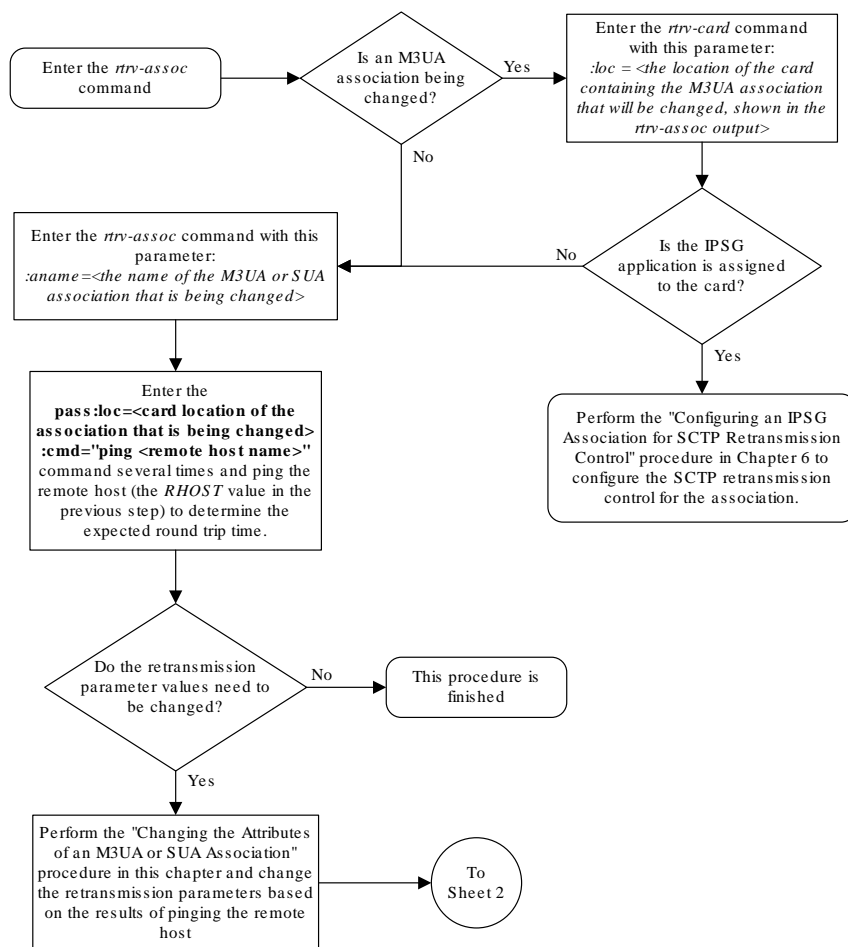
```
none left tosend = 0  
none left rwnd gate = 5  
none left cwnd gate = 8
```

```
SCTP command complete
```

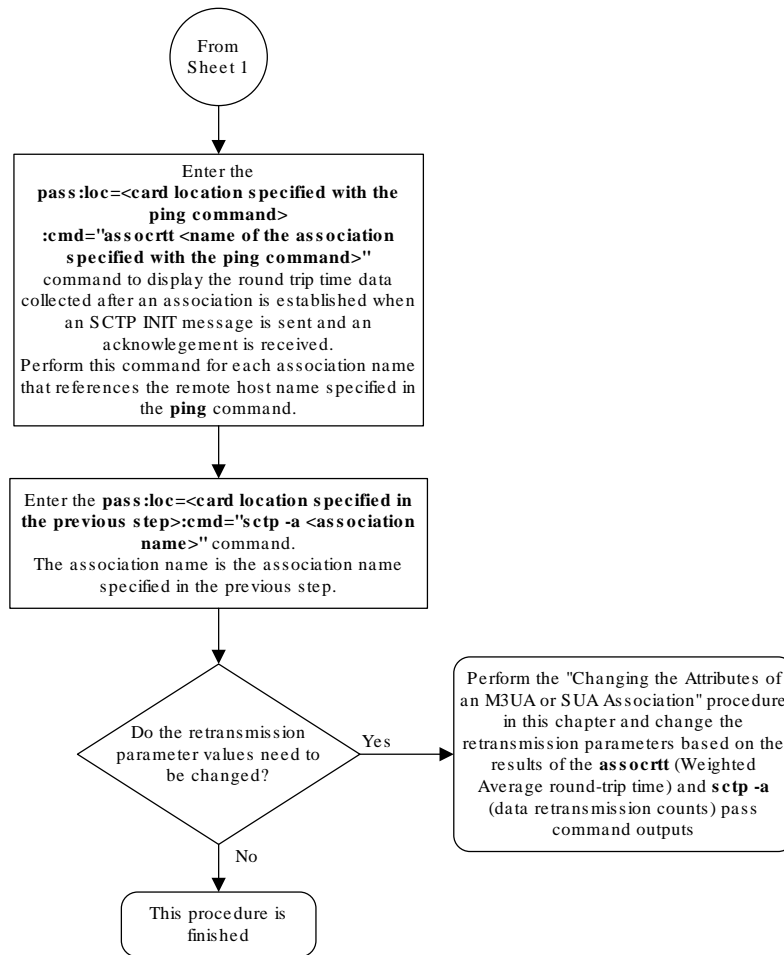
8. Perform the [Changing the Attributes of a M3UA or SUA Association](#) procedure to change the retransmission parameters of the association based on the results of the outputs of [6](#) and [7](#).

The Weighted Average round-trip time shown in the `assocrtt pass` command output in [5](#), and the data retransmission counts shown in the `sctp -a` pass command output in [6](#) are used as a guide to determine the appropriate values for the `rmode`, `rmin`, `rmax`, and `rtimes` parameters. If the retransmission parameters do not have to be adjusted, do not perform this step. This procedure is finished.

Figure 4-39 Configuring SCTP Retransmission Control for a M3UA or SUA Association



Sheet 1 of 2



Sheet 2 of 2

4.34 Changing an Application Server

This procedure is used change the characteristics of an existing application server using the `chg-as` command.

The `chg-as` command uses these parameters:

:*asname* – The name of the application server being changed.

:*mode* – The traffic mode assigned to the application server, either `loadshare` or `override`.

:*tr* – The application server recovery timer, 10 - 2000 milliseconds.

The `mode` parameter value cannot be changed unless the `open` parameter value of the all the associations assigned to the application server is set to `no`. This can be verified with the `rtrv-assoc` command.

The association assignments for an application server cannot be changed with this procedure. To change an association assignment for an application server, go to the [Removing an Association from an Application Server](#) procedure and remove the association from the application server, then perform one of these procedures to add another association to the application server:

- [Adding a New Association to an Existing Application Server](#)
- [Adding an Existing Association to an Existing Application Server.](#)

Canceling the `RTRV-AS` and `RTRV-ASSOC` Commands

Because the `rtrv-as` and `rtrv-assoc` commands used in this procedure can output information for a long period of time, the `rtrv-as` and `rtrv-assoc` commands can be canceled and the output to the terminal stopped. There are three ways that the `rtrv-as` and `rtrv-assoc` commands can be canceled.

- Press the `F9` function key on the keyboard at the terminal where the `rtrv-as` or `rtrv-assoc` commands were entered.
- Enter the `canc-cmd` without the `trm` parameter at the terminal where the `rtrv-as` or `rtrv-assoc` commands were entered.
- Enter the `canc-cmd:trm=<xx>`, where `<xx>` is the terminal where the `rtrv-as` or `rtrv-assoc` commands were entered, from another terminal other than the terminal where the `rtrv-as` or `rtrv-assoc` commands were entered. To enter the `canc-cmd:trm=<xx>` command, the terminal must allow Security Administration commands to be entered from it and the user must be allowed to enter Security Administration commands. The terminal's permissions can be verified with the `rtrv-secu-trm` command. The user's permissions can be verified with the `rtrv-user` or `rtrv-secu-user` commands.

For more information about the `canc-cmd` command, go to *Commands User's Guide*.

1. Display the application servers in the database using the `rtrv-as` command.

This is an example of possible output.

```
rlghncxa03w 06-10-28 09:12:36 GMT EAGLE5 36.0.0
```

AS Name	Mode	Tr ms	Association Names
as1	LOADSHARE	10	assoc1
			assoc2
			assoc3
			assoc5
			assoc6

```
as2          OVERRIDE    10      assoc7
as3          LOADSHARE   10      assoc4
```

AS table is (2 of 250) 1% full.

 **Note:**

If the `mode` parameter will not be specified with the `chg-as` command in 5, continue the procedure with 5.

2. Display one of the associations assigned to the application server shown in 1 using the `rtrv-assoc` command and specifying the association name shown in the `rtrv-as` output in 1.

For this example, enter this command.

```
rtrv-assoc:aname=assoc1
```

This is an example of possible output.

```
rlghncxa03w 09-05-28 09:12:36 GMT EAGLE5 41.0.0
ANAME assoc1
      LOC      1203          IPLNK PORT  A          LINK  A
      ADAPTER  M3UA          VER          M3UA RFC
      LHOST    gw105.nc.tekelec.com
      ALHOST    ---
      RHOST    gw100.ncd-economic-development.southeastern-corridor-
ash.gov
      ARHOST    ---
      LPORT    1030          RPORT      2345
      ISTRMS   2            OSTRMS     2            BUFSIZE  16
      RMODE    LIN          RMIN       120          RMAX     800
      RTIMES   10          CWMIN      3000         UAPS     10
      OPEN     YES          ALW        YES          RTXTHR   10000
      RHOSTVAL RELAXED

      ASNAMES
      as1
```

```
IP Appl Sock table is (4 of 4000) 1% full
Assoc Buffer Space Used (16 KB of 800 KB) on LOC = 1203
```

 **Note:**

If the value of the `open` parameter shown in this step is `no`, continue the procedure with 5.

3. Change the value of the `open` parameter to `no` by specifying the `chg-assoc` command with the `open=no` parameter.

For this example, enter this command.

```
chg-assoc:aname=assoc1:open=no
```

When this command has successfully completed, this message should appear.

```
rlghncxa03w 06-10-28 09:12:36 GMT EAGLE5 36.0.0
CHG-ASSOC: MASP A - COMPLTD
```

 **Note:**

If all the associations assigned to the application server been displayed, continue the procedure with 5.

4. Repeat 2 and 3 for all associations assigned to the application server being changed.
5. Change the application server in the database using the `chg-as` command.

For this example, enter this command

```
chg-as:asname=as1:mode=override:tr=1000
```

This is an example of possible inputs and outputs:

```
rlghncxa03w 06-10-28 09:12:36 GMT EAGLE5 36.0.0
CHG-AS: MASP A - COMPLTD;
```

6. Verify the changes using the `rtrv-as` command.

This is an example of possible output.

```
rlghncxa03w 06-10-28 09:12:36 GMT EAGLE5 36.0.0

AS Name           Mode           Tr ms   Association Names
as1                OVERRIDE      1000    assoc1
                  assoc2
                  assoc3
                  assoc5
                  assoc6

as2                OVERRIDE      10      assoc7
as3                LOADSHARE     10      assoc4

AS table is (2 of 250) 1% full
```

 **Note:**

If the value of the `open` parameter was not changed in 3, continue the procedure with 8.

7. Change the value of the `open` parameter to `yes` by specifying the `chg-assoc` command with the `open=yes` parameter.

For this example, enter this command.

```
chg-assoc:aname=assoc1:open=yes
```

When this command has successfully completed, this message should appear.

```
rlghncxa03w 06-10-28 09:12:36 GMT EAGLE5 36.0.0  
CHG-ASSOC: MASP A - COMPLTD
```

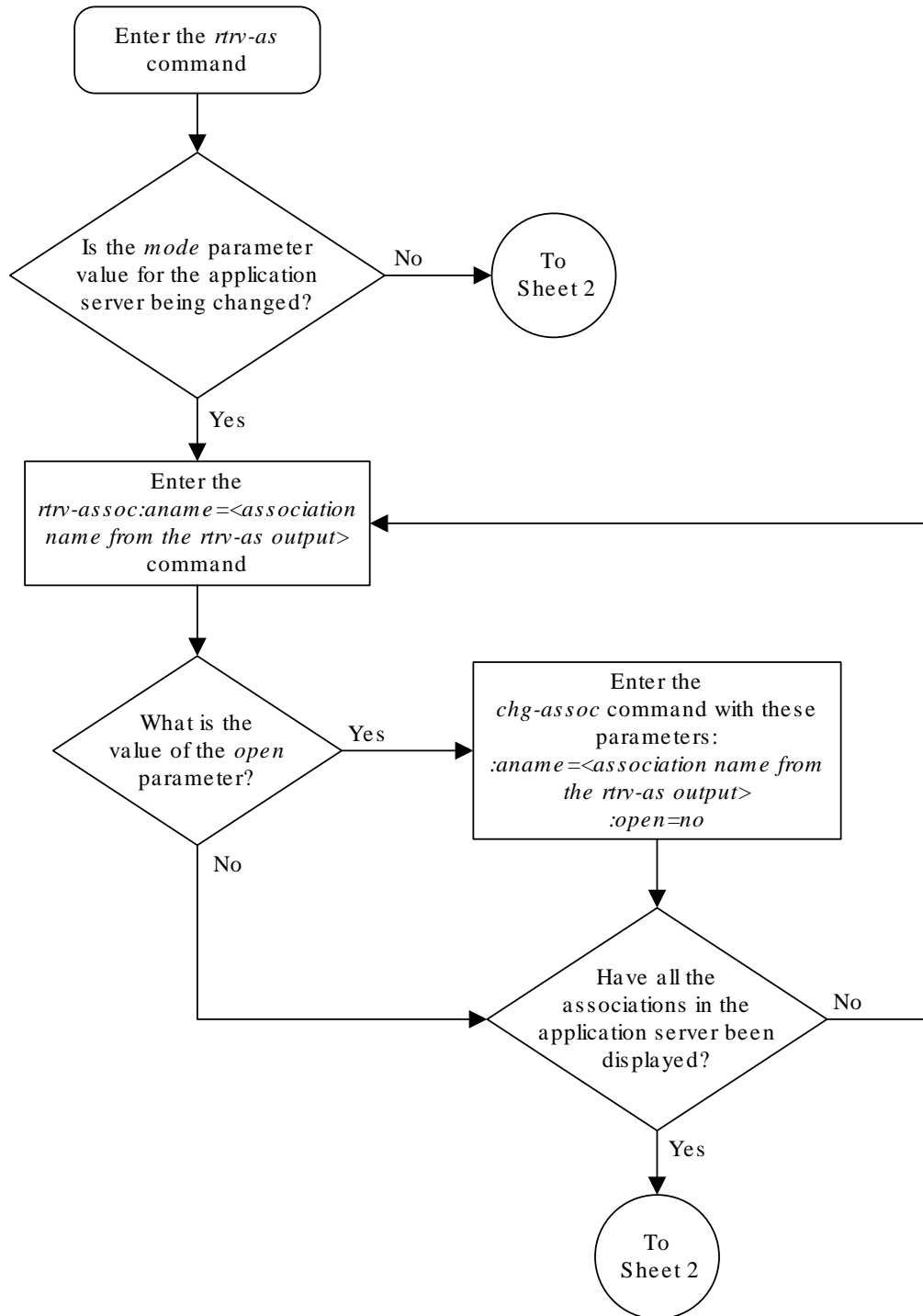
Repeat this step for all associations that were changed in 3.

8. Back up the new changes, using the `chg-db:action=backup:dest=fixed` command.

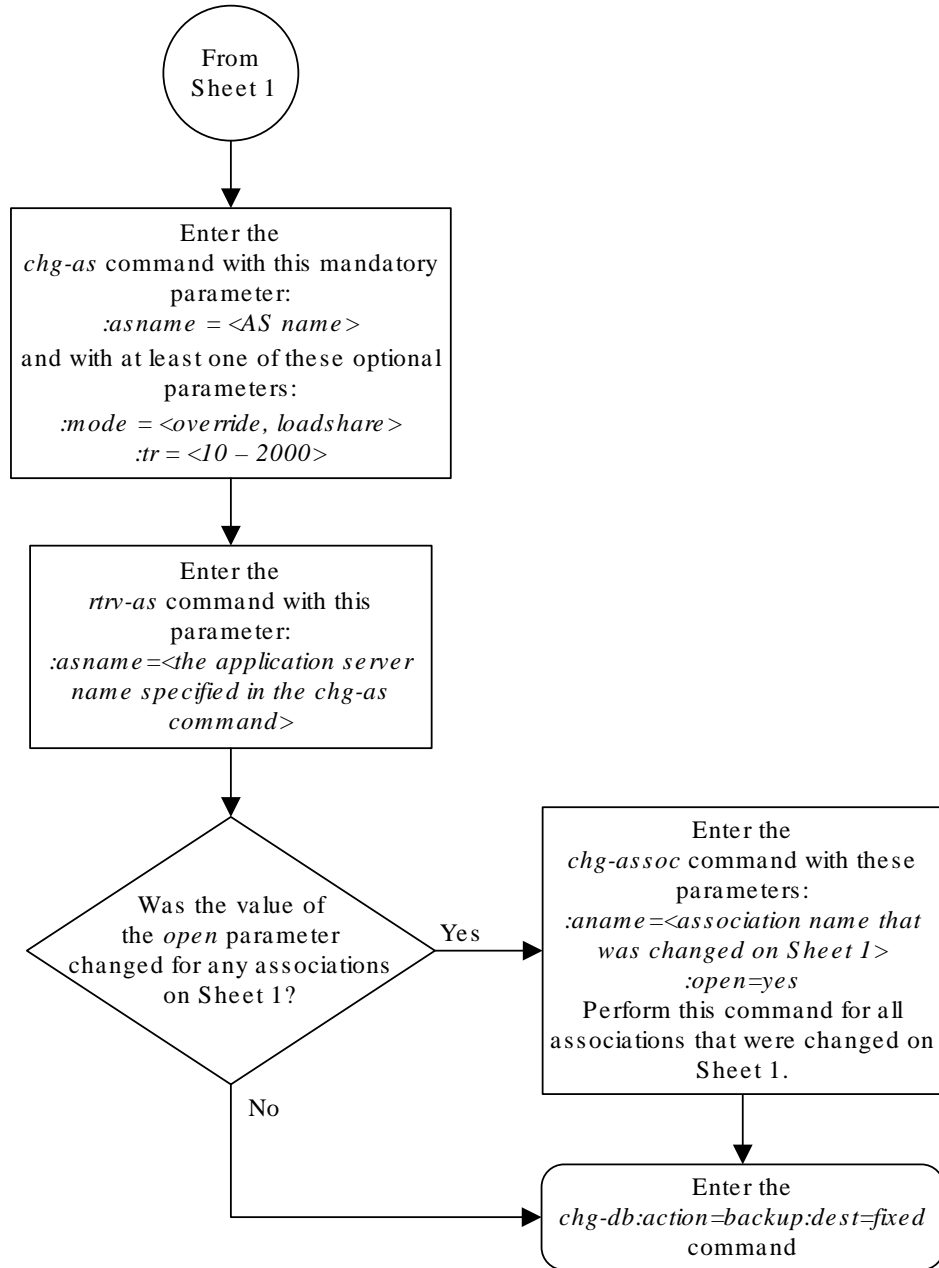
These messages should appear; the active **Maintenance and Administration Subsystem Processor (MASP)** appears first.

```
BACKUP (FIXED) : MASP A - Backup starts on active MASP.  
BACKUP (FIXED) : MASP A - Backup on active MASP to fixed disk complete.  
BACKUP (FIXED) : MASP A - Backup starts on standby MASP.  
BACKUP (FIXED) : MASP A - Backup on standby MASP to fixed disk complete.
```


Figure 4-40 Changing an Application Server



Sheet 1 of 2



4.35 Changing the CIC Values in an Existing Routing Key Containing an Application Server

This procedure is used to change the **CIC** values in an existing routing key using the `chg-appl-rtkey` command. These parameters are used in this procedure.

`:dpc/dpca/dpci/dpcn/dpcn24` – **Destination** point code value that is used to filter incoming **MSUs**.

`:opc/opca/opci/opcn/opcn24` - The originating point code value that is used to filter incoming **MSUs**. This value must not specify a cluster route.



Note:

See the “**Point Code Formats**” section in the *Database Administration - SS7 User's Guide* for a definition of the point code types that are used on the **EAGLE** and for a definition of the different formats that can be used for **ITU** national point codes.

`:si` – The service indicator value that is used to filter incoming **MSUs**. The range of values for the service indicator parameter (`si`) can be a numerical value either 4, 5, or 13, or for selected service indicator values, a text string can be used instead of numbers. [Table 4-18](#) shows the text strings that can be used in place of numbers for the service indicator values.

Table 4-18 Service Indicator Text String Values

Service Indicator Value	Text String
4	tup
5	isup
13	qbicc

`:cics` - Starting circuit identification code that is used to filter incoming **MSUs**. Specify with `cice` to identify the routing key to be changed.

`:cice` - Ending circuit identification code that is used to filter incoming **MSUs**. Specify with `cics` to identify the routing key to be changed.

`:ncics` - New starting circuit identification code that is used to filter incoming **MSUs**. Specify the `ncics` parameter and/or the `ncice` parameter to change the range of circuit identification codes assigned to the routing key.

`:ncice` - New ending circuit identification code that is used to filter incoming **MSUs**. Specify the `ncice` parameter and/or the `ncics` parameter to change the range of circuit identification codes assigned to the routing key.

`:split` - The circuit identification code value where the specified range of **CIC** values for the routing key specified by the `cics` and `cice` values is to be split into two routing keys. The **CIC** values in one routing key ranges from the `cics` value of the original routing key to a

value equal to one less than the `split` value. The **CIC** values in the other routing key ranges from the `split` value to the `cice` value of the original routing key. All other parameters in both routing keys remain the same as in the original routing key. The range of **CIC** values cannot be split if the routing key contains a routing context parameter value.

`:type` - **Key type**. Identifies the type of routing key that will be changed. One of three values, `type=full/partial/default`. If `type` is not explicitly specified, `type=full` is assumed. Only the `type=full` parameter can be used in this procedure.

`:rcontext` – The routing context parameter value assigned to the routing key.

The `chg-appl-rtkey` command contains other parameters that are not used in this procedure.

`:ssn` – The subsystem number value that is used to filter incoming **MSUs**. See the [Adding a Routing Key Containing an Application Server](#) procedure for more information on using the `ssn` parameter with a routing key.

`:nrcontext` – The new routing context parameter value.

See the [Changing the Routing Context Value in an Existing Routing Key](#) procedure for changing the routing context parameter value in an existing routing key.

Rules for Changing the Range of CIC Values in an Existing Routing Key

The parameter combinations used by the `chg-appl-rtkey` command to change the range of **CIC** values in the routing key are shown in [Table 4-19](#).

Table 4-19 Routing Key Parameter Combinations for Changing the Range of CIC Values in an Existing Routing Key

SI=4 (TUP)	SI=5 (ISUP)	SI=13 (QBICC)	
dpci/dpcn/ dpcn24=<the DPC assigned to the routing key> (See Note 1)	dpc/dpca=<the DPC assigned to the routing key> (See Note 1)	dpci/dpcn/ dpcn24=<the DPC assigned to the routing key> (See Note 1)	dpc/dpca/dpci/ dpcn/dpcn24=<the DPC assigned to the routing key> (See Note 1)
si=4 (See Note 1)	si=5 (See Note 1)	si=5 (See Note 1)	si=13 (See Note 1)
opci/opcn/ opcn24=<the OPC assigned to the routing key> (See Note 1)	opc/opca=<the OPC assigned to the routing key> (See Note 1)	opci/opcn/ opcn24=<the OPC assigned to the routing key> (See Note 1)	opc/opca/opci/ opcn/opcn24=<the OPC assigned to the routing key> (See Note 1)
cics=<the CICS value assigned to the routing key> (See Notes 1 and 2)	cics=<the CICS value assigned to the routing key> ^{1, 2}	cics=<the CICS value assigned to the routing key> (See Notes 1 and 2)	cics=<the CICS value assigned to the routing key> (See Notes 1 and 2)
cice=<the CICE value assigned to the routing key> (See Notes 1 and 2)	cice=<the CICE value assigned to the routing key> (See Notes 1 and 2)	cice=<the CICE value assigned to the routing key> (See Notes 1 and 2)	cice=<the CICE value assigned to the routing key> (See Notes 1 and 2)
type=full	type=full	type=full	type=full

Table 4-19 (Cont.) Routing Key Parameter Combinations for Changing the Range of CIC Values in an Existing Routing Key

SI=4 (TUP)	SI=5 (ISUP)		SI=13 (QBICC)
ncics=<0 to 4095> (See Notes 2 and 3)	ncics=<0 to 16383> (See Notes 2 and 3)	ncics=<0 to 4095> (See Notes 2 and 3)	ncics=<0 to 4294967295> (See Notes 2 and 3)
ncice=<0 to 4095> (See Notes 2 and 3)	ncice=<0 to 16383> (See Notes 2 and 3)	ncice=<0 to 4095> (See Notes 2 and 3)	ncice=<0 to 4294967295> (See Notes 2 and 3)
rcontext=<the current routing context value assigned to the routing key> (See Notes 4 and 5)	rcontext=<the current routing context value assigned to the routing key> (See Notes 4 and 5)	rcontext=<the current routing context value assigned to the routing key> (See Notes 4 and 5)	rcontext=<the current routing context value assigned to the routing key> (See Notes 4 and 5)

1. The values for these parameters must be entered exactly as shown in the `rtrv-appl-rtkey` command output for the routing key being changed. However, text strings can be used in place of some numerical service indicator values. See [Table 4-18](#) for a list of these text strings. The text string must correspond to the numerical value shown in the routing key being changed.

2. The `cics` and `cice` parameters must be specified and either the `ncics` or `ncice` parameters, or both, must be specified. If both the `ncics` and `ncice` parameters are specified, the value of the `ncics` parameter must be less than the value of the `ncice` parameter. If the `ncics` parameter is not specified, the value of the `ncice` parameter must be greater than or equal to the `cics` parameter value. If the `ncice` parameter is not specified, the value of the `ncics` parameter must be less than or equal to the `cice` parameter value.

3. The new **CIC** range cannot overlap the **CIC** range in an existing routing key.

4. If the routing key contains a numerical value in the `RCONTEXT` column in the `rtrv-appl-rtkey` output, the `rcontext` parameter and value can be used in place of the `dpc`, `si`, `opc`, `cics`, `cice`, or `type=full` parameters and values to identify the routing that is being changed with the `chg-appl-rtkey` command. However, if only the `rcontext` parameter is used to identify the routing key being changed, only one of these parameters, `ncics` or `ncice` can be specified with the `chg-appl-rtkey` parameter. If you wish to specify the `ncics` and `ncice` parameters with the `chg-appl-rtkey` parameter, the `dpc`, `si`, `opc`, `cics`, `cice`, or `type=full` parameters and values must be specified with the `chg-appl-rtkey` command.

5. If the routing key contains dashes in the `RCONTEXT` column in the `rtrv-appl-rtkey` output, the `dpc`, `si`, `opc`, `cics`, `cice`, or `type` parameters and values must be used with the `chg-appl-rtkey` command to identify the routing key being changed.

Rules for Splitting the Range of CIC Values in an Existing Routing Key

The parameter combinations used by the `chg-appl-rtkey` command to split the range of **CIC** values in the routing key are shown in [Table 4-20](#).

Splitting the range of **CIC** values creates two routing keys. The **CIC** values in one routing key ranges from the `cics` value of the original routing key to a value equal to one less than the `split` value. The **CIC** values in the other routing key ranges from the `split` value to the `cice` value of the original routing key. All other parameters in both routing keys remain the same as in the original routing key. The range of **CIC** values cannot be split if the routing key contains a routing context parameter value.

Table 4-20 Routing Key Parameter Combinations for Splitting the Range of CIC Values in an Existing Routing Key

SI=4 (TUP)	SI=5 (ISUP)	SI=13 (QBICC)	
dpci/dpcn/ dpcn24=<the DPC assigned to the routing key> (See Note 1)	dpc/dpca=<the DPC assigned to the routing key> (See Note 1)	dpci/dpcn/ dpcn24=<the DPC assigned to the routing key> (See Note 1)	dpc/dpca/dpci/ dpcn/dpcn24=<the DPC assigned to the routing key> (See Note 1)
si=4 (See Note 1)	si=5 (See Note 1)	si=5 (See Note 1)	si=13 (See Note 1)
opci/opcn/ opcn24=<the OPC assigned to the routing key> (See Note 1)	opc/opca=<the OPC assigned to the routing key> (See Note 1)	opci/opcn/ opcn24=<the OPC assigned to the routing key> (See Note 1)	opc/opca/opci/ opcn/opcn24=<the OPC assigned to the routing key> (See Note 1)
cics=<the CICS value assigned to the routing key> (See Note 1)	cics=<the CICS value assigned to the routing key> (See Note 1)	cics=<the CICS value assigned to the routing key> (See Note 1)	cics=<the CICS value assigned to the routing key> (See Note 1)
cice=<the CICE value assigned to the routing key> (See Note 1)	cice=<the CICE value assigned to the routing key> (See Note 1)	cice=<the CICE value assigned to the routing key> (See Note 1)	cice=<the CICE value assigned to the routing key> (See Note 1)
type=full	type=full	type=full	type=full
split=<0 to 4095> (See Note 2)	split=<0 to 16383> (See Note 2)	split=<0 to 4095> (See Note 2)	split=<0 to 4294967295> (See Note 2)

1. The values for these parameters must be entered exactly as shown in the `rtrv-appl-rtkey` command output for the routing key being changed. However, text strings can be used in place of some numerical service indicator values. See [Table 4-18](#) for a list of these text strings. The text string must correspond to the numerical value shown in the routing key being changed.

2. The `split` parameter value must be greater than the `cics` parameter value and less than the `cice` parameter value.

Canceling the `RTRV-APPL-RTKEY` Command

Because the `rtrv-appl-rtkey` command used in this procedure can output information for a long period of time, the `rtrv-appl-rtkey` command can be canceled and the output to the terminal stopped. There are three ways that the `rtrv-appl-rtkey` command can be canceled.

- Press the `F9` function key on the keyboard at the terminal where the `rtrv-appl-rtkey` command was entered.
- Enter the `canc-cmd` without the `trm` parameter at the terminal where the `rtrv-appl-rtkey` command was entered.
- Enter the `canc-cmd:trm=<xx>`, where `<xx>` is the terminal where the `rtrv-appl-rtkey` command was entered, from another terminal other than the terminal where the `rtrv-appl-rtkey` command was entered. To enter the `canc-cmd:trm=<xx>` command, the terminal must allow Security Administration commands to be entered from it and the user must be allowed to enter Security

Administration commands. The terminal's permissions can be verified with the `rtrv-secu-trm` command. The user's permissions can be verified with the `rtrv-user` or `rtrv-secu-user` commands.

For more information about the `canc-cmd` command, go to *Commands User's Guide*.

1. Display the current routing key information in the database by entering the `rtrv-appl-rtkey` command.

The following is an example of the possible output.

```
rlghncxa03w 08-04-28 21:15:37 GMT EAGLE5 38.0.0
```

RCONTEXT	DPC	SI	ADPTR	ASNAME	TYPE
-----	123-234-123	5	M3UA	as12	FULL
-----	005-005-001	5	M3UA	as9	FULL
-----	005-005-001	5	M3UA	as9	FULL
2500	006-006-001	5	SUA	as10	FULL

RCONTEXT	DPCI	SI	ADPTR	ASNAME	TYPE
-----	2-100-7	6	M3UA	as4	FULL
100	3-137-6	6	SUA	as1	FULL
225	4-035-7	5	SUA	as7	FULL
-----	6-006-6	5	M3UA	as2	FULL
-----	6-006-7	5	M3UA	as8	FULL
-----	6-006-6	5	M3UA	as2	FULL
-----	6-006-6	5	M3UA	as2	FULL
-----	6-006-8	3	M3UA	as3	FULL
-----	6-006-8	5	M3UA	as5	FULL
-----	6-024-7	5	M3UA	as4	FULL
-----	6-024-7	5	M3UA	as4	FULL
300	7-008-7	6	SUA	as6	FULL

RCONTEXT	DPC	SI	ADPTR	ASNAME	TYPE
-----	*****	**	M3UA	as11	DEFAULT

STATIC Route Key table is (17 of 2000) 1% full

STATIC Route Key Socket Association table is (17 of 32000) 1% full

2. Display the specific routing key information for the routing key being changed by entering the `rtrv-appl-rtkey` command with the `display=all` parameter.

If the routing key being changed contains a routing context value, specify the `rcontext` parameter and value shown in the `rtrv-appl-rtkey` output in **1** for the routing key being changed.

If the routing key being changed does not contain a routing context value, specify the `DPC`, `SI`, and `TYPE` values shown in the `rtrv-appl-rtkey` output in **1** for the routing key being changed. The service indicator value for the routing key to be used in this procedure is either 4, 5, or 13.

For this example, enter these commands.

```
rtrv-appl-rtkey:dpc=123-234-123:si=5:type=full:display=all
```


This is an example of the possible output.

```
rlghncxa03w 08-04-28 21:16:37 GMT EAGLE5 38.0.0

RCONTEXT  DPC          SI SSN OPC          CICS      CICE
-----  123-234-123    5 --- 122-124-125    1         1000

      ADPTR  TYPE      ASNAME
      M3UA  FULL     as12

      ANAMES
      assoc20

STATIC Route Key table is (17 of 2000) 1% full
STATIC Route Key Socket Association table is (17 of 32000) 1% full
```

```
rtrv-appl-rtkey:rcontext=225:display=all
```

This is an example of the possible output.

```
rlghncxa03w 06-10-28 21:16:37 GMT EAGLE5 36.0.0

RCONTEXT  DPCI          SI SSN OPCI          CICS      CICE
-----  4-035-7      5 --- 2-007-3    2000     3000

      ADPTR  TYPE      ASNAME
      M3UA  FULL     as7

      ANAMES
      assoc15

STATIC Route Key table is (17 of 2000) 1% full
STATIC Route Key Socket Association table is (17 of 32000) 1% full
```

3. Change the **CIC** values of the routing key by entering the `chg-appl-rtkey` command.

The parameters required for the `chg-appl-rtkey` command are determined by the type of change being made to the routing key. Go to one of these sections to determine the required parameter combination.

- [Rules for Changing the Range of CIC Values in an Existing Routing Key](#)
- [Rules for Splitting the Range of CIC Values in an Existing Routing Key](#)

To change the range of **CIC** values for this example, enter these commands.

```
chg-appl-
rtkey:dpca=123-234-123:si=5:opca=122-124-125:cics=1:cice=100
0:ncice=2000

chg-appl-
rtkey:dpci=4-035-7:si=5:opci=2-007-3:cics=2000:cice=3000:nci
ce=4000
```

If a routing context value is assigned to the routing key, the `rcontext` parameter and value assigned to the routing key can be used to identify the routing key being

changed instead of the `dpc`, `si`, `opc`, `cics`, and `cice` parameters. If the `rcontext` parameter is specified only one of these parameters, `ncics` or `ncice`, can be specified with the `chg-appl-rtkey` parameter.

For this example, enter this command.

```
chg-appl-rtkey:rcontext=225:ncice=4000
```

To split the range of **CIC** values for this example, enter this command.

```
chg-appl-rtkey:dpca=123-234-123:si=5:opca=122-124-125:cics=1:cice=1000:split=500
```

When this command has successfully completed, the following message should appear.

```
rlghncxa03w 06-10-28 21:16:37 GMT EAGLE5 36.0.0
CHG-APPL-RTKEY: MASP A - COMPLTD
```

4. Display the new routing key information in the database by entering the `rtrv-appl-rtkey` command with the `display=all` parameter.

If the routing key being changed contains a routing context value, specify the `rcontext` parameter and value specified in the `chg-appl-rtkey` command in 3. The `DPC`, `SI`, `CICS`, and `CICE` parameters and values used in 3 can be specified in the `rtrv-appl-rtkey` command for routing keys containing routing context values.

If the routing key being changed does not contain a routing context value, specify the `DPC`, `SI`, `CICS`, and `CICE` parameters and values specified in the `chg-appl-rtkey` command in 3. If the `ncics` or `ncice` parameters were specified in 3, the `NCICS` or `NCICE` values specified in 3 must be specified for the `cics` or `cice` parameters in this step.

For this example, enter these commands.

```
rtrv-appl-rtkey:dpca=123-234-123:si=5:cics=1:cice=2000:display=all
```

```
rlghncxa03w 08-04-28 21:16:37 GMT EAGLE5 38.0.0
```

RCONTEXT	DPC	SI	SSN	OPC	CICS	CICE
-----	123-234-123	5	---	122-124-125	1	2000

ADPTR	TYPE	ASNAME
M3UA	FULL	as12

```
ANAMES
assoc20
```

```
STATIC Route Key table is (17 of 2000) 1% full
STATIC Route Key Socket Association table is (17 of 32000) 1% full
```

```
rtrv-appl-rtkey:dpca=123-234-123:si=5:cics=2000:cice=4000 :display=all
```

or

```
rtrv-appl-rtkey:rcontext=225:display=all
```

This is an example of the possible output.

```
rlghncxa03w 08-04-28 21:16:37 GMT EAGLE5 38.0.0
RCONTEXT  DPCI          SI SSN OPCI          CICS      CICE
225        4-035-7        5 --- 2-007-3        2000      4000

ADPTR  TYPE      ASNAME
SUA    FULL     as7

ANAMES
assoc15
```

```
STATIC Route Key table is (17 of 2000) 1% full
STATIC Route Key Socket Association table is (17 of 32000) 1% full
```

```
rtrv-appl-
rtkey:dpca=123-234-123:si=5:cics=1:cice=1000 :display=all
```

```
rlghncxa03w 08-04-28 21:16:37 GMT EAGLE5 38.0.0
RCONTEXT  DPC          SI SSN OPC          CICS      CICE
----- 123-234-123  5 --- 100-100-100    1          499

ADPTR  TYPE      ASNAME
M3UA   FULL     as12

ANAMES
assoc20
```

```
RCONTEXT  DPC          SI SSN OPC          CICS      CICE
----- 123-234-123  5 --- 122-124-125    500       1000

ADPTR  TYPE      ASNAME
M3UA   FULL     as12

ANAMES
assoc20
```

```
STATIC Route Key table is (18 of 2000) 1% full
STATIC Route Key Socket Association table is (18 of 32000) 1% full
```

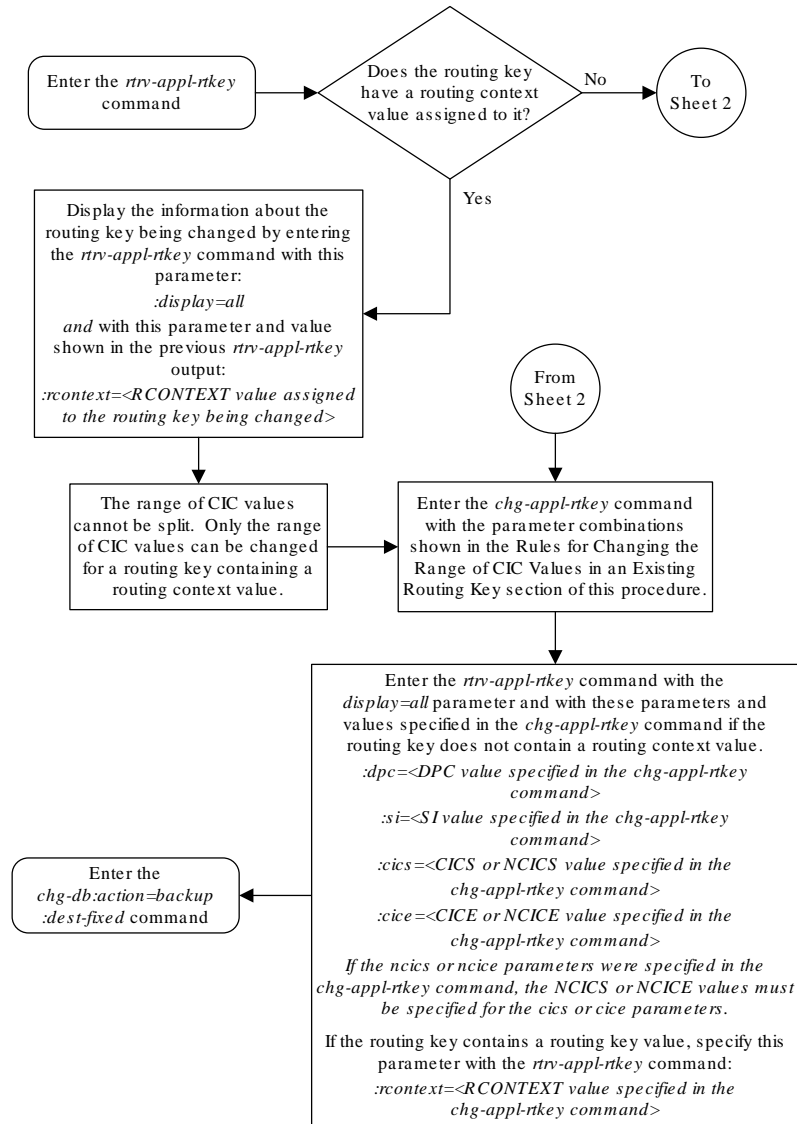
5. Back up the new changes using the `chg-db:action=backup:dest=fixed` command.

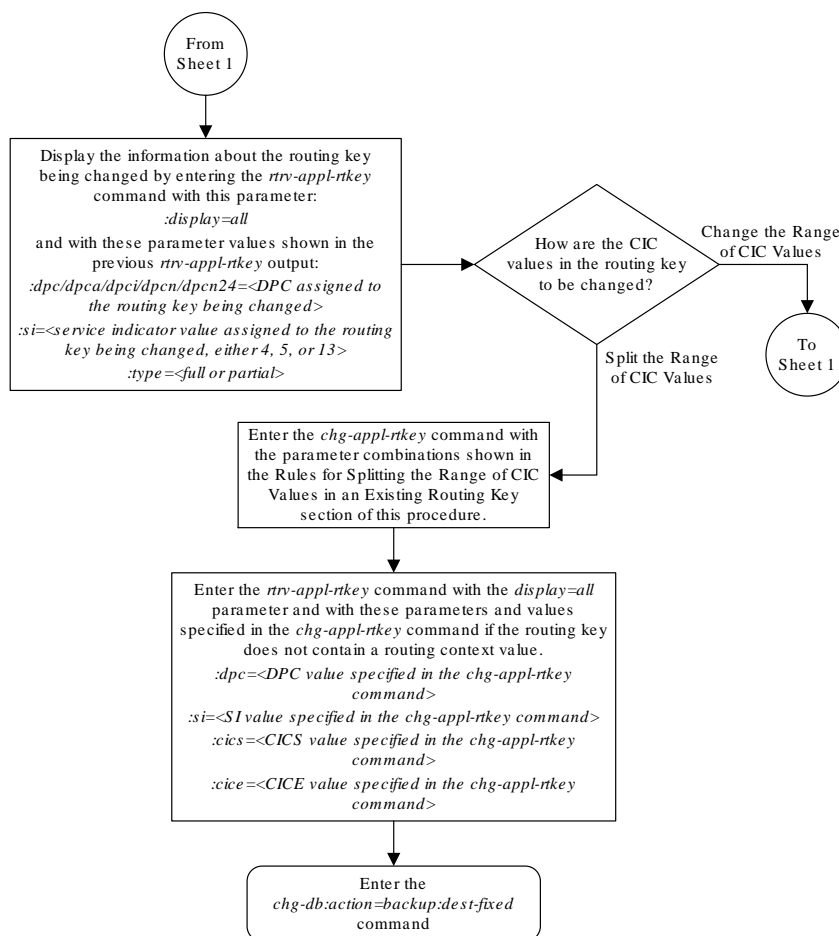
These messages should appear, the active **Maintenance and Administration Subsystem** Processor (**MASP**) appears first.

```
BACKUP (FIXED) : MASP A - Backup starts on active MASP.
BACKUP (FIXED) : MASP A - Backup on active MASP to fixed disk
complete.
BACKUP (FIXED) : MASP A - Backup starts on standby MASP.
```

BACKUP (FIXED) : MASP A - Backup on standby MASP to fixed disk complete.

Figure 4-41 Changing the CIC Values in an Existing Routing Key Containing an Application Server





Sheet 2 of 2

4.36 Changing the Routing Context Value in an Existing Routing Key

This procedure is used to change the routing context value in an existing routing key using the `chg-appl-rtkey` command.

The routing key being changed in this procedure must contain a number for the routing context value. If the routing context value shown for the routing key contains dashes

(-), this routing key cannot be used in this procedure. The dashes shows that the routing key does not have a routing context assigned to it.

To assign a routing context value to an existing **M3UA** routing key, the routing key must be removed by performing the [Removing a Routing Key Containing an Application Server](#) procedure, then re-enter the routing key with the routing context value by performing the [Adding a Routing Key Containing an Application Server](#) procedure. A routing context value must always be assigned to an **SUA** routing key.

These parameters are used in this procedure.

`:rcontext` – The current routing context parameter value, which has two functions:

- Provides an index of the application server traffic that the sending **ASP** is configured or registered to receive.
- Identifies the **SS7** network context for the message. The routing context parameter implicitly defines the **SS7** point code format used, the **SS7** network indicator value, and the **SCCP** protocol type/variant/version used.

`:nrcontext` – The new routing context parameter value, from 0 to 4294967295. The new routing context value cannot be assigned to other routing keys.

The `chg-appl-rtkey` command contains other parameters that are not used in this procedure.

`:dpc/dpca/dpci/dpcn/dpcn24` – **Destination** point code value that is used to filter incoming **MSUs**.

`:opc/opca/opci/opcn/opcn24` - The originating point code value that is used to filter incoming **MSUs**. This value must not specify a cluster route.

`:si` – The service indicator value that is used to filter incoming **MSUs**. The range of values for the service indicator parameter (`si`) can be a numerical value from 0 to 15, or for selected service indicator values, a text string can be used instead of numbers. [Table 4-21](#) shows the text strings that can be used in place of numbers for the service indicator values.

Table 4-21 Service Indicator Text String Values

Service Indicator Value	Text String	Service Indicator Value	Text String
0	snm	4	tup
1	regtest	5	isup
2	spltst	13	qbicc
3	sccp		

`:ssn` – The subsystem number value that is used to filter incoming **MSUs**.

`:cics` - Starting circuit identification code that is used to filter incoming **MSUs**.

`:cice` - Ending circuit identification code that is used to filter incoming **MSUs**.

`:type` - **Key** type. Identifies the type of routing key that will be changed. One of three values, `type=full/partial/default`. If `type` is not explicitly specified, `type=full` is assumed.

`:ncics` - New starting circuit identification code that is used to filter incoming **MSUs**.

:ncice - New ending circuit identification code that is used to filter incoming **MSUs**.

:split - The circuit identification code value where the specified range of the routing key specified by the cics and cice values is to be split into two entries.

See the [Changing the CIC Values in an Existing Routing Key Containing an Application Server](#) procedure for changing a routing key using the ncics, ncice, and split parameters.

Canceling the RTRV-APPL-RTKEY Command

Because the rtrv-appl-rtkey command used in this procedure can output information for a long period of time, the rtrv-appl-rtkey command can be canceled and the output to the terminal stopped. There are three ways that the rtrv-appl-rtkey command can be canceled.

- Press the F9 function key on the keyboard at the terminal where the rtrv-appl-rtkey command was entered.
- Enter the cancel-cmd without the trm parameter at the terminal where the rtrv-appl-rtkey command was entered.
- Enter the cancel-cmd:trm=<xx>, where <xx> is the terminal where the rtrv-appl-rtkey command was entered, from another terminal other than the terminal where the rtrv-appl-rtkey command was entered. To enter the cancel-cmd:trm=<xx> command, the terminal must allow Security Administration commands to be entered from it and the user must be allowed to enter Security Administration commands. The terminal's permissions can be verified with the rtrv-secu-trm command. The user's permissions can be verified with the rtrv-user or rtrv-secu-user commands.

For more information about the cancel-cmd command, go to *Commands User's Guide*.

1. Display the current routing key information in the database by entering the rtrv-appl-rtkey command. The following is an example of the possible output.

```
rlghncxa03w 08-04-28 21:15:37 GMT EAGLE5 38.0.0
```

RCONTEXT	DPC	SI	ADPTR	ASNAME	TYPE
-----	123-234-123	5	M3UA	as12	FULL
-----	005-005-001	5	M3UA	as9	FULL
-----	005-005-001	5	M3UA	as9	FULL
2500	006-006-001	5	SUA	as10	FULL

RCONTEXT	DPCI	SI	ADPTR	ASNAME	TYPE
-----	2-100-7	6	M3UA	as4	FULL
100	3-137-6	6	SUA	as1	FULL
225	4-035-7	5	M3UA	as7	FULL
310	6-006-6	5	SUA	as2	FULL
-----	6-006-7	5	M3UA	as8	FULL
1000	6-006-6	5	SUA	as2	FULL
500	6-006-6	5	SUA	as2	FULL
-----	6-006-8	3	M3UA	as3	FULL
-----	6-006-8	5	M3UA	as5	FULL
-----	6-024-7	5	M3UA	as4	FULL
-----	6-024-7	5	M3UA	as4	FULL

```

300          7-008-7      6  SUA    as6          FULL
RCONTEXT    DPC          SI  ADPTR  ASNAME      TYPE
-----    *****    **  M3UA   as11        DEFAULT

```

```

STATIC Route Key table is (17 of 2000) 1% full
STATIC Route Key Socket Association table is (17 of 32000) 1% full

```

2. Display the specific routing key information for the routing key being changed by entering the `rtrv-appl-rtkey` command with the `display=all` parameter and the `RCONTEXT` value shown in the `rtrv-appl-rtkey` output in 1 for the routing key being changed. For this example, enter this command.

```
rtrv-appl-rtkey:rcontext=310:display=all
```

This is an example of the possible output.

```

rlghncxa03w 08-04-28 21:16:37 GMT EAGLE5 38.0.0

RCONTEXT    DPCI          SI  SSN  OPCI          CICS    CICE
310          6-006-6      5  ---  1-002-3      75      100
  ADPTR  TYPE      ASNAME
  SUA    FULL      as2

ANAMES
assoc1

```

```

STATIC Route Key table is (17 of 2000) 1% full
STATIC Route Key Socket Association table is (17 of 32000) 1% full

```

If the routing context value shown for the routing key is dashes (-), this routing key cannot be used in this procedure. The dashes show that the routing key does not have a routing context assigned to it.

To assign a routing context value to a **M3UA** routing key that does not have a routing context value, the routing key must be removed by performing the [Removing a Routing Key Containing an Application Server](#) procedure. Re-enter the routing key with the routing context value by performing the [Adding a Routing Key Containing an Application Server](#) procedure. If you do not wish to assign a routing context value to this routing key, but you wish to change the routing context value in another routing key, repeat this step with another routing key shown in 1. If you do not wish to assign a routing context value to this routing key, and do not wish to change the routing context value in another routing key, this procedure cannot be performed.

If the routing key contains a routing context value, continue the procedure with 3.

3. Display the association displayed in the `rtrv-appl-rtkey` output in 2, using the `rtrv-assoc` command with the association name shown in 2.

```
rtrv-assoc:aname=assoc1
```

This is an example of possible output.

```

rlghncxa03w 09-05-28 09:12:36 GMT EAGLE5 41.0.0
ANAME assoc1

```



```

LOC      1203          IPLNK PORT  A          LINK  A
ADAPTER  SUA            VER        SUA RFC
LHOST    gw105.nc.tekelec.com
ALHOST   ---
RHOST    gw100.nc.tekelec.com
ARHOST   ---
LPORT    1030          RPORT      1030
ISTRMS   2              OSTRMS     2          BUFSIZE  16
RMODE    LIN          RMIN       120        RMAX     800
RTIMES   10          CWMIN      3000       UAPS     10
OPEN     YES          ALW        YES         RTXTHR   10000
RHOSTVAL RELAXED

ASNAMES
as2

```

```

IP Appl Sock table is (4 of 4000) 1% full
Assoc Buffer Space Used (16 KB of 800 KB) on LOC = 1203

```

Repeat this step for each association name displayed in 2.

 **Note:**

If the `open` parameter value for all the associations assigned to the application server is `no` (shown in 3), continue the procedure with 5.

4. Change the value of the `open` parameter to `no` by specifying the `chg-assoc` command with the `open=no` parameter. For this example, enter this command.

```
chg-assoc:aname=assoc1:open=no
```

When this command has successfully completed, this message should appear.

```

rlghncxa03w 06-10-28 09:12:36 GMT EAGLE5 36.0.0
CHG-ASSOC: MASP A - COMPLTD;

```

 **Caution:**

The IP connections using the associations specified in this step will not be able to carry any traffic when the `open` parameter is changed to `no`.

Repeat this step for all the associations assigned to the application server that have the `open=yes` parameter value.

5. Change the routing key information to the database by entering the `chg-appl-rtkey` command with the current and new routing context values. For this example, enter this command.

```
chg-appl-rtkey:nrcontext=5280:rcontext=310
```

When this command has successfully completed, the following message should appear.

```
rlghncxa03w 06-10-28 21:16:37 GMT EAGLE5 36.0.0
CHG-APPL-RTKEY: MASP A - COMPLTD
```

6. Display the new routing key information in the database by entering the `rtrv-appl-rtkey` command with the new routing context value specified in 5 and the `display=all` parameter. For this example, enter this command.

```
rtrv-appl-rtkey:rcontext=5280:display=all
```

This is an example of the possible output.

```
rlghncxa03w 08-04-28 21:15:37 GMT EAGLE5 38.0.0
RCONTEXT  DPCI          SI SSN OPCI          CICS      CICE
5280      6-006-6          5 ---  1-002-3          75        100
      ADPTR  TYPE      ASNAME
      SUA   FULL      as2

      ANAMES
      assoc1

STATIC Route Key table is (17 of 2000) 1% full
STATIC Route Key Socket Association table is (17 of 32000) 1% full
```

 **Note:**

If 4 was not performed in this procedure, continue the procedure with 8.

7. Change the value of the `open` parameter of the associations that were changed in 4 to `yes` by specifying the `chg-assoc` command with the `open=yes` parameter. For this example, enter this command.

```
chg-assoc:aname=assoc1:open=yes
```

When this command has successfully completed, this message should appear.

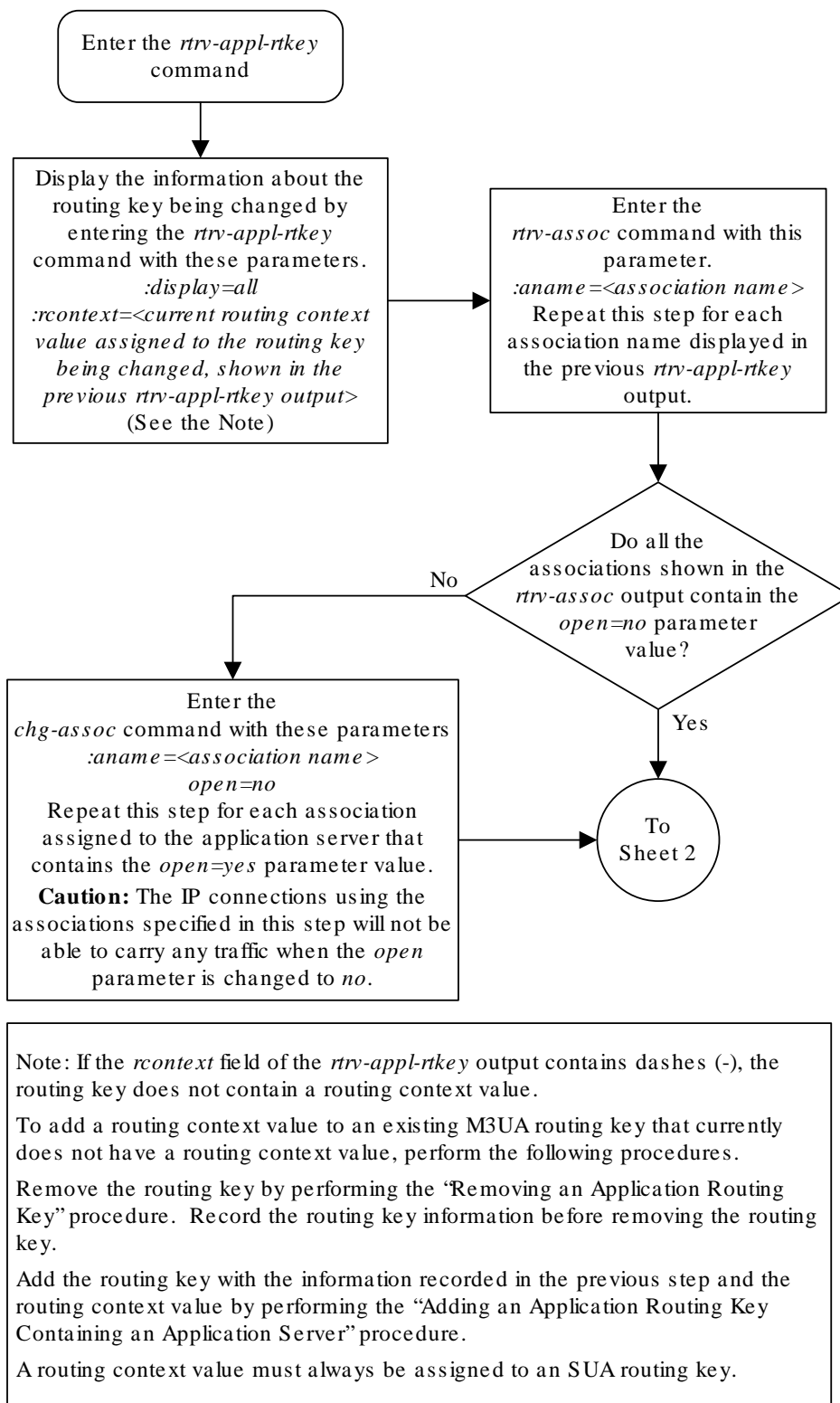
```
rlghncxa03w 06-10-28 09:12:36 GMT EAGLE5 36.0.0
CHG-ASSOC: MASP A - COMPLTD;
```

Repeat this step for all the associations that were changed in 4.

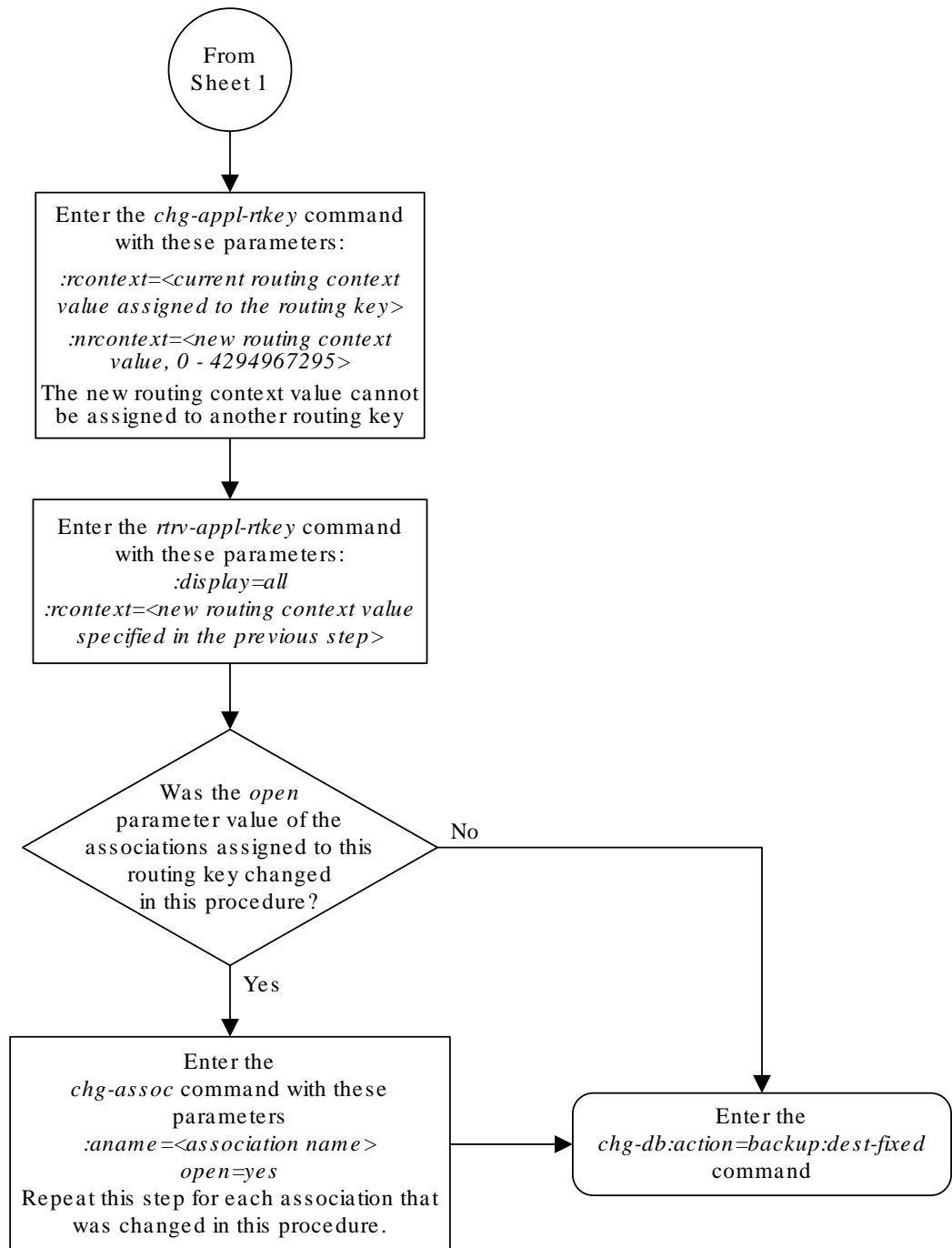
8. Back up the new changes using the `chg-db:action=backup:dest=fixed` command. These messages should appear, the active **Maintenance and Administration Subsystem Processor (MASP)** appears first.

```
BACKUP (FIXED) : MASP A - Backup starts on active MASP.
BACKUP (FIXED) : MASP A - Backup on active MASP to fixed disk complete.
BACKUP (FIXED) : MASP A - Backup starts on standby MASP.
BACKUP (FIXED) : MASP A - Backup on standby MASP to fixed disk complete.
```

Figure 4-42 Changing the Routing Context Value in an Existing Routing Key



Sheet 1 of 2



4.37 Changing the SCTP Checksum Algorithm Option for M3UA and SUA Associations

Use this procedure to change the **SCTP** checksum algorithm, either Adler-32 or **CRC-32c**, applied to traffic on **SCTP** associations. The `sctpcsum` parameter of the `chg-sg-opts` command is used to change this option. The Adler-32 and CRC-32c checksum algorithms specified in this procedure applies to all the associations that are assigned to all the IP cards running the SS7IPGW or IPGWI applications. This option is a system-wide option. To apply this option to associations assigned to cards running the IPLIM, IPLIMI, or IPSP applications, perform these procedures.

- [Changing the SCTP Checksum Algorithm Option for IPSP M2PA Associations](#)
- [Changing the SCTP Checksum Algorithm Option for IPSP M3UA Associations](#)
- [Changing the SCTP Checksum Algorithm Option for M2PA Associations](#)

The `sctpcsum` parameter contains another value, `percard`, that allows either the Adler-32 or CRC-32c SCTP checksum algorithm to be specified for the all the associations assigned to a specific card. With this option specified, the Adler-32 checksum algorithm can be specified for the associations on one card and the CRC-32c checksum algorithm can be specified for the associations on another card. Setting the `sctpcsum` parameter to `percard` changes the SCTP checksum algorithm for the associations assigned to a card to the SCTP checksum algorithm value for that card. The checksum algorithm for individual cards is provisioned by performing the [Configuring an IP Card](#) procedure.

Once the **SCTP** checksum option has been changed, the associations on each **IP** card need to be reset by changing the `open` parameter value for each association to `no`, then back to `yes`. This ensures that the associations on the **IP** card are using the new **SCTP** checksum algorithm.

Canceling the `RTRV-ASSOC` Command

Because the `rtrv-assoc` command used in this procedure can output information for a long period of time, the `rtrv-assoc` command can be canceled and the output to the terminal stopped. There are three ways that the `rtrv-assoc` command can be canceled.

- Press the `F9` function key on the keyboard at the terminal where the `rtrv-assoc` command was entered.
- Enter the `canc-cmd` without the `trm` parameter at the terminal where the `rtrv-assoc` command was entered.
- Enter the `canc-cmd:trm=<xx>`, where `<xx>` is the terminal where the `rtrv-assoc` command was entered, from another terminal other than the terminal where the `rtrv-assoc` command was entered. To enter the `canc-cmd:trm=<xx>` command, the terminal must allow Security Administration commands to be entered from it and the user must be allowed to enter Security Administration commands. The terminal's permissions can be verified with the `rtrv-secu-trm` command. The user's permissions can be verified with the `rtrv-user` or `rtrv-secu-user` commands.

For more information about the `canc-cmd` command, go to *Commands User's Guide*.

1. Display the current **IP** options in the database by entering the `rtrv-sg-opts` command. The following is an example of the possible output.

```
rlghncxa03w 06-10-28 21:16:37 GMT EAGLE5 36.0.0
SCTPCSUM:      adler32
```

The `rtrv-sg-opts` command output contains other fields that are not used by this procedure. If you wish to see all the fields displayed by the `rtrv-sg-opts` command, see the `rtrv-sg-opts` command description in *Commands User's Guide*.

2. Display the cards in the **EAGLE** by entering the `rtrv-card` command. This is an example of the possible output.

```
rlghncxa03w 13-06-15 16:34:56 GMT EAGLE5 45.0.0
CARD   TYPE      APPL      LSET NAME      LINK SLC  LSET NAME
LINK SLC
1101   DSM         VSCCP
1102   TSM         GLS
1113   E5MCAP     EOAM
1114   E5TDM-A
1115   E5MCAP     EOAM
1116   E5TDM-B
1117   E5MDAL
1201   LIMDS0     SS7ANSI   lsn1           A    0    lsn2
B      1
1202   DCM         IPLIM     ipnode2       A    1
1203   LIMDS0     SS7ANSI   lsn2           A    0    lsn1
B      1
1204   LIMATM     ATMANSI   atmgwy        A    0
1205   DCM         IPLIM     ipnode1       A    0    ipnode3
B      1
1207   DCM         IPLIM     ipnode2       A    0
1303   DCM         IPLIM     ipnode3       A    0    ipnode1
B      1
1305   DCM         IPLIM     ipnode4       A    0
1308   DCM         IPLIM     ipnode3       B    2
          ipnode1       A1   2    ipnode4
B2     1
1315   DCM         SS7IPGW   ipgtwy1       A
1317   DCM         IPGWI     ipgtwy2       A
```

Record the card location, shown in the `LOC` column, and signaling link, shown in the `LINK` column, information for all cards running the **SS7IPGW** and **IPGWI** applications.

3. At the **IP** near end node, stop all traffic to one of the **IP** cards running the **SS7IPGW** or **IPGWI** applications on the **EAGLE**.
4. At the **EAGLE**, enter the `msucount -l` pass command with the card location of the **IP** card selected in 3. For this example, enter this command.

```
pass:loc=1315:cmd="msucount -l"
```

The following is an example of the possible output.

```

rlghncxa03w 06-10-28 21:16:37 GMT EAGLE5 36.0.0
PASS: Command sent to card

rlghncxa03w 06-10-28 21:16:37 GMT EAGLE5 36.0.0
MSUCOUNT: Command In Progress

rlghncxa03w 06-10-28 21:16:37 GMT EAGLE5 36.0.0

MSUCOUNT: MSU Count Report

-----
Link Measurements (Link A)
-----

Transmit Counts                                Receive Counts
-----
rate  msus      bytes                                rate  msus      bytes
-----
2000  4294967295  4294967295                            2000  4294967295  4294967295
MTP Primitive (MTPP) counts                    Reroute Counts
-----
sent pdus   rcvd pdus   dscrd pdus   sent msus   rcvd msus
-----
4294967295  4294967295  4294967295  4294967295  4294967295

END of Report

```

5. Display the IP addresses of the IP links in the database by entering the `rtrv-ip-lnk` command. The following is an example of the possible output.

```

rlghncxa03w 08-12-28 21:17:37 GMT EAGLE5 40.0.0
LOC  PORT IPADDR          SUBMASK          DUPLEX  SPEED  MACTYPE  AUTO
MCAST
1202 A   192.1.1.10      255.255.255.0   HALF    10     DIX      NO   NO
1202 B   -----         -----         HALF    10     DIX      NO   NO
1205 A   192.1.1.12      255.255.255.0   HALF    10     DIX      NO   NO
1205 B   -----         -----         HALF    10     DIX      NO   NO
1207 A   192.1.1.14      255.255.255.0   HALF    10     DIX      NO   NO
1207 B   -----         -----         HALF    10     DIX      NO   NO
1303 A   192.1.1.20      255.255.255.0   HALF    10     DIX      NO   NO
1303 B   -----         -----         HALF    10     DIX      NO   NO
1305 A   192.1.1.22      255.255.255.0   HALF    10     DIX      NO   NO
1305 B   -----         -----         HALF    10     DIX      NO   NO
1308 A   192.1.1.24      255.255.255.0   HALF    10     DIX      NO   NO
1308 B   -----         -----         HALF    10     DIX      NO   NO
1315 A   192.1.1.50      255.255.255.0   HALF    10     DIX      NO   NO
1315 B   -----         -----         HALF    10     DIX      NO   NO
1317 A   192.1.1.52      255.255.255.0   HALF    10     DIX      NO   NO
1317 B   -----         -----         HALF    10     DIX      NO   NO

IP-LNK  table is (16 of 2048) 1% full.

```


6. Display the current **IP** host information in the database by entering the `rtrv-ip-host:display=all` command. The following is an example of the possible output.

```
rlghncxa03w 08-12-28 21:17:37 GMT EAGLE5 40.0.0
LOCAL IPADDR    LOCAL HOST
192.1.1.10     IPNODE1-1201
192.1.1.12     IPNODE1-1203
192.1.1.14     IPNODE1-1205
192.1.1.20     IPNODE2-1201
192.1.1.22     IPNODE2-1203
192.1.1.24     IPNODE2-1205
192.1.1.32     KC-HLR2
192.1.1.50     DN-MS1
192.1.1.52     DN-MS2
REMOTE IPADDR   REMOTE HOST
150.1.1.5      NCDEPTECONOMIC_DEVELOPMENT.
SOUTHEASTERN_COORIDOR_ASHVL. GOV
```

IP Host table is (10 of 4096) .24% full

7. Display the associations assigned to the **IP** card specified in 4, using the `rtrv-assoc` command with the local host name of the associations assigned to the **IP** card. To find the local host name of the association, the card location of the **IP** card is assigned to an **IP** address in the **IP** link table (`rtrv-ip-lnk` output). The **IP** address is assigned to a hostname in the **IP** host table (`rtrv-ip-host` output).

For this example, the local host name of associations assigned to the **IP** card 1315 (the card specified in 4) is **DN-MS1**. Enter this command.

```
rtrv-assoc:lhost=dn-ms1
```

The following is an example of the possible output.

```
rlghncxa03w 06-10-28 21:17:37 GMT EAGLE5 36.0.0
CARD IPLNK
ANAME      LOC  PORT  LINK ADAPTER  LPORT  RPORT  OPEN  ALW
assoc3     1315 A    A    SUA      2345  1025  YES  YES
assoc6     1315 A    A    SUA      4156  1025  YES  YES
```

IP Appl Sock/Assoc table is (9 of 4000) 1% full

Assoc Buffer Space Used (32 KB of 3200 KB) on LOC = 1315

8. At the **EAGLE**, enter the `msucount -a` pass command with the card location specified in 4 and the association names shown in 7. For this example, enter this command.

```
pass:loc=1315:cmd="msucount -a assoc3"
```

The following is an example of the possible output.

```
rlghncxa03w 06-10-28 21:17:37 GMT EAGLE5 36.0.0
PASS: Command sent to card
```

```
rlghncxa03w 06-10-28 21:17:37 GMT EAGLE5 36.0.0
MSUCOUNT: Command In Progress
```

```
rlghncxa03w 06-10-28 21:17:37 GMT EAGLE5 36.0.0
MSUCOUNT: MSU Count Report
```

```
-----
IP Connection Measurements
-----
Receive Counts                               Transmit Counts
-----
msus          bytes                          msus          bytes
-----
4294967295    4294967295                                4294967295    4294967295
Receive Discard Counts                      Transmit Discard Counts
-----
reason          count                                reason          count
-----
link state      4294967295                            sccp msg type   4294967295
sccp msg type   4294967295                            sccp class      4294967295
sccp class      4294967295                            normalization error 4294967295
sccp called party 4294967295                            invalid traffic type 4294967295
sccp calling party 4294967295                            M3UA conversion error 4294967295
isup sio        4294967295                            SUA conversion error 4294967295
normalization error 4294967295
error in XSRV packet 4294967295
M3UA PDU error  4294967295
SUA PDU error   4294967295
invalid rcontext 4294967295
Stored Transmit Discard Data
-----
no stored transmit discard data
Stored Receive Discard Data
-----
53 41 53 49 69 73 6f 74 11 00 87 0a 01 03 01 05
05 00 01 02 03 04 05 06 07 08 09 00 00 00 00 00

END of Report
```

```
pass:loc=1315:cmd="msucount -a assoc6"
```

The following is an example of the possible output.

```
rlghncxa03w 06-10-28 21:17:37 GMT EAGLE5 36.0.0
PASS: Command sent to card
```

```
rlghncxa03w 06-10-28 21:17:37 GMT EAGLE5 36.0.0
MSUCOUNT: Command In Progress
```

```
rlghncxa03w 06-10-28 21:17:37 GMT EAGLE5 36.0.0
MSUCOUNT: MSU Count Report
```

```
-----
IP Connection Measurements
```

```

-----
Receive Counts                               Transmit Counts
-----
msus          bytes                          msus          bytes
-----
4294967295    4294967295                                4294967295    4294967295
Receive Discard Counts                      Transmit Discard Counts
-----
reason        count                                reason        count
-----
link state    4294967295                                sccp msg type 4294967295
sccp msg type 4294967295                                sccp class    4294967295
sccp class    4294967295                                normalization error 4294967295
sccp called party 4294967295                            invalid traffic type 4294967295
sccp calling party 4294967295                    M3UA conversion error 4294967295
isup sio      4294967295                                SUA conversion error 4294967295
normalization error 4294967295
error in XSRV packet 4294967295
M3UA PDU error 4294967295
SUA PDU error 4294967295
invalid rcontext 4294967295
Stored Transmit Discard Data
-----
no stored transmit discard data
Stored Receive Discard Data
-----
53 41 53 49 69 73 6f 74 11 00 87 0a 01 03 01 05
05 00 01 02 03 04 05 06 07 08 09 00 00 00 00 00

END of Report

```

9. At the **IP** near end node, disconnect all the associations attached to the **IP** card specified in 8.
10. At the **EAGLE**, place the signaling link on this **IP** card out of service using the `dact-slk` command. For this example, enter this command.

```
dact-slk:loc=1315:link=a
```

When this command has successfully completed, this message appears.

```
rlghncxa03w 06-10-12 09:12:36 GMT EAGLE5 36.0.0
Deactivate Link message sent to card
```

11. Change the **SCTP** checksum option in the database using the `chg-sg-opts` command. For this example, enter this command.

```
chg-sg-opts:sctpcsum=crc32c
```

When this command has successfully completed, the following message should appear.

```
rlghncxa03w 06-10-28 21:19:37 GMT EAGLE5 36.0.0
CHG-SG-OPTS: MASP A - COMPLTD
```

Continue the procedure by performing one of these actions.

- If the `sctpchecksum` parameter value was changed to either `adler32` or `crc32c`, continue the procedure with [12](#).
 - If the `sctpchecksum` parameter value was changed to `percard`, perform the [Configuring an IP Card](#) procedure to assign an `sctpchecksum` parameter value to all the cards running the IPLIM or IPLIMI applications. After the [Configuring an IP Card](#) procedure has been performed, continue the procedure with [13](#).
- 12.** Verify that the **SCTP** checksum algorithm was changed using the `rtrv-sg-opts` command. The **SCTP** checksum algorithm option value is shown in the `SCTPCSUM` parameter. The following is an example of the possible output.

```
rlghncxa03w 06-10-28 21:16:37 GMT EAGLE5 36.0.0
SCTPCSUM:          crc32c
```

The `rtrv-sg-opts` command output contains other fields that are not used by this procedure. If you wish to see all the fields displayed by the `rtrv-sg-opts` command, see the `rtrv-sg-opts` command description in *Commands User's Guide*.

- 13.** Change the value of the `open` parameter of the associations shown in [7](#) to `no` by specifying the `chg-assoc` command with the `open=no` parameter. For this example, enter this command.

```
chg-assoc:aname=assoc3:open=no
chg-assoc:aname=assoc6:open=no
```

When this command has successfully completed, this message should appear.

```
rlghncxa03w 06-10-28 09:12:36 GMT EAGLE5 36.0.0
CHG-ASSOC: MASP A - COMPLTD;
```

- 14.** Change the value of the `open` parameter of the associations changed in [13](#) to `yes` by specifying the `chg-assoc` command with the `open=yes` parameter. For this example, enter this command.

```
chg-assoc:aname=assoc3:open=yes
chg-assoc:aname=assoc6:open=yes
```

When this command has successfully completed, this message should appear.

```
rlghncxa03w 06-10-28 09:12:36 GMT EAGLE5 36.0.0
CHG-ASSOC: MASP A - COMPLTD;
```

- 15.** Verify the checksum algorithm that is assigned to the associations shown in [14](#) by entering the `sctp -a pass` command with the card location of the **IP** card specified in [10](#) and the name of the associations specified in [14](#). For this example, enter this command.

```
pass:loc=1315:cmd="sctp -a assoc3 "
```

The following is an example of the possible output.

```
rlghncxa03w 10-12-28 21:16:37 GMT EAGLE5 43.0.0
Aname          Local          Local   Primary      Remote
                IP Address      Port    Address      Port
```

```

assoc3          192.1.1.50          2345  192.168.112.4  1025
                192.1.1.50

```

```

Configuration                               State
Retransmission Mode = LIN                   State = OPEN
Min. Retransmission Timeout = 10000        ULP association id = 18
Max. Retransmission Timeout = 800000      Number of nets = 2
Max. Number of Retries = 10                Inbound Streams = 1
Min. Congestion Window = 3000             Outbound Streams = 2
Inbound Streams = 2
Outbound Streams = 2
Checksum Algorithm = crc32c
Send/Rcv Buffer Size = 204800

```

Nets Data

```

IP Address  192.168.112.4  State  Reachable
Port        1025           Primary YES
MTU         1500           cwnd  16384
ssthresh    16384         RTO   120

IP Address  192.168.112.5  State  Reachable
Port        7777           Primary NO
MTU         1500           cwnd  16384
ssthresh    16384         RTO   120

```

```

Last Net Sent To = 192.168.112.4
Last Net Rcvd From = 192.168.112.4
Over All Error Count = 0
Peers Rwnd = 13880
My Rwnd = 16384
Max Window = 16384
Initial Seq Number = 24130
Next Sending Seq Number = 124686
Last Acked Seq Number = 124669
Maximum Outbound Char Count = 16384
Current Outbound Char Count = 2112
Number Unsent Char Count = 0
Outbound Data Chunk Count = 16
Number Unsent = 0
Number To Retransmit = 0

```

```

ip datagrams rcvd = 155402
ip datagrams with data chunks rcvd = 120844
data chunks rcvd = 367908
data chunks read = 367900
dup tsns rcvd = 8
sacks rcvd = 38734
gap ack blocks rcvd = 3
heartbeat requests rcvd = 135
heartbeat acks rcvd = 52
heartbeat requests sent = 52
ip datagrams sent = 129254

```

```

ip datagrams with data chunks sent = 73084
    data chunks sent = 396330
    retransmit data chunks sent = 135
        sacks sent = 64872
        send failed = 0
    retransmit timer count = 0
    consecutive retransmit timeouts = 0
RTT between RMIN and RMAX inclusive = 6
    RTT greater than RMAX = 0
    fast retransmit count = 135
        recv timer count = 0
    heartbeat timer count = 244
        none left tosend = 0
        none left rwnd gate = 5
        none left cwnd gate = 8

```

;

```
rlghncxa03w 10-12-28 21:16:37 GMT EAGLE5 43.0.0
```

```
SCTP command complete
```

```
rlghncxa03w 08-04-28 21:16:37 GMT EAGLE5 38.0.0
```

Aname	Local	Local	Primary	Remote
	IP Address	Port	Address	Port
assoc3	192.1.1.50	2345	192.168.112.4	1025
	192.1.1.50			

Configuration	State
Retransmission Mode = LIN	State = OPEN
Min. Retransmission Timeout = 10	ULP association id = 18
Max. Retransmission Timeout = 800	Number of nets = 2
Max. Number of Retries = 10	Inbound Streams = 1
Min. Congestion Window = 3000	Outbound Streams = 2
Inbound Streams = 2	
Outbound Streams = 2	
Checksum Algorithm = crc32c	

Nets Data

IP Address	192.168.112.4	State	Reachable
Port	1025	Primary	YES
MTU	1500	cwnd	16384
ssthresh	16384	RTO	120
IP Address	192.168.112.5	State	Reachable
Port	7777	Primary	NO
MTU	1500	cwnd	16384
ssthresh	16384	RTO	120

```

Last Net Sent To = 192.168.112.4
Last Net Rcvd From = 192.168.112.4

```

```

Over All Eror Count = 0
    Peers Rwnd = 13880
        My Rwnd = 16384
            Max Window = 16384
                Initial Seq Number = 24130
                    Next Sending Seq Number = 124686
                        Last Acked Seq Number = 124669
                            Maximum Outbound Char Count = 16384
                                Current Outbound Char Count = 2112
                                    Number Unsent Char Count = 0
                                        Outbound Data Chunk Count = 16
                                            Number Unsent = 0
                                                Number To Retransmit = 0

ip datagrams rcvd = 155402
ip datagrams with data chunks rcvd = 120844
    data chunks rcvd = 367908
    data chunks read = 367900
        dup tsns rcvd = 8
            sacks rcvd = 38734
                gap ack blocks rcvd = 3
                    heartbeat requests rcvd = 135
                        heartbeat acks rcvd = 52
                            heartbeat requests sent = 52
                                ip datagrams sent = 129254
                                    ip datagrams with data chunks sent = 73084
                                        data chunks sent = 396330
                                            retransmit data chunks sent = 135
                                                sacks sent = 64872
                                                    send failed = 0
                                                        retransmit timer count = 0
                                                            consecutive retransmit timeouts = 0
                                                                RTT between RMIN and RMAX inclusive = 6
                                                                    RTT greater than RMAX = 0
                                                                        fast retransmit count = 135
                                                                            rcv timer count = 0
                                                                                heartbeat timer count = 244
                                                                                    none left tosend = 0
                                                                                        none left rwnd gate = 5
                                                                                            none left cwnd gate = 8

;

rlghncxa03w 08-04-28 21:16:37 GMT EAGLE5 38.0.0

SCTP command complete

```

```
pass:loc=1315:cmd="sctp -a assoc6 "
```

The following is an example of the possible output.

```

rlghncxa03w 10-12-28 21:16:37 GMT EAGLE5 43.0.0
Aname          Local          Local  Primary

```

```

Remote
      IP Address      Port      Address      Port
  assoc6      192.1.1.50      4156      192.168.112.4      1025
              192.1.1.50

```

```

Configuration                               State
Retransmission Mode = LIN                   State = OPEN
Min. Retransmission Timeout = 10000         ULP association id = 18
Max. Retransmission Timeout = 800000       Number of nets = 2
Max. Number of Retries = 10                Inbound Streams = 1
Min. Congestion Window = 3000              Outbound Streams = 2
      Inbound Streams = 2
      Outbound Streams = 2
Checksum Algorithm = crc32c
Send/Rcv Buffer Size = 204800

```

Nets Data

```

IP Address      192.168.112.4      State      Reachable
  Port          1025                Primary    YES
  MTU           1500                cwnd      16384
  ssthresh      16384                RTO       120

IP Address      192.168.112.5      State      Reachable
  Port          7777                Primary    NO
  MTU           1500                cwnd      16384
  ssthresh      16384                RTO       120

```

```

      Last Net Sent To = 192.168.112.4
      Last Net Rcvd From = 192.168.112.4
      Over All Error Count = 0
      Peers Rwnd = 13880
      My Rwnd = 16384
      Max Window = 16384
      Initial Seq Number = 24130
      Next Sending Seq Number = 124686
      Last Acked Seq Number = 124669
      Maximum Outbound Char Count = 16384
      Current Outbound Char Count = 2112
      Number Unsent Char Count = 0
      Outbound Data Chunk Count = 16
      Number Unsent = 0
      Number To Retransmit = 0

```

```

      ip datagrams rcvd = 155402
ip datagrams with data chunks rcvd = 120844
      data chunks rcvd = 367908
      data chunks read = 367900
      dup tsns rcvd = 8
      sacks rcvd = 38734
      gap ack blocks rcvd = 3
      heartbeat requests rcvd = 135
      heartbeat acks rcvd = 52

```



```

        heartbeat requests sent = 52
          ip datagrams sent = 129254
    ip datagrams with data chunks sent = 73084
      data chunks sent = 396330
    retransmit data chunks sent = 135
      sacks sent = 64872
      send failed = 0
    retransmit timer count = 0
    consecutive retransmit timeouts = 0
    RTT between RMIN and RMAX inclusive = 6
      RTT greater than RMAX = 0
    fast retransmit count = 135
      rcv timer count = 0
    heartbeat timer count = 244
      none left tosend = 0
      none left rwnd gate = 5
      none left cwnd gate = 8

```

;

```
rlghncxa03w 10-12-28 21:16:37 GMT EAGLE5 43.0.0
```

```
SCTP command complete
```

```
rlghncxa03w 08-04-28 21:16:37 GMT EAGLE5 38.0.0
```

Aname	Local	Local	Primary	Remote
	IP Address	Port	Address	Port
assoc6	192.1.1.50	4156	192.168.112.4	1025
	192.1.1.50			

Configuration	State
Retransmission Mode = LIN	State = OPEN
Min. Retransmission Timeout = 10	ULP association id = 18
Max. Retransmission Timeout = 800	Number of nets = 2
Max. Number of Retries = 10	Inbound Streams = 1
Min. Congestion Window = 3000	Outbound Streams = 2
Inbound Streams = 2	
Outbound Streams = 2	
Checksum Algorithm = crc32c	

Nets Data

IP Address	Port	State	Reachable
192.168.112.4	1025	Primary	YES
	MTU	cwnd	16384
	ssthresh	RTO	120
192.168.112.5	7777	Primary	NO
	MTU	cwnd	16384
	ssthresh	RTO	120

```

        Last Net Sent To = 192.168.112.4
        Last Net Rcvd From = 192.168.112.4
    Over All Eror Count = 0
        Peers Rwnd = 13880
        My Rwnd = 16384
        Max Window = 16384
        Initial Seq Number = 24130
    Next Sending Seq Number = 124686
    Last Acked Seq Number = 124669
    Maximum Outbound Char Count = 16384
    Current Outbound Char Count = 2112
    Number Unsent Char Count = 0
    Outbound Data Chunk Count = 16
        Number Unsent = 0
        Number To Retransmit = 0

        ip datagrams rcvd = 155402
    ip datagrams with data chunks rcvd = 120844
        data chunks rcvd = 367908
        data chunks read = 367900
        dup tsns rcvd = 8
        sacks rcvd = 38734
        gap ack blocks rcvd = 3
    heartbeat requests rcvd = 135
        heartbeat acks rcvd = 52
    heartbeat requests sent = 52
        ip datagrams sent = 129254
    ip datagrams with data chunks sent = 73084
        data chunks sent = 396330
    retransmit data chunks sent = 135
        sacks sent = 64872
        send failed = 0
        retransmit timer count = 0
    consecutive retransmit timeouts = 0
    RTT between RMIN and RMAX inclusive = 6
    RTT greater than RMAX = 0
    fast retransmit count = 135
        rcv timer count = 0
    heartbeat timer count = 244
        none left tosend = 0
        none left rwnd gate = 5
        none left cwnd gate = 8

;

    rlghncxa03w 08-04-28 21:16:37 GMT EAGLE5 38.0.0

    SCTP command complete

```

If the checksum algorithm shown in any of the associations displayed in this step do not match the checksum algorithm specified in [11](#), contact the Customer Care Center. Refer to [My Oracle Support \(MOS\)](#) for the contact information.

If the checksum algorithm shown in all of the associations displayed in this step match the checksum algorithm specified in step 11, continue the procedure with step 16.

16. At the **IP** near end node, configure all the associations attached to the **IP** card specified in 14 to use the **SCTP** checksum algorithm.
17. Put the signaling link that was placed out of service in step 9 back into service using the `act-slk` command. For example, enter this command.

```
act-slk:loc=1315:link=a
```

When this command has successfully completed, this message appears.

```
rlghncxa03w 06-10-07 11:11:28 GMT EAGLE5 36.0.0
Activate Link message sent to card
```

18. Verify the in-service normal (**IS-NR**) status of the signaling link by using the `rept-stat-slk` command and specifying the card location and link value specified in 17. For example, enter this command.

```
rept-stat-slk:loc=1315:link=a
```

The following is an example of the possible output.

```
rlghncxa03w 06-10-28 21:16:37 GMT EAGLE5 36.0.0
SLK      LSN      CLLI      PST      SST      AST
1315,A  ipgtwy1  -----  IS-NR    Avail    ----
Command Completed.
```

19. At the **IP** near end node, connect one of the associations attached to the **IP** card specified in step 13.
20. At the **EAGLE**, enter the `rept-stat-assoc` command specifying the association names specified with the `chg-assoc` command in step 13 and step 14 to verify that the association is established with the **IP** near end node. For this example, enter this command.

```
rept-stat-assoc:aname=assoc3
```

The following is an example of the possible output.

```
rlghncxa03w 06-10-28 21:16:37 GMT EAGLE5 36.0.0

          CARD  IPLNK
ANAME      LOC  PORT  LINK  PST      SST      ASPID
as1        1315 A    A    IS-NR    ESTABLISHED 4294967295

ASNAME      ANAME      ASP-STATE
assoc3      as1        ASP-ACTIVE
```

Command Completed.

```
rept-stat-assoc:aname=assoc6
```

The following is an example of the possible output.

```
rlghncxa03w 06-10-28 21:16:37 GMT EAGLE5 36.0.0

                CARD IPLNK
ANAME           LOC  PORT  LINK  PST           SST           ASPID
as6             1315 A    A    IS-NR        ESTABLISHED  4294967295

ASNAME          ANAME          ASP-STATE
assoc6         as6             ASP-ACTIVE
```

Command Completed.

21. Enter the `netstat -p sctp pass` command with the card location of the IP card to determine if any errors have occurred. For this example, enter this command. For this example, enter this command.

```
pass:loc=1315:cmd="netstat -p sctp"
```

The following is an example of the possible output.

```
rlghncxa03w 08-04-28 21:16:37 GMT EAGLE5 38.0.0
ip packets sent..... 1474882
  ip packets sent with data chunk..... 306354
  control chunks (excluding retransmissions)..... 1172759
  ordered data chunks (excluding retransmissions).. 1534350
  unordered data chunks (excluding retransmissions) 0
  user messages fragmented due to MTU..... 0
  retransmit data chunks sent..... 4
  sacks sent..... 496302
  send failed..... 0
ip packets received..... 1816035
  ip packets received with data chunk..... 989957
  control chunks (excluding duplicates)..... 833141
  ordered data chunks (excluding duplicates)..... 989968
  unordered data chunks (excluding duplicates).... 0
  user messages reassembled..... 0
  data chunks read..... 988601
  duplicate tsns received..... 0
  sacks received..... 153763
  gap ack blocks received..... 0
  out of the blue..... 4
  with invalid checksum..... 0
connections established..... 2954
  by upper layer..... 0
  by remote endpoint..... 2958
connections terminated..... 4
  ungracefully..... 2952
  gracefully..... 0
associations dropped due to retransmits..... 0
consecutive retransmit timeouts..... 4
retransmit timer count..... 6
fast retransmit count..... 0
heartbeat requests received..... 330275
heartbeat acks received..... 340239
```

```

heartbeat requests sent..... 340258
associations supported..... 50
milliseconds cookie life at 4-way start-up handshake. 5000
retransmission attempts allowed at start-up phase.... 8

;

rlghncxa03w 08-04-28 21:16:37 GMT EAGLE5 38.0.0

NETSTAT command complete

```

If errors are shown in the pass command output, contact the Customer Care Center. Refer to [My Oracle Support \(MOS\)](#) for the contact information.

22. At the **IP** near end node, connect all the other associations attached to the **IP** card specified in 21.
23. At the **IP** near end node, activate one of the associations attached to the **IP** card specified in 21.
24. At the **EAGLE**, enter the `msucount -l` pass command with the card location of the **IP** card specified in 21. For this example, enter this command.

```
pass:loc=1315:cmd="msucount -l"
```

The following is an example of the possible output.

```

rlghncxa03w 06-10-28 21:16:37 GMT EAGLE5 36.0.0
PASS: Command sent to card

rlghncxa03w 06-10-28 21:16:37 GMT EAGLE5 36.0.0
MSUCOUNT: Command In Progress

rlghncxa03w 06-10-28 21:16:37 GMT EAGLE5 36.0.0
MSUCOUNT: MSU Count Report

-----
Link Measurements (Link A)
-----

Transmit Counts                                Receive Counts
-----
rate  msus      bytes          rate  msus      bytes
-----
2000  4294967295  4294967295    2000  4294967295  4294967295

MTP Primitive (MTPP) counts                    Reroute Counts
-----
sent pdu   rcvd pdu   dscrd pdu   sent msus  rcvd msus
-----
4294967295 4294967295 4294967295 4294967295 4294967295

END of Report

```

25. At the **EAGLE**, enter the `msucount -a` pass command with the card location specified in 24 and the association names specified in 20. For this example, enter this command.

```
pass:loc=1315:cmd="msucount -a assoc3"
```

The following is an example of the possible output.

```
rlghncxa03w 06-10-28 21:17:37 GMT EAGLE5 36.0.0
PASS: Command sent to card

rlghncxa03w 06-10-28 21:17:37 GMT EAGLE5 36.0.0
MSUCOUNT: Command In Progress

rlghncxa03w 06-10-28 21:17:37 GMT EAGLE5 36.0.0
MSUCOUNT: MSU Count Report

-----
IP Connection Measurements
-----

Receive Counts                               Transmit Counts
-----
msus          bytes                          msus          bytes
-----
4294967295    4294967295                                4294967295    4294967295
Receive Discard Counts                       Transmit Discard Counts
-----
reason          count                                       reason          count
-----
link state      4294967295                                sccp msg type   4294967295
sccp msg type   4294967295                                sccp class      4294967295
sccp class      4294967295                                normalization error 4294967295
sccp called party 4294967295                                invalid traffic type 4294967295
sccp calling party 4294967295                                M3UA conversion error 4294967295
isup sio        4294967295                                SUA conversion error 4294967295
normalization error 4294967295
error in XSRV packet 4294967295
M3UA PDU error  4294967295
SUA PDU error   4294967295
invalid rcontext 4294967295

Stored Transmit Discard Data
-----
no stored transmit discard data
Stored Receive Discard Data
-----
53 41 53 49 69 73 6f 74 11 00 87 0a 01 03 01 05
05 00 01 02 03 04 05 06 07 08 09 00 00 00 00 00

END of Report

pass:loc=1315:cmd="msucount -a assoc6"
```

The following is an example of the possible output.

```

rlghncxa03w 06-10-28 21:17:37 GMT EAGLE5 36.0.0
PASS: Command sent to card

rlghncxa03w 06-10-28 21:17:37 GMT EAGLE5 36.0.0
MSUCOUNT: Command In Progress

rlghncxa03w 06-10-28 21:17:37 GMT EAGLE5 36.0.0
MSUCOUNT: MSU Count Report

-----
IP Connection Measurements
-----
Receive Counts                               Transmit Counts
-----
msus             bytes                               msus             bytes
-----
4294967295      4294967295                               4294967295      4294967295
Receive Discard Counts                       Transmit Discard Counts
-----
reason             count                               reason             count
-----
link state         4294967295                          sccp msg type     4294967295
sccp msg type     4294967295                          sccp class        4294967295
sccp class        4294967295                          normalization error 4294967295
sccp called party 4294967295                          invalid traffic type 4294967295
sccp calling party 4294967295                          M3UA conversion error 4294967295
isup sio          4294967295                          SUA conversion error 4294967295
normalization error 4294967295
error in XSRV packet 4294967295
M3UA PDU error    4294967295
SUA PDU error     4294967295
invalid rcontext  4294967295
Stored Transmit Discard Data
-----
no stored transmit discard data
Stored Receive Discard Data
-----
53 41 53 49 69 73 6f 74 11 00 87 0a 01 03 01 05
05 00 01 02 03 04 05 06 07 08 09 00 00 00 00 00

END of Report

```

If the outputs of the pass commands in [24](#) and [25](#) show that traffic is not flowing over the association, contact the Customer Care Center. Refer to [My Oracle Support \(MOS\)](#) for the contact information.

26. At the **IP** near end node, activate all the other associations attached to the **IP** card specified in [25](#).
27. Repeat [3](#) through [26](#) to update the other **IP** cards in the **EAGLE** running the **SS7IPGW** and **IPGWI** applications with the new **SCTP** checksum algorithm.

28. Back up the new changes using the `chg-db:action=backup:dest=fixed` command. These messages should appear, the active **Maintenance and Administration Subsystem Processor (MASP)** appears first.

```
BACKUP (FIXED) : MASP A - Backup starts on active MASP.  
BACKUP (FIXED) : MASP A - Backup on active MASP to fixed disk complete.  
BACKUP (FIXED) : MASP A - Backup starts on standby MASP.  
BACKUP (FIXED) : MASP A - Backup on standby MASP to fixed disk complete.
```

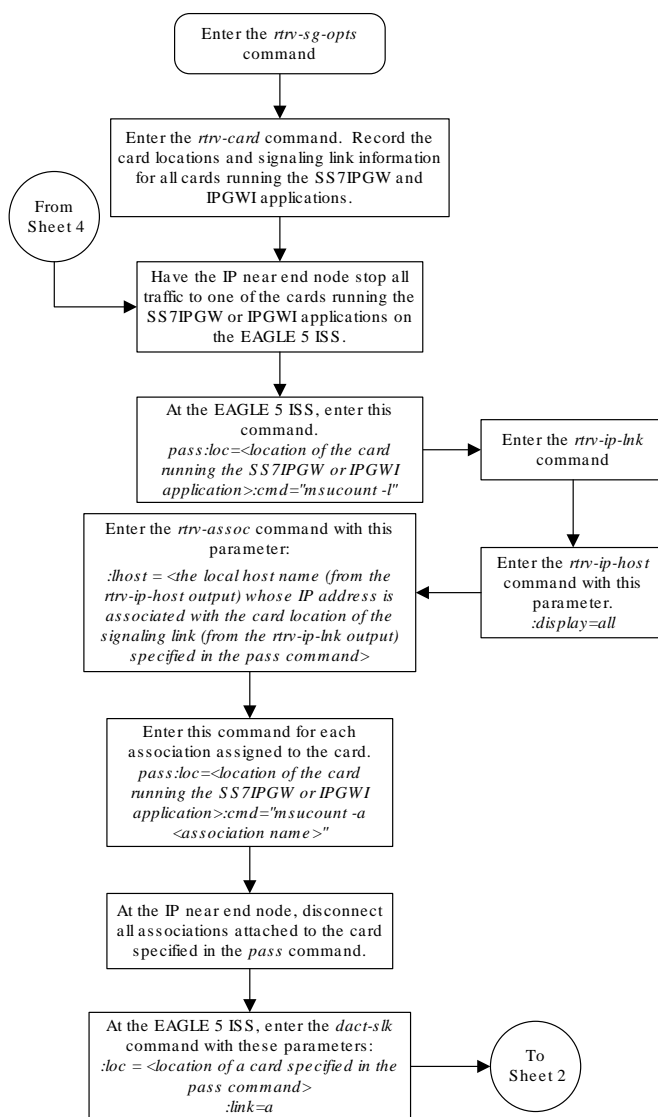
29. If the `rtrv-card` output in 2 shows cards running the **IPLIM** or **IPLIMI** applications, perform the [Changing the SCTP Checksum Algorithm Option for M2PA Associations](#) procedure.

If the `rtrv-card` output in 2 shows cards running the **IPSG** application, perform these procedures.

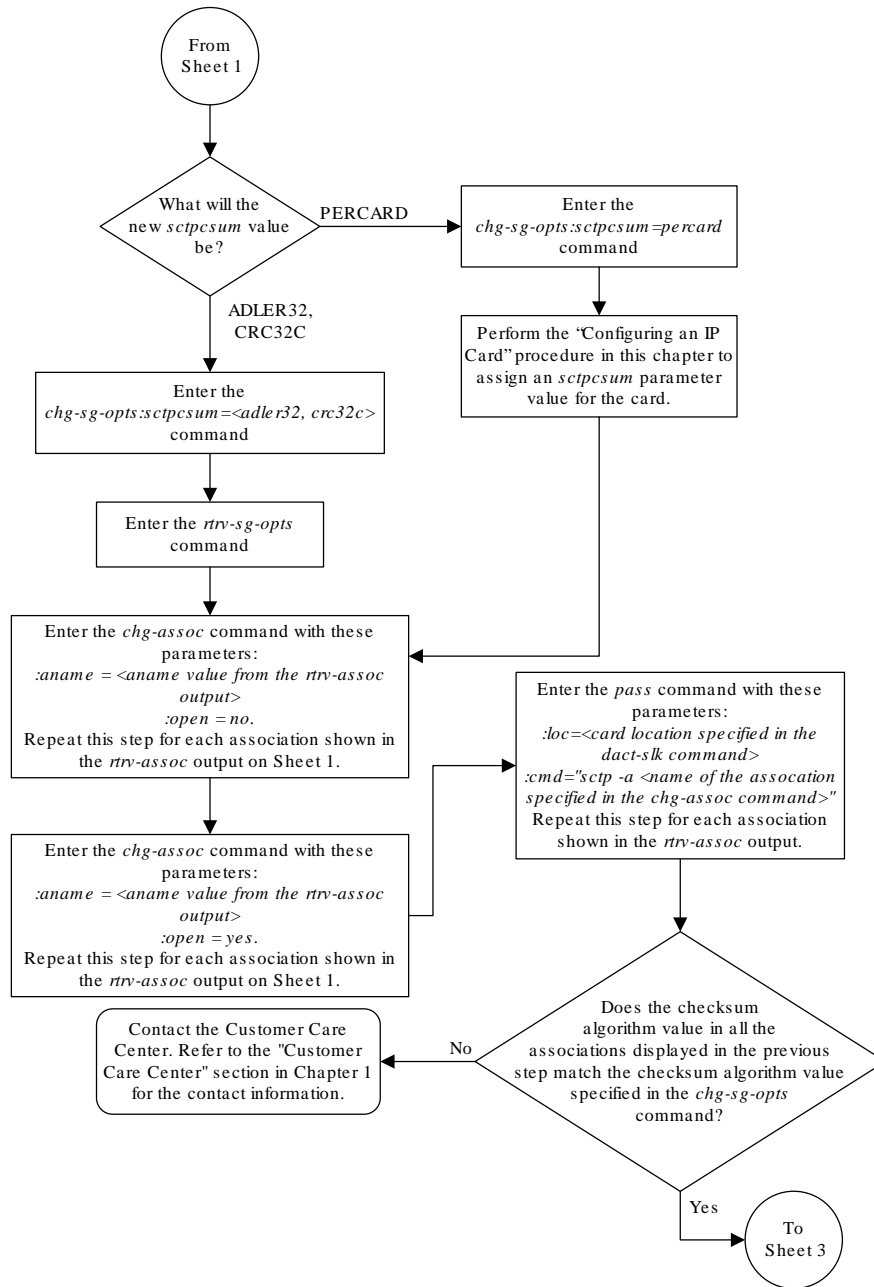
- [Changing the SCTP Checksum Algorithm Option for IPSG M3UA Associations](#)
- [Changing the SCTP Checksum Algorithm Option for IPSG M2PA Associations](#)

If the `rtrv-card` output in 2 shows that there are no cards running the **IPLIM**, **IPLIMI**, or **IPSG** applications, this procedure is finished.

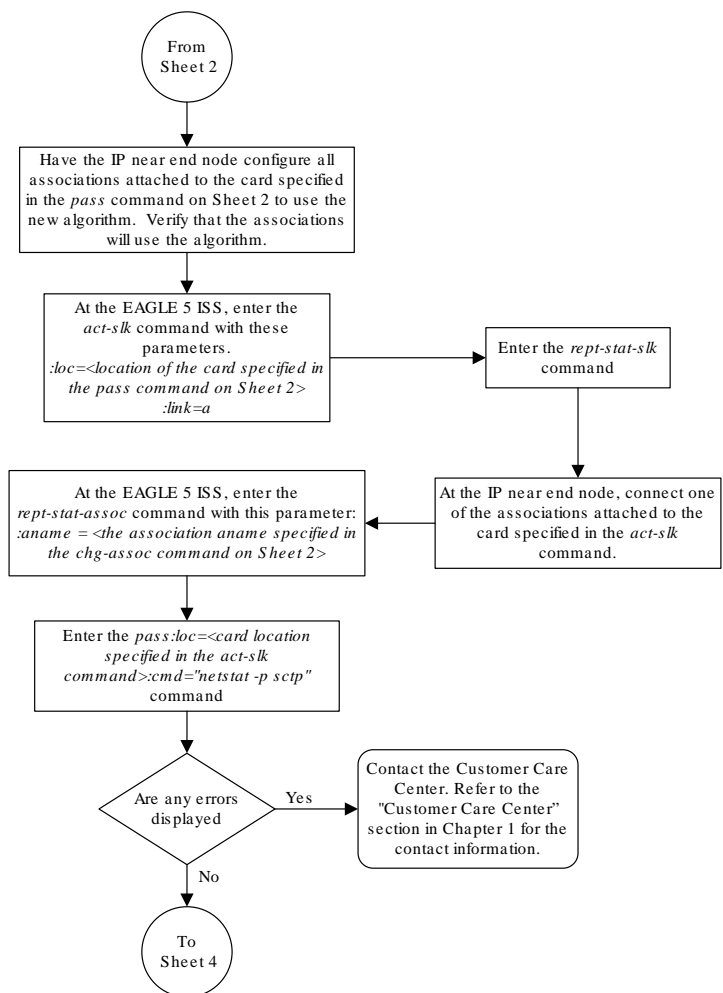
Figure 4-43 Changing the SCTP Checksum Algorithm Option for M3UA and SUA Associations

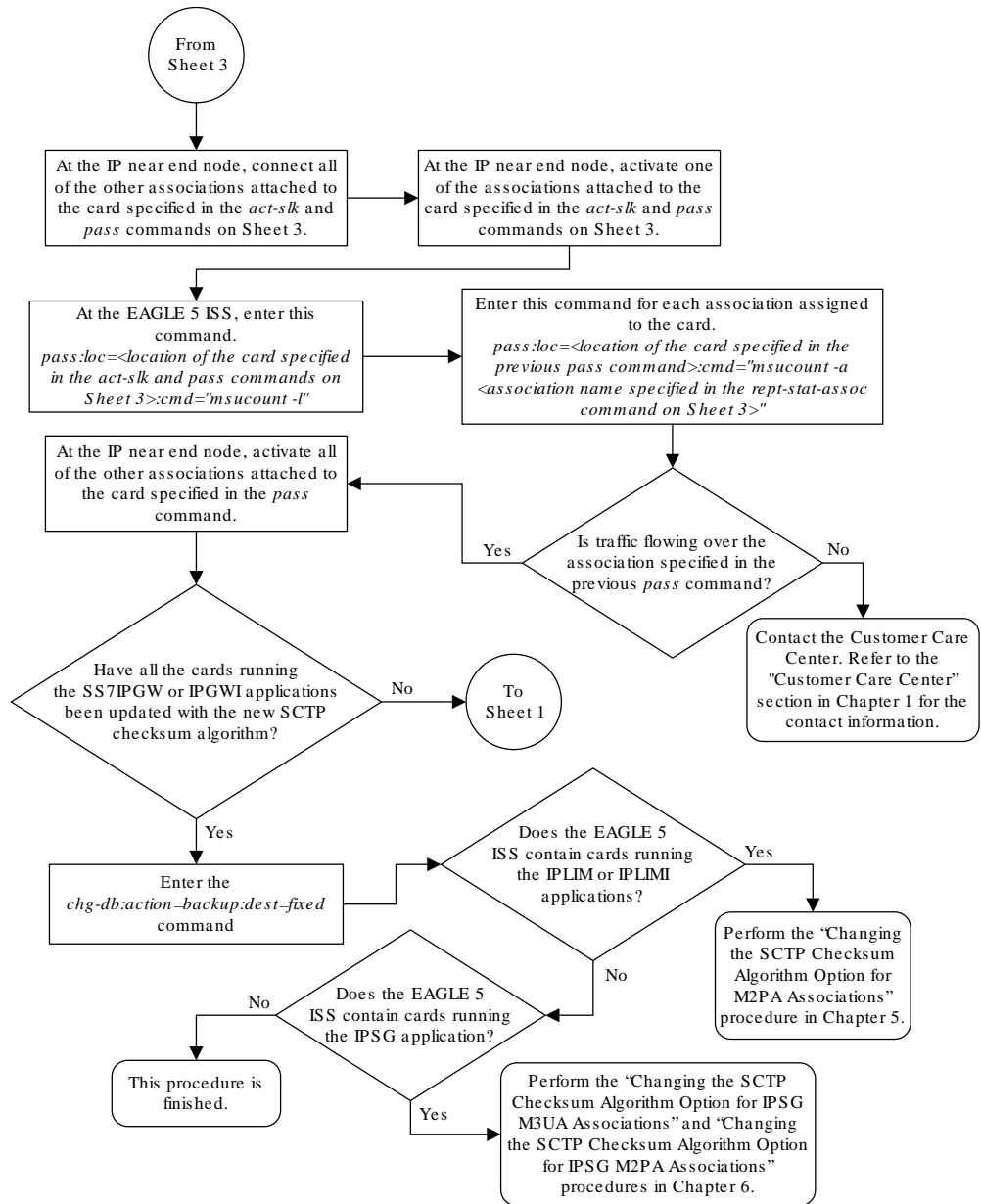


Sheet 1 of 4



Sheet 2 of 4





Sheet 4 of 4

4.38 Changing a UA Parameter Set

Use this procedure to change the values in a **UA** (user adapter) parameter set using the `chg-uaps` command. The `chg-uaps` command uses these parameters.

`:set` – the **UA** parameter set being changed, from 1 - 9

`:scrset` – the source **UA** parameter set used to copy the values from one **UA** parameter set to another, from 1 to 10.

`:timer` – the timer being changed, from 1 to 10. Currently, there are only three timers defined:

- Timer 2 – The False **IP** Connection Congestion Timer – the maximum amount of time (in milliseconds) that an association is allowed to remain congested before failing due to false connection congestion.
- Timer 3 – The **UA** Heartbeat Period Timer – The frequency, in milliseconds, that heartbeat messages are transmitted.
- Timer 4 – The **UA** Heartbeat Received Timer – The amount of time, in milliseconds, that the **EAGLE** waits for a response to the heartbeat message that was transmitted. If a response to the heartbeat message is not received in the amount of time defined by Timer 4, the association is torn down

`:tvalue` – The value of the timer specified by the `timer` parameter.

- The value of timer 2 is from 10 to 30,000 milliseconds. The system default value is 3,000 milliseconds.
- The value of timer 3 is from 100 to 60,000 milliseconds. The system default value is 10,000 milliseconds.
- The value of timer 4 is from 100 to 10,000 milliseconds. The system default value is 5,000 milliseconds.

`:parm` – the **UA** parameters, from 1 to 10. Currently, only four UA parameters are defined.

- 1 – Controlling **ASPSNM** Behavior
- 2 – Controlling **ASP/Application Server** State Notification Behavior
- 3 – **UA** Serviceability Options
- 4 – **SCTP** Payload Protocol Indicator Option

`:pvalue` – the value of the **UA** parameters, which is dependent on the `parm` parameter value. The value of the `pvalue` parameter is a bit-mapped value, requiring a 0 in the specific bit position to disable the item, or a 1 in the specific bit position to enable the item. The value of the `pvalue` parameter is a 32-bit number. Any bits not specified in the following lists are not used.

- If the `parm` value is 1, the bits used by the `pvalue` parameter are:
 - 1 – Response Method – controls the sending of an SNM **TFC/UPU** as a reply to a message received on an association for an unavailable destination. The SNM **TFC/UPU** is replicated to all associations that have this capability and meet the Response **SNM** Criteria. The default is to allow the response to be sent.
 - 1 – Response Method – controls the sending of an SNM **TFC/UPU** as a reply to a message received on an association for an unavailable destination. The SNM **TFC/UPU** is replicated to all associations that have this capability and meet the Response **SNM** Criteria. The default is to allow the response to be sent.
 - 6 – Broadcast Congestion Status Change – controls the sending of unsolicited congestion status changes by an **ASP**. Unsolicited congestion status messages (**TFCs** generated when a destination's congestion status changes)

are replicated to all **ASPs** who have this capability and meet the Multicast **SNM** Criteria. The default is to generate no unsolicited congestion status changes.

Table 4-22 shows the values can be entered for the `pvalue` parameter if the `parm` value is 1. The `pvalue` parameter value can be entered as a hexadecimal or a decimal number.

Table 4-22 Valid PVALUE Parameter Values if PARM=1

Bits Enabled	Bits Disabled	Hexadecimal Value	Decimal Value
None	Bit 0 - Broadcast Bit 1 - Response Method Bit 6 - Broadcast Congestion Status Change	h'0	0
Bit 0 - Broadcast	Bit 1 - Response Method Bit 6 - Broadcast Congestion Status Change	h'1	1
Bit 1 - Response Method	Bit 0 - Broadcast Bit 6 - Broadcast Congestion Status Change	h'2	2
Bit 0 - Broadcast Bit 1 - Response Method	Bit 6 - Broadcast Congestion Status Change	h'3*	3*
Bit 6 - Broadcast Congestion Status Change	Bit 0 - Broadcast Bit 1 - Response Method	h'40	64
Bit 6 - Broadcast Congestion Status Change Bit 0 - Broadcast	Bit 1 - Response Method	h'41	65
Bit 6 - Broadcast Congestion Status Change Bit 1 - Response Method	Bit 0 - Broadcast	h'42	66
Bit 0 - Broadcast Bit 1 - Response Method Bit 6 - Broadcast Congestion Status Change	None	h'43	67

* The system default value

- If the `parm` value is 2, the bits used by the `pvalue` parameter are:
 - 0 – **ASP Active Notifications** – controls the sending of **ASP-Active** notifications. If this value is specified, an **ASP-Default** notification is sent when an **ASP** transitions to the **ASP-ACTIVE** state. The default is not to send **ASP-Active** notifications.
 - 1 – **ASP Inactive Notifications** – controls the sending of **ASP-Inactive** notifications. If this value is specified, an **ASP-Inactive** notification is sent when an **ASP** transitions to the **ASP-INACTIVE** state. The default is not to send **ASP-Inactive** notifications.

 **Note:**

To see the **ASP** activations and inactivations, bits 0 and 1 of the `pvalue` parameter value need to be enabled. See [Table 4-23](#).

- 2 – **ASPAS** State Query – controls the sending of **ASP/AS** State notifications on request by an **ASP**. If this value is specified, the **EAGLE** responds with **ASP** and **AS** state notifications if the remote **ASP** sends **ASP-UP** or **ASP-INACTIVE**, while the local **ASP** is in the **ASP-INACTIVE** state, or the remote **ASP** sends an **ASP-ACTIVE** notification while the local **ASP** is in the **ASP-ACTIVE** state. The default is not to send **ASP/AS** state notifications.

[Table 4-23](#) shows the values can be entered for the `pvalue` parameter if the `parm` value is 2. The `pvalue` parameter value can be entered as a hexadecimal or a decimal number.

Table 4-23 Valid PVALUE Parameter Values if PARM=2

Bits Enabled	Bits Disabled	Hexadecimal Value	Decimal Value
None	Bit 0 - ASP Activate Notifications Bit 1 - ASP Inactivate Notifications Bit 2 - ASP AS State Query	h'0*	0*
Bit 0 - ASP Activate Notifications	Bit 1 - ASP Inactivate Notifications Bit 2 - ASP AS State Query	h'1	1
Bit 1 - ASP Inactivate Notifications	Bit 0 - ASP Activate Notifications Bit 2 - ASP AS State Query	h'2	2
Bit 0 - ASP Activate Notifications Bit 1 - ASP Inactivate Notifications	Bit 2 - ASP AS State Query	h'3	3
Bit 2 - ASP AS State Query	Bit 0 - ASP Activate Notifications Bit 1 - ASP Inactivate Notifications	h'4	4
Bit 0 - ASP Activate Notifications Bit 2 - ASP AS State Query	Bit 1 - ASP Inactivate Notifications	h'5	5
Bit 1 - ASP Inactivate Notifications Bit 2 - ASP AS State Query	Bit 0 - ASP Activate Notifications	h'6	6
Bit 0 - ASP Activate Notifications Bit 1 - ASP Inactivate Notifications Bit 2 - ASP AS State Query	None	h'7	7

Table 4-23 (Cont.) Valid PVALUE Parameter Values if PARM=2

Bits Enabled	Bits Disabled	Hexadecimal Value	Decimal Value
* The system default value			

- If the `parm` value is 3, the bits used by the `pvalue` parameter are:
 - 0 – UA Heartbeats – heartbeat messages are sent on connections from the EAGLE to the far-end node that are in the **ASP-Down**, **ASP-Active**, and **ASP-Inactive** states if the bit is enabled.
 - 1 – UA Graceful Shutdown – enables the graceful shutdown of IPSP M3UA connections if the bit is enabled.

Table 4-24 shows the values can be entered for the `pvalue` parameter if the `parm` value is 3. The `pvalue` parameter value can be entered as a hexadecimal or a decimal number.

Table 4-24 Valid PVALUE Parameter Values if PARM=3

Bits Enabled	Bits Disabled	Hexadecimal Value	Decimal Value
None	Bit 0 - UA Heartbeats Bit 1 - UA Graceful Shutdown	h'0*	0*
Bit 0 - UA Heartbeats	Bit 1 - UA Graceful Shutdown	h'1	1
Bit 1 - UA Graceful Shutdown	Bit 0 - UA Heartbeats	h'2	2
Bit 0 - UA Heartbeats Bit 1 - UA Graceful Shutdown	None	h'3	3
* The system default value			

- If the `parm` value is 4, the bit 0, the SCTP Payload Protocol Indicator byte order option, is used by the `pvalue` parameter. This bit indicates whether the SCTP Payload Protocol Indicator (PPI) in the received or transmitted message should be in the Big Endian and Little Endian byte format.

Table 4-25 shows the values can be entered for the `pvalue` parameter if the `parm` value is 4. The `pvalue` parameter value can be entered as a hexadecimal or a decimal number.

Table 4-25 Valid PVALUE Parameter Values if PARM=4

SCTP Payload Protocol Indicator Byte Order Option - Bit 0	Hexadecimal Value	Decimal Value
Big Endian Byte Format	h'0*	0*
Little Endian Byte Format	h'1	1
* The system default value		

UA parameter set 10 contains the default values for the UA parameter sets and cannot be changed.

The `set` and `scrset` parameter values cannot be the same.

If the `scrset` parameter is specified, no other optional parameter may be specified.

The `timer` and `tvalue` parameters must be specified together. If one is specified, the other must be specified.

The `parm` and `pvalue` parameters must be specified together. If one is specified, the other must be specified.

Canceling the `RTRV-UAPS` Command

Because the `rtrv-uaps` command used in this procedure can output information for a long period of time, the `rtrv-uaps` command can be canceled and the output to the terminal stopped. There are three ways that the `rtrv-uaps` command can be canceled.

- Press the `F9` function key on the keyboard at the terminal where the `rtrv-uaps` command was entered.
- Enter the `canc-cmd` without the `trm` parameter at the terminal where the `rtrv-uaps` command was entered.
- Enter the `canc-cmd:trm=<xx>`, where `<xx>` is the terminal where the `rtrv-uaps` command was entered, from another terminal other than the terminal where the `rtrv-uaps` command was entered. To enter the `canc-cmd:trm=<xx>` command, the terminal must allow Security Administration commands to be entered from it and the user must be allowed to enter Security Administration commands. The terminal's permissions can be verified with the `rtrv-secu-trm` command. The user's permissions can be verified with the `rtrv-user` or `rtrv-secu-user` commands.

For more information about the `canc-cmd` command, go to *Commands User's Guide*.

1. Display the values in the **UA** parameter set being changed by entering the `rtrv-uaps` command and specifying the desired **UA** parameter set number, from 1 to 9. For this example, enter this command.

```
rtrv-uaps:set=3
```

This is an example of possible output.

```
rlghncxa03w 10-07-28 09:12:36 GMT EAGLE5 42.0.0
  SET  TIMER      TVALUE  PARM      PVALUE
   3    1           0        1         3
   3    2          3000      2         0
   3    3          10000     3         0
   3    4           5000      4         0
   3    5           0         5         0
   3    6           0         6         0
   3    7           0         7         0
   3    8           0         8         0
   3    9           0         9         0
   3   10           0        10        0
```

```
TIMER 2: False IP Connection Congestion Timer, max time an
         association can be congested before failing due to
false
         congestion. SS7IPGW and IPGWI applications enforce
         0-30000(ms). Not supported on IPSPG application.
TVALUE : Valid range = 32-bits
```

TIMER 3: UA HeartBeat Period Timer T(beat), time (ms) between sending of BEAT msgs by NE. IPSP, SS7IPGW and IPGWI applications enforce 100(ms)-60000(ms).

TVALUE : Valid range = 32-bits

TIMER 4: UA HeartBeat Received Timer T(beat ack), timeout period for response BEAT ACK msgs by NE. IPSP, SS7IPGW and IPGWI applications enforce 100(ms)-10000(ms).

TVALUE : Valid range = 32-bits

PARAM 1: ASP SNM options. Each bit is used as an enabled/disabled flag for a particular ASP SNM option. Not supported on IPSP application.

PVALUE : Valid range = 32-bits

BIT	BIT VALUE
0=Broadcast	0=Disabled , 1=Enabled
1=Response Method	0=Disabled , 1=Enabled
2-5=Reserved	
6=Broadcast Congestion Status Change	0=Disabled , 1=Enabled
7-31=Reserved	

PARAM 2: ASP/AS Notification options. Each bit is used as an enabled/disabled flag for a particular ASP/AS Notification option. Not supported on IPSP application.

PVALUE : Valid range = 32-bits

BIT	BIT VALUE
0=ASP Active Notifications	0=Disabled , 1=Enabled
1=ASP Inactive Notifications	0=Disabled , 1=Enabled
2=ASP AS State Query	0=Disabled , 1=Enabled
3-31=Reserved	

PARAM 3: UA Serviceability Options. Each bit is used as an enabled/disabled flag for a particular UA Serviceability option. Supported on IPSP, SS7IPGW, and IPGWI applications. UA Graceful Shutdown supported on IPSP for M3UA only.

PVALUE : Valid range = 32-bits

BIT	BIT VALUE
0=UA Heartbeats	0=Disabled , 1=Enabled
1=UA Graceful Shutdown	0=Disabled , 1=Enabled
2-31=Reserved	

PARAM 4: SCTP Payload Protocol Indicator byte order option. Bit indicates PPI value is RCV/TX in Big Endian or Little Endian byte format.

Supported on IPSP-M2PA associations only.

PVALUE : Valid range = 32-bits

BIT	BIT VALUE
0=Payload Protocol Indicator	0=Big Endian , 1=Little Endian
1-31=Reserved	

If the new values of the UA parameter set are being copied from another UA parameter set, continue the procedure with 2.

If the new values of the UA parameter set are not being copied from another UA parameter set, continue the procedure with 3.

2. Display the values in the **UA** parameter set that will be copied to the UA parameter set displayed in 1 by entering the `rtrv-uaps` command and specifying the desired **UA** parameter set number, from 1 to 10. For this example, enter this command.

```
rtrv-uaps:set=10
```

This is an example of possible output.

```
rlghncxa03w 10-07-28 09:12:36 GMT EAGLE5 42.0.0
  SET  TIMER      TVALUE  PARM      PVALUE
  10   1           0       1         3
  10   2          3000    2         0
  10   3          10000   3         0
  10   4           5000    4         0
  10   5           0       5         0
  10   6           0       6         0
  10   7           0       7         0
  10   8           0       8         0
  10   9           0       9         0
  10  10           0      10        0
```

TIMER 2: False IP Connection Congestion Timer, max time an association can be congested before failing due to false

congestion. SS7IPGW and IPGWI applications enforce 0-30000(ms). Not supported on IPSG application.

TVALUE : Valid range = 32-bits

TIMER 3: UA HeartBeat Period Timer T(beat), time (ms) between sending

of BEAT msgs by NE. IPSG, SS7IPGW and IPGWI applications

enforce 100(ms)-60000(ms).

TVALUE : Valid range = 32-bits

TIMER 4: UA HeartBeat Received Timer T(beat ack), timeout period for

response BEAT ACK msgs by NE. IPSG, SS7IPGW and IPGWI applications enforce 100(ms)-10000(ms).

TVALUE : Valid range = 32-bits

PARM 1: ASP SNM options. Each bit is used as an enabled/disabled

flag for a particular ASP SNM option. Not supported on IPSG

application.

PVALUE : Valid range = 32-bits

BIT

0=Broadcast

BIT VALUE

0=Disabled ,

```

1=Enabled
1=Response Method                                0=Disabled , 1=Enabled
2-5=Reserved
6=Broadcast Congestion Status Change 0=Disabled , 1=Enabled
7-31=Reserved

PARM 2: ASP/AS Notification options. Each bit is used as an
enabled/disabled flag for a particular ASP/AS
Notification option. Not supported on IPSP application.
PVALUE : Valid range = 32-bits
BIT                                             BIT VALUE
0=ASP Active Notifications                    0=Disabled , 1=Enabled
1=ASP Inactive Notifications                  0=Disabled , 1=Enabled
2=ASP AS State Query                          0=Disabled , 1=Enabled
3-31=Reserved

PARM 3: UA Serviceability Options. Each bit is used as an
enabled/disabled flag for a particular UA Serviceability
option. Supported on IPSP, SS7IPGW, and IPGWI applications.
UA Graceful Shutdown supported on IPSP for M3UA only.
PVALUE : Valid range = 32-bits
BIT                                             BIT VALUE
0=UA Heartbeats                              0=Disabled , 1=Enabled
1=UA Graceful Shutdown                       0=Disabled , 1=Enabled
2-31=Reserved

PARM 4: SCTP Payload Protocol Indicator byte order option. Bit
indicates
PPI value is RCV/TX in Big Endian or Little Endian byte
format.
Supported on IPSP-M2PA associations only.
PVALUE : Valid range = 32-bits
BIT                                             BIT VALUE
0=Payload Protocol Indicator                 0=Big Endian , 1=Little
Endian
1-31=Reserved

```

3. Change the UA parameter set values using the `chg-uaps` command with the UA parameter set value used in 1. If the `parm` and `pvalue` parameters are being specified, see these tables for the valid values of the `pvalue` parameter.

- [Table 4-22](#)
- [Table 4-23](#)
- [Table 4-24](#)
- [Table 4-25](#)

For this example, enter this command.

```

chg-
uaps:set=3:timer=2:tvalue=2000:parm=2:pvalue=1:parm=3:pvalue=3

```

The value of the `pvalue` parameter can be entered as either a decimal value or a hexadecimal value. This example shows the `pvalue` parameter value of the `chg-uaps` command being entered as a decimal value. If the decimal value of the `pvalue`

parameter is 3, specify the `pvalue=h' 3` parameter to specify the hexadecimal value for the `pvalue` parameter.

```
chg-
uaps:set=3:timer=2:tvalue=2000:parm=2:pvalue=h' 1:parm=3:pvalue=h' 3
```

If the values from one **UA** parameter set are being copied to another **UA** parameter set, only the `set` and `scrset` parameters can be specified with the `chg-uaps` command. For example, to copy the values from **UA** parameter set 10 to **UA** parameter set 5, enter this command.

```
chg-uaps:set=5:scrset=10
```

When this command has successfully completed, this message should appear.

```
rlghncxa03w 06-10-28 09:12:36 GMT EAGLE5 36.0.0
CHG-UAPS: MASP A - COMPLTD
```

4. Verify the changes using the `rtrv-uaps` command with the **UA** parameter set name used in 3. For this example, enter this command.

```
rtrv-uaps:set=3
```

This is an example of possible output.

```
rlghncxa03w 10-07-28 09:12:36 GMT EAGLE5 42.0.0
      SET  TIMER      TVALUE  PARM      PVALUE
      3    1          0        1         3
      3    2         2000       2         1
      3    3        10000       3         3
      3    4         5000       4         0
      3    5          0         5         0
      3    6          0         6         0
      3    7          0         7         0
      3    8          0         8         0
      3    9          0         9         0
      3   10          0        10         0
```

TIMER 2: False IP Connection Congestion Timer, max time an association can be congested before failing due to false

congestion. SS7IPGW and IPGWI applications enforce 0-30000(ms). Not supported on IPSP application.

TVALUE : Valid range = 32-bits

TIMER 3: UA HeartBeat Period Timer T(beat), time (ms) between sending

of BEAT msgs by NE. IPSP, SS7IPGW and IPGWI applications

enforce 100(ms)-60000(ms).

TVALUE : Valid range = 32-bits

TIMER 4: UA HeartBeat Received Timer T(beat ack), timeout period for

```

        response BEAT ACK msgs by NE. IPSP, SS7IPGW and IPGWI
        applications enforce 100(ms)-10000(ms).
TVALUE : Valid range = 32-bits

PARM 1: ASP SNM options. Each bit is used as an enabled/disabled
        flag for a particular ASP SNM option. Not supported on IPSP
        application.
PVALUE : Valid range = 32-bits
        BIT                                     BIT VALUE
        0=Broadcast                             0=Disabled , 1=Enabled
        1=Response Method                       0=Disabled , 1=Enabled
        2-5=Reserved
        6=Broadcast Congestion Status Change 0=Disabled , 1=Enabled
        7-31=Reserved

PARM 2: ASP/AS Notification options. Each bit is used as an
        enabled/disabled flag for a particular ASP/AS
        Notification option. Not supported on IPSP application.
PVALUE : Valid range = 32-bits
        BIT                                     BIT VALUE
        0=ASP Active Notifications              0=Disabled , 1=Enabled
        1=ASP Inactive Notifications            0=Disabled , 1=Enabled
        2=ASP AS State Query                    0=Disabled , 1=Enabled
        3-31=Reserved

PARM 3: UA Serviceability Options. Each bit is used as an
        enabled/disabled flag for a particular UA Serviceability
        option. Supported on IPSP, SS7IPGW, and IPGWI applications.
        UA Graceful Shutdown supported on IPSP for M3UA only.
PVALUE : Valid range = 32-bits
        BIT                                     BIT VALUE
        0=UA Heartbeats                         0=Disabled , 1=Enabled
        1=UA Graceful Shutdown                  0=Disabled , 1=Enabled
        2-31=Reserved

        PARM 4: SCTP Payload Protocol Indicator byte order option. Bit
        indicates
        PPI value is RCV/TX in Big Endian or Little Endian byte
        format.
        Supported on IPSP-M2PA associations only.
PVALUE : Valid range = 32-bits
        BIT                                     BIT VALUE
        0=Payload Protocol Indicator            0=Big Endian , 1=Little
        Endian
        1-31=Reserved

```

If 2 was performed, for this example, enter this command.

```
rtrv-uaps:set=5
```

This is an example of possible output.

```
rlghncxa03w 10-07-28 09:12:36 GMT EAGLE5 42.0.0
```

SET	TIMER	TVALUE	PARM	PVALUE
5	1	0	1	3
5	2	3000	2	0
5	3	10000	3	0
5	4	5000	4	0
5	5	0	5	0
5	6	0	6	0
5	7	0	7	0
5	8	0	8	0
5	9	0	9	0
5	10	0	10	0

TIMER 2: False IP Connection Congestion Timer, max time an association can be congested before failing due to false

congestion. SS7IPGW and IPGWI applications enforce 0-30000(ms). Not supported on IPSPG application.

TVALUE : Valid range = 32-bits

TIMER 3: UA HeartBeat Period Timer T(beat), time (ms) between sending

of BEAT msgs by NE. IPSPG, SS7IPGW and IPGWI

applications

enforce 100(ms)-60000(ms).

TVALUE : Valid range = 32-bits

TIMER 4: UA HeartBeat Received Timer T(beat ack), timeout period for

response BEAT ACK msgs by NE. IPSPG, SS7IPGW and IPGWI applications enforce 100(ms)-10000(ms).

TVALUE : Valid range = 32-bits

PARM 1: ASP SNM options. Each bit is used as an enabled/disabled

flag for a particular ASP SNM option. Not supported on IPSPG application.

PVALUE : Valid range = 32-bits

BIT	BIT VALUE
0=Broadcast	0=Disabled ,
1=Enabled	
1=Enabled	1=Response Method
	0=Disabled ,
	2-5=Reserved
1=Enabled	6=Broadcast Congestion Status Change 0=Disabled ,
	7-31=Reserved

PARM 2: ASP/AS Notification options. Each bit is used as an enabled/disabled flag for a particular ASP/AS Notification option. Not supported on IPSPG application.

PVALUE : Valid range = 32-bits

BIT	BIT VALUE
0=ASP Active Notifications	0=Disabled ,

```

1=Enabled
1=ASP Inactive Notifications          0=Disabled , 1=Enabled
2=ASP AS State Query                  0=Disabled , 1=Enabled
3-31=Reserved

PARM 3: UA Serviceability Options. Each bit is used as an
enabled/disabled flag for a particular UA Serviceability
option. Supported on IPSP, SS7IPGW, and IPGWI applications.
UA Graceful Shutdown supported on IPSP for M3UA only.
PVALUE : Valid range = 32-bits
BIT                                     BIT VALUE
0=UA Heartbeats                        0=Disabled , 1=Enabled
1=UA Graceful Shutdown                 0=Disabled , 1=Enabled
2-31=Reserved

PARM 4: SCTP Payload Protocol Indicator byte order option. Bit
indicates
PPI value is RCV/TX in Big Endian or Little Endian byte
format.
Supported on IPSP-M2PA associations only.
PVALUE : Valid range = 32-bits
BIT                                     BIT VALUE
0=Payload Protocol Indicator           0=Big Endian , 1=Little
Endian
1-31=Reserved

```

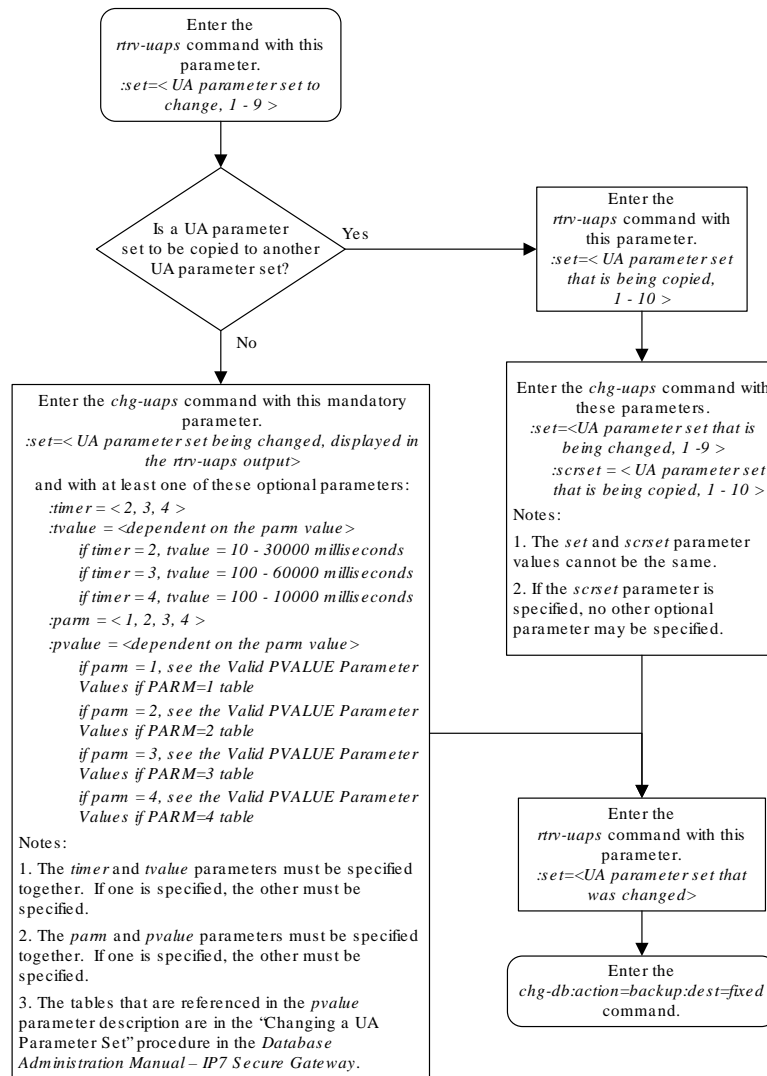
5. Back up the new changes, using the `chg-db:action=backup:dest=fixed` command. These messages should appear; the active **Maintenance and Administration Subsystem Processor (MASP)** appears first.

```

BACKUP (FIXED) : MASP A - Backup starts on active MASP.
BACKUP (FIXED) : MASP A - Backup on active MASP to fixed disk complete.
BACKUP (FIXED) : MASP A - Backup starts on standby MASP.
BACKUP (FIXED) : MASP A - Backup on standby MASP to fixed disk complete.

```


Figure 4-44 Changing a UA Parameter Set



4.39 Turning Off the Large MSU Support for IP Signaling Feature

This procedure is used to turn off the Large **MSU** Support for **IP** Signaling feature, using the `chg-ctrl-feat` command.

The `chg-ctrl-feat` command uses these parameters:

:partnum – The part number of the Large **MSU** Support for IP Signaling feature, 893018401.

:status=off – used to turn off the Large MSU Support for **IP** Signaling feature.

The status of the Large MSU Support for IP Signaling feature must be on and is shown with the `rtrv-ctrl-feat` command.

▲ Caution:

If the Large MSU Support for IP Signaling feature is turned off, the EAGLE will not process messages with a signaling information field (**SIF**) that is larger than 272 bytes.

1. Display the status of the Large MSU Support for IP Signaling feature by entering the `rtrv-ctrl-feat:partnum=893018401` command. The following is an example of the possible output.

```
rlghncxa03w 10-04-28 21:15:37 GMT EAGLE5 42.0.0  
The following features have been permanently enabled:
```

Feature Name	Partnum	Status	Quantity
Large MSU for IP Sig	893018401	on	----

The following features have been temporarily enabled:

Feature Name	Partnum	Status	Quantity	Trial Period Left
Zero entries found.				

The following features have expired temporary keys:

Feature Name	Partnum
Zero entries found.	

If the status of the Large MSU Support for IP Signaling feature is off, or if the Large MSU Support for IP Signaling feature is not enabled, this procedure cannot be performed.

2. Turn off the Large MSU Support for IP Signaling feature by entering the `chg-ctrl-feat` command with the `status=off` parameter. For example, enter this command.

```
chg-ctrl-feat:partnum=893018401:status=off
```

When this command has successfully completed, the following message should appear.

```
rlghncxa03w 06-10-28 21:15:37 GMT EAGLE5 36.0.0  
CHG-CTRL-FEAT: MASP B - COMPLTD
```

3. Verify that the Large MSU Support for IP Signaling feature has been turned off by using the `rtrv-ctrl-feat:partnum=893018401` command. The following is an example of the possible output.

```
rlghncxa03w 10-04-28 21:15:37 GMT EAGLE5 42.0.0
The following features have been permanently enabled:
```

Feature Name	Partnum	Status	Quantity
Large MSU for IP Sig	893018401	off	----

The following features have been temporarily enabled:

Feature Name	Partnum	Status	Quantity	Trial Period Left
Zero entries found.				

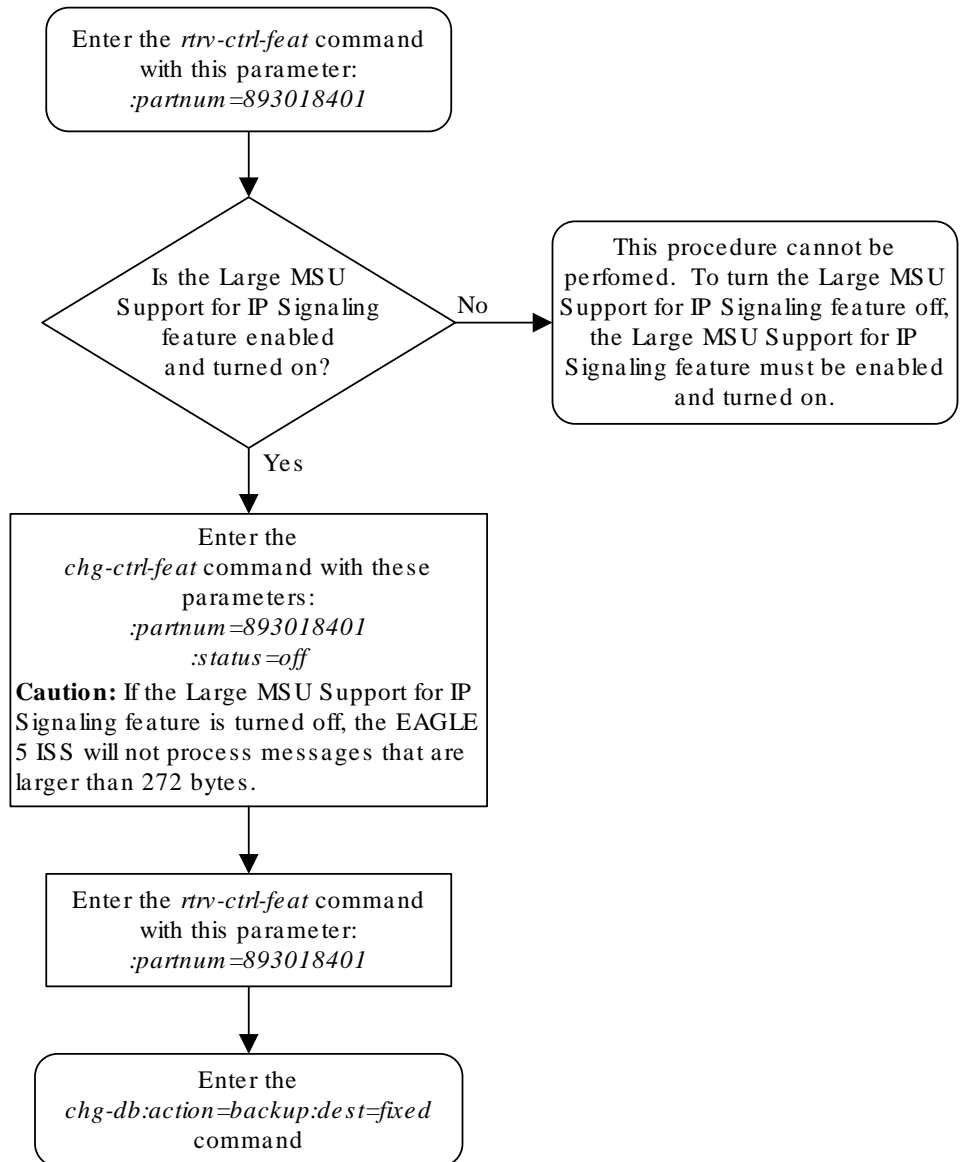
The following features have expired temporary keys:

Feature Name	Partnum
Zero entries found.	

4. Back up the new changes using the `chg-db:action=backup:dest=fixed` command. These messages should appear, the active **Maintenance and Administration Subsystem Processor (MASP)** appears first.

```
BACKUP (FIXED) : MASP A - Backup starts on active MASP.
BACKUP (FIXED) : MASP A - Backup on active MASP to fixed disk
complete.
BACKUP (FIXED) : MASP A - Backup starts on standby MASP.
BACKUP (FIXED) : MASP A - Backup on standby MASP to fixed disk
complete.
```

Figure 4-45 Turning the Large MSU Support for IP Signaling Feature Off



5

End Office Support

Chapter 5, End Office Support, describes the procedures necessary to allow the **EAGLE** to share its true point code (TPC) with an IP-based node without the need for a separate point code for the IP node.

5.1 Overview

End Office Support enables the **EAGLE** to share its true point code (**TPC**) with an **IP**-based node without the need for a separate point code for the **IP** node. When the End Office Support feature is in use, the **EAGLE** shares a point code for up to three network types with attached **IP** network elements.

The **EAGLE** lets you take advantage of next generation network technology by migrating existing signaling end points from the **PSTN** to the **IP** network. The fact that the **EAGLE** is a signaling transfer point and has its own point code, however, can present a significant network management issue. This feature provides the means to perform the migration without obtaining a new point code or reconfiguring the network to interface with both the **EAGLE** and an **IP** end office node.

Characteristics of this feature include:

- The **EAGLE** allows a set of **IP** network elements to share its true point code.
- The **EAGLE** allows messages destined to its true point code and having **SI**≥3 to be forwarded to an **IP** network element.
- The **EAGLE** enables **IP** networks elements sharing its true point code to participate in network management.
- The **EAGLE** supports **ANSI**, **ITU** national and international end office nodes.
- The **EAGLE** implements the **MTP** procedures required for an end office node.
- The End Office Support feature does not reduce the rated **TPS** of any **EAGLE** application.

The Remote Application Table contains fields for assigning each user part to an end office node. The default value is 'not assigned'.

New Remote Application Table commands provide for adding, deleting, and retrieving user-part assignments:

- `ent-rmt-appl`
- `dlt-rmt-appl`
- `rtrv-rmt-appl`

The user parts **SI**=0, **SI**=1, and **SI**=2 cannot be assigned to an end office node. The **SNM** case is a special case in that **UPUs** may be forwarded, even though **SI**=0 cannot be assigned to a remote application. All other **SNMs** are processed as destined to the **EAGLE** rather than the end office node. This often results in a multicast throughout the **EAGLE** that updates the routing tables on all cards. An end office node can receive these messages via replication performed by **MTPP**.

Each **SS7**-based application that receives a message destined to a **TSPC** checks the user-part assignment within the Remote Application Table. If the user-part is assigned and the **SI** is greater than or equal to 3, then the message is forwarded to the appropriate application, otherwise it is processed as though destined to the **EAGLE**.

To assign a remote application for the **SCCP** (**SI=3**) user part, you must also specify a subsystem number. The Remote Application Table maintains a record of assignments for all possible subsystems (256). Subsystems are either assigned or not assigned.

**Note:**

SSN=0 is normally an invalid value. This feature makes use of **SSN=0** for the purpose of forwarding certain **MSUs** to the end office node.

- Received **SCCP** Messages that indicate route-on-global-title are treated as having **SSN=0** for remote application assignment. If a remote application is assigned to **SSN=0**, then the message is forwarded, otherwise it is distributed to the local **SCCP** application. In previous releases, this would occur only for mis-configured networks. Messages indicating route-on-global-title and intended for the **EAGLE**, not the end office node, should be sent to the **EAGLE**'s capability point code.
- Received **SCCP** Messages that lack a Called Party **SS** are treated as having **SSN=0** for remote application assignment. If a remote application is assigned to **SSN=0**, then the message is forwarded, otherwise it is distributed to the local **SCCP** application.
- Received **SCCP** Messages having a Called Party **SS** equal to **SCMG** (**SSN=1**) are processed and terminated by the **EAGLE**, and if **SSN=1** has a remote application assigned, the **MSU** is also replicated and forwarded to the end office node.
- Received **SCCP** Messages having a Called Party **SSN** not equal to 0 or **SCMG** (1) and for which a remote application is assigned are forwarded to the end office node. Messages received for unassigned subsystems are distributed to the local **SCCP** application.
- The end office node cannot share **SCCP** subsystems (other than **SCMG**) with the **EAGLE**. If the end office node assigns a given subsystem, such as **LNP**, then the subsystem local to the **EAGLE** cannot receive messages. Remote applications take priority over local applications.

Internal Point Code

To route **SS7** messages to the **IP** address without adding another external point code, the End Office feature uses an internal point code (**IPC**). This point code is private to the **EAGLE**, and the **PSTN** has no awareness of it. Its sole purpose is to allow messages destined to the End Office Node to be routed from the inbound **LIM** to the **IPGWx** card (a card running either the **SS7IPGW** or **IPGWI** applications). An **IPC** must be entered as a destination and must be assigned for each network type having an end office node. This point code is also used internally by the **EAGLE** in order to route inbound messages to the outbound **IPGWx** card. The **EAGLE** can have up to three **IPCs**, one for **ANSI**, one for **ITU** International, and one for **ITU** National networks.

[Table 5-1](#) displays a sample Remote Application Table. The Network Type and **SI** are used to index into the table, rather than being stored in the table.

Table 5-1 Sample IPC Values

IPC	Assigned to End Office Node	Assigned SSNs	Network Type	User-Part (SI)	Action taken when MSU is received for the TPC
p-0-1-0	FALSE	n/a	ANSI	0	No application can be assigned for SI=0 . Note that TFCs are processed, replicated and sent to an end office node, if an application is assigned to any other user part. UPUs are forwarded if the application specified by the affected SI is assigned.
	FALSE	n/a		1	No application can be assigned for SI=1 .
	FALSE	n/a		2	No application can be assigned for SI=2 .
	TRUE	3, 7, 100		3	SCCP messages destined to the TSPC and with SSN assigned are forwarded to an end office node. SCCP messages destined to a TSPC and SSN not assigned are distributed to subsystems local to the EAGLE (e.g. LNP).
	FALSE	n/a		4	Terminate with UPU .
	TRUE	n/a		5	ISUP messages destined to a TSPC are forwarded to the end office node.
	FALSE	n/a		6 - 15	Terminate with UPU .
110	FALSE	n/a	ITU-N	0	No application can be assigned for SI=0 . TFCs are processed, replicated and sent to an end office node, if an application is assigned to any other user part. UPUs are forwarded if the application specified by the affected SI is assigned.
	FALSE	n/a		1	No application can be assigned for SI=1 .
	FALSE	n/a		2	No application can be assigned for SI=2 .
	FALSE	NULL		3	Distribute to local SCCP .
	TRUE	n/a		4	TUP messages destined to the TSPC are forwarded to the end office node.
	FALSE	n/a		5 - 12	Terminate with UPU .
	TRUE	n/a		13	QBICC messages destined to the TSPC are forwarded to the end office node.
	FALSE	n/a		14, 15	Terminate with UPU .

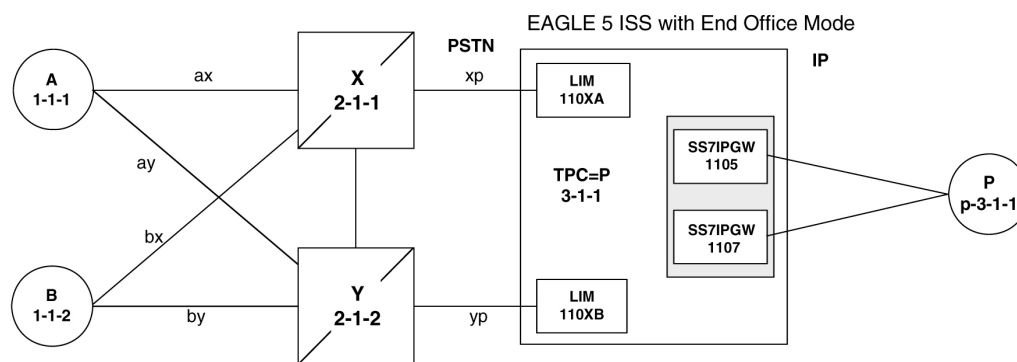
Table 5-1 (Cont.) Sample IPC Values

IPC	Assigned to End Office Node	Assigned SSNs	Network Type	User-Part (SI)	Action taken when MSU is received for the TPC
0-10-1	FALSE	n/a	ITU-I	0	No application can be assigned for SI=0 . TFCs are processed, replicated and sent to an end office node, if an application is assigned to any other user part. UPUs are forwarded if the application specified by the application specified by the affected SI is assigned.
	FALSE	n/a		1	No application can be assigned for SI=1 .
	FALSE	n/a		2	No application can be assigned for SI=2 .
	FALSE	NULL		3	Distribute to local SCCP .
	TRUE	n/a		4	TUP messages destined to the TSPC are forwarded to the end office node.
	FALSE	n/a		5 - 15	Terminate with UPU .

New Installation of VXI Behind a EAGLE with End Office Support

Figure 5-1 depicts a network in which a **VXI** node is deployed behind a **EAGLE** with End Office Support. Note that the **VXI** node resides in the **IP** network and shares the **EAGLE's** true point code. The **PSTN** views the **EAGLE** and **VXI** as one network element (one point code).

Figure 5-1 An EAGLE with End Office Support and VXI Node



One Node Migrates from PSTN to IP

Figure 5-2 and Figure 5-3 depict the migration of a signaling end point from the **PSTN** to an **IP** network using the **EAGLE** with the End Office Support feature.

Figure 5-2 Network Before an EAGLE with End Office, Node P is to Migrate

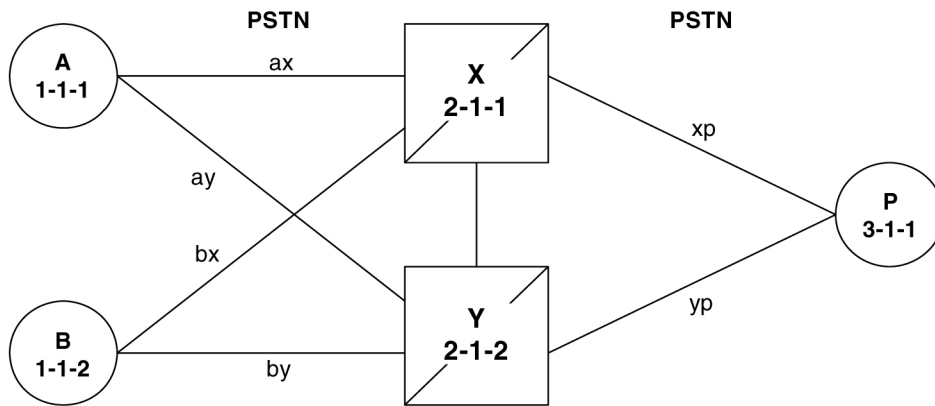
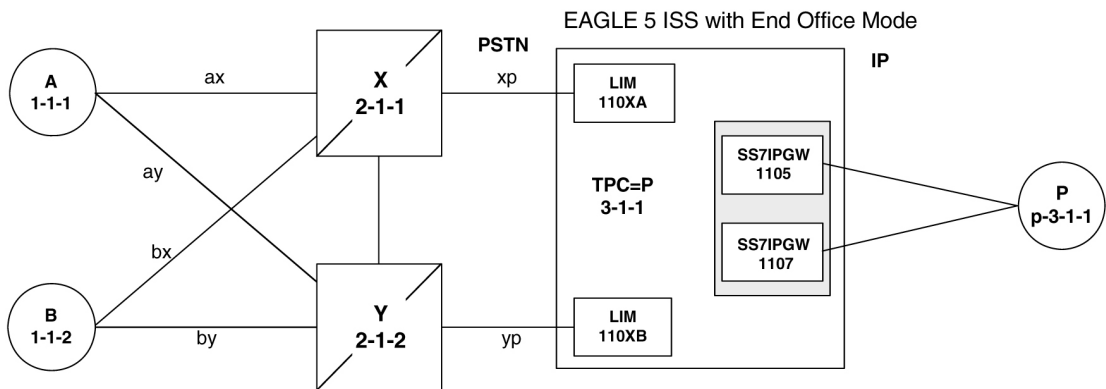


Figure 5-3 Network After an EAGLE with End Office, Node P has Migrated



In [Figure 5-3](#) the **EAGLE** no longer acts like a signaling transfer point, but rather acts like a signaling end point that has an **IP**-attached application user-part. The **EAGLE** and the **IP** network element share the point code P. All messages received by the **EAGLE** should be destined to P and all messages sent to the **PSTN** from the **EAGLE** have an **OPC** of P.

A Signaling End Point is Added to a Deployed EAGLE Using End Office

Another possible scenario for the End Office feature is that a customer has a deployed **EAGLE** with attached **IP** nodes, and wants to make use of the End Office feature to add a new **IP** node. Consider the following network diagrams, [Figure 5-4](#) and [Figure 5-5](#).

Figure 5-4 Original Network with Deployed EAGLE

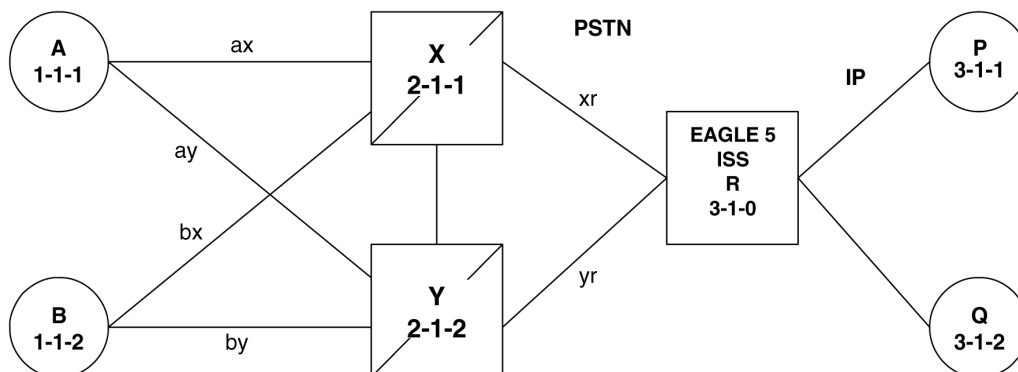
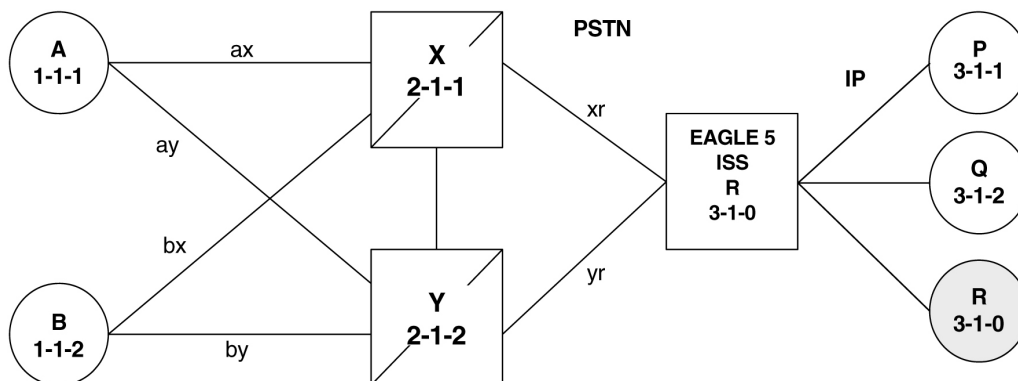


Figure 5-5 New Network with an EAGLE Using End Office and End Node R



In [Figure 5-5](#) the customer saves a point code by using the End Office feature and making the new IP network element an end office node. No change is required in the PSTN or at P or Q. Non-network-management and non-test messages destined to R are now forwarded to an IP network element, rather than terminated by the EAGLE.

Two Signaling End Points Move from PSTN to IP Using End Office

A more complex scenario arises when multiple signaling end points are to migrate from the PSTN to an IP network using the End Office feature. Consider [Figure 5-6](#) and [Figure 5-7](#).

Figure 5-6 Network before Two Signaling End Points Migrate from PSTN to IP

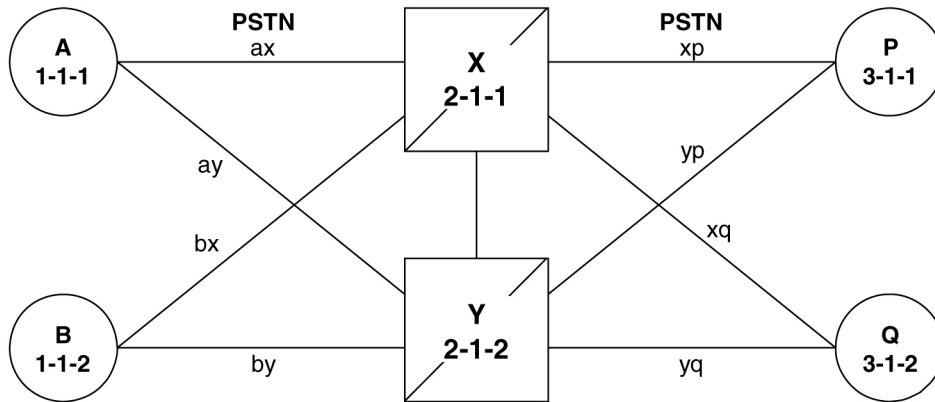
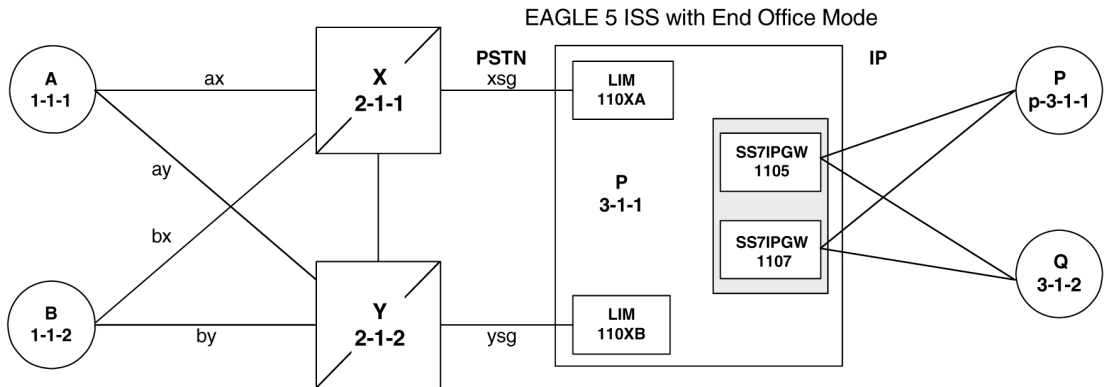


Figure 5-7 Network after Two Signaling End Points Migrate from PSTN to IP



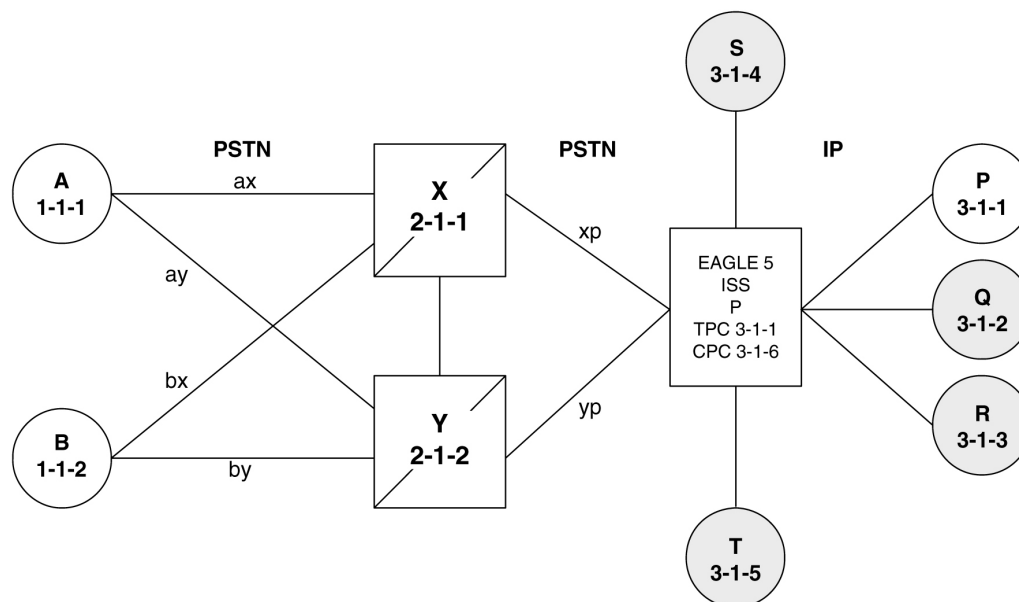
In [Figure 5-7](#), P is an end office node, and so P serves as the adjacent point code for nodes X and Y. The following are key points about this figure:

- Q is not an end office node, and so the **EAGLE** behaves as an **STP** for messages originated by and destined to Q.
- Reprovisioning is required in the **PSTN**, since the Q is now behind P. One example of this is that the linksets between X and Q and between Y and Q must change.
- Traffic between P and Q are no longer routed through X/Y, but are routed within the **EAGLE**.

The EAGLE Simultaneously Acts as STP and End Office

[Figure 5-8](#) depicts the **EAGLE** supporting three **IP** network elements, only one of which use the End Office feature, and two **PSTN** network elements. In addition, a capability point code is provisioned on the **EAGLE**, thereby allowing the use of **GTT**.

Figure 5-8 The EAGLE Simultaneously Acts as STP and End Office



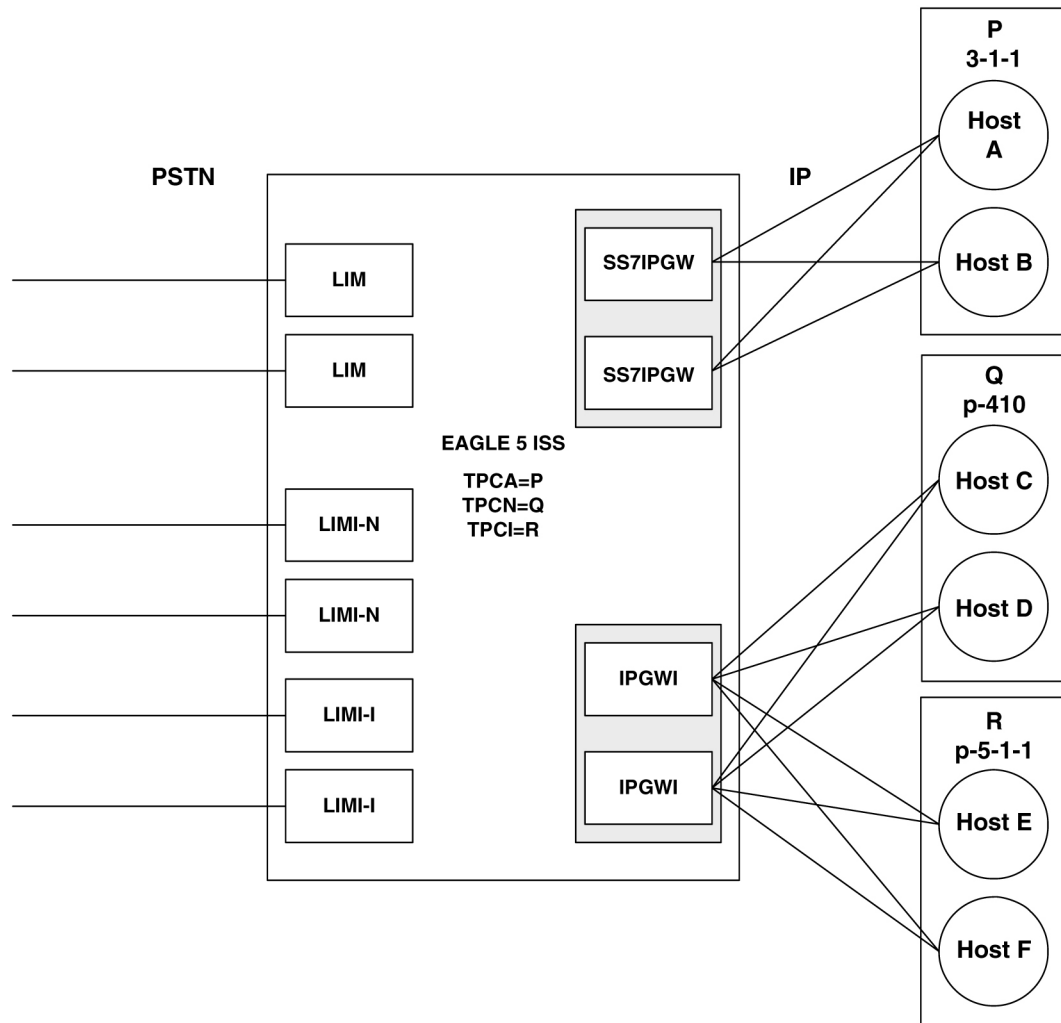
Notes regarding [Figure 5-8](#):

- P is the end office node, and so the **EAGLETPC=P**.
- Assume that end node P has an application assignment for **SCCP**.
- **SCCP** traffic destined to P is forwarded to the **IP** node via the **SS7IPGW** application.
- **SCCP** traffic destined to the **CPC** is distributed to the **EAGLE**'s local **SCCP** application (e.g. **GTT**).
- Network elements Q, R, S, and T are not end office nodes, and so the **EAGLE** generates **TFx** network management concerning them.
- **IP** Network element P is an end office node, and so the **EAGLE** generates only **UPU/SSP** concerning it.

The EAGLE Supports Multiple Network Types and Multiple Hosts as an End Node

In [Figure 5-9](#) the **EAGLE** supports an end office node for each of the three network types. Each end office node comprises multiple **IP** network elements. The **IP** network elements are distinguished by the remote host and remote port values of the **IP** network elements (**IP** address parameters).

Figure 5-9 Three Multiple-Element End Office Nodes



Mated Pair Supports Two End Office Nodes

Figure 5-10 depicts a mated pair of **EAGLEs** with each **EAGLE** supporting an End Office Node. Note that **EAGLE P** lacks **IP** links to **IPNE-Q** and **EAGLE Q** lacks **IP** links to **IPNE-P**, since such links would conflict with the C-links of linkset pq.

Figure 5-10 Mated Pair Supports Two End Office Nodes

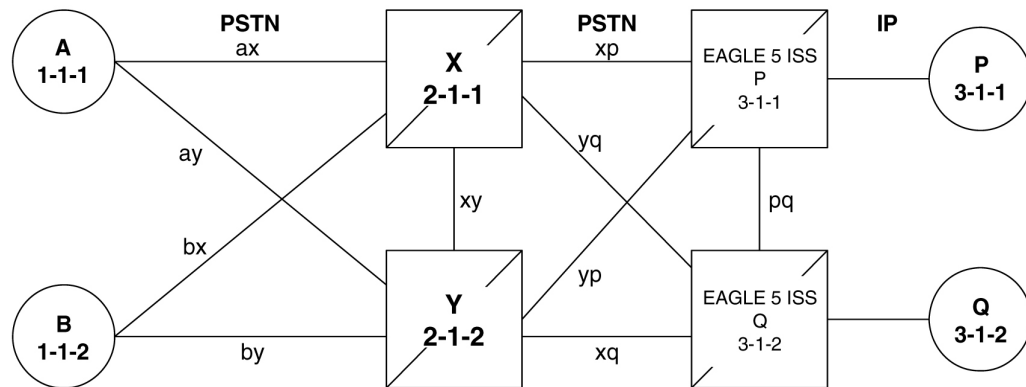


Figure 5-10 shows that a mated pair of **EAGLEs** cannot share an End Office Node. Each **EAGLE** requires its own unique point code and so any attached End Office Nodes share those point codes. It would be possible for a single **IP** network element to act as both P and Q (have **IP** connections to both **EAGLE P** and **EAGLE Q**). This configuration, however, would not provide true redundancy. Messages destined to P are terminated either at **EAGLE P** or **IPNE-P**, and message destined to Q are terminated either at **EAGLE Q** or **IPNE-Q**. Should the **IP** link between **EAGLE P** and **IPNE-P** fail, this feature provides no way for **EAGLE P** to forward messages to the End Office Node using the linkset **pq** (the linkset between systems P and Q).

5.2 End Office Support Configuration

In addition to the internal point code provisioned in the database with the [Adding an End Node Internal Point Code](#) procedure, other entities must be configured in the database to support the End Office feature.

For IPGWx entities, these entities must be configured in the database.

- The internal point code must be in the destination point code table - go to the “Adding a **Destination Point Code**” procedure in *Database Administration - SS7 User's Guide*.
- An **SS7** route to the internal point code - go to either the “Adding a **Route** containing an **SS7DPC**” or “Adding a **Route** Containing an **IPGWx Linkset**” procedure in the *Database Administration - SS7 User's Guide*.
- Signaling links assigned to the cards running either the **SS7IPGW** or **IPGWI** applications - [Adding an IPGWx Signaling Link](#) in [End Office Support](#)
- IPGWx associations (with the corresponding application servers):
 - [Adding an M3UA or SUA Association](#) procedure in [IETF M3UA and SUA Configuration Procedures](#)
 - [Adding a New Association to a New Application Server](#) procedure in [IETF M3UA and SUA Configuration Procedures](#)
 - [Adding an Existing Association to a New Application Server](#) procedure in [IETF M3UA and SUA Configuration Procedures](#)
 - [Adding a New Association to an Existing Application Server](#) procedure in [IETF M3UA and SUA Configuration Procedures](#)

- [Adding an Existing Association to an Existing Application Server](#) procedure in [IETF M3UA and SUA Configuration Procedures](#)
- Routing key matching the user part specified in the [Adding an End Node Internal Point Code](#) procedure and with the **DPC** of the routing key equal to the true point code of the **EAGLE** (shown in the `rtrv-sid` output) - See the [Adding a Routing Key Containing an Application Server](#) procedure in [IETF M3UA and SUA Configuration Procedures](#) .

For IPSPG entities, these entities must be configured in the database.

- The internal point code must be in the destination point code table - perform the “Adding a **Destination Point Code**” procedure in *Database Administration - SS7 User's Guide*.
- An **SS7** route to the internal point code - perform the “Adding a **Route** containing an **SS7DPC**” procedure in *Database Administration - SS7 User's Guide*.
- M3UA Linksets - [Adding an IPSPG M3UA Linkset](#) procedure in [IPSPG M2PA and M3UA Configuration Procedures](#)
- M3UA associations - [Adding an IPSPG M3UA Association](#) procedure in [IPSPG M2PA and M3UA Configuration Procedures](#)
- Signaling links assigned to the IPSPG cards - [Adding an IPSPG M3UA Signaling Link](#) procedure in [IPSPG M2PA and M3UA Configuration Procedures](#)

5.3 Adding an End Node Internal Point Code

This procedure is used to assign user parts to an internal point code (IPC), and thereby to an end office node using the `ent-rmt-appl` command. An internal point code is assigned to remote applications.

Only one IPC value for each network type can be configured. If you are adding an IPC value of the same network type as an existing IPC (for example, adding an ANSI IPC when the `rtrv-rmt-appl` output contains an ANSI IPC), the IPC value must be the same as the existing IPC value.

The `ent-rmt-appl` command uses these parameters:

`:ipc/ipca/ipci/ipcn/ipcn24` – The end node's internal point code can be an ANSI (`ipc/ipca`), ITU-I or ITU-I spare (`ipci`), 14-bit ITU-N or 14-bit ITU-N spare (`ipcn`), or 24-bit ITU-N (`ipcn24`) point code.

Note:

The point code value can also be either a private (p-) or a private spare (ps-) point code, but does not have to be a private or private spare point code. Any point code can be a private point code. Only ITU-I or 14-bit ITU-N point codes can be private spare point codes. The point code value must be shown in the `rtrv-dstn` command output.

Note:

The EAGLE can contain 14-bit ITU-N point codes or 24-bit ITU-N point codes, but not both at the same time.

:*si* – The service indicator value designates which MSU user part is being assigned to a remote application. Valid values range from 3 to 15.

:*ssn* – The SCCP subsystem number parameter. This parameter is required if the *si=3* parameter is specified and is not valid for any other *si* value. If the *ssne* parameter is also specified, then the *ssn* parameter serves as the starting value of a range. Valid values range from 0 to 255.

:*ssne* – The SCCP subsystem number range end parameter. The *ssne* value can be specified only if the *si=3* parameter is specified and is not valid for any other *si* value. This parameter serves as an end of a range, and so must be greater than the *ssn* parameter value. Valid values range from 1 to 255.

The specified assignment cannot be an existing assignment, including SSN subsets.

1. Display a report listing the remote application assignments using the `rtrv-rmt-appl` command.

This is an example of possible output:

```
rlghncxa03w 06-10-28 09:12:36 GMT EAGLE5 36.0.0
  IPCA          SI SSN
  003-003-003   3 100, 110-119, 200
                5

  IPCI          SI SSN
  p-3-003-3     3 5, 50-100, 250
                5

  IPCN          SI SSN

  IPCN24        SI SSN
```

2. Display the current destination point codes, using the `rtrv-dstn` command.

This is an example of the possible output.

```
rlghncxa03w 10-12-10 11:43:04 GMT EAGLE5 43.0.0
Extended Processing Time may be Required

  DPCA          CLLI          BEI ELEI  ALIASI
ALIASN/N24     DMN
  003-003-003   ----- yes --- -----
-----
                SS7
  030-045-*     rlghncbb010 yes yes -----
-----
                SS7
  111-011-*     rlghncbb000 yes yes -----
-----
                SS7
  240-012-004   rlghncbb001 yes --- 1-111-1
2500           SS7
  240-012-005   rlghncbb002 yes --- 1-112-2
1357           SS7
  240-012-006   rlghncbb003 yes --- 1-112-3
4257           SS7
  240-012-008   ----- yes --- 1-113-5
6939           SS7
```



```

p-003-003-003 ----- yes --- ----- SS7

DPCI      CLLI      BEI  ELEI   ALIASA      ALIASN/N24  DMN
2-131-1   rlghncbb023 no --- 222-210-000 10789      SS7
2-131-2   ----- no --- 222-211-001 1138      SS7
2-131-3   ----- no --- 222-211-002 1298      SS7
p-3-003-3 ----- no --- ----- SS7

DPCN      CLLI      BEI  ELEI   ALIASA      ALIASI      DMN
7701     rlghncbb013 no --- 222-200-200 2-121-1    SS7
11038    rlghncbb013 no --- 222-200-201 2-121-2    SS7
p-16380  ----- no --- -----
SS77

```

```

DESTINATION ENTRIES ALLOCATED: 2000
FULL DPC(s): 12
EXCEPTION DPC(s): 0
NETWORK DPC(s): 0
CLUSTER DPC(s): 2
TOTAL DPC(s): 14
CAPACITY (% FULL): 1%
ALIASES ALLOCATED: 12000
ALIASES USED: 18
CAPACITY (% FULL): 1%
X-LIST ENTRIES ALLOCATED: 500

```

If the IPC being added to the database is not shown in the `rtrv-dstn` output, go to the “Adding a Destination Point Code” procedure in *Database Administration - SS7 User's Guide* and add the IPC to the DPC table.

3. Add the remote application assignments using the `ent-rmt-appl` command.

For this example, enter these commands.

```

ent-rmt-appl:ipcn=p-16380:si=3:ssn=250

ent-rmt-appl:ipcn=p-16380:si=5

ent-rmt-appl:ipca=003-003-003:si=13

ent-rmt-appl:ipca=003-003-003:si=3:ssn=50:ssne=75

```

When each of these commands have successfully completed, the following message should appear.

```

rlghncxa03w 06-10-28 09:12:36 GMT EAGLE5 36.0.0
ENT-RMT-APPL: MASP A - COMPLTD;

```

4. Verify the changes using the `rtrv-rmt-appl` command.

This is an example of possible output:

```

rlghncxa03w 06-10-28 09:12:36 GMT EAGLE5 36.0.0
IPCA      SI  SSN
003-003-003 3 50-75, 100, 110-119, 200

```

```

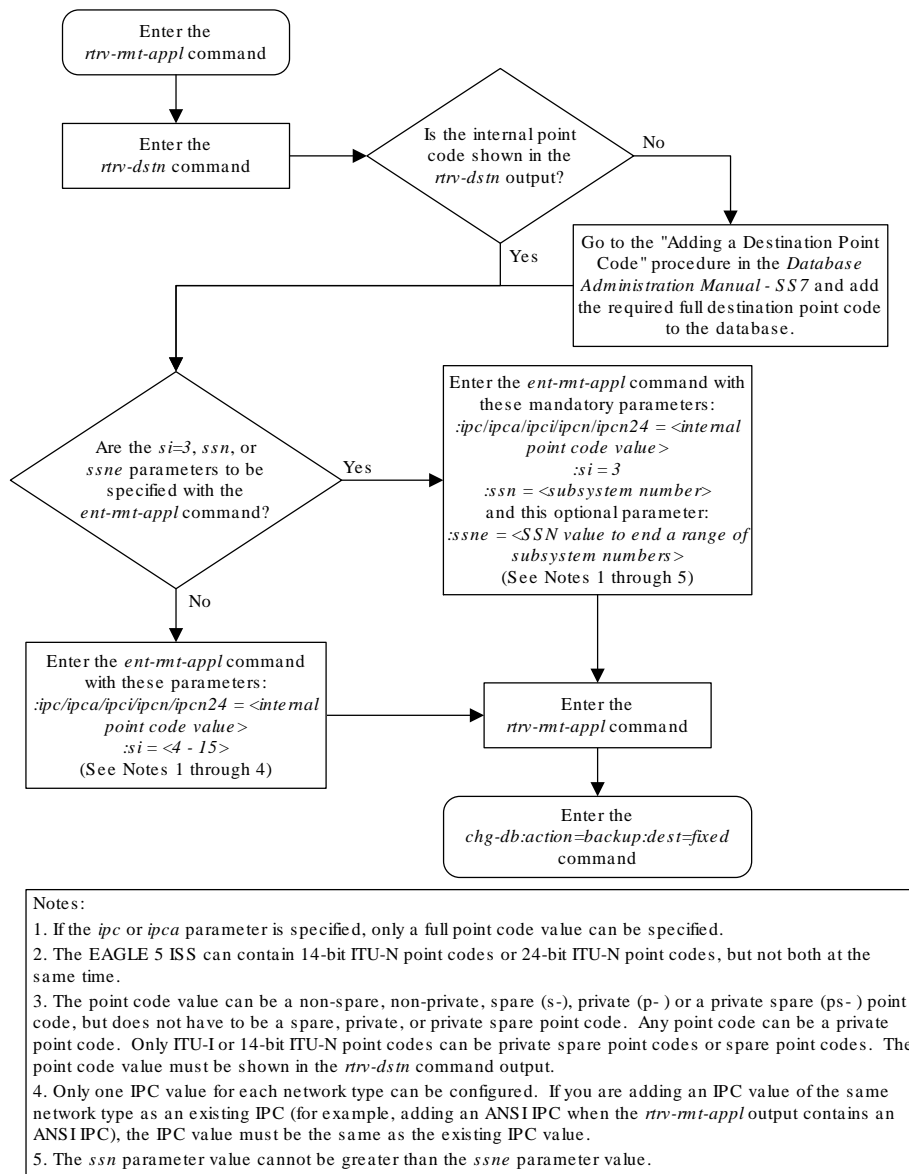
                    5
                    13
IPCI                SI SSN
p-3-003-3          3 5, 50-100, 250
                    5
IPCN                SI SSN
p-16380           3 250
                    5
IPCN24             SI SSN
```

5. Back up the new changes, using the `chg-db:action=backup:dest=fixed` command.

These messages should appear; the active Maintenance and Administration Subsystem Processor (MASP) appears first.

```
BACKUP (FIXED) : MASP A - Backup starts on active MASP.
BACKUP (FIXED) : MASP A - Backup on active MASP to fixed disk
complete.
BACKUP (FIXED) : MASP A - Backup starts on standby MASP.
BACKUP (FIXED) : MASP A - Backup on standby MASP to fixed disk
complete.
```

Figure 5-11 Add an End Node Internal Point Code



5.4 Removing an End Node Internal Point Code

The `dlt-rmt-appl` command is used to remove remote application assignments from the database.

The `dlt-rmt-appl` command uses these parameters:

`:ipc/ipca/ipci/ipcn/ipcn24` – The end node's internal point code can be an **ANSI**, **ANSI private** (`ipc/ipca`), **ITU-I**, **ITU-I spare**, **ITU-I private spare** (`ipci`), **14-bit ITU-N**, **14-bit ITU-N spare**, **14-bit ITU-N private spare** (`ipcn`), or **24-bit ITU-N**, or **24-bit ITU-N private** (`ipcn24`) point code.

`:si` – The service indicator value designates which **MSU** user part is being assigned to a remote application. Valid values range from 3 to 15.

`:ssn` – The **SCCP** subsystem number parameter. This parameter is required if the `si=3` parameter is specified and is not valid for any other `si` value. If the `ssne` parameter is also specified, then the `ssn` parameter serves as the starting value of a range. Valid values range from 0 to 255.

`:ssne` – The **SCCP** subsystem number range end parameter. The `ssne` value can be specified only if the `si=3` parameter is specified and is not valid for any other `si` value. This parameter serves as an end of a range, and so must be greater than the `ssn` parameter value. Valid values range from 1 to 255.

1. Display a report listing the remote application assignments using the `rtrv-rmt-appl` command.

This is an example of possible output:

```
rlghncxa03w 06-10-28 09:12:36 GMT EAGLE5 36.0.0
  IPCA          SI SSN
  003-003-003   3 50-75, 100, 110-119, 200
                5
                13

  IPCI          SI SSN
  p-3-003-3     3 5, 50-100, 250
                5

  IPCN          SI SSN
  p-16380       3 250
                5

  IPCN24        SI SSN
```

2. Delete remote application assignments using the `dlt-rmt-appl` command.

For this example, enter these commands.

```
dlt-rmt-appl:ipca=003-003-003:si=3:ssn=100
dlt-rmt-appl:ipca=003-003-003:si=13
```

When each of these commands have successfully completed, the following message should appear.

```
rlghncxa03w 06-10-28 09:12:36 GMT EAGLE5 36.0.0
DLT-RMT-APPL: MASP A - COMPLTD;
```

3. Verify the changes using the `rtrv-rmt-appl` command.

This is an example of possible output:

```
rlghncxa03w 06-10-28 09:12:36 GMT EAGLE5 36.0.0
  IPCA          SI SSN
  003-003-003  3 50-75, 110-119, 200
                5

  IPCI          SI SSN
  p-3-003-3    3 5, 50-100, 250
                5

  IPCN          SI SSN
  p-16380      3 250
                5

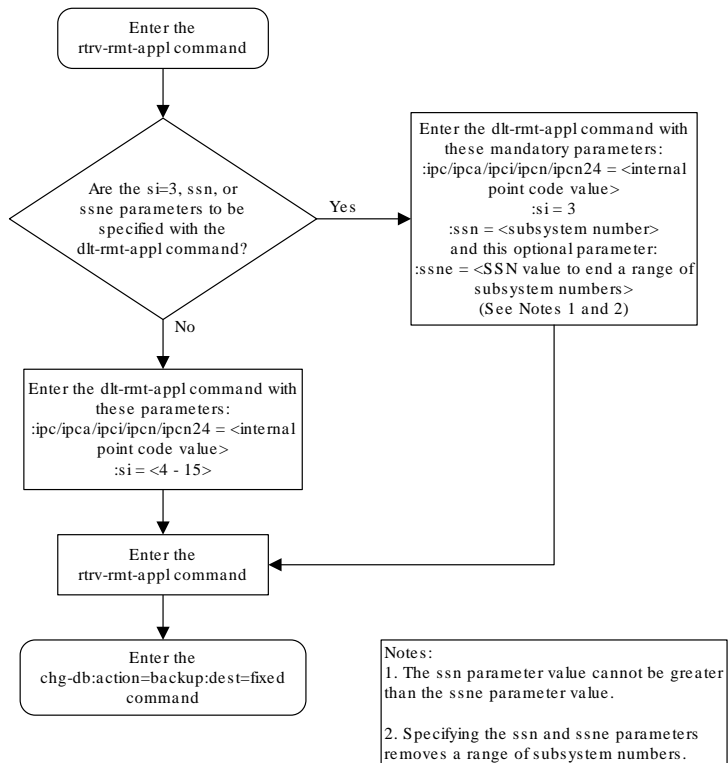
  IPCN24       SI SSN
```

4. Back up the new changes, using the `chg-db:action=backup:dest=fixed` command.

These messages should appear; the active **Maintenance and Administration Subsystem Processor (MASP)** appears first.

```
BACKUP (FIXED) : MASP A - Backup starts on active MASP.
BACKUP (FIXED) : MASP A - Backup on active MASP to fixed disk complete.
BACKUP (FIXED) : MASP A - Backup starts on standby MASP.
BACKUP (FIXED) : MASP A - Backup on standby MASP to fixed disk complete.
```

Figure 5-12 Removing an End Node Internal Point Code



6

IPSG M2PA and M3UA Configuration Procedures

Chapter 6, IPSG M2PA and M3UA Configuration Procedures, describes the procedures necessary to configure the components necessary to establish IP connections using M2PA or M3UA associations on IPSG signaling links.

6.1 Adding IPSG Components

This section describes how to configure the components necessary to establish connections using IPSG **M2PA** associations on **IPSG** signaling links, and IPSG M3UA associations on IPSG signaling links.

The configuration of these connections consists of these items.

1. Configure the **IPSG** card with the [Adding an IPSG Card](#) procedure.
2. Configure the required destination point codes - see Chapter 2, "Configuring Destination Tables," in *Database Administration - SS7 User's Guide*.
3. Configure the required IPSG linksets - perform the [Adding an IPSG M2PA Linkset](#) or the [Adding an IPSG M3UA Linkset](#) procedures.
4. **IP** addresses must be assigned to the **IPSG** card configured in step 1 by performing the [Configuring an IP Link](#) procedure. There are other **IP** link parameters that are assigned to the **IPSG** card when the **IPSG** card is configured. Default values are assigned to these parameters when the **IPSG** card is configured. These values can be displayed by the `rtrv-ip-lnk` command. These values can be changed by performing the [Configuring an IP Link](#) procedure.
5. Local **IP** hosts, assigned to the **IP** addresses assigned to step 4, must be configured in the database by performing the [Adding an IP Host](#) procedure. Verify the hosts with the `rtrv-ip-host` command. This establishes a relationship between the **IPSG** card related information and the association related information.
6. When the **IPSG** cards are added to the database in step 1, there are **IP** parameters that control the **IP** stack that are assigned default values. These parameter values can be displayed by the `rtrv-ip-card` command. These values can be changed by performing the [Configuring an IP Card](#) procedure.
7. Static **IP** routes provide more flexibility in selecting the path to the remote destination and reduces the dependence on default routers. Static **IP** routes are provisioned by performing the [Adding an IP Route](#) procedure.
8. IPSG Associations specify a connection between a local host/**TCP** port and a remote host/**TCP** port. Two types of IPSG associations can be provisioned: **M2PA** and **M3UA**. Associations that are assigned to **IPSG** M2PA signaling links must be **IPSG M2PA** associations. Associations that are assigned to IPSG M3UA signaling links must be **IPSG M3UA** associations. The **IPSG M2PA** association is configured by performing the [Adding an IPSG M2PA Association](#) procedure. The **IPSG M3UA** association is configured by performing the [Adding an IPSG M3UA Association](#) procedure. Associations can be assigned to IPLIMx or IPGWx signaling links also. These associations are configured by

performing the [Adding an M2PA Association](#) or [Adding an M3UA or SUA Association](#) procedures. A number of fields in the association cannot be configured with the [Adding an IPSP M2PA Association](#) or [Adding an IPSP M3UA Association](#) procedures and are set to default values. The values of these fields can be displayed using the `rtrv-assoc` command after the [Adding an IPSP M2PA Association](#) or [Adding an IPSP M3UA Association](#) procedures are performed. These values can be changed by performing the [Changing the Attributes of an IPSP Association](#) procedure.

9. There are two versions of IPSP **M2PA** associations, **RFC** and Draft 6, that can be configured in the database. When an IPSP **M2PA** association is added to the database with the [Adding an IPSP M2PA Association](#) procedure, the association is configured as an **RFCM2PA** association. The **RFC** version of **M2PA** timer set 1 is also assigned to the association when the IPSP **M2PA** association is added to the database.

There are two different versions, **RFC** and Draft 6, of **M2PA** timer sets that can be assigned to IPSP **M2PA** associations. Each version of the **M2PA** timer sets contains 20 timer sets. The values of these timer sets can be changed with the [Changing an M2PA Timer Set](#) procedure.

The version of the IPSP **M2PA** association and the **M2PA** timer set assigned to the association can be changed with [Changing the Attributes of an IPSP Association](#) procedure. The **M2PA** version of the association determines the version of the **M2PA** timer set that is assigned to the association. For example, if **M2PA** timer set 3 is assigned to the IPSP **M2PA** association, and the association is an **RFC M2PA** association, the **RFC** version of **M2PA** timer set 3 is used with the association. If **M2PA** timer set 7 is assigned to the IPSP **M2PA** association, and the association is a Draft 6 **M2PA** association, the Draft 6 version of **M2PA** timer set 7 is used with the association.

10. When an IPSP **M3UA** association is added to the database, **UA** parameter set 10 is assigned to the association. There are 10 **UA** parameter sets that can be assigned to an association, but the **UA** parameter set assignment can be changed, using the [Changing the Attributes of an IPSP Association](#) procedure. The values assigned to each **UA** parameter set can be changed, except for **UA** parameter set 10, using the [Changing a UA Parameter Set](#) procedure.
11. Configure the **IPSP** signaling links with either the [Adding an IPSP M2PA Linkset](#) or [Adding an IPSP M3UA Signaling Link](#) procedures. If the addition of these signaling links will exceed the current number of signaling links the **EAGLE** is allowed to have, the [Enabling the Large System # Links Controlled Feature](#) procedure will have to be performed to increase the quantity of signaling links.
12. Configure the required routes - see Chapter 3, "SS7 Configuration," in *Database Administration - SS7 User's Guide*.
13. An internal point code can be provisioned to provide routing to an **IP** end office node. Configure the internal point codes by performing the [Adding an End Node Internal Point Code](#) procedure.
14. The network appearance field identifies the **SS7** network context for the message, for the purpose of logically separating the signaling traffic between the **SGP** (signaling gateway process) and the application server over a common **SCTP** (stream control transmission protocol) association. This field is contained in the **DATA**, **DUNA**, **DAVA**, **DRST**, **DAUD**, **SCON**, and **DUPU** messages. Network appearances are configured by performing the [Adding a Network Appearance](#) procedure.

- The EAGLE processes messages with a service information field (**SIF**) that is 272 bytes or smaller. The Large MSU Support for IP Signaling feature allows the EAGLE to process messages with a service indicator value of 6 to 15 and with a SIF that is larger than 272 bytes. Perform the [Activating the Large MSU Support for IP Signaling Feature](#) procedure to enable and turn on the Large MSU Support for IP Signaling feature.

6.2 Adding an IP SG Card

This procedure is used to add an **IP SG** card to the database using the `ent-card` command. An IP SG card is an E5-ENET-B or SLIC card that is running the IP SG application.

The `ent-card` command uses these parameters.

`:loc` – The location of the card being added to the database.

`:type` – The type of card being added to the database. For this procedure, the value of this parameter is `enet` for an E5-ENET card and `enetb` for E5-ENET-B. When provisioning the SLIC, the card type is `slic`.

`:appl` – The application software that is assigned to the card. For this procedure, the value of this parameter is `ipsg`.

`:force` – If the global title translation feature is on, the `force=yes` parameter allows the **IP SG** card to be added to the database even if the current **SCCP** transactions-per-second threshold is unable to support the additional **SCCP** transaction-per-second capacity created by adding the **IP** card. This parameter is obsolete and is no longer used.

Card Slot Selection

The **E5-ENET** card can be inserted into any card slot, except for card slots that must remain empty to accommodate dual-slot cards, slots 09 and 10 in each shelf, and slots 1113 through 1118.

To provision a E5-ENET card, the shelf containing the E5-ENET card must have HIPR2 cards installed in slots 9 and 10 in that shelf. If HIPR2 cards are not installed in the shelf that the E5-ENET card will occupy, the E5-ENET card will be auto-inhibited when the E5-ENET card is inserted into the shelf. Enter the `rept-stat-gpl:gpl=hipr2` command to verify whether or not **HIPR2** cards are installed in the same shelf as the E5-ENET card being provisioned in this procedure.

- Display the total provisioned system TPS by entering the `rtrv-tps` command.

This is an example of the possible output.

```
rlghncxa03w 10-07-30 16:20:46 GMT EAGLE 42.0.0

Total provisioned IPGW      TPS = 30000
Total provisioned IP SG    TPS = 400000
Total provisioned IPLIM    TPS = 20000
Total provisioned ATM      TPS = 3668

Total provisioned System TPS (453668 of 500000) 91%

Command Completed.
```

See [Maximum Card Capacity for Different Card Types](#) for MaxTPS values. If adding the new IPSG card will not exceed the maximum total provisioned system TPS, continue the procedure with 2.

If adding the new IPSG card will exceed the maximum total provisioned system TPS, and the maximum total provisioned system TPS is 500,000, perform the "Activating the HIPR2 High Rate Mode" feature in *Database Administration - System Management User's Guide* to enable and turn on the HIPR2 High Rate Mode feature. When the HIPR2 High Rate Mode feature is enabled and turned on, the maximum total provisioned system TPS is increased to 1,000,000 (1M). After the HIPR2 High Rate Mode feature has been enabled and turned on, continue the procedure with 2.

If adding the new IPSG card will exceed the maximum total provisioned system TPS, and the maximum total provisioned system TPS is 1M, This procedure cannot be performed. The maximum total provisioned system TPS the EAGLE can have is 1M,

2. Display the cards in the database using the `rtrv-card` command.

This is an example of the possible output. Cards should be distributed throughout the EAGLE for proper power distribution. Refer to *Installation Guide* for the shelf power distribution.

```
rlghncxa03w 13-06-05 08:12:53 GMT 45.0.0
CARD   TYPE      APPL      LSET NAME      LINK SLC LSET NAME
LINK SLC
1101   DSM        VSCCP
1102   TSM        GLS
1113   E5MCAP    EOAM
1114   E5TDM-A
1115   E5MCAP    EOAM
1116   E5TDM-B
1117   E5MDAL
1201   LIMDS0    SS7ANSI   sp2            A    0    sp1
B      0
1203   LIMDS0    SS7ANSI   sp3            A    0
1204   LIMDS0    SS7ANSI   sp3            A    1
1206   LIMDS0    SS7ANSI   nsp3           A    1    nsp4
B      1
1301   LIMDS0    SS7ANSI   sp6            A    1    sp7
B      0
1302   LIMDS0    SS7ANSI   sp7            A    1    sp5
B      1
1303   DCM       IPLIM     ipnode1        A    0    ipnode3
B      1
1305   DCM       IPLIM     ipnode4        A    0
2101   ENET      IPG
2103   ENET      IPG
2105   ENET      IPG
2107   ENET      IPG
2201   DCM       IPLIM
2203   DCM       IPLIM
2207   DCM       IPLIM
2211   DCM       SS7IPGW
2213   DCM       SS7IPGW
```

```

2215 DCM      IPGWI
2217 DCM      IPGWI
2301 DCM      SS7IPGW
2303 DCM      SS7IPGW
2305 DCM      IPGWI
2307 DCM      IPGWI
2311 DCM      IPLIMI
2313 DCM      ILIMI

```

Continue the procedure by performing one of these actions.

- If the required unprovisioned card slots (see the Card Slot Selection section) are shown in the `rtrv-card` output, continue the procedure with 5.
 - If the required unprovisioned card slots are not shown in the `rtrv-card` output, 3 must be performed.
3. Display the shelves in the database by entering the `rtrv-shlf` command. This is an example of the possible output.

```

rlghncxa03w 08-03-05 08:12:53 GMT 38.0.0
SHELF DISPLAY
FRAME SHELF      TYPE
  1      1      CONTROL
  1      2      EXTENSION
  1      3      EXTENSION
  2      1      EXTENSION
  2      2      EXTENSION
  2      3      EXTENSION

```

If all the shelves are provisioned in the database, then the remainder of this procedure cannot be performed. There are no available card slots for the new **IPSG** card.

If all the shelves have not been provisioned in the database, continue the procedure with 4.

4. Add the required shelf using the `ent-shlf` command with the location of the shelf and the `type=ext` parameter. The shelf location values are 1200, 1300, 2100, 2200, 2300, 3100, 3200, 3300, 4100, 4200, 4300, 5100, 5200, 5300, and 6100. For this example, enter this command.

```
ent-shlf:loc=3100:type=ext
```

When this command has successfully completed, this message should appear.

```

rlghncxa03w 07-05-01 09:12:36 GMT EAGLE5 37.0.0
ENT-SHLF: MASP A - COMPLTD

```

5. Verify that the card to be entered has been physically installed into the proper location (see the [Card Slot Selection](#) section). If the card has not been installed, insert the card into the desired card location following the rules described in the [Card Slot Selection](#) section.

▲ Caution:

If the versions of the flash GPLs on the IPSG card do not match the flash GPL versions in the database when the IPSG card is inserted into the card slot, **UAM 0002** is generated indicating that these **GPL** versions do not match. If UAM 0002 has been generated, perform the alarm clearing procedure for UAM 0002 in *Unsolicited Alarm and Information Messages Reference* before proceeding with this procedure.

- Verify that **HIPR2** cards are installed in card locations 9 and 10 in the shelf containing the E5-ENET card being added in this procedure. Enter this command.

```
rept-stat-gpl:gpl=hipr2
```

This is an example of the possible output.

```
rlghncxa03w 09-07-05 08:12:53 GMT 41.1.0
GPL          CARD      RUNNING          APPROVED        TRIAL
HIPR2       1109      132-002-000     132-002-000    132-003-000
HIPR2       1110      132-002-000     132-002-000    132-003-000
HIPR2       1209      132-002-000     132-002-000    132-003-000
HIPR2       1210      132-002-000     132-002-000    132-003-000
HIPR2       1309      132-002-000     132-002-000    132-003-000
HIPR2       1310      132-002-000     132-002-000    132-003-000
HIPR2       2109      132-002-000     132-002-000    132-003-000
HIPR2       2110      132-002-000     132-002-000    132-003-000
HIPR2       2209      132-002-000     132-002-000    132-003-000
HIPR2       2210      132-002-000     132-002-000    132-003-000
HIPR2       2309      132-002-000     132-002-000    132-003-000
HIPR2       2310      132-002-000     132-002-000    132-003-000
Command Completed
```

If **HIPR2** cards are installed in the shelf containing the **E5-ENET** card, continue the procedure with [11](#).

If HIPR or HIPR2 cards are not installed on the shelf containing the E5-ENET card, go to *Installation Guide* and install the HIPR or HIPR2 cards. Once the HIPR or HIPR2 cards have been installed, continue the procedure with [11](#).

- Enter the `rtrv-stpopts` command to verify whether or not the MFC option is on.

This is an example of the possible output.

```
rlghncxa03w 11-10-17 16:02:05 GMT EAGLE5 44.0.0
STP OPTIONS
-----
MFC                               off
```

The `rtrv-stpopts` command output contains other fields that are not used by this procedure. To see all fields displayed by the `rtrv-stpopts` command, see the `rtrv-stpopts` command description in *Commands User's Guide*.

If the **MFC** option is off, perform the Configuring the MFC Option procedure in *Database Administration - System Management User's Guide* to turn on the MFC option.

If the MFC option is on or the Configuring the MFC Option procedure in *Database Administration - System Management User's Guide* was performed in this step, continue the procedure with 8.

 **Note:**

The Fan feature must be purchased before you turn this feature on with the `chg-feat` command. If you are not sure if you have purchased the Fan feature, contact your Sales Representative or Account Representative.

8. Enter the `rtrv-feat` command to verify that the Fan feature is on.

If the Fan feature is on, shown in the `rtrv-feat` output, the `FAN` field should be set to `on`.

The `rtrv-feat` command output contains other fields that are not used by this procedure. To see all fields displayed by the `rtrv-feat` command, see the `rtrv-feat` command description in *Commands User's Guide*.

If the Fan feature is on, continue the procedure with 10.

If the Fan feature is off, continue the procedure with 8.

9. Turn the Fan feature on by entering this command.

```
chg-feat:fan=on
```

 **Note:**

Once the Fan feature is turned on with the `chg-feat` command, it cannot be turned off.

When the `chg-feat` has successfully completed, this message appears.

```
rlghncxa03w 11-10-28 11:43:04 GMT EAGLE5 44.0.0  
CHG-FEAT: MASP A - COMPLTD
```

10. The shelf containing the E5-ENET-B card that is being added in this procedure must have fans installed. Verify whether or not fans are installed on the shelf.

If the fans are installed, continue the procedure with 11.

If the fans are not installed on the shelf containing the E5-ENET-B card, go to *Installation Guide* and install the fans. After the fans have been installed and tested, continue the procedure with 11.

11. Add the card using the `ent-card` command. For this example, enter these commands.

```
ent-card:loc=1311:type=enetb:appl=ipsg  
ent-card:loc=1313:type=slic:appl=ipsg
```

When each of these commands have successfully completed, this message should appear.

```
rlghncxa03w 06-10-12 09:12:36 GMT EAGLE5 36.0.0  
ENT-CARD: MASP A - COMPLTD
```

12. Verify the changes using the `rtrv-card` command with the card location specified in 11. For this example, enter these commands.

```
rtrv-card:loc=1311
```

This is an example of the possible output.

```
rlghncxa03w 06-10-28 09:12:36 GMT EAGLE5 36.0.0  
CARD   TYPE      APPL      LSET NAME      LINK SLC LSET NAME  
LINK SLC  
1311   ENETB      IPSP
```

```
rtrv-card:loc=1313
```

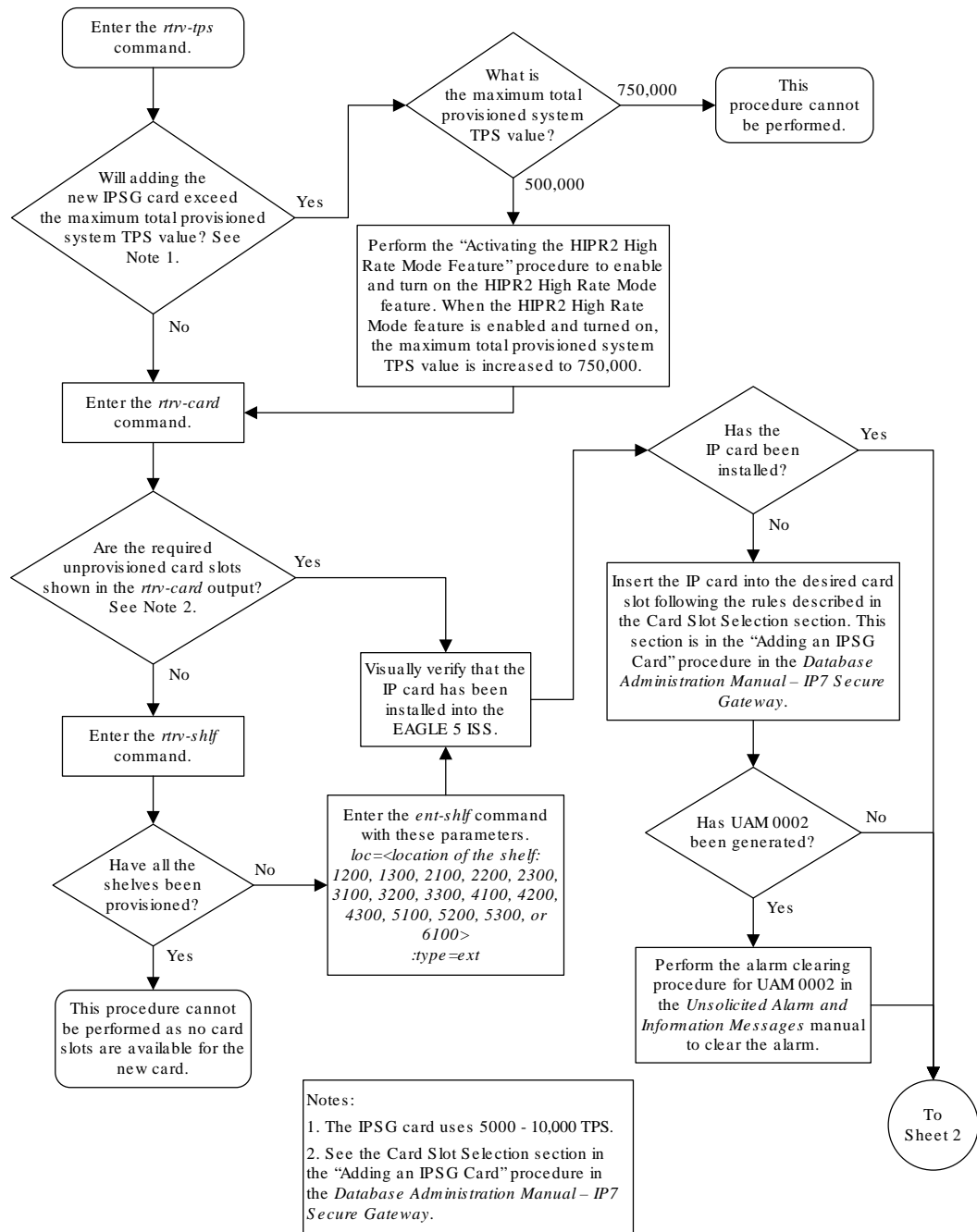
This is an example of the possible output.

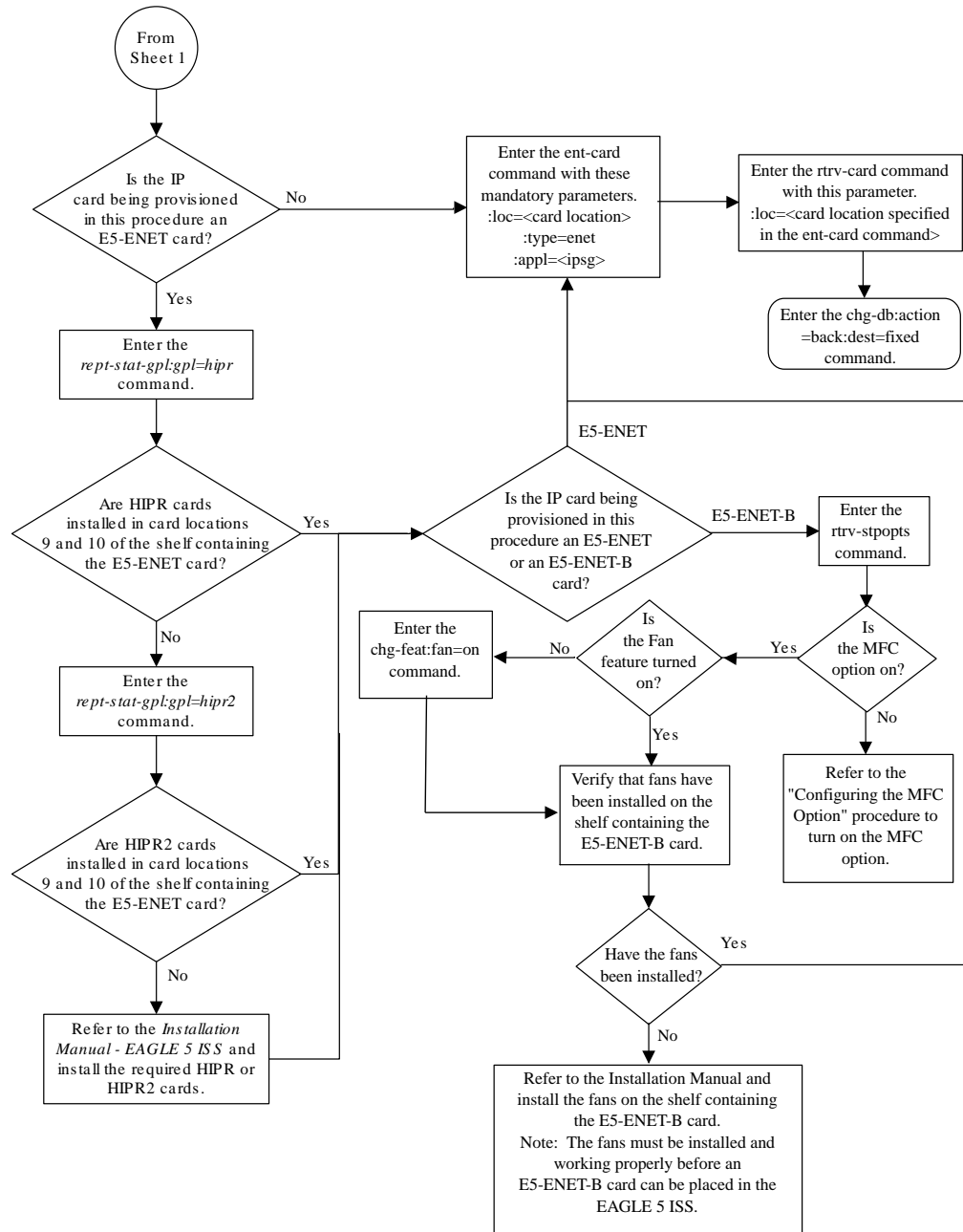
```
rlghncxa03w 06-10-28 09:12:36 GMT EAGLE5 36.0.0  
CARD   TYPE      APPL      LSET NAME      LINK SLC LSET NAME  
LINK SLC  
1313   SLIC      IPSP
```

13. Back up the new changes using the `chg-db:action=backup:dest=fixed` command. These messages should appear, the active **Maintenance and Administration Subsystem Processor (MASP)** appears first.

```
BACKUP (FIXED) : MASP A - Backup starts on active MASP.  
BACKUP (FIXED) : MASP A - Backup on active MASP to fixed disk  
complete.  
BACKUP (FIXED) : MASP A - Backup starts on standby MASP.  
BACKUP (FIXED) : MASP A - Backup on standby MASP to fixed disk  
complete.
```

Figure 6-1 Adding an IPSG Card





Sheet 2 of 2

6.3 Adding an IP SG M2PA Linkset

This procedure is used to configure **IP SG** M2PA linksets in the EAGLE using the `ent-1s` commands with these parameters.

:*lsn* – The name of the linkset. The linkset name can contain up to 10 characters, with the first character being a letter. However, the **SEAS** interface supports only eight characters. If this linkset is displayed on the SEAS interface and the linkset name contains more than eight characters, only the first eight characters in the linkset name are shown. If this linkset name contains more than eight characters, and is specified with the linkset commands on the SEAS interface, only the first eight characters can be specified.

:*apc/apca/apci/apcn/apcn24* – Adjacent point code – the point code identifying the node that is next to the EAGLE. The adjacent point code can be one of the following types of point codes:

:*apc/apca* – **ANSI** point code, ANSI private point code

:*apci* – **ITU-I** point code, **ITU-I** spare point code, ITU-I private point code, ITU-I private spare point code.

:*apcn* – 14-bit ITU-N point code, 14-bit ITU-N spare point code, 14-bit **ITU-N** private point code, 14-bit ITU-N private spare point code.

:*apcn24* – 24-bit ITU-N point code, 24-bit ITU-N private point code.



Note:

See the “**Point Code** Formats” section in *Database Administration - SS7 User's Guide* for a definition of the point code types that are used on the **EAGLE** and for a definition of the different formats that can be used for **ITU** national point codes.

:*lst* – The linkset type of the specified linkset, a, b, c, d, e. The linkset type *prx* can also be specified for an IPSP M2PA linkset. For more information on using the *prx* linkset type, refer to the “Adding an SS7 Linkset” procedure in *Database Administration - SS7 User's Guide*.

:*ipsg* – This parameter specifies whether or not the linkset is an IPSP linkset. This parameter has two values, *yes* (if the linkset is an IPSP linkset) or *no* (if the linkset is not an IPSP linkset). For this procedure, the *ipsg* parameter value must be *yes*.

:*maxslktps* – The maximum number of transactions per second (TPS) for all signaling links that are assigned to the IPSP M2PA linkset. See [Maximum Card Capacity for Different Card Types](#) for MaxTPS values.

:*rsvdslktps* – The number of transactions per second (TPS) that is assigned to each IPSP signaling link that will be in the linkset. See [Maximum Card Capacity for Different Card Types](#) for MaxTPS values. The *slktps* parameter can be used in place of the *rsvdslktps* parameter.

:*tpsalmtype* – The TPS threshold that will generate alarms. This parameter has two values.

- *rsvdslktps* - The **RSVDSLKTPS** threshold generates alarms.
- *maxslktps* - The **MAXSLKTPS** threshold generates alarms.

:*lsusealm* – The linkset's TPS alarm threshold, from 10 to 100 percent of the linkset's IPTPS. When this threshold is reached, a major alarm (**UAM 0115**) is generated. When the linkset's IPTPS falls below this threshold, **UAM 0115** is automatically cleared and **UAM 0118** is generated.

:slkusealm – The signaling link TPS alarm threshold, from 10 to 100 percent of the signaling link's fair share of the linkset's TPS from 10 to 100 percent of the **IPSP** card's capacity See [Maximum Card Capacity for Different Card Types](#) for MaxTPS values. This threshold is reached when the signaling link's actual usage exceeds the percentage of the signaling link's fair share of the linkset's TPS or the percentage of the IPGWx card's capacity.

A signaling link's fair share of linkset's TPS is the linkset's TPS divided by the number of in-service links in the linkset. For example, if the linkset TPS is 4000 and there are 4 signaling links in the linkset, all in-service, then the signaling link's fair-share would be 1000 TPS (4000/4=1000). [Table 6-1](#) shows this calculation for a linkset with 1, 2, 3 and 4 in-service signaling links.

Table 6-1 Signaling Link Fair Share Example

Number of In-Service Signaling Links	Linkset TPS	Signaling Link Fair Share of the Linkset TPS
4	4000	1000
3	4000	1333
2	4000	2000
1	4000	4000

When this threshold is exceeded, a minor alarm (**UAM 0116**) is generated. When the amount of traffic on the signaling link falls below this threshold, **UAM 0116** is automatically cleared and **UAM 0119** is generated.

The signaling link TPS alarm shows that the linkset TPS is set too low for the linkset or that the **IPSP** card's capacity has been exceeded. Setting the signaling link TPS alarm threshold lower than the linkset TPS alarm threshold can give the user an earlier indication that the linkset TPS is inadequate or that traffic is not balanced across the links in the linkset.

:adapter - This parameter specifies the adapter layer for the signaling links that will be assigned to the IPSP M2PA linkset. This parameter has two values, m2pa and m3ua. For an IPSP M2PA linkset, the adapter parameter value must be m2pa.

The adjacent point code (**APC**) for the linkset must be defined in the database, must be in the SS7 domain and cannot match the point code or capability point code of the EAGLE. The domain of the point code is shown in the DMN field in the output of the rtrv-dstn command. The point code of the EAGLE is shown in the PCA, PCN, PCN24, or PCI fields and the capability point code of the EAGLE are shown in the CPCA, CPCN, CPCN24, or CPCI fields in the output of the rtrv-sid command. An **ANSI** adjacent point code must be a full point code and cannot be a cluster point code or a network routing point code.

If the **APC** is not in the destination point code table, go to the “Adding a **Destination Point Code**” procedure in *Database Administration - SS7 User's Guide* and add the **APC** to the destination point code table.

Adding the IPSP M2PA linkset cannot exceed the maximum total provisioned system TPS shown in the rtrv-tps output. An IPSP M2PA linkset uses from 100 to MaxTPS (see [Maximum Card Capacity for Different Card Types](#) for MaxTPS values, as provisioned by the maxslktps parameter.

If adding the IPGS M2PA linkset will exceed the maximum total provisioned system TPS, and the maximum total provisioned system TPS is 500,000, perform the "Activating the HIPR2 High Rate Mode" feature in *Database Administration - System Management User's Guide* to enable and turn on the HIPR2 High Rate Mode feature. When the HIPR2 High Rate Mode feature is enabled and turned on, the maximum total provisioned system TPS is increased to 1,000,000 (1M). If the maximum total provisioned system TPS is 1M, or the maximum total provisioned system TPS is 500,000 and will not be increased, and adding the IPGS M2PA linkset will exceed the maximum total provisioned system TPS, the IPGS M2PA linkset cannot be added unless the amount of available TPS is reduced enough to allow the IPGS M2PA linkset to be added. The available TPS can be reduced by performing one or more of these actions.

- The IP TPS values of some IPGWx linksets have to be changed.
- The MAXSLKTPS values of some IPGS linksets (and the RSVDSLKTPS values if necessary) have to be changed.
- Some ATM high-speed signaling links have to be removed.
- An IPLIMx card that contains signaling links has to be removed.

Other Optional Parameters

There are other optional parameters that can be used to configure an IPGS M2PA linkset. These parameters are not required for configuring an IPGS M2PA linkset. These parameters are discussed in more detail in *Commands User's Guide* or in these sections.

- These procedures in this manual:
 - [Adding a Mate IPGWx Linkset to another IPGWx Linkset](#)
 - [Removing a Mate IPGWx Linkset from another IPGWx Linkset](#)
 - [Configuring an IPGWx Linkset](#)
- These procedures in *Database Administration - SS7 User's Guide*
 - Adding an SS7 Linkset
 - Changing an SS7 Linkset
 - Configuring an ITU Linkset with a Secondary Adjacent Point Code (SAPC)
- The "Configuring a Linkset for the GSM MAP Screening Feature" procedure in *Database Administration - Features User's Guide*.

Canceling the RTRV-LS and RTRV-DSTN Commands

Because the `rtrv-ls` and `rtrv-dstn` commands used in this procedure can output information for a long period of time, the `rtrv-ls` and `rtrv-dstn` commands can be canceled and the output to the terminal stopped. There are three ways that the `rtrv-ls` and `rtrv-dstn` commands can be canceled.

- Press the F9 function key on the keyboard at the terminal where the `rtrv-ls` or `rtrv-dstn` commands were entered.
- Enter the `canc-cmd` without the `trm` parameter at the terminal where the `rtrv-ls` or `rtrv-dstn` commands were entered.
- Enter the `canc-cmd:trm=<xx>`, where `<xx>` is the terminal where the `rtrv-ls` or `rtrv-dstn` commands were entered, from another terminal other than the terminal where the `rtrv-ls` or `rtrv-dstn` commands were entered. To enter the `canc-cmd:trm=<xx>` command, the terminal must allow Security Administration commands to

be entered from it and the user must be allowed to enter Security Administration commands. The terminal's permissions can be verified with the `rtrv-secu-trm` command. The user's permissions can be verified with the `rtrv-user` or `rtrv-secu-user` commands.

For more information about the `canc-cmd` command, go to *Commands User's Guide*.

1. Display the current linksets in the database using the `rtrv-ls` command.

This is an example of the possible output.

```
rlghncxa03w 10-07-10 11:43:04 GMT EAGLE5 42.0.0
```

LSN	APCA (SS7)	SCRN	L3T SET	SLT SET	BEI	LST	LNKS	GWS ACT	GWS MES	GWS DIS
SLSCI NIS ipgwx1 no off	001-001-002	none	1	1	no	A	8	off	off	off
ipgwx2 no off	001-001-003	none	1	1	no	A	8	off	off	off
ipgwx3 no off	001-001-004	none	1	1	no	A	0	off	off	off
ls1305 no off	001-005-000	none	1	1	no	A	1	off	off	off
ls1307 no off	001-007-000	none	1	1	no	A	1	off	off	off
lsniplim no off	002-002-002	none	1	1	no	A	3	off	off	off
ipsglsn no off	003-003-003	none	1	1	no	A	6	off	off	off
lsn2 no off	003-003-004	none	1	1	no	A	1	off	off	off
lsn1 no off	003-003-005	none	1	1	no	A	1	off	off	off
ipsglsn2 no off	005-005-005	none	1	1	no	A	1	off	off	off
lsnds0 no off	009-009-009	none	1	1	no	A	2	off	off	off

LSN	APCI (SS7)	SCRN	L3T SET	SLT SET	BEI	LST	LNKS	GWS ACT	GWS MES	GWS DIS
SLSCI NIS lsnituatm no off	1-002-3	none	1	2	no	A	1	off	off	off

Link set table is (12 of 1024) 1% full.

2. Display the point code and capability point code of the **EAGLE** by using the `rtrv-sid` command.

This is an example of the possible output.

```
rlghncxa03w 10-07-10 11:43:04 GMT EAGLE5 42.0.0
```

```

PCA          PCI          PCN          CLLI          PCTYPE
001-001-001  1-200-6        13482        rlghncxa03w   OTHER

CPCA
002-002-001  002-002-003    002-002-004  002-002-005
002-002-006  002-002-007    002-002-008  002-002-009
004-002-001  004-003-003    144-212-003

CPCA (LNP)
005-005-002  005-005-004    005-005-006

CPCI
1-001-1      1-001-2        1-001-3      1-001-4

CPCN
02091        02092          02094        02097
02191        02192          11177

```

3. Display the destination point codes in the database by entering the `rtrv-dstn` command. This is an example of the possible output.

```

rlghncxa03w 10-12-10 11:43:04 GMT EAGLE5 43.0.0
Extended Processing Time may be Required

```

```

DPCA          CLLI          BEI  ELEI  ALIASI          ALIASN/N24  DMN
001-207-000  ----- no  --- -----
001-001-002  ----- no  --- -----
001-001-003  ----- no  --- -----
001-001-004  ----- no  --- -----
001-005-000  ----- no  --- -----
001-007-000  ----- no  --- -----
002-002-002  ----- no  --- -----
003-002-004  ----- no  --- -----
003-003-003  ----- no  --- -----
003-003-004  ----- no  --- -----
003-003-005  ----- no  --- -----
005-005-005  ----- no  --- -----
008-012-003  ----- no  --- -----
009-002-003  ----- no  --- -----
009-009-009  ----- no  --- -----
010-020-005  ----- no  --- -----

DPCI          CLLI          BEI  ELEI  ALIASA          ALIASN/N24  DMN
1-002-3      ----- no  --- -----
1-207-0      ----- no  --- -----
0-015-0      ----- no  --- -----
0-017-0      ----- no  --- -----
1-011-1      ----- no  --- -----
1-011-2      ----- no  --- -----

```

```

Destination table is (22 of 2000) 2% full
Alias table is (0 of 12000) 0% full

```

If the new adjacent point code is not shown in the `rtrv-dstn` output, perform the "Adding a Destination Point Code" procedure in *Database Administration - SS7 User's Guide* to add the required point code. After the new adjacent point code has been added, continue the procedure with 7.

If the new adjacent point code is shown in the `rtrv-dstn` output, continue the procedure with 4.

4. Display the adjacent point code of the new linkset in the destination point code table by using the `rtrv-dstn` command and specifying the point code. For this example, enter this command.

```
rtrv-dstn:dpca=010-020-005
```

This is an example of the possible output.

```
rlghncxa03w 10-12-10 11:43:04 GMT EAGLE5 43.0.0

      DPCA          CLLI          BEI ELEI  ALIASI
ALIASN/N24  DMN
      010-020-005  ----- no  --- -----
-----
                SS7

      SPCA          NCAI          RCAUSE NPRST SPLITIAM HMSMSC HMSCP
SCCPMSGCNV
      -----  ----                none  off  none    no    no    none

Destination table is (14 of 2000) 1% full
Alias table is (0 of 12000) 0% full
```

5. The **APC** of the linkset cannot be the **DPC** of any exception route. Verify that the adjacent point code of the linkset is not the **DPC** of any exception route by entering the `rtrv-rtx` command with the `dpc/dpca/dpci/dpcn/dpcn24` parameter. The `dpc/dpca/dpci/dpcn/dpcn24` parameter value is the adjacent point code value that will be specified for the linkset.

For this example, enter this command.

```
rtrv-rtx:dpca=010-020-005
```

This is an example of the possible output.

```
rlghncxa03w 06-10-10 11:43:04 GMT EAGLE5 37.5.0

      DPCA          RTX-CRITERIA          LSN          RC          APC

      010-020-005  OPCA
                        007-008-009          1s1305          20
001-005-000
                        008-008-008          1s1307          40
001-007-000

DESTINATION ENTRIES ALLOCATED: 2000
FULL DPC(s) : 13
EXCEPTION DPC(s) : 5
NETWORK DPC(s) : 0
CLUSTER DPC(s) : 1
```

```
TOTAL DPC(s) : 19
CAPACITY (% FULL) : 1%
ALIASES ALLOCATED: 12000
ALIASES USED: 0
CAPACITY (% FULL) : 0%
X-LIST ENTRIES ALLOCATED: 500
```

If the adjacent point code of the linkset is not the **DPC** of a route exception table entry, no entries are displayed in the `rtrv-rtx` output, but a summary of the point code quantities is displayed, as shown in the following output example.

```
rlghncxa03w 06-10-10 11:43:04 GMT EAGLE5 37.5.0
```

```
DESTINATION ENTRIES ALLOCATED: 2000
FULL DPC(s) : 15
EXCEPTION DPC(s) : 5
NETWORK DPC(s) : 0
CLUSTER DPC(s) : 1
TOTAL DPC(s) : 21
CAPACITY (% FULL) : 1%
ALIASES ALLOCATED: 12000
ALIASES USED: 0
CAPACITY (% FULL) : 0%
X-LIST ENTRIES ALLOCATED: 500
```

If the point code specified in this step is shown in the `DPCA/DPCI/DPCN/ DPCN24` columns in this step, the point code value cannot be used as an adjacent point code unless one of two actions are taken:

- Choose another adjacent point code value and repeat the procedure from 2.
- Remove all the entries displayed in this step by performing the “Removing a Route Exception Entry” procedure in *Database Administration - SS7 User's Guide*. After the entries have been removed, continue the procedure with 6.

If the adjacent point code of the linkset is not the **DPC** of a route exception table entry, continue the procedure with 6.

6. Display any entries in the route table whose **DPC** value is also the adjacent point code of the new linkset being added in this procedure, or the new adjacent point code of the existing linkset being changed in this procedure. Enter the `rtrv-rte` command with the `dpc/dpca/dpci/dpcn/dpcn24` parameter. The `dpc/dpca/dpci/dpcn/dpcn24` parameter value is the adjacent point code value that will be specified for the linkset. For this example, enter this command.

```
rtrv-rte:dpca=010-020-005
```

This is an example of the possible output.

```
rlghncxa03w 10-07-10 11:43:04 GMT EAGLE5 42.0.0
```

DPCA	ALIASI	ALIASN/N24	LSN	RC	APCA
010-020-005	-----	-----	lsn1	1	003-003-005

```

                                lsn2      2
003-003-004
                                RTX:No
CLLI=-----

```

If the adjacent point code of the linkset is not the **DPC** of a route, the point code entry is displayed in the `rtrv-rte` output, but the **LSN**, **RC**, and **APC** columns contain dashes, as shown in the following output example.

```

rlghncxa03w 10-07-10 11:43:04 GMT EAGLE5 42.0.0

  DPCA          ALIASI      ALIASN/N24      LSN          RC      APCA
  010-020-005  -----  -----  -----  --
-----
                                RTX:No
CLLI=-----

```

If the point code specified in this step is shown in the `DPCA/DPCI/DPCN/ DPCN24` columns in this step, the point code value cannot be used as an adjacent point code unless one of two actions are taken:

- Choose another adjacent point code value and repeat the procedure with [2](#).
- Remove all the entries displayed in this step by performing the “Removing a **Route**” procedure in *Database Administration - SS7 User's Guide*. After the entries have been removed, continue the procedure with [12](#)

If the adjacent point code of the linkset is not the **DPC** of a route, continue the procedure with [7](#).

7. Display the total provisioned system TPS by entering the `rtrv-tps` command. This is an example of the possible output.

```

rlghncxa03w 10-07-10 16:20:46 GMT EAGLE 42.0.0

CARD      NUM      NUM      RSVD      MAX
TYPE     CARDS   LINKS    TPS      TPS
-----  -----  -----  -----  -----
IPGW      17      16      48000    80000
IPSG      3       7       4200     8000
IPLIM     2       4       8000     8000
ATM       2       2       3668     3668

Total provisioned System TPS (99668 of 500000) 20%

Command Completed.

```

An IPSG M2PA linkset uses 100 to MaxTPS (see [Maximum Card Capacity for Different Card Types](#) for MaxTPS values), as provisioned by the `maxslktps` parameter. If adding the new IPSG M2PA linkset will not exceed the maximum total provisioned system TPS, continue the procedure with [12](#).

If adding the new IPSP M2PA linkset will exceed the maximum total provisioned system TPS, and the maximum total provisioned system TPS is 500,000 shown, perform the "Activating the HIPR2 High Rate Mode Feature" procedure in *Database Administration - System Management User's Guide* to enable and turn on the HIPR2 High Rate Mode feature. When the HIPR2 High Rate Mode feature is enabled and turned on, the maximum total provisioned system TPS is increased to 1M. After the HIPR2 High Rate Mode feature has been enabled and turned on, continue the procedure with [12](#).

If the maximum total provisioned system TPS is 1M, or the maximum total provisioned system TPS is 500,000 and will not be increased, and adding the IPSP M2PA linkset will exceed the maximum total provisioned system TPS, the IPSP M2PA linkset cannot be added unless the amount of available TPS is reduced enough to allow the IPSP M2PA linkset to be added. The available TPS can be increased by performing one or more of these actions.

- The IP TPS values of some IPGWx linksets have to be changed. To perform this action, continue the procedure with [10](#).
 - The MAXSLKTPS values of some IPSP linksets (and the RSVDSLKTPS values if necessary) have to be changed. To perform this action, continue the procedure with [10](#).
 - Some ATM high-speed signaling links have to be removed. To perform this action, continue the procedure with [8](#).
 - An IPLIMx card that contains signaling links has to be removed. To perform this action, continue the procedure with [9](#).
8. Display the ATM high-speed signaling links by entering this command.

```
rtrv-slk:type=saal
```

This is an example of the possible output.

```
rlghncxa03w 10-07-19 21:16:37 GMT EAGLE5 42.0.0
```

LOC	LINK	LSN	SLC	TYPE	LP	ATM	VCI	VPI	LL	
					SET	BPS	TSEL			
1303	A	lsnds0	1	LIMATM	1	1.544M	LINE	5	0	0

LOC	LINK	LSN	SLC	TYPE	LP	ATM	VCI	VPI	CRC4	SI
					SET	BPS	TSEL			
1306	A	lsnituatm	0	LIME1ATM	21	2.048M	LINE	5	0	ON 3 0

```
SLK table is (30 of 1200) 2% full.
```

If ATM high-speed signaling links are shown in the `rtrv-slk` output, perform the "Removing an SS7 Signaling Link" procedure in *Database Administration - SS7 User's Guide* to remove some of the ATM high-speed signaling links.

If ATM high-speed signaling links are not displayed in the `rtrv-slk` output, perform one or more of these actions to increase the available TPS.

 **Note:**

If one or more of these actions are not performed to increase the available TPS and the available TPS will not allow the IPSG M2PA linkset to be added, the IPSG M2PA linkset cannot be added and the remainder of this procedure cannot be performed.

- The IP TPS values of some IPGWx linksets have to be changed. To perform this action, continue the procedure with [10](#).
- The MAXSLKTPS values of some IPSG linksets (and the RSVDSLKTPS values if necessary) have to be changed. To perform this action, continue the procedure with [10](#).
- An IPLIMx card that contains signaling links has to be removed. To perform this action, continue the procedure with [9](#).

If you do not wish to perform other actions to increase the available TPS and the available TPS will allow the IPSG M2PA linkset to be added, continue the procedure with [12](#).

9. Display the signaling links that are assigned to IPLIMx cards by entering this command.

```
rtrv-slk:type=iplim
```

This is an example of the possible output.

```
rlghncxa03w 10-07-19 21:16:37 GMT EAGLE5 42.0.0
```

LOC	LINK	LSN	SLC	TYPE	ANAME	SLKTPS
1301	A	lsniplim	0	IPLIM	M2PA	
1301	A1	lsniplim	1	IPLIM	M2PA	
1301	B1	lsniplim	2	IPLIM	M2PA	
1317	A	lsniplimi	0	IPLIMI	M2PA	

```
SLK table is (30 of 1200) 2% full.
```

If IPLIMx cards containing signaling links are shown in the `rtrv-slk` output, perform the [Removing an IPLIMx Card](#) procedure to remove an IPLIMx card and its associated signaling links.

If IPLIMx cards containing signaling links are not displayed in the `rtrv-slk` output, perform one or more of these actions to increase the available TPS.

 **Note:**

If one or more of these actions are not performed to increase the available TPS and the available TPS will not allow the IPSG M2PA linkset to be added, the IPSG M2PA linkset cannot be added and the remainder of this procedure cannot be performed.

- The IP TPS values of some IPGWx linksets have to be changed. To perform this action, continue the procedure with 10.
- The MAXSLKTPS values of some IPSP linksets (and the RSVDSLKTPS values if necessary) have to be changed. To perform this action, continue the procedure with 10.
- Some ATM high-speed signaling links have to be removed. To perform this action, continue the procedure with 8.

If you do not wish to perform other actions to increase the available TPS and the available TPS will allow the IPSP M2PA linkset to be added, continue the procedure with 12.

10. Display the IPGWx and IPSP linksets by entering this command.

```
rept-stat-iptps
```

This is an example of the possible output.

```
rlghncxa03w 10-07-19 21:16:37 GMT EAGLE5 42.0.0
IP TPS USAGE REPORT
```

	THRESH	CONFIG/ RSVD	CONFIG/ MAX		TPS	PEAK	PEAKTIMESTAMP

LSN							
ipgw1	100%	----	32000	TX:	3700	4000	10-07-19 09:49:19
				RCV:	3650	4000	10-07-19 09:49:19
ipgw2	100%	----	16000	TX:	4800	5000	10-07-19 09:49:09
				RCV:	4850	5000	10-07-19 09:49:09
ipgw3	100%	----	32000	TX:	427	550	10-07-19 09:49:19
				RCV:	312	450	10-07-19 09:49:19
ipsglsn	100%	600	24000	TX:	4800	5000	10-07-19 09:49:19
				RCV:	4800	5000	10-07-19
09:49:19							
ipsglsn2	100%	600	4000	TX:	427	550	10-07-19 09:49:19
				RCV:	312	450	10-07-19
09:49:19							

Command Completed.

If linksets are displayed in the `rept-stat-iptps` output, continue the procedure with 11.

If linksets are not displayed in the `rept-stat-iptps` output, perform one or more of these actions to increase the available TPS.

 **Note:**

If one or more of these actions are not performed to increase the available TPS and the available TPS will not allow the IPSP M2PA linkset to be added, the IPSP M2PA linkset cannot be added and the remainder of this procedure cannot be performed.

- An IPLIMx card that contains signaling links has to be removed. To perform this action, continue the procedure with 9.
- Some ATM high-speed signaling links have to be removed. To perform this action, continue the procedure with 8.

If you do not wish to perform other actions to increase the available TPS and the available TPS will allow the IPSG M2PA linkset to be added, continue the procedure with 12.

11. Display the attributes of the linksets shown in 10 by entering the `rtrv-ls` command with the name of the linkset shown in 10.

For this example enter these commands.

```
rtrv-ls:lsn=ipgwx1
```

This is an example of the possible output.

```
rlghncxa03w 10-07-19 21:16:37 GMT EAGLE5 42.0.0

LSN              APCA  (SS7)  SCRN SET SET BEI LST LNKS ACT MES DIS
SLSCI NIS
ipgwx1           001-001-002  none 1  1  no  A  8  off off off
no      off

              SPCA              CLLI              TFATCABMLQ MTPRSE ASL8
              -----
              4              ---      no

RANDSLS
off

IPSG  IPGWAPC  GTTMODE              CGGTMOD
no    yes    CdPA              no

MATELSN  IPTPS  LSUSEALM  SLKUSEALM
-----  32000  100%    80%

LOC  LINK  SLC  TYPE
1101 A    0    SS7IPGW
1102 A    1    SS7IPGW
1103 A    2    SS7IPGW
1104 A    3    SS7IPGW
1105 A    4    SS7IPGW
1106 A    5    SS7IPGW
1107 A    6    SS7IPGW
1108 A    7    SS7IPGW
```

Link set table is (8 of 1024) 1% full.

```
rtrv-ls:lsn=ipgwx2
```

This is an example of the possible output.

```
rlghncxa03w 10-07-19 21:16:37 GMT EAGLE5 42.0.0
```

```

                L3T SLT                GWS GWS GWS
LSN            APCA  (SS7)  SCRN SET SET BEI LST LNKS ACT MES DIS SLSCI
NIS
ipgwx2         001-001-003  none 1  1  no  A  8  off off off no
off

```

```

                SPCA                CLLI                TFATCABMLQ MTPRSE ASL8
-----
                4                ---                no

```

```
RANDSLS
off
```

```

IPSG  IPGWAPC  GTTMODE                CGGTMOD
no    yes      CdPA                no

```

```

MATELSN      IPTPS      LSUSEALM  SLKUSEALM
----- 16000      100%      80%

```

```

LOC  LINK  SLC  TYPE
1111 A    0   SS7IPGW
1112 A    1   SS7IPGW
1201 A    2   SS7IPGW
1202 A    3   SS7IPGW
1203 A    4   SS7IPGW
1204 A    5   SS7IPGW
1205 A    6   SS7IPGW
1206 A    7   SS7IPGW

```

Link set table is (8 of 1024) 1% full.

```
rtrv-ls:lsn=ipgwx3
```

This is an example of the possible output.

```
rlghncxa03w 10-07-19 21:16:37 GMT EAGLE5 42.0.0
```

```

                L3T SLT                GWS GWS GWS
LSN            APCA  (SS7)  SCRN SET SET BEI LST LNKS ACT MES DIS SLSCI
NIS
ipgwx3         001-001-004  none 1  1  no  A  0  off off off no
off

```

```

                SPCA                CLLI                TFATCABMLQ MTPRSE ASL8
-----
                1                ---                no

```

```
RANDSLS
off
```

```

IPSG  IPGWAPC  GTTMODE          CGGTMOD
no    yes     CdPA              no

MATELSN  IPTPS  LSUSEALM  SLKUSEALM
-----  -----  -----  -----
          32000  100%     80%

```

Link set table is (8 of 1024) 1% full.

rtrv-ls:lsn=ipsglsn

This is an example of the possible output.

rlghncxa03w 10-07-19 21:16:37 GMT EAGLE5 42.0.0

```

LSN          APCA  (SS7)  L3T SLT          GWS GWS GWS
SLSCI NIS
ipsglsn      003-003-003  none 1  1  no  A  6  off off off
no          off

```

```

          SPCA          CLLI          TFATCABMLQ  MTPRSE  ASL8
-----  -----  -----  ---  ---
          3          ---  no

```

```

RANDSLS
off

```

```

IPSG  IPGWAPC  GTTMODE          CGGTMOD
yes   no      CdPA              no

```

```

ADAPTER  RSVDSLKTPS  MAXSLKTPS
m2pa     600      4000

```

```

TPSALM  LSUSEALM  SLKUSEALM
rsvdsktps 100%  100%

```

```

LOC  LINK  SLC  TYPE  ANAME
1303 A  0  IPG  ipsgm2pa1
1303 A1 1  IPG  ipsgm2pa2
1303 B1 2  IPG  ipsgm2pa3
1303 A2 3  IPG  ipsgm2pa4
1303 A3 4  IPG  ipsgm2pa5
1307 A  5  IPG  m2pa2

```

Link set table is (8 of 1024) 1% full.

rtrv-ls:lsn=ipsglsn2

This is an example of the possible output.

rlghncxa03w 10-07-19 21:16:37 GMT EAGLE5 42.0.0

```

                L3T SLT                GWS GWS GWS
LSN            APCA  (SS7)  SCRN SET SET BEI LST LNKS ACT MES DIS SLSCI
NIS
ipsglsn2      005-005-005  none 1   1   no  A   1   off off off no
off

                SPCA                CLLI                TFATCABMLQ MTPRSE ASL8
-----
RANDSLS
off

IPSG  IPGWAPC  GTTMODE                CGGTMOD
yes   no       CdPA                    no

ADAPTER  RSVDSLKTPS  MAXSLKTPS
m2pa     600         4000

TPSALM   LSUSEALM   SLKUSEALM
rsvdslktps 100%     100%

LOC  LINK  SLC  TYPE  ANAME
1303 B3   0   IPG   ipsgm2pa6

```

Link set table is (8 of 1024) 1% full.

Perform one or both of these actions as necessary.

- Perform the [Configuring an IPGWx Linkset](#) procedure to change the IPTPS value for any linksets shown in the `rtrv-ls` output whose IPGWAPC value is `yes`.
- Perform the [Changing an IPSG M2PA Linkset](#) procedure (for linkset whose IPSG value is `yes` and ADAPTER value is M2PA) or the [Changing an IPSG M3UA Linkset](#) procedure (for linkset whose IPSG value is `yes` and ADAPTER value is M3UA) to change the MAXSLKTPS value (and RSVDSLKTPS value if necessary) for any linksets shown in the `rtrv-ls` output.

Perform one or both of these actions to increase the available TPS if needed.

- An IPLIMx card that contains signaling links has to be removed. To perform this action, continue the procedure with [9](#).
- Some ATM high-speed signaling links have to be removed. To perform this action, continue the procedure with [8](#).

If you do not wish to perform other actions to increase the available TPS and the available TPS will allow the IPSG M2PA linkset to be added, continue the procedure with [12](#).

12. Add the new linkset to the database using the `ent-ls` command. The new linkset must meet these conditions.

The name of this linkset cannot be used by another linkset – the linkset configuration is shown in the output of [1](#).

The **APC** of the new linkset must be in the destination point code table, but cannot be either the **EAGLE**'s point code or the **EAGLE**'s capability point code – shown in the

outputs of 2, 3, and 4. The adjacent point code can be one of the following types of point codes:

:apc/apca – ANSI point code, ANSI private point code

:apci – ITU-I point code, ITU-I spare point code, ITU-I private point code, ITU-I private spare point code.

:apcn – 14-bit ITU-N point code, 14-bit ITU-N spare point code, 14-bit ITU-N private point code, 14-bit ITU-N private spare point code.

:apcn24 – 24-bit ITU-N point code, 24-bit ITU-N private point code.

These parameters and values must also be specified for the IPSP M2PA linkset:

- ipsg=yes
- adapter=m2pa
- lst=<a,b,c,d,e>
- maxslktps=<100 - > see [Maximum Card Capacity for Different Card Types](#).
- rsvdslktps=<0 - > see [Maximum Card Capacity for Different Card Types](#).

 **Note:**

The maxslktps parameter value must be greater than or equal to the rsvdslktps parameter value. The slktps parameter can be used in place of the rsvdslktps parameter.

- The ipgwapc, iptps, rcontext, and asnotif parameters cannot be specified for an IPSP M2PA linkset.
- These optional parameters can be specified with the ent-ls command.
 - lsusealm - the linkset's IP TPS alarm threshold. The default value for the lsusealm parameter is 100.
 - slkusealm - the signaling link IP TPS alarm threshold. The default value for the slkusealm parameter is 80.
 - tpsalmtype - The TPS threshold that will generate alarms, either rsvdslktps or maxslktps. The default value for the tpsalmtype parameter is rsvdslktps.

For this example, enter this command.

```
ent-
ls:lsn=lsgw1107:apca=010-020-005:lst=a:ipsg=yes:rsvdslktps=2
00:maxslktps=1000 :lsusealm=70:slkusealm=70:adapter=m2pa
```

When this command has successfully completed, this message should appear.

```
rlghncxa03w 06-10-17 16:23:21 GMT EAGLE5 37.5.0
Link set table is ( 14 of 1024) 1% full
ENT-LS: MASP A - COMPLTD
```


13. Verify the changes using the `rtrv-ls` command specifying the linkset name specified in 12 with the `lsn` parameter. For this example, enter these commands.

```
rtrv-ls:lsn=lsgw1107
```

This is an example of the possible output.

```
rlghncxa03w 10-07-17 11:43:04 GMT EAGLE5 42.0.0
```

```

                                L3T SLT                                GWS GWS GWS
LSN          APCA   (SS7)  SCRN  SET SET BEI LST LNKS ACT MES DIS SLSCI
NIS
lsgw1107     010-020-005  none  1  1  no  A  0   off off off no
off

```

```

                                SPCA                                CLLI                                TFATCABMLQ MTPRSE ASL8
-----
                                1                                ---      no

```

```
RANDSLS
off
```

```

IPSP  IPGWAPC  GTTMODE                                CGGTMOD
yes   no      CdPA                                no

```

```

ADAPTER      RSVDSLKTPS  MAXSLKTPS
m2pa         200        1000

```

```

TPSALM      LSUSEALM  SLKUSEALM
rsvdslktps  70%       70%

```

```
Link set table is ( 14 of 1024) 1% full
```

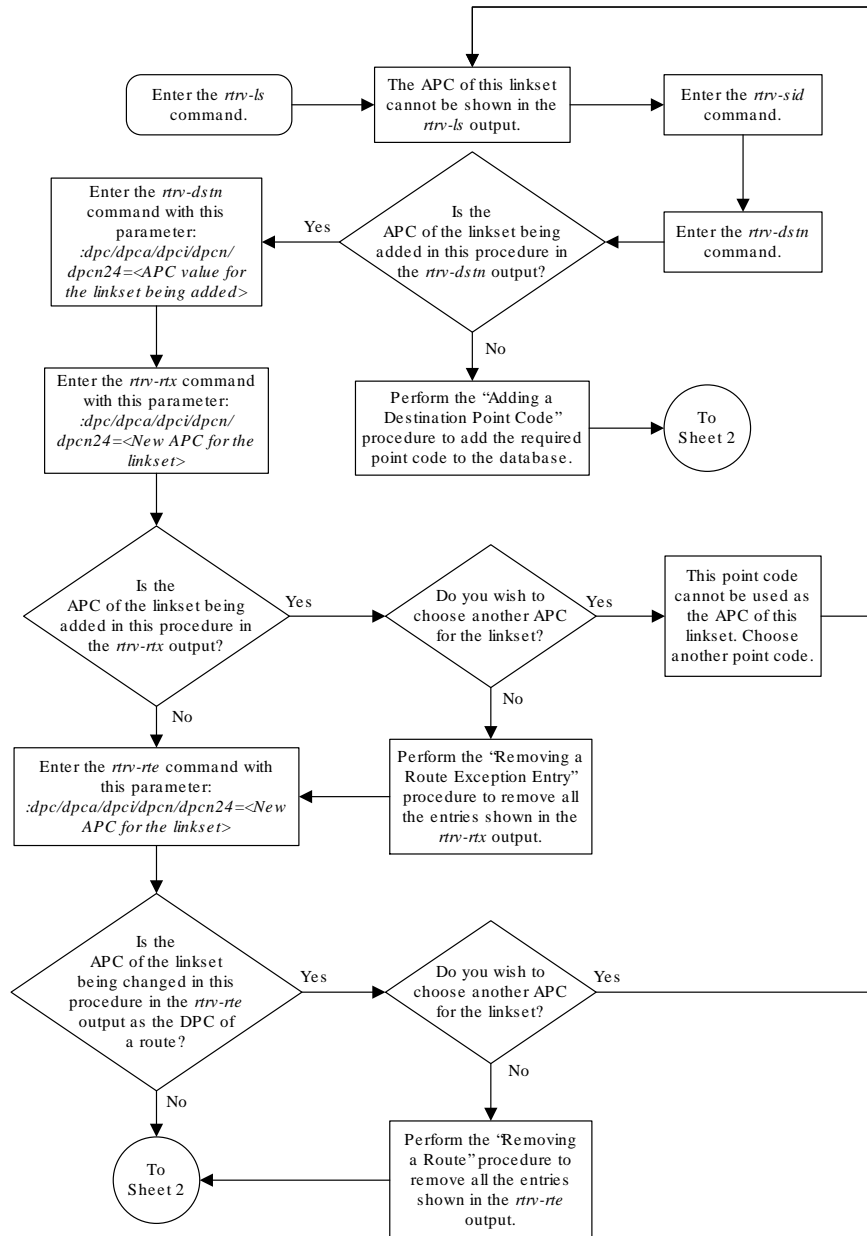
14. Back up the new changes using the `chg-db:action=backup:dest=fixed` command. These messages should appear, the active **Maintenance and Administration Subsystem Processor (MASP)** appears first.

```

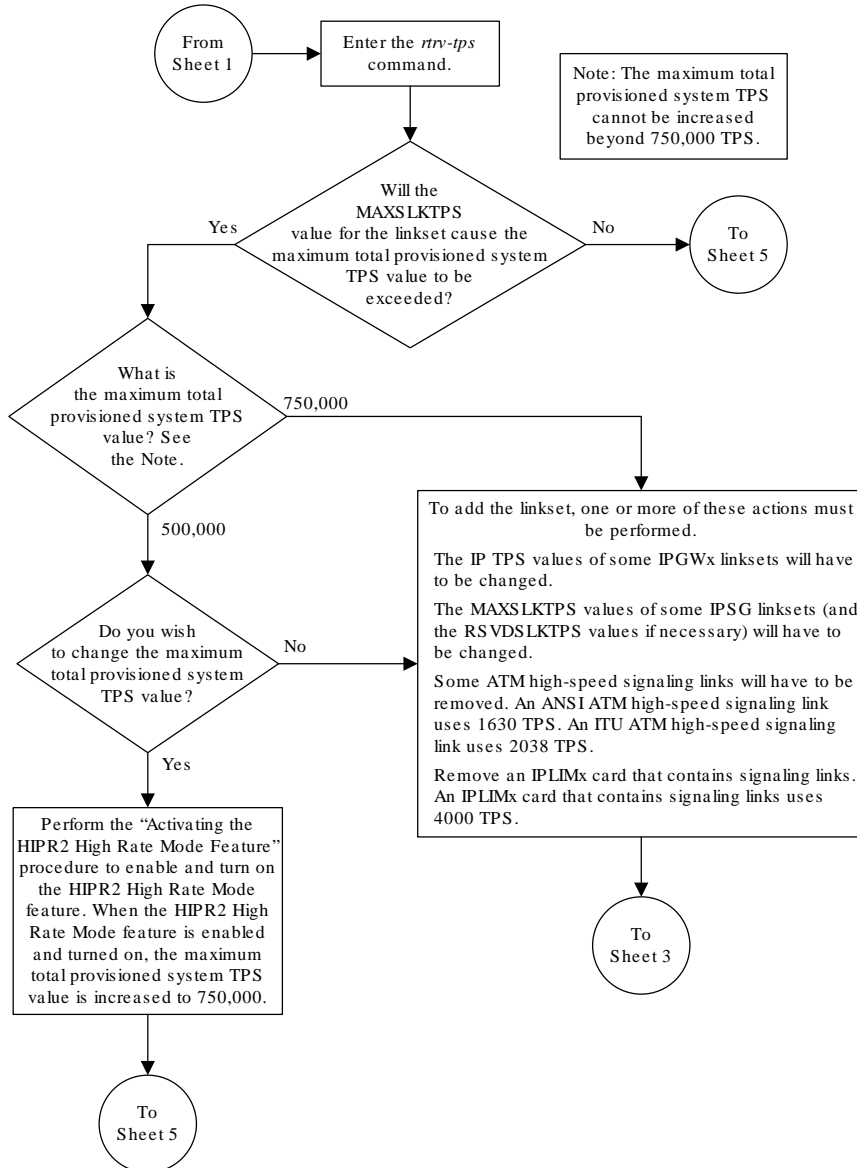
BACKUP (FIXED) : MASP A - Backup starts on active MASP.
BACKUP (FIXED) : MASP A - Backup on active MASP to fixed disk complete.
BACKUP (FIXED) : MASP A - Backup starts on standby MASP.
BACKUP (FIXED) : MASP A - Backup on standby MASP to fixed disk complete.

```

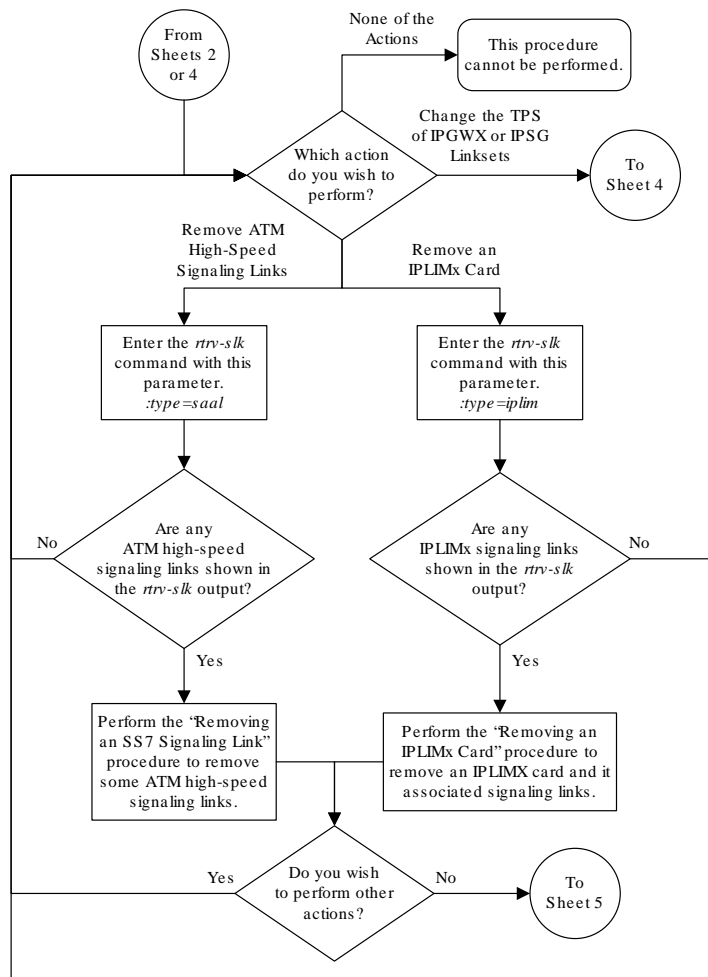
Figure 6-2 Adding an IPSP M2PA Linkset



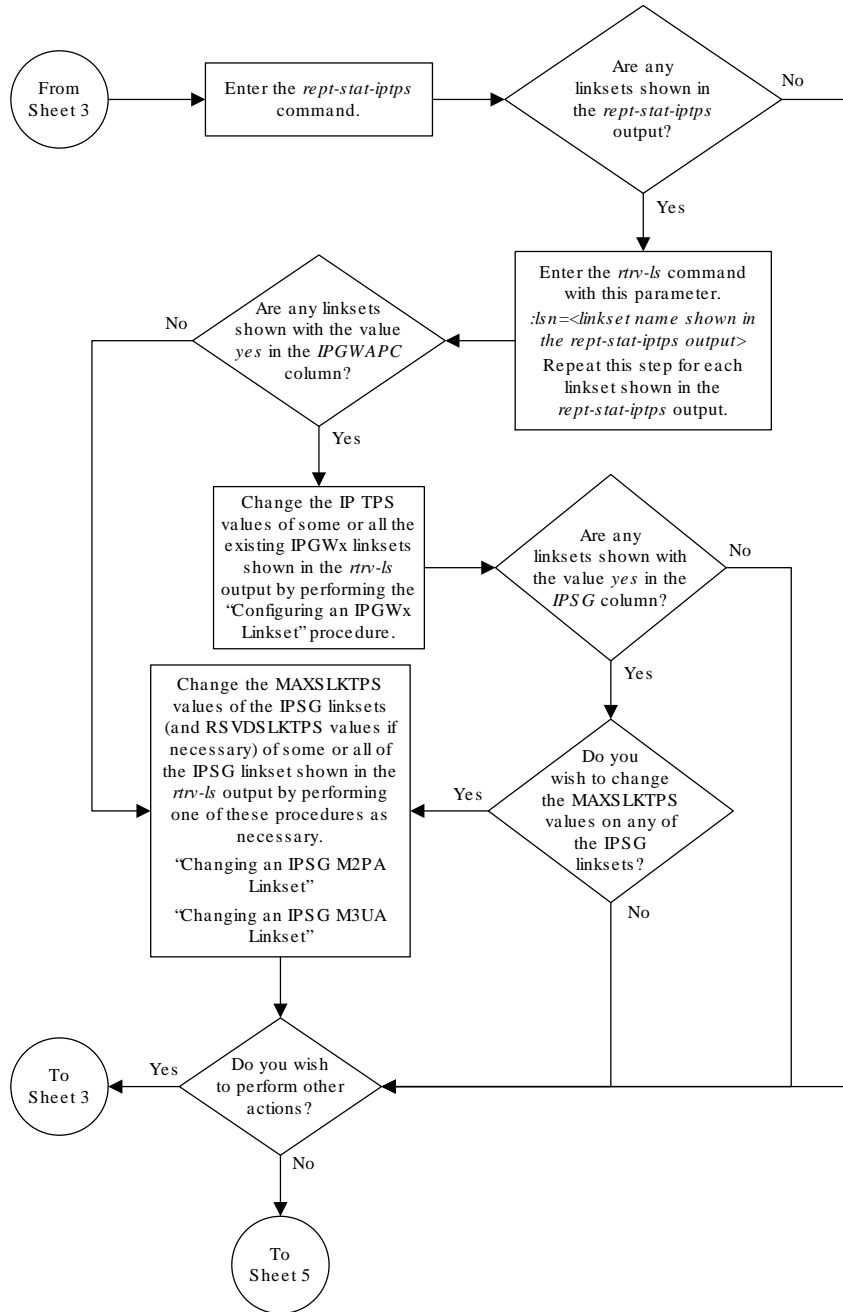
Sheet 1 of 5



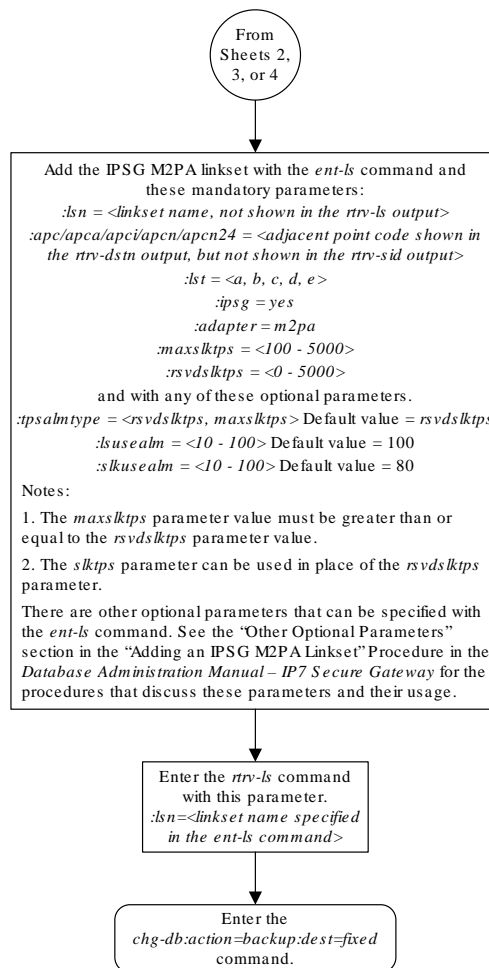
Sheet 2 of 5



Sheet 3 of 5



Sheet 4 of 5



Sheet 5 of 5

6.4 Adding an IPSG M3UA Linkset

This procedure is used to configure **IPSG** M3UA linksets in the **EAGLE** using the `ent-ls` command with these parameters.

`:lsn` – The name of the linkset. The linkset name can contain up to 10 characters, with the first character being a letter. However, the **SEAS** interface supports only eight characters. If this linkset is displayed on the **SEAS** interface and the linkset name contains more than eight characters, only the first eight characters in the linkset name are shown. If this linkset name contains more than eight characters, and is specified

with the linkset commands on the **SEAS** interface, only the first eight characters can be specified.

:apc/apca/apci/apcn/apcn24 – Adjacent point code – the point code identifying the node that is next to the **EAGLE**. The adjacent point code can be one of the following types of point codes:

:apc/apca – **ANSI** point code, **ANSI** private point code

:apci – **ITU-I** point code, **ITU-I** spare point code, **ITU-I** private point code, **ITU-I** private spare point code.

:apcn – 14-bit **ITU-N** point code, 14-bit **ITU-N** spare point code, 14-bit **ITU-N** private point code, 14-bit **ITU-N** private spare point code.

:apcn24 – 24-bit **ITU-N** point code, 24-bit **ITU-N** private point code.

 **Note:**

See the “**Point Code Formats**” section in *Database Administration - SS7 User's Guide* for a definition of the point code types that are used on the **EAGLE** and for a definition of the different formats that can be used for **ITU** national point codes.

:lst – The linkset type of the linkset. For an IPSP M3UA linkset, only one value can be specified, A.

:ipsg – This parameter specifies whether or not the linkset is an IPSP linkset. This parameter has two values, *yes* (if the linkset is an IPSP linkset) or *no* (if the linkset is not an IPSP linkset). For this procedure, the *ipsg* parameter value must be *yes*.

:maxslktps – The maximum number of transactions per second (TPS) for all signaling links that are assigned to the IPSP M3UA linkset. See [Maximum Card Capacity for Different Card Types](#) for MaxTPS values.

:rsvdslktps – The number of transactions per second (TPS) that is assigned to each IPSP signaling link that will be in the linkset. See [Maximum Card Capacity for Different Card Types](#) for MaxTPS values. The *slktps* parameter can be used in place of the *rsvdslktps* parameter.

:tpsalmttype – The TPS threshold that will generate alarms. This parameter has two values.

- *rsvdslktps* - The **RSVDSLKTPS** threshold generates alarms.
- *maxslktps* - The **MAXSLKTPS** threshold generates alarms.

:lsusealm – The linkset's TPS alarm threshold, from 10 to 100 percent of the linkset's TPS. When this threshold is reached, a major alarm (**UAM 0115**) is generated. When the linkset's TPS falls below this threshold, **UAM 0115** is automatically cleared and **UAM 0118** is generated.

:slkusealm – The signaling link TPS alarm threshold, from 10 to 100 percent of the signaling link's fair share of the linkset's TPS from 10 to 100 percent of the **IPSP** card's capacity (5000 TPS). This threshold is reached when the signaling link's actual usage exceeds the percentage of the signaling link's fair share of the linkset's TPS or the percentage of the **IPSP** card's capacity.

A signaling link's fair share of linkset's TPS is the linkset's TPS divided by the number of in-service links in the linkset. For example, if the linkset TPS is 4000 and there are 4 signaling links in the linkset, all in-service, then the signaling link's fair-share would be 1000 TPS ($4000/4=1000$). Table 6-2 shows this calculation for a linkset with 1, 2, 3 and 4 in-service signaling links.

Table 6-2 Signaling Link Fair Share Example

Number of In-Service Signaling Links	Linkset TPS	Signaling Link Fair Share of the Linkset TPS
4	4000	1000
3	4000	1333
2	4000	2000
1	4000	4000

When this threshold is exceeded, a minor alarm (**UAM 0116**) is generated. When the amount of traffic on the signaling link falls below this threshold, **UAM 0116** is automatically cleared and **UAM 0119** is generated.

The signaling link TPS alarm shows that the linkset TPS is set too low for the linkset or that the **IPSP** card's capacity has been exceeded. Setting the signaling link TPS alarm threshold lower than the linkset TPS alarm threshold can give the user an earlier indication that the linkset TPS is inadequate or that traffic is not balanced across the links in the linkset.

:adapter - This parameter specifies the adapter layer for the signaling links that will be assigned to the IPSP M3UA linkset. This parameter has two values, **m2pa** and **m3ua**. For an IPSP M3UA linkset, the **adapter** parameter value must be **m3ua**.

:rcontext - This parameter specifies the routing context value that is assigned to the IPSP M3UA linkset. The value for this parameter is from 0 to 4294967295. The default value for this parameter is **none**, no value is specified.

:asnotif - This parameter specifies whether or not AS notifications will be sent for the IPSP M3UA linkset. This parameter has two values, **yes**, AS notifications will be sent for the linkset, and **no**, AS notifications will not be sent for the linkset. The default value for this parameter is **yes**.

The adjacent point code (**APC**) for the linkset must be defined in the database, must be in the **SS7** domain, and cannot match the point code or capability point code of the **EAGLE**. The domain of the point code is shown in the **DMN** field in the output of the **rtrv-dstn** command. The point code of the **EAGLE** is shown in the **PCA**, **PCN**, **PCN24**, or **PCI** fields and the capability point code of the **EAGLE** are shown in the **CPCA**, **CPCN**, **CPCN24**, or **CPCI** fields in the output of the **rtrv-sid** command. An **ANSI** adjacent point code must be a full point code and cannot be a cluster point code or a network routing point code. The adjacent point code of the linkset cannot be a proxy point code, cannot have a proxy point code assigned to it, and cannot be assigned to another linkset.

If the **APC** is not in the destination point code table, go to the "Adding a **Destination Point Code**" procedure in *Database Administration - SS7 User's Guide* and add the **APC** to the destination point code table.

Adding the IPSG M3UA linkset cannot exceed the maximum total provisioned system TPS shown in the `rtrv-tps` output. An IPSG M3UA linkset uses from 100 to 5000 TPS, as provisioned by the `maxslktps` parameter.

If adding the IPSG M3UA linkset will exceed the maximum total provisioned system TPS, and the maximum total provisioned system TPS is 500,000, perform the "Activating the HIPR2 High Rate Mode" feature in the *Database Administration - System Management User's Guide* to enable and turn on the HIPR2 High Rate Mode feature. When the HIPR2 High Rate Mode feature is enabled and turned on, the maximum total provisioned system TPS is increased to 1,000,000 (1M). If the maximum total provisioned system TPS is 1M, or the maximum total provisioned system TPS is 500,000 and will not be increased, and adding the IPSG M3UA linkset will exceed the maximum total provisioned system TPS, the IPSG M3UA linkset cannot be added unless the amount of available TPS is reduced enough to allow the IPSG M3UA linkset to be added. The available TPS can be reduced by performing one or more of these actions.

- The IP TPS values of some IPGWx linksets have to be changed.
- The MAXSLKTPS values of some IPSG linksets (and the RSVDSLKTPS values if necessary) have to be changed.
- Some ATM high-speed signaling links have to be removed.
- An IPLIMx card that contains signaling links has to be removed.

Other Optional Parameters

There are other optional parameters that can be used to configure an IPSG M3UA linkset. These parameters are not required for configuring an IPSG M3UA linkset. These parameters are discussed in more detail in *Commands User's Guide* or in these sections.

- These procedures in this manual:
 - [Adding a Mate IPGWx Linkset to another IPGWx Linkset](#)
 - [Removing a Mate IPGWx Linkset from another IPGWx Linkset](#)
 - [Configuring an IPGWx Linkset](#)
- These procedures in *Database Administration - SS7 User's Guide*
 - Adding an SS7 Linkset
 - Changing an SS7 Linkset
 - Configuring an ITU Linkset with a Secondary Adjacent Point Code (SAPC)
- The "Configuring a Linkset for the GSM MAP Screening Feature" procedure in *Database Administration - Features User's Guide*.



Note:

The `mtprse`, `spc/spca/spci/spcn/spcn24`, and `ppc/ppca/ppci/ppcn/ppcn24` parameters cannot be specified for an IPSG M3UA linkset.

Canceling the `RTRV-LS` and `RTRV-DSTN` Commands

Because the `rtrv-ls` and `rtrv-dstn` commands used in this procedure can output information for a long period of time, the `rtrv-ls` and `rtrv-dstn` commands can be

canceled and the output to the terminal stopped. There are three ways that the `rtrv-ls` and `rtrv-dstn` commands can be canceled.

- Press the F9 function key on the keyboard at the terminal where the `rtrv-ls` or `rtrv-dstn` commands were entered.
- Enter the `canc-cmd` without the `trm` parameter at the terminal where the `rtrv-ls` or `rtrv-dstn` commands were entered.
- Enter the `canc-cmd:trm=<xx>`, where `<xx>` is the terminal where the `rtrv-ls` or `rtrv-dstn` commands were entered, from another terminal other than the terminal where the `rtrv-ls` or `rtrv-dstn` commands were entered. To enter the `canc-cmd:trm=<xx>` command, the terminal must allow Security Administration commands to be entered from it and the user must be allowed to enter Security Administration commands. The terminal's permissions can be verified with the `rtrv-secu-trm` command. The user's permissions can be verified with the `rtrv-user` or `rtrv-secu-user` commands.

For more information about the `canc-cmd` command, go to *Commands User's Guide*.

1. Display the current linksets in the database using the `rtrv-ls` command.

This is an example of the possible output.

```
rlghncxa03w 10-07-10 11:43:04 GMT EAGLE5 42.0.0
```

LSN	APCA (SS7)	SCRN	L3T SET	SLT SET	BEI	LST	LNKS	GWS ACT	GWS MES	GWS DIS
SLSCI NIS										
ipgwx1	001-001-002	none	1	1	no	A	8	off	off	off
no off										
ipgwx2	001-001-003	none	1	1	no	A	8	off	off	off
no off										
ipgwx3	001-001-004	none	1	1	no	A	0	off	off	off
no off										
ls1305	001-005-000	none	1	1	no	A	1	off	off	off
no off										
ls1307	001-007-000	none	1	1	no	A	1	off	off	off
no off										
lsniplim	002-002-002	none	1	1	no	A	3	off	off	off
no off										
ipsglsn	003-003-003	none	1	1	no	A	6	off	off	off
no off										
lsn2	003-003-004	none	1	1	no	A	1	off	off	off
no off										
lsn1	003-003-005	none	1	1	no	A	1	off	off	off
no off										
ipsglsn2	005-005-005	none	1	1	no	A	1	off	off	off
no off										
lsnds0	009-009-009	none	1	1	no	A	2	off	off	off
no off										

LSN	APCI (SS7)	SCRN	L3T SET	SLT SET	BEI	LST	LNKS	GWS ACT	GWS MES	GWS DIS
SLSCI NIS										
lsnituatm	1-002-3	none	1	2	no	A	1	off	off	off

```
no off
```

```
Link set table is (12 of 1024) 1% full.
```

2. Display the point code and capability point code of the **EAGLE** by using the `rtrv-sid` command.

This is an example of the possible output.

```
rlghncxa03w 10-07-10 11:43:04 GMT EAGLE5 42.0.0
PCA          PCI          PCN          CLLI          PCTYPE
001-001-001  1-200-6          13482        rlghncxa03w  OTHER

CPCA
002-002-001  002-002-003      002-002-004  002-002-005
002-002-006  002-002-007      002-002-008  002-002-009
004-002-001  004-003-003      144-212-003

CPCA (LNP)
005-005-002  005-005-004      005-005-006

CPCI
1-001-1      1-001-2          1-001-3      1-001-4

CPCN
02091        02092            02094        02097
02191        02192            11177
```

3. Display the destination point codes in the database by entering the `rtrv-dstn` command. This is an example of the possible output.

```
rlghncxa03w 10-12-10 11:43:04 GMT EAGLE5 43.0.0
Extended Processing Time may be Required

DPCA          CLLI          BEI ELEI  ALIASI          ALIASN/N24  DMN
001-207-000  ----- no  --- -----  -----  SS7
001-001-002  ----- no  --- -----  -----  SS7
001-001-003  ----- no  --- -----  -----  SS7
001-001-004  ----- no  --- -----  -----  SS7
001-005-000  ----- no  --- -----  -----  SS7
001-007-000  ----- no  --- -----  -----  SS7
002-002-002  ----- no  --- -----  -----  SS7
003-002-004  ----- no  --- -----  -----  SS7
003-003-003  ----- no  --- -----  -----  SS7
003-003-004  ----- no  --- -----  -----  SS7
003-003-005  ----- no  --- -----  -----  SS7
005-005-005  ----- no  --- -----  -----  SS7
008-012-003  ----- no  --- -----  -----  SS7
009-002-003  ----- no  --- -----  -----  SS7
009-009-009  ----- no  --- -----  -----  SS7
010-020-005  ----- no  --- -----  -----  SS7
```

```

      DPCI          CLLI          BEI ELEI  ALIASA
ALIASN/N24  DMN
  1-002-3      ----- no  --- -----
-----      SS7
  1-207-0      ----- no  --- -----
-----      SS7
  0-015-0      ----- no  --- -----
-----      SS7
  0-017-0      ----- no  --- -----
-----      SS7
  1-011-1      ----- no  --- -----
-----      SS7
  1-011-2      ----- no  --- -----
-----      SS7

```

Destination table is (22 of 2000) 2% full
Alias table is (0 of 12000) 0% full

If the adjacent point code is not shown in the `rtrv-dstn` output, perform the "Adding a Destination Point Code" procedure in *Database Administration - SS7 User's Guide* to add the required point code. This point code cannot be a proxy point code (the `prx=yes` value assigned to the point code) and a proxy point code (a point code value is shown in the `PPC` column) cannot be assigned to the point code. After the adjacent point code has been added, continue the procedure with 7.

If the adjacent point code is shown in the `rtrv-dstn` output, continue the procedure with 4.

4. Display the adjacent point code of the new linkset in the destination point code table by using the `rtrv-dstn` command and specifying the point code. For this example, enter this command.

```
rtrv-dstn:dpca=010-020-005
```

This is an example of the possible output.

```
rlghncxa03w 10-12-10 11:43:04 GMT EAGLE5 43.0.0
```

```

      DPCA          CLLI          BEI ELEI  ALIASI
ALIASN/N24  DMN
  010-020-005  ----- no  --- -----
-----      SS7

      SPCA          NCAI          RCAUSE NPRST SPLITIAM HMSMSC HMSCP
SCCPMSGCNV
  -----      -----      none  off  none  no  no  none

```

Destination table is (14 of 2000) 1% full
Alias table is (0 of 12000) 0% full

This point code cannot be a proxy point code (the `prx=yes` value assigned to the point code) and a proxy point code (a point code value is shown in the `PPC` column) cannot be assigned to the point code. If a proxy point code is shown in

this step, or if the point code is a proxy point code, choose another point code and repeat this procedure from 2.

If a proxy point code is not shown in this step, or if the point code is not a proxy point code, continue this procedure with 5.

5. The **APC** of the linkset cannot be the **DPC** of any exception route. Verify that the adjacent point code of the linkset is not the **DPC** of any exception route by entering the `rtrv-rtx` command with the `dpc/dpca/dpci/dpcn/dpcn24` parameter. The `dpc/dpca/dpci/dpcn/dpcn24` parameter value is the adjacent point code value that will be specified for the linkset.

For this example, enter this command.

```
rtrv-rtx:dpca=010-020-005
```

This is an example of the possible output.

```
rlghncxa03w 06-10-10 11:43:04 GMT EAGLE5 37.5.0
      DPCA          RTX-CRITERIA          LSN          RC          APC

      010-020-005   OPCA
                        007-008-009          1s1305        20          001-005-000
                        008-008-008          1s1307        40          001-007-000

DESTINATION ENTRIES ALLOCATED:    2000
  FULL DPC(s) :                    13
  EXCEPTION DPC(s) :                5
  NETWORK DPC(s) :                   0
  CLUSTER DPC(s) :                   1
  TOTAL DPC(s) :                     19
  CAPACITY (% FULL) :                1%
ALIASES ALLOCATED:                12000
  ALIASES USED:                      0
  CAPACITY (% FULL) :                0%
X-LIST ENTRIES ALLOCATED:         500
```

If the adjacent point code of the linkset is not the **DPC** of a route exception table entry, no entries are displayed in the `rtrv-rtx` output, but a summary of the point code quantities is displayed, as shown in the following output example.

```
rlghncxa03w 06-10-10 11:43:04 GMT EAGLE5 37.5.0

  DESTINATION ENTRIES ALLOCATED:    2000
    FULL DPC(s) :                    15
    EXCEPTION DPC(s) :                5
    NETWORK DPC(s) :                   0
    CLUSTER DPC(s) :                   1
    TOTAL DPC(s) :                     21
    CAPACITY (% FULL) :                1%
ALIASES ALLOCATED:                12000
  ALIASES USED:                      0
  CAPACITY (% FULL) :                0%
X-LIST ENTRIES ALLOCATED:         500
```

If the point code specified in this step is shown in the `DPCA/DPCI/DPCN/ DPCN24` columns in this step, the point code value cannot be used as an adjacent point code unless one of two actions are taken:

- Choose another adjacent point code value and repeat the procedure from 2.
- Remove all the entries displayed in this step by performing the “Removing a **Route Exception Entry**” procedure in the *Database Administration - SS7 User's Guide*. After the entries have been removed, continue the procedure with 6.

If the point code specified in this step is not shown in the `DPCA/DPCI/DPCN/ DPCN24` columns in this step, continue this procedure with 6.

6. Display any entries in the route table whose **DPC** value is also the adjacent point code of the new linkset being added in this procedure, or the new adjacent point code of the existing linkset being changed in this procedure. Enter the `rtrv-rte` command with the `dpc/dpca/dpci/dpcn/dpcn24` parameter. The `dpc/dpca/dpci/dpcn/dpcn24` parameter value is the adjacent point code value that will be specified for the linkset. For this example, enter this command.

```
rtrv-rte:dpca=010-020-005
```

This is an example of the possible output.

```
rlghncxa03w 10-07-10 11:43:04 GMT EAGLE5 42.0.0

      DPCA          ALIASI      ALIASN/N24      LSN          RC          APCA
      010-020-005 -----
003-003-005                                     lsn1         1
003-003-004                                     lsn2         2
RTX:No
CLLI=-----
```

If the adjacent point code of the linkset is not the **DPC** of a route, the point code entry is displayed in the `rtrv-rte` output, but the **LSN**, **RC**, and **APC** columns contain dashes, as shown in the following output example.

```
rlghncxa03w 10-07-10 11:43:04 GMT EAGLE5 42.0.0

      DPCA          ALIASI      ALIASN/N24      LSN          RC          APCA
      010-020-005 -----
003-003-005                                     lsn1         1
003-003-004                                     lsn2         2
RTX:No
CLLI=-----
```

If the point code specified in this step is shown in the `DPCA/DPCI/DPCN/ DPCN24` columns in this step, the point code value cannot be used as an adjacent point code unless one of two actions are taken:

- Choose another adjacent point code value and repeat and repeat the procedure from 2.

- Remove all the entries displayed in this step by performing the “Removing a **Route**” procedure in *Database Administration - SS7 User's Guide*. After the entries have been removed, continue the procedure with 7.

If the point code specified in this step is not shown in the DPCA/DPCI/DPCN/ DPCN24 columns in this step, continue this procedure with 7.

- Display the total provisioned system TPS by entering the `rtrv-tps` command. This is an example of the possible output.

```
rlghncxa03w 10-07-10 16:20:46 GMT EAGLE 42.0.0
```

CARD TYPE	NUM CARDS	NUM LINKS	RSVD TPS	MAX TPS
-----	-----	-----	-----	-----
IPGW	17	16	48000	80000
IPSG	3	7	4200	8000
IPLIM	2	4	8000	8000
ATM	2	2	3668	3668

```
Total provisioned System TPS (99668 of 500000) 20%
```

```
Command Completed.
```

An IP SG M3UA linkset uses 100 to MaxTPS (see [Maximum Card Capacity for Different Card Types](#) for MaxTPS values), as provisioned by the `maxslktps` parameter. If adding the new IP SG M3UA linkset will not exceed the maximum total provisioned system TPS, continue the procedure with 12.

If adding the new IP SG M3UA linkset will exceed the maximum total provisioned system TPS, and the maximum total provisioned system TPS is 500,000 shown, perform the "Activating the HIPR2 High Rate Mode Feature" procedure in *Database Administration - System Management User's Guide* to enable and turn on the HIPR2 High Rate Mode feature. When the HIPR2 High Rate Mode feature is enabled and turned on, the maximum total provisioned system TPS is increased to 1M. After the HIPR2 High Rate Mode feature has been enabled and turned on, continue the procedure with 12.

If the maximum total provisioned system TPS is 1M, or the maximum total provisioned system TPS is 500,000 and will not be increased, and adding the IP SG M3UA linkset will exceed the maximum total provisioned system TPS, the IP SG M3UA linkset cannot be added unless the amount of available TPS is reduced enough to allow the IP SG M3UA linkset to be added. The available TPS can be increased by performing one or more of these actions.

- The IP TPS values of some IPGWx linksets have to be changed. To perform this action, continue the procedure with 10.
 - The MAXSLKTPS values of some IP SG linksets (and the RSVDSLKTPS values if necessary) have to be changed. To perform this action, continue the procedure with 10.
 - Some ATM high-speed signaling links have to be removed. To perform this action, continue the procedure with 8.
 - An IPLIMx card that contains signaling links has to be removed. To perform this action, continue the procedure with 9.
- Display the ATM high-speed signaling links by entering this command.

```
rtrv-slk:type=saal
```

This is an example of the possible output.

```
rlghncxa03w 10-07-19 21:16:37 GMT EAGLE5 42.0.0
```

LOC	LINK	LSN	SLC	TYPE	LP	ATM	VCI	VPI	LL
1303	A	lsnds0	1	LIMATM	1	1.544M	LINE	5	0

LOC	LINK	LSN	SLC	TYPE	LP	ATM	VCI	VPI
1306	A	lsnituatm	0	LIME1ATM	21	2.048M	LINE	5

E1ATM
CRC4 SI SN
ON 3 0

SLK table is (30 of 1200) 2% full.

If ATM high-speed signaling links are shown in the `rtrv-slk` output, perform the "Removing an SS7 Signaling Link" procedure in the *Database Administration - SS7 User's Guide* to remove some of the ATM high-speed signaling links.

If ATM high-speed signaling links are not displayed in the `rtrv-slk` output, perform one or more of these actions to increase the available TPS.

Note:

If one or more of these actions are not performed to increase the available TPS and the available TPS will not allow the IPSP M3UA linkset to be added, the IPSP M3UA linkset cannot be added and the remainder of this procedure cannot be performed.

- The IP TPS values of some IPGWx linksets have to be changed. To perform this action, continue the procedure with [10](#).
- The MAXSLKTPS values of some IPSP linksets (and the RSVDSLKTPS values if necessary) have to be changed. To perform this action, continue the procedure with [10](#).
- An IPLIMx card that contains signaling links has to be removed. To perform this action, continue the procedure with [9](#).

If you do not wish to perform other actions to increase the available TPS and the available TPS will allow the IPSP M3UA linkset to be added, continue the procedure with [12](#).

9. Display the signaling links that are assigned to IPLIMx cards by entering this command.

```
rtrv-slk:type=iplim
```


This is an example of the possible output.

```
rlghncxa03w 10-07-19 21:16:37 GMT EAGLE5 42.0.0
```

LOC	LINK	LSN	SLC	TYPE	ANAME	SLKTPS
1301	A	lsniplim	0	IPLIM	M2PA	
1301	A1	lsniplim	1	IPLIM	M2PA	
1301	B1	lsniplim	2	IPLIM	M2PA	
1317	A	lsniplimi	0	IPLIMI	M2PA	

SLK table is (30 of 1200) 2% full.

If IPLIMx cards containing signaling links are shown in the `rtrv-slk` output, perform the [Removing an IPLIMx Card](#) procedure to remove an IPLIMx card and its associated signaling links.

If IPLIMx cards containing signaling links are not displayed in the `rtrv-slk` output, perform one or more of these actions to increase the available TPS.

 **Note:**

If one or more of these actions are not performed to increase the available TPS and the available TPS will not allow the IPSG M3UA linkset to be added, the IPSG M3UA linkset cannot be added and the remainder of this procedure cannot be performed.

- The IP TPS values of some IPGWx linksets have to be changed. To perform this action, continue the procedure with [10](#).
- The MAXSLKTPS values of some IPSG linksets (and the RSVDSLKTPS values if necessary) have to be changed. To perform this action, continue the procedure with [10](#).
- Some ATM high-speed signaling links have to be removed. To perform this action, continue the procedure with [8](#).

If you do not wish to perform other actions to increase the available TPS and the available TPS will allow the IPSG M3UA linkset to be added, continue the procedure with [12](#).

10. Display the IPGWx and IPSG linksets by entering this command.

```
rept-stat-iptps
```

This is an example of the possible output.

```
rlghncxa03w 10-07-19 21:16:37 GMT EAGLE5 42.0.0
```

```
IP TPS USAGE REPORT
```

LSN	THRESH	CONFIG/ RSVD	CONFIG/ MAX	TPS	PEAK	PEAKTIMESTAMP
ipgwx1	100%	----	32000	TX: 3700	4000	10-07-19 09:49:19

```

                                RCV:  3650  4000  10-07-19
09:49:19
ipgwx2      100%  ----  16000  TX:  4800  5000  10-07-19
09:49:09
                                RCV:  4850  5000  10-07-19
09:49:09
ipgwx3      100%  ----  32000  TX:   427   550  10-07-19
09:49:19
                                RCV:   312   450  10-07-19
09:49:19
ipsglsn     100%   600  24000  TX:  4800  5000  10-07-19
09:49:19
                                RCV:  4800  5000  10-07-19
09:49:19
ipsglsn2    100%   600   4000  TX:   427   550  10-07-19
09:49:19
                                RCV:   312   450  10-07-19
09:49:19
-----
-----

```

Command Completed.

If linksets are displayed in the `rept-stat-iptps` output, continue the procedure with [11](#).

If linksets are not displayed in the `rept-stat-iptps` output, perform one or more of these actions to increase the available TPS.

 **Note:**

If one or more of these actions are not performed to increase the available TPS and the available TPS will not allow the IPSP M3UA linkset to be added, the IPSP M3UA linkset cannot be added and the remainder of this procedure cannot be performed.

- An IPLIMx card that contains signaling links has to be removed. To perform this action, continue the procedure with [9](#).
- Some ATM high-speed signaling links have to be removed. To perform this action, continue the procedure with [8](#).

If you do not wish to perform other actions to increase the available TPS and the available TPS will allow the IPSP M3UA linkset to be added, continue the procedure with [12](#).

11. Display the attributes of the linksets shown in [10](#) by entering the `rtrv-ls` command with the name of the linkset shown in [10](#).

For this example enter these commands.

```
rtrv-ls:lsn=ipgwx1
```

This is an example of the possible output.

```
rlghncxa03w 10-07-19 21:16:37 GMT EAGLE5 42.0.0

LSN          APCA   (SS7)   SCRN SET SET BEI LST LNKS ACT MES DIS SLSCI
NIS
ipgwx1       001-001-002  none 1  1  no  A  8  off off off no
off

          SPCA          CLLI          TFATCABMLQ MTPRSE ASL8
-----
                                4          ---   no

RANDSLS
off

IPSG  IPGWAPC  GTTMODE          CGGTMOD
no    yes     CdPA          no

MATELSN  IPTPS  LSUSEALM  SLKUSEALM
-----  32000  100%     80%

LOC  LINK  SLC  TYPE
1101 A    0  SS7IPGW
1102 A    1  SS7IPGW
1103 A    2  SS7IPGW
1104 A    3  SS7IPGW
1105 A    4  SS7IPGW
1106 A    5  SS7IPGW
1107 A    6  SS7IPGW
1108 A    7  SS7IPGW
```

Link set table is (8 of 1024) 1% full.

```
rtrv-ls:lsn=ipgwx2
```

This is an example of the possible output.

```
rlghncxa03w 10-07-19 21:16:37 GMT EAGLE5 42.0.0

LSN          APCA   (SS7)   SCRN SET SET BEI LST LNKS ACT MES DIS SLSCI
NIS
ipgwx2       001-001-003  none 1  1  no  A  8  off off off no
off

          SPCA          CLLI          TFATCABMLQ MTPRSE ASL8
-----
                                4          ---   no

RANDSLS
off
```

```

IPSP  IPGWAPC  GTTMODE          CGGTMOD
no    yes     CdPA              no

MATELSN  IPTPS  LSUSEALM  SLKUSEALM
-----  16000  100%     80%

LOC  LINK  SLC  TYPE
1111 A    0   SS7IPGW
1112 A    1   SS7IPGW
1201 A    2   SS7IPGW
1202 A    3   SS7IPGW
1203 A    4   SS7IPGW
1204 A    5   SS7IPGW
1205 A    6   SS7IPGW
1206 A    7   SS7IPGW

```

Link set table is (8 of 1024) 1% full.

rtrv-ls:lsn=ipgwx3

This is an example of the possible output.

rlghncxa03w 10-07-19 21:16:37 GMT EAGLE5 42.0.0

```

LSN          APCA  (SS7)  L3T SLT          GWS GWS GWS
SLSCI NIS    SCRN SET SET BEI LST LNKS ACT MES DIS
ipgwx3      001-001-004  none 1  1  no  A  0  off off off
no  off

          SPCA          CLLI          TFATCABMLQ MTPRSE ASL8
-----  -----  1          ---  no

RANDSLS
off

IPSP  IPGWAPC  GTTMODE          CGGTMOD
no    yes     CdPA              no

MATELSN  IPTPS  LSUSEALM  SLKUSEALM
-----  32000  100%     80%

```

Link set table is (8 of 1024) 1% full.

rtrv-ls:lsn=ipsglsn

This is an example of the possible output.

rlghncxa03w 10-07-19 21:16:37 GMT EAGLE5 42.0.0

```

L3T SLT          GWS GWS GWS

```

```

LSN          APCA   (SS7)  SCRN SET SET BEI LST LNKS ACT MES DIS SLSCI
NIS
ipsglsn     003-003-003  none 1   1   no  A   6   off off off no
off

          SPCA          CLLI          TFATCABMLQ MTPRSE ASL8
-----
          3           ---          no

RANDSLS
off

IPSG  IPGWAPC  GTTMODE          CGGTMOD
yes   no       CdPA          no

ADAPTER  RSVDSLKTPS  MAXSLKTPS
m2pa     600        4000

TPSALM   LSUSEALM   SLKUSEALM
rsvdslktps 100%    100%

LOC  LINK  SLC  TYPE  ANAME
1303 A    0   IPG   ipsgm2pa1
1303 A1   1   IPG   ipsgm2pa2
1303 B1   2   IPG   ipsgm2pa3
1303 A2   3   IPG   ipsgm2pa4
1303 A3   4   IPG   ipsgm2pa5
1307 A    5   IPG   m2pa2

```

Link set table is (8 of 1024) 1% full.

rtrv-ls:lsn=ipsglsn2

This is an example of the possible output.

rlghncxa03w 10-07-19 21:16:37 GMT EAGLE5 42.0.0

```

          L3T SLT          GWS GWS GWS
LSN          APCA   (SS7)  SCRN SET SET BEI LST LNKS ACT MES DIS SLSCI
NIS
ipsglsn2     005-005-005  none 1   1   no  A   1   off off off no
off

          SPCA          CLLI          TFATCABMLQ MTPRSE ASL8
-----
          1           ---          no

RANDSLS
off

IPSG  IPGWAPC  GTTMODE          CGGTMOD
yes   no       CdPA          no

ADAPTER  RSVDSLKTPS  MAXSLKTPS
m2pa     600        4000

```

```

TPSALM      LSUSEALM      SLKUSEALM
rsvdslktps 100%          100%

LOC  LINK  SLC  TYPE  ANAME
1303 B3   0   IPSG  ipsgm2pa6

```

Link set table is (8 of 1024) 1% full.

Perform one or both of these actions as necessary.

- Perform the [Configuring an IPGWx Linkset](#) procedure to change the `IPTPS` value for any linksets shown in the `rtrv-ls` output whose `IPGWAPC` value is `yes`.
- Perform the [Changing an IPSG M2PA Linkset](#) procedure (for linkset whose `IPSG` value is `yes` and `ADAPTER` value is `M2PA`) or the [Changing an IPSG M3UA Linkset](#) procedure (for linkset whose `IPSG` value is `yes` and `ADAPTER` value is `M3UA`) to change the `MAXSLKTPS` value (and `RSVDSLKTPS` value if necessary) for any linksets shown in the `rtrv-ls` output.

Perform one or both of these actions to increase the available TPS if needed.

- An IPLIMx card that contains signaling links has to be removed. To perform this action, continue the procedure with [9](#).
- Some ATM high-speed signaling links have to be removed. To perform this action, continue the procedure with [8](#).

If you do not wish to perform other actions to increase the available TPS and the available TPS will allow the IPSG M3UA linkset to be added, continue the procedure with [12](#).

12. Add the new linkset to the database using the `ent-ls` command. The new linkset must meet these conditions.

The name of this linkset cannot be used by another linkset – the linkset configuration is shown in the output of [1](#).

The **APC** of the new linkset must be in the destination point code table, but cannot be either the **EAGLE**'s point code or the **EAGLE**'s capability point code – shown in the outputs of [2](#), [3](#), and [4](#). The adjacent point code can be one of the following types of point codes:

`:apc/apca` – ANSI point code, ANSI private point code

`:apci` – ITU-I point code, ITU-I spare point code, ITU-I private point code, ITU-I private spare point code.

`:apcn` – 14-bit ITU-N point code, 14-bit ITU-N spare point code, 14-bit ITU-N private point code, 14-bit ITU-N private spare point code.

`:apcn24` – 24-bit ITU-N point code, 24-bit ITU-N private point code.

These parameters and values must also be specified for the IPSG M3UA linkset:

- `ipsg=yes`
- `adapter=m3ua`
- `lst=a`

- `maxslktps=<100` - > see [Maximum Card Capacity for Different Card Types](#).
- `rsvdslktps=<0` - > see [Maximum Card Capacity for Different Card Types](#).

 **Note:**

The `maxslktps` parameter value must be greater than or equal to the `rsvdslktps` parameter value. The `slktps` parameter can be used in place of the `rsvdslktps` parameter.

- The `ipgwapc`, `iptps`, `mtprse`, `multgc`, `spc/spca/spci/spcn/spcn24`, `ppc/ppca/ppci/ppcn/ppcn24`, and `sapci/sapcn/sapcn24` parameters cannot be specified for an IPSP M3UA linkset.
- These optional parameters can be specified with the `ent-ls` command.
 - `lsusealm` - the linkset's IP TPS alarm threshold. The default value for the `lsusealm` parameter is 100.
 - `slkusealm` - the signaling link IP TPS alarm threshold. The default value for the `slkusealm` parameter is 80.
 - `rcontext` - the routing context value. The default value for the `rcontext` parameter is `none`.
 - `asnotif` - Are AS notifications for the linkset sent. The default value for the `asnotif` parameter is `yes`.
 - `tpsalmttype` - The TPS threshold that will generate alarms, either `rsvdslktps` or `maxslktps`. The default value for the `tpsalmttype` parameter is `rsvdslktps`.

 **Note:**

There are other optional parameters that can be specified with the `ent-ls` command, but are not required for an IPSP M3UA linkset. These parameters and their usage are discussed in the [Other Optional Parameters](#) section of this procedure.

For this example, enter this command.

```
ent-
ls:lsn=lsgw1107:apca=010-020-005:lst=a:ipsg=yes:rsvdslktps=300:ma
xslktps=1000 :lsusealm=70:slkusealm=70:adapter=m3ua:rcontext=250
```

When this command has successfully completed, this message should appear.

```
rlghncxa03w 06-10-17 16:23:21 GMT EAGLE5 37.5.0
Link set table is ( 14 of 1024) 1% full
ENT-LS: MASP A - COMPLTD
```

13. Verify the changes using the `rtrv-ls` command specifying the linkset name specified in [12](#) with the `lsn` parameter. For this example, enter these commands.

```
rtrv-ls:lsn=lsgw1107
```

This is an example of the possible output.

```
rlghncxa03w 10-07-17 11:43:04 GMT EAGLE5 42.0.0
```

```

                L3T SLT                GWS GWS GWS
LSN            APCA  (SS7)  SCRN  SET SET BEI LST LNKS ACT MES DIS
SLSCI NIS
lsgw1107      010-020-005  none  1  1  no  A  0  off off off
no           off

                SPCA                CLLI                TFATCABMLQ MTPRSE ASL8
-----
                IPSP  IPGWAPC  GTTMODE                CGGTMOD
                yes  no        CdPA                no

                ADAPTER  RSVDSLKTPS  MAXSLKTPS
                m3ua    300          1000

                TPSALM  LSUSEALM    SLKUSEALM
                rsvdslktps 70%          70%

                RCONTEXT  ASNOTIF      NUMSLKALW  NUMSLKRSTR
NUMSLKPROH    250          yes          1          1          1

```

```
Link set table is ( 14 of 1024) 1% full
```

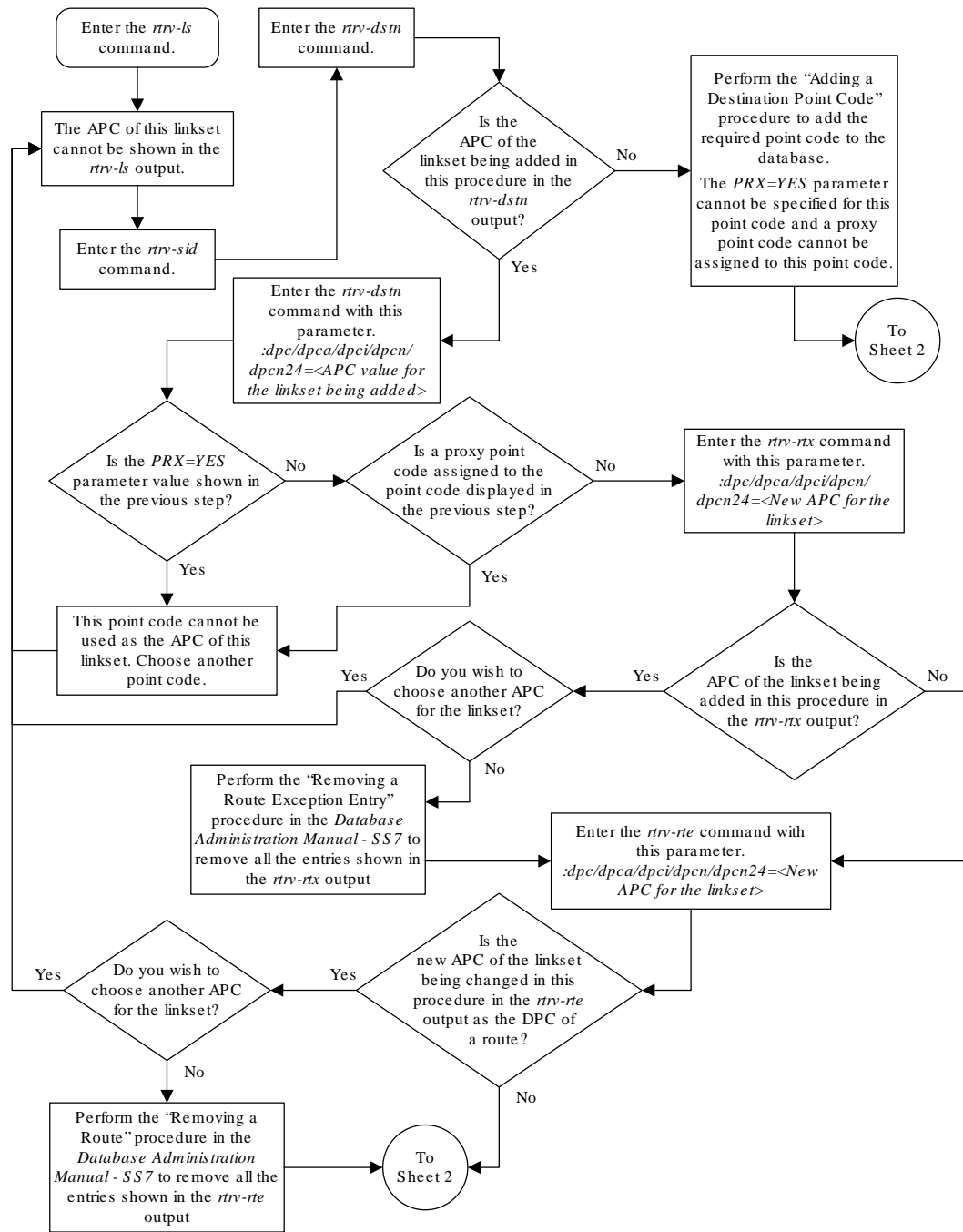
- Back up the new changes using the `chg-db:action=backup:dest=fixed` command. These messages should appear, the active **Maintenance and Administration Subsystem Processor (MASP)** appears first.

```

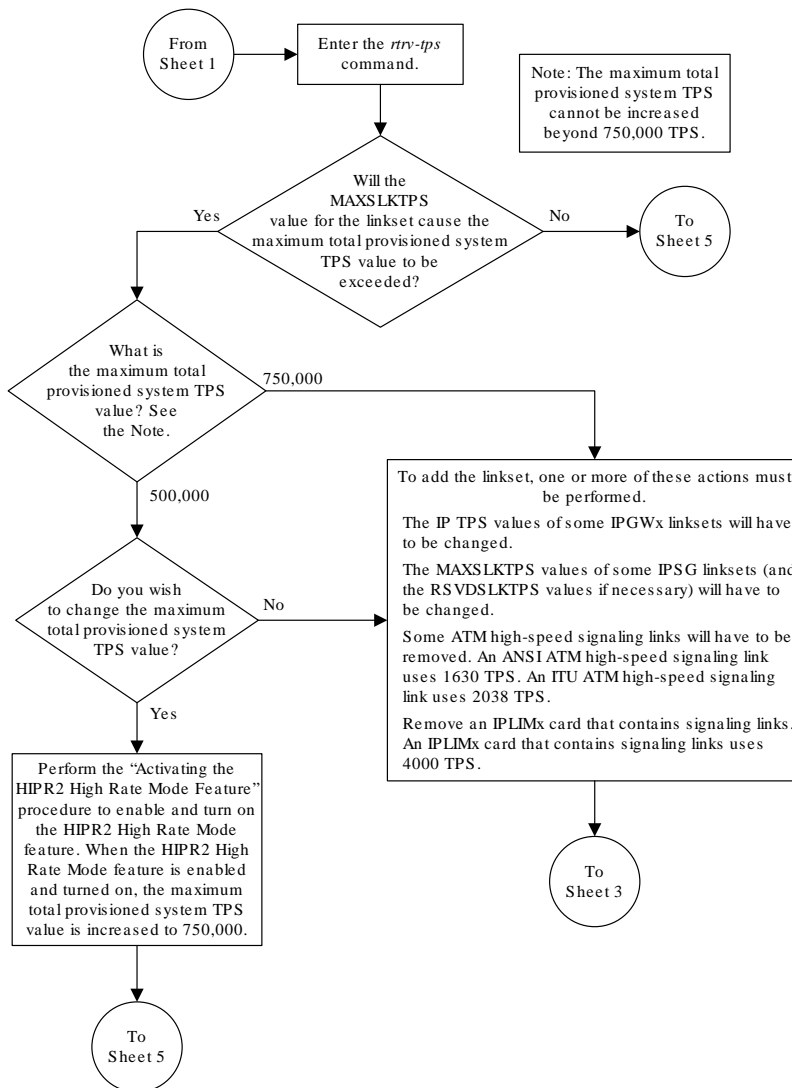
BACKUP (FIXED) : MASP A - Backup starts on active MASP.
BACKUP (FIXED) : MASP A - Backup on active MASP to fixed disk
complete.
BACKUP (FIXED) : MASP A - Backup starts on standby MASP.
BACKUP (FIXED) : MASP A - Backup on standby MASP to fixed disk
complete.

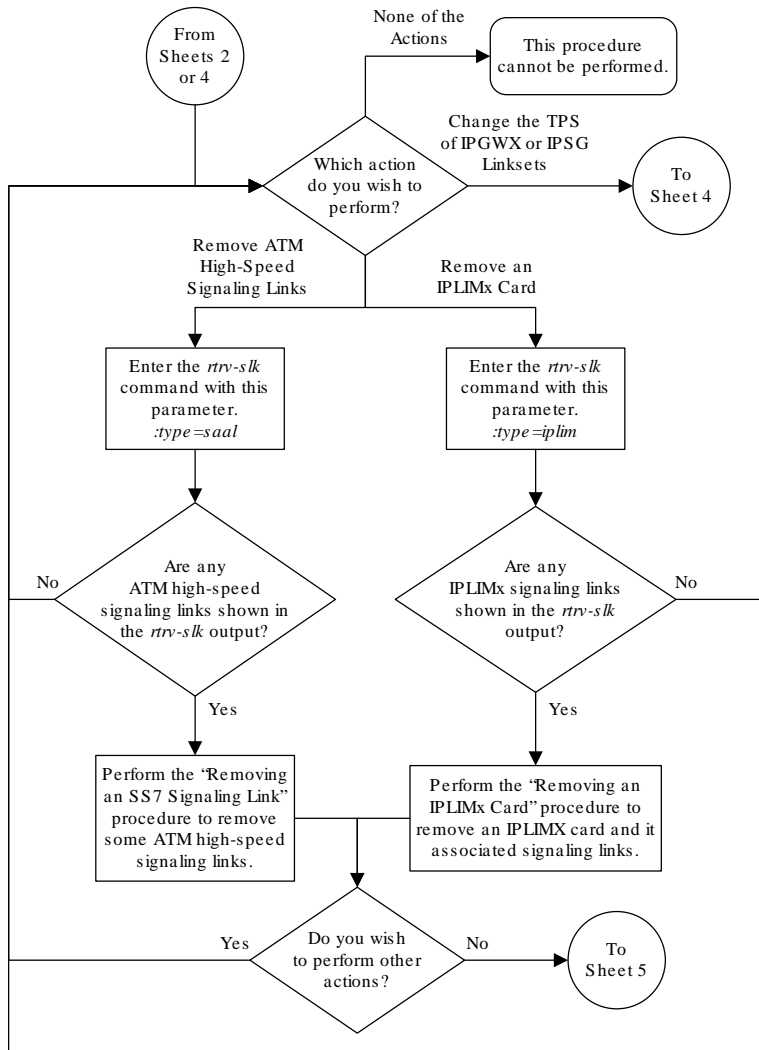
```


Figure 6-3 Adding an IPSG M3UA Linkset

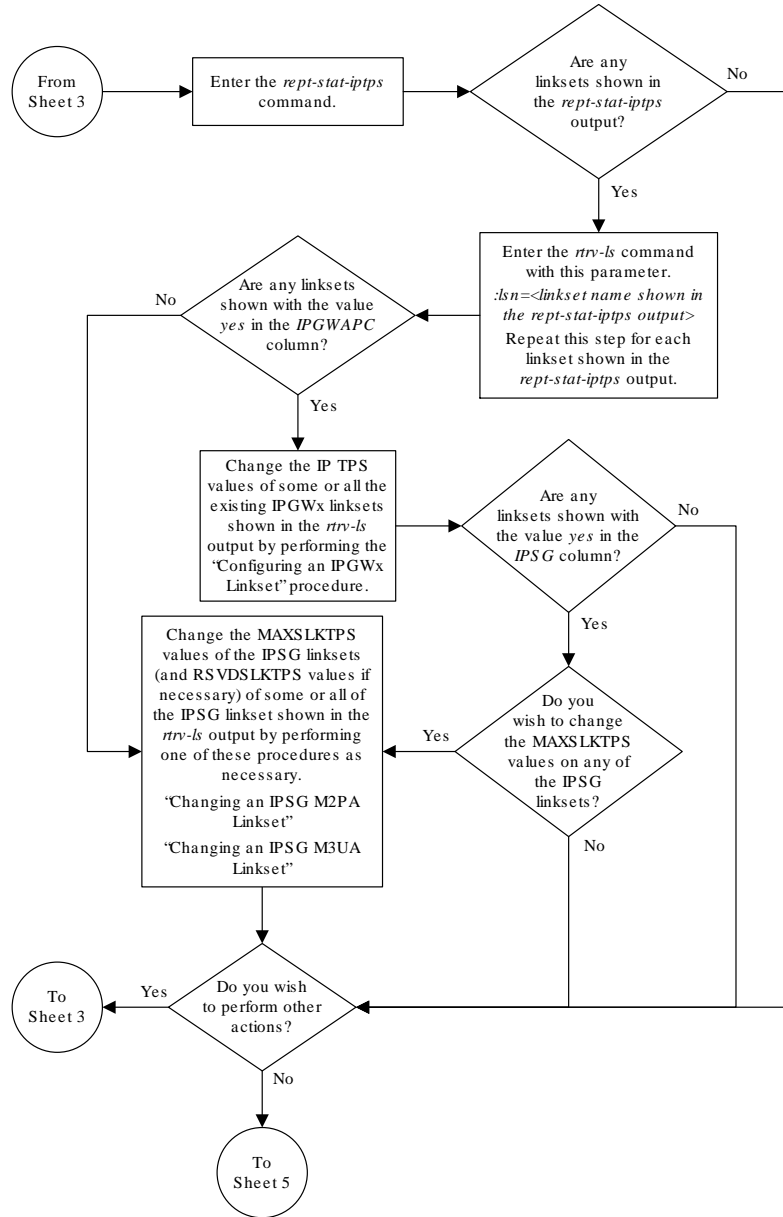


Sheet 1 of 5

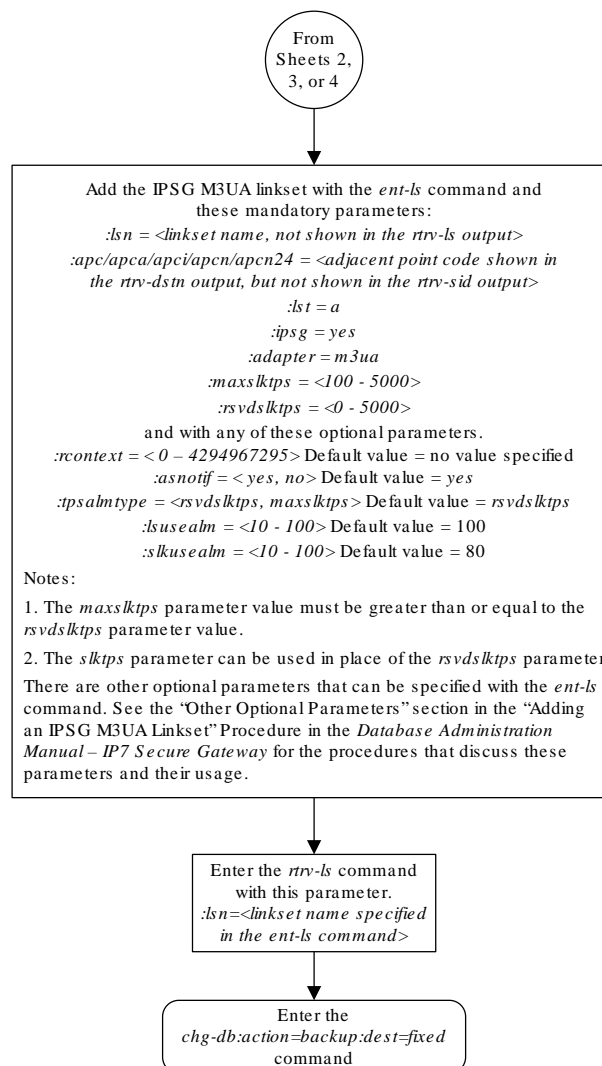




Sheet 3 of 5



Sheet 4 of 5



Sheet 5 of 5

6.5 Configuring an IP Link

This procedure is used to configure the link parameters for **IP** cards using the `chg-ip-lnk` command. These link parameters are used to configure the Ethernet hardware.

The `chg-ip-lnk` command uses the following parameters.

`:loc` – The card location of the **IP** card.

`:port` – The Ethernet interface on the **IP** card, A or B.

`:ipaddr` – **IP** address assigned to the Ethernet interface on the **IP** card. This is an **IP** address expressed in standard “dot notation.” **IP** addresses consist of the system’s network number and the machine’s unique host number.

`:submask` – The subnet mask of the **IP** interface. A subnet mask is an **IP** address with a restricted range of values. The bits in the mask must be a string of one’s followed by a string of zero’s. There must be at least two one’s in the mask, and the mask cannot be all one’s. See [Table 6-3](#) to assign the correct parameter values.

`:auto` – Tells hardware whether to automatically detect the `duplex` and `speed`.

`:duplex` – This is the mode of operation of the interface.

`:speed` – This is the bandwidth in megabits per second of the interface.

`:mactype` – This is the Media Access Control Type of the interface.

`:mcast` – The multicast control flag. This parameter enables or disables multicast support for the interface.

The EAGLE can contain a maximum of 2048 IP links.

A zero `ipaddr` parameter value (0.0.0.0) indicates the **IP** card Ethernet interface to **IP** link association is disabled. The host to the original **IP** address must be removed before the `ipaddr=0.0.0.0` can be specified.

If the `defrouter` parameter of the `chg-ip-card` command contains an **IP** address for the card specified in this procedure, the network portion of one of the **IP** addresses assigned to the card in this procedure must match the network portion of the **IP** address specified by the `defrouter` parameter of the `chg-ip-card` command.

The network portion of the **IP** address is based on the class of the **IP** address (shown in [Table 6-3](#)). If the **IP** address is a Class A **IP** address, the first field is the network portion of the **IP** address. If the **IP** address is a Class B **IP** address, the first two fields are the network portion of the **IP** address. If the **IP** address is a Class C **IP** address, the first three fields are the network portion of the **IP** address. For example, if the **IP** address is 193.5.207.150, a Class C **IP** address, the network portion of the **IP** address is 193.5.207.

If the `auto=yes` parameter is specified, then the `duplex` and `speed` parameters are not allowed.

The `loc` parameter value must be shown in the `rtrv-ip-card` output.

The **IP** card must be placed out of service.

If either the `ipaddr` or `submask` parameters are specified, then both parameters must be specified. If the `ipaddr` parameter value is zero (0.0.0.0), the `submask` parameter is not required.

The **IP** address and subnet mask values cannot be changed to an address representing a different network if:

- If the network interface specified by the `loc` and `port` parameters has a default router, `dnasa`, or `dsnb` parameter values assigned to it, as shown in the `rtrv-ip-card` output.

- Any IP routes, shown in the `rtrv-ip-rte` output, reference the IP address for the network interface specified by the `loc` and `port` parameters.

The IP link cannot be changed if open associations reference the IP link being changed.

The network portion of the IP addresses assigned to the IP links on an IP card must be unique. For example, if IP links are assigned to IP card 1103, the network portion of the IP address for Ethernet interface A (`port=a`) must be different from the IP address for Ethernet interface B (`port=b`).

The `submask` parameter value is based upon the `ipaddr` setting. See [Table 6-3](#) for the valid input values for the `submask` and `ipaddr` parameter combinations.

Table 6-3 Valid Subnet Mask Parameter Values

Network Class	IP Network Address Range	Valid Subnet Mask Values
A	1.0.0.0 to 127.0.0.0	255.0.0.0 (the default value for a class A IP address)
		255.192.0.0
		255.224.0.0
		255.240.0.0
		255.248.0.0
		255.252.0.0
		255.254.0.0
		255.255.128.1
A+B	128.0.0.0 to 191.255.0.0	255.255.0.0 (the default value for a class B IP address)
		255.255.192.0
		255.255.224.0
		255.255.240.0
		255.255.248.0
		255.255.252.0
		255.255.254.0
		255.255.255.128
A+B+C	192.0.0.0 to 223.255.255.0	255.255.255.0 (the default value for a class C IP address)
		255.255.255.192
		255.255.255.224
		255.255.255.240
		255.255.255.248
		255.255.255.252

If a Class B IP address is specified for the `ipaddr` parameter of the `chg-ip-lnk` command, the subnet address that results from the `ipaddr` and `submask` parameter values cannot be the same as the subnet address that results from the `pvn` and `pvnmask`, `fcna` and `fcnamask`, or `fcnb` and `fcnbmask` parameter values of the `chg-netopts` command. The `pvn` and `pvnmask`, `fcna` and `fcnamask`, or `fcnb` and `fcnbmask` parameter values can be verified by entering the `rtrv-netopts` command. Choose `ipaddr` and `submask` parameter values for the IP link whose resulting subnet address is not be the same as the subnet address resulting from the `pvn` and `pvnmask`, `fcna` and `fcnamask`, or `fcnb` and `fcnbmask` parameter values of the `chg-netopts` command.

Canceling the RTRV-ASSOC Command

Because the `rtrv-assoc` command used in this procedure can output information for a long period of time, the `rtrv-assoc` command can be canceled and the output to the terminal stopped. There are three ways that the `rtrv-assoc` command can be canceled.

- Press the F9 function key on the keyboard at the terminal where the `rtrv-assoc` command was entered.
- Enter the `canc-cmd` without the `trm` parameter at the terminal where the `rtrv-assoc` command was entered.
- Enter the `canc-cmd:trm=<xx>`, where `<xx>` is the terminal where the `rtrv-assoc` command was entered, from another terminal other than the terminal where the `rtrv-assoc` command was entered. To enter the `canc-cmd:trm=<xx>` command, the terminal must allow Security Administration commands to be entered from it and the user must be allowed to enter Security Administration commands. The terminal's permissions can be verified with the `rtrv-secu-trm` command. The user's permissions can be verified with the `rtrv-user` or `rtrv-secu-user` commands.

For more information about the `canc-cmd` command, go to *Commands User's Guide*.

1. Display the current link parameters associated with the IP card in the database by entering the `rtrv-ip-lnk` command.

The following is an example of the possible output.

```
rlghncxa03w 08-12-28 21:14:37 GMT EAGLE5 40.0.0
LOC  PORT IPADDR          SUBMASK          DUPLEX  SPEED  MACTYPE
AUTO MCAST
1201  A    192.1.1.10          255.255.255.128  HALF    10     802.3
NO   NO
1201  B    -----            -----            HALF    10     DIX
NO   NO
1203  A    192.1.1.12          255.255.255.0   ----    ---    DIX
YES  NO
1203  B    -----            -----            HALF    10     DIX
NO   NO
1205  A    192.1.1.14          255.255.255.0   FULL    100    DIX
NO   NO
1205  B    -----            -----            HALF    10     DIX
NO   NO
2101  A    192.1.1.20          255.255.255.0   FULL    100    DIX
NO   NO
2101  B    -----            -----            HALF    10     DIX
NO   NO
2103  A    192.1.1.22          255.255.255.0   FULL    100    DIX
NO   NO
2103  B    -----            -----            HALF    10     DIX
NO   NO
2105  A    192.1.1.24          255.255.255.0   FULL    100    DIX
NO   NO
2105  B    -----            -----            HALF    10     DIX
NO   NO
```



```

2205 A 192.1.1.30      255.255.255.0  FULL  100  DIX  NO  NO
2205 B -----            -----            HALF  10   DIX  NO  NO
2207 A 192.1.1.32      255.255.255.0  FULL  100  DIX  NO  NO
2207 B -----            -----            HALF  10   DIX  NO  NO
2213 A 192.1.1.50      255.255.255.0  FULL  100  DIX  NO  NO
2213 B -----            -----            HALF  10   DIX  NO  NO
2301 A 192.1.1.52      255.255.255.0  FULL  100  DIX  NO  NO
2301 B -----            -----            HALF  10   DIX  NO  NO

```

IP-LNK table (20 of 2048) 1% full.

 **Note:**

If the `ipaddr=0.0.0.0` is not being specified in this procedure, continue the procedure with [3](#).

2. If **IP** address information is being added or changed (not deleted) in the link parameters, verify that the **IP** address is present in the **IP** host table by using the `rtrv-ip-host:display=all` command.

The following is an example of the possible output.

```

rlghncxa03w 08-12-28 21:15:37 GMT EAGLE5 40.0.0

LOCAL IPADDR      LOCAL HOST
192.1.1.10        IPNODE1-1201
192.1.1.12        IPNODE1-1203
192.1.1.14        IPNODE1-1205
192.1.1.20        IPNODE2-1201
192.1.1.22        IPNODE2-1203
192.1.1.24        IPNODE2-1205
192.1.1.30        KC-HLR1
192.1.1.32        KC-HLR2
192.1.1.50        DN-MSC1
192.1.1.52        DN-MSC2

REMOTE IPADDR     REMOTE HOST
150.1.1.5         NCDEPTECONOMIC_DEVELOPMENT. SOUTHEASTERN_COORIDOR_ASHVL.
GOV

IP Host table is (11 of 4096) 0.26% full

```

If the current **IP** address of the **IP** link is shown in the `rtrv-ip-host` output, remove the host assigned to the **IP** address by performing the [Removing an IP Host Assigned to an IP SG Card](#) procedure.

3. To change **IP** link parameters, the signaling links assigned to the **IP** card and the **IP** card have to be inhibited.

Display the signaling links assigned to the card shown in [1](#) using the `rtrv-slk` command specifying the card location.

For this example, enter this command.

```
rtrv-slk:loc=1201
```

This is an example of the possible output.

```
rlghncxa03w 08-04-12 15:36:20 GMT 38.0.0

LOC LINK LSN          SLC TYPE   ANAME          SLKTPS
1201 A   nc001          0   IPSG         m2pa1          1015

IPTPS for LOC = 1102 is (1015 of 5000) 20%
```

4. Retrieve the status of the signaling links assigned to the **IP** card to be changed using the `rept-stat-slk` command.

For example, enter this command.

```
rept-stat-slk:loc=1201:link=a
```

The output lists the signaling link assigned to this card:

```
rlghncxa03w 06-10-28 21:16:37 GMT EAGLE5 36.0.0
SLK      LSN          CLLI          PST          SST          AST
1201,A   nc001          ----- IS-NR
Command Completed.
```

If the signaling link is in service-normal (**IS-NR**), continue the procedure with [5](#) to deactivate the signaling link. If the signaling link is out-of-service-maintenance disabled (**OOS-MT-DSBLD**), continue the procedure with [7](#) to verify the **IP** card status.

5. Deactivate the signaling links assigned to the **IP** card using the `dact-slk` command.

For example, enter this command.

```
dact-slk:loc=1201:link=a
```

Caution:

This command impacts network performance and should only be used during periods of low traffic.

After this command has successfully completed, this message appears.

```
rlghncxa03w 06-10-12 09:12:36 GMT EAGLE5 36.0.0
Deactivate Link message sent to card.
```

6. Verify the new link status using the `rept-stat-slk` command.

For example, enter this command.

```
rept-stat-slk:loc=1201:link=a
```

The output displays the link status as **OOS-MT-DSBLD** and gives off a minor alarm:

```
rlghncxa03w 06-10-27 17:00:36 GMT EAGLE5 36.0.0
SLK      LSN      CLLI      PST      SST      AST
1201,A   nc001      ----- OOS-MT-DSBLD AVAIL   ---
ALARM STATUS = * 0236 REPT-LKS:not aligned
UNAVAIL REASON = NA
Command Completed.
```

7. Verify the status of the **IP** card to be inhibited using the `rept-stat-card` command.

For example, enter this command.

```
rept-stat-card:loc=1201
```

This is an example of the possible output.

```
rlghncxa03w 10-12-01 09:12:36 GMT EAGLE5 43.0.0
CARD  VERSION  TYPE  GPL  PST  SST  AST
1201  133-003-000 E5ENET IPSP  IS-NR  Active  -----
ALARM STATUS      = No Alarms.
BLIXP  GPL version = 133-003-000
IMT BUS A          = Conn
IMT BUS B          = Conn
CURRENT TEMPERATURE = 32C ( 90F)      [ALARM TEMP: 60C (140F)]
PEAK TEMPERATURE:  = 39C (103F)      [06-05-02 13:40]
SIGNALING LINK STATUS
      SLK  PST          LS          CLLI
      A   IS-NR          nc001      -----
```

Command Completed.

If the **IP** card to be inhibited is in service-normal (**IS-NR**), continue the procedure with [8](#) to inhibit the card. If the **IP** card is out-of-service-maintenance disabled (**OOS-MT-DSBLD**), continue the procedure with [10](#) to change the **IP** link parameters.

8. Inhibit the **IP** card using the `inh-card` command.

For example, enter this command.

```
inh-card:loc=1201
```

This message should appear.

```
rlghncxa03w 06-10-28 21:18:37 GMT EAGLE5 36.0.0
Card has been inhibited.
```

9. Display the status of the **IP** card to verify that it is out-of-service maintenance-disabled (**OOS-MT-DSBLD**).

Enter this command.

```
rept-stat-card:loc=1201
```

This is an example of the possible output.

```
rlghncxa03w 06-10-01 09:12:36 GMT EAGLE5 36.0.0
CARD   VERSION      TYPE      GPL      PST      SST
AST
1201   133-003-000   E5ENET   IPSEG    OOS-MT-DSBLD  Manual
-----
ALARM STATUS      = No Alarms.
BLIXP  GPL version = 133-003-000
IMT BUS A         = Conn
IMT BUS B         = Conn
CURRENT TEMPERATURE = 32C ( 90F)      [ALARM TEMP: 60C (140F)]
PEAK TEMPERATURE: = 39C (103F)      [06-05-02 13:40]
SIGNALING LINK STATUS
      SLK   PST           LS           CLLI
      A    IS-NR         nc001       -----
```

Command Completed

10. Display the attributes of the **IP** card assigned to the **IP** link being changed by entering the `rtrv-ip-card` command and specifying the card location of the **IP** link.

 **Note:**

If the `ipaddr` or `submask` parameter values are not being changed, continue the procedure with [13](#).

For this example, enter this command.

```
rtrv-ip-card:loc=1201
```

This is an example of the possible output.

```
rlghncxa03w 08-06-28 21:17:37 GMT EAGLE5 39.0.0
LOC 1201
SRCHORDR  LOCAL
DNSA      150.1.1.1
DNSB      -----
DEFROUTER -----
DOMAIN    -----
SCTPCSUM  crc32c
BPIPADDR  -----
BPSUBMASK -----
```

If the `rtrv-ip-card` output shows an **IP** address for the default router (`DEFROUTER`) whose network portion matches the network portion of the **IP** address being changed, perform the [Configuring an IP Card](#) procedure and change the **IP** address of the default router to `0.0.0.0`.

11. Display any **IP** routes referencing the **IP** link being changed by entering the `rtrv-ip-rte` command and specifying the card location of the **IP** link.

For this example, enter this command.

```
rtrv-ip-rte:loc=1201
```

This is an example of the possible output.

```
rlghncxa03w 06-10-28 21:17:37 GMT EAGLE5 36.0.0
LOC   DEST           SUBMASK           GTWY
1201  128.252.10.5    255.255.255.255  140.188.13.33
1201  128.252.0.0     255.255.0.0      140.188.13.34
1201  150.10.1.1      255.255.255.255  140.190.15.3
```

```
IP Route table is (5 of 2048) 0.24% full
```

If the `rtrv-ip-rte` output shows that the card has **IP** routes assigned to it, perform the [Removing an IP Route](#) procedure and remove the **IP** routes from the database.

12. The subnet address that results from the `ipaddr` and `submask` parameter values of the `chg-ip-lnk` command cannot be the same as the subnet address that results from the `pvn` and `pvnmask`, `fcna` and `fcnamask`, or `fcnb` and `fcnbmask` parameter values of the `chg-netopts` command.

 **Note:**

If a Class A or **CIP** address (see [Table 6-3](#)) will be specified for the `ipaddr` parameter in [14](#), continue the procedure with [13](#).

Display the `pvn`, `pvnmask`, `fcna`, `fcnamask`, `fcnb`, and `fcnbmask` parameter values of the `chg-netopts` command by entering the `rtrv-netopts` command.

If error message `E3967 Cmd Rej: E5IS must be on` is displayed after the `rtrv-netopts` command is executed, the `pvn`, `pvnmask`, `fcna`, `fcnamask`, `fcnb`, and `fcnbmask` parameters are not configured. Continue the procedure with [13](#).

This is an example of the possible output if the **E5IS** feature is on.

```
rlghncxa03w 09-02-28 21:17:37 GMT EAGLE5 40.1.0
NETWORK OPTIONS
-----
PVN           = 128.20.30.40
PVNMASK       = 255.255.192.0
FCNA          = 170.120.50.0
FCNAMASK      = 255.255.240.0
FCNB          = 170.121.50.0
FCNBMASK      = 255.255.254.0
```

Choose `ipaddr` and `submask` parameter values for the **IP** link whose resulting subnet address is not be the same as the subnet address resulting from the `pvn` and `pvnmask`,

`fcna` and `fcnamask`, or `fcnb` and `fcnbmask` parameter values of the `chg-netopts` command. Continue the procedure with [13](#).

13. Display the associations referencing the local host name that is associated with the IP link being changed by entering the `rtrv-assoc` command and specifying the local host name shown in the `rtrv-ip-host` output in [2](#).

For this example, enter this command.

```
rtrv-assoc:lhost="ipnode-1201"
```

This is an example of the possible output.

```
rlghncxa03w 06-10-28 09:12:36 GMT EAGLE5 36.0.0
                CARD IPLNK
ANAME          LOC  PORT  LINK ADAPTER LPORT RPORT OPEN ALW
swbel32        1201 A    A    M2PA    1030  2345  YES  YES

IP Appl Sock/Assoc table is (3 of 4000) 1% full
Assoc Buffer Space Used (16 KB of 3200 KB) on LOC = 1201
```

If no associations are displayed in this step, continue the procedure with [14](#).

If the `rtrv-assoc` output shows that the `open` parameter for any associations is `yes`, perform the [Changing the Attributes of an IPSG Association](#) procedure to change the value of the `open` parameter the associations to `no`.

14. Change the link parameters associated with the IP card in the database using the `chg-ip-lnk` command.

For this example, enter this command.

```
chg-ip-
lnk:loc=1201:port=a:ipaddr=192.1.1.10:submask=255.255.255.0
:auto=yes:mactype=dix
```

When this command has successfully completed, the following message should appear.

```
rlghncxa03w 06-10-28 21:18:37 GMT EAGLE5 36.0.0
CHG-IP-LNK: MASP A - COMPLTD
```

15. Verify the new link parameters associated with the IP card that was changed in [14](#) by entering the `rtrv-ip-lnk` command with the card location specified in [14](#).

For this example, enter this command.

The following is an example of the possible output.

```
rlghncxa03w 07-05-28 21:14:37 GMT EAGLE5 37.0.0
LOC  PORT IPADDR          SUBMASK          DUPLEX  SPEED  MACTYPE
AUTO MCAST
1201 A    192.1.1.10          255.255.255.128  HALF    10     DIX
YES  NO
```

```
1201 B ----- HALF 10 DIX NO NO
```

16. Allow the IP card that was inhibited in 8 by using by using the `alw-card` command.

 **Note:**

If 8 was not performed, continue the procedure with 18.

For example, enter this command.

```
alw-card:loc=1201
```

This message should appear.

```
rlghncxa03w 06-10-28 21:20:37 GMT EAGLE5 36.0.0
Card has been allowed.
```

17. Verify the in-service normal (IS-NR) status of the IP card using the `rept-stat-card` command.

For example, enter this command.

```
rept-stat-card:loc=1201
```

This is an example of the possible output.

```
rlghncxa03w 10-12-01 09:12:36 GMT EAGLE5 43.0.0
CARD  VERSION      TYPE      GPL      PST      SST      AST
1201  133-003-000  E5ENET   IPSP     IS-NR    Active   -----
ALARM STATUS      = No Alarms.
BLIXP  GPL version = 133-003-000
IMT BUS A         = Conn
IMT BUS B         = Conn
CURRENT TEMPERATURE = 32C ( 90F)      [ALARM TEMP: 60C (140F)]
PEAK TEMPERATURE:  = 39C (103F)      [06-05-02 13:40]
SIGNALING LINK STATUS
SLK   PST      LS      CLLI
A     IS-NR    nc001   -----
```

Command Completed.

18. Activate the signaling link from 5 using the `act-slk` command.

 **Note:**

If 5 was not performed, continue the procedure with 20.

For example, enter this command.

```
act-slk:loc=1201:link=a
```

The link changes its state from **OOS-MT-DSBLD** (out-of-service maintenance-disabled) to **IS-NR** (in-service normal).

The output confirms the activation.

```
rlghncxa03w 06-10-07 11:11:28 GMT EAGLE5 36.0.0
Activate Link message sent to card
```

19. Verify the in-service normal (**IS-NR**) status of the signaling link using the `rept-stat-slk` command.

For example, enter this command.

```
rept-stat-slk:loc=1201:link=a
```

This message should appear.

```
rlghncxa03w 06-10-28 21:16:37 GMT EAGLE5 36.0.0
SLK      LSN      CLLI      PST      SST      AST
1201,A   nc001      -----  IS-NR
Command Completed.
```

20. Perform the [Configuring an IP Card](#) procedure and change the **IP** address of the default router to a non-zero value, where the network portion of the default router **IP** address matches the network portion of the **IP** link's new **IP** address.

 **Note:**

If the `ipaddr` or `submask` values were not changed, continue the procedure with [22](#).

 **Note:**

If the **IP** address of the default router was not changed to 0.0.0.0 in [10](#), continue the procedure with [21](#).

21. Perform the [Adding an IP Route](#) procedure and add the **IP** routes back into the database.

 **Note:**

If **IP** routes were not removed in [11](#), continue the procedure with [22](#).

22. Perform the [Changing the Attributes of an IPSPG Association](#) procedure and change the value of the `open` parameter of the association to `yes`.

 **Note:**

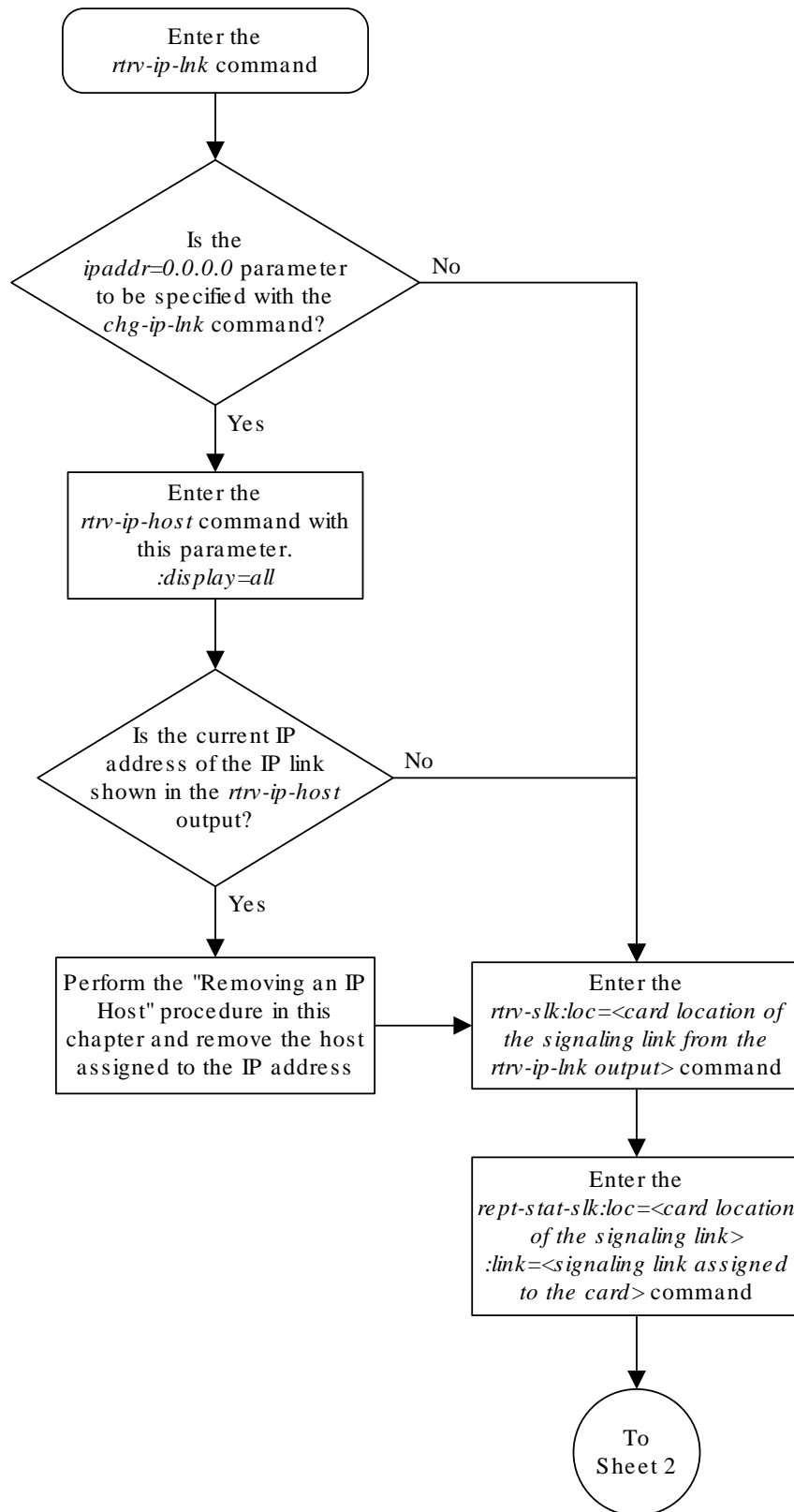
If the `open` parameter value for an association was not changed in 13, continue the procedure with 23.

23. Back up the new changes using the `chg-db:action=backup:dest=fixed` command.

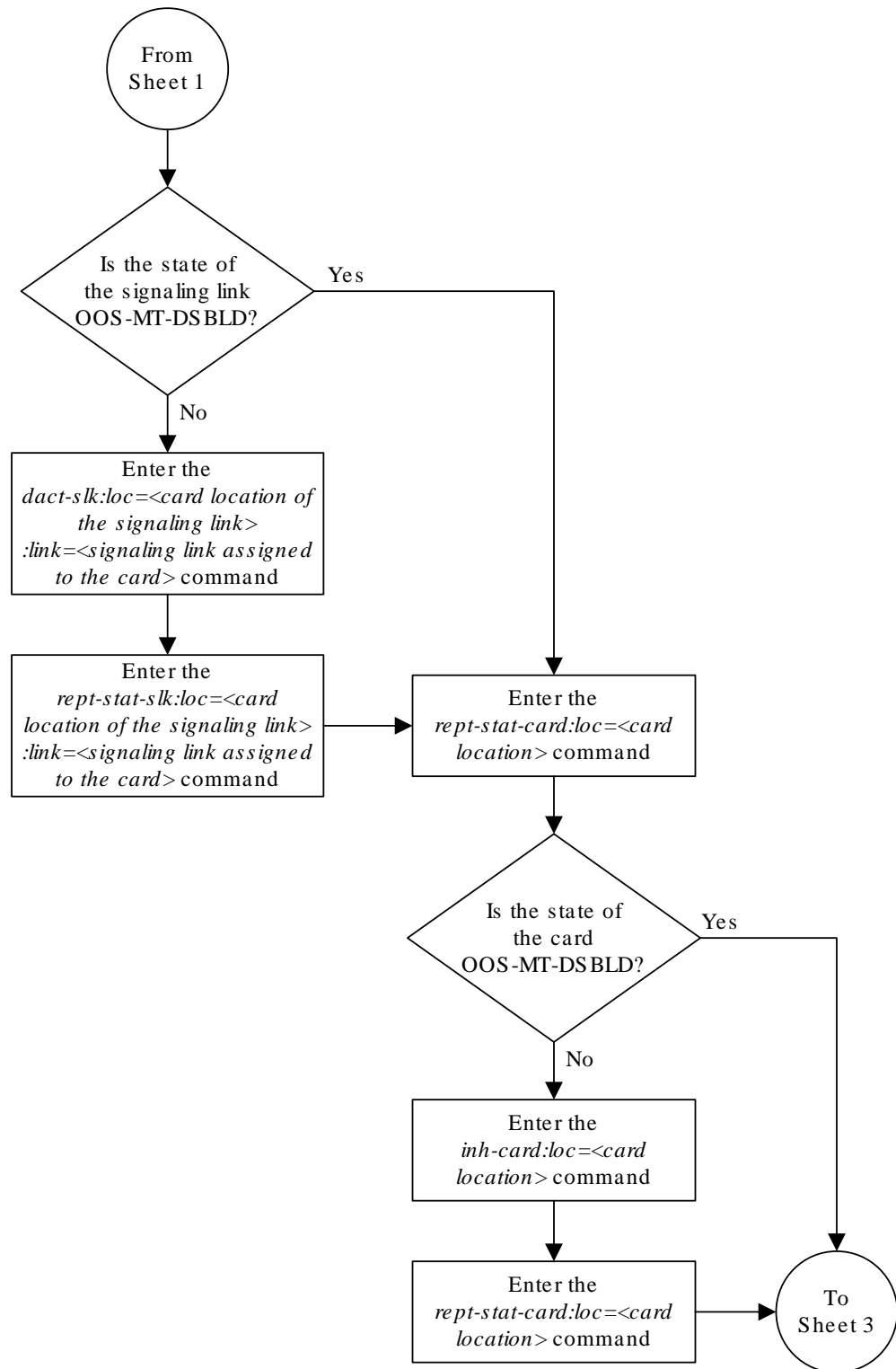
These messages should appear, the active **Maintenance and Administration Subsystem Processor (MASP)** appears first.

```
BACKUP (FIXED) : MASP A - Backup starts on active MASP.  
BACKUP (FIXED) : MASP A - Backup on active MASP to fixed disk complete.  
BACKUP (FIXED) : MASP A - Backup starts on standby MASP.  
BACKUP (FIXED) : MASP A - Backup on standby MASP to fixed disk complete.
```

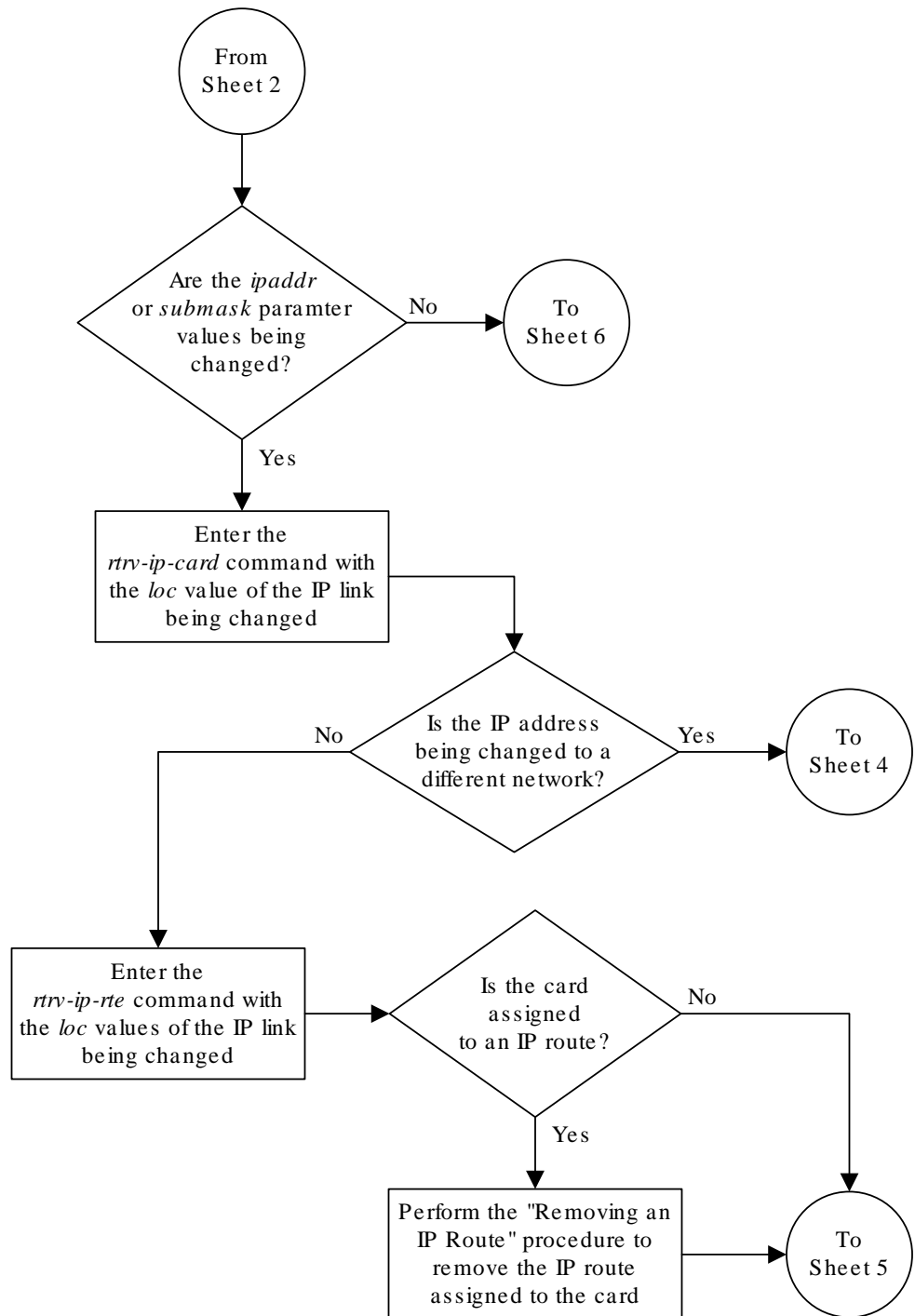
Figure 6-4 Configuring an IP Link



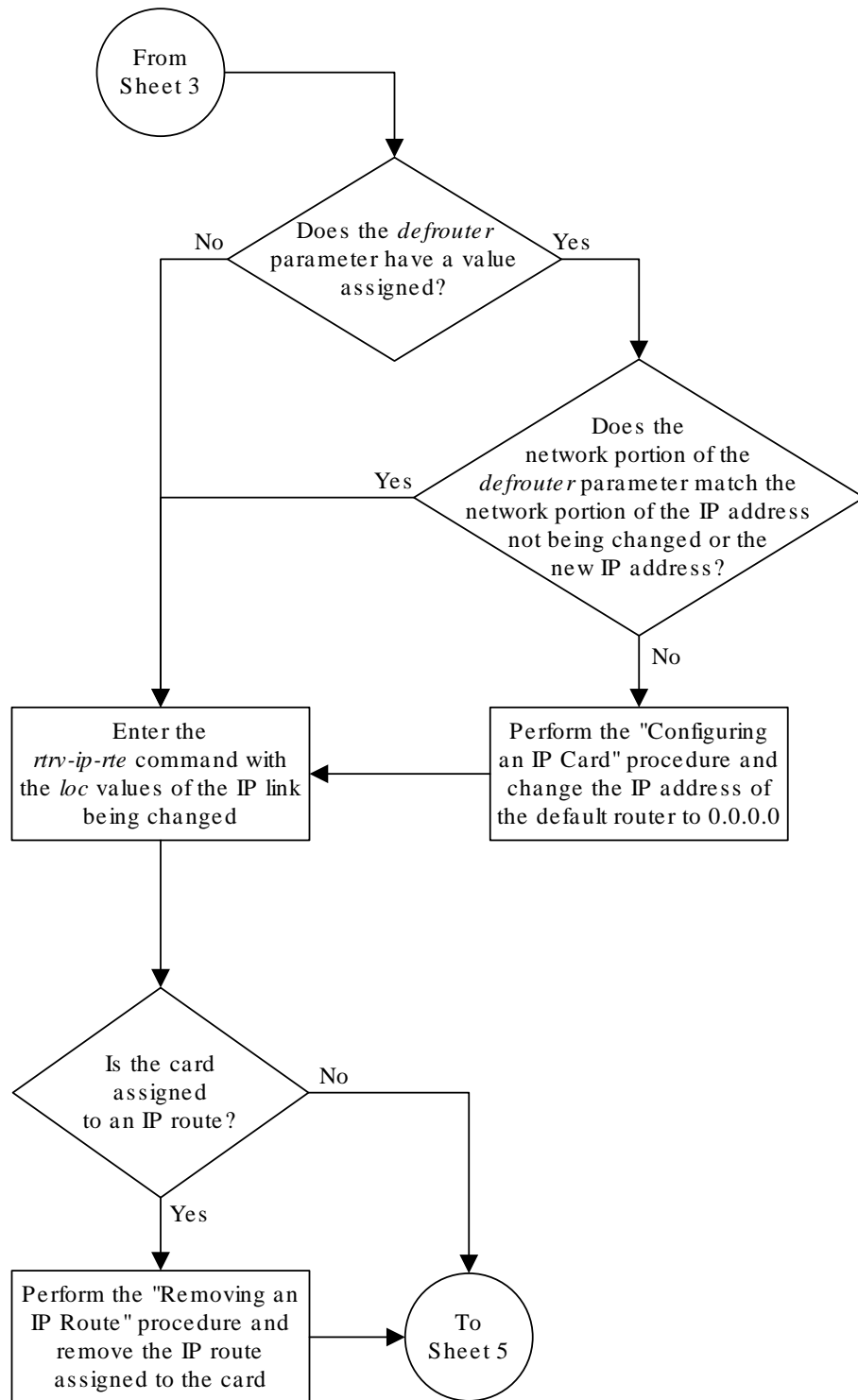
Sheet 1 of 9



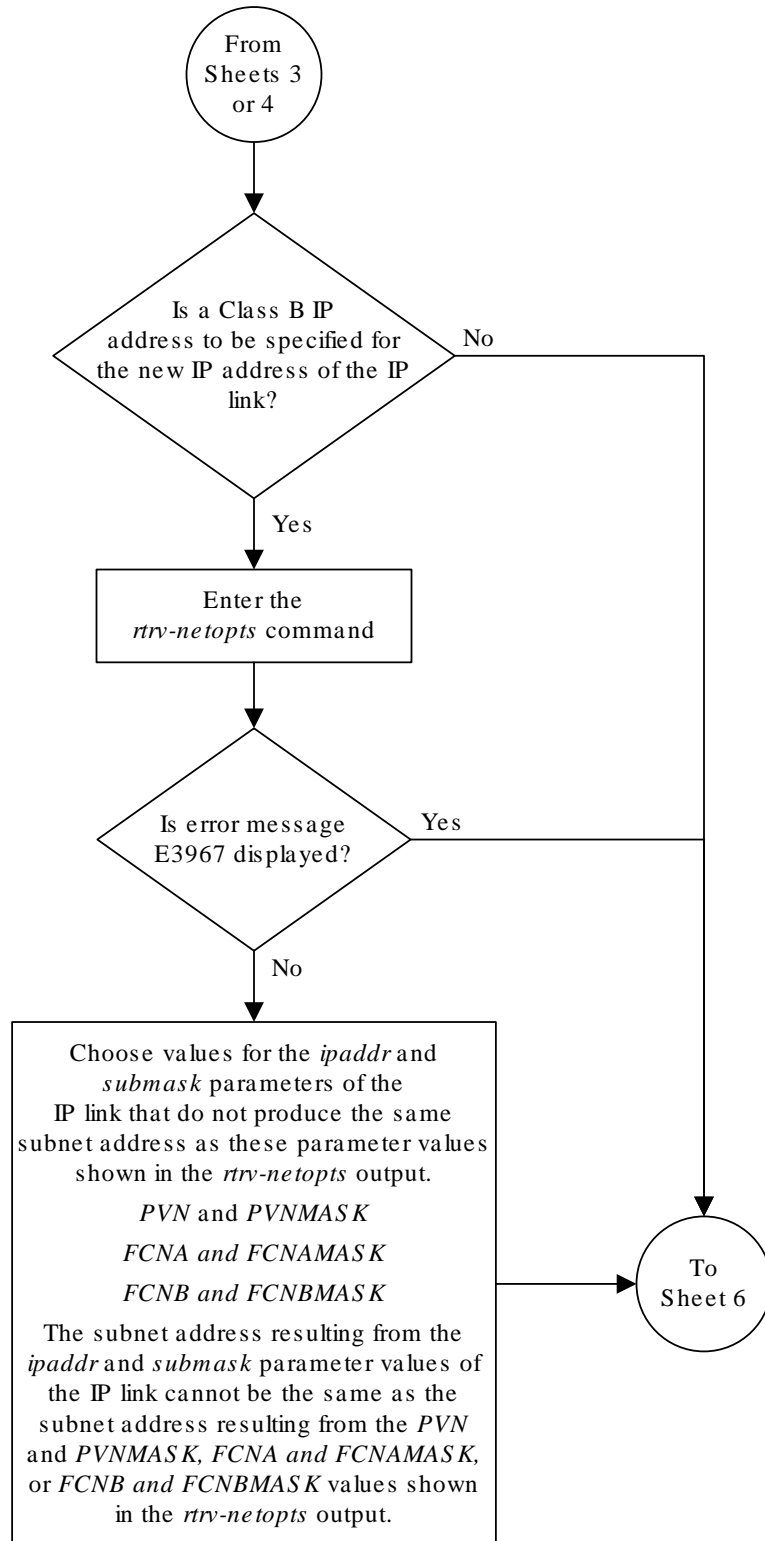
Sheet 2 of 9



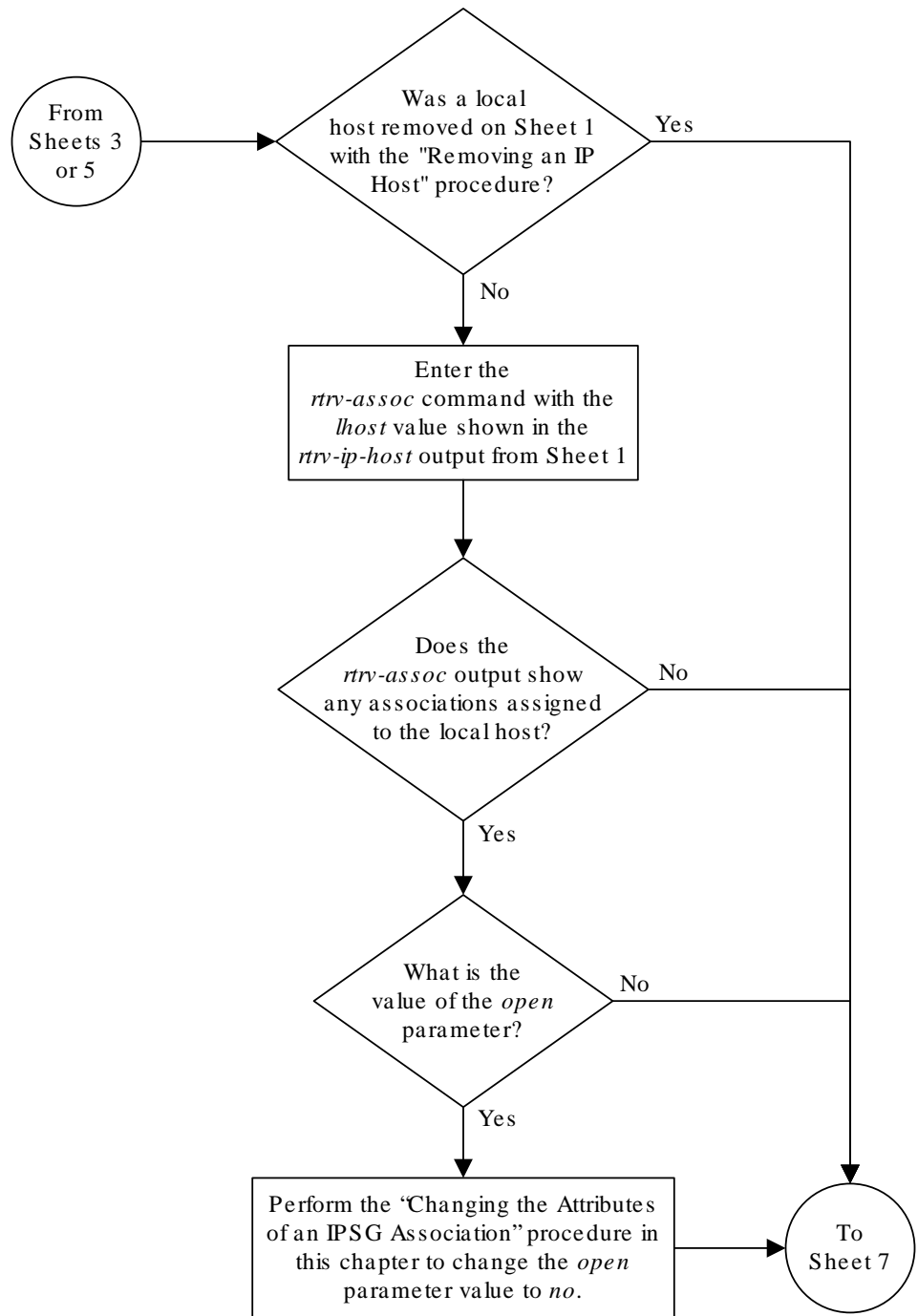
Sheet 3 of 9



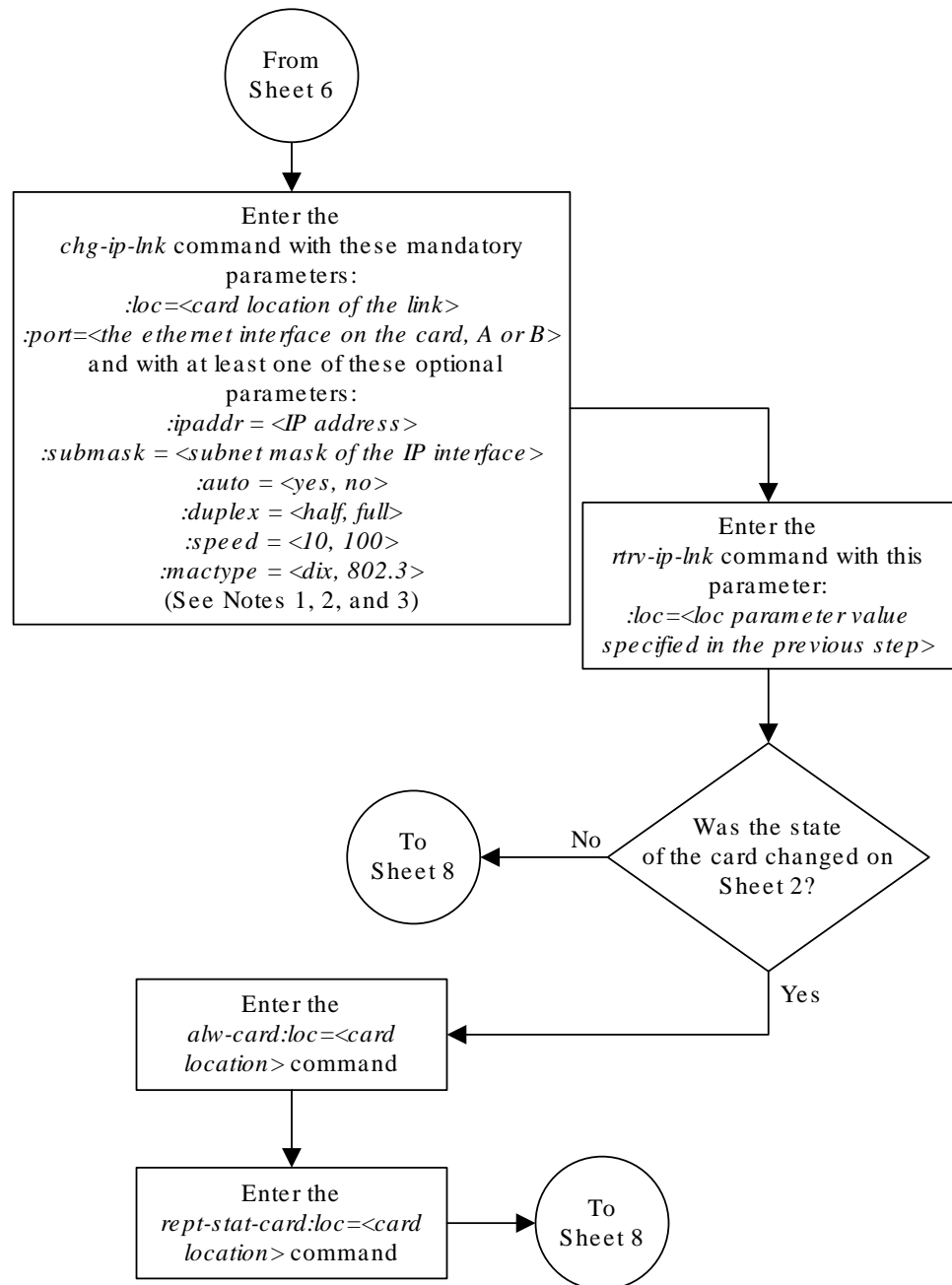
Sheet 4 of 9



Sheet 5 of 9



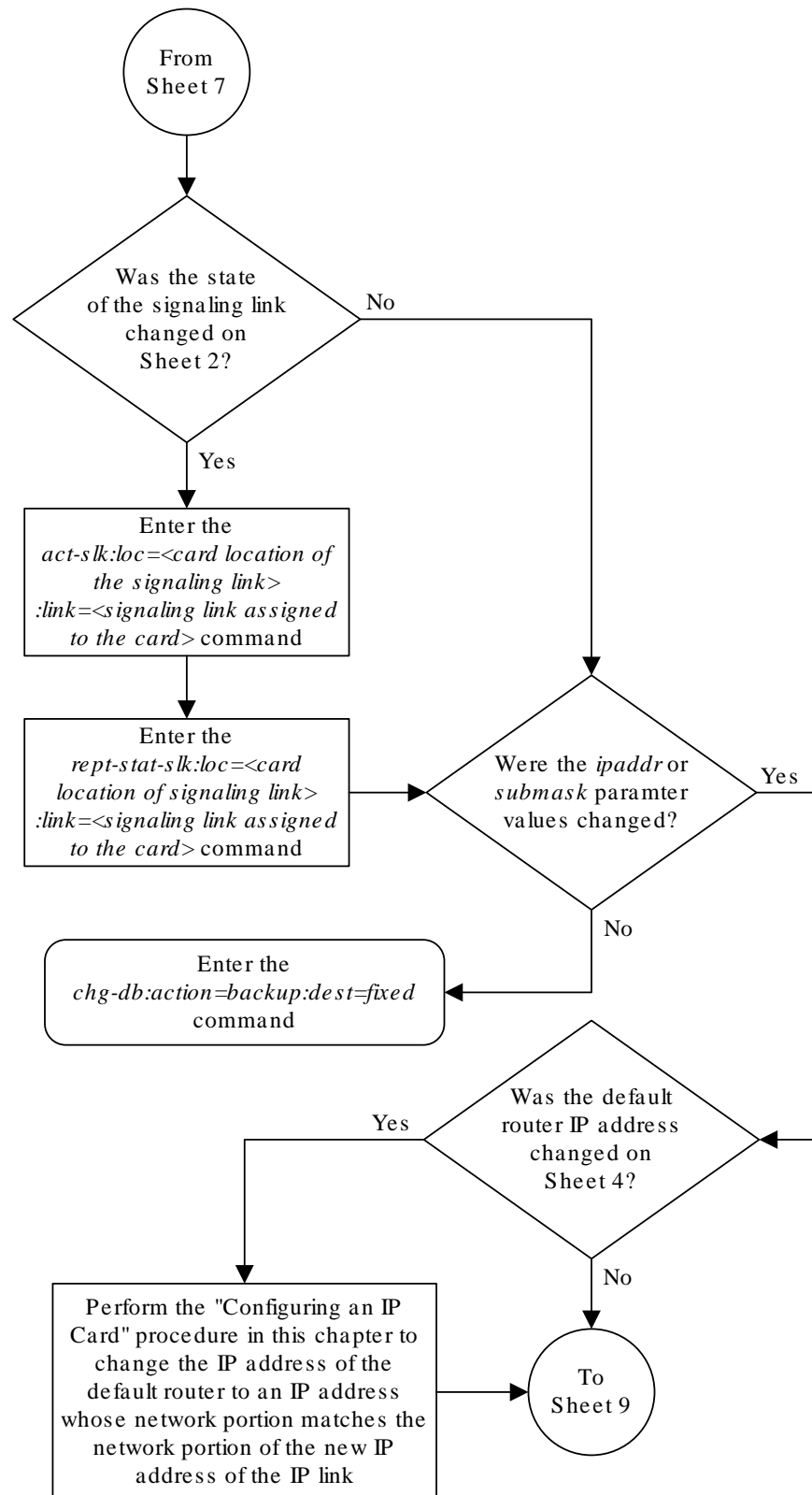
Sheet 6 of 9



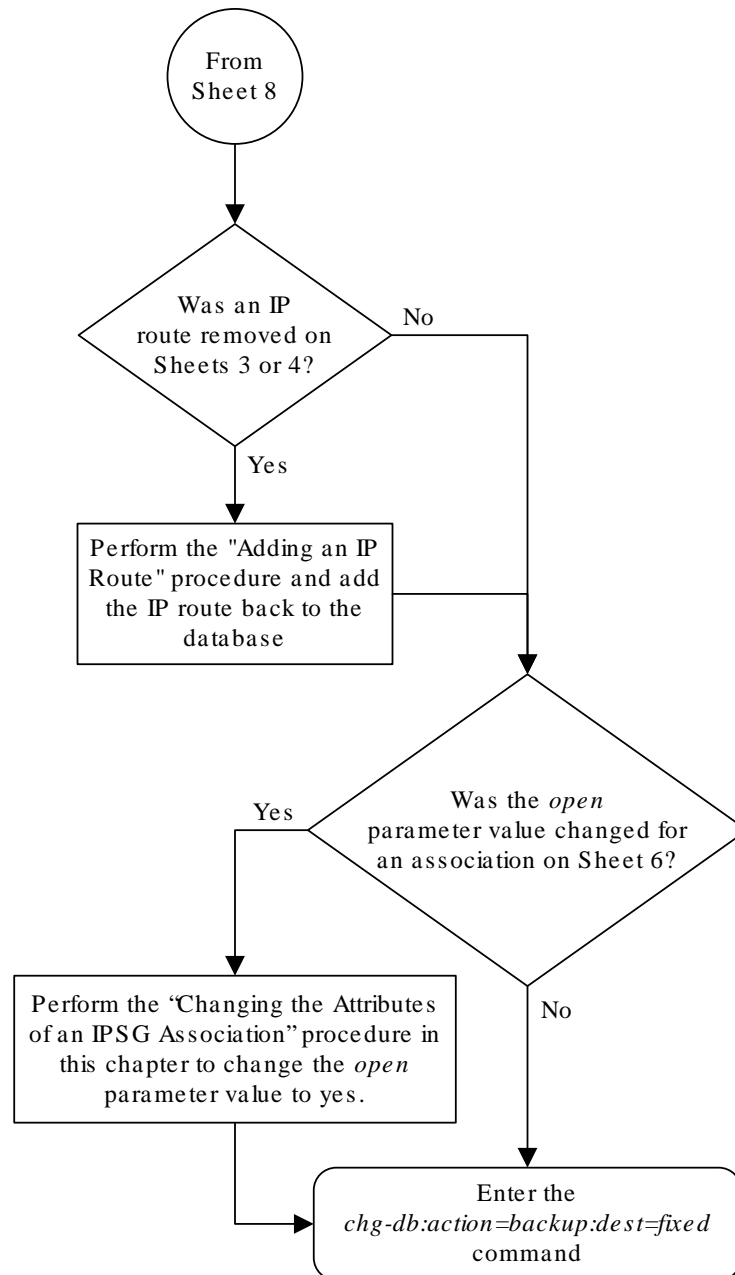
Notes:

1. If either the *ipaddr* or *submask* parameters are specified, then both parameters must be specified, unless the *ipaddr=0.0.0.0* parameter is specified, then the *submask* parameter is not required.
2. The *ipaddr=0.0.0.0* parameter disables the IP link.
3. If the *auto=yes* parameter is specified, then the *duplex* and *speed* parameters cannot be specified.

Sheet 7 of 9



Sheet 8 of 9



6.6 Adding an IP Host

This procedure associates hostnames with **IP** addresses using the `ent-ip-host` command.

The `ent-ip-host` command uses the following parameters.

`:host` – The host name to be associated with the **IP** address. This parameter identifies the logical name assigned to the device with the **IP** address indicated. The host name can contain up to 60 characters (using only these characters: a-z, A-Z, 0-9, -, .) and is not case sensitive. The host name must begin with a letter. Host names containing a dash (-) must be enclosed in double quotes.

`:ipaddr` – The **IP** address to be associated with the hostname. The node's **IP** address. This is an **IP** address expressed in standard "dot notation." **IP** addresses consist of the system's network number and the machine's unique host number.

`:type` – Specifies if the host resides on the **IP** card on the **EAGLE 5** (`type=local`, the default value), or if the host resides on equipment that is not in the **EAGLE 5** (`type=remote`). This parameter is optional.

The **EAGLE 5** can contain a maximum of 4026 IP hosts.

The **IP** address for a local host must be shown in the `rtrv-ip-lnk` output.

The **IP** address for a remote host must not be shown in the `rtrv-ip-lnk` output.

1. Display the current **IP** host information in the database by entering the `rtrv-ip-host:display=all` command.

The following is an example of the possible output.

```
rlghncxa03w 13-06-28 21:17:37 GMT EAGLE5 45.0.0
LOCAL IPADDR    LOCAL HOST
192.1.1.10      IPNODE1-1201
192.1.1.12      IPNODE1-1203
192.1.1.14      IPNODE1-1205
192.1.1.20      IPNODE2-1201
192.1.1.22      IPNODE2-1203
192.1.1.24      IPNODE2-1205
192.1.1.32      KC-HLR2
192.1.1.50      DN-MS1
192.1.1.52      DN-MS2

REMOTE IPADDR   REMOTE HOST
150.1.1.5       NCDEPTECONOMIC_DEVELOPMENT. SOUTHEASTERN_COORIDOR_ASHVL.
GOV
```

```
IP Host table is (10 of 4096) .24% full
```

2. Verify that the **IP** address assigned to the **IP** links by entering the `rtrv-ip-lnk` command.

The following is an example of the possible output.

```

rlghncxa03w 08-12-28 21:14:37 GMT EAGLE5 40.0.0
LOC  PORT IPADDR          SUBMASK          DUPLEX  SPEED  MACTYPE
AUTO MCAST
1201  A    192.1.1.10        255.255.255.128  HALF    10     802.3
NO   NO
1201  B    -----          -----          HALF    10     DIX
NO   NO
1203  A    192.1.1.12        255.255.255.0   ----    ---    DIX
YES  NO
1203  B    -----          -----          HALF    10     DIX
NO   NO
1205  A    192.1.1.14        255.255.255.0   FULL    100    DIX
NO   NO
1205  B    -----          -----          HALF    10     DIX
NO   NO
2101  A    192.1.1.20        255.255.255.0   FULL    100    DIX
NO   NO
2101  B    -----          -----          HALF    10     DIX
NO   NO
2103  A    192.1.1.22        255.255.255.0   FULL    100    DIX
NO   NO
2103  B    -----          -----          HALF    10     DIX
NO   NO
2105  A    192.1.1.24        255.255.255.0   FULL    100    DIX
NO   NO
2105  B    -----          -----          HALF    10     DIX
NO   NO
2207  A    192.1.1.32        255.255.255.0   FULL    100    DIX
NO   NO
2207  B    -----          -----          HALF    10     DIX
NO   NO
2213  A    192.1.1.50        255.255.255.0   FULL    100    DIX
NO   NO
2213  B    -----          -----          HALF    10     DIX
NO   NO
2301  A    192.1.1.52        255.255.255.0   FULL    100    DIX
NO   NO
2301  B    -----          -----          HALF    10     DIX
NO   NO

IP-LNK  table is (20 of 2048) 1 % full.

```

If a local host is being configured in this procedure, the **IP** address assigned to the local host must be shown in the `rtrv-ip-lnk` output. If the **IP** address is not shown in the `rtrv-ip-lnk` output, add the **IP** address by performing the [Configuring an IP Link](#) procedure.

If a remote host is being configured in this procedure, the **IP** address assigned to the remote host cannot be shown in the `rtrv-ip-lnk` output.

3. Add **IP** host information to the database by entering the `ent-ip-host` command.

If a local host is being configured, enter the `ent-ip-host` command with the IP address from 2, and the `type=local` parameter or without the `type` parameter. If the `type` parameter is not specified with the `ent-ip-host` command, the `type` parameter value defaults to `local`.

If a remote host is being configured, enter the `ent-ip-host` command with the IP address that is not shown in 2, and the `type=remote` parameter.

For example, enter this command.

```
ent-ip-host:host="kc-hlr1":ipaddr=192.1.1.30
```

When this command has successfully completed, the following message should appear.

```
rlghncxa03w 06-10-28 21:18:37 GMT EAGLE5 36.0.0  
ENT-IP-HOST: MASP A - COMPLTD
```

4. Verify the new IP host information in the database by entering the `rtrv-ip-host` command with the `host` parameter value specified in 3.

For this example, enter this command.

```
rtrv-ip-host:host="kc-hlr1"
```

The following is an example of the possible output.

```
rlghncxa03w 13-06-28 21:19:37 GMT EAGLE5 45.0.0  
LOCAL IPADDR    LOCAL HOST  
192.1.1.30      KC-HLR1
```

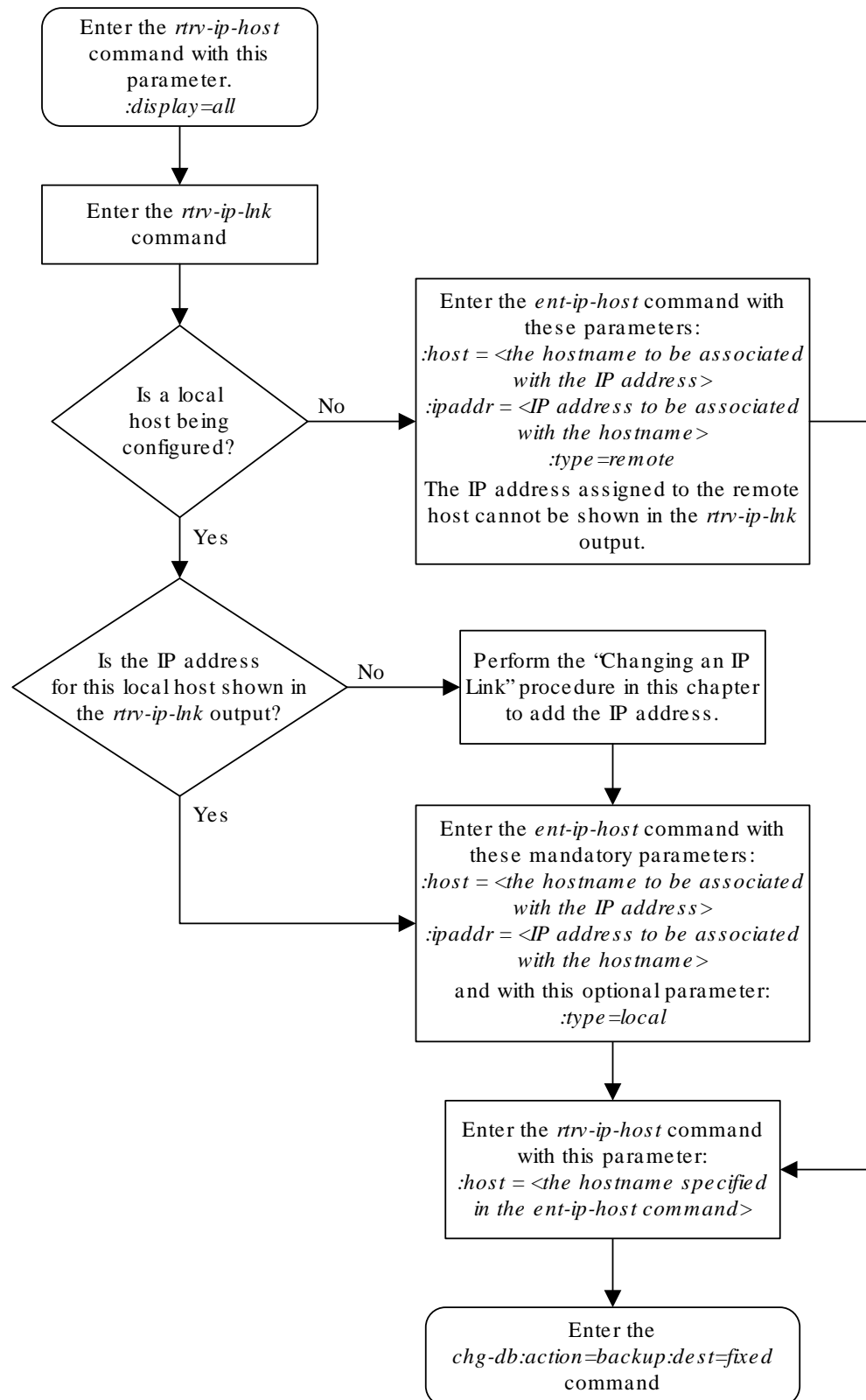
```
IP Host table is (11 of 4096) .26% full
```

5. Back up the new changes using the `chg-db:action=backup:dest=fixed` command.

These messages should appear, the active **Maintenance and Administration Subsystem Processor (MASP)** appears first.

```
BACKUP (FIXED) : MASP A - Backup starts on active MASP.  
BACKUP (FIXED) : MASP A - Backup on active MASP to fixed disk complete.  
BACKUP (FIXED) : MASP A - Backup starts on standby MASP.  
BACKUP (FIXED) : MASP A - Backup on standby MASP to fixed disk complete.
```

Figure 6-5 Adding an IP Host



6.7 Configuring an IP Card

This procedure is used to change the **IP** stack parameters associated with an **IP** card in the database using the `chg-ip-card` command.

The `chg-ip-card` command uses the following parameters.

`:loc` – The card location of the **IP** card

`:srchordr` – Host Table Search Order

`:dnlsa` – **Domain** name server A's **IP** address. This is an **IP** address expressed in standard "dot notation." **IP** addresses consist of the system's network number and the machine's unique host number.

`:dnspb` – **Domain** name server B's **IP** address. This is an **IP** address expressed in standard "dot notation." **IP** addresses consist of the system's network number and the machine's unique host number.

`:domain` – The domain name is used to construct a fully-qualified **DNS** name consisting of 120 characters or less. For example, a domain name can be `tekelec.com`, the hostname is `john.doe`. The fully-qualified **DNS** name would be `john.doe@tekelec.com`.

`:defrouter` – Default router **IP** address. This is an **IP** address expressed in standard "dot notation." **IP** addresses consist of the system's network number and the machine's unique host number.

`:rstdomain` – Reset **Domain** name. The parameter is used to reset the domain to a **NULL** value.

`:sctpcsum` – The SCTP checksum algorithm that will be applied to the traffic on the IP card, either `adler32` or `crc32c`. The `sctpcsum` parameter can be specified only if the `SCTPCSUM` value in the `rtrv-sg-opts` output is `percard`.

The `chg-ip-card` command contains other parameters that cannot be used in this procedure. Refer to *Commands User's Guide* for more information about these parameters.

The **IP** card must be placed out of service.

The `rstdomain` parameter cannot be specified if the `domain` parameter is specified.

There is only one default router (`defrouter` parameter) for each **IP** card. The default router is used as the primary route unless a static **IP** routes is defined for the destination **IP** address. Static **IP** routes are assigned using the `ent-ip-rte` command in the [Adding an IP Route](#) procedure.

The network portion of the **IP** address of the default router must match the network portion of one of the **IP** addresses assigned to the card.

The network portion of the **IP** address is based on the class of the **IP** address (shown in [Table 6-3](#)). If the **IP** address is a Class A **IP** address, the first field is the network portion of the **IP** address. If the **IP** address is a Class B **IP** address, the first two fields are the network portion of the **IP** address. If the **IP** address is a Class C **IP** address, the first three fields are the network portion of the **IP** address. For example, if the **IP** address is 193.5.207.150, a Class C **IP** address, the network portion of the **IP** address is 193.5.207.

The default router can be associated with only one **IP** address assigned to the card if the defrouter parameter is specified. For example, the `dnrsa` value for card 1101 is 150.1.1.10. The `dnrsb` value for card 1101 is 160.25.37.1. A default router is provisioned with the **IP** address 150.1.1.4. The default router is associated with the Ethernet A **IP** address (the `dnrsa` parameter value), but not the Ethernet B **IP** address (the `dnrsb` parameter value).

If the default router is associated with one of the **IP** card's **IP** addresses, a second gateway router can be assigned to the other **IP** address on the **IP** card by provisioning a static **IP** route for the **IP** card using the `ent-ip-rte` command in the [Adding an IP Route](#) procedure. Static **IP** routes can provide gateway routers associated with the other **IP** address on the **IP** card. To provision the gateway router (the `gtwy` parameter of the `ent-ip-rte` command) for the other **IP** address assigned to the **IP** card, the network portion of the gateway router's **IP** address must match the network portion of the other **IP** address assigned to the **IP** card.

Specifying the **IP** address 0.0.0.0 for the `dnrsa` or `dnrsb` parameters, removes the **IP** address for Ethernet A (`dnrsa`) or Ethernet B (`dnrsb`).

When an **IP** card is entered into the database with the `ent-card` command, the **IP** stack parameters associated with this card are initially set with these default values:

- `:srchordr` – **SRVR**
- `:dnrsa` – No **DNSA** **IP** address is specified
- `:dnrsb` – No **DNSB** **IP** address is specified
- `:domain` – No domain name is specified
- `:defrouter` – No default router **IP** address is specified
- `:rstdomain` – No
- `:sctpcsum` – **CRC32C**

The value of any optional parameter not specified with the `chg-ip-card` command is not changed.

1. Display the current **IP** parameters associated with card in the database by entering the `rtrv-ip-card` command.

The following is an example of the possible output.

```
rlghncxa03w 08-06-28 21:17:37 GMT EAGLE5 39.0.0
  LOC 1201
    SRCHORDR  SRVR
    DNSA      150.1.1.1
    DNSB      -----
    DEFROUTER -----
    DOMAIN    -----
    SCTPCSUM  crc32c
    BPIPADDR  -----
    BPSUBMASK -----
  LOC 1203
    SRCHORDR  LOCAL
    DNSA      192.1.1.40
    DNSB      -----
```



```

DEFROUTER -----
DOMAIN    NC. TEKELEC. COM
SCTPCSUM  crc32c
BPIPADDR  -----
BPSUBMASK -----
LOC 1205
SRCHORDR  SRVRONLY
DNSA      192.1.1.40
DNSB      -----
DEFROUTER -----
DOMAIN    NC. TEKELEC. COM
SCTPCSUM  crc32c
BPIPADDR  -----
BPSUBMASK -----

```

To change the parameters of an **IP** card, the signaling link to the card and the card have to be inhibited.

2. Display the signaling link associated with the card shown in 1 using the `rtrv-slk` command specifying the card location.

For this example, enter this command.

```
rtrv-slk:loc=1201
```

This is an example of the possible output.

```

rlghncxa03w 08-04-12 15:36:20 GMT 38.0.0

LOC LINK LSN          SLC TYPE      ANAME          SLKTPS
1201 A   nc001          0   IPSP         m2pa1          1015

IPTPS for LOC = 1102 is (1015 of 5000) 20%

```

3. Retrieve the status of the signaling link shown in 2 using the `rept-stat-slk` command specifying the card location and signaling link.

For example, enter this command.

```
rept-stat-slk:loc=1201:link=a
```

The output lists the signaling link assigned to this card:

```

rlghncxa03w 06-10-28 21:16:37 GMT EAGLE5 36.0.0
SLK      LSN          CLLI          PST          SST          AST
1201,A   nc001          -----      IS-NR
          Avail      ----
Command Completed.

```

If the signaling link is in service-normal (**IS-NR**), continue the procedure with 4 to deactivate the signaling link. If the signaling link is out-of-service-maintenance disabled (**OOS-MT-DSBLD**), continue the procedure with 6 to verify the card status.

4. Deactivate the signaling link assigned to the **IP** card using the `rept-stat-slk` command.

For example, enter this command.

```
dact-slk:loc=1201:link=a
```

Caution:

This command impacts network performance and should only be used during periods of low traffic.

After this command has successfully completed, this message appears.

```
rlghncxa03w 06-10-12 09:12:36 GMT EAGLE5 36.0.0
Deactivate Link message sent to card.
```

5. Verify the new link status using the `rept-stat-slk` command.

For example, enter this command.

```
rept-stat-slk:loc=1201:link=a
```

The output displays the link status as **OOS-MT-DSBLD** and gives off a minor alarm:

```
rlghncxa03w 06-10-27 17:00:36 GMT EAGLE5 36.0.0
SLK      LSN      CLLI      PST      SST      AST
1201,A   nc001      ----- OOS-MT-DSBLD AVAIL   ---
ALARM STATUS = * 0236 REPT-LKS:not aligned
UNAVAIL REASON = NA
Command Completed.
```

6. Verify the status of the IP card to be inhibited using the `rept-stat-card` command.

For example, enter this command.

```
rept-stat-card:loc=1201
```

This is an example of the possible output.

```
rlghncxa03w 10-12-01 09:12:36 GMT EAGLE5 43.0.0
CARD  VERSION  TYPE      GPL      PST      SST
AST
1201  133-003-000 E5ENET    IP SG     IS-NR     Active
-----
ALARM STATUS      = No Alarms.
BLIXP  GPL version = 133-003-000
IMT BUS A         = Conn
IMT BUS B         = Conn
CURRENT TEMPERATURE = 32C ( 90F)      [ALARM TEMP: 60C (140F)]
PEAK TEMPERATURE:  = 39C (103F)      [06-05-02 13:40]
SIGNALING LINK STATUS
      SLK      PST      LS      CLLI
      A      IS-NR     nc001     -----
```

Command Completed.

If the **IP** card to be inhibited is in service-normal (**IS-NR**), continue the procedure with [7](#) to inhibit the card. If the **IP** card is out-of-service-maintenance disabled (**OOS-MT-DSBLD**), continue the procedure with [9](#).

- Inhibit the **IP** card using the `inh-card` command.

For example, enter this command.

```
inh-card:loc=1201
```

This message should appear.

```
rlghncxa03w 06-10-28 21:18:37 GMT EAGLE5 36.0.0
Card has been inhibited.
```

- Display the status of the **IP** card to verify that it is out-of-service maintenance-disabled (**OOS-MT-DSBLD**).

Enter this command.

```
rept-stat-card:loc=1201
```

This is an example of the possible output.

```
rlghncxa03w 10-12-01 09:12:36 GMT EAGLE5 43.0.0
CARD   VERSION      TYPE      GPL      PST      SST      AST
1201   133-003-000    E5ENET   IPSTG    OOS-MT-DSBLD  Manual  -----
ALARM STATUS      = No Alarms.
BLIXP  GPL version = 133-003-000
IMT BUS A          = Conn
IMT BUS B          = Conn
CURRENT TEMPERATURE = 32C ( 90F)      [ALARM TEMP: 60C (140F)]
PEAK TEMPERATURE:  = 39C (103F)      [06-05-02 13:40]
SIGNALING LINK STATUS
      SLK   PST           LS           CLLI
      A    IS-NR          nc001        -----
```

Command Completed

If the `defrouter` parameter will be specified in [11](#), continue the procedure with [11](#).

If the `defrouter` parameter will not be specified in [11](#), continue the procedure by performing one of these steps.

- If the `setpcsum` parameter value for the card will not be changed, continue the procedure with [11](#).
 - If the `setpcsum` parameter value for the card will be changed, continue the procedure with [10](#).
- Verify that the **IP** address of either Ethernet A or B (the address whose network portion matches the network portion of the `defrouter` parameter value to be used in [11](#)) is in the **IP** link table by entering the `rtrv-ip-lnk` command with the card location specified in this procedure.

For this example, enter this command.

```
rtrv-ip-lnk:loc=1201
```

The following is an example of the possible output.

```
rlghncxa03w 06-10-28 21:17:37 GMT EAGLE5 36.0.0
LOC   PORT IPADDR          SUBMASK          DUPLEX   SPEED  MACTYPE
AUTO MCAST
1201  A    192.1.1.10      255.255.255.0    ----    ---   DIX
YES   NO
1201  B    -----         -----         ----    ---   DIX
YES   NO
```

If the network portion of the **IP** address specified by the `defrouter` value does not match the network portions of either **IP** address displayed in this step, perform one of these actions:

- Choose another value for the `defrouter` parameter, making sure that the network portion of the new **IP** address matches the network portion of one of the **IP** addresses displayed in this step.
- Perform the [Configuring an IP Link](#) procedure and change one of the **IP** addresses shown in this step so that the network portion of the new **IP** address changed in the [Configuring an IP Link](#) procedure matches the network portion of the **IP** address value for the `defrouter` parameter.

After this step has been completed, continue the procedure by performing one of these steps.

- If the `sctpcsum` parameter value for the card will not be changed, continue the procedure with [11](#).
 - If the `sctpcsum` parameter value for the card will be changed, continue the procedure with [11](#).
- 10.** To change the `sctpcsum` parameter value for the IP card, the `sctpcsum` parameter value in the `rtrv-sg-opts` output must be `percard`. Verify the `sctpcsum` parameter value by entering the `rtrv-sg-opts` command.

The following is an example of the possible output.

```
rlghncxa03w 08-04-13 09:19:43 GMT EAGLE5 38.0.0
SRKQ:          1500
SNMPCONT:      tekelec
GETCOMM:       public
SETCOMM:       private
TRAPCOMM:      public
SCTPCSUM:      adler32
IPGWABATE:     NO
UAMEASUSEDFTAS: NO
```

If the `sctpcsum` parameter value in the `rtrv-sg-opts` output is `percard`, continue the procedure with [11](#).

If the `sctpcsum` parameter value in the `rtrv-sg-opts` output is `adler 32` or `crc32c`, perform the one of these procedures to change the `sctpcsum` parameter value to `perc`, depending on the `ADAPTER` value of the association.

- [Changing the SCTP Checksum Algorithm Option for IPSP M2PA Associations](#)
- [Changing the SCTP Checksum Algorithm Option for IPSP M3UA Associations](#)

After the SCTP checksum algorithm has been changed, continue the procedure with [11](#).

11. Change the **IP** stack parameters associated with an **IP** card in the database using the `chg-ip-card` command.

For this example, enter this command.

```
chg-ip-
card:loc=1201:srchordr=local:dnsa=192.1.1.40:domain=nc.tekelec.co
m :sctpcsum=adler32
```

When this command has successfully completed, the following message should appear.

```
rlghncxa03w 06-10-28 21:20:37 GMT EAGLE5 36.0.0
CHG-IP-CARD: MASP A - COMPLTD
```

12. Verify the new **IP** parameters associated with the **IP** card that was changed in [11](#) by entering the `rtrv-ip-card` command with the card location specified in [11](#).

For this example, enter this command.

```
rtrv-ip-card:loc=1201
```

The following is an example of the possible output.

```
rlghncxa03w 08-06-28 21:17:37 GMT EAGLE5 39.0.0
LOC 1201
  SRCHORDR  LOCAL
  DNSA      192.1.1.40
  DNSB      -----
  DEFROUTER -----
  DOMAIN    NC. TEKELEC. COM
  SCTPCSUM  adler32
  BPIPADDR  -----
  BPSUBMASK -----
```

 **Note:**

If [7](#) was not performed, continue the procedure with [15](#).

13. Allow the **IP** card that was inhibited in [7](#) by using the `alw-card` command.

For example, enter this command.

```
alw-card:loc=1201
```

This message should appear.

```
rlghncxa03w 06-10-28 21:22:37 GMT EAGLE5 36.0.0
Card has been allowed.
```

14. Verify the in-service normal (**IS-NR**) status of the **IP** card using the `rept-stat-card` command.

For example, enter this command.

```
rept-stat-card:loc=1201
```

This is an example of the possible output.

```
rlghncxa03w 10-12-01 09:12:36 GMT EAGLE5 43.0.0
CARD  VERSION      TYPE      GPL      PST      SST
AST
1201  133-003-000  E5ENET   IPG      IS-NR    Active
-----
ALARM STATUS      = No Alarms.
BLIXP  GPL version = 133-003-000
IMT BUS A        = Conn
IMT BUS B        = Conn
CURRENT TEMPERATURE = 32C ( 90F)      [ALARM TEMP: 60C (140F)]
PEAK TEMPERATURE: = 39C (103F)     [06-05-02 13:40]
SIGNALING LINK STATUS
SLK   PST          LS          CLLI
A     IS-NR        nc001      -----
```

Command Completed.

15. Activate the signaling link from 4 using the `act-slk` command.

 **Note:**

If 4 was not performed, continue the procedure with 17.

For example, enter this command.

```
act-slk:loc=1201:link=a
```

The link changes its state from **OOS-MT-DSBLD** (out-of-service maintenance-disabled) to **IS-NR** (in-service normal).

The output confirms the activation.

```
rlghncxa03w 06-10-07 11:11:28 GMT EAGLE5 36.0.0
Activate Link message sent to card
```

16. Verify the in-service normal (**IS-NR**) status of the signaling link using the `rept-stat-slk` command.

For example, enter this command.

```
rept-stat-slk:loc=1201:link=a
```

This message should appear.

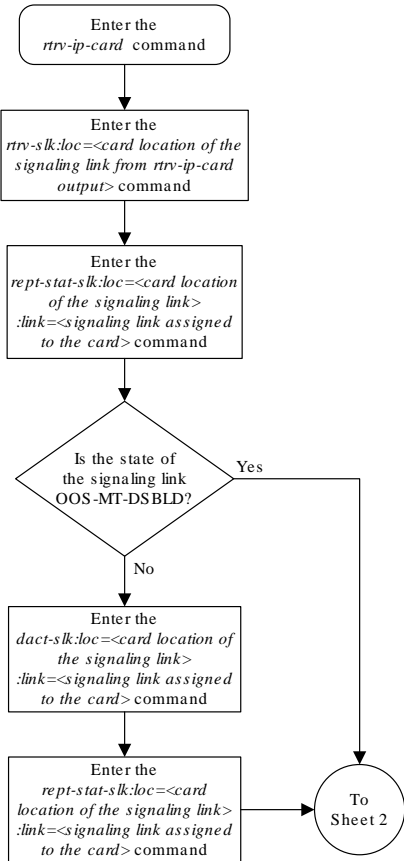
```
rlghncxa03w 06-10-28 21:16:37 GMT EAGLE5 36.0.0
SLK      LSN      CLLI      PST      SST      AST
1201,A   nc001      -----   IS-NR
          Avail    ----
Command Completed.
```

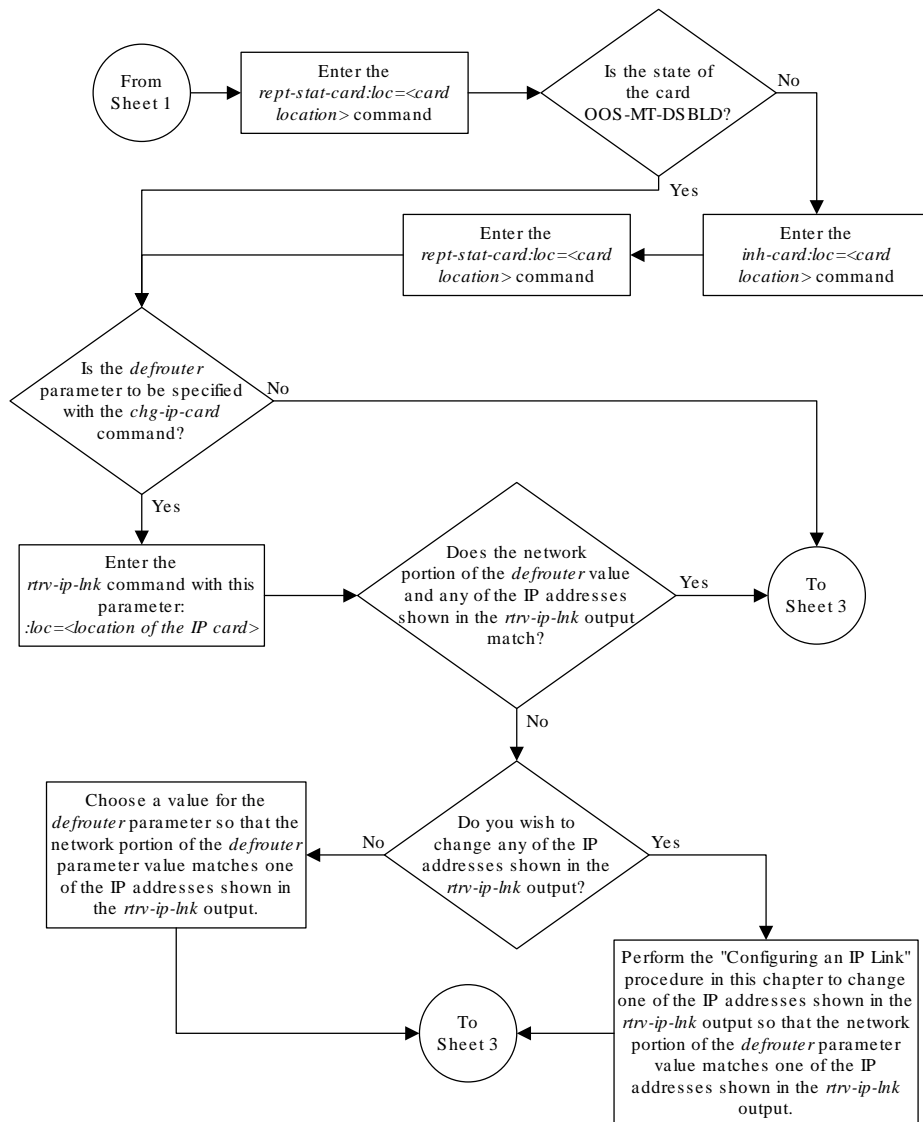
17. Back up the new changes using the `chg-db:action=backup:dest=fixed` command.

These messages should appear, the active **Maintenance and Administration Subsystem Processor (MASP)** appears first.

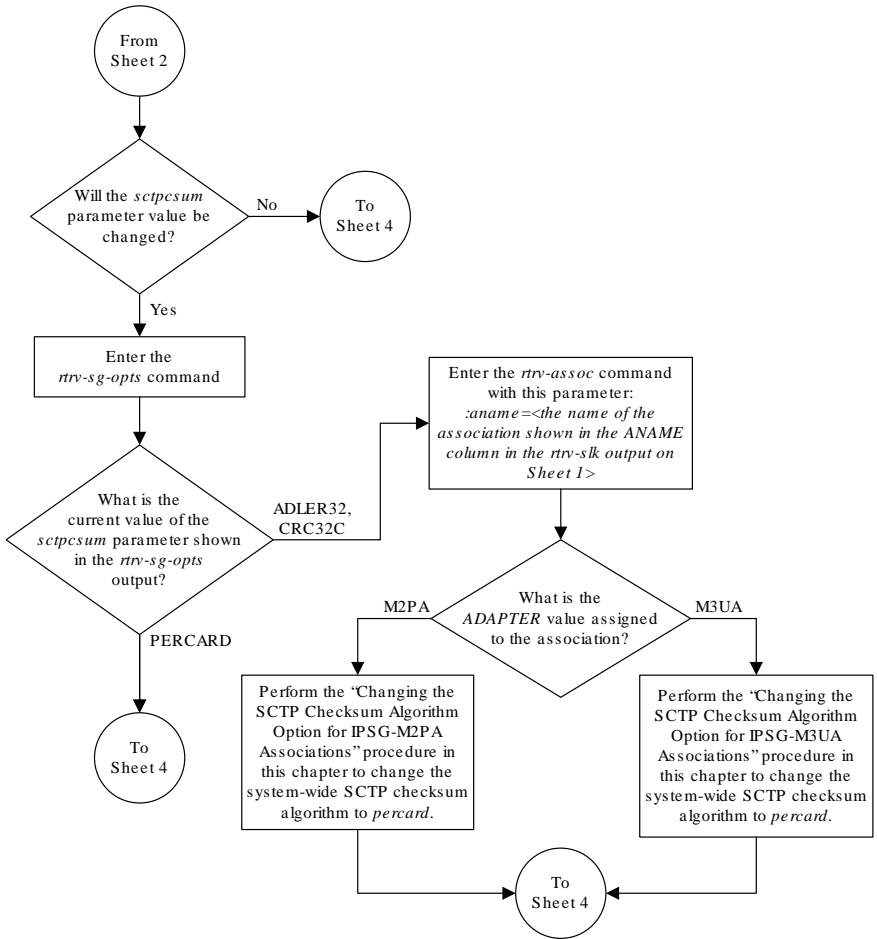
```
BACKUP (FIXED) : MASP A - Backup starts on active MASP.
BACKUP (FIXED) : MASP A - Backup on active MASP to fixed disk complete.
BACKUP (FIXED) : MASP A - Backup starts on standby MASP.
BACKUP (FIXED) : MASP A - Backup on standby MASP to fixed disk complete.
```

Figure 6-6 Configuring an IP Card

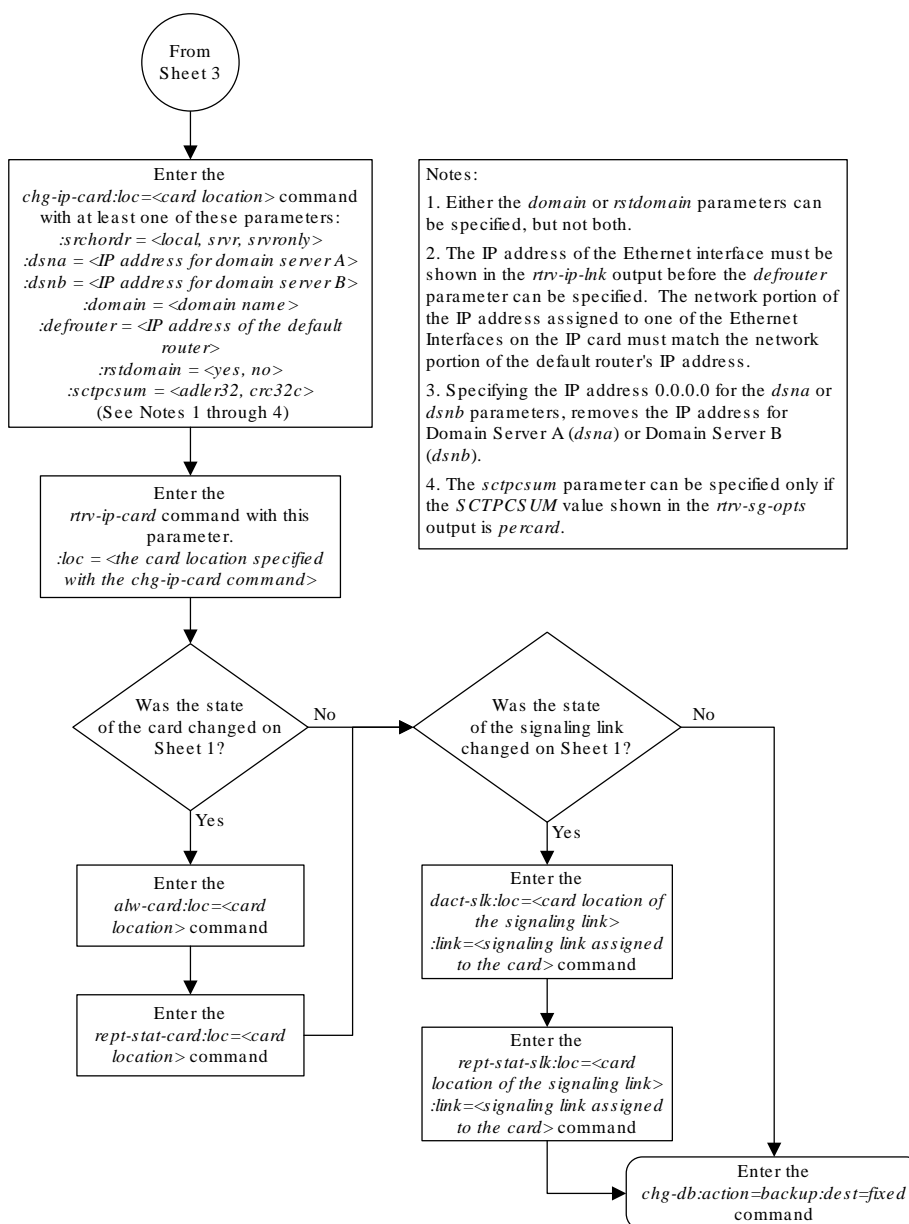




Sheet 2 of 4



Sheet 3 of 4



Sheet 4 of 4

6.8 Adding an IP Route

This procedure is used to add an **IP** route to the database using the `ent-ip-rte` command.

The `ent-ip-rte` command uses these parameters.

`:loc` – The location of the **IP** card that the **IP** route will be assigned to.

: `dest` – The **IP** address of the remote host or network.

: `submask` – The subnet mask of the destination **IP** address.

: `gtwy` – The **IP** address of the gateway or router that will send the **IP** data to its final destination.

There can be a maximum of 64 **IP** routes assigned to an **IP** card.

The **EAGLE** can contain a maximum of 2048 **IP** routes.

Ethernet Interfaces A and B on the **IP** card specified by the `loc` parameter can be used.

The network portion of the **IP** address value of the `gtwy` parameter must be the same as the network portion of the **IP** addresses shown for either the A or B interfaces in the `rtrv-ip-card` output.

The value of the `dest` and `gtwy` parameters cannot be 127.x.x.x (the loopback address), 0.0.0.0, or the **IP** addresses of the A or B interfaces on the **IP** card, and cannot be assigned to another **IP** card.

If the `dest` parameter value represents a host **IP** address, the value for the `submask` parameter must be 255.255.255.255. Otherwise, the `submask` parameter value identifies the network/host **ID** portions that must be entered when the `dest` parameter value represents a network address.

The submask is applied to the **IP** address which is being routed to see if it yields a route match. For example, if **IP** address 192.1.1.2 is being routed and the **IP** routing table contains these entries.

Table 6-4 Sample IP Routing Table

IP address	Submask	Gateway
191.1.0.0	255.255.0.0	192.168.110.250
192.0.0.0	255.0.0.0	192.168.110.251

IP routing occurs as follows:

1. The subnet mask of route 1 (255.255.0.0) is applied to the **IP** address being routed (192.1.1.2) with the resulting **IP** address of 192.1.0.0. **IP** address 192.1.0.0 does not match **IP** address 191.1.0.0 in the **IP** routing table, so the next route is chosen.
2. The subnet mask of route 2 (255.0.0.0) is applied to the **IP** address being routed (192.1.1.2) with the resulting **IP** address of 192.0.0.0 which matches the second route in the **IP** routing table, so this route is selected for routing this datagram.

See [Table 6-5](#) for the valid input values for the `submask` and `dest` parameter combinations.

Table 6-5 Valid Subnet Mask Parameter Values

Network Class	IP Network Address Range	Valid Subnet Mask Values
A	1.0.0.0 to 127.0.0.0	255.0.0.0 (the default value for a class A IP address)
		255.192.0.0
		255.224.0.0
		255.240.0.0
		255.248.0.0
		255.252.0.0
		255.254.0.0
A+B	128.1.0.0 to 191.255.0.0	255.255.128.1
		255.255.0.0 (the default value for a class B IP address)
		255.255.192.0
		255.255.224.0
		255.255.240.0
		255.255.248.0
A+B+C	192.0.0.0 to 223.255.255.0	255.255.252.0
		255.255.254.0
		255.255.255.128
		255.255.255.0 (the default value for a class C IP address)
		255.255.255.192
		255.255.255.224
		255.255.255.240
		255.255.255.248
		255.255.255.252

If a Class B IP address is specified for the `dest` parameter of the `ent-ip-rte` command, the subnet address that results from the `dest` and `submask` parameter values cannot be the same as the subnet address that results from the `pvn` and `pvnmask`, `fcna` and `fcnamask`, or `fcnb` and `fcnbmask` parameter values of the `chg-netopts` command. The `pvn` and `pvnmask`, `fcna` and `fcnamask`, or `fcnb` and `fcnbmask` parameter values can be verified by entering the `rtrv-netopts` command. Choose `dest` and `submask` parameter values for the IP route whose resulting subnet address is not be the same as the subnet address resulting from the `pvn` and `pvnmask`, `fcna` and `fcnamask`, or `fcnb` and `fcnbmask` parameter values of the `chg-netopts` command.

1. Display the IP routes in the database with the `rtrv-ip-rte` command.

This is an example of the possible output.

```
rlghncxa03w 06-10-28 09:12:36 GMT EAGLE5 36.0.0
LOC  DEST          SUBMASK          GTWY
1301 128.252.10.5     255.255.255.255 140.188.13.33
1301 128.252.0.0      255.255.0.0      140.188.13.34
1301 150.10.1.1       255.255.255.255 140.190.15.3
1303 192.168.10.1     255.255.255.255 150.190.15.23
```

```
1303 192.168.0.0      255.255.255.0      150.190.15.24

IP Route table is (5 of 2048) 0.24% full
```

2. Display the IP cards in the database with the `rtrv-ip-card` command.

This is an example of the possible output.

```
rlghncxa03w 08-08-28 21:17:37 GMT EAGLE5 39.0.0
  LOC 1212
    SRCHORDR LOCAL
    DNSA      150.1.1.1
    DNSB      -----
    DEFROUTER 150.1.1.100
    DOMAIN    NC. TEKELEC. COM
    SCTPCSUM  crc32c
    BPIPADDR  -----
    BPSUBMASK -----
  LOC 1301
    SRCHORDR SRVROONLY
    DNSA      140.188.13.10
    DNSB      140.190.15.28
    DEFROUTER -----
    DOMAIN    NC. TEKELEC. COM
    SCTPCSUM  crc32c
    BPIPADDR  -----
    BPSUBMASK -----
  LOC 1303
    SRCHORDR LOCAL
    DNSA      150.190.15.1
    DNSB      -----
    DEFROUTER 150.190.15.25
    DOMAIN    NC. TEKELEC. COM
    SCTPCSUM  crc32c
    BPIPADDR  -----
    BPSUBMASK -----
```

If the required IP card is not shown in the `rtrv-ip-card` output, perform the [Adding an IP Card](#) procedure to add the card to the database.

Perform the [Configuring an IP Link](#) procedure and make sure that the network portion of the IP addresses assigned for the A or B interfaces of the IP card is the same as the network portion of the IP address that will be assigned to the `gtwy` parameter of the IP route

 **Note:**

If a Class A or C IP address (see [Table 6-5](#)) will be specified for the `dest` parameter in 4, continue the procedure with 4.

3. The subnet address that results from the `dest` and `submask` parameter values of the `ent-ip-rte` command cannot be the same as the subnet address that

results from the `pvn` and `pvnmask`, `fcna` and `fcnamask`, or `fcnb` and `fcnbmask` parameter values of the `chg-netopts` command.

Display the `pvn`, `pvnmask`, `fcna`, `fcnamask`, `fcnb`, and `fcnbmask` parameter values of the `chg-netopts` command by entering the `rtrv-netopts` command.

If error message `E3967 Cmd Rej: E5IS must be on` is displayed after the `rtrv-netopts` command is executed, the `pvn`, `pvnmask`, `fcna`, `fcnamask`, `fcnb`, and `fcnbmask` parameters are not configured. Continue the procedure with 4.

This is an example of the possible output if the **E5IS** feature is on.

```
rlghncxa03w 09-02-28 21:17:37 GMT EAGLE5 40.1.0
NETWORK OPTIONS
-----
PVN          = 128.20.30.40
PVNMASK      = 255.255.192.0
FCNA         = 170.120.50.0
FCNAMASK     = 255.255.240.0
FCNB         = 170.121.50.0
FCNBMASK     = 255.255.254.0
```

Choose `dest` and `submask` parameter values for the **IP** route whose resulting subnet address is not be the same as the subnet address resulting from the `pvn` and `pvnmask`, `fcna` and `fcnamask`, or `fcnb` and `fcnbmask` parameter values of the `chg-netopts` command. Continue the procedure with 4.

4. Add the **IP** route to the database using the `ent-ip-rte` command.

For this example, enter this command.

```
ent-ip-
rte:loc=1212:dest=132.10.175.20:submask=255.255.255.255 :gtwy=150
.1.1.50
```

When this command has successfully completed, this message should appear.

```
rlghncxa03w 06-10-12 09:12:36 GMT EAGLE5 36.0.0
ENT-IP-RTE: MASP A - COMPLTD
```

5. Verify the changes using the `rtrv-ip-rte` command with the card location specified with the `ent-ip-rte` command in 4.

For this example, enter these commands.

```
rtrv-ip-rte:loc=1212
```

This is an example of the possible output.

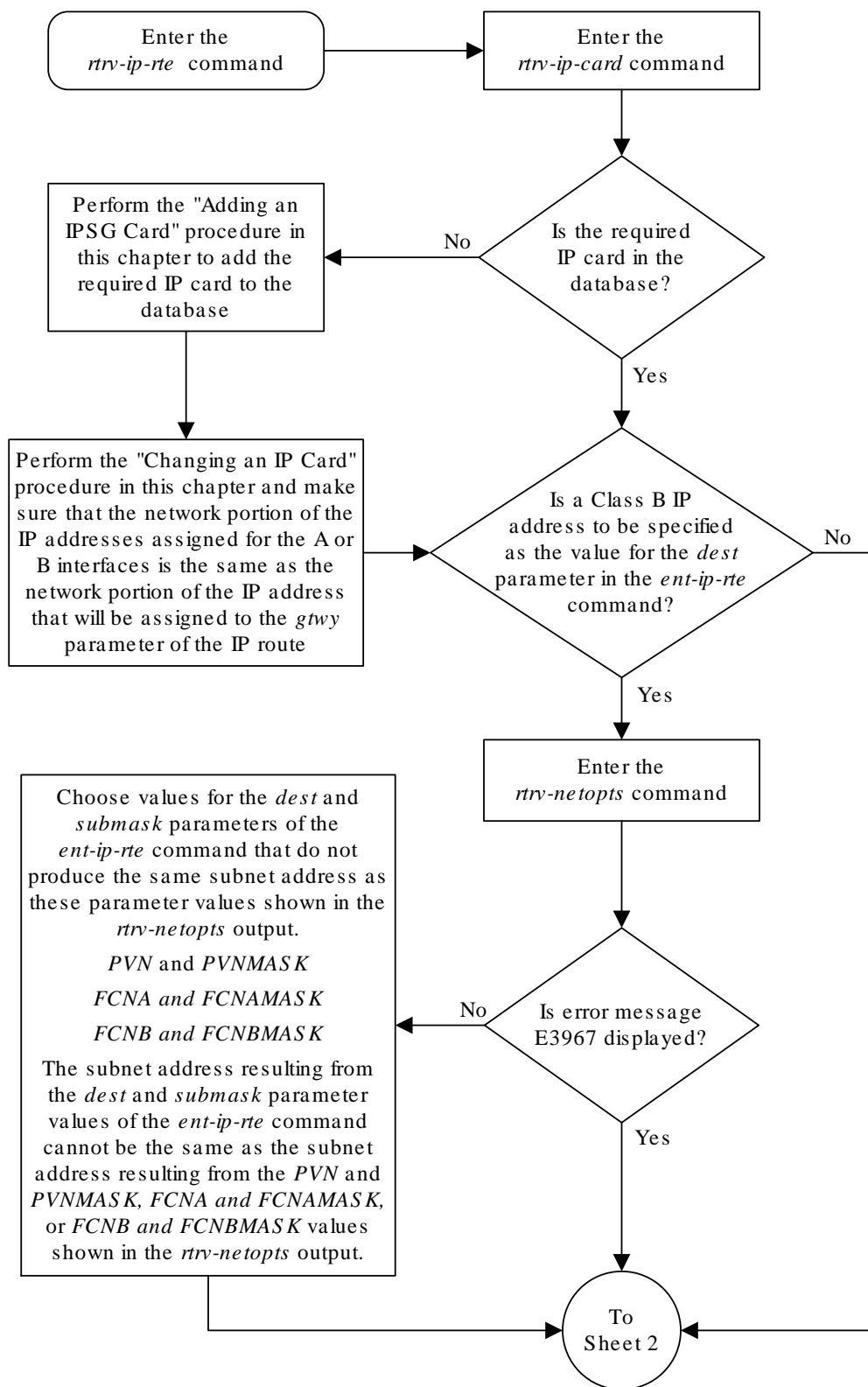
```
rlghncxa03w 06-10-28 09:12:36 GMT EAGLE5 36.0.0
LOC  DEST          SUBMASK          GTWY
1212 132.10.175.20  255.255.255.255  150.1.1.50
IP Route table is (6 of 2048) 0.29% full
```

6. Back up the new changes using the `chg-db:action=backup:dest=fixed` command.

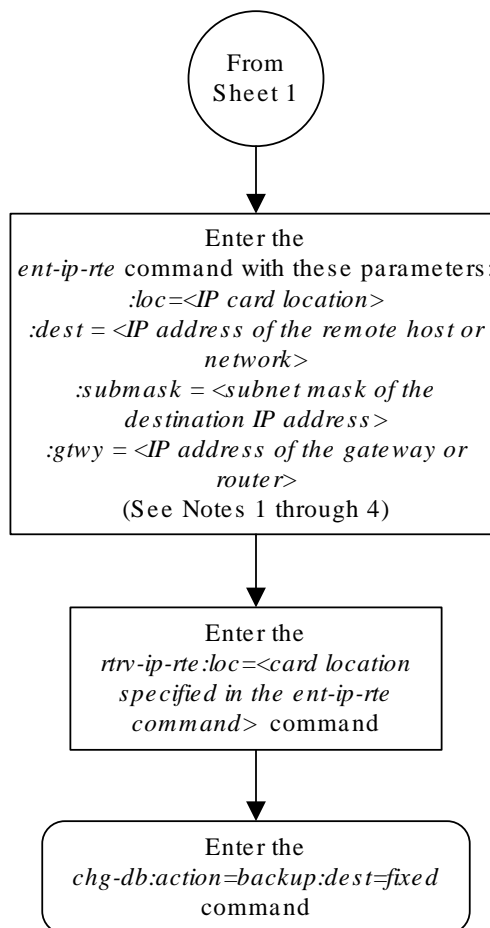
These messages should appear, the active **Maintenance and Administration Subsystem Processor (MASP)** appears first.

```
BACKUP (FIXED) : MASP A - Backup starts on active MASP.  
BACKUP (FIXED) : MASP A - Backup on active MASP to fixed disk  
complete.  
BACKUP (FIXED) : MASP A - Backup starts on standby MASP.  
BACKUP (FIXED) : MASP A - Backup on standby MASP to fixed disk  
complete.
```


Figure 6-7 Adding an IP Route



Sheet 1 of 2



Notes:

1. The network portion of the IP address value of the *gtwy* parameter must be the same as the network portion of the IP addresses shown for either the A or B interfaces in the *rtrv-ip-card* output.
2. The value of the *dest* and *gtwy* parameters cannot be 127.x.x.x (the loopback address), 0.0.0.0, or the IP addresses of the A or B interfaces on the IP card, and cannot be assigned to another IP card.
3. There can be a maximum of 64 IP routes assigned to an IP card.
4. The EAGLE 5 ISS can contain a maximum of 1024 IP routes.

6.9 Adding an IPSP M2PA Association

This procedure is used to configure IPSP **M2PA** associations using the `ent-assoc` command. The combination of a local host, local **SCTP** port, remote host and remote **SCTP** port defines an association. IPSP **M2PA** associations are assigned to E5-ENET cards running the **IPSP** application (**IPSP** cards).

The `ent-assoc` command uses these parameters to add an IPSP M2PA association to the database.

`:aname` – The name assigned to the association. Valid association names can contain up to 15 alphanumeric characters where the first character is a letter and the remaining characters are alphanumeric characters. The `aname` parameter value is not case-sensitive.

`:lhost` – Local Hostname. The logical name assigned to the local host device.

`:lport` – The **SCTP** port number for the local host.

`:rhost` – Remote Hostname. The logical name assigned to the remote host device.

`:rport` – The **SCTP** port number for the remote host.

`:adapter` – The adapter layer for this association, `m2pa`. The `adapter` parameter is optional. The default value for the `adapter` parameter is `m2pa`.

`:alhost` – The alternate local host name.

`:m2patset` – The **M2PA** timer set assigned to the association. The `m2patset` parameter can be specified only with the `adapter=m2pa` parameter. If the `adapter=m2pa` parameter is specified, and the `m2patset` parameter is not specified with the `ent-assoc` command, the default value for the `m2patset` parameter (1 - **M2PA** timer set 1) is assigned to the association.

Associations contain fields whose values are not assigned using the `ent-assoc` command. When an association is added to the database, these fields receive their default values. If a different value is desired, the `chg-assoc` command must be used. To change these values perform the [Changing the Attributes of an IPSP Association](#) procedure.

These fields and their default values are shown in [Table 6-6](#).

Table 6-6 IPSP M2PA Association Fields and Default Values

<code>open=no</code>	<code>rmax=800</code>	<code>cwmin=3000</code>	<code>alw=no</code>	<code>uaps=10</code>
<code>istrms=2</code>	<code>rmode=lin</code>	<code>rtimes=10</code>	<code>ostrms=2</code>	<code>rmin=120</code>
<code>ver=rfc</code>	<code>bufsize=200</code>	<code>rtxthr=0</code>	<code>rhostval=rel</code>	<code>axed</code>

The `link` parameter cannot be specified for an IPSP M2PA association.

An IPSP M2PA association can contain an alternate remote host. The alternate remote host is provisioned with the `rhost` and `rhostype=alternate` parameters of

the `chg-assoc` command. A primary remote host can be provisioned on this procedure by specifying the `rhost` parameter with the `ent-assoc` command. To provision an alternate remote host for an IPSP M2PA association, perform [Changing the Attributes of an IPSP Association](#).

The size of the buffers on the IPSP cards is 3200 KB. The size of the buffers assigned to each association that is assigned to the **IPSP** card cannot exceed the maximum buffer size for the **IPSP** card. When a new association is added, the default buffer size for the association is assigned to the association. If adding the new association causes the total buffer size for all the associations on the **IPSP** card to exceed the maximum buffer size for that **IPSP** card, the `ent-assoc` command will be rejected. If you wish to add the association and the maximum buffer size for the **IPSP** card will be exceeded, the buffer size of the other associations assigned to the **IPSP** card must be decreased by performing the [Changing the Buffer Size of an IPSP Association](#) procedure. The available size of the buffers on the **IPSP** card can be verified by entering this command.

```
rtrv-assoc:lhost=<local host name assigned to the association>
```

The `alhost` parameter can also be used with the `rtrv-assoc` command to display the available size of the buffers on the **IPSP** card.

The `aname` parameter can be used with the `rtrv-assoc` command to display the available size of the buffers on the **IPSP** card and the size of the buffer assigned to the association.

The value of the `lhost`, `rhost`, or `alhost` parameters is a text string of up to 60 characters, with the first character being a letter. The command line on the terminal can contain up to 150 characters. If the host names are too long to fit on the `ent-assoc` command line, perform the `chg-assoc` command with the parameters and values necessary to complete the entry of the M2PA association.

The **EAGLE** can contain a maximum of 4000 connections (association to application server assignments).

A maximum of 32 IPSP M2PA associations can be assigned to an IPSP card.

The B Ethernet interface of the **IPSP** card can be used.

To activate the association after the association is assigned to a signaling link, the association must contain values for the `lhost`, `lport`, `rhost`, and `rport` parameters.

Uni-homed endpoints are associations configured with the `lhost` parameter only. The `lhost` parameter value represents an **IP** address that corresponds to either the A or B network interface of the **IPSP** card. Multi-homed endpoints are associations configured with both the `lhost` and `alhost` parameters. The `lhost` parameter value represents an **IP** address corresponding to one of the network interfaces (A or B) of the **IP** card while the `alhost` parameter value represents an **IP** address corresponding to the other network interface of the same **IPSP** card.

An alternate remote host can be configured for multi-homed associations using the `rhost` and `rhosttype` parameters of the `chg-assoc` command. The `rhost` parameter value with the `rhosttype=primary` parameter represents an **IP** address that corresponds to one of the network interfaces at the remote end while the `rhost` parameter value with the `rhosttype=alternate` parameter represents an **IP** address that corresponds to the other network interface at the remote end.

Canceling the RTRV-ASSOC Command

Because the `rtrv-assoc` command used in this procedure can output information for a long period of time, the `rtrv-assoc` command can be canceled and the output to the terminal stopped. There are three ways that the `rtrv-assoc` command can be canceled.

- Press the `F9` function key on the keyboard at the terminal where the `rtrv-assoc` command was entered.
- Enter the `canc-cmd` without the `trm` parameter at the terminal where the `rtrv-assoc` command was entered.
- Enter the `canc-cmd:trm=<xx>`, where `<xx>` is the terminal where the `rtrv-assoc` command was entered, from another terminal other than the terminal where the `rtrv-assoc` command was entered. To enter the `canc-cmd:trm=<xx>` command, the terminal must allow Security Administration commands to be entered from it and the user must be allowed to enter Security Administration commands. The terminal's permissions can be verified with the `rtrv-secu-trm` command. The user's permissions can be verified with the `rtrv-user` or `rtrv-secu-user` commands.

For more information about the `canc-cmd` command, go to *Commands User's Guide*.

1. Display the associations in the database using the `rtrv-assoc` command. This is an example of possible output.

```
rlghncxa03w 08-04-28 09:12:36 GMT EAGLE5 38.0.0
CARD IPLNK
ANAME          LOC  PORT  LINK ADAPTER  LPORT  RPORT  OPEN  ALW
swbel132       1201 A    A    M3UA   1030  2345  YES  YES
a2             1305 A    A    SUA    1030  2345  YES  YES
a3             1307 A    A    SUA    1030  2346  YES  YES
assoc3         1203 A    A1   M2PA   2048  1030  NO   NO
```

Perform one of these actions.

- If the desired IP link (shown by the entries in the `CARD` `LOC` and `IPLNK` `PORT` columns for an association whose `ADAPTER` value is `M2PA`) is shown in the `rtrv-assoc` output, continue the procedure with [2](#).
 - If the desired IP link is not shown in the `rtrv-assoc` output, continue the procedure with [4](#).
2. Display the card that the new M2PA association will be assigned to by entering the `rtrv-card` command with the card location displayed in [1](#). For this example, enter this command.

```
rtrv-card:loc=1203
```

The following is an example of the possible output.

```
rlghncxa03w 08-04-28 09:12:36 GMT EAGLE5 38.0.0
CARD  TYPE      APPL      LSET NAME    LINK SLC  LSET NAME    LINK SLC
1203  ENET         IPSP      m2pa1       A1    0
```

If the value in the `TYPE` column is `IPSP`, continue the procedure with [3](#).

If the value in the `TYPE` column is either `IPLIM` or `IPLIMI`, the host assigned to this card cannot be used in this procedure. If you wish to use this card to configure an M2PA association, perform the [Adding an M2PA Association](#) procedure.

If you do not wish to use this card to configure an IPSG M2PA association, perform one of these actions.

- Choose another card from the `rtrv-assoc` output in [1](#) and repeat this step.
 - Continue the procedure with [4](#) to choose another IPSG card and IP link for the new IPSG M2PA association.
3. Display the associations assigned to the card that the new association will be assigned to by entering the `rtrv-assoc` command with the card location specified in [2](#). For this example, enter this command.

```
rtrv-assoc:loc=1203
```

The following is an example of the possible output.

```
rlghncxa03w 08-04-28 09:12:36 GMT EAGLE5 38.0.0
                CARD IPLNK
ANAME          LOC  PORT  LINK ADAPTER LPORT RPORT OPEN ALW
assoc3         1203  A    A1  M2PA    2048  1030  NO   NO
```

```
IP Appl Sock/Assoc table is (4 of 4000) 1% full
Assoc Buffer Space Used (200 KB of 800 KB) on LOC = 1203
```

An IPSG card can contain a maximum of 32 IPSG M2PA or M3UA associations when running on the E5-ENET/E5--ENET-B card or DEIR card. An IPSG application running on the SLIC card can contain a maximum of 128 associations.. If 32 associations are displayed in the `rtrv-assoc` output, the new IPSG M2PA association cannot be added to this card. Choose another IPSG card and repeat this procedure from [1](#).

If less than 32 associations are shown in the `rtrv-assoc` output, continue the procedure with [6](#).

4. Display the IP links in the database by entering the `rtrv-ip-lnk` command. The following is an example of the possible output.

```
rlghncxa03w 08-12-28 21:14:37 GMT EAGLE5 40.0.0
LOC  PORT IPADDR          SUBMASK          DUPLEX  SPEED  MACTYPE  AUTO
MCAST
1201  A    192.1.1.10          255.255.255.128  HALF    10     802.3    NO   NO
1201  B    -----             -----          HALF    10     DIX      NO   NO
1203  A    192.1.1.12          255.255.255.0   ----    ---    DIX      YES  NO
1203  B    -----             -----          HALF    10     DIX      NO   NO
1205  A    192.1.1.14          255.255.255.0   FULL    100    DIX      NO   NO
1205  B    -----             -----          HALF    10     DIX      NO   NO
2101  A    192.1.1.20          255.255.255.0   FULL    100    DIX      NO   NO
2101  B    -----             -----          HALF    10     DIX      NO   NO
2103  A    192.1.1.22          255.255.255.0   FULL    100    DIX      NO   NO
2103  B    -----             -----          HALF    10     DIX      NO   NO
2105  A    192.1.1.24          255.255.255.0   FULL    100    DIX      NO   NO
2105  B    -----             -----          HALF    10     DIX      NO   NO
2205  A    192.1.1.30          255.255.255.0   FULL    100    DIX      NO   NO
```

```

2205 B ----- HALF 10 DIX
NO NO
2207 A 192.1.1.32 255.255.255.0 FULL 100 DIX
NO NO
2207 B ----- HALF 10 DIX
NO NO
2213 A 192.1.1.50 255.255.255.0 FULL 100 DIX
NO NO
2213 B ----- HALF 10 DIX
NO NO
2301 A 192.1.1.52 255.255.255.0 FULL 100 DIX
NO NO
2301 B ----- HALF 10 DIX
NO NO

```

IP-LNK table is (20 of 2048) 1% full.

If the required **IP** link is not in the database, add the **IP** link using the [Configuring an IP Link](#) procedure.

5. Verify that the local host name to be assigned to the association is in the database by using the `rtrv-ip-host:display=all` command. The following is an example of the possible output.

```
rlghncxa03w 13-06-28 21:15:37 GMT EAGLE5 45.0.0
```

```

LOCAL IPADDR    LOCAL HOST
192.1.1.10      IPNODE1-1201
192.1.1.12      IPNODE1-1203
192.1.1.14      IPNODE1-1205
192.1.1.20      IPNODE2-1201
192.1.1.22      IPNODE2-1203
192.1.1.24      IPNODE2-1205
192.1.1.30      KC-HLR1
192.1.1.32      KC-HLR2
192.1.1.50      DN-MS1
192.1.1.52      DN-MS2

REMOTE IPADDR    REMOTE HOST
150.1.1.5       NCDEPTECONOMIC_DEVELOPMENT.
SOUTHEASTERN_COORIDOR_ASHVL. GOV

```

IP Host table is (11 of 4096) .26% full

The **IP** address of the **IP** link should be assigned to the local host name that will be assigned to the association.

The values of the `lhost` and `alhost` parameters must be in the `LOCAL HOST` column in the `rtrv-ip-host` output.

If the required hostname is not in the database, add the **IP** host name using the [Adding an IP Host](#) procedure.

6. Verify the values of the **M2PA** timer set you wish to assign to the association by entering the `rtrv-m2pa-tset` command with the `ver=rfc` parameter.

When an IPSP **M2PA** association is provisioned in this procedure, the **RFC M2PA** version is assigned to the IPSP **M2PA** association by default.

The **M2PA** version of the association determines the version of the **M2PA** timer set that is assigned to the association. For example, if **M2PA** timer set 3 is assigned to the IPSP **M2PA** association, and the association is an **RFC IPSP M2PA** association, the **RFC** version of **M2PA** timer set 3 is used with the association. If **M2PA** timer set 7 is assigned to the IPSP **M2PA** association, and the association is a Draft 6 IPSP **M2PA** association, the Draft 6 version of **M2PA** timer set 7 is used with the association.

If you wish to assign the Draft 6 **M2PA** version to this association and use the Draft 6 **M2PA** timer sets, perform the [Changing the Attributes of an IPSP Association](#) procedure after this procedure is completed to change the **M2PA** version of this association.

 **Note:**

If the `m2patset` parameter will not be specified with the `ent-assoc` command, the **M2PA** timer set 1 will be assigned to the association.

To display the **M2PA** Draft 6 timer values, enter this command.

```
rtrv-m2pa-tset:ver=d6
```

This is an example of the possible output.

```
rlghncxa03w 08-04-28 21:16:37 GMT EAGLE5 38.0.0
```

```
M2PA Draft 6 Timers (in msec, T16 in microsec)
TSET T1      T2      T3      T4N    T4E    T5      T6      T7      T16     T17    T18
1     6000    ----- 5000   20000  500    5000   4000  1000   100000  150    500
2     7500    ----- 1500   2000   500    9000   1250  300    150000  175    600
3     100000   ----- 2000   3000   500    4000   1500  500    170000  200    800
4     200000   ----- 20000  4000   500    6000   2000  700    480000  225    900
5     250000   ----- 30000  30000  500    100    2250  400    400000  400    8000
6     50000    ----- 50000  60000  500    500    4500  800    300000  300    7000
7     10000    ----- 10000  10000  500    1000   3000  1200   200000  250    1000
8     80000    ----- 1500   15000  500    8000   2750  1100   350000  350    5000
9     27500    ----- 3850   4859   450    5700   3750  1150   250     375    8750
10    90000    ----- 2500   50000  500    7500   5000  1750   440000  450    3000
11    20000    ----- 4500   5500   500    6500   5500  1600   250000  475    4500
12    30000    ----- 7500   7000   500    750    4250  1800   275000  275    3500
13    40000    ----- 35000  9000   500    1250   3500  1900   500     325    9000
14    70000    ----- 45000  11000  500    1500   1750  900    1000    125    6000
15    9000     ----- 25000  40000  500    2500   3250  600    5000    425    5500
16    75000    ----- 15000  25000  500    4500   1600  1400   6000    240    9500
17    350000   ----- 60000  70000  600    10000  6000  2000   500000  500    10000
18    150000   ----- 55000  35000  500    3500   5750  1500   125000  440    750
19    175000   ----- 12500  45000  500    1100   2600  1300   7000    340    850
20    1000     ----- 1000   1000   400    80     1000  200    100     100    100
```

To display the **M2PARFC** values, enter this command.

```
rtrv-m2pa-tset:ver=rfc
```

This is an example of the possible output.

```
rlghncxa03w 08-04-28 21:16:37 GMT EAGLE5 38.0.0
```

```
M2PA RFC Timers (in msec, T16 in microsec)
```

TSET	T1	T2	T3	T4N	T4E	T5	T6	T7	T16	T17	T18
1	6000	75000	5000	20000	500	5000	4000	1000	100000	150	500
2	7500	8000	1500	2000	500	9000	1250	300	150000	175	600
3	100000	10000	2000	3000	500	4000	1500	500	170000	200	800
4	200000	6000	20000	4000	500	6000	2000	700	480000	225	900
5	250000	140000	30000	30000	500	100	2250	400	400000	400	
6	50000	100000	50000	60000	500	500	4500	800	300000	300	
7	300000	20000	2000	10000	500	1000	3000	1200	200000	250	
8	80000	130000	1500	15000	500	8000	2750	1100	350000	350	
9	27500	120000	3850	4859	450	5700	3750	1150	250	375	
10	90000	9000	2500	50000	500	7500	5000	1750	440000	450	
11	20000	60000	4500	5500	500	6500	5500	1600	250000	475	
12	30000	50000	7500	7000	500	750	4250	1800	275000	275	
13	40000	90000	35000	9000	500	1250	3500	1900	500	325	
14	70000	45000	45000	11000	500	1500	1750	900	1000	125	
15	9000	30000	25000	40000	500	2500	3250	600	5000	425	
16	75000	15000	15000	25000	500	4500	1600	1400	6000	240	
17	350000	150000	60000	70000	600	10000	6000	2000	500000	500	
18	150000	20000	55000	35000	500	3500	5750	1500	125000	440	750
19	175000	12500	12500	45000	500	1100	2600	1300	7000	340	850
20	1000	5000	1000	1000	400	80	1000	200	100	100	100

If the `ver` parameter is not specified when entering the `rtrv-m2pa-tset` command, both the Draft 6 and RFC values are displayed. This is an example of the possible output.

```
rlghncxa03w 08-04-28 21:16:37 GMT EAGLE5 38.0.0
```

```
M2PA Draft 6 Timers (in msec, T16 in microsec)
```

TSET	T1	T2	T3	T4N	T4E	T5	T6	T7	T16	T17	T18
1	6000	-----	5000	20000	500	5000	4000	1000	100000	150	500
2	7500	-----	1500	2000	500	9000	1250	300	150000	175	600
3	100000	-----	2000	3000	500	4000	1500	500	170000	200	800

```

4  200000  ----- 20000 4000  500  6000  2000 700  480000 225  900
5  250000  ----- 30000 30000 500  100  2250 400  400000 400  8000
6  50000   ----- 50000 60000 500  500  4500 800  300000 300  7000
7  10000   ----- 10000 10000 500  1000 3000 1200 200000 250  1000
8  80000   ----- 1500  15000 500  8000 2750 1100 350000 350  5000
9  27500   ----- 3850  4859  450  5700 3750 1150  250  375  8750
10 90000   ----- 2500  50000 500  7500 5000 1750 440000 450  3000
11 20000   ----- 4500  5500  500  6500 5500 1600 250000 475  4500
12 30000   ----- 7500  7000  500  750  4250 1800 275000 275  3500
13 40000   ----- 35000 9000  500  1250 3500 1900  500  325  9000
14 70000   ----- 45000 11000 500  1500 1750 900  1000 125  6000
15 9000    ----- 25000 40000 500  2500 3250 600  5000 425  5500
16 75000   ----- 15000 25000 500  4500 1600 1400  6000 240  9500
17 350000  ----- 60000 70000 600  10000 6000 2000 500000 500  10000
18 150000  ----- 55000 35000 500  3500 5750 1500 125000 440  750
19 175000  ----- 12500 45000 500  1100 2600 1300  7000 340  850
20 1000    ----- 1000  1000  400  80  1000 200  100  100  100

```

M2PA RFC Timers (in msec, T16 in microsec)

TSET	T1	T2	T3	T4N	T4E	T5	T6	T7	T16	T17	T18
1	6000	75000	5000	20000	500	5000	4000	1000	100000	150	500
2	7500	8000	1500	2000	500	9000	1250	300	150000	175	600
3	100000	10000	2000	3000	500	4000	1500	500	170000	200	800
4	200000	6000	20000	4000	500	6000	2000	700	480000	225	900
5	250000	140000	30000	30000	500	100	2250	400	400000	400	8000
6	50000	100000	50000	60000	500	500	4500	800	300000	300	7000
7	300000	20000	2000	10000	500	1000	3000	1200	200000	250	1000
8	80000	130000	1500	15000	500	8000	2750	1100	350000	350	5000
9	27500	120000	3850	4859	450	5700	3750	1150	250	375	8750
10	90000	9000	2500	50000	500	7500	5000	1750	440000	450	3000
11	20000	60000	4500	5500	500	6500	5500	1600	250000	475	4500
12	30000	50000	7500	7000	500	750	4250	1800	275000	275	3500
13	40000	90000	35000	9000	500	1250	3500	1900	500	325	9000
14	70000	45000	45000	11000	500	1500	1750	900	1000	125	6000
15	9000	30000	25000	40000	500	2500	3250	600	5000	425	5500
16	75000	15000	15000	25000	500	4500	1600	1400	6000	240	9500
17	350000	150000	60000	70000	600	10000	6000	2000	500000	500	10000
18	150000	20000	55000	35000	500	3500	5750	1500	125000	440	750
19	175000	12500	12500	45000	500	1100	2600	1300	7000	340	850
20	1000	5000	1000	1000	400	80	1000	200	100	100	100

If the **M2PA** timer set you wish to assign to the association does not contain the desired values, go to the [Changing an M2PA Timer Set](#) procedure and changed the desired timer values.

Caution:

Changing an **M2PA** timer set may affect the performance of any associations using the timer set being changed.

7. Verify the available buffer size for the **IPSG** card that will contain the association being added in this procedure by entering the `rtrv-assoc` command with the local host name assigned to the association being added. For this example, enter this command.

 **Note:**

If a new host was added in **5**, continue the procedure with **8**.

```
rtrv-assoc:lhost="IPNODE2-1203"
```

This is an example of the possible output.

```
rlghncxa03w 08-04-28 09:12:36 GMT EAGLE5 38.0.0
                CARD IPLNK
ANAME          LOC  PORT  LINK ADAPTER LPORT RPORT OPEN ALW
assoc3         1203 A    A1  M2PA   2048  1030  NO   NO
```

```
IP Appl Sock/Assoc table is (8 of 4000) 1% full
Assoc Buffer Space Used (200 KB of 1600 KB) on LOC = 1203
```

If adding the new association causes the total buffer size for all the associations on the **IP** card to exceed the maximum buffer size for that **IP** card, the `ent-assoc` command will be rejected.

The default buffer value for an **IPSG** M2PA association is 200.

If the you wish to add the association and the maximum buffer size for the **IP** card will be exceeded, the buffer size of the other associations assigned to the **IP** card must be decreased by performing the [Changing the Buffer Size of an IPSG Association](#) procedure.

8. Add the associations using the `ent-assoc` command. For this example, enter this command.

```
ent-
assoc:aname=assoc2:lhost=gw107.nc.tekelec.com:lport=2000:
rhost=gw100.nc.tekelec.com:rport=1030:adapter=m2pa
```

These are the rules that apply to adding IPSG M2PA associations.

- a. The EAGLE can contain a maximum of 4000 connections (association – application server assignments).
- b. The default value for the `adapter` parameter is `m2pa`.
- c. A maximum of 32 IPSG M2PA or M3UA associations can be assigned to the IPSG card running on the E5-ENET/E5--ENET-B card or DEIR card. An IPSG application running on the SLIC card can contain a maximum of 128 associations.
- d. The value of the `lhost`, `rhost`, or `alhost` parameters is a text string of up to 60 characters, with the first character being a letter. The command line on the terminal can contain up to 150 characters. If the host names are too long to fit on the `ent-assoc` command line, perform the `chg-assoc` command with the

parameters and values necessary to complete the entry of the IPSP M2PA association.

- e. To activate the association after the association is assigned to a signaling link, the association must contain values for the `lhost`, `rhost`, `lport`, and `rport` parameters.
- f. If the `lhost` and `alhost` parameters are specified, the `lhost` parameter value represents the IP address corresponding to one of the network interfaces (A or B) on the IP card while the `alhost` parameter value represents the IP address corresponding to the other network interface of the same IP card.
- g. The `m2patset` parameter can be specified only with the `adapter=m2pa` parameter.
- h. The `m2patset` parameter value defaults to M2PA timer set 1 (`m2patset=1`) if the `m2patset` parameter is not specified.
- i. When the `adapter=m2pa` parameter is specified, the RFC M2PA version is assigned to the M2PA association by default. If you wish to assign the Draft 6 M2PA version to this association, perform the [Changing the Attributes of an IPSP Association](#) procedure after this procedure is completed to change the M2PA version of this association.

When this command has successfully completed, this message should appear.

```
rlghncxa03w 08-04-28 09:12:36 GMT EAGLE5 38.0.0
ENT-ASSOC: MASP A - COMPLTD
```

9. Verify the changes using the `rtrv-assoc` command specifying the association name specified in 8. For this example, enter this command.

```
rtrv-assoc:aname=assoc2
```

This is an example of possible output.

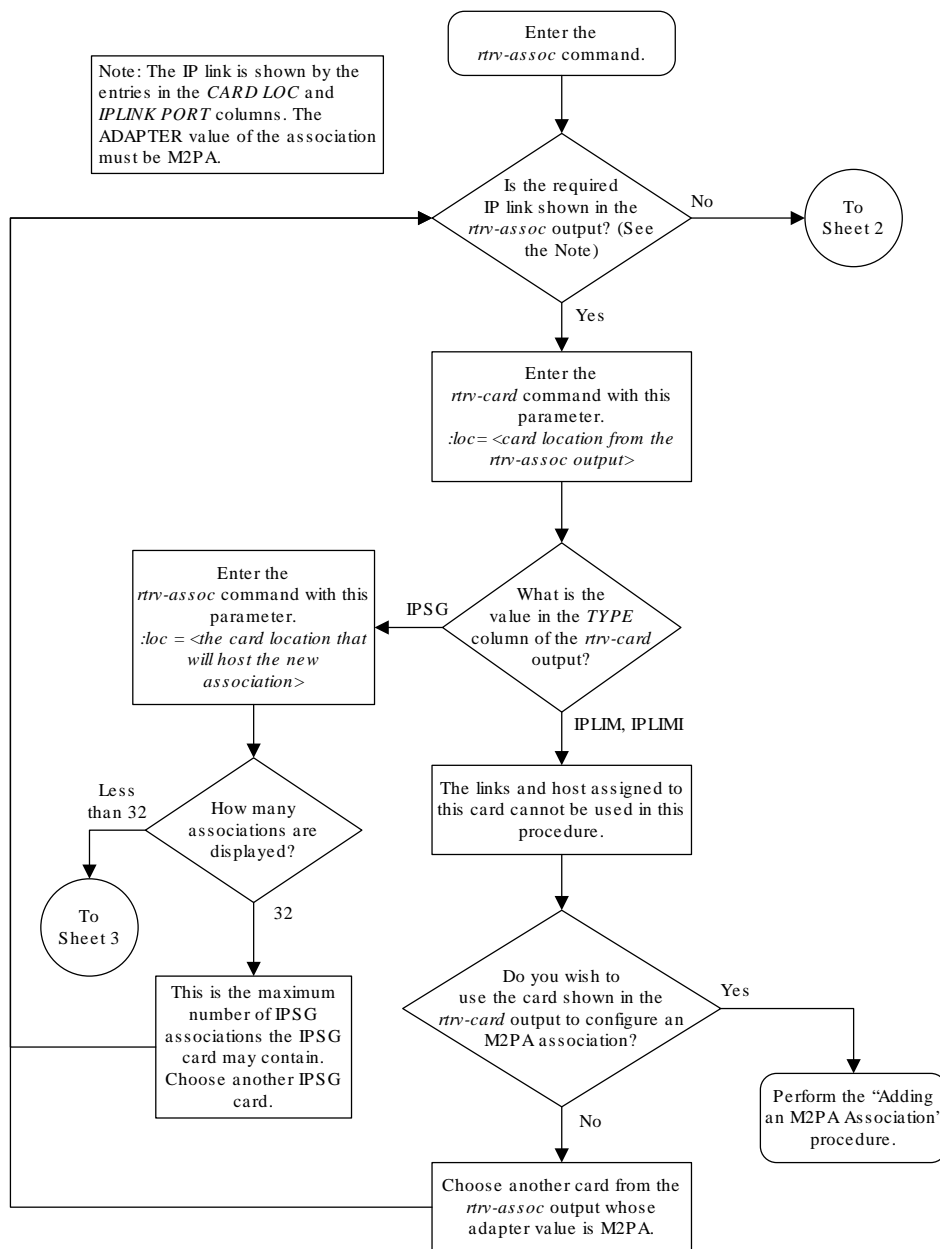
```
rlghncxa03w 10-07-28 09:12:36 GMT EAGLE5 42.0.0
ANAME assoc2
      LOC      1203          IPLNK PORT A          LINK      --
ADAPTER M2PA          VER      M2PA RFC
LHOST gw105.nc.tekelec.com
ALHOST ---
RHOST gw100.nc.tekelec.com
ARHOST ---
LPORT 1030          RPORT      1030
ISTRMS 2          OSTRMS      2          BUFSIZE 200
RMODE LIN          RMIN      120          RMAX      800
RTIMES 10          CWMIN      3000          UAPS      10
OPEN NO          ALW      YES          RTXTHR    0
RHOSTVAL RELAXED          M2PATSET 1
```

```
IP Appl Sock table is (5 of 4000) 1% full
Assoc Buffer Space Used (400 KB of 1600 KB) on LOC = 1203
```

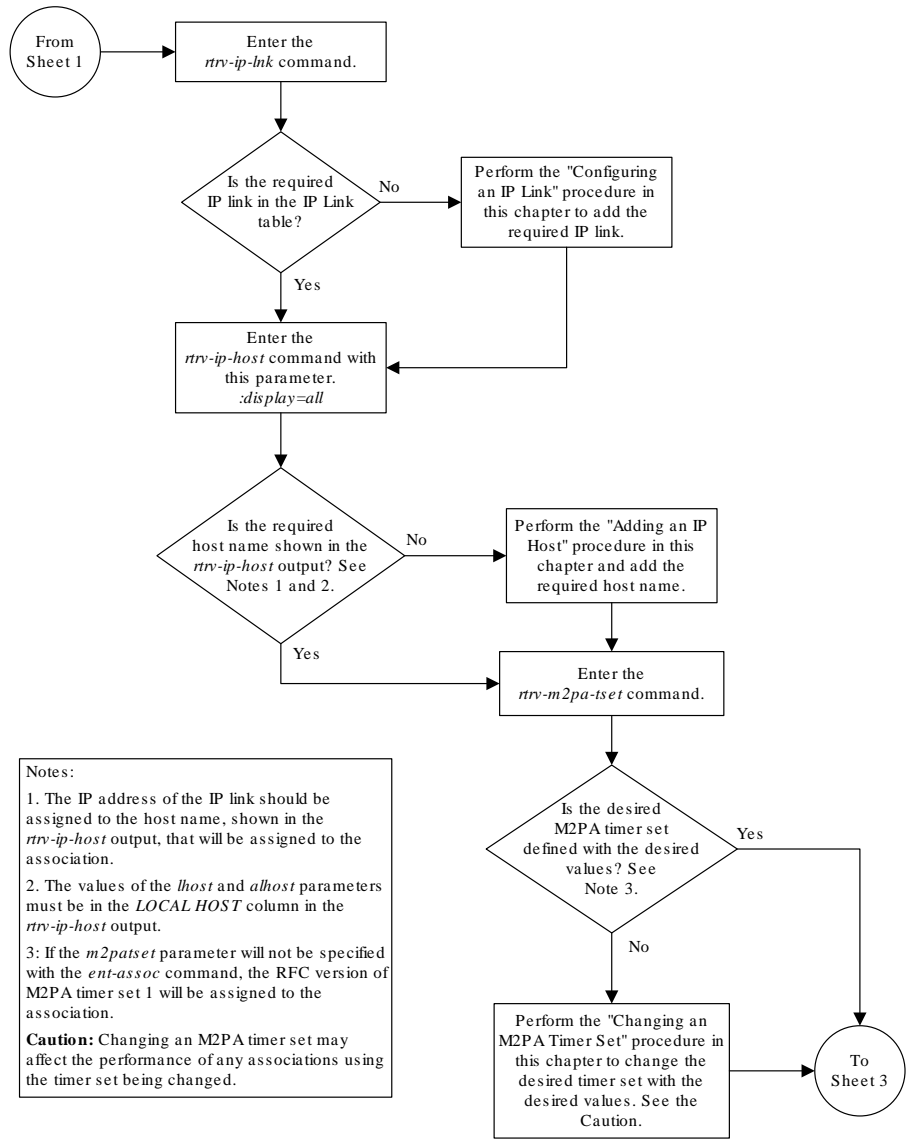
10. Back up the new changes, using the `chg-db:action=backup:dest=fixed` command. These messages should appear; the active **Maintenance and Administration Subsystem Processor (MASP)** appears first.

```
BACKUP (FIXED) : MASP A - Backup starts on active MASP.  
BACKUP (FIXED) : MASP A - Backup on active MASP to fixed disk  
complete.  
BACKUP (FIXED) : MASP A - Backup starts on standby MASP.  
BACKUP (FIXED) : MASP A - Backup on standby MASP to fixed disk  
complete.
```

Figure 6-8 Adding an IP SG M2PA Association



Sheet 1 of 4

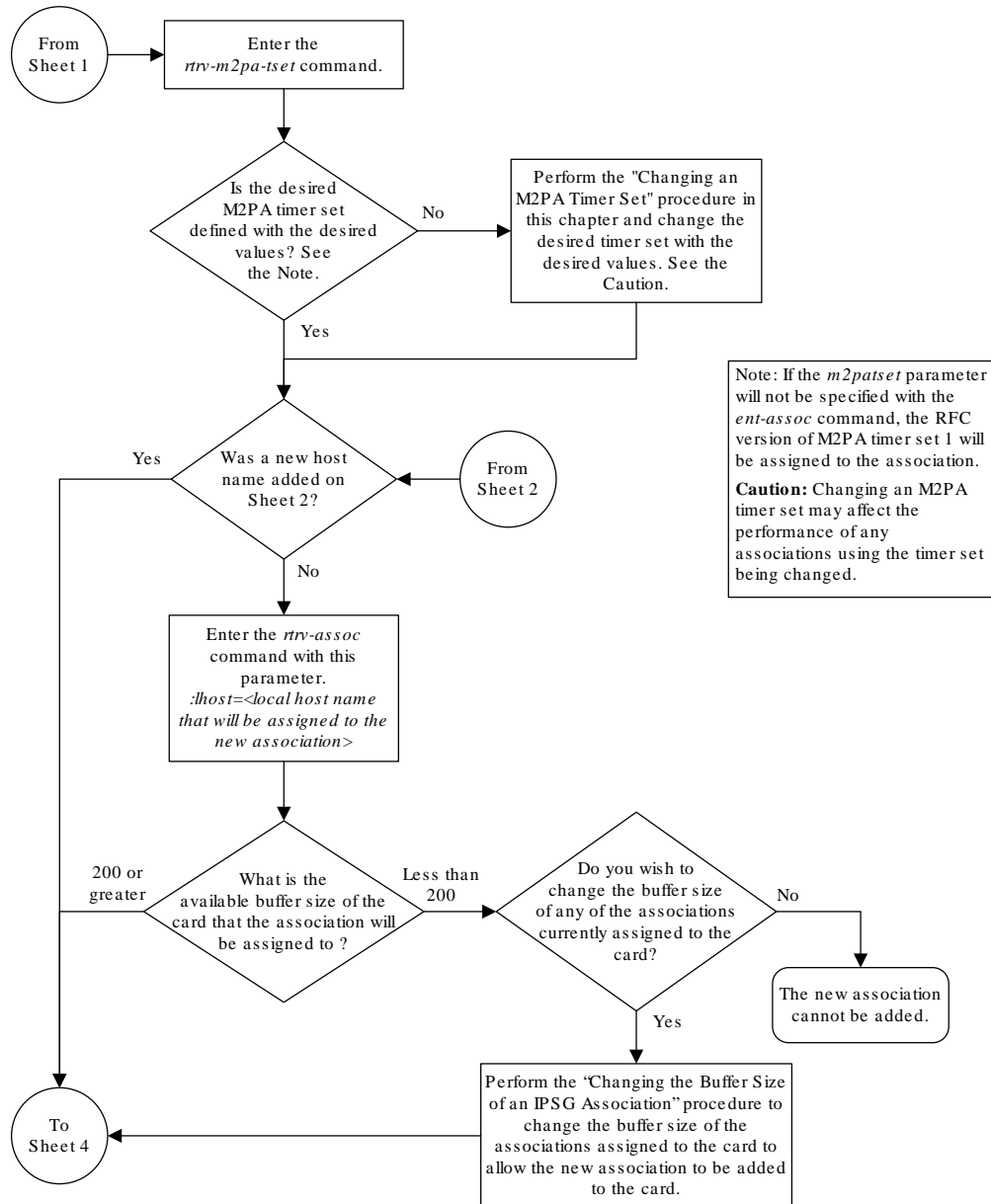


Notes:

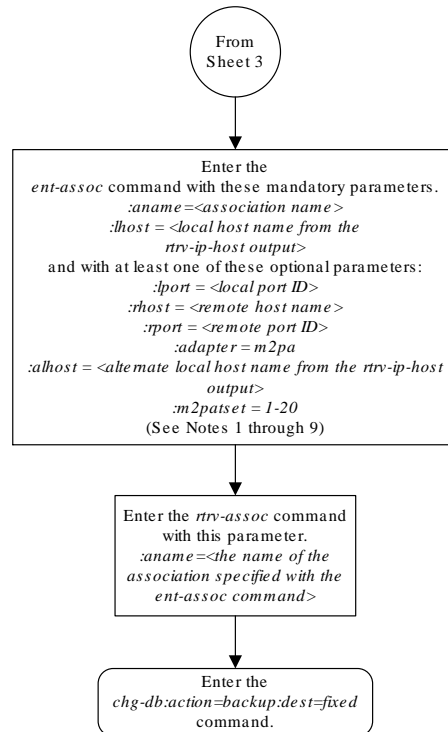
1. The IP address of the IP link should be assigned to the host name, shown in the *rrv-ip-host* output, that will be assigned to the association.
2. The values of the *lhost* and *ahost* parameters must be in the *LOCAL HOST* column in the *rrv-ip-host* output.
- 3: If the *m2patset* parameter will not be specified with the *ent-assoc* command, the RFC version of M2PA timer set 1 will be assigned to the association.

Caution: Changing an M2PA timer set may affect the performance of any associations using the timer set being changed.

Sheet 2 of 4



Sheet 3 of 4



- Notes:
1. The EAGLE 5 ISS can contain a maximum of 4000 connections (association – application server assignments).
 2. The default value for the *adapter* parameter is *m2pa*.
 3. A maximum of 32 IP SG M2PA or M3UA associations can be assigned to the IP SG card.
 4. The value of the *lhost*, *rhost*, or *alhost* parameters is a text string of up to 60 characters, with the first character being a letter. The command line on the terminal can contain up to 150 characters. If the host names are too long to fit on the *ent-assoc* command line, perform the *chg-assoc* command with the parameters and values necessary to complete the entry of the IP SG M2PA association.
 5. To activate the association after the association is assigned to a signaling link, the association must contain values for the *lhost*, *rhost*, *lport*, and *rport* parameters.
 6. If the *lhost* and *alhost* parameters are specified, the *lhost* parameter value represents the IP address corresponding to one of the network interfaces (A or B) on the IP card while the *alhost* parameter value represents the IP address corresponding to the other network interface of the same IP card.
 7. The *m2patset* parameter can be specified only with the *adapter=m2pa* parameter.
 8. The *m2patset* parameter value defaults to M2PA timer set 1 (*m2patset=1*) if the *m2patset* parameter is not specified.
 9. When the *adapter=m2pa* parameter is specified, the RFC M2PA version is assigned to the M2PA association by default. If you wish to assign the Draft 6 M2PA version to this association, perform the “Changing the Attributes of an IP SG Association” procedure in this chapter after this procedure is completed to change the M2PA version of this association.

Sheet 4 of 4

6.10 Adding an IP SG M3UA Association

This procedure is used to configure IP SG **M3UA** associations using the `ent-assoc` command. The combination of a local host, local **SCTP** port, remote host and remote **SCTP** port defines an association. IP SG M3UA associations are assigned to E5-ENET cards running the **IP SG** application (**IP SG** cards).

The `ent-assoc` command uses these parameters to add an IP SG M3UA association to the database.

:aname – The name assigned to the association. Valid association names can contain up to 15 alphanumeric characters where the first character is a letter and the remaining characters are alphanumeric characters. The aname parameter value is not case-sensitive.

:lhost – Local Hostname. The logical name assigned to the local host device.

:lport – The **SCTP** port number for the local host.

:rhost – Remote Hostname. The logical name assigned to the remote host device.

:rport – The **SCTP** port number for the remote host.

:adapter – The adapter layer for this association, m3ua. The adapter parameter is required for adding an IPSG M3UA association. The default value for the adapter parameter is m2pa.

:alhost – The alternate local host name.

The link parameter cannot be specified for an IPSG M3UA association.

The adapter=m2pa and m2patset parameters can be used only when configuring **M2PA** associations. Perform the [Adding an M2PA Association](#) or [Adding an IPSG M2PA Association](#) procedures to configure **M2PA** associations.

Associations contain fields whose values are not assigned using the ent-assoc command. When an association is added to the database, these fields receive their default values. If a different value is desired, the chg-assoc command must be used. To change these values perform the [Changing the Attributes of an IPSG Association](#) procedure.

These fields and their default values are shown in [Table 6-7](#).

Table 6-7 IPSG M3UA Association Fields and Default Values

open=no	rmax=800	cwmin=3000	alw=no	uaps=10
istrms=2	rmode=lin	rtimes=10	ostrms=2	rmin=120
bufsize=200	rtxthr=0	rhostval=relaxed		

An IPSG M3UA association can contain an alternate remote host. The alternate remote host is provisioned with the rhost and rhostype=alternate parameters of the chg-assoc command. A primary remote host can be provisioned on this procedure by specifying the rhost parameter with the ent-assoc command. To provision an alternate remote host for an IPSG M3UA association, perform [Changing the Attributes of an IPSG Association](#).

The size of the buffers on the IPSG cards is 3200 KB. The size of the buffers assigned to each association that is assigned to the **IPSG** card cannot exceed the maximum buffer size for the **IPSG** card. When a new association is added, the default buffer size for the association is assigned to the association. If adding the new association causes the total buffer size for all the associations on the **IPSG** card to exceed the maximum buffer size for that **IPSG** card, the ent-assoc command will be rejected. If the you wish to add the association and the maximum buffer size for the **IPSG** card will be exceeded, the buffer size of the other associations assigned to the **IPSG** card must be decreased by performing the [Changing the Buffer Size of an IPSG Association](#) procedure. The available size of the buffers on the **IPSG** card can be verified by entering this command.

```
rtrv-assoc:lhost=<local host name assigned to the association  
being changed>
```

The `alhost` parameter can also be used with the `rtrv-assoc` command to display the available size of the buffers on the **IP** card.

The `aname` parameter can be used with the `rtrv-assoc` command to display the available size of the buffers on the **IP** card and the size of the buffer assigned to the association.

The value of the `lhost`, `rhost`, or `alhost` parameters is a text string of up to 60 characters, with the first character being a letter. The command line on the terminal can contain up to 150 characters. If the host names are too long to fit on the `ent-
assoc` command line, perform the `chg-assoc` command with the parameters and values necessary to complete the entry of the M3UA association.

The **EAGLE** can contain a maximum of 4000 connections (association to application server assignments).

The B Ethernet interface of the **IPSP** card can be used.

To activate the association after the association is assigned to a signaling link, the association must contain values for the `lhost`, `lport`, `rhost`, `rport` parameters.

Uni-homed endpoints are associations configured with the `lhost` parameter only. The `lhost` parameter value represents an **IP** address that corresponds to either the A or B network interface of the **IPSP** card. Multi-homed endpoints are associations configured with both the `lhost` and `alhost` parameters. The `lhost` parameter value represents an **IP** address corresponding to one of the network interfaces (A or B) of the **IPSP** card while the `alhost` parameter value represents an **IP** address corresponding to the other network interface of the same **IPSP** card.

An alternate remote host can be configured for multi-homed associations using the `rhost` and `rhosttype` parameters of the `chg-assoc` command. The `rhost` parameter value with the `rhosttype=primary` parameter represents an IP address that corresponds to one of the network interfaces at the remote end while the `rhost` parameter value with the `rhosttype=alternate` parameter represents an IP address that corresponds to the other network interface at the remote end.

Canceling the RTRV-ASSOC Command

Because the `rtrv-assoc` command used in this procedure can output information for a long period of time, the `rtrv-assoc` command can be canceled and the output to the terminal stopped. There are three ways that the `rtrv-assoc` command can be canceled.

- Press the F9 function key on the keyboard at the terminal where the `rtrv-assoc` command was entered.
- Enter the `canc-cmd` without the `trm` parameter at the terminal where the `rtrv-
assoc` command was entered.
- Enter the `canc-cmd:trm=<xx>`, where `<xx>` is the terminal where the `rtrv-
assoc` command was entered, from another terminal other than the terminal where the `rtrv-
assoc` command was entered. To enter the `canc-cmd:trm=<xx>` command, the terminal must allow Security Administration commands to be entered from it and the user must be allowed to enter Security Administration commands. The terminal's permissions can be verified with the `rtrv-secu-trm`

command. The user's permissions can be verified with the `rtrv-user` or `rtrv-secu-user` commands.

For more information about the `canc-cmd` command, go to *Commands User's Guide*.

1. Display the associations in the database using the `rtrv-assoc` command. This is an example of possible output.

```
rlghncxa03w 06-10-28 09:12:36 GMT EAGLE5 36.0.0
CARD IPLNK
ANAME      LOC  PORT  LINK ADAPTER LPORT RPORT OPEN ALW
swbel32    1201 A    A    M3UA  1030  2345 YES  YES
a2         1305 A    A    SUA   1030  2345 YES  YES
a3         1307 A    A    SUA   1030  2346 YES  YES
assoc3     1203 A    A1   M2PA  2048  1030 NO   NO
```

Perform one of these actions.

- If the desired IP link (shown by the entries in the `CARD LOC` and `IPLNK PORT` columns for an association whose `ADAPTER` value is `M3UA`) is shown in the `rtrv-assoc` output, continue the procedure with [2](#).
 - If the desired IP link is not shown in the `rtrv-assoc` output, continue the procedure with [4](#).
2. Display the card that the new M3UA association will be assigned to by entering the `rtrv-card` command with the card location displayed in [1](#). For this example, enter this command.

```
rtrv-card:loc=1201
```

The following is an example of the possible output.

```
rlghncxa03w 08-04-28 09:12:36 GMT EAGLE5 38.0.0
CARD  TYPE      APPL      LSET NAME    LINK SLC LSET NAME    LINK SLC
1201  ENET        IPSP      m3ua1        A    0
```

If the value in the `TYPE` column is `IPSP`, continue the procedure with [3](#).

If the value in the `TYPE` column is either `SS7IPGW` or `IPGWI`, the host assigned to this card cannot be used in this procedure. If you wish to use this card to configure an M3UA association, perform the [Adding an M3UA or SUA Association](#) procedure.

If you do not wish to use this card to configure an M3UA association, perform one of these actions.

- Choose another card from the `rtrv-assoc` output in [1](#) and repeat this step.
 - Continue the procedure with [4](#) to choose another IPSP card and IP link for the new IPSP M3UA association.
3. Display the associations assigned to the card that the new association will be assigned to by entering the `rtrv-assoc` command with the card location specified in [2](#). For this example, enter this command.

```
rtrv-assoc:loc=1203
```

The following is an example of the possible output.

```
rlghncxa03w 08-04-28 09:12:36 GMT EAGLE5 38.0.0
                CARD  IPLNK
ANAME          LOC   PORT  LINK ADAPTER LPORT RPORT OPEN ALW
swbel32        1201  A    A    M3UA    1030  2345  YES  YES
```

```
IP Appl Sock/Assoc table is (4 of 4000) 1% full
Assoc Buffer Space Used (200 KB of 800 KB) on LOC = 1203
```

An IPSG card can contain a maximum of 32 IPSG M2PA or M3UA associations when running on the E5-ENET/E5--ENET-B card or DEIR card. An IPSG application running on the SLIC card can contain a maximum of 128 associations. If 32 associations are displayed in the `rtrv-assoc` output, the new IPSG M3UA association cannot be added to this card. Choose another IPSG card and repeat this procedure from 1.

If less than 32 associations are shown in the `rtrv-assoc` output, continue the procedure with 6.

4. Display the IP links in the database by entering the `rtrv-ip-lnk` command. The following is an example of the possible output.

```
rlghncxa03w 08-12-28 21:14:37 GMT EAGLE5 40.0.0
LOC  PORT IPADDR          SUBMASK          DUPLEX  SPEED  MACTYPE
AUTO MCAST
1201  A    192.1.1.10        255.255.255.128  HALF    10     802.3
NO   NO
1201  B    -----          -----          HALF    10     DIX
NO   NO
1203  A    192.1.1.12        255.255.255.0   ----    ---    DIX
YES  NO
1203  B    -----          -----          HALF    10     DIX
NO   NO
1205  A    192.1.1.14        255.255.255.0   FULL    100    DIX
NO   NO
1205  B    -----          -----          HALF    10     DIX
NO   NO
2101  A    192.1.1.20        255.255.255.0   FULL    100    DIX
NO   NO
2101  B    -----          -----          HALF    10     DIX
NO   NO
2103  A    192.1.1.22        255.255.255.0   FULL    100    DIX
NO   NO
2103  B    -----          -----          HALF    10     DIX
NO   NO
2105  A    192.1.1.24        255.255.255.0   FULL    100    DIX
NO   NO
2105  B    -----          -----          HALF    10     DIX
NO   NO
2205  A    192.1.1.30        255.255.255.0   FULL    100    DIX
NO   NO
2205  B    -----          -----          HALF    10     DIX
```

```

NO    NO
2207 A   192.1.1.32      255.255.255.0    FULL    100    DIX    NO    NO
2207 B   -----            -----            HALF    10     DIX    NO    NO
2213 A   192.1.1.50      255.255.255.0    FULL    100    DIX    NO    NO
2213 B   -----            -----            HALF    10     DIX    NO    NO
2301 A   192.1.1.52      255.255.255.0    FULL    100    DIX    NO    NO
2301 B   -----            -----            HALF    10     DIX    NO    NO

```

```
IP-LNK table (20 of 2048) 1% full.
```

If the required **IP** link is not in the database, add the **IP** link using the [Configuring an IP Link](#) procedure.

- Verify that the local host name to be assigned to the association is in the database by using the `rtrv-ip-host:display=all` command. The following is an example of the possible output.

```
rlghncxa03w 13-06-28 21:15:37 GMT EAGLE5 45.0.0
```

```

LOCAL IPADDR    LOCAL HOST
192.1.1.10      IPNODE1-1201
192.1.1.12      IPNODE1-1203
192.1.1.14      IPNODE1-1205
192.1.1.20      IPNODE2-1201
192.1.1.22      IPNODE2-1203
192.1.1.24      IPNODE2-1205
192.1.1.30      KC-HLR1
192.1.1.32      KC-HLR2
192.1.1.50      DN-MSC1
192.1.1.52      DN-MSC2

REMOTE IPADDR    REMOTE HOST
150.1.1.5       NCDEPTECONOMIC_DEVELOPMENT. SOUTHEASTERN_COORIDOR_ASHVL.
GOV

```

```
IP Host table is (11 of 4096) .26% full
```

The **IP** address of the **IP** link should be assigned to the local host name that will be assigned to the association.

The values of the `lhost` and `alhost` parameters must be in the `LOCAL HOST` column in the `rtrv-ip-host` output.

If the required hostname is not in the database, add the **IP** host name using the [Adding an IP Host](#) procedure.

- Verify the available buffer size for the **IP** card that will contain the association being added in this procedure by entering the `rtrv-assoc` command with the local host name assigned to the association being added. For this example, enter this command.

 **Note:**

If a new **IP** host was added in 5, continue the procedure with 7.

```
rtrv-assoc:lhost="IPNODE2-1305"
```

This is an example of the possible output.

```
rlghncxa03w 06-10-28 09:12:36 GMT EAGLE5 36.0.0
                CARD IPLNK
ANAME          LOC  PORT  LINK ADAPTER LPORT RPORT OPEN ALW
a2             1305 A    A    SUA      1030  2345  YES  YES
```

```
IP Appl Sock/Assoc table is (8 of 4000) 1% full
Assoc Buffer Space Used (16 KB of 800 KB) on LOC = 1305
```

If adding the new association causes the total buffer size for all the associations on the **IP** card to exceed the maximum buffer size for that **IP** card, the `ent-assoc` command will be rejected.

The default buffer value for an **M3UA** or **SUA** association is 16.

If you wish to add the association and the maximum buffer size for the **IP** card will be exceeded, the buffer size of the other associations assigned to the **IP** card must be decreased by performing the [Changing the Buffer Size of an IPSG Association](#) procedure.

7. Add the associations using the `ent-assoc` command. For this example, enter these commands.

```
ent-
assoc:aname=assoc1:lhost=gw105.nc.tekelec.com:lport=1030:
rhost=gw100.nc.tekelec.com:rport=1030:adapter=m3ua
```

These are the rules that apply to adding IPSG M3UA associations.

- a. The EAGLE can contain a maximum of 4000 connections (association – application server assignments).
- b. A maximum of 32 IPSG M2PA or M3UA associations can be assigned to the IPSG card running on the E5-ENET/E5--ENET-B card or DEIR card. An IPSG application running on the SLIC card can contain a maximum of 128 associations.
- c. The value of the `lhost`, `rhost`, or `alhost` parameters is a text string of up to 60 characters, with the first character being a letter. The command line on the terminal can contain up to 150 characters. If the host names are too long to fit on the `ent-assoc` command line, perform the `chg-assoc` command with the parameters and values necessary to complete the entry of the IPSG M3UA association.
- d. To activate the association after the association is assigned to a signaling link, the association must contain values for the `lhost`, `rhost`, `lport`, and `rport` parameters.
- e. If the `lhost` and `alhost` parameters are specified, the `lhost` parameter value represents the IP address corresponding to one of the network interfaces (A or B) on the IP card while the `alhost` parameter value represents the IP address corresponding to the other network interface of the same IP card.

When each of these commands have successfully completed, this message should appear.

```
rlghncxa03w 06-10-28 09:12:36 GMT EAGLE5 36.0.0  
ENT-ASSOC: MASP A - COMPLTD
```

8. Verify the changes using the `rtrv-assoc` command specifying the association name specified in 7. For this example, enter these commands.

```
rtrv-assoc:aname=assoc1
```

This is an example of possible output.

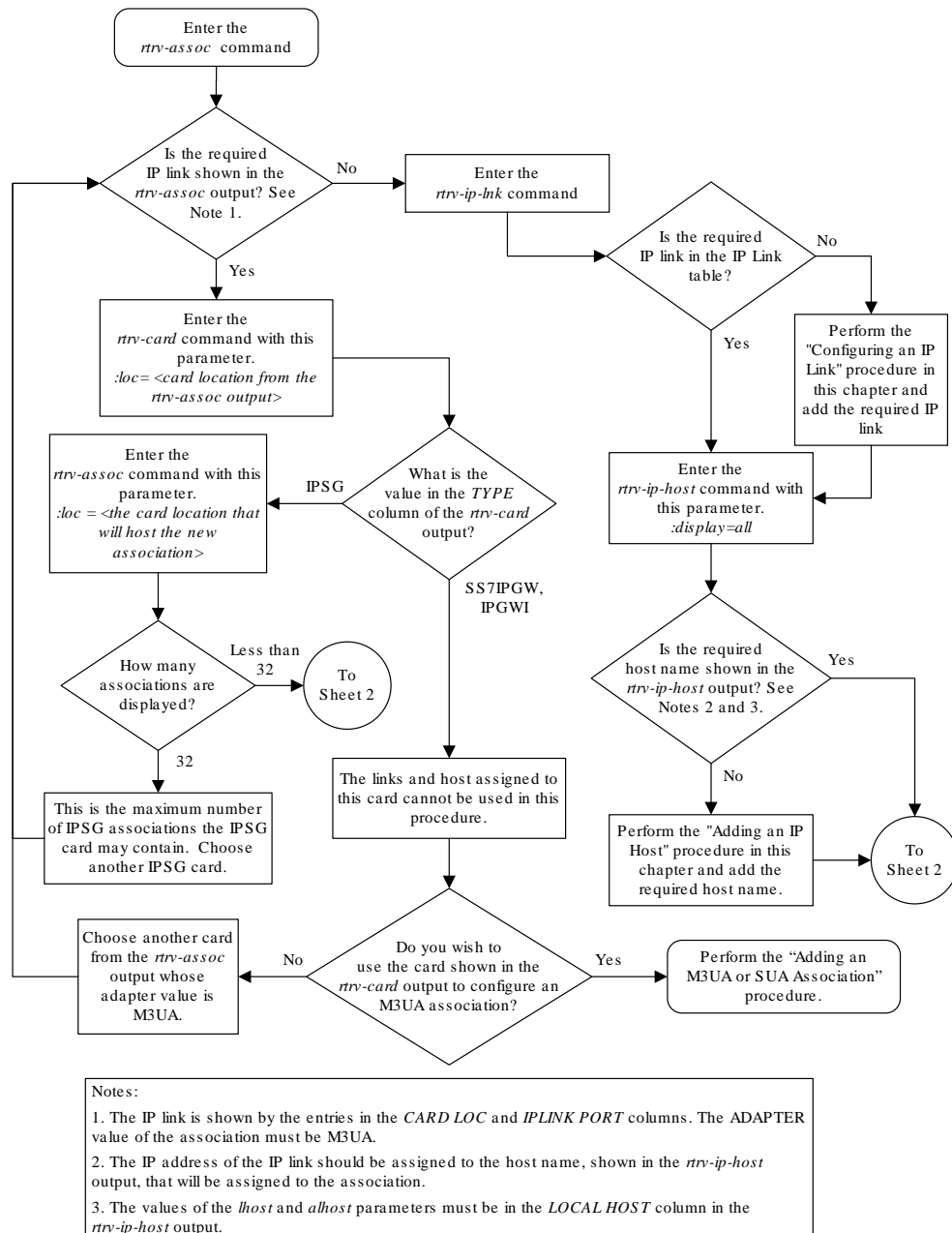
```
rlghncxa03w 09-05-28 09:12:36 GMT EAGLE5 41.0.0  
ANAME assoc1  
LOC      1305          IPLNK PORT  A          LINK  A  
ADAPTER  M3UA            VER        M3UA RFC  
LHOST    gw105.nc.tekelec.com  
ALHOST    ---  
RHOST    gw100.nc.tekelec.com  
ARHOST    ---  
LPORT    1030          RPORT      1030  
ISTRMS   2              OSTRMS     2          BUFSIZE  16  
RMODE    LIN          RMIN       120        RMAX     800  
RTIMES   10           CWMIN      3000       UAPS     10  
OPEN     YES          ALW        YES         RTXTHR   0  
RHOSTVAL RELAXED
```

```
IP Appl Sock table is (5 of 4000) 1% full  
Assoc Buffer Space Used (16 KB of 800 KB) on LOC = 1305
```

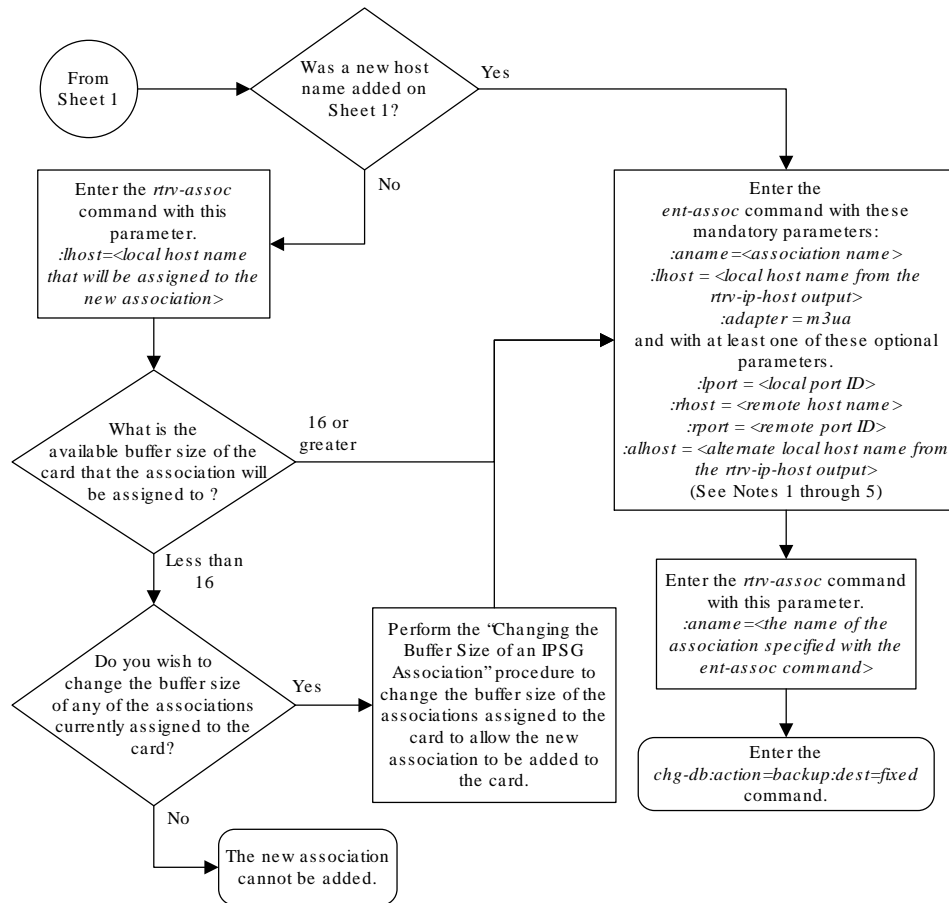
9. Back up the new changes, using the `chg-db:action=backup:dest=fixed` command. These messages should appear; the active **Maintenance and Administration Subsystem Processor (MASP)** appears first.

```
BACKUP (FIXED) : MASP A - Backup starts on active MASP.  
BACKUP (FIXED) : MASP A - Backup on active MASP to fixed disk complete.  
BACKUP (FIXED) : MASP A - Backup starts on standby MASP.  
BACKUP (FIXED) : MASP A - Backup on standby MASP to fixed disk complete.
```

Figure 6-9 Adding an IP SG M3UA Association



Sheet 1 of 2



- Notes:
1. The EAGLE 5 ISS can contain a maximum of 4000 connections (association – application server assignments).
 2. A maximum of 32 IPSG M2PA or M3UA associations can be assigned to the IPSG card.
 3. The value of the *lhost*, *rhost*, or *alhost* parameters is a text string of up to 60 characters, with the first character being a letter. The command line on the terminal can contain up to 150 characters. If the host names are too long to fit on the *ent-assoc* command line, perform the *chg-assoc* command with the parameters and values necessary to complete the entry of the IPSG M3UA association.
 4. To activate the association after the association is assigned to a signaling link, the association must contain values for the *lhost*, *rhost*, *lport*, and *rport* parameters.
 5. If the *lhost* and *alhost* parameters are specified, the *lhost* parameter value represents the IP address corresponding to one of the network interfaces (A or B) on the IP card while the *alhost* parameter value represents the IP address corresponding to the other network interface of the same IP card.

Sheet 2 of 2

6.11 Adding an IPSG M2PA Signaling Link

This procedure is used to add an **IPSG** M2PA signaling link to the database using the `ent-slk` command. An IPSG M2PA signaling link is a signaling link that is assigned to an IPSG card and that contains an IPSG linkset and IPSG association whose `ADAPTER` value is M2PA. The `ent-slk` command uses these parameters to add an IPSG M2PA signaling link.

:loc – The card location of the **IPSP** card that the **IPSP** M2PA signaling link will be assigned to. The cards specified by this parameter are **E5-ENET** cards running the **IPSP** application.

:link – The signaling link on the card specified in the loc parameter.

:lsn – The name of the linkset that will contain the signaling link.

:slc – The signaling link code. The **SLC** must be unique within the linkset. It must be the same at both the **EAGLE** location and the distant node.

:aname – The name of the IPSP M2PA association that will be assigned to the IPSP M2PA signaling link.

The `ent-slk` command contains other optional parameters that are not used to configure an IPGWx signaling link. These parameters are discussed in more detail in *Commands User's Guide* or in these sections.

- These procedures in this manual:
 - [Adding an IPLIMx Signaling Link](#)
 - [Adding an IPGWx Signaling Link](#)
- These procedures in *Database Administration - SS7 User's Guide*
 - Adding an SS7 Signaling Link
 - Adding an E1 Signaling Link
 - Adding a T1 Signaling Link
 - Adding an ATM High-Speed Signaling Link

These items must be configured in the database before an **IPSP** M2PA signaling link can be added:

- Shelf – perform the "Adding a Shelf" procedure in *Database Administration - System Management User's Guide*.
- IPSP Card – perform the [Adding an IPSP Card](#) procedure.
- Destination **Point Code** – perform the "Adding a **Destination Point Code**" procedure in *Database Administration - SS7 User's Guide*.
- IPSP M2PA Linkset – perform the [Adding an IPSP M2PA Linkset](#) procedure.
- IPSP M2PA Association - perform the [Adding an IPSP M2PA Association](#) procedure.

Verify that the link has been physically installed (all cable connections have been made).

To configure the **EAGLE** to perform circular routing detection test on the signaling links, "Configuring Circular **Route** Detection" procedure in *Database Administration - SS7 User's Guide*.

 **Note:**

Circular route detection is not supported in **ITU** networks.

To provision a EAGLE with more than 1200 signaling links, the EAGLE must have certain levels of hardware installed. See the [EAGLE](#) section for more information on these hardware requirements.

The **EAGLE** can contain a mixture of low-speed, **E1**, **T1**, **ATM** high-speed, and **IP** signaling links. The [Determining the Number of High-Speed and Low-Speed Signaling Links](#) section describes how to determine the quantities of the different types of signaling links the **EAGLE** can have.

When the IPSP M2PA signaling link is added, the `RSVDSLKTPS` value that is assigned to the linkset will be assigned to the signaling link. The sum of the TPS used by all the signaling links that are assigned to the IPSP card cannot exceed `MaxTPS`. See [Maximum Card Capacity for Different Card Types](#) for `MaxTPS` values. The TPS used by the IPSP card and the TPS used by each signaling link that is assigned to the IPSP card is shown by entering the `rtrv-slk` command with the location of the IPSP card. If the `MaxTPS` limit for the IPSP card will be exceeded by adding the IPSP M2PA signaling link, one of these actions must be performed.

- Another IPSP card must be used for the IPSP M2PA signaling link.
- The `RSVDSLKTPS` values for the linksets shown in the `rtrv-slk` output for the IPSP card must be reduced enough to allow the IPSP M2PA linkset to be added.

If adding the IPSP M2PA signaling link will exceed the maximum total provisioned system TPS, and the maximum total provisioned system TPS is 500,000, perform the "Activating the HIPR2 High Rate Mode" feature in *Database Administration - System Management User's Guide* to enable and turn on the HIPR2 High Rate Mode feature. When the HIPR2 High Rate Mode feature is enabled and turned on, the maximum total provisioned system TPS is increased to 1,000,000 (1M). If the maximum total provisioned system TPS is 1M, or the maximum total provisioned system TPS is 500,000 and will not be increased, and adding the IPSP M2PA signaling link will exceed the maximum total provisioned system TPS, the IPSP M2PA signaling link cannot be added unless the amount of available TPS is reduced enough to allow the IPSP M2PA signaling link to be added. The available TPS can be reduced by performing one or more of these actions.

- The IP TPS values of some IPGWx linksets have to be changed.
- The `MAXSLKTPS` values of some IPSP linksets (and the `RSVDSLKTPS` values if necessary) have to be changed.
- Some ATM high-speed signaling links have to be removed.
- An IPLIMx card that contains signaling links has to be removed.

Canceling the `REPT-STAT-SLK`, `RTRV-LS`, and `RTRV-SLK` Commands

Because the `rept-stat-slk`, `rtrv-ls`, and `rtrv-slk` commands used in this procedure can output information for a long period of time, the `rept-stat-slk`, `rtrv-ls`, and `rtrv-slk` commands can be canceled and the output to the terminal stopped. There are three ways that the `rept-stat-slk`, `rtrv-ls`, and `rtrv-slk` commands can be canceled.

- Press the F9 function key on the keyboard at the terminal where the `rept-stat-slk`, `rtrv-ls`, or `rtrv-slk` commands were entered.
- Enter the `canc-cmd` without the `trm` parameter at the terminal where the `rept-stat-slk`, `rtrv-ls`, or `rtrv-slk` commands were entered.
- Enter the `canc-cmd:trm=<xx>`, where `<xx>` is the terminal where the `rept-stat-slk`, `rtrv-ls`, or `rtrv-slk` commands were entered, from another terminal other than the terminal where the `rept-stat-slk`, `rtrv-ls`, or `rtrv-slk` commands was

entered. To enter the `canc-cmd:trm=<xx>` command, the terminal must allow Security Administration commands to be entered from it and the user must be allowed to enter Security Administration commands. The terminal's permissions can be verified with the `rtrv-secu-trm` command. The user's permissions can be verified with the `rtrv-user` or `rtrv-secu-user` commands.

For more information about the `canc-cmd` command, go to *Commands User's Guide*.

1. Display the maximum number of signaling links the EAGLE can have and the number of signaling links that are currently provisioned by entering the `rtrv-tbl-capacity` command.

This is an example of the possible output.

```
rlghncxa03w 09-07-19 21:16:37 GMT EAGLE5 41.1.0
SLK      table is (      5 of      1200)   1% full
```

 **Note:**

The `rtrv-tbl-capacity` command output contains other fields that are not used by this procedure. If you wish to see all the fields displayed by the `rtrv-tbl-capacity` command, refer to the `rtrv-tbl-capacity` command description in *Commands User's Guide*.

If the addition of the new signaling link will not exceed the maximum number of signaling links the EAGLE can have, continue the procedure with 2.

If the addition of the new signaling link will exceed the maximum number of signaling links the EAGLE can have, and the maximum number of signaling links is less than 2800, perform the [Enabling the Large System # Links Controlled Feature](#) procedure to enable the desired quantity of signaling links. After the new quantity of signaling links has been enabled, continue the procedure with 2.

If the addition of the new signaling link will exceed the maximum number of signaling links the EAGLE can have (in this example, the maximum number of signaling links is 1200), and the maximum number of signaling links is 2800, this procedure cannot be performed. The EAGLE cannot contain more than 2800 signaling links.

2. Display the current signaling link configuration using the `rtrv-slk` command.

```
rlghncxa03w 10-07-19 21:16:37 GMT EAGLE5 42.0.0
rtrv-slk
Command entered at terminal #4.
```

LOC	LINK	LSN	SLC	TYPE	L2T	BPS	ECM	PCR	PCR
					SET			N1	N2
1312	A	lsnds0	0	LIMDS0	1	56000	BASIC	----	-----

LOC	LINK	LSN	SLC	TYPE	LP	BPS	ATM	VCI	VPI	LL
					SET		TSEL			
1305	A	lsnds0	1	LIMATM	1	1.544M	LINE	5	0	0

LOC	LINK	LSN	SLC	TYPE	LP SET BPS	ATM TSEL	VCI	VPI	E1ATM CRC4 SI	
1306	A	lsnituatm	0	LIME1ATM	21 2.048M	LINE	5	0	ON	3 0

LOC	LINK	LSN	SLC	TYPE	ANAME	SLKTPS
1303	A	ipsglsn	0	IPSG	ipsgm2pa1	600
1303	A1	ipsglsn	1	IPSG	ipsgm2pa2	600
1303	B1	ipsglsn	2	IPSG	ipsgm2pa3	600
1303	A2	ipsglsn	3	IPSG	ipsgm2pa4	600
1303	A3	ipsglsn	4	IPSG	ipsgm2pa5	600
1303	B3	ipsglsn2	0	IPSG	ipsgm2pa6	1000
1307	A	ipsglsn	5	IPSG	m2pa2	600
2204	B	lsnlp2	0	IPSG	m2pa	500

LOC	LINK	LSN	SLC	TYPE	IPLIML2
1301	A	lsniplim	0	IPLIM	M2PA
1301	A1	lsniplim	1	IPLIM	M2PA
1301	B1	lsniplim	2	IPLIM	M2PA

LOC	LINK	LSN	SLC	TYPE
1201	A	ipgwx2	2	SS7IPGW
1202	A	ipgwx2	3	SS7IPGW
1203	A	ipgwx2	4	SS7IPGW
1204	A	ipgwx2	5	SS7IPGW
1205	A	ipgwx2	6	SS7IPGW
1206	A	ipgwx2	7	SS7IPGW
1101	A	ipgwx1	0	SS7IPGW
1102	A	ipgwx1	1	SS7IPGW
1103	A	ipgwx1	2	SS7IPGW
1104	A	ipgwx1	3	SS7IPGW
1105	A	ipgwx1	4	SS7IPGW
1106	A	ipgwx1	5	SS7IPGW
1107	A	ipgwx1	6	SS7IPGW
1108	A	ipgwx1	7	SS7IPGW
1111	A	ipgwx2	0	SS7IPGW
1112	A	ipgwx2	1	SS7IPGW

SLK table is (30 of 1200) 2% full.

3. Display the cards in the database using the `rtrv-card` command.

This is an example of the possible output.

```
rlghncxa03w 13-06-28 09:12:36 GMT EAGLE5 45.0.0
CARD   TYPE      APPL      LSET NAME   LINK SLC LSET NAME   LINK SLC
1101   DCM        SS7IPGW   ipgwx1     A    0
1102   DCM        SS7IPGW   ipgwx1     A    1
1103   DCM        SS7IPGW   ipgwx1     A    2
1104   DCM        SS7IPGW   ipgwx1     A    3
1105   DCM        SS7IPGW   ipgwx1     A    4
1106   DCM        SS7IPGW   ipgwx1     A    5
1107   DCM        SS7IPGW   ipgwx1     A    6
```

1108	DCM	SS7IPGW	ipgwx1	A	7				
1111	DCM	SS7IPGW	ipgwx2	A	0				
1112	DCM	SS7IPGW	ipgwx2	A	1				
1113	E5MCAP	OAMHC							
1114	E5TDM-A								
1115	E5MCAP	OAMHC							
1116	E5TDM-B								
1117	E5MDAL								
1201	DCM	SS7IPGW	ipgwx2	A	2				
1202	DCM	SS7IPGW	ipgwx2	A	3				
1203	DCM	SS7IPGW	ipgwx2	A	4				
1204	DCM	SS7IPGW	ipgwx2	A	5				
1205	DCM	SS7IPGW	ipgwx2	A	6				
1206	DCM	SS7IPGW	ipgwx2	A	7				
1301	DCM	IPLIM	lsniplim	A	0	lsniplim	A1	1	
			lsniplim	B1	2				
1303	ENET	IPSG	ipsglsn	A	0	ipsglsn	A1	1	
			ipsglsn	B1	2	ipsglsn	A2	3	
			ipsglsn	A3	4	ipsglsn2	B3	0	
1305	LIMATM	ATMANSI	lsnds0	A	1				
1306	LIME1ATM	ATMITU	lsnituatm	A	0				
1307	ENET	IPSG	ipsglsn	A	5				
1311	DCM	IPLIM							
1312	LIMDS0	SS7ANSI	lsnds0	A	0				

If the required IPSG card is not in the database, perform the [Adding an IPSG Card](#) procedure and add the **IPSG** card to the database. After the IPSG card has been added, continue the procedure with [5](#).

If the required IPSG card is in the database, continue the procedure with [4](#).

4. Display the signaling links assigned to the IPSG card by entering the `rtrv-slk` command with the card location of the IPSG card. For this example, enter this command.

```
rtrv-slk:loc=2204
```

This is an example of the possible output.

```
rlghncxa03w 06-10-28 09:12:36 GMT EAGLE5 36.0.0
```

LOC	LINK	LSN	SLC	TYPE	ANAME	SLKTPS
2204	B	lsnlp2	0	IPSG	m2pa	500

```
IPTPS for LOC = 2204 is ( 500 of 5000) 10%
```

An IPSG card can contain a maximum of 32 (128 for SLIC) IPSG signaling links. If 32 signaling links are shown in the `rtrv-slk` output, the new signaling link cannot be added to this card. Choose another IPSG card and repeat this procedure from [3](#).

If fewer than 32 signaling links are shown in the `rtrv-slk` output, continue the procedure by performing one of these actions.

- If the IPTPS value shown in the `rtrv-slk` output is less than the MaxTPS (see [Maximum Card Capacity for Different Card Types](#) for MaxTPS values, continue the procedure with 5.
 - If the IPTPS value shown in the `rtrv-slk` output is the MaxTPS, the new signaling link cannot be added to this card. Choose another IPSP card and repeat this procedure from 3.
5. Display the IPSP and IPGWx linksets by entering the `rept-stat-iptps` command.

This is an example of the possible output.

```
rlghncxa03w 10-07-19 21:16:37 GMT EAGLE5 42.0.0
IP TPS USAGE REPORT
```

	THRESH	CONFIG/ RSVD	CONFIG/ MAX		TPS	PEAK	PEAKTIMESTAMP

LSN							
ipgwx1	100%	----	32000	TX:	3700	4000	10-07-19 09:49:19
				RCV:	3650	4000	10-07-19 09:49:19
ipgwx2	100%	----	16000	TX:	4800	5000	10-07-19 09:49:09
				RCV:	4850	5000	10-07-19 09:49:09
ipgwx3	100%	----	32000	TX:	427	550	10-07-19 09:49:19
				RCV:	312	450	10-07-19 09:49:19
ipsglsn	100%	600	24000	TX:	4800	5000	10-07-19 09:49:19
				RCV:	4800	5000	10-07-19
09:49:19							
ipsglsn2	100%	600	4000	TX:	427	550	10-07-19 09:49:19
				RCV:	312	450	10-07-19 09:49:19
isipgw	100%	500	4000	TX:	427	550	10-07-19 09:49:19
				RCV:	312	450	10-07-19
09:49:19							

Command Completed.

If the desired linkset is shown in the `rept-stat-iptps` output, continue the procedure with 6.

If the desired linkset is not shown in the `rept-stat-iptps` output, add the linkset by performing the [Adding an IPSP M2PA Linkset](#) procedure. Continue the procedure with one of these actions.

- If a new IPSP card was added in 3, continue the procedure with 7.
- If the signaling link will be assigned to an existing IPSP card, the `RSVDSLKTPS` value that is assigned to the linkset will be assigned to the signaling link. The sum of the TPS used by all the signaling links that are assigned to the IPSP card cannot exceed the MaxTPS. See [Maximum Card Capacity for Different Card Types](#) for MaxTPS values. The TPS used by the IPSP card and the TPS used by each signaling link that is assigned to the IPSP card is shown by entering the `rtrv-slk` command with the location of the IPSP card. If the MaxTPS limit for the IPSP card will be exceeded by adding the IPSP M2PA signaling link, one of these actions must be performed.

- Another IPSP card must be used for the IPSP M2PA signaling link. Repeat this procedure from 3.
- The RSVDSLKTPS values for the linksets shown in the rtrv-slk output for the IPSP card, shown in 4, must be reduced enough to allow the IPSP M2PA linkset to be added. Perform these procedures as necessary to change the RSVDSLKTPS values for the linksets. After the linksets have been changed, continue the procedure with 7.
- * [Changing an IPSP M2PA Linkset](#)
- * [Changing an IPSP M3UA Linkset](#)

6. Display the linkset that the signaling link is being assigned to using the rtrv-ls command, specifying the name of the linkset that the signaling link is being assigned to.

For this example, enter this command.

```
rtrv-ls:lsn=lsipgw
```

This is an example of the possible output.

```
rlghncxa03w 10-07-17 11:43:04 GMT EAGLE5 42.0.0
                                     L3T SLT                               GWS GWS GWS
LSN      APCN  (SS7)  SCRN  SET SET BEI LST LNKS ACT MES DIS
SLSCI NIS
lsipgw   2968          none  1  1  no  A  1  off off off
---  off

                                     SPCN          CLLI          TFATCABMLQ MTPRSE ASL8
-----
                                     1          ---  ---

SLSRSB RANDSL S ITUTFR
1      off  off

IPSP  IPGWAPC  GTTMODE          CGGTMOD
yes   no      CdPA          no

ADAPTER  RSVDSLKTPS  MAXSLKTPS
m2pa     500        4000

TPSALM  LSUSEALM  SLKUSEALM
rsvdslktps 100%    100%

LOC  LINK  SLC  TYPE  ANAME
1317 A    0    IPSP  m2pa2
```

Link set table is (13 of 1024) 1% full.

If the IPSP value of the linkset is no, choose another linkset and repeat this procedure from 5.

If the IPSP value of the linkset is yes and the ADAPTER value is m3ua, choose another linkset and repeat this procedure from 5.

If the `IPSG` value of the linkset is `yes`, and the `ADAPTER` value is `m2pa`, continue the procedure by performing one of these actions.

- If a new IPSG card was added in 3, continue the procedure with 7.
 - If the signaling link will be assigned to an existing IPSG card, the `RSVDSLKTPS` value that is assigned to the linkset will be assigned to the signaling link. The sum of the TPS used by all the signaling links that are assigned to the IPSG card cannot exceed the `MaxTPS`. See [Maximum Card Capacity for Different Card Types](#) for `MaxTPS` values. The TPS used by the IPSG card and the TPS used by each signaling link that is assigned to the IPSG card is shown by entering the `rtrv-slk` command with the location of the IPSG card. If the `MaxTPS` limit for the IPSG card will be exceeded by adding the IPSG M2PA signaling link, one of these actions must be performed.
 - Another IPSG card must be used for the IPSG M2PA signaling link. Repeat this procedure from 3.
 - The `RSVDSLKTPS` values for the linksets shown in the `rtrv-slk` output for the IPSG card, shown in 4, must be reduced enough to allow the IPSG M2PA linkset to be added. Perform these procedures as necessary to change the `RSVDSLKTPS` values for the linksets. After the linksets have been changed, continue the procedure with 7.
 - * [Changing an IPSG M2PA Linkset](#)
 - * [Changing an IPSG M3UA Linkset](#)
7. Display the total provisioned system TPS by entering the `rtrv-tps` command. This is an example of the possible output.

```
rlghncxa03w 10-07-10 16:20:46 GMT EAGLE 42.0.0

CARD      NUM      NUM      RSDV      MAX
TYPE     CARDS   LINKS    TPS       TPS
-----
IPGW      17      16      48000    80000
IPSG      4       8       4700     12000
IPLIM     2       4       8000     8000
ATM       2       2       3668     3668

Total provisioned System TPS (103668 of 500000) 21%

Command Completed.
```

An IPSG M2PA signaling link uses can use as much as the `MaxTPS` (see [Maximum Card Capacity for Different Card Types](#) for `MaxTPS` values, as provisioned by the `rsvdsstktps` parameter of the linkset that the IPSG M2PA signaling link will be added to. If adding the new IPSG M2PA signaling link will not exceed the maximum total provisioned system TPS, continue the procedure with 11.

If adding the new IPSG M2PA signaling link will exceed the maximum total provisioned system TPS, and the maximum total provisioned system TPS is 500,000 shown, perform the "Activating the HIPR2 High Rate Mode Feature" procedure in *Database Administration - System Management User's Guide* to enable and turn on the HIPR2 High Rate Mode feature. When the HIPR2 High Rate Mode feature is enabled and turned on, the maximum total provisioned system TPS is increased to 1M. After the HIPR2 High Rate Mode feature has been enabled and turned on, continue the procedure with 11.

If the maximum total provisioned system TPS is 1M, or the maximum total provisioned system TPS is 500,000 and will not be increased, and adding the IPSP M2PA signaling link will exceed the maximum total provisioned system TPS, the IPSP M2PA signaling link cannot be added unless the amount of available TPS is reduced enough to allow the IPSP M2PA signaling link to be added. The available TPS can be increased by performing one or more of these actions.

- Some ATM high-speed signaling links have to be removed. To perform this action, continue the procedure with 8.
- An IPLIMx card that contains signaling links has to be removed. To perform this action, continue the procedure with 9.
- The IP TPS values of some IPGWx linksets have to be changed or the MAXSLKTPS values of some IPSP linksets (and the RSVDSLKTPS values if necessary) have to be changed.
If linksets are displayed in the `rept-stat-iptps` output in 5, continue the procedure with 10.

If linksets are not displayed in the `rept-stat-iptps` output in 5, perform one or more of these actions to increase the available TPS.

 **Note:**

If one or more of these actions are not performed to increase the available TPS and the available TPS will not allow the IPSP M2PA signaling link to be added, the IPSP M2PA signaling link cannot be added and the remainder of this procedure cannot be performed.

- An IPLIMx card that contains signaling links has to be removed. To perform this action, continue the procedure with 9.
- Some ATM high-speed signaling links have to be removed. To perform this action, continue the procedure with 8.

8. Display the ATM high-speed signaling links by entering this command.

```
rtrv-slk:type=saal
```

This is an example of the possible output.

```
rlghncxa03w 10-07-19 21:16:37 GMT EAGLE5 42.0.0

LOC LINK LSN          SLC TYPE          LP          ATM
1303 A  lsnds0          1  LIMATM          1  1.544M LINE      5  0  0

E1ATM
LOC LINK LSN          SLC TYPE          LP          ATM
1306 A  lsnituatm        0  LIME1ATM         21  2.048M LINE      5  0
ON  3  0

SLK table is (30 of 1200) 2% full.
```

If ATM high-speed signaling links are shown in the `rtrv-slk` output, perform the "Removing an SS7 Signaling Link" procedure in *Database Administration - SS7 User's Guide* to remove some of the ATM high-speed signaling links.

If ATM high-speed signaling links are not displayed in the `rtrv-slk` output, perform one or more of these actions to increase the available TPS.

 **Note:**

If one or more of these actions are not performed to increase the available TPS and the available TPS will not allow the IPSP M2PA signaling link to be added, the IPSP M2PA signaling link cannot be added and the remainder of this procedure cannot be performed.

- An IPLIMx card that contains signaling links has to be removed. To perform this action, continue the procedure with [9](#).
- The IP TPS values of some IPGWx linksets have to be changed or the MAXSLKTPS values of some IPSP linksets (and the RSVDSLKTPS values if necessary) have to be changed.
If linksets are displayed in the `rept-stat-iptps` output in [5](#), continue the procedure with [10](#).
If linksets are not displayed in the `rept-stat-iptps` output in [5](#), an IPLIMx card that contains signaling links has to be removed. To perform this action, continue the procedure with [9](#).

If you do not wish to perform other actions to increase the available TPS and the available TPS will allow the IPSP M2PA signaling link to be added, continue the procedure with [11](#).

9. Display the signaling links that are assigned to IPLIMx cards by entering this command.

```
rtrv-slk:type=iplim
```

This is an example of the possible output.

```
rlghncxa03w 10-07-19 21:16:37 GMT EAGLE5 42.0.0
```

LOC	LINK	LSN	SLC	TYPE	ANAME	SLKTPS
1301	A	lsniplim	0	IPLIM	M2PA	
1301	A1	lsniplim	1	IPLIM	M2PA	
1301	B1	lsniplim	2	IPLIM	M2PA	
1317	A	lsniplimi	0	IPLIMI	M2PA	

```
SLK table is (30 of 1200) 2% full.
```

If IPLIMx cards containing signaling links are shown in the `rtrv-slk` output, perform the [Removing an IPLIMx Card](#) procedure to remove an IPLIMx card and its associated signaling links.

If IPLIMx cards containing signaling links are not displayed in the `rtrv-slk` output, perform one or more of these actions to increase the available TPS.

 **Note:**

If one or more of these actions are not performed to increase the available TPS and the available TPS will not allow the IPSP M2PA signaling link to be added, the IPSP M2PA signaling link cannot be added and the remainder of this procedure cannot be performed.

- Some ATM high-speed signaling links have to be removed. To perform this action, continue the procedure with 8.
- The IP TPS values of some IPGWx linksets have to be changed or the MAXSLKTPS values of some IPSP linksets (and the RSVDSLKTPS values if necessary) have to be changed.
If linksets are displayed in the `rept-stat-iptps` output in 5, continue the procedure with 10.

If linksets are not displayed in the `rept-stat-iptps` output in 5, some ATM high-speed signaling links have to be removed. To perform this action, continue the procedure with 8.

If you do not wish to perform other actions to increase the available TPS and the available TPS will allow the IPSP M2PA signaling link to be added, continue the procedure with 11.

10. Display the attributes of the linksets shown in 5 by entering the `rtrv-ls` command with the name of the linkset shown in 5.

For this example enter these commands.

```
rtrv-ls:lsn=ipgwx1
```

This is an example of the possible output.

```
rlghncxa03w 10-07-19 21:16:37 GMT EAGLE5 42.0.0

LSN              APCA  (SS7)  L3T SLT          GWS GWS GWS
SLSCI NIS        SCRN SET SET BEI LST LNKS ACT MES DIS
ipgwx1          001-001-002  none 1  1  no  A  8  off off off
no             off

              SPCA          CLLI          TFATCABMLQ MTPRSE ASL8
-----
              4          ---          no

RANDSLS
off

IPSP  IPGWAPC  GTTMODE          CGGTMOD
no    yes     CdPA          no

MATELSN  IPTPS  LSUSEALM  SLKUSEALM
-----  32000  100%     80%

LOC  LINK  SLC  TYPE
1101 A    0    SS7IPGW
```

```

1102 A 1 SS7IPGW
1103 A 2 SS7IPGW
1104 A 3 SS7IPGW
1105 A 4 SS7IPGW
1106 A 5 SS7IPGW
1107 A 6 SS7IPGW
1108 A 7 SS7IPGW

```

Link set table is (8 of 1024) 1% full.

rtrv-ls:lsn=ipgwx2

This is an example of the possible output.

rlghncxa03w 10-07-19 21:16:37 GMT EAGLE5 42.0.0

```

LSN          APCA  (SS7)  SCRN SET SET BEI LST LNKS ACT MES DIS SLSCI
NIS
ipgwx2      001-001-003  none 1  1  no  A  8  off off off no
off

```

```

          SPCA          CLLI          TFATCABMLQ MTPRSE ASL8
-----
          4          ---          no

```

RANDSLS
off

```

IPSG  IPGWAPC  GTTMODE          CGGTMOD
no    yes     CdPA          no

```

```

MATELSN  IPTPS  LSUSEALM  SLKUSEALM
-----  16000  100%     80%

```

```

LOC  LINK  SLC  TYPE
1111 A  0  SS7IPGW
1112 A  1  SS7IPGW
1201 A  2  SS7IPGW
1202 A  3  SS7IPGW
1203 A  4  SS7IPGW
1204 A  5  SS7IPGW
1205 A  6  SS7IPGW
1206 A  7  SS7IPGW

```

Link set table is (8 of 1024) 1% full.

rtrv-ls:lsn=ipgwx3

This is an example of the possible output.

rlghncxa03w 10-07-19 21:16:37 GMT EAGLE5 42.0.0

```

                                L3T SLT                GWS GWS GWS
LSN          APCA  (SS7)  SCR N SET SET BEI LST LNKS ACT MES DIS
SLSCI NIS
ipgwx3      001-001-004  none 1  1  no  A  0   off off off
no         off

                                SPCA                CLLI                TFATCABMLQ MTPRSE ASL8
-----
                                1                ---      no

RANDSLS
off

IPSP IPGWAPC GTTMODE                CGGTMOD
no   yes    CdPA                    no

MATELSN  IPTPS  LSUSEALM  SLKUSEALM
-----  32000  100%    80%

```

Link set table is (8 of 1024) 1% full.

rtrv-ls:lsn=ipsglsn

This is an example of the possible output.

rlghncxa03w 10-07-19 21:16:37 GMT EAGLE5 42.0.0

```

                                L3T SLT                GWS GWS GWS
LSN          APCA  (SS7)  SCR N SET SET BEI LST LNKS ACT MES DIS
SLSCI NIS
ipsglsn     003-003-003  none 1  1  no  A  6   off off off
no         off

                                SPCA                CLLI                TFATCABMLQ MTPRSE ASL8
-----
                                3                ---      no

RANDSLS
off

IPSP IPGWAPC GTTMODE                CGGTMOD
yes  no     CdPA                    no

ADAPTER  SLKTPS  LSUSEALM  SLKUSEALM  RCONTEXT
ASNOTIF
m2pa     600    100%    80%        none      no

LOC  LINK  SLC  TYPE  ANAME
1303 A   0   IPSP  ipsgm2pa1
1303 A1  1   IPSP  ipsgm2pa2
1303 B1  2   IPSP  ipsgm2pa3
1303 A2  3   IPSP  ipsgm2pa4
1303 A3  4   IPSP  ipsgm2pa5
1307 A   5   IPSP  m2pa2

```


Link set table is (8 of 1024) 1% full.

rtrv-ls:lsn=ipsglsn2

This is an example of the possible output.

rlghncxa03w 10-07-19 21:16:37 GMT EAGLE5 42.0.0

```

LSN          APCA   (SS7)   SCRN SET SET BEI LST LNKS ACT MES DIS SLSCI
NIS
ipsglsn2    005-005-005  none 1  1  no  A  1  off off off no
off

          SPCA          CLLI          TFATCABMLQ MTPRSE ASL8
-----
          1          ---          no

RANDSLS
off

IPSP  IPGWAPC  GTTMODE          CGGTMOD
yes  no      CdPA          no

ADAPTER  SLKTPS  LSUSEALM  SLKUSEALM  RCONTEXT  ASNOTIF
m2pa    1000   100%     80%        none      no

LOC  LINK  SLC  TYPE  ANAME
1303 B3  0    IPSP  ipsgm2pa6

```

Link set table is (8 of 1024) 1% full.

Perform one or both of these actions as necessary.

- Perform the [Configuring an IPGWx Linkset](#) procedure to change the IPTPS value for any linksets shown in the rtrv-ls output whose IPGWAPC value is yes.
- Perform the [Changing an IPSP M2PA Linkset](#) procedure (for linkset whose IPSP value is yes and ADAPTER value is M2PA) or the [Changing an IPSP M3UA Linkset](#) procedure (for linkset whose IPSP value is yes and ADAPTER value is M3UA) to change the MAXSLKTPS value (and RSVDSLKTPS value if necessary) for any linksets shown in the rtrv-ls output.

Perform one or both of these actions to increase the available TPS if needed.

- An IPLIMx card that contains signaling links has to be removed. To perform this action, continue the procedure with [9](#).
- Some ATM high-speed signaling links have to be removed. To perform this action, continue the procedure with [8](#).

If you do not wish to perform other actions to increase the available TPS and the available TPS will allow the IPSP M2PA signaling link to be added, continue the procedure with [11](#).

11. Display the associations that are assigned to the card that will be assigned to the signaling link by entering `rtv-assoc` command with the location of the card. For this example, enter this command.

```
rtv-assoc:loc=2204
```

This is an example of the possible output.

```
rlghncxa03w 08-04-22 19:24:18 EST 38.0.0
```

ANAME	CARD		IPLNK		ADAPTER	LPORT	RPORT	OPEN	ALW
	LOC	PORT	LINK	ADAPTER					
m2pa2	2204	A	B	M2PA	3001	3000	NO	YES	
m2pa3	2204	A	--	M2PA	3002	3000	YES	YES	
m2pa4	2204	A	--	M2PA	3003	3000	YES	YES	

```
IP Appl Sock/Assoc table is (7 of 4000) 1% full
Assoc Buffer Space Used (1400 KB of 6400 KB) on LOC = 2204
```

Associations that can be assigned to an IPSP M2PA signaling link cannot be assigned to a signaling link shown by dashes in the `LINK` column, and the `ADAPTER` value of the association must be `M2PA`. If the associations displayed in this step do not meet these requirements, add the IPSP M2PA association by performing the [Adding an IPSP M2PA Association](#) procedure. After the association has been added, continue the procedure with [12](#).

If the associations displayed in this step meet these requirements, continue the procedure with [12](#).

12. Add the signaling link to the database using the `ent-slk` command.

[Table 6-8](#) shows the parameters and values that can be specified with the `ent-slk` command.

Table 6-8 IPSP M2PA Signaling Link Parameter Combinations

IPSP M2PA Signaling Link
Mandatory Parameters
:loc = location of the IPSP card
:link = a - a15, b - b15
:lsn = linkset name
:slc = 0 - 15
:aname = the name of the IPSP M2PA association

For this example, enter this command.

```
ent-slk:loc=2204:link=a10:lsn=lsipgw:slc=1:aname=m2pa3
```

When this command has successfully completed, this message should appear.

```
rlghncxa03w 06-10-07 08:29:03 GMT EAGLE5 36.0.0
ENT-SLK: MASP A - COMPLTD
```

 **Note:**

If adding the new signaling link will result in more than 700 signaling links in the database and the OAMHCMEAS value in the `rtrv-measopts` output is `on`, the scheduled UI measurement reports will be disabled.

13. Verify the changes using the `rtrv-slk` command with the card location and link parameter values specified in 12. For this example, enter these commands.

```
rtrv-slk:loc=2204:link=a10
```

This is an example of the possible output.

```
rlghncxa03w 06-10-19 21:16:37 GMT EAGLE5 36.0.0
```

LOC	LINK	LSN	SLC	TYPE	ANAME	SLKTPS
2204	A10	lsipgw	1	IPSP	m2pa3	500

14. If any cards contain the first signaling link on a card, those cards must be brought into service with the `rst-card` command, specifying the location of the card. For this example, enter this command.

```
rst-card:loc=2205
```

When this command has successfully completed, this message should appear.

```
rlghncxa03w 06-10-23 13:05:05 GMT EAGLE5 36.0.0
Card has been allowed.
```

15. Activate all signaling links on the cards using the `act-slk` command, specifying the card location and link parameter value of each signaling link. For this example, enter this command.

```
act-slk:loc=2204:link=a10
```

When this command has successfully completed, this message should appear.

```
rlghncxa03w 06-10-07 08:31:24 GMT EAGLE5 36.0.0
Activate Link message sent to card
```

16. Check the status of the signaling links added in 12 using the `rept-stat-slk` command with the card location and link parameter values specified in 12. The state of each signaling link should be in service normal (**IS-NR**) after the link has completed alignment (shown in the **PST** field). For this example, enter these commands.

```
rept-stat-slk:loc=2204:link=a10
```

This is an example of the possible output.

```
rlghncxa03w 07-05-23 13:06:25 GMT EAGLE5 37.0.0
SLK      LSN      CLLI      PST      SST      AST
2204,A10 lsipgw    ----- IS-NR      Avail    ----
```

```
ALARM STATUS      =  
UNAVAIL REASON    =
```

17. Change the `open` parameter value of the association that was assigned to the signaling link by entering the `chg-assoc` command with the `open=yes` parameter and the name of the association that was association. For this example, enter this command.

```
chg-assoc:aname=m2pa3:open=yes
```

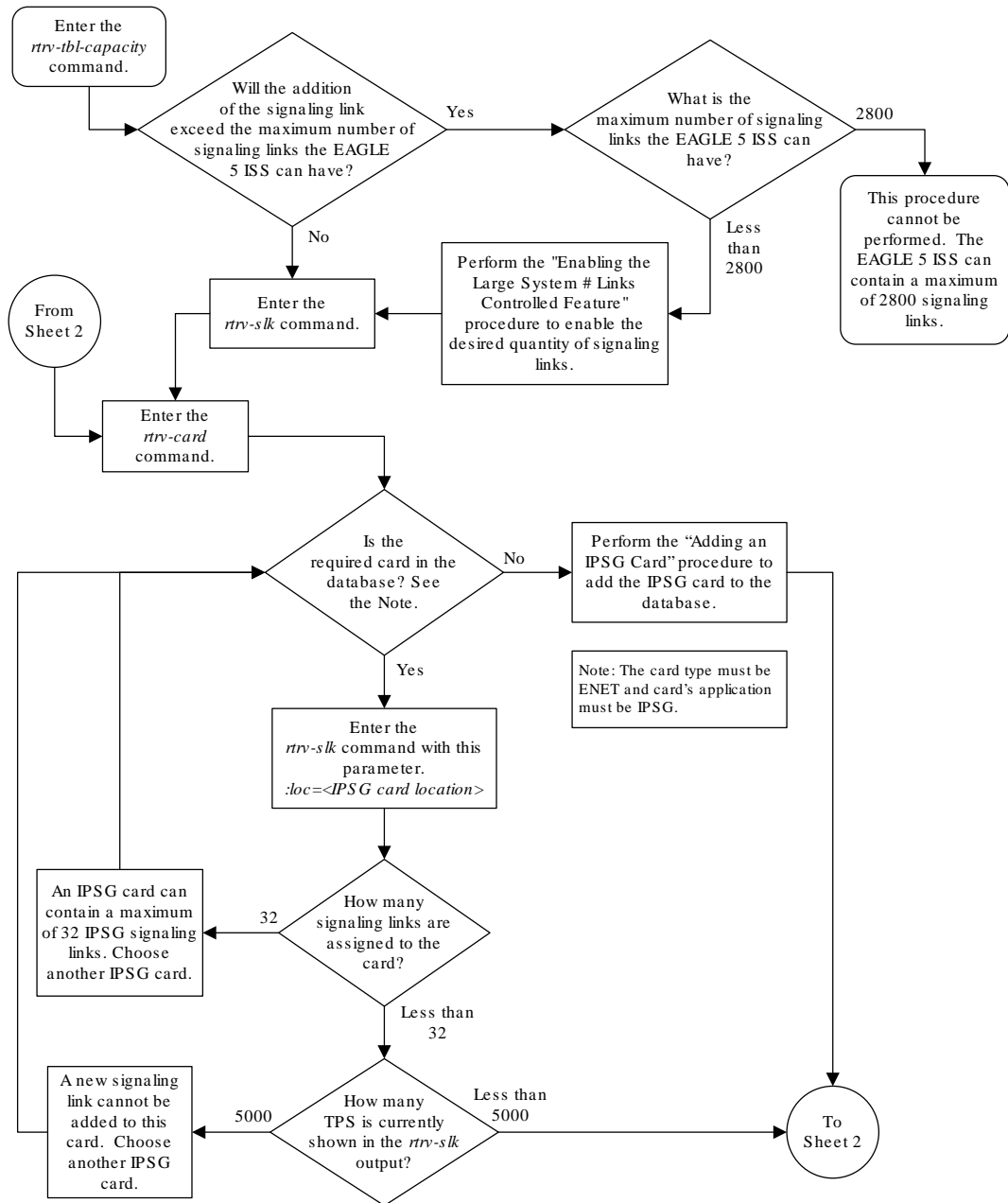
When this command has successfully completed, this message should appear.

```
rlghncxa03w 06-10-07 08:29:03 GMT  EAGLE5 36.0.0  
CHG-ASSOC: MASP A - COMPLTD
```

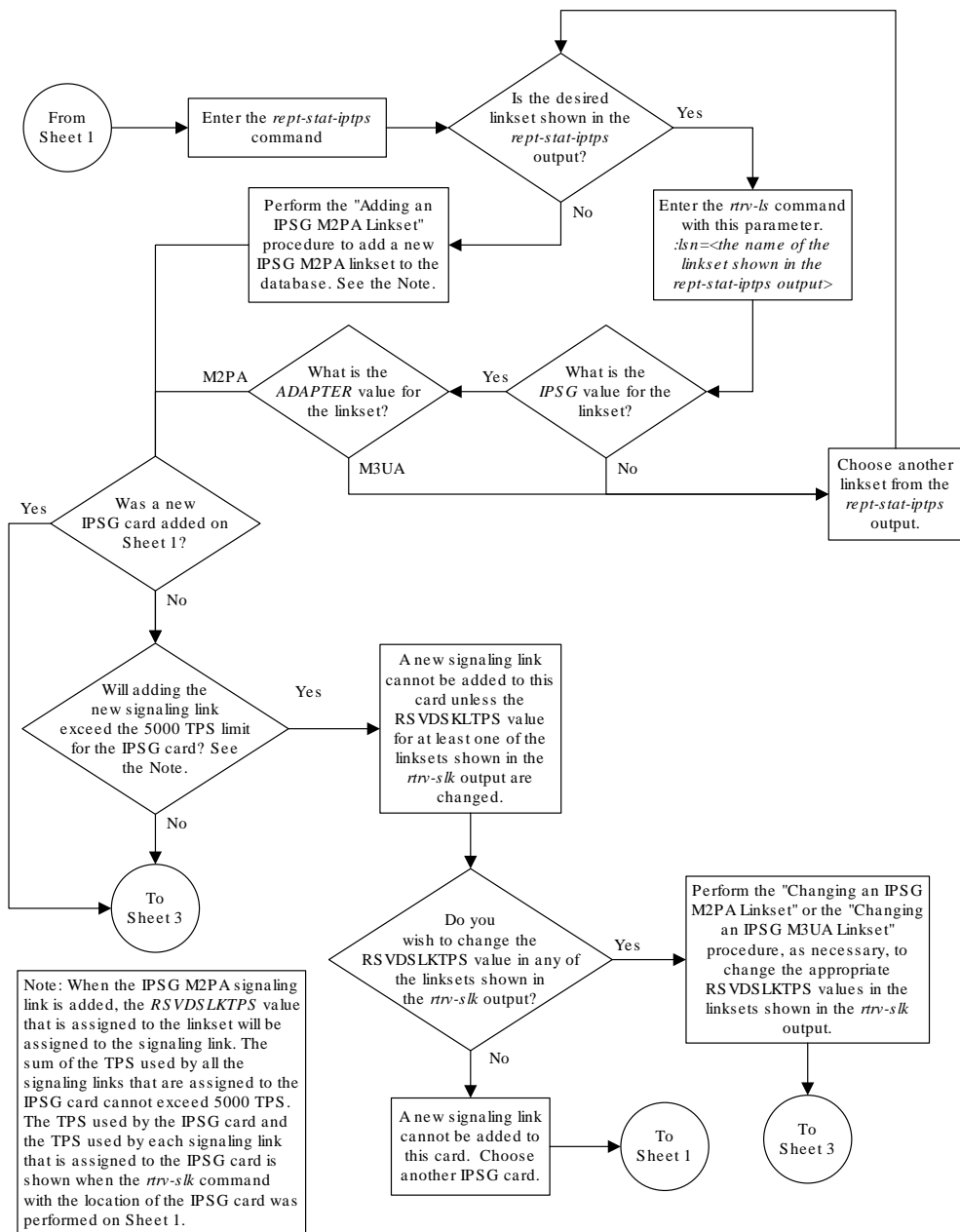
18. Back up the new changes using the `chg-db:action=backup:dest=fixed` command. These messages should appear, the active **Maintenance and Administration Subsystem Processor (MASP)** appears first.

```
BACKUP (FIXED) : MASP A - Backup starts on active MASP.  
BACKUP (FIXED) : MASP A - Backup on active MASP to fixed disk  
complete.  
BACKUP (FIXED) : MASP A - Backup starts on standby MASP.  
BACKUP (FIXED) : MASP A - Backup on standby MASP to fixed disk  
complete.
```

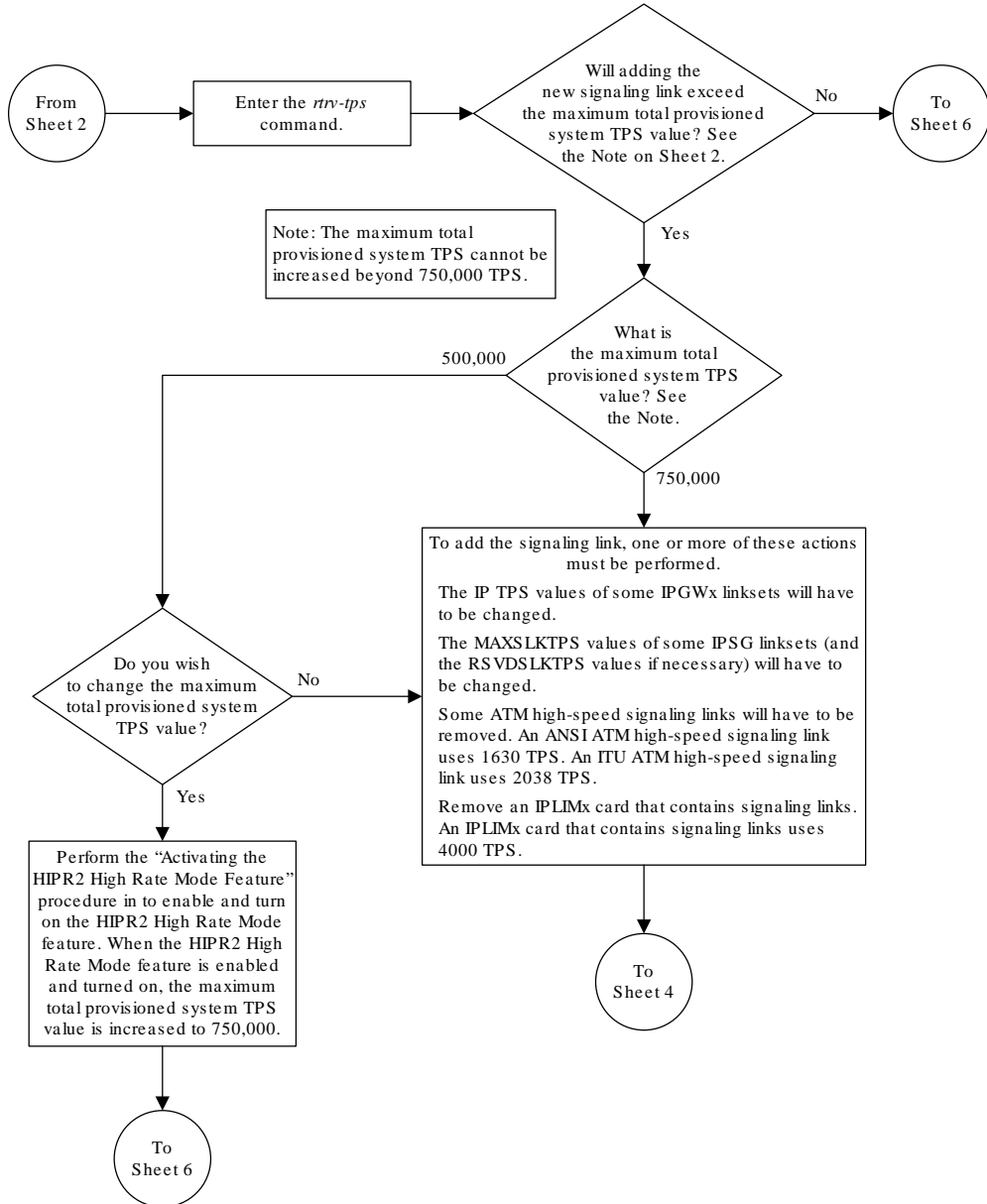
Figure 6-10 Adding an IP SG M2PA Signaling Link



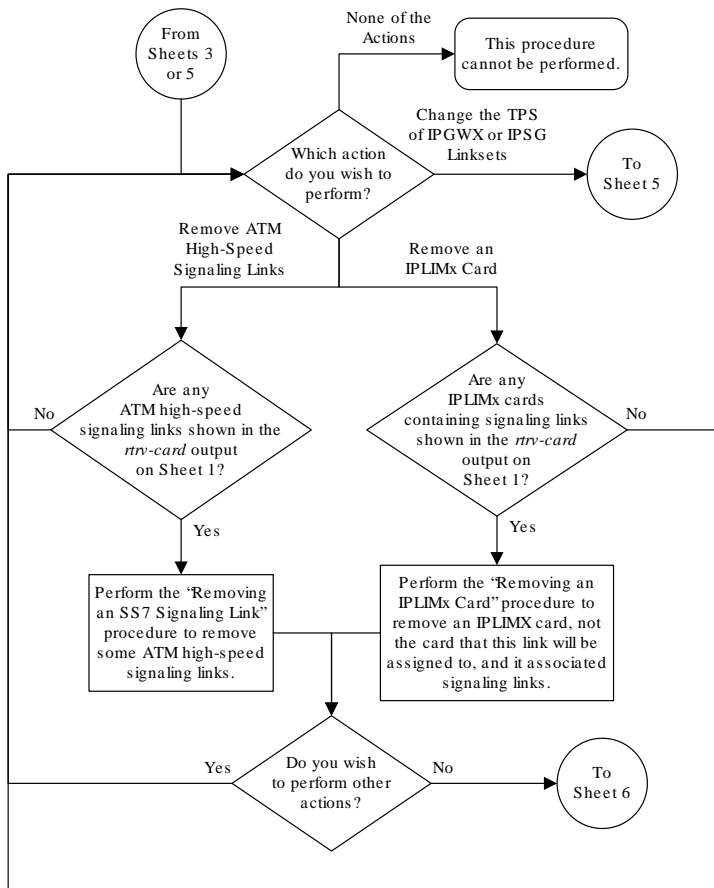
Sheet 1 of 6



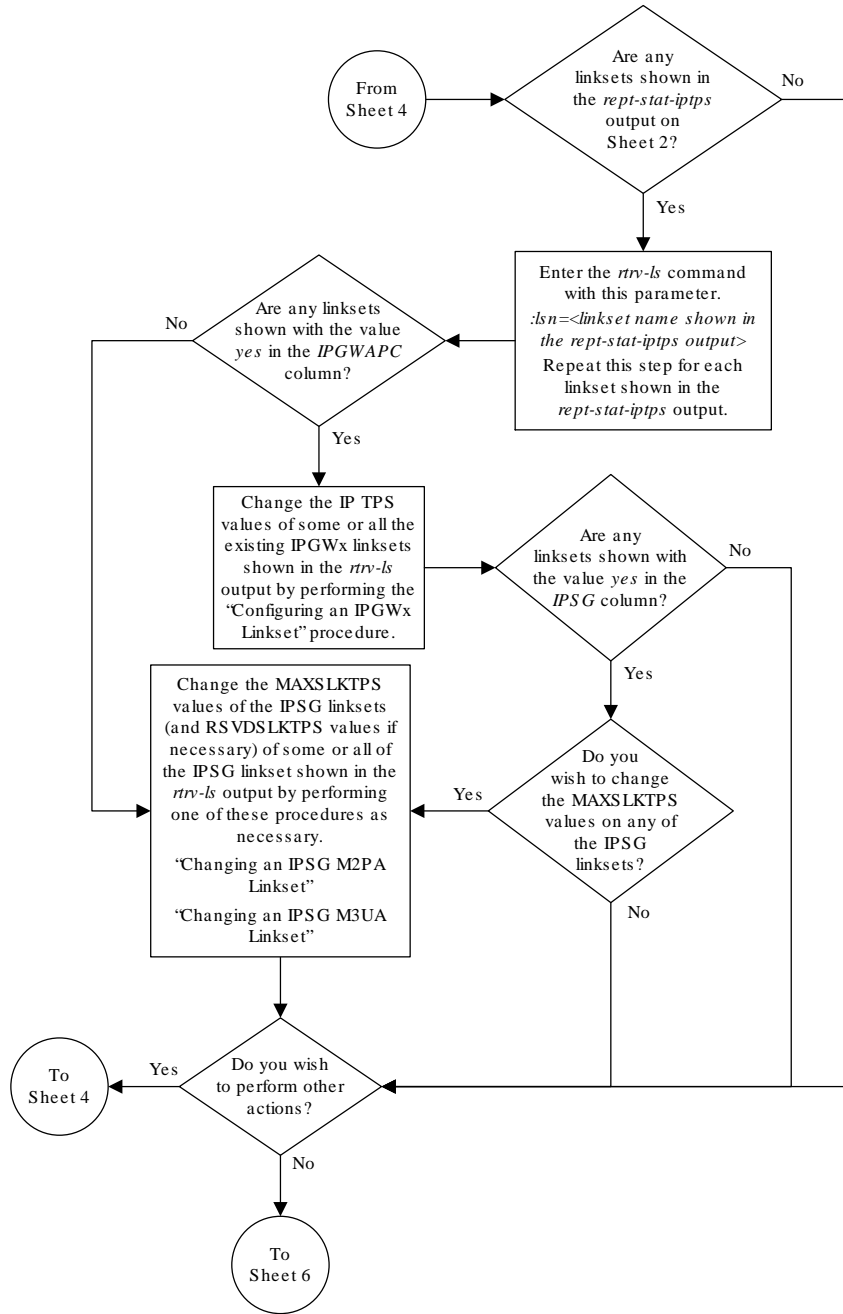
Sheet 2 of 6



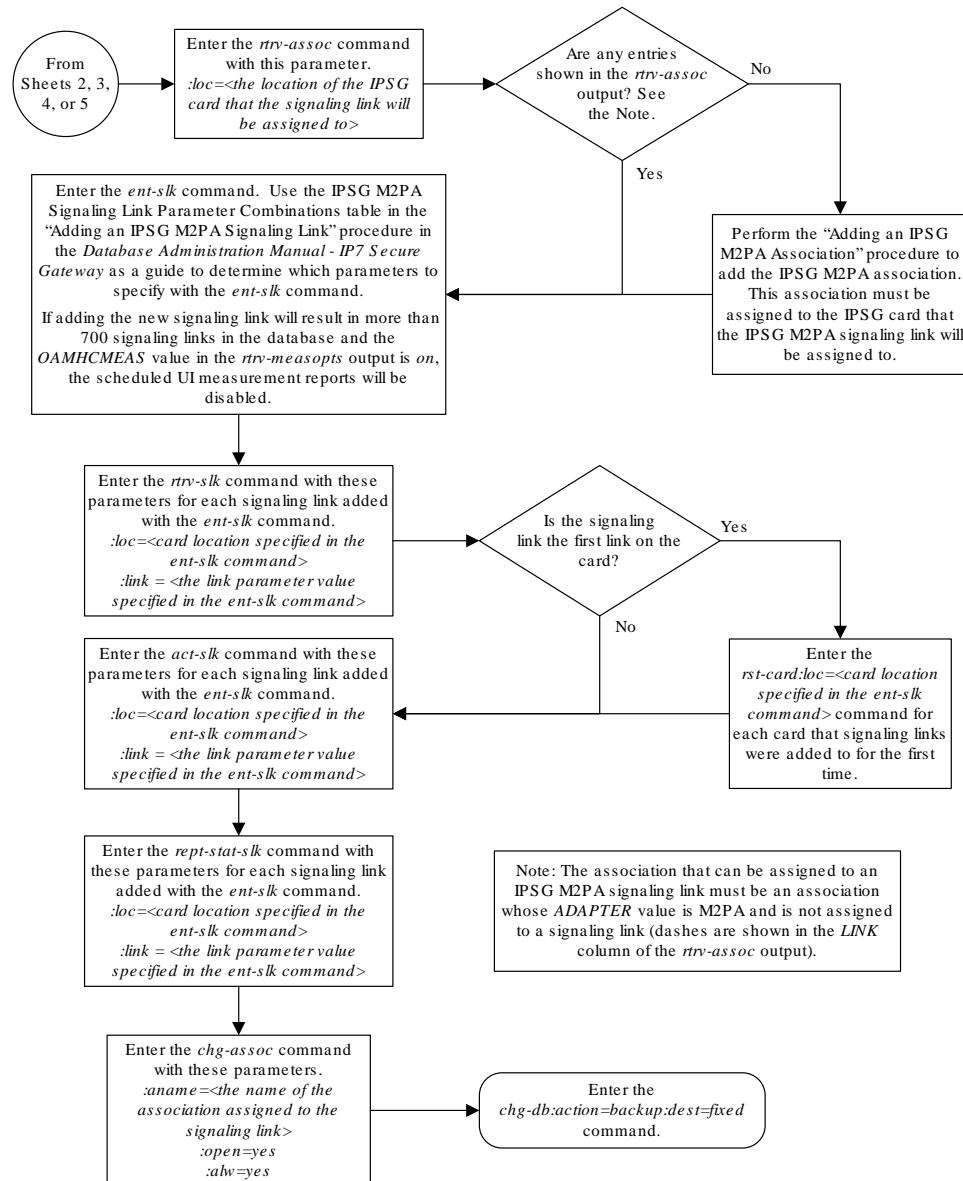
Sheet 3 of 6



Sheet 4 of 6



Sheet 5 of 6



Sheet 6 of 6

6.12 Adding an IPSG M3UA Signaling Link

This procedure is used to add an **IPSG** M3UA signaling link to the database using the `ent-sl k` command. An IP SG M3UA signaling link is a signaling link that is assigned to an IP SG card and that contains an IP SG linkset and IP SG association whose `ADAPTER` value is M3UA. The `ent-sl k` command uses these parameters to add an IP SG M3UA signaling link.

:loc – The card location of the **IPSP** card that the **IPSP** M3UA signaling link will be assigned to. The cards specified by this parameter are **E5-ENET** cards running the **IPSP** application.

:link – The signaling link on the card specified in the loc parameter.

:lsn – The name of the linkset that will contain the signaling link.

:slc – The signaling link code. The **SLC** must be unique within the linkset. It must be the same at both the **EAGLE** location and the distant node.

:aname – The name of the IPSP M3UA association that will be assigned to the IPSP M3UA signaling link.

The `ent-slk` command contains other optional parameters that are not used to configure an IPGWx signaling link. These parameters are discussed in more detail in *Commands User's Guide* or in these sections.

- These procedures in this manual:
 - [Adding an IPLIMx Signaling Link](#)
 - [Adding an IPGWx Signaling Link](#)
- These procedures in *Database Administration - SS7 User's Guide*
 - Adding an SS7 Signaling Link
 - Adding an E1 Signaling Link
 - Adding a T1 Signaling Link
 - Adding an ATM High-Speed Signaling Link

These items must be configured in the database before an **IPSP** M3UA signaling link can be added:

- Shelf – perform the "Adding a Shelf" procedure in *Database Administration - System Management User's Guide*.
- IPSP Card – perform the [Adding an IPSP Card](#) procedure.
- Destination **Point Code** – perform the "Adding a **Destination Point Code**" procedure in *Database Administration - SS7 User's Guide*.
- IPSP M3UA Linkset – perform the [Adding an IPSP M3UA Linkset](#) procedure.
- IPSP M3UA Association - perform the [Adding an IPSP M3UA Association](#) procedure.

Verify that the link has been physically installed (all cable connections have been made).

To configure the **EAGLE** to perform circular routing detection test on the signaling links, "Configuring Circular **Route** Detection" procedure in the *Database Administration - SS7*.

 **Note:**

Circular route detection is not supported in **ITU** networks.

To provision a **EAGLE** with more than 1200 signaling links, the **EAGLE** must have certain levels of hardware installed. See the [Requirements for EAGLEs Containing more than 1200 Signaling Links](#) section for more information on these hardware requirements.

The **EAGLE** can contain a mixture of low-speed, **E1**, **T1**, **ATM** high-speed, and **IP** signaling links. The [Determining the Number of High-Speed and Low-Speed Signaling Links](#) section describes how to determine the quantities of the different types of signaling links the **EAGLE** can have.

- **HC-MIM**
- **E5-E1/T1**
- **E5-ATM**
- **E5-SM4G**
- **E5-ENET**
- E5-based control cards
- **E5-STC** card for the EAGLE Integrated Monitoring Support feature

When the IPSP M3UA signaling link is added, the `RSVDSLKTPS` value that is assigned to the linkset will be assigned to the signaling link. The sum of the TPS used by all the signaling links that are assigned to the IPSP card cannot exceed the `MaxTPS`. See [Maximum Card Capacity for Different Card Types](#) for `MaxTPS` values. The TPS used by the IPSP card and the TPS used by each signaling link that is assigned to the IPSP card is shown by entering the `rtrv-slk` command with the location of the IPSP card. If the `MaxTPS` limit for the IPSP card will be exceeded by adding the IPSP M3UA signaling link, one of these actions must be performed.

- Another IPSP card must be used for the IPSP M3UA signaling link.
- The `RSVDSLKTPS` values for the linksets shown in the `rtrv-slk` output for the IPSP card must be reduced enough to allow the IPSP M3UA linkset to be added.

If adding the IPSP M3UA signaling link will exceed the maximum total provisioned system TPS, and the maximum total provisioned system TPS is 500,000, perform the "Activating the HPR2 High Rate Mode" feature in *Database Administration - System Management* to enable and turn on the HPR2 High Rate Mode feature. When the HPR2 High Rate Mode feature is enabled and turned on, the maximum total provisioned system TPS is increased to 1,000,000 (1M). If the maximum total provisioned system TPS is 1M, or the maximum total provisioned system TPS is 500,000 and will not be increased, and adding the IPSP M3UA signaling link will exceed the maximum total provisioned system TPS, the IPSP M3UA signaling link cannot be added unless the amount of available TPS is reduced enough to allow the IPSP M3UA signaling link to be added. The available TPS can be reduced by performing one or more of these actions.

- The IP TPS values of some IPGWx linksets have to be changed.
- The `MAXSLKTPS` values of some IPSP linksets (and the `RSVDSLKTPS` values if necessary) have to be changed.
- Some ATM high-speed signaling links have to be removed.
- An IPLIMx card that contains signaling links has to be removed.

Canceling the `REPT-STAT-SLK`, `RTRV-LS`, and `RTRV-SLK` Commands

Because the `rept-stat-slk`, `rtrv-ls`, and `rtrv-slk` commands used in this procedure can output information for a long period of time, the `rept-stat-slk`, `rtrv-ls`, and `rtrv-slk` commands can be canceled and the output to the terminal stopped. There are three ways that the `rept-stat-slk`, `rtrv-ls`, and `rtrv-slk` commands can be canceled.

- Press the F9 function key on the keyboard at the terminal where the `rept-stat-slk`, `rtrv-ls`, or `rtrv-slk` commands were entered.
- Enter the `canc-cmd` without the `trm` parameter at the terminal where the `rept-stat-slk`, `rtrv-ls`, or `rtrv-slk` commands were entered.
- Enter the `canc-cmd:trm=<xx>`, where `<xx>` is the terminal where the `rept-stat-slk`, `rtrv-ls`, or `rtrv-slk` commands were entered, from another terminal other than the terminal where the `rept-stat-slk`, `rtrv-ls`, or `rtrv-slk` commands were entered. To enter the `canc-cmd:trm=<xx>` command, the terminal must allow Security Administration commands to be entered from it and the user must be allowed to enter Security Administration commands. The terminal's permissions can be verified with the `rtrv-secu-trm` command. The user's permissions can be verified with the `rtrv-user` or `rtrv-secu-user` commands.

For more information about the `canc-cmd` command, go to *Commands User's Guide*.

1. Display the maximum number of signaling links the EAGLE can have and the number of signaling links that are currently provisioned by entering the `rtrv-tbl-capacity` command.

This is an example of the possible output.

```
rlghncxa03w 09-07-19 21:16:37 GMT EAGLE5 41.1.0
SLK          table is (          5 of      1200)   1% full
```

Note:

The `rtrv-tbl-capacity` command output contains other fields that are not used by this procedure. If you wish to see all the fields displayed by the `rtrv-tbl-capacity` command, refer to the `rtrv-tbl-capacity` command description in the *Commands User's Guide*.

If the addition of the new signaling link will not exceed the maximum number of signaling links the EAGLE can have, continue the procedure with 2.

If the addition of the new signaling link will exceed the maximum number of signaling links the EAGLE can have, and the maximum number of signaling links is less than 2800, perform the [Enabling the Large System # Links Controlled Feature](#) procedure to enable the desired quantity of signaling links. After the new quantity of signaling links has been enabled, continue the procedure with 2.

If the addition of the new signaling link will exceed the maximum number of signaling links the EAGLE can have (in this example, the maximum number of signaling links is 1200), and the maximum number of signaling links is 2800, this procedure cannot be performed. The EAGLE cannot contain more than 2800 signaling links.

2. Display the current signaling link configuration using the `rtrv-slk` command.

```
rlghncxa03w 10-07-19 21:16:37 GMT EAGLE5 42.0.0
rtrv-slk
Command entered at terminal #4.
```

```

LOC LINK LSN          SLC TYPE          L2T          PCR PCR
1312 A  lsnds0        0  LIMDS0        1  56000  BASIC  ----  -----

LOC LINK LSN          SLC TYPE          LP          ATM
1305 A  lsnds0        1  LIMATM        1  1.544M  LINE   5    0    0

E1ATM
LOC LINK LSN          SLC TYPE          SET BPS      TSEL          VCI  VPI
CRC4 SI SN
1306 A  lsnituatm    0  LIME1ATM    21  2.048M  LINE   5    0
ON 3 0

LOC LINK LSN          SLC TYPE          ANAME          SLKTPS
1303 A  ipsglsn      0  IPSG        ipsgm2pa1     600
1303 A1 ipsglsn      1  IPSG        ipsgm2pa2     600
1303 B1 ipsglsn      2  IPSG        ipsgm2pa3     600
1303 A2 ipsglsn      3  IPSG        ipsgm2pa4     600
1303 A3 ipsglsn      4  IPSG        ipsgm2pa5     600
1303 B3 ipsglsn2     0  IPSG        ipsgm2pa6    1000
1307 A  ipsglsn      5  IPSG        m2pa2         600
2204 B  lsnlp2        0  IPSG        m3ua          500

LOC LINK LSN          SLC TYPE          IPLIML2
1301 A  lsniplim     0  IPLIM      M2PA
1301 A1 lsniplim     1  IPLIM      M2PA
1301 B1 lsniplim     2  IPLIM      M2PA

LOC LINK LSN          SLC TYPE
1201 A  ipgwx2        2  SS7IPGW
1202 A  ipgwx2        3  SS7IPGW
1203 A  ipgwx2        4  SS7IPGW
1204 A  ipgwx2        5  SS7IPGW
1205 A  ipgwx2        6  SS7IPGW
1206 A  ipgwx2        7  SS7IPGW
1101 A  ipgwx1        0  SS7IPGW
1102 A  ipgwx1        1  SS7IPGW
1103 A  ipgwx1        2  SS7IPGW
1104 A  ipgwx1        3  SS7IPGW
1105 A  ipgwx1        4  SS7IPGW
1106 A  ipgwx1        5  SS7IPGW
1107 A  ipgwx1        6  SS7IPGW
1108 A  ipgwx1        7  SS7IPGW
1111 A  ipgwx2        0  SS7IPGW
1112 A  ipgwx2        1  SS7IPGW

```

SLK table is (30 of 1200) 2% full.

3. Display the cards in the database using the `rtrv-card` command.

This is an example of the possible output.

```
rlghncxa03w 13-06-28 09:12:36 GMT EAGLE5 45.0.0
CARD   TYPE      APPL      LSET NAME   LINK SLC LSET NAME   LINK SLC
1101   DCM          SS7IPGW   ipgwx1      A    0
1102   DCM          SS7IPGW   ipgwx1      A    1
1103   DCM          SS7IPGW   ipgwx1      A    2
1104   DCM          SS7IPGW   ipgwx1      A    3
1105   DCM          SS7IPGW   ipgwx1      A    4
1106   DCM          SS7IPGW   ipgwx1      A    5
1107   DCM          SS7IPGW   ipgwx1      A    6
1108   DCM          SS7IPGW   ipgwx1      A    7
1111   DCM          SS7IPGW   ipgwx2      A    0
1112   DCM          SS7IPGW   ipgwx2      A    1
1113   E5MCAP      OAMHC
1114   E5TDM-A
1115   E5MCAP      OAMHC
1116   E5TDM-B
1117   E5MDAL
1201   DCM          SS7IPGW   ipgwx2      A    2
1202   DCM          SS7IPGW   ipgwx2      A    3
1203   DCM          SS7IPGW   ipgwx2      A    4
1204   DCM          SS7IPGW   ipgwx2      A    5
1205   DCM          SS7IPGW   ipgwx2      A    6
1206   DCM          SS7IPGW   ipgwx2      A    7
1301   DCM          IPLIM     lsniplim   A    0   lsniplim   A1   1
        lsniplim   B1   2
1303   ENET         IPSG      ipsglsn    A    0   ipsglsn    A1   1
        ipsglsn    B1   2   ipsglsn    A2   3
        ipsglsn    A3   4   ipsglsn2   B3   0
1305   LIMATM      ATMANSI   lsnds0     A    1
1306   LIME1ATM    ATMITU    lsnituatm  A    0
1307   ENET         IPSG      ipsglsn    A    5
1311   DCM          IPLIM
1312   LIMDS0      SS7ANSI   lsnds0     A    0
```

If the required IPSG card is not in the database, perform the [Adding an IPSG Card](#) procedure and add the **IPSG** card to the database. After the IPSG card has been added, continue the procedure with [5](#).

If the required IPSG card is in the database, continue the procedure with [4](#).

4. Display the signaling links assigned to the IPSG card by entering the `rtrv-slk` command with the card location of the IPSG card. For this example, enter this command.

```
rtrv-slk:loc=2204
```

This is an example of the possible output.

```
rlghncxa03w 06-10-28 09:12:36 GMT EAGLE5 36.0.0

LOC LINK LSN          SLC TYPE      ANAME          SLKTPS
2204 B   lsnlp2          0   IPSG      m3ua          500
```

IPTPS for LOC = 2204 is (500 of 5000) 10%

An IPSG card can contain a maximum of 32 (128 for SLIC) IPSG signaling links. If 32 signaling links are shown in the `rtrv-slk` output, the new signaling link cannot be added to this card. Choose another IPSG card and repeat this procedure from 3.

If fewer than 32 signaling links are shown in the `rtrv-slk` output, continue the procedure by performing one of these actions.

- If the IPTPS value shown in the `rtrv-slk` output is less than the MaxTPS (see [Maximum Card Capacity for Different Card Types](#) for MaxTPS values), continue the procedure with 5.
 - If the IPTPS value shown in the `rtrv-slk` output is the MaxTPS, the new signaling link cannot be added to this card. Choose another IPSG card and repeat this procedure from 3.
5. Display the IPSG and IPGWx linksets by entering the `rept-stat-iptps` command.

This is an example of the possible output.

```
rlghncxa03w 10-07-19 21:16:37 GMT EAGLE5 42.0.0
IP TPS USAGE REPORT
```

PEAKTIMESTAMP	THRESH	CONFIG/ RSVD	CONFIG/ MAX		TPS	PEAK	

LSN							
ipgwx1	100%	----	32000	TX:	3700	4000	10-07-19
09:49:19				RCV:	3650	4000	10-07-19
09:49:19							
ipgwx2	100%	----	16000	TX:	4800	5000	10-07-19
09:49:09				RCV:	4850	5000	10-07-19
09:49:09							
ipgwx3	100%	----	32000	TX:	427	550	10-07-19
09:49:19				RCV:	312	450	10-07-19
09:49:19							
ipsglsn	100%	600	24000	TX:	4800	5000	10-07-19
09:49:19				RCV:	4800	5000	10-07-19
09:49:19							
ipsglsn2	100%	600	4000	TX:	427	550	10-07-19
09:49:19				RCV:	312	450	10-07-19
09:49:19							
isipgw	100%	500	4000	TX:	427	550	10-07-19
09:49:19				RCV:	312	450	10-07-19

09:49:19

Command Completed.

If the desired linkset is shown in the `rept-stat-iptps` output, continue the procedure with 6.

If the desired linkset is not shown in the `rept-stat-iptps` output, add the linkset by performing the [Adding an IPSP M2PA Linkset](#) procedure. Continue the procedure with one of these actions.

- If a new IPSP card was added in 3, continue the procedure with 7.
 - If the signaling link will be assigned to an existing IPSP card, the `RSVDSLKTPS` value that is assigned to the linkset will be assigned to the signaling link. The sum of the TPS used by all the signaling links that are assigned to the IPSP card cannot exceed the `MaxTPS`. See [Maximum Card Capacity for Different Card Types](#) for `MaxTPS` values. The TPS used by the IPSP card and the TPS used by each signaling link that is assigned to the IPSP card is shown by entering the `rtrv-slk` command with the location of the IPSP card. If the `MaxTPS` limit for the IPSP card will be exceeded by adding the IPSP M2PA signaling link, one of these actions must be performed.
 - Another IPSP card must be used for the IPSP M2PA signaling link. Repeat this procedure from 3.
 - The `RSVDSLKTPS` values for the linksets shown in the `rtrv-slk` output for the IPSP card, shown in 4, must be reduced enough to allow the IPSP M2PA linkset to be added. Perform these procedures as necessary to change the `RSVDSLKTPS` values for the linksets. After the linksets have been changed, continue the procedure with 7.
- * [Changing an IPSP M2PA Linkset](#)
- * [Changing an IPSP M3UA Linkset](#)
6. Display the linkset that the signaling link will be assigned to using the `rtrv-ls` command, specifying the name of the linkset that the signaling link is being assigned to.

For this example, enter this command.

```
rtrv-ls:lsn=lsipgw
```

This is an example of the possible output.

```
rlghncxa03w 10-07-17 11:43:04 GMT EAGLE5 42.0.0

LSN          APCA  (SS7)  SCRNL3T SLT          GWS GWS GWS
NIS          010-010-101  none  1  1  no  A  1  off off off ---
lsipgw
off

          SPCN          CLLI          TFATCABMLQ MTPRSE ASL8
-----
RANDSLS
off
```

```

IPSG  IPGWAPC  GTTMODE                CGGTMOD
yes   no      CdPA                    no

ADAPTER  RSVDSLKTPS  MAXSLKTPS
m3ua    500         4000

TPSALM   LSUSEALM    SLKUSEALM
rsvdslktps 80%      80%

RCONTEXT ASNOTIF     NUMSLKALW  NUMSLKRSTR  NUMSLKPROH
none     yes        1          1           1

LOC  LINK  SLC  TYPE  ANAME
1317 A  0    IPSG  m3ua20

```

Link set table is (13 of 1024) 1% full.

If the `IPSG` value of the linkset is `no`, choose another linkset and repeat this procedure from 5.

If the `IPSG` value of the linkset is `yes` and the `ADAPTER` value is `m2pa`, choose another linkset and repeat this procedure from 5.

If the `IPSG` value of the linkset is `yes`, and the `ADAPTER` value is `m3ua`, continue the procedure by performing one of these actions.

- If a new IPSG card was added in 3, continue the procedure with 7.
- If the signaling link will be assigned to an existing IPSG card, the `RSVDSLKTPS` value that is assigned to the linkset will be assigned to the signaling link. The sum of the TPS used by all the signaling links that are assigned to the IPSG card cannot exceed `MaxTPS`. See [Maximum Card Capacity for Different Card Types](#) for `MaxTPS` values. The TPS used by the IPSG card and the TPS used by each signaling link that is assigned to the IPSG card is shown by entering the `rtrv-slk` command with the location of the IPSG card. If the `MaxTPS` limit for the IPSG card will be exceeded by adding the IPSG M2PA signaling link, one of these actions must be performed.
 - Another IPSG card must be used for the IPSG M2PA signaling link. Repeat this procedure from 3.
 - The `RSVDSLKTPS` values for the linksets shown in the `rtrv-slk` output for the IPSG card, shown in 4, must be reduced enough to allow the IPSG M2PA linkset to be added. Perform these procedures as necessary to change the `RSVDSLKTPS` values for the linksets. After the linksets have been changed, continue the procedure with 7.

7. Display the total provisioned system TPS by entering the `rtrv-tps` command. This is an example of the possible output.

```
rlghncxa03w 10-07-10 16:20:46 GMT EAGLE 42.0.0
```

CARD TYPE	NUM CARDS	NUM LINKS	RSVD TPS	MAX TPS
IPGW	17	16	48000	80000
IPSG	4	8	4700	12000
IPLIM	2	4	8000	8000
ATM	2	2	3668	3668

Total provisioned System TPS (103668 of 500000) 21%

Command Completed.

An IP SG M3UA signaling link uses can use as much as the MaxTPS RSVDSLKTPS (see [Maximum Card Capacity for Different Card Types](#) for MaxTPS values), as provisioned by the `rsvdslktps` parameter of the linkset that the IP SG M3UA signaling link will be added to. If adding the new IP SG M3UA signaling link will not exceed the maximum total provisioned system TPS, continue the procedure with [11](#).

If adding the new IP SG M3UA signaling link will exceed the maximum total provisioned system TPS, and the maximum total provisioned system TPS is 500,000 shown, perform the "Activating the HIPR2 High Rate Mode Feature" procedure in the *Database Administration - System Management* to enable and turn on the HIPR2 High Rate Mode feature. When the HIPR2 High Rate Mode feature is enabled and turned on, the maximum total provisioned system TPS is increased to 1M. After the HIPR2 High Rate Mode feature has been enabled and turned on, continue the procedure with [11](#).

If the maximum total provisioned system TPS is 1M, or the maximum total provisioned system TPS is 500,000 and will not be increased, and adding the IP SG M3UA signaling link will exceed the maximum total provisioned system TPS, the IP SG M3UA signaling link cannot be added unless the amount of available TPS is reduced enough to allow the IP SG M3UA signaling link to be added. The available TPS can be increased by performing one or more of these actions.

- Some ATM high-speed signaling links have to be removed. To perform this action, continue the procedure with [8](#).
- An IPLIMx card that contains signaling links has to be removed. To perform this action, continue the procedure with [9](#).
- The IP TPS values of some IPGWx linksets have to be changed or the MAXSLKTPS values of some IPSG linksets (and the RSVDSLKTPS values if necessary) have to be changed.

If linksets are displayed in the `rept-stat-iptps` output in [5](#), continue the procedure with [10](#).

If linksets are not displayed in the `rept-stat-iptps` output in [5](#), perform one or more of these actions to increase the available TPS.

Note:

If one or more of these actions are not performed to increase the available TPS and the available TPS will not allow the IP SG M3UA signaling link to be added, the IP SG M3UA signaling link cannot be added and the remainder of this procedure cannot be performed.

- An IPLIMx card that contains signaling links has to be removed. To perform this action, continue the procedure with 9.
- Some ATM high-speed signaling links have to be removed. To perform this action, continue the procedure with 8.

8. Display the ATM high-speed signaling links by entering this command.

```
rtrv-slk:type=saal
```

This is an example of the possible output.

```
rlghncxa03w 10-07-19 21:16:37 GMT EAGLE5 42.0.0

LOC LINK LSN          SLC TYPE          LP          ATM
1303 A   lsnds0        1  LIMATM        1  1.544M LINE      5  0  0

                                LP          ATM
E1ATM
LOC LINK LSN          SLC TYPE          SET BPS      TSEL          VCI  VPI
CRC4 SI SN
1306 A   lsnituatm    0  LIME1ATM    21  2.048M LINE      5  0
ON   3  0

SLK table is (30 of 1200) 2% full.
```

If ATM high-speed signaling links are shown in the `rtrv-slk` output, perform the "Removing an SS7 Signaling Link" procedure in *Database Administration - SS7* to remove some of the ATM high-speed signaling links.

If ATM high-speed signaling links are not displayed in the `rtrv-slk` output, perform one or more of these actions to increase the available TPS.

 **Note:**

If one or more of these actions are not performed to increase the available TPS and the available TPS will not allow the IPSG M3UA signaling link to be added, the IPSG M3UA signaling link cannot be added and the remainder of this procedure cannot be performed.

- An IPLIMx card that contains signaling links has to be removed. To perform this action, continue the procedure with 9.
- The IP TPS values of some IPGWx linksets have to be changed or the MAXSLKTPS values of some IPGS linksets (and the RSVDSLKTPS values if necessary) have to be changed.
If linksets are displayed in the `rept-stat-iptps` output in 5, continue the procedure with 10.
If linksets are not displayed in the `rept-stat-iptps` output in 5, an IPLIMx card that contains signaling links has to be removed. To perform this action, continue the procedure with 9.

If you do not wish to perform other actions to increase the available TPS and the available TPS will allow the IPSG M3UA signaling link to be added, continue the procedure with [11](#).

9. Display the signaling links that are assigned to IPLIMx cards by entering this command.

```
rtrv-slk:type=iplim
```

This is an example of the possible output.

```
rlghncxa03w 10-07-19 21:16:37 GMT EAGLE5 42.0.0
```

LOC	LINK	LSN	SLC	TYPE	ANAME	SLKTPS
1301	A	lsniplim	0	IPLIM	M2PA	
1301	A1	lsniplim	1	IPLIM	M2PA	
1301	B1	lsniplim	2	IPLIM	M2PA	
1317	A	lsniplimi	0	IPLIMI	M2PA	

```
SLK table is (30 of 1200) 2% full.
```

If IPLIMx cards containing signaling links are shown in the `rtrv-slk` output, perform the [Removing an IPLIMx Card](#) procedure to remove an IPLIMx card and its associated signaling links.

If IPLIMx cards containing signaling links are not displayed in the `rtrv-slk` output, perform one or more of these actions to increase the available TPS.

Note:

If one or more of these actions are not performed to increase the available TPS and the available TPS will not allow the IPSG M3UA signaling link to be added, the IPSG M3UA signaling link cannot be added and the remainder of this procedure cannot be performed.

- Some ATM high-speed signaling links have to be removed. To perform this action, continue the procedure with [8](#).
- The IP TPS values of some IPGWx linksets have to be changed or the MAXSLKTPS values of some IPGS linksets (and the RSVDSLKTPS values if necessary) have to be changed.
If linksets are displayed in the `rept-stat-iptps` output in [5](#), continue the procedure with [10](#).
If linksets are not displayed in the `rept-stat-iptps` output in [5](#), some ATM high-speed signaling links have to be removed. To perform this action, continue the procedure with [8](#).

If you do not wish to perform other actions to increase the available TPS and the available TPS will allow the IPSG M3UA signaling link to be added, continue the procedure with [11](#).

10. Display the attributes of the linksets shown in [5](#) by entering the `rtrv-ls` command with the name of the linkset shown in [5](#).

For this example enter these commands.

rtrv-ls:lsn=ipgwx1

This is an example of the possible output.

rlghncxa03w 10-07-19 21:16:37 GMT EAGLE5 42.0.0

LSN	APCA	(SS7)	SCRN	L3T SET	SLT SET	BEI	LST	LNKS	GWS ACT	GWS MES	GWS DIS
ipgwx1	001-001-002		none	1	1	no	A	8	off	off	off
no	off										

SPCA	CLLI	TFATCABMLQ	MTPRSE	ASL8
-----	-----	4	---	no

RANDSLS
 off

IPSP	IPGWAPC	GTTMODE	CGGTMOD
no	yes	CdPA	no

MATELSN	IPTPS	LSUSEALM	SLKUSEALM
-----	32000	100%	80%

LOC	LINK	SLC	TYPE
1101	A	0	SS7IPGW
1102	A	1	SS7IPGW
1103	A	2	SS7IPGW
1104	A	3	SS7IPGW
1105	A	4	SS7IPGW
1106	A	5	SS7IPGW
1107	A	6	SS7IPGW
1108	A	7	SS7IPGW

Link set table is (8 of 1024) 1% full.

rtrv-ls:lsn=ipgwx2

This is an example of the possible output.

rlghncxa03w 10-07-19 21:16:37 GMT EAGLE5 42.0.0

LSN	APCA	(SS7)	SCRN	L3T SET	SLT SET	BEI	LST	LNKS	GWS ACT	GWS MES	GWS DIS
ipgwx2	001-001-003		none	1	1	no	A	8	off	off	off
no	off										

SPCA	CLLI	TFATCABMLQ	MTPRSE	ASL8
-----	-----	4	---	no

RANDSLS

```

off

IPSG  IPGWAPC  GTTMODE          CGGTMOD
no    yes     CdPA             no

MATELSN  IPTPS  LSUSEALM  SLKUSEALM
-----  16000  100%     80%

LOC  LINK  SLC  TYPE
1111 A    0   SS7IPGW
1112 A    1   SS7IPGW
1201 A    2   SS7IPGW
1202 A    3   SS7IPGW
1203 A    4   SS7IPGW
1204 A    5   SS7IPGW
1205 A    6   SS7IPGW
1206 A    7   SS7IPGW

```

Link set table is (8 of 1024) 1% full.

rtrv-ls:lsn=ipgwx3

This is an example of the possible output.

rlghncxa03w 10-07-19 21:16:37 GMT EAGLE5 42.0.0

```

LSN          APCA  (SS7)  L3T  SLT          GWS  GWS  GWS
NIS          SCRN  SET  SET  BEI  LST  LNKS  ACT  MES  DIS  SLSCI
ipgwx3      001-001-004  none  1   1   no  A   0   off  off  off  no
off

          SPCA          CLLI          TFATCABMLQ  MTPRSE  ASL8
-----  -----  1          ---   no

```

```

RANDSLS
off

IPSG  IPGWAPC  GTTMODE          CGGTMOD
no    yes     CdPA             no

MATELSN  IPTPS  LSUSEALM  SLKUSEALM
-----  32000  100%     80%

```

Link set table is (8 of 1024) 1% full.

rtrv-ls:lsn=ipsglsn

This is an example of the possible output.

rlghncxa03w 10-07-19 21:16:37 GMT EAGLE5 42.0.0

```

                                L3T SLT
LSN          APCA  (SS7)  SCRN SET SET BEI LST LNKS ACT MES DIS
SLSCI NIS
ipsglsn     003-003-003  none 1  1  no  A  6  off off off
no         off

                                SPCA          CLLI          TFATCABMLQ MTPRSE ASL8
-----
                                3          ---          no

RANDSLS
off

IPSG  IPGWAPC  GTTMODE          CGGTMOD
yes   no      CdPA          no

ADAPTER  SLKTPS  LSUSEALM  SLKUSEALM  RCONTEXT
ASNOTIF
m2pa     600     100%     80%          none          no

LOC  LINK  SLC  TYPE    ANAME
1303 A    0    IPSG    ipsgm2pa1
1303 A1   1    IPSG    ipsgm2pa2
1303 B1   2    IPSG    ipsgm2pa3
1303 A2   3    IPSG    ipsgm2pa4
1303 A3   4    IPSG    ipsgm2pa5
1307 A    5    IPSG    m2pa2

```

Link set table is (8 of 1024) 1% full.

rtrv-ls:lsn=ipsglsn2

This is an example of the possible output.

rlghncxa03w 10-07-19 21:16:37 GMT EAGLE5 42.0.0

```

                                L3T SLT
LSN          APCA  (SS7)  SCRN SET SET BEI LST LNKS ACT MES DIS
SLSCI NIS
ipsglsn2    005-005-005  none 1  1  no  A  1  off off off
no         off

                                SPCA          CLLI          TFATCABMLQ MTPRSE ASL8
-----
                                1          ---          no

RANDSLS
off

IPSG  IPGWAPC  GTTMODE          CGGTMOD
yes   no      CdPA          no

ADAPTER  SLKTPS  LSUSEALM  SLKUSEALM  RCONTEXT
ASNOTIF

```



```

m2pa      1000    100%    80%      none      no

LOC LINK SLC TYPE      ANAME
1303 B3  0   IPSG      ipsgm2pa6

```

Link set table is (8 of 1024) 1% full.

Perform one or both of these actions as necessary.

- Perform the [Configuring an IPGWx Linkset](#) procedure to change the IPTPS value for any linksets shown in the `rtrv-ls` output whose IPGWAPC value is `yes`.
- Perform the [Changing an IPSG M2PA Linkset](#) procedure (for linkset whose IPSP value is `yes` and ADAPTER value is M2PA) or the [Changing an IPSG M3UA Linkset](#) procedure (for linkset whose IPSP value is `yes` and ADAPTER value is M3UA) to change the MAXSLKTPS value (and RSVDSLKTPS value if necessary) for any linksets shown in the `rtrv-ls` output.

Perform one or both of these actions to increase the available TPS if needed.

- An IPLIMx card that contains signaling links has to be removed. To perform this action, continue the procedure with [9](#).
- Some ATM high-speed signaling links have to be removed. To perform this action, continue the procedure with [8](#).

If you do not wish to perform other actions to increase the available TPS and the available TPS will allow the IPSG M3UA signaling link to be added, continue the procedure with [11](#).

11. Display the associations that are assigned to the card that will be assigned to the signaling link by entering `rtrv-assoc` command with the location of the card. For this example, enter this command.

```
rtrv-assoc:loc=2204
```

This is an example of the possible output.

```
rlghncxa03w 06-10-17 11:43:04 GMT EAGLE5 36.0.0
```

ANAME	CARD		LINK	ADAPTER	LPORT	RPORT	OPEN	ALW
	LOC	PORT						
m3ua2	2204	A	B	M3UA	3001	3000	NO	YES
m3ua3	2204	A	--	M3UA	3002	3000	YES	YES
m3ua4	2204	A	**	M3UA	3003	3000	YES	YES

IP Appl Sock/Assoc table is (7 of 4000) 1% full

Assoc Buffer Space Used (1400 KB of 6400 KB) on LOC = 2204

To assign an association to an IPSG M3UA signaling link, the ADAPTER value for that association must be M3UA. If the ADAPTER value for the associations displayed in this step is not M3UA, add the IPSG M3UA association by performing the [Adding an IPSG M3UA Association](#) procedure. After the association has been added, continue the procedure with [15](#).

If the ADAPTER value of the associations displayed in this step is M3UA, and the association is not assigned to a signaling link (shown by dashes in the LINK column), continue the procedure with 15.

If the ADAPTER value of the associations displayed in this step is M3UA, and the association is assigned to a signaling link, continue the procedure with 12.

12. Display the signaling links that the association is assigned to by entering the `rtrv-slk` command with the name of the association that will be added to the signaling link. For this example, enter this command.

```
rtrv-slk:aname=m3ua4
```

This is an example of the possible output.

```
rlghncxa03w 06-10-17 11:43:04 GMT EAGLE5 36.0.0
```

LOC	LINK	LSN	SLC	TYPE	ANAME	SLKTPS
2204	A	m3ua1	0	IPSG	m3ua4	300
2204	A2	m3ua2	0	IPSG	m3ua4	300
2204	A12	m3ua3	1	IPSG	m3ua4	300

An IPSG M3UA association can be assigned to a maximum of 16 IPSG M3UA signaling links. If 16 signaling links are shown in this step, choose another IPSG card and repeat this procedure from 3.

If 15 or less signaling links are shown in this step, continue the procedure from 13.

13. Display all the linksets that contain the signaling links shown in 12 by entering the `rtrv-ls` command with the linkset name shown in 12. For this example, enter this command.

```
rtrv-ls:lsn=m3ua1
```

This is an example of the possible output.

```
rlghncxa03w 10-07-17 11:43:04 GMT EAGLE5 42.0.0
```

LSN	APCA	(SS7)	SCRN	L3T	SLT	BEI	LST	LNKS	GWS	GWS	GWS
SLSCI	NIS			SET	SET			ACT	MES	DIS	
m3ua1		002-002-003	none	1	1	no	A	1	off	off	off
no	off										

SPCA	CLLI	TFATCABMLQ	MTPRSE	ASL8
-----	-----	---	---	no

```
RANDSLS  
off
```

IPSG	IPGWAPC	GTTMODE	CGGTMOD
yes	no	CdPA	no

ADAPTER	RSVDSLKTPS	MAXSLKTPS
m3ua	300	4000

```

TPSALM      LSUSEALM      SLKUSEALM
rsvdslktps 100%          80%

RCONTEXT    ASNOTIF      NUMSLKALW  NUMSLKRSTR  NUMSLKPROH
25          yes         1           1            1

LOC  LINK  SLC  TYPE  ANAME
2204 A    0   IPSG  m3ua4

```

Link set table is (13 of 1024) 1% full.

rtrv-ls:lsn=m3ua2

This is an example of the possible output.

rlghncxa03w 10-07-17 11:43:04 GMT EAGLE5 42.0.0

```

LSN          APCA      (SS7)  SCRN  SET  SET  BEI  LST  LNKS  ACT  MES  DIS  SLSCI
NIS
m3ua2       002-002-004  none  1    1    no  A   1    off  off  off  no
off

```

```

          SPCA          CLLI          TFATCABMLQ  MTPRSE  ASL8
-----

```

```

RANDSLS
off

```

```

IPSG  IPGWAPC  GTTMODE          CGGTMOD
yes   no      CdPA          no

```

```

ADAPTER      RSVDSLKTPS  MAXSLKTPS
m3ua         300          4000

```

```

TPSALM      LSUSEALM      SLKUSEALM
rsvdslktps 100%          80%

```

```

RCONTEXT    ASNOTIF      NUMSLKALW  NUMSLKRSTR  NUMSLKPROH
50          yes         1           1            1

```

```

LOC  LINK  SLC  TYPE  ANAME
2204 A2   0   IPSG  m3ua4

```

Link set table is (13 of 1024) 1% full.

rtrv-ls:lsn=m3ua3

This is an example of the possible output.

rlghncxa03w 10-07-17 11:43:04 GMT EAGLE5 42.0.0

```

LSN          APCA  (SS7)  SCRN  SET  SET  BEI  LST  LNKS  ACT  MES  DIS
SLSCI NIS
m3ua3       002-002-005  none  1   1   no   A   1   off off off
no         off

          SPCA          CLLI          TFATCABMLQ  MTPRSE  ASL8
-----
RANDSLS
off

IPSG  IPGWAPC  GTTMODE          CGGTMOD
yes   no       CdPA          no

ADAPTER  RSVDSLKTPS  MAXSLKTPS
m3ua     300         4000

TPSALM   LSUSEALM   SLKUSEALM
rsvdslktps 100%     80%

RCONTEXT  ASNOTIF   NUMSLKALW  NUMSLKRSTR  NUMSLKPROH
75         yes     1           1           1

LOC  LINK  SLC  TYPE  ANAME
2204 A12  0   IPSG  m3ua4

```

Link set table is (13 of 1024) 1% full.

- Display the linkset that will be assigned to the new signaling link by entering the `rtrv-ls` command with the name of the linkset. For this example, enter this command.

```
rtrv-ls:lsn=lsipgw
```

This is an example of the possible output.

```
rlghncxa03w 10-07-17 11:43:04 GMT EAGLE5 42.0.0
```

```

LSN          APCA  (SS7)  SCRN  SET  SET  BEI  LST  LNKS  ACT  MES  DIS
SLSCI NIS
lsipgw       010-010-101  none  1   1   no   A   1   off off off
---         off

          SPCN          CLLI          TFATCABMLQ  MTPRSE  ASL8
-----
RANDSLS
off

IPSG  IPGWAPC  GTTMODE          CGGTMOD
yes   no       CdPA          no

```

```

ADAPTER      RSVDSLKTPS  MAXSLKTPS
m3ua         500         4000

TPSALM      LSUSEALM    SLKUSEALM
rsvdslktps  100%       80%

RCONTEXT    ASNOTIF     NUMSLKALW  NUMSLKRSTR  NUMSLKPROH
none        yes         1           1           1

LOC  LINK  SLC  TYPE  ANAME
1317 A    0    IPGS  m3ua20

```

Link set table is (13 of 1024) 1% full.

To assign an IPSG M3UA association to more than one signaling link, the linksets that contain the signaling links must contain unique routing context (RCONTEXT) values. If the linkset displayed in this step contains a unique routing context value, compared to the routing context values shown in 13, continue the procedure with 15.

If the linkset displayed in this step does not contain a unique routing context value, perform the [Changing an IPSG M3UA Linkset](#) procedure to change the routing context value in this linkset that is unique, compared to the routing context values shown in 13. After the [Changing an IPSG M3UA Linkset](#) procedure has been performed, continue the procedure with 15.

15. Add the signaling link to the database using the `ent-slk` command.

[Table 6-9](#) shows the parameters and values that can be specified with the `ent-slk` command.

Table 6-9 IPSG M3UA Signaling Link Parameter Combinations

IPSG M3UA Signaling Link
Mandatory Parameters
:loc = location of the IPGS card
:link = a - a15, b - b15
:lsn = linkset name
:slc = 0 - 15
:aname = the name of the IPSG M3UA association

For this example, enter this command.

```
ent-slk:loc=2204:link=a10:lsn=lsipgw:slc=1:aname=m3ua4
```

When this command has successfully completed, this message should appear.

```
rlghncxa03w 06-10-07 08:29:03 GMT EAGLE5 36.0.0
ENT-SLK: MASP A - COMPLTD
```

 **Note:**

If adding the new signaling link will result in more than 700 signaling links in the database and the OAMHCMEAS value in the `rtrv-measopts` output is `on`, the scheduled UI measurement reports will be disabled.

16. Verify the changes using the `rtrv-slk` command with the card location and link parameter values specified in 15. For this example, enter these commands.

```
rtrv-slk:loc=2204:link=a10
```

This is an example of the possible output.

```
rlghncxa03w 06-10-19 21:16:37 GMT EAGLE5 36.0.0
```

LOC	LINK	LSN	SLC	TYPE	ANAME	SLKTPS
2204	A10	lsipgw	1	IPSP	m3ua4	500

17. If any cards contain the first signaling link on a card, those cards must be brought into service with the `rst-card` command, specifying the location of the card. For this example, enter this command.

```
rst-card:loc=2205
```

When this command has successfully completed, this message should appear.

```
rlghncxa03w 06-10-23 13:05:05 GMT EAGLE5 36.0.0
Card has been allowed.
```

18. Activate all signaling links on the cards using the `act-slk` command, specifying the card location and link parameter value of each signaling link. For this example, enter this command.

```
act-slk:loc=2204:link=a10
```

When this command has successfully completed, this message should appear.

```
rlghncxa03w 06-10-07 08:31:24 GMT EAGLE5 36.0.0
Activate Link message sent to card
```

19. Check the status of the signaling links added in 15 using the `rept-stat-slk` command with the card location and link parameter values specified in 15. The state of each signaling link should be in service normal (**IS-NR**) after the link has completed alignment (shown in the **PST** field). For this example, enter these commands.

```
rept-stat-slk:loc=2204:link=a10
```

This is an example of the possible output.

```
rlghncxa03w 07-05-23 13:06:25 GMT EAGLE5 37.0.0
SLK      LSN      CLLI      PST      SST      AST
2204,A10 lsipgw  ----- IS-NR      Avail    ----
```

```
ALARM STATUS      =  
UNAVAIL REASON    =
```

If the `OPEN` value of the association that was assigned to the signaling link is `yes`, continue the procedure with 21.

If the `OPEN` value of the association that was assigned to the signaling link is `nos`, continue the procedure with 20.

20. Change the `open` parameter value of the association that was assigned to the signaling link by entering the `chg-assoc` command with the `open=yes` parameter and the name of the association that was association. For this example, enter this command.

```
chg-assoc:aname=m3ua4:open=yes
```

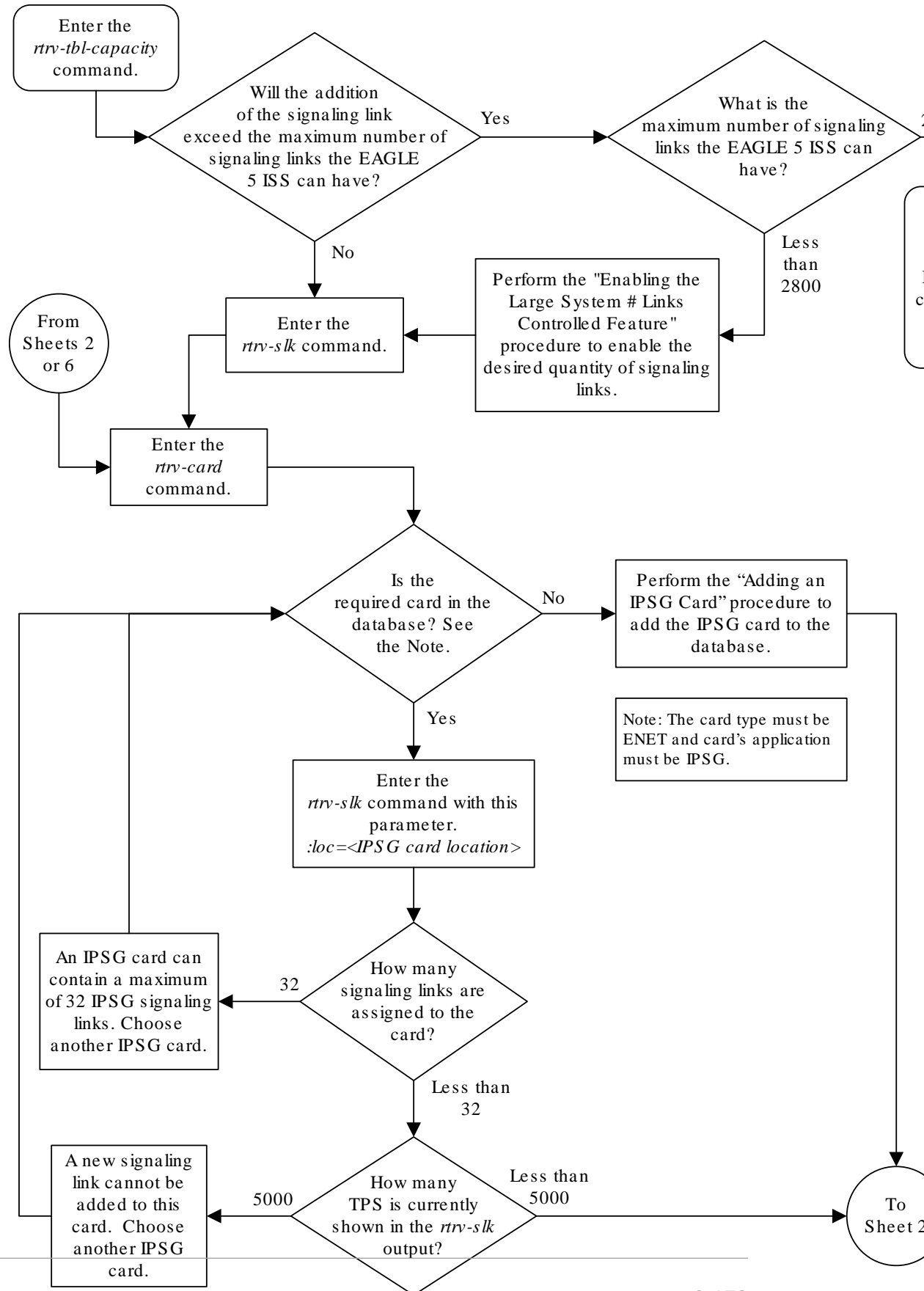
When this command has successfully completed, this message should appear.

```
rlghncxa03w 06-10-07 08:29:03 GMT  EAGLE5 36.0.0  
CHG-ASSOC: MASP A - COMPLTD
```

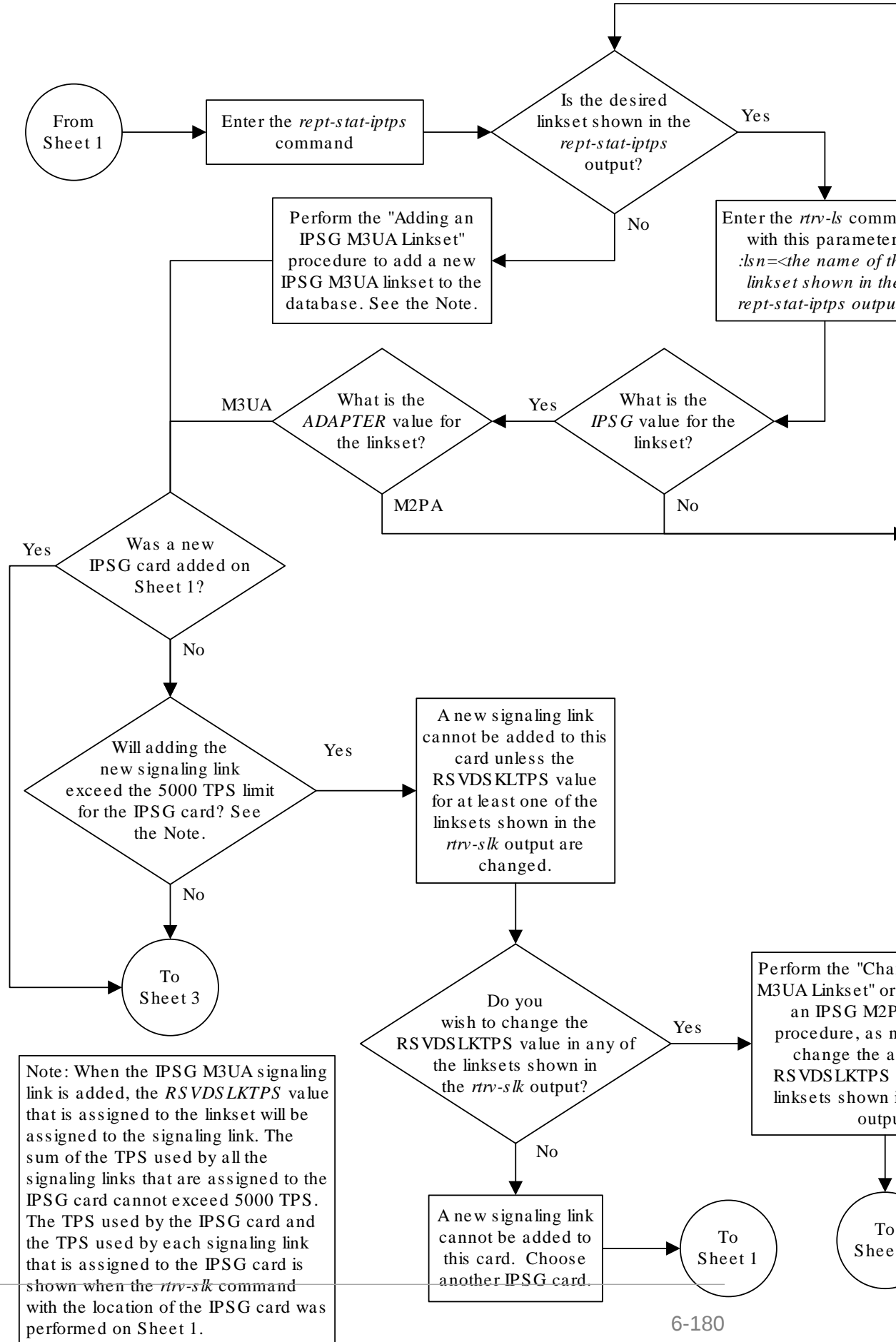
21. Back up the new changes using the `chg-db:action=backup:dest=fixed` command. These messages should appear, the active **Maintenance and Administration Subsystem Processor (MASP)** appears first.

```
BACKUP (FIXED) : MASP A - Backup starts on active MASP.  
BACKUP (FIXED) : MASP A - Backup on active MASP to fixed disk complete.  
BACKUP (FIXED) : MASP A - Backup starts on standby MASP.  
BACKUP (FIXED) : MASP A - Backup on standby MASP to fixed disk complete.
```

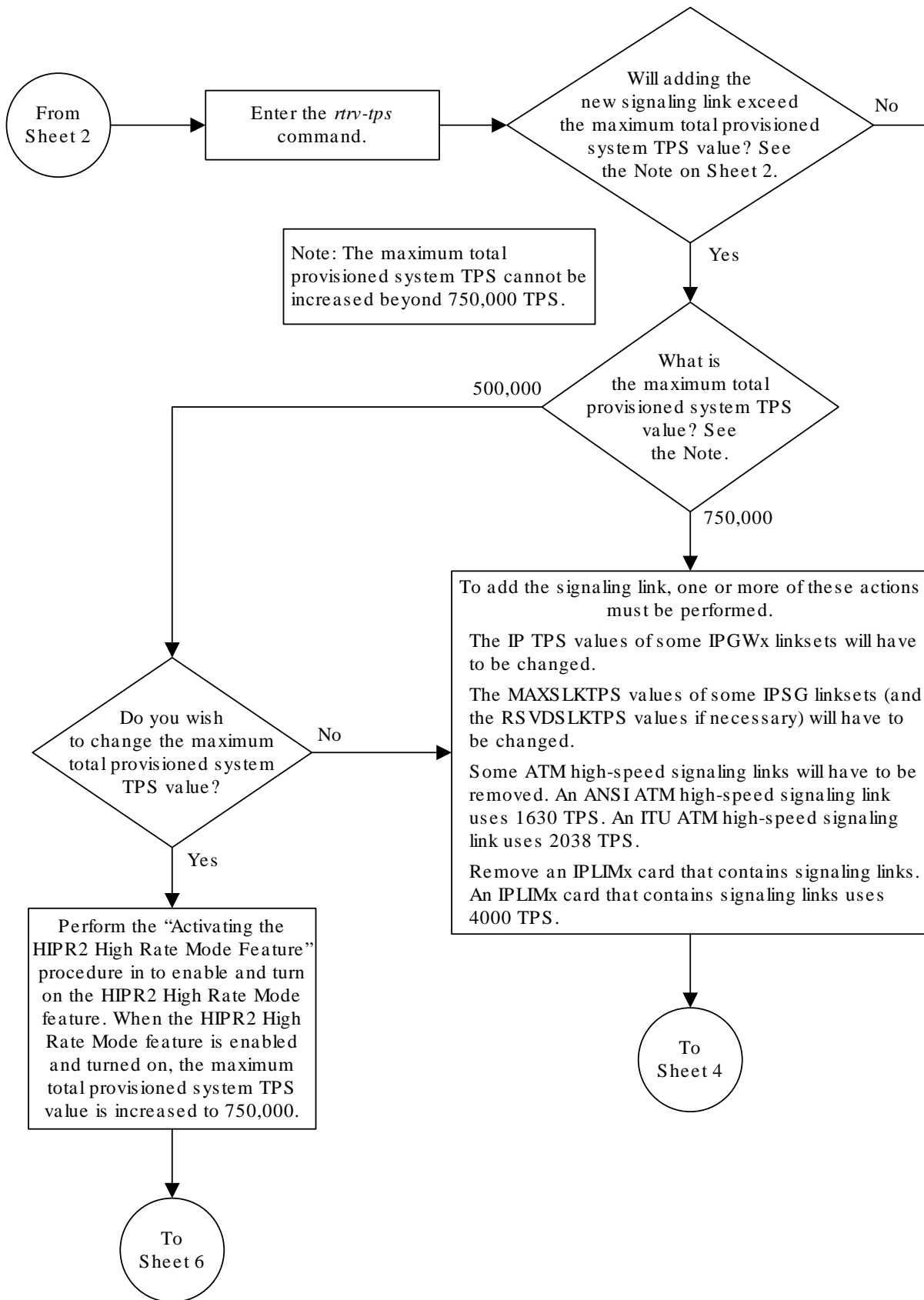
Figure 6-11 Adding an IPSP M3UA Signaling Link

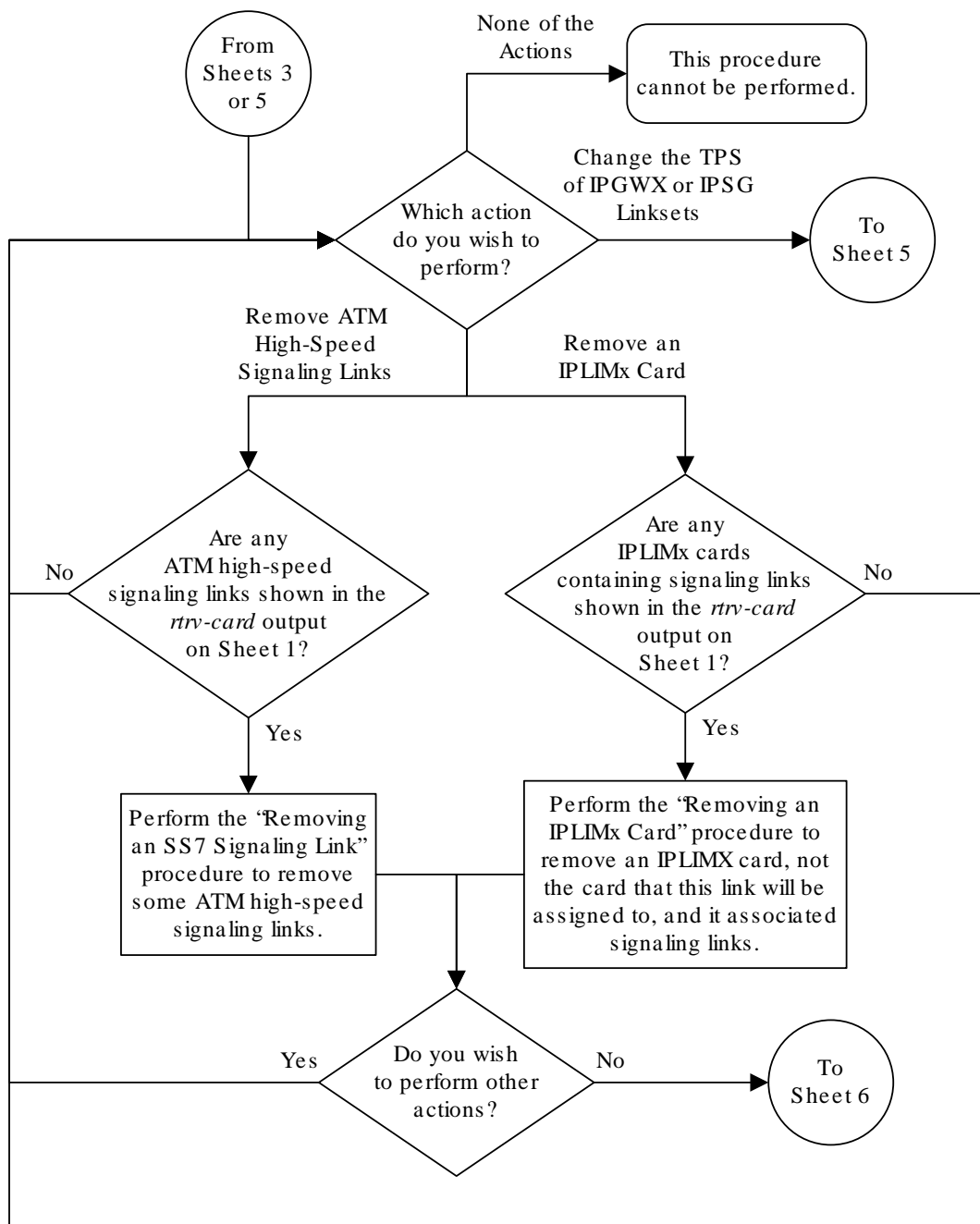


Sheet 1 of 7

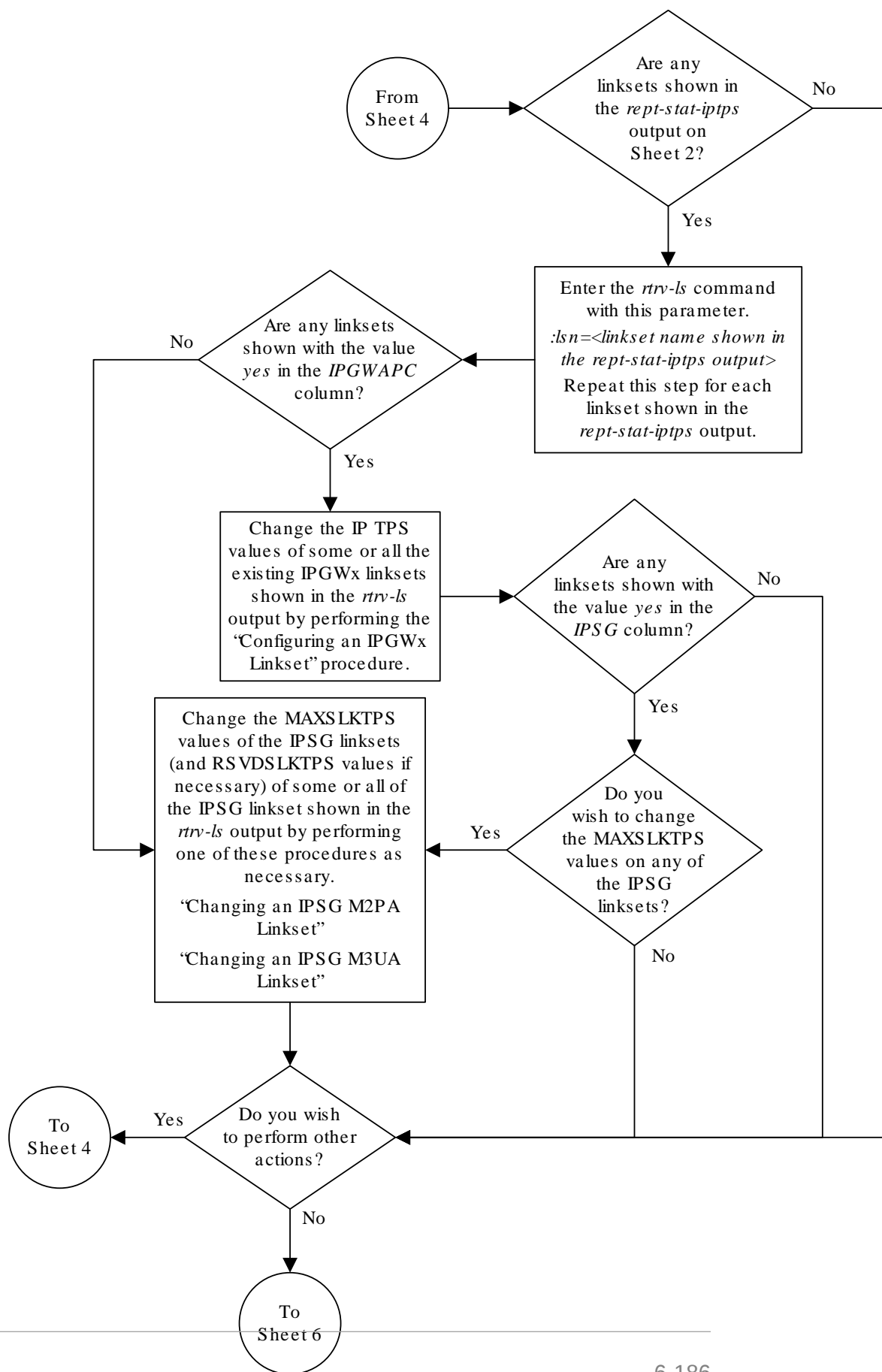


Sheet 2 of 7

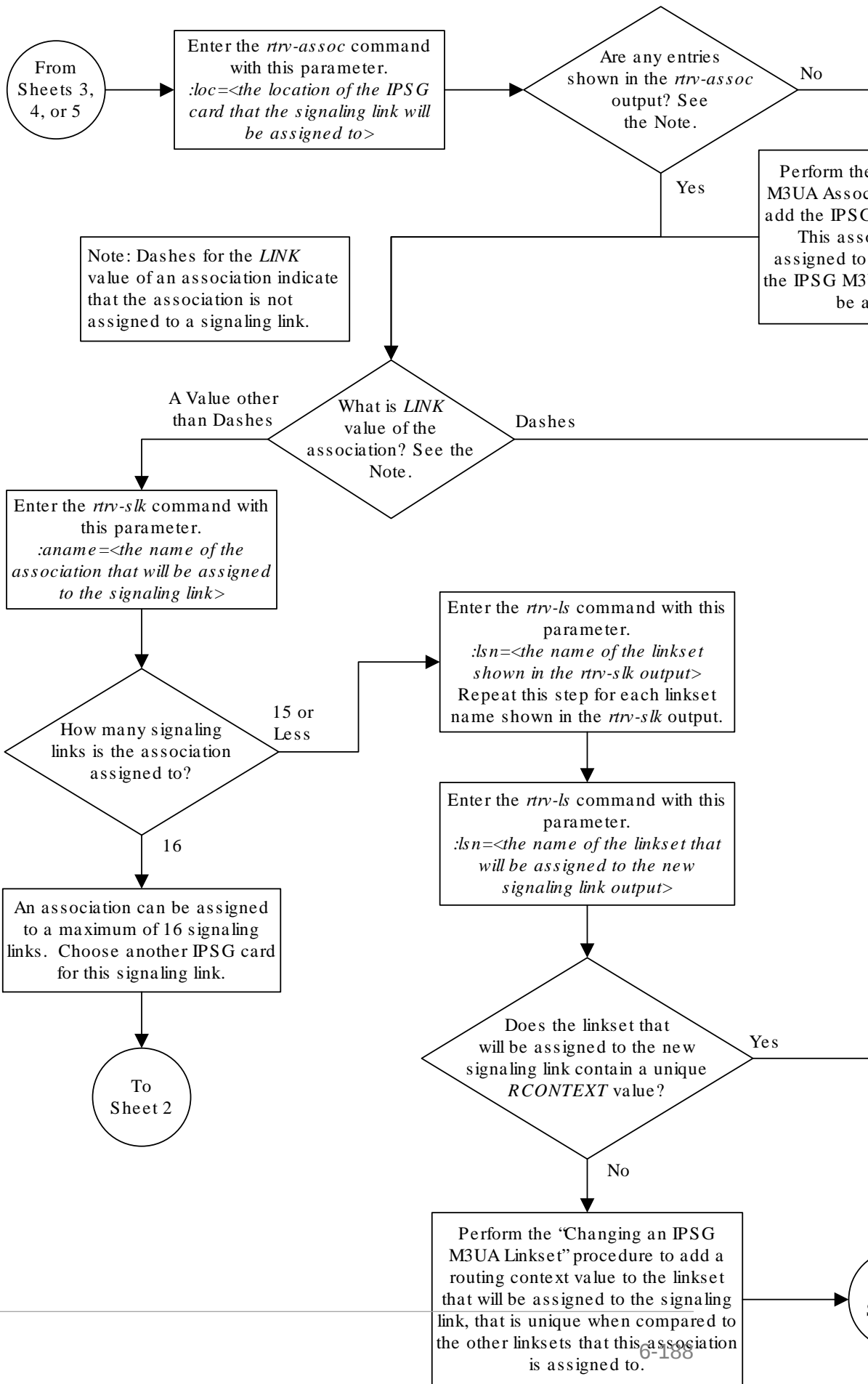




Sheet 4 of 7



Sheet 5 of 7



From
Sheet 6

Enter the *ent-slk* command. Use the IPSG M3UA Signaling Link Parameter Combinations table in the “Adding an IPSG M3UA Signaling Link” procedure in the *Database Administration Manual - IP7 Secure Gateway* as a guide to determine which parameters to specify with the *ent-slk* command.

If adding the new signaling link will result in more than 700 signaling links in the database and the *OAMHCMEAS* value in the *rtrv-measopts* output is *on*, the scheduled UI measurement reports will be disabled.

Enter the *rtrv-slk* command with these parameters for each signaling link added with the *ent-slk* command.

:loc=<card location specified in the *ent-slk* command>
:link = <the link parameter value specified in the *ent-slk* command>

Is the signaling link the first link on the card?

Enter the *rst-card:loc*=<card location specified in the *ent-slk* command> command for each card that signaling links were added to for the first time.

Enter the *act-slk* command with these parameters for each signaling link added with the *ent-slk* command.

:loc=<card location specified in the *ent-slk* command>
:link = <the link parameter value specified in the *ent-slk* command>

Enter the *rept-stat-slk* command with these parameters for each signaling link added with the *ent-slk* command.

:loc=<card location specified in the *ent-slk* command>
:link = <the link parameter value specified in the *ent-slk* command>

What was the *OPEN* value of the association that was assigned to the signaling link?

Enter the *chg-assoc* command with these parameters.

:aname=<the name of the association assigned to the signaling link>
:open=yes

6-190
Enter the *chg-db:action=backup:dest=fixed* command.

Sheet 7 of 7

6.13 Adding a Network Appearance

The network appearance field identifies the **SS7** network context for the message, for the purpose of logically separating the signaling traffic between the **SGP** (signaling gateway process) and the **ASP** (application server process) over a common **SCTP** (stream control transmission protocol) association. This field is contained in the **DATA**, **DUNA**, **DAVA**, **DRST**, **DAUD**, **SCON**, and **DUPU** messages.

The network appearance is provisioned in the database using the `ent-na` command with these parameters.

`:na` – the 32-bit value of the network appearance, from 0 to 4294967295.

`:type` – the network type of the network appearance, `ansi` (**ANSI**), `itui` (**ITU-I**), `itun` (14-bit **ITU-N**), `itun24` (24-bit **ITU-N**), `ituis` (**ITU-I Spare**), `ituns` (14-bit **ITU-N Spare**).

`:gc` – the specific **ITU-N** group code associated with the network appearance.

The `gc` parameter can be specified only with the `type=itun` or `type=ituns` parameters.

The `gc` parameter must be specified with the `type=itun` or `type=ituns` parameters if the **ITU Duplicate Point Code** feature is on. If the **ITU Duplicate Point Code** feature is off, the `gc` parameter cannot be specified.

The `gc` parameter value must be shown in the `rtrv-spc` or `rtrv-sid` outputs.

The `ituis` or `ituns` parameters can be specified only if the **ITU National and International Spare Point Code Support** feature is enabled.

1. Display the network appearances in the database with the `rtrv-na` command. This is an example of the possible output.

```
rlghncxa03w 06-10-28 09:12:36 GMT EAGLE5 36.0.0
TYPE  GC          NA
ANSI  --          100
ITUN  FR  4000000000
ITUN  GE  1000000000
```

Note:

If the `gc` parameter is not being specified in this procedure, continue the procedure with 4.

2. Display the self-identification of the **EAGLE** using the `rtrv-sid` command. This is an example of the possible output.

```
rlghncxa03w 06-10-28 09:12:36 GMT EAGLE5 36.0.0
PCA          PCI          PCN          CLLI          PCTYPE
001-001-001  1-200-6          13482        rlghncxa03w  OTHER
```

```

CPCA
002-002-002      002-002-003      002-002-004      002-002-005
002-002-006      002-002-007      002-002-008      002-002-009
004-002-001      004-003-003      144-212-003

CPCA (LNP)
005-005-002      005-005-004      005-005-005

CPCI
1-001-1          1-001-2          1-001-3          1-001-4

CPCN
02091            02092            02094            02097
02191            02192            11177

```

If the desired group code is shown in the `rtrv-sid` output, continue the procedure with 4.

3. Display the secondary point codes in the database with the `rtrv-spc` command. This is an example of the possible output.

```

rlghncxa03w 06-10-28 09:12:36 GMT EAGLE5 36.0.0
SPC (Secondary Point Codes)

SPCA
001-010-010
002-010-010
003-010-010

SPC-I
1-253-5
2-254-6
3-255-7

SPC-N
10-01-11-1-fr
13-02-12-0-ge
13-02-12-0-uk

SPC-N24
none

Secondary Point Code table is (9 of 40) 23% full

```

If the desired group code is not shown in the `rtrv-spc` or `rtrv-sid` outputs, go to the “Adding a **Secondary Point Code**” procedure in *Database Administration - SS7 User's Guide* to turn the ITU Duplicate **Point Code** feature on, and add a secondary point code to the database with the desired group code value.

If the `ituis` or `ituns` parameters will not be specified in this procedure, continue the procedure with 5.

If the `ituis` or `ituns` parameters will be specified in this procedure, and **ITU-I** spare or 14-bit **ITU-N** spare network appearances are shown in the `rtrv-na` output in 1, or **ITU-I** spare or 14-bit **ITU-N** spare point codes are shown in the `rtrv-sid` output in 2, continue the procedure with 5.

4. Display the status of the **ITU National and International Spare Point Code Support** feature by entering the `rtrv-ctrl-feat` command with the **ITU National and International Spare Point Code Support** feature part number. Enter this command.

```
rtrv-ctrl-feat:partnum=893013601
```

The following is an example of the possible output.

```
rlghncxa03w 06-10-28 21:15:37 GMT EAGLE5 36.0.0
```

The following features have been permanently enabled:

Feature Name	Partnum	Status	Quantity
Spare Point Code Support	893013601	on	----

The following features have been temporarily enabled:

Feature Name	Partnum	Status	Quantity	Trial Period
Left				

Zero entries found.

The following features have expired temporary keys:

Feature Name	Partnum
Zero entries found.	

If the **ITU National and International Spare Point Code Support** feature is not enabled, perform the “Activating the **ITU National and International Spare Point Code Support** feature” procedure in *Database Administration - SS7 User's Guide* and enable and turn on the **ITU National and International Spare Point Code Support** feature.

5. Add the network appearance to the database with the `ent-na` command.

If the `gc` parameter is specified with the `ent-na` command, the `gc` parameter value must be shown in the `rtrv-sid` output in 2, or assigned to an **ITU-N** point code (**SPC-N**) shown in the `rtrv-spc` output in 3. For this example, enter these commands.

```
ent-na:na=1000:type=itui
ent-na:na=3:type=itun24
ent-na:na=150000:type=itun:gc=uk
ent-na:na=2000:type=ituis
ent-na:na=5000:type=ituns:gc=sp
```

When each of these commands have successfully completed, this message should appear.

```
rlghncxa03w 06-10-28 09:12:36 GMT EAGLE5 36.0.0
ENT-NA: MASP A - COMPLTD
```

6. Verify the changes using the `rtrv-na` command. This is an example of the possible output.

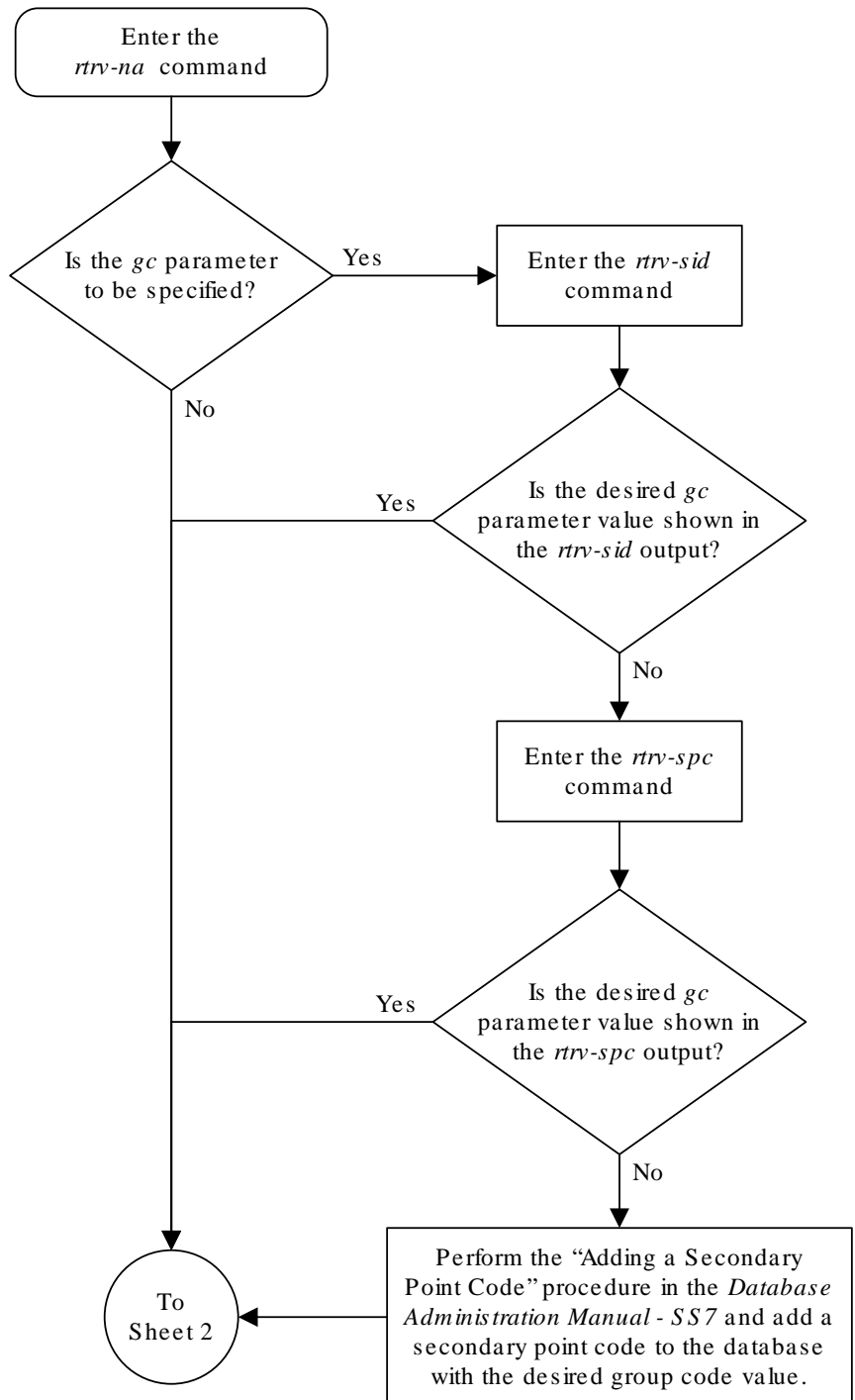
```
rlghncxa03w 06-10-28 09:12:36 GMT EAGLE5 36.0.0
TYPE      GC          NA
ANSI      --          100
ITUI      --          1000
ITUN      uk          150000
ITUN      fr          4000000000
ITUN      ge          10000000000
ITUN24    --           3
ITUIS     --          2000
ITUNS     sp          5000
```

7. Back up the new changes, using the `chg-db:action=backup:dest=fixed` command.

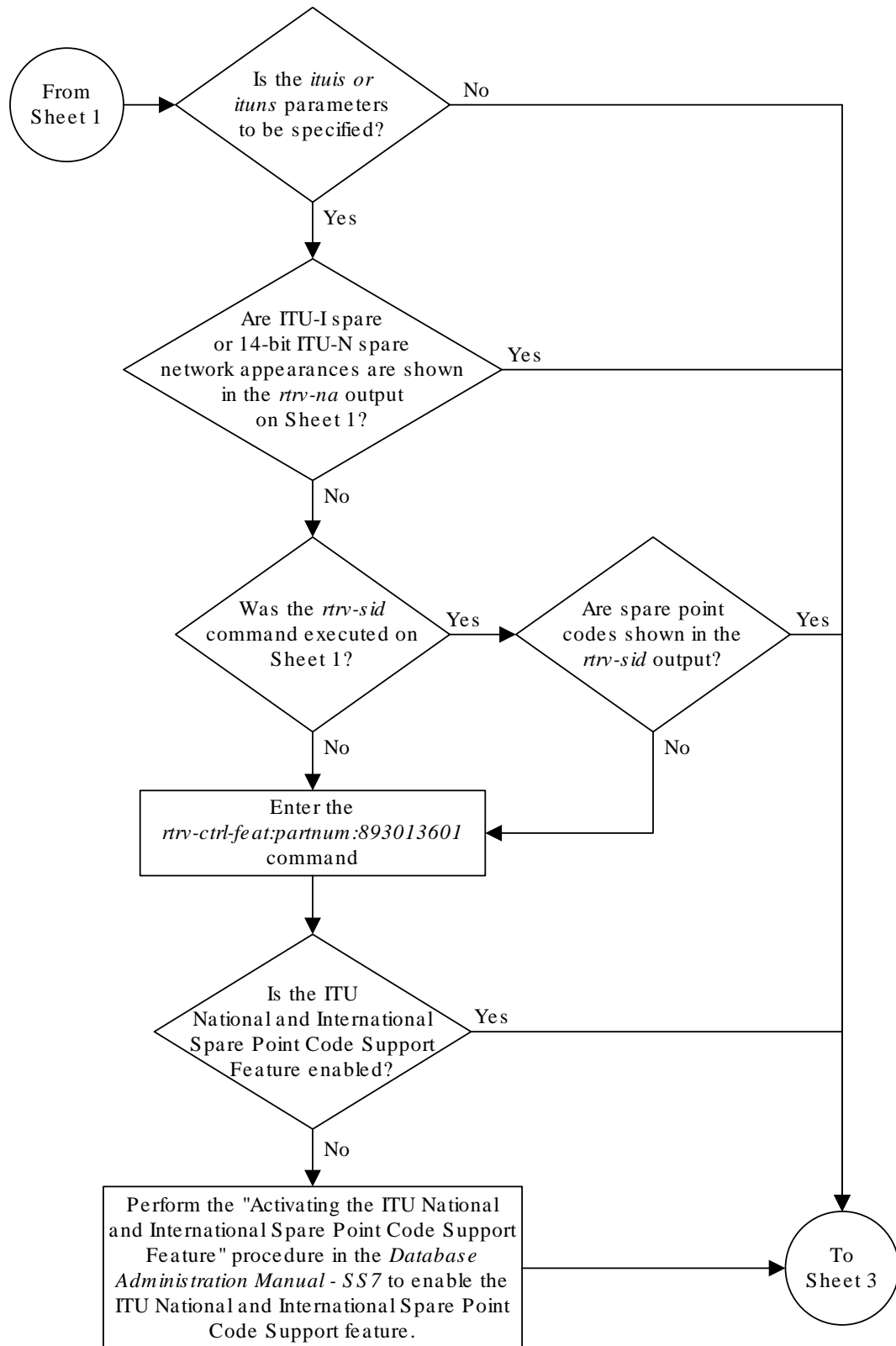
These messages should appear; the active **Maintenance and Administration Subsystem Processor (MASP)** appears first.

```
BACKUP (FIXED) : MASP A - Backup starts on active MASP.
BACKUP (FIXED) : MASP A - Backup on active MASP to fixed disk
complete.
BACKUP (FIXED) : MASP A - Backup starts on standby MASP.
BACKUP (FIXED) : MASP A - Backup on standby MASP to fixed disk
complete.
```

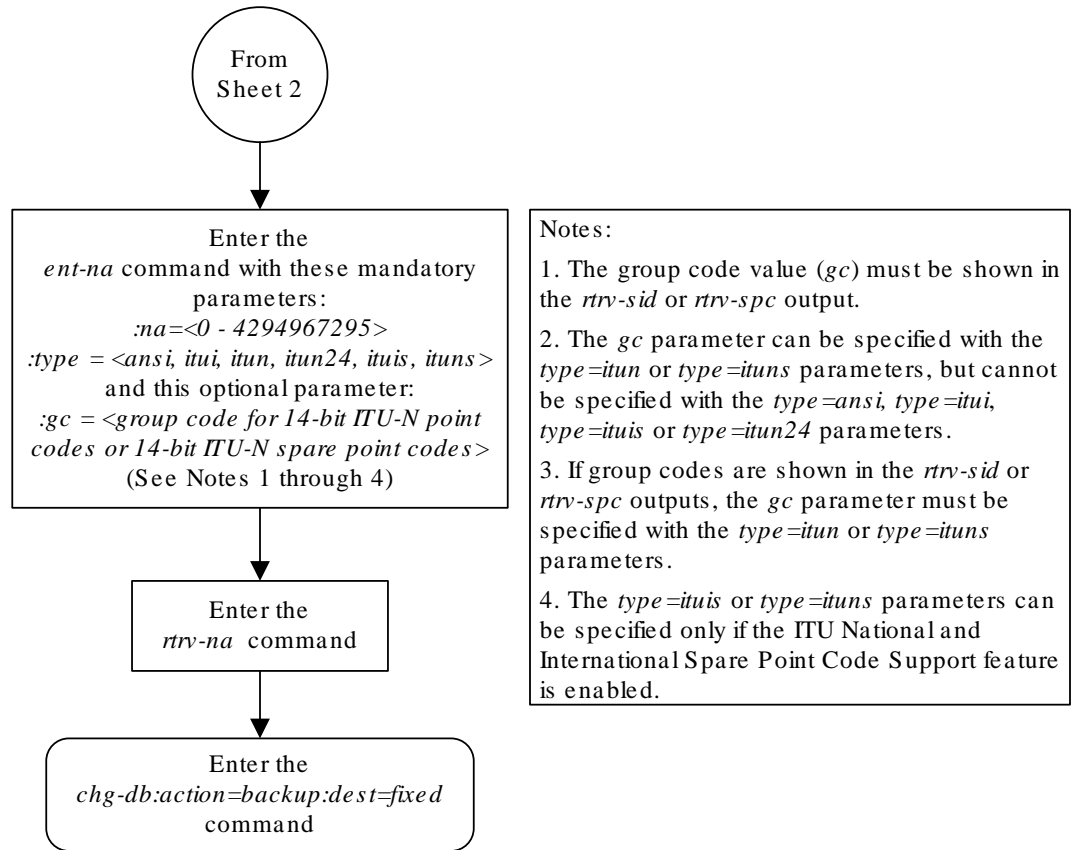

Figure 6-12 Adding a Network Appearance



Sheet 1 of 3



Sheet 2 of 3



6.14 Activating the Large MSU Support for IP Signaling Feature

This procedure is used to enable and turn on the Large **MSU** Support for **IP** Signaling feature using the feature's part number and a feature access key.

The feature access key for the Large **MSU** Support for **IP** Signaling feature is based on the feature's part number and the serial number of the **EAGLE**, making the feature access key site-specific.

The `enable-ctrl-feat` command enables the controlled feature by inputting the controlled feature's access key and the controlled feature's part number with these parameters:

 **Note:**

As of Release 46.3, the `fak` parameter is no longer required. This parameter is only used for backward compatibility.

`:fak` – The feature access key provided by Oracle. The feature access key contains 13 alphanumeric characters and is not case sensitive.

`:partnum` – The Oracle-issued part number of the Large MSU Support for IP Signaling feature, 893018401.

The `enable-ctrl-feat` command requires that the database contain a valid serial number for the **EAGLE**, and that this serial number is locked. This can be verified with the `rtv-serial-num` command. The **EAGLE** is shipped with a serial number in the database, but the serial number is not locked. The serial number can be changed, if necessary, and locked once the **EAGLE** is on-site, by using the `ent-serial-num` command. The `ent-serial-num` command uses these parameters.

`:serial` – The serial number assigned to the **EAGLE**. The serial number is not case sensitive.

`:lock` – Specifies whether or not the serial number is locked. This parameter has only one value, `yes`, which locks the serial number. Once the serial number is locked, it cannot be changed.

 **Note:**

To enter and lock the **EAGLE**'s serial number, the `ent-serial-num` command must be entered twice, once to add the correct serial number to the database with the `serial` parameter, then again with the `serial` and the `lock=yes` parameters to lock the serial number. You should verify that the serial number in the database is correct before locking the serial number. The serial number can be found on a label affixed to the control shelf (shelf 1100).

This feature cannot be temporarily enabled (with the temporary feature access key).

Once this feature has been enabled, the feature must be turned on with the `chg-ctrl-feat` command. The `chg-ctrl-feat` command uses these parameters:

`:partnum` – The Oracle-issued part number of the Large MSU Support for IP Signaling feature, 893018401.

`:status=on` – used to turn the Large MSU Support for IP Signaling feature on.

Once the Large MSU Support for IP Signaling feature has been turned on, it can be turned off. For more information about turning the Large MSU Support for IP Signaling feature off, go to the [Turning Off the Large MSU Support for IP Signaling Feature](#) procedure.

The status of the features in the **EAGLE** is shown with the `rtrv-ctrl-feat` command.

The Large MSU Support for IP Signaling feature allows the **EAGLE** to process messages with a service indicator value of 6 to 15 and with a service information field (**SIF**) that is larger than 272 bytes. The large messages are processed only on E5-ENET cards. There are certain software components that if enabled or provisioned, that will not process large messages even if the Large MSU Support for IP Signaling feature is enabled and turned on. UIMs are displayed when most of these circumstances occur. These UIMs are:

- **UIM 1333** – Displayed when a large message is received on an **M3UA** association and the Large MSU Support for IP Signaling feature is not enabled or is enabled and turned off. The large message is discarded.
- **UIM 1350** – Displayed when a M2PA IP connection receives message with an **SIF** greater than 272 bytes and the Large MSU Support for IP Signaling feature is not enabled or is enabled and turned off. The large message is discarded.
- **UIM 1352** – Displayed when a message with an **SIF** greater than 272 bytes is received; the Large MSU Support for IP Signaling feature is enabled and turned on; there are routes available for the destination point code; but the selected outbound card does not support large messages.
- **UIM 1353** – Displayed when a large message passes a gateway screening screenset that redirects messages for the Database Transport Access (**DTA**) feature. Large messages are not redirected for the **DTA** feature.

For more information on these **UIMs**, refer to *Unsolicited Alarm and Information Messages Reference*.

 **Note:**

Large messages are not monitored by the EAGLE 5 Integrated Monitoring Support feature and are not sent to the IMF. A UIM is not generated.

1. Display the status of the controlled features by entering the `rtrv-ctrl-feat` command.

The following is an example of the possible output.

```
rlghncxa03w 08-04-28 21:15:37 GMT EAGLE5 38.0.0
The following features have been permanently enabled:
```

Feature Name	Partnum	Status	Quantity
Command Class Management	893005801	on	----
LNP Short Message Service	893006601	on	----
Intermed GTT Load Sharing	893006901	on	----
XGTT Table Expansion	893006101	on	400000
XMAP Table Expansion	893007710	off	----
Large System # Links	893005910	on	2000
Routesets	893006401	on	6000
HC-MIM SLK Capacity	893012707	on	64

The following features have been temporarily enabled:

Feature Name	Partnum	Status	Quantity	Trial
Period Left				
Zero entries found.				

The following features have expired temporary keys:

Feature Name	Partnum
Zero entries found.	

If the Large MSU Support for IP Signaling feature is enabled and turned on, no further action is necessary. This procedure does not need to be performed.

If the Large MSU Support for IP Signaling feature is enabled and but not turned on, continue this procedure with 7.

If the Large MSU Support for IP Signaling feature is not enabled, continue this procedure with 2.

 **Note:**

If the `rtrv-ctrl-feat` output in 1 shows any controlled features, continue this procedure with 6. If the `rtrv-ctrl-feat` output shows only the HC-MIM SLK Capacity feature with a quantity of 64, 2 through 5 must be performed.

2. Display the serial number in the database with the `rtrv-serial-num` command.

This is an example of the possible output.

```
rlghncxa03w 06-10-28 21:15:37 GMT EAGLE5 36.0.0  
System serial number = nt00001231
```

System serial number is not locked.

```
rlghncxa03w 06-10-28 21:15:37 GMT EAGLE5 36.0.0  
Command Completed
```

 **Note:**

If the serial number is correct and locked, continue the procedure with [6](#). If the serial number is correct but not locked, continue the procedure with [5](#). If the serial number is not correct, but is locked, this feature cannot be enabled and the remainder of this procedure cannot be performed. Contact the Customer Care Center to get an incorrect and locked serial number changed. Refer to [My Oracle Support \(MOS\)](#) for the contact information. The serial number can be found on a label affixed to the control shelf (shelf 1100).

3. Enter the correct serial number into the database using the `ent-serial-num` command with the `serial` parameter.

For this example, enter this command.

```
ent-serial-num:serial=<EAGLE's correct serial number>
```

When this command has successfully completed, the following message should appear.

```
rlghncxa03w 06-10-28 21:15:37 GMT EAGLE5 36.0.0  
ENT-SERIAL-NUM: MASP A - COMPLTD
```

4. Verify that the serial number entered into [3](#) was entered correctly using the `rtrv-serial-num` command.

This is an example of the possible output.

```
rlghncxa03w 06-10-28 21:15:37 GMT EAGLE5 36.0.0  
System serial number = nt00001231
```

System serial number is not locked.

```
rlghncxa03w 06-10-28 21:15:37 GMT EAGLE5 36.0.0  
Command Completed
```

If the serial number was not entered correctly, repeat [3](#) and [4](#) and re-enter the correct serial number.

5. Lock the serial number in the database by entering the `ent-serial-num` command with the serial number shown in [2](#), if the serial number shown in [2](#) is correct, or with the serial

number shown in 4, if the serial number was changed in 3, and with the `lock=yes` parameter.

For this example, enter this command.

```
ent-serial-num:serial=<EAGLE's serial number>;lock=yes
```

When this command has successfully completed, the following message should appear.

```
rlghncxa03w 06-10-28 21:15:37 GMT EAGLE5 36.0.0
ENT-SERIAL-NUM: MASP A - COMPLTD
```

6. Enable the Large MSU Support for IP Signaling feature with the `enable-ctrl-feat` command specifying the part number for the Large MSU Support for IP Signaling feature and the feature access key. Enter this command.

```
enable-ctrl-feat:partnum=893018401:fak=<Large MSU Support
for IP Signaling feature access key>
```

 **Note:**

A temporary feature access key cannot be specified to enable this feature.

 **Note:**

The values for the feature access key (the `fak` parameter) are provided by Oracle. If you do not have the feature access key for the feature you wish to enable, contact your Sales Representative or Account Representative.

When the `enable-ctrl-feat` command has successfully completed, this message should appear.

```
rlghncxa03w 06-10-28 21:15:37 GMT EAGLE5 36.0.0
ENABLE-CTRL-FEAT: MASP B - COMPLTD
```

7. Turn the Large MSU Support for IP Signaling feature on with the `chg-ctrl-feat` command specifying the part number for the Large MSU Support for IP Signaling feature and the `status=on` parameter. Enter this command.

```
chg-ctrl-feat:partnum=893018401:status=on
```

When the `chg-ctrl-feat` command has successfully completed, this message should appear.

```
rlghncxa03w 07-05-28 21:15:37 GMT EAGLE5 37.0.0
CHG-CTRL-FEAT: MASP B - COMPLTD
```

8. Verify the changes by entering the `rtrv-ctrl-feat` command with the Large MSU Support for IP Signaling feature part number. Enter this command.

```
rtrv-ctrl-feat:partnum=893018401
```

The following is an example of the possible output.

```
rlghncxa03w 10-04-28 21:15:37 GMT EAGLE5 42.0.0
```

The following features have been permanently enabled:

Feature Name	Partnum	Status	Quantity
Large MSU for IP Sig	893018401	on	----

The following features have been temporarily enabled:

Feature Name	Partnum	Status	Quantity	Trial Period
Left				

Zero entries found.

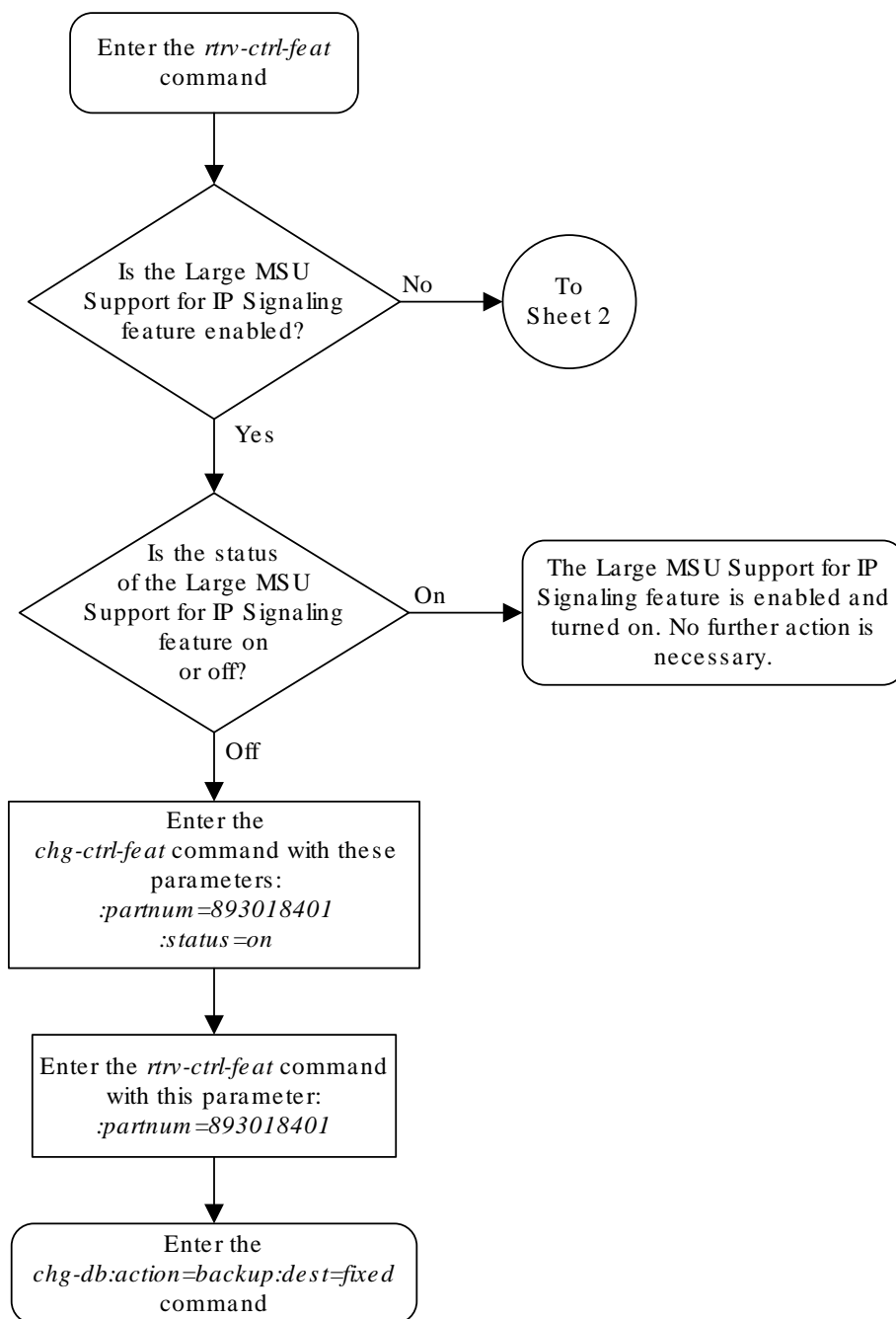
The following features have expired temporary keys:

Feature Name	Partnum
Zero entries found.	

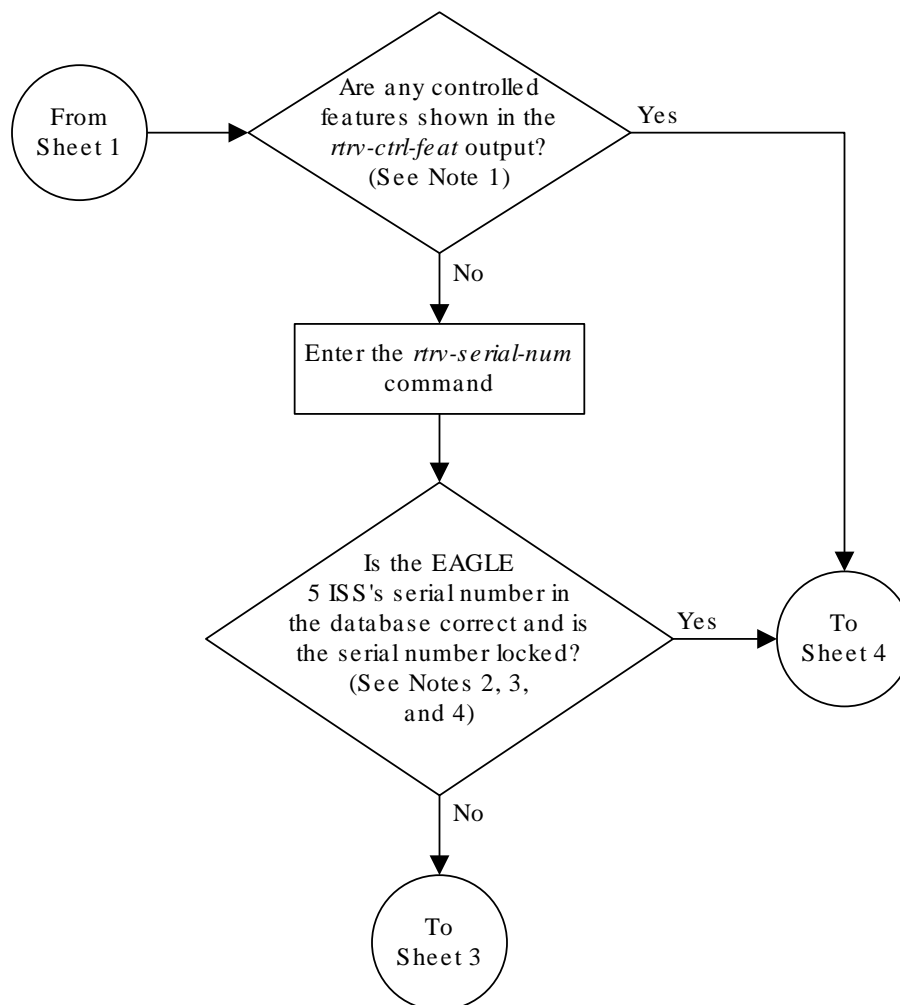
9. Back up the new changes using the `chg-db:action=backup:dest=fixed` command. These messages should appear, the active **Maintenance and Administration Subsystem Processor (MASP)** appears first.

```
BACKUP (FIXED) : MASP A - Backup starts on active MASP.  
BACKUP (FIXED) : MASP A - Backup on active MASP to fixed disk complete.  
BACKUP (FIXED) : MASP A - Backup starts on standby MASP.  
BACKUP (FIXED) : MASP A - Backup on standby MASP to fixed disk complete.
```

Figure 6-13 Activating the Large MSU Support for IP Signaling Feature



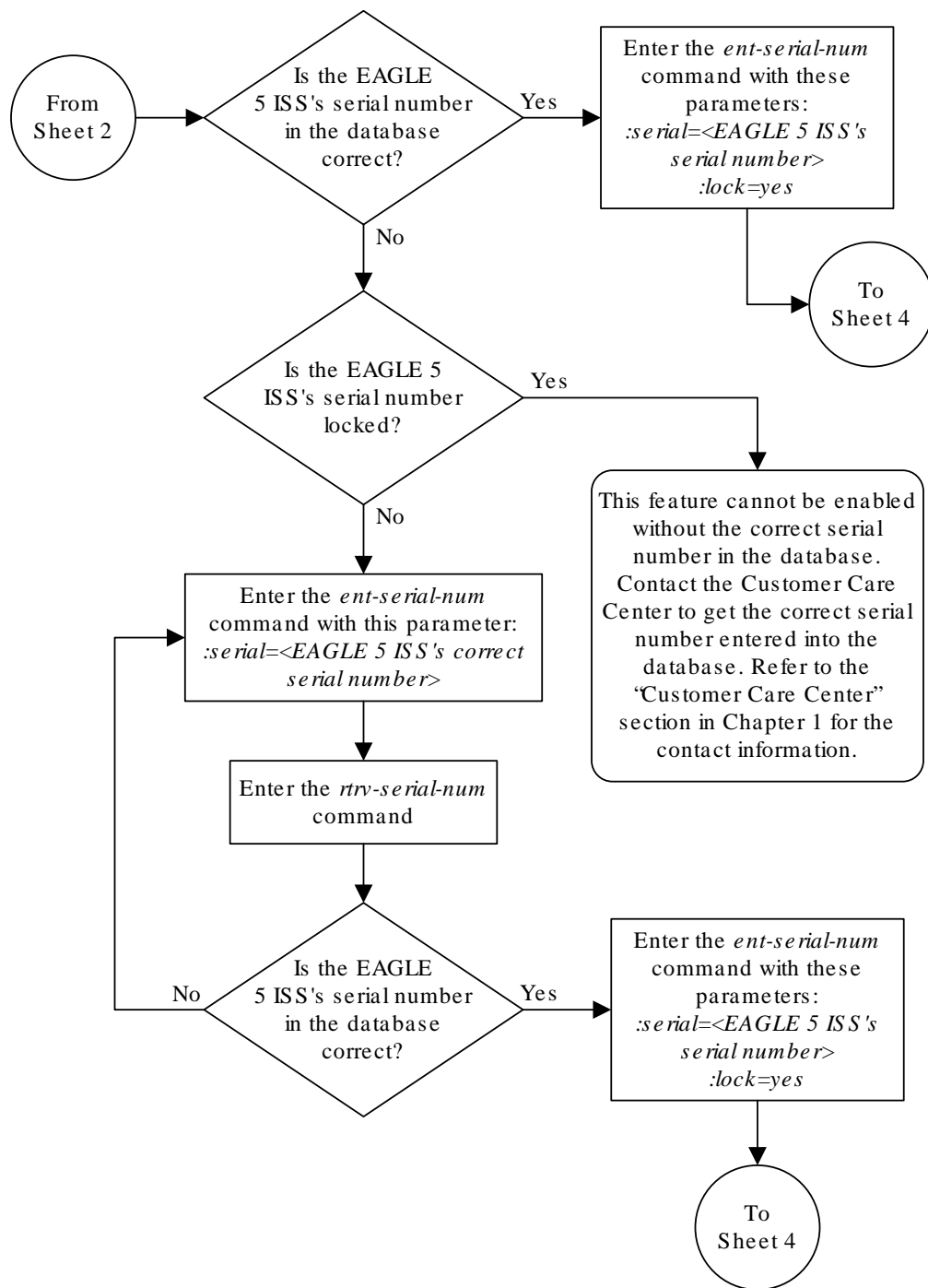
Sheet 1 of 4

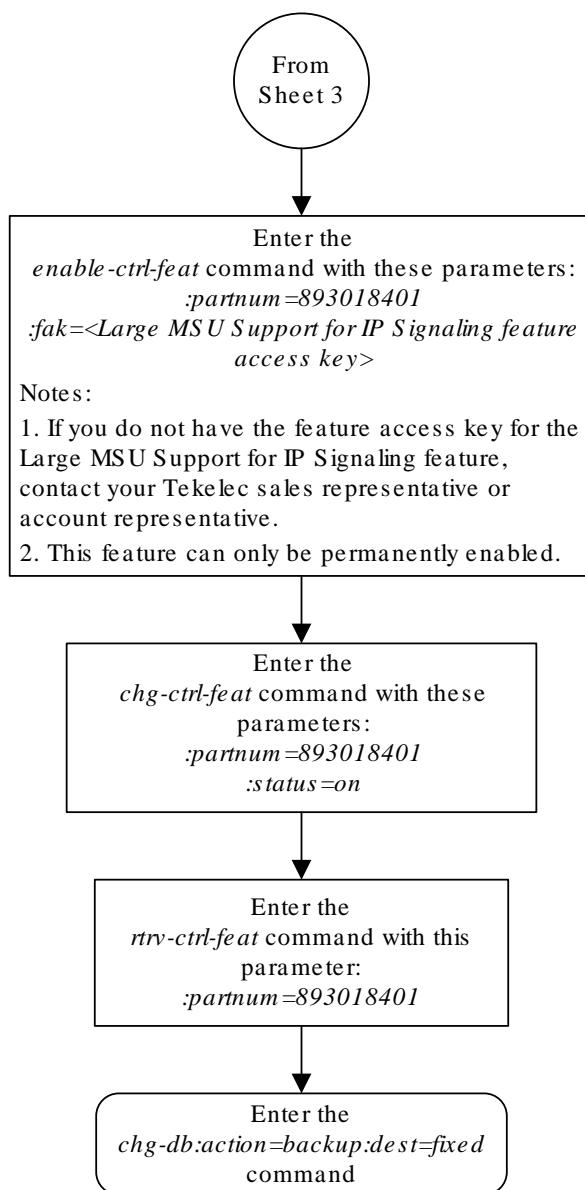


Notes:

1. If the *rrv-ctrl-feat* output shows only the HC-MIM SLK Capacity feature with a quantity of 64, the answer to this question is no and the Eagle 5 ISS's serial number must be verified. This is the default entry for the *rrv-ctrl-feat* output. This entry is shown whether or not the Eagle 5 ISS's serial number is in the database.
2. If the serial number is locked, it cannot be changed.
3. If the serial number is not locked, the controlled feature cannot be enabled.
4. The serial number can be found on a label affixed to the control shelf (shelf 1100).

Sheet 2 of 4





6.15 Removing IPSG Components

This section describes how to remove the following components from the database.

- An **IPSG** Card – Perform the [Removing an IPSG Card](#) procedure
- An IPSG Linkset – Perform the [Removing an IPSG Linkset](#) procedure
- An **IP** Host – Perform the [Removing an IP Host Assigned to an IPSG Card](#) procedure
- An **IP** Route – Perform the [Removing an IP Route](#) procedure
- An IPSG Association – Perform the [Removing an IPSG Association](#) procedure
- An **IPSG** M2PA Signaling Link – Perform the [Removing an IPSG M2PA Signaling Link](#) procedure
- An **IPSG** M2PA Signaling Link – Perform the [Removing an IPSG M3UA Signaling Link](#) procedure

6.16 Removing an IPSG Card

Use this procedure to remove an **IPSG** card, a card running the `ipsg` application, from the database using the `dlt-card` command.

The card cannot be removed if it does not exist in the database. Before removing the card from the database, the signaling links assigned to the card must be removed.

Caution:

If the **IPGWx** card is the last **IP** card in service, removing this card from the database will cause traffic to be lost.

1. Display the cards in the database using the `rtrv-card` command.

This is an example of the possible output.

```
rlghncxa03w 09-04-13 17:00:02 GMT EAGLE5 41.0.0
CARD   TYPE      APPL      LSET NAME      LINK SLC LSET NAME      LINK SLC
1101   DSM       VSCCP
1102   TSM       GLS
1113   GSPM     EOAM
1114   TDM-A
1115   GSPM     EOAM
1116   TDM-B
1117   MDAL
1201   LIMDS0   SS7ANSI   lsn1           A    0    lsn2           B    1
1203   LIMDS0   SS7ANSI   lsn2           A    0    lsn1           B    1
1204   LIMATM   ATMANSI   atmgwy        A    0
1205   ENET     IPSG     ipsgnode1     A    0    ipsgnode1     B    1
1207   ENET     IPSG     ipsgnode2     A    0
```

```
1303 DCM IPLIM ipnode1 A 0 ipnode3
B 0
1305 DCM IPLIM ipnode4 A 0
```

Select a card whose application is IPSG.

2. Display the linksets that are assigned to the IPSG card by entering the `rtrv-ls` command with the names of the linksets that are assigned to the IPSG card, shown in the `rtrv-card` output in 1.

For this example, enter these commands.

```
rtrv-ls:lsn=ipsgnode1
```

This is an example of the possible output.

```
rlghncxa03w 08-04-13 17:00:02 GMT 38.0.0

LSN          APCA  (SS7)  SCRNR SET SET BEI LST LNKS ACT MES DIS
SLSCI NIS
ipsgnode1    001-001-003  none 1 1 no A 2 off off off
no off

          SPCA          CLLI          TFATCABMLQ MTPRSE ASL8
-----
IPSG IPGWAPC GTTMODE          CGGTMOD
yes no CdPA no

ADAPTER SLKTPS LSUSEALM SLKUSEALM RCONTEXT
ASNOTIF
m2pa 1015 100% 80% none no

LOC LINK SLC TYPE ANAME
1205 A 0 IPSG m2pa1
1205 B 1 IPSG m2pa1
```

Link set table is (11 of 1024) 1% full.

```
rtrv-ls:lsn=ipsgnode2
```

This is an example of the possible output.

```
rlghncxa03w 08-04-13 17:17:00 GMT 38.0.0

LSN          APCA  (SS7)  SCRNR SET SET BEI LST LNKS ACT MES DIS
SLSCI NIS
ipsgnode2    003-003-004  none 1 1 no A 1 off off off
no off

          SPCA          CLLI          TFATCABMLQ MTPRSE ASL8
```

```

-----
IPSG  IPGWAPC  GTTMODE          CGGTMOD
yes   no      CdPA             no

ADAPTER  SLKTPS  LSUSEALM  SLKUSEALM  RCONTEXT  ASNOTIF
m3ua    2000    100%      80%        none      yes

NUMSLKALW  NUMSLKRSTR  NUMSLKPROH
1           1           1

LOC  LINK  SLC  TYPE  ANAME
1207 A   0   IPSG  m3ua1

```

Link set table is (11 of 1024) 1% full.

If the `ADAPTER` value assigned to the linkset is `m2pa`, perform the [Removing an IPSG M2PA Signaling Link](#) procedure to remove the M2PA signaling links assigned to the card.

If the `ADAPTER` value assigned to the linkset is `m3ua`, perform the [Removing an IPSG M3UA Signaling Link](#) procedure to remove the M3UA signaling links assigned to the card.

After the signaling links have been removed from the database, continue the procedure with [3](#).

3. Remove the card from the database using the `dlt-card` command.

The `dlt-card` command has only one parameter, `loc`, which is the location of the card. For this example, enter these commands.

```
dlt-card:loc=1205
dlt-card:loc=1207
```

When these commands have successfully completed, this message appears.

```
rlghncxa03w 08-04-13 17:00:02 GMT  EAGLE5 36.0.0
DLT-CARD: MASP A - COMPLTD
```

4. Verify the changes using the `rtrv-card` command and specifying the card that was removed in [3](#).

For this example, enter these commands.

```
rtrv-card:loc=1205
rtrv-card:loc=1207
```

When these commands have successfully completed, this message appears.

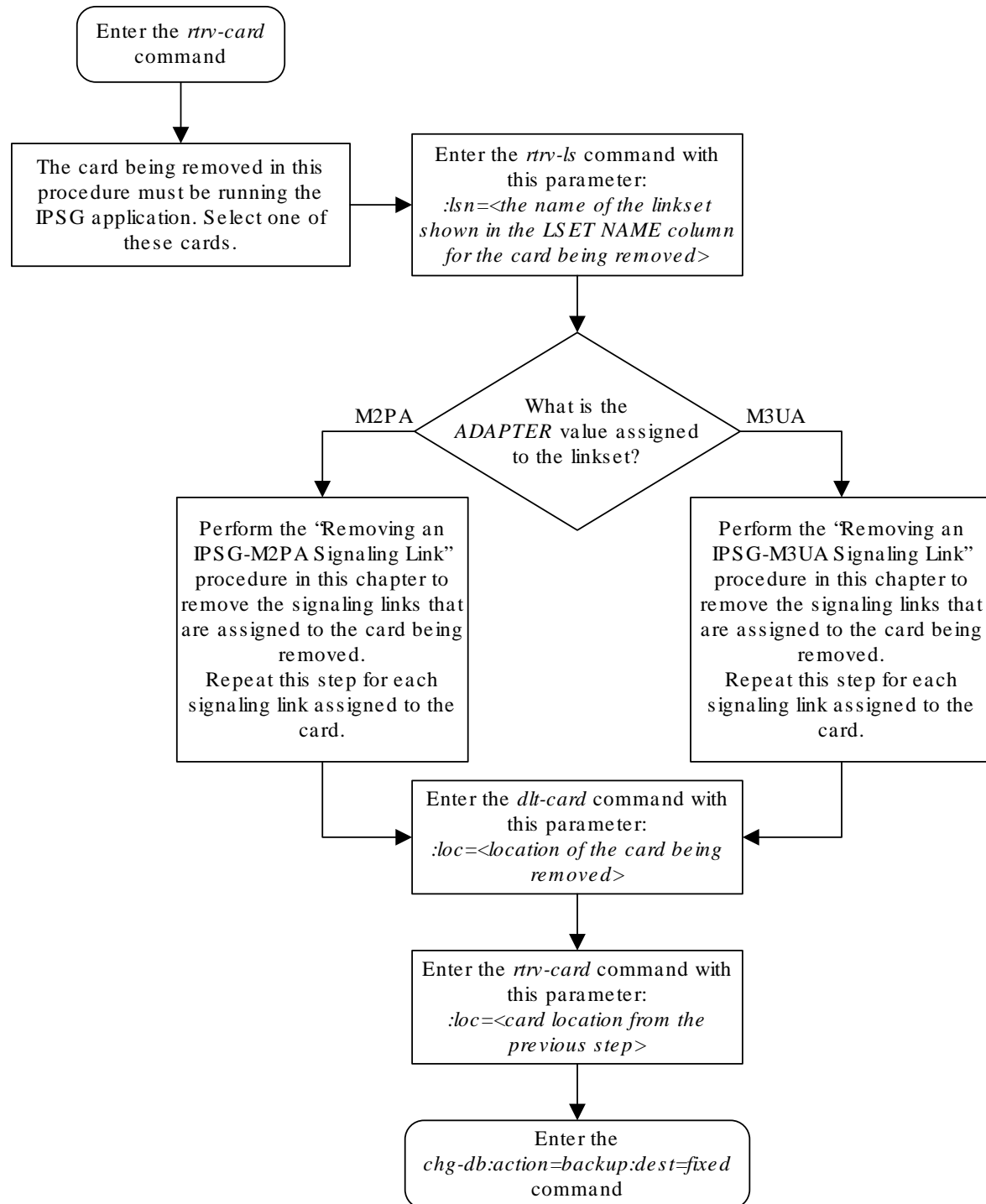
```
E2144 Cmd Rej: Location invalid for hardware configuration
```

5. Back up the new changes using the `chg-db:action=backup:dest=fixed` command.

These messages appear, the active **Maintenance and Administration Subsystem Processor (MASP)** appears first.

```
BACKUP (FIXED) : MASP A - Backup starts on active MASP.  
BACKUP (FIXED) : MASP A - Backup on active MASP to fixed disk  
complete.  
BACKUP (FIXED) : MASP A - Backup starts on standby MASP.  
BACKUP (FIXED) : MASP A - Backup on standby MASP to fixed disk  
complete.
```

Figure 6-14 Removing an IPSG Card



6.17 Removing an IPSG Linkset

This procedure is used to remove a IPSG linkset from the database using the `dlt-ls` command. An IPSG linkset is a linkset whose `ipsg` parameter value is `yes`.

The `dlt-ls` command has only one parameter, `lsn`, which is the name of the linkset to be removed from the database.

The linkset to be removed must exist in the database.

To remove a linkset, all links associated with the linkset must be removed.

The linkset to be removed cannot be referenced by a routeset.

If the Flexible Linkset Optional Based Routing feature is enabled and turned on, and the linkset is referenced by a GTT selector, the linkset cannot be removed.

A proxy linkset whose APC is assigned to more than one proxy linkset cannot be removed if the linkset contains the proxy point code (shown in the `PPCA/PPCI/PPCN/PPCN24` field in the `rtrv-ls:apc/apca/apci/apcn/apcn24=<APC of the linkset>` output) that is also assigned to the APC of the linkset. The proxy point code assigned to the APC of the linkset is shown in the `rtrv-dstn:dpc/dpca/dpci/dpcn/dpcn24=<APC of the linkset>` output. The linksets that do not contain the proxy point code that is assigned to the APC of the linkset must be removed before the linkset containing proxy point code that is assigned to the APC of the linkset can be removed.

Canceling the `RTRV-LS` Command

Because the `rtrv-ls` command used in this procedure can output information for a long period of time, the `rtrv-ls` command can be canceled and the output to the terminal stopped. There are three ways that the `rtrv-ls` command can be canceled.

- Press the `F9` function key on the keyboard at the terminal where the `rtrv-ls` command was entered.
- Enter the `canc-cmd` without the `trm` parameter at the terminal where the `rtrv-ls` command was entered.
- Enter the `canc-cmd:trm=<xx>`, where `<xx>` is the terminal where the `rtrv-ls` command was entered, from another terminal other than the terminal where the `rtrv-ls` command was entered. To enter the `canc-cmd:trm=<xx>` command, the terminal must allow Security Administration commands to be entered from it and the user must be allowed to enter Security Administration commands. The terminal's permissions can be verified with the `rtrv-secu-trm` command. The user's permissions can be verified with the `rtrv-user` or `rtrv-secu-user` commands.

For more information about the `canc-cmd` command, go to *Commands User's Guide*.

1. Display the IPSG linksets by entering the `rept-stat-iptps` command. This is an example of the possible output.

```
rlghncxa03w 10-07-19 21:16:37 GMT EAGLE5 42.0.0
IP TPS USAGE REPORT
```


	THRESH	CONFIG/ RSVD	CONFIG/ MAX		TPS	PEAK	PEAKTIMESTAMP

LSN							
isl	100%	500	2000	TX:	427	550	10-07-19 09:49:19
				RCV:	312	450	10-07-19
09:49:19							

Command Completed.

- Display the linkset that will be removed by entering the `rtrv-ls` command with the name of the linkset shown in 1. This is an example of the possible output.

```
rtrv-ls:lsn=ls1
```

This is an example of the possible output.

```
tekelecstp 18-01-22 05:31:51 EST EAGLE 46.6.0.0.0-71.21.0
```

LSN	APCA	(SS7)	SCRN	L3T	SLT	SET	BEI	LST	LNKS	GWS	GWS	GWS
ACT	MES	DIS										
SLSCI	NIS											
ls1	003-003-003		gws1	1	1	no	A	15		on	on	on
yes	off											
SPCA			CLLI	TFATCABMLQ		MTPRSE	ASL8					
-----			-----	7		no	no					
RANDSLS												
off												
IPSG	GTTMODE		CGGTMOD									
no	CdPA		no									
LOC	LINK	SLC	TYPE	LP	ATM							
1102	A	2	LIMATM	SET	BPS	TSEL	VCI	VPI	LL			
				1	1.544M	EXTERNAL	5	0	0			
LOC	LINK	SLC	TYPE	IPLIML2								
1201	A	5	IPLIM	M2PA								
LOC	LINK	SLC	TYPE	L2T	PCR		PCR	E1	E1			
				SET	BPS	ECM	N1	N2	LOC			
PORT	TS											
1205	A	6	LIME1	1	56000	BASIC	---	-----	1205			
1	1											
LOC	LINK	SLC	TYPE	L2T	PCR		PCR	T1	T1			
				SET	BPS	ECM	N1	N2	LOC			
PORT	TS											
1206	A	10	LIMT1	1	56000	BASIC	---	-----	1206			
1	1											

Link set table is (7 of 1024) 1% full.

If the IPSP value of the linkset is `no`, perform the "Removing a Linkset Containing SS7 Signaling Links" procedure to remove the linkset.

If the IPSP value of the linkset is `yes`, perform one of these actions.

- If the linkset being removed is a proxy linkset (`LST=PRX`), and more than one linkset is shown in the `rtrv-ls` output that contains the APC of the linkset being removed, continue the procedure with 3.
 - If the linkset being removed is not a proxy linkset, or is a proxy linkset whose APC is not used by more than one linkset, continue the procedure with 5.
3. Display the linksets that contain the APC of the linkset being removed by entering the `rtrv-ls` command with the APC of the linkset. For this example, enter this command.

```
rtrv-ls:apca=150-001-002
```

This is an example of the possible output.

```
rlghncxa03w 07-08-23 11:09:57 EST 37.0.0
```

```
APCA = 150-001-002
```

LSN	PPCA	SCRN	L3T	SLT	BEI	LST	LNKS	GWS ACT	GWS MES	GWS DIS
SLSCI NIS										
lsn150	150-001-001	none	1	1	no	PRX	1	off	off	off
no off										
lsn151	150-001-004	none	1	1	no	PRX	1	off	off	off
no off										

Link set table is (14 of 1024) 1% full.

4. Display the attributes of the APC of the linkset being removed by entering the `rtrv-dstn` command with the APC of the linkset. For this example, enter this command.

```
rtrv-dstn:dpca=150-001-002
```

This is an example of the possible output.

```
rlghncxa03w 10-12-15 09:22:39 GMT EAGLE5 43.0.0
```

DPCA	CLLI	BEI	ELEI	ALIASI
ALIASN/N24	DMN			
150-001-002	-----	no	---	-----
-----	SS7			

PPCA	NCAI	PRX	RCAUSE	NPRST	SPLITIAM	HMSMSC	HMSCP
SCCPMSGCNV							
150-001-001	----	no	50	on	20	no	no none

```
Destination table is (14 of 2000) 1% full
Alias table is (0 of 12000) 0% full
PPC table is (2 of 10) 20% full
```

A proxy linkset whose APC is assigned to more than one proxy linkset cannot be removed if the linkset contains the proxy point code (shown in the PPCA/PPCI/PPCN/PPCN24 field in 3) that is also assigned to the APC of the linkset (shown in 4). The linksets that do not contain the proxy point code that is assigned to the APC of the linkset must be removed before the linkset containing proxy point code that is assigned to the APC of the linkset can be removed.

5. Display the routes in the database by using the `rtrv-rte` command, specifying the name of the linkset you wish to remove. For this example, enter this command.

```
rtrv-rte:lsn=ls1
```

This is an example of the possible output.

```
rlghncxa03w 07-05-10 11:43:04 GMT EAGLE5 37.0.0
LSN          DPC
RC
ls1          240-012-004  10
```

If any routes reference the linkset to be removed, remove these routes by performing the "Removing a Route" procedure in the *Database Administration - SS7 User's Guide*.

6. Remove all links in the linkset by performing one of these procedures.

If the ADAPTER value of the linkset is M2PA, shown in the `rtrv-ls` output in 2, perform the [Removing an IPSP M2PA Signaling Link](#) procedure.

If the ADAPTER value of the linkset is M3UA, shown in the `rtrv-ls` output in 2, perform the [Removing an IPSP M3UA Signaling Link](#) procedure.

7. Display any entires in the route exception table whose linkset name is the name of the linkset being removed in this procedure. Enter the `rtrv-rtx` command with the `lsn` parameter. For this example, enter this command.

```
rtrv-rtx:lsn=ls1
```

This is an example of the possible output.

```
rlghncxa03w 07-05-10 11:43:04 GMT EAGLE5 37.0.0

      DPCA          RTX-CRITERIA          LSN          RC          APC

240-012-006  OPCA
              008-008-008          ls1          40          240-012-004

DESTINATION ENTRIES ALLOCATED:  2000
FULL DPC(s) :                   15
EXCEPTION DPC(s) :               5
NETWORK DPC(s) :                 0
CLUSTER DPC(s) :                 1
TOTAL DPC(s) :                   21
CAPACITY (% FULL) :              1%
```

```

ALIASES ALLOCATED:          12000
ALIASES USED:              0
CAPACITY (% FULL):        0%
X-LIST ENTRIES ALLOCATED:  500

```

If the linkset being removed in this procedure is not assigned to a route exception table entry, no entries are displayed in the `rtrv-rtx` output, but a summary of the point code quantities is displayed.

If the name of the linkset being removed in this procedure shown in the `LSN` column in this step, perform one of these procedures:

- a. Change the name of the linkset in the entries displayed in this step by performing the "Changing a Route Exception Entry" procedure in the *Database Administration - SS7 User's Guide*.
 - b. Remove all the entries displayed in this step by performing the "Removing a Route Exception Entry" procedure in the *Database Administration - SS7 User's Guide*.
8. Verify whether or not the Flexible Linkset Optional Based Routing feature is enabled and turned on by entering this command.

```
rtrv-ctrl-feat:partnum=893027701
```

This is an example of the possible output.

```
rlghncxa03w 09-05-10 11:43:04 GMT EAGLE5 41.0.0
```

The following features have been permanently enabled:

Feature Name	Partnum	Status	Quantity
Flex Lset Optnl Based Rtg	893027701	on	----

The following features have been temporarily enabled:

Feature Name	Partnum	Status	Quantity	Trial Period
Left				
Zero entries found.				

The following features have expired temporary keys:

Feature Name	Partnum
Zero entries found.	

If the Flexible Linkset Optional Based Routing feature is enabled and turned on, continue the procedure with [9](#).

If the Flexible Linkset Optional Based Routing feature is not enabled or not turned on, continue the procedure with [10](#).

9. Display the GTT selectors that contain the linkset that is being removed by entering the `rtrv-gttssel` command with the name of the linkset. For this example, enter this command.

```
rtrv-gttssel:lsn=ls1
```

This is an example of the possible output.

```
rlghncxa03w 09-05-10 11:43:04 GMT EAGLE5 41.0.0
```

```
GTI          CG          CDPA          CGPA
ANSI TT NP      NAI SSN SELID LSN      GTTSET      GTTSET
2    180 --      --- any none ls1      -----      (--- ) cdgta4
(cdgta)
```

```
GTI          CG          CDPA          CGPA
INTL TT NP      NAI SSN SELID LSN      GTTSET      GTTSET
```

```
GTI          CG          CDPA          CGPA
NATL TT NP      NAI SSN SELID LSN      GTTSET      GTTSET
```

```
GTI          CG          CDPA          CGPA
N24 TT NP      NAI SSN SELID LSN      GTTSET      GTTSET
```

If GTT selectors are shown in the `rtrv-gttset` output, perform the "Removing a GTT Selector" procedure in the *Database Administration - GTT User's Guide* to remove all entries shown in this step. After the GTT selectors have been removed, continue the procedure with [10](#).

If GTT selectors are not shown in the `rtrv-gttset` output, continue the procedure with [10](#).

- Remove the linkset using the `dlt-ls` command. For this example, enter this command.

```
dlt-ls:lsn=ls1
```

When this command has successfully completed, this message should appear.

```
rlghncxa03w 07-05-17 16:03:12 GMT EAGLE5 37.0.0
Link set table is ( 23 of 1024) 2% full
DLT-LS: MASP A - COMPLTD
```

- Verify the changes using the `rtrv-ls` command with the linkset name used in [10](#).

For this example, enter this command.

```
rtrv-ls:lsn=ls1
```

If the removal of the linkset was successful, the following message is displayed.

```
E2346 Cmd Rej: Linkset not defined
```

Continue the procedure with [12](#) if the linkset that was removed in [10](#) has any of these attributes:

- The linkset was not a proxy linkset.

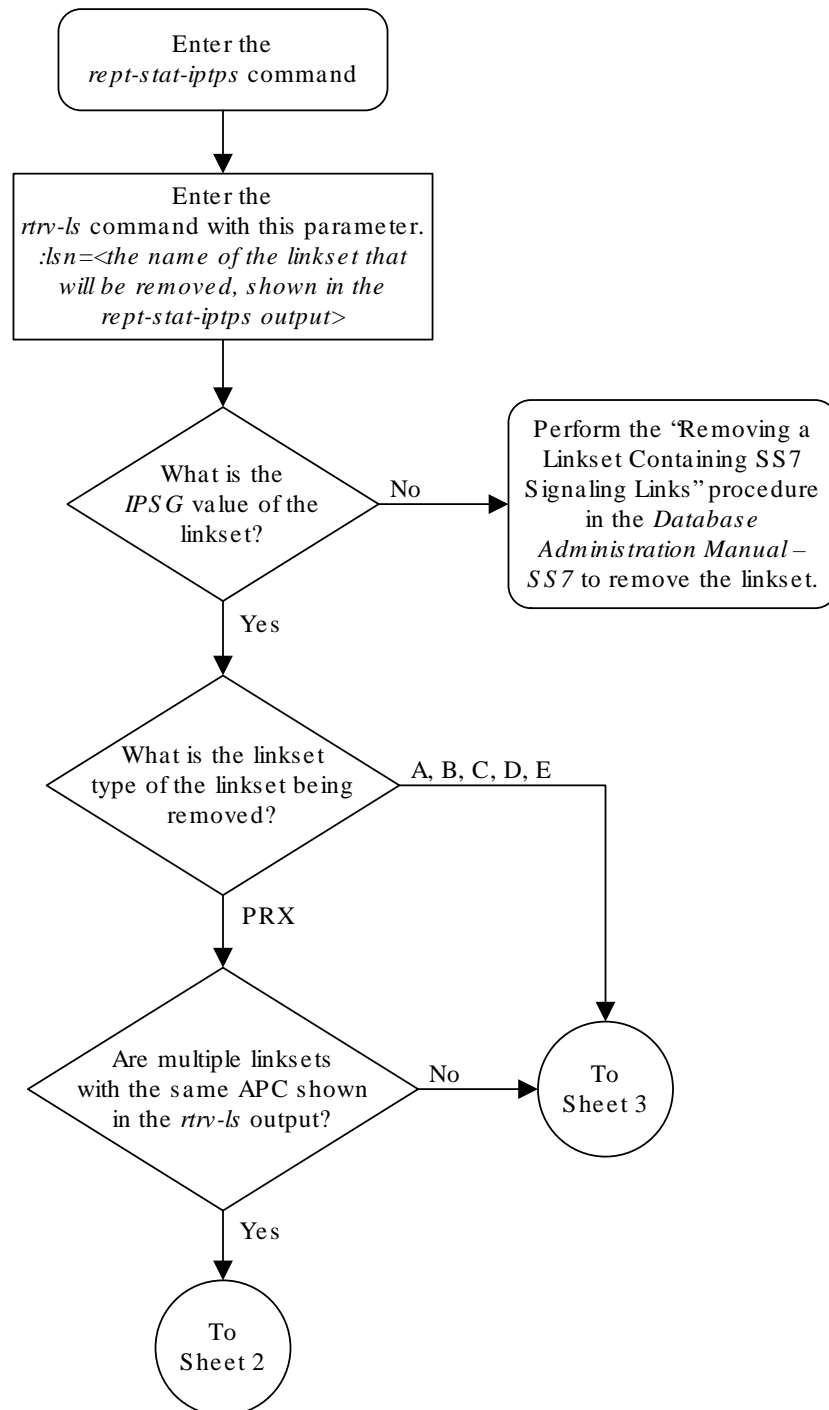
- The linkset was a proxy linkset whose APC was assigned to only the proxy linkset that was removed in 10.
- The linkset was a proxy linkset and:
 - The APC of this linkset is assigned to more than one linkset.
 - The linkset did not contain the proxy point code that was assigned to the APC of the linkset.
 - The linkset that contains the proxy point code that is assigned to the APC of the linkset will not be removed from the database.

If you wish to remove the proxy linkset that contains the proxy point code that is also assigned to the APC of the linkset, and the database contains other linksets that are assigned to this APC, these other linksets must be removed before the proxy linkset that contains the proxy point code that is also assigned to the APC of the linkset can be removed. Repeat this procedure from 4 to remove these linksets. After these linksets have been removed, perform this procedure again from 4 to remove the proxy linkset that contains the proxy point code that is also assigned to the APC of the linkset.

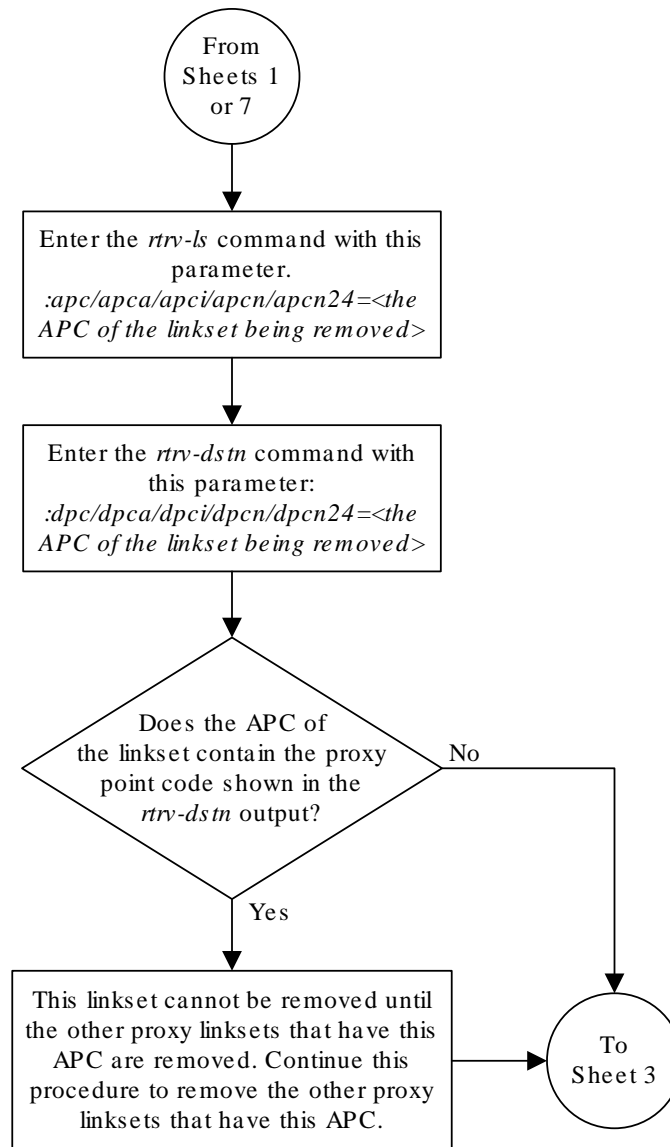
12. Back up the new changes using the `chg-db:action=backup:dest=fixed` command. These messages should appear, the active **Maintenance and Administration Subsystem Processor (MASP)** appears first.

```
BACKUP (FIXED) : MASP A - Backup starts on active MASP.  
BACKUP (FIXED) : MASP A - Backup on active MASP to fixed disk  
complete.  
BACKUP (FIXED) : MASP A - Backup starts on standby MASP.  
BACKUP (FIXED) : MASP A - Backup on standby MASP to fixed disk  
complete.
```

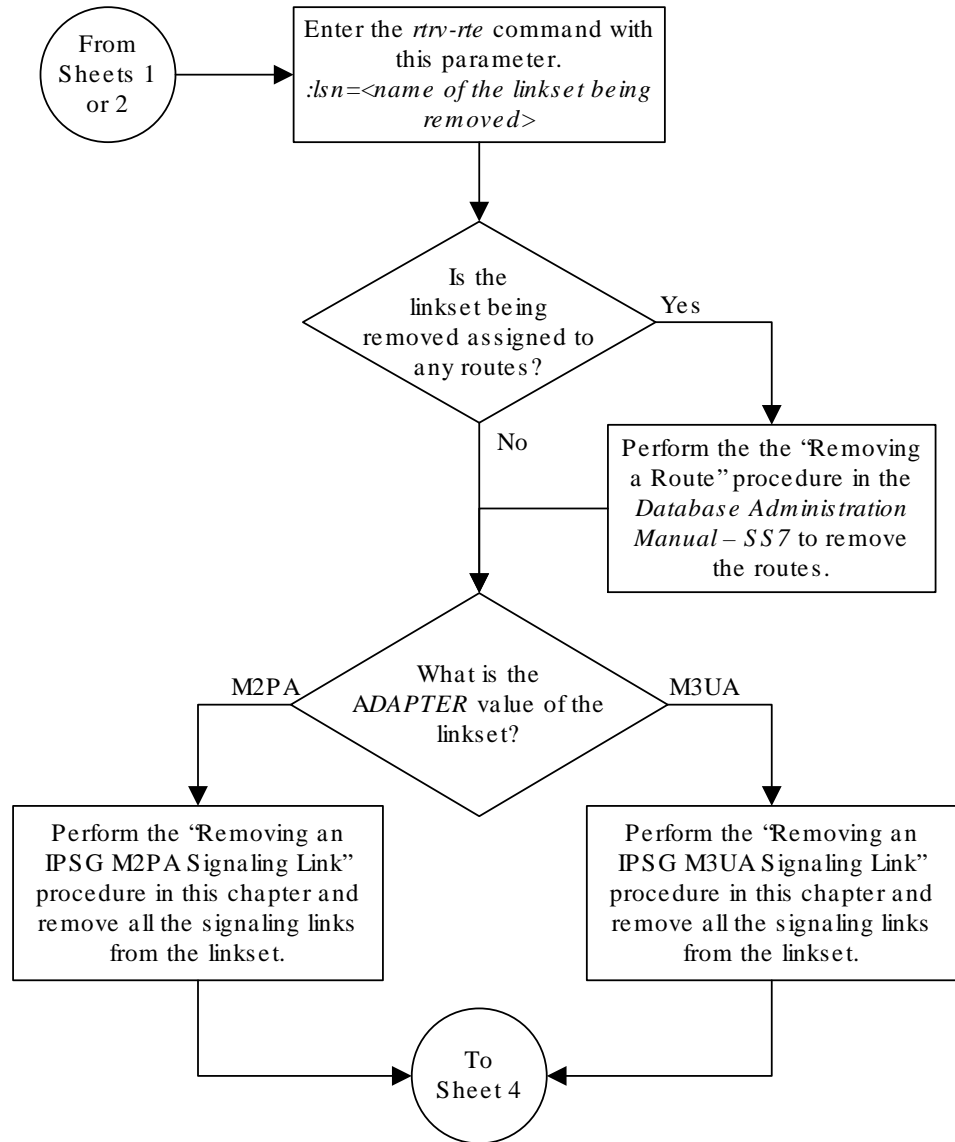
Figure 6-15 Removing an IPSG Linkset



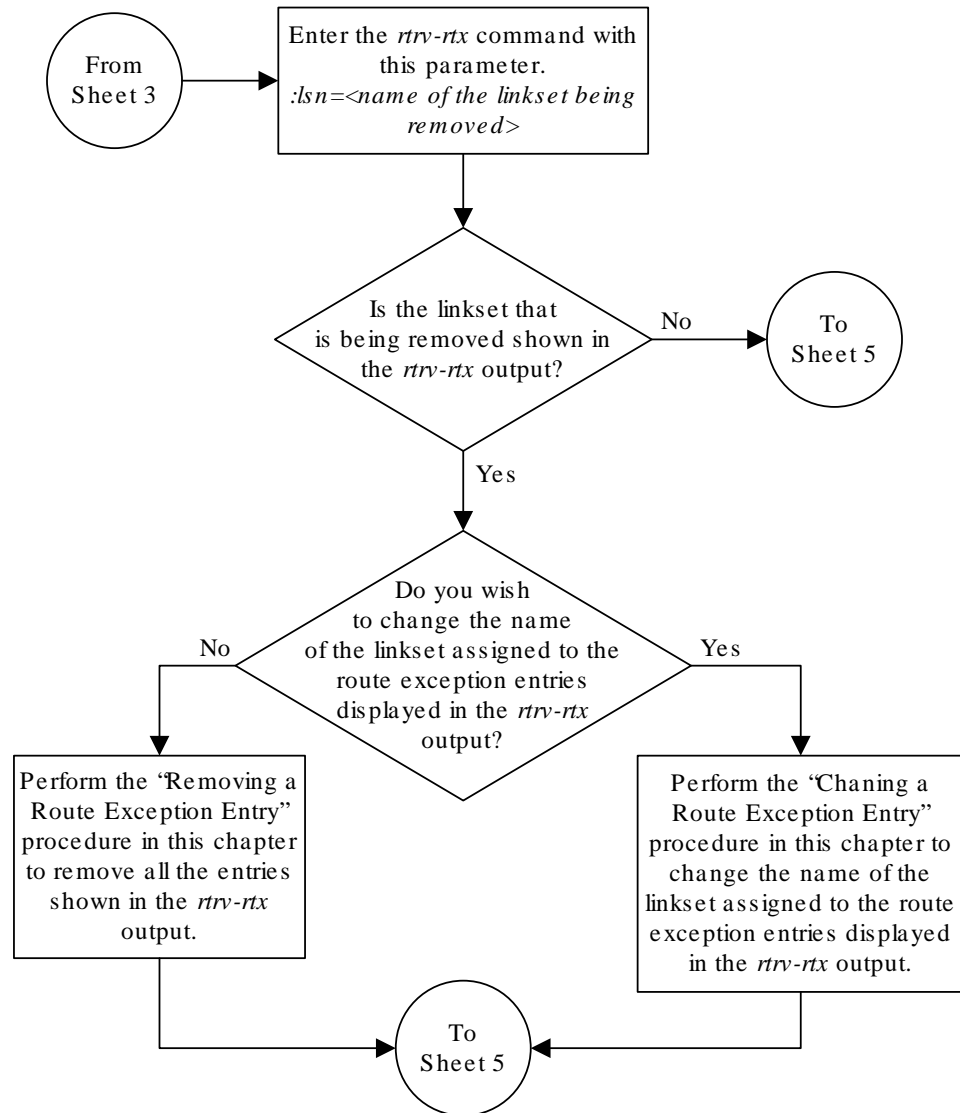
Sheet 1 of 7



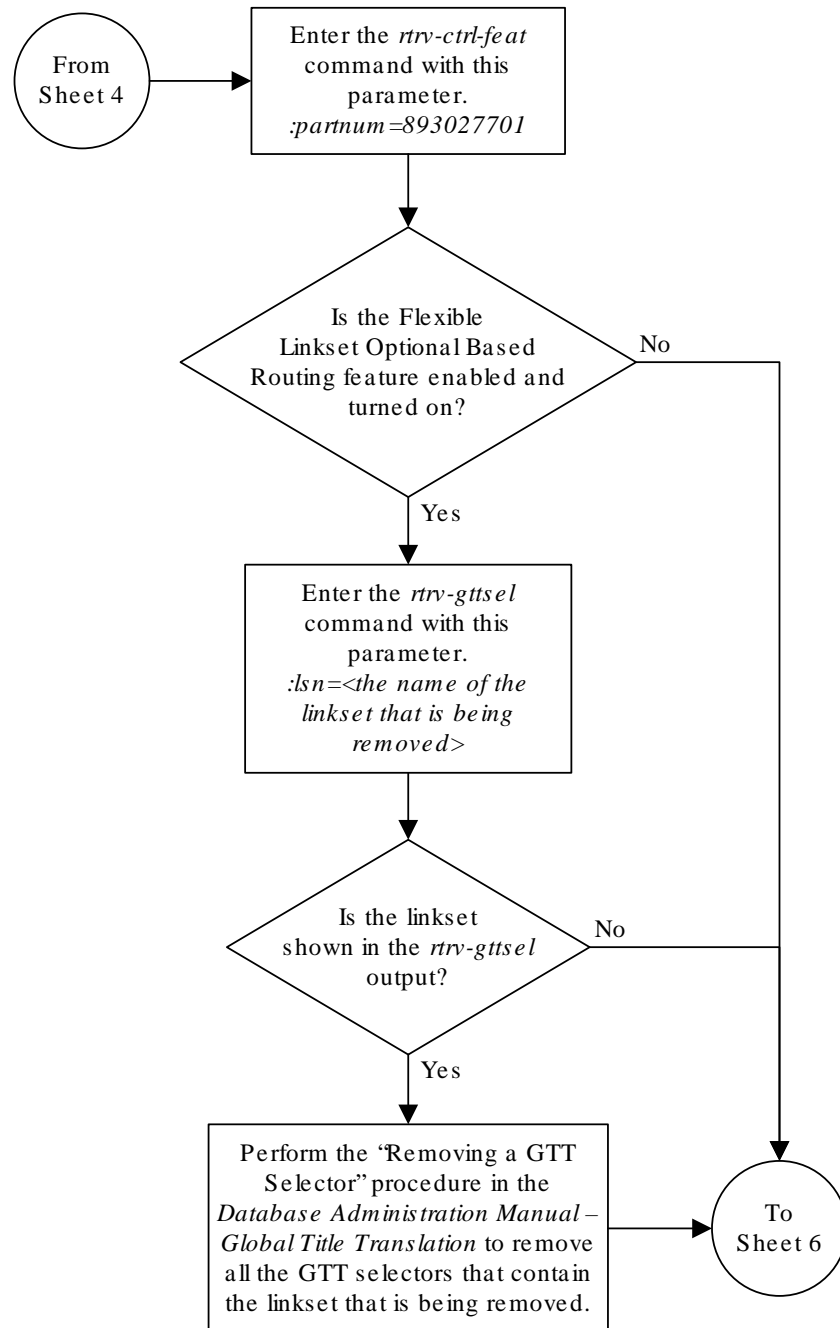
Sheet 2 of 7



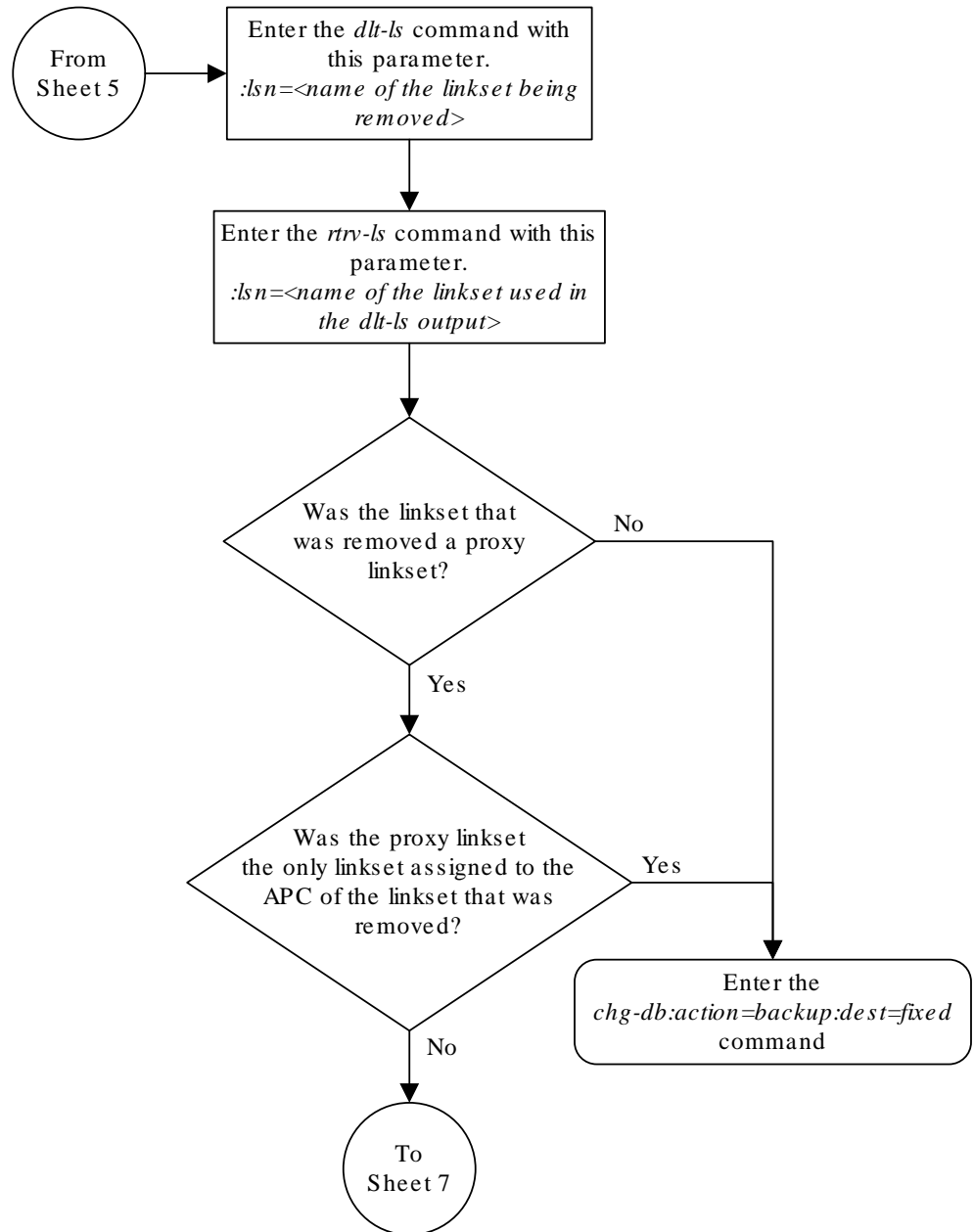
Sheet 3 of 7



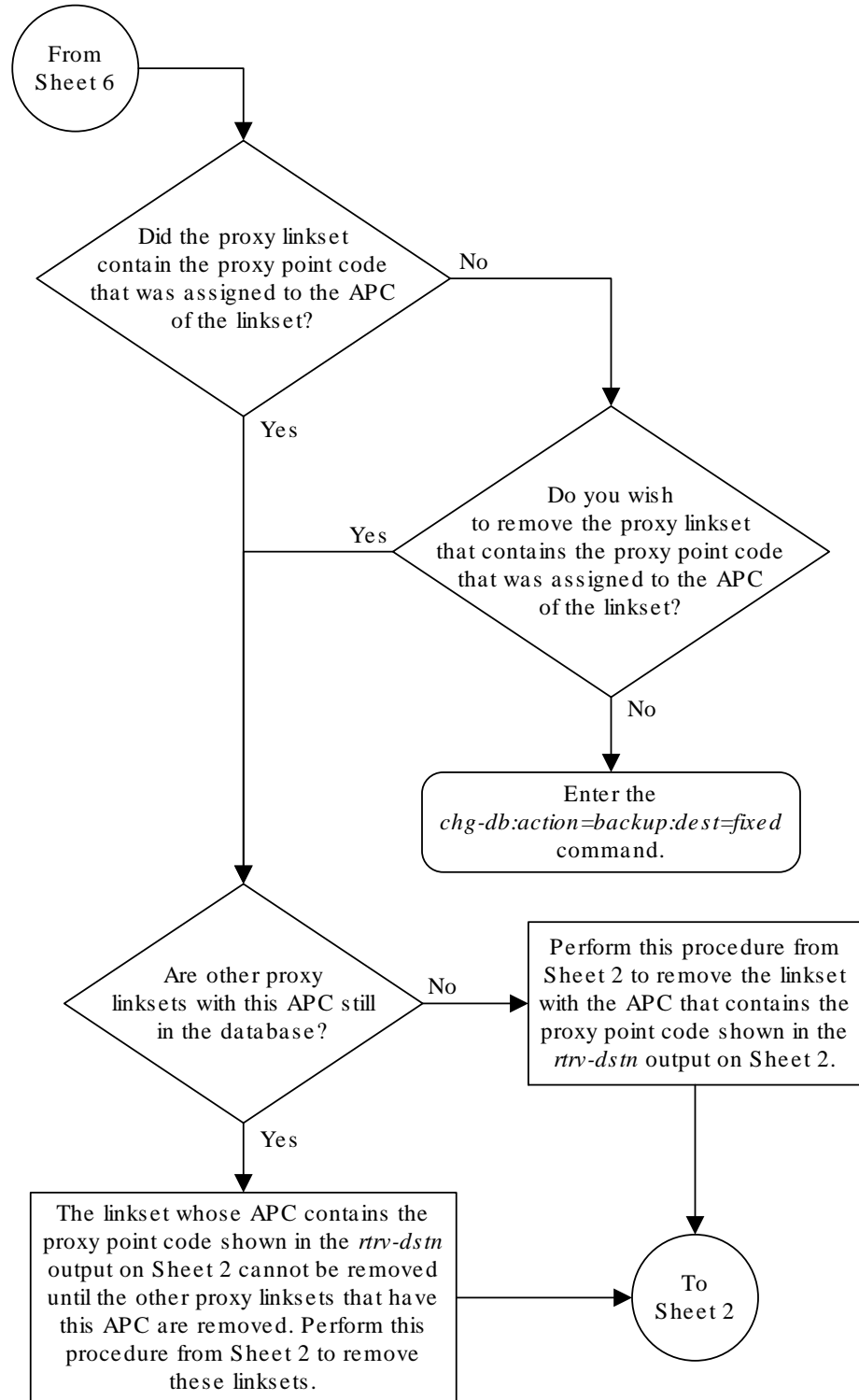
Sheet 4 of 7



Sheet 5 of 7



Sheet 6 of 7



Sheet 7 of 7

6.18 Removing an IP Host Assigned to an IP SG Card

This procedure removes an IP host that is assigned to an IP SG card using the `dlt-ip-host` command.

The `dlt-ip-host` command uses the following parameter.

`:host` – Hostname. The hostname to be removed. This parameter identifies the logical name assigned to a device with an **IP** address.

No associations can reference the host name being removed in this procedure.

The associations referencing the host name can be removed by performing the [Removing an IP SG Association](#) procedure or the host name in these associations can be changed by performing the [Changing the Host Values of an IP SG Association](#) procedure. The host name assigned to associations is displayed in the `rtrv-assoc` outputs.

1. Display the current **IP** host information in the database by entering the `rtrv-ip-host:display=all` command.

The following is an example of the possible output.

```
rlghncxa03w 13-06-28 21:17:37 GMT EAGLE5 45.0.0
```

```
LOCAL IPADDR      LOCAL HOST
192.1.1.10        IPNODE1-1201
192.1.1.12        IPNODE1-1203
192.1.1.14        IPNODE1-1205
192.1.1.20        IPNODE2-1201
192.1.1.22        IPNODE2-1203
192.1.1.24        IPNODE2-1205
192.1.1.30        KC-HLR1
192.1.1.32        KC-HLR2
192.1.1.50        DN-MS1
192.1.1.52        DN-MS2
192.3.3.33        GW100. NC. TEKELEC. COM

REMOTE IPADDR     REMOTE HOST
150.1.1.5         NCDEPTECONOMIC_DEVELOPMENT.
SOUTHEASTERN_COORIDOR_ASHVL. GOV
```

```
IP Host table is (12 of 4096) .29% full
```

If the IP host that is being removed is a remote host, continue the procedure with [5](#).

If the IP host that is being removed is a local host, continue the procedure with [2](#).

2. Display the current link parameters associated with the IP card in the database by entering the `rtrv-ip-lnk` command. The following is an example of the possible output.

```
rlghncxa03w 08-12-28 21:14:37 GMT EAGLE5 40.0.0
LOC  PORT IPADDR          SUBMASK          DUPLEX  SPEED MACTYPE AUTO
MCAST
1303  A   192.1.1.10      255.255.255.128 HALF     10   802.3  NO  NO
1303  B   -----          -----          HALF     10   DIX    NO  NO
1305  A   192.1.1.12      255.255.255.0   ----    ---   DIX    YES NO
1305  B   -----          -----          HALF     10   DIX    NO  NO
1313  A   192.1.1.14      255.255.255.0   FULL    100  DIX    NO  NO
1313  B   -----          -----          HALF     10   DIX    NO  NO
2101  A   192.1.1.20      255.255.255.0   FULL    100  DIX    NO  NO
2101  B   -----          -----          HALF     10   DIX    NO  NO
2103  A   192.1.1.22      255.255.255.0   FULL    100  DIX    NO  NO
2103  B   -----          -----          HALF     10   DIX    NO  NO
2105  A   192.1.1.24      255.255.255.0   FULL    100  DIX    NO  NO
2105  B   -----          -----          HALF     10   DIX    NO  NO
2205  A   192.1.1.30      255.255.255.0   FULL    100  DIX    NO  NO
2205  B   -----          -----          HALF     10   DIX    NO  NO
2207  A   192.1.1.32      255.255.255.0   FULL    100  DIX    NO  NO
2207  B   -----          -----          HALF     10   DIX    NO  NO
2213  A   192.1.1.50      255.255.255.0   FULL    100  DIX    NO  NO
2213  B   -----          -----          HALF     10   DIX    NO  NO
2301  A   192.1.1.52      255.255.255.0   FULL    100  DIX    NO  NO
2301  B   -----          -----          HALF     10   DIX    NO  NO
2305  A   192.3.3.33      255.255.255.0   FULL    100  DIX    NO  NO
2305  B   -----          -----          HALF     10   DIX    NO  NO
```

IP-LNK table is (22 of 2048) 1% full.

3. Display the cards in the database using the `rtrv-card` command. This is an example of the possible output.

```
rlghncxa03w 13-05-28 09:12:36 GMT EAGLE5 45.0.0
CARD  TYPE      APPL      LSET NAME      LINK SLC  LSET NAME      LINK SLC
1101  DSM       VSCCP
1102  TSM       GLS
1113  E5MCAP    EOAM
1114  E5TDM-A
1115  E5MCAP    EOAM
1116  E5TDM-B
1117  E5MDAL
1201  LIMDS0    SS7ANSI    sp2             A    0    sp1             B    0
1203  LIMDS0    SS7ANSI    sp3             A    0
1204  LIMDS0    SS7ANSI    sp3             A    1
1206  LIMDS0    SS7ANSI    nsp3            A    1    nsp4            B    1
1301  LIMDS0    SS7ANSI    sp6             A    1    sp7             B    0
1302  LIMDS0    SS7ANSI    sp7             A    1    sp5             B    1
1303  DCM       IPLIM      ipnode1         A    0    ipnode3         B    1
1305  DCM       IPLIM      ipnode4         A    0
1313  DCM       SS7IPGW    ipgtwy1         A    0
2101  ENET      IPSC       ipgtwy2         A    0
```

```

2103 DCM SS7IPGW ipgtwy3 A 0
2105 DCM IPLIM ipnode1 A1 1 ipnode5
B 2
2205 DCM IPLIM ipnode3 A2 0 ipnode6
B1 2
2207 DCM IPLIM ipnode5 A 0 ipnode4
B3 1
2213 DCM IPLIM ipnode5 A3 1 ipnode3
B2 2
2301 DCM IPLIM ipnode6 A 0 ipnode1
B 2
2305 ENET IP SG ipnode6 A1 1 ipnode1
B1 3
  
```

Select an **IP** host whose **IP address** is assigned to a card running the **IP SG** application.

4. Display the associations referencing the host name being removed in this procedure by entering the `rtrv-assoc` command with the local host name.

For this example, enter these commands.

```
rtrv-assoc:lhost=gw100.nc.tekelec.com
```

The following is an example of the possible output.

```

rlghncxa03w 06-10-28 21:14:37 GMT EAGLE5 36.0.0
CARD IPLNK
ANAME LOC PORT LINK ADAPTER LPORT RPORT OPEN ALW
a2 2305 A A M2PA 7205 7001 NO NO

IP Appl Sock/Assoc table is (4 of 4000) 1% full
Assoc Buffer Space Used (200 KB of 1600 KB) on LOC = 2305
  
```

```
rtrv-assoc:lhost=ipnode2-1201
```

The following is an example of the possible output.

```

rlghncxa03w 06-10-28 21:14:37 GMT EAGLE5 36.0.0
CARD IPLNK
ANAME LOC PORT LINK ADAPTER LPORT RPORT OPEN ALW
m3ua1 2101 A A M3UA 2000 2000 NO NO

IP Appl Sock/Assoc table is (4 of 4000) 1% full
Assoc Buffer Space Used (16 KB of 800 KB) on LOC = 2101
  
```

If no associations referencing the host name being removed in this procedure are shown in this step, continue the procedure with [5](#).

Any associations referencing the host name must either be removed or the host name assigned to the association must be changed.

To remove the associations, perform the [Removing an IP SG Association](#) procedure.

Continue the procedure with [5](#) after the associations have been removed.

To change the host name assigned to the associations, perform the [Changing the Host Values of an IPSP Association](#) procedure.

Continue the procedure with [5](#) after the host name assigned to the associations have been changed.

5. Delete **IP** host information from the database by entering the `dlt-ip-host` command.

For example, enter these commands.

```
dlt-ip-host:host=gw100.nc.tekelec.com
dlt-ip-host:host="ipnode2-1201"
```

When these commands have successfully completed, the following message should appear.

```
rlghncxa03w 06-10-28 21:19:37 GMT EAGLE5 36.0.0
DLT-IP-HOST: MASP A - COMPLTD
```

6. Verify the changes by entering the `rtrv-ip-host` command with the host name specified in [5](#).

For this example, enter these commands.

```
rtrv-ip-host:host=gw100.nc.tekelec.com
rtrv-ip-host:host="ipnode2-1201"
```

The following is an example of the possible output.

```
rlghncxa03w 13-06-28 21:20:37 GMT EAGLE5 45.0.0

No matching entries found.

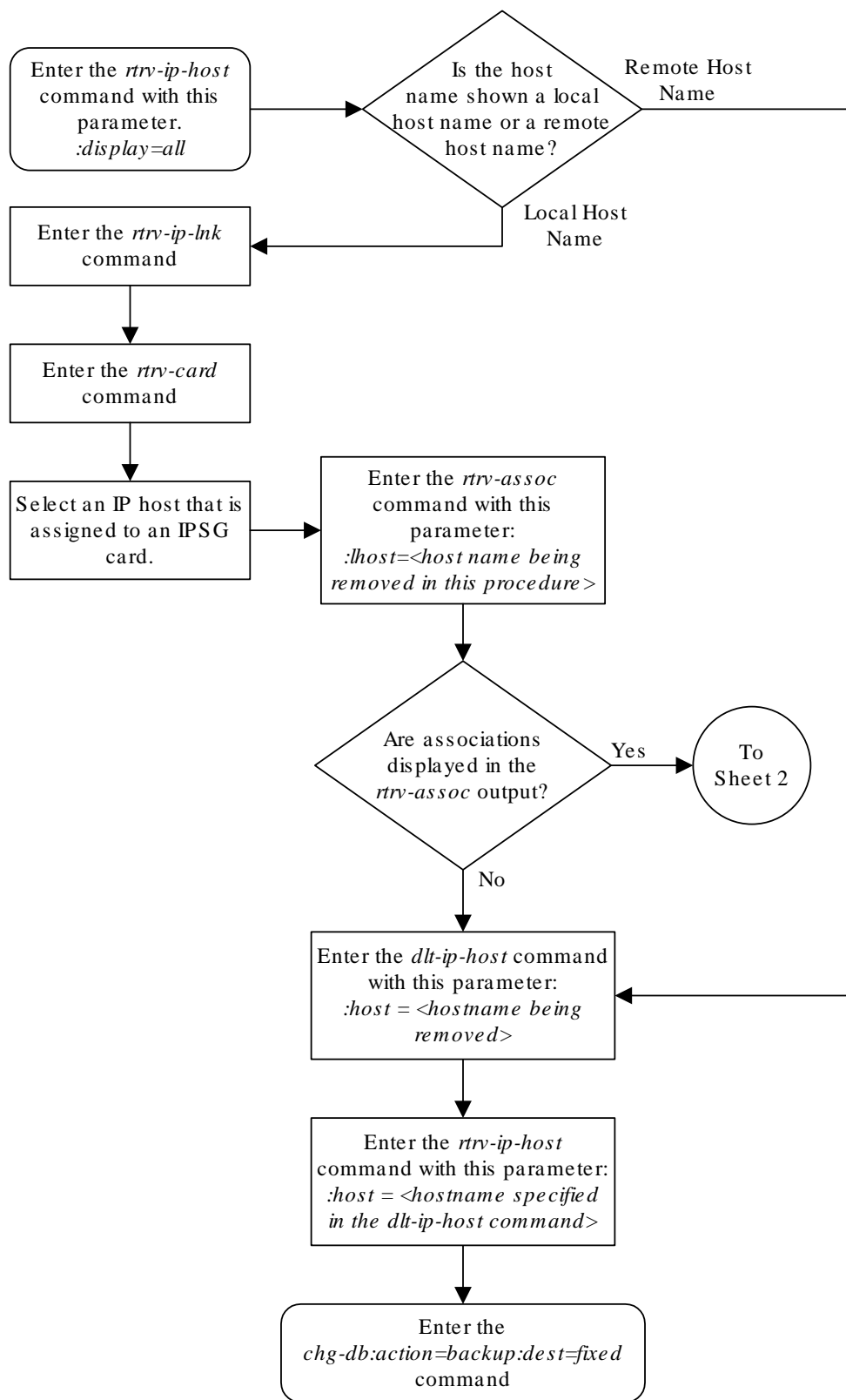
IP Host table is (10 of 4096) .24% full
```

7. Back up the new changes using the `chg-db:action=backup:dest=fixed` command.

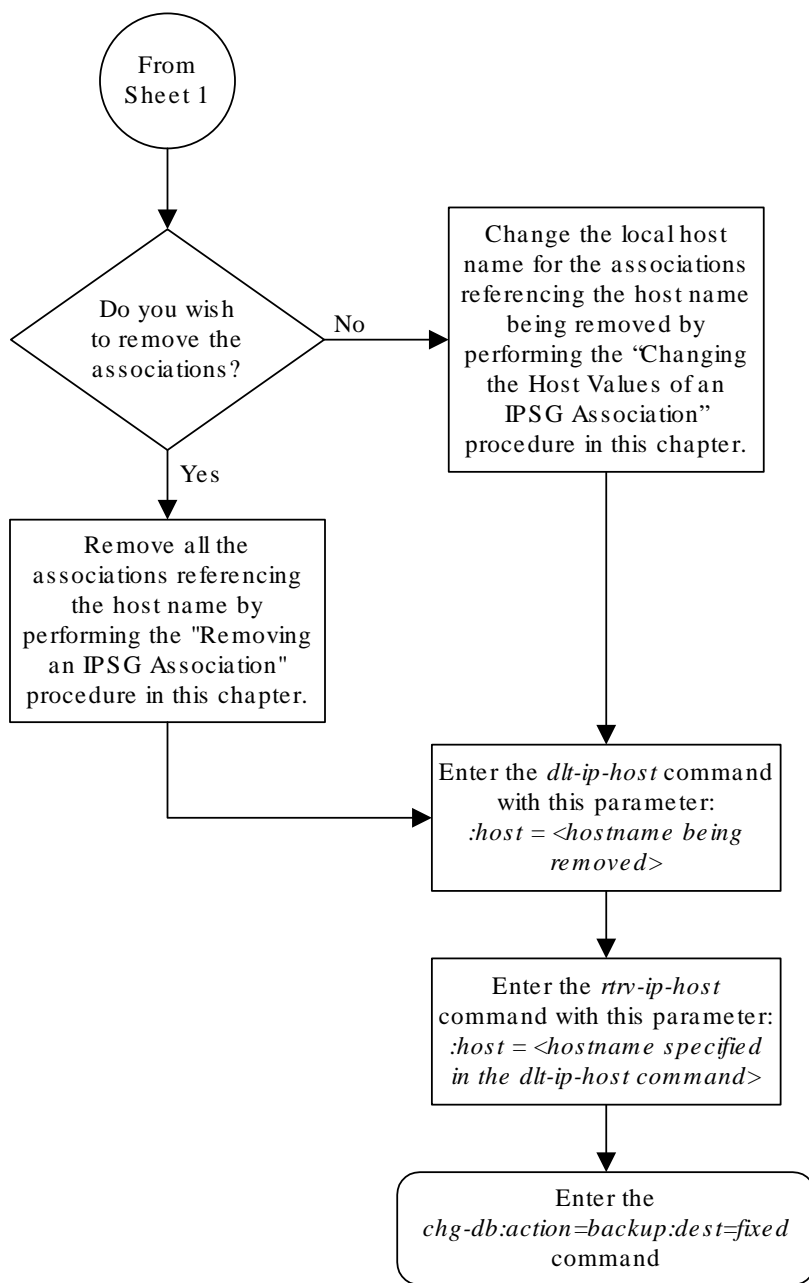
These messages should appear, the active **Maintenance and Administration Subsystem Processor (MASP)** appears first.

```
BACKUP (FIXED) : MASP A - Backup starts on active MASP.
BACKUP (FIXED) : MASP A - Backup on active MASP to fixed disk complete.
BACKUP (FIXED) : MASP A - Backup starts on standby MASP.
BACKUP (FIXED) : MASP A - Backup on standby MASP to fixed disk complete.
```

Figure 6-16 Removing an IP Host Assigned to an IP SG Card



Sheet 1 of 2



Sheet 2 of 2

6.19 Removing an IP Route

This procedure is used to remove an **IP** route from the database using the `dlt-ip-rte` command.

The `dlt-ip-rte` command uses these parameters.

`:loc` – The location of the **IP** card containing the **IP** route being removed.

`:dest` – The **IP** address of the remote host or network assigned to the **IP** route being removed.

`:force` – To remove the **IP** route, the **IP** card that the route is assigned to must be out of service, or the `force=yes` parameter must be specified with the `dlt-ip-rte` command. The `force=yes` parameter allows the **IP** route to be removed if the **IP** card is in service.

▲ Caution:

Removing an **IP** route while the **IP** card is still in service can result in losing the ability to route outbound **IP** traffic on the **IP** card. This can cause both **TCP** and **SCTP** sessions on the **IP** card to be lost.

1. Display the **IP** routes in the database with the `rtrv-ip-rte` command.

This is an example of the possible output.

```
rlghncxa03w 06-10-28 09:12:36 GMT EAGLE5 36.0.0
LOC  DEST          SUBMASK          GTWY
1212 132.10.175.20    255.255.0.0      150.1.1.50
1301 128.252.10.5     255.255.255.255  140.188.13.33
1301 128.252.0.0      255.255.0.0      140.188.13.34
1301 150.10.1.1       255.255.255.255  140.190.15.3
1303 192.168.10.1     255.255.255.255  150.190.15.23
1303 192.168.0.0      255.255.255.0    150.190.15.24
```

```
IP Route table is (6 of 2048) 0.29% full
```

2. Verify the state of the **IP** card containing the **IP** route being removed by entering the `rept-stat-card` command and specifying the card location of the **IP** card.

The **IP** card should be in the out-of-service maintenance-disabled (**OOS-MT-DSBLD**) in order to remove the **IP** route. If the **IP** card's state is out-of-service maintenance-disabled, the entry **OOS-MT-DSBLD** is shown in the **PST** column of the `rept-stat-card` output.

For this example, enter this command.

```
rept-stat-card:loc=1301
```

This is an example of the possible output.

```
rlghncxa03w 10-12-01 09:12:36 GMT EAGLE5 43.0.0
```

```

CARD   VERSION   TYPE   GPL   PST   SST
AST
1301  133-003-000  E5ENET  IPST  IS-NR  Active
-----
ALARM STATUS      = No Alarms.
BLIXP  GPL version = 133-003-000
IMT BUS A        = Conn
IMT BUS B        = Conn
CURRENT TEMPERATURE = 32C ( 90F)    [ALARM TEMP: 60C (140F)]
PEAK TEMPERATURE: = 39C (103F)    [06-05-02 13:40]
SIGNALING LINK STATUS
      SLK   PST           LS           CLLI
      A    IS-NR        nc001        -----

```

Command Completed.

 **Note:**

If the output of 2 shows that the **IP** card's state is not **OOS-MT-DSBLD**, and you do not wish to change the state of the **IP** card, continue the procedure with 4.

3. Change the **IP** card's state to **OOS-MT-DSBLD** using the `inh-card` command and specifying the card location of the **IP** card.

For this example, enter these commands.

```
inh-card:loc=1301
```

When this command has successfully completed, this message appears.

```
rlghncxa03w 06-10-12 09:12:36 GMT EAGLE5 36.0.0
Card has been inhibited.
```

4. Remove the **IP** route from the database using the `dlt-ip-rte` command.

If the state of the **IP** card is not **OOS-MT-DSBLD**, the `force=yes` parameter must be specified with the `dlt-ip-rte` command. For this example, enter this command.

```
dlt-ip-rte:loc=1301:dest=128.252.0.0
```

 **Caution:**

Removing an **IP** route while the **IP** card is still in service can result in losing the ability to route outbound **IP** traffic on the **IP** card. This can cause both **TCP** and **SCTP** sessions on the **IP** card to be lost.

When this command has successfully completed, this message should appear.

```
rlghncxa03w 06-10-12 09:12:36 GMT EAGLE5 36.0.0
DLT-IP-RTE: MASP A - COMPLTD
```

5. Verify the changes using the `rtrv-ip-rte` command.

This is an example of the possible output.

```
rlghncxa03w 06-10-28 09:12:36 GMT EAGLE5 36.0.0
LOC  DEST          SUBMASK          GTWY
1212 132.10.175.20   255.255.0.0     150.1.1.50
1301 128.252.10.5    255.255.255.255 140.188.13.33
1301 150.10.1.1      255.255.255.255 140.190.15.3
1303 192.168.10.1    255.255.255.255 150.190.15.23
1303 192.168.0.0     255.255.0.0     150.190.15.24
```

```
IP Route table is (5 of 2048) 0.24% full
```

6. Place the **IP** card back into service by using the `alw-card` command.

 **Note:**

If the **IP** card containing the **IP** route that was removed from the database does not contain other **IP** routes, continue the procedure with 7.

For example, enter this command.

```
alw-card:loc=1301
```

This message should appear.

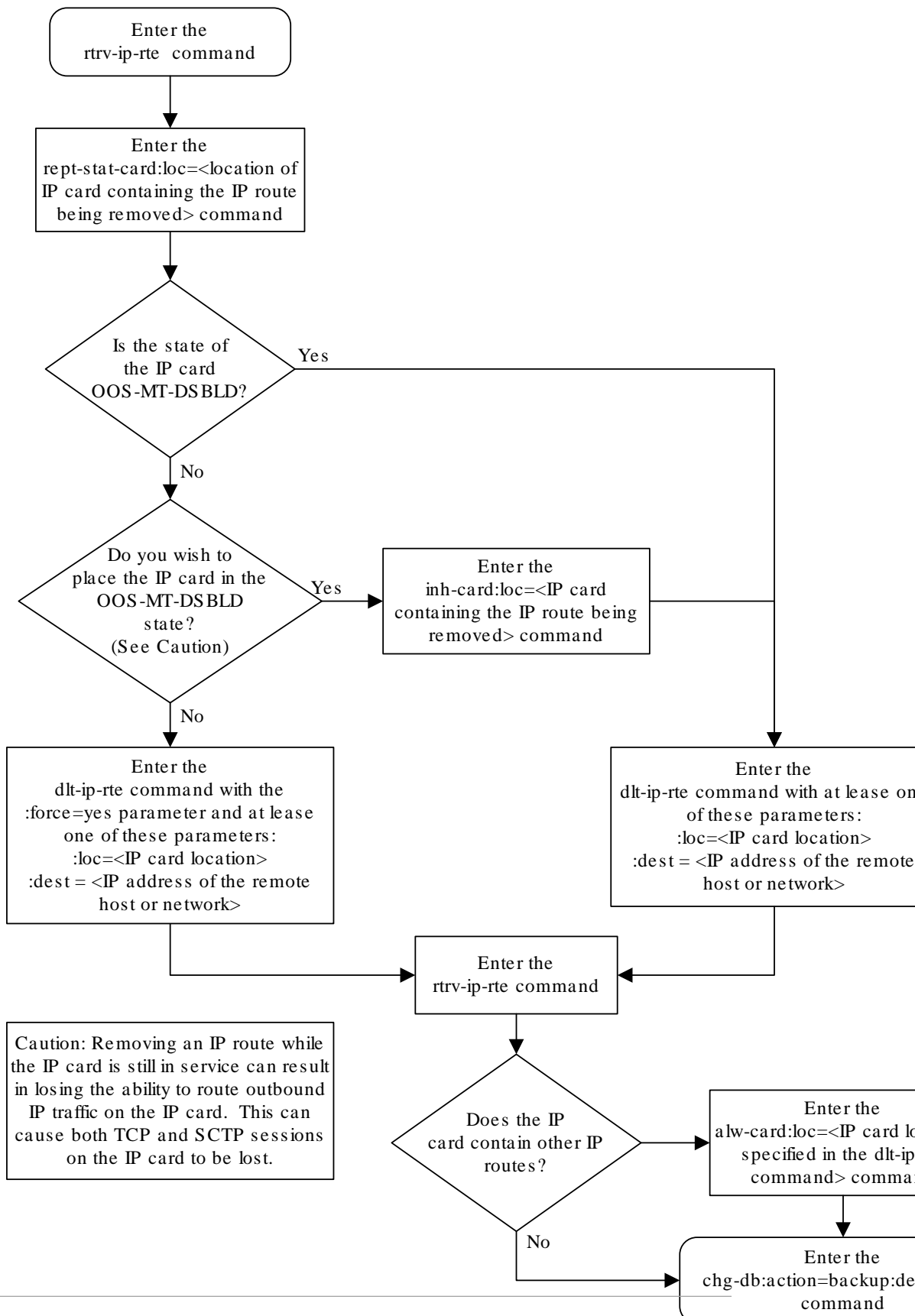
```
rlghncxa03w 06-10-28 21:22:37 GMT EAGLE5 36.0.0
Card has been allowed.
```

7. Back up the new changes using the `chg-db:action=backup:dest=fixed` command.

These messages should appear, the active **Maintenance and Administration Subsystem Processor (MASP)** appears first.

```
BACKUP (FIXED) : MASP A - Backup starts on active MASP.
BACKUP (FIXED) : MASP A - Backup on active MASP to fixed disk complete.
BACKUP (FIXED) : MASP A - Backup starts on standby MASP.
BACKUP (FIXED) : MASP A - Backup on standby MASP to fixed disk complete.
```

Figure 6-17 Removing an IP Route



6.20 Removing an IPSG Association

This procedure is used to remove an IPSG association from the database using the `dlt-assoc` command. An IPSG association is an M2PA or M3UA association that is assigned to an IPSG card.

The `dlt-assoc` command uses one parameter, `aname`, the name of the association being removed from the database. The association being removed must be in the database.

The `open` parameter must be set to `no` before the association can be removed. Use the `chg-assoc` command to change the value of the `open` parameter.

The `adapter` value assigned to the association being removed in this procedure must be either `m2pa` or `m3ua`. The application assigned to the card that is hosting the association must be IPSG.

If the `adapter` value of the association is `m2pa` and the application assigned to the card is either IPLIM or IPLIMI (an IPLIMx card), perform the [Removing an M2PA Association](#) to remove an M2PA association assigned to an IPLIMx card.

If the `adapter` value of the association is `m3ua` and the application assigned to the card is either SS7IPGW or IPGWI (an IPGWx card), perform the [Removing a M3UA or SUA Association](#) to remove an M3UA association assigned to an IPGWx card.

Canceling the RTRV-ASSOC Command

Because the `rtrv-assoc` command used in this procedure can output information for a long period of time, the `rtrv-assoc` command can be canceled and the output to the terminal stopped. There are three ways that the `rtrv-assoc` command can be canceled.

- Press the F9 function key on the keyboard at the terminal where the `rtrv-assoc` command was entered.
- Enter the `canc-cmd` without the `trm` parameter at the terminal where the `rtrv-assoc` command was entered.
- Enter the `canc-cmd:trm=<xx>`, where `<xx>` is the terminal where the `rtrv-assoc` command was entered, from another terminal other than the terminal where the `rtrv-assoc` command was entered. To enter the `canc-cmd:trm=<xx>` command, the terminal must allow Security Administration commands to be entered from it and the user must be allowed to enter Security Administration commands. The terminal's permissions can be verified with the `rtrv-secu-trm` command. The user's permissions can be verified with the `rtrv-user` or `rtrv-secu-user` commands.

For more information about the `canc-cmd` command, go to *Commands User's Guide*.

1. Display the associations in the database using the `rtrv-assoc` command.

This is an example of possible output.

```
rlghncxa03w 06-10-28 09:12:36 GMT EAGLE5 36.0.0
```

ANAME	CARD		LINK	ADAPTER	LPORT	RPORT	OPEN	ALW
	LOC	PORT						
swbel32	1201	A	A	M3UA	1030	2345	YES	YES
a2	1305	A	A	SUA	1030	2345	YES	YES

```
a3          1307 A    A    SUA    1030 2346 YES YES
assoc1     1203 A    A1   M2PA   2048 1030 NO  NO
```

Select an association whose `ADAPTER` value is either `M3UA` or `M2PA`.

2. Enter the `rtrv-card` command with the location of the card that is hosting the association that will be removed in this procedure. For this example, enter these commands.

```
rtrv-card:loc=1201
```

This is an example of possible output.

```
rlghncxa03w 08-03-06 15:17:20 EST EAGLE5 38.0.0
CARD  TYPE      APPL      LSET NAME   LINK SLC LSET NAME   LINK SLC
1201  ENET        IPSG      lsn2        A    0
```

```
rtrv-card:loc=1203
```

This is an example of possible output.

```
rlghncxa03w 08-03-06 15:17:20 EST EAGLE5 38.0.0
CARD  TYPE      APPL      LSET NAME   LINK SLC LSET NAME   LINK SLC
1203  ENET        IPSG      lsn1        A1   0
```

If the application assigned to the card is `IPSG`, shown in the `APPL` column, and signaling links are not assigned to the card, continue the procedure with [3](#).

If the application assigned to the card is `IPSG`, shown in the `APPL` column, and signaling links are assigned to the card, perform one of these procedures depending on the `ADAPTER` value that is assigned to the association that will be removed.

- If the `ADAPTER` value is `M2PA`, perform the [Removing an IPSG M2PA Signaling Link](#) procedure.
- If the `ADAPTER` value is `M3UA`, perform the [Removing an IPSG M3UA Signaling Link](#) procedure.

After the signaling links have been removed from the card, continue the procedure with [3](#).

If the application assigned to the card is `IPLIM` or `IPLIMI`, perform the [Removing an M2PA Association](#) procedure.

If the application assigned to the card is `SS7IPGW` or `IPGWI`, perform the [Removing a M3UA or SUA Association](#) procedure.

3. Change the value of the `open` parameter to `no` by specifying the `chg-assoc` command with the `open=no` parameter.

 **Note:**

If the value of the `open` parameter for the association being removed from the database (shown in 1) is `no`, continue this procedure with 4.

For this example, enter these commands.

```
chg-assoc:aname=assoc1:open=no
chg-assoc:aname=swbel32:open=no
```

When the `chg-assoc` command has successfully completed, this message should appear.

```
rlghncxa03w 06-10-28 09:12:36 GMT EAGLE5 36.0.0
CHG-ASSOC: MASP A - COMPLTD;
```

4. Remove the association from the database using the `dlt-assoc` command.

For this example, enter these commands.

```
dlt-assoc:aname=assoc1
dlt-assoc:aname=swbel32
```

When this command has successfully completed, this message should appear.

```
rlghncxa03w 06-10-28 09:12:36 GMT EAGLE5 36.0.0
DLT-ASSOC: MASP A - COMPLTD
```

5. Verify the changes using the `rtrv-assoc` command with the name of the association specified in 4.

For this example, enter these commands.

```
rtrv-assoc:aname=assoc1
rtrv-assoc:aname=swbel32
```

This is an example of possible output.

```
rlghncxa03w 06-10-28 09:12:36 GMT EAGLE5 36.0.0

No matching entries found

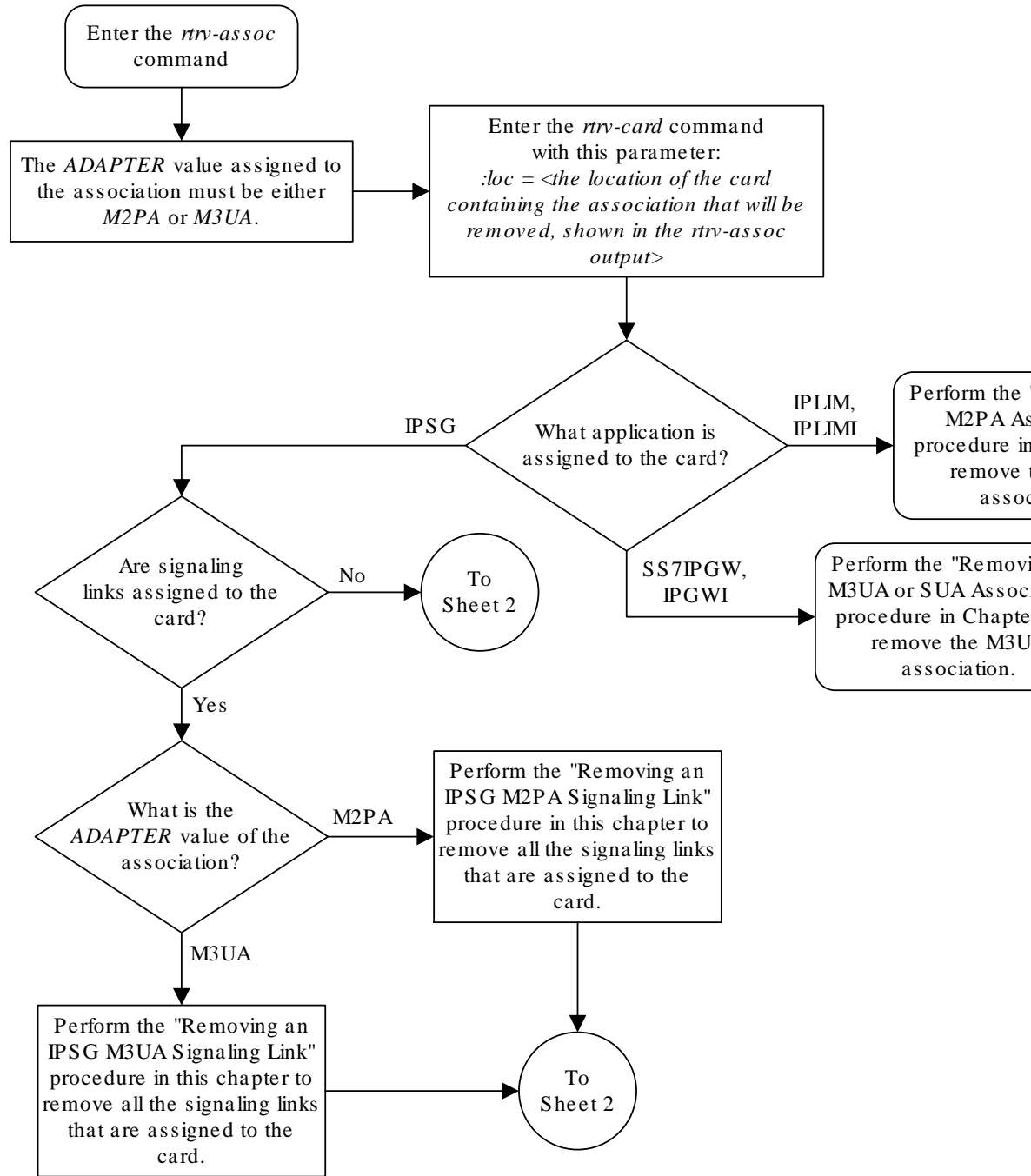
IP Appl Sock table is (2 of 4000) 1% full
```

6. Back up the new changes, using the `chg-db:action=backup:dest=fixed` command. These messages should appear; the active **Maintenance and Administration Subsystem Processor (MASP)** appears first.

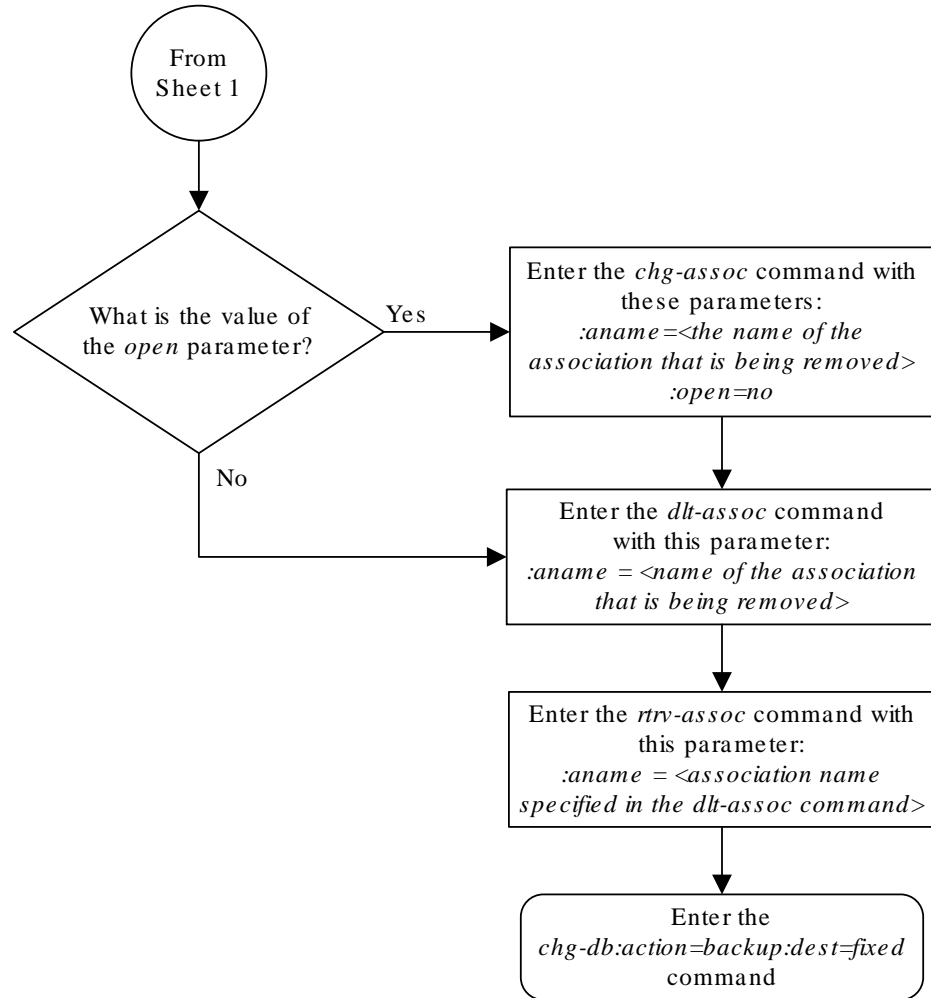
```
BACKUP (FIXED) : MASP A - Backup starts on active MASP.
BACKUP (FIXED) : MASP A - Backup on active MASP to fixed disk complete.
```

```
BACKUP (FIXED) : MASP A - Backup starts on standby MASP.  
BACKUP (FIXED) : MASP A - Backup on standby MASP to fixed disk  
complete.
```

Figure 6-18 Removing an IPSG Association



Sheet 1 of 2



Sheet 2 of 2

6.21 Removing an IPSP M2PA Signaling Link

This procedure is used to remove an **IPSP** M2PA signaling link from the database using the `dlt-slk` command. The `dlt-slk` command uses these parameters.

`:loc` – The card location of the **IPSP** card that the **IPSP** M2PA signaling link is assigned to.

`:link` – The signaling link on the card specified in the `loc` parameter.

`:force` – This parameter must be used to remove the last link in a linkset without having to remove all of the routes that referenced the linkset.

The `tfatcabmlq` parameter (**TFA/TCA Broadcast Minimum Link Quantity**), assigned to linksets, shows the minimum number of links in the given linkset (or in the combined link set in which it resides) that must be available for traffic. When the number of signaling links in the specified linkset is equal to or greater than the value of the `tfatcabmlq` parameter, the status of the routes that use the specified linkset is set to allowed and can carry traffic. Otherwise, these routes are restricted. The value of the `tfatcabmlq` parameter cannot exceed the total number of signaling links contained in the linkset.

If the linkset type of the linkset that contains the signaling link that is being removed is either A, B, D, E, or PRX, the signaling link can be removed regardless of the `tfatcabmlq` parameter value of the linkset and regardless of the `LSRESTRICT` option value. When a signaling link in one of these types of linksets is removed, the `tfatcabmlq` parameter value of the linkset is decreased automatically.

If the linkset type of the linkset that contains the signaling link that is being removed is C, the signaling link can be removed only:

- If the `LSRESTRICT` option is off. The `LSRESTRICT` option value is shown in the `rtrv-ss7opts` output.
- If the `LSRESTRICT` option is on and the number of signaling links assigned to the linkset will be equal to or greater than the value of the `tfatcabmlq` parameter value of the linkset after the signaling link is removed.
The `tfatcabmlq` parameter value of the linkset is shown in the `TFATCABMLQ` column of the `rtrv-ls:lsn=<linkset name>` output. The `tfatcabmlq` parameter value can be a fixed value (1 to 16) or 0. If the `tfatcabmlq` parameter value of the linkset is a fixed value, the number of signaling links that are in the linkset after the signaling link is removed must be equal to or greater than the `tfatcabmlq` parameter value of the linkset.

If the `tfatcabmlq` parameter value is 0, the signaling link can be removed. When the `tfatcabmlq` parameter value is 0, the value displayed in the `TFATCABMLQ` column of the `rtrv-ls` output is 1/2 of the number of signaling links contained in the linkset. If the number of signaling links in the linkset is an odd number, the `tfatcabmlq` parameter value is rounded up to the next whole number. As the signaling links are removed, the `tfatcabmlq` parameter value of the linkset is decreased automatically.

Canceling the `RTRV-SLK` Command

Because the `rtrv-slk` command used in this procedure can output information for a long period of time, the `rtrv-slk` command can be canceled and the output to the terminal stopped. There are three ways that the `rtrv-slk` command can be canceled.

- Press the F9 function key on the keyboard at the terminal where the `rtrv-slk` command was entered.
- Enter the `canc-cmd` without the `trm` parameter at the terminal where the `rtrv-slk` command was entered.
- Enter the `canc-cmd:trm=<xx>`, where `<xx>` is the terminal where the `rtrv-slk` command was entered, from another terminal other than the terminal where the `rtrv-slk` command was entered. To enter the `canc-cmd:trm=<xx>` command, the terminal must allow Security Administration commands to be entered from it and the user must be allowed to enter Security Administration commands. The terminal's permissions can be verified with the `rtrv-secu-trm` command. The user's permissions can be verified with the `rtrv-user` or `rtrv-secu-user` commands.

For more information about the `canc-cmd` command, go to *Commands User's Guide*.

1. Display the IPSP signaling links by entering this command.

```
rtrv-slk:type=ipsg
```

This is an example of the possible output.

```
rlghncxa03w 06-10-19 21:16:37 GMT EAGLE5 36.0.0
```

LOC	LINK	LSN	SLC	TYPE	ANAME	SLKTPS
2202	A	lsnlp1	0	IPSP	assoc2	500
2205	A	lsnip1	1	IPSP	assoc3	500
2204	A	ls04	0	IPSP	assoc1	500
2213	A	lsnip5	0	IPSP	assoc4	750
2215	A	lsnlp2	1	IPSP	assoc5	1000

2. Display the associations assigned to the IPSP card containing the signaling link that will be removed by entering the `rtrv-assoc` command and specifying the card location of the IPSP card. For this example, enter this command.

For this example, enter this command.

```
rtrv-assoc:loc=2204
```

This is an example of possible output.

```
rlghncxa03w 06-10-28 09:12:36 GMT EAGLE5 36.0.0
```

```

CARD IPLNK
ANAME          LOC  PORT  LINK ADAPTER LPORT RPORT OPEN ALW
assoc1         2204 A    A    M2PA   1030 1030 YES  YES

```

```
IP Appl Sock/Assoc table is (4 of 4000) 1% full
```

```
Assoc Buffer Space Used (16 KB of 3200 KB) on LOC = 2204
```

If the `ADAPTER` value of the associations shown in this step is `M2PA`, continue the procedure with **3**.

If the ADAPTER value for the associations is M3UA, perform one of these actions.

- If you wish to remove the signaling link assigned to this card, perform the [Removing an IPSP M3UA Signaling Link](#).
 - If you do not wish to remove the signaling link assigned to this card, select another card from 1 and repeat this step.
3. Display the linkset that contains the signaling link that is being removed by entering the `rtrv-ls` command with the name of the linkset shown in the LSN column of the `rtrv-slk` output.

For this example, enter these commands.

```
rtrv-ls:lsn=ls04
```

This is an example of the possible output.

```
rlghncxa03w 10-07-17 11:43:04 GMT EAGLE5 42.0.0

LSN          APCA   (SS7)   L3T SLT          GWS GWS GWS
SLSCI NIS    SCRNR SET SET BEI LST LNKS ACT MES DIS
ls04         002-009-003 scr2 1 1 no a 1 on off on
no off

          SPCA          CLLI          TFATCABMLQ MTPRSE ASL8
-----
          1          no          no

RANDSLS
off

IPSP IPGWAPC GTTMODE          CGGTMOD
yes  no      CdPA          no

ADAPTER  RSVDSLKTPS  MAXSLKTPS
m2pa    1000      4000

TPSALM  LSUSEALM  SLKUSEALM
rsvdslktps 100%    100%

LOC LINK SLC TYPE ANAME
2204 A 0 IPSP m2pa2
```

Link set table is (20 of 1024) 2% full

If the linkset type of the linkset is A, B, D, E, or PRX, continue the procedure by performing one of these steps.

- If the OPEN or ALW values for the associations is YES, continue the procedure with 6.
- If the OPEN and ALW values for the associations is NO, continue the procedure with 7.

If the linkset type of the linkset is C, continue the procedure with 4.

4. Display the LSRESTRICT option value by entering the `rtrv-ss7opts` command.

This is an example of the possible output.

```
rlghncxa03w 10-07-30 15:09:00 GMT 42.0.0

SS7 OPTIONS
-----
LSRESTRICT      on
```

 **Note:**

The `rtrv-feat` command output contains other fields that are not used by this procedure. If you wish to see all the fields displayed by the `rtrv-feat` command, refer to the `rtrv-feat` command description in *Commands User's Guide*.

The signaling link cannot be removed, if the `LSRESTRICT` option is `on` and the number of signaling links assigned to the linkset will be less than the value of the `tfatcabmlq` parameter value of the linkset if the signaling link is removed.

If the `LSRESTRICT` option is `on` and the number of signaling links assigned to the linkset will be less than the value of the `tfatcabmlq` parameter value of the linkset if the signaling link is removed, the signaling link cannot be removed unless the `tfatcabmlq` parameter value of the linkset is changed to 0. Continue the procedure with 5.

If the `LSRESTRICT` option is `on` and the number of signaling links assigned to the linkset will be equal to or greater than the value of the `tfatcabmlq` parameter value of the linkset if the signaling link is removed, the "Configuring the Restricted Linkset Option" procedure has been performed, or if the `LSRESTRICT` value is `off`, continue the procedure by performing one of these steps.

- If the `OPEN` or `ALW` values for the associations is `YES`, continue the procedure with 6.
 - If the `OPEN` and `ALW` values for the associations is `NO`, continue the procedure with 7.
5. Change the `tfatcabmlq` parameter value of the linkset to 0 by entering the `chg-ls` command with the name of the linkset that contains the signaling link that is being removed and the `tfatcabmlq` parameters. For this example, enter this command.

```
chg-ls:lsn=ls17:tfatcabmlq=0
```

When this command has successfully completed, this message should appear.

```
rlghncxa03w 10-07-07 08:41:12 GMT EAGLE5 42.0.0

Link set table is (20 of 1024) 2% full.

CHG-LS: MASP A - COMPLTD
```

Continue the procedure by performing one of these steps.

- If the `OPEN` or `ALW` values for the associations is `YES`, continue the procedure with 6.
- If the `OPEN` and `ALW` values for the associations is `NO`, continue the procedure with 7.

- Change the value of the `open` and `alw` parameters to `no` by specifying the `chg-assoc` command with the `open=no` and `alw=no` parameters, as necessary.

For this example, enter this command.

```
chg-assoc:aname=assoc1:open=no:alw=no
```

When this command has successfully completed, this message should appear.

```
rlghncxa03w 06-10-28 09:12:36 GMT EAGLE5 36.0.0
CHG-ASSOC: MASP A - COMPLTD;
```

- Deactivate the link to be removed using the `dact-slk` command, using the output from [1](#) to obtain the card location and `link` parameter value of the signaling link to be removed.

For this example, enter these commands.

```
dact-slk:loc=2204:link=a
```

When this command has successfully completed, this message should appear.

```
rlghncxa03w 06-10-07 08:41:12 GMT EAGLE5 36.0.0
Deactivate Link message sent to card
```

- Verify that the link is out of service - maintenance disabled (**OOS-MT-DSBLD**) using the `rept-stat-slk` command with the card location and `link` parameter values specified in [7](#).

For this example, enter this command.

```
rept-stat-slk:loc=2204:link=a
```

This is an example of the possible output.

```
rlghncxa03w 06-10-23 13:06:25 GMT EAGLE5 36.0.0
SLK      LSN      CLLI      PST      SST      AST
2204,A   ls04      ls04clli  OOS-MT   Unavail  ----
  ALARM STATUS      = *    0235 REPT-LNK-MGTINH: local inhibited
  UNAVAIL REASON    = LI
```

- If the signaling link to be removed is the last signaling link on a card, the card must be inhibited before the signaling link is removed.

 **Note:**

If the signaling link being removed is not the last signaling link on the card, continue the procedure with [11](#).

Enter the `rmv-card` command and specify the location of the card to be inhibited. The card location is shown in the output of `rept-stat-slk` command executed in [8](#).

In the example used for this procedure, the signaling link is the last signaling link on the card and must be inhibited. Enter this command.

```
rmv-card:loc=2204
```

When each of these command has successfully completed, this message should appear.

```
rlghncxa03w 06-10-07 08:41:12 GMT EAGLE5 36.0.0
Card has been inhibited.
```

- Verify that the card has been inhibited by entering the `rept-stat-card` command with the card location specified in 9. For this example, enter this command.

```
rept-stat-card:loc=2204
```

This is an example of the possible output.

```
rlghncxa03w 10-12-01 09:12:36 GMT EAGLE5 43.0.0
CARD   VERSION      TYPE      GPL      PST      SST      AST
2204   133-003-000    E5ENET   IPSP     OOS-MT-DSBLD  Isolated  -----
  ALARM STATUS      = No Alarms.
  BLIXP  GPL version = 133-003-000
  IMT BUS A          = Disc
  IMT BUS B          = Disc
  CURRENT TEMPERATURE = 32C ( 90F)   [ALARM TEMP: 60C (140F)]
  PEAK TEMPERATURE:  = 39C (103F)   [06-05-02 13:40]
  SIGNALING LINK STATUS
    SLK   PST      LS      CLLI
    A     OOS-MT   lsnlp2  -----
```

Command Completed.

- Display the linkset that contains the signaling link that is being removed by entering the `rtrv-ls` command with the name of the linkset shown in the `LSN` column in 10. For this example, enter this command.

```
rtrv-ls:lsn=ls04
```

This is an example of the possible output.

```
rlghncxa03w 08-05-27 16:43:42 GMT EAGLE5 38.0.0

LSN          APCA  (SS7)  SCRN SET SET BEI LST LNKS ACT MES DIS SLSCI
NIS
ls04         001-001-003  none 1  1  no  A  1  off off off no
off

          SPCA          CLLI          TFATCABMLQ MTPRSE ASL8
          -----
          1          no          no

IPSP  IPGWAPC  GTTMODE          CGGTMOD
yes   no      CdPA          no

ADAPTER  SLKTPS  LSUSEALM  SLKUSEALM  RCONTEXT  ASNOTIF
```

```

m2pa      500      100%      80%      none      no

LOC LINK SLC TYPE      ANAME
1102 A   2   IPSG      assoc1

```

Link set table is (22 of 1024) 2% full.

- Remove the signaling link from the **EAGLE** using the `dlt-slk` command.

If there is only one signaling link in the linkset, shown in [11](#), the `force=yes` parameter must be specified to remove the signaling link.

In the example used in this procedure, the signaling link is the last signaling link in the linkset. Enter this command.

```
dlt-slk:loc=2204:link=a:force=yes
```

When this command has successfully completed, this message should appear.

```

rlghncxa03w 06-10-07 08:41:17 GMT EAGLE5 36.0.0
DLT-SLK: MASP A - COMPLTD

```

 **Note:**

If removing the signaling link will result in 700 or less signaling links in the database and the `OAMHCMEAS` value in the `rtrv-measopts` output is on, the scheduled UI measurement reports will be enabled.

- Verify the changes using the `rtrv-slk` command with the card location and link values specified in [12](#). For this example, enter this command.

```
rtrv-slk:loc=2204:link=a
```

When the `rtrv-slk` command has completed, the specified signaling link is not shown in the `rtrv-slk` output, as shown in this example.

```

rlghncxa03w 09-09-18 13:43:31 GMT EAGLE5 41.1.0
E2373 Cmd Rej: Link is unequipped in the database

```

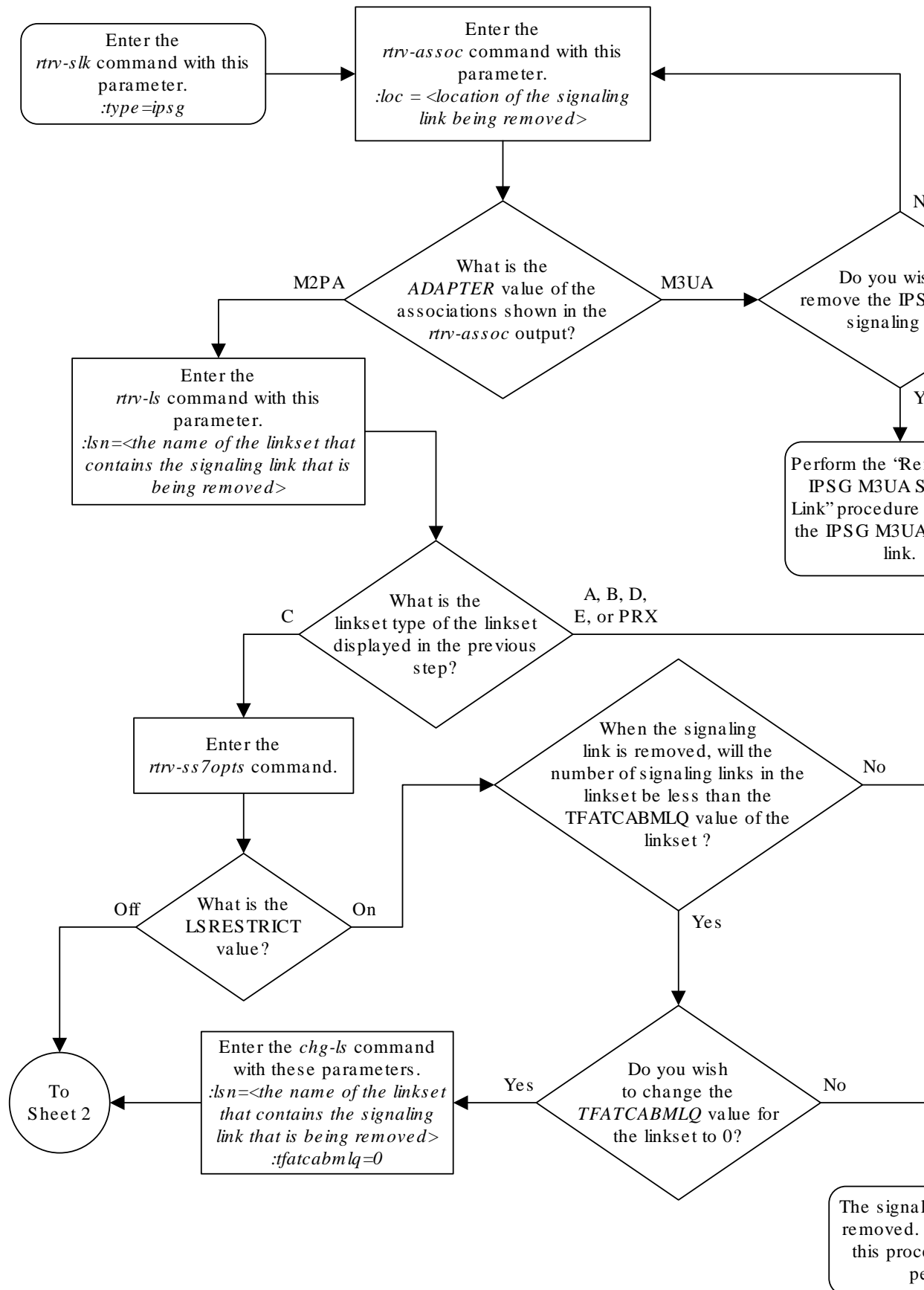
- Back up the new changes using the `chg-db:action=backup:dest=fixed` command. These messages should appear, the active **Maintenance and Administration Subsystem Processor (MASP)** appears first.

```

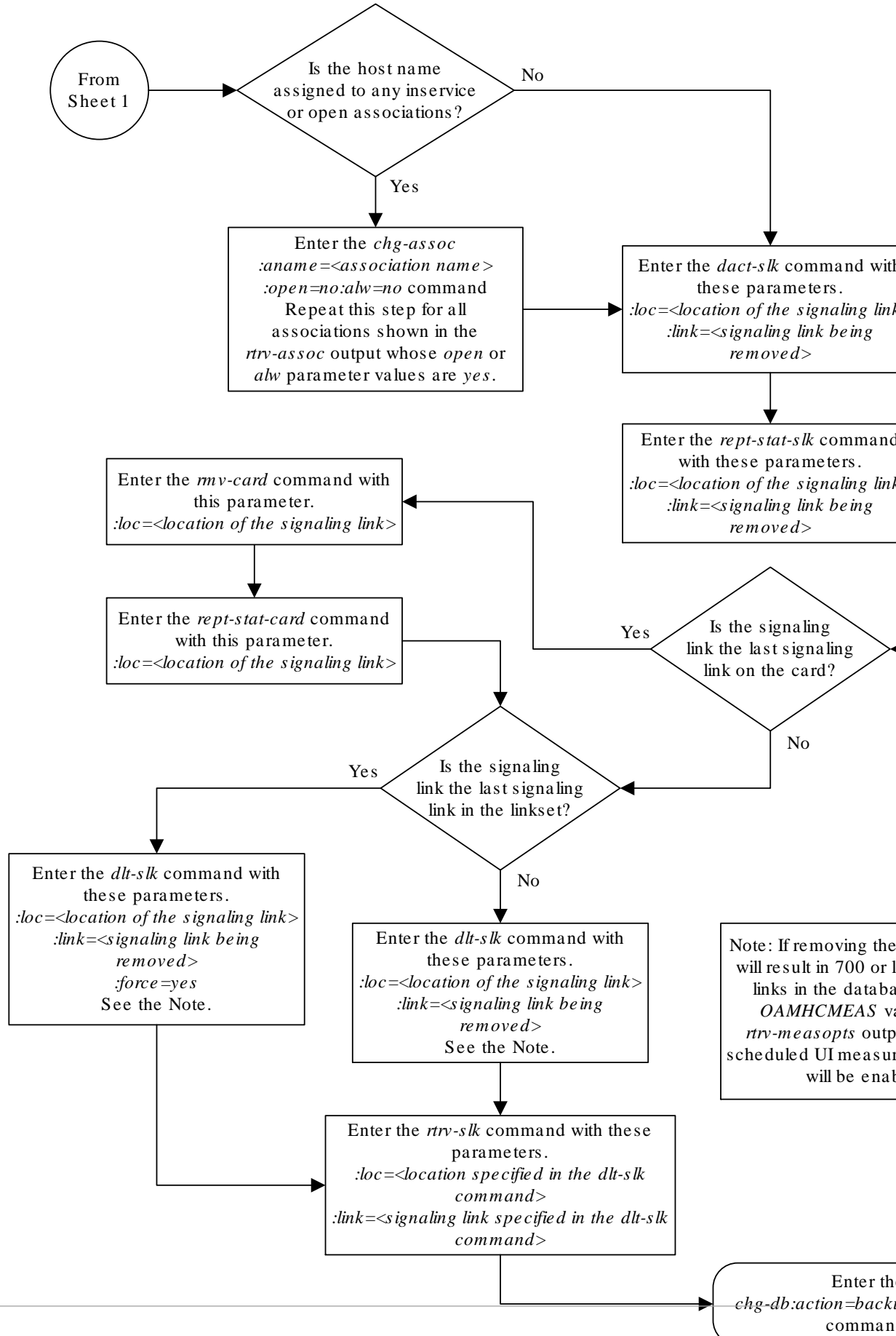
BACKUP (FIXED) : MASP A - Backup starts on active MASP.
BACKUP (FIXED) : MASP A - Backup on active MASP to fixed disk
complete.
BACKUP (FIXED) : MASP A - Backup starts on standby MASP.
BACKUP (FIXED) : MASP A - Backup on standby MASP to fixed disk
complete.

```

Figure 6-19 Removing an IPSP M2PA Signaling Link



Sheet 1 of 2



Note: If removing the signaling link will result in 700 or less signaling links in the database, the OAMHCMEAS v3 and rtrv-measopts output will be scheduled UI measurement will be enabled.

6.22 Removing an IPSP M3UA Signaling Link

This procedure is used to remove an **IPSP** M3UA signaling link from the database using the `dlt-slk` command. The `dlt-slk` command uses these parameters.

`:loc` – The card location of the **IPSP** card that the **IPSP** M3UA signaling link is assigned to.

`:link` – The signaling link on the card specified in the `loc` parameter.

`:force` – This parameter must be used to remove the last link in a linkset without having to remove all of the routes that referenced the linkset.

The IPSP M3UA signaling link cannot be removed if removing the IPSP M3UA signaling link will cause the number of IS-NR IPSP M3UA signaling links in the linkset to be less than the `NUMSLKALW`, `NUMSLKRSTR`, or `NUMSLKPROH` values shown in the `rtrv-ls` output. The `NUMSLKALW`, `NUMSLKRSTR`, and `NUMSLKPROH` values are defined as follows.

- `NUMSLKALW` - specifies the number of **IS-NR** (in-service normal) signaling links in the IPSP M3UA linkset required to change the state of the linkset from the Restricted or Prohibited state to the Allowed state.
- `NUMSLKRSTR` - specifies the number of signaling links in the IPSP M3UA linkset required to change the state of the linkset from the Allowed state to the Restricted state.
- `NUMSLKPROH` - specifies the number of signaling links in the IPSP M3UA linkset required to change the state of the linkset from the Allowed or Restricted state to the Prohibited state.

For more information about the `NUMSLKALW`, `NUMSLKRSTR`, and `NUMSLKPROH` values, refer to the [Configuring IPSP M3UA Linkset Options](#) procedure.

If the `NUMSLKALW`, `NUMSLKRSTR`, and `NUMSLKPROH` values are 1 or 0, then the IPSP M3UA signaling link can be removed. The value 0 is shown in the `rtrv-ls` output as a number with an asterisk (*), for example, 2*.

Canceling the `RTRV-SLK` Command

Because the `rtrv-slk` command used in this procedure can output information for a long period of time, the `rtrv-slk` command can be canceled and the output to the terminal stopped. There are three ways that the `rtrv-slk` command can be canceled.

- Press the F9 function key on the keyboard at the terminal where the `rtrv-slk` command was entered.
- Enter the `canc-cmd` without the `trm` parameter at the terminal where the `rtrv-slk` command was entered.
- Enter the `canc-cmd:trm=<xx>`, where `<xx>` is the terminal where the `rtrv-slk` command was entered, from another terminal other than the terminal where the `rtrv-slk` command was entered. To enter the `canc-cmd:trm=<xx>` command, the terminal must allow Security Administration commands to be

entered from it and the user must be allowed to enter Security Administration commands. The terminal's permissions can be verified with the `rtrv-secu-trm` command. The user's permissions can be verified with the `rtrv-user` or `rtrv-secu-user` commands.

For more information about the `canc-cmd` command, go to *Commands User's Guide*.

1. Display the IPSG signaling links by entering this command.

```
rtrv-slk:type=ipsg
```

This is an example of the possible output.

```
rlghncxa03w 06-10-19 21:16:37 GMT EAGLE5 36.0.0
```

LOC	LINK	LSN	SLC	TYPE	ANAME	SLKTPS
2202	A	lsnlp1	0	IPSG	assoc2	500
2205	A	lsnip1	1	IPSG	assoc3	500
2204	A	ls04	0	IPSG	assoc1	500
2207	A	lsnlp3	0	IPSG	assoc11	850
2211	A	lsnlp4	0	IPSG	assoc12	950
2213	A	lsnip5	0	IPSG	assoc4	750
2215	A	lsnlp2	1	IPSG	assoc5	1000

2. Display the associations assigned to the IPSG card containing the signaling link that will be removed by entering the `rtrv-assoc` command and specifying the card location of the IPSG card. For this example, enter this command.

For this example, enter this command.

```
rtrv-assoc:loc=2207
```

This is an example of possible output.

```
rlghncxa03w 06-10-28 09:12:36 GMT EAGLE5 36.0.0
```

```

CARD IPLNK
ANAME      LOC  PORT  LINK ADAPTER LPORT RPORT OPEN ALW
assoc11    2207 A    A    M3UA  1030  1030 YES  YES

```

```
IP Appl Sock/Assoc table is (7 of 4000) 1% full
```

```
Assoc Buffer Space Used (16 KB of 3200 KB) on LOC = 2207
```

If the `ADAPTER` value of the associations shown in this step is `M3UA`, continue the procedure with [3](#).

If the `ADAPTER` value for the associations is `M2PA`, perform one of these actions.

- If you wish to remove the signaling link assigned to this card, perform the [Removing an IPSG M2PA Signaling Link](#).
- If you do not wish to remove the signaling link assigned to this card, select another card from [1](#) and repeat this step.

3. Display the linkset that contains the signaling link that is being removed by entering the `rtrv-ls` command with the name of the linkset shown in the LSN column in 1. For this example, enter this command.

```
rtrv-ls:lsn=lsnlp3
```

This is an example of the possible output.

```
rlghncxa03w 08-05-27 16:43:42 GMT EAGLE5 38.0.0

LSN          APCA   (SS7)  SCRNL3T SLT          GWS GWS GWS
SLSCI NIS
lsnlp3       001-001-003  none 1 1 no A 1 off off off
no off

          SPCA          CLLI          TFATCABMLQ MTPRSE ASL8
          -----
          IPSP IPGWAPC GTTMODE          CGGTMOD
          yes no CdPA          no

ADAPTER SLKTPS LSUSEALM SLKUSEALM RCONTEXT
ASNOTIF
m3ua 500 100% 80% none yes

NUMSLKALW NUMSLKRSTR NUMSLKPROH
1 1 1

LOC LINK SLC TYPE ANAME
2207 A 0 IPSP assoc11
```

Link set table is (22 of 1024) 2% full.

The IPSP M3UA signaling link cannot be removed if removing the IPSP M3UA signaling link will cause the number of IS-NR IPSP M3UA signaling links in the linkset to be less than the NUMSLKALW, NUMSLKRSTR, and NUMSLKPROH values shown in the `rtrv-ls` output. If the NUMSLKALW, NUMSLKRSTR, and NUMSLKPROH values are 1 or 0, then the IPSP M3UA signaling link can be removed. The value 0 is shown in the `rtrv-ls` output as a number with an asterisk (*) is displayed in the `rtrv-ls` output, for example, 2*.

If you do not wish to change the NUMSLKALW, NUMSLKRSTR, or NUMSLKPROH values, this signaling link cannot be removed and the remainder of this procedure cannot be performed.

If you wish to change the NUMSLKALW, NUMSLKRSTR, or NUMSLKPROH values, perform the [Configuring IPSP M3UA Linkset Options](#) procedure to change the required values. After the [Configuring IPSP M3UA Linkset Options](#) has been performed, continue the procedure with 4

4. Any in-service IP connections on the signaling link being removed in this procedure must be placed out of service.

Have the far-end node for the signaling link being removed place the M3UA associations in either the **ASP-INACTIVE** or **ASP-DOWN** state.

- If the `OPEN` or `ALW` values for the associations is `YES`, continue the procedure with 5.
 - If the `OPEN` and `ALW` values for the associations is `NO`, continue the procedure with 6.
5. Change the value of the `open` and `alw` parameters to `no` by specifying the `chg-assoc` command with the `open=no` and `alw=no` parameters, as necessary. For this example, enter this command.

```
chg-assoc:aname=assoc11:open=no:alw=no
```

When this command has successfully completed, this message should appear.

```
rlghncxa03w 06-10-28 09:12:36 GMT EAGLE5 36.0.0
CHG-ASSOC: MASP A - COMPLTD;
```

6. Deactivate the link to be removed using the `dact-slk` command, using the output from 1 to obtain the card location and `link` parameter value of the signaling link to be removed. For this example, enter these commands.

```
dact-slk:loc=2207:link=a
```

When each of these command has successfully completed, this message should appear.

```
rlghncxa03w 06-10-07 08:41:12 GMT EAGLE5 36.0.0
Deactivate Link message sent to card
```

7. Verify that the link is out of service - maintenance disabled (**OOS-MT-DSBLD**) using the `rept-stat-slk` command with the card location and `link` parameter values specified in 6. For this example, enter these commands.

```
rept-stat-slk:loc=2207:link=a
```

This is an example of the possible output.

```
rlghncxa03w 06-10-23 13:06:25 GMT EAGLE5 36.0.0
SLK      LSN      CLLI      PST      SST      AST
2207,A   lsnlp3   ls07clli  OOS-MT   Unavail  ----
  ALARM STATUS      = *   0235 REPT-LNK-MGTINH: local inhibited
  UNAVAIL REASON    = LI
```

8. Place the card that contains the signaling link shown in 7 out of service by entering the `rmv-card` command specifying the card location shown in 7. For this example, enter this command.

```
rmv-card:loc=2207
```

When this command has successfully completed, this message should appear.

```
rlghncxa03w 06-10-07 08:41:12 GMT EAGLE5 36.0.0
Card has been inhibited.
```

9. Verify that the card has been inhibited by entering the `rept-stat-card` command with the card location specified in 8. For this example, enter this command.

```
rept-stat-card:loc=2207
```

This is an example of the possible output.

```
rlghncxa03w 10-12-01 09:12:36 GMT EAGLE5 43.0.0
CARD  VERSION      TYPE      GPL      PST      SST
AST
2207  133-003-000  E5ENET   IPSP     OOS-MT-DSBLD  Isolated
-----
ALARM STATUS      = No Alarms.
BLIXP  GPL version = 133-003-000
IMT BUS A        = Disc
IMT BUS B        = Disc
CURRENT TEMPERATURE = 32C ( 90F)      [ALARM TEMP: 60C (140F)]
PEAK TEMPERATURE: = 39C (103F)    [06-05-02 13:40]
SIGNALING LINK STATUS
      SLK  PST      LS      CLLI
      A   OOS-MT      lsnlp2  -----
```

Command Completed.

- Remove the signaling link from the **EAGLE** using the `dlt-slk` command. If there is only one signaling link in the linkset, the `force=yes` parameter must be specified to remove the signaling link.

In the example used in this procedure, the signaling link is the last signaling link in the linkset. Enter this command.

```
dlt-slk:loc=2207:link=a:force=yes
```

When this command has successfully completed, this message should appear.

```
rlghncxa03w 06-10-07 08:41:17 GMT EAGLE5 36.0.0
DLT-SLK: MASP A - COMPLTD
```

 **Note:**

If removing the signaling link will result in 700 or less signaling links in the database and the `OAMHCMEAS` value in the `rtrv-measopts` output is on, the scheduled UI measurement reports will be enabled.

- Verify the changes using the `rtrv-slk` command, with the card location and link values specified in 10. For this example, enter this command.

```
rtrv-slk:loc=2207:link=a
```

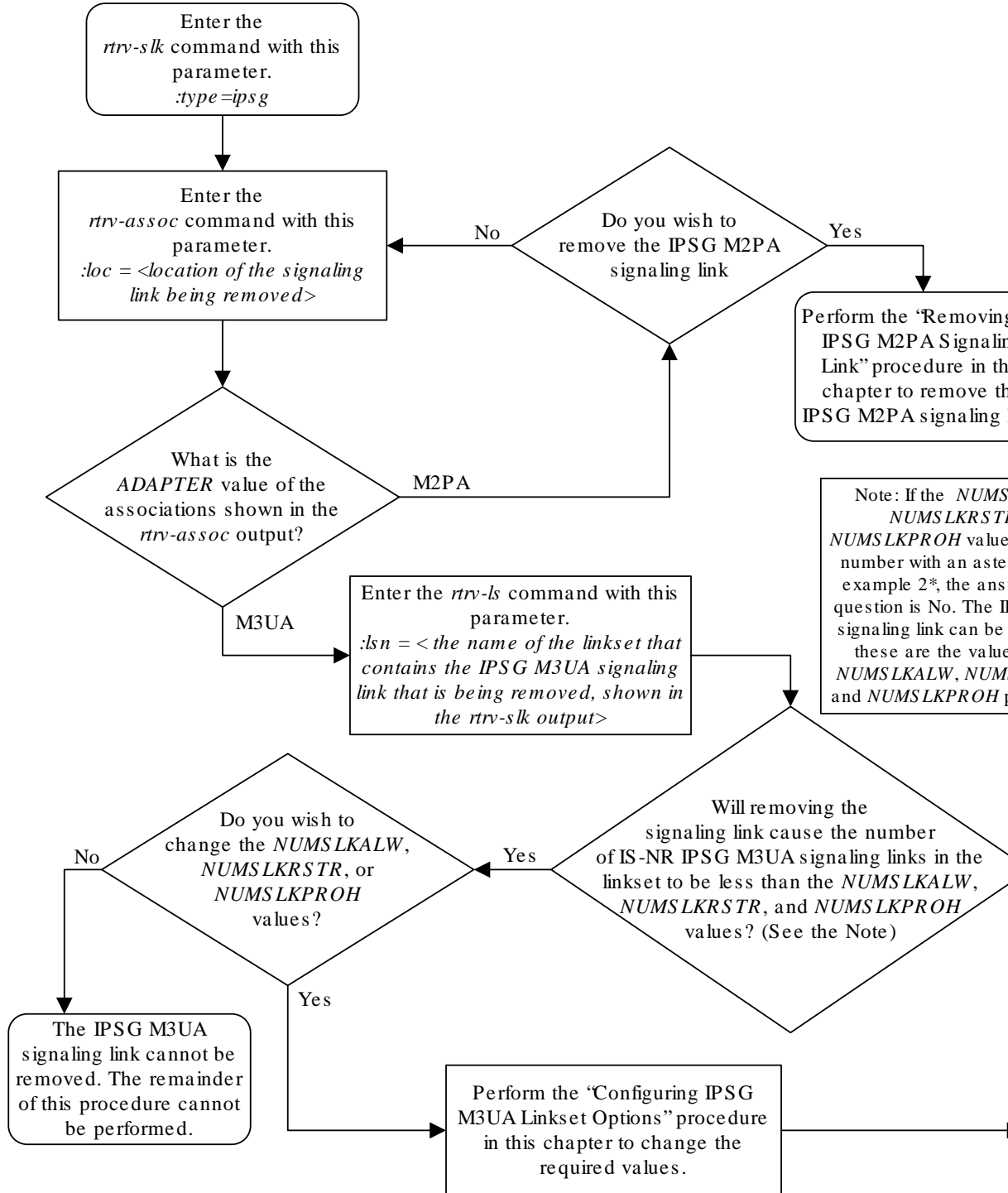
When the `rtrv-slk` command has completed, no entry is displayed showing that the signaling link has been removed.

```
rlghncxa03w 09-09-18 13:43:31 GMT EAGLE5 41.1.0
E2373 Cmd Rej: Link is unequipped in the database
```

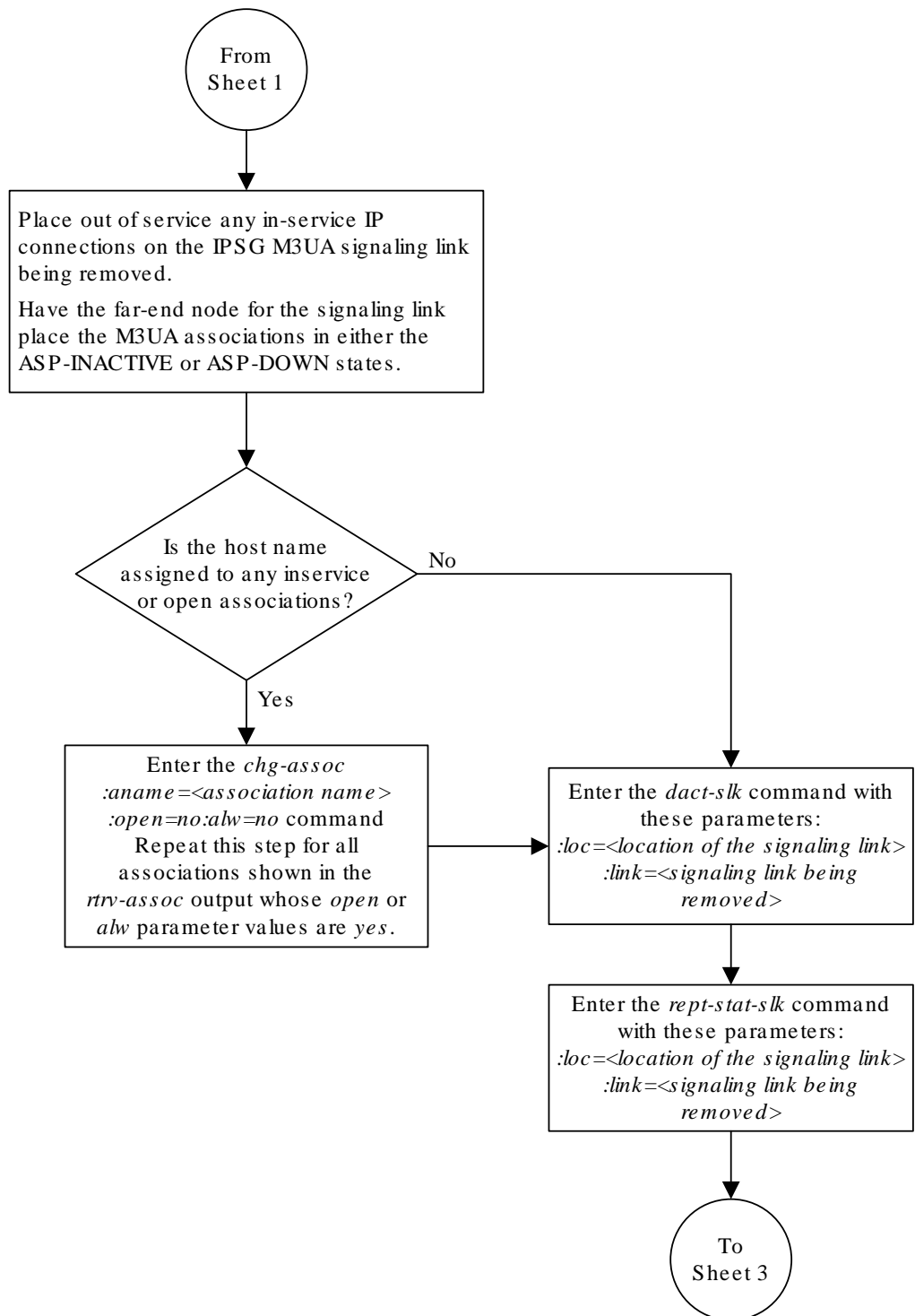
12. Back up the new changes using the `chg-db:action=backup:dest=fixed` command. These messages should appear, the active **Maintenance and Administration Subsystem Processor (MASP)** appears first.

```
BACKUP (FIXED) : MASP A - Backup starts on active MASP.  
BACKUP (FIXED) : MASP A - Backup on active MASP to fixed disk complete.  
BACKUP (FIXED) : MASP A - Backup starts on standby MASP.  
BACKUP (FIXED) : MASP A - Backup on standby MASP to fixed disk complete.
```

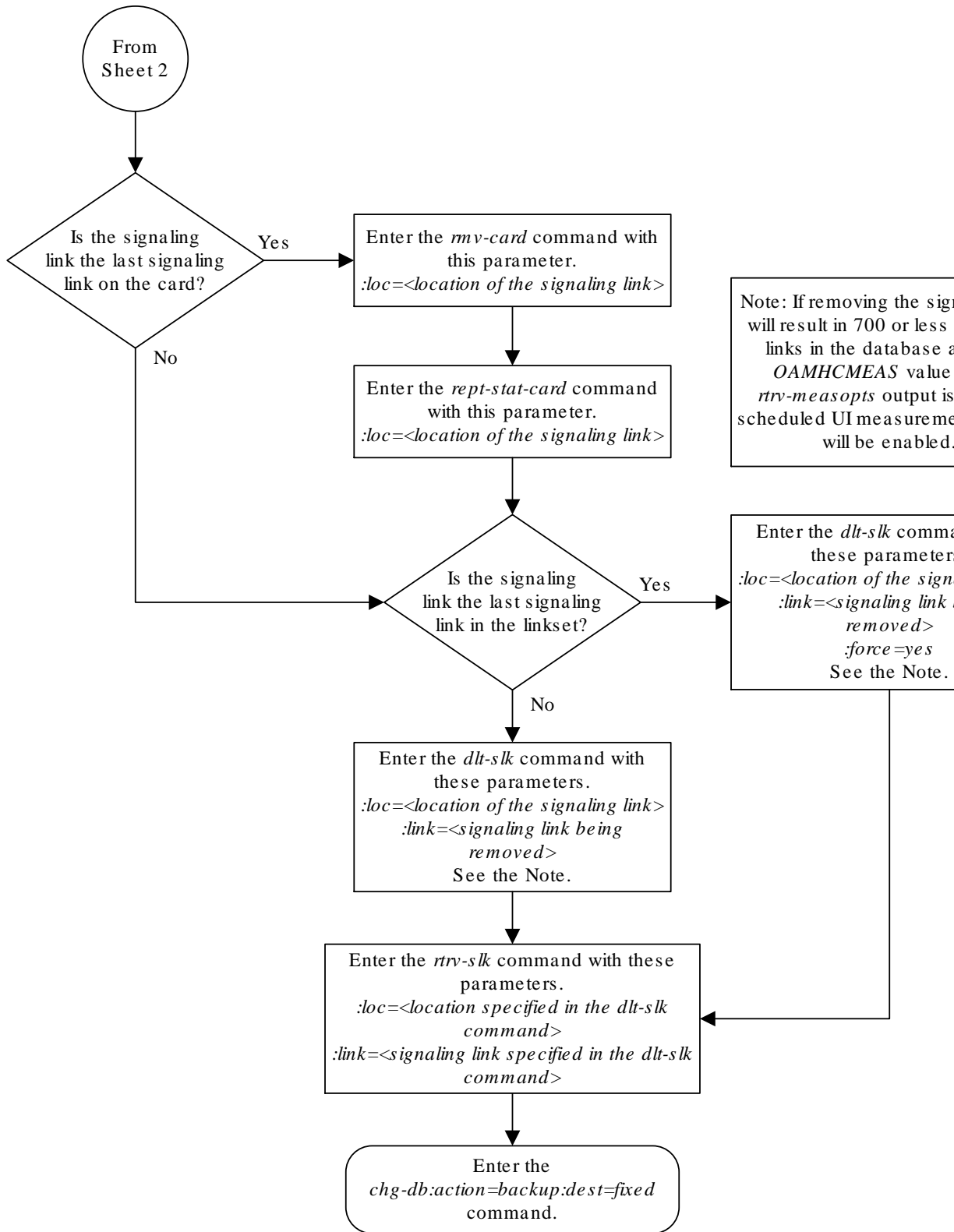
Figure 6-20 Removing an IP SG M3UA Signaling Link



Sheet 1 of 3



Sheet 2 of 3



6.23 Removing a Network Appearance

This procedure removes the network appearance from the database using the `dlt-na` command with these parameters.

`:na` – the 32-bit value of the network appearance, from 0 to 4294967295.

`:type` – the network type of the network appearance, `ansi` (**ANSI**), `itui` (**ITU-I**), `itun` (**14-bit ITU-N**), `itun24` (**24-bit ITU-N**), `ituis` (**ITU-I Spare**), `ituns` (**14-bit ITU-N Spare**).

`:gc` – the specific **ITU-N** group code associated with the network appearance.

Specifying the `gc` parameter removes the specific network appearance containing the `na` and `gc` parameter values.

Specifying the `type=itun` or `type=ituns` parameter without the `gc` parameter removes all 14-bit **ITU-N** or 14-bit **ITU-N** spare network appearances containing the specified `na` parameter value.

1. Display the network appearances in the database with the `rtrv-na` command.

This is an example of the possible output.

```
rlghncxa03w 06-10-28 09:12:36 GMT EAGLE5 36.0.0
TYPE      GC          NA
ANSI      --           100
ITUI      --           1000
ITUN      uk          150000
ITUN      fr          4000000000
ITUN      ge          1000000000
ITUN24    --           3
ITUIS     --           2000
ITUNS     sp           5000
```

2. Remove the network appearance from the database with the `dlt-na` command.

For this example, enter these commands.

```
dlt-na:na=100:type=ansi
```

```
dlt-na:na=4000000000:type=itun:gc=fr
```

When each of these commands have successfully completed, this message should appear.

```
rlghncxa03w 06-10-28 09:12:36 GMT EAGLE5 36.0.0
DLT-NA:  MASP A - COMPLTD
```

3. Verify the changes using the `rtrv-na` command.

This is an example of possible output.

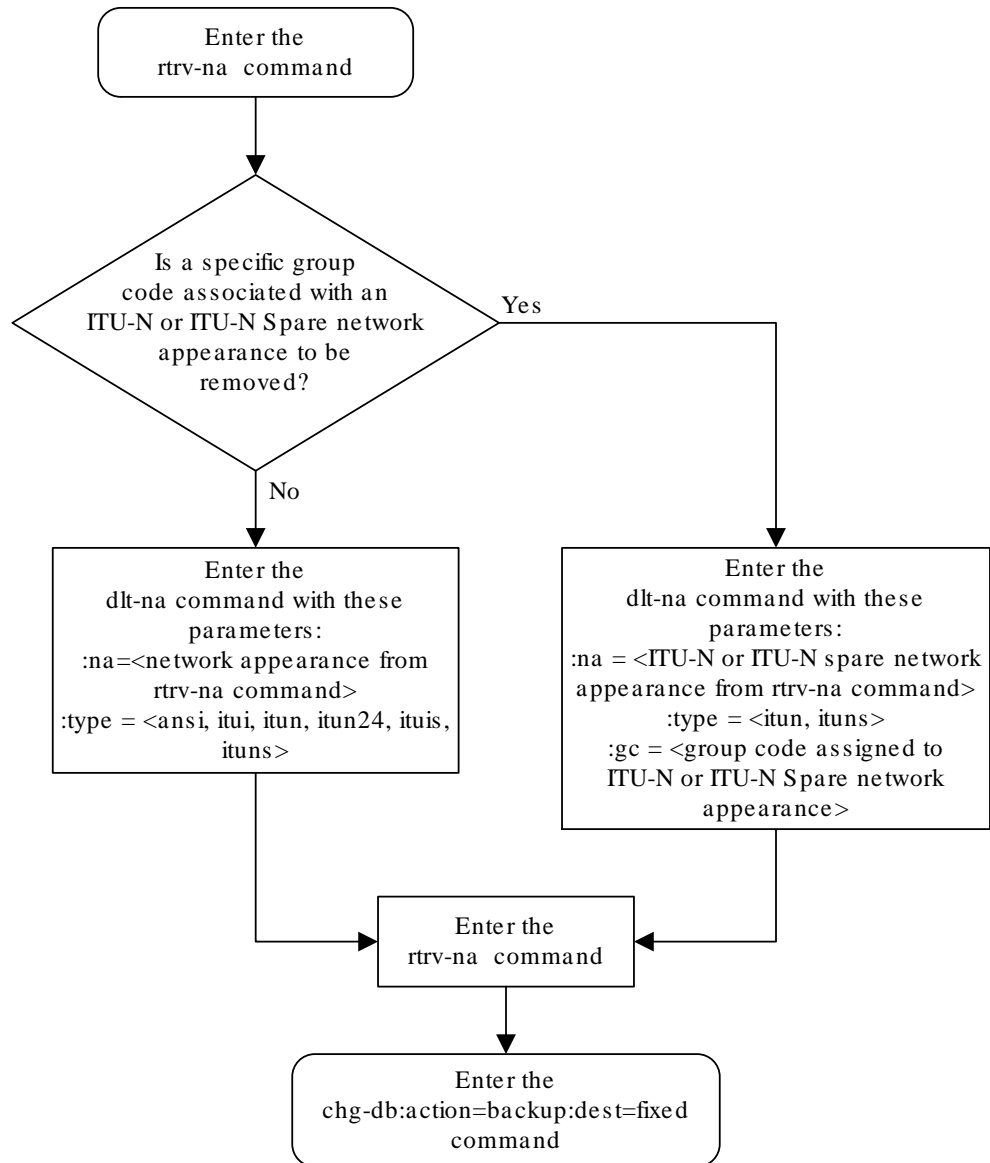
```
rlghncxa03w 06-10-28 09:12:36 GMT EAGLE5 36.0.0
TYPE      GC          NA
ITUI      --          1000
ITUN      uk          150000
ITUN      ge          1000000000
ITUN24    --          3
ITUIS     --          2000
ITUNS     sp          5000
```

4. Back up the new changes, using the `chg-db:action=backup:dest=fixed` command.

These messages should appear; the active **Maintenance and Administration Subsystem Processor (MASP)** appears first.

```
BACKUP (FIXED) : MASP A - Backup starts on active MASP.
BACKUP (FIXED) : MASP A - Backup on active MASP to fixed disk
complete.
BACKUP (FIXED) : MASP A - Backup starts on standby MASP.
BACKUP (FIXED) : MASP A - Backup on standby MASP to fixed disk
complete.
```

Figure 6-21 Removing a Network Appearance



6.24 Changing IPSP Components

This section describes how to change the attributes of the following components in the database.

- Changing an IPLIMx card that contains IPLIMx M2PA signaling links to an IPSP card that contains IPSP M2PA signaling links – perform the [Changing an IPLIMx Card to an IPSP Card](#) procedure.
- IP options – perform the [Configuring IP Options](#) procedure.
- The options for an IPSP M3UA linkset – perform the [Configuring IPSP M3UA Linkset Options](#) procedure.
- An IPSP Linkset – Perform these procedures.
 - [Changing an IPSP M2PA Linkset](#)
 - [Changing an IPSP M3UA Linkset](#)
- An IPSP Association – Perform these procedures.
 - [Changing the Attributes of an IPSP Association](#)
 - [Changing the Buffer Size of an IPSP Association](#)
 - [Changing the Host Values of an IPSP Association](#)
- The **SCTP** retransmission parameters – Perform the [Configuring an IPSP Association for SCTP Retransmission Control](#) procedure.
- The **SCTP** Checksum Algorithm – Perform these procedures.
 - [Changing the SCTP Checksum Algorithm Option for IPSP M2PA Associations](#)
 - [Changing the SCTP Checksum Algorithm Option for IPSP M3UA Associations](#)
- The M2PA timer set for an IPSP M2PA association – perform the [Changing an M2PA Timer Set](#) procedure.
- The UA parameter set for an IPSP M3UA association – perform the [Changing a UA Parameter Set](#) procedure.
- Turn off the Large MSU Support for **IP** Signaling feature – Perform the [Turning Off the Large MSU Support for IP Signaling Feature](#) procedure.

6.25 Changing an IPLIMx Card to an IPSP Card

This procedure is used to change an IPLIMx card to an IPSP card. The linksets, signaling links, and M2PA associations that are assigned to the IPLIMx card are changed to IPSP M2PA linksets, IPSP M2PA signaling links, and IPSP M2PA associations. To change an IPLIMx card to an IPSP card, the `chg-card` command is used with these parameters.

`:loc` – The card location of the IPLIMx card.

`:napp1` – The new application that is assigned to the card, `ipsp`.

The IPLIMx card must be an E5-ENET card that is running either the IPLIM or IPLIMI applications. IPLIMx signaling links must be assigned to the card. M2PA associations must be assigned to the signaling links. Before the `chg-card` command can be executed, the IPLIMx card and its signaling links must be taken out of service.

If adding the IPLIMx signaling link will exceed the maximum total provisioned system TPS, and the maximum total provisioned system TPS is 500,000, perform the "Activating the HIPR2 High Rate Mode" feature in *Database Administration - System Management* to enable and turn on the HIPR2 High Rate Mode feature. When the HIPR2 High Rate Mode feature is enabled and turned on, the maximum total provisioned system TPS is increased to 1,000,000 (1M). If the maximum total provisioned system TPS is 1M, or the maximum total provisioned system TPS is 500,000 and will not be increased, and adding the IPLIMx signaling link will exceed the maximum total provisioned system TPS, the IPLIMx signaling link cannot be added unless the amount of available TPS is reduced enough to allow the IPLIMx signaling link to be added. The available TPS can be reduced by performing one or more of these actions.

1. Display the cards in the database by entering the `rtrv-card` command.

This is an example of the possible output.

```
rlghncxa03w 13-06-19 21:16:37 GMT EAGLE5 45.0.0
CARD   TYPE      APPL      LSET NAME      LINK SLC LSET NAME      LINK SLC
1101   DSM        VSCCP
1102   TSM        GLS
1113   E5MCAP     EOAM
1114   E5TDM-A
1115   E5MCAP     EOAM
1116   E5TDM-B
1117   E5MDAL
1201   LIMDS0     SS7ANSI    sp2             A      0      sp1             B      0
1203   LIMDS0     SS7ANSI    sp3             A      0
1204   LIMDS0     SS7ANSI    sp3             A      1
1206   LIMDS0     SS7ANSI    nsp3            A      1      nsp4            B      1
1301   LIMDS0     SS7ANSI    sp6             A      1      sp7             B      0
1302   LIMDS0     SS7ANSI    sp7             A      1      sp5             B      1
1303   DCM        IPLIM      ipnode1         A      0      ipnode3         B      0
1305   DCM        IPLIM      ipnode4         A      0
2101   ENET       IPGS
2103   ENET       IPGS
2105   ENET       IPGS
2107   ENET       IPGS
2201   DCM        IPLIM
2203   DCM        IPLIM
2207   DCM        IPLIM
2211   DCM        SS7IPGW
2213   DCM        SS7IPGW
2215   DCM        IPGWI
2217   DCM        IPGWI
2301   DCM        SS7IPGW
2303   DCM        SS7IPGW
2305   DCM        IPGWI
2307   DCM        IPGWI
2311   DCM        IPLIMI
2313   DCM        IPLIMI
```

If no card that are assigned to the IPLIM or IPLIMI applications are shown in the `rtrv-card` output, this procedure cannot be performed.

If cards that are assigned to the IPLIM or IPLIMI applications are shown in the `rtrv-card` output, continue the procedure with 2.

2. Display the attributes of the IPLIMx card that will be changed by entering the `rept-stat-card` command with the card location of the IPLIMx card. For this example, enter this command.

```
rept-stat-card:loc=1303
```

This is an example of possible output.

```
rlghncxa03w 10-12-28 09:12:36 GMT EAGLE5 43.0.0
CARD   VERSION      TYPE      GPL      PST      SST
AST
1303   133-003-000  ENET      IPLIM    IS-NR    Active
-----
ALARM STATUS      = No Alarms.
BLIXP  GPL version = 133-003-000
IMT BUS A        = Conn
IMT BUS B        = Conn
CURRENT TEMPERATURE = 32C ( 90F)      [ALARM TEMP: 60C (140F)]
PEAK TEMPERATURE: = 39C (103F)    [06-05-02 13:40]
SIGNALING LINK STATUS
  SLK   PST          LS          CLLI
  A     IS-NR        ipnode1     -----
  B     IS-NR        ipnode3     -----
```

Command Completed.

If the `TYPE` value for the card is not `ENET`, this card is not an E5-ENET card. Choose another card from the `rtrv-card` output in 1 and repeat this step.

If the `TYPE` value for the card is `ENET`, this card is an E5-ENET card.

If signaling links are not assigned to the card, this procedure cannot be performed. To make this card an IPSP card, perform the [Removing an IPLIMx Card](#) to remove the card from the database. After the card has been removed from the database, perform the procedures in [IPSP M2PA and M3UA Configuration Procedures](#) to configure an IPSP card with IPSP M2PA signaling links.

If signaling links are assigned to the card, continue the procedure by performing one of these steps.

- If the state of all the signaling links that are assigned to the card is `OOS-MT-DSBLD` and the state of the card is `OOS-MT-DSBLD`, continue the procedure with 5.
 - If the state of all the signaling links that are assigned to the card is `OOS-MT-DSBLD`, but the state of the card is not `OOS-MT-DSBLD`, continue the procedure with 4.
 - If the state of any of the signaling links that are assigned to the card is not `OOS-MT-DSBLD`, continue the procedure with 3.
3. Place the signaling links shown in 2 whose state is not `OOS-MT-DSBLD` out of service by entering the `dact-slk` command with the card location shown in the `CARD` column of the `rept-stat-card` output, and `link` value of the signaling link shown in the `SLK` column of the `rept-stat-card` output.

For this example, enter these commands.

```
dact-slk:loc=1303:link=a
dact-slk:loc=1303:link=b
```

When these commands have successfully completed, this message appears.

```
rlghncxa03w 10-07-17 11:43:04 GMT EAGLE5 42.0.0
Deactivate Link message sent to card.
```

Continue the procedure by performing one of these steps.

- If the state of the card is OOS-MT-DSBLD, continue the procedure with 5.
 - If the state of the card is not OOS-MT-DSBLD, continue the procedure with 4.
4. Place the card out of service by entering the `rmv-card` command with the card location shown in the `CARD` column of the `rept-stat-card` output 2. For this example, enter this command.

```
rmv-card:loc=1303
```

When the command has successfully completed, this message appears.

```
rlghncxa03w 10-07-17 11:43:04 GMT EAGLE5 42.0.0
Card has been inhibited.
```

5. Display the linksets that contain the signaling links shown in the `rept-stat-card` output in 2 by entering the `rtrv-ls` command with the name of the linkset shown in the `LS` column in the `rept-stat-card` output. Repeat this step for each linkset shown in the `rept-stat-card` output.

For this example, enter these commands.

```
rtrv-ls:lsn=ipnode1
```

This is an example of possible output.

```
rlghncxa03w 10-07-17 11:43:04 GMT EAGLE5 42.0.0

LSN              APCA  (SS7)  SCRN  SET  SET  BEI  LST  LNKS  ACT  MES  DIS  SLSCI
NIS
ipnode1          002-002-002  none  1   1   no  A   1   off  off  off  no
off

              SPCA              CLLI              TFATCABMLQ  MTPRSE  ASL8
-----
RANDSLS
off

IPSG  IPGWAPC  GTTMODE              CGGTMOD
no    no      CdPA              no
```

```
LOC LINK SLC TYPE IPLIML2
1303 A 0 IPLIM M2PA
```

Link set table is (25 of 1024) 2% full.

```
rtrv-ls:lsn=ipnode3
```

This is an example of possible output.

```
rlghncxa03w 10-07-17 11:43:04 GMT EAGLE5 42.0.0
```

```
LSN          APCA  (SS7)  SCRN SET SET BEI LST LNKS ACT MES DIS
SLSCI NIS
ipnode3      002-002-003  none 1  1  no  A  1  off off off
no off
```

```
SPCA          CLLI          TFATCABMLQ MTPRSE ASL8
-----
1 no no
```

```
RANDSLS
off
```

```
IPSG IPGWAPC GTTMODE          CGGTMOD
no no CdPA no
```

```
LOC LINK SLC TYPE IPLIML2
1303 B 0 IPLIM M2PA
```

Link set table is (25 of 1024) 2% full.

When the `chg-card` command is executed, the `RSVDSLKTPS` and `MAXSLKTPS` values of the linkset will be assigned based on the current `IPSG` value of the linkset.

If the current `IPSG` value of the linkset is `no`, the `RSVDSLKTPS` value of the linkset will be 0 (zero) and the `MAXSLKTPS` value of the linkset will be 4000.

If the current `IPSG` value of the linkset is `yes`, the `RSVDSLKTPS` and the `MAXSLKTPS` values will not be changed. The total TPS used by the signaling links in this linkset will be the number of signaling links in the linkset multiplied by the `RSVDSLKTPS` value of the linkset.

6. Display the associations that are assigned to the card by entering the `rtrv-
assoc` command with the card location of the card that is being changed.

For this example, enter this command.

```
rtrv-assoc:loc=1303
```

This is an example of possible output.

```
rlghncxa03w 10-07-17 11:43:04 GMT EAGLE5 42.0.0
CARD IPLNK
ANAME LOC PORT LINK ADAPTER LPORT RPORT OPEN ALW
```

```
iplim1          1303  A    A    M2PA    2000  2000  YES  YES
iplim2          1303  A    B    M2PA    3000  2000  YES  YES
```

```
IP Appl Sock/Assoc ( 19 of 4000) 1%
Assoc Buffer Space Used (400 KB of 3200 KB) on LOC = 1303
```

If M2PA associations are not shown in the `rtrv-assoc` output, perform the [Adding an M2PA Association](#) procedure to add M2PA associations to the card.

If M2PA associations are shown in the `rtrv-assoc` output, or after the M2PA associations have been added in this step, continue the procedure by performing one of these actions.

- If the current IPSG value of all the linksets shown in 5 is `no`, continue the procedure with 7.
 - If the current IPSG value of all the linksets shown in 5 is `yes`, and the card's MaxTPS (see [Maximum Card Capacity for Different Card Types](#) for MaxTPS values) will not be exceeded when the `chg-card` command is executed, continue the procedure with 7.
 - If the current IPSG value of any of the linksets shown in 5 is `yes`, and the card's MaxTPS value will be exceeded when the `chg-card` command is executed, perform the [Changing an IPSG M2PA Linkset](#) procedure to change the `RSVDSLKTPS` value, and the `MAXSLKTPS` value if necessary, of each IPSG linkset shown in the `rept-stat-card` output in 2 as required. After the linksets have been changed, continue the procedure with 7.
7. Display the total provisioned system TPS by entering the `rtrv-tps` command. This is an example of the possible output.

```
rlghncxa03w 10-07-10 16:20:46 GMT EAGLE 42.0.0
```

CARD TYPE	NUM CARDS	NUM LINKS	RSVD TPS	MAX TPS
IPGW	17	16	48000	80000
IPSG	4	8	4700	12000
IPLIM	2	4	8000	8000
ATM	2	2	3668	3668

```
Total provisioned System TPS (103668 of 500000) 21%
```

```
Command Completed.
```

If the `RSVDSLKTPS` or the `MAXSLKTPS` values of each linkset shown in 5 will not exceed the maximum total provisioned system TPS value shown in the `rtrv-tps` output, continue the procedure with 8.

If the `RSVDSLKTPS` or the `MAXSLKTPS` values of any linkset shown in 5 will exceed the maximum total provisioned system TPS value shown in the `rtrv-tps` output, continue the procedure by performing one of these actions.

- If the maximum total provisioned system TPS value is 500,000, perform the "Activating the HIPR2 High Rate Mode Feature" procedure in *Database*

Administration - System Management to increase the maximum total provisioned system TPS value to 1M. After the "Activating the HIPR2 High Rate Mode Feature" procedure has been performed, continue the procedure with 8

- If the maximum total provisioned system TPS value is 1M, perform the [Changing an IPSP M2PA Linkset](#) procedure as necessary to change the MAXSLKTPS value, and the RSVDSLKTPS value if necessary, of the linksets shown in 2 to allow the IPLIMx card to be changed to an IPSP card with this procedure. After the [Changing an IPSP M2PA Linkset](#) procedure has been performed, continue the procedure with 8.
8. Change the IPLIMx card to an IPSP card by entering the `chg-card` command with the card location of the card being changed and the new card application, `ipsp`.

For this example, enter this command.

```
chg-card:loc=1303:nappl=ipsp
```

When this command has successfully completed, this message should appear.

```
rlghncxa03w 10-07-10 16:20:46 GMT EAGLE 42.0.0
CHG-CARD: MASP A - COMPLTD
```

9. Verify that the card has been changed by entering the `rtrv-card` command with the card location specified in 8.

For this example, enter this command.

```
rtrv-card:loc=1303
```

This is an example of the possible output.

```
rlghncxa03w 10-07-10 16:20:46 GMT EAGLE 42.0.0
CARD  TYPE      APPL      LSET NAME      LINK SLC LSET NAME
LINK SLC
1311  ENET        IPSP      ipnode1        A    0    ipnode3
B    0
```

10. Display the linksets that were displayed in 5 by entering the `rtrv-ls` command with the name of each linkset that was specified in 5.

For this example, enter these commands.

```
rtrv-ls:lsn=ipnode1
```

This is an example of possible output.

```
rlghncxa03w 10-07-17 11:43:04 GMT EAGLE5 42.0.0

LSN          APCA  (SS7)  SCRN SET SET BEI LST LNKS ACT MES DIS
SLSCI NIS
ipnode1      002-002-002  none 1  1  no  A  1  off off off
no          off
```

```

          SPCA          CLLI          TFATCABMLQ MTPRSE ASL8
-----
          1          ---          no

RANDSLS
off

IPSG  IPGWAPC  GTTMODE          CGGTMOD
yes   no      CdPA          no

ADAPTER  RSVDSLKTPS  MAXSLKTPS
m2pa    0            4000

TPSALM   LSUSEALM   SLKUSEALM
rsvdslktps 80%     100%

LOC  LINK  SLC  TYPE  ANAME
1303 A  0  IPG  iplim1

```

Link set table is (25 of 1024) 2% full.

rtrv-ls:lsn=ipnode3

This is an example of possible output.

rlghncxa03w 10-07-17 11:43:04 GMT EAGLE5 42.0.0

```

          L3T  SLT          GWS  GWS  GWS
LSN      APCA  (SS7)  SCRN SET SET BEI  LST  LNKS ACT MES DIS SLSCI
NIS
ipnode3  002-002-003  none 1  1  no  A  1  off off off no
off

```

```

          SPCA          CLLI          TFATCABMLQ MTPRSE ASL8
-----
          1          ---          no

RANDSLS
off

IPSG  IPGWAPC  GTTMODE          CGGTMOD
yes   no      CdPA          no

ADAPTER  RSVDSLKTPS  MAXSLKTPS
m2pa    0            4000

TPSALM   LSUSEALM   SLKUSEALM
rsvdslktps 80%     100%

LOC  LINK  SLC  TYPE  ANAME
1303 B  0  IPG  iplim2

```

Link set table is (25 of 1024) 2% full.

Continue the procedure by performing these steps or actions as needed.

- If IPSP value of the linksets displayed in this step was `no` when this procedure was started, and you wish to change the RSVDSLKTPS value of any of the linksets, perform the [Changing an IPSP M2PA Linkset](#) procedure to change the RSVDSLKTPS value, and the MAXSLKTPS value if necessary, of each IPSP linkset.
 - If 4 was performed to the state of the IPLIMx card, continue the procedure with 11.
 - If 3 was performed to change the state of the signaling links in the linksets, continue the procedure with 12.
 - If IPSP value of the linksets displayed in this step was `yes` when this procedure was started, 4 was not performed to the state of the IPLIMx card, and 3 was not performed to change the state of the signaling links in the linksets, continue the procedure with 13.
11. Put the card back into service by entering the `rst-card` command with the card location specified in 9.

For this example, enter this command.

```
rst-card:loc=1303
```

When this command has successfully completed, this message should appear.

```
rlghncxa03w 10-07-17 11:43:04 GMT EAGLE5 42.0.0  
Card has been allowed.
```

If 3 was not performed to change the state of the signaling links in the linksets, continue the procedure with 13.

If 3 was performed to change the state of the signaling links in the linksets, continue the procedure with 12.

12. Put the signaling links that were taken out of service in 3 back into service by entering the `act-slk` command with the card location and link values specified in 3. For this example, enter these commands.

```
act-slk:loc=1303:link=a  
act-slk:loc=1303:link=b
```

When these commands have successfully completed, this message appears.

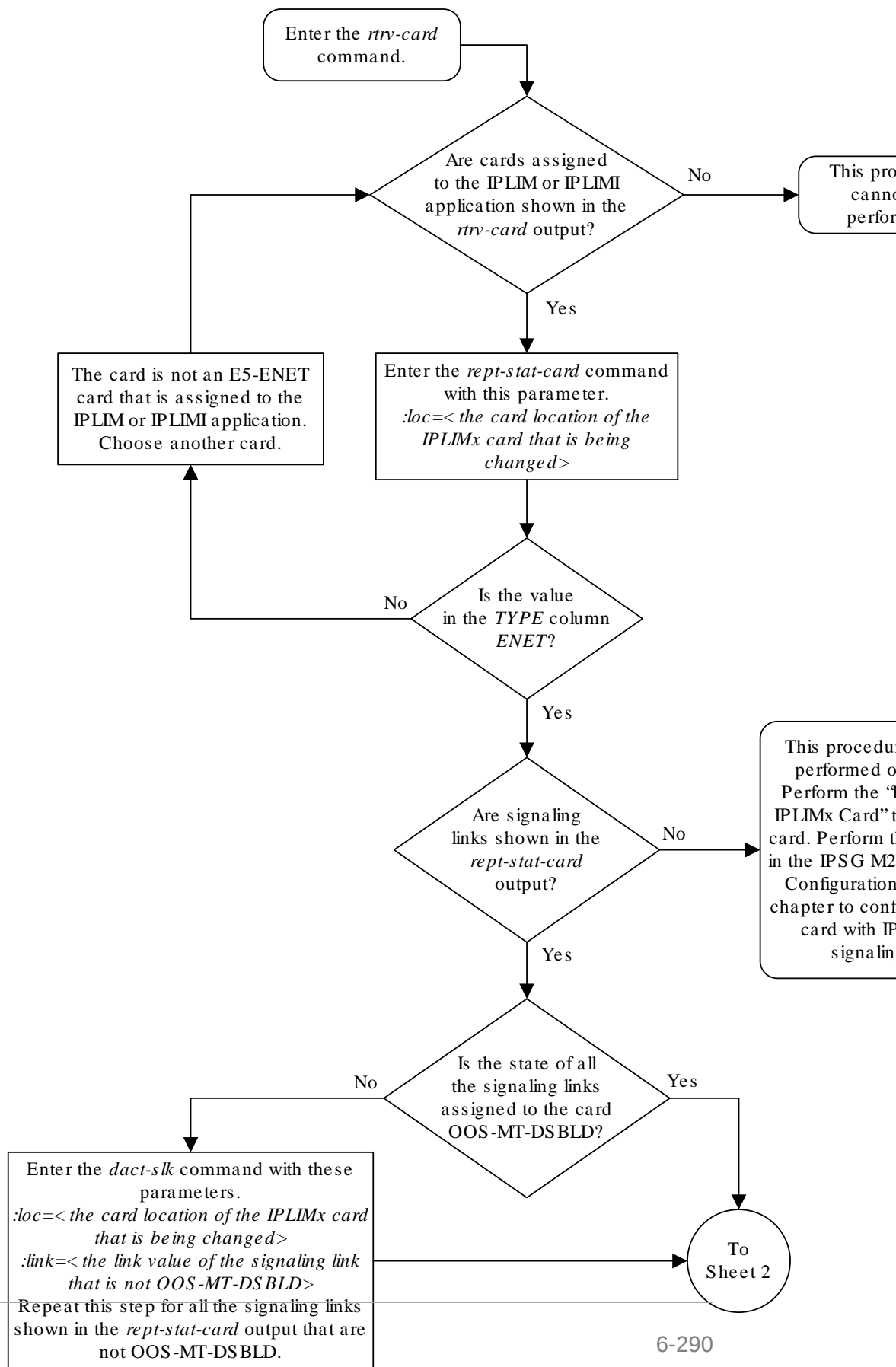
```
rlghncxa03w 10-07-17 11:43:04 GMT EAGLE5 42.0.0  
Activate Link message sent to card
```

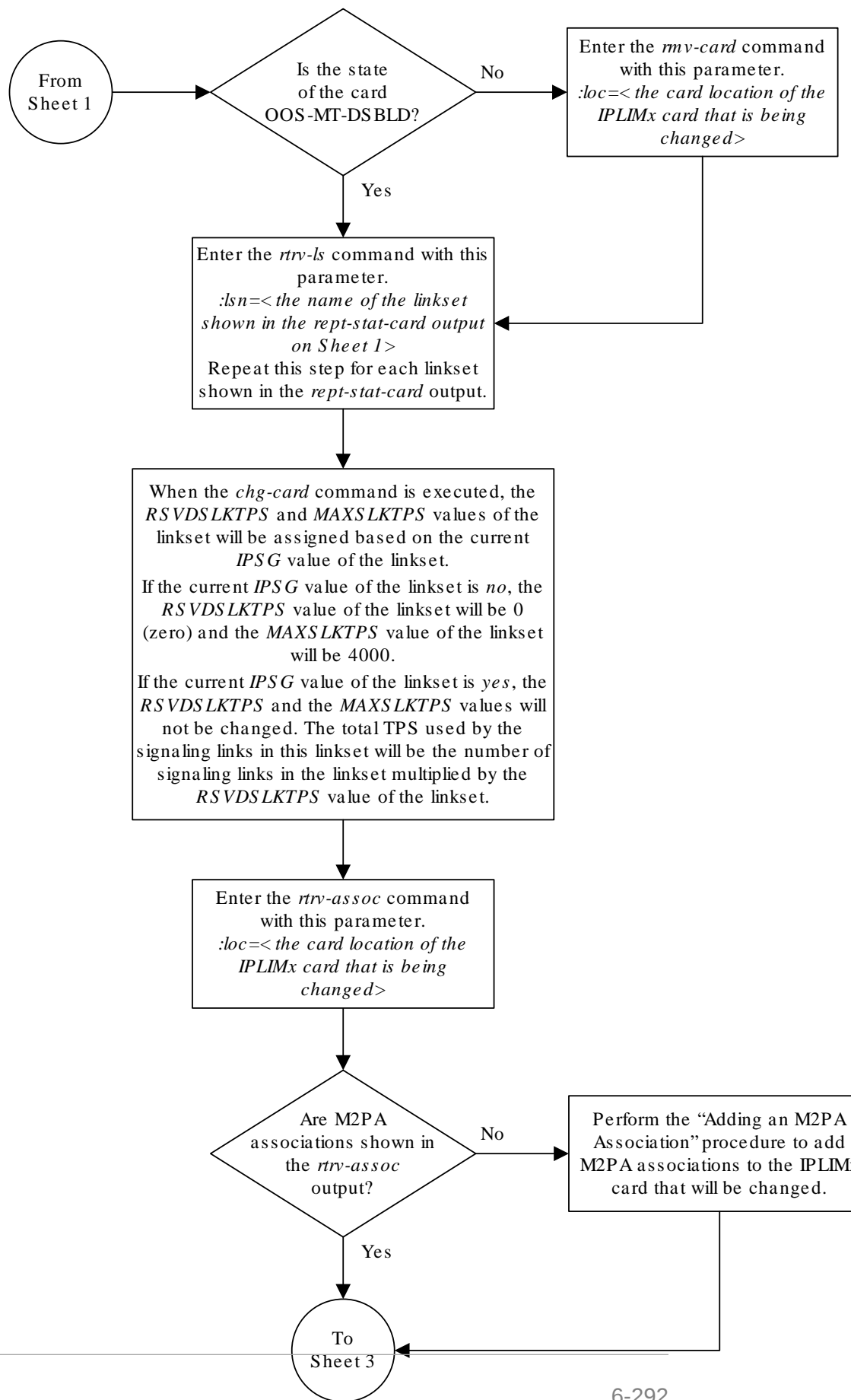
13. Back up the new changes using the `chg-db:action=backup:dest=fixed` command. These messages should appear, the active **Maintenance and Administration Subsystem Processor (MASP)** appears first.

```
BACKUP (FIXED) : MASP A - Backup starts on active MASP.  
BACKUP (FIXED) : MASP A - Backup on active MASP to fixed disk  
complete.  
BACKUP (FIXED) : MASP A - Backup starts on standby MASP.
```

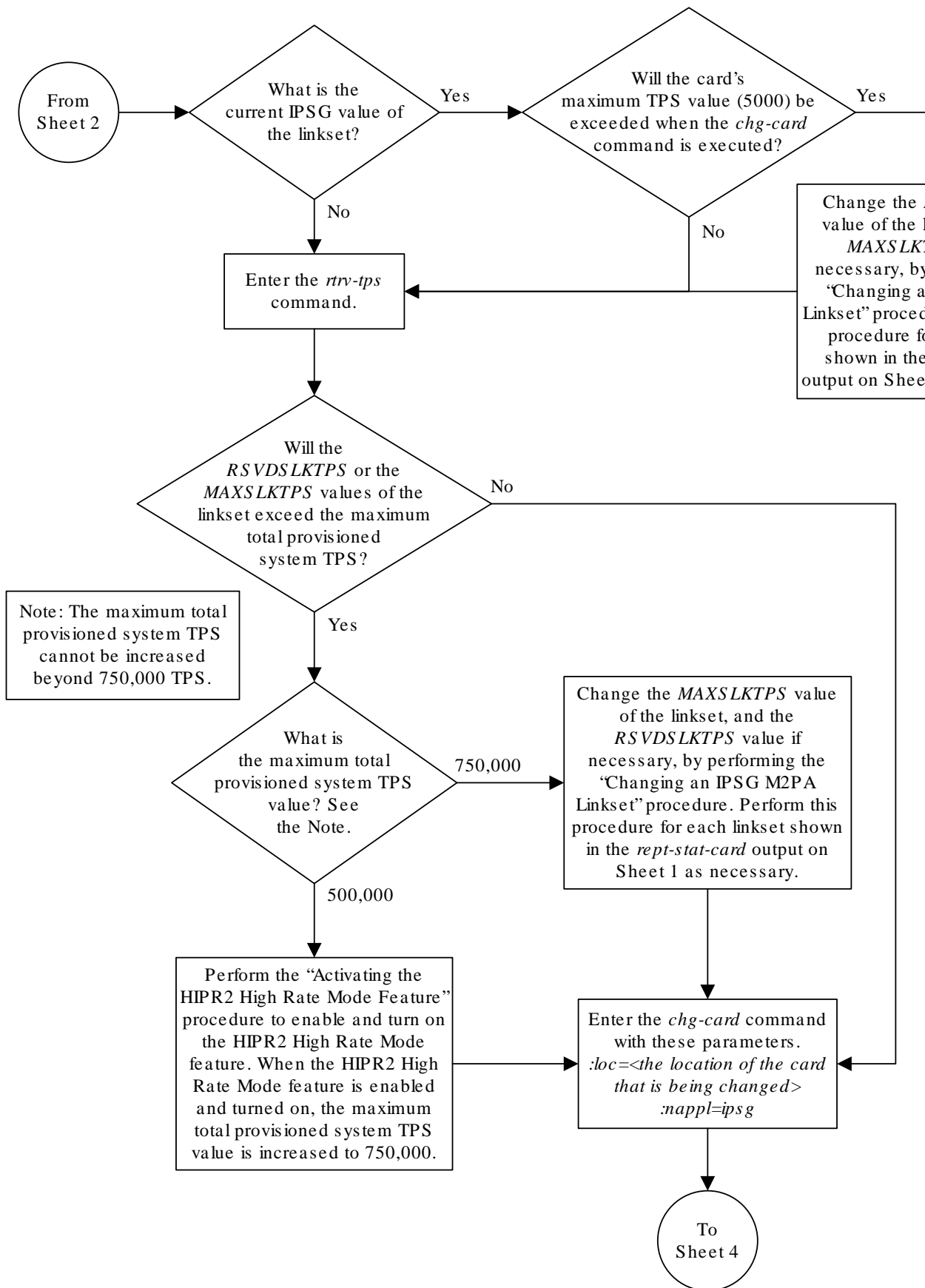
BACKUP (FIXED) : MASP A - Backup on standby MASP to fixed disk complete.

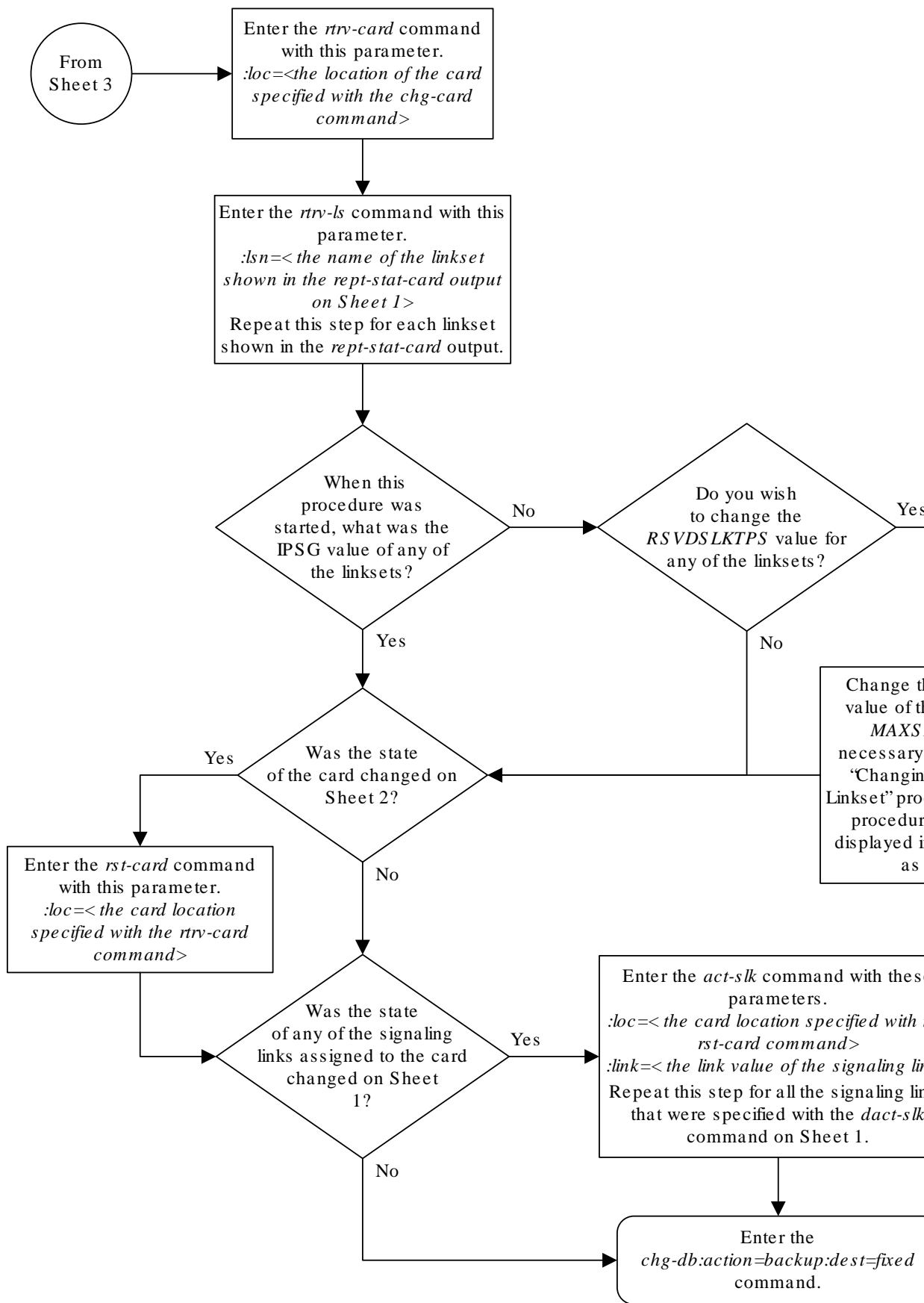
Figure 6-22 Changing IPLIMx Card to IPSG Card





Sheet 2 of 4





Sheet 4 of 4

6.26 Configuring IP Options

Use this procedure to change the **IP** options defined by these parameters: `getcomm`, `setcomm`, `snmpcont`, `srkq`, `trapcomm`, `ipgwabate`, and `uameasusedftas`.

The `chg-sg-opts` command also contains the `sctpcsum` parameter. Perform the one of these procedures to change the `sctpcsum` parameter value.

- [Changing the SCTP Checksum Algorithm Option for M3UA and SUA Associations](#)
- [Changing the SCTP Checksum Algorithm Option for M2PA Associations](#)
- [Changing the SCTP Checksum Algorithm Option for IPSP M2PA Associations](#)
- [Changing the SCTP Checksum Algorithm Option for IPSP M3UA Associations](#)

`:getcomm` – The community name used to validate **SNMP** *Get* and *GetNext* requests. This value applies to each **IP** card **SNMP** agent.

`:setcomm` – The community name used to validate **SNMP** *Set* requests. This value applies to each **IP** card **SNMP** agent.

`:snmpcont` – The system contact information for each **IP** card **SNMP** agent, used to define the `sysContact` object in the **SNMP MIB II** System Group.

`:srkq` – The static routing key quantity used to specify the maximum number of static routing key entries in the **Routing Key** table of each `ss7ipgw` and `ipgwi` card.

`:trapcomm` – The community name used when sending **SNMP** traps. This value applies to each **IP** card **SNMP** agent.

`:ipgwabate` – enables (`ipgwabate=yes`) or disables (`ipgwabate=no`) **SS7** congestion abatement procedures for **IPGWx** signaling links (signaling links assigned to cards running the `ss7ipgw` or `ipgwi` applications). The default value for this parameter is `no`.

`:uameasusedftas` - specifies whether UA measurements are pegged against the default application server or against the application server shown by the routing context. The values for this parameter are `yes` and `no`. The system default value for this parameter is `yes`.

- `yes` - UA measurement registers are pegged against the default application server.
- `no` - UA measurements are pegged against the application server shown by the routing context.

The maximum value of the `srkq` parameter is 2500.

The value specified for the `srkq` parameter cannot be less than the current number of provisioned routing keys. The number of routing keys that are currently provisioned is shown in the `rtrv-appl-rtkey` or `rtrv-tbl-capacity` command outputs.

The values of the `snmpcont`, `getcomm`, `setcomm`, and `trapcomm` parameters are a string of up to 32 characters that is not case sensitive. If the character string contains characters other than alphanumeric characters, the character string must be enclosed in single quotes.

1. Display the current **IP** options in the database by entering the `rtrv-sg-opts` command.

The following is an example of the possible output.

```
rlghncxa03w 08-04-28 21:17:37 GMT EAGLE5 38.0.0
SRKQ:          250
SNMPCONT:     john doe 555-123-4567
GETCOMM:      public
SETCOMM:      private
TRAPCOMM:     public
SCTPCSUM:     crc32c
IPGWABATE:    NO
UAMEASUSEDFTAS YES
```

If the `srkq` parameter value will not be changed, continue the procedure with [3](#).

If the `srkq` parameter value will be changed, verify the number of routing keys that are currently provisioned by performing [2](#).

2. Enter the `rtrv-tbl-capacity` command to verify the number of routing keys that are currently provisioned.

The following is an example of the possible output.

```
rlghncxa03w 08-04-28 21:17:37 GMT EAGLE5 38.0.0

RTEKEY  table is (          53 of          2500)  2% full
```

 **Note:**

The `rtrv-tbl-capacity` command output contains other fields that are not used by this procedure. If you wish to see all the fields displayed by the `rtrv-tbl-capacity` command, see the `rtrv-tbl-capacity` command description in the *Commands Manual*.

The number of routing keys that are currently provisioned is shown in the `RTEKEY` row of the `rtrv-tbl-capacity` output. In this example, there are 53 routing keys provisioned in the database. The new `srkq` parameter value cannot be less than 53.

3. Change the **IP** options in the database using the `chg-sg-opts` command.

For this example, enter this command.

```
chg-sg-opts:srkq=200:ipgwabate=yes:uameasusedftas=no
```

When this command has successfully completed, the following message should appear.

```
rlghncxa03w 08-04-28 21:18:37 GMT EAGLE5 38.0.0
CHG-SG-OPTS: MASP A - COMPLTD
```

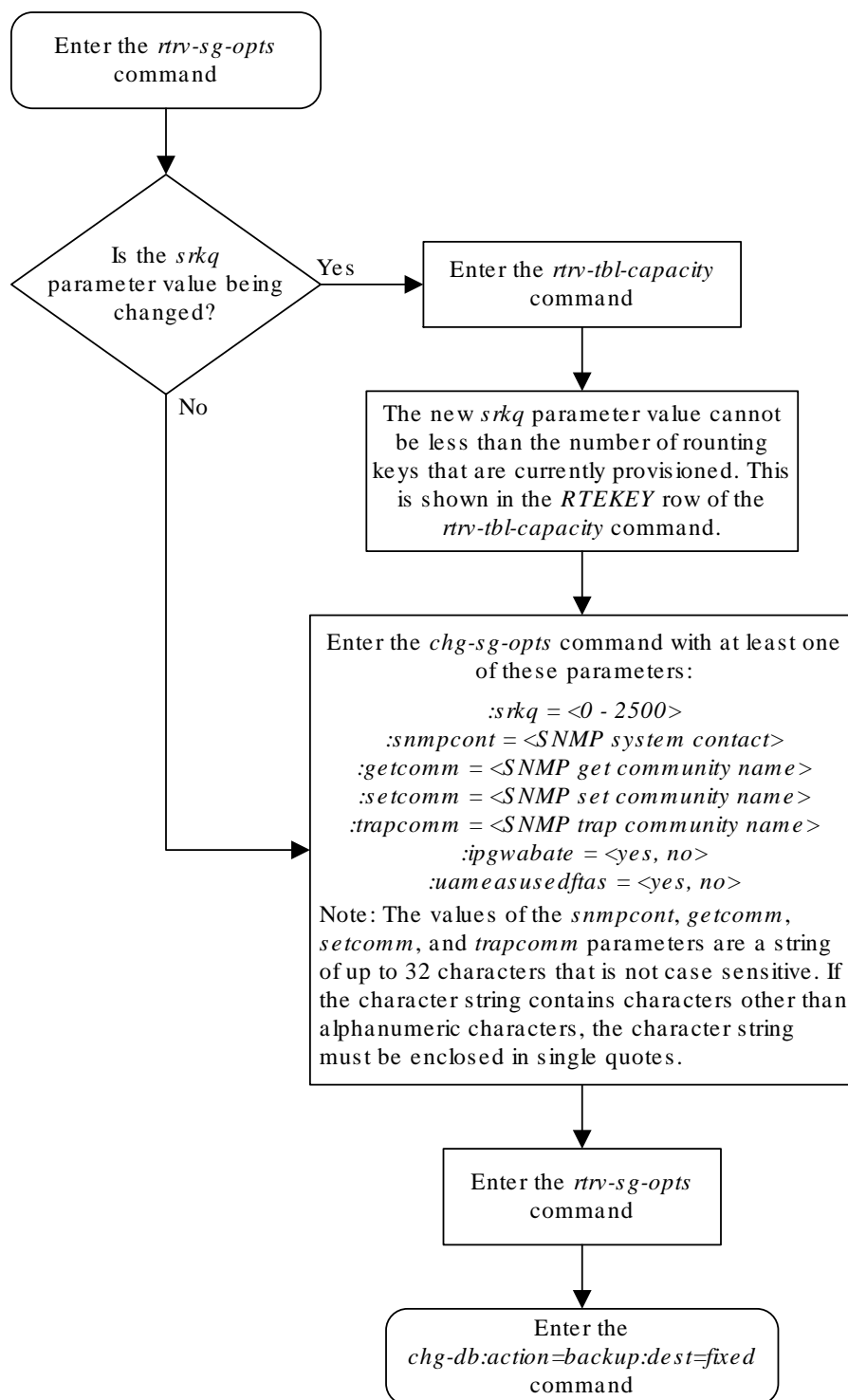

4. Verify the new IP options in the database by entering the `rtrv-sg-opts` command. The following is an example of the possible output.

```
rlghncxa03w 08-04-28 21:19:37 GMT EAGLE5 38.0.0
SRKQ:          200
SNMPCONT:     john doe 555-123-4567
GETCOMM:      public
SETCOMM:      private
TRAPCOMM:     public
SCTPCSUM:     crc32c
IPGWABATE:    YES
UAMEASUSEDFTAS NO
```

5. Back up the new changes using the `chg-db:action=backup:dest=fixed` command. These messages should appear, the active **Maintenance and Administration Subsystem Processor (MASP)** appears first.

```
BACKUP (FIXED) : MASP A - Backup starts on active MASP.
BACKUP (FIXED) : MASP A - Backup on active MASP to fixed disk complete.
BACKUP (FIXED) : MASP A - Backup starts on standby MASP.
BACKUP (FIXED) : MASP A - Backup on standby MASP to fixed disk complete.
```

Figure 6-23 Configuring IP Options



6.27 Configuring IPSG M3UA Linkset Options

This procedure is used to configure the options for an IPSG M3UA linkset with the `chg-lsopts` command and these parameters.

`:lsn` - The name of the IPSG M3UA linkset.

`:numslkalw` - This parameter specifies the number of **IS-NR** (in-service normal) signaling links in the IPSG M3UA linkset required to change the state of the linkset from the Restricted or Prohibited state to the Allowed state. When the number of IS-NR signaling links in the linkset changes from a value that is less than the `numslkalw` parameter value to a value that is equal or greater than the `numslkalw` value, the state of the linkset changes to the Allowed state. The value of this parameter is from 0 to 16. The value of this parameter cannot exceed the number of signaling links that are assigned to the linkset. The value 0 represents half the number of signaling links that are assigned to the linkset. If this parameter is not specified, the current value of this parameter is not changed. The system default value for this parameter is 1.

`:numslkrstr` - This parameter specifies the number of signaling links in the IPSG M3UA linkset required to change the state of the linkset from the Allowed state to the Restricted state. When the number of IS-NR signaling links in the linkset changes from a value that is equal to or greater than the `numslkrstr` parameter value to a value that is less than the `numslkrstr` parameter value and greater than the `numslkproh` parameter value, the state of the linkset changes from the Allowed state to the Restricted state. Changing the state of the linkset from the Prohibited state to the Restricted state is not supported. The value of this parameter is from 0 to 16. The value of this parameter cannot exceed the number of signaling links that are assigned to the linkset. The value 0 represents half the number of signaling links that are assigned to the linkset. If this parameter is not specified, the current value of this parameter is not changed. The system default value for this parameter is 1.

`:numslkproh` - This parameter specifies the number of signaling links in the IPSG M3UA linkset required to change the state of the linkset from the Allowed or Restricted state to the Prohibited state. When the number of IS-NR signaling links in the linkset changes from a value that is equal to or greater than the `numslkproh` parameter value to a value that is less than the `numslkproh` parameter value, the state of the linkset changes from the Allowed or Restricted state to the Prohibited state. The value of this parameter is from 0 to 16. The value of this parameter cannot exceed the number of signaling links that are assigned to the linkset. The value 0 represents half the number of signaling links that are assigned to the linkset. If this parameter is not specified, the current value of this parameter is not changed. The system default value for this parameter is 1.

An IPSG M3UA linkset is a linkset that contains these values: `IPSG=yes`, `ADAPTER=m3ua`.

If the IPSG M3UA linkset contains no signaling links, the value of the `numslkalw`, `numslkrstr`, or `numslkproh` parameters can only be changed to 0 or 1.

If 0 is specified as the value of the `numslkalw`, `numslkrstr`, or `numslkproh` parameters, a number with an asterisk (*) is shown as the value of the `numslkalw`, `numslkrstr`, or `numslkproh` parameter.

1. Display the IPSG and IPGWx linksets that are provisioned in the database by entering the `rept-stat-iptps` command.

The following is an example of the possible output.

```
rlghncxa03w 10-07-19 21:16:37 GMT EAGLE5 42.0.0
IP TPS USAGE REPORT
```

PEAKTIMESTAMP	THRESH	CONFIG/ RSVD	CONFIG/ MAX	TPS	PEAK		

LSN							
ipgwx1	100%	----	32000	TX:	3700	4000	10-07-19
09:49:19							
				RCV:	3650	4000	10-07-19
09:49:19							
ipgwx2	100%	----	16000	TX:	4800	5000	10-07-19
09:49:09							
				RCV:	4850	5000	10-07-19
09:49:09							
ipgwx3	100%	----	32000	TX:	427	550	10-07-19
09:49:19							
				RCV:	312	450	10-07-19
09:49:19							
ipsglsn	100%	600	24000	TX:	4800	5000	10-07-19
09:49:19							
				RCV:	4800	5000	10-07-19
09:49:19							
ipsglsn2	100%	600	4000	TX:	427	550	10-07-19
09:49:19							
				RCV:	312	450	10-07-19
09:49:19							
ipsgm3ua	100%	100	500	TX:	312	450	10-07-19
09:49:19							
				RCV:	312	450	10-07-19
09:49:19							

Command Completed.

If no linksets are shown in this step, this procedure cannot be performed.

If linksets are shown in this step, continue the procedure with [2](#).

2. Display one of the linksets shown in [1](#) by entering the `rtrv-ls` command with the name of one of the linksets shown in [1](#). For this example, enter this command.

```
rtrv-ls:lsn=ipsgm3ua
```

The following is an example of the possible output.

```
tekelecstp 18-01-22 05:43:50 EST EAGLE
46.6.0.0-71.21.00
```

```

          L3T SLT          GWS GWS GWS
          LSN          APCA  (SS7) SCRN SET SET BEI LST LNKS ACT MES DIS
SLSCI NIS
  ipsgm3ua          008-008-004  none 1  1  no  A  3  off off off
no  off

          SPCA          CLLI          TFATCABMLQ MTPRSE ASL8
-----
RANDSLS
off

IPSP GTTMODE          CGGTMOD
yes  CdPA          no

ADAPTER  RSVDSLKTPS  MAXSLKTPS
m3ua    100          100

TPSALM  LSUSEALM    SLKUSEALM
rsvdslktps 80%    80%

RCONTEXT ASNOTIF    NUMSLKALW  NUMSLKRSTR  NUMSLKPROH
1234567890 yes    2*        1          1

LOC  LINK  SLC  TYPE    ANAME
1102 A2  0  IPSP    ipsgm3ua1102
1202 A3  1  IPSP    ipsgm3ua1202
1302 A4  2  IPSP    ipsgm3ua1302

```

Link set table is (1 of 1024) 1% full.

;

IPSP M3UA linksets are shown by the entry `m3ua` in the `ADAPTER` column of the `rtv-ls` output. If the linkset is an IPSP M3UA linkset, continue the procedure with [3](#)

If the linkset is not an IPSP M3UA linkset, perform one of these actions.

- Choose another linkset from [1](#) and repeat this step.
- If you do not wish to choose another linkset, the remainder of this procedure cannot be performed. This procedure is finished.

3. Change the IPSP M3UA linkset options by entering the `chg-lsopts` command.

For this example, enter this command.

```
chg-lsopts:lsn=ipsgm3ua:numslkalw=3:numslkrstr=2:numslkproh=2
```

The value of the `numslkalw`, `numslkrstr`, or `numslkproh` parameters cannot exceed the number of signaling links that are assigned to the linkset.

The value of the `numslkrstr` parameter must be less than or equal to the `numslkalw` parameter value.

The value of the `numslkproh` parameter must be less than or equal to the `numslkrstr` parameter value.

When this command has successfully completed, the following message should appear.

```
rlghncxa03w 08-04-28 21:18:37 GMT EAGLE5 38.0.0
Link set table is (13 of 1024) 1% full.
CHG-LSOPTS: MASP A - COMPLTD
```

4. Verify the changes by entering the `rtrv-ls` command with the name of the linkset specified in 3. For this example, enter this command.

```
rtrv-ls:lsn=ipsgm3ua
```

The following is an example of the possible output.

```
tekelecstp 18-01-22 05:43:50 EST EAGLE
46.6.0.0-71.21.00

      LSN              APCA  (SS7)  L3T SLT              GWS GWS GWS
DIS SLSCI NIS        SCRN SET SET BEI LST LNKS ACT MES
  ipsgm3ua          008-008-004  none 1  1  no  A   3   off off
off no             off

      SPCA              CLLI              TFATCABMLQ MTPRSE ASL8
-----
RANDSLS
off

IPSP  GTTMODE          CGGTMOD
yes   CdPA             no

ADAPTER  RSVDSLKTPS  MAXSLKTPS
m3ua     100          100

TPSALM   LSUSEALM    SLKUSEALM
rsvdslktps 80%      80%

RCONTEXT ASNOTIF      NUMSLKALW  NUMSLKRSTR
NUMSLKPROH
1234567890 yes      2*         1           1

LOC  LINK  SLC  TYPE  ANAME
1102 A2   0   IPSP  ipsgm3ua1102
1202 A3   1   IPSP  ipsgm3ua1202
1302 A4   2   IPSP  ipsgm3ua1302

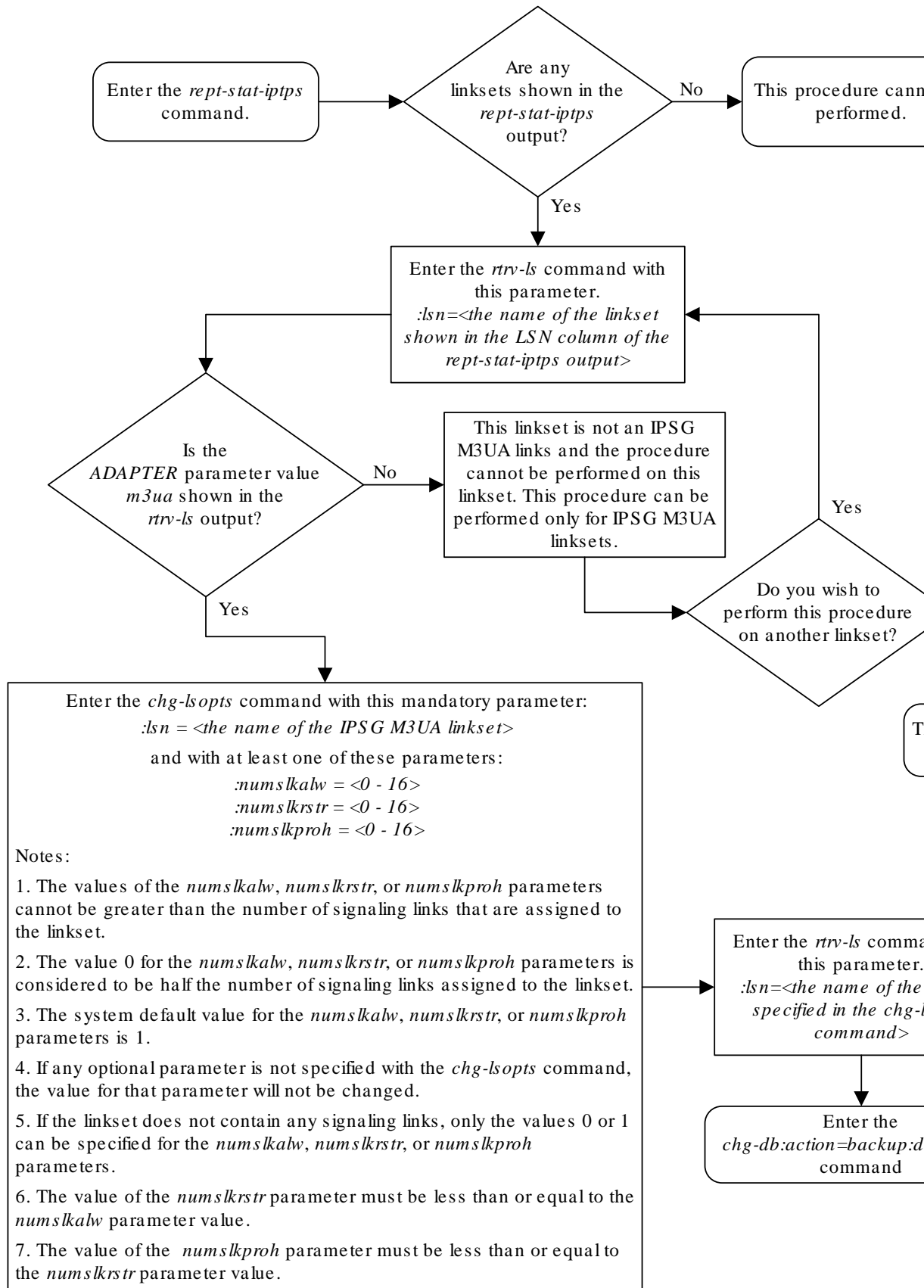
Link set table is (1 of 1024) 1% full.
```

;

5. Back up the new changes using the `chg-db:action=backup:dest=fixed` command. These messages should appear, the active **Maintenance and Administration Subsystem Processor (MASP)** appears first.

```
BACKUP (FIXED) : MASP A - Backup starts on active MASP.  
BACKUP (FIXED) : MASP A - Backup on active MASP to fixed disk complete.  
BACKUP (FIXED) : MASP A - Backup starts on standby MASP.  
BACKUP (FIXED) : MASP A - Backup on standby MASP to fixed disk complete.
```

Figure 6-24 Configuring IPSP M3UA Linkset Options



6.28 Changing an IPSP M2PA Linkset

This procedure is used to change an IPSP M2PA linkset, a linkset that contains the `IPSP` value `yes` and whose `ADAPTER` value is `m2pa`, in the **EAGLE** using the `chg-ls` commands with these parameters.

`:lsn` – The name of the linkset that will be changed, shown in the `rtrv-ls` output.

`:ipsg` – This parameter specifies whether or not the linkset is an IPSP linkset. This parameter has two values, `yes` (if the linkset is an IPSP linkset) or `no` (if the linkset is not an IPSP linkset). For this procedure, the `ipsg` parameter value must be `yes`.

`:maxslktps` – The maximum number of transactions per second (TPS) for all signaling links that are assigned to the IPSP M2PA linkset. See [Maximum Card Capacity for Different Card Types](#) for MaxTPS values.

`:rsvdslktps` – The number of transactions per second (TPS) that is assigned to each IPSP signaling link that will be in the linkset. See [Maximum Card Capacity for Different Card Types](#) for MaxTPS values. The `slktps` parameter can be used in place of the `rsvdslktps` parameter.

`:tpsalmtpe` – The TPS threshold that will generate alarms. This parameter has two values.

- `rsvdslktps` - The `RSVDSLKTPS` threshold generates alarms.
- `maxslktps` - The `MAXSLKTPS` threshold generates alarms.

`:adapter` - This parameter specifies the adapter layer for the signaling links that will be assigned to the IPSP M2PA linkset. This parameter has two values, `m2pa` and `m3ua`. For an IPSP M2PA linkset, the `adapter` parameter value must be `m2pa`.

`:lsusealm` – The linkset's TPS alarm threshold, from 10 to 100 percent of the linkset's TPS. When this threshold is reached, a major alarm (**UAM 0115**) is generated. When the linkset's TPS falls below this threshold, **UAM 0115** is automatically cleared and **UAM 0118** is generated.

`:slkusealm` – The signaling link TPS alarm threshold, from 10 to 100 percent of the signaling link's fair share of the linkset's TPS or from 10 to 100 percent of the **IPSP** card's capacity. See [Maximum Card Capacity for Different Card Types](#) for MaxTPS values. This threshold is reached when the signaling link's actual usage exceeds the percentage of the signaling link's fair share of the linkset's TPS or the percentage of the **IPSP** card's capacity.

A signaling link's fair share of linkset's TPS is the linkset's TPS divided by the number of in-service links in the linkset. For example, if the linkset TPS is 4000 and there are 4 signaling links in the linkset, all in-service, then the signaling link's fair-share would be 1000 TPS ($4000/4=1000$). [Table 6-10](#) shows this calculation for a linkset with 1, 2, 3 and 4 in-service signaling links.

Table 6-10 Signaling Link Fair Share Example

Number of In-Service Signaling Links	Linkset TPS	Signaling Link Fair Share of the Linkset TPS
4	4000	1000
3	4000	1333

Table 6-10 (Cont.) Signaling Link Fair Share Example

Number of In-Service Signaling Links	Linkset TPS	Signaling Link Fair Share of the Linkset TPS
2	4000	2000
1	4000	4000

When this threshold is exceeded, a minor alarm (**UAM 0116**) is generated. When the amount of traffic on the signaling link falls below this threshold, **UAM 0116** is automatically cleared and **UAM 0119** is generated.

The signaling link TPS alarm shows that the linkset TPS is set too low for the linkset or that the **IPSG** card's capacity has been exceeded. Setting the signaling link TPS alarm threshold lower than the linkset TPS alarm threshold can give the user an earlier indication that the linkset TPS is inadequate or that traffic is not balanced across the links in the linkset.

Changing the **MAXSLKTPS** or **RSVDSLKTPS** values for the IPSG M2PA linkset cannot exceed the maximum total provisioned system TPS shown in the `rtrv-tps` output. If changing the IPSG M2PA linkset will exceed the maximum total provisioned system TPS, and the maximum total provisioned system TPS is 500,000, perform the "Activating the HIPR2 High Rate Mode" feature in *Database Administration - System Management* to enable and turn on the HIPR2 High Rate Mode feature. When the HIPR2 High Rate Mode feature is enabled and turned on, the maximum total provisioned system TPS is increased to 1,000,000 (1M). If the maximum total provisioned system TPS is 1M or the maximum total provisioned system TPS is 500,000 and will not be increased, and changing the **MAXSLKTPS** or **RSVDSLKTPS** values for the IPSG M2PA linkset will exceed the maximum total provisioned system TPS, the **MAXSLKTPS** or **RSVDSLKTPS** values for the IPSG M2PA linkset cannot be changed unless the amount of available TPS is reduced enough to allow the **MAXSLKTPS** or **RSVDSLKTPS** values for the IPSG M2PA linkset to be changed. The available TPS can be reduced by performing one or more of these actions.

- The IP TPS values of some IPGWx linksets have to be changed.
- The **MAXSLKTPS** values of some IPSG linksets (and the **RSVDSLKTPS** values if necessary) have to be changed.
- Some ATM high-speed signaling links have to be removed.
- An IPLIMx card that contains signaling links has to be removed.

This procedure can also be used to change an IPSG M3UA linkset or a non-IPSG linkset to an IPSG M2PA linkset.

Other Optional Parameters

There are other optional parameters for an IPSG M2PA that can be changed. These parameters are not required for IPSG M2PA linkset. These parameters are discussed in more detail in *Commands User's Guide* or in these sections.

- These procedures in this manual:
 - [Adding a Mate IPGWx Linkset to another IPGWx Linkset](#)
 - [Removing a Mate IPGWx Linkset from another IPGWx Linkset](#)
 - [Configuring an IPGWx Linkset](#)

- These procedures in *Database Administration - SS7 User's Guide*
 - Adding an SS7 Linkset
 - Changing an SS7 Linkset
 - Configuring an ITU Linkset with a Secondary Adjacent Point Code (SAPC)
- The "Configuring a Linkset for the GSM MAP Screening Feature" procedure in *Database Administration - Features User's Guide*.

Canceling the RTRV-LS Command

Because the `rtrv-ls` command used in this procedure can output information for a long period of time, the `rtrv-ls` command can be canceled and the output to the terminal stopped. There are three ways that the `rtrv-ls` command can be canceled.

- Press the F9 function key on the keyboard at the terminal where the `rtrv-ls` command was entered.
- Enter the `canc-cmd` without the `trm` parameter at the terminal where the `rtrv-ls` command was entered.
- Enter the `canc-cmd:trm=<xx>`, where `<xx>` is the terminal where the `rtrv-ls` command was entered, from another terminal other than the terminal where the `rtrv-ls` command was entered. To enter the `canc-cmd:trm=<xx>` command, the terminal must allow Security Administration commands to be entered from it and the user must be allowed to enter Security Administration commands. The terminal's permissions can be verified with the `rtrv-secu-trm` command. The user's permissions can be verified with the `rtrv-user` or `rtrv-secu-user` commands.

For more information about the `canc-cmd` command, go to *Commands User's Guide*.

1. Display the current linksets in the database using the `rtrv-ls` command.

This is an example of the possible output.

```
rlghncxa03w 08-04-10 11:43:04 GMT EAGLE5 38.0.0
                L3T SLT                GWS GWS GWS
LSN            APCA   (SS7)  SCRN  SET SET BEI LST LNKS ACT MES DIS SLSCI
NIS
e1e2           001-207-000  none  1  1  no  B   6   off off off no
off
e1m1s1         001-001-001  none  1  1  no  A   7   off off off no
off
e1m1s2         001-001-002  none  1  1  no  A   7   off off off no
off
ls1305         001-005-000  none  1  1  no  A   1   off off off no
off
ls1307         001-007-000  none  1  1  no  A   1   off off off no
off
lsgw1101       008-012-003  none  1  1  no  A   1   off off off no
off
lsgw1103       003-002-004  none  1  1  no  A   1   off off off no
off
lsgw1105       009-002-003  none  1  1  no  A   1   off off off no
off
```

LSN	APCI	(SS7)	SCRN	L3T SET	SLT SET	BEI	LST	LNKS	GWS ACT	GWS MES	GWS DIS
e1e2i	1-207-0		none	1	1	no	B	4	off	off	off
---	on										
ls1315	0-015-0		none	1	1	no	A	1	off	off	off
---	off										
ls1317	0-017-0		none	1	1	no	A	1	off	off	off
---	on										
e1m2s1	1-011-1		none	1	1	no	A	7	off	off	off
---	off										
e1m2s2	1-011-2		none	1	1	no	A	7	off	off	off
---	off										

Link set table is (13 of 1024) 1% full.

2. Display a linkset shown in 1 by entering the `rtrv-ls` command with the name of the linkset shown in 1. For this example, enter these commands.

```
rtrv-ls:lsn=lsgw1101
```

This is an example of the possible output.

If you do not wish to change this linkset, choose another linkset from 1 and repeat this step.

If this linkset will be changed, perform one of these steps.

- If the `IPGWAPC` value of the linkset is `yes` or if the `IPGWAPC` and `IPSG` values of the linkset are `no`, the linkset must be removed from the database and then an IPSG M2PA linkset must be added. Perform the "Removing a Linkset Containing SS7 Signaling Links" procedure in *Database Administration - SS7 User's Guide* to remove the linkset. After the linkset has been removed, perform the [Adding an IPSG M2PA Linkset](#) procedure to add the IPSG M2PA linkset. After the IPSG M2PA linkset has been added, perform the [Adding an IPSG M2PA Signaling Link](#) procedure to add IPSG M2PA signaling links to the new IPSG M2PA linkset. This procedure is finished.
- If the `IPSG` value of the linkset is `yes`, continue the procedure with one of these steps.
 - If the `ADAPTER` value of the linkset is `M3UA`, perform the [Adding an IPSG M3UA Signaling Link](#) procedure to remove the IPSG M3UA signaling links from the linkset. After the IPSG M3UA linksets have been removed from the linkset, continue the procedure with 3.
 - If the `ADAPTER` value of the linkset is `M2PA`, continue the procedure with one of these steps.
 - * If the `RSVDSLKTPS` value of the linkset will not be changed, continue the procedure with 5 .
 - * If the `RSVDSLKTPS` value of the linkset will be changed, continue the procedure with 4.

3. Change the `ADAPTER` value of the linkset to `M2PA` by entering the `chg-ls` command with the `adapter=m2pa` parameter and the name of the linkset that is being changed. For this example, enter this command.

```
chg-ls:lsn=lssg1101:adapter=m2pa
```

When the `chg-ls` command has successfully completed, this message should appear.

```
rlghncxa03w 08-04-20 13:34:40 GMT EAGLE5 38.0.0
Link set table is (13 of 1024) 1% full.
CHG-LS: MASP A - COMPLTD
```

After the `ADAPTER` value of the linkset has been changed, continue the procedure by performing one of these steps.

- If the `RSVDSLKTPS` value of the linkset will not be changed, continue the procedure with [5](#).
 - If the `RSVDSLKTPS` value of the linkset will be changed, continue the procedure with [4](#).
4. The new `RSVDSLKTPS` value for the linkset cannot allow the sum of the TPS used by all the IPSP signaling links that are assigned to each IPSP card shown in the linkset to exceed the `MaxTPS` (see [Maximum Card Capacity for Different Card Types](#) for `MaxTPS` values) and cannot exceed the maximum total provisioned system TPS.

To verify the TPS for the IPSP cards containing the IPSP signaling links in the linkset, enter the `rtrv-slk` command with the card location of each signaling link that is assigned to the linkset. For this example, enter these commands.

```
rtrv-slk:loc=1101
```

This is an example of the possible output.

```
rlghncxa03w 08-04-24 14:02:40 EST 38.0.0
rtrv-slk:loc=1101
Command entered at terminal #4.

LOC LINK LSN          SLC TYPE      ANAME          SLKTPS
1101 A2  lssg1101      0   IPSP         m2pa2          1000

IPTPS for LOC = 1101 is (1000 of 5000) 20%

rtrv-slk:loc=1105
```

This is an example of the possible output.

```
rlghncxa03w 08-04-24 14:02:40 EST 38.0.0
rtrv-slk:loc=1101
Command entered at terminal #4.

LOC LINK LSN          SLC TYPE      ANAME          SLKTPS
1105 A7  lssg1101      0   IPSP         m2pa2          1000

IPTPS for LOC = 1105 is (1000 of 5000) 20%
```

If the new `RSVDSLKTPS` value for the linkset will allow the TPS for the IPSG cards containing the IPSG signaling links in the linkset to exceed the MaxTPS (See [Maximum Card Capacity for Different Card Types](#) for MaxTPS values), choose an `RSVDSLKTPS` value that will not exceed the MaxTPS limit for the IPSG card.

5. Display the total provisioned system TPS by entering the `rtrv-tps` command. This is an example of the possible output.

```
rlghncxa03w 10-07-10 16:20:46 GMT EAGLE 42.0.0
```

CARD TYPE	NUM CARDS	NUM LINKS	RSVD TPS	MAX TPS
IPGW	17	16	48000	80000
IPSG	3	7	4200	8000
IPLIM	2	4	8000	8000
ATM	2	2	3668	3668

```
Total provisioned System TPS (99668 of 500000) 20%
```

```
Command Completed.
```

An IPSG M2PA linkset uses `MAXSLKTPS` (see [Maximum Card Capacity for Different Card Types](#) for MaxTPS values), as provisioned by the `maxslktps` parameter. If adding the new IPSG M2PA linkset will not exceed the maximum total provisioned system TPS, continue the procedure with [11](#).

If adding the new IPSG M2PA linkset will exceed the maximum total provisioned system TPS, and the maximum total provisioned system TPS is 500,000 shown, perform the "Activating the HIPR2 High Rate Mode Feature" procedure in *Database Administration - System Management User's Guide* to enable and turn on the HIPR2 High Rate Mode feature. When the HIPR2 High Rate Mode feature is enabled and turned on, the maximum total provisioned system TPS is increased to 1M. After the HIPR2 High Rate Mode feature has been enabled and turned on, continue the procedure with [11](#).

If the maximum total provisioned system TPS is 1M, or the maximum total provisioned system TPS is 500,000 and will not be increased, and adding the IPSG M2PA linkset will exceed the maximum total provisioned system TPS, the IPSG M2PA linkset cannot be added unless the amount of available TPS is reduced enough to allow the IPSG M2PA linkset to be changed. The available TPS can be increased by performing one or more of these actions.

- The IP TPS values of some IPGWx linksets have to be changed. To perform this action, continue the procedure with [8](#).
 - The `MAXSLKTPS` values of some IPSG linksets (and the `RSVDSLKTPS` values if necessary) have to be changed. To perform this action, continue the procedure with [8](#).
 - Some ATM high-speed signaling links have to be removed. To perform this action, continue the procedure with [6](#).
 - An IPLIMx card that contains signaling links has to be removed. To perform this action, continue the procedure with [7](#).
6. Display the ATM high-speed signaling links by entering this command.

```
rtrv-slk:type=saal
```

This is an example of the possible output.

```
rlghncxa03w 10-07-19 21:16:37 GMT EAGLE5 42.0.0
```

LOC	LINK	LSN	SLC	TYPE	LP	ATM	VCI	VPI	LL	
1303	A	lsnds0	1	LIMATM	1	1.544M	LINE	5	0	0

LOC	LINK	LSN	SLC	TYPE	LP	ATM	VCI	VPI	CRC4	SI
1306	A	lsnituatm	0	LIME1ATM	21	2.048M	LINE	5	0	ON 3 0

SLK table is (30 of 1200) 2% full.

If ATM high-speed signaling links are shown in the `rtrv-slk` output, perform the "Removing an SS7 Signaling Link" procedure in *Database Administration - SS7 User's Guide* to remove some of the ATM high-speed signaling links.

If ATM high-speed signaling links are not displayed in the `rtrv-slk` output, perform one or more of these actions to increase the available TPS.

 **Note:**

If one or more of these actions are not performed to increase the available TPS and the available TPS will not allow the IPSP M2PA linkset to be changed, the IPSP M2PA linkset cannot be added and the remainder of this procedure cannot be performed.

- The IP TPS values of some IPGWx linksets have to be changed. To perform this action, continue the procedure with [8](#).
- The MAXSLKTPS values of some IPSP linksets (and the RSVDSLKTPS values if necessary) have to be changed. To perform this action, continue the procedure with [8](#).
- An IPLIMx card that contains signaling links has to be removed. To perform this action, continue the procedure with [7](#).

If you do not wish to perform other actions to increase the available TPS and the available TPS will allow the IPSP M2PA linkset to be changed, continue the procedure with [11](#).

7. Display the signaling links that are assigned to IPLIMx cards by entering this command.

```
rtrv-slk:type=iplim
```

This is an example of the possible output.

```
rlghncxa03w 10-07-19 21:16:37 GMT EAGLE5 42.0.0
```

LOC	LINK	LSN	SLC	TYPE	ANAME	SLKTPS
-----	------	-----	-----	------	-------	--------

```
1301 A    lsniplim    0    IPLIM    M2PA
1301 A1   lsniplim    1    IPLIM    M2PA
1301 B1   lsniplim    2    IPLIM    M2PA
1317 A    lsniplimi   0    IPLIMI   M2PA
```

SLK table is (30 of 1200) 2% full.

If IPLIMx cards containing signaling links are shown in the `rtrv-slk` output, perform the [Removing an IPLIMx Card](#) procedure to remove an IPLIMx card and its associated signaling links.

If IPLIMx cards containing signaling links are not displayed in the `rtrv-slk` output, perform one or more of these actions to increase the available TPS.

 **Note:**

If one or more of these actions are not performed to increase the available TPS and the available TPS will not allow the IPSP M2PA linkset to be changed, the IPSP M2PA linkset cannot be added and the remainder of this procedure cannot be performed.

- The IP TPS values of some IPGWx linksets have to be changed. To perform this action, continue the procedure with [8](#).
- The MAXSLKTPS values of some IPSP linksets (and the RSVDSLKTPS values if necessary) have to be changed. To perform this action, continue the procedure with [8](#).
- Some ATM high-speed signaling links have to be removed. To perform this action, continue the procedure with [6](#).

If you do not wish to perform other actions to increase the available TPS and the available TPS will allow the IPSP M2PA linkset to be changed, continue the procedure with [11](#).

8. Display the IPGWx and IPSP linksets by entering this command.

```
rept-stat-iptps
```

This is an example of the possible output.

```
rlghncxa03w 10-07-19 21:16:37 GMT EAGLE5 42.0.0
IP TPS USAGE REPORT
```

PEAKTIMESTAMP	THRESH	CONFIG/ RSVD	CONFIG/ MAX		TPS	PEAK	
-----	-----						
LSN							
ipgw1	100%	----	32000	TX:	3700	4000	10-07-19
09:49:19							
				RCV:	3650	4000	10-07-19
09:49:19							
ipgw2	100%	----	16000	TX:	4800	5000	10-07-19


```

09:49:09
                                RCV:  4850  5000  10-07-19 09:49:09
ipgwx3      100%    ----    32000  TX:   427   550  10-07-19 09:49:19
                                RCV:   312   450  10-07-19 09:49:19
ipsglsn     100%     600    24000  TX:   4800  5000  10-07-19 09:49:19
                                RCV:   4800  5000  10-07-19
09:49:19
ipsglsn2    100%     600     4000  TX:   427   550  10-07-19 09:49:19
                                RCV:   312   450  10-07-19
09:49:19
-----

```

Command Completed.

If linksets are displayed in the `rept-stat-iptps` output, continue the procedure with [9](#).

If linksets are not displayed in the `rept-stat-iptps` output, perform one or more of these actions to increase the available TPS.

 **Note:**

If one or more of these actions are not performed to increase the available TPS and the available TPS will not allow the IPSP M2PA linkset to be changed, the IPSP M2PA linkset cannot be added and the remainder of this procedure cannot be performed.

- An IPLIMx card that contains signaling links has to be removed. To perform this action, continue the procedure with [7](#).
- Some ATM high-speed signaling links have to be removed. To perform this action, continue the procedure with [6](#).

If you do not wish to perform other actions to increase the available TPS and the available TPS will allow the IPSP M2PA linkset to be changed, continue the procedure with [11](#).

9. Display the attributes of the linksets shown in [8](#) by entering the `rtrv-ls` command with the name of the linkset shown in [8](#).

For this example enter these commands.

```
rtrv-ls:lsn=ipgwx1
```

This is an example of the possible output.

```

rlghncxa03w 10-07-19 21:16:37 GMT EAGLE5 42.0.0

                                L3T SLT                                GWS GWS GWS
LSN          APCA  (SS7)  SCRN SET SET BEI LST LNKS ACT MES DIS SLSCI
NIS
ipgwx1       001-001-002  none 1   1   no  A   8   off off off no
off

                                SPCA          CLLI          TFATCABMLQ MTPRSE ASL8
-----
                                4          ---          no

```

```

RANDSLS
off

IPSG  IPGWAPC  GTTMODE          CGGTMOD
no    yes     CdPA             no

MATELSN  IPTPS  LSUSEALM  SLKUSEALM
-----  -----  -----  -----
          32000  100%     80%

LOC  LINK  SLC  TYPE
1101 A    0   SS7IPGW
1102 A    1   SS7IPGW
1103 A    2   SS7IPGW
1104 A    3   SS7IPGW
1105 A    4   SS7IPGW
1106 A    5   SS7IPGW
1107 A    6   SS7IPGW
1108 A    7   SS7IPGW

```

Link set table is (8 of 1024) 1% full.

rtrv-ls:lsn=ipgwx2

This is an example of the possible output.

rlghncxa03w 10-07-19 21:16:37 GMT EAGLE5 42.0.0

```

LSN          APCA  (SS7)  SCRN  SET  SET  BEI  LST  LNKS  ACT  MES  DIS
SLSCI NIS
ipgwx2      001-001-003  none  1   1   no  A   8   off  off  off
no         off

```

```

          SPCA          CLLI          TFATCABMLQ  MTPRSE  ASL8
-----  -----  -----  ---  ---
          4          ---  no

```

```

RANDSLS
off

IPSG  IPGWAPC  GTTMODE          CGGTMOD
no    yes     CdPA             no

MATELSN  IPTPS  LSUSEALM  SLKUSEALM
-----  -----  -----  -----
          16000  100%     80%

LOC  LINK  SLC  TYPE
1111 A    0   SS7IPGW
1112 A    1   SS7IPGW
1201 A    2   SS7IPGW
1202 A    3   SS7IPGW
1203 A    4   SS7IPGW
1204 A    5   SS7IPGW

```

```
1205 A    6    SS7IPGW
1206 A    7    SS7IPGW
```

Link set table is (8 of 1024) 1% full.

```
rtrv-ls:lsn=ipgwx3
```

This is an example of the possible output.

```
rlghncxa03w 10-07-19 21:16:37 GMT EAGLE5 42.0.0
```

```

                L3T SLT                GWS GWS GWS
LSN            APCA  (SS7)  SCRN SET SET BEI LST LNKS ACT MES DIS SLSCI
NIS
ipgwx3        001-001-004  none 1   1   no  A   0   off off off no
off

                SPCA            CLLI            TFATCABMLQ MTPRSE ASL8
-----
                1                ---         no

RANDSLS
off

IPSP  IPGWAPC  GTTMODE            CGGTMOD
no    yes     CdPA                no

MATELSN  IPTPS  LSUSEALM  SLKUSEALM
-----  32000  100%     80%
```

Link set table is (8 of 1024) 1% full.

```
rtrv-ls:lsn=ipsglsn
```

This is an example of the possible output.

```
rlghncxa03w 10-07-19 21:16:37 GMT EAGLE5 42.0.0
```

```

                L3T SLT                GWS GWS GWS
LSN            APCA  (SS7)  SCRN SET SET BEI LST LNKS ACT MES DIS SLSCI
NIS
ipsglsn       003-003-003  none 1   1   no  A   6   off off off no
off

                SPCA            CLLI            TFATCABMLQ MTPRSE ASL8
-----
                3                ---         no

RANDSLS
off

IPSP  IPGWAPC  GTTMODE            CGGTMOD
yes   no      CdPA                no
```

```

ADAPTER      RSVDSLKTPS  MAXSLKTPS
m2pa         600          4000

TPSALM       LSUSEALM    SLKUSEALM
rsvdslktps  100%         100%

LOC  LINK  SLC  TYPE   ANAME
1303 A    0    IPSG   ipsgm2pa1
1303 A1   1    IPSG   ipsgm2pa2
1303 B1   2    IPSG   ipsgm2pa3
1303 A2   3    IPSG   ipsgm2pa4
1303 A3   4    IPSG   ipsgm2pa5
1307 A    5    IPSG   m2pa2

```

Link set table is (8 of 1024) 1% full.

```
rtrv-ls:lsn=ipsglsn2
```

This is an example of the possible output.

```
rlghncxa03w 10-07-19 21:16:37 GMT EAGLE5 42.0.0
```

```

LSN          APCA   (SS7)  SCRN  SET  SET  BEI  LST  LNKS  ACT  MES  DIS
SLSCI NIS
ipsglsn2    005-005-005  none  1   1   no  A   1   off  off  off
no         off

```

```

          SPCA          CLLI          TFATCABMLQ  MTPRSE  ASL8
-----
          1          ---          no

```

```
RANDSLS
off
```

```

IPSG  IPGWAPC  GTTMODE          CGGTMOD
yes   no       CdPA          no

```

```

ADAPTER      RSVDSLKTPS  MAXSLKTPS
m2pa         600          4000

```

```

TPSALM       LSUSEALM    SLKUSEALM
rsvdslktps  100%         100%

```

```

LOC  LINK  SLC  TYPE   ANAME
1303 B3  0    IPSG   ipsgm2pa6

```

Link set table is (8 of 1024) 1% full.

Perform these actions as necessary.

- Perform the [Configuring an IPGWx Linkset](#) procedure to change the IPTPS value for any linksets shown in the `rtrv-ls` output whose IPGWAPC value is `yes`.
- Perform one of these actions to change the MAXSLKTPS value (and RSVDSLKTPS value if necessary) for any linksets shown in the `rtrv-ls` output whose IPSP value is `yes`.
 - If the ADAPTER value of the linkset is M3UA, perform the [Changing an IPSP M3UA Linkset](#) procedure.
 - If the ADAPTER value of the linkset is M2PA, continue the procedure with 10.

Perform one or both of these actions to increase the available TPS if needed.

- An IPLIMx card that contains signaling links has to be removed. To perform this action, continue the procedure with 7.
- Some ATM high-speed signaling links have to be removed. To perform this action, continue the procedure with 6.

If you do not wish to perform other actions to increase the available TPS and the available TPS will allow the IPSP M2PA linkset to be changed, continue the procedure with 11.

10. Reduce the MAX SLKTPS, and RSVDSLKTPS value if necessary, for the linksets displayed in 9 by entering the `chg-ls` command with the new `maxslktps` and `rsvdslktps` values. For this example, enter these commands.

```
chg-ls:lsn=ipsglsn:maxslktps=3000
chg-ls:lsn=ipsglsn2:maxslktps=3000
```

 **Note:**

The `rsvdslktps` value must be less than or equal to the `maxslktps` value.

When this command has successfully completed, this message should appear.

```
rlghncxa03w 10-07-17 16:23:21 GMT EAGLE5 42.0.0
Link set table is ( 13 of 1024) 1% full
CHG-LS: MASP A - COMPLTD
```

11. Change the linkset by entering the `chg-ls` command with the name of the linkset and at least one of these optional parameters and values.
 - `rsvdslktps = 100 - MaxTPS`
 - `maxslktps = 0 - MaxTPS`
 - `tpsalmtype = rsvdslktps or maxslktps`
 - `lsusealm = 10 - 100`
 - `slkusealm = 10 - 100`

For this example, enter this command.

```
chg-
ls:lsn=lssg1101:rsvdsltktps=500:maxslktps=3000:tpsalmtpe=max
slktps :lsusealm=60:slkusealm=70
```

 **Note:**

The `rsvdsltktps` value must be less than or equal to the `maxslktps` value.

When this command has successfully completed, this message should appear.

```
rlghncxa03w 06-10-17 16:23:21 GMT EAGLE5 37.5.0

Link set table is ( 13 of 1024) 1% full

CHG-LS: MASP A - COMPLTD
```

 **Note:**

There are other optional parameters that can be specified with the `chg-ls` command, but are not required for an **IPSP** M2PA linkset. These parameters and their usage are discussed in the **Other Optional Parameters** section of this procedure.

- Verify the changes using the `rtrv-ls` command specifying the linkset name specified in 11. For this example, enter this command.

```
rtrv-ls:lsn=lssg1101
```

This is an example of the possible output.

```
rlghncxa03w 10-07-20 13:34:40 GMT EAGLE5 42.0.0

LSN              APCA   (SS7)  SCRN SET SET BEI LST LNKS ACT MES DIS
SLSCI NIS
lssg1101         008-012-003  none 1  1  no  A  2  off off off
no    off

              SPCA              CLLI              TFATCABMLQ MTPRSE ASL8
              -----
              2              ---    no

RANDSLS
off

IPSP  IPGWAPC  GTTMODE              CGGTMOD
yes   no      CdPA              no

ADAPTER  RSVDSLKTPS  MAXSLKTPS
m2pa     500      3000
```

```
TPSALM      LSUSEALM      SLKUSEALM
maxslktps   60%          70%

LOC  LINK  SLC  TYPE      ANAME
1101 A2    0    IPSP      m2pa2
1105:A7  1    IPSP      m2pa3
```

Link set table is (13 of 1024) 1% full.

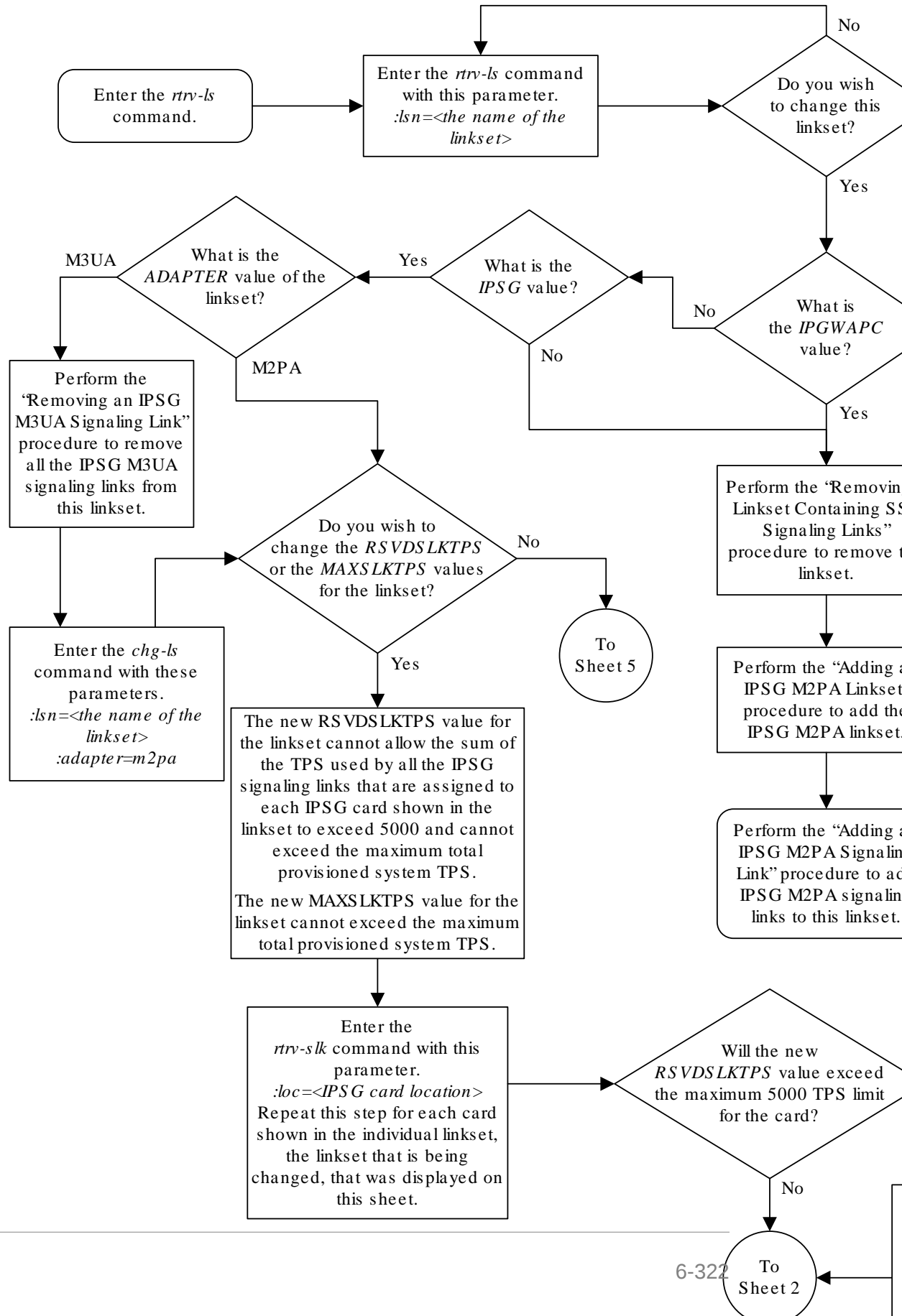
13. Back up the new changes using the `chg-db:action=backup:dest=fixed` command. These messages should appear, the active **Maintenance and Administration Subsystem Processor (MASP)** appears first.

```
BACKUP (FIXED) : MASP A - Backup starts on active MASP.
BACKUP (FIXED) : MASP A - Backup on active MASP to fixed disk complete.
BACKUP (FIXED) : MASP A - Backup starts on standby MASP.
BACKUP (FIXED) : MASP A - Backup on standby MASP to fixed disk complete.
```

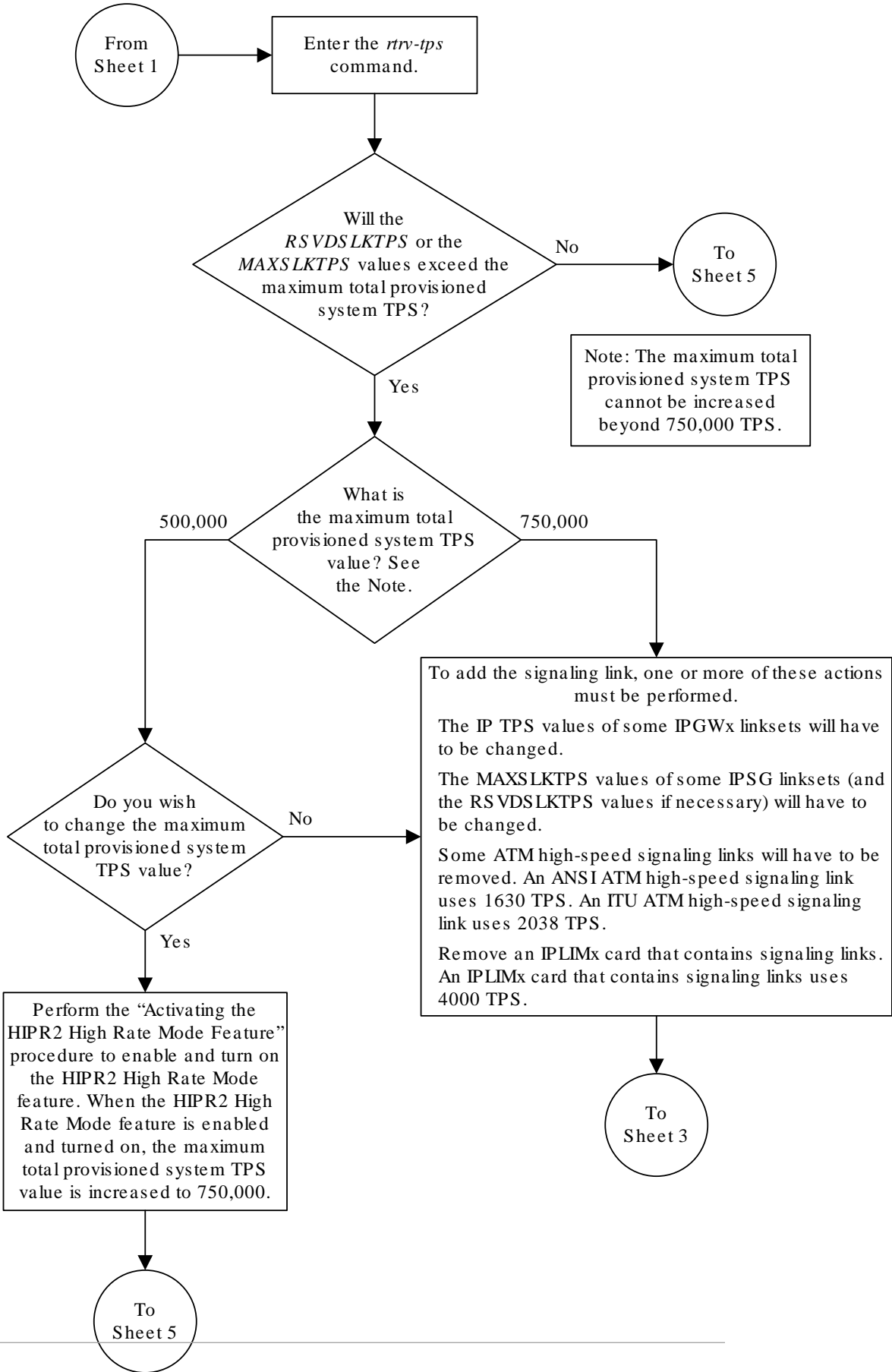
If the linkset that was changed in this procedure was an IPSP M2PA linkset when this procedure was started, this procedure is finished.

If the linkset that was changed in this procedure was either a non-IPSP linkset or an IPSP M3UA linkset when this procedure was started, perform the [Adding an IPSP M2PA Signaling Link](#) procedure to add IPSP M2PA signaling links to the linkset.

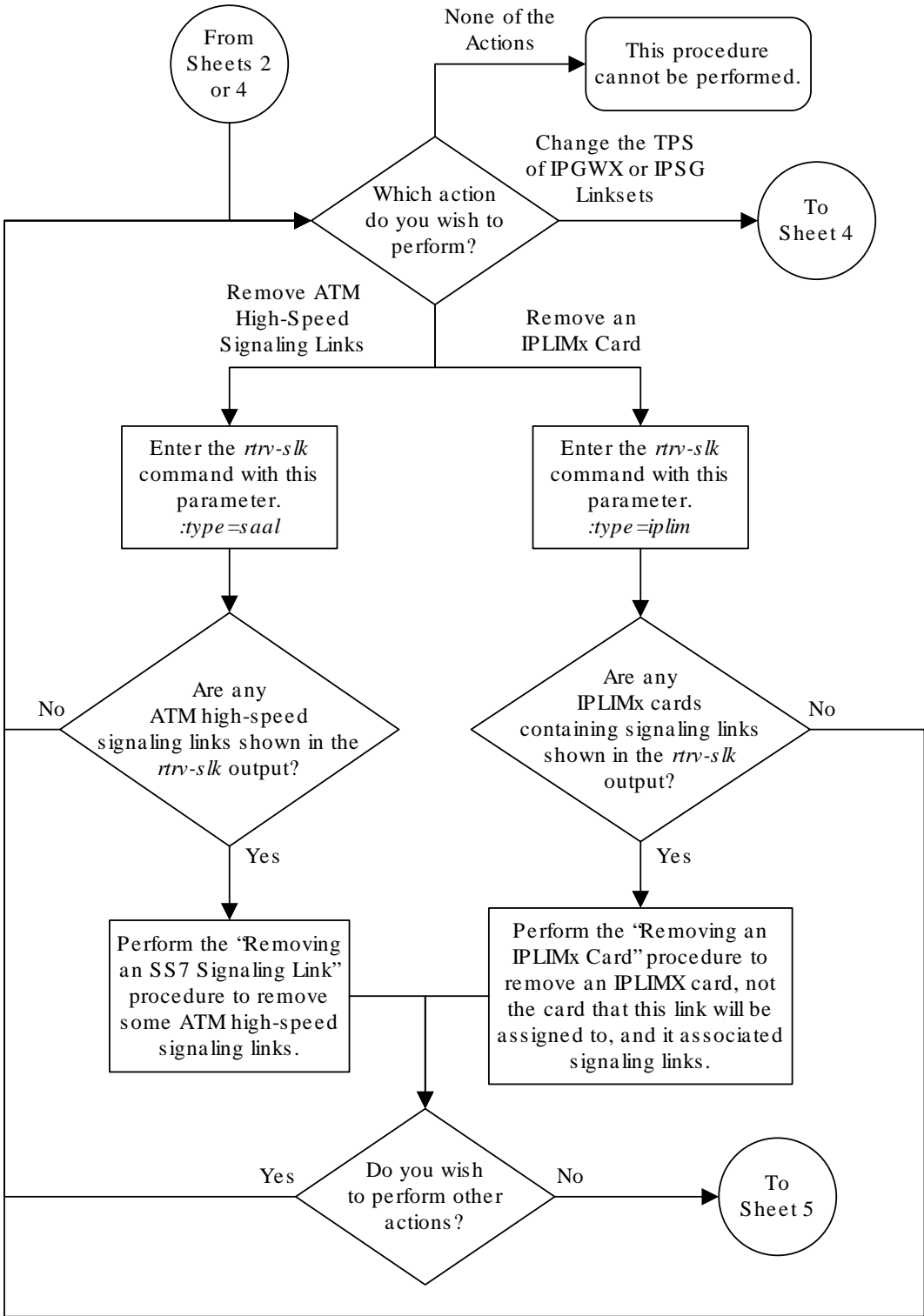
Figure 6-25 Changing an IP SG M2PA Linkset



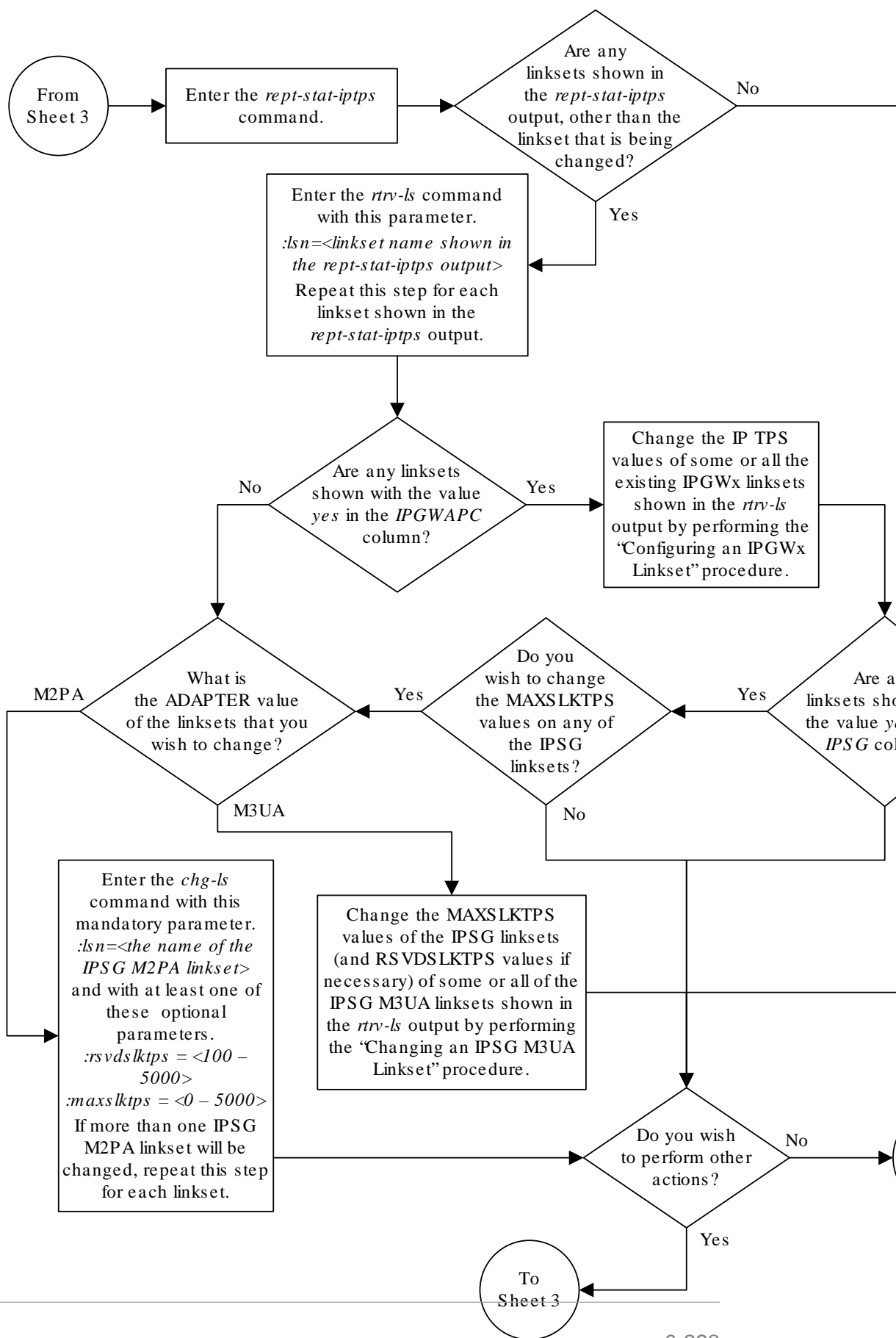
Sheet 1 of 5



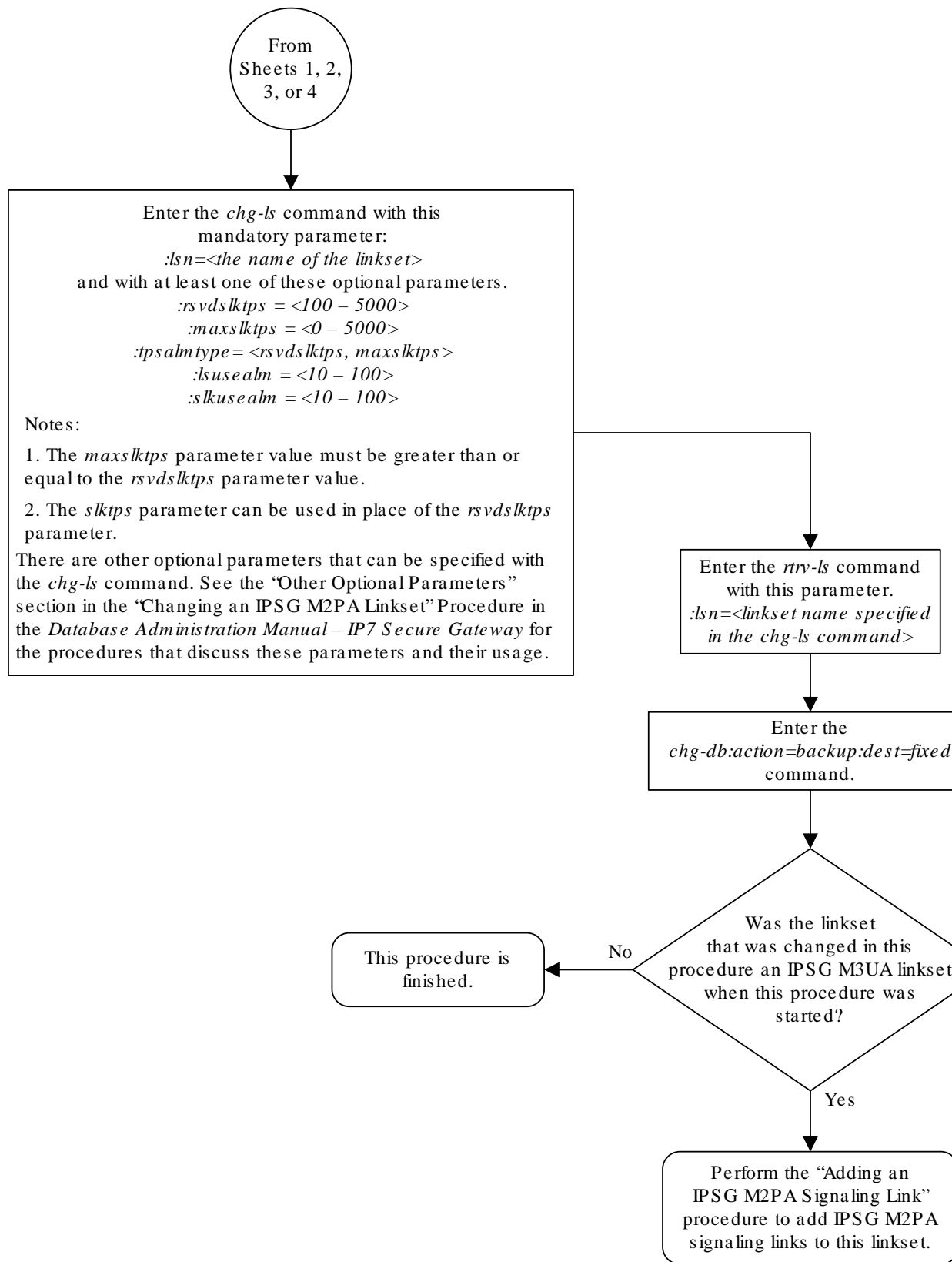
Sheet 2 of 5



Sheet 3 of 5



Sheet 4 of 5



6.29 Changing an IPSP M3UA Linkset

This procedure is used to change an IPSP M3UA linkset, a linkset that contains the IPSP value `yes` and whose `ADAPTER` value is `m3ua`, in the **EAGLE** using the `chg-ls` commands with these parameters.

`:lsn` – The name of the linkset that will be changed, shown in the `rtrv-ls` output.

`:ipsg` – This parameter specifies whether or not the linkset is an IPSP linkset. This parameter has two values, `yes` (if the linkset is an IPSP linkset) or `no` (if the linkset is not an IPSP linkset). For this procedure, the `ipsg` parameter value must be `yes`.

`:maxslktps` – The maximum number of transactions per second (TPS) for all signaling links that are assigned to the IPSP M3UA linkset. See [Maximum Card Capacity for Different Card Types](#) for MaxTPS values.

`:rsvdslktps` – The number of transactions per second (TPS) that is assigned to each IPSP signaling link that will be in the linkset. See [Maximum Card Capacity for Different Card Types](#) for MaxTPS values. The `slktps` parameter can be used in place of the `rsvdslktps` parameter.

`:tpsalmtyp` – The TPS threshold that will generate alarms. This parameter has two values.

- `rsvdslktps` - The `RSVDSLKTPS` threshold generates alarms.
- `maxslktps` - The `MAXSLKTPS` threshold generates alarms.

`:adapter` - This parameter specifies the adapter layer for the signaling links that will be assigned to the IPSP M3UA linkset. This parameter has two values, `m2pa` and `m3ua`. For an IPSP M3UA linkset, the `adapter` parameter value must be `m3ua`.

`:rcontext` - This parameter specifies the routing context value that is assigned to the IPSP M3UA linkset. The value for this parameter is from 0 to 4294967295. The default value for this parameter is `none`, no value is specified.

`:action=delete` - This parameter is used to remove an existing routing context (`RCONTEXT`) value from the IPSP M3UA linkset. If the `rcontext` value for the IPSP M3UA linkset is `none`, the linkset does not contain a routing context value.

`:asnotif` - This parameter specifies whether or not AS notifications will be sent for the IPSP M3UA linkset. This parameter has two values, `yes`, AS notifications will be sent for the linkset, and `no`, AS notifications will not be sent for the linkset. The default value for this parameter is `yes`.

`:lsusealm` – The linkset's TPS alarm threshold, from 10 to 100 percent of the linkset's TPS. When this threshold is reached, a major alarm (**UAM 0115**) is generated. When the linkset's TPS falls below this threshold, **UAM 0115** is automatically cleared and **UAM 0118** is generated.

`:slkusealm` – The signaling link TPS alarm threshold, from 10 to 100 percent of the signaling link's fair share of the linkset's TPS or from 10 to 100 percent of the **IPSP** card's capacity. See [Maximum Card Capacity for Different Card Types](#) for MaxTPS values. This

threshold is reached when the signaling link's actual usage exceeds the percentage of the signaling link's fair share of the linkset's TPS or the percentage of the **IPSP** card's capacity.

A signaling link's fair share of linkset's TPS is the linkset's TPS divided by the number of in-service links in the linkset. For example, if the linkset TPS is 4000 and there are 4 signaling links in the linkset, all in-service, then the signaling link's fair-share would be 1000 TPS ($4000/4=1000$). [Table 6-11](#) shows this calculation for a linkset with 1, 2, 3 and 4 in-service signaling links.

Table 6-11 Signaling Link Fair Share Example

Number of In-Service Signaling Links	Linkset TPS	Signaling Link Fair Share of the Linkset TPS
4	4000	1000
3	4000	1333
2	4000	2000
1	4000	4000

When this threshold is exceeded, a minor alarm (**UAM 0116**) is generated. When the amount of traffic on the signaling link falls below this threshold, **UAM 0116** is automatically cleared and **UAM 0119** is generated.

The signaling link TPS alarm shows that the linkset TPS is set too low for the linkset or that the **IPSP** card's capacity has been exceeded. Setting the signaling link TPS alarm threshold lower than the linkset TPS alarm threshold can give the user an earlier indication that the linkset TPS is inadequate or that traffic is not balanced across the links in the linkset.

Changing the MAXSLKTPS or RSVDSLKTPS values for the IPSP M3UA linkset cannot exceed the maximum total provisioned system TPS shown in the `rtrv-tps` output. If changing the IPSP M3UA linkset will exceed the maximum total provisioned system TPS, and the maximum total provisioned system TPS is 500,000, perform the "Activating the HIPR2 High Rate Mode" feature in *Database Administration - System Management User's Guide* to enable and turn on the HIPR2 High Rate Mode feature. When the HIPR2 High Rate Mode feature is enabled and turned on, the maximum total provisioned system TPS is increased to 1,000,000 (1M). If the maximum total provisioned system TPS is 1M or the maximum total provisioned system TPS is 500,000 and will not be increased, and changing the MAXSLKTPS or RSVDSLKTPS values for the IPSP M3UA linkset will exceed the maximum total provisioned system TPS, the MAXSLKTPS or RSVDSLKTPS values for the IPSP M3UA linkset cannot be changed unless the amount of available TPS is reduced enough to allow the MAXSLKTPS or RSVDSLKTPS values for the IPSP M3UA linkset to be changed. The available TPS can be reduced by performing one or more of these actions.

- The IP TPS values of some IPGWx linksets have to be changed.
- The MAXSLKTPS values of some IPSP linksets (and the RSVDSLKTPS values if necessary) have to be changed.
- Some ATM high-speed signaling links have to be removed.
- An IPLIMx card that contains signaling links has to be removed.

This procedure can also be used to change an IPSP M2PA linkset or a non-IPSP linkset to an IPSP M3UA linkset.

Other Optional Parameters

There are other optional parameters for an IPSP M3UA that can be changed. These parameters are not required for IPSP M3UA linkset. These parameters are discussed in more detail in the *Commands User's Guide* or in these sections.

- The [Configuring IPSP M3UA Linkset Options](#) procedure in this manual.
- These procedures in *Database Administration - SS7 User's Guide*
 - Adding an SS7 Linkset
 - Changing an SS7 Linkset
 - Configuring an ITU Linkset with a Secondary Adjacent Point Code (SAPC)
- The "Configuring a Linkset for the GSM MAP Screening Feature" procedure in the *Database Administration - Features User's Guide*.

Note:

The `mtrpse`, `spc/spca/spci/spcn/spcn24`, `sapci/sapcn/sapcn24`, and `ppc/ppca/ppci/ppcn/ppcn24` parameters cannot be specified for an IPSP M3UA linkset.

Canceling the RTRV-LS Command

Because the `rtrv-ls` command used in this procedure can output information for a long period of time, the `rtrv-ls` command can be canceled and the output to the terminal stopped. There are three ways that the `rtrv-ls` command can be canceled.

- Press the F9 function key on the keyboard at the terminal where the `rtrv-ls` command was entered.
- Enter the `canc-cmd` without the `trm` parameter at the terminal where the `rtrv-ls` command was entered.
- Enter the `canc-cmd:trm=<xx>`, where `<xx>` is the terminal where the `rtrv-ls` command was entered, from another terminal other than the terminal where the `rtrv-ls` command was entered. To enter the `canc-cmd:trm=<xx>` command, the terminal must allow Security Administration commands to be entered from it and the user must be allowed to enter Security Administration commands. The terminal's permissions can be verified with the `rtrv-secu-trm` command. The user's permissions can be verified with the `rtrv-user` or `rtrv-secu-user` commands.

For more information about the `canc-cmd` command, go to *Commands User's Guide*.

1. Display the current linksets in the database using the `rtrv-ls` command.

This is an example of the possible output.

```
rlghncxa03w 08-04-10 11:43:04 GMT EAGLE5 38.0.0
                                     L3T SLT                               GWS GWS GWS
LSN          APCA   (SS7)  SCRN  SET SET BEI LST LNKS ACT MES DIS SLSCI
NIS
e1e2          001-207-000  none  1   1   no  B   6   off off off no
off
```

```

e1mls1      001-001-001  none 1  1  no  A  7  off off off
no  off
e1mls2      001-001-002  none 1  1  no  A  7  off off off
no  off
ls1305      001-005-000  none 1  1  no  A  1  off off off
no  off
ls1307      001-007-000  none 1  1  no  A  1  off off off
no  off
lsgw1101    008-012-003  none 1  1  no  A  1  off off off
no  off
lsgw1103    003-002-004  none 1  1  no  A  1  off off off
no  off
lsgw1105    009-002-003  none 1  1  no  A  1  off off off
no  off

```

```

LSN          APCI  (SS7)  SCRNR  L3T  SLT          GWS  GWS  GWS
SLSCI  NIS
e1e2i        1-207-0      none 1  1  no  B  4  off off off
---  on
ls1315       0-015-0      none 1  1  no  A  1  off off off
---  off
ls1317       0-017-0      none 1  1  no  A  1  off off off
---  on
e1m2s1       1-011-1      none 1  1  no  A  7  off off off
---  off
e1m2s2       1-011-2      none 1  1  no  A  7  off off off
---  off

```

Link set table is (13 of 1024) 1% full.

2. Display a linkset shown in 1 by entering the `rtrv-ls` command with the name of the linkset shown in 1. For this example, enter these commands.

```
rtrv-ls:lsn=lsgw1101
```

This is an example of the possible output.

```
rlghncxa03w 10-07-20 13:34:40 GMT  EAGLE5 42.0.0
```

```

LSN          APCA  (SS7)  SCRNR  L3T  SLT          GWS  GWS  GWS
SLSCI  NIS
lssg1101     008-012-003  none 1  1  no  A  2  off off off
no  off

```

```

SPCA          CLLI          TFATCABMLQ  MTPRSE  ASL8
-----
2          ---  no

```

```
RANDSLS
off
```

```

IPSG  IPGWAPC  GTTMODE          CGGTMOD
yes  no      CdPA          no

```

```

ADAPTER      RSVDSLKTPS  MAXSLKTPS
m3ua         1000        4000

TPSALM      LSUSEALM    SLKUSEALM
rsvdslktps  100%       80%

RCONTEXT    ASNOTIF     NUMSLKALW  NUMSLKRSTR  NUMSLKPROH
100         no          1           1            1

LOC  LINK  SLC  TYPE  ANAME
1101 A2   0   IPGS  mu3a2
1105 A7   1   IPGS  m3ua3

```

Link set table is (13 of 1024) 1% full.

If you do not wish to change this linkset, choose another linkset from [1](#) and repeat this steps.

If this linkset will be changed, perform one of these steps.

- If the `IPGWAPC` value of the linkset is `yes`, the linkset must be removed from the database and then an IPSG M3UA linkset must be added. Perform the "Removing a Linkset Containing SS7 Signaling Links" procedure in *Database Administration - SS7 User's Guide* to remove the linkset. After the linkset has been removed, perform the [Adding an IPSG M3UA Linkset](#) procedure to add the IPSG M3UA linkset. After the IPSG M3UA linkset has been added, perform the [Adding an IPSG M3UA Signaling Link](#) procedure to add IPSG M3UA signaling links to the new IPSG M3UA linkset. This procedure is finished.
- If the `IPGWAPC` value of the linkset is `no`, continue the procedure by performing one of these steps.
 - If the `LST` value of the linkset is `PRX`, the linkset must be removed from the database and then an IPSG M3UA linkset must be added. Perform the "Removing a Linkset Containing SS7 Signaling Links" procedure in *Database Administration - SS7 User's Guide* to remove the linkset. After the linkset has been removed, perform the [Adding an IPSG M3UA Linkset](#) procedure to add the IPSG M3UA linkset. After the IPSG M3UA linkset has been added, perform the [Adding an IPSG M3UA Signaling Link](#) procedure to add IPSG M3UA signaling links to the new IPSG M3UA linkset. This procedure is finished.
 - If the `LST` value of the linkset is a value other than `PRX` and the `IPSG` value of the linkset is `no`, remove the signaling links from the linkset by performing these procedures as necessary.
 - * [Removing an SS7 Signaling Link in Database Administration - SS7 User's Guide](#).
 - * [Removing an IPLIMx Signaling Link](#)
After the signaling links have been removed from the linkset, continue the procedure with [3](#)
- If the `IPSG` value of the linkset is `yes`, continue the procedure with one of these steps.
 - If the `ADAPTER` value of the linkset is `M2PA`, remove the signaling links from the linkset by performing these procedures as necessary.

- * Removing an SS7 Signaling Link in the *Database Administration - SS7 User's Guide*.
 - * [Removing an IPLIMx Signaling Link](#)
 - * [Removing an IPSP M2PA Signaling Link](#)
After the signaling links have been removed from the linkset, continue the procedure with 4 if the linkset type for the linkset is B, C, D, or E. If the linkset type of the linkset is A, continue the procedure with 5.
- If the ADAPTER value of the linkset is M3UA, continue the procedure with one of these steps.
- * If the RSVDSLKTPS value of the linkset will not be changed, continue the procedure with 12.
 - * If the RSVDSLKTPS value of the linkset will be changed, continue the procedure with 5.
3. Change the IPSP value of the linkset by entering the `chg-ls` command with the `ipsg=yes` parameter and the name of the linkset that is being changed. For this example, enter this command.

```
chg-ls:lsn=lssg1101:ipsg=yes
```

When the `chg-ls` command has successfully completed, this message should appear.

```
rlghncxa03w 08-04-20 13:34:40 GMT EAGLE5 38.0.0
```

```
Link set table is (13 of 1024) 1% full.
```

```
CHG-LS: MASP A - COMPLTD
```

After the IPSP value of the linkset has been changed, continue the procedure with 5.

When the IPSP value is changed to `yes`, the ADAPTER value of the linkset is set to `m2pa`, the RSVDSLKTPS value of the linkset is set to 5000.

4. The linkset type of an IPSP M3UA linkset must be A. If the linkset type of the linkset is not A, change the linkset type of the linkset by entering the `chg-ls` command with the name of the linkset and the `lst=a` parameter. For this example, enter this command.

If the linkset type of the linkset is A, this step does not need to be performed. Continue the procedure with 5.

```
chg-ls:lsn=lssg1101:lst=a
```

When the `chg-ls` command has successfully completed, this message should appear.

```
rlghncxa03w 08-04-20 13:34:40 GMT EAGLE5 38.0.0
```

```
Link set table is (13 of 1024) 1% full.
```

CHG-LS: MASP A - COMPLTD

- The new RSVDSLKTPS value for the linkset cannot allow the sum of the TPS used by all the IPSG signaling links that are assigned to each IPSG card shown in the linkset to exceed the MaxTPS (see [Maximum Card Capacity for Different Card Types](#) for MaxTPS values) and cannot exceed the maximum total provisioned system TPS.

To verify the TPS for the IPSG cards containing the IPSG signaling links in the linkset, enter the `rtrv-slk` command with the card location of each signaling link that is assigned to the linkset. For this example, enter these commands.

```
rtrv-slk:loc=1101
```

This is an example of the possible output.

```
rlghncxa03w 08-04-24 14:02:40 EST 38.0.0
```

LOC	LINK	LSN	SLC	TYPE	ANAME	SLKTPS
1101	A2	lssg1101	0	IPSG	m3ua2	1000

IPTPS for LOC = 1101 is (1000 of 5000) 20%

```
rtrv-slk:loc=1105
```

This is an example of the possible output.

```
rlghncxa03w 08-04-24 14:02:40 EST 38.0.0
```

LOC	LINK	LSN	SLC	TYPE	ANAME	SLKTPS
1105	A7	lssg1101	0	IPSG	m3ua3	1000

IPTPS for LOC = 1105 is (1000 of 5000) 20%

If the new RSVDSLKTPS value for the linkset will allow the TPS for the IPSG cards containing the IPSG signaling links in the linkset to exceed the MaxTPS (see [Maximum Card Capacity for Different Card Types](#) for MaxTPS values), choose an RSVDSLKTPS value that will not exceed the MaxTPS limit for the IPSG card.

- Display the total provisioned system TPS by entering the `rtrv-tps` command. This is an example of the possible output.

```
rlghncxa03w 10-07-10 16:20:46 GMT EAGLE 42.0.0
```

CARD TYPE	NUM CARDS	NUM LINKS	RSVD TPS	MAX TPS
IPGW	17	16	48000	80000
IPSG	3	7	4200	8000
IPLIM	2	4	8000	8000
ATM	2	2	3668	3668

Total provisioned System TPS (99668 of 500000) 20%

Command Completed.

An IPSP M3UA linkset uses 100 to MAXSLKTPS (see [Maximum Card Capacity for Different Card Types](#) for MaxTPS values), as provisioned by the `maxslktps` parameter. If adding the new IPSP M3UA linkset will not exceed the maximum total provisioned system TPS, continue the procedure with [12](#).

If adding the new IPSP M3UA linkset will exceed the maximum total provisioned system TPS, and the maximum total provisioned system TPS is 500,000 shown, perform the "Activating the HIPR2 High Rate Mode Feature" procedure in *Database Administration - System Management User's Guide* to enable and turn on the HIPR2 High Rate Mode feature. When the HIPR2 High Rate Mode feature is enabled and turned on, the maximum total provisioned system TPS is increased to 1M. After the HIPR2 High Rate Mode feature has been enabled and turned on, continue the procedure with [12](#).

If the maximum total provisioned system TPS is 1M, or the maximum total provisioned system TPS is 500,000 and will not be increased, and adding the IPSP M3UA linkset will exceed the maximum total provisioned system TPS, the IPSP M3UA linkset cannot be added unless the amount of available TPS is reduced enough to allow the IPSP M3UA linkset to be changed. The available TPS can be increased by performing one or more of these actions.

- The IP TPS values of some IPGWx linksets have to be changed. To perform this action, continue the procedure with [9](#).
 - The MAXSLKTPS values of some IPSP linksets (and the RSVDSLKTPS values if necessary) have to be changed. To perform this action, continue the procedure with [9](#).
 - Some ATM high-speed signaling links have to be removed. To perform this action, continue the procedure with [7](#).
 - An IPLIMx card that contains signaling links has to be removed. To perform this action, continue the procedure with [8](#).
7. Display the ATM high-speed signaling links by entering this command.

```
rtrv-slk:type=saal
```

This is an example of the possible output.

```
rlghncxa03w 10-07-19 21:16:37 GMT EAGLE5 42.0.0

LOC LINK LSN          SLC TYPE          LP          ATM
1303 A   lsnds0          1  LIMATM          1  1.544M LINE      5  0  0

E1ATM
LOC LINK LSN          SLC TYPE          LP          ATM
1306 A   lsnituatm        0  LIMELATM         21  2.048M LINE      5  0
ON      3  0
```

SLK table is (30 of 1200) 2% full.

If ATM high-speed signaling links are shown in the `rtrv-slk` output, perform the "Removing an SS7 Signaling Link" procedure in *Database Administration - SS7 User's Guide* to remove some of the ATM high-speed signaling links.

If ATM high-speed signaling links are not displayed in the `rtrv-slk` output, perform one or more of these actions to increase the available TPS.

 **Note:**

If one or more of these actions are not performed to increase the available TPS and the available TPS will not allow the IPSP M3UA linkset to be changed, the IPSP M3UA linkset cannot be added and the remainder of this procedure cannot be performed.

- The IP TPS values of some IPGWx linksets have to be changed. To perform this action, continue the procedure with [9](#).
- The MAXSLKTPS values of some IPSP linksets (and the RSVDSLKTPS values if necessary) have to be changed. To perform this action, continue the procedure with [9](#).
- An IPLIMx card that contains signaling links has to be removed. To perform this action, continue the procedure with [8](#).

If you do not wish to perform other actions to increase the available TPS and the available TPS will allow the IPSP M3UA linkset to be changed, continue the procedure with [12](#).

8. Display the signaling links that are assigned to IPLIMx cards by entering this command.

```
rtrv-slk:type=iplim
```

This is an example of the possible output.

```
rlghncxa03w 10-07-19 21:16:37 GMT EAGLE5 42.0.0
```

LOC	LINK	LSN	SLC	TYPE	ANAME	SLKTPS
1301	A	lsniplim	0	IPLIM	M2PA	
1301	A1	lsniplim	1	IPLIM	M2PA	
1301	B1	lsniplim	2	IPLIM	M2PA	
1317	A	lsniplimi	0	IPLIMI	M2PA	

```
SLK table is (30 of 1200) 2% full.
```

If IPLIMx cards containing signaling links are shown in the `rtrv-slk` output, perform the [Removing an IPLIMx Card](#) procedure to remove an IPLIMx card and its associated signaling links.

If IPLIMx cards containing signaling links are not displayed in the `rtrv-slk` output, perform one or more of these actions to increase the available TPS.

 **Note:**

If one or more of these actions are not performed to increase the available TPS and the available TPS will not allow the IP SG M3UA linkset to be changed, the IP SG M3UA linkset cannot be added and the remainder of this procedure cannot be performed.

- The IP TPS values of some IP GWx linksets have to be changed. To perform this action, continue the procedure with [9](#).
- The MAXSLKTPS values of some IP SG linksets (and the RSVDSLKTPS values if necessary) have to be changed. To perform this action, continue the procedure with [9](#).
- Some ATM high-speed signaling links have to be removed. To perform this action, continue the procedure with [7](#).

If you do not wish to perform other actions to increase the available TPS and the available TPS will allow the IP SG M3UA linkset to be changed, continue the procedure with [12](#).

9. Display the IP GWx and IP SG linksets by entering this command.

```
rept-stat-iptps
```

This is an example of the possible output.

```
rlghncxa03w 10-07-19 21:16:37 GMT EAGLE5 42.0.0
IP TPS USAGE REPORT
```

PEAKTIMESTAMP	THRESH	CONFIG/ RSVD	CONFIG/ MAX		TPS	PEAK	

LSN							
ipgwx1	100%	----	32000	TX:	3700	4000	10-07-19
09:49:19							
				RCV:	3650	4000	10-07-19
09:49:19							
ipgwx2	100%	----	16000	TX:	4800	5000	10-07-19
09:49:09							
				RCV:	4850	5000	10-07-19
09:49:09							
ipgwx3	100%	----	32000	TX:	427	550	10-07-19
09:49:19							
				RCV:	312	450	10-07-19
09:49:19							
ipsglsn	100%	600	24000	TX:	4800	5000	10-07-19
09:49:19							
				RCV:	4800	5000	10-07-19
09:49:19							
ipsglsn2	100%	600	4000	TX:	427	550	10-07-19
09:49:19							
				RCV:	312	450	10-07-19

09:49:19

Command Completed.

If linksets are displayed in the `rept-stat-iptps` output, continue the procedure with [10](#).

If linksets are not displayed in the `rept-stat-iptps` output, perform one or more of these actions to increase the available TPS.

 **Note:**

If one or more of these actions are not performed to increase the available TPS and the available TPS will not allow the IPSP M3UA linkset to be changed, the IPSP M3UA linkset cannot be added and the remainder of this procedure cannot be performed.

- An IPLIMx card that contains signaling links has to be removed. To perform this action, continue the procedure with [8](#).
- Some ATM high-speed signaling links have to be removed. To perform this action, continue the procedure with [7](#).

If you do not wish to perform other actions to increase the available TPS and the available TPS will allow the IPSP M3UA linkset to be changed, continue the procedure with [12](#).

10. Display the attributes of the linksets shown in [9](#) by entering the `rtrv-ls` command with the name of the linkset shown in [9](#).

For this example enter these commands.

```
rtrv-ls:lsn=ipgwx1
```

This is an example of the possible output.

```
rlghncxa03w 10-07-19 21:16:37 GMT EAGLE5 42.0.0

LSN          APCA      (SS7)  SCRN SET SET BEI LST LNKS ACT MES DIS SLSCI
NIS
ipgwx1       001-001-002  none 1   1   no  A   8   off off off no
off

          SPCA          CLLI          TFATCABMLQ MTPRSE ASL8
          -----
                                4          ---   no

RANDSLS
off

IPSP  IPGWAPC  GTTMODE          CCGTMOD
no    yes    CdPA          no

MATELSN  IPTPS  LSUSEALM  SLKUSEALM
```

```

----- 32000 100% 80%

LOC LINK SLC TYPE
1101 A 0 SS7IPGW
1102 A 1 SS7IPGW
1103 A 2 SS7IPGW
1104 A 3 SS7IPGW
1105 A 4 SS7IPGW
1106 A 5 SS7IPGW
1107 A 6 SS7IPGW
1108 A 7 SS7IPGW

```

Link set table is (8 of 1024) 1% full.

rtrv-ls:lsn=ipgwx2

This is an example of the possible output.

rlghncxa03w 10-07-19 21:16:37 GMT EAGLE5 42.0.0

```

                                L3T SLT                GWS GWS GWS
LSN          APCA  (SS7)  SCRN SET SET BEI LST LNKS ACT MES DIS
SLSCI NIS
ipgwx2      001-001-003  none 1  1  no  A  8  off off off
no         off

                                SPCA          CLLI          TFATCABMLQ MTPRSE ASL8
-----  -----  -----  4          ---  no

RANDSLS
off

IPSG  IPGWAPC  GTTMODE          CGGTMOD
no    yes     CdPA          no

MATELSN  IPTPS  LSUSEALM  SLKUSEALM
-----  16000  100%     80%

LOC LINK SLC TYPE
1111 A 0 SS7IPGW
1112 A 1 SS7IPGW
1201 A 2 SS7IPGW
1202 A 3 SS7IPGW
1203 A 4 SS7IPGW
1204 A 5 SS7IPGW
1205 A 6 SS7IPGW
1206 A 7 SS7IPGW

```

Link set table is (8 of 1024) 1% full.

rtrv-ls:lsn=ipgwx3

This is an example of the possible output.

```
rlghncxa03w 10-07-19 21:16:37 GMT EAGLE5 42.0.0
```

```

                L3T SLT                GWS GWS GWS
LSN            APCA  (SS7)  SCRN SET SET BEI LST LNKS ACT MES DIS SLSCI
NIS
ipgwx3        001-001-004  none 1   1   no  A   0   off off off no
off

                SPCA                CLLI                TFATCABMLQ MTPRSE ASL8
-----
                                1                ---    no

RANDSLS
off

IPSP  IPGWAPC  GTTMODE                CGGTMOD
no    yes      CdPA                    no

MATELSN  IPTPS  LSUSEALM  SLKUSEALM
-----  32000  100%    80%

```

Link set table is (8 of 1024) 1% full.

```
rtrv-ls:lsn=ipsglsn
```

This is an example of the possible output.

```
rlghncxa03w 10-07-19 21:16:37 GMT EAGLE5 42.0.0
```

```

                L3T SLT                GWS GWS GWS
LSN            APCA  (SS7)  SCRN SET SET BEI LST LNKS ACT MES DIS SLSCI
NIS
ipsglsn        003-003-003  none 1   1   no  A   6   off off off no
off

                SPCA                CLLI                TFATCABMLQ MTPRSE ASL8
-----
                                3                ---    no

RANDSLS
off

IPSP  IPGWAPC  GTTMODE                CGGTMOD
yes   no       CdPA                    no

ADAPTER  RSVDSLKTPS  MAXSLKTPS
m3ua     600         4000

TPSALM   LSUSEALM  SLKUSEALM
maxslktps 100%    100%

RCONTEXT  ASNOTIF  NUMSLKALW  NUMSLKRSTR  NUMSLKPROH

```

```

400          yes          1          1          1

LOC LINK SLC TYPE      ANAME
1303 A    0    IPSG    ipsgm2pa1
1303 A1   1    IPSG    ipsgm2pa2
1303 B1   2    IPSG    ipsgm2pa3
1303 A2   3    IPSG    ipsgm2pa4
1303 A3   4    IPSG    ipsgm2pa5
1307 A    5    IPSG    m2pa2

```

Link set table is (8 of 1024) 1% full.

```
rtrv-ls:lsn=ipsglsn2
```

This is an example of the possible output.

```
rlghncxa03w 10-07-19 21:16:37 GMT EAGLE5 42.0.0
```

```

LSN          APCA      (SS7)  SCRN SET SET BEI LST LNKS ACT MES DIS
SLSCI NIS
ipsglsn2     005-005-005  none 1   1   no  A   1   off off off
no          off

          SPCA          CLLI          TFATCABMLQ MTPRSE ASL8
-----
          1          ---          no

RANDSLS
off

IPSG IPGWAPC GTTMODE          CGGTMOD
yes  no      CdPA          no

ADAPTER  RSVDSLKTPS  MAXSLKTPS
m3ua     600      4000

TPSALM  LSUSEALM    SLKUSEALM
maxslktps 100%    100%

RCONTEXT ASNOTIF    NUMSLKALW  NUMSLKRSTR  NUMSLKPROH
300      yes      1          1          1

LOC LINK SLC TYPE      ANAME
1303 B3  0    IPSG    ipsgm2pa6

```

Link set table is (8 of 1024) 1% full.

Perform these actions as necessary.

- Perform the [Configuring an IPGWx Linkset](#) procedure to change the IPTPS value for any linksets shown in the rtrv-ls output whose IPGWAPC value is yes.

- Perform one of these actions to change the `MAXSLKTPS` value (and `RSVDSLKTPS` value if necessary) for any linksets shown in the `rtrv-ls` output whose `IPSP` value is `yes`.
 - If the `ADAPTER` value of the linkset is `M2PA`, perform the [Changing an IPSP M2PA Linkset](#) procedure.
 - If the `ADAPTER` value of the linkset is `M3UA`, continue the procedure with [11](#).

Perform one or both of these actions to increase the available TPS if needed.

- An IPLIMx card that contains signaling links has to be removed. To perform this action, continue the procedure with [8](#).
- Some ATM high-speed signaling links have to be removed. To perform this action, continue the procedure with [7](#).

If you do not wish to perform other actions to increase the available TPS and the available TPS will allow the IPSP M3UA linkset to be changed, continue the procedure with [12](#).

11. Reduce the `MAX SLKTPS`, and `RSVDSLKTPS` value if necessary, for the linksets displayed in [10](#) by entering the `chg-ls` command with the new `maxslktps` and `rsvdslktps` values. For this example, enter these commands.

```
chg-ls:lsn=ipsglsn:maxslktps=3000
chg-ls:lsn=ipsglsn2:maxslktps=3000
```

 **Note:**

The `rsvdslktps` value must be less than or equal to the `maxslktps` value.

When this command has successfully completed, this message should appear.

```
rlghncxa03w 10-07-17 16:23:21 GMT EAGLE5 42.0.0

Link set table is ( 13 of 1024) 1% full

CHG-LS: MASP A - COMPLTD
```

12. Change the linkset by entering the `chg-ls` command with the name of the linkset and any of these optional parameters and values.

if the `ADAPTER`, `SLKTPS`, `ASNOTIF`, `LSUSEALM`, and `SLKUSEALM` values will not be changed, do not perform this step. Continue the procedure with [16](#).

- `adapter = m3ua`
- `rsvdslktps = 100 - MaxTPS`
- `maxslktps = 0 - MaxTPS`
- `tpsalmtype = rsvdslktps or maxslktps`
- `lsusealm = 10 - 100`
- `slkusealm = 10 - 100`

- `asnotif = yes or no`

For this example, enter this command.

```
chg-ls:lsn=lssg1101:slktps=500:lsusealm=60:slkusealm=70
chg-
ls:lsn=lssg1101:rsvdslktps=500:maxslktps=3000:tpsalmtpe=max
slktps :lsusealm=60:slkusealm=70
```

 **Note:**

The `rsvdslktps` value must be less than or equal to the `maxslktps` value.

When the `chg-ls` command has successfully completed, this message should appear.

```
rlghncxa03w 06-10-17 16:23:21 GMT EAGLE5 37.5.0
Link set table is ( 13 of 1024) 1% full
CHG-LS: MASP A - COMPLTD
```

 **Note:**

There are other optional parameters that can be specified with the `chg-ls` command, but are not required for an IPSP M3UA linkset. These parameters and their usage are discussed in the Other Optional Parameters section of this procedure.

If you do not wish to change the `RCONTEXT` value of the linkset, continue the procedure with [17](#).

If you wish to change the `RCONTEXT` value of the linkset, continue the procedure with by performing one of these steps.

- If the `ADAPTER` value of the linkset was changed to `m3ua` in [12](#) continue the procedure with [16](#).
- If the `ADAPTER` value of the linkset was `m3ua` when this procedure was started, and the linkset contains signaling links, continue the procedure with [13](#).
- If the `ADAPTER` value of the linkset was `m3ua` when this procedure was started, and the linkset does not contains signaling links, continue the procedure with [16](#).
- If the `ADAPTER` value of the linkset was `m3ua` when this procedure was started, the `RCONTEXT` value is being removed from the linkset, perform one of these actions. If the linkset does not contains signaling links, continue the procedure with [16](#). If the linkset does contain signaling links, remove the signaling links from the linkset by performing the [Removing an IPSP M3UA](#)

Signaling Link procedure. After the signaling links have been removed, continue the procedure with [16](#).

13. Deactivate all the signaling links in the linkset by entering the `dact-slk` command with the location and link value of each signaling link in the linkset. For this example, enter these commands.

```
dact-slk:loc=1101:link=a2
```

```
dact-slk:loc=1101:link=a7
```

When the `dact-slk` command has successfully completed, this message should appear.

```
rlghncxa03w 08-04-25 06:49:44 EST 38.0.0
Deactivate Link message sent to card
Command Completed.
```

14. Display the signaling links that the association, shown in the `rtrv-ls` output in [2](#), is assigned to by entering the `rtrv-slk` command with the name of the association that will be added to the signaling link. For this example, enter this command.

```
rtrv-slk:aname=m3ua2
```

This is an example of the possible output.

```
rlghncxa03w 06-10-17 11:43:04 GMT EAGLE5 36.0.0

LOC LINK LSN          SLC TYPE    ANAME        SLKTPS
1101 A2  lssg1101         0  IPSP      m3ua2         1000
2204 A   m3ua1           0  IPSP      m3ua2         300
```

```
rtrv-slk:aname=m3ua3
```

This is an example of the possible output.

```
rlghncxa03w 06-10-17 11:43:04 GMT EAGLE5 36.0.0

LOC LINK LSN          SLC TYPE    ANAME        SLKTPS
1105 A7  lssg1101         1  IPSP      m3ua3         1000
2204 B6  m3ua1           1  IPSP      m3ua3         300
```

15. Display all the linksets that contain the signaling links shown in [14](#), other than the linkset that is being changed in this procedure (this linkset has been displayed in [2](#)), by entering the `rtrv-ls` command with the linkset name shown in [14](#). For this example, enter this command.

```
rtrv-ls:lsn=m3ua1
```

This is an example of the possible output.

```
rlghncxa03w 10-07-17 11:43:04 GMT EAGLE5 42.0.0
```

```

                                L3T SLT
LSN          APCA  (SS7)  SCRN SET SET BEI LST LNKS ACT MES DIS
SLSCI NIS
m3ua1       002-002-003  none 1  1  no  A  2  off off off
no         off

                                SPCA          CLLI          TFATCABMLQ MTPRSE ASL8
-----
RANDSLS
off

IPSP IPGWAPC GTTMODE          CGGTMOD
yes  no      CdPA            no

ADAPTER  RSVDSLKTPS  MAXSLKTPS
m3ua     300         4000

TPSALM   LSUSEALM   SLKUSEALM
rsvdslktps 100%     80%

RCONTEXT ASNOTIF  NUMSLKALW  NUMSLKRSTR  NUMSLKPROH
25        yes     1           1             1

LOC  LINK SLC TYPE  ANAME
2204 A  0  IPSP  m3ua2
2204 B6 1  IPSP  m3ua3

```

Link set table is (13 of 1024) 1% full.

An IPSP M3UA association can be assigned to different signaling links in different linksets only if the routing context (RCONTEXT) values in the linksets are different. Choose a routing context value for the linkset that is being changed that is different from the routing context values shown in this step.

- Change the existing routing context value by entering the `chg-ls` command with the `rcontext` parameter.

If the routing context value of the linkset is being changed to a new value, for this example, enter this command.

```
chg-ls:lsn=lssg1101:rcontext=200
```

If the existing routing context value is being removed from the linkset, for this example, enter this command.

```
chg-ls:lsn=lssg1101:rcontext=100:action=delete
```

When the `chg-ls` command has successfully completed, this message should appear.

```
rlghncxa03w 06-10-17 16:23:21 GMT  EAGLE5 37.5.0
```

Link set table is (13 of 1024) 1% full

```
CHG-LS: MASP A - COMPLTD
```

17. Verify the changes using the `rtrv-ls` command specifying the linkset name specified in 12 and 16. For this example, enter this command.

```
rtrv-ls:lsn=lssg1101
```

This is an example of the possible output.

```
rlghncxa03w 10-07-20 13:34:40 GMT EAGLE5 42.0.0

LSN          APCA   (SS7)  SCRN SET SET BEI LST LNKS ACT MES DIS SLSCI
NIS
lssg1101     008-012-003  none 1  1  no  A  2  off off off no
off

          SPCA          CLLI          TFATCABMLQ MTPRSE ASL8
-----
          2          ---          no

RANDSLS
off

IPSG  IPGWAPC  GTTMODE          CGGTMOD
yes   no      CdPA          no

ADAPTER  RSVDSLKTPS  MAXSLKTPS
m3ua     500          4000

TPSALM   LSUSEALM    SLKUSEALM
maxslktps 60%        70%

RCONTEXT  ASNOTIF    NUMSLKALW  NUMSLKRSTR  NUMSLKPROH
200       yes        1           1            1

LOC  LINK  SLC  TYPE  ANAME
1101 A2    0    IPSG  m2pa2
1105:A7 1    IPSG  m2pa3
```

Link set table is (13 of 1024) 1% full.

If signaling links were deactivated in 13, continue the procedure with 18.

If signaling links were not deactivated in 13, continue the procedure with 19.

18. Activate all signaling links that were deactivated in 13 using the `act-slk` command, specifying the card location and `link` parameter value of each signaling link. For this example, enter this command.

```
act-slk:loc=1101:link=a2
```

```
act-slk:loc=1101:link=a7
```

When the `act-slk` command has successfully completed, this message should appear.

```
rlghncxa03w 06-10-07 08:31:24 GMT EAGLE5 36.0.0
Activate Link message sent to card
```

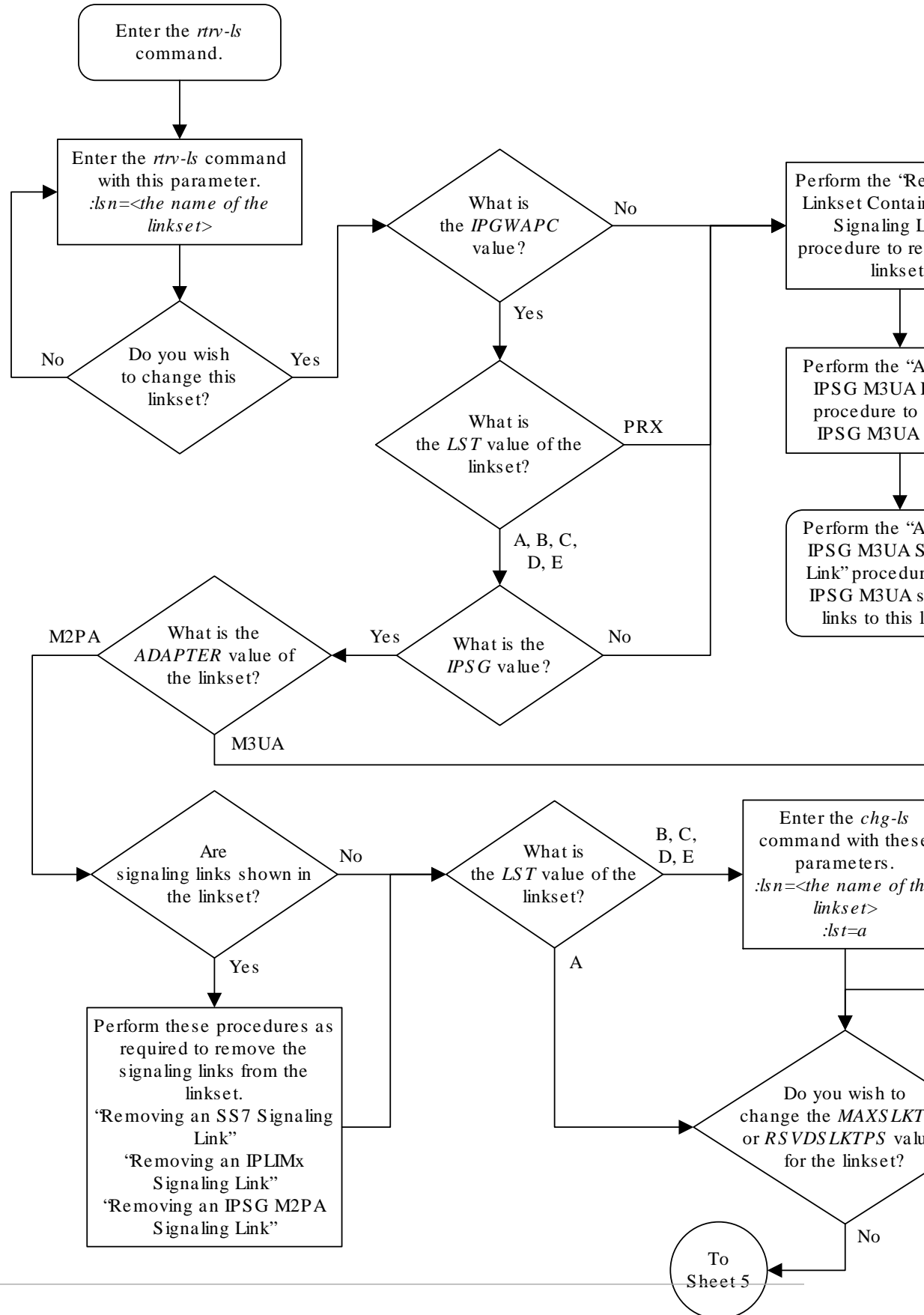
19. Back up the new changes using the `chg-db:action=backup:dest=fixed` command. These messages should appear, the active **Maintenance and Administration Subsystem Processor (MASP)** appears first.

```
BACKUP (FIXED) : MASP A - Backup starts on active MASP.  
BACKUP (FIXED) : MASP A - Backup on active MASP to fixed disk  
complete.  
BACKUP (FIXED) : MASP A - Backup starts on standby MASP.  
BACKUP (FIXED) : MASP A - Backup on standby MASP to fixed disk  
complete.
```

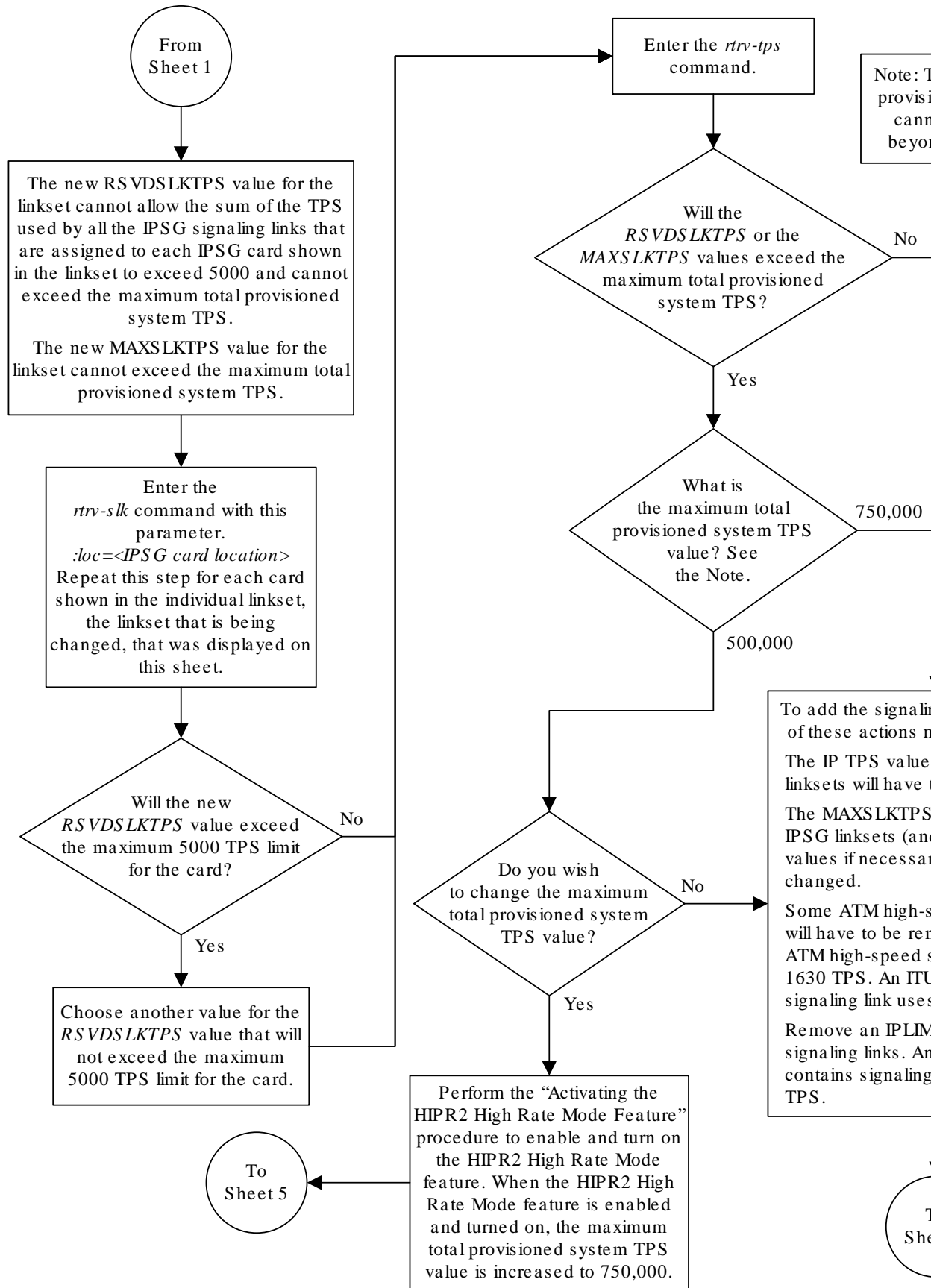
If the linkset that was changed in this procedure contained signaling links that were deactivated when [16](#) was performed, this procedure is finished.

If the linkset that was changed in this procedure contained no signaling links when [12](#) or [16](#) were performed, perform the [Adding an IPSP M3UA Signaling Link](#) procedure to add IPSP M3UA signaling links to the linkset.

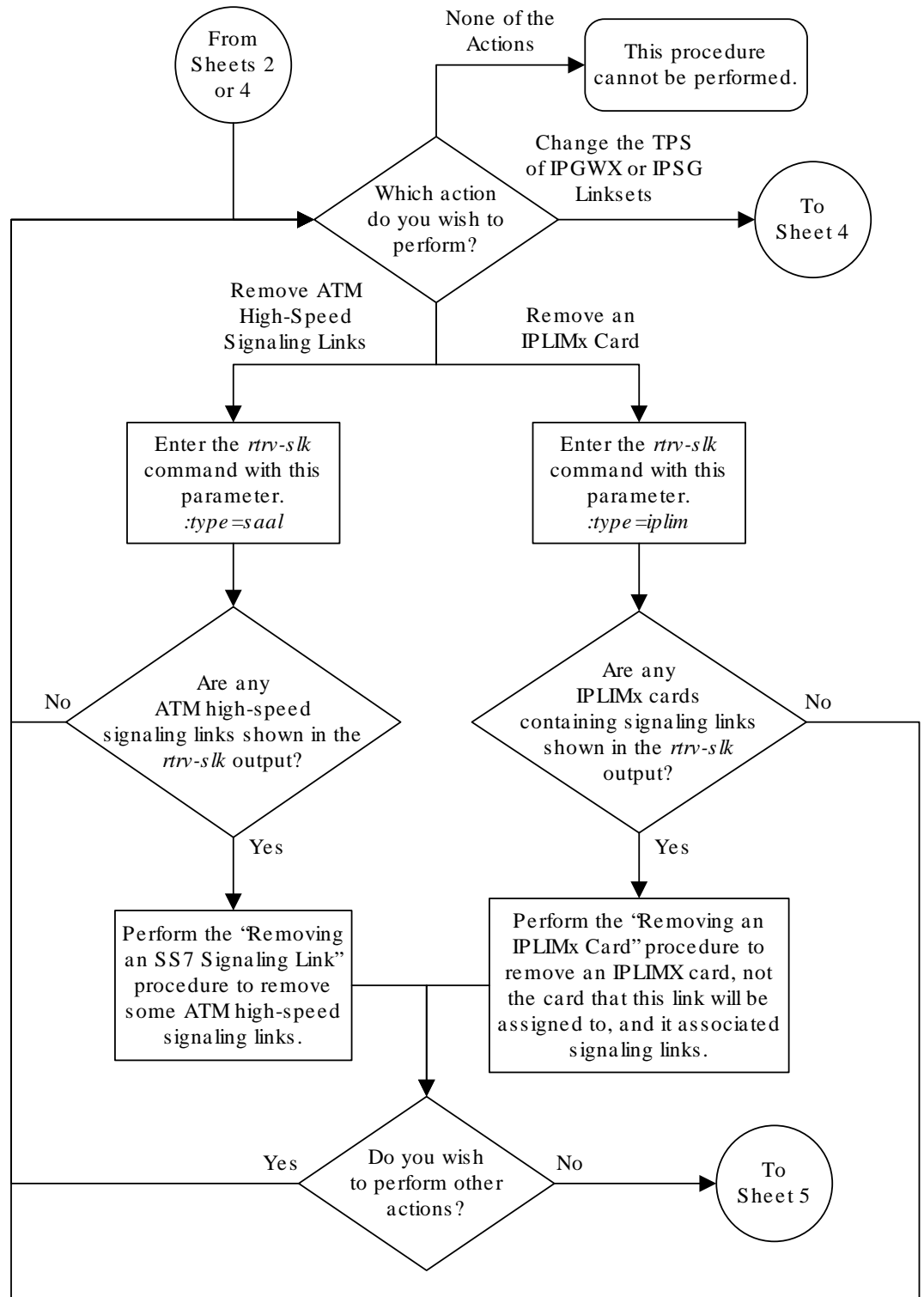
Figure 6-26 Changing an IP SG M3UA Linkset



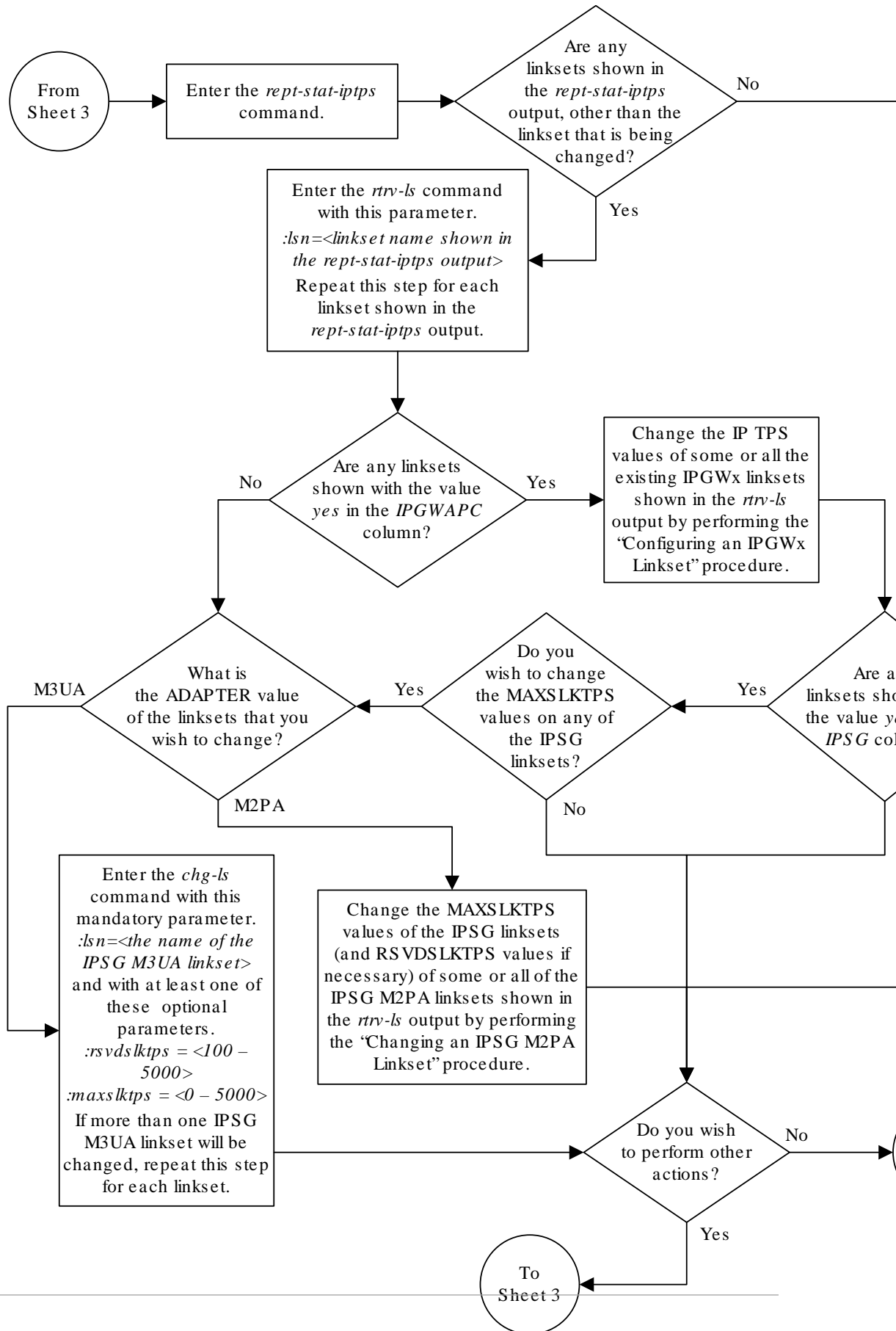
Sheet 1 of 8



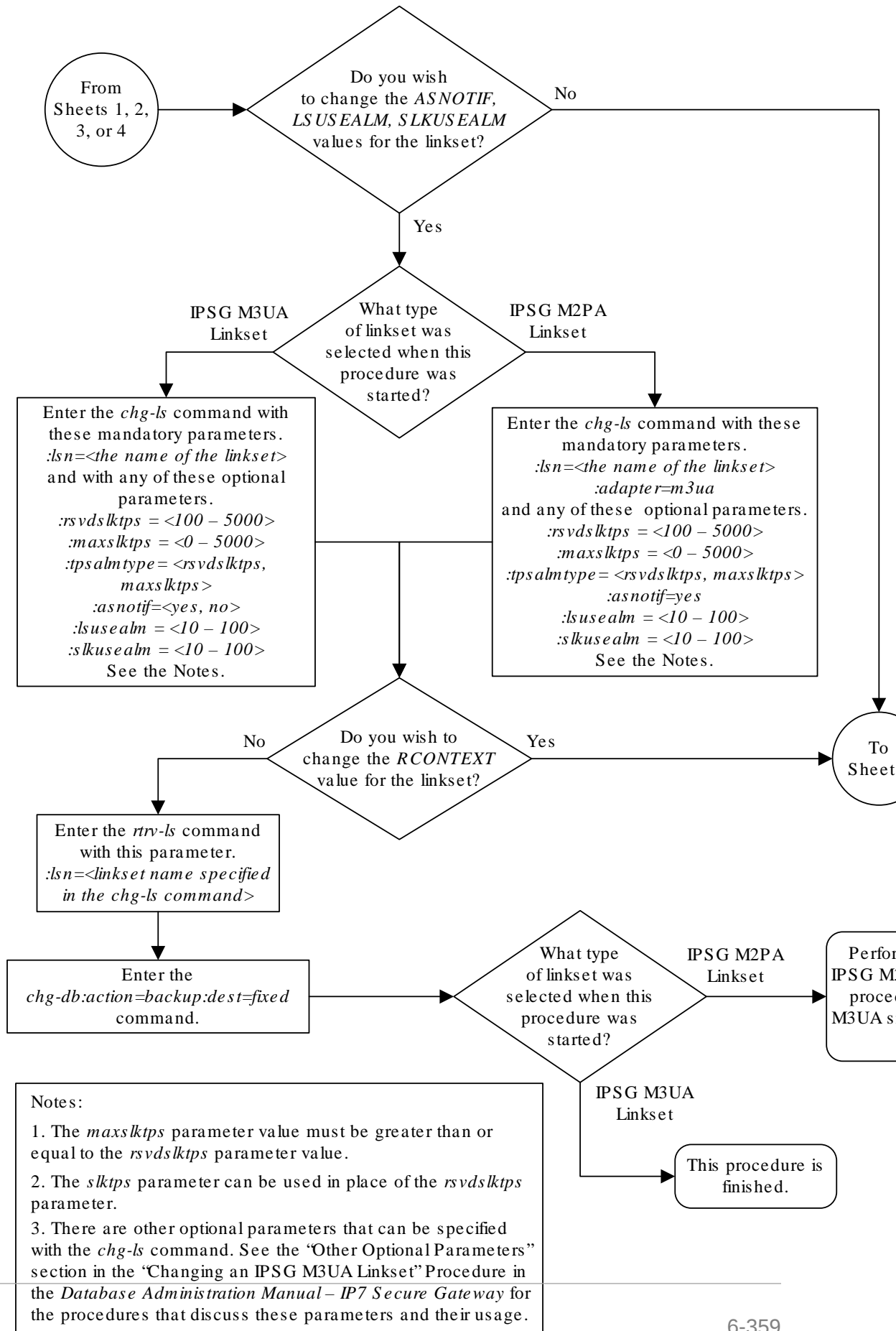
Sheet 2 of 8



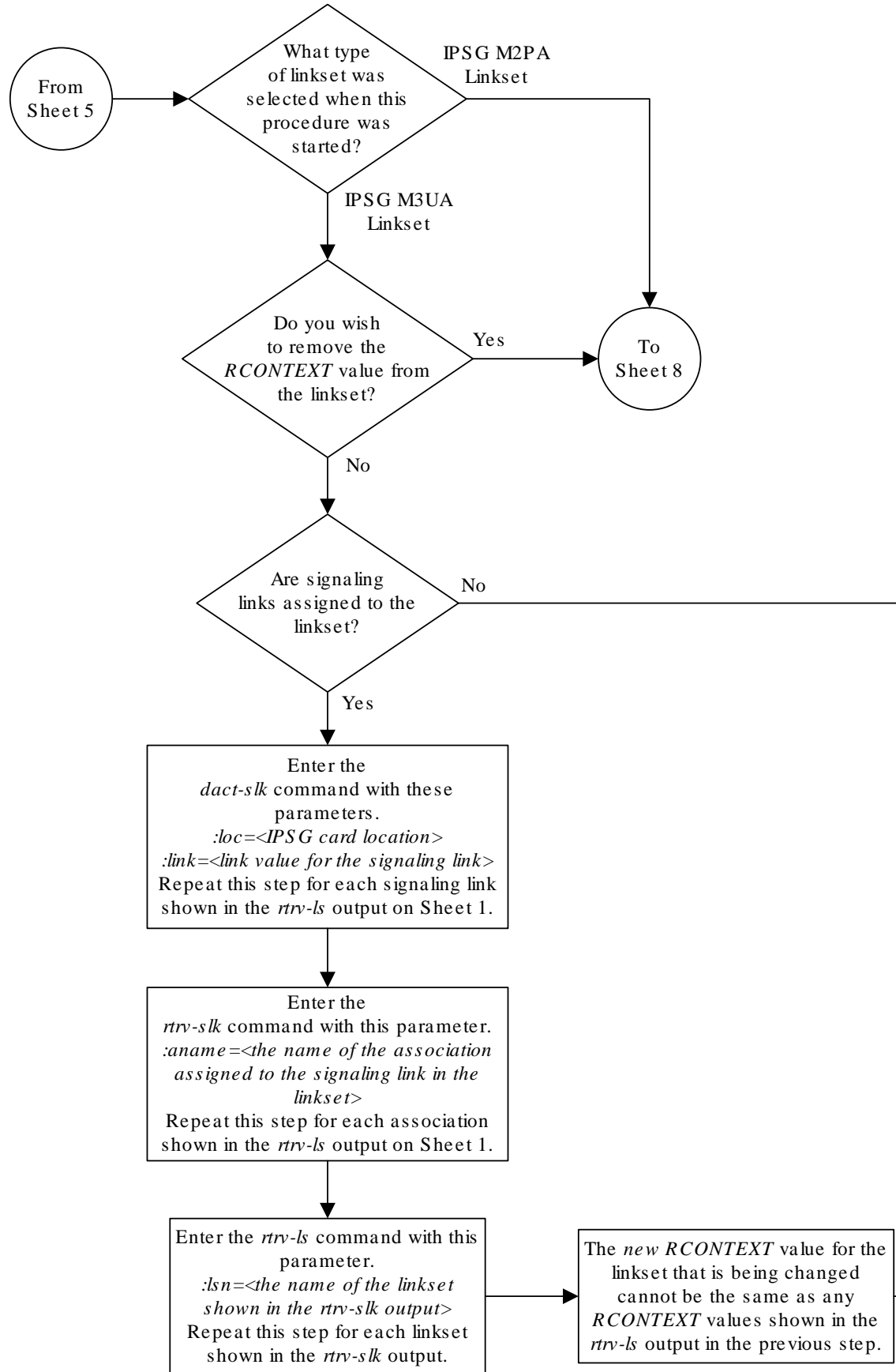
Sheet 3 of 8



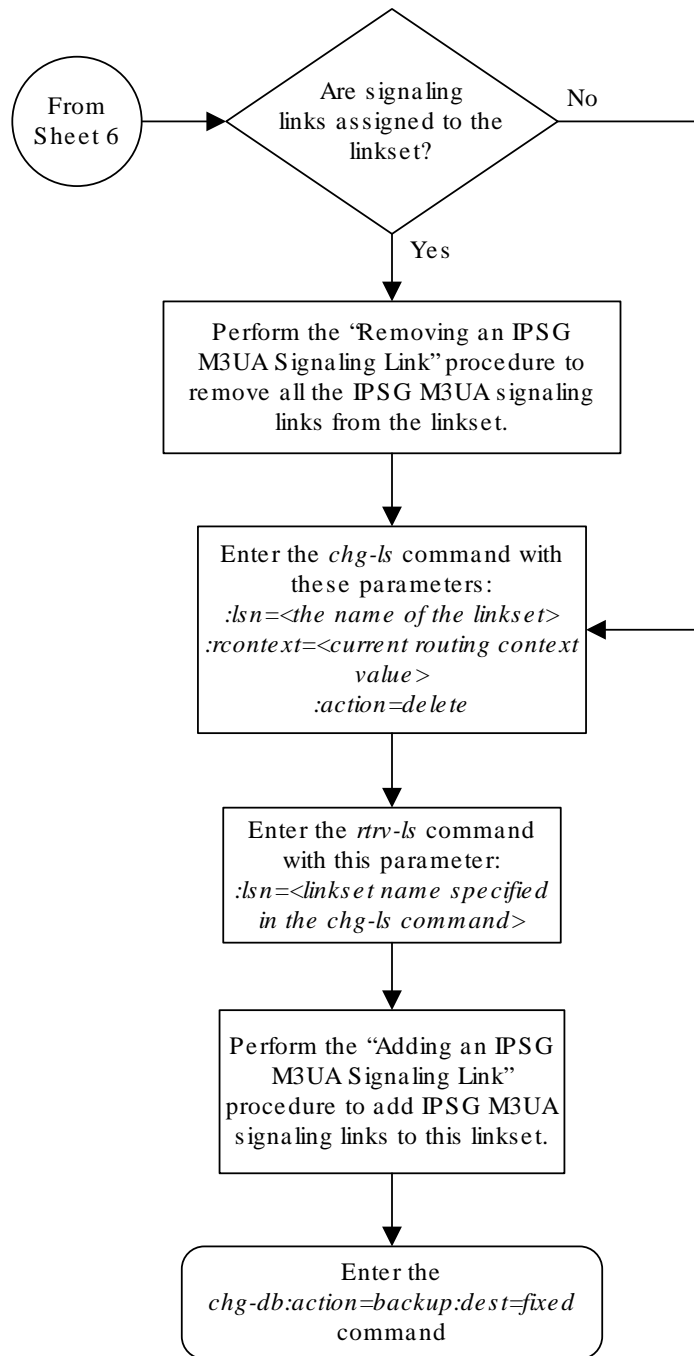
Sheet 4 of 8



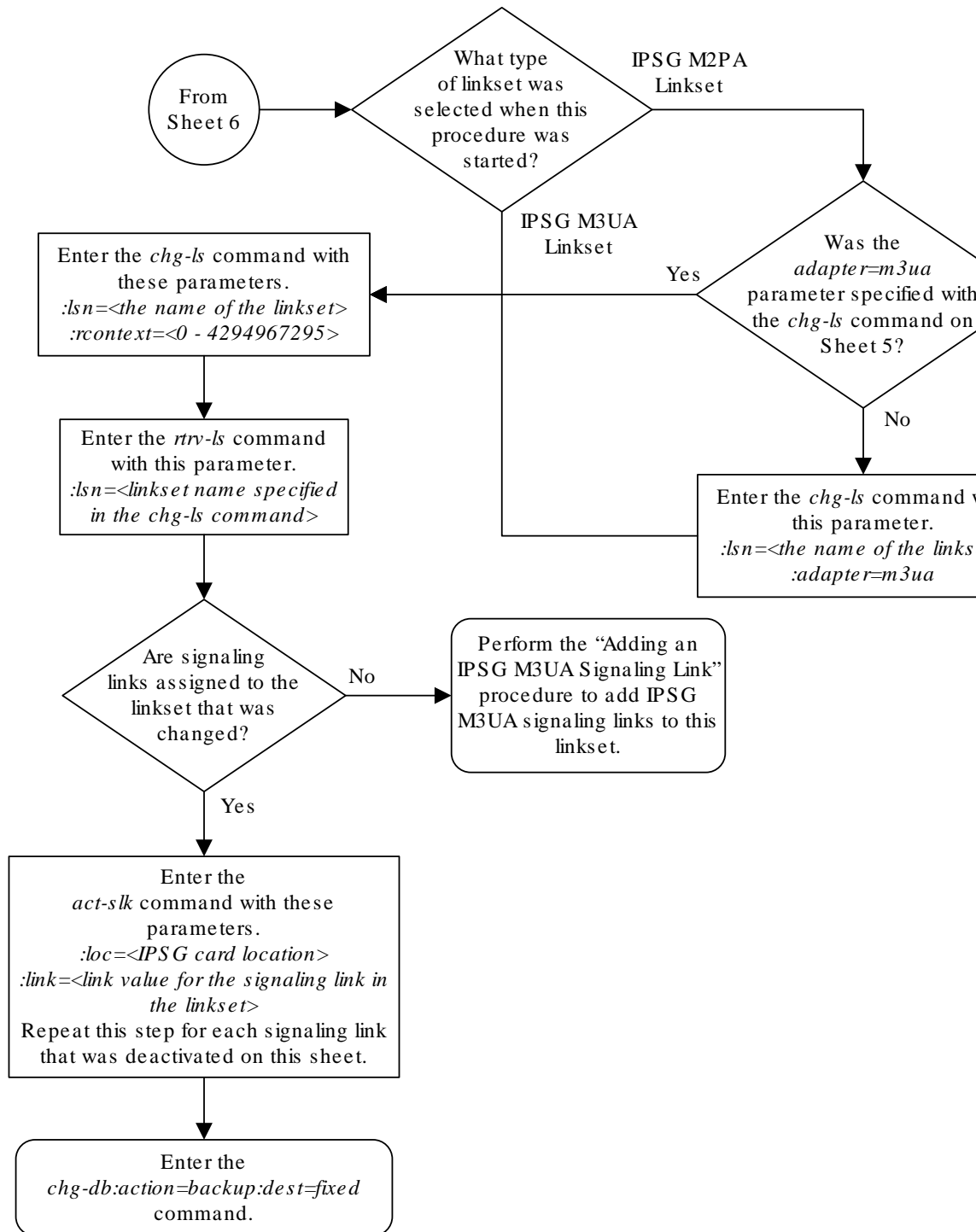
Sheet 5 of 8



Sheet 6 of 8



Sheet 7 of 8



6.30 Changing the Attributes of an IPSP Association

This procedure is used to change the values of the attributes of an IPSP association, assigned to cards that are running the IPSP application, IPSP cards, using the `chg-assoc` command and the following parameters.

Table 6-12 Change IPSP Association Parameters

aname	lport	rhost	rport	open	alw
rmode	rmin	rmax	rtimes	cwmin	istrms
ostrms	m2patset	ver	rtxthr	uaps	rhosttype
rhostval					

If you wish to change the attributes of M2PA associations assigned to cards that are running the IPLIM or IPLIMI applications, perform [Changing the Attributes of an M2PA Association](#).

If you wish to change the attributes of M3UA associations assigned to cards that are running the SS7IPGW or IPGWI applications, perform [Changing the Attributes of a M3UA or SUA Association](#).

The `chg-assoc` command contains other parameters that are not used in this procedure. To change these parameters, perform these procedures.

- `lhost` and `alhost` - [Changing the Host Values of an IPSP Association](#).
- `bufsize` - [Changing the Buffer Size of an IPSP Association](#)

`:aname` – The name assigned to the association, shown in the `rtrv-assoc` output.

`:lport` – The **SCTP** port number for the local host.

`:rhost` – The host name for the remote host, `rhost` can be any string of characters starting with a letter and comprising these characters [‘a’..‘z’, ‘A’..‘Z’, ‘0’..‘9’, ‘-’, ‘.’, ‘_’]. Hostnames are not case-sensitive and can contain up to 60 characters. The default value of this optional parameter is empty (null string).

`:rport` – The **SCTP** port number for the remote host.

`:open` – The connection state for this association. Valid values are `yes` or `no`. When the `open=yes` parameter is specified, the connection manager opens the association if the association is operational. When the `open=no` parameter is specified, the connection manager will not open the association. If the `open=no` parameter is specified for an established IPSP M3UA association, and the UA Graceful Shutdown option is enabled (refer to [Changing a UA Parameter Set](#) for more information), the IPSP M3UA connection will be gracefully shutdown.

`:alw` – The connection state for this association. Valid values are `yes` or `no`. When the `alw=yes` parameter is specified, the connection manager allows the association to carry **SS7** traffic. When the `alw=no` parameter is specified, the connection manager prohibits the association from carrying **SS7** traffic.

 **Note:**

If the `adapter` parameter value for the association is `M3UA`, the `alw` parameter cannot be specified.

`:rmode` – The retransmission policy used when packet loss is detected. The values are `rfc` or `lin`.

- `rfc` – Standard **RFC 2960** algorithm in the retransmission delay doubles after each retransmission. The **RFC 2960** standard for congestion control is also used.
- `lin` – Oracle's linear retransmission policy where each retransmission timeout value is the same as the initial transmission timeout and only the slow start algorithm is used for congestion control.

`:rmin` – The minimum value of the calculated retransmission timeout in milliseconds, from 10 - 1000.

`:rmax` – The maximum value of the calculated retransmission timeout in milliseconds, from 10 - 1000.

`:rtimes` – The number of times a data retransmission will occur before closing the association from 3 - 12.

`:cwmmin` – The minimum size in bytes of the association's congestion window and the initial size in bytes of the congestion window, from 1500 - 409600. The `cwmmin` parameter value must be less than or equal to the size of the buffer used by the association, shown by the `bufsize` parameter value. If the buffer size for the association needs to be changed, perform [Changing the Buffer Size of a M2PA Association](#).

The `rmode`, `rmin`, `rmax`, `rtimes`, and `cwmmin` parameters are used to configure the **SCTP** retransmission controls for an association, in addition to other commands. Perform [Configuring SCTP Retransmission Control for a M2PA Association](#) to configure the **SCTP** retransmission controls for an association.

`:istrms` – The number of inbound streams (1 or 2) advertised by the **SCTP** layer for the association.

`:ostrms` – The number of outbound streams (1 or 2) advertised by the **SCTP** layer for the association.

`:m2patset` – The **M2PA** timer set assigned to the association. The `m2patset` parameter can be specified only with the `adapter=m2pa` parameter, or if the association already has the `adapter=m2pa` parameter assigned and the `adapter` parameter value is not being changed. If the `adapter` parameter value is being changed to `m2pa`, and the `m2patset` parameter is not specified, the default value for the `m2patset` parameter (1 - **M2PA** timer set 1) is assigned to the association. If the `adapter` parameter value for the association is `m2pa`, is not being changed, and the `m2patset` parameter is not specified with the `chg-assoc` command, the `m2patset` parameter value is not changed.

`:ver` – The **M2PA** version assigned to the **M2PA** association, either the **RFC** version (`ver=rfc`), or the Draft 6 version (`ver=d6`). The `ver` parameter can be specified only if, when this procedure is completed, the `adapter` parameter value is `m2pa`. If the `adapter` parameter value is being changed to `m2pa`, and the `ver` parameter is not specified, the

default **M2PA** version of **RFC** is assigned to the association. To change the `ver` parameter value, the `open` parameter value for the association must be `no`.

`:uaps` – The **UA** parameter set value being assigned to an M2PA or an **M3UA** association.

`:rtxthr` – The retransmission threshold for the association. The `rtxthr` parameter value indicates the number of retransmissions that can occur on the association that when exceeded will generate UAM 0537, Ethernet Error Threshold Exceeded. The value of this parameter is 0 to 65,535. The value of this parameter is shown in the `RTXTHR` field of the `rtrv-assoc:aname=<association name>` output. The `rtxthr` parameter value can be changed if the `open` parameter value is either `yes` or `no`.

`:rhosttype` – The type of remote host assigned to the association, `primary` or `alternate`. The primary remote host is shown in the `RHOST` field of the `rtrv-assoc:aname=<association name>` output. The alternate remote host is shown in the `ARHOST` field of the `rtrv-assoc:aname=<association name>` output.

An alternate remote host can be configured for multi-homed associations using the `rhost` and `rhosttype` parameters of the `chg-assoc` command. The `rhost` parameter value with the `rhosttype=primary` parameter represents an IP address that corresponds to one of the network interfaces at the remote end while the `rhost` parameter value with the `rhosttype=alternate` parameter represents an IP address that corresponds to the other network interface at the remote end.

`:rhostval` – The validation mode used for the association when an SCTP INIT/INIT-ACK message is received. The value of this parameter is shown in the `RHOSTVAL` field of the `rtrv-assoc:aname=<association name>` output. This parameter has two values.

- `relaxed` - accept the message if the IP address for the primary or alternate remote host matches the IP address, source IP address, or the host name in the message.
- `match` - accept the message if the message contains the primary remote host value and the alternate remote host value (if the alternate remote host is provisioned). If the alternate remote host is not provisioned, then accept the message if the message contains the primary remote host value. Reject the message if it contains any IP address other than that of the primary or alternate remote host.
Refer to the `chg-assoc` command description in *Commands User's Guide* for more information about this parameter.

If the value of the `open` parameter is `yes`, only the value of the `alw` and `rtxthr` parameters can be changed. To change the values of other parameters, the value of the `open` parameter must be `no`.

To set the `open` parameter value to `yes`, the association specified by the `aname` parameter must contain values for the `lhost`, `lport`, `rhost`, and `rport` parameters. The association must be assigned to a signaling link.

At least one optional parameter is required.

The command input is limited to 150 characters, including the hostnames.

The value of the `rmin` parameter must be less than or equal to the `rmax` parameter value.

The `m2patset` and `ver` parameters can be specified only for IPSP M2PA associations.

Canceling the `RTRV-ASSOC` Command

Because the `rtrv-assoc` command used in this procedure can output information for a long period of time, the `rtrv-assoc` command can be canceled and the output to the terminal stopped. There are three ways that the `rtrv-assoc` command can be canceled.

- Press the `F9` function key on the keyboard at the terminal where the `rtrv-assoc` command was entered.
- Enter the `canc-cmd` without the `trm` parameter at the terminal where the `rtrv-assoc` command was entered.
- Enter the `canc-cmd:trm=<xx>`, where `<xx>` is the terminal where the `rtrv-assoc` command was entered, from another terminal other than the terminal where the `rtrv-assoc` command was entered. To enter the `canc-cmd:trm=<xx>` command, the terminal must allow Security Administration commands to be entered from it and the user must be allowed to enter Security Administration commands. The terminal's permissions can be verified with the `rtrv-secu-trm` command. The user's permissions can be verified with the `rtrv-user` or `rtrv-secu-user` commands.

For more information about the `canc-cmd` command, go to *Commands User's Guide*.

1. Display the associations in the database using the `rtrv-assoc` command.

This is an example of possible output.

```
rlghncxa03w 06-10-28 09:12:36 GMT EAGLE5 36.0.0
```

ANAME	CARD		IPLNK	LINK ADAPTER	LPORT	RPORT	OPEN	ALW
	LOC	PORT						
swbel32	1201	A	A	M3UA	1030	2345	YES	YES
a2	1305	A	A	SUA	1030	2345	YES	YES
a3	1307	A	A	SUA	1030	2346	YES	YES
assoc1	1201	A	A	M3UA	2000	1030	YES	YES
assoc2	1205	A	A	M2PA	2048	2048	YES	YES
assoc3	1205	A	B2	M2PA	3000	3000	YES	YES
assoc5	1205	A	A3	M2PA	1500	3000	YES	YES

2. Enter the `rtrv-card` command with the location of the card that is hosting the M2PA or M3UA association that will be changed in this procedure. For this example, enter these commands.

```
rtrv-card:loc=1205
```

This is an example of possible output.

```
rlghncxa03w 08-04-06 15:17:20 EST EAGLE5 38.0.0
```

CARD	TYPE	APPL	LSET NAME	LINK	SLC	LSET NAME	LINK	SLC
1205	ENET	IPSP	e5e6a	A	0	e5e6a	B2	1
			e5e6a	A3	2			

```
rtrv-card:loc=1201
```

This is an example of possible output.

```
rlghncxa03w 08-04-06 15:17:20 EST EAGLE5 38.0.0
CARD   TYPE      APPL      LSET NAME   LINK SLC LSET NAME   LINK SLC
1201   ENET        IPSP      ipsgm3ua1   A     0
```

If the application assigned to the card is IPSP, shown in the `APPL` column, and the values of any of these parameters are being changed: `lport`, `rhost`, `rport`, `rmode`, `rmin`, `rmax`, `rtimes`, `cwmin`, `istrms`, `ostrms`, `ver`, `m2patset`, or `uaps`, continue the procedure by performing one of these steps.

- If the `open` parameter value for the association is `yes`, continue the procedure with [3](#).
- If the `open` parameter value for the association is `no`, continue the procedure with [4](#).

If the application assigned to the card is IPSP, shown in the `APPL` column, and only the values of the `alw`, `open`, or `rtxthr` parameters are being changed, continue the procedure by performing one of these steps.

 **Note:**

If the `adapter` parameter value for the association is M3UA, the `alw` parameter cannot be specified.

- If only the values of the `alw` parameter is being changed, or the `open` parameter value is being changed to `no`, continue the procedure with [10](#).
- If the value of the `rtxthr` parameter is being changed, continue the procedure with [4](#).
- If the value of the `open` parameter value is being changed to `yes`, the association must be assigned to a signaling link. If the association is assigned to a signaling link, the signaling link value is shown in the `LINK` column in the `rtrv-assoc` output, in [1](#). If the association is not assigned to a signaling link, dashes are shown in the `LINK` column in the `rtrv-assoc` output. If association is assigned to a signaling link, perform one of these actions.
 - If only the `alw` parameter is being specified with the `open=yes` parameter, continue the procedure with [10](#).
 - If the value of the `rtxthr` parameter is being changed, continue the procedure with [4](#).
- If the value of the `open` parameter value is being changed to `yes` and the association is not assigned to a signaling link, perform one of these procedures.
 - If the `ADAPTER` value of the association is M2PA, perform [Adding an IPSP M2PA Signaling Link](#).
 - If the `ADAPTER` value of the association is M3UA, perform [Adding an IPSP M3UA Signaling Link](#).

- After the association has been assigned to a signaling link, perform one of these actions.
 - If only the `alw` parameter is being specified with the `open=yes` parameter, continue the procedure with 10.
 - If the value of the `rtxtthr` parameter is being changed, continue the procedure with 4.

If the application assigned to the card is IPLIM or IPLIMI, perform [Changing the Attributes of an M2PA Association](#).

If the application assigned to the card is SS7IPGW or IPGWI, perform [Changing the Attributes of a M3UA or SUA Association](#).

3. Change the value of the `open` parameter to `no` by specifying the `chg-assoc` command with the `open=no` parameter.

For this example, enter these commands.

```
chg-assoc:aname=assoc2:open=no
chg-assoc:aname=assoc1:open=no
```

When these commands have successfully completed, this message should appear.

```
rlghncxa03w 06-10-28 09:12:36 GMT EAGLE5 36.0.0
CHG-ASSOC: MASP A - COMPLTD;
```

4. Display the association being changed by entering the `rtrv-assoc` command with the `aname` parameter specified in 3 or selected in 1.

For this example, enter these commands.

```
rtrv-assoc:aname=assoc2
```

This is an example of the possible output.

```
rlghncxa03w 10-07-28 21:14:37 GMT EAGLE5 42.0.0
ANAME assoc2
      LOC      1205          IPLNK PORT  A          LINK  A
ADAPTER M2PA          VER          M2PA RFC
LHOST    IPNODE2-1205
ALHOST   ---
RHOST    remotehost1
ARHOST   ---
LPORT    2048          RPORT      2048
ISTRMS   2          OSTRMS     2          BUFSIZE  400
RMODE    LIN          RMIN       120         RMAX     800
RTIMES   10          CWMIN      3000        UAPS     10
OPEN     NO          ALW        YES         RTXTTHR  2000
RHOSTVAL RELAXED      M2PATSET   1
LSN
e5e6a
```

```
IP Appl Sock/Assoc table is (7 of 4000) 1% full
Assoc Buffer Space Used (800 KB of 6400 KB) on LOC = 1205
```

```
rtrv-assoc:aname=assoc1
```

This is an example of the possible output.

```
rlghncxa03w 09-05-28 21:14:37 GMT EAGLE5 41.0.0
```

```

ANAME assoc1
  LOC      1201          IPLNK PORT A          LINK      A
  ADAPTER  M3UA          VER           M3UA RFC
  LHOST    m3ua1
  ALHOST   ---
  RHOST    remotel
  ARHOST   ---
  LPORT    2000          RPORT        1030
  ISTRMS   2            OSTRMS       2            BUFSIZE   200
  RMODE    LIN          RMIN         120          RMAX      800
  RTIMES   10          CWMIN        3000          UAPS      10
  OPEN     NO           ALW          NO           RTXTHR    0
  RHOSTVAL RELAXED

  LSN
  ipsgm3ua1

```

```

IP Appl Sock/Assoc table is (7 of 4000) 1% full
Assoc Buffer Space Used (200 KB of 6400 KB) on LOC = 1201

```

Continue the procedure by performing one of these actions.

- If the `cwmin` parameter will be specified in this procedure, continue the procedure with [5](#).
5. To change the `cwmin` value, the new `cwmin` parameter value must be less than or equal to the `bufsize` parameter value.

The `cwmin` parameter is the number of bytes specified for the association's congestion window. The `bufsize` is the number of kilobytes specified for the size of the association's buffer. To determine whether or not the `cwmin` value is less than or equal to the `bufsize` value, perform one of these actions.

- Multiply the `bufsize` value by 1024.
- Divide the `cwmin` value by 1024.

Continue the procedure by performing one of these actions.

- If the new `cwmin` value is less than or equal to the `bufsize` value, continue the procedure with by performing one of these actions.
 - If the `m2patset` parameter will be specified for an M2PA association, continue the procedure with [6](#).
 - If the `uaps` parameter will be specified for an M3UA association, continue the procedure with [7](#).
 - If the `rhost` parameter will be specified for the association, continue the procedure with [8](#).

- If the `m2patset`, `uaps`, or `rhost` parameter will not be specified for the association, continue the procedure with 10.
- If the new `cwmin` value is not less than or equal to the `bufsize` value, either choose another value for the `cwmin` parameter that is less than or equal to the `bufsize` value, or perform [Changing the Buffer Size of an IPSG Association](#) to change the `bufsize` value so that the `bufsize` value is greater than or equal to the `cwmin` value. After the new `cwmin` value has been chosen or the `bufsize` value has been changed, continue the procedure by performing one of these actions.
 - If the `m2patset` parameter will be specified for an M2PA association, continue the procedure with 6.
 - If the `uaps` parameter will be specified for an M3UA association, continue the procedure with 7.
 - If the `rhost` parameter will be specified for the association, continue the procedure with 8.
 - If the `m2patset`, `uaps`, or `rhost` parameter will not be specified for the association, continue the procedure with 10.
- 6. Verify the values of the **M2PA** timer set you wish to assign to the association by entering the `rtrv-m2pa-tset` command with the **M2PA** version (either `ver=rfc` to display the **RFCM2PA** timer values or `ver=d6` to display the Draft 6 **M2PA** timer values) of the timer set you wish to assign to the association.

If the `ver` parameter is not specified with the `rtrv-m2pa-tset` command, both the **RFC** and Draft 6 timer values are displayed.

To display the **M2PA** Draft 6 timer values, enter this command.

```
rtrv-m2pa-tset:ver=d6
```

This is an example of the possible output.

```
rlghncxa03w 06-10-28 21:16:37 GMT EAGLE5 36.0.0
```

```
M2PA Draft 6 Timers (in msec, T16 in microsec)
```

TSET	T1	T2	T3	T4N	T4E	T5	T6	T7	T16	T17	T18
1	6000	-----	5000	20000	500	5000	4000	1000	100000	150	500
2	7500	-----	1500	2000	500	9000	1250	300	150000	175	600
3	100000	-----	2000	3000	500	4000	1500	500	170000	200	800
4	200000	-----	20000	4000	500	6000	2000	700	480000	225	900
5	250000	-----	30000	30000	500	100	2250	400	400000	400	8000
6	50000	-----	50000	60000	500	500	4500	800	300000	300	7000
7	10000	-----	10000	10000	500	1000	3000	1200	200000	250	1000
8	80000	-----	1500	15000	500	8000	2750	1100	350000	350	5000
9	27500	-----	3850	4859	450	5700	3750	1150	250	375	8750
10	90000	-----	2500	50000	500	7500	5000	1750	440000	450	3000
11	20000	-----	4500	5500	500	6500	5500	1600	250000	475	4500
12	30000	-----	7500	7000	500	750	4250	1800	275000	275	3500
13	40000	-----	35000	9000	500	1250	3500	1900	500	325	9000
14	70000	-----	45000	11000	500	1500	1750	900	1000	125	6000
15	9000	-----	25000	40000	500	2500	3250	600	5000	425	5500
16	75000	-----	15000	25000	500	4500	1600	1400	6000	240	9500
17	350000	-----	60000	70000	600	10000	6000	2000	500000	500	10000

```

18 150000 ----- 55000 35000 500 3500 5750 1500 125000 440 750
19 175000 ----- 12500 45000 500 1100 2600 1300 7000 340 850
20 1000 ----- 1000 1000 400 80 1000 200 100 100 100

```

To display the **M2PARFC** values, enter this command.

```
rtrv-m2pa-tset:ver=rfc
```

This is an example of the possible output.

```
rlghncxa03w 06-10-28 21:16:37 GMT EAGLE5 36.0.0
```

M2PA RFC Timers (in msec, T16 in microsec)

TSET	T1	T2	T3	T4N	T4E	T5	T6	T7	T16	T17	T18
1	6000	75000	5000	20000	500	5000	4000	1000	100000	150	500
2	7500	8000	1500	2000	500	9000	1250	300	150000	175	600
3	100000	10000	2000	3000	500	4000	1500	500	170000	200	800
4	200000	6000	20000	4000	500	6000	2000	700	480000	225	900
5	250000	140000	30000	30000	500	100	2250	400	400000	400	
6	50000	100000	50000	60000	500	500	4500	800	300000	300	
7	300000	20000	2000	10000	500	1000	3000	1200	200000	250	
8	80000	130000	1500	15000	500	8000	2750	1100	350000	350	
9	27500	120000	3850	4859	450	5700	3750	1150	250	375	
10	90000	9000	2500	50000	500	7500	5000	1750	440000	450	
11	20000	60000	4500	5500	500	6500	5500	1600	250000	475	
12	30000	50000	7500	7000	500	750	4250	1800	275000	275	
13	40000	90000	35000	9000	500	1250	3500	1900	500	325	
14	70000	45000	45000	11000	500	1500	1750	900	1000	125	
15	9000	30000	25000	40000	500	2500	3250	600	5000	425	
16	75000	15000	15000	25000	500	4500	1600	1400	6000	240	
17	350000	150000	60000	70000	600	10000	6000	2000	500000	500	
18	150000	20000	55000	35000	500	3500	5750	1500	125000	440	750
19	175000	12500	12500	45000	500	1100	2600	1300	7000	340	850
20	1000	5000	1000	1000	400	80	1000	200	100	100	100

If the `ver` parameter is not specified when entering the `rtrv-m2pa-tset` command, both the Draft 6 and RFC values are displayed. This is an example of the possible output.

rlghncxa03w 06-10-28 21:16:37 GMT EAGLE5 36.0.0

M2PA Draft 6 Timers (in msec, T16 in microsec)

TSET	T1	T2	T3	T4N	T4E	T5	T6	T7	T16	T17	T18
1	6000	-----	5000	20000	500	5000	4000	1000	100000	150	500
2	7500	-----	1500	2000	500	9000	1250	300	150000	175	600
3	100000	-----	2000	3000	500	4000	1500	500	170000	200	800
4	200000	-----	20000	4000	500	6000	2000	700	480000	225	900
5	250000	-----	30000	30000	500	100	2250	400	400000	400	8000
6	50000	-----	50000	60000	500	500	4500	800	300000	300	7000
7	10000	-----	10000	10000	500	1000	3000	1200	200000	250	1000
8	80000	-----	1500	15000	500	8000	2750	1100	350000	350	5000
9	27500	-----	3850	4859	450	5700	3750	1150	250	375	8750
10	90000	-----	2500	50000	500	7500	5000	1750	440000	450	3000
11	20000	-----	4500	5500	500	6500	5500	1600	250000	475	4500
12	30000	-----	7500	7000	500	750	4250	1800	275000	275	3500
13	40000	-----	35000	9000	500	1250	3500	1900	500	325	9000
14	70000	-----	45000	11000	500	1500	1750	900	1000	125	6000
15	9000	-----	25000	40000	500	2500	3250	600	5000	425	5500
16	75000	-----	15000	25000	500	4500	1600	1400	6000	240	9500
17	350000	-----	60000	70000	600	10000	6000	2000	500000	500	10000
18	150000	-----	55000	35000	500	3500	5750	1500	125000	440	750
19	175000	-----	12500	45000	500	1100	2600	1300	7000	340	850
20	1000	-----	1000	1000	400	80	1000	200	100	100	100

M2PA RFC Timers (in msec, T16 in microsec)

TSET	T1	T2	T3	T4N	T4E	T5	T6	T7	T16	T17	T18
1	6000	75000	5000	20000	500	5000	4000	1000	100000	150	500
2	7500	8000	1500	2000	500	9000	1250	300	150000	175	600
3	100000	10000	2000	3000	500	4000	1500	500	170000	200	800
4	200000	6000	20000	4000	500	6000	2000	700	480000	225	900
5	250000	140000	30000	30000	500	100	2250	400	400000	400	8000
6	50000	100000	50000	60000	500	500	4500	800	300000	300	7000
7	300000	20000	2000	10000	500	1000	3000	1200	200000	250	1000
8	80000	130000	1500	15000	500	8000	2750	1100	350000	350	5000
9	27500	120000	3850	4859	450	5700	3750	1150	250	375	8750
10	90000	9000	2500	50000	500	7500	5000	1750	440000	450	3000
11	20000	60000	4500	5500	500	6500	5500	1600	250000	475	4500
12	30000	50000	7500	7000	500	750	4250	1800	275000	275	3500
13	40000	90000	35000	9000	500	1250	3500	1900	500	325	9000
14	70000	45000	45000	11000	500	1500	1750	900	1000	125	6000
15	9000	30000	25000	40000	500	2500	3250	600	5000	425	5500
16	75000	15000	15000	25000	500	4500	1600	1400	6000	240	9500
17	350000	150000	60000	70000	600	10000	6000	2000	500000	500	10000
18	150000	20000	55000	35000	500	3500	5750	1500	125000	440	750
19	175000	12500	12500	45000	500	1100	2600	1300	7000	340	850
20	1000	5000	1000	1000	400	80	1000	200	100	100	100

▲ Caution:

Changing an **M2PA** timer set may affect the performance of any associations using the timer set being changed.

If the **M2PA** timer set you wish to assign to the association does not contain the desired values, perform the [Changing an M2PA Timer Set](#) procedure to change the desired timer values.

After the M2PA timer set values have been changed, or if you have decided not to change the M2PA timer set values, continue the procedure by performing one of these actions.

- If the `uaps` parameter will be specified for an M3UA association, continue the procedure with [7](#).
 - If the `rhost` parameter will be specified for the association, continue the procedure with [8](#).
 - If the `uaps` or `rhost` parameter will not be specified for the association, continue the procedure with [10](#).
7. Verify the values of the **UA** parameter set you wish to assign to the association by entering the `rtrv-uaps` command with the desired parameter set.

For this example, enter this command.

```
rtrv-uaps:set=3
```

This is an example of possible output.

```
rlghncxa03w 10-07-28 09:12:36 GMT EAGLE5 42.0.0
  SET  TIMER      TVALUE  PARM      PVALUE
    3    1          10      1          3
    3    2         3000     2          0
    3    3        10000     3          1
    3    4          5000     4          0
    3    5           0      5          0
    3    6           0      6          0
    3    7           0      7          0
    3    8           0      8          0
    3    9           0      9          0
    3   10           0     10          0
```

```
TIMER 2: False IP Connection Congestion Timer, max time an
association can be congested before failing due to
false
```

```
congestion. SS7IPGW and IPGWI applications enforce
0-30000(ms). Not supported on IPSP application.
```

```
TVALUE : Valid range = 32-bits
```

```
TIMER 3: UA HeartBeat Period Timer T(beat), time (ms) between
sending
```

```
of BEAT msgs by NE. IPSP, SS7IPGW and IPGWI
applications
```

```
enforce 100(ms)-60000(ms).
```

TVALUE : Valid range = 32-bits

TIMER 4: UA HeartBeat Received Timer T(beat ack), timeout period for response BEAT ACK msgs by NE. IPSP, SS7IPGW and IPGWI applications enforce 100(ms)-10000(ms).

TVALUE : Valid range = 32-bits

PARAM 1: ASP SNM options. Each bit is used as an enabled/disabled flag for a particular ASP SNM option. Not supported on IPSP application.

PVALUE : Valid range = 32-bits

BIT	BIT VALUE
0=Broadcast	0=Disabled , 1=Enabled
1=Response Method	0=Disabled , 1=Enabled
2-5=Reserved	
6=Broadcast Congestion Status Change	0=Disabled , 1=Enabled
7-31=Reserved	

PARAM 2: ASP/AS Notification options. Each bit is used as an enabled/disabled flag for a particular ASP/AS Notification option. Not supported on IPSP application.

PVALUE : Valid range = 32-bits

BIT	BIT VALUE
0=ASP Active Notifications	0=Disabled , 1=Enabled
1=ASP Inactive Notifications	0=Disabled , 1=Enabled
2=ASP AS State Query	0=Disabled , 1=Enabled
3-31=Reserved	

PARAM 3: UA Serviceability Options. Each bit is used as an enabled/disabled flag for a particular UA Serviceability option. Supported on IPSP, SS7IPGW, and IPGWI applications. UA Graceful Shutdown supported on IPSP for M3UA only.

PVALUE : Valid range = 32-bits

BIT	BIT VALUE
0=UA Heartbeats	0=Disabled , 1=Enabled
1=UA Graceful Shutdown	0=Disabled , 1=Enabled
2-31=Reserved	

PARAM 4: SCTP Payload Protocol Indicator byte order option. Bit indicates PPI value is RCV/TX in Big Endian or Little Endian byte format. Supported on IPSP-M2PA associations only.

PVALUE : Valid range = 32-bits

BIT	BIT VALUE
0=Payload Protocol Indicator	0=Big Endian , 1=Little Endian
1-31=Reserved	

▲ Caution:

Changing a **UA** parameter set may affect the performance of any associations using the parameter set being changed.

If the **UA** parameter set you wish to assign to the association does not contain the desired values, perform the [Changing a UA Parameter Set](#) procedure to change the desired parameter set values.

After the UA parameter set values have been changed, or if you have decided not to change the UA parameter set values, continue the procedure by performing one of these actions.

- If the `rhost` parameter will be specified for the association, continue the procedure with [8](#).
 - If the `uaps` or `rhost` parameter will not be specified for the association, continue the procedure with [10](#).
- 8.** The remote hosts assigned to the association can be changed by specifying the `rhost` and `rhosttype` parameters with the `chg-assoc` command.

If the primary and alternate remote hosts are not being changed in this procedure, or if only the primary remote host is being changed, continue the procedure with [10](#).

To change the alternate remote host value for the association, the association must have a primary remote host assigned to it. If the association has a primary remote host, continue the procedure with [10](#). If the association does not have a primary remote host, continue the procedure with [9](#).

- 9.** Assign a primary remote host to the association by entering the `chg-assoc` command with the name of the association and the primary remote host name.

For this example, enter this command.

```
chg-assoc:aname=assoc2:rhost="gw200.nc-Oracle.com"
```

The `rhosttype=primary` parameter can be specified with the `chg-assoc` command, but is not necessary.

When this command has successfully completed, this message should appear.

```
rlghncxa03w 09-05-28 09:12:36 GMT EAGLE5 41.0.0
CHG-ASSOC: MASP A - COMPLTD;
```

- 10.** Change the association using the `chg-assoc` command.

For this example, enter these commands.

```
chg-assoc:aname=assoc2:rhost="gw200.nc-
Oracle.com" :rport=3000:rtxthr=10000:rhostval=match
chg-
assoc:aname=assoc1:rport=3000:rtxthr=10000:uaps=3:rhostval=m
atch
```

If an alternate remote host is being specified for the association, for this example enter this command.


```
chg-assoc:aname=assoc2:rhost="gw210.nc-
Oracle.com":rhosttype=alternate :rport=3000:rtxthr=10000:rhostval
=match
```

 **Note:**

The `m2patset` and `ver` parameters can be specified only for M2PA associations.

If only the `alw`, `open`, `rtxthr` parameter values are being changed in this step, for this example, enter this command.

 **Note:**

If the `adapter` parameter value for the association is M3UA, the `alw` parameter cannot be specified.

```
chg-assoc:aname=assoc2:alw=no:open=yes:rtxthr=10000
```

These are the rules that apply to changing the attributes of an IPSG association.

- a. If any optional parameters are not specified with the `chg-assoc` command, those values are not changed.
- b. The value of the `rhost` parameter is a text string of up to 60 characters, with the first character being a letter. The command input is limited to 150 characters, including the hostname.
- c. If the value of the `open` parameter is `yes`, only the values of the `alw` and `rtxthr` parameters can be changed. To change the values of the other parameters, the value of the `open` parameter value must be `no`.
- d. The value of the `rmin` parameter must be less than or equal to the `rmax` parameter value.
- e. The M2PA version of the association determines the version of the M2PA timer set that is assigned to the association. For example, if M2PA timer set 3 is assigned to the M2PA association, and the association is an RFC M2PA association, the RFC version of M2PA timer set 3 is used with the association. If M2PA timer set 7 is assigned to the M2PA association, and the association is a Draft 6 M2PA association, the Draft 6 version of M2PA timer set 7 is used with the association.
- f. The `m2patset` and `ver` parameters can be specified only for IPSG M2PA associations.
- g. If the `adapter` parameter value for the association is M3UA, the `alw` parameter cannot be specified.

When these commands have successfully completed, this message should appear.

```
rlghncxa03w 06-10-28 09:12:36 GMT EAGLE5 36.0.0
CHG-ASSOC: MASP A - COMPLTD;
```

If the value of the `open` parameter was not changed in 3, continue the procedure with Oracle.

11. Change the value of the `open` parameter to `yes` by specifying the `chg-assoc` command with the `open=yes` parameter.

For this example, enter these commands.

```
chg-assoc:aname=assoc2:open=yes
chg-assoc:aname=assoc1:open=yes
```

When this command has successfully completed, this message should appear.

```
rlghncxa03w 06-10-28 09:12:36 GMT EAGLE5 36.0.0
CHG-ASSOC: MASP A - COMPLTD;
```

12. Verify the changes using the `rtrv-assoc` command specifying the association name specified in 10 and 11.

For this example, enter these commands.

```
rtrv-assoc:aname=assoc2
```

This is an example of possible output.

```
rlghncxa03w 10-07-28 21:14:37 GMT EAGLE5 42.0.0
ANAME assoc2
      LOC      1205      IPLNK PORT  A      LINK  A
ADAPTER M2PA      VER      M2PA RFC
LHOST IPNODE2-1205
ALHOST ---
RHOST gw200.nc-Oracle.com
ARHOST gw210.nc-Oracle.com
LPORT 2048      RPORT      2048
ISTRMS 2      OSTRMS      2      BUFSIZE 400
RMODE LIN      RMIN      120      RMAX      800
RTIMES 10      CWMIN      3000    UAPS      10
OPEN YES      ALW      NO      RTXTHR 10000
RHOSTVAL MATCH      M2PATSET 1

      LSN
      e5e6a
```

```
IP Appl Sock/Assoc table is (7 of 4000) 1% full
Assoc Buffer Space Used (800 KB of 6400 KB) on LOC = 1205
```

```
rtrv-assoc:aname=assoc1
```

This is an example of the possible output.

```
rlghncxa03w 09-05-28 21:14:37 GMT EAGLE5 41.0.0
ANAME assoc1
      LOC      1201      IPLNK PORT  A      LINK  A
```

```

ADAPTER M3UA          VER          M3UA RFC
LHOST   m3ua1
ALHOST  ---
RHOST   remotel
ARHOST  ---
LPORT   2000          RPORT     3000
ISTRMS  2            OSTRMS    2          BUFSIZE  200
RMODE   LIN          RMIN      120        RMAX     800
RTIMES  10          CWMIN     3000      UAPS     3
OPEN    YES          ALW       NO         RTXTHR  10000
RHOSTVAL MATCH

LSN
ipsgm3ua1
  
```

IP Appl Sock/Assoc table is (7 of 4000) 1% full
 Assoc Buffer Space Used (200 KB of 6400 KB) on LOC = 1201

13. Back up the new changes, using the `chg-db:action=backup:dest=fixed` command.

These messages should appear; the active **Maintenance and Administration Subsystem Processor (MASP)** appears first.

```

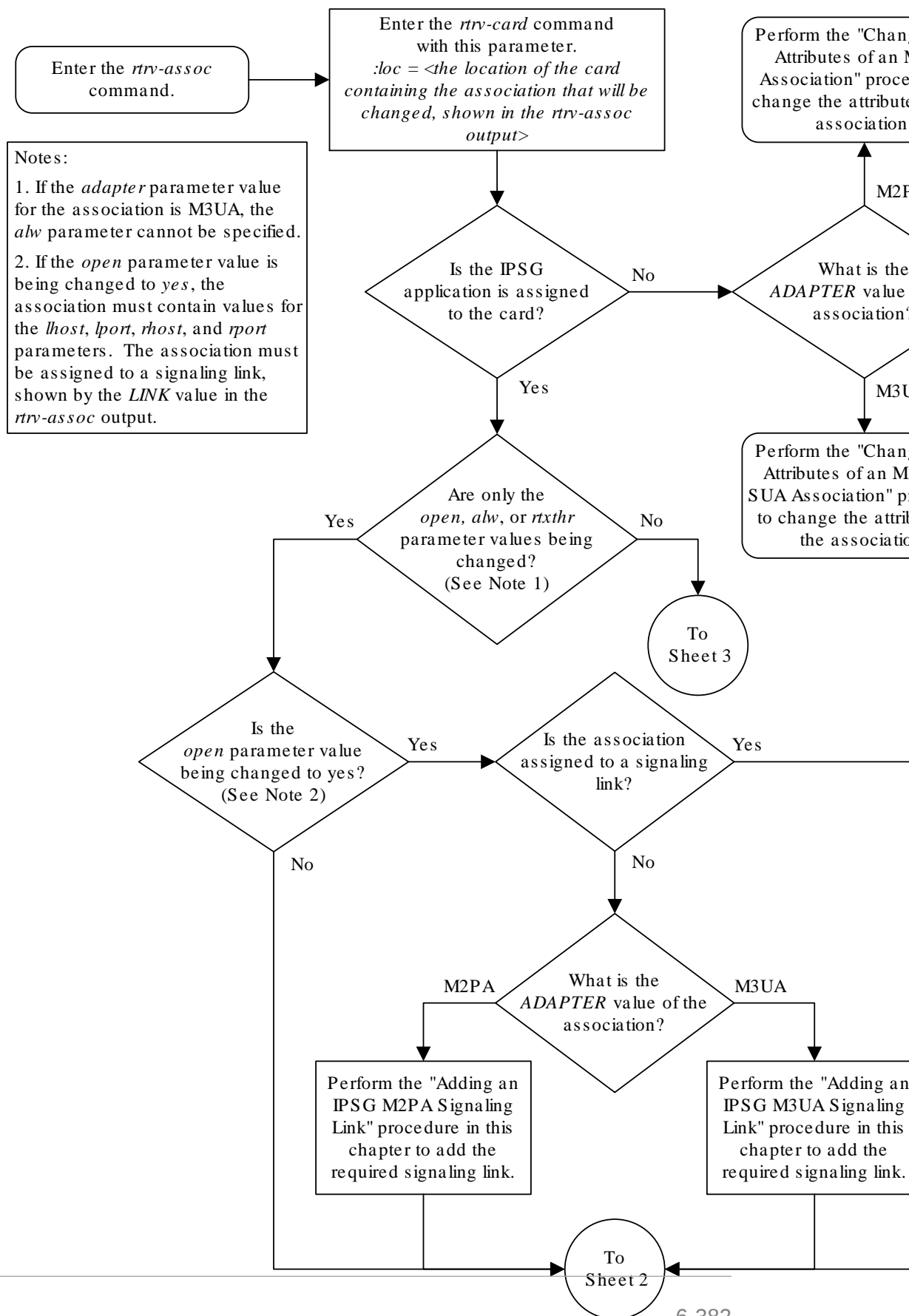
BACKUP (FIXED) : MASP A - Backup starts on active MASP.
BACKUP (FIXED) : MASP A - Backup on active MASP to fixed disk complete.
BACKUP (FIXED) : MASP A - Backup starts on standby MASP.
BACKUP (FIXED) : MASP A - Backup on standby MASP to fixed disk complete.
  
```

If you wish to change the `lhost`, `alhost`, or `bufsize` values of the IPSP association, perform one of these procedures.

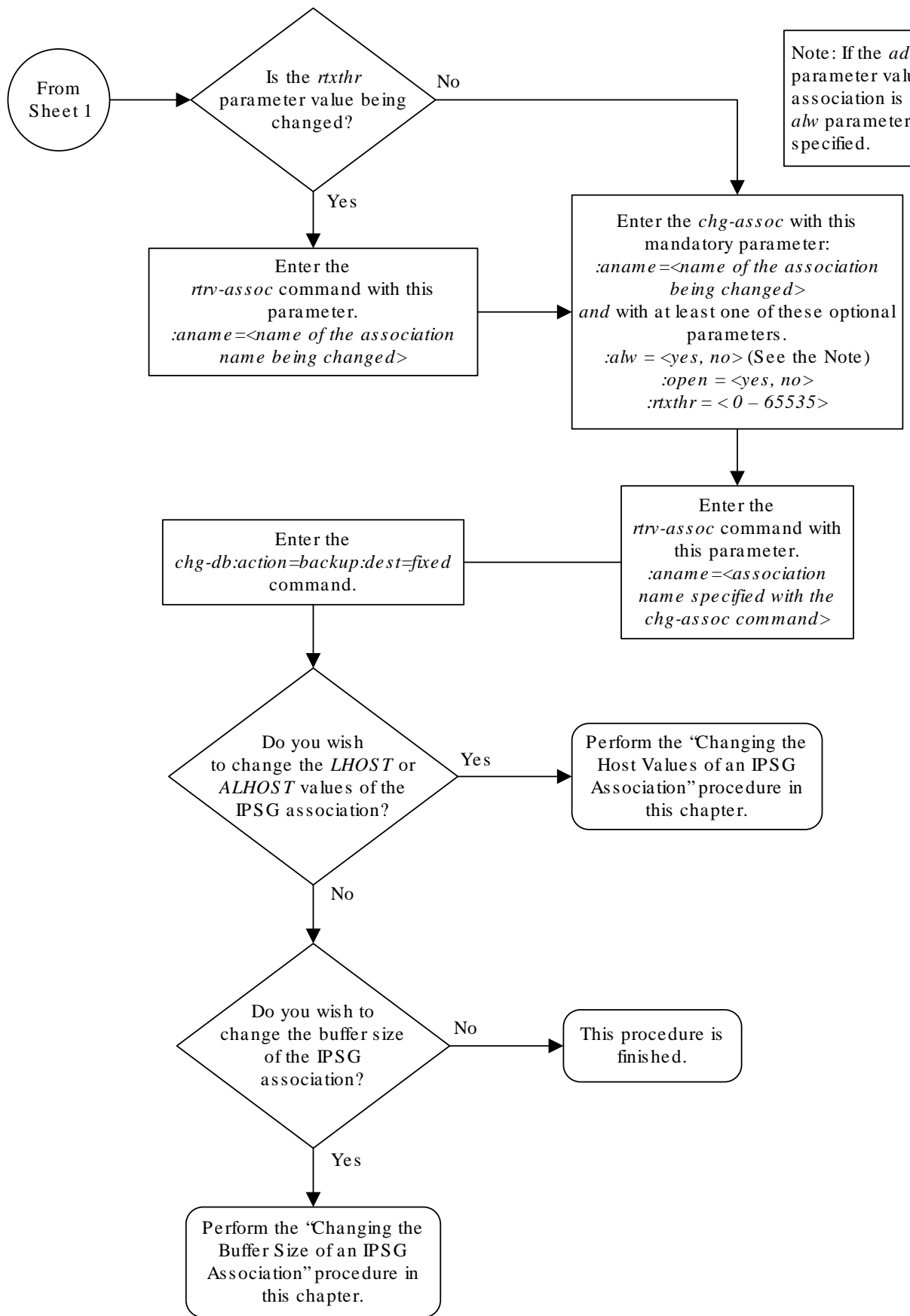
- `lhost` and `alhost` - [Changing the Host Values of an IPSP Association](#)
- `bufsize` - [Changing the Buffer Size of an IPSP Association](#)

If you do not wish to change the `lhost`, `alhost`, `bufsize`, or `link` values of the IPSP association, this procedure is finished.

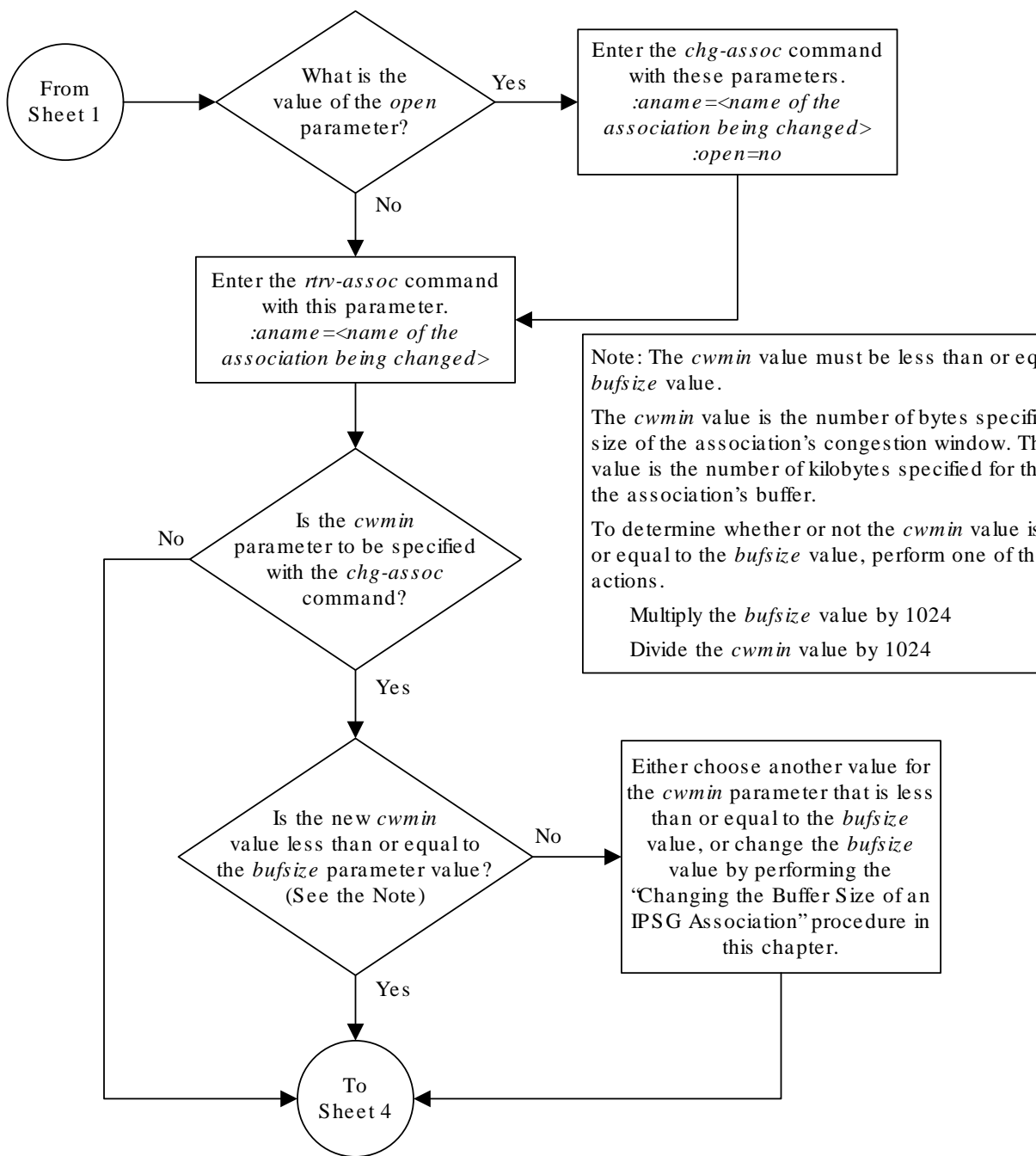
Figure 6-27 Changing the Attributes of an IPSG Association



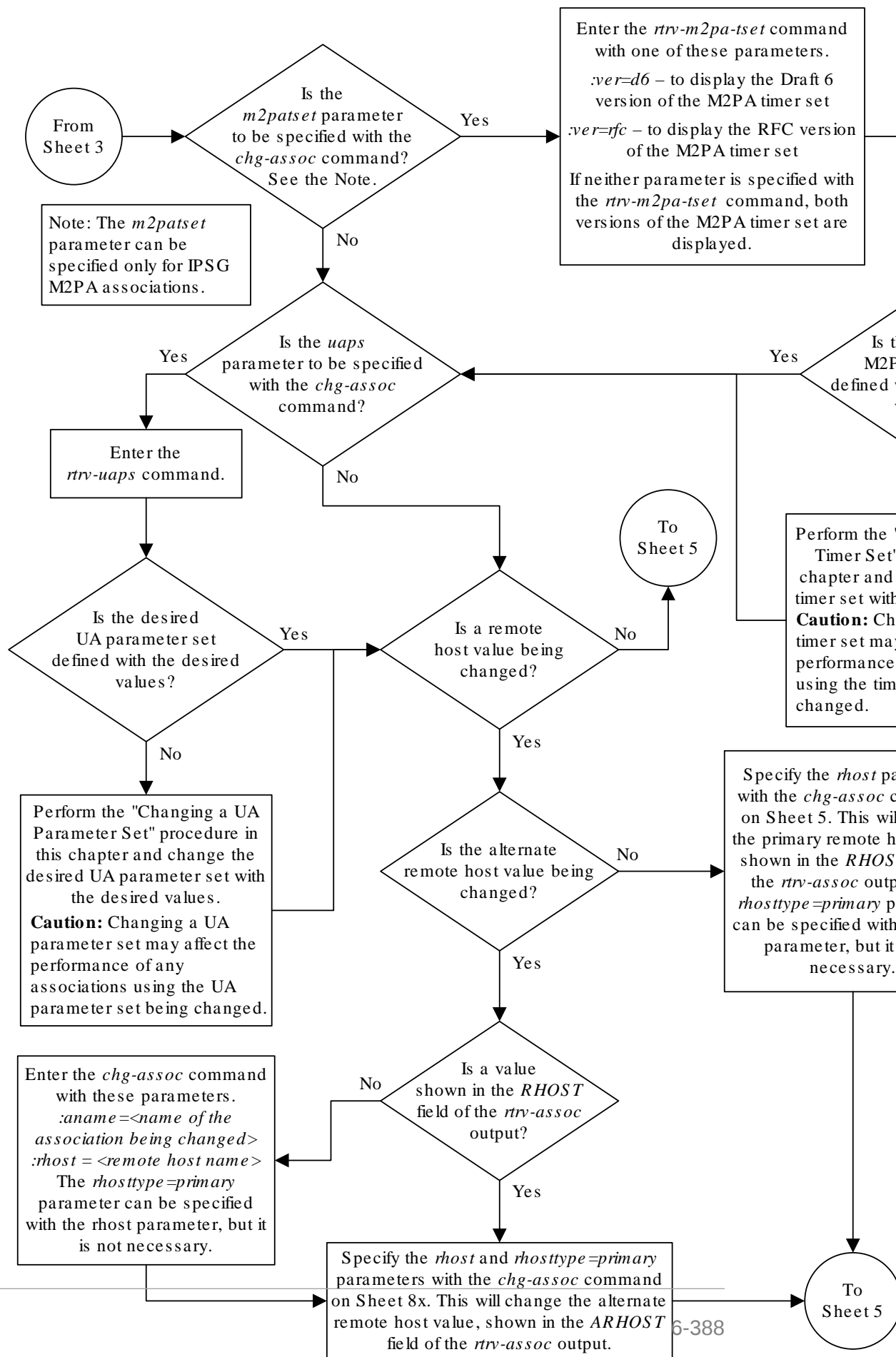
Sheet 1 of 5



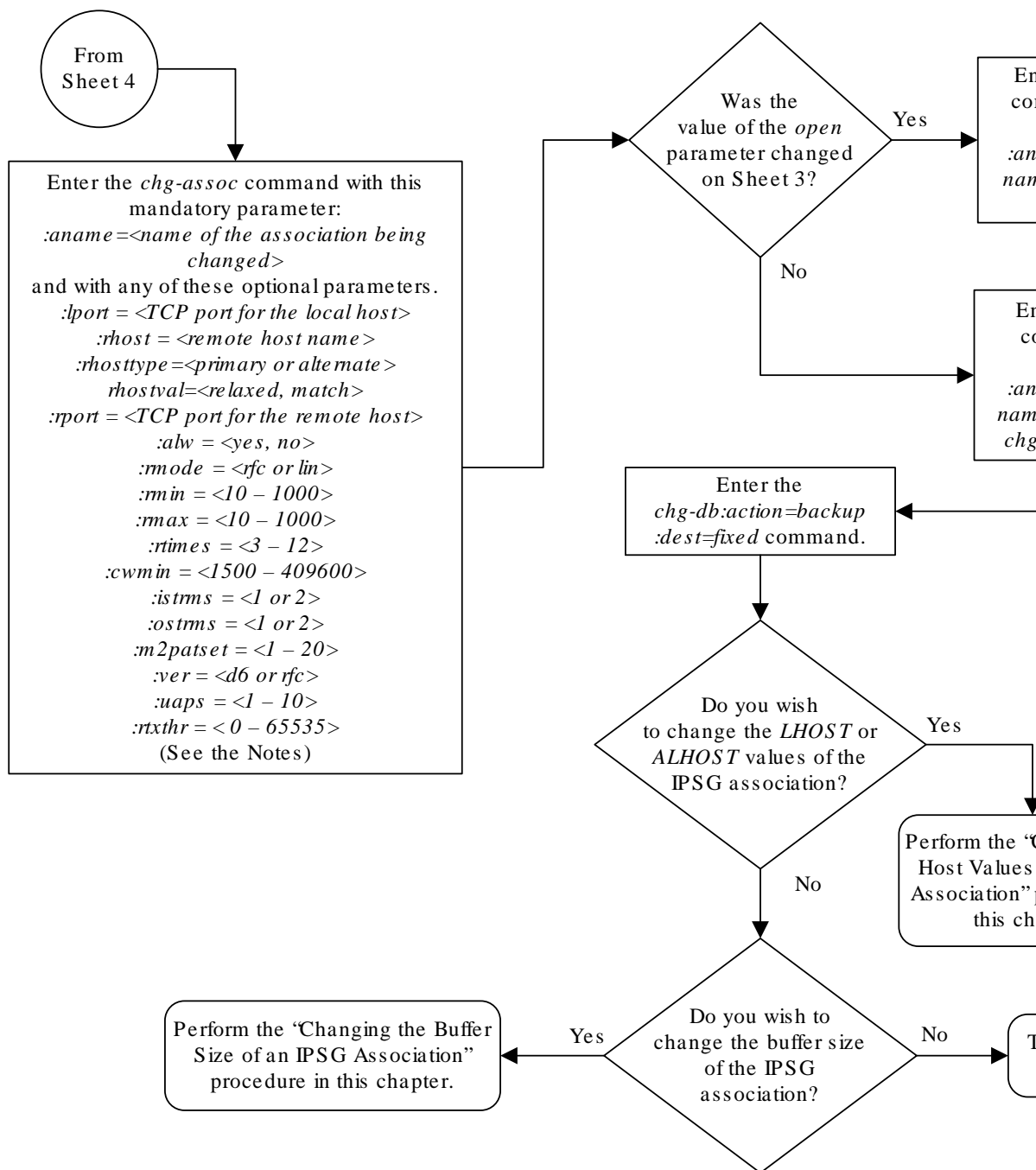
Sheet 2 of 5



Sheet 3 of 5



Sheet 4 of 5



- Notes:
1. If any optional parameters are not specified with the *chg-assoc* command, those values are not changed.
 2. The value of the *rhost* parameter is a text string of up to 60 characters, with the first character being a letter. The input is limited to 150 characters, including the hostname.
 3. If the value of the *open* parameter is *yes*, only the values of the *alw* and *rtxthr* parameters can be changed. If the value of the *open* parameter is *no*, the values of the other parameters, the value of the *open* parameter value must be *no*.
 4. The value of the *rmin* parameter must be less than or equal to the *rmax* parameter value.
 5. The M2PA version of the association determines the version of the M2PA timer set that is assigned to the association. For example, if M2PA timer set 3 is assigned to the M2PA association, and the association is an RFC M2PA association, the RFC version of M2PA timer set 3 is used with the association. If M2PA timer set 7 is assigned to the M2PA association, and the association is a Draft 6 M2PA association, the Draft 6 version of M2PA timer set 7 is used with the association.
 6. The *m2patset* and *ver* parameters can be specified only for IPSG M2PA associations.
 7. If the *adapter* parameter value for the association is M3UA, the *alw* parameter cannot be specified.

6.31 Changing the Buffer Size of an IPSG Association

This procedure is used to change the buffer size of an **IPSG** association, assigned to E5-ENET cards that are running the IPSG application, IPSG cards, using the `chg-assoc` command.

If you wish to change the buffer size of M2PA associations assigned to cards that are running the IPLIM or IPLIMI applications, perform the [Changing the Buffer Size of a M2PA Association](#) procedure.

If you wish to change the buffer size of M3UA associations assigned to cards that are running the SS7IPGW or IPGWI applications, perform the [Changing the Buffer Size of a M3UA or SUA Association](#) procedure.

These parameters of the `chg-assoc` command are used in this procedure:

`:aname` – The name assigned to the association, shown in the `rtrv-assoc` output.

`:open` – The connection state for this association. Valid values are `yes` or `no`. When the `open=yes` parameter is specified, the connection manager opens the association if the association is operational. When the `open=no` parameter is specified, the connection manager will not open the association. If the `open=no` parameter is specified for an established IPSG M3UA association, and the UA Graceful Shutdown option is enabled (refer to [Changing a UA Parameter Set](#) for more information), the IPSG M3UA connection will be gracefully shutdown.

`:bufsize` – The size, in kilobytes, of the buffer used by the association. The values for this parameter are 8 kilobytes to 400 kilobytes. The maximum size of the buffers on an IPSG card is 6400 KB.

The size of the buffers assigned to each association that is assigned to the **IP** card cannot exceed the maximum buffer size for that card. If the `bufsize` parameter value causes the total buffer size for all the associations on the **IPSG** card to exceed the maximum buffer size for that **IPSG** card, the `chg-assoc` command will be rejected. The available size of the buffers on the **IPSG** card can be verified by entering this command.

```
rtrv-assoc:lhost=<local host name assigned to the association being changed>
```

The `alhost` parameter can also be used with the `rtrv-assoc` command to display the available size of the buffers on the **IP** card.

The `aname` parameter can be used with the `rtrv-assoc` command to display the available size of the buffers on the **IP** card and the size of the buffer assigned to the association.

If you wish to increase the buffer size for this association to a value that is greater than available buffer size for the card, the buffer size of the other associations assigned to the card must be decreased.

The `chg-assoc` command contains other parameters that are not used in this procedure. To change these parameters, perform these procedures.

- `lhost` and `alhost` - [Changing the Host Values of an IPSG Association](#)

- Other attributes of the IPSP Association - [Changing the Buffer Size of an IPSP Association](#)

Canceling the `RTRV-ASSOC` Command

Because the `rtrv-assoc` command used in this procedure can output information for a long period of time, the `rtrv-assoc` command can be canceled and the output to the terminal stopped. There are three ways that the `rtrv-assoc` command can be canceled.

- Press the `F9` function key on the keyboard at the terminal where the `rtrv-assoc` command was entered.
- Enter the `canc-cmd` without the `trm` parameter at the terminal where the `rtrv-assoc` command was entered.
- Enter the `canc-cmd:trm=<xx>`, where `<xx>` is the terminal where the `rtrv-assoc` command was entered, from another terminal other than the terminal where the `rtrv-assoc` command was entered. To enter the `canc-cmd:trm=<xx>` command, the terminal must allow Security Administration commands to be entered from it and the user must be allowed to enter Security Administration commands. The terminal's permissions can be verified with the `rtrv-secu-trm` command. The user's permissions can be verified with the `rtrv-user` or `rtrv-secu-user` commands.

For more information about the `canc-cmd` command, go to *Commands User's Guide*.

1. Display the associations in the database using the `rtrv-assoc` command.

This is an example of possible output.

```
rlghncxa03w 06-10-28 09:12:36 GMT EAGLE5 36.0.0

          CARD IPLNK
ANAME      LOC  PORT  LINK ADAPTER  LPORT  RPORT  OPEN  ALW
swbel132   1201 A    A    M3UA   1030  2345  YES  YES
a2         1305 A    A    SUA    1030  2345  YES  YES
a3         1307 A    A    SUA    1030  2346  YES  YES
assoc1     1201 A    A    M3UA   2000  1030  YES  YES
assoc2     1205 A    A    M2PA   2048  2048  YES  YES
assoc3     1205 A    B2   M2PA   3000  3000  YES  YES
assoc5     1205 A    A3   M2PA   1500  3000  YES  YES
```

2. Enter the `rtrv-card` command with the location of the card that is hosting the association that will be changed in this procedure. For this example, enter this command.

```
rtrv-card:loc=1205
```

This is an example of possible output.

```
rlghncxa03w 08-04-06 15:17:20 EST EAGLE5 38.0.0
CARD  TYPE      APPL      LSET NAME    LINK SLC LSET NAME    LINK SLC
1205  ENET         IPSP      e5e6a        A    0   e5e6a        B2   1
      e5e6a        A3    2
```

```
rtrv-card:loc=1201
```

This is an example of possible output.

```
rlghncxa03w 08-04-06 15:17:20 EST EAGLE5 38.0.0
CARD   TYPE      APPL      LSET NAME   LINK SLC LSET NAME   LINK SLC
1201   ENET         IPSG      ipsgm3ua1   A      0
```

If the application assigned to the card is IPSG, shown in the `APPL` column, continue the procedure by performing one of these steps.

- If the `open` parameter value for the association being changed is `yes`, continue the procedure with [3](#).
- If the `open` parameter value for the association being changed is `no`, continue the procedure with [4](#).

If the application assigned to the card is IPLIM or IPLIMI, perform the [Changing the Buffer Size of a M2PA Association](#) procedure.

If the application assigned to the card is SS7IPGW or IPGWI, perform the [Changing the Buffer Size of a M3UA or SUA Association](#) procedure.

3. Change the value of the `open` parameter to `no` by specifying the `chg-assoc` command with the `open=no` parameter.

For this example, enter these commands.

```
chg-assoc:aname=assoc2:open=no
chg-assoc:aname=assoc1:open=no
```

When these commands have successfully completed, this message should appear.

```
rlghncxa03w 06-10-28 09:12:36 GMT EAGLE5 36.0.0
CHG-ASSOC: MASP A - COMPLTD;
```

4. Display the association that is being changed by entering the `rtrv-assoc` command with the `aname` parameter and the name of the association specified in [3](#).

For this example, enter this command.

```
rtrv-assoc:aname=assoc2
```

This is an example of the possible output.

```
rlghncxa03w 10-07-28 21:14:37 GMT EAGLE5 42.0.0
ANAME assoc2
      LOC      1205          IPLNK PORT  A          LINK  A
ADAPTER M2PA          VER          M2PA RFC
LHOST   IPNODE2-1205
ALHOST  ---
RHOST   remotehost1
ARHOST  ---
LPORT   2048          RPORT      2048
ISTRMS  2             OSTRMS     2          BUFSIZE  300
RMODE   LIN          RMIN       120       RMAX     800
```

```

RTIMES 10          CWMIN 3000      UAPS 10
OPEN   NO          ALW   YES        RTXTHR 2000
RHOSTVAL RELAXED  M2PATSET 1

```

```

LSN
e5e6a

```

IP Appl Sock/Assoc table is (7 of 4000) 1% full
Assoc Buffer Space Used (700 KB of 6400 KB) on LOC = 1205

```
rtrv-assoc:aname=assoc1
```

This is an example of the possible output.

```
rlghncxa03w 09-05-28 21:14:37 GMT EAGLE5 41.0.0
```

```

ANAME assoc1
LOC 1201          IPLNK PORT A          LINK A
ADAPTER M3UA      VER          M3UA RFC
LHOST m3ua1
ALHOST ---
RHOST remotel
ARHOST ---
LPORT 2000       RPORT 1030
ISTRMS 2         OSTRMS 2          BUFSIZE 200
RMODE LIN        RMIN 120          RMAX 800
RTIMES 10        CWMIN 3000       UAPS 10
OPEN NO          ALW YES          RTXTHR 0
RHOSTVAL RELAXED

```

```

LSN
ipsgm3ua1

```

IP Appl Sock/Assoc table is (7 of 4000) 1% full
Assoc Buffer Space Used (400 KB of 6400 KB) on LOC = 1201

5. If the `bufsize` parameter value causes the total buffer size for all the associations on the **IPSG** card to exceed the maximum buffer size for that **IPSG** card, the `chg-assoc` command will be rejected.

If you wish to increase the buffer size for this association to a value that is greater than available buffer size for the card, the buffer size of the other associations assigned to the card must be decreased. Perform this step, 6, 7, and 8.

If the buffers on the other associations assigned to the card do not need to be changed, continue the procedure with 9.

Display the associations assigned to the **IP** card (and its corresponding local host) by entering the `rtrv-assoc` command with the local host name assigned to the association being changed. For this example, enter these commands.

```
rtrv-assoc:lhost=IPNODE2-1205
```


This is an example of the possible output.

```
rlghncxa03w 06-10-28 21:14:37 GMT EAGLE5 36.0.0
      CARD IPLNK
ANAME      LOC  PORT  LINK ADAPTER LPORT RPORT OPEN ALW
assoc2     1205 A    A    M2PA   2048  2048  YES  YES
assoc3     1205 A    B2   M2PA   3000  3000  YES  YES
assoc5     1205 A    A3   M2PA   1500  3000  YES  YES
```

```
IP Appl Sock/Assoc table is (7 of 4000) 1% full
Assoc Buffer Space Used (800 KB of 6400 KB) on LOC = 1205
```

```
rtrv-assoc:lhost=m3ua1
```

This is an example of the possible output.

```
rlghncxa03w 06-10-28 09:12:36 GMT EAGLE5 36.0.0
      CARD IPLNK
ANAME      LOC  PORT  LINK ADAPTER LPORT RPORT OPEN ALW
swbel132   1201 A    A    M3UA   1030  2345  YES  YES
assoc1     1201 A    A    M3UA   2000  1030  YES  YES
```

```
IP Appl Sock/Assoc table is (7 of 4000) 1% full
Assoc Buffer Space Used (400 KB of 6400 KB) on LOC = 1201
```

- Display each association shown in 5 by entering the `rtrv-assoc` command with the name of each association shown in 5.

For this example, enter these commands.

```
rtrv-assoc:aname=assoc2
```

This is an example of the possible output.

```
ANAME assoc2
      LOC      1205      IPLNK PORT  A      LINK  A
      ADAPTER  M2PA      VER      M2PA RFC
      LHOST    IPNODE2-1205
      ALHOST    ---
      RHOST    remotehost1
      ARHOST    ---
      LPORT    2048      RPORT      2048
      ISTRMS   2      OSTRMS     2      BUFSIZE  300
      RMODE    LIN      RMIN       120      RMAX     800
      RTIMES   10      CWMIN      3000     UAPS     10
      OPEN     NO      ALW        YES      RTXTHR   2000
      RHOSTVAL RELAXED  M2PATSET   1
```

```
LSN
e5e6a
```

IP Appl Sock/Assoc table is (7 of 4000) 1% full
 Assoc Buffer Space Used (700 KB of 6400 KB) on LOC = 1205

rtrv-assoc:aname=assoc3

This is an example of the possible output.

```

ANAME assoc3
  LOC      1205          IPLNK PORT  A          LINK  B2
  ADAPTER  M2PA          VER          M2PA RFC
  LHOST    IPNODE2-1205
  ALHOST    ---
  RHOST    remotehost3
  ARHOST    ---
  LPORT    3000          RPORT          3000
  ISTRMS   2            OSTRMS         2            BUFSIZE  200
  RMODE    LIN           RMIN           120          RMAX      800
  RTIMES   10           CWMIN          3000         UAPS      10
  OPEN     YES           ALW            YES           RTXTHR
2000
  RHOSTVAL RELAXED      M2PATSET      1

  LSN
  e5e6a
  
```

IP Appl Sock/Assoc table is (7 of 4000) 1% full
 Assoc Buffer Space Used (700 KB of 6400 KB) on LOC = 1205

rtrv-assoc:aname=assoc5

This is an example of the possible output.

```

ANAME assoc5
  LOC      1205          IPLNK PORT  A          LINK  A3
  ADAPTER  M2PA          VER          M2PA RFC
  LHOST    IPNODE2-1205
  ALHOST    ---
  RHOST    remotehost3
  ARHOST    ---
  LPORT    1500          RPORT          3000
  ISTRMS   2            OSTRMS         2            BUFSIZE  200
  RMODE    LIN           RMIN           120          RMAX      800
  RTIMES   10           CWMIN          3000         UAPS      10
  OPEN     YES           ALW            YES           RTXTHR
2000
  RHOSTVAL RELAXED      M2PATSET      1

  LSN
  e5e6a
  
```

IP Appl Sock/Assoc table is (7 of 4000) 1% full
 Assoc Buffer Space Used (700 KB of 6400 KB) on LOC = 1205

```
rtrv-assoc:aname=assoc1
```

This is an example of the possible output.

```
rlghncxa03w 09-05-28 21:14:37 GMT EAGLE5 41.0.0
```

```
ANAME assoc1
  LOC      1201          IPLNK PORT A          LINK      A
  ADAPTER  M3UA          VER           M3UA RFC
  LHOST    m3ua1
  ALHOST   ---
  RHOST    remotel
  ARHOST   ---
  LPORT    2000          RPORT         1030
  ISTRMS   2            OSTRMS        2            BUFSIZE   200
  RMODE    LIN           RMIN          120           RMAX      800
  RTIMES   10           CWMIN         3000          UAPS      10
  OPEN     NO            ALW           YES            RTXTHR    0
  RHOSTVAL RELAXED

  LSN
  ipsgm3ua1
```

```
IP Appl Sock/Assoc table is (7 of 4000) 1% full
Assoc Buffer Space Used (400 KB of 6400 KB) on LOC = 1201
```

```
rtrv-assoc:aname=swbel32
```

This is an example of the possible output.

```
rlghncxa03w 09-05-28 21:14:37 GMT EAGLE5 41.0.0
```

```
ANAME swbel32
  LOC      1201          IPLNK PORT A          LINK      A
  ADAPTER  M3UA          VER           M3UA RFC
  LHOST    m3ua1
  ALHOST   ---
  RHOST    remotel
  ARHOST   ---
  LPORT    1030          RPORT         2345
  ISTRMS   2            OSTRMS        2            BUFSIZE   200
  RMODE    LIN           RMIN          120           RMAX      800
  RTIMES   10           CWMIN         3000          UAPS      10
  OPEN     NO            ALW           YES            RTXTHR    0
  RHOSTVAL RELAXED

  LSN
  ipsgm3ua1
```

```
IP Appl Sock/Assoc table is (7 of 4000) 1% full
Assoc Buffer Space Used (400 KB of 6400 KB) on LOC = 1201
```

7. To change the `bufsize` value for the associations shown in 6, the new `bufsize` parameter value must be greater than or equal to the `cwmin` parameter value.

The `cwmin` parameter is the number of bytes specified for the association's congestion window. The `bufsize` is the number of kilobytes specified for the size of the association's buffer. To determine whether or not the `cwmin` value is less than or equal to the `bufsize` value, perform one of these actions.

- Multiply the `bufsize` value by 1024.
- Divide the `cwmin` value by 1024.

Continue the procedure by performing one of these actions.

- If the new `bufsize` value is greater than or equal to the `cwmin` value, continue the procedure with 8.
 - If the new `bufsize` value is not greater than or equal to the `cwmin` value, either choose another value for the `bufsize` parameter that is greater than or equal to the `cwmin` value, or perform the [Changing the Attributes of an IPSP Association](#) procedure to change the `bufsize` value so that the `bufsize` value is greater than or equal to the `cwmin` value. After the new `bufsize` value has been chosen or the `cwmin` value has been changed, continue the procedure with 8.
8. Change the size of the buffers for one or more of the associations displayed in 6 to allow the buffer of the association displayed in 4 to be changed.

Enter the `chg-assoc` command with the `bufsize` parameter. For this example, enter this command.

```
chg-assoc:aname=assoc3:bufsize=100
```

When this command has successfully completed, this message should appear.

```
rlghncxa03w 06-10-28 09:12:36 GMT EAGLE5 36.0.0  
CHG-ASSOC: MASP A - COMPLTD;
```

9. To change the `bufsize` value for the association shown in 4, the new `bufsize` parameter value must be greater than or equal to the `cwmin` parameter value.

The `cwmin` parameter is the number of bytes specified for the association's congestion window. The `bufsize` is the number of kilobytes specified for the size of the association's buffer. To determine whether or not the `cwmin` value is less than or equal to the `bufsize` value, perform one of these actions.

- Multiply the `bufsize` value by 1024.
- Divide the `cwmin` value by 1024.

Continue the procedure by performing one of these actions.

- If the new `bufsize` value is greater than or equal to the `cwmin` value, continue the procedure with 10.
- If the new `bufsize` value is not greater than or equal to the `cwmin` value, either choose another value for the `bufsize` parameter that is greater than or equal to the `cwmin` value, or perform the [Changing the Attributes of an IPSP Association](#) procedure to change the `bufsize` value so that the `bufsize` value is greater than or equal to the `cwmin` value. After the new `bufsize`

value has been chosen or the `cwmin` value has been changed, continue the procedure with [10](#).

10. Change the association using the `chg-assoc` command.

For this example, enter these commands.

```
chg-assoc:aname=assoc2:bufsize=400
chg-assoc:aname=assoc1:bufsize=400
```

When these commands have successfully completed, this message should appear.

```
rlghncxa03w 06-10-28 09:12:36 GMT EAGLE5 36.0.0
CHG-ASSOC: MASP A - COMPLTD;
```

If the value of the `open` parameter was not changed in [3](#), continue the procedure with [12](#).

If the value of the `open` parameter was changed in [3](#), continue the procedure with [11](#).

11. Change the value of the `open` parameter to `yes` by specifying the `chg-assoc` command with the `open=yes` parameter.

For this example, enter this command.

```
chg-assoc:aname=assoc2:open=yes
chg-assoc:aname=assoc1:open=yes
```

When this command has successfully completed, this message should appear.

```
rlghncxa03w 06-10-28 09:12:36 GMT EAGLE5 36.0.0
CHG-ASSOC: MASP A - COMPLTD;
```

12. Verify the changes using the `rtrv-assoc` command specifying the association name specified in [10](#) and [11](#).

For this example, enter these commands.

```
rtrv-assoc:aname=assoc2
```

This is an example of possible output.

```

RTIMES    10          CWMIN      3000      UAPS       10
OPEN      NO           ALW        YES       RTXTHR    2000
RHOSTVAL  RELAXED      M2PATSET   1

```



```

ANAME assoc2
LOC      1205          IPLNK PORT  A         LINK      A
ADAPTER  M2PA           VER        M2PA RFC
LHOST    IPNODE2-1205
ALHOST   ---
RHOST    remotehost1
ARHOST   ---
LPORT    2048          RPORT      2048
ISTRMS   2             OSTRMS     2         BUFSIZE   400
RMODE    LIN        RMIN       120      RMAX      800

```

```

RTIMES    10          CWMIN      3000      UAPS      10
OPEN      YES         ALW       YES       RTXTHR   2000
RHOSTVAL  RELAXED    M2PATSET  1

```

```

LSN
e5e6a

```

IP Appl Sock/Assoc table is (7 of 4000) 1% full
 Assoc Buffer Space Used (800 KB of 6400 KB) on LOC = 1205

For this example, enter these commands.

```
rtrv-assoc:aname=assoc1
```

```
rlghncxa03w 09-05-28 21:14:37 GMT EAGLE5 41.0.0
```

```

ANAME assoc1
LOC      1201          IPLNK PORT A          LINK      A
ADAPTER  M3UA         VER           M3UA RFC
LHOST    m3ua1
ALHOST   ---
RHOST    remote1
ARHOST   ---
LPORT    2000          RPORT        1030
ISTRMS   2            OSTRMS       2           BUFSIZE   400
RMODE    LIN          RMIN         120         RMAX      800
RTIMES   10          CWMIN        3000       UAPS      10
OPEN     YES         ALW          YES         RTXTHR    0
RHOSTVAL RELAXED

LSN
ipsgm3ua1

```

IP Appl Sock/Assoc table is (7 of 4000) 1% full
 Assoc Buffer Space Used (600 KB of 6400 KB) on LOC = 1201

13. Back up the new changes, using the `chg-db:action=backup:dest=fixed` command.

These messages should appear; the active **Maintenance and Administration Subsystem Processor (MASP)** appears first.

```

BACKUP (FIXED) : MASP A - Backup starts on active MASP.
BACKUP (FIXED) : MASP A - Backup on active MASP to fixed disk
complete.
BACKUP (FIXED) : MASP A - Backup starts on standby MASP.
BACKUP (FIXED) : MASP A - Backup on standby MASP to fixed disk
complete.

```

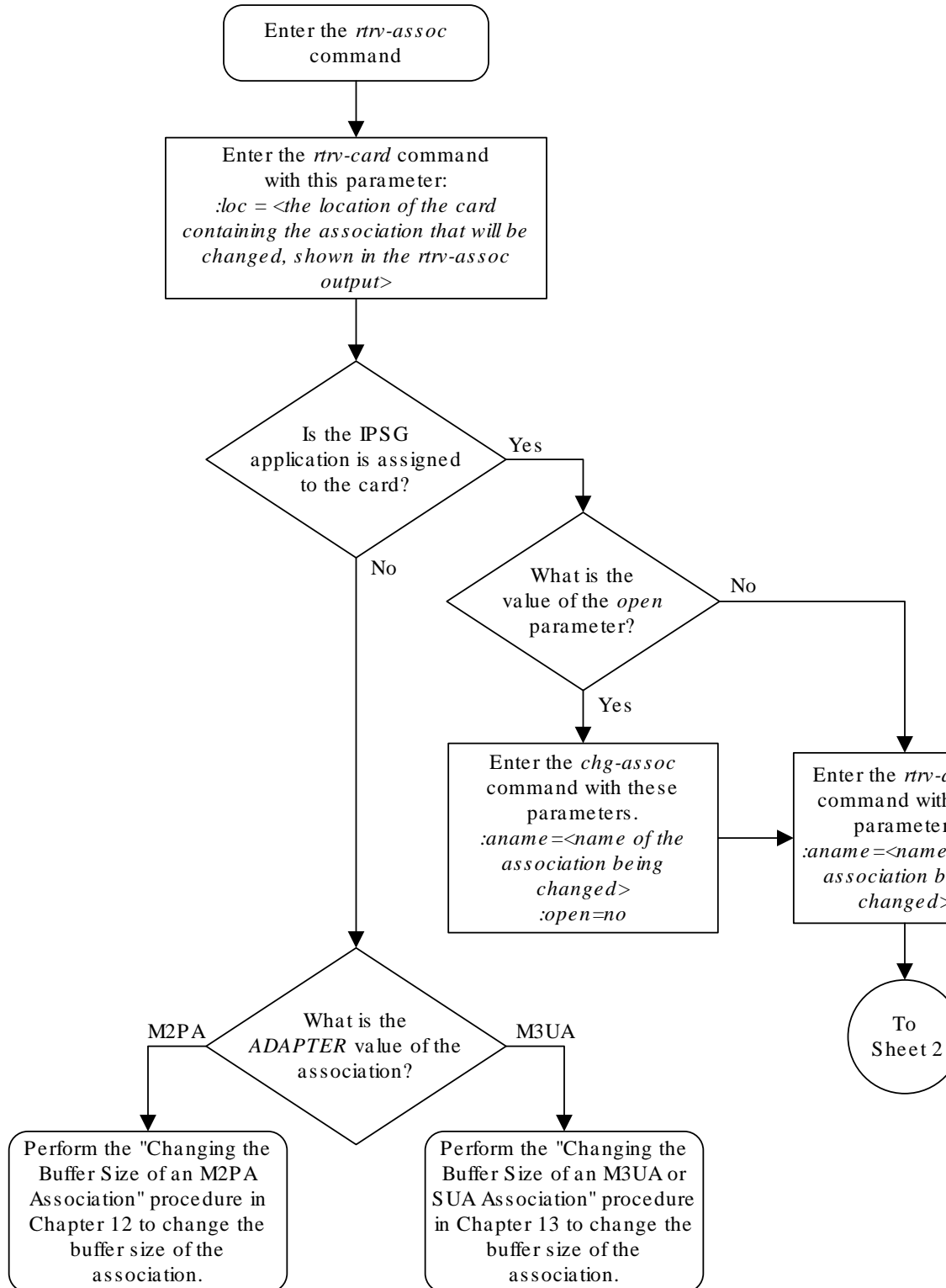
If you wish to change the other attributes of the IPSP association, perform one of these procedures.

- `lhost` and `alhost` - [Changing the Host Values of an IPSP Association](#)

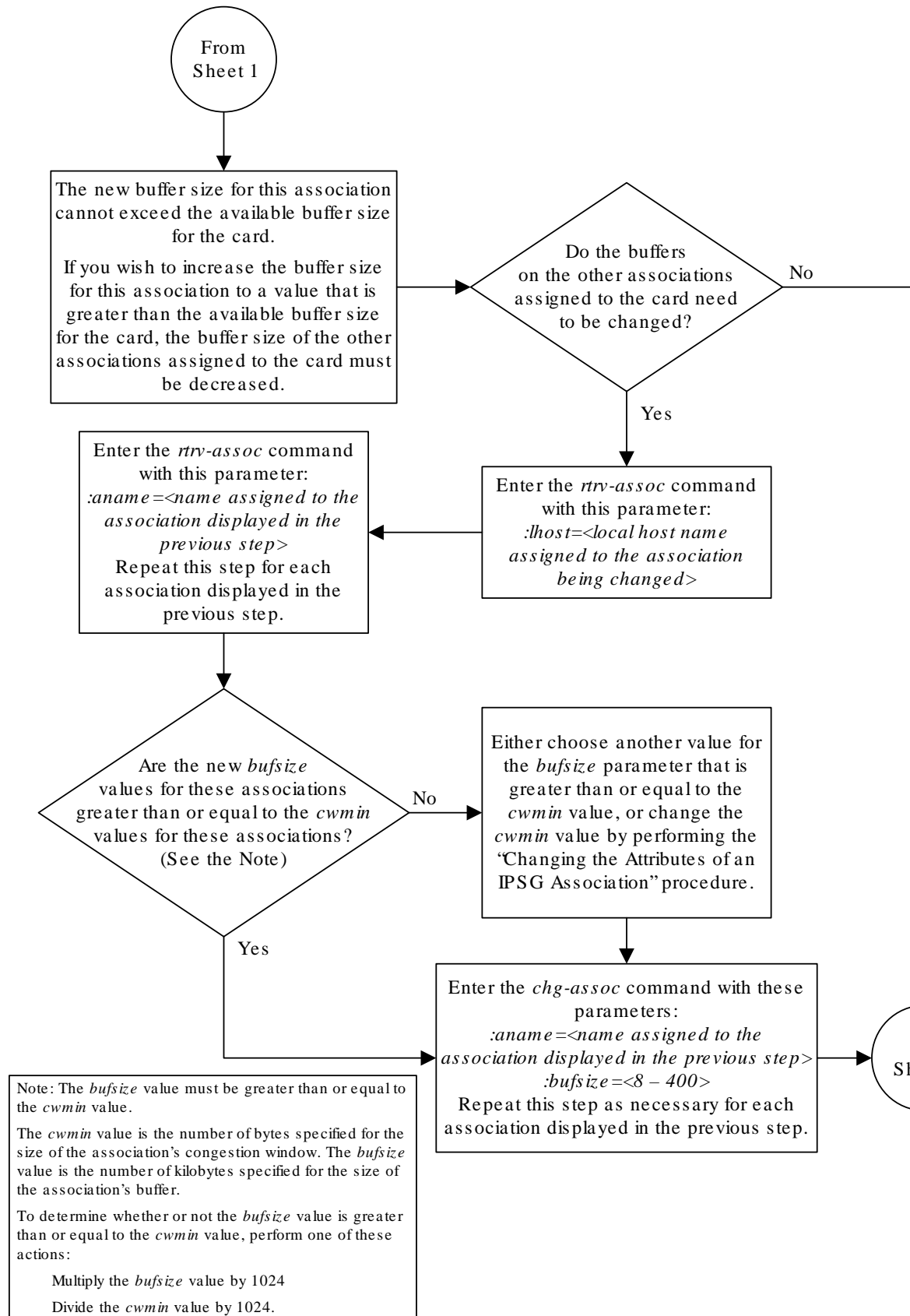
- Other attributes of the IPSP Association - [Changing the Attributes of an IPSP Association](#)

If you do not wish to change the other attributes of the IPSP association, this procedure is finished.

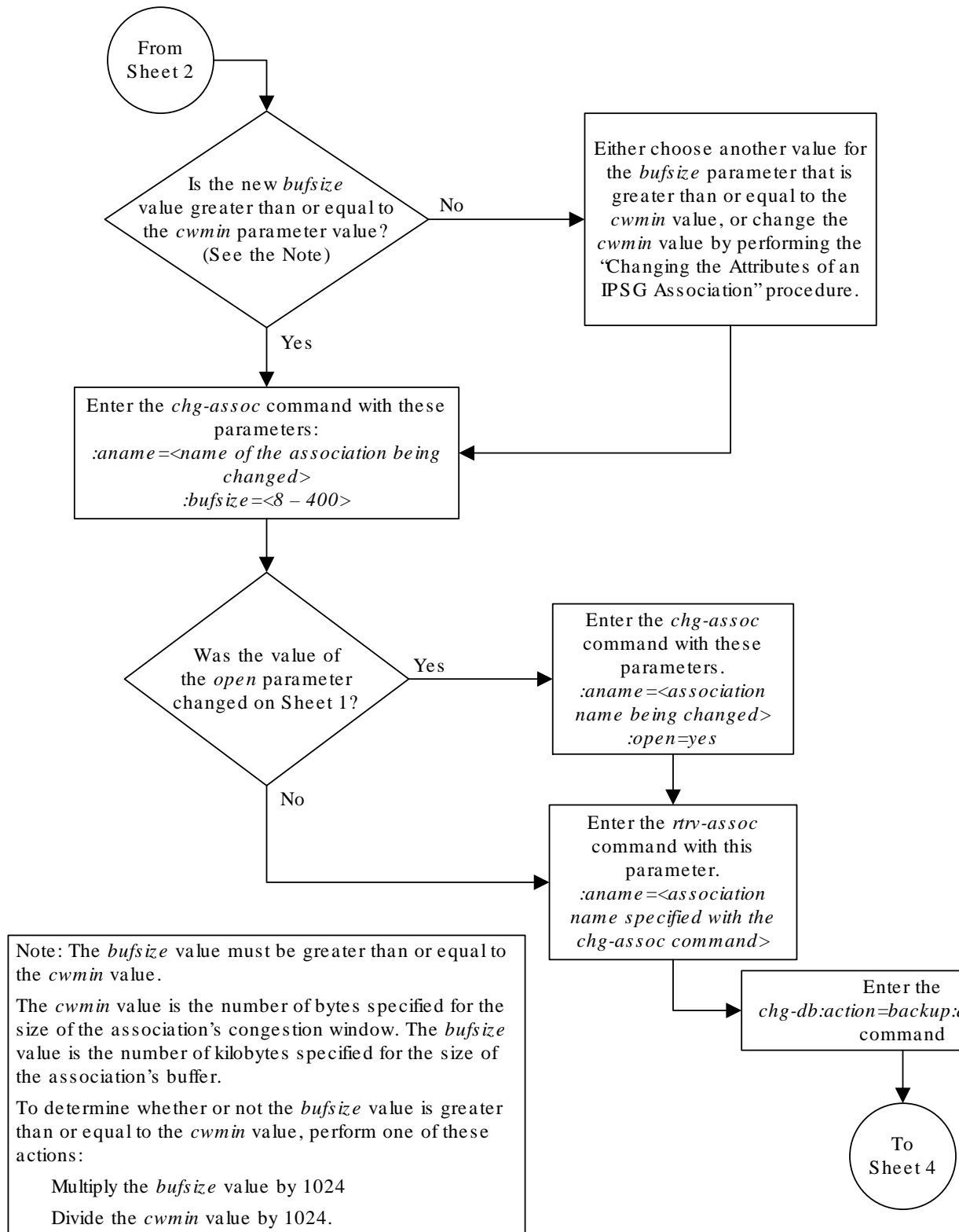
Figure 6-28 Changing the Buffer Size of an IPSG Association



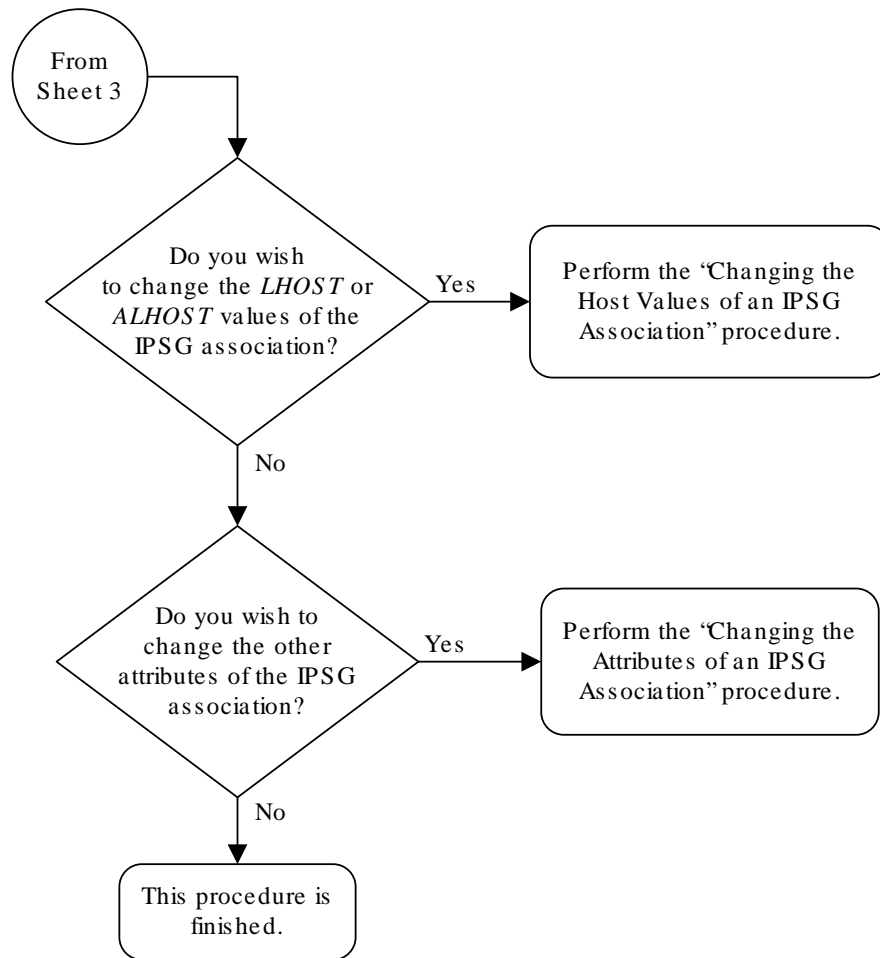
Sheet 1 of 4



Sheet 2 of 4



Sheet 3 of 4



6.32 Changing the Host Values of an IPSG Association

This procedure is used to change the host values of an **IPSG** association, assigned to E5-ENET cards that are running the IPSG application, IPSG cards, using the `chg-assoc` command.

If you wish to change the host values of M2PA associations assigned to cards that are running the IPLIM or IPLIMI applications, perform the [Changing the Host Values of a M2PA Association](#) procedure.

If you wish to change the host values of M3UA associations assigned to cards that are running the SS7IPGW or IPGWI applications, perform the [Changing the Host Values of a M3UA or SUA Association](#) procedure.

These parameters of the `chg-assoc` command are used in this procedure:

`:aname` – The name assigned to the association, shown in the `rtrv-assoc` output.

`:lhost` – The host name for the local host, shown in the `rtrv-ip-host` output.

`:lport` – The **SCTP** port number for the local host.

`:alhost` – The alternate local host name, shown in the `rtrv-ip-host` output.

`:adapter` – The adapter layer for this association, `m2pa` or `m3ua`.

`:open` – The connection state for this association. Valid values are `yes` or `no`. When the `open=yes` parameter is specified, the connection manager opens the association if the association is operational. When the `open=no` parameter is specified, the connection manager will not open the association. If the `open=no` parameter is specified for an established IPSG M3UA association, and the UA Graceful Shutdown option is enabled (refer to [Changing a UA Parameter Set](#) for more information), the IPSG M3UA connection will be gracefully shutdown.

`:m2patset` – The **M2PA** timer set assigned to the association. The `m2patset` parameter can be specified only with the `adapter=m2pa` parameter, or if the association already has the `adapter=m2pa` parameter assigned and the `adapter` parameter value is not being changed. If the `adapter` parameter value is being changed to `m2pa`, and the `m2patset` parameter is not specified, the default value for the `m2patset` parameter (1 - **M2PA** timer set 1) is assigned to the association. If the `adapter` parameter value for the association is `m2pa`, is not being changed, and the `m2patset` parameter is not specified with the `chg-assoc` command, the `m2patset` parameter value is not changed.

`:ver` – The **M2PA** version assigned to the **M2PA** association, either the **RFC** version (`ver=rfc`), or the Draft 6 version (`ver=d6`). The `ver` parameter can be specified only if, when this procedure is completed, the `adapter` parameter value is `m2pa`. If the `adapter` parameter value is being changed to `m2pa`, and the `ver` parameter is not specified, the default **M2PA** version of **RFC** is assigned to the association. To change the `ver` parameter value, the `open` parameter value for the association must be `no`.

`:uaps` – The **UA** parameter set value being assigned to an M2PA or an M3UA association.

The `chg-assoc` command contains other parameters that are not used in this procedure. To change these parameters, perform these procedures.

- `bufsize` - [Changing the Buffer Size of an IPSP Association](#)
- Other attributes of the IPSP association - [Changing the Attributes of an IPSP Association](#)

At least one optional parameter must be specified.

The command input is limited to 150 characters, including the hostnames.

The **EAGLE** can contain a maximum of 4000 connections.

A maximum of 32 associations can be assigned to an IPSP card running on an E5-ENET/E5--ENET-B card or DEIR card.

An IPSP application running on the SLIC card can contain a maximum of 128 associations.

Before the local host value of the IPSP association can be changed, the signaling link that the association is assigned to must be removed by performing one of these procedures.

- If the `ADAPTER` value of the association is M2PA, perform the [Removing an IPSP M2PA Signaling Link](#) procedure.
- If the `ADAPTER` value of the association is M3UA, perform the [Removing an IPSP M3UA Signaling Link](#) procedure.

Uni-homed endpoints are associations configured with the `lhost` parameter only. The `lhost` parameter value represents an **IP** address that corresponds to either the A or B network interface of the **IPSP** card. Multi-homed endpoints are associations configured with both the `lhost` and `alhost` parameters. The `lhost` parameter value represents an **IP** address corresponding to one of the network interfaces (A or B) of the **IPSP** card while the `alhost` parameter value represents an **IPSP** address corresponding to the other network interface of the same **IPSP** card.

The `alhost=none` parameter removes the alternate local host from the specified association, which also removes the multi-homed endpoint capability.

Canceling the `RTRV-ASSOC` Command

Because the `rtrv-assoc` command used in this procedure can output information for a long period of time, the `rtrv-assoc` command can be canceled and the output to the terminal stopped. There are three ways that the `rtrv-assoc` command can be canceled.

- Press the F9 function key on the keyboard at the terminal where the `rtrv-assoc` command was entered.
- Enter the `canc-cmd` without the `trm` parameter at the terminal where the `rtrv-assoc` command was entered.
- Enter the `canc-cmd:trm=<xx>`, where `<xx>` is the terminal where the `rtrv-assoc` command was entered, from another terminal other than the terminal where the `rtrv-assoc` command was entered. To enter the `canc-cmd:trm=<xx>` command, the terminal must allow Security Administration commands to be entered from it and the user must be allowed to enter Security Administration commands. The terminal's permissions can be verified with the `rtrv-secu-trm` command. The user's permissions can be verified with the `rtrv-user` or `rtrv-secu-user` commands.

For more information about the `canc-cmd` command, go to *Commands User's Guide*.

1. Display the associations in the database using the `rtrv-assoc` command.

This is an example of possible output.

```
rlghncxa03w 08-04-28 09:12:36 GMT EAGLE5 38.0.0

CARD IPLNK
ANAME      LOC  PORT  LINK ADAPTER LPORT RPORT OPEN ALW
swbel132   1201 A    A    M3UA  1030  2345 YES  YES
a2         1305 A    A    SUA   1030  2345 YES  YES
a3         1307 A    A    SUA   1030  2346 YES  YES
assoc1     1201 A    A    M3UA  2000  1030 YES  YES
assoc2     2105 A    A    M2PA  2048  2048 YES  YES
assoc3     2105 A    B2   M2PA  3000  3000 YES  YES
assoc5     2105 A    A3   M2PA  1500  3000 YES  YES
```

2. Enter the `rtrv-card` command with the location of the card that is hosting the IPSG association that will be changed in this procedure. For this example, enter this command.

```
rtrv-card:loc=2105
```

This is an example of possible output.

```
rlghncxa03w 08-04-06 15:17:20 EST EAGLE5 38.0.0
CARD  TYPE      APPL      LSET NAME    LINK SLC LSET NAME    LINK SLC
2105  ENET        IPSG      e5e6a       A    0    e5e6a       B2    1
                e5e6a       A3    2
```

If the application assigned to the card is IPSG, shown in the `APPL` column, continue the procedure by performing one of these steps.

- If the `open` parameter value for the association being changed is `yes`, continue the procedure with [3](#).
- If the `open` parameter value for the association being changed is `no`, continue the procedure with [Oracle](#).

If the application assigned to the card is IPLIM or IPLIMI, perform the [Changing the Host Values of a M2PA Association](#) procedure.

If the application assigned to the card is SS7IPGW or IPGWI, perform the [Changing the Host Values of a M3UA or SUA Association](#) procedure.

3. Change the value of the `open` parameter to `no` by specifying the `chg-assoc` command with the `open=no` parameter.

For this example, enter this command.

```
chg-assoc:aname=assoc2:open=no
```

When this command has successfully completed, this message should appear.

```
rlghncxa03w 08-04-28 09:12:36 GMT EAGLE5 38.0.0
CHG-ASSOC: MASP A - COMPLTD;
```

4. Display the association being changed by entering the `rtrv-assoc` command with the `aname` parameter specified in 3.

For this example, enter this command.

```
rtrv-assoc:aname=assoc2
```

This is an example of the possible output.

```
rlghncxa03w 10-07-28 21:14:37 GMT EAGLE5 42.0.0
ANAME assoc2
      LOC      2105          IPLNK PORT  A,B          LINK  A
ADAPTER M2PA          VER          M2PA RFC
LHOST  IPNODE2-1205
ALHOST M2PA1
RHOST  gw200.nc-Oracle.com
ARHOST ---
LPORT  2048          RPORT      2048
ISTRMS 2          OSTRMS     2          BUFSIZE  400
RMODE  LIN          RMIN       120        RMAX     800
RTIMES 10         CWMIN      3000      UAPS     10
OPEN    NO          ALW        YES        RTXTHR  2000
RHOSTVAL RELAXED    M2PATSET   1

      LSN
      e5e6a
```

```
IP Appl Sock/Assoc table is (8 of 4000) 1% full
Assoc Buffer Space Used (800 KB of 6400 KB) on LOC = 2105
```

Continue the procedure by performing one of these actions.

- If the association does not have an `ALHOST` value, continue the procedure with 5.
 - If the association does have an `ALHOST` value, and the `ALHOST` value will be removed along with changing the `LHOST` value of the association, continue the procedure with 5.
 - If the association does have an `ALHOST` value, and the only action that will be performed in this procedure is to remove the `ALHOST` value from the association, continue the procedure with 11.
5. Verify that the local host name to be assigned to the association is in the database by entering the `rtrv-ip-host:display=all` command.

The following is an example of the possible output.

```
rlghncxa03w 13-06-28 21:15:37 GMT EAGLE5 45.0.0

LOCAL IPADDR      LOCAL HOST
192.1.1.10        IPNODE1-1201
192.1.1.12        GW105. NC. Oracle. COM
192.1.1.14        IPNODE1-1205
192.1.1.20        IPNODE2-1201
192.1.1.22        IPNODE2-1203
```

```

192.1.1.24      IPNODE2-1205
192.1.1.30      KC-HLR1
192.1.1.32      KC-HLR2
192.1.1.50      DN-MS1
192.1.1.52      DN-MS2
192.1.1.54      M2PA1

REMOTE IPADDR  REMOTE HOST
150.1.1.5      NCDEPTECONOMIC_DEVELOPMENT. SOUTHEASTERN_COORIDOR_ASHVL.
GOV

```

IP Host table is (12 of 4096) .29% full

If the required IP host is shown in the `rtrv-ip-host` output, continue the procedure with [7](#).

If the required IP host is not shown in the `rtrv-ip-host` output, continue the procedure with [6](#).

6. Display the IP links in the database by entering the `rtrv-ip-lnk` command.

The following is an example of the possible output.

```

rlghncxa03w 08-12-28 21:14:37 GMT EAGLE5 40.0.0
LOC  PORT  IPADDR          SUBMASK          DUPLEX  SPEED  MACTYPE  AUTO
MCAST
1201  A    192.1.1.20      255.255.255.0    FULL    100    DIX      NO    NO
1201  B    -----          -----          HALF    10     DIX      NO    NO
1303  A    192.1.1.10      255.255.255.128  HALF    10     802.3    NO    NO
1303  B    -----          -----          HALF    10     DIX      NO    NO
1305  A    192.1.1.12      255.255.255.0    ----    ---    DIX      YES   NO
1305  B    -----          -----          HALF    10     DIX      NO    NO
1313  A    192.1.1.14      255.255.255.0    FULL    100    DIX      NO    NO
1313  B    -----          -----          HALF    10     DIX      NO    NO
2103  A    192.1.1.22      255.255.255.0    FULL    100    DIX      NO    NO
2103  B    -----          -----          HALF    10     DIX      NO    NO
2105  A    192.1.1.24      255.255.255.0    FULL    100    DIX      NO    NO
2105  B    192.1.1.54      255.255.255.0    FULL    100    DIX      NO    NO
2205  A    192.1.1.30      255.255.255.0    FULL    100    DIX      NO    NO
2205  B    -----          -----          HALF    10     DIX      NO    NO
2207  A    192.1.1.32      255.255.255.0    FULL    100    DIX      NO    NO
2207  B    -----          -----          HALF    10     DIX      NO    NO
2213  A    192.1.1.50      255.255.255.0    FULL    100    DIX      NO    NO
2213  B    -----          -----          HALF    10     DIX      NO    NO
2301  A    192.1.1.52      255.255.255.0    FULL    100    DIX      NO    NO
2301  B    -----          -----          HALF    10     DIX      NO    NO

```

IP-LNK table is (20 of 2048) 1% full.

If the required IP link, one that contains the desired IP address, is not shown in the `rtrv-ip-lnk` output, add the IP link using the [Configuring an IP Link](#) procedure. After the IP link has been added, assign the IP address of the IP link to the IP host name using the [Adding an IP Host](#) procedure.

If the required **IP** link is shown in the `rtrv-ip-lnk` output, but the IP host is not shown in the `rtrv-ip-host` output in 5, assign the **IP** address of the **IP** link to the **IP** host name using the [Adding an IP Host](#) procedure.

 **Note:**

The `rtrv-ip-host` output must contain a host name for the association's `slhost` parameter and a host name for the association's `alhost` parameter, if the `alhost` parameter will be specified for the association. The IP address of the IP link should be assigned to the host name, shown in the `rtrv-ip-host` output, that will be used as the association's `slhost` parameter value. If the `alhost` parameter will be specified for the association, the IP address of the IP link must be assigned to the host name that will be used as the `alhost` parameter value. The IP links associated with the association's `slhost` and `alhost` values must be assigned to the same card.

After the new IP host has been added, continue the procedure by performing one of these steps.

- If the `ADAPTER` value of the association is not being changed, continue the procedure with 11.
- If the `ADAPTER` value of the association is being changed, continue the procedure by performing one of these steps.
 - If the `ADAPTER` value of the association is being changed to M2PA, perform one of these steps.
 - * If the `m2patset`, `ver`, and `uaps` parameters will not be specified for the association, continue the procedure with 11.
 - * If the `m2patset` and `ver` parameters will be specified for the association, continue the procedure with 9.
 - * If only the `uaps` parameter will be specified for the association, continue the procedure with 10.
 - If the `ADAPTER` value of the association is being changed to M3UA, perform one of these steps.
 - * If the `uaps` parameter will not be specified for the association, continue the procedure with 11.
 - * If the `uaps` parameter will be specified for the association, continue the procedure with 10.
- 7. Display the associations that are assigned to the new local host by entering the `rtrv-assoc` command with the name of the new local host. For this example, enter this command.

```
rtrv-assoc:lhost="IPNODE2-1201"
```

The following is an example of the possible output.

```
rlghncxa03w 08-04-19 21:17:04 GMT EAGLE5 38.0.0
CARD IPLNK
```

ANAME	LOC	PORT	LINK	ADAPTER	LPORT	RPORT	OPEN	ALW
swbel32	1201	A	A	M3UA	1030	2345	YES	YES
assoc1	1201	A	A	M3UA	2000	1030	YES	YES

IP Appl Sock/Assoc table is (7 of 4000) 1% full
Assoc Buffer Space Used (400 KB of 6400 KB) on LOC = 1201

A maximum of 32 associations can be assigned to a local host. If 32 associations are shown in this steps, repeat this procedure from 5 and choose another local host.

If the number of associations shown in this step is less than 32, continue the procedure with 8.

8. Before the local host of the association can be changed, the association cannot be assigned to a signaling link.

If dashes are shown in the `LINK` column of the `rtrv-assoc` output in 1, the association is not assigned to a signaling link.

If the association is assigned to a signaling link, perform one of these procedures.

- If the `ADAPTER` value of the association is `M2PA`, perform the [Removing an IPSP M2PA Signaling Link](#) procedure.
- If the `ADAPTER` value of the association is `M3UA`, perform the [Removing an IPSP M3UA Signaling Link](#) procedure.

After the signaling link has been removed, or if the association is not assigned to a signaling link, continue the procedure by performing one of these steps.

- If the `ADAPTER` value of the association is not being changed, continue the procedure with 11.
 - If the `ADAPTER` value of the association is being changed, continue the procedure by performing one of these steps.
 - If the `ADAPTER` value of the association is being changed to `M2PA`, perform one of these steps.
 - * If the `m2patset`, `ver`, and `uaps` parameters will not be specified for the association, continue the procedure with 11.
 - * If the `m2patset` and `ver` parameters will be specified for the association, continue the procedure with 9.
 - * If only the `uaps` parameter will be specified for the association, continue the procedure with 10.
 - If the `ADAPTER` value of the association is being changed to `M3UA`, perform one of these steps.
 - * If the `uaps` parameter will not be specified for the association, continue the procedure with 11.
 - * If the `uaps` parameter will be specified for the association, continue the procedure with 10.
9. Verify the values of the **M2PA** timer set you wish to assign to the association by entering the `rtrv-m2pa-tset` command with the **M2PA** version (either `ver=rfc` to display the **RFCM2PA** timer values or `ver=d6` to display the Draft 6 **M2PA** timer values) of the timer set you wish to assign to the association.

If the `ver` parameter is not specified with the `rtrv-m2pa-tset` command, both the **RFC** and Draft 6 timer values are displayed.

To display the **M2PA** Draft 6 timer values, enter this command.

```
rtrv-m2pa-tset:ver=d6
```

This is an example of the possible output.

```
rlghncxa03w 06-10-28 21:16:37 GMT EAGLE5 36.0.0
```

```
M2PA Draft 6 Timers (in msec, T16 in microsec)
```

TSET	T1	T2	T3	T4N	T4E	T5	T6	T7	T16	T17	T18
1	6000	-----	5000	20000	500	5000	4000	1000	100000	150	500
2	7500	-----	1500	2000	500	9000	1250	300	150000	175	600
3	100000	-----	2000	3000	500	4000	1500	500	170000	200	800
4	200000	-----	20000	4000	500	6000	2000	700	480000	225	900
5	250000	-----	30000	30000	500	100	2250	400	400000	400	
6	50000	-----	50000	60000	500	500	4500	800	300000	300	
7	10000	-----	10000	10000	500	1000	3000	1200	200000	250	
8	80000	-----	1500	15000	500	8000	2750	1100	350000	350	
9	27500	-----	3850	4859	450	5700	3750	1150	250	375	
10	90000	-----	2500	50000	500	7500	5000	1750	440000	450	
11	20000	-----	4500	5500	500	6500	5500	1600	250000	475	
12	30000	-----	7500	7000	500	750	4250	1800	275000	275	
13	40000	-----	35000	9000	500	1250	3500	1900	500	325	
14	70000	-----	45000	11000	500	1500	1750	900	1000	125	
15	9000	-----	25000	40000	500	2500	3250	600	5000	425	
16	75000	-----	15000	25000	500	4500	1600	1400	6000	240	
17	350000	-----	60000	70000	600	10000	6000	2000	500000	500	
18	150000	-----	55000	35000	500	3500	5750	1500	125000	440	750
19	175000	-----	12500	45000	500	1100	2600	1300	7000	340	850
20	1000	-----	1000	1000	400	80	1000	200	100	100	100

To display the **M2PARFC** values, enter this command.

```
rtrv-m2pa-tset:ver=rfc
```

This is an example of the possible output.

```
rlghncxa03w 06-10-28 21:16:37 GMT EAGLE5 36.0.0
```

M2PA RFC Timers (in msec, T16 in microsec)

TSET	T1	T2	T3	T4N	T4E	T5	T6	T7	T16	T17	T18
1	6000	75000	5000	20000	500	5000	4000	1000	100000	150	500
2	7500	8000	1500	2000	500	9000	1250	300	150000	175	600
3	100000	10000	2000	3000	500	4000	1500	500	170000	200	800
4	200000	6000	20000	4000	500	6000	2000	700	480000	225	900
5	250000	140000	30000	30000	500	100	2250	400	400000	400	8000
6	50000	100000	50000	60000	500	500	4500	800	300000	300	7000
7	300000	20000	2000	10000	500	1000	3000	1200	200000	250	1000
8	80000	130000	1500	15000	500	8000	2750	1100	350000	350	5000
9	27500	120000	3850	4859	450	5700	3750	1150	250	375	8750
10	90000	9000	2500	50000	500	7500	5000	1750	440000	450	3000
11	20000	60000	4500	5500	500	6500	5500	1600	250000	475	4500
12	30000	50000	7500	7000	500	750	4250	1800	275000	275	3500
13	40000	90000	35000	9000	500	1250	3500	1900	500	325	9000
14	70000	45000	45000	11000	500	1500	1750	900	1000	125	6000
15	9000	30000	25000	40000	500	2500	3250	600	5000	425	5500
16	75000	15000	15000	25000	500	4500	1600	1400	6000	240	9500
17	350000	150000	60000	70000	600	10000	6000	2000	500000	500	10000
18	150000	20000	55000	35000	500	3500	5750	1500	125000	440	750
19	175000	12500	12500	45000	500	1100	2600	1300	7000	340	850
20	1000	5000	1000	1000	400	80	1000	200	100	100	100

If the `ver` parameter is not specified when entering the `rtrv-m2pa-tset` command, both the Draft 6 and RFC values are displayed. This is an example of the possible output.

rlghncxa03w 06-10-28 21:16:37 GMT EAGLE5 36.0.0

M2PA Draft 6 Timers (in msec, T16 in microsec)

TSET	T1	T2	T3	T4N	T4E	T5	T6	T7	T16	T17	T18
1	6000	-----	5000	20000	500	5000	4000	1000	100000	150	500
2	7500	-----	1500	2000	500	9000	1250	300	150000	175	600
3	100000	-----	2000	3000	500	4000	1500	500	170000	200	800
4	200000	-----	20000	4000	500	6000	2000	700	480000	225	900
5	250000	-----	30000	30000	500	100	2250	400	400000	400	8000
6	50000	-----	50000	60000	500	500	4500	800	300000	300	7000
7	10000	-----	10000	10000	500	1000	3000	1200	200000	250	1000
8	80000	-----	1500	15000	500	8000	2750	1100	350000	350	5000
9	27500	-----	3850	4859	450	5700	3750	1150	250	375	8750
10	90000	-----	2500	50000	500	7500	5000	1750	440000	450	3000
11	20000	-----	4500	5500	500	6500	5500	1600	250000	475	4500
12	30000	-----	7500	7000	500	750	4250	1800	275000	275	3500
13	40000	-----	35000	9000	500	1250	3500	1900	500	325	9000
14	70000	-----	45000	11000	500	1500	1750	900	1000	125	6000
15	9000	-----	25000	40000	500	2500	3250	600	5000	425	5500
16	75000	-----	15000	25000	500	4500	1600	1400	6000	240	9500
17	350000	-----	60000	70000	600	10000	6000	2000	500000	500	10000
18	150000	-----	55000	35000	500	3500	5750	1500	125000	440	750
19	175000	-----	12500	45000	500	1100	2600	1300	7000	340	850
20	1000	-----	1000	1000	400	80	1000	200	100	100	100

M2PA RFC Timers (in msec, T16 in microsec)

TSET	T1	T2	T3	T4N	T4E	T5	T6	T7	T16	T17	T18
1	6000	75000	5000	20000	500	5000	4000	1000	100000	150	500
2	7500	8000	1500	2000	500	9000	1250	300	150000	175	600
3	100000	10000	2000	3000	500	4000	1500	500	170000	200	800
4	200000	6000	20000	4000	500	6000	2000	700	480000	225	900
5	250000	140000	30000	30000	500	100	2250	400	400000	400	
6	50000	100000	50000	60000	500	500	4500	800	300000	300	
7	300000	20000	2000	10000	500	1000	3000	1200	200000	250	
8	80000	130000	1500	15000	500	8000	2750	1100	350000	350	
9	27500	120000	3850	4859	450	5700	3750	1150	250	375	
10	90000	9000	2500	50000	500	7500	5000	1750	440000	450	
11	20000	60000	4500	5500	500	6500	5500	1600	250000	475	
12	30000	50000	7500	7000	500	750	4250	1800	275000	275	
13	40000	90000	35000	9000	500	1250	3500	1900	500	325	
14	70000	45000	45000	11000	500	1500	1750	900	1000	125	
15	9000	30000	25000	40000	500	2500	3250	600	5000	425	
16	75000	15000	15000	25000	500	4500	1600	1400	6000	240	
17	350000	150000	60000	70000	600	10000	6000	2000	500000	500	
18	150000	20000	55000	35000	500	3500	5750	1500	125000	440	750
19	175000	12500	12500	45000	500	1100	2600	1300	7000	340	850
20	1000	5000	1000	1000	400	80	1000	200	100	100	100

Caution:

Changing an M2PA timer set may affect the performance of any associations using the timer set being changed.

If the M2PA timer set you wish to assign to the association does not contain the desired values, go to the [Changing an M2PA Timer Set](#) procedure and changed the desired timer values.

After the M2PA timer set values have been changed, of if you do not wish to change any of the M2PA timer set values, continue the procedure by performing one of these steps.

- If the `uaps` parameter will not be specified for the association, continue the procedure with [11](#).

- If the `uaps` parameter will be specified for the association, continue the procedure with 10.
10. Verify the values of the **UA** parameter set you wish to assign to the association by entering the `rtrv-uaps` command with the desired parameter set.

For this example, enter this command.

```
rtrv-uaps:set=3
```

This is an example of possible output.

```
rlghncxa03w 10-07-28 09:12:36 GMT EAGLE5 42.0.0
SET  TIMER      TVALUE  PARM      PVALUE
  3     1         10      1         3
  3     2        3000     2         0
  3     3       10000     3         1
  3     4         5000     4         0
  3     5          0       5         0
  3     6          0       6         0
  3     7          0       7         0
  3     8          0       8         0
  3     9          0       9         0
  3    10          0      10         0
```

TIMER 2: False IP Connection Congestion Timer, max time an association can be congested before failing due to false congestion. SS7IPGW and IPGWI applications enforce 0-30000(ms). Not supported on IPSG application.

TVALUE : Valid range = 32-bits

TIMER 3: UA HeartBeat Period Timer T(beat), time (ms) between sending of BEAT msgs by NE. IPSG, SS7IPGW and IPGWI applications enforce 100(ms)-60000(ms).

TVALUE : Valid range = 32-bits

TIMER 4: UA HeartBeat Received Timer T(beat ack), timeout period for response BEAT ACK msgs by NE. IPSG, SS7IPGW and IPGWI applications enforce 100(ms)-10000(ms).

TVALUE : Valid range = 32-bits

PARM 1: ASP SNM options. Each bit is used as an enabled/disabled flag for a particular ASP SNM option. Not supported on IPSG application.

PVALUE : Valid range = 32-bits

BIT	BIT VALUE
0=Broadcast	0=Disabled , 1=Enabled
1=Response Method	0=Disabled , 1=Enabled
2-5=Reserved	
6=Broadcast Congestion Status Change	0=Disabled , 1=Enabled
7-31=Reserved	

PARM 2: ASP/AS Notification options. Each bit is used as an enabled/disabled flag for a particular ASP/AS Notification option. Not supported on IPSG application.

PVALUE : Valid range = 32-bits

	BIT	BIT VALUE
1=Enabled	0=ASP Active Notifications	0=Disabled ,
1=Enabled	1=ASP Inactive Notifications	0=Disabled ,
1=Enabled	2=ASP AS State Query	0=Disabled ,
	3-31=Reserved	

PARM 3: UA Serviceability Options. Each bit is used as an enabled/disabled flag for a particular UA Serviceability option. Supported on IPSP, SS7IPGW, and IPGWI applications.

UA Graceful Shutdown supported on IPSP for M3UA only.

PVALUE : Valid range = 32-bits

	BIT	BIT VALUE
1=Enabled	0=UA Heartbeats	0=Disabled ,
1=Enabled	1=UA Graceful Shutdown	0=Disabled ,
	2-31=Reserved	

PARM 4: SCTP Payload Protocol Indicator byte order option. Bit indicates PPI value is RCV/TX in Big Endian or Little Endian byte format.

Supported on IPSP-M2PA associations only.

PVALUE : Valid range = 32-bits

	BIT	BIT VALUE
1=Little Endian	0=Payload Protocol Indicator	0=Big Endian ,
	1-31=Reserved	

If you do not wish to change the UA parameter set values, continue the procedure with [11](#).

If the **UA** parameter set you wish to assign to the association does not contain the desired values, go to the [Changing a UA Parameter Set](#) procedure and change the desired parameter set values. After the UA parameter set values have been changed, continue the procedure with [11](#).

 **Caution:**

Changing a **UA** parameter set may affect the performance of any associations using the parameter set being changed.

11. Change the association using the `chg-assoc` command.

For this example, enter this command.

```
chg-assoc:aname=assoc2:lhost=m2pa2:alhost=m2pa3
```

 **Note:**

See (Sheet 7) for the rules that apply to the `chg-assoc` command.

These are the rules that apply to changing the host values of an IPSG association.

- If any optional parameters are not specified with the `chg-assoc` command, those values are not changed.
- The EAGLE can contain a maximum of 4000 connections.
- The host of an IPSG association can contain a maximum of 32 IPSG associations.
- The value of the `lhost` parameter is a text string of up to 60 characters, with the first character being a letter. The command input is limited to 150 characters, including the hostnames.
- Specifying the `lhost` parameter only creates a uni-homed endpoint. The network portion of the endpoint's IP address must be the same as the network portion of the IP address assigned to either the A or B network interface of the IP card.
- Specifying the `lhost` and `alhost` parameters creates a multi-homed endpoint. The network portion of the IP address associated with the `lhost` parameter must be the same as the network portion of the IP address assigned to one of the network interfaces (A or B) of the IP card, and the network portion of the IP address associated with the `alhost` parameter must be the same as the network portion of the IP address assigned to the other network interface on the IP card.
- The `alhost=none` parameter removes the alternate local host from the specified association, which also removes the multi-homed endpoint capability.
- The `m2patset` and `ver` parameters can be specified only for IPSG M2PA associations.
- If the `mp2atset` parameter is not specified with the `chg-assoc` command, and the `adapter` parameter value is being changed to `m2pa`, the `m2patset` parameter value defaults to M2PA timer set 1 (`m2patset=1`).
- The M2PA version of the association determines the version of the M2PA timer set that is assigned to the association. For example, if M2PA timer set 3 is assigned to the M2PA association, and the association is an RFC M2PA association, the RFC version of M2PA timer set 3 is used with the association. If M2PA timer set 7 is assigned to the M2PA association, and the association is a Draft 6 M2PA association, the Draft 6 version of M2PA timer set 7 is used with the association.
- If the `adapter` parameter value of the association is changed to `m2pa` in this procedure and the `ver` parameter is not specified, the version of the association will be RFC. To make this association a M2PA Draft 6 association, the `ver=d6` parameter must be specified for this association.

When this command has successfully completed, this message should appear.

```
rlghncxa03w 08-04-28 09:12:36 GMT EAGLE5 38.0.0
CHG-ASSOC: MASP A - COMPLTD;
```

Continue the procedure by performing one of these steps.

- If the association was not assigned to a signaling link when this procedure was started, and the `open` parameter value was not changed in 3, continue the procedure with [Oracle](#).
 - If the association was not assigned to a signaling link when this procedure was started, and the `open` parameter value was changed in 3, continue the procedure with [12](#).
 - If the association was assigned to a signaling link when this procedure was started, continue the procedure with [12](#).
- 12.** Assign the association to a signaling link by performing one of these procedures.

If the `ADAPTER` value of the association is M2PA, perform the [Adding an IPSP M2PA Signaling Link](#) procedure.

If the `ADAPTER` value of the association is M3UA, perform the [Adding an IPSP M3UA Signaling Link](#) procedure.

After the association has been assigned to a signaling link, continue the procedure with one of these steps.

- If the `open` parameter value was not changed in 3, continue the procedure with [Oracle](#).
 - If the `open` parameter value was changed in 3, continue the procedure with [13](#)
- 13.** Change the value of the `open` parameter to `yes` by specifying the `chg-assoc` command with the `open=yes` parameter.

For this example, enter this command.

```
chg-assoc:aname=assoc2:open=yes
```

When this command has successfully completed, this message should appear.

```
rlghncxa03w 08-04-28 09:12:36 GMT EAGLE5 38.0.0
CHG-ASSOC: MASP A - COMPLTD;
```

- 14.** Verify the changes using the `rtrv-assoc` command specifying the association name specified in [11](#) and [13](#).

For this example, enter this command.

```
rtrv-assoc:aname=assoc2
```

This is an example of possible output.

```
rlghncxa03w 10-07-28 21:14:37 GMT EAGLE5 42.0.0
ANAME assoc2
  LOC      2107          IPLNK PORT  A,B          LINK  --
  ADAPTER  M2PA         VER        M2PA RFC
  LHOST    M2PA2
  ALHOST   M2PA3
  RHOST    gw200.nc-tekelec.com
  ARHOST   ---
  LPORT    2048          RPORT      2048
  ISTRMS   2            OSTRMS     2            BUFSIZE  400
  RMODE    LIN          RMIN       120          RMAX     800
  RTIMES   10           CWMIN      3000         UAPS     10
```

```

OPEN      NO          ALW      YES      RTXTHR  2000
RHOSTVAL  RELAXED     M2PATSET 1
LSN
e5e6a

```

IP Appl Sock/Assoc table is (8 of 4000) 1% full
Assoc Buffer Space Used (200 KB of 6400 KB) on LOC = 2107

```

rlghncxa03w 09-05-28 21:14:37 GMT EAGLE5 41.0.0
ANAME assoc2
LOC      2107          IPLNK PORT  A,B      LINK  --
ADAPTER  M2PA          VER        M2PA RFC
LHOST    M2PA2
ALHOST   M2PA3
RHOST    gw200.nc-tekelec.com
ARHOST   ---
LPORT    2048          RPORT      2048
ISTRMS   2             OSTRMS     2         BUFSIZE  400
RMODE    LIN          RMIN       120       RMAX     800
RTIMES   10          CWMIN      3000     M2PATSET 1
OPEN     NO          ALW      YES      RTXTHR  2000
RHOSTVAL  RELAXED
LSN
e5e6a

```

IP Appl Sock/Assoc table is (8 of 4000) 1% full
Assoc Buffer Space Used (200 KB of 6400 KB) on LOC = 2107

15. Back up the new changes, using the `chg-db:action=backup:dest=fixed` command.

These messages should appear; the active **Maintenance and Administration Subsystem Processor (MASP)** appears first.

```

BACKUP (FIXED) : MASP A - Backup starts on active MASP.
BACKUP (FIXED) : MASP A - Backup on active MASP to fixed disk complete.
BACKUP (FIXED) : MASP A - Backup starts on standby MASP.
BACKUP (FIXED) : MASP A - Backup on standby MASP to fixed disk complete.

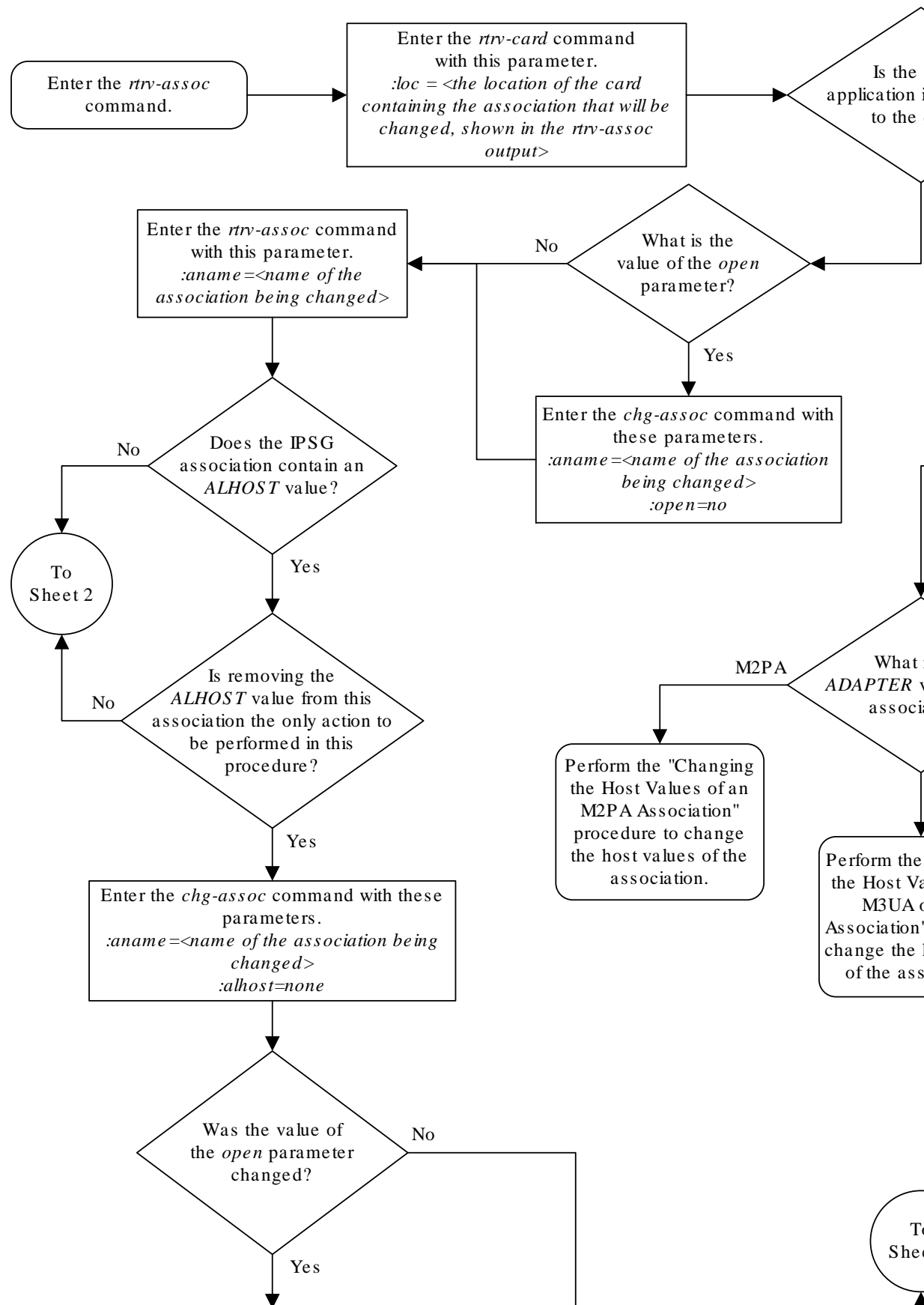
```

If you wish to change the other attributes of the IPSG association, perform one of these procedures.

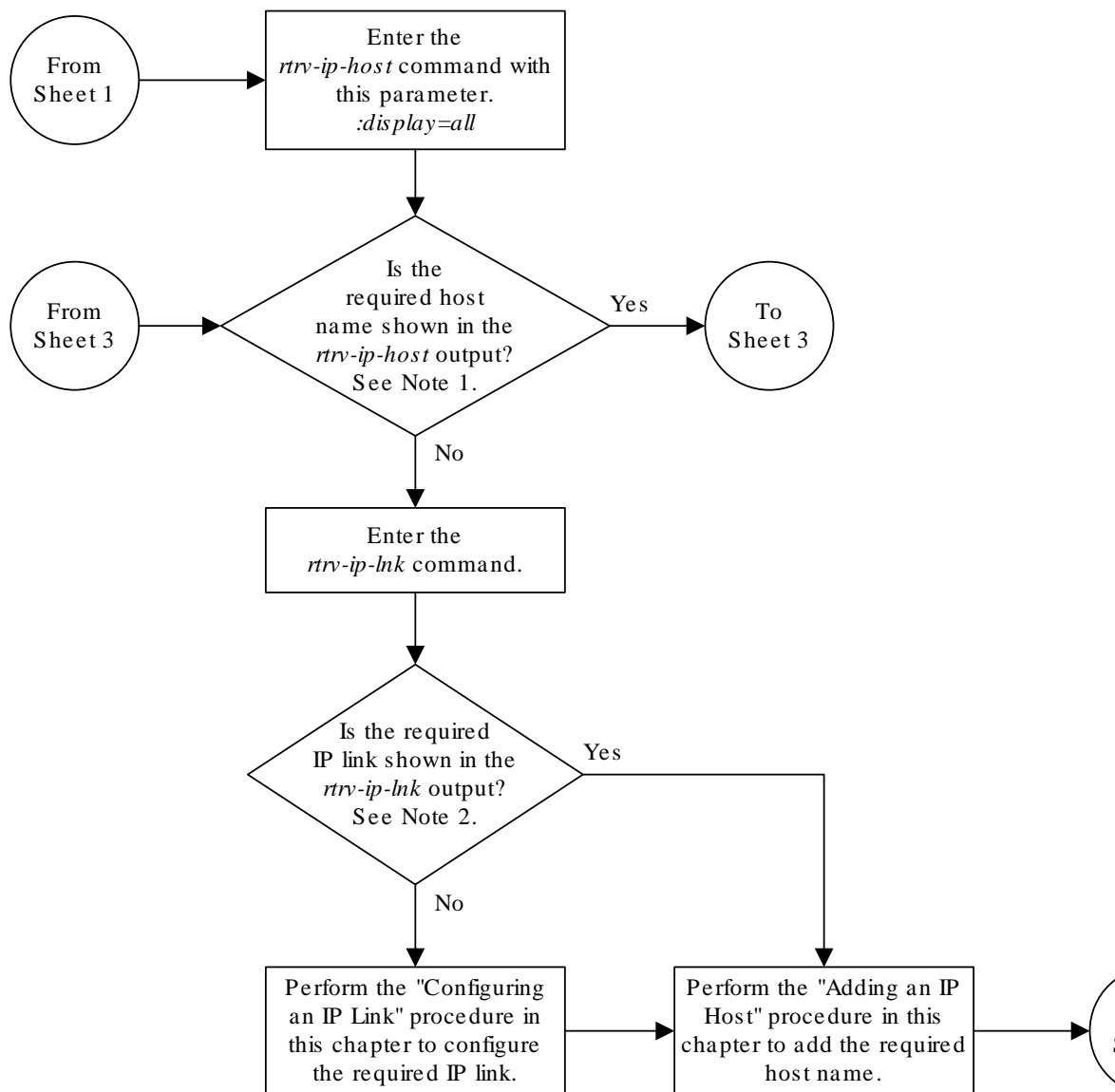
- `bufsize` - [Changing the Buffer Size of an IPSG Association](#)
- Other attributes of the IPSG Association - [Changing the Attributes of an IPSG Association](#)

If you do not wish to change the other attributes of the IPSG association, this procedure is finished.

Figure 6-29 Changing the Host Values of an IPSG Association



Sheet 1 of 6

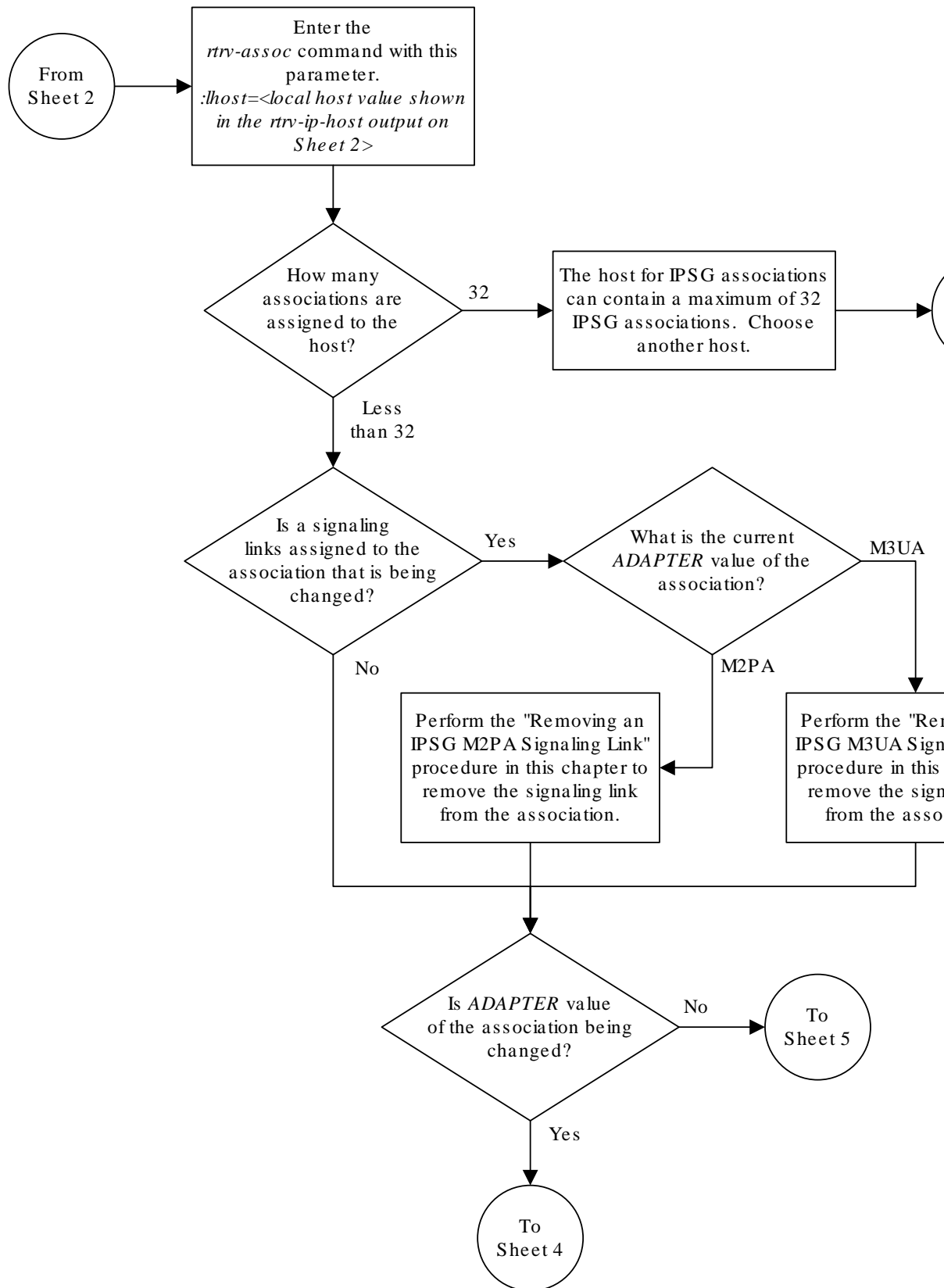


Notes:

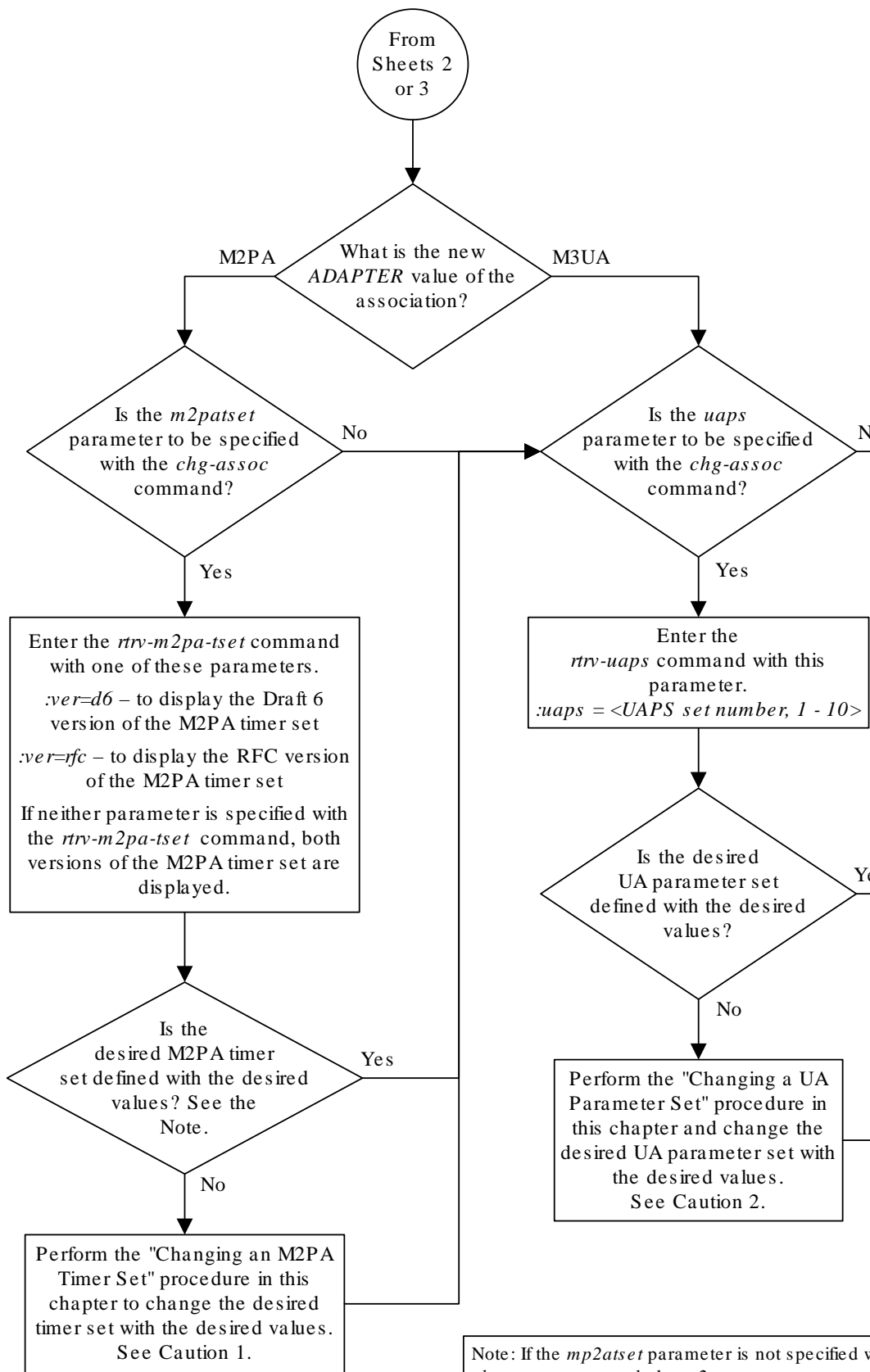
1. The *rtrv-ip-host* output must contain a host name for the association's *lhost* parameter and a host name for the association's *ahost* parameter, if the *ahost* parameter will be specified for the association.

2. The IP address of the IP link should be assigned to the host name, shown in the *rtrv-ip-host* output, that will be used as the association's *lhost* parameter value. If the *ahost* parameter will be specified for the association, the IP address of the IP link must be assigned to the host name that will be used as the *ahost* parameter value. The IP links associated with the association's *lhost* and *ahost* values must be assigned to the same card.

Sheet 2 of 6



Sheet 3 of 6

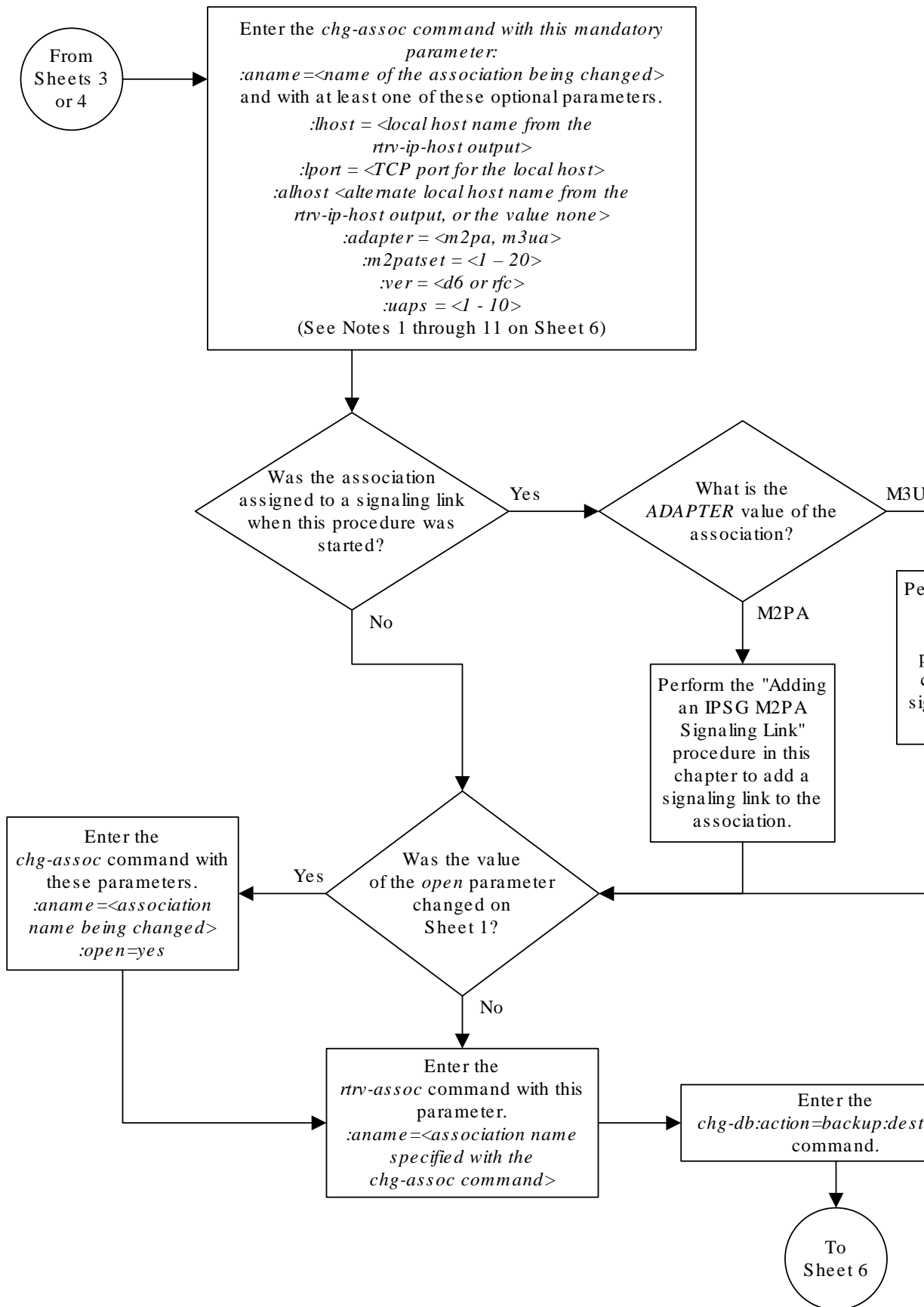


Note: If the *mp2atset* parameter is not specified with the *chg-assoc* command, the *m2patset* parameter value defaults to M2PA timer set 1 (*m2patset=1*).

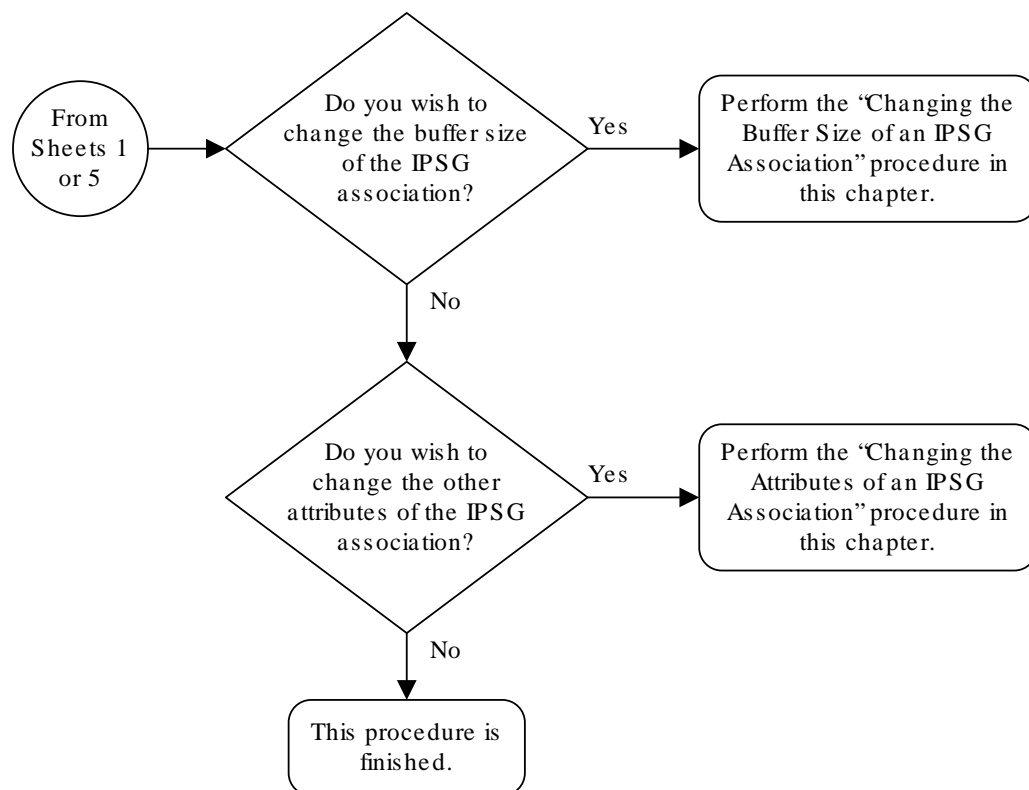
Caution 1: Changing an M2PA timer set may affect the performance of any associations using the timer set being changed.

Caution 2: Changing a UA parameter set may affect the performance of any associations using the UA parameter set being changed.

Sheet 4 of 6



Sheet 5 of 6



Notes:

1. If any optional parameters are not specified with the *chg-assoc* command, those values are not changed.
2. The EAGLE 5 ISS can contain a maximum of 4000 connections.
3. The host of an IPSG association can contain a maximum of 32 IPSG associations.
4. The value of the *lhost* and *rhost* parameters is a text string of up to 60 characters, with the first character being a letter. The command input is limited to 150 characters, including the hostnames.
5. Specifying the *lhost* parameter only creates a uni-homed endpoint. The network portion of the endpoint's IP address must be the same as the network portion of the IP address assigned to either the A or B network interface of the IP card.
6. Specifying the *lhost* and *alhost* parameters creates a multi-homed endpoint. The network portion of the IP address associated with the *lhost* parameter must be the same as the network portion of the IP address assigned to one of the network interfaces (A or B) of the IP card, and the network portion of the IP address associated with the *alhost* parameter must be the same as the network portion of the IP address assigned to the other network interface on the IP card.
7. The *alhost=none* parameter removes the alternate local host from the specified association, which also removes multi-homed endpoint capability.
8. The *m2patset* and *ver* parameters can be specified only for IPSG M2PA associations.
9. If the *mp2atset* parameter is not specified with the *chg-assoc* command, and the *adapter* parameter value is being changed to *m2pa*, the *m2patset* parameter value defaults to M2PA timer set 1 (*m2patset=1*).
10. The M2PA version of the association determines the version of the M2PA timer set that is assigned to the association. For example, if M2PA timer set 3 is assigned to the M2PA association, and the association is an RFC M2PA association, the RFC version of M2PA timer set 3 is used with the association. If M2PA timer set 7 is assigned to the M2PA association, and the association is a Draft 6 M2PA association, the Draft 6 version of M2PA timer set 7 is used with the association.
11. If the *adapter* parameter value of the association is changed to *m2pa* in this procedure and the *ver* parameter is not specified, the version of the association will be RFC. To make this association a M2PA Draft 6 association, the *ver=6* parameter must be specified for this association.

6.33 Configuring an IPSG Association for SCTP Retransmission Control

This procedure is used to gather the information required to configure the retransmission parameters for M2PA or M3UA associations assigned to cards running the IPSG application. Perform the [Configuring SCTP Retransmission Control for a M2PA Association](#) procedure to configure the retransmission parameters for M2PA associations assigned to IPLIMx cards. Perform the [Configuring SCTP Retransmission Control for a M3UA or SUA Association](#) procedure to configure the retransmission parameters for M3UA associations assigned to IPLIMx cards. If any assistance is needed to configure the retransmission parameters for associations, contact [My Oracle Support \(MOS\)](#).

The retransmission parameters are configured using the `rmode`, `rmin`, `rmax`, `rtimes`, and `cwmin` parameters of the `chg-assoc` command.

`:rmode` – The retransmission mode used when packet loss is detected. The values are `rfc` or `lin`.

- `rfc` – Standard **RFC** 2960 algorithm in the retransmission delay doubles after each retransmission. The **RFC** 2960 standard for congestion control is also used.
- `lin` – Oracle's linear retransmission mode where each retransmission timeout value is the same as the initial transmission timeout and only the slow start algorithm is used for congestion control.

`:rmin` – The minimum value of the calculated retransmission timeout in milliseconds.

`:rmax` – The maximum value of the calculated retransmission timeout in milliseconds.

 **Note:**

The `rmin` and `rmax` parameter values form a range of retransmission values. The value of the `rmin` parameter must be less than or equal to the `rmax` parameter value.

`:rtimes` – The number of times a data retransmission occurs before closing the association.

`:cwmin` – The minimum size in bytes of the association's congestion window and the initial size in bytes of the congestion window.

The [Changing the Attributes of an IPSG Association](#) procedure is used to change the values of these parameters. In addition to using the [Changing the Attributes of an IPSG Association](#) procedure, these pass commands are also used in this procedure.

- `ping` – tests for the presence of hosts on the network.
- `assocrtt` – displays the **SCTP** round trip times for a specified association. Minimum, maximum, and average times are kept for each open association. The Retransmission Mode (**RFC** or **LIN**) and the configured Minimum and Maximum Retransmission Timeout limits are also displayed.

- `sctp` – provides a summary list of all **SCTP** instances.
- `sctp -a <association name>` – displays the measurements and information for a specific association.

 **Note:**

The values for the minimum and maximum retransmission times in the output from this command are shown in microseconds.

For more information on the `pass` commands, see *Commands User's Guide*.

The `chg-assoc` command contains other optional parameters that can be used to configure an association. These parameters are not shown here because they are not necessary for configuring the **SCTP** retransmission parameters. These parameters are explained in more detail in the [Changing the Attributes of an IPSPG Association](#) procedure, or in the `chg-assoc` command description in *Commands User's Guide*.

Canceling the `RTRV-ASSOC` Command

Because the `rtrv-assoc` command used in this procedure can output information for a long period of time, the `rtrv-assoc` command can be canceled and the output to the terminal stopped. There are three ways that the `rtrv-assoc` command can be canceled.

- Press the `F9` function key on the keyboard at the terminal where the `rtrv-assoc` command was entered.
- Enter the `canc-cmd` without the `trm` parameter at the terminal where the `rtrv-assoc` command was entered.
- Enter the `canc-cmd:trm=<xx>`, where `<xx>` is the terminal where the `rtrv-assoc` command was entered, from another terminal other than the terminal where the `rtrv-assoc` command was entered. To enter the `canc-cmd:trm=<xx>` command, the terminal must allow Security Administration commands to be entered from it and the user must be allowed to enter Security Administration commands. The terminal's permissions can be verified with the `rtrv-secu-trm` command. The user's permissions can be verified with the `rtrv-user` or `rtrv-secu-user` commands.

For more information about the `canc-cmd` command, go to *Commands User's Guide*.

1. Display the associations in the database using the `rtrv-assoc` command.

This is an example of possible output.

```
rlghncxa03w 06-10-28 09:12:36 GMT EAGLE5 36.0.0
```

ANAME	CARD		IPLNK	LINK	ADAPTER	LPORT	RPORT	OPEN	ALW
	LOC	PORT							
swbel32	1201	A	A	M3UA	1030	2345	YES	YES	
a2	1305	A	A	SUA	1030	2345	YES	YES	
a3	1307	A	A	SUA	1030	2346	YES	YES	
assoc1	1201	A	A	M2PA	2000	1030	YES	YES	

2. Enter the `rtrv-card` command with the location of the card that is hosting the M2PA association that will be changed in this procedure. For this example, enter this command.

```
rtrv-card:loc=1201
```

This is an example of possible output.

```
rlghncxa03w 08-03-06 15:17:20 EST EAGLE5 38.0.0
CARD   TYPE      APPL      LSET NAME   LINK SLC LSET NAME   LINK SLC
1201   DCM          IPLIM     lsn1        A     0
```

If the application assigned to the card is IPSG, shown in the `APPL` column, continue the procedure with [3](#).

If the application assigned to the card is IPLIM or IPLIMI, perform the [Configuring SCTP Retransmission Control for a M2PA Association](#) procedure.

If the application assigned to the card is SS7IPGW or IPGWI, perform the [Configuring SCTP Retransmission Control for a M3UA or SUA Association](#) procedure.

3. Display the association that will be changed by entering the `rtrv-assoc` command with the name of the association. For this example, enter this command.

```
rtrv-assoc:aname=assoc1
```

This is an example of the possible output.

```
rlghncxa03w 10-07-28 21:14:37 GMT EAGLE5 42.0.0
ANAME assoc1
      LOC      1201          IPLNK PORT  A          LINK  A
      ADAPTER  M2PA          VER          M2PA RFC
      LHOST    IPNODE2-1205
      ALHOST    ---
      RHOST    gw100.nc.tekelec.com
      ARHOST    ---
      LPORT    2000          RPORT        1030
      ISTRMS   2          OSTRMS        2          BUFSIZE  400
      RMODE    LIN          RMIN          120        RMAX      800
      RTIMES   10          CWMIN         3000       UAPS      10
      OPEN     NO          ALW           YES         RTXTHR   2000
      RHOSTVAL RELAXED      M2PATSET     1
```

```
IP Appl Sock/Assoc table is (8 of 4000) 1% full
Assoc Buffer Space Used (1600 KB of 1600 KB) on LOC = 1201
```

4. Enter the `ping pass` command specifying the card location of the local host, shown in [3](#), and the name of the remote host assigned to the association being changed, shown in [3](#).

This command is entered several times to obtain the average round trip time. For this example, enter this command.

```
pass:loc=1201:cmd="ping gw100.nc.tekelec.com"
```

The following is an example of the possible output

```
rlghncxa03w 06-10-28 21:15:37 GMT EAGLE5 36.0.0
```

```

PASS: Command sent to card

rlghncxa03w 06-10-28 21:15:37 GMT EAGLE5 36.0.0
PING command in progress

rlghncxa03w 06-10-28 21:15:37 GMT EAGLE5 36.0.0
PING GW100. NC. TEKELEC. COM (192.1.1.30): 56 data bytes
64 bytes from tekral.nc.tekelec.com (192.1.1.30): icmp_seq=0.
time=5. ms
64 bytes from tekral.nc.tekelec.com (192.1.1.30): icmp_seq=1.
time=9. ms
64 bytes from tekral.nc.tekelec.com (192.1.1.30): icmp_seq=2.
time=14. ms
----tekral PING Statistics----
3 packets transmitted, 3 packets received, 0% packet loss
round-trip (ms)  min/avg/max = 5/9/14

PING command complete

```

If the **SCTP** retransmission parameters are not to be changed, do not perform 5 through 8. This procedure is finished.

5. Perform the [Changing the Attributes of an IPSG Association](#) procedure to change the retransmission parameters of the association based on the results of pinging the remote host.
6. Enter the `assocrft` pass command to display the round trip time data collected after an association is established when an **SCTP** INIT message is sent and an acknowledgment is received.

The `assocrft` command is entered with the card location from 4 (the card location assigned to the association being changed), and the name of the association being changed. This association must contain the host name used in 4. For this example, enter this command.

```
pass:loc=1201:cmd="assocrft assoc1"
```

The following is an example of the possible output

```

rlghncxa03w 06-10-28 21:15:37 GMT EAGLE5 36.0.0
PASS: Command sent to card

rlghncxa03w 06-10-28 21:15:37 GMT EAGLE5 36.0.0

ASSOCRTT: Association round-trip time report (in milliseconds)

Retransmission Configuration
  Retransmission Mode           : LIN
  Minimum RTO: 120
  Maximum RTO: 800

Traffic Round-Trip Times

  Minimum round-trip time       : 5
  Maximum round-trip time       : 120
  Weighted Average round-trip time : 10

```

```

Last recorded round-trip time      : 10

Measured Congested Traffic Round-Trip Times

Minimum round-trip time           : 0
Maximum round-trip time           : 0
Weighted Average round-trip time : 0
Last recorded round-trip time     : 0
;
rlghncxa03w 06-10-28 21:15:37 GMT EAGLE5 36.0.0
ASSOCRTT command complete

```

7. Enter the `sctp -a <association name> pass` command to determine if retransmissions have occurred.

The association name is the association name specified in 6. Specify the card location used in 6. For this example, enter this command.

```
pass:loc=1201:cmd="sctp -a assoc1"
```

The following is an example of the possible output

```

rlghncxa03w 10-12-28 21:15:37 GMT EAGLE5 43.0.0

Aname          Local          Local Remote      Remote
                IP Address     Port  Address     Port
Assoc1         192.168.110.12 2222  192.168.112.4 5555
                192.168.112.12

Configuration                                     State
Retransmission Mode = LIN                        State = OPEN
Min. Retransmission Timeout = 10                 ULP association id = 18
Max. Retransmission Timeout = 800                Number of nets = 2
Max. Number of Retries = 10                      Inbound Streams = 1
Min. Congestion Window = 3000                   Outbound Streams = 2
Inbound Streams = 2
Outbound Streams = 2
Checksum Algorithm = crc32c
Send/Rcv Buffer Size = 204800

Nets Data

IP Address  192.168.112.4      State  Reachable
Port        7777                Primary YES
MTU         1500                cwnd  16384
ssthresh    16384                RTO   120

IP Address  192.168.113.5      State  Reachable
Port        7777                Primary NO
MTU         1500                cwnd  16384
ssthresh    16384                RTO   120

Last Net Sent To = 192.168.112.4
Last Net Rcvd From = 192.168.112.4
Over All Error Count = 0

```

```

        Peers Rwnd = 13880
        My Rwnd = 16384
        Max Window = 16384
        Initial Seq Number = 24130
        Next Sending Seq Number = 124686
        Last Acked Seq Number = 124669
        Maximum Outbound Char Count = 16384
        Current Outbound Char Count = 2112
        Number Unsent Char Count = 0
        Outbound Data Chunk Count = 16
        Number Unsent = 0
        Number To Retransmit = 0

        ip datagrams rcvd = 155402
ip datagrams with data chunks rcvd = 120844
        data chunks rcvd = 367908
        data chunks read = 367900
        dup tsns rcvd = 8
        sacks rcvd = 38734
        gap ack blocks rcvd = 3
        heartbeat requests rcvd = 135
        heartbeat acks rcvd = 52
        heartbeat requests sent = 52
        ip datagrams sent = 129254
ip datagrams with data chunks sent = 73084
        data chunks sent = 396330
        retransmit data chunks sent = 135
        sacks sent = 64872
        send failed = 0
        retransmit timer count = 0
        consecutive retransmit timeouts = 0
RTT between RMIN and RMAX inclusive = 6
        RTT greater than RMAX = 0
        fast retransmit count = 135
        rcv timer count = 0
        heartbeat timer count = 244
        none left tosend = 0
        none left rwnd gate = 5
        none left cwnd gate = 8

;

rlghncxa03w 10-12-28 21:15:37 GMT EAGLE5 43.0.0

SCTP command complete

rlghncxa03w 06-10-28 21:15:37 GMT EAGLE5 36.0.0

Aname          Local          Local Remote          Remote
                IP Address      Port  Address          Port
Assoc1         192.168.110.12 2222  192.168.112.4   5555
                192.168.112.12

```

Configuration	State
Retransmission Mode = LIN	State = OPEN
Min. Retransmission Timeout = 10	ULP association id = 18
Max. Retransmission Timeout = 800	Number of nets = 2
Max. Number of Retries = 10	Inbound Streams = 1
Min. Congestion Window = 3000	Outbound Streams = 2
Inbound Streams = 2	
Outbound Streams = 2	

Nets Data

IP Address	192.168.112.4	State	Reachable
Port	7777	Primary	YES
MTU	1500	cwnd	16384
ssthresh	16384	RTO	120
IP Address	192.168.113.5	State	Reachable
Port	7777	Primary	NO
MTU	1500	cwnd	16384
ssthresh	16384	RTO	120

```

Last Net Sent To = 192.168.112.4
Last Net Rcvd From = 192.168.112.4
Over All Error Count = 0
  Peers Rwnd = 13880
  My Rwnd = 16384
  Max Window = 16384
  Initial Seq Number = 24130
  Next Sending Seq Number = 124686
  Last Acked Seq Number = 124669
Maximum Outbound Char Count = 16384
Current Outbound Char Count = 2112
Number Unsent Char Count = 0
Outbound Data Chunk Count = 16
  Number Unsent = 0
  Number To Retransmit = 0

ip datagrams rcvd = 155402
ip datagrams with data chunks rcvd = 120844
  data chunks rcvd = 367908
  data chunks read = 367900
  dup tsns rcvd = 8
  sacks rcvd = 38734
  gap ack blocks rcvd = 3
  heartbeat requests rcvd = 135
  heartbeat acks rcvd = 52
  heartbeat requests sent = 52
  ip datagrams sent = 129254
ip datagrams with data chunks sent = 73084
  data chunks sent = 396330
retransmit data chunks sent = 135
  sacks sent = 64872
  send failed = 0
retransmit timer count = 0

```

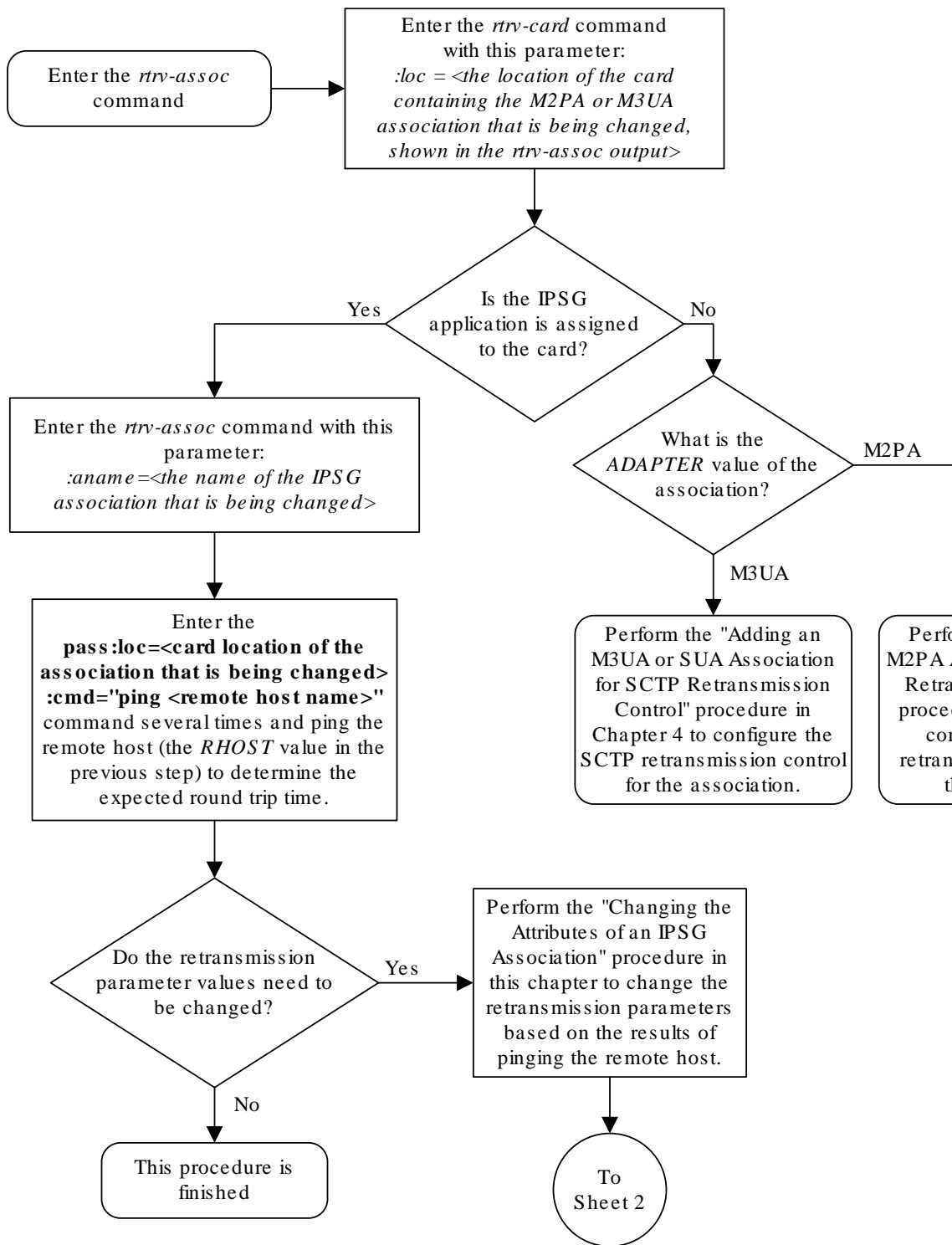
```
consecutive retransmit timeouts = 0
RTT between RMIN and RMAX inclusive = 6
    RTT greater than RMAX = 0
fast retransmit count = 135
    recv timer count = 0
    heartbeat timer count = 244
    none left tosend = 0
    none left rwnd gate = 5
    none left cwnd gate = 8
```

```
SCTP command complete
```

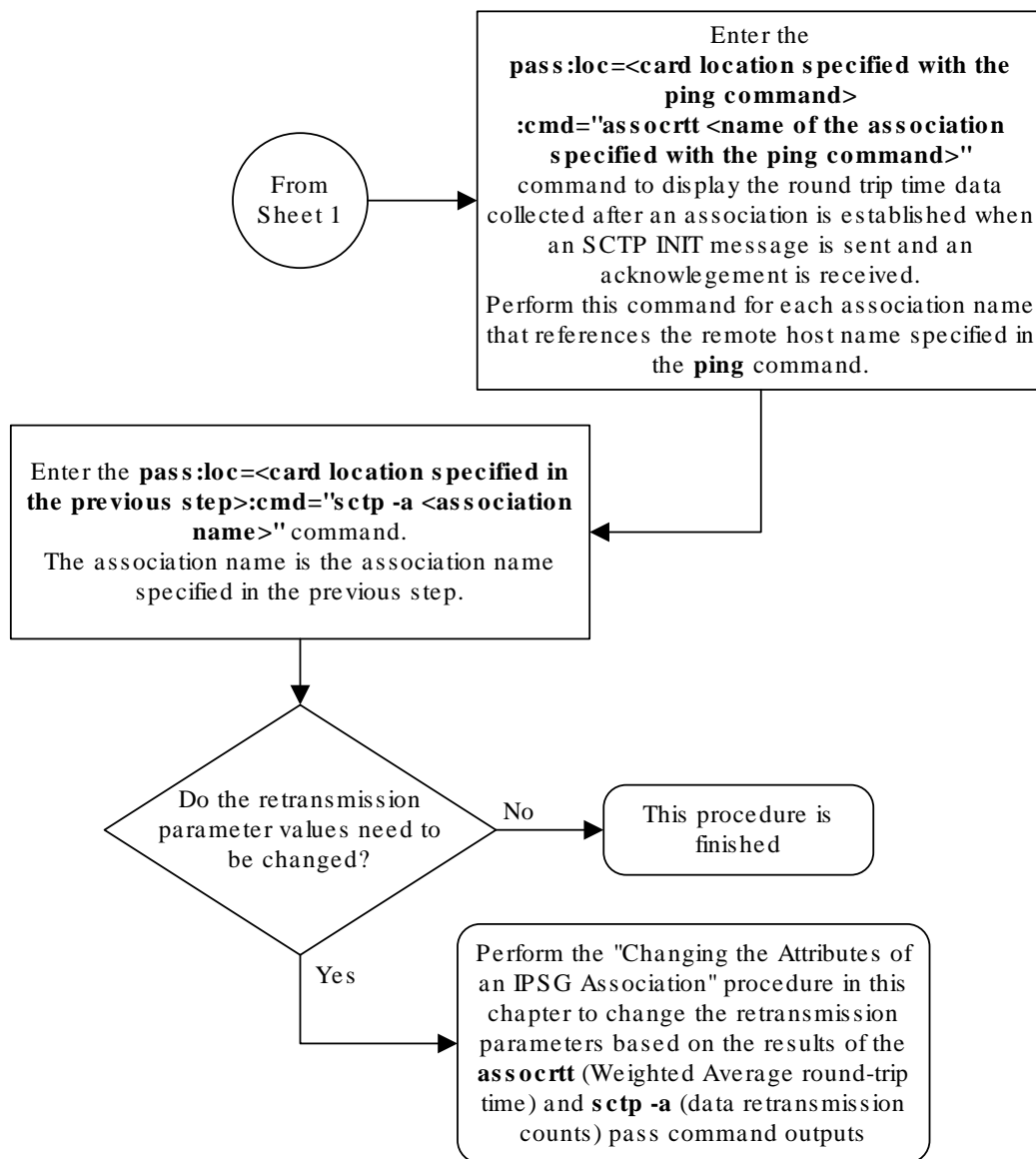
8. Perform the [Changing the Attributes of an IPSG Association](#) procedure to change the retransmission parameters of the association based on the results of the outputs of [6](#) and [7](#).

The Weighted Average round-trip time shown in the `assocrtt pass` command output in [6](#), and the data retransmission counts shown in the `sctp -a pass` command output in [7](#) are used as a guide to determine the appropriate values for the `rmode`, `rmin`, `rmax`, and `rtimes` parameters. If the retransmission parameters do not have to be adjusted, do not perform this step. This procedure is finished.

Figure 6-30 Configuring an IPSG Association for SCTP Retransmission Control



Sheet 1 of 2



6.34 Changing the SCTP Checksum Algorithm Option for IPSP M2PA Associations

Use this procedure to change the **SCTP** checksum algorithm, either Adler-32 or CRC-32c, applied to traffic on **SCTP** associations. The `sctpchecksum` parameter of the `chg-sg-opts` command is used to change this option. The Adler-32 and CRC-32c checksum algorithms specified in this procedure applies to all the M2PA associations that are assigned to all the IP cards running the IPSP application. This option is a system-wide option. To apply this option to associations assigned to cards running the IPLIM, IPLIMI, SS7IPGW, or IPGWI applications, or to IPSP M3UA associations, perform these procedures.

- [Changing the SCTP Checksum Algorithm Option for M3UA and SUA Associations](#)
- [Changing the SCTP Checksum Algorithm Option for M2PA Associations](#)
- [Changing the SCTP Checksum Algorithm Option for IPSP M3UA Associations](#)

The `sctpchecksum` parameter contains another value, `percard`, that allows either the Adler-32 or CRC-32c SCTP checksum algorithm to be specified for the all the associations assigned to a specific card. With this option specified, the Adler-32 checksum algorithm can be specified for the associations on one card and the CRC-32c checksum algorithm can be specified for the associations on another card. Setting the `sctpchecksum` parameter to `percard` changes the SCTP checksum algorithm for the associations assigned to a card to the SCTP checksum algorithm value for that card. The checksum algorithm for individual cards is provisioned by performing the [Configuring an IP Link](#) procedure.

Once the **SCTP** checksum option has been changed, the associations on each **IP** card need to be reset by changing the `open` parameter value for each association to `no`, then back to `yes`. This ensures that the associations on the **IP** card are using the new **SCTP** checksum algorithm.

Canceling the `RTRV-ASSOC` Command

Because the `rtrv-assoc` command used in this procedure can output information for a long period of time, the `rtrv-assoc` command can be canceled and the output to the terminal stopped. There are three ways that the `rtrv-assoc` command can be canceled.

- Press the F9 function key on the keyboard at the terminal where the `rtrv-assoc` command was entered.
- Enter the `canc-cmd` without the `trm` parameter at the terminal where the `rtrv-assoc` command was entered.
- Enter the `canc-cmd:trm=<xx>`, where `<xx>` is the terminal where the `rtrv-assoc` command was entered, from another terminal other than the terminal where the `rtrv-assoc` command was entered. To enter the `canc-cmd:trm=<xx>` command, the terminal must allow Security Administration commands to be entered from it and the user must be allowed to enter Security Administration commands. The terminal's permissions can be verified with the `rtrv-secu-trm`

command. The user's permissions can be verified with the `rtrv-user` or `rtrv-secu-user` commands.

For more information about the `canc-cmd` command, go to *Commands User's Guide*.

1. Display the current **IP** options in the database by entering the `rtrv-sg-opts` command. The following is an example of the possible output.

```
rlghncxa03w 06-10-28 21:16:37 GMT EAGLE5 36.0.0
SCTPCSUM:      adler32
```

The `rtrv-sg-opts` command output contains other fields that are not used by this procedure. If you wish to see all the fields displayed by the `rtrv-sg-opts` command, see the `rtrv-sg-opts` command description in *Commands User's Guide*.

2. Display the cards in the **EAGLE** by entering the `rtrv-card` command. This is an example of the possible output.

```
rlghncxa03w 09-10-15 16:34:56 GMT EAGLE5 41.0.0
CARD  TYPE      APPL      LSET NAME      LINK SLC  LSET NAME      LINK SLC
1101  DSM          VSCCP
1102  TSM          GLS
1113  GSPM        EOAM
1114  TDM-A
1115  GSPM        EOAM
1116  TDM-B
1117  MDAL
1201  LIMDSO      SS7ANSI    lsn1           A    0    lsn2           B    1
1202  DCM         IPLIM     ipnode2        A    1
1203  LIMDSO      SS7ANSI    lsn2           A    0    lsn1           B    1
1204  LIMATM      ATMANSI    atmgwy         A    0
1205  DCM         IPLIM     ipnode1        A    0    ipnode3        B    1
1207  DCM         IPLIM     ipnode2        A    0
1303  DCM         IPLIM     ipnode3        A    0    ipnode1        B    1
1305  DCM         IPLIM     ipnode4        A    0
1308  ENET        IPSP      ipnode3        B    2
      ipnode1        A1   2    ipnode4        B2   1
1315  DCM         SS7IPGW   ipgtwy1        A
1317  DCM         IPGWI     ipgtwy2        A
```

Record the card location, shown in the `LOC` column, and signaling link, shown in the `LINK` column, information for all cards running the **IPSP** application.

3. Select one of the IPSP cards shown in 2. Display the associations assigned to the IPSP card by entering the `rrtrv-assoc` command and specifying the card location of the IPSP card. For this example, enter this command.

```
rtrv-assoc:loc=1308
```

The following is an example of the possible output.

```
rlghncxa03w 08-04-28 09:12:36 GMT EAGLE5 38.0.0
CARD  IPLNK
```

ANAME	LOC	PORT	LINK	ADAPTER	LPORT	RPORT	OPEN	ALW
assoc2	1308	A	A1	M2PA	2187	1025	YES	YES
assoc4	1308	A	B	M2PA	3290	1025	YES	YES
assoc5	1308	A	B2	M2PA	1057	1025	YES	YES

```
IP Appl Sock/Assoc table is (9 of 4000) 1% full
Assoc Buffer Space Used (600 KB of 3200 KB) on LOC = 1308
```

If the ADAPTER value of the associations shown in the `rtrv-assoc` output is M2PA, continue the procedure with 4.

If the ADAPTER value of the associations shown in the `rtrv-assoc` output is M3UA, do not perform the remainder of this procedure. Perform the [Changing the SCTP Checksum Algorithm Option for IPSP M3UA Associations](#) procedure to change the SCTP checksum algorithm for IPSP M3UA associations.

4. Change the **SCTP** checksum option in the database using the `chg-sg-opts` command. For this example, enter this command.

```
chg-sg-opts:sctpcsum=crc32c
```

When this command has successfully completed, the following message should appear.

```
rlghncxa03w 06-10-28 21:19:37 GMT EAGLE5 36.0.0
CHG-SG-OPTS: MASP A - COMPLTD
```

Continue the procedure by performing one of these actions.

- If the `sctpcsum` parameter value was changed to either `adler32` or `crc32c`, continue the procedure with 5.
 - If the `sctpcsum` parameter value was changed to `percard`, perform the [Configuring an IP Card](#) procedure to assign an `sctpcsum` parameter value to all the cards containing IPSP M2PA associations. After the [Configuring an IP Card](#) procedure has been performed, continue the procedure with 6.
5. Verify that the **SCTP** checksum algorithm was changed using the `rtrv-sg-opts` command. The **SCTP** checksum algorithm option value is shown in the `SCTPCSUM` parameter. The following is an example of the possible output.

```
rlghncxa03w 06-10-28 21:16:37 GMT EAGLE5 36.0.0
SCTPCSUM:          crc32c
```

The `rtrv-sg-opts` command output contains other fields that are not used by this procedure. If you wish to see all the fields displayed by the `rtrv-sg-opts` command, see the `rtrv-sg-opts` command description in *Commands User's Guide*.

6. Place the signaling links assigned to the IPSP card out of service using the `dact-slk` command, specifying the LOC and LINK values shown in 3. For this example, enter these commands.

```
dact-slk:loc=1308:link=a1
dact-slk:loc=1308:link=b
```

```
dact-slk:loc=1308:link=b2
```

When these commands have successfully completed, this message appears.

```
rlghncxa03w 06-10-12 09:12:36 GMT EAGLE5 36.0.0
Deactivate Link message sent to card
```

- Change the value of the `open` parameter of the associations shown in 3 to `no` by specifying the `chg-assoc` command with the `open=no` parameter. For this example, enter this command.

```
chg-assoc:aname=assoc2:open=no
chg-assoc:aname=assoc4:open=no
chg-assoc:aname=assoc5:open=no
```

When this command has successfully completed, this message should appear.

```
rlghncxa03w 06-10-28 09:12:36 GMT EAGLE5 36.0.0
CHG-ASSOC: MASP A - COMPLTD;
```

- Change the value of the `open` parameter of the associations changed in 7 to `yes` by specifying the `chg-assoc` command with the `open=yes` parameter. For this example, enter this command.

```
chg-assoc:aname=assoc2:open=yes
chg-assoc:aname=assoc4:open=yes
chg-assoc:aname=assoc5:open=yes
```

When this command has successfully completed, this message should appear.

```
rlghncxa03w 06-10-28 09:12:36 GMT EAGLE5 36.0.0
CHG-ASSOC: MASP A - COMPLTD;
```

- Verify the checksum algorithm that is assigned to the associations shown in 8 by entering the `sctp -a` pass command with the card location of the IP card specified in 6 and the name of the associations specified in 8. For this example, enter this command.

```
pass:loc=1308:cmd="sctp -a assoc2 "
```

The following is an example of the possible output.

```
rlghncxa03w 10-12-28 21:16:37 GMT EAGLE5 43.0.0
Aname          Local          Local   Primary      Remote
                IP Address    Port    Address      Port
assoc2         192.1.1.24    2187   192.168.112.4 1025
                192.1.1.24

                Configuration          State
                Retransmission Mode = LIN          State = OPEN
                Min. Retransmission Timeout = 10000          ULP association id = 18
                Max. Retransmission Timeout = 800000          Number of nets = 2
                Max. Number of Retries = 10                    Inbound Streams = 1
                Min. Congestion Window = 3000                  Outbound Streams = 2
                Inbound Streams = 2
```

```

Outbound Streams = 2
Checksum Algorithm = crc32c
Send/Rcv Buffer Size = 204800

```

Nets Data

IP Address	192.168.112.4	State	Reachable
Port	1025	Primary	YES
MTU	1500	cwnd	16384
ssthresh	16384	RTO	120
IP Address	192.168.112.5	State	Reachable
Port	7777	Primary	NO
MTU	1500	cwnd	16384
ssthresh	16384	RTO	120

```

Last Net Sent To = 192.168.112.4
Last Net Rcvd From = 192.168.112.4
Over All Error Count = 0
Peers Rwnd = 13880
My Rwnd = 16384
Max Window = 16384
Initial Seq Number = 24130
Next Sending Seq Number = 124686
Last Acked Seq Number = 124669
Maximum Outbound Char Count = 16384
Current Outbound Char Count = 2112
Number Unsent Char Count = 0
Outbound Data Chunk Count = 16
Number Unsent = 0
Number To Retransmit = 0

```

```

ip datagrams rcvd = 155402
ip datagrams with data chunks rcvd = 120844
data chunks rcvd = 367908
data chunks read = 367900
dup tsns rcvd = 8
sacks rcvd = 38734
gap ack blocks rcvd = 3
heartbeat requests rcvd = 135
heartbeat acks rcvd = 52
heartbeat requests sent = 52
ip datagrams sent = 129254
ip datagrams with data chunks sent = 73084
data chunks sent = 396330
retransmit data chunks sent = 135
sacks sent = 64872
send failed = 0
retransmit timer count = 0
consecutive retransmit timeouts = 0
RTT between RMIN and RMAX inclusive = 6
RTT greater than RMAX = 0
fast retransmit count = 135
recv timer count = 0

```



```

heartbeat timer count = 244
  none left tosend = 0
  none left rwnd gate = 5
  none left cwnd gate = 8

```

;

```
rlghncxa03w 10-12-28 21:16:37 GMT EAGLE5 43.0.0
```

```
SCTP command complete
```

```
rlghncxa03w 08-04-28 21:16:37 GMT EAGLE5 38.0.0
```

Aname	Local	Local	Primary	Remote
	IP Address	Port	Address	Port
assoc2	192.1.1.24	2187	192.168.112.4	1025
	192.1.1.24			

Configuration	State
Retransmission Mode = LIN	State = OPEN
Min. Retransmission Timeout = 10	ULP association id = 18
Max. Retransmission Timeout = 800	Number of nets = 2
Max. Number of Retries = 10	Inbound Streams = 1
Min. Congestion Window = 3000	Outbound Streams = 2
Inbound Streams = 2	
Outbound Streams = 2	
Checksum Algorithm = crc32c	

Nets Data

IP Address	192.168.112.4	State	Reachable
Port	1025	Primary	YES
MTU	1500	cwnd	16384
ssthresh	16384	RTO	120
IP Address	192.168.112.5	State	Reachable
Port	7777	Primary	NO
MTU	1500	cwnd	16384
ssthresh	16384	RTO	120

```

Last Net Sent To = 192.168.112.4
Last Net Rcvd From = 192.168.112.4
Over All Error Count = 0
  Peers Rwnd = 13880
  My Rwnd = 16384
  Max Window = 16384
  Initial Seq Number = 24130
  Next Sending Seq Number = 124686
  Last Acked Seq Number = 124669
Maximum Outbound Char Count = 16384
Current Outbound Char Count = 2112
Number Unsent Char Count = 0
Outbound Data Chunk Count = 16

```

```

        Number Unsent = 0
        Number To Retransmit = 0

        ip datagrams rcvd = 155402
ip datagrams with data chunks rcvd = 120844
        data chunks rcvd = 367908
        data chunks read = 367900
        dup tsns rcvd = 8
        sacks rcvd = 38734
        gap ack blocks rcvd = 3
        heartbeat requests rcvd = 135
        heartbeat acks rcvd = 52
        heartbeat requests sent = 52
        ip datagrams sent = 129254
ip datagrams with data chunks sent = 73084
        data chunks sent = 396330
        retransmit data chunks sent = 135
        sacks sent = 64872
        send failed = 0
        retransmit timer count = 0
        consecutive retransmit timeouts = 0
RTT between RMIN and RMAX inclusive = 6
        RTT greater than RMAX = 0
        fast retransmit count = 135
        rcv timer count = 0
        heartbeat timer count = 244
        none left tosend = 0
        none left rwnd gate = 5
        none left cwnd gate = 8

;

rlghncxa03w 08-04-28 21:16:37 GMT EAGLE5 38.0.0

SCTP command complete

```

```
pass:loc=1308:cmd="sctp -a assoc4 "
```

The following is an example of the possible output.

```

rlghncxa03w 10-12-28 21:16:37 GMT EAGLE5 43.0.0
Aname          Local          Local  Primary
Remote
          IP Address          Port  Address          Port
assoc4      192.1.1.24          3290  192.168.112.4  1025
          192.1.1.24

Configuration          State
Retransmission Mode = LIN          State = OPEN
Min. Retransmission Timeout = 10000          ULP association id = 18
Max. Retransmission Timeout = 800000          Number of nets = 2
Max. Number of Retries = 10          Inbound Streams = 1
Min. Congestion Window = 3000          Outbound Streams = 2

```

```

Inbound Streams = 2
Outbound Streams = 2
Checksum Algorithm = crc32c
Send/Rcv Buffer Size = 204800

```

Nets Data

IP Address	192.168.112.4	State	Reachable
Port	1025	Primary	YES
MTU	1500	cwnd	16384
ssthresh	16384	RTO	120
IP Address	192.168.112.5	State	Reachable
Port	7777	Primary	NO
MTU	1500	cwnd	16384
ssthresh	16384	RTO	120

```

Last Net Sent To = 192.168.112.4
Last Net Rcvd From = 192.168.112.4
Over All Error Count = 0
Peers Rwnd = 13880
My Rwnd = 16384
Max Window = 16384
Initial Seq Number = 24130
Next Sending Seq Number = 124686
Last Acked Seq Number = 124669
Maximum Outbound Char Count = 16384
Current Outbound Char Count = 2112
Number Unsent Char Count = 0
Outbound Data Chunk Count = 16
Number Unsent = 0
Number To Retransmit = 0

ip datagrams rcvd = 155402
ip datagrams with data chunks rcvd = 120844
data chunks rcvd = 367908
data chunks read = 367900
dup tsns rcvd = 8
sacks rcvd = 38734
gap ack blocks rcvd = 3
heartbeat requests rcvd = 135
heartbeat acks rcvd = 52
heartbeat requests sent = 52
ip datagrams sent = 129254
ip datagrams with data chunks sent = 73084
data chunks sent = 396330
retransmit data chunks sent = 135
sacks sent = 64872
send failed = 0
retransmit timer count = 0
consecutive retransmit timeouts = 0
RTT between RMIN and RMAX inclusive = 6
RTT greater than RMAX = 0

```

```

fast retransmit count = 135
  recv timer count = 0
heartbeat timer count = 244
  none left tosend = 0
  none left rwnd gate = 5
  none left cwnd gate = 8

;

rlghncxa03w 10-12-28 21:16:37 GMT EAGLE5 43.0.0

SCTP command complete

rlghncxa03w 08-04-28 21:16:37 GMT EAGLE5 38.0.0
Aname          Local          Local  Primary
Remote
                IP Address      Port    Address      Port
assoc4         192.1.1.24      3290    192.168.112.4 1025
                192.1.1.24

Configuration                                State
Retransmission Mode = LIN                    State = OPEN
Min. Retransmission Timeout = 10             ULP association id = 18
Max. Retransmission Timeout = 800           Number of nets = 2
Max. Number of Retries = 10                 Inbound Streams = 1
Min. Congestion Window = 3000               Outbound Streams = 2
Inbound Streams = 2
Outbound Streams = 2
Checksum Algorithm = crc32c

Nets Data

IP Address 192.168.112.4  State Reachable
Port 1025 Primary YES
MTU 1500 cwnd 16384
ssthresh 16384 RTO 120

IP Address 192.168.112.5  State Reachable
Port 7777 Primary NO
MTU 1500 cwnd 16384
ssthresh 16384 RTO 120

Last Net Sent To = 192.168.112.4
Last Net Rcvd From = 192.168.112.4
Over All Error Count = 0
Peers Rwnd = 13880
My Rwnd = 16384
Max Window = 16384
Initial Seq Number = 24130
Next Sending Seq Number = 124686
Last Acked Seq Number = 124669
Maximum Outbound Char Count = 16384

```

```

Current Outbound Char Count = 2112
Number Unsent Char Count = 0
Outbound Data Chunk Count = 16
    Number Unsent = 0
    Number To Retransmit = 0

    ip datagrams rcvd = 155402
ip datagrams with data chunks rcvd = 120844
    data chunks rcvd = 367908
    data chunks read = 367900
        dup tsns rcvd = 8
        sacks rcvd = 38734
    gap ack blocks rcvd = 3
    heartbeat requests rcvd = 135
    heartbeat acks rcvd = 52
    heartbeat requests sent = 52
    ip datagrams sent = 129254
ip datagrams with data chunks sent = 73084
    data chunks sent = 396330
    retransmit data chunks sent = 135
        sacks sent = 64872
        send failed = 0
    retransmit timer count = 0
    consecutive retransmit timeouts = 0
RTT between RMIN and RMAX inclusive = 6
    RTT greater than RMAX = 0
    fast retransmit count = 135
    rcv timer count = 0
    heartbeat timer count = 244
    none left tosend = 0
    none left rwnd gate = 5
    none left cwnd gate = 8

;

rlghncxa03w 08-04-28 21:16:37 GMT EAGLE5 38.0.0

SCTP command complete

```

```
pass:loc=1308:cmd="sctp -a assoc5 "
```

The following is an example of the possible output.

```

rlghncxa03w 10-12-28 21:16:37 GMT EAGLE5 43.0.0
Aname          Local          Local   Primary      Remote
                IP Address      Port    Address      Port
assoc5         192.1.1.24     1057   192.168.112.4 1025
                192.1.1.24

Configuration                                     State
Retransmission Mode = LIN                          State = OPEN
Min. Retransmission Timeout = 10000                 ULP association id = 18
Max. Retransmission Timeout = 800000                Number of nets = 2

```

```

Max. Number of Retries = 10           Inbound Streams = 1
Min. Congestion Window = 3000       Outbound Streams = 2
      Inbound Streams = 2
      Outbound Streams = 2
Checksum Algorithm = crc32c
Send/Rcv Buffer Size = 204800

```

Nets Data

IP Address	192.168.112.4	State	Reachable
Port	1025	Primary	YES
MTU	1500	cwnd	16384
ssthresh	16384	RTO	120

IP Address	192.168.112.5	State	Reachable
Port	7777	Primary	NO
MTU	1500	cwnd	16384
ssthresh	16384	RTO	120

```

      Last Net Sent To = 192.168.112.4
      Last Net Rcvd From = 192.168.112.4
Over All Error Count = 0
      Peers Rwnd = 13880
      My Rwnd = 16384
      Max Window = 16384
      Initial Seq Number = 24130
      Next Sending Seq Number = 124686
      Last Acked Seq Number = 124669
Maximum Outbound Char Count = 16384
Current Outbound Char Count = 2112
Number Unsent Char Count = 0
Outbound Data Chunk Count = 16
      Number Unsent = 0
      Number To Retransmit = 0

```

```

      ip datagrams rcvd = 155402
ip datagrams with data chunks rcvd = 120844
      data chunks rcvd = 367908
      data chunks read = 367900
      dup tsns rcvd = 8
      sacks rcvd = 38734
      gap ack blocks rcvd = 3
      heartbeat requests rcvd = 135
      heartbeat acks rcvd = 52
      heartbeat requests sent = 52
      ip datagrams sent = 129254
ip datagrams with data chunks sent = 73084
      data chunks sent = 396330
      retransmit data chunks sent = 135
      sacks sent = 64872
      send failed = 0
      retransmit timer count = 0
      consecutive retransmit timeouts = 0
RTT between RMIN and RMAX inclusive = 6

```

```

RTT greater than RMAX = 0
fast retransmit count = 135
  recv timer count = 0
heartbeat timer count = 244
  none left tosend = 0
  none left rwnd gate = 5
  none left cwnd gate = 8

;

rlghncxa03w 10-12-28 21:16:37 GMT EAGLE5 43.0.0

SCTP command complete

rlghncxa03w 08-04-28 21:16:37 GMT EAGLE5 38.0.0
Aname          Local          Local  Primary      Remote
                IP Address      Port   Address      Port
assoc5         192.1.1.24     1057   192.168.112.4 1025
                192.1.1.24

Configuration                                State
Retransmission Mode = LIN                    State = OPEN
Min. Retransmission Timeout = 10             ULP association id = 18
Max. Retransmission Timeout = 800           Number of nets = 2
Max. Number of Retries = 10                 Inbound Streams = 1
Min. Congestion Window = 3000               Outbound Streams = 2
  Inbound Streams = 2
  Outbound Streams = 2
Checksum Algorithm = crc32c

Nets Data

IP Address  192.168.112.4  State  Reachable
Port        1025             Primary YES
MTU         1500             cwnd  16384
ssthresh    16384             RTO   120

IP Address  192.168.112.5  State  Reachable
Port        7777             Primary NO
MTU         1500             cwnd  16384
ssthresh    16384             RTO   120

Last Net Sent To = 192.168.112.4
Last Net Rcvd From = 192.168.112.4
Over All Eror Count = 0
  Peers Rwnd = 13880
  My Rwnd = 16384
  Max Window = 16384
  Initial Seq Number = 24130
Next Sending Seq Number = 124686
Last Acked Seq Number = 124669
Maximum Outbound Char Count = 16384

```

```

Current Outbound Char Count = 2112
Number Unsent Char Count = 0
Outbound Data Chunk Count = 16
    Number Unsent = 0
    Number To Retransmit = 0

    ip datagrams rcvd = 155402
ip datagrams with data chunks rcvd = 120844
    data chunks rcvd = 367908
    data chunks read = 367900
        dup tsns rcvd = 8
        sacks rcvd = 38734
    gap ack blocks rcvd = 3
    heartbeat requests rcvd = 135
    heartbeat acks rcvd = 52
    heartbeat requests sent = 52
    ip datagrams sent = 129254
ip datagrams with data chunks sent = 73084
    data chunks sent = 396330
    retransmit data chunks sent = 135
        sacks sent = 64872
        send failed = 0
    retransmit timer count = 0
    consecutive retransmit timeouts = 0
RTT between RMIN and RMAX inclusive = 6
    RTT greater than RMAX = 0
    fast retransmit count = 135
    rcv timer count = 0
    heartbeat timer count = 244
    none left tosend = 0
    none left rwnd gate = 5
    none left cwnd gate = 8

;

rlghncxa03w 08-04-28 21:16:37 GMT EAGLE5 38.0.0

SCTP command complete

```

If the checksum algorithm shown in any of the associations displayed in this step do not match the checksum algorithm specified in 4, contact the Customer Care Center. Refer to [My Oracle Support \(MOS\)](#) for the contact information.

If the checksum algorithm shown in all of the associations displayed in this step match the checksum algorithm specified in 4, continue the procedure with 10.

10. Put the signaling links that were placed out of service in 6 back into service using the `act-slk` command. For example, enter this command.

```

act-slk:loc=1308:link=a1
act-slk:loc=1308:link=b
act-slk:loc=1308:link=b2

```


When these commands have successfully completed, this message appears.

```
rlghncxa03w 06-10-07 11:11:28 GMT EAGLE5 36.0.0
Activate Link message sent to card
```

11. Verify the in-service normal (**IS-NR**) status of the signaling link by using the `rept-stat-slk` command and specifying the card location and link values specified in 10.

For example, enter these commands.

```
rept-stat-slk:loc=1308:link=a1
```

This message should appear.

```
rlghncxa03w 06-10-28 21:16:37 GMT EAGLE5 36.0.0
SLK      LSN      CLLI      PST      SST      AST
1308,A1  ipnode1  -----  IS-NR    Avail    ----
Command Completed.
```

```
rept-stat-slk:loc=1308:link=b
```

This message should appear.

```
rlghncxa03w 06-10-28 21:16:37 GMT EAGLE5 36.0.0
SLK      LSN      CLLI      PST      SST      AST
1308,B   ipnode3  -----  IS-NR    Avail    ----
Command Completed.
```

```
rept-stat-slk:loc=1308:link=b2
```

This message should appear.

```
rlghncxa03w 06-10-28 21:16:37 GMT EAGLE5 36.0.0
SLK      LSN      CLLI      PST      SST      AST
1308,B2  ipnode4  -----  IS-NR    Avail    ----
Command Completed.
```

12. Enter the `netstat -p sctp pass` command with the card location of the IP card to determine if any errors have occurred. For this example, enter this command.

```
pass:loc=1308:cmd="netstat -p sctp"
```

The following is an example of the possible output.

```
rlghncxa03w 08-04-28 21:16:37 GMT EAGLE5 38.0.0
ip packets sent..... 1474882
  ip packets sent with data chunk..... 306354
  control chunks (excluding retransmissions)..... 1172759
  ordered data chunks (excluding retransmissions).. 1534350
  unordered data chunks (excluding retransmissions) 0
  user messages fragmented due to MTU..... 0
  retransmit data chunks sent..... 4
```

```

        sacks sent..... 496302
        send failed..... 0
    ip packets received..... 1816035
        ip packets received with data chunk..... 989957
        control chunks (excluding duplicates)..... 833141
        ordered data chunks (excluding duplicates)..... 989968
        unordered data chunks (excluding duplicates)..... 0
        user messages reassembled..... 0
        data chunks read..... 988601
        duplicate tsns received..... 0
        sacks received..... 153763
        gap ack blocks received..... 0
        out of the blue..... 4
        with invalid checksum..... 0
    connections established..... 2954
        by upper layer..... 0
        by remote endpoint..... 2958
    connections terminated..... 4
        ungracefully..... 2952
        gracefully..... 0
    associations dropped due to retransmits..... 0
    consecutive retransmit timeouts..... 4
    retransmit timer count..... 6
    fast retransmit count..... 0
    heartbeat requests received..... 330275
    heartbeat acks received..... 340239
    heartbeat requests sent..... 340258
    associations supported..... 50
    milliseconds cookie life at 4-way start-up handshake. 5000
    retransmission attempts allowed at start-up phase.... 8

;

    rlgncxa03w 08-04-28 21:16:37 GMT EAGLE5 38.0.0

    NETSTAT command complete

```

If errors are shown in the pass command output, contact the Customer Care Center. Refer to [My Oracle Support \(MOS\)](#) for the contact information.

13. Repeat 6 through 12 to update the other IPSPG cards in the EAGLE that contain IPSPG M2PA associations with the new SCTP checksum algorithm.
14. Back up the database by entering the `chg-db:action=backup:dest=fixed` command. These messages should appear, the active **Maintenance and Administration Subsystem Processor (MASP)** appears first.

```

BACKUP (FIXED) : MASP A - Backup starts on active MASP.
BACKUP (FIXED) : MASP A - Backup on active MASP to fixed disk
complete.
BACKUP (FIXED) : MASP A - Backup starts on standby MASP.
BACKUP (FIXED) : MASP A - Backup on standby MASP to fixed disk
complete.

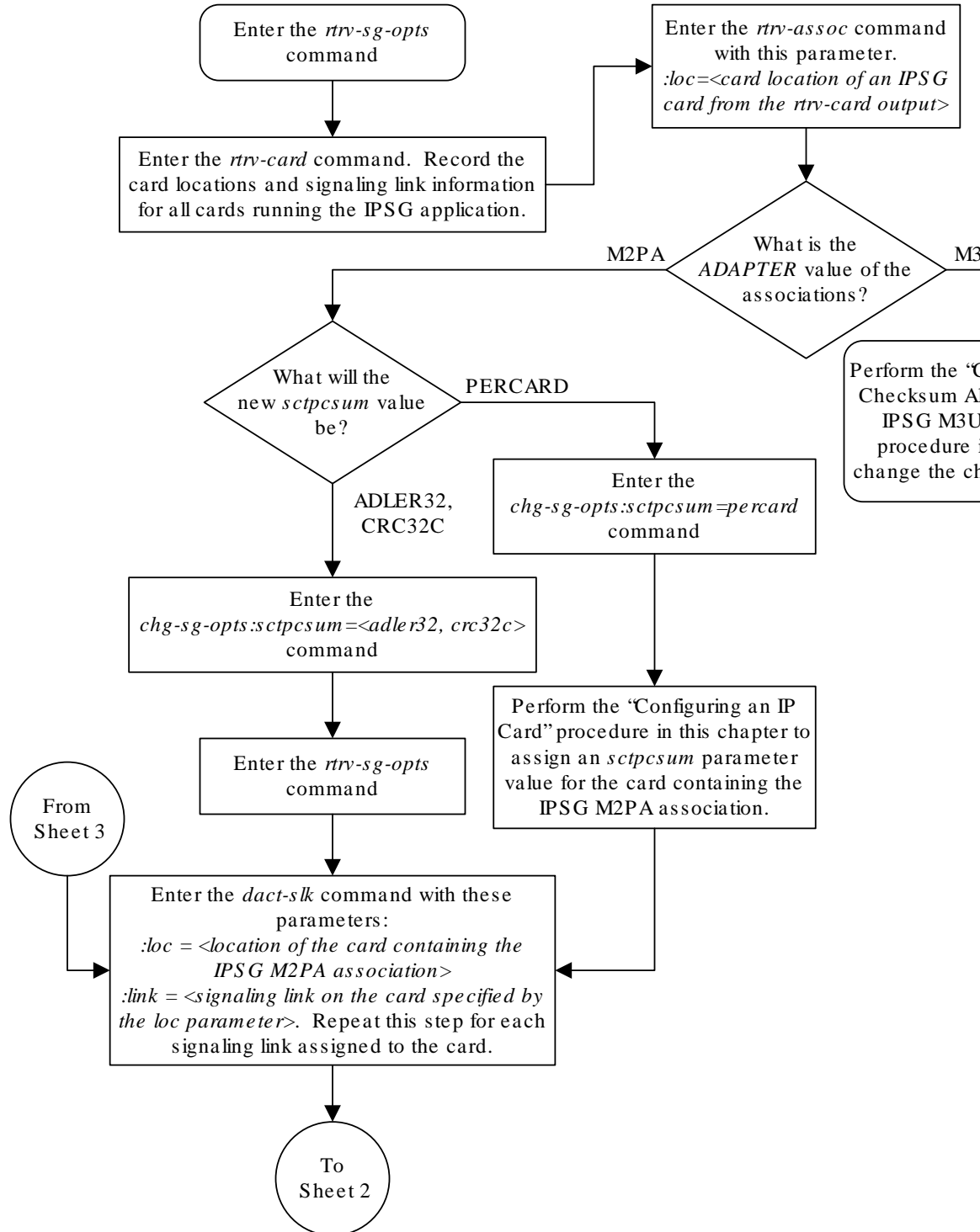
```

15. If the `rtrv-card` output in 2 shows cards running the **SS7IPGW** or **IPGWI** applications, perform the [Changing the SCTP Checksum Algorithm Option for M3UA and SUA Associations](#) procedure.

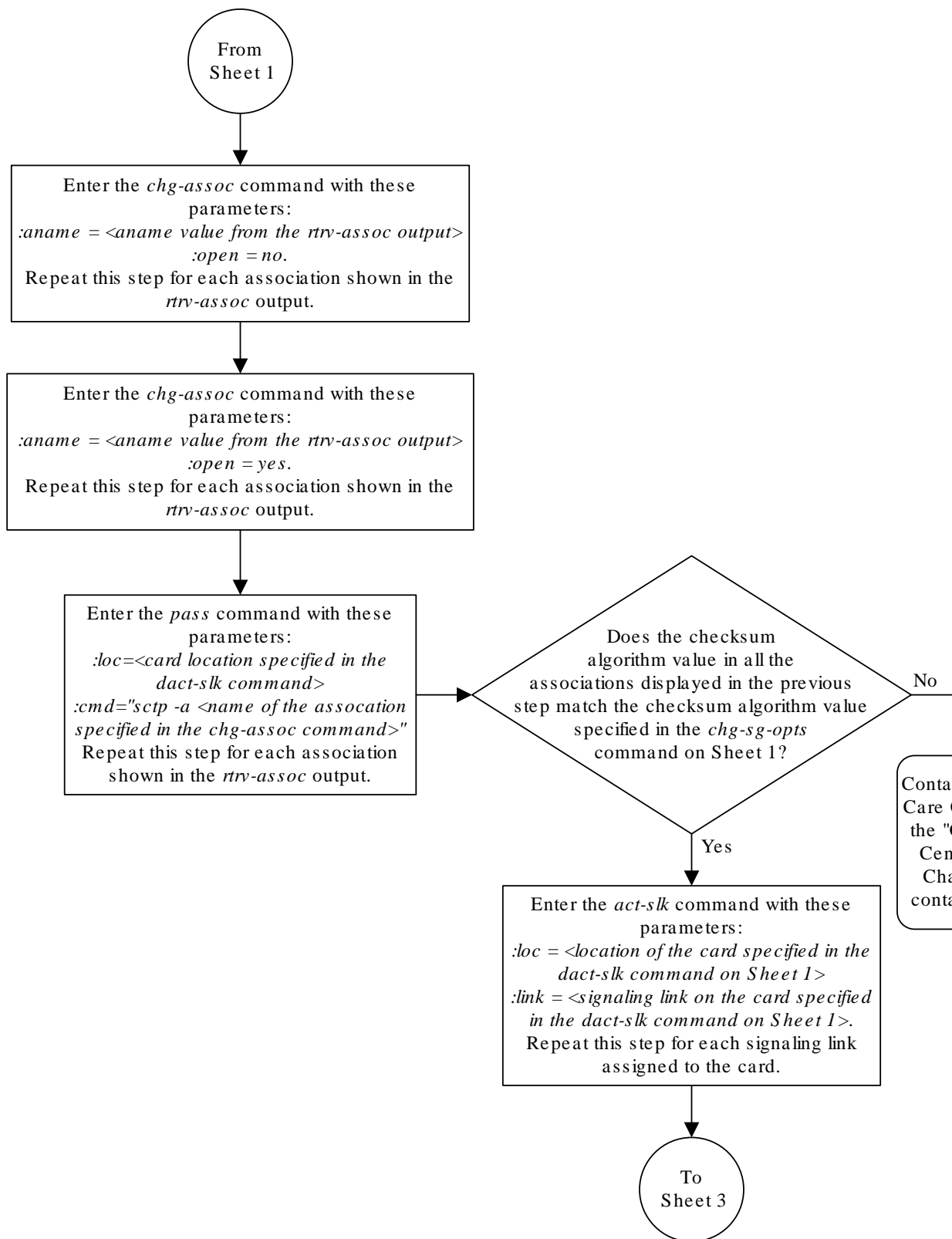
If the `rtrv-card` output in 2 shows cards running the **IPLIM** or **IPLIMI** applications, perform the [Changing the SCTP Checksum Algorithm Option for M2PA Associations](#) procedure.

If the `rtrv-card` output in 2 shows that there are no cards running the **SS7IPGW**, **IPGWI**, **IPLIM**, or **IPLIMI** applications, this procedure is finished.

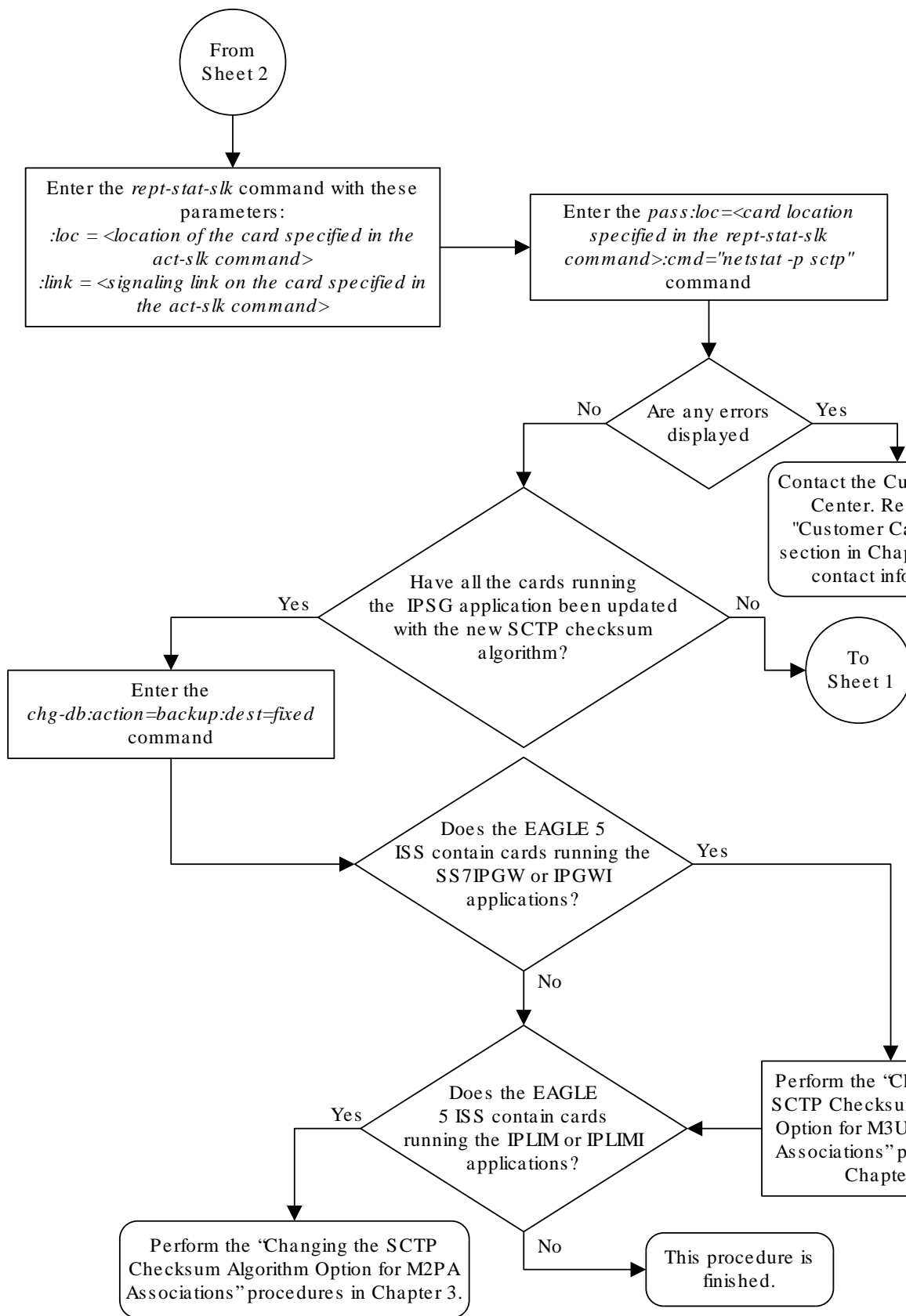
Figure 6-31 Changing the SCTP Checksum Algorithm Option for IPSP M2PA Associations



Sheet 1 of 3



Sheet 2 of 3



6.35 Changing the SCTP Checksum Algorithm Option for IPSP M3UA Associations

Use this procedure to change the **SCTP** checksum algorithm, either Adler-32 or **CRC-32c**, applied to traffic on **SCTP** associations. The `sctpchecksum` parameter of the `chg-sg-opts` command is used to change this option. The Adler-32 and CRC-32c checksum algorithms specified in this procedure applies to all the M3UA associations that are assigned to all the IP cards running the IPSP application. This option is a system-wide option. To apply this option to associations assigned to cards running the IPLIM, IPLIMI, SS7IPGW, or IPGWI applications, or to IPSP M2PA associations, perform these procedures.

- [Changing the SCTP Checksum Algorithm Option for IPSP M2PA Associations](#)
- [Changing the SCTP Checksum Algorithm Option for M3UA and SUA Associations](#)
- [Changing the SCTP Checksum Algorithm Option for M2PA Associations](#)

The `sctpchecksum` parameter contains another value, `percard`, that allows either the Adler-32 or CRC-32c SCTP checksum algorithm to be specified for the all the associations assigned to a specific card. With this option specified, the Adler-32 checksum algorithm can be specified for the associations on one card and the CRC-32c checksum algorithm can be specified for the associations on another card. Setting the `sctpchecksum` parameter to `percard` changes the SCTP checksum algorithm for the associations assigned to a card to the SCTP checksum algorithm value for that card. The checksum algorithm for individual cards is provisioned by performing the [Configuring an IP Card](#) procedure.

Once the **SCTP** checksum option has been changed, the associations on each **IP** card need to be reset by changing the `open` parameter value for each association to `no`, then back to `yes`. This ensures that the associations on the **IP** card are using the new **SCTP** checksum algorithm.

Canceling the `RTRV-ASSOC` Command

Because the `rtrv-assoc` command used in this procedure can output information for a long period of time, the `rtrv-assoc` command can be canceled and the output to the terminal stopped. There are three ways that the `rtrv-assoc` command can be canceled.

- Press the `F9` function key on the keyboard at the terminal where the `rtrv-assoc` command was entered.
- Enter the `canc-cmd` without the `trm` parameter at the terminal where the `rtrv-assoc` command was entered.
- Enter the `canc-cmd:trm=<xx>`, where `<xx>` is the terminal where the `rtrv-assoc` command was entered, from another terminal other than the terminal where the `rtrv-assoc` command was entered. To enter the `canc-cmd:trm=<xx>` command, the terminal must allow Security Administration commands to be entered from it and the user must be allowed to enter Security Administration commands. The terminal's permissions can be verified with the `rtrv-secu-trm` command. The user's permissions can be verified with the `rtrv-user` or `rtrv-secu-user` commands.

For more information about the `canc-cmd` command, go to *Commands User's Guide*.

1. Display the current **IP** options in the database by entering the `rtrv-sg-opts` command. The following is an example of the possible output.

```
rlghncxa03w 06-10-28 21:16:37 GMT EAGLE5 36.0.0
SCTPCSUM:      adler32
```

The `rtrv-sg-opts` command output contains other fields that are not used by this procedure. If you wish to see all the fields displayed by the `rtrv-sg-opts` command, see the `rtrv-sg-opts` command description in *Commands User's Guide*.

2. Display the cards in the **EAGLE** by entering the `rtrv-card` command. This is an example of the possible output.

```
rlghncxa03w 09-10-15 16:34:56 GMT EAGLE5 41.0.0
CARD   TYPE      APPL      LSET NAME      LINK SLC  LSET NAME
LINK SLC
1101   DSM         VSCCP
1102   TSM         GLS
1113   GSPM        EOAM
1114   TDM-A
1115   GSPM        EOAM
1116   TDM-B
1117   MDAL
1201   LIMDS0     SS7ANSI   lsn1           A    0    lsn2
B      1
1202   DCM        IPLIM     ipnode2       A    1
1203   LIMDS0     SS7ANSI   lsn2           A    0    lsn1
B      1
1204   LIMATM     ATMANSI   atmgwy        A    0
1205   DCM        IPLIM     ipnode1       A    0    ipnode3
B      1
1207   DCM        IPLIM     ipnode2       A    0
1303   DCM        IPLIM     ipnode3       A    0    ipnode1
B      1
1305   DCM        IPLIM     ipnode4       A    0
1308   DCM        IPLIM     ipnode3       B    2
          ipnode1       A1   2    ipnode4
B2     1
1315   ENET       IPSP      ipgtwy1       A
1317   DCM        IPGWI     ipgtwy2       A
```

Record the card location, shown in the `LOC` column, and signaling link, shown in the `LINK` column, information for all cards running the **IPSP** application.

3. Select one of the IPSP cards shown in 2. Display the associations assigned to the IPSP card by entering the `rtrv-assoc` command and specifying the card location of the IPSP card. For this example, enter this command.

```
rtrv-assoc:loc=1315
```

The following is an example of the possible output.

```
rlghncxa03w 08-04-28 09:12:36 GMT EAGLE5 38.0.0
                CARD  IPLNK
ANAME          LOC   PORT  LINK ADAPTER LPORT RPORT OPEN ALW
assoc3         1315  A     A    M3UA     2345 1025 YES  YES
```

```
IP Appl Sock/Assoc table is (9 of 4000) 1% full
Assoc Buffer Space Used (19 KB of 800 KB) on LOC = 1315
```

If the ADAPTER value of the associations shown in the `rtrv-assoc` output is M3UA, continue the procedure with 4.

If the ADAPTER value of the associations shown in the `rtrv-assoc` output is M2PA, do not perform the remainder of this procedure. Perform the [Changing the SCTP Checksum Algorithm Option for M2PA Associations](#) procedure to change the SCTP checksum algorithm for IPSP M2PA associations.

4. At the IP near end node, stop all traffic to the IP card specified in 3 on the EAGLE.
5. At the EAGLE, enter the `msucount -l` pass command with the card location of the IP card selected in 3. For this example, enter this command.

```
pass:loc=1315:cmd="msucount -l"
```

The following is an example of the possible output.

```
rlghncxa03w 06-10-28 21:16:37 GMT EAGLE5 36.0.0
PASS: Command sent to card

rlghncxa03w 06-10-28 21:16:37 GMT EAGLE5 36.0.0
MSUCOUNT: Command In Progress

rlghncxa03w 06-10-28 21:16:37 GMT EAGLE5 36.0.0

MSUCOUNT: MSU Count Report

-----
Link Measurements (Link A)
-----
Transmit Counts                                Receive Counts
-----
rate  msus      bytes                                rate  msus      bytes
-----
2000  4294967295  4294967295                                2000  4294967295  4294967295
MTP Primitive (MTPP) counts                    Reroute Counts
-----
sent pdus   rcvd pdus   dscrd pdus   sent msus   rcvd msus
-----
4294967295  4294967295  4294967295   4294967295  4294967295

END of Report
```

6. At the EAGLE, enter the `msucount -a` pass command with the card location specified in 5 and the association names shown in 3. For this example, enter this command.

```
pass:loc=1315:cmd="msucount -a assoc3"
```

The following is an example of the possible output.

```
rlghncxa03w 06-10-28 21:17:37 GMT EAGLE5 36.0.0
PASS: Command sent to card
```

```
rlghncxa03w 06-10-28 21:17:37 GMT EAGLE5 36.0.0
MSUCOUNT: Command In Progress
```

```
rlghncxa03w 06-10-28 21:17:37 GMT EAGLE5 36.0.0
MSUCOUNT: MSU Count Report
```

```
-----
IP Connection Measurements
-----
Receive Counts                               Transmit Counts
-----
msus          bytes                               msus          bytes
-----
4294967295    4294967295                               4294967295    4294967295
Receive Discard Counts                       Transmit Discard Counts
-----
reason          count                               reason          count
-----
link state      4294967295                          sccp msg type   4294967295
sccp msg type   4294967295                          sccp class      4294967295
sccp class      4294967295                          normalization error 4294967295
sccp called party 4294967295                          invalid traffic type 4294967295
sccp calling party 4294967295                          M3UA conversion error 4294967295
isup sio        4294967295                          SUA conversion error 4294967295
normalization error 4294967295
error in XSRV packet 4294967295
M3UA PDU error  4294967295
SUA PDU error   4294967295
invalid rcontext 4294967295
Stored Transmit Discard Data
-----
no stored transmit discard data
Stored Receive Discard Data
-----
53 41 53 49 69 73 6f 74 11 00 87 0a 01 03 01 05
05 00 01 02 03 04 05 06 07 08 09 00 00 00 00 00

END of Report
```

7. At the **IP** near end node, disconnect all the associations attached to the **IP** card specified in 6.
8. At the **EAGLE**, place the signaling link on this **IP** card out of service using the `dact-slk` command. For this example, enter this command.

```
dact-slk:loc=1315:link=a
```

When this command has successfully completed, this message appears.

```
rlghncxa03w 06-10-12 09:12:36 GMT EAGLE5 36.0.0
Deactivate Link message sent to card
```

9. Change the **SCTP** checksum option in the database using the `chg-sg-opts` command. For this example, enter this command.

```
chg-sg-opts:sctpcsum=crc32c
```

When this command has successfully completed, the following message should appear.

```
rlghncxa03w 06-10-28 21:19:37 GMT EAGLE5 36.0.0
CHG-SG-OPTS: MASP A - COMPLTD
```

Continue the procedure by performing one of these actions.

- If the `sctpcsum` parameter value was changed to either `adler32` or `crc32c`, continue the procedure with [10](#).
 - If the `sctpcsum` parameter value was changed to `percard`, perform the [Configuring an IP Card](#) procedure to assign an `sctpcsum` parameter value to all the cards running the IPLIM or IPLIMI applications. After the [Configuring an IP Card](#) procedure has been performed, continue the procedure with [11](#).
10. Verify that the **SCTP** checksum algorithm was changed using the `rtrv-sg-opts` command. The **SCTP** checksum algorithm option value is shown in the `SCTPCSUM` parameter. The following is an example of the possible output.

```
rlghncxa03w 06-10-28 21:16:37 GMT EAGLE5 36.0.0
SCTPCSUM:          crc32c
```

The `rtrv-sg-opts` command output contains other fields that are not used by this procedure. If you wish to see all the fields displayed by the `rtrv-sg-opts` command, see the `rtrv-sg-opts` command description in *Commands User's Guide*.

11. Change the value of the `open` parameter of the associations shown in [3](#) to `no` by specifying the `chg-assoc` command with the `open=no` parameter. For this example, enter this command.

```
chg-assoc:aname=assoc3:open=no
```

When this command has successfully completed, this message should appear.

```
rlghncxa03w 06-10-28 09:12:36 GMT EAGLE5 36.0.0
CHG-ASSOC: MASP A - COMPLTD;
```

12. Change the value of the `open` parameter of the associations changed in [11](#) to `yes` by specifying the `chg-assoc` command with the `open=yes` parameter. For this example, enter this command.

```
chg-assoc:aname=assoc3:open=yes
```

When this command has successfully completed, this message should appear.

```
rlghncxa03w 06-10-28 09:12:36 GMT EAGLE5 36.0.0
CHG-ASSOC: MASP A - COMPLTD;
```

13. Verify the checksum algorithm that is assigned to the associations shown in 12 by entering the `sctp -a pass` command with the card location of the IP card specified in 8 and the name of the associations specified in 12. For this example, enter this command.

```
pass:loc=1315:cmd="sctp -a assoc3 "
```

The following is an example of the possible output.

```
rlghncxa03w 10-12-28 21:16:37 GMT EAGLE5 43.0.0
Aname          Local          Local  Primary
Remote
                IP Address      Port    Address      Port
assoc3         192.1.1.50      2345   192.168.112.4 1025
                192.1.1.50
```

```
Configuration                               State
Retransmission Mode = LIN                    State = OPEN
Min. Retransmission Timeout = 10000          ULP association id = 18
Max. Retransmission Timeout = 800000        Number of nets = 2
Max. Number of Retries = 10                 Inbound Streams = 1
Min. Congestion Window = 3000              Outbound Streams = 2
Inbound Streams = 2
Outbound Streams = 2
Checksum Algorithm = crc32c
Send/Rcv Buffer Size = 204800
```

Nets Data

```
IP Address 192.168.112.4 State Reachable
Port 1025 Primary YES
MTU 1500 cwnd 16384
ssthresh 16384 RTO 120

IP Address 192.168.112.5 State Reachable
Port 7777 Primary NO
MTU 1500 cwnd 16384
ssthresh 16384 RTO 120
```

```
Last Net Sent To = 192.168.112.4
Last Net Rcvd From = 192.168.112.4
Over All Error Count = 0
Peers Rwnd = 13880
My Rwnd = 16384
Max Window = 16384
Initial Seq Number = 24130
Next Sending Seq Number = 124686
Last Acked Seq Number = 124669
Maximum Outbound Char Count = 16384
Current Outbound Char Count = 2112
```

```

Number Unsent Char Count = 0
Outbound Data Chunk Count = 16
    Number Unsent = 0
    Number To Retransmit = 0

    ip datagrams rcvd = 155402
ip datagrams with data chunks rcvd = 120844
    data chunks rcvd = 367908
    data chunks read = 367900
    dup tsns rcvd = 8
    sacks rcvd = 38734
    gap ack blocks rcvd = 3
    heartbeat requests rcvd = 135
    heartbeat acks rcvd = 52
    heartbeat requests sent = 52
    ip datagrams sent = 129254
ip datagrams with data chunks sent = 73084
    data chunks sent = 396330
    retransmit data chunks sent = 135
    sacks sent = 64872
    send failed = 0
    retransmit timer count = 0
    consecutive retransmit timeouts = 0
RTT between RMIN and RMAX inclusive = 6
    RTT greater than RMAX = 0
    fast retransmit count = 135
    rcv timer count = 0
    heartbeat timer count = 244
    none left tosend = 0
    none left rwnd gate = 5
    none left cwnd gate = 8

;

rlghncxa03w 10-12-28 21:16:37 GMT EAGLE5 43.0.0

SCTP command complete

rlghncxa03w 08-04-28 21:16:37 GMT EAGLE5 38.0.0
Aname          Local          Local Primary      Remote
              IP Address    Port  Address      Port
assoc3         192.1.1.50    2345  192.168.112.4 1025
              192.1.1.50

Configuration          State
Retransmission Mode = LIN          State = OPEN
Min. Retransmission Timeout = 10   ULP association id = 18
Max. Retransmission Timeout = 800  Number of nets = 2
Max. Number of Retries = 10        Inbound Streams = 1
Min. Congestion Window = 3000      Outbound Streams = 2
Inbound Streams = 2
Outbound Streams = 2

```

Checksum Algorithm = crc32c

Nets Data

IP Address	192.168.112.4	State	Reachable
Port	1025	Primary	YES
MTU	1500	cwnd	16384
ssthresh	16384	RTO	120
IP Address	192.168.112.5	State	Reachable
Port	7777	Primary	NO
MTU	1500	cwnd	16384
ssthresh	16384	RTO	120

Last Net Sent To = 192.168.112.4

Last Net Rcvd From = 192.168.112.4

Over All Error Count = 0

Peers Rwnd = 13880

My Rwnd = 16384

Max Window = 16384

Initial Seq Number = 24130

Next Sending Seq Number = 124686

Last Acked Seq Number = 124669

Maximum Outbound Char Count = 16384

Current Outbound Char Count = 2112

Number Unsent Char Count = 0

Outbound Data Chunk Count = 16

Number Unsent = 0

Number To Retransmit = 0

ip datagrams rcvd = 155402

ip datagrams with data chunks rcvd = 120844

data chunks rcvd = 367908

data chunks read = 367900

dup tsns rcvd = 8

sacks rcvd = 38734

gap ack blocks rcvd = 3

heartbeat requests rcvd = 135

heartbeat acks rcvd = 52

heartbeat requests sent = 52

ip datagrams sent = 129254

ip datagrams with data chunks sent = 73084

data chunks sent = 396330

retransmit data chunks sent = 135

sacks sent = 64872

send failed = 0

retransmit timer count = 0

consecutive retransmit timeouts = 0

RTT between RMIN and RMAX inclusive = 6

RTT greater than RMAX = 0

fast retransmit count = 135

recv timer count = 0

heartbeat timer count = 244


```

        none left tosend = 0
        none left rwnd gate = 5
        none left cwnd gate = 8

;

rlghncxa03w 08-04-28 21:16:37 GMT EAGLE5 38.0.0

SCTP command complete

```

If the checksum algorithm shown in any of the associations displayed in this step do not match the checksum algorithm specified in 9, contact the Customer Care Center. Refer to [My Oracle Support \(MOS\)](#) for the contact information.

If the checksum algorithm shown in all of the associations displayed in this step match the checksum algorithm specified in 9, continue the procedure with 14.

14. At the **IP** near end node, configure all the associations attached to the **IP** card specified in 12 to use the **SCTP** checksum algorithm.
15. Put the signaling link that was placed out of service in 7 back into service using the `act-slk` command. For example, enter this command.

```
act-slk:loc=1315:link=a
```

When this command has successfully completed, this message appears.

```
rlghncxa03w 06-10-07 11:11:28 GMT EAGLE5 36.0.0
Activate Link message sent to card

```

16. Verify the in-service normal (**IS-NR**) status of the signaling link by using the `rept-stat-slk` command and specifying the card location and link value specified in 15. For example, enter this command.

```
rept-stat-slk:loc=1315:link=a
```

The following is an example of the possible output.

```
rlghncxa03w 06-10-28 21:16:37 GMT EAGLE5 36.0.0
SLK      LSN      CLLI      PST      SST      AST
1315,A   ipgtwy1   -----  IS-NR    Avail    ----
Command Completed.

```

17. At the **IP** near end node, connect one of the associations attached to the **IP** card specified in 11.
18. At the **EAGLE**, enter the `rept-stat-assoc` command specifying the association names specified with the `chg-assoc` command in 11 and 12 to verify that the association is established with the **IP** near end node. For this example, enter this command.

```
rept-stat-assoc:aname=assoc3
```

The following is an example of the possible output.

```
rlghncxa03w 06-10-28 21:16:37 GMT EAGLE5 36.0.0
```

```

          CARD IPLNK
        ANAME      LOC  PORT  LINK PST
SST
  as1             1315 A      A    IS-NR
ESTABLISHED      undefined

          LSN      ANAME      ASP STATE
  lpgtwy1        assoc3      ACTIVE

```

Command Completed.

19. Enter the `netstat -p sctp pass` command with the card location of the IP card to determine if any errors have occurred. For this example, enter this command. For this example, enter this command.

```
pass:loc=1315:cmd="netstat -p sctp"
```

The following is an example of the possible output.

```
rlghncxa03w 08-04-28 21:16:37 GMT EAGLE5 38.0.0
ip packets sent..... 1474882
  ip packets sent with data chunk..... 306354
  control chunks (excluding retransmissions)..... 1172759
  ordered data chunks (excluding retransmissions).. 1534350
  unordered data chunks (excluding retransmissions) 0
  user messages fragmented due to MTU..... 0
  retransmit data chunks sent..... 4
  sacks sent..... 496302
  send failed..... 0
ip packets received..... 1816035
  ip packets received with data chunk..... 989957
  control chunks (excluding duplicates)..... 833141
  ordered data chunks (excluding duplicates)..... 989968
  unordered data chunks (excluding duplicates).... 0
  user messages reassembled..... 0
  data chunks read..... 988601
  duplicate tsns received..... 0
  sacks received..... 153763
  gap ack blocks received..... 0
  out of the blue..... 4
  with invalid checksum..... 0
connections established..... 2954
  by upper layer..... 0
  by remote endpoint..... 2958
connections terminated..... 4
  ungracefully..... 2952
  gracefully..... 0
associations dropped due to retransmits..... 0
consecutive retransmit timeouts..... 4
retransmit timer count..... 6
fast retransmit count..... 0
```

```

heartbeat requests received..... 330275
heartbeat acks received..... 340239
heartbeat requests sent..... 340258
associations supported..... 50
milliseconds cookie life at 4-way start-up handshake. 5000
retransmission attempts allowed at start-up phase.... 8

;

rlghncxa03w 08-04-28 21:16:37 GMT EAGLE5 38.0.0

NETSTAT command complete

```

If errors are shown in the pass command output, contact the Customer Care Center. Refer to [My Oracle Support \(MOS\)](#) for the contact information.

20. At the **IP** near end node, connect all the other associations attached to the **IP** card specified in 19.
21. At the **IP** near end node, activate one of the associations attached to the **IP** card specified in 19.
22. At the **EAGLE**, enter the `msucount -l` pass command with the card location of the **IP** card specified in 19. For this example, enter this command.

```
pass:loc=1315:cmd="msucount -l"
```

The following is an example of the possible output.

```

rlghncxa03w 06-10-28 21:16:37 GMT EAGLE5 36.0.0
PASS: Command sent to card

rlghncxa03w 06-10-28 21:16:37 GMT EAGLE5 36.0.0
MSUCOUNT: Command In Progress

rlghncxa03w 06-10-28 21:16:37 GMT EAGLE5 36.0.0
MSUCOUNT: MSU Count Report

-----
Link Measurements (Link A)
-----

Transmit Counts                                Receive Counts
-----
rate  msus      bytes          rate  msus      bytes
-----
2000  4294967295  4294967295   2000  4294967295  4294967295

MTP Primitive (MTPP) counts                    Reroute Counts
-----
sent pdu   rcvd pdu   dscrd pdu   sent msus  rcvd msus
-----
4294967295 4294967295 4294967295 4294967295 4294967295

END of Report

```

23. At the **EAGLE**, enter the `msucount -a` pass command with the card location specified in 22 and the association names specified in 18. For this example, enter this command.

```
pass:loc=1315:cmd="msucount -a assoc3"
```

The following is an example of the possible output.

```
rlghncxa03w 06-10-28 21:17:37 GMT EAGLE5 36.0.0
PASS: Command sent to card

rlghncxa03w 06-10-28 21:17:37 GMT EAGLE5 36.0.0
MSUCOUNT: Command In Progress

rlghncxa03w 06-10-28 21:17:37 GMT EAGLE5 36.0.0
MSUCOUNT: MSU Count Report

-----
IP Connection Measurements
-----

Receive Counts                               Transmit Counts
-----
msus          bytes                          msus          bytes
-----
4294967295    4294967295                                4294967295    4294967295
Receive Discard Counts                       Transmit Discard Counts
-----
reason          count                                reason          count
-----
link state      4294967295                            sccp msg type   4294967295
sccp msg type   4294967295                            sccp class      4294967295
sccp class      4294967295                            normalization error 4294967295
sccp called party 4294967295                            invalid traffic type 4294967295
sccp calling party 4294967295                            M3UA conversion error 4294967295
isup sio        4294967295                            SUA conversion error 4294967295
normalization error 4294967295
error in XSRV packet 4294967295
M3UA PDU error  4294967295
SUA PDU error   4294967295
invalid rcontext 4294967295

Stored Transmit Discard Data
-----
no stored transmit discard data
Stored Receive Discard Data
-----
53 41 53 49 69 73 6f 74 11 00 87 0a 01 03 01 05
05 00 01 02 03 04 05 06 07 08 09 00 00 00 00 00

END of Report
```

If the outputs of the pass commands in 22 and 23 show that traffic is not flowing over the association, refer to [My Oracle Support \(MOS\)](#).

24. At the **IP** near end node, activate all the other associations attached to the **IP** card specified in 23.
25. Repeat 4 through 24 to update the other **IPSP** cards in the **EAGLE** that contain IPSP M3UA associations with the new **SCTP** checksum algorithm.
26. Back up the new changes using the `chg-db:action=backup:dest=fixed` command. These messages should appear, the active **Maintenance and Administration Subsystem Processor (MASP)** appears first.

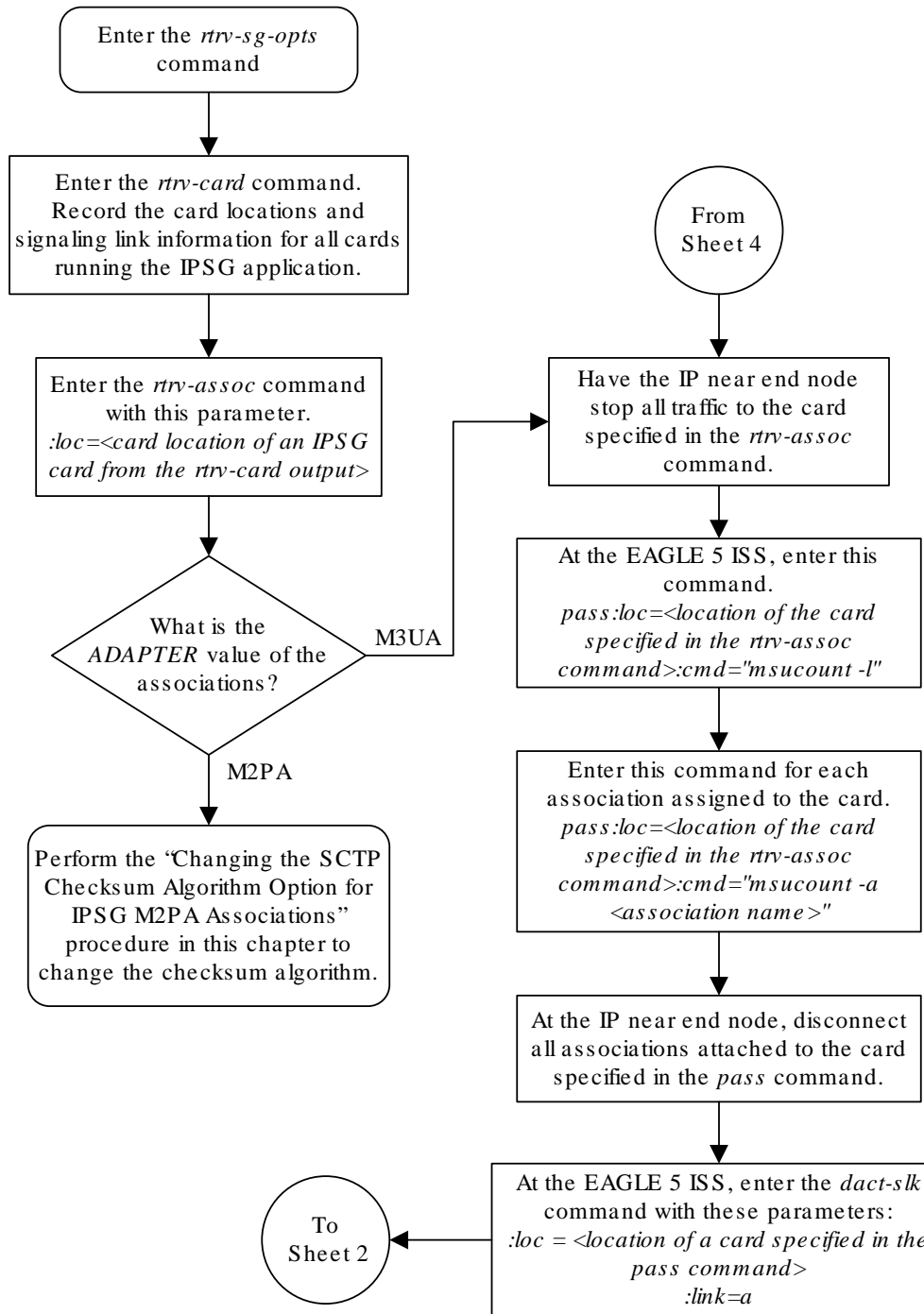
```
BACKUP (FIXED) : MASP A - Backup starts on active MASP.  
BACKUP (FIXED) : MASP A - Backup on active MASP to fixed disk complete.  
BACKUP (FIXED) : MASP A - Backup starts on standby MASP.  
BACKUP (FIXED) : MASP A - Backup on standby MASP to fixed disk complete.
```

27. If the `rtrv-card` output in 2 shows cards running the **IPLIM** or **IPLIMI** applications, perform the [Changing the SCTP Checksum Algorithm Option for M2PA Associations](#) procedure.

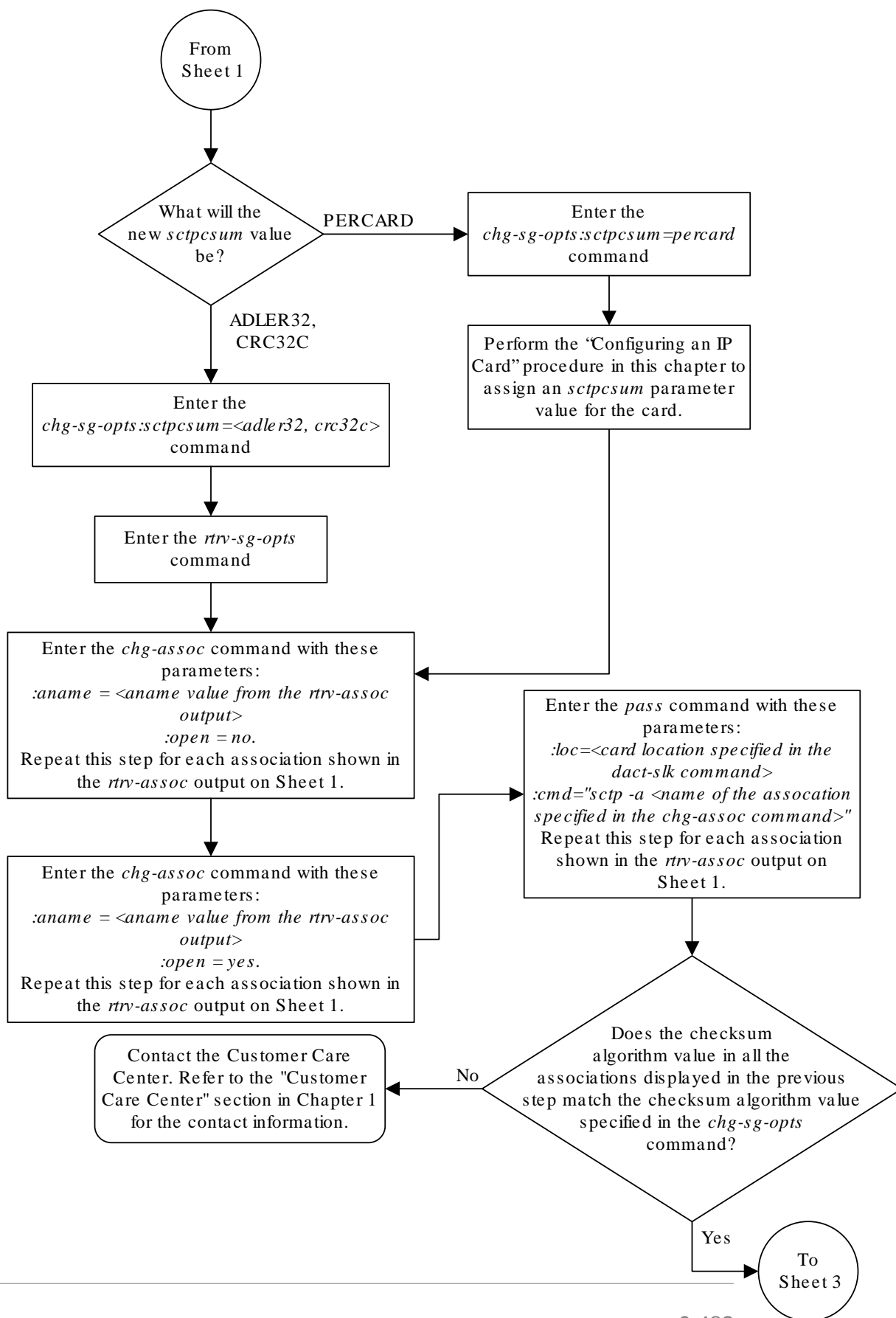
If the `rtrv-card` output in 2 shows cards running the **SS7IPGW** or **IPGWI** applications, perform the [Changing the SCTP Checksum Algorithm Option for M3UA and SUA Associations](#) procedure.

If the `rtrv-card` output in 2 shows that there are no cards running the **IPLIM**, **IPLIMI**, **SS7IPGW**, or **IPGWI** applications, this procedure is finished.

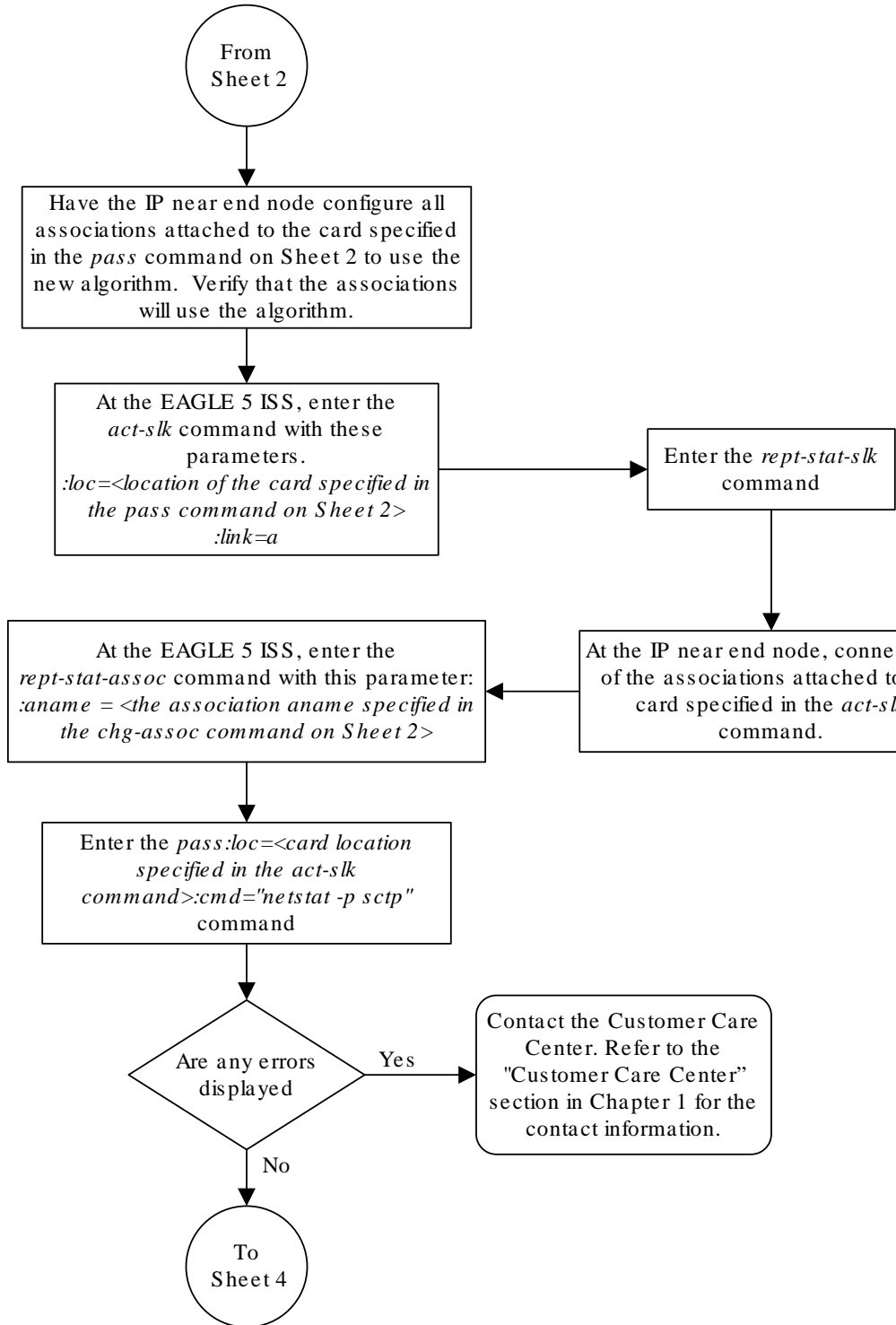
Figure 6-32 Changing the SCTP Checksum Algorithm Option for IPSG M3UA Associations



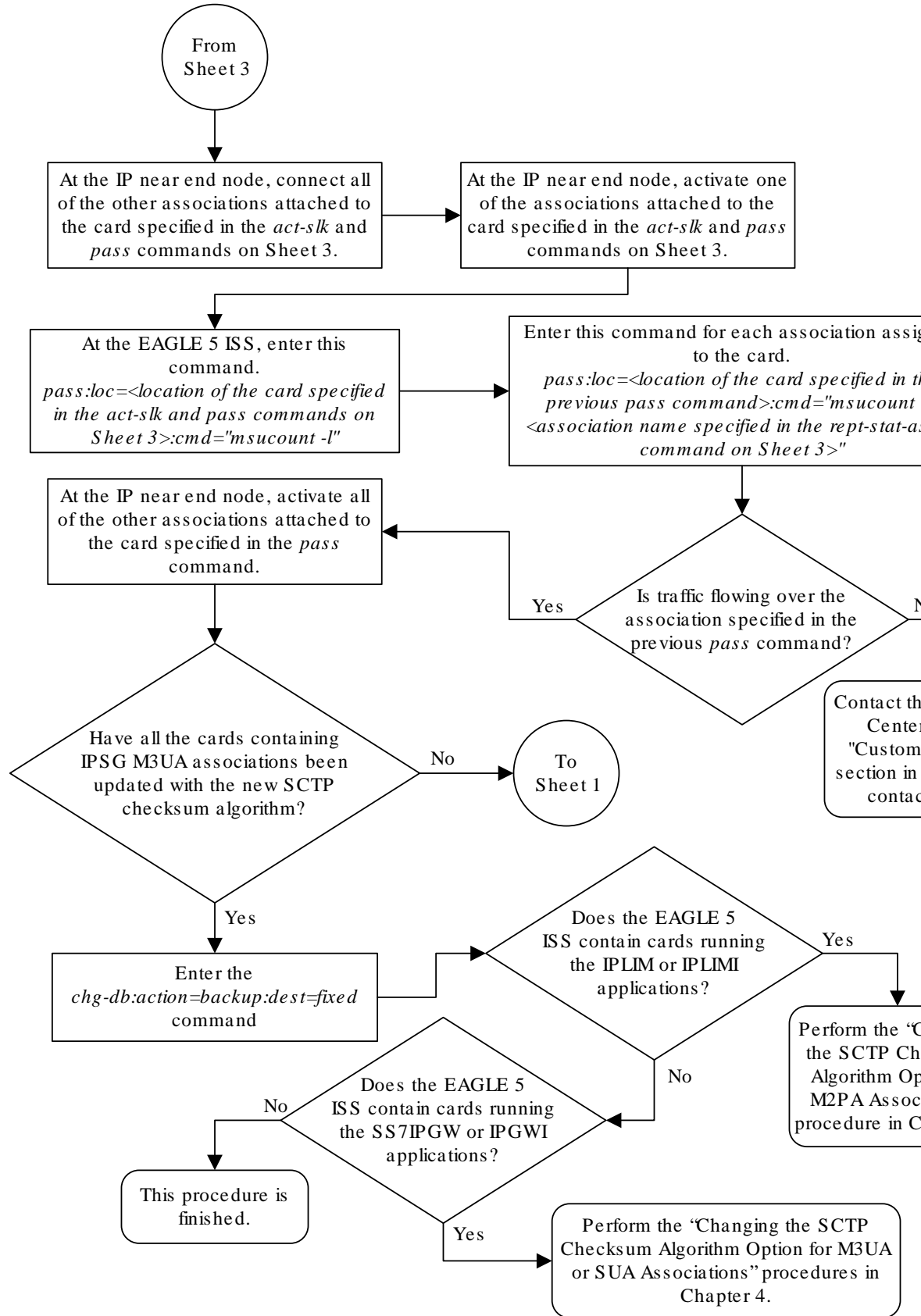
Sheet 1 of 4



Sheet 2 of 4



Sheet 3 of 4



6.36 Changing an M2PA Timer Set

This procedure is used to change the values of the **M2PA** timers in an **M2PA** timer set using the `chg-m2pa-tset` command. The **M2PA** timers are used to control the behavior of the signaling link assigned to an **M2PA** association (an association containing the **M2PA** adapter layer - `adapter=m2pa`) during signaling link alignment and proving, and during times of transmit congestion.

The **EAGLE** contains 20 **M2PA** timer sets. One of these timer sets is assigned to an **M2PA** association using the `m2patset` parameter of either the `ent-assoc` or `chg-assoc` command. If the `m2patset` parameter is not specified with the `ent-assoc` command, or with the `chg-assoc` command if the adapter layer for that association is being changed to **M2PA**, timer set 1 is automatically assigned to the association.

Caution:

Changing an **M2PA** timer set may affect the performance of any associations using the timer set being changed.

The `chg-m2pa-tset` command uses these parameters.

`:tset` – The **M2PA** timer set being changed, 1 - 20.

`:srctset` – The timer values in an existing **M2PA** timer set can be copied to another **M2PA** timer set, specified by the `tset` parameter. The `srctset` parameter specifies the timer set that is to be copied. If the `srctset` parameter is specified, no other timer values can be specified. The `srctset` parameter value cannot be the timer set specified by the `tset` parameter.

`:ver` – The **M2PA** version, either Draft 6 (`ver=d6`) or **RFC** (`ver=rfc`).

Note:

The definitions of timers **T1** and **T3** for the Draft 6 version are different from the **RFC** version. The **T2** timer applies only to the **RFC** version. The definitions of timers **T4N**, **T4E**, **T5**, **T6**, **T7**, **T16**, **T17** and **T18** for are the same for the Draft 6 version and the **RFC** version.

The timer parameter descriptions and values are shown in [Table 6-13](#).

Table 6-13 M2PA Timers

Timer	Draft 6 Timer Name	RFC Timer Name	Definition	Value (in msecs)	DRAFT 6 System Default Value (in msecs)	RFC System Default Value (in msecs)
:t1	N/A	Ready Timer	The amount of time after proving the M2PA adapter layer waits to receive a Link Status Ready message from the peer.	1000 - 350000	N/A	300000
:t1	Alignment Timer	N/A	The amount of time the M2PA adapter layer waits to receive a Link Status Alignment message from the peer.	1000 - 350000	10000	N/A
:t2 *	N/A	Not Aligned Timer	The the amount of time the M2PA adapter layer waits to receive a Link Status Alignment/Link Status Proving message after sending a Link Status Alignment message. Timer T2 is not used in M2PA Draft 6 timer sets.	5000 - 150000	N/A	20000
:t3	N/A	Alignment Timer	The amount of time the M2PA layer waits to receive a Link Status Alignment message from the peer.	1000 - 60000	N/A	2000
:t3	Ready Timer	N/A	The amount of time after proving the M2PA adapter layer waits to receive a Link Status Ready message from the peer.	1000 - 60000	10000	N/A
:t4n	Proving Timer (Normal)		The amount of time the M2PA adapter layer generates Link Status Proving messages during normal proving.	1000 - 70000	10000	30000
:t4e	Proving Timer (Emergency)		The amount of time the M2PA adapter layer generates Link Status Proving messages during emergency proving.	400 - 5000	500	500
:t5	Busy Rate Timer		The amount of time between sending Link Status Busy messages while the link is in-service.	80 - 10000	1000	100
:t6	Remote Congestion Timer		The amount of time that a congested link will remain in service.	1000 - 6000	3000	3000

Table 6-13 (Cont.) M2PA Timers

Timer	Draft 6 Timer Name	RFC Timer Name	Definition	Value (in msecs)	DRAFT 6 System Default Value (in msecs)	RFC System Default Value (in msecs)
:t7	Excess Delay in Acknowledgement Timer		The maximum amount of time that may pass between when a user data message is transmitted and an acknowledgement for that message is received from the peer. If this timer expires, the link is taken out of service.	200 - 2000	1200	1200
:t16	Proving Rate Timer		The amount of time between sending Link Status Proving messages while the T4N or T4E timer is running.	100 - 500000 **	200000 **	200000 **
:t17	Ready Rate Timer		The amount of time between sending Link Status Ready messages while the T3 timer is running.	100 - 500	250	250
:t18	Processor Outage Rate Timer		The amount of time between sending Link Status Processor Outage messages while the link is in-service.	100 - 10000	1000	1000

msecs - milliseconds

* The T2 Timer can be specified only for the **M2PA RFC** version.

** The value of the T16 Timer is in microseconds.

The value of any timer parameter not specified with the `chg-m2pa-tset` command is not changed.

1. Display the **M2PA** timer sets in the database by entering the `rtrv-m2pa-tset` command with the version of the **M2PA** timer sets you wish to change with the `ver` parameter.

To display the **M2PA** Draft 6 timer values, enter this command.

```
rtrv-m2pa-tset:ver=d6
```

```
rlghncxa03w 06-10-28 21:16:37 GMT EAGLE5 36.0.0
```

```
M2PA Draft 6 Timers (in msec, T16 in microsec)
```

TSET	T1	T2	T3	T4N	T4E	T5	T6	T7	T16	T17	T18
1	6000	-----	5000	20000	500	5000	3000	1000	200000	250	1000
2	10000	-----	10000	10000	500	1000	3000	1200	200000	250	1000
3	10000	-----	10000	10000	500	1000	3000	1200	200000	250	1000
4	10000	-----	10000	10000	500	1000	3000	1200	200000	250	1000
5	10000	-----	10000	10000	500	1000	3000	1200	200000	250	1000
6	10000	-----	10000	10000	500	1000	3000	1200	200000	250	1000
7	10000	-----	10000	10000	500	1000	3000	1200	200000	250	1000

```

8    10000  ----- 10000 10000 500  1000  3000 1200  200000 250
1000
9    27500  ----- 3850  4859  450  5700  3750 1150  250    375
8750
10   10000  ----- 10000 10000 500  1000  3000 1200  200000 250
1000
11   10000  ----- 10000 10000 500  1000  3000 1200  200000 250
1000
12   10000  ----- 10000 10000 500  1000  3000 1200  200000 250
1000
13   10000  ----- 10000 10000 500  1000  3000 1200  200000 250
1000
14   10000  ----- 10000 10000 500  1000  3000 1200  200000 250
1000
15   10000  ----- 10000 10000 500  1000  3000 1200  200000 250
1000
16   10000  ----- 10000 10000 500  1000  3000 1200  200000 250
1000
17   10000  ----- 10000 10000 500  1000  3000 1200  200000 250
1000
18   10000  ----- 10000 10000 500  1000  3000 1200  200000 250
1000
19   10000  ----- 10000 10000 500  1000  3000 1200  200000 250
1000
20   10000  ----- 10000 10000 500  1000  3000 1200  200000 250
1000

```

To display the **M2PARFC** timer values, enter this command.

```
rtrv-m2pa-tset:ver=rfc
```

```
rlghncxa03w 06-10-28 21:16:37 GMT EAGLE5 36.0.0
```

M2PA RFC Timers (in msec, T16 in microsec)

TSET	T1	T2	T3	T4N	T4E	T5	T6	T7	T16	T17	T18
1	6000	20000	5000	20000	500	5000	3000	1000	200000	250	
	1000										
1	300000	20000	2000	30000	500	100	3000	1200	200000	250	
	1000										
2	300000	20000	2000	30000	500	100	3000	1200	200000	250	
	1000										
3	300000	20000	2000	30000	500	100	3000	1200	200000	250	
	1000										
4	300000	20000	2000	30000	500	100	3000	1200	200000	250	
	1000										
5	300000	20000	2000	30000	500	100	3000	1200	200000	250	
	1000										
6	300000	20000	2000	30000	500	100	3000	1200	200000	250	
	1000										
7	300000	20000	2000	30000	500	100	3000	1200	200000	250	
	1000										
8	300000	20000	2000	30000	500	100	3000	1200	200000	250	
	1000										


```

9    27500 10000 3850 4859 450 5700 3750 1150 250 375 8750
10   300000 20000 2000 30000 500 100 3000 1200 200000 250 1000
11   300000 20000 2000 30000 500 100 3000 1200 200000 250 1000
12   300000 20000 2000 30000 500 100 3000 1200 200000 250 1000
13   300000 20000 2000 30000 500 100 3000 1200 200000 250 1000
14   300000 20000 2000 30000 500 100 3000 1200 200000 250 1000
15   300000 20000 2000 30000 500 100 3000 1200 200000 250 1000
16   300000 20000 2000 30000 500 100 3000 1200 200000 250 1000
17   300000 20000 2000 30000 500 100 3000 1200 200000 250 1000
18   300000 20000 2000 30000 500 100 3000 1200 200000 250 1000
19   300000 20000 2000 30000 500 100 3000 1200 200000 250 1000
20   300000 20000 2000 30000 500 100 3000 1200 200000 250 1000

```

If the `ver` parameter is not specified when entering the `rtrv-m2pa-tset` command, both the Draft 6 and RFC values are displayed. This is an example of the possible output.

```
rlghncxa03w 06-10-28 21:16:37 GMT EAGLE5 36.0.0
```

M2PA Draft 6 Timers (in msec, T16 in microsec)

TSET	T1	T2	T3	T4N	T4E	T5	T6	T7	T16	T17	T18
1	6000	-----	5000	20000	500	5000	3000	1000	200000	250	1000
2	10000	-----	10000	10000	500	1000	3000	1200	200000	250	1000
3	10000	-----	10000	10000	500	1000	3000	1200	200000	250	1000
4	10000	-----	10000	10000	500	1000	3000	1200	200000	250	1000
5	10000	-----	10000	10000	500	1000	3000	1200	200000	250	1000
6	10000	-----	10000	10000	500	1000	3000	1200	200000	250	1000
7	10000	-----	10000	10000	500	1000	3000	1200	200000	250	1000
8	10000	-----	10000	10000	500	1000	3000	1200	200000	250	1000
9	27500	-----	3850	4859	450	5700	3750	1150	250	375	8750
10	10000	-----	10000	10000	500	1000	3000	1200	200000	250	1000
11	10000	-----	10000	10000	500	1000	3000	1200	200000	250	1000
12	10000	-----	10000	10000	500	1000	3000	1200	200000	250	1000
13	10000	-----	10000	10000	500	1000	3000	1200	200000	250	1000
14	10000	-----	10000	10000	500	1000	3000	1200	200000	250	1000
15	10000	-----	10000	10000	500	1000	3000	1200	200000	250	1000
16	10000	-----	10000	10000	500	1000	3000	1200	200000	250	1000
17	10000	-----	10000	10000	500	1000	3000	1200	200000	250	1000
18	10000	-----	10000	10000	500	1000	3000	1200	200000	250	1000
19	10000	-----	10000	10000	500	1000	3000	1200	200000	250	1000
20	10000	-----	10000	10000	500	1000	3000	1200	200000	250	1000

M2PA RFC Timers (in msec, T16 in microsec)

TSET	T1	T2	T3	T4N	T4E	T5	T6	T7	T16	T17	T18
1	6000	20000	5000	20000	500	5000	3000	1000	200000	250	1000
2	300000	20000	2000	30000	500	100	3000	1200	200000	250	1000
3	300000	20000	2000	30000	500	100	3000	1200	200000	250	1000
4	300000	20000	2000	30000	500	100	3000	1200	200000	250	1000
5	300000	20000	2000	30000	500	100	3000	1200	200000	250	1000
6	300000	20000	2000	30000	500	100	3000	1200	200000	250	1000
7	300000	20000	2000	30000	500	100	3000	1200	200000	250	1000
8	300000	20000	2000	30000	500	100	3000	1200	200000	250	1000

```

9    27500  10000  3850  4859  450  5700  3750  1150  250   375
8750
10   300000 20000  2000  30000 500  100   3000  1200  200000 250
1000
11   300000 20000  2000  30000 500  100   3000  1200  200000 250
1000
12   300000 20000  2000  30000 500  100   3000  1200  200000 250
1000
13   300000 20000  2000  30000 500  100   3000  1200  200000 250
1000
14   300000 20000  2000  30000 500  100   3000  1200  200000 250
1000
15   300000 20000  2000  30000 500  100   3000  1200  200000 250
1000
16   300000 20000  2000  30000 500  100   3000  1200  200000 250
1000
17   300000 20000  2000  30000 500  100   3000  1200  200000 250
1000
18   300000 20000  2000  30000 500  100   3000  1200  200000 250
1000
19   300000 20000  2000  30000 500  100   3000  1200  200000 250
1000
20   300000 20000  2000  30000 500  100   3000  1200  200000 250
1000

```

2. Change the desired timer set with the `chg-m2pa-tset` command. To change a specific timer set, enter the `chg-m2pa-tset` command with the `tset` and `ver` parameters and the timer parameters you wish to change. For this example, to change the values of the **RFC** version of timer set 1, enter this command.

```

chg-m2pa-
tset:tset=1:t1=27500:t2=10000:t3=3850:t4e=450:t4n=45000:t5=5
700 :t6=3750:t7=1150:t16=250000:t17=375:t18=8750:ver=rfc

```

To change the values of the Draft 6 version of timer set 1, enter this command.

```

chg-m2pa-
tset:tset=1:t1=27500:t3=3850:t4e=450:t4n=45000:t5=5700 :t6=3
750:t7=1150:t16=250000:t17=375:t18=8750:ver=d6

```

 **Note:**

The values for the **M2PA** timers are shown in [Table 6-13](#).

To copy an **M2PA** timer set to another timer set, enter the `chg-m2pa-tset` command with the `tset`, `ver`, and `srctset` parameters. For this example, to copy the **RFC** version of timer set 9 to timer set 1, enter this command.

```

chg-m2pa-tset:tset=1:srctset=9:ver=rfc

```

To copy the Draft 6 version of timer set 9 to timer set 1, enter this command.

```

chg-m2pa-tset:tset=1:srctset=9:ver=d6

```

 **Note:**

The `ver` parameter is optional and does not have to be specified to change the **M2PARFC** timer values. The default value for the `ver` parameter is `rfc`. If you wish to change the **M2PA Draft 6** timer values, the `ver=d6` parameter must be specified with the `chg-m2pa-tset` command.

When the `chg-m2pa-tset` command has successfully completed, the following message should appear.

```
rlghncxa03w 06-10-28 21:16:37 GMT EAGLE5 36.0.0
CHG-M2PA-TSET: MASP A - COMPLTD
```

3. Verify the changes by entering the `rtrv-m2pa-tset` command specifying the timer set and version parameter values specified in 2. For this example, enter one of these commands.

```
rtrv-m2pa-tset:tset=1:ver=rfc
```

```
rlghncxa03w 06-10-28 21:16:37 GMT EAGLE5 36.0.0
```

```
M2PA RFC Timers (in msec, T16 in microsec)
```

TSET	T1	T2	T3	T4N	T4E	T5	T6	T7	T16	T17	T18
1	27500	10000	3850	45000	450	5700	3750	1150	250000	375	8750

```
rtrv-m2pa-tset:tset=1:ver=d6
```

```
rlghncxa03w 06-10-28 21:16:37 GMT EAGLE5 36.0.0
```

```
M2PA Draft 6 Timers (in msec, T16 in microsec)
```

TSET	T1	T2	T3	T4N	T4E	T5	T6	T7	T16	T17	T18
1	27500	-----	3850	45000	450	5700	3750	1150	250000	375	8750

```
rtrv-m2pa-tset:tset=9:ver=rfc
```

```
rlghncxa03w 06-10-28 21:16:37 GMT EAGLE5 36.0.0
```

```
M2PA RFC Timers (in msec, T16 in microsec)
```

TSET	T1	T2	T3	T4N	T4E	T5	T6	T7	T16	T17	T18
9	27500	10000	3850	45000	450	5700	3750	1150	250000	375	8750

```
rtrv-m2pa-tset:tset=9:ver=d6
```

```
rlghncxa03w 06-10-28 21:16:37 GMT EAGLE5 36.0.0
```

```
M2PA Draft 6 Timers (in msec, T16 in microsec)
```

TSET	T1	T2	T3	T4N	T4E	T5	T6	T7	T16	T17
T18										
9	27500	-----	3850	45000	450	5700	3750	1150	250000	375
	8750									

4. Back up the new changes, using the `chg-db:action=backup:dest=fixed` command. These messages should appear; the active **Maintenance and Administration Subsystem Processor (MASP)** appears first.

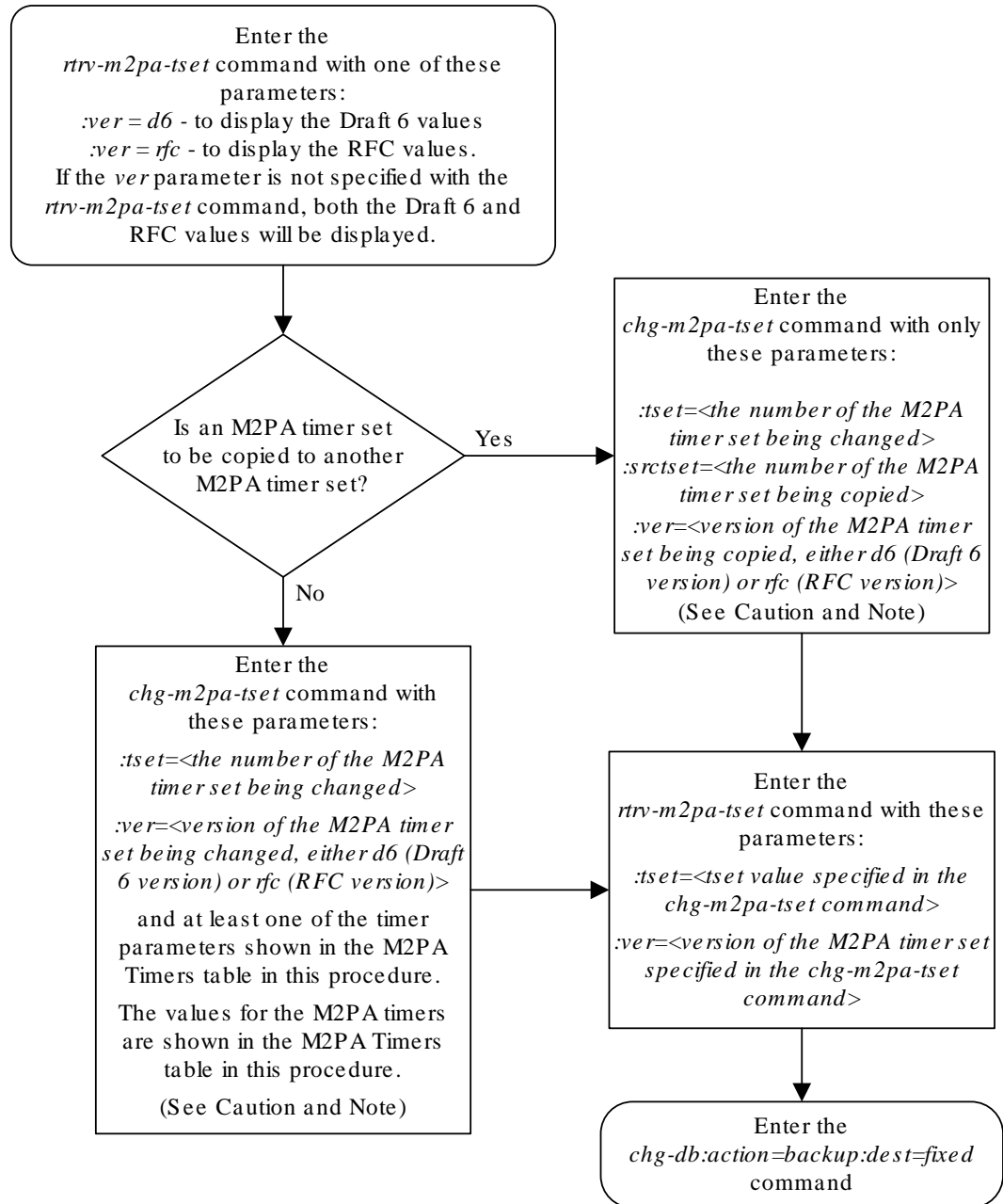
```
BACKUP (FIXED) : MASP A - Backup starts on active MASP.
```

```
BACKUP (FIXED) : MASP A - Backup on active MASP to fixed disk complete.
```

```
BACKUP (FIXED) : MASP A - Backup starts on standby MASP.
```

```
BACKUP (FIXED) : MASP A - Backup on standby MASP to fixed disk complete.
```

Figure 6-33 Changing an M2PA Timer Set



Notes:

1. Either the timer parameters or the *srctset* parameter must be specified with the *chg-m2pa-tset* command. Both the timer parameters and the *srctset* parameter cannot be specified with the *chg-m2pa-tset* command.
2. If the *ver* parameter is not specified with the *chg-m2pa-tset* command, the RFC values will be changed. To change the Draft 6 values, the *ver=d6* parameter must be specified with the *chg-m2pa-tset* command.

Caution: Changing an M2PA timer set may affect the performance of any associations using the timer set being changed.

6.37 Changing a UA Parameter Set

Use this procedure to change the values in a **UA** (user adapter) parameter set using the `chg-uaps` command. The `chg-uaps` command uses these parameters.

`:set` – the **UA** parameter set being changed, from 1 - 9

`:scrsset` – the source **UA** parameter set used to copy the values from one **UA** parameter set to another, from 1 to 10.

`:timer` – the timer being changed, from 1 to 10. Currently, there are only three timers defined:

- Timer 2 – The False **IP** Connection Congestion Timer – the maximum amount of time (in milliseconds) that an association is allowed to remain congested before failing due to false connection congestion.
- Timer 3 – The **UA** Heartbeat Period Timer – The frequency, in milliseconds, that heartbeat messages are transmitted.
- Timer 4 – The **UA** Heartbeat Received Timer – The amount of time, in milliseconds, that the **EAGLE** waits for a response to the heartbeat message that was transmitted. If a response to the heartbeat message is not received in the amount of time defined by Timer 4, the association is torn down

`:tvalue` – The value of the timer specified by the `timer` parameter.

- The value of timer 2 is from 10 to 30,000 milliseconds. The system default value is 3,000 milliseconds.
- The value of timer 3 is from 100 to 60,000 milliseconds. The system default value is 10,000 milliseconds.
- The value of timer 4 is from 100 to 10,000 milliseconds. The system default value is 5,000 milliseconds.

`:parm` – the **UA** parameters, from 1 to 10. Currently, only four UA parameters are defined.

- 1 – Controlling **ASPSNM** Behavior
- 2 – Controlling **ASP/Application Server** State Notification Behavior
- 3 – **UA** Serviceability Options
- 4 – **SCTP** Payload Protocol Indicator Option

`:pvalue` – the value of the **UA** parameters, which is dependent on the `parm` parameter value. The value of the `pvalue` parameter is a bit-mapped value, requiring a 0 in the specific bit position to disable the item, or a 1 in the specific bit position to enable the item. The value of the `pvalue` parameter is a 32-bit number. Any bits not specified in the following lists are not used.

- If the `parm` value is 1, the bits used by the `pvalue` parameter are:
 - 0 – Broadcast – controls broadcast phase **SNMTFPs**, **TFRs** and **TFAs** that are sent when a destination's status changes. If this flag is set, **SNMTFPs/TFRs/TFAs** are replicated to all associations/sockets that meet the Multicast **SNM** Criteria and have this enabled. The default is to enable all broadcast phase messages.

- 1 – Response Method – controls the sending of an **SNMTFC/UPU** as a reply to a message received on an association/socket for an unavailable destination. The **SNMTFC/UPU** is replicated to all associations/sockets that have this capability and meet the Response **SNM** Criteria. The default is to allow the response to be sent.
- 6 – Broadcast Congestion Status Change – controls the sending of unsolicited congestion status changes by an **ASP**. Unsolicited congestion status messages (**TFCs** generated when a destination's congestion status changes) are replicated to all **ASPs** who have this capability and meet the Multicast **SNM** Criteria. The default is to generate no unsolicited congestion status changes.

Table 6-14 shows the values can be entered for the `pvalue` parameter if the `parm` value is 1. The `pvalue` parameter value can be entered as a hexadecimal or a decimal number.

Table 6-14 Valid PVALUE Parameter Values if PARM=1

Bits Enabled	Bits Disabled	Hexadecimal Value	Decimal Value
None	Bit 0 - Broadcast Bit 1 - Response Method Bit 6 - Broadcast Congestion Status Change	h'0	0
Bit 0 - Broadcast	Bit 1 - Response Method Bit 6 - Broadcast Congestion Status Change	h'1	1
Bit 1 - Response Method	Bit 0 - Broadcast Bit 6 - Broadcast Congestion Status Change	h'2	2
Bit 0 - Broadcast Bit 1 - Response Method	Bit 6 - Broadcast Congestion Status Change	h'3*	3*
Bit 6 - Broadcast Congestion Status Change	Bit 0 - Broadcast Bit 1 - Response Method	h'40	64
Bit 6 - Broadcast Congestion Status Change Bit 0 - Broadcast	Bit 1 - Response Method	h'41	65
Bit 6 - Broadcast Congestion Status Change Bit 1 - Response Method	Bit 0 - Broadcast	h'42	66
Bit 0 - Broadcast Bit 1 - Response Method Bit 6 - Broadcast Congestion Status Change	None	h'43	67

* The system default value

- If the `parm` value is 2, the bits used by the `pvalue` parameter are:
 - 0 – **ASP Active Notifications** – controls the sending of **ASP-Active** notifications. If this value is specified, an **ASP-Default** notification is sent when an **ASP** transitions to the **ASP-ACTIVE** state. The default is not to send **ASP-Active** notifications.

- 1 – **ASP Inactive Notifications** – controls the sending of **ASP-Inactive** notifications. If this value is specified, an **ASP-Inactive** notification is sent when an **ASP** transitions to the **ASP-INACTIVE** state. The default is not to send **ASP-Inactive** notifications.

 **Note:**

To see the **ASP** activations and inactivations, bits 0 and 1 of the `pvalue` parameter value need to be enabled. See [Table 6-15](#).

- 2 – **ASPAS State Query** – controls the sending of **ASP/AS** State notifications on request by an **ASP**. If this value is specified, the **EAGLE** responds with **ASP** and **AS** state notifications if the remote **ASP** sends **ASP-UP** or **ASP-INACTIVE**, while the local **ASP** is in the **ASP-INACTIVE** state, or the remote **ASP** sends an **ASP-ACTIVE** notification while the local **ASP** is in the **ASP-ACTIVE** state. The default is not to send **ASP/AS** state notifications.

[Table 6-15](#) shows the values can be entered for the `pvalue` parameter if the `parm` value is 2. The `pvalue` parameter value can be entered as a hexadecimal or a decimal number.

Table 6-15 Valid PVALUE Parameter Values if PARM=2

Bits Enabled	Bits Disabled	Hexadecimal Value	Decimal Value
None	Bit 0 - ASP Activate Notifications Bit 1 - ASP Inactivate Notifications Bit 2 - ASP AS State Query	h'0*	0*
Bit 0 - ASP Activate Notifications	Bit 1 - ASP Inactivate Notifications Bit 2 - ASP AS State Query	h'1	1
Bit 1 - ASP Inactivate Notifications	Bit 0 - ASP Activate Notifications Bit 2 - ASP AS State Query	h'2	2
Bit 0 - ASP Activate Notifications Bit 1 - ASP Inactivate Notifications	Bit 2 - ASP AS State Query	h'3	3
Bit 2 - ASP AS State Query	Bit 0 - ASP Activate Notifications Bit 1 - ASP Inactivate Notifications	h'4	4
Bit 0 - ASP Activate Notifications Bit 2 - ASP AS State Query	Bit 1 - ASP Inactivate Notifications	h'5	5
Bit 1 - ASP Inactivate Notifications Bit 2 - ASP AS State Query	Bit 0 - ASP Activate Notifications	h'6	6

Table 6-15 (Cont.) Valid PVALUE Parameter Values if PARM=2

Bits Enabled	Bits Disabled	Hexadecimal Value	Decimal Value
Bit 0 - ASP Activate Notifications			
Bit 1 - ASP Inactivate Notifications	None	h'7	7
Bit 2 - ASP AS State Query			
* The system default value			

- If the `parm` value is 3, the bits used by the `pvalue` parameter are:
 - 0 – UA Heartbeats – heartbeat messages are sent on connections from the EAGLE to the far-end node that are in the **ASP-Down**, **ASP-Active**, and **ASP-Inactive** states if the bit is enabled.
 - 1 – UA Graceful Shutdown – enables the graceful shutdown of IPSG M3UA connections if the bit is enabled.

[Table 6-16](#) shows the values can be entered for the `pvalue` parameter if the `parm` value is 3. The `pvalue` parameter value can be entered as a hexadecimal or a decimal number.

Table 6-16 Valid PVALUE Parameter Values if PARM=3

Bits Enabled	Bits Disabled	Hexadecimal Value	Decimal Value
None	Bit 0 - UA Heartbeats Bit 1 - UA Graceful Shutdown	h'0*	0*
Bit 0 - UA Heartbeats	Bit 1 - UA Graceful Shutdown	h'1	1
Bit 1 - UA Graceful Shutdown	Bit 0 - UA Heartbeats	h'2	2
Bit 0 - UA Heartbeats Bit 1 - UA Graceful Shutdown	None	h'3	3
* The system default value			

- If the `parm` value is 4, the bit 0, the SCTP Payload Protocol Indicator byte order option, is used by the `pvalue` parameter. This bit indicates whether the SCTP Payload Protocol Indicator (PPI) in the received or transmitted message should be in the Big Endian and Little Endian byte format.

[Table 6-17](#) shows the values can be entered for the `pvalue` parameter if the `parm` value is 4. The `pvalue` parameter value can be entered as a hexadecimal or a decimal number.

Table 6-17 Valid PVALUE Parameter Values if PARM=4

SCTP Payload Protocol Indicator Byte Order Option - Bit 0	Hexadecimal Value	Decimal Value
Big Endian Byte Format	h'0*	0*
Little Endian Byte Format	h'1	1
* The system default value		

UA parameter set 10 contains the default values for the **UA** parameter sets and cannot be changed.

The `set` and `scrset` parameter values cannot be the same.

If the `scrset` parameter is specified, no other optional parameter may be specified.

The `timer` and `tvalue` parameters must be specified together. If one is specified, the other must be specified.

The `parm` and `pvalue` parameters must be specified together. If one is specified, the other must be specified.

Canceling the `RTRV-UAPS` Command

Because the `rtrv-uaps` command used in this procedure can output information for a long period of time, the `rtrv-uaps` command can be canceled and the output to the terminal stopped. There are three ways that the `rtrv-uaps` command can be canceled.

- Press the F9 function key on the keyboard at the terminal where the `rtrv-uaps` command was entered.
- Enter the `canc-cmd` without the `trm` parameter at the terminal where the `rtrv-uaps` command was entered.
- Enter the `canc-cmd:trm=<xx>`, where `<xx>` is the terminal where the `rtrv-uaps` command was entered, from another terminal other than the terminal where the `rtrv-uaps` command was entered. To enter the `canc-cmd:trm=<xx>` command, the terminal must allow Security Administration commands to be entered from it and the user must be allowed to enter Security Administration commands. The terminal's permissions can be verified with the `rtrv-secu-trm` command. The user's permissions can be verified with the `rtrv-user` or `rtrv-secu-user` commands.

For more information about the `canc-cmd` command, go to *Commands User's Guide*.

1. Display the values in the **UA** parameter set being changed by entering the `rtrv-uaps` command and specifying the desired **UA** parameter set number, from 1 to 9. For this example, enter this command.

```
rtrv-uaps:set=3
```

This is an example of possible output.

```
rlghncxa03w 10-07-28 09:12:36 GMT EAGLE5 42.0.0
  SET  TIMER      TVALUE  PARM      PVALUE
   3    1           0        1          3
   3    2          3000      2          0
   3    3          10000     3          0
   3    4           5000      4          0
   3    5           0         5          0
   3    6           0         6          0
   3    7           0         7          0
   3    8           0         8          0
   3    9           0         9          0
   3   10           0        10          0
```

TIMER 2: False IP Connection Congestion Timer, max time an association can be congested before failing due to false congestion. SS7IPGW and IPGWI applications enforce 0-30000(ms). Not supported on IPSPG application.

TVALUE : Valid range = 32-bits

TIMER 3: UA HeartBeat Period Timer T(beat), time (ms) between sending of BEAT msgs by NE. IPSPG, SS7IPGW and IPGWI applications enforce 100(ms)-60000(ms).

TVALUE : Valid range = 32-bits

TIMER 4: UA HeartBeat Received Timer T(beat ack), timeout period for response BEAT ACK msgs by NE. IPSPG, SS7IPGW and IPGWI applications enforce 100(ms)-10000(ms).

TVALUE : Valid range = 32-bits

PARAM 1: ASP SNM options. Each bit is used as an enabled/disabled flag for a particular ASP SNM option. Not supported on IPSPG application.

PVALUE : Valid range = 32-bits

BIT	BIT VALUE
0=Broadcast	0=Disabled , 1=Enabled
1=Response Method	0=Disabled , 1=Enabled
2-5=Reserved	
6=Broadcast Congestion Status Change	0=Disabled , 1=Enabled
7-31=Reserved	

PARAM 2: ASP/AS Notification options. Each bit is used as an enabled/disabled flag for a particular ASP/AS Notification option. Not supported on IPSPG application.

PVALUE : Valid range = 32-bits

BIT	BIT VALUE
0=ASP Active Notifications	0=Disabled , 1=Enabled
1=ASP Inactive Notifications	0=Disabled , 1=Enabled
2=ASP AS State Query	0=Disabled , 1=Enabled
3-31=Reserved	

PARAM 3: UA Serviceability Options. Each bit is used as an enabled/disabled flag for a particular UA Serviceability option. Supported on IPSPG, SS7IPGW, and IPGWI applications. UA Graceful Shutdown supported on IPSPG for M3UA only.

PVALUE : Valid range = 32-bits

BIT	BIT VALUE
0=UA Heartbeats	0=Disabled , 1=Enabled
1=UA Graceful Shutdown	0=Disabled , 1=Enabled
2-31=Reserved	

PARAM 4: SCTP Payload Protocol Indicator byte order option. Bit indicates

PPI value is RCV/TX in Big Endian or Little Endian byte format.

Supported on IPSPG-M2PA associations only.

PVALUE : Valid range = 32-bits

BIT	BIT VALUE
0=Payload Protocol Indicator	0=Big Endian , 1=Little

Endian
1-31=Reserved

If the new values of the UA parameter set are being copied from another UA parameter set, continue the procedure with 2.

If the new values of the UA parameter set are not being copied from another UA parameter set, continue the procedure with 3.

2. Display the values in the **UA** parameter set that will be copied to the UA parameter set displayed in 1 by entering the `rtrv-uaps` command and specifying the desired **UA** parameter set number, from 1 to 10. For this example, enter this command.

```
rtrv-uaps:set=10
```

This is an example of possible output.

```
rlghncxa03w 10-07-28 09:12:36 GMT EAGLE5 42.0.0
  SET  TIMER      TVALUE  PARM      PVALUE
   10    1         0        1         3
   10    2        3000       2         0
   10    3       10000       3         0
   10    4         5000       4         0
   10    5          0        5         0
   10    6          0        6         0
   10    7          0        7         0
   10    8          0        8         0
   10    9          0        9         0
   10   10          0       10         0
```

TIMER 2: False IP Connection Congestion Timer, max time an association can be congested before failing due to false

congestion. SS7IPGW and IPGWI applications enforce 0-30000(ms). Not supported on IPSP application.

TVALUE : Valid range = 32-bits

TIMER 3: UA HeartBeat Period Timer T(beat), time (ms) between sending

of BEAT msgs by NE. IPSP, SS7IPGW and IPGWI applications

enforce 100(ms)-60000(ms).

TVALUE : Valid range = 32-bits

TIMER 4: UA HeartBeat Received Timer T(beat ack), timeout period for

response BEAT ACK msgs by NE. IPSP, SS7IPGW and IPGWI applications enforce 100(ms)-10000(ms).

TVALUE : Valid range = 32-bits

PARM 1: ASP SNM options. Each bit is used as an enabled/disabled

flag for a particular ASP SNM option. Not supported on

```

IPSG
    application.
    PVALUE : Valid range = 32-bits
            BIT
            0=Broadcast
            1=Response Method
            2-5=Reserved
            6=Broadcast Congestion Status Change
            7-31=Reserved
            BIT VALUE
            0=Disabled , 1=Enabled
            0=Disabled , 1=Enabled
            0=Disabled , 1=Enabled

    PARM 2: ASP/AS Notification options. Each bit is used as an
            enabled/disabled flag for a particular ASP/AS
            Notification option. Not supported on IPSG application.
    PVALUE : Valid range = 32-bits
            BIT
            0=ASP Active Notifications
            1=ASP Inactive Notifications
            2=ASP AS State Query
            3-31=Reserved
            BIT VALUE
            0=Disabled , 1=Enabled
            0=Disabled , 1=Enabled
            0=Disabled , 1=Enabled

    PARM 3: UA Serviceability Options. Each bit is used as an
            enabled/disabled flag for a particular UA Serviceability
            option. Supported on IPSG, SS7IPGW, and IPGWI applications.
            UA Graceful Shutdown supported on IPSG for M3UA only.
    PVALUE : Valid range = 32-bits
            BIT
            0=UA Heartbeats
            1=UA Graceful Shutdown
            2-31=Reserved
            BIT VALUE
            0=Disabled , 1=Enabled
            0=Disabled , 1=Enabled

    PARM 4: SCTP Payload Protocol Indicator byte order option. Bit
    indicates
            PPI value is RCV/TX in Big Endian or Little Endian byte
            format.
            Supported on IPSG-M2PA associations only.
    PVALUE : Valid range = 32-bits
            BIT
            0=Payload Protocol Indicator
            1-31=Reserved
            BIT VALUE
            0=Big Endian , 1=Little
    Endian

```

3. Change the **UA** parameter set values using the `chg-uaps` command with the **UA** parameter set value used in 1. If the `parm` and `pvalue` parameters are being specified, see these tables for the valid values of the `pvalue` parameter.

- [Table 6-14](#)
- [Table 6-15](#)
- [Table 6-16](#)
- [Table 6-17](#)

For this example, enter this command.

```

chg-
uaps:set=3:timer=2:tvalue=2000:parm=2:pvalue=1:parm=3:pvalue=3

```

The value of the `pvalue` parameter can be entered as either a decimal value or a hexadecimal value. This example shows the `pvalue` parameter value of the `chg-uaps` command being entered as a decimal value. If the decimal value of the `pvalue` parameter is 3, specify the `pvalue=h'3` parameter to specify the hexadecimal value for the `pvalue` parameter.

```
chg-
uaps:set=3:timer=2:tvalue=2000:parm=2:pvalue=h'1:parm=3:pval
ue=h'3
```

If the values from one **UA** parameter set are being copied to another **UA** parameter set, only the `set` and `scrset` parameters can be specified with the `chg-uaps` command. For example, to copy the values from **UA** parameter set 10 to **UA** parameter set 5, enter this command.

```
chg-uaps:set=5:scrset=10
```

When this command has successfully completed, this message should appear.

```
rlghncxa03w 06-10-28 09:12:36 GMT EAGLE5 36.0.0
CHG-UAPS: MASP A - COMPLTD
```

4. Verify the changes using the `rtrv-uaps` command with the **UA** parameter set name used in 3. For this example, enter this command.

```
rtrv-uaps:set=3
```

This is an example of possible output.

```
rlghncxa03w 10-07-28 09:12:36 GMT EAGLE5 42.0.0
  SET  TIMER      TVALUE  PARM    PVALUE
   3    1           0       1       3
   3    2          2000     2       1
   3    3          10000    3       3
   3    4           5000     4       0
   3    5           0        5       0
   3    6           0        6       0
   3    7           0        7       0
   3    8           0        8       0
   3    9           0        9       0
   3   10           0       10       0
```

```
TIMER 2: False IP Connection Congestion Timer, max time an
         association can be congested before failing due to
false
```

```
         congestion. SS7IPGW and IPGWI applications enforce
         0-30000(ms). Not supported on IPSP application.
```

```
TVALUE : Valid range = 32-bits
```

```
TIMER 3: UA HeartBeat Period Timer T(beat), time (ms) between
sending
```

```
         of BEAT msgs by NE. IPSP, SS7IPGW and IPGWI
applications
```

```
         enforce 100(ms)-60000(ms).
```

```
TVALUE : Valid range = 32-bits
```

TIMER 4: UA HeartBeat Received Timer T(beat ack), timeout period for response BEAT ACK msgs by NE. IPSP, SS7IPGW and IPGWI applications enforce 100(ms)-10000(ms).

TVALUE : Valid range = 32-bits

PARAM 1: ASP SNM options. Each bit is used as an enabled/disabled flag for a particular ASP SNM option. Not supported on IPSP application.

PVALUE : Valid range = 32-bits

BIT	BIT VALUE
0=Broadcast	0=Disabled , 1=Enabled
1=Response Method	0=Disabled , 1=Enabled
2-5=Reserved	
6=Broadcast Congestion Status Change	0=Disabled , 1=Enabled
7-31=Reserved	

PARAM 2: ASP/AS Notification options. Each bit is used as an enabled/disabled flag for a particular ASP/AS Notification option. Not supported on IPSP application.

PVALUE : Valid range = 32-bits

BIT	BIT VALUE
0=ASP Active Notifications	0=Disabled , 1=Enabled
1=ASP Inactive Notifications	0=Disabled , 1=Enabled
2=ASP AS State Query	0=Disabled , 1=Enabled
3-31=Reserved	

PARAM 3: UA Serviceability Options. Each bit is used as an enabled/disabled flag for a particular UA Serviceability option. Supported on IPSP, SS7IPGW, and IPGWI applications. UA Graceful Shutdown supported on IPSP for M3UA only.

PVALUE : Valid range = 32-bits

BIT	BIT VALUE
0=UA Heartbeats	0=Disabled , 1=Enabled
1=UA Graceful Shutdown	0=Disabled , 1=Enabled
2-31=Reserved	

PARAM 4: SCTP Payload Protocol Indicator byte order option. Bit indicates

PPI value is RCV/TX in Big Endian or Little Endian byte format.

Supported on IPSP-M2PA associations only.

PVALUE : Valid range = 32-bits

BIT	BIT VALUE
0=Payload Protocol Indicator	0=Big Endian , 1=Little Endian
1-31=Reserved	

If 2 was performed, for this example, enter this command.

```
rtrv-uaps:set=5
```

This is an example of possible output.

```
rlghncxa03w 10-07-28 09:12:36 GMT EAGLE5 42.0.0
SET  TIMER      TVALUE  PARM      PVALUE
5     1           0        1          3
5     2          3000     2          0
5     3         10000    3          0
5     4           5000     4          0
5     5           0         5          0
5     6           0         6          0
5     7           0         7          0
5     8           0         8          0
5     9           0         9          0
5    10           0        10         0
```

TIMER 2: False IP Connection Congestion Timer, max time an association can be congested before failing due to false congestion. SS7IPGW and IPGWI applications enforce 0-30000(ms). Not supported on IPSP application.
TVALUE : Valid range = 32-bits

TIMER 3: UA HeartBeat Period Timer T(beat), time (ms) between sending of BEAT msgs by NE. IPSP, SS7IPGW and IPGWI applications enforce 100(ms)-60000(ms).
TVALUE : Valid range = 32-bits

TIMER 4: UA HeartBeat Received Timer T(beat ack), timeout period for response BEAT ACK msgs by NE. IPSP, SS7IPGW and IPGWI applications enforce 100(ms)-10000(ms).
TVALUE : Valid range = 32-bits

PARM 1: ASP SNM options. Each bit is used as an enabled/disabled flag for a particular ASP SNM option. Not supported on IPSP application.
PVALUE : Valid range = 32-bits

BIT	BIT VALUE
0=Broadcast	0=Disabled ,
1=Enabled	
1=Enabled	1=Response Method 0=Disabled ,
	2-5=Reserved
1=Enabled	6=Broadcast Congestion Status Change 0=Disabled ,
	7-31=Reserved

PARM 2: ASP/AS Notification options. Each bit is used as an enabled/disabled flag for a particular ASP/AS Notification option. Not supported on IPSP

application.

```
PVALUE : Valid range = 32-bits
      BIT
      0=ASP Active Notifications          0=Disabled , 1=Enabled
      1=ASP Inactive Notifications       0=Disabled , 1=Enabled
      2=ASP AS State Query               0=Disabled , 1=Enabled
      3-31=Reserved
```

PARM 3: UA Serviceability Options. Each bit is used as an enabled/disabled flag for a particular UA Serviceability option. Supported on IPSP, SS7IPGW, and IPGWI applications. UA Graceful Shutdown supported on IPSP for M3UA only.

```
PVALUE : Valid range = 32-bits
      BIT
      0=UA Heartbeats                    0=Disabled , 1=Enabled
      1=UA Graceful Shutdown             0=Disabled , 1=Enabled
      2-31=Reserved
```

PARM 4: SCTP Payload Protocol Indicator byte order option. Bit indicates

PPI value is RCV/TX in Big Endian or Little Endian byte format.

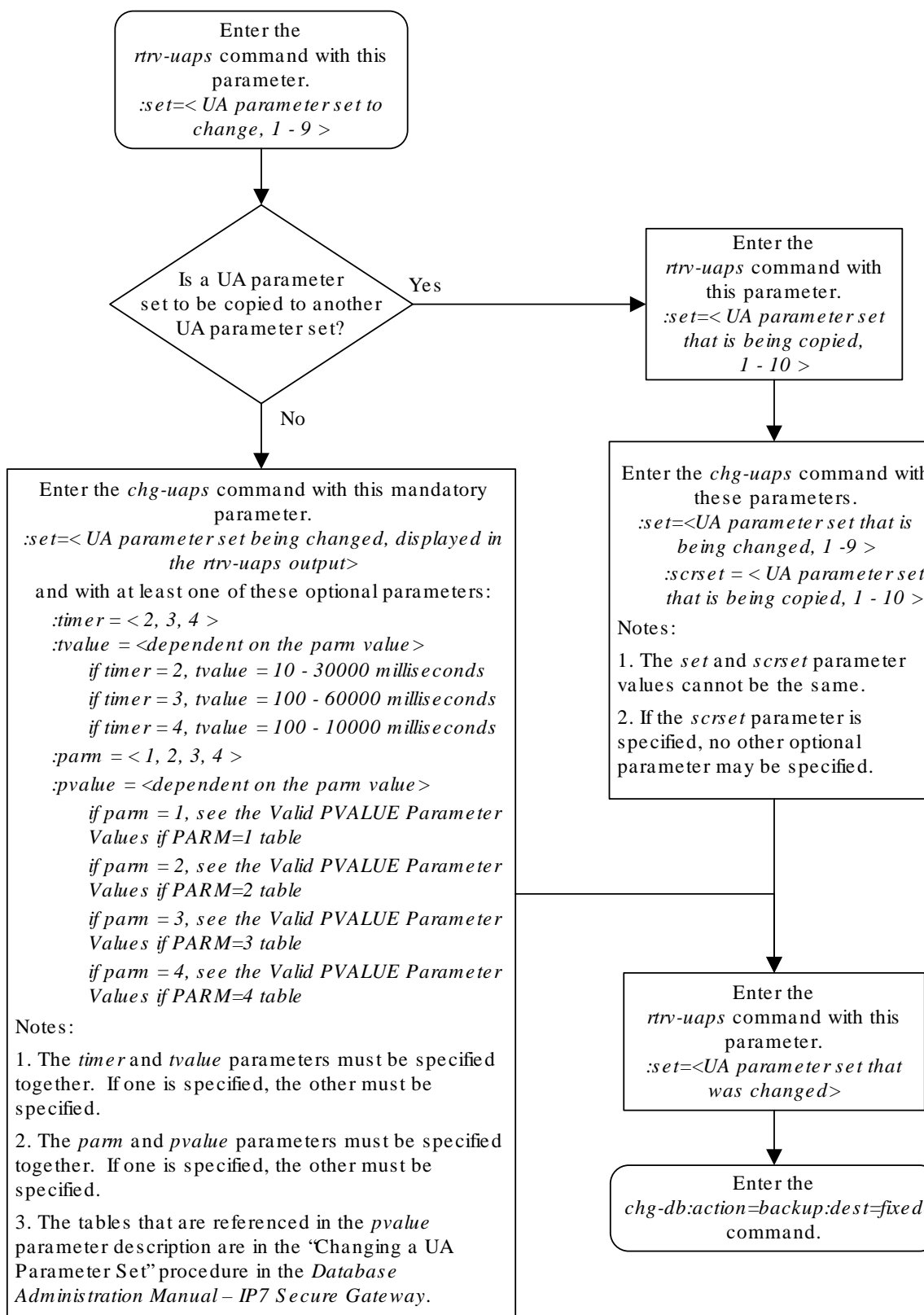
Supported on IPSP-M2PA associations only.

```
PVALUE : Valid range = 32-bits
      BIT
      0=Payload Protocol Indicator       0=Big Endian , 1=Little
      1-31=Reserved
```

5. Back up the new changes, using the `chg-db:action=backup:dest=fixed` command. These messages should appear; the active **Maintenance and Administration Subsystem Processor (MASP)** appears first.

```
BACKUP (FIXED) : MASP A - Backup starts on active MASP.
BACKUP (FIXED) : MASP A - Backup on active MASP to fixed disk complete.
BACKUP (FIXED) : MASP A - Backup starts on standby MASP.
BACKUP (FIXED) : MASP A - Backup on standby MASP to fixed disk complete.
```

Figure 6-34 Changing a UA Parameter Set



6.38 Turning Off the Large MSU Support for IP Signaling Feature

This procedure is used to turn off the Large **MSU** Support for **IP** Signaling feature, using the `chg-ctrl-feat` command.

The `chg-ctrl-feat` command uses these parameters:

`:partnum` – The part number of the Large **MSU** Support for **IP** Signaling feature, 893018401.

`:status=off` – used to turn off the Large **MSU** Support for **IP** Signaling feature.

The status of the Large **MSU** Support for **IP** Signaling feature must be on and is shown with the `rtrv-ctrl-feat` command.

Caution:

If the Large MSU Support for IP Signaling feature is turned off, the EAGLE will not process messages with a signaling information field (**SIF**) that is larger than 272 bytes.

1. Display the status of the Large MSU Support for **IP** Signaling feature by entering the `rtrv-ctrl-feat:partnum=893018401` command. The following is an example of the possible output.

```
rlghncxa03w 10-04-28 21:15:37 GMT EAGLE5 42.0.0
```

The following features have been permanently enabled:

Feature Name	Partnum	Status	Quantity
Large MSU for IP Sig	893018401	on	----

The following features have been temporarily enabled:

Feature Name	Partnum	Status	Quantity	Trial Period Left
Zero entries found.				

The following features have expired temporary keys:

Feature Name	Partnum
Zero entries found.	

If the status of the Large MSU Support for IP Signaling feature is off, or if the Large MSU Support for IP Signaling feature is not enabled, this procedure cannot be performed.

2. Turn off the Large MSU Support for IP Signaling feature by entering the `chg-ctrl-feat` command with the `status=off` parameter. For example, enter this command.

```
chg-ctrl-feat:partnum=893018401:status=off
```

When this command has successfully completed, the following message should appear.

```
rlghncxa03w 06-10-28 21:15:37 GMT EAGLE5 36.0.0
CHG-CTRL-FEAT: MASP B - COMPLTD
```

3. Verify that the Large MSU Support for IP Signaling feature has been turned off by using the `rtrv-ctrl-feat:partnum=893018401` command. The following is an example of the possible output.

```
rlghncxa03w 10-04-28 21:15:37 GMT EAGLE5 42.0.0
The following features have been permanently enabled:
```

Feature Name	Partnum	Status	Quantity
Large MSU for IP Sig	893018401	off	----

The following features have been temporarily enabled:

Feature Name	Partnum	Status	Quantity	Trial Period Left
Zero entries found.				

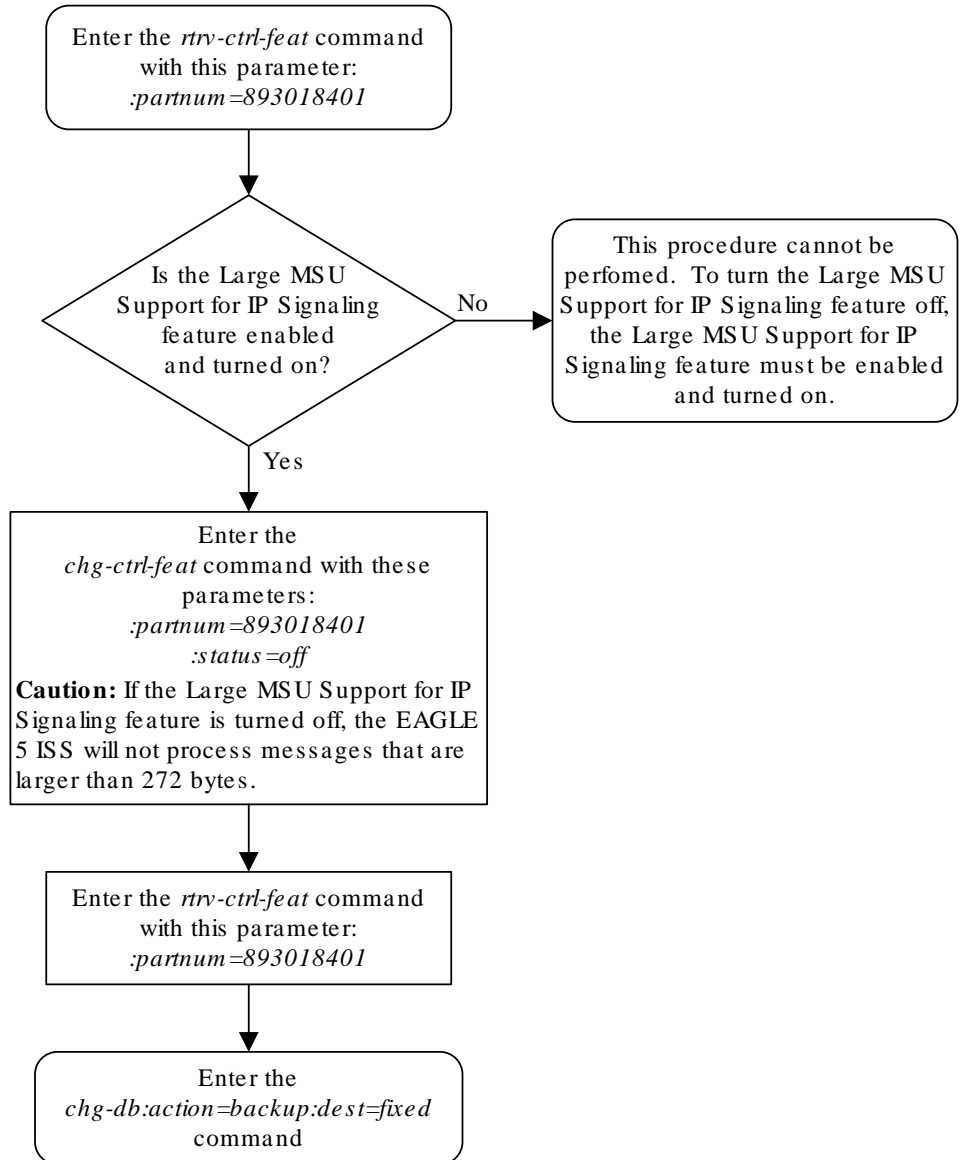
The following features have expired temporary keys:

Feature Name	Partnum
Zero entries found.	

4. Back up the new changes using the `chg-db:action=backup:dest=fixed` command. These messages should appear, the active **Maintenance and Administration Subsystem Processor (MASP)** appears first.

```
BACKUP (FIXED) : MASP A - Backup starts on active MASP.
BACKUP (FIXED) : MASP A - Backup on active MASP to fixed disk
complete.
BACKUP (FIXED) : MASP A - Backup starts on standby MASP.
BACKUP (FIXED) : MASP A - Backup on standby MASP to fixed disk
complete.
```

Figure 6-35 Turning Off the Large MSU Support for IP Signaling Feature



A

Reference Information

Appendix D, Reference Information, contains the following information that is used by more than one procedure in this manual: Requirements for EAGLEs Containing more than 700 Signaling Links Determining the Number of High-Speed and Low-Speed Signaling Links

A.1 Maximum Card Capacity for Different Card Types

Maximum Card Capacity (MaxTPS), Maximum RSVDSLKTPS and MAXSLKTPS, and Allowable Value Ranges for RSVDSLKTPS and MAXSLKTPS.

If the E5-ENET-B IPSP High Throughput feature is turned ON, then the maximum capacity supported on the E5-ENET-B IPSP card is 9500 TPS, otherwise the capacity is limited to a maximum of 6500 TPS. The SLIC card supports a maximum capacity of 10K when the feature is turned OFF. Turning the feature ON for the SLIC card will not result in rates exceeding 10K. See the following table:

Table A-1 MaxTPS Per Card

Card Type	IPSP High Throughput FAK Status	MaxTPS (Maximum Card Capacity)	Max RSVDSLKTPS	Max MAXSLKTPS	Range	
					RSVDSLKTPS	MAXSLKTPS
E5-ENET-A	N/A	5000	5000	5000	0-5000	100-5000
E5-ENET-B	OFF	6500	6500	6500	0-6500	100-6500
E5-ENET-B	ON	9500	9500	9500	0-9500	100-9500
SLIC	OFF	12000	12000	12000	0-12000	100-12000
SLIC	ON	12000	12000	12000	0-12000	100-12000

A.2 Requirements for EAGLEs Containing more than 1200 Signaling Links

To provision an EAGLE with more than 1200 signaling links (currently the EAGLE can have maximum capacities of 1200, 1500, 2000, or 2800 signaling links), the following additional requirements must be met:

- The Measurements Platform feature must be enabled. Perform these procedures in *Database Administration - System Management User's Guide* to enable the Measurements Platform Feature:
 - Adding an MCPM
 - Configuring the IP Communications Link for the Measurements Platform Feature
 - Adding an FTP Server

- To provision more than 1200 signaling links, the Large System # Links controlled feature must be enabled for 1500, 2000, or 2800 signaling links. For more information on enabling this feature, go to the [Enabling the Large System # Links Controlled Feature](#) procedure.

A.3 Determining the Number of High-Speed and Low-Speed Signaling Links

The EAGLE can contain these quantities of signaling links.

- The maximum number of IP signaling links (signaling links assigned to IPLIMx cards, IPGWx cards, or IPSPG cards) or ATM high-speed signaling links (signaling links assigned to cards running either **ATMANSI** or **ATMITU** applications), is limited by the total provisioned system **TPS** (transactions per second). If the HIPR2 High Rate Mode feature is not enabled or turned on, the total provisioned system TPS is 500,000 TPS. If the HIPR2 High Rate Mode feature is enabled and turned on, the total provisioned system TPS is 1,000,000 (1M) TPS. The total provisioned system TPS is shown in the `rtrv-tps` output. The EAGLE supports these quantities.
 - 187 IPLIMx cards with each card supporting 4000 TPS. An IPLIMx card can contain up to 16 signaling links. For more information about configuring an IPLIMx signaling link, see the "Adding an IPLIMx Signaling Link" procedure in *Database Administration - IP7 User's Guide*. The EAGLE can support a maximum of 250 IPLIMx cards but not all the IPLIMx cards can contain provisioned signaling links.
 - 187 IPGWx cards with each card supporting 4000 TPS. An IPGWx card can contain one signaling link. For more information about configuring an IPGWx signaling link, see the "Adding an IPGWx Signaling Link" procedure in *Database Administration - IP7 User's Guide*. The EAGLE can support a maximum of 250 IPGWx cards if the TPS that is assigned to some of the IPGWx cards is less than 4000, and there are no other types of cards are in the database other than the control cards.
 - 150 IPSPG cards with each card supporting 5000 TPS. An IPSPG card can contain up to 32 (128 for SLIC) signaling links. For more information about configuring an IPSPG signaling link, see the "Adding an IPSPG M2PA Signaling Link" procedure or "Adding an IPSPG M3UA Signaling Link" procedure in *Database Administration - IP7 User's Guide*. The EAGLE can support a maximum of 250 IPSPG cards if the TPS that is assigned to some of the IPSPG cards is less than 5000, and there are no other types of cards are in the database other than the control cards.
 - The amount of TPS for an ANSI ATM high-speed signaling link is 1630. The amount of TPS for an ITU ATM high-speed signaling link is 2038. The EAGLE supports a maximum of 460 ANSI ATM high-speed signaling links and a maximum or 368 ITU ATM high-speed signaling links.
- A maximum of 80 unchannelized **E1** signaling links. An HC MIM can contain two unchannelized E1 signaling links. An E5-E1T1 card can contain one unchannelized E1 signaling link.
- A maximum of 180 unchannelized T1 signaling links. An unchannelized T1 signaling link can be assigned only to an E5-E1T1 card. An E5-E1T1 card can contain one unchannelized T1 signaling link.

The EAGLE can contain a maximum of 250 cards. This quantity does not include the control cards. The sum of the quantities of the signaling links shown in this list cannot be provisioned in the EAGLE as the EAGLE cannot contain enough cards to support the sum of the quantities of these signaling links.

Other signaling links, not shown in this list, can be provisioned if there is space in the shelves for the cards that support these signaling links, and the enabled signaling link quantity is not exceeded.

This hardware is the only hardware that is supported for an EAGLE containing 2001 to 2800 signaling links.

- **E5-E1/T1/E5-E1T1-B**
- **E5-ATM-E5-ATM-B**
- **E5-SM4G/E5-SM8G**
- **E5-ENET/E5-ENET-B**
- **E5-STC** card for the EAGLE 5 Integrated Monitoring Support feature

A.4 Enabling the Large System # Links Controlled Feature

This procedure is used to enable the Large System # Links controlled feature using the feature's part number and a feature access key.

The feature access key for the Large System # Links controlled feature is based on the feature's part number and the serial number of the **EAGLE**, making the feature access key site-specific.

This feature allows the **EAGLE** to contain a maximum of either 1500, 2000, or 2800 signaling links.

The `enable-ctrl-feat` command enables the controlled feature by inputting the controlled feature's access key and the controlled feature's part number with these parameters:

Note:

As of Release 46.3, the `fak` parameter is no longer required. This parameter is only used for backward compatibility.

`:fak` – The feature access key provided by Oracle. The feature access key contains 13 alphanumeric characters and is not case sensitive.

`:partnum` – The Oracle-issued part number associated with the signaling link quantity being enabled:

- 893005901 for the 1500 signaling link quantity
- 893005910 for the 2000 signaling link quantity.
- 893005911 for the 2800 signaling link quantity.

The `enable-ctrl-feat` command requires that the database contain a valid serial number for the **EAGLE**, and that this serial number is locked. This can be verified with the `rtv-serial-num` command. The **EAGLE** is shipped with a serial number in the database, but the serial number is not locked. The serial number can be changed, if necessary, and locked

once the **EAGLE** is on-site, by using the `ent-serial-num` command. The `ent-serial-num` command uses these parameters.

`:serial` – The serial number assigned to the EAGLE. The serial number is not case sensitive.

`:lock` – Specifies whether or not the serial number is locked. This parameter has only one value, `yes`, which locks the serial number. Once the serial number is locked, it cannot be changed.

 **Note:**

To enter and lock the **EAGLE**'s serial number, the `ent-serial-num` command must be entered twice, once to add the correct serial number to the database with the `serial` parameter, then again with the `serial` and the `lock=yes` parameters to lock the serial number. You should verify that the serial number in the database is correct before locking the serial number. The serial number can be found on a label affixed to the control shelf (shelf 1100).

This feature cannot be temporarily enabled (with the temporary feature access key).

Once this feature is enabled with the `enable-ctrl-feat` command, the feature is also activated. The `chg-ctrl-feat` command is not necessary to activate the feature.

This feature cannot be turned off with the `chg-ctrl-feat` command and the `status=off` parameter.

Hardware Supported for Signaling Link Quantities Greater than 2000

This hardware is the only hardware that is supported for an EAGLE containing 2001 to 2800 signaling links.

- **HC-MIM**
- **E5-E1/T1**
- **E5-ATM**
- **E5-SM4G**
- **E5-ENET**
- E5-based control cards
- **E5-STC** card for the EAGLE Integrated Monitoring Support feature

To increase the signaling link quantity to more than 2000 signaling links, or HIPR2 cards must be installed into card locations 9 and 10 in each shelf in the **EAGLE**. Enter the `rept-stat-gpl:gpl=hipr2` command to verify whether or not **HIPR2** cards are installed in the EAGLE shelves.

1. Display the status of the Large System # Links controlled feature by entering the `rtrv-ctrl-feat` command.

The following is an example of the possible output.

```
rlghncxa03w 06-10-28 21:15:37 GMT EAGLE5 36.0.0
The following features have been permanently enabled:
```

Feature Name	Partnum	Status	Quantity
Command Class Management	893005801	on	----
LNP Short Message Service	893006601	on	----
Intermed GTT Load Sharing	893006901	on	----
XGTT Table Expansion	893006101	on	400000
XMAP Table Expansion	893007710	off	----
Routesets	893006401	on	6000
HC-MIM SLK Capacity	893012707	on	64

The following features have been temporarily enabled:

Feature Name	Partnum	Status	Quantity	Trial Period
Left				
Zero entries found.				

The following features have expired temporary keys:

Feature Name	Partnum
Zero entries found.	

If the `rtrv-ctrl-feat` output shows that the controlled feature is enabled for the desired quantity or for a quantity that is greater than the desired quantity, no further action is necessary. This procedure does not need to be performed.

2. Display the serial number in the database with the `rtrv-serial-num` command.

This is an example of the possible output.

```
rlghncxa03w 06-10-28 21:15:37 GMT EAGLE5 36.0.0
System serial number = nt00001231
```

System serial number is not locked.

```
rlghncxa03w 06-10-28 21:15:37 GMT EAGLE5 36.0.0
Command Completed
```

If the serial number is correct and locked, continue the procedure by performing one of these steps.

- If the enabled quantity will be 1500, continue the procedure with [8](#).
- If the enabled quantity will be 2000 or 2800, continue the procedure with [6](#).

If the serial number is correct but not locked, continue the procedure with [5](#).

If the serial number is not correct and not locked, continue the procedure with [3](#).

If the serial number is not correct, but is locked, this feature cannot be enabled and the remainder of this procedure cannot be performed. Contact the Customer Care Center to get an incorrect and locked serial number changed. Refer to [My Oracle Support \(MOS\)](#)

for the contact information. The serial number can be found on a label affixed to the control shelf (shelf 1100).

3. Enter the correct serial number into the database using the `ent-serial-num` command with the `serial` parameter.

For this example, enter this command.

```
ent-serial-num:serial=<EAGLE's correct serial number>
```

When this command has successfully completed, the following message should appear.

```
rlghncxa03w 06-10-28 21:15:37 GMT EAGLE5 36.0.0
ENT-SERIAL-NUM:  MASP A - COMPLTD
```

4. Verify that the serial number entered into 3 was entered correctly using the `rtrv-serial-num` command.

This is an example of the possible output.

```
rlghncxa03w 06-10-28 21:15:37 GMT EAGLE5 36.0.0
System serial number = nt00001231
```

System serial number is not locked.

```
rlghncxa03w 06-10-28 21:15:37 GMT EAGLE5 36.0.0
Command Completed
```

If the serial number was not entered correctly, repeat 3 and 4 and re-enter the correct serial number.

5. Lock the serial number in the database by entering the `ent-serial-num` command with the serial number shown in 2, if the serial number shown in 2 is correct, or with the serial number shown in 4, if the serial number was changed in 3, and with the `lock=yes` parameter.

For this example, enter this command.

```
ent-serial-num:serial=<EAGLE's serial number>:lock=yes
```

When this command has successfully completed, the following message should appear.

```
rlghncxa03w 06-10-28 21:15:37 GMT EAGLE5 36.0.0
ENT-SERIAL-NUM:  MASP A - COMPLTD
```

Continue the procedure by performing one of these steps.

- If the enabled quantity will be 1500, continue the procedure with 8.
 - If the enabled quantity will be 2000 or 2800, continue the procedure with 6.
6. Verify that HIPR2 cards are installed in card locations 9 and 10 in each shelf of the EAGLE. Enter this command.

```
rept-stat-gpl:gpl=hipr2
```

This is an example of the possible output.

```
rlghncxa03w 09-07-01 11:40:26 GMT EAGLE5 41.1.0
GPL          CARD      RUNNING      APPROVED    TRIAL
HIPR2       1109     132-002-000 132-002-000 132-003-000
HIPR2       1110     132-002-000 132-002-000 132-003-000
HIPR2       1209     132-002-000 132-002-000 132-003-000
HIPR2       1210     132-002-000 132-002-000 132-003-000
HIPR2       1309     132-002-000 132-002-000 132-003-000
HIPR2       1310     132-002-000 132-002-000 132-003-000
HIPR2       2109     132-002-000 132-002-000 132-003-000
HIPR2       2110     132-002-000 132-002-000 132-003-000
Command Completed
```

7. Before the 2000 or 2800 signaling link quantity can be enabled, make sure the EAGLE is configured with the hardware shown in the [“Hardware Supported for Signaling Link Quantities Greater than 2000”](#) section.

If hardware other than the hardware shown in the [“Hardware Supported for Signaling Link Quantities Greater than 2000”](#) section is installed and provisioned, contact the Customer Care Center before enabling the 2000 or 2800 signaling link quantity. Refer to [My Oracle Support \(MOS\)](#) for the contact information.

8. Enable the Large System # Links controlled feature for the desired quantity with the `enable-ctrl-feat` command specifying the part number corresponding to the new quantity of signaling links and the feature access key.

To increase the number of signaling links the **EAGLE** can contain to 1500, enter this command.

```
enable-ctrl-feat:partnum=893005901:fak=<feature access key>
```

To increase the number of signaling links the **EAGLE** can contain to 2000, enter this command.

```
enable-ctrl-feat:partnum=893005910:fak=<feature access key>
```

To increase the number of signaling links the EAGLE can contain to 2800, enter this command.

```
enable-ctrl-feat:partnum=893005911:fak=<feature access key>
```

 **Note:**

A temporary feature access key cannot be specified to enable this feature.

 **Note:**

The values for the feature access key (the `fak` parameter) are provided by Oracle. If you do not have the feature access key for the feature you wish to enable, contact your Sales Representative or Account Representative.

When the `enable-ctrl-feat` command has successfully completed, this message should appear.

```
rlghncxa03w 06-10-28 21:15:37 GMT EAGLE5 36.0.0
ENABLE-CTRL-FEAT: MASP B - COMPLTD
```

9. Verify the changes by entering the `rtrv-ctrl-feat` command with the part number specified in 8.

If the 1500 signaling link quantity was enabled in 8, enter this command.

```
rtrv-ctrl-feat:partnum=893005901
```

The following is an example of the possible output.

```
rlghncxa03w 06-10-28 21:15:37 GMT EAGLE5 36.0.0
The following features have been permanently enabled:
```

Feature Name	Partnum	Status	Quantity
Large System # Links	893005901	on	1500

The following features have been temporarily enabled:

Feature Name	Partnum	Status	Quantity	Trial
Period Left				
Zero entries found.				

The following features have expired temporary keys:

Feature Name	Partnum
Zero entries found.	

If the 2000 signaling link quantity was enabled in 8, enter this command.

```
rtrv-ctrl-feat:partnum=893005910
```

The following is an example of the possible output.

```
rlghncxa03w 06-10-28 21:15:37 GMT EAGLE5 36.0.0
The following features have been permanently enabled:
```

Feature Name	Partnum	Status	Quantity
Large System # Links	893005910	on	2000

The following features have been temporarily enabled:

Feature Name	Partnum	Status	Quantity	Trial
Period Left				
Zero entries found.				

The following features have expired temporary keys:

```
Feature Name          Partnum
Zero entries found.
```

If the 2800 signaling link quantity was enabled in 8, enter this command.

```
rtrv-ctrl-feat:partnum=893005911
```

The following is an example of the possible output.

```
rlghncxa03w 09-07-28 21:15:37 GMT EAGLE5 41.1.0
The following features have been permanently enabled:
```

Feature Name	Partnum	Status	Quantity
Large System # Links	893005911	on	2800

The following features have been temporarily enabled:

Feature Name	Partnum	Status	Quantity	Trial Period
Left				

Zero entries found.

The following features have expired temporary keys:

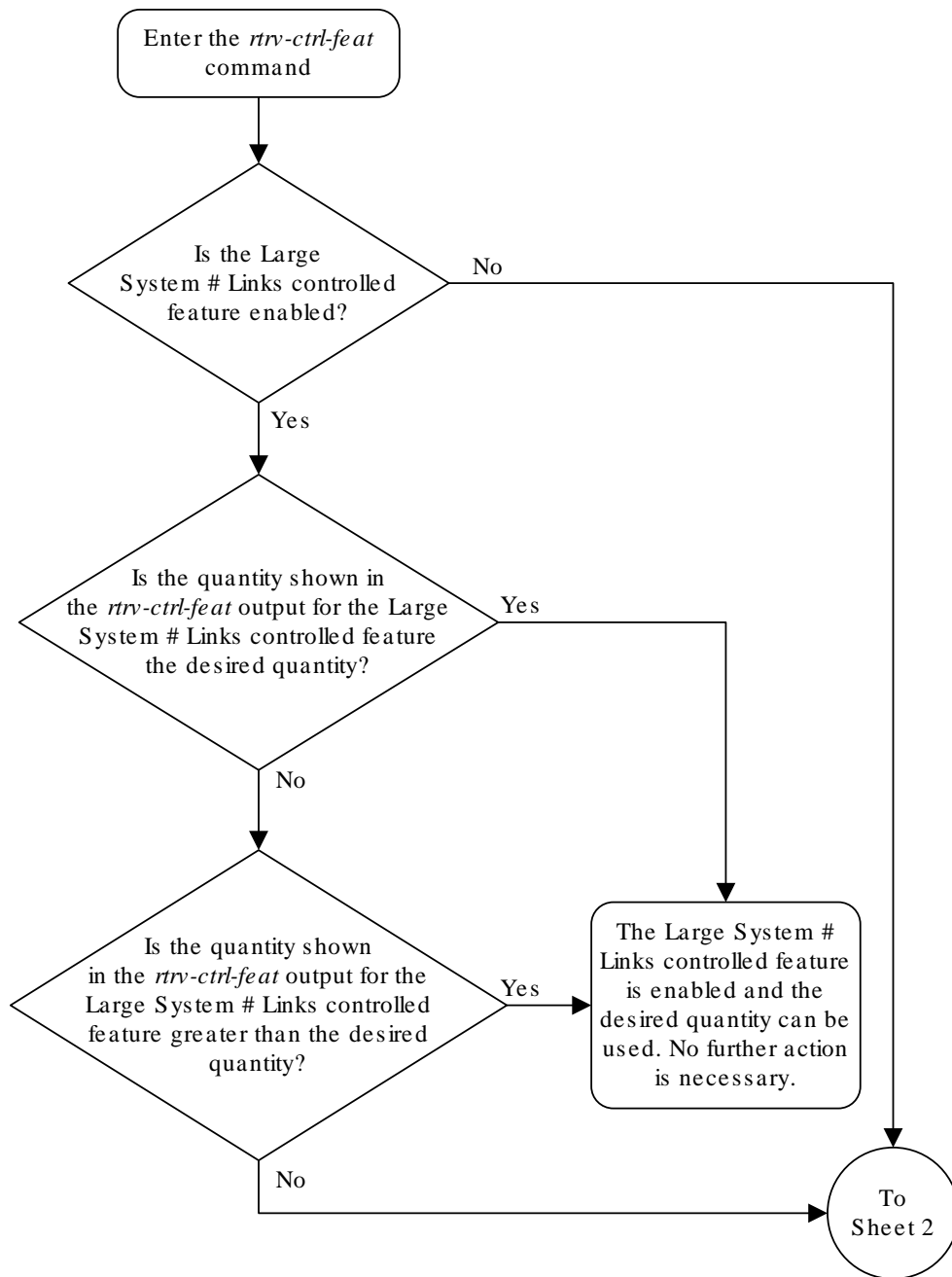
```
Feature Name          Partnum
Zero entries found.
```

10. Back up the new changes using the `chg-db:action=backup:dest=fixed` command.

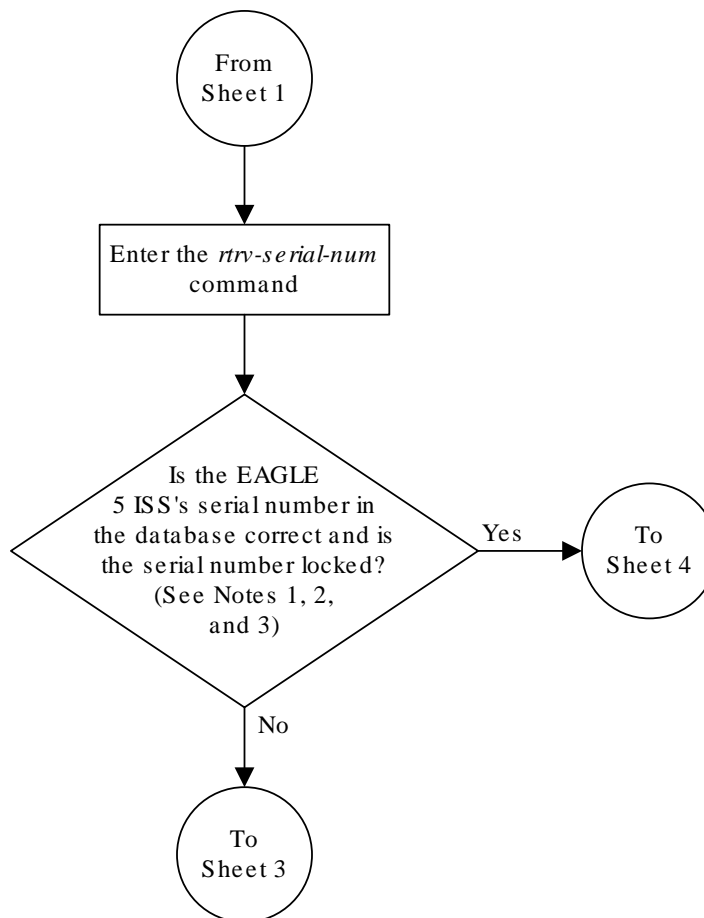
These messages should appear, the active **Maintenance and Administration Subsystem Processor (MASP)** appears first.

```
BACKUP (FIXED) : MASP A - Backup starts on active MASP.
BACKUP (FIXED) : MASP A - Backup on active MASP to fixed disk complete.
BACKUP (FIXED) : MASP A - Backup starts on standby MASP.
BACKUP (FIXED) : MASP A - Backup on standby MASP to fixed disk complete.
```

Figure A-1 Enabling the Large System # Links Controlled Feature



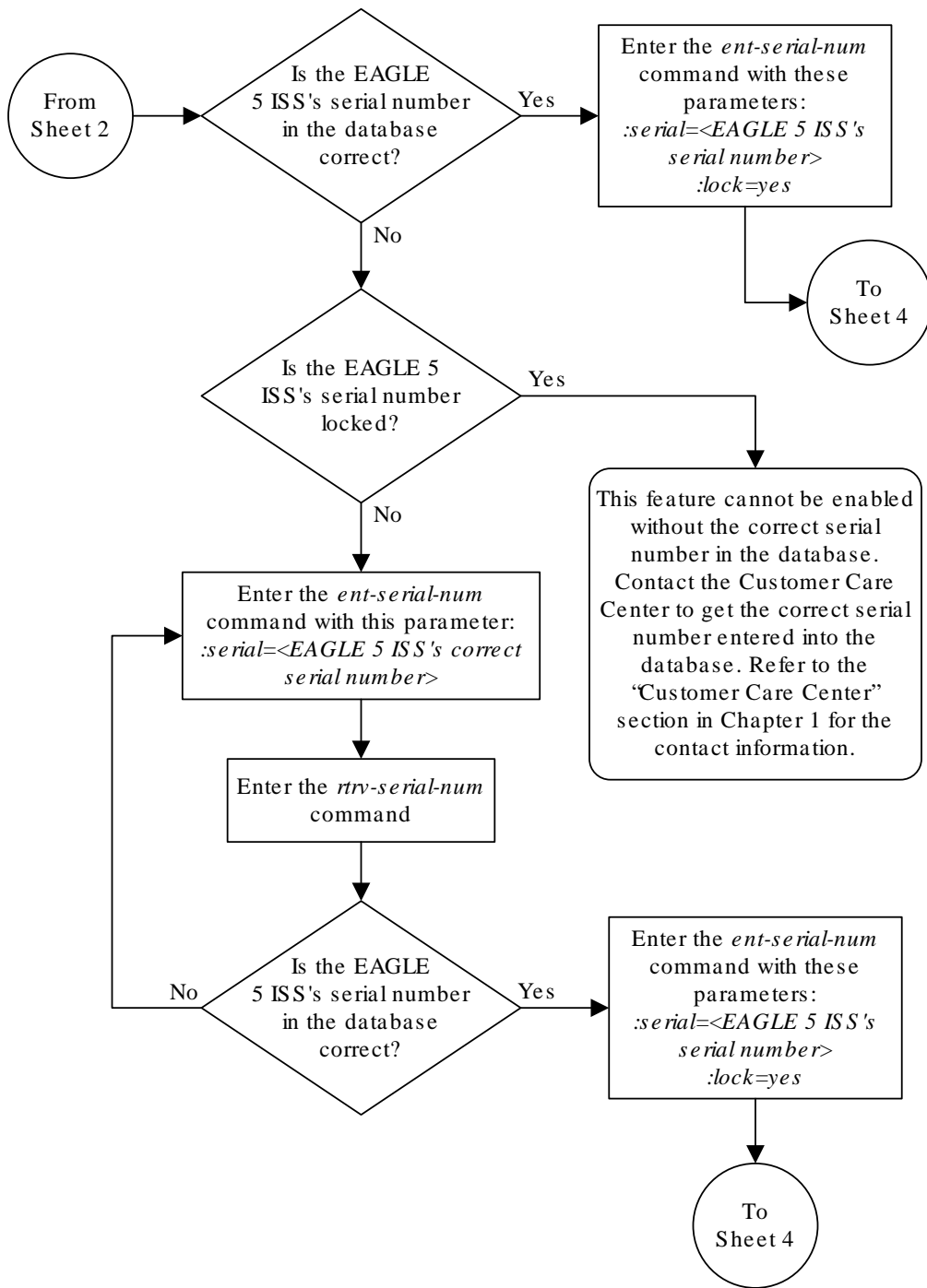
Sheet 1 of 6



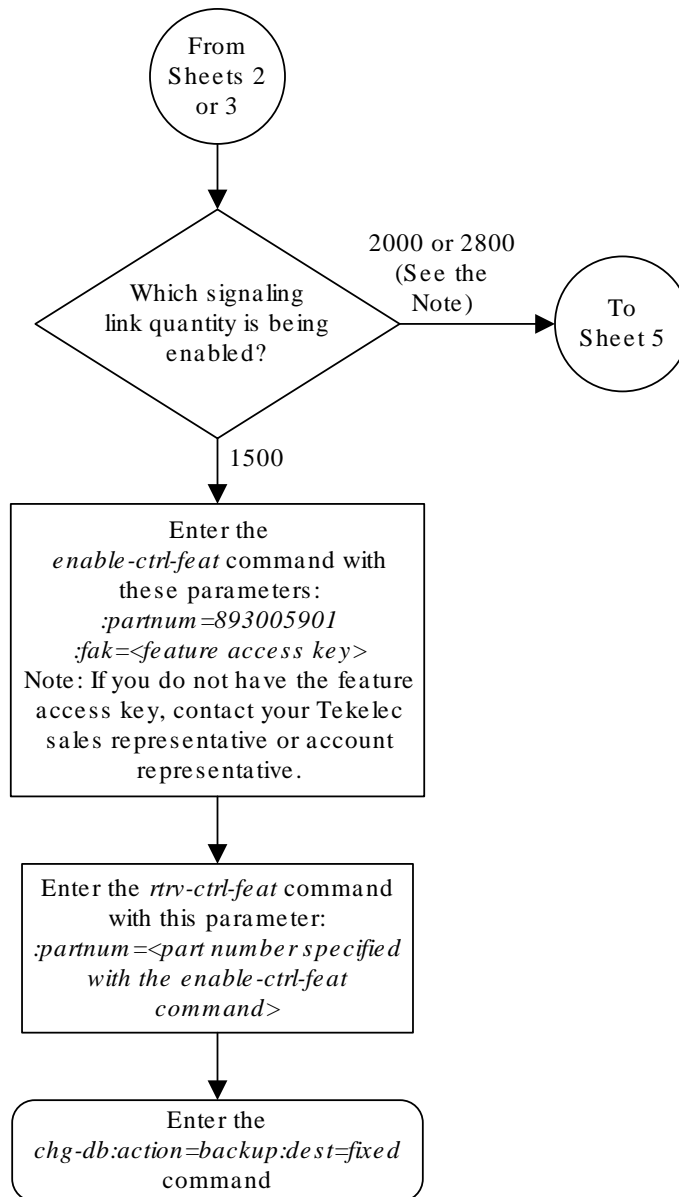
Notes:

1. If the serial number is locked, it cannot be changed.
2. If the serial number is not locked, the controlled feature cannot be enabled.
3. The serial number can be found on a label affixed to the control shelf (shelf 1100).

Sheet 2 of 6



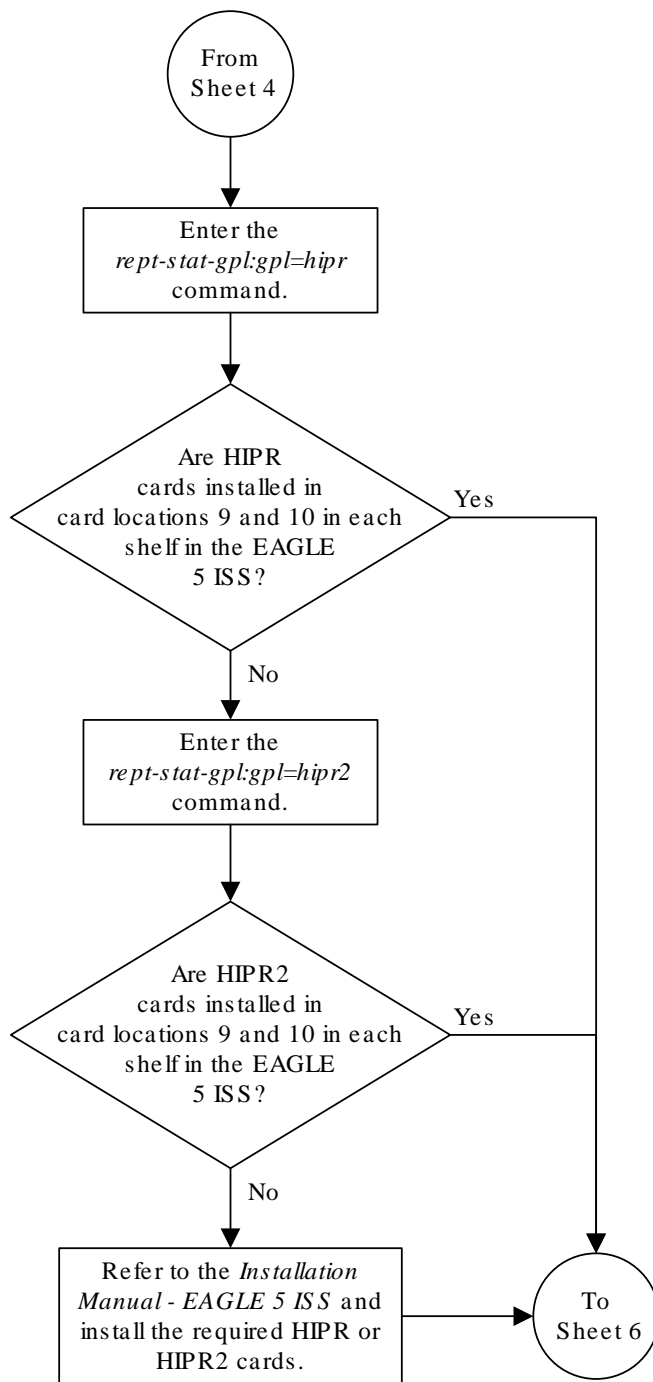
Sheet 3 of 6



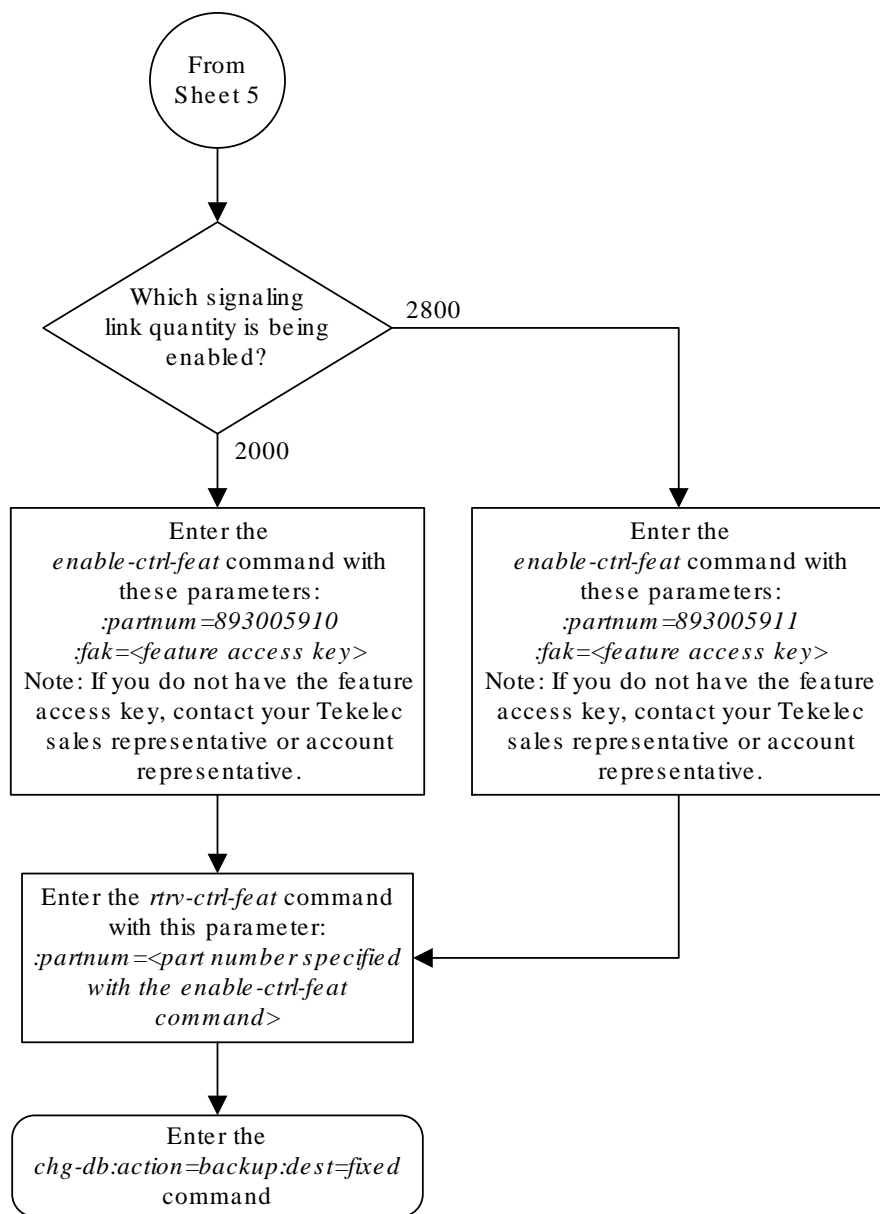
Note: Before the 2800 signaling link quantity is enabled, make sure the EAGLE 5 ISS is configured with the required hardware shown in the “Hardware Supported for Signaling Link Quantities Greater than 2000” section in this procedure.

If hardware other than the hardware shown in the “Hardware Supported for Signaling Link Quantities Greater than 2000” section is installed and provisioned, contact the Customer Care Center before enabling the 2800 signaling link quantity. Refer to the “Customer Care Center” section in Chapter 1 for the contact information.

Sheet 4 of 6



Sheet 5 of 6



Sheet 6 of 6