

Oracle® Communications Billing and Revenue Management

Installation Guide



Release 15.0
F86238-04
September 2024

The Oracle logo, consisting of a solid red square with the word "ORACLE" in white, uppercase, sans-serif font centered within it.

ORACLE®

Copyright © 2017, 2024, Oracle and/or its affiliates.

This software and related documentation are provided under a license agreement containing restrictions on use and disclosure and are protected by intellectual property laws. Except as expressly permitted in your license agreement or allowed by law, you may not use, copy, reproduce, translate, broadcast, modify, license, transmit, distribute, exhibit, perform, publish, or display any part, in any form, or by any means. Reverse engineering, disassembly, or decompilation of this software, unless required by law for interoperability, is prohibited.

The information contained herein is subject to change without notice and is not warranted to be error-free. If you find any errors, please report them to us in writing.

If this is software, software documentation, data (as defined in the Federal Acquisition Regulation), or related documentation that is delivered to the U.S. Government or anyone licensing it on behalf of the U.S. Government, then the following notice is applicable:

U.S. GOVERNMENT END USERS: Oracle programs (including any operating system, integrated software, any programs embedded, installed, or activated on delivered hardware, and modifications of such programs) and Oracle computer documentation or other Oracle data delivered to or accessed by U.S. Government end users are "commercial computer software," "commercial computer software documentation," or "limited rights data" pursuant to the applicable Federal Acquisition Regulation and agency-specific supplemental regulations. As such, the use, reproduction, duplication, release, display, disclosure, modification, preparation of derivative works, and/or adaptation of i) Oracle programs (including any operating system, integrated software, any programs embedded, installed, or activated on delivered hardware, and modifications of such programs), ii) Oracle computer documentation and/or iii) other Oracle data, is subject to the rights and limitations specified in the license contained in the applicable contract. The terms governing the U.S. Government's use of Oracle cloud services are defined by the applicable contract for such services. No other rights are granted to the U.S. Government.

This software or hardware is developed for general use in a variety of information management applications. It is not developed or intended for use in any inherently dangerous applications, including applications that may create a risk of personal injury. If you use this software or hardware in dangerous applications, then you shall be responsible to take all appropriate fail-safe, backup, redundancy, and other measures to ensure its safe use. Oracle Corporation and its affiliates disclaim any liability for any damages caused by use of this software or hardware in dangerous applications.

Oracle®, Java, MySQL, and NetSuite are registered trademarks of Oracle and/or its affiliates. Other names may be trademarks of their respective owners.

Intel and Intel Inside are trademarks or registered trademarks of Intel Corporation. All SPARC trademarks are used under license and are trademarks or registered trademarks of SPARC International, Inc. AMD, Epyc, and the AMD logo are trademarks or registered trademarks of Advanced Micro Devices. UNIX is a registered trademark of The Open Group.

This software or hardware and documentation may provide access to or information about content, products, and services from third parties. Oracle Corporation and its affiliates are not responsible for and expressly disclaim all warranties of any kind with respect to third-party content, products, and services unless otherwise set forth in an applicable agreement between you and Oracle. Oracle Corporation and its affiliates will not be responsible for any loss, costs, or damages incurred due to your access to or use of third-party content, products, or services, except as set forth in an applicable agreement between you and Oracle.

Contents

Preface

Audience	xiv
Documentation Accessibility	xiv
Diversity and Inclusion	xiv

Part I Preparing for BRM Installation

1 BRM Installation Overview

About Planning and Installing a BRM System	1-1
Types of BRM Systems	1-2
BRM Demonstration or Development System	1-2
BRM Production System	1-2
Small Production System	1-3
Mid-Size Production System	1-4
High-Availability Production System	1-5
A BRM Multischema Production System	1-5
Installation Overview	1-8
Installing and Configuring a Localized Version of BRM	1-9
Selecting the Database Character Encoding	1-9

2 Planning Your Database Configuration

Configuring Development or Demonstration System Databases	2-1
Tablespace Mapping	2-1
Creating Tablespaces	2-1
Configuring init.ora Parameters for Development or Demonstration Systems	2-1
Configuring Production System Databases	2-2
Storage Considerations, Redo, and Undo	2-3
Estimating the Database Size	2-3
International Version Sizing Considerations	2-4
Selecting the Storage Model	2-4
Creating Tablespace Storage	2-4

Mapping Tablespaces to Logical Devices	2-5
Tablespace Priorities	2-6
Tablespace Mapping for Data	2-7
Tablespace Mapping for Indexes	2-8
Creating Tablespaces	2-8
Running Configuration Scripts to Create the BRM Database	2-8
Configuring init.ora Parameters	2-8
Using Optimization	2-9
About Using Virtual Columns	2-9

3 System Requirements

Overview of Hardware and Software Requirements	3-1
Operating System Requirements	3-1
About Critical Patch Updates	3-2
Disk Space Requirements	3-2
Hardware Guidelines	3-2
CM and DM RAM and Swap Guidelines	3-2
Database Requirements	3-3
Network Requirements	3-3
TCP/IP	3-3
IP Addresses	3-3
Assigning Disks for the Operating System and for BRM	3-4
About Network Performance	3-4
About Oracle Exalogic and Oracle Exadata	3-4
Additional Requirements	3-4
Information Requirements for BRM Installation	3-5
Information Requirements for All BRM Installations	3-5
BRM File Location Details	3-5
BRM Oracle Wallet Details	3-6
BRM Database SSL Details	3-6
BRM Database System User Details	3-7
BRM Database Connection Details	3-7
BRM Connection Manager Details	3-7
Enterprise Application Integration Framework Details	3-8
Oracle Data Manager Details	3-8
BRM Table and Index Tablespace Details	3-8
Additional Information Requirements for BRM Complete Installation	3-8
Oracle Connection Manager Proxy Details	3-9
Oracle Connection Manager Master Process Details	3-9
Pipeline Schema User Details	3-9

Part II Installing BRM

4 BRM Preinstallation Tasks

Installing the Database	4-1
Collecting Information Before Installing the Oracle Database Software	4-2
About Capturing Information When Installing the Oracle Database Software	4-2
Before Installing Oracle Database Software	4-2
Installing and Configuring Your Oracle Database: Task List	4-2
Installing the Oracle Database Software	4-3
Creating your BRM Database	4-3
Setting Environment Variables for the Database	4-4
Setting Up Your Database for BRM	4-4
Setting Up Oracle RAC	4-6
Installing the Database and Oracle DM on Separate Machines	4-9
Modifying Your Oracle Database Installation	4-9
Installing Third-Party Tools	4-10
Installing Java	4-10
Installing Perl	4-10
Installing Apache Kafka	4-11
Preparing the Environment	4-12
Downloading the ojdbc8.jar File	4-12
Creating and Configuring pin_user	4-12
Setting the Environment Variables for Installation	4-13
Setting BRM Wallet Location in sqlnet.ora	4-14

5 Installing BRM

About the BRM Installation Package	5-1
Installing BRM: Task List	5-3
Downloading the BRM Software	5-4
Installing BRM in GUI Mode	5-4
Starting the BRM GUI Installer	5-4
Installing a Typical BRM System	5-6
Installing All BRM Components	5-12
Installing Individual BRM Components	5-21
Installing CM and DM on Separate Machines	5-22
Installing BRM in Silent Mode	5-23
Creating a Response File	5-23
Performing a Silent Installation	5-24

6 BRM Postinstallation Tasks

Scheduling Backups	6-1
Referencing Environment Variables in pin.conf Files	6-1
Postinstallation Tasks for a BRM Non-Production System	6-2
Editing the pin_setup.values File	6-2
Running the pin_setup Script	6-4
Changing Your Database Partitions	6-5
Setting Environment Variables for Pipeline Manager	6-5
Updating Client Wallet for Pipeline Manager	6-6
Copying Files for Compiling CM and FM Modules	6-6
Editing and Loading the Event Notification List	6-7
Loading the Tailor-Made Stored Procedure	6-7
Postinstallation Tasks for a BRM Production Installation	6-8
Editing the pin_tables.values File	6-9
Enabling Different Classes for Partitioning during Installation	6-9
Editing Optional Components Configuration Entries	6-10
Maintaining a BRM Database	6-10
Maintaining the Connection to the Database	6-11
Monitoring Database Space	6-11
Rebuilding Indexes	6-12
What's Next?	6-12

7 Installing a Multischema System

Before Installing a Multischema System	7-1
Multischema Installation Overview	7-1
Installing a Multischema System: Task List	7-2
Installing BRM on the Primary Installation Machine	7-4
Installing BRM on a Secondary Installation Machine	7-5
Verifying That the Installation Machines Connect to All Schemas	7-6
Using testnap to Verify Access to Your Schemas	7-6
Installing and Configuring Multidatabase Manager on the Primary Installation Machine	7-7
Disabling Creation of Uniqueness Objects	7-8
Configuring pin_multidb.conf on the Primary Installation Machine	7-8
Configuring Client Wallet on the Primary Installation Machine	7-11
Connecting to SSL-Enabled Oracle Database	7-12
Granting System Privileges to Each Database Schema	7-12
Running pin_multidb.pl on the Primary Installation Machine	7-13
Running pin_multidb.pl -i	7-13

Running pin_multidb.pl -f	7-15
Enforcing the Creation of Unique Account Numbers	7-16
Setting Up Schema Qualifications	7-17
What's Next?	7-19

8 Installing BRM Thick Clients

About Installing BRM Clients	8-1
About BRM Client Package	8-2
Installing Self-Care Manager	8-3
Installing Customer Center	8-3
Installing Pricing Center	8-4
Installing Suspense Management Center	8-4
Downloading the BRM Client Software	8-5
Installing BRM Clients in GUI Mode	8-5
Installing All BRM Clients	8-5
Installing Individual BRM Clients	8-7
Installing BRM Clients in Silent Mode	8-10
Creating a Response File	8-10
Performing a Silent Installation	8-11
Configuring the Localization SDK on Windows	8-12
Granting Administrative Privileges to Pricing Center Users	8-12
Modifying the Database Configuration File	8-13
Modifying the pricing_admin.pl Script Configuration File	8-13
Setting Up the Database Server for the Pipeline Manager Administrator	8-15
Initializing the Pricing Admin Configuration Object	8-16
Specifying Administrative Privileges for Pipeline Manager Users	8-16
Removing Pricing Admins	8-17
Starting a BRM Client Application on Linux	8-17
Starting a BRM Client Application on Windows	8-18
Starting a BRM Client Application from Java Web Start	8-18
Problems Installing BRM Client Applications	8-18
Problem: Cannot Start a Client Application after Installation	8-18
Possible Cause	8-18
Solution	8-18
What's Next?	8-18

9 Installing Pipeline Configuration Center

PCC Installation Overview	9-1
About the PCC Architecture	9-2
Overview of the PCC Installation Procedure	9-2

Performing a Secure PCC Installation	9-3
Ensuring a Successful PCC Installation	9-3
PCC System Requirements	9-4
Software Requirements	9-4
Hardware Requirements	9-4
Overview of Preinstallation Tasks	9-4
Installing and Configuring Oracle WebLogic Server	9-5
Installing Oracle WebLogic Server	9-5
Installing and Configuring Oracle Application Development Runtime	9-5
Creating an Oracle WebLogic Server Domain	9-5
Configuring SSL for the Oracle WebLogic Server Domain	9-6
Setting the JAVA_HOME Environment Variable	9-6
Downloading the ojdbc8.jar File for PCC	9-7
Installing and Configuring BRM	9-7
Setting Up the Business Parameter	9-7
Downloading the PCC Software	9-8
Installing PCC	9-8
Installing PCC in GUI Mode	9-9
Installing PCC in Silent Mode	9-14
About the Response File Template	9-14
Creating a Response File	9-14
Installing PCC in Silent Mode	9-15
About Installation Logs	9-16
PCC Postinstallation Tasks	9-16
Creating a PCC User after Installing PCC	9-16
Using Secure Cookies	9-17
Configuring the Session Timeout	9-18
Verifying the PCC Installation	9-19
Checking the State of the Installed Components	9-19
Logging In to PCC	9-20
About File Permissions	9-20
Verifying Configuration Entries	9-20
Uninstalling PCC	9-21
Uninstalling PCC in Silent Mode	9-22
Deleting Files after Uninstalling PCC	9-22
Administering PCC	9-22
Managing PCC Security	9-22
Monitoring PCC	9-23
Managing PCC	9-23
Troubleshooting PCC	9-23
Troubleshooting Checklist	9-23
Using Error Logs to Troubleshoot PCC	9-24

Diagnosing PCC Problems	9-24
Refreshing the Browser	9-24
Unable to Perform Any Task after Logging In	9-24
Getting Help for PCC Problems	9-24
Secure Deployment Checklist	9-25

10 Installing BRM REST Services Manager

Downloading the BRM REST Services Manager Package	10-1
Generating an SSL Certificate for BRM REST Services Manager	10-1
Installing BRM REST Services Manager	10-2
Installing BRM REST Services Manager in GUI Mode	10-2
Installing BRM REST Services Manager in Silent Mode	10-5
Creating a Response File	10-5
Installing BRM REST Services Manager in Silent Mode	10-6
BRM REST Services Manager Postinstallation Tasks	10-7
Excluding the BRM REST Services Manager SDK	10-7
Importing Java KeyStore Certificates	10-7
Updating BRM Connection Details	10-8
Updating the Base URL	10-8
Modifying BRM REST Services Manager Properties	10-8
Setting Up Zipkin Tracing in BRM REST Services Manager	10-9
Connecting BRM REST Services Manager to Oracle Analytics Publisher	10-10
Configuring BRM REST Services Manager for High Availability	10-10
Allowing the Use of Deprecated Cyphers	10-11
Troubleshooting SSL Connection Errors	10-11

11 Troubleshooting the BRM Installation

Problems Installing the Database	11-1
Problem: Cannot Start the Oracle Listener	11-1
Possible Cause	11-1
Solution	11-1
Problem: Cannot Connect to the Oracle Database as the System User	11-1
Possible Causes	11-1
Solution	11-1
Problems Installing BRM	11-2
Problem: An Error Occurred When pin_setup is Run During Installation	11-2
Possible Cause	11-2
Solution	11-2
Problem: An Error Occurred during the Move Data Process	11-2
Possible Cause	11-2

Solution	11-3
Problem: Errors Are Recorded in the Log File When dm_oracle Starts	11-3
Possible Cause	11-3
Solution	11-3
Problem: An Error Occurs in the dm_fusa.pinlog file during pin_setup of Paymentech Manager	11-3
Possible Cause	11-3
Solution	11-3
Problems Connecting to the Database	11-3
Problem: Pointer to the Wrong Database Name	11-3
Possible Cause	11-3
Solution	11-4
Problem: Cannot Log In to the Database	11-4
Possible Cause	11-4
Solution	11-4
Problem: Out of Memory on Linux	11-4
Possible Cause	11-4
Solution	11-4

12 Installing Multiple BRM Instances on One System for Testing

Installing and Configuring Multiple Instances of BRM on One Machine	12-1
Creating Multiple Users	12-1
Installing and Configuring the Oracle Database for Multiple Instances	12-2
(Optional) Creating Tablespaces for Each User	12-2
(Optional) Creating Multiple BRM Users	12-2
Installing Multiple Instances of BRM	12-3
Configuring Each BRM Instance	12-4
Reinitializing the Database	12-5
Reinitializing BRM Server and Optional Component Data	12-5
Reinitializing Optional Component Data Only	12-6
Removing BRM Data from the Database	12-8

13 Uninstalling BRM

Uninstalling the BRM Software	13-1
Uninstalling Optional Components	13-1
Uninstalling BRM	13-2
Uninstalling BRM Client Applications	13-3
Uninstalling BRM Client Applications on Linux	13-3
Uninstalling BRM Client Applications on Windows	13-4

Part III Upgrading BRM

14 About Upgrading from BRM 12.0 to BRM 15.0

About Upgrading BRM to a New Release	14-1
Considerations for Upgrading to BRM 15.0	14-2
Planning Your Upgrade	14-3
Identifying Your Upgrade Team	14-3
Identifying Who Is Affected by the Upgrade	14-3
Collecting Information about Your System	14-4
Determining the Impact of New Features	14-4
Estimating How Long the Upgrade Will Take	14-5
How Long Will It Take to Run the Database Upgrade Scripts?	14-5
How Long Will It Take to Plan, Prepare for, Test, and Perform the Upgrade?	14-5
Updating Your System Environment	14-5
Creating Test Environments	14-6
Old Baseline Release	14-6
Old Customized Release	14-7
New Baseline Release	14-7
New Customized Release (Test System)	14-7
Transferring Customizations to the New Release	14-7
Upgrading Customized Policy Source Files	14-8
Updating Configuration Files	14-8
Updating Database Customizations	14-8
Modifying the Content of Custom Tables	14-8
Modifying the Structure of Custom Tables	14-9
Fixing Standard Database Objects with Nonstandard Object IDs	14-9
Updating Custom Reports	14-9
Updating Custom Applications	14-9
Testing Your Upgraded System	14-10
Running Old and New Versions in Parallel	14-10
Testing the BRM Database	14-10
Troubleshooting Your Upgraded System	14-11
Testing Checklist	14-11
Preparing for the Production System Upgrade	14-12
Upgrading Your Production System	14-12

15 Upgrading BRM and Pipeline Manager from BRM 12.0 to BRM 15.0

About the Upgrade	15-1
Tasks Involved in the Upgrade Process	15-2
Preparing for the Upgrade	15-3
Shutting Down the Current Instance	15-3
Turning Off BRM Service Authentication and Authorization	15-3
Creating a Complete Backup of Your BRM 12.0 Data	15-3
Backing Up BRM Files	15-3
Backing Up Your BRM and Pipeline Manager 12.0 Databases	15-4
Creating Your BRM 15.0 Database	15-5
Upgrading to BRM 15.0	15-5
Importing Your BRM 12.0 Data	15-5
Setting the Environment Variables for Upgrade	15-5
Installing BRM and Pipeline Manager for Upgrade	15-7
Upgrading Your Data to BRM 15.0	15-10
Pointing the BRM 15.0 Installation to the Database Schema	15-10
Upgrading the BRM Database Schema to the BRM 15.0 Schema	15-10
Upgrading the Schema on Single-Schema Systems	15-10
Upgrading the Schema on Multischema Systems	15-12
Upgrading the Pipeline Manager Database Schema to the BRM 15.0 Schema	15-15
Completing the Upgrade	15-16
Creating Large Indexes	15-16
Installing the BRM 15.0 Client Applications	15-17
Adding Optional Components	15-17
Updating Configurations	15-17
Update the Default Settings for the pin_rel Utility	15-18
Updating the Settings for the pin_virtual_time Utility	15-18
Upgrading AMM in a Multischema System	15-18
Restoring Customizations	15-18
Post-Upgrade Procedures	15-19
Loading the pin_notify File	15-19
Copying Files for Compiling CMs	15-19
Migrating Custom Code to a 64-bit Environment	15-20
Updating Queue Handling	15-21
Setting the Environment Variables for Pipeline Manager	15-21
Configuring SSL for the BRM Database	15-22
Removing Invalid Objects from the Database	15-22
Modifying the Root Encryption Key	15-22
Modifying the Root Encryption Key on Single-Schema Systems	15-23
Modifying the Root Encryption Key on Multischema Systems	15-23
Setting the Bill State for Preexisting Bills	15-25

Migrating Tax Codes	15-26
Updating pin_inv_doc_gen Infranet.properties	15-26

16 Upgrading BRM 15.0 to a Later Release of BRM 15.0

About Installing the Later Release	16-1
Performing a Zero Downtime Upgrade	16-2
Tasks Involved in the Upgrade Process for a New Release	16-3
Preparing for the Upgrade to the New Release	16-4
Shutting Down the Current Instance	16-4
Backing Up Files	16-5
Backing Up Your BRM and Pipeline Manager Databases	16-5
Installing Optional Components	16-6
Upgrading to the New Release	16-6
Upgrading BRM for the New Release	16-7
Upgrading BRM for the New Release in Silent Mode	16-8
Creating a Response File	16-8
Upgrading the Release in Silent Mode	16-9
Upgrading the BRM Database Schema to the New Release	16-10
Upgrading the Schema on Single-Schema Systems	16-10
Upgrading the Schema on Multischema Systems	16-11
Upgrading the Pipeline Manager Database Schema to the New Release	16-15
Adding Customizations	16-16
Post-Upgrade Procedures for the New Release	16-16
Installing Optional Components After the Release Upgrade	16-16
Rolling Back the New BRM Release	16-17

Preface

This guide provides an overview of the ways to configure an Oracle Communications Billing and Revenue Management (BRM) system. This guide also describes the system requirements and procedures for installing and configuring BRM.

This guide has been updated to include changes and new feature content added for release 15.0.1.

Audience

This guide is intended for system administrators and those involved in planning BRM systems.

Documentation Accessibility

For information about Oracle's commitment to accessibility, visit the Oracle Accessibility Program website at <http://www.oracle.com/pls/topic/lookup?ctx=acc&id=docacc>.

Access to Oracle Support

Oracle customers that have purchased support have access to electronic support through My Oracle Support. For information, visit <http://www.oracle.com/pls/topic/lookup?ctx=acc&id=info> or visit <http://www.oracle.com/pls/topic/lookup?ctx=acc&id=trs> if you are hearing impaired.

Diversity and Inclusion

Oracle is fully committed to diversity and inclusion. Oracle respects and values having a diverse workforce that increases thought leadership and innovation. As part of our initiative to build a more inclusive culture that positively impacts our employees, customers, and partners, we are working to remove insensitive terms from our products and documentation. We are also mindful of the necessity to maintain compatibility with our customers' existing technologies and the need to ensure continuity of service as Oracle's offerings and industry standards evolve. Because of these technical constraints, our effort to remove insensitive terms is ongoing and will take time and external cooperation.

Part I

Preparing for BRM Installation

This part provides information about preparing for your Oracle Communications Billing and Revenue Management (BRM) installation. It contains the following chapters:

- [BRM Installation Overview](#)
- [Planning Your Database Configuration](#)
- [System Requirements](#)

1

BRM Installation Overview

Learn about the high-level steps for installing your Oracle Communications Billing and Revenue Management (BRM) system.

Topics in this document:

- [About Planning and Installing a BRM System](#)
- [Types of BRM Systems](#)
- [Installation Overview](#)
- [Installing and Configuring a Localized Version of BRM](#)
- [Selecting the Database Character Encoding](#)

Before installing BRM, you must understand the following:

- Basic BRM concepts and system architecture. See "BRM System Overview" in *BRM Concepts*.
- Basic database administration concepts. See the Oracle database documentation.

About Planning and Installing a BRM System

To install and use BRM, you must plan your system by performing the following tasks:

- Determine the services you want to provide (for example, email, telephony, and GSM wireless).
- Determine the type of events you want to rate, how you want to rate them (for example, online rating and offline rating), and the payment type for each service (prepaid or postpaid).
- Depending on these decisions, decide on the BRM system to install and configure (typical, complete, or custom), and if you select a custom system, choose the components you want to install.
- Install BRM and the optional components.
- Configure the components to connect to the appropriate servers. For example, configure the Connection Managers (CMs) to point to the Data Managers (DMs), and the DMs to point to the database.

Each BRM component includes a configuration file, such as a **pin.conf**, **.reg**, or **.properties** file, which you edit to set the environment variables and connection parameters for the component. The configuration files include instructions for all the entries. See "Using Configuration Files" in *BRM System Administrator's Guide*.

By default, the BRM installer stores sensitive information, such as database and account passwords, in the Oracle wallet. BRM applications retrieve the passwords from the Oracle wallet.

Types of BRM Systems

The type of BRM system you install depends on your business needs and the licensing agreement you have with Oracle. For more information about BRM system architecture, see "BRM System Architecture" in *BRM Concepts*.

 **Note:**

For more information about operating system and software compatibility, see "[Overview of Hardware and Software Requirements](#)".

BRM Demonstration or Development System

For a simple demonstration system or a small application development environment, you can run all of the BRM components, including the database server, on a single computer as shown in [Figure 1-1](#).

Figure 1-1 Simple Demonstration System Configuration

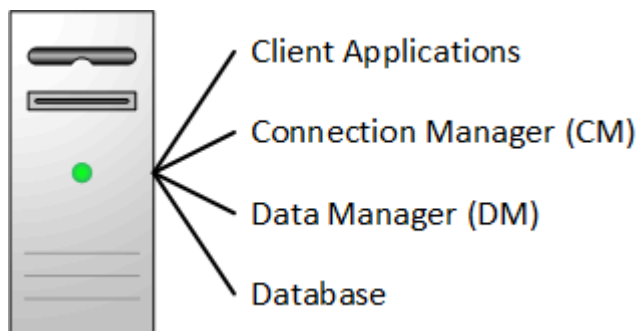

For example, you can use a demonstration system for testing your business policies and product offerings. After you create test accounts, you can generate events to ensure that your product offerings are working correctly. For final preproduction testing, however, you should use a test system that mirrors your production system configuration.

 **Note:**

A single-computer configuration is not adequate for a typical production BRM system.

BRM Production System

For best performance on a production system, you must distribute the BRM components among several computers as shown in [Figure 1-2](#).

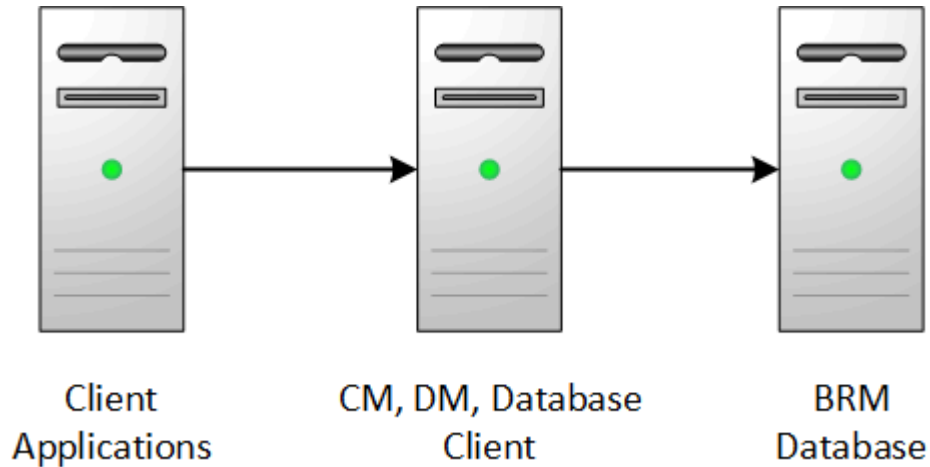
Figure 1-2 Production System Configuration

By using this basic production configuration, you can expand your BRM system to meet your production needs. You can also add components while BRM is running.

- You can set up multiple machines that each run the CM and DM to increase reliability and performance and to ensure that you continuously have at least one copy of the processes running.
- For additional reliability, you can also set up CM Master Processes (CMMPs) that route requests to an alternate CM when a CM fails. For more information on CMMPs, see "About Connection Manager Master Processes (CMMPs)" in *BRM Concepts*.
- You can use redundant subnets for CM and DM systems, and CMs and DMs can share the same subnet. The only access point is the BRM database, which can be replicated as needed.

The following examples show how you can distribute these components across multiple computers.

Small Production System

[Figure 1-3](#) shows the minimum level of distributed components. This is a typical configuration for a test deployment.

- All BRM client applications, such as Billing Care or Customer Center, are installed on the same machine.
- The CM and DM are installed on the same machine to optimize performance.
- The database client is installed on the DM machine.

Note:

If your database and DM are on separate machines, you must install the database client on the DM machine.

Figure 1-3 Minimum Level of Distributed Components

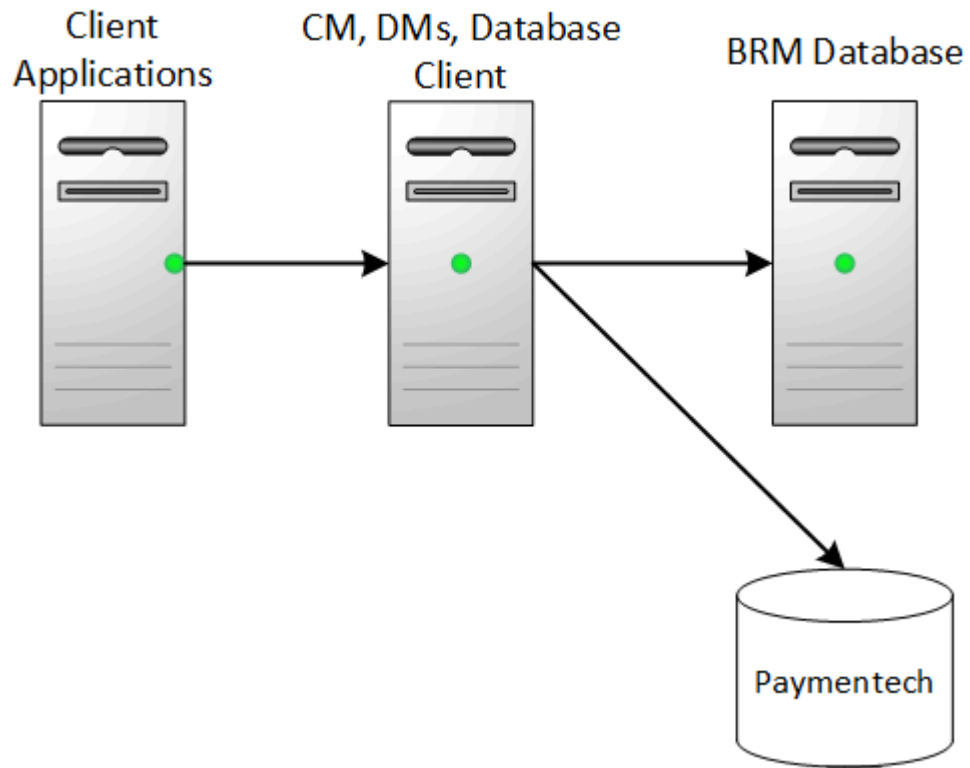

Mid-Size Production System

Figure 1-4 shows a typical mid-size production system that uses multiple machines for the CM and DM. A CMMP is added to route connections from the client applications to the different CMs.

Figure 1-4 Mid-Size Production System Distributed Components

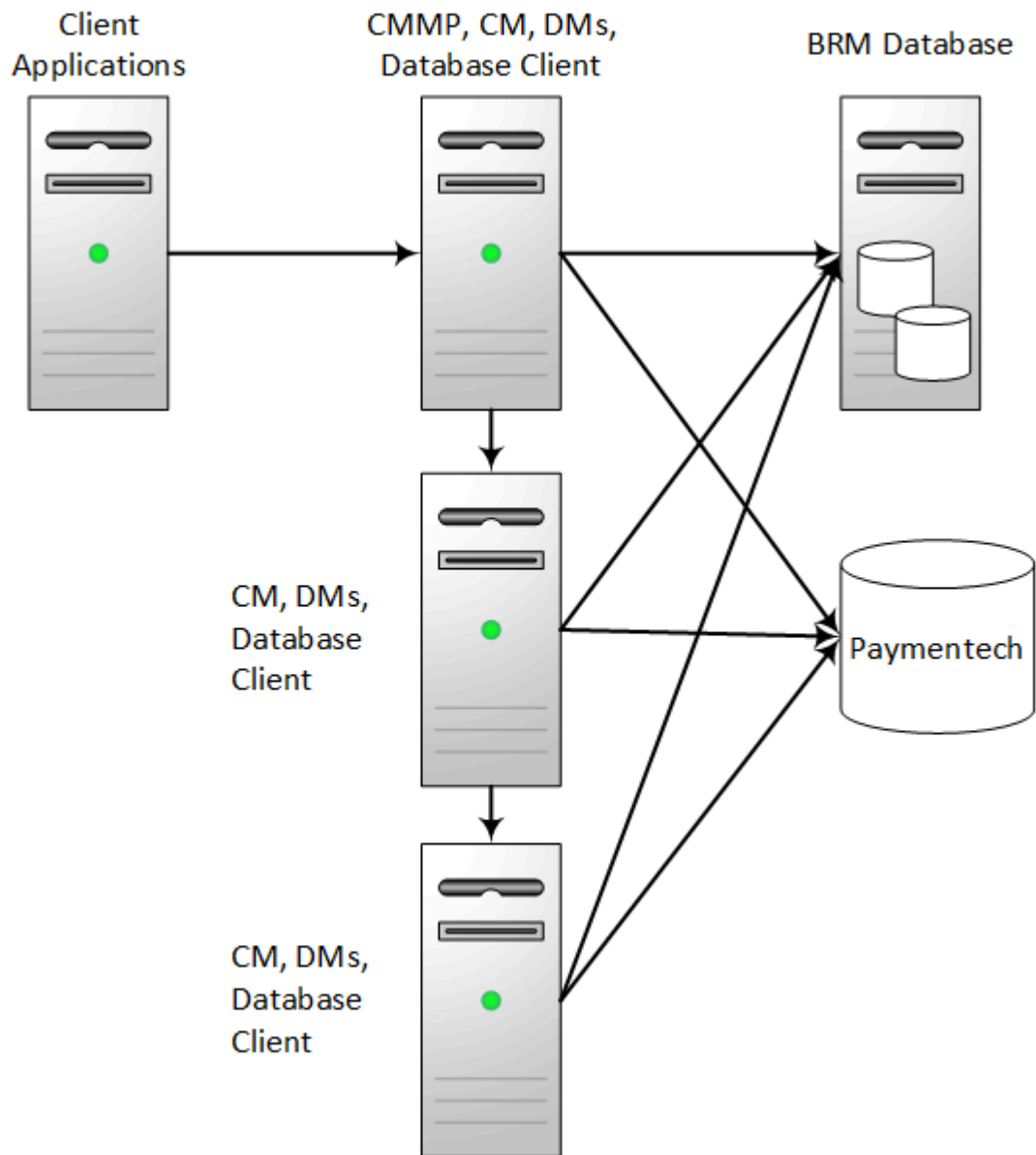

High-Availability Production System

To create a high-availability system, you must install and configure *at least* two instances of each component and then connect each instance to all instances of the appropriate servers. This ensures that if one instance of a component fails, another one is available to process data.

A BRM Multischema Production System

Although BRM works well with a single database schema for BRM data, you can improve scalability and support load balancing by distributing BRM data among multiple schemas as shown in [Figure 1-5](#).

Figure 1-5 BRM Multischema Production System

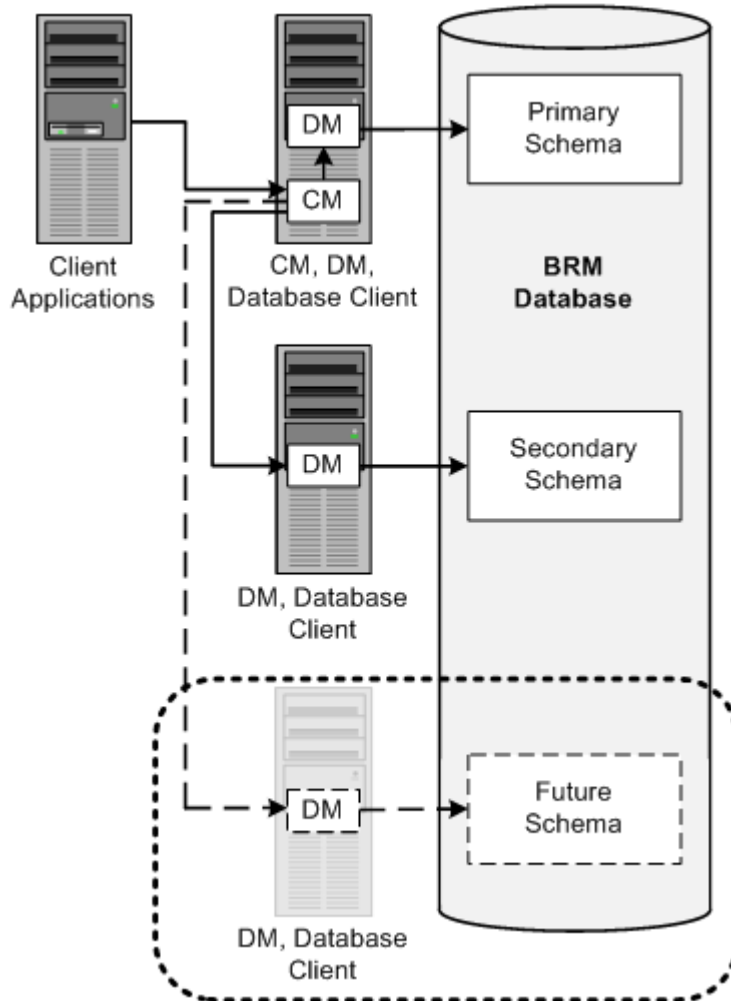

Designing the Optimal Multischema System

To optimize the benefits of a multischema system, you must decide the following when designing your multischema system:

- How to split BRM applications among multiple schemas
- How to split subscriber data among multiple schemas

To reduce contention at the primary database schema, Oracle recommends the following:

- Set every application to connect to the primary schema.

Note:

Any application or utility that directly changes the configuration data, such as PDC and Developer Center, must be connected to the primary schema.

- Distribute accounts among the secondary schemas.

In this configuration, all accounts and associated data are stored in the secondary schemas. Configuration, pricing, audit trail, and uniqueness data is stored and updated in the primary schema and then made available to the secondary schemas.

If the primary schema goes down, you can still access accounts in the secondary schemas. However, to ensure data integrity, you cannot make updates to the primary schema when it is down.

Assigning Accounts to a Database Schema

To set up account distribution for your multischema system, you must first understand that the Multidatabase Manager assigns accounts to a particular database schema based on, in order, account hierarchy, schema status, and schema priority.

Account Hierarchy

The Multidatabase Manager stores data as follows:

- All nonpaying child bill units (**/billinfo** objects) are stored in the same schema as the accounts that own their paying parent bill units.
- All sponsored accounts are stored in the same schema as their sponsor group.
- All accounts associated with a device are stored in the same schema as the device.

This is the first consideration for account storage. Therefore, even if the schema has a status of closed or unavailable, the Multidatabase Manager assigns a child account to the same schema as the parent account.

Database Schema Status

Database schemas are either open, closed, or unavailable. Open schemas are always available for account creation. At installation time, only the primary schema is set to open.

Closed schemas are not used for account creation under most circumstances. Accounts are created in a closed schema only if the account's parent, branded, or sponsoring account belongs to that schema or if all schemas are closed. If all schemas are closed, the Multidatabase Manager chooses a closed schema at random in which to create accounts and continues to create accounts in that schema until a schema becomes open. A schema's status can be manually changed to closed to limit the number of accounts created in the schema, or it can be automatically changed by the Multidatabase Manager when the schema reaches a predefined maximum limit.

Unavailable schemas are not used for account creation unless the schema contains the account's parent, sponsoring, or branded account. You can change a schema's status to unavailable at any time to suit your system requirements. You might do this, for example, to prevent accounts from being created in the primary schema.

For information on how to set the schema status, see "Setting Database Schema Status" in *BRM System Administrator's Guide*.

Database Schema Priority

Database schema priority determines when customer accounts are created on a particular schema relative to other schemas. The Multidatabase Manager assigns accounts to an open schema with the highest priority number. In the example shown in [Figure 1-6](#), the Multidatabase Manager assigns accounts to schema 3 because it has the highest priority number of all open schemas.

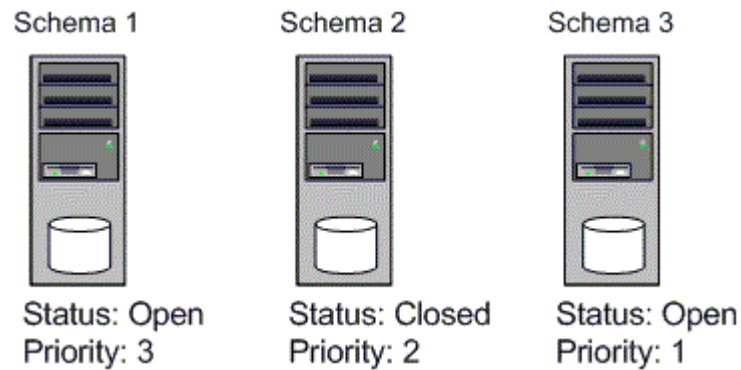
Figure 1-6 Multischema Account Creation Based on Status and Priority

If all schemas have the same priority, the Multidatabase Manager chooses an open schema at random each time it assigns an account. This distributes accounts evenly across all schemas.

For information on how to set the schema priority, see "Setting Database Schema Priorities" in *BRM System Administrator's Guide*.

Installation Overview

The BRM system uses a four-tier architecture. To set up this system, you must ensure that each component of the architecture connects to the other components. This section provides a high-level breakdown of the four-tier installation process.

Note:

This section provides guidance only on configuring the components of a BRM system. It does not discuss processes documented for the Oracle database.

To complete your four-tier BRM installation, follow these general steps:

1. Plan your installation. When planning your installation, you do the following:
 - Determine the scale of your implementation, for example, a small test system or a large production system.
 - Determine how many physical machines you need, and which software components to install on each machine.
 - Plan the system topology, for example, how the system components connect to each other over the network.
2. Review system requirements. System requirements include:
 - Hardware requirements, such as disk space
 - System software requirements, such as operating system versions
 - Information requirements, such as IP addresses and host names

See "[Overview of Hardware and Software Requirements](#)".

3. Install and configure your database.

- See "[BRM Preinstallation Tasks](#)".
4. Install and configure the BRM software.
See "[Installing BRM](#)".
 5. Install the BRM client applications.
See "[Installing BRM Thick Clients](#)".
 6. Tune the BRM software for optimal performance.
See "Improving BRM Performance" in *BRM System Administrator's Guide* and "[Planning Your Database Configuration](#)".

Installing and Configuring a Localized Version of BRM

For general information about using a localized version of BRM, see "Using BRM in International Markets" in *BRM Developer's Guide*.

Selecting the Database Character Encoding

For new BRM installations, use the appropriate database character sets when setting up your database.

For Oracle, select AL32UTF8 for the standard character set and for the national character set.



Note:

BRM supports **AL32UTF8** as its default character set. It also continues to support the **UTF8** character set for backward compatibility. The unicode character set **AL32UTF8** is recommended for all new BRM deployments.

2

Planning Your Database Configuration

Learn about guidelines for configuring your Oracle Communications Billing and Revenue Management (BRM) database.

Topics in this document:

- [Configuring Development or Demonstration System Databases](#)
- [Configuring Production System Databases](#)
- [Maintaining a BRM Database](#)

Configuring Development or Demonstration System Databases

The following information will assist you in configuring your database for a development or demonstration system.

Tablespace Mapping

In general, you do not need to map tablespaces for development or demonstration systems manually. You can use the default configuration. However, see "[Mapping Tablespaces to Logical Devices](#)" for information if you are using more than one tablespace for either tables or indexes.

For information about managing tablespaces, see "[Managing Tablespaces](#)" in *Database Administrator's Guide* in the Oracle database documentation.

Creating Tablespaces

Create the actual tablespaces before running the **pin_setup** configuration script since they require existing tablespaces. Only the two default tablespaces must be created if you have not edited the **pin_tables.values** file to assign tables to nondefault tablespaces.

Configuring init.ora Parameters for Development or Demonstration Systems

[Table 2-1](#) provides guidelines for some database and operating system configuration options specific to BRM. For information on other parameters, see the Oracle database documentation.

For information about memory configuration, see "[Tuning Database Memory](#)" in *Database Performance Tuning Guide* and "[Managing Memory](#)" in *Database Administrator's Guide* in the Oracle database documentation.

Table 2-1 Configuration Options for Development or Demonstration Systems

Configuration Options	Guidelines
log_buffer	Set the log_buffer option to approximately 2 MB. Sample value setting for the log_buffer parameter: 2621440 .

Table 2-1 (Cont.) Configuration Options for Development or Demonstration Systems

Configuration Options	Guidelines
open_cursors	A minimum number for open_cursors is 1080 . There is no penalty, however, for having this parameter set to a high value. Set open_cursors to match the value of the stmt_cache_entries entry in the DM Oracle configuration (pin.conf) file. If using a statement cache size of 1080 , for example, the stmt_cache_entries entry appears as follows in the DM pin.conf file: <code>- dm stmt_cache_entries -1080</code>
session_cached_cursors	Set the session_cached_cursors option to a nonzero value to enable the database to maintain cursors used in the repeated parsing of SQL statements. Use 150 as a starting point.
db_files	Sample value setting for the db_files parameter: 300 to 1020 .
processes	Sample value setting for the processes parameter: 320 .
db_block_size	Sample value setting for the db_block_size parameter: 8192 .

Configuring Production System Databases

For information about configuring the Oracle database, see the Oracle documentation. In particular, consult the following:

- For information about memory configuration, see "[Tuning Database Memory](#)" in *Database Performance Tuning Guide* and "[Managing Memory](#)" in *Database Administrator's Guide* in the Oracle database documentation.

The benchmark testing uses Automatic Shared Memory Management.
- For information about managing tablespaces, see "[Managing Tablespaces](#)" in *Database Administrator's Guide* in the Oracle database documentation.
- For information about configuring a high-availability system for best performance, see "[Oracle Database High Availability Best Practices](#)" in *High Availability Overview and Best Practices* in the Oracle database documentation.

The following sections contain information about configuring the database for a production system:

- [Storage Considerations, Redo, and Undo](#)
- [Estimating the Database Size](#)
- [International Version Sizing Considerations](#)
- [Selecting the Storage Model](#)
- [Creating Tablespace Storage](#)
- [Mapping Tablespaces to Logical Devices](#)
- [Creating Tablespaces](#)
- [Running Configuration Scripts to Create the BRM Database](#)

Storage Considerations, Redo, and Undo

To determine the storage device type to select, and for other storage considerations, see "[I/O Configuration and Design](#)" in *Database Performance Tuning Guide* in the Oracle database documentation.

For information about the redo log buffer, see "[Configuring the Redo Log Buffer](#)" in *Database Performance Tuning Guide* in the Oracle database documentation.

Oracle strongly recommends that you run your database in automatic undo management mode instead of using rollback segments. For more information, see "[Managing Undo](#)" in *Database Administrator's Guide* in the Oracle database documentation.

Temporary storage should be three to four times the size of the largest table (usually EVENT_T).

Estimating the Database Size

The objects that require the most storage space in a default BRM installation are accounts, bills, and events. The tables that correspond to these objects are also the ones with the most activity:

- ACCOUNT_T
- BAL_GRP_T
- BAL_GRP_BALS_T
- BAL_GRP_SUB_BALS_T
- PURCHASED_DISCOUNT_T
- PURCHASED_PRODUCT_T
- BILL_T
- BILLINFO_T
- ITEM_T
- INVOICE_FORMATS_T
- SERVICE_T

For most customers, the following event tables will be very large:

- EVENT_BAL_IMPACTS_T
- EVENT_BILLING_PRODUCT_T
- EVENT_ESSENTIALS_T
- EVENT_T

For Telco service customers, the following tables will be very large:

- EVENT_DLAY_SESS_TLCS_T
- EVENT_DLYD_SESSION_TLCO_GPRS_T
- EVENT_DLYD_SESSION_TLCO_GSM_T

Your customizations might create additional large tables. For example, if you store a lot of account profile data, the following tables will also be large:

- PROFILE_T

- PROFILE_SERV_EXTRATING_DA_T
- PROFILE_SERV_EXTRATING_T

Other tables may be large depending on your implementation. Your estimate should not include space gained by archiving.

International Version Sizing Considerations

English databases store VARCHARs as one byte per character. Localized versions of BRM can store these strings in AL32UTF8 or UTF8 format. BRM uses the AL32UTF8 character set. Character strings such as names, addresses, descriptions, and notes that can be manipulated by BRM GUI tools can vary in size. To size the database, you must determine roughly what percentage of the database consists of strings that can vary in size.

Selecting the Storage Model

Choose a storage model based on the total size of your database, which you can determine by summing your data, index, rollback, and temporary tablespaces.

- Use **Test** or **Small** for test or demonstration databases.
- Use **Large** for production databases.

You can set the storage option during installation. See "[Installing BRM](#)".

During installation, BRM tables are created using one of the storage models. Therefore, the default storage clause is not used at installation. (The default storage clause specifies the storage parameters to use if no storage clause is provided.) However, if you create custom tables, you must specify a storage clause, or else the default storage clause is used.

Creating Tablespace Storage

For information about managing tablespaces, see "[Managing Tablespaces](#)" in *Database Administrator's Guide* in the Oracle database documentation.

In our benchmark implementations, we use locally managed tablespaces with the bigfile option and Automatic Space Management (ASM). This is much easier than managing them manually. If you use the bigfile option, make sure that you monitor the file space usage so that disks don't become full. The following is a sample command to create a data file this way.

```
create bigfile tablespace tbsName DATAFILE '+DATA' SIZE tbsSizeM AUTOEXTEND
ON NEXT extentSizeM MAXSIZE UNLIMITED;
```

where *tbsName* is the name of your tablespace, *tbsSize* is the initial size of the tablespace, and *extentSize* is the size of the extents.

For more information about locally managed tablespaces, see "[Locally Managed Tablespaces](#)" in *Database Administrator's Guide* in the Oracle database documentation.

For more information about ASM, see "[Introducing Oracle Automatic Storage Management](#)" in *Administrator's Guide* in the Oracle database documentation.

If you are using Oracle RAC, for more information about managing storage, see "[Storage Considerations for Oracle Grid Infrastructure and Oracle RAC](#)" in *Grid Infrastructure Installation and Upgrade Guide for Linux* in the Oracle database documentation.

If you use Automatic Storage Management, you generally do not need to map tables to tablespaces.

However, if you want to manage tables to tablespaces, after BRM installation, you can use the **pin_tables.values** file to determine which tables map to which tablespaces. Then sum the storage required for the tablespace. This can be done for the larger tables and tablespaces. The smaller tablespaces do not need more than a few Gigabytes for their initial storage. See "[Tablespace Priorities](#)".

The size of the database, in turn, determines the minimum number of disks required for the database. Remember to consider disk space required for other purposes, for example, the operating system, BRM, log files, temporary storage, and swap files.

You should have enough disks to avoid performance bottlenecks. In addition, you can increase performance by spreading the most-used tables over multiple disks.

 **Note:**

You can add disks and logical devices at any time after BRM has been installed.

After determining the number of disks available for the database, divide the tablespaces among those disks.

Half the remaining space will be used for mirroring. Put mirrors on different disks than their corresponding tables and indexes. The number of mirror logical devices will be equal, in number and size, to their corresponding table and index logical devices.

After allocating disk space for mirrors, divide the remaining disk space using the ratio of 2:1 between tables and indexes. That is, two-thirds of the space will be used for table logical devices and one-third of the space will be used for index logical devices.

 **Note:**

The logical devices may not be the same size, because some tablespaces will be more active than others. See "[Tablespace Priorities](#)".

Create the logical devices over the remaining physical disks using the above guidelines. The next step is mapping tablespaces to logical devices.

Mapping Tablespaces to Logical Devices

In our benchmark implementations, we use locally managed tablespaces. If you use locally managed tablespaces, you do not have to manually map tablespaces to logical devices.

If you want to use it, logical-to-physical table and index mapping is defined in the *BRM_home/setup/scripts/pin_tables.values* file. This file lists 36 logical tablespaces for indexes and 36 logical tablespaces for data.

In the default BRM installation, all 72 BRM logical tablespaces map to two separate physical tablespaces: one for all the tables (`$PIN_CONF_DM_DB_TABLES_GROUP`) and one for all the indexes (`$PIN_CONF_DM_DB_INDEX_GROUP`). When you install BRM, the physical

tablespace names PIN00 and PINX00 are substituted for the configuration variable names in the file. Following is a sample line from the **pin_tables.values** file:

```
$PIN_CONF_TBLSPACE0="$PIN_CONF_TABLESPACE_ID $PIN_CONF_DM_DB_TABLES_GROUP";
```

To map logical and physical devices, you modify the entries in the right-hand column. You can edit the file before or after creating the logical devices, however, you must create logical and physical tablespaces before running the **pin_setup** script, because it uses the values in the **pin_tables.values** file.

Tablespace Priorities

BRM tablespaces are ranked according to highest level of activity. [Table 2-2](#) shows the default priority.

Table 2-2 Tablespace Priorities

Priority	Table	Index
1	tablespace5	tablespacex15
2	tablespace0	tablespacex14
3	tablespace15	tablespacex1
4	tablespace1	tablespacex0
5	tablespace6	tablespacex7
6	tablespace2	tablespacex11
7	tablespace3	tablespacex5
8	tablespace7	tablespacex12
9	tablespace4	tablespacex9
10	tablespace8	tablespacex6
11	tablespace14	tablespacex13
12	tablespace13	tablespacex2
13	tablespace12	tablespacex3
14	tablespace10	tablespacex10
15	tablespace11	tablespacex4
16	tablespace9	tablespacex8

In most cases you should not change table to tablespace mappings. Instead, change the tablespace priorities, the number of logical priorities, or both. Your goal should be to maintain the best performance based on your customizations and customer usage patterns.

To change table-to-tablespace mapping, use the same tablespace for tables whose sizes result from different conditions. In this way, tables grow at different rates, resulting in more efficient space allocation within one tablespace. If tablespaces are not large enough, they fill up and an error is returned to BRM. This usually happens with the event tables first.

For best results, 36 tablespaces have been provided for data and another 36 tablespaces for indexes in the **pin_tables.values** file. Depending on your installation size, available hardware, and the functionality you are implementing, such as using the Rated Event (RE) Loader, you may or may not use all 36 of these tablespaces for the database. BRM recommends the use of at least 18 tablespaces for data and another 16 for indexes.



Note:

If you are using RE Loader, you may need additional tablespaces for related tables.

If there are fewer than 72 logical devices, you can choose your own method to map the logical tablespaces to the smaller number of physical tablespaces. For example, you can allocate a few physical tablespaces to the highest-priority logical tablespaces, and allocate the remaining logical tablespaces using round-robin. Or, you can simply map all tablespaces using round-robin.

For example, assume that you have 6 logical devices for tables, and 4 logical devices for indexes. These 10 logical devices are mapped to 10 physical tablespaces. The two highest priority logical tablespaces are mapped to their own physical tablespaces, using the priorities defined in the priority table. The remaining 30 logical tablespaces are then mapped to the remaining tablespaces using round-robin. To do this, first assign the physical tablespace to the physical tablespace configuration variable:

```
#####
# default tablespace or filegroup names
#####
$PIN_CONF_DM_DB_TABLES_GROUP = "pin00";
$PIN_CONF_DM_DB_TABLES_GROUP1 = "pin01";
$PIN_CONF_DM_DB_TABLES_GROUP2 = "pin02";
$PIN_CONF_DM_DB_TABLES_GROUP3 = "pin03";
$PIN_CONF_DM_DB_TABLES_GROUP4 = "pin04";
$PIN_CONF_DM_DB_TABLES_GROUP5 = "pin05";
$PIN_CONF_DM_DB_INDEX_GROUP = "pinx00";
$PIN_CONF_DM_DB_INDEX_GROUP1 = "pinx01"
$PIN_CONF_DM_DB_INDEX_GROUP2 = "pinx02"
$PIN_CONF_DM_DB_INDEX_GROUP3 = "pinx03"
```

Then change the default logical tablespace to physical tablespace mapping as follows, using the priority table:

Tablespace Mapping for Data

```
$PIN_CONF_TBLSPACE0 = "$PIN_CONF_TABLESPACE_ID $PIN_CONF_DM_DB_TABLES_GROUP1";
$PIN_CONF_TBLSPACE1 = "$PIN_CONF_TABLESPACE_ID $PIN_CONF_DM_DB_TABLES_GROUP3";
$PIN_CONF_TBLSPACE2 = "$PIN_CONF_TABLESPACE_ID $PIN_CONF_DM_DB_TABLES_GROUP5";
$PIN_CONF_TBLSPACE3 = "$PIN_CONF_TABLESPACE_ID $PIN_CONF_DM_DB_TABLES_GROUP2";
$PIN_CONF_TBLSPACE4 = "$PIN_CONF_TABLESPACE_ID $PIN_CONF_DM_DB_TABLES_GROUP4";
$PIN_CONF_TBLSPACE5 = "$PIN_CONF_TABLESPACE_ID $PIN_CONF_DM_DB_TABLES_GROUP";
$PIN_CONF_TBLSPACE6 = "$PIN_CONF_TABLESPACE_ID $PIN_CONF_DM_DB_TABLES_GROUP4";
$PIN_CONF_TBLSPACE7 = "$PIN_CONF_TABLESPACE_ID $PIN_CONF_DM_DB_TABLES_GROUP3";
$PIN_CONF_TBLSPACE8 = "$PIN_CONF_TABLESPACE_ID $PIN_CONF_DM_DB_TABLES_GROUP5";
$PIN_CONF_TBLSPACE9 = "$PIN_CONF_TABLESPACE_ID $PIN_CONF_DM_DB_TABLES_GROUP3";
$PIN_CONF_TBLSPACE10 = "$PIN_CONF_TABLESPACE_ID $PIN_CONF_DM_DB_TABLES_GROUP5";
$PIN_CONF_TBLSPACE11 = "$PIN_CONF_TABLESPACE_ID $PIN_CONF_DM_DB_TABLES_GROUP2";
$PIN_CONF_TBLSPACE12 = "$PIN_CONF_TABLESPACE_ID $PIN_CONF_DM_DB_TABLES_GROUP4";
$PIN_CONF_TBLSPACE13 = "$PIN_CONF_TABLESPACE_ID $PIN_CONF_DM_DB_TABLES_GROUP3";
$PIN_CONF_TBLSPACE14 = "$PIN_CONF_TABLESPACE_ID $PIN_CONF_DM_DB_TABLES_GROUP2";
$PIN_CONF_TBLSPACE15 = "$PIN_CONF_TABLESPACE_ID $PIN_CONF_DM_DB_TABLES_GROUP2";
...
...
```

Tablespace Mapping for Indexes

```

$PIN_CONF_TBLSPACEX0 = "$PIN_CONF_TABLESPACE_ID $PIN_CONF_DM_DB_INDEX_GROUP3";
$PIN_CONF_TBLSPACEX1 = "$PIN_CONF_TABLESPACE_ID $PIN_CONF_DM_DB_INDEX_GROUP2";
$PIN_CONF_TBLSPACEX2 = "$PIN_CONF_TABLESPACE_ID $PIN_CONF_DM_DB_INDEX_GROUP3";
$PIN_CONF_TBLSPACEX3 = "$PIN_CONF_TABLESPACE_ID $PIN_CONF_DM_DB_INDEX_GROUP";
$PIN_CONF_TBLSPACEX4 = "$PIN_CONF_TABLESPACE_ID $PIN_CONF_DM_DB_INDEX_GROUP2";
$PIN_CONF_TBLSPACEX5 = "$PIN_CONF_TABLESPACE_ID $PIN_CONF_DM_DB_INDEX_GROUP2";
$PIN_CONF_TBLSPACEX6 = "$PIN_CONF_TABLESPACE_ID $PIN_CONF_DM_DB_INDEX_GROUP1";
$PIN_CONF_TBLSPACEX7 = "$PIN_CONF_TABLESPACE_ID $PIN_CONF_DM_DB_INDEX_GROUP";
$PIN_CONF_TBLSPACEX8 = "$PIN_CONF_TABLESPACE_ID $PIN_CONF_DM_DB_INDEX_GROUP3";
$PIN_CONF_TBLSPACEX9 = "$PIN_CONF_TABLESPACE_ID $PIN_CONF_DM_DB_INDEX_GROUP";
$PIN_CONF_TBLSPACEX10 = "$PIN_CONF_TABLESPACE_ID $PIN_CONF_DM_DB_INDEX_GROUP1";
$PIN_CONF_TBLSPACEX11 = "$PIN_CONF_TABLESPACE_ID $PIN_CONF_DM_DB_INDEX_GROUP1";
$PIN_CONF_TBLSPACEX12 = "$PIN_CONF_TABLESPACE_ID $PIN_CONF_DM_DB_INDEX_GROUP3";
$PIN_CONF_TBLSPACEX13 = "$PIN_CONF_TABLESPACE_ID $PIN_CONF_DM_DB_INDEX_GROUP2";
$PIN_CONF_TBLSPACEX14 = "$PIN_CONF_TABLESPACE_ID $PIN_CONF_DM_DB_INDEX_GROUP1";
$PIN_CONF_TBLSPACEX15 = "$PIN_CONF_TABLESPACE_ID $PIN_CONF_DM_DB_INDEX_GROUP";
...
...

```

The details on changing configuration variables in the configuration scripts can be found in the comments in those scripts.

Be sure to assign custom tables (new tables created for new objects that are not part of the default BRM installation) to explicit tablespaces. These can be new tablespaces that you create or existing ones. If you do not make a tablespace assignment for these tables, the new tables will go into a default tablespace which may cause performance or storage problems as the new tables grow or are accessed.

Creating Tablespaces

Create the actual tablespaces before running the **pin_setup** configuration script since they require existing tablespaces. Only the two default tablespaces must be created if you have not edited the **pin_tables.values** file to assign tables to nondefault tablespaces.

Running Configuration Scripts to Create the BRM Database

See "[BRM Preinstallation Tasks](#)" for information about creating the BRM database.

Configuring init.ora Parameters

[Table 2-3](#) provides guidelines for some database and operating system configuration options specific to BRM. For information on other parameters, see the Oracle database documentation.

For information about memory configuration, see "[Tuning Database Memory](#)" in *Database Performance Tuning Guide* and "[Managing Memory](#)" in *Database Administrator's Guide* in the Oracle database documentation.

For information about database performance tuning, see "[Oracle Database Configuration Best Practices](#)" in *High Availability Overview and Best Practices* in the Oracle database documentation.

Table 2-3 Configuration Options for Production Systems

Configuration Options	Guidelines
db_writer_processes	You can improve I/O performance by increasing the number of DB writer processes from the default, single process. Setting db_writer_processes between 5 and 10 (for the largest systems) can improve I/O throughput. If db_writer_processes is set, dbwr_io_slaves must not be specified.
DML locks	Use 5000 for DML locks for very heavy workloads. Sample value setting for the dml_locks parameter: 5000 .
freelist and pctfree	If you are using locally managed tablespaces, you do not need to set these parameters. If you are not using locally managed tablespaces, consider creating tablespaces with additional room for inserting. The storage parameters are pctfree and freelist. Although using freelists requires more disk and memory, insert speed is greatly enhanced. The default is 1. The most active tables should be in tablespaces with at least 10 – 20 freelists, depending on the size of the installation.
open_cursors	A minimum number for open_cursors is 1080 . There is no penalty, however, for having this parameter set to a high value. Set open_cursors to match the value of the stmt_cache_entries entry in the DM Oracle configuration (pin.conf) file. If using a statement cache size of 1080 , for example, the stmt_cache_entries entry appears as follows in the DM pin.conf file: - dm stmt_cache_entries -1080 The statement-handle caching performance feature requires a large number of open_cursors . Increase the open_cursors parameter to 4192 by adding the following line to the initSID.ora file. open_cursors = 4192 (minimum value: statement cache size + number of dm_backends)
session_cached_cursors	Set the session_cached_cursors option to a nonzero value to enable the database to maintain cursors used in the repeated parsing of SQL statements. Use 150 as a starting point.
processes	Sample value setting for the processes parameter: 800 .
db_block_size	Sample value setting for the db_block_size parameter: 8192 .

Using Optimization

For information about using the optimizer, see "[Influencing the Optimizer](#)" and "[Optimizer Statistics Concepts](#)" in *SQL Tuning Guide* in the Oracle database documentation.

In our benchmark implementations, we use the **ALL_ROWS** optimizer mode. For performance reasons, it is important to gather good optimizer statistics.

About Using Virtual Columns

Virtual columns are columns whose values are defined by an expression, are computed when you query the data, and are not physically stored in the database. Oracle Database supports virtual columns by default. You can use virtual columns in the BRM database.

Implementations of BRM have shown that a high percentage of the BRM database storage space can be used by the event tables. BRM can use virtual columns in a way that results in space savings for event records. To enable virtual columns in the BRM database, you convert event storable classes (**Ievent** and its subclasses) in the BRM schema. The savings in

database storage applies to event data that the system creates *after* the virtual columns are generated (not to existing event data). Virtual column functionality is transparent to BRM.

For information about virtual columns in general, see the Oracle Database documentation.

For information about generating virtual columns on BRM event tables, see "Generating Virtual Columns on Event Tables" in *BRM System Administrator's Guide*.

3

System Requirements

Learn about the hardware and software requirements for an Oracle Communications Billing and Revenue Management (BRM) system.

Topics in this document:

- [Overview of Hardware and Software Requirements](#)
- [Assigning Disks for the Operating System and for BRM](#)
- [About Network Performance](#)
- [About Oracle Exalogic and Oracle Exadata](#)
- [Additional Requirements](#)
- [Information Requirements for BRM Installation](#)



Note:

Before you configure your system, see "Improving BRM Performance" in *BRM System Administrator's Guide* and "[Planning Your Database Configuration](#)". These documents contain information about configuring hardware and software for optimal performance with BRM. They also contain a detailed description of memory configuration for the Connection Manager (CM) and Data Manager (DM).

Overview of Hardware and Software Requirements

Running BRM requires the following:

- A compatible operating system.
See "[Operating System Requirements](#)".
- Available disk space.
See "[Disk Space Requirements](#)".
- Database software.
See "[Database Requirements](#)".
- Network connections.
See "[Network Requirements](#)".

Operating System Requirements

The BRM software is available for the Linux operating system. To determine which versions of the operating system are currently supported by BRM, see "BRM Software Compatibility" in *BRM Compatibility Matrix*.

About Critical Patch Updates

Install all Critical Patch Updates as soon as possible. To download Critical Patch Updates, find out about security alerts, and enable email notifications about Critical Patch Updates, see "Critical Patch Updates, Security Alerts and Bulletins" on the Oracle website.

Disk Space Requirements

Table 3-1 shows disk space requirements for the BRM server processes:

Table 3-1 Server Disk Space Requirements

BRM System Component	Required Disk Space
BRM server	300 MB
BRM database	2 to 5 GB per 10,000 customers per year. Note: This requirement varies greatly with the number of accounts and the amount of activity.

For information on determining your database requirements, see "[Planning Your Database Configuration](#)".

Hardware Guidelines

- Use large disk controller RAM size.
- Maximize the processor cache size on the database and DM servers. For best performance, use caches that are at least 1 MB.
- In most cases, performance is best when there are approximately one and a half times as many CPUs on the CM/DM systems as on the database server system.
- The total number of CM CPUs (regardless of the number of CMs) is approximately 25% - 33% of the total number of CPUs on the database server.
- CM and DM systems need less RAM than the database system.
- CM and DM systems have very low disk requirements. Disks are needed only for the operating system, BRM software, and swap space. Two 9-GB disks on each CM or DM system is usually enough, as long as these systems are not being used for non-BRM workloads.

Two disks are recommended so that access to temp space, the operating system, swap, and BRM code are not bottlenecked on a single disk.

CM and DM RAM and Swap Guidelines

Each CM system should have at least 128 MB of RAM. Too much more than 256 MB might not add additional performance unless there are a large number of connections to the CM.

DM RAM can be lower than 512 MB for smaller installations. For larger installations with eight or more DM CPUs on a single SMP box, 512 MB to 1 GB is recommended. Heavy usage of certain business policies and large searches can greatly increase CM memory requirements.

A typical requirement for swap on a CM/DM system is two to three times the amount of RAM, but this depends upon the operating system and the number of processes running on the CM/DM system.

Database Requirements

BRM supports Oracle databases on the Linux platform.

To run BRM with an Oracle database, you need the following:

- Oracle Enterprise Edition.
- AL32UTF8 database character set.

 **Note:**

BRM supports **AL32UTF8** as its default character set. You use the Unicode character set **AL32UTF8** for all new BRM deployments.

- (Optional) Oracle Partitioning. You need this to partition the tables in your BRM database. See "Partitioning Tables" in *BRM System Administrator's Guide*.

To determine which versions of the Oracle software are currently supported by BRM, see "BRM Software Compatibility" in *BRM Compatibility Matrix*.

Network Requirements

To set up networking and communications channels, you need TCP/IP. You also need a permanent IP address for each computer that hosts a BRM process or application.

Any kind of network connection that supports TCP/IP supports BRM, for example, local area network, virtual private network, and PPP.

TCP/IP

BRM requires TCP/IP on every machine that runs a BRM component, including custom client programs.

 **Note:**

BRM also needs very large bandwidth to handle traffic between the DM and the database.

IP Addresses

Every computer that runs a BRM component, including the database server, must have its own unique IP address.

 **Note:**

BRM uses IP addresses to identify specific machines, so IP addresses cannot be dynamically allocated.

Assigning Disks for the Operating System and for BRM

Allocate separate disks for the BRM software, operating system, and operating system SWAP space. These disks should not be used for any other purpose.

About Network Performance

Any kind of network connection that supports TCP/IP supports BRM (for example, local area network, virtual private network, and PPP).

The network bandwidth needs are relatively simple. BRM has an OLTP footprint (as opposed to Decision Support). This means that transactions are normally small and network traffic will consist of smaller packets. The only requirement for network connectivity is TCP/IP. The real constraint is to have enough bandwidth between the DM systems and the database server; otherwise, the network might become a bottleneck even under moderate loads.

- Use 100BaseT or FDDI between each DM system and the database server. 10 Mbit Ethernets have too little bandwidth to handle heavy DM-to-database-server traffic. To minimize any collisions, the DM-to-database connections should use a separate physical connection (or a switch) and each of these should be a separate network.
- For switch-connected systems, connect all systems in the BRM configuration by using a single switch. For the largest configurations, use gigabit connections.
- When the development systems have multiple network cards, verify that the operating system network routing tables are configured to avoid bottlenecks. By default (depending on the system), output from the database server system may go through one LAN card, even though you have several configured, and even though input comes in through the multiple cards from different DMs. Examine and fix the routing tables as necessary. Ensure that each DM-to-database-server connection is explicit so all traffic between the two machines goes through the single dedicated physical path. The most common environment where you might find this problem is when there are multiple paths between the same sets of systems.
- For best performance, ensure all the systems in the environment are connected to the same hub with no intermediate hops.

About Oracle Exalogic and Oracle Exadata

BRM is supported on Oracle Exalogic and Oracle Exadata systems. You can install BRM server and client software on an Oracle Exalogic system (with 32-bit libraries) on Oracle Linux and the BRM database on an Oracle Exadata system.

You can install and configure the BRM database with Oracle RAC. See the Oracle Exadata documentation for more information about creating an Oracle RAC instance in Oracle Exadata.

When both Oracle Exalogic and Oracle Exadata are available and connected together using InfiniBand network, you can configure a database listener for the network to serve all connection requests from BRM.

Additional Requirements

You need additional software packages to create a complete customer management and billing solution for your business. These packages allow you to take best advantage of BRM functionality:

- Internet software
- Credit card processing software
- Tax calculation software
- Invoice formatting software
- Compilers

You need the following third-party software for installing BRM. See "BRM Software Compatibility" in *BRM Compatibility Matrix* for information about the compatible versions.

- Latest certified version of Java Platform, Standard Edition (Java SE), containing Java Development Kit (JDK) and Java Runtime Environment (JRE)

Important: To protect from security vulnerabilities, ensure you apply the latest critical patch updates. See "[About Critical Patch Updates](#)" for more information.

For information about installing Java, see "[Installing Java](#)".

- Latest certified version of Perl

For information about installing Perl, see "[Installing Perl](#)".

- Latest certified version of Apache Kafka

For instructions on installing Apache Kafka, see "[Installing Apache Kafka](#)".

For a list of other third-party software supported by BRM, see "BRM Software Compatibility" in *BRM Compatibility Matrix*.

Information Requirements for BRM Installation

This section describes the information that you will be required to provide during the BRM server installation process.



Note:

Oracle recommends that you record the values in this section for future reference.

Information Requirements for All BRM Installations

This section describes the information requirements common to all BRM server installations.

In each section that follows, you can use the **Value** column of the tables to note the values of the fields for your specific installation.

BRM File Location Details

[Table 3-2](#) lists the BRM file location details you should find out or determine before installing BRM.

Table 3-2 BRM File Location Details

Field	Description	Value
Inventory directory	The full path to the inventory directory, if it is different from the default. The default location of the Oracle inventory is in the /etc/orainst.loc directory	-
Operating system group name	The name of the operating system group that has write permission to the inventory directory	-
BRM software installation directory	The location you intend to install the BRM software	-
Prerequisite library location	Location of the ojdbc8.jar file See " Downloading the ojdbc8.jar File " for more information.	-

BRM Oracle Wallet Details

[Table 3-3](#) lists the BRM Oracle wallet details you should find out or determine before installing BRM.

Table 3-3 BRM Oracle Wallet Details

Field	Description	Value
Client wallet password	The client password for the Oracle wallet	-
Root wallet password	The root password for the Oracle wallet	-
Server wallet password	The server password for the Oracle wallet	-

BRM Database SSL Details

[Table 3-4](#) lists the BRM database SSL details you should find out or determine before installing BRM.

Table 3-4 BRM Database SSL Details

Field	Description	Value
Database SSL option	Type of SSL (one-way or two-way) supported by your database, if any	-
TrustStore type	(If your database supports SSL) The type of TrustStore file: SSO or PKCS12	-
TrustStore location	(If your database supports SSL) The directory in which the TrustStore file is located	-
TrustStore password	(If your database supports SSL) The password for the TrustStore	-
KeyStore type	(If your database supports SSL) The type of KeyStore file: SSO or PKCS12	-

Table 3-4 (Cont.) BRM Database SSL Details

Field	Description	Value
KeyStore location	(If your database supports SSL) The directory in which the KeyStore file is located	-
KeyStore password	(If your database supports SSL) The password for the KeyStore	-

BRM Database System User Details

[Table 3-5](#) lists the BRM database system user details you should find out before installing BRM.

Table 3-5 BRM Database System User Details

Field	Description	Value
Host name	The host name or IP address of the machine on which the BRM database is installed	-
Port number	The port number assigned to the BRM database service	-
Database name	The BRM database alias	-
User name	The name of the BRM database system user This user should have the following capabilities on the BRM database: create user, grant any role, grant any privileges, select any table for Enterprise edition, and DBA for XE.	-
Password	The BRM database system user password	-

BRM Database Connection Details

[Table 3-6](#) lists the BRM database connection details you should find out or determine before installing BRM.

Table 3-6 BRM Database Connection Details

Field	Description	Value
User name	The BRM database schema user name	-
Password	The BRM database schema user password	-

BRM Connection Manager Details

[Table 3-7](#) lists the BRM Connection Manager (CM) details you should determine before installing BRM.

Table 3-7 BRM Connection Manager Details

Field	Description	Value
User name	The fully qualified host name or IP address of your CM machine	-
Port number	The port number for your CM	-

Enterprise Application Integration Framework Details

[Table 3-8](#) lists the Enterprise Application Integration (EAI) framework details you should determine before installing BRM.

Table 3-8 Enterprise Application Integration Framework Details

Field	Description	Value
Port number	The port number for your EAI Manager	-

Oracle Data Manager Details

[Table 3-9](#) lists the Oracle Data Manager (DM) details you should determine before installing BRM.

Table 3-9 Oracle Data Manager Details

Field	Description	Value
Database number	The DM database number	-
Port number	The port number for your DM	-

BRM Table and Index Tablespace Details

[Table 3-10](#) lists the BRM table and index tablespace details you should determine before installing BRM.

Table 3-10 BRM Table and Index Tablespace Details

Field	Description	Value
Table tablespace	The name of your data tablespace	-
Index tablespace	The name of your index tablespace	-

Additional Information Requirements for BRM Complete Installation

This section describes the additional information requirements for a complete BRM server installation.

In each section that follows, you can use the **Value** column of the tables to note the values of the fields for your specific installation.

Oracle Connection Manager Proxy Details

[Table 3-11](#) lists the CM proxy details you should determine before installing BRM.

Table 3-11 Oracle Connection Manager Proxy Details

Field	Description	Value
Port number	The port number for your CM Proxy	-

Oracle Connection Manager Master Process Details

[Table 3-12](#) lists the CM Master Process (CMMP) details you should determine before installing BRM.

Table 3-12 Oracle Connection Manager Master Process Details

Field	Description	Value
Port number	The port number for your CMMP	-

Pipeline Schema User Details

[Table 3-13](#) lists the Pipeline schema user details you should determine before installing BRM.

Table 3-13 Pipeline Schema User Details

Field	Description	Value
User name	The name of the Pipeline schema user	-
Password	The Pipeline schema user password	-
Table tablespace	The name of the data tablespace for the pipeline schema	-
Index tablespace	The name of the index tablespace for the pipeline schema	-

BRM Schema User Details

[Table 3-14](#) lists the BRM schema user details you should find out or determine before installing BRM.

Table 3-14 BRM Schema User Details

Field	Description	Value
User name	The name of the BRM database schema user	-
Password	The BRM database schema user password	-
Table tablespace	The name of your BRM data tablespace	-
Index tablespace	The name of your BRM index tablespace	-

Part II

Installing BRM

This part describes how to install Oracle Communications Billing and Revenue Management (BRM) server and client components. It contains the following chapters:

- [BRM Preinstallation Tasks](#)
- [Installing BRM](#)
- [BRM Postinstallation Tasks](#)
- [Installing a Multischema System](#)
- [Installing BRM Thick Clients](#)
- [Installing Pipeline Configuration Center](#)
- [Installing BRM REST Services Manager](#)
- [Troubleshooting the BRM Installation](#)
- [Installing Multiple BRM Instances on One System for Testing](#)
- [Uninstalling BRM](#)

4

BRM Preinstallation Tasks

Learn about the tasks to perform before installing the Oracle Communications Billing and Revenue Management (BRM) system.

To install BRM, you need the following:

- A directory with sufficient space for the BRM software (at least 440 MB).
- A user ID, such as **pin**, with the privileges to access the files under your BRM home directory and to run BRM and third-party applications.
- The BRM-related information that you noted when installing your database.
See "[About Capturing Information When Installing the Oracle Database Software](#)".

You must also perform the following tasks:

- [Installing the Database](#)
- [Installing Third-Party Tools](#)
- [Preparing the Environment](#)

The person installing BRM should be familiar with the following:

- Linux commands and the Linux operating system
- Database installation and configuration
- Network Management Systems
- SQL*Plus
- A Linux text editor, such as **vi** or **nano**

Installing the Database

Learn how to install and configure the database to work with the Oracle Communications Billing and Revenue Management (BRM) system.

Topics in this document:

- [Collecting Information Before Installing the Oracle Database Software](#)
- [Before Installing Oracle Database Software](#)
- [Installing and Configuring Your Oracle Database: Task List](#)
- [Installing the Database and Oracle DM on Separate Machines](#)
- [Modifying Your Oracle Database Installation](#)

The person installing and configuring the Oracle database should be familiar with the following:

- Linux commands and the Linux operating system
- Database installation and configuration
- Network Management Systems
- SQL*Plus

- A Linux text editor, such as **vi** or **nano**

Collecting Information Before Installing the Oracle Database Software

You will need the following documents while installing and configuring the Oracle database software:

- Oracle documentation:
 - Oracle installation documentation for Linux.
 - The current release notes for your Oracle software.
 - The Oracle Administrator's Guide for instructions about configuring the network.
- A Linux operating system reference guide.

About Capturing Information When Installing the Oracle Database Software

As you install the Oracle software, record the following important information. You will need this information later, when you install BRM.

- Host name of the Oracle database instance.
- IP address of the Oracle database instance.
- Port number of the Oracle database instance.
- User login name and password.
- SID for the BRM database name (the BRM default is **pindbhostname**).
- Oracle database alias/Global Database Name (for example, **pindbhostname.example.com**).

See the tables in "[Information Requirements for BRM Installation](#)" for more information about the information that should be collected.

Before Installing Oracle Database Software

Before installing the Oracle database software on your system, verify the following:

- Your system meets the minimum hardware and software requirements.
See "[System Requirements](#)".
- You have all the software required to run BRM with an Oracle database.
See "[Database Requirements](#)".
- You planned your Oracle database according to the guidelines in "Improving BRM Performance" in *BRM System Administrator's Guide* and "[Planning Your Database Configuration](#)".

Installing and Configuring Your Oracle Database: Task List

Installing and configuring your Oracle database for BRM includes these major tasks:



Note:

This list is not a substitute for the Oracle documentation or the most recent release notes for the database.

1. [Installing the Oracle Database Software](#)
2. [Creating your BRM Database](#)
3. [Setting Environment Variables for the Database](#)
4. [Setting Up Your Database for BRM](#)
5. (Optional) [Setting Up Oracle RAC](#)

Installing the Oracle Database Software

Install the Oracle database software according to the instructions in the Oracle documentation. When you install the software, pay particular attention to the following requirements.

- Install the **Oracle Enterprise Edition**.
- Choose a **Customized** installation. This option lets you configure Oracle with the AL32UTF8 database character set.



Note:

If you installed your database before referring to this document and used the **Complete** installation option, your database might have been installed with another character set. See "[Modifying Your Oracle Database Installation](#)" for information on how to modify your existing database.

- To configure discounts in BRM, install the following Oracle components:
 - **Oracle XML DB**. For more information, see the Oracle documentation.
 - **Oracle XML Developer's Kit (XDK)**. For more information, see the Oracle documentation.
- Install Oracle JServer as part of the Oracle Database installation.
- To partition the tables in your BRM database, you must install the **Oracle Partitioning** component. See "Partitioning Tables" in *BRM System Administrator's Guide*.

Creating your BRM Database

Create your database by using the Oracle Database Configuration Assistant, which can be started automatically by the Oracle installer or started manually. If you start it manually, choose the **Custom** option.

 **Note:**

BRM supports **AL32UTF8** as its default character set. It also continues to support the **UTF8** character set for backward compatibility. The unicode character set **AL32UTF8** is recommended for all new BRM deployments.

As you create your database, pay particular attention to the following:

- Specify a **Global Database Name** using the format *DatabaseName.DomainName*, where *DatabaseName* is the database name and *DomainName* is the network domain in which the database is located. For example, **pindbhostname.example.com**. Most BRM databases use a *DatabaseName* of **pindbhostname**, but you can use another name.

 **Note:**

You can modify your machine's default domain name in the **\$ORACLE_HOME/network/admin/sqlnet.ora** file. For information, see your Oracle documentation.

- Specify a **System Identifier (SID)** for your database. For clarity, it should be the same as your Oracle database name. Most BRM databases are named **pindbhostname**, but you can use another name.
 - Set the **Character Set** to **AL32UTF8**.
 - Set the **National Character Set** to **AL16UTF16**.

For detailed instructions on how to create your database, see the Oracle documentation.

Setting Environment Variables for the Database

Set the environment variables shown in [Table 4-1](#).

Table 4-1 Environment Variables

Environment Variable	Value
LD_LIBRARY_PATH	\$ORACLE_HOME/lib
NLS_LANG	American_America.AL32UTF8 You must use American_America as the language and territory, regardless of your locale, and the UTF8 or AL32UTF8 character set.
TNS_SERVICE_NAME	Set this to the service name of your primary database.

Setting Up Your Database for BRM

For development or demonstration systems, you have the option to configure your database manually or let the BRM installer configure your database automatically. For production systems, you should configure your database manually. Set up your database using one of the following options:

- [Using the BRM Installer to Configure Your Database for Demonstration Systems](#)

- [Configuring Your Database Manually for Demonstration Systems](#)
- [Configuring Your Database Manually for Production Systems](#)

Using the BRM Installer to Configure Your Database for Demonstration Systems

The BRM installer provides the option to automatically configure your database for demonstration or development systems. The installer configures your database by creating one data, one index, and one temporary tablespace; creating the BRM user; and granting connection privileges to the BRM user. If you want the BRM installer to configure your database, your Oracle installation is complete and you can go directly to "[Installing BRM](#)".

Configuring Your Database Manually for Demonstration Systems

To configure your database so that it uses additional or larger tablespaces, you can perform the following general tasks:

- [Creating BRM Tablespaces](#)
- Creating the BRM user: see "[Creating and Configuring pin_user](#)" for details



Note:

You can also create the additional tablespaces and the BRM user during the BRM server installation.

Creating BRM Tablespaces

For a simple demonstration BRM system, you must create a minimum of three tablespaces for BRM. The following section shows the steps required to create the following tablespaces:

- **pin00** (for data)
- **pinx00** (for indexes)
- **PINTEMP** (for a temporary tablespace)

To create your tablespaces:

1. Create a directory for the tablespaces, such as **/u02/oradata/pindb**.

This directory is referred to as *table_location*.

2. Connect to the Oracle database with SQL*Plus:

```
% sqlplus system@DatabaseAlias
Enter password: password
```

3. Create the data, index, and temporary tablespaces, making sure:

- Data tablespaces are at least 600 MB with an extent ("next") size of 64 KB.
- Index tablespaces are at least 400 MB with an extent size of 64 KB.
- Temporary tablespaces are at least 100 MB with an extent size of 64 KB.

```
SQL> create tablespace pin00 datafile 'table_location/pin00.dbf'
      size 600M reuse autoextend on extent management
      local uniform size 64K segment space management auto;
```

Tablespace created.

```
SQL> create tablespace pinx00 datafile 'table_location/pinx00.dbf'
      size 400M reuse autoextend on default
      storage( initial 64K next 64K pctincrease 0 );
```

Tablespace created.

```
SQL> create temporary tablespace PINTEMP tempfile
      'table_location/PINTEMP.dbf'
      size 100M reuse autoextend on maxsize unlimited
      storage(initial 64K next 64K pctincrease 0);
```

Tablespace created.

Configuring Your Database Manually for Production Systems

To create a production system, you must create multiple tablespaces for the BRM data and indexes. For information on how to estimate your database size, create multiple tablespaces, and map the tablespaces to BRM tables, see ["Planning Your Database Configuration"](#).

Setting Up Oracle RAC

To configure Oracle RAC:

1. Set up an Oracle RAC instance for each database schema that you plan to create.
For more information, see your Oracle RAC documentation.
2. Configure Oracle database services.
See ["Configuring Oracle Database Services"](#).
3. Add entries for the Oracle database services to all **tnsnames.ora** files that will be referenced by the Oracle DMs in your system.
See ["Defining Connections to the Oracle Database Services"](#).

Configuring Oracle Database Services

You use Oracle database services to connect Oracle DMs to Oracle RAC instances. You must map each database service to one Oracle RAC instance.

Note:

Oracle RAC systems are typically configured for high availability, so a backup Oracle RAC instance is included in the examples in this section. The backup instance is not required, however, for a multischema system.

For example, for a single-schema system with two RAC instances, configure the database services as shown in [Table 4-2](#).

Table 4-2 Example Database Service Configuration (Single Schema)

Database Service	Oracle RAC Instance	Backup Oracle RAC Instance for High Availability
Service1	Oracle RAC instance 1	Oracle RAC instance 2

To create the services in [Table 4-2](#), log on to any Oracle RAC node as the Oracle database administrator, and run the following command:

```
srvctl add service -d racDatabaseName -s service1 -r racInstanceName1 -a
racInstanceName2 -P Basic
```

For a multischema system, the following example shows the setup for a system with four database schemas and five Oracle RAC instances. In this case, configure the database services as shown in [Table 4-3](#).

Table 4-3 Example Database Service Configuration (Multischema)

Database Service	Oracle RAC Instance	Backup Oracle RAC Instance for High Availability
Service1	Oracle RAC instance 1	Oracle RAC instance 5
Service2	Oracle RAC instance 2	Oracle RAC instance 5
Service3	Oracle RAC instance 3	Oracle RAC instance 5
Service4	Oracle RAC instance 4	Oracle RAC instance 5

To create the services in the preceding table, log on to any Oracle RAC node as the Oracle database administrator, and run the following commands:

```
srvctl add service -d racDatabaseName -s service1 -r racInstanceName1 -a
racInstanceName5 -P Basic
srvctl add service -d racDatabaseName -s service2 -r racInstanceName2 -a
racInstanceName5 -P Basic
srvctl add service -d racDatabaseName -s service3 -r racInstanceName3 -a
racInstanceName5 -P Basic
srvctl add service -d racDatabaseName -s service4 -r racInstanceName4 -a
racInstanceName5 -P Basic
```

For information about the **srvctl** command, see your Oracle RAC documentation.

Defining Connections to the Oracle Database Services

Perform the following procedure in the appropriate **tnsnames.ora** files.

To define connections to the Oracle database services:

1. Open the **tnsnames.ora** file in a text editor.
By default, that file is in the *Oracle_home/network/admin/* directory.
2. For each database service, add the following connect descriptor:

```
connectionString =
  (DESCRIPTION =
    (ADDRESS = (PROTOCOL = TCP) (HOST = primaryRacInstanceHostName) (PORT =
oraHostPortNo)
    (ADDRESS = (PROTOCOL = TCP) (HOST = backupRacInstanceHostName) (PORT =
oraHostPortNo)
    (LOAD_BALANCE = OFF)
    (CONNECT_DATA =
      (SERVER = DEDICATED)
      (SERVICE_NAME = serviceName)
      (FAILOVER_MODE =
        (TYPE = SELECT)
```

```

        (METHOD = BASIC)
        (RETRIES = 180)
        (DELAY = 5)
    )
)
)

```

where:

- *connectionString* is the connection name.

 **Note:**

The **sm_database** entry in the Oracle DM **pin.conf** file must match this entry. See "[Completing the Installation](#)" for single-schema systems or "[Installing BRM on the Primary Installation Machine](#)" and "[Installing BRM on a Secondary Installation Machine](#)" for multischema systems.

- **ADDRESS** defines a single listener protocol address. Add an entry for the primary Oracle RAC instance's listener and the backup Oracle RAC instance's listener.
- *primaryRacInstanceHostName* is the name of the computer on which the service's primary Oracle RAC instance resides.
- *backupRacInstanceHostName* is the name of the computer on which the service's backup Oracle RAC instance resides.
- *oraHostPortNo* is the port number for the Oracle database on the host computer. Typically, this number is 1521.
- **LOAD_BALANCE** specifies whether to distribute connection requests across the listeners specified in the **ADDRESS** entries. For high-availability BRM systems, set this to **OFF**.
- *serviceName* specifies the name of the database service.

 **Note:**

The **sm_svcname** entry in the Oracle DM **pin.conf** file must match this entry. It should match the **SERVICE_NAME** entry in the connect descriptor specified in the **connectionString** above.

- For **FAILOVER MODE**,
 - TYPE = SELECT** specifies that work in progress is not lost when failover occurs from the primary to the backup Oracle RAC node.
 - METHOD = BASIC** specifies that applications connect to a backup Oracle RAC node only *after* their connection to the primary Oracle RAC node fails. Backup connections are not established ahead of time.

 **Note:**

The **ADDRESS** line for the backup instance is not required if you do not have a backup instance.

3. Save and close the file.

Installing the Database and Oracle DM on Separate Machines

If you are installing your Oracle database and Oracle DM on separate machines, you must perform the following on the machine containing the Oracle DM:

1. Install the Oracle database client. For the list of supported database clients, see "BRM Software Compatibility" in *BRM Compatibility Matrix*.

 **Note:**

For BRM installation to be successful:

- Install the same version of the database server and database client software.
- Install the 64-bit version of the Oracle database client.

2. Modify the `Oracle_home/network/admin/tnsnames.ora` file to include entries for connecting to your BRM database.

 **Note:**

If you are installing the BRM server and Pipeline Manager on separate machines, ensure that you include the database alias for connecting to the BRM database and the Pipeline Manager database in the `Oracle_home/network/admin/tnsnames.ora` file. The database alias for each database must be unique.

3. Use SQL*Plus to ensure that you can connect to your database.

For information, see the Oracle database software documentation.

Modifying Your Oracle Database Installation

If you installed your Oracle database before referring to this document and accepted the default options, your database installation might have defaulted to an unsupported character set. If this occurred, you must move your data to a database installation that supports the AL32UTF8 or the UTF8 character set. By default, BRM uses the AL32UTF8 character set.

 **Note:**

After you create a database, you *cannot change* the character set.

To export your existing data to a database installation that supports the AL32UTF8 character set:

1. Back up your existing database. See your Oracle documentation for details.
2. Uninstall your existing database. See your Oracle documentation for details.
3. Create a new Oracle database that supports the AL32UTF8 character set.
See "[Creating your BRM Database](#)".
4. Use the Oracle Import utility to import your existing data to the new database.
See your Oracle documentation for more information.

Installing Third-Party Tools

To install BRM, you need to perform the following tasks:

- [Installing Java](#)
- [Installing Perl](#)
- [Installing Apache Kafka](#)

Installing Java

Install Java Platform, Standard Edition (Java SE), containing Java Development Kit (JDK) and Java Runtime Environment (JRE). JRE is required for the BRM installation. It is not included in the BRM software pack.

See "BRM Software Compatibility" in *BRM Compatibility Matrix* for the compatible version of Java.

For instructions on installing Java, see Oracle Java documentation.

Installing Perl

Perl is required for the BRM installation. It is not included in the BRM software distribution.

See "BRM Software Compatibility" in *BRM Compatibility Matrix* for the compatible version of Perl.



Note:

Ensure you compile Perl on the version of Linux specified in "Linux" in *BRM Compatibility Matrix*.

Before installing Perl (64-bit) on Linux, do the following:

1. Set the environment variables for installing Perl by running the following command:

- For Bash shell:

```
export -n PATH
export -n LD_LIBRARY_PATH
export PATH=/usr/bin:/usr/local/bin:/bin
```

- For C shell:

```
unsetenv PATH
unsetenv LD_LIBRARY_PATH
setenv PATH /usr/bin:/usr/local/bin:/bin
```

To install Perl on Linux:

1. Download the source code for the compatible version of Perl to a temporary directory (*temp_dir*).

See *BRM Compatibility Matrix* for the compatible version of Perl.

2. Go to the *temp_dir* directory and unzip the source code by running the following command:

```
gunzip perl-version.tar.gz
tar -xf perl-version.tar
```

where *version* is the compatible version of Perl.

3. Run the following command:

```
cd perl-version
sh Configure-des
    -Accflags=-fPIC -Dcc="gcc -m64 -D_FORTIFY_SOURCE=1" -Dusethreads -
Duserelocatableinc
    -Dprefix='perl_path'
```

where *perl_path* is the path to the directory in which you want to install Perl.

Note:

If you receive errors, use this command instead, which unsets the `LD_LIBRARY_PATH` variable:

```
sh Configure -des
    -Dcc="gcc -m64 -D_FILE_OFFSET_BITS=64-D_LARGE_FILE_SOURCE=1" -
Dusethreads -Dusemorebits
    -Uselargefiles -Duserelocatableinc -Dprefix='perl_path'
```

4. Run the following make commands:

```
make
make test
make install
```

5. Verify the Perl version by running the following command:

```
Perl -v
```

The Perl version is displayed.

If the latest version of Perl certified with BRM is not displayed, the latest Perl is not installed.

Installing Apache Kafka

Install the latest compatible version of Apache Kafka, which is required for the BRM installation. It is not included in the BRM software pack.

For the latest compatible version, see "BRM Software Compatibility" in *BRM Compatibility Matrix*.

For instructions on downloading and installing Kafka, see "[Apache Kafka Quickstart](#)" on the Apache Kafka website.

Preparing the Environment

You need to perform the following tasks before installing BRM:

- [Downloading the ojdbc8.jar File](#)
- (Optional) [Creating and Configuring pin_user](#)
- [Setting the Environment Variables for Installation](#)
- [Setting BRM Wallet Location in sqlnet.ora](#)

Downloading the ojdbc8.jar File

Download the **ojdbc8.jar** file and save it in a directory on the machine on which you want to install BRM. Note the path to this directory; you are required to specify this path in the Specify Prerequisite Libraries Location window during the BRM installation.

You can download **ojdbc8.jar** from the following location:

<https://www.oracle.com/database/technologies/appdev/jdbc-downloads.html>

Creating and Configuring pin_user

You can create *pin_user* before installing BRM or during the BRM installation process. If you create *pin_user* before you install BRM, you must grant execute permission to *pin_user* as well.

Create a new BRM user who can access the Oracle database. The Oracle Data Manager (DM) gains access to the Oracle database by using this Oracle user. This Oracle user owns all the tables created and used by BRM. Usually, the BRM database is set up with the user name **pin**, but you can choose another name.



Note:

If you are installing a multischema system, the primary and secondary database schemas must *not* use the same user name. If they do, multischema installation will fail.

To create and configure the BRM user:

1. Log in to your database as user **sysdba**:

```
% sqlplus system@databaseAlias AS SYSDBA
Enter password: password
```

where:

- *password* is the Oracle system database user password.
- *databaseAlias* is the Oracle system database alias.

2. Create the Oracle user *pin_user* (for example, **pin**), grant the user the resource to connect to Oracle and set the default tablespaces:

```
create user pin_user identified by password;  
grant resource, connect to pin_user;  
alter user pin_user default tablespace data_ts;  
alter user pin_user temporary tablespace temp_ts;
```

3. Grant execute privileges to *pin_user*:

```
grant unlimited tablespaces to pin_user;  
grant alter session to pin_user;  
grant execute on dbms_lock to pin_user;  
grant execute on dbms_aq to pin_user;  
grant execute on dbms_aqadm to pin_user;  
grant select on sys.gv_$aq to pin_user;  
grant select on v_$session to BRM_user;  
grant select on sys.dba_2pc_pending to pin_user;  
grant create synonym, create any synonym, create public synonym, drop  
public synonym, create view, create sequence, create table, create any  
index, create procedure to pin_user;
```

 **Note:**

If this user is the user for a secondary schema in a multischema installation, you must also run the following command:

```
grant select any table to pin_user;
```

4. Type **exit** to exit SQL*Plus.

Setting the Environment Variables for Installation

Before installing BRM, you must set the environment variables for BRM and the Java, Perl, and (if used) Apache Kafka software. For information about the latest compatible versions of Java, Perl, and Kafka, see "BRM Software Compatibility" in *BRM Compatibility Matrix*.

You must also set the environment variables required by the database. See "[Setting Environment Variables for the Database](#)" for details.

To set the environment variables, perform the following for all users you are going to use to install or run the BRM server:

1. Set the **PIN_HOME** environment variable to the location you intend to install BRM:

```
setenv PIN_HOME install_path
```

where *install_path* is the path to the directory in which you are planning to install BRM.

2. Set the **JAVA_HOME** environment variable to the directory in which the latest version of Java certified with BRM is installed by running the following command:

```
setenv JAVA_HOME java_path
```

where *java_path* is the path to the directory in which the latest version of Java certified with BRM is installed; for example `/Linux/x86_64/packages/jdk/jdk1.8.0_381`.

3. Verify the Java version by running the following command:

```
java -version
```

The Java version is displayed.

If the latest version of Java certified with BRM is not displayed, the latest Java version is not installed in the directory specified by `JAVA_HOME`.

4. Set the `PERL_HOME` environment variable:

```
setenv PERL_HOME Perl_path
```

where *Perl_path* is the path to the directory in which the latest version of Perl certified with BRM is installed; for example `/perl_5_36.0/linux`.

5. Set the `PATH` environment variable:

```
setenv PATH $JAVA_HOME/bin:$PERL_HOME/bin:${PATH}
```

6. Set the `HOSTNAME` environment variable:

```
setenv HOSTNAME hostName
```

where *hostName* is the fully qualified domain name of the machine on which you want to install the BRM server.

7. If your BRM client wallet is not stored in the default location, set the `BRM_CONF_WALLET` and `BRM_WALLET` environment variables to point to the directory in which the BRM client wallet is stored:

```
setenv BRM_CONF_WALLET brm_wallet_path  
setenv BRM_WALLET brm_wallet_path
```

8. If you will be using the Kafka Data Manager (DM), set the Kafka environment variables::

```
setenv KAFKA_HOME Kafka_path  
setenv KAFKA_BOOTSTRAP_SERVER_LIST KafkaHost1:port1,KafkaHost2:port2
```

where:

- *Kafka_path* is the path to the directory in which the Kafka library JARs are installed.
- *KafkaHost1:port1,KafkaHost2:port2* are the hosts and ports that the Kafka client will connect to in a bootstrap Kafka cluster the first time it starts. You can specify any number of hosts and ports in this list.
You can alternatively set this list in the `dm_kafka_config.xml` after installing BRM. See "Mapping Business Events to Kafka Topics" in *BRM Developer's Guide*.

Setting BRM Wallet Location in `sqlnet.ora`

By default, the BRM client wallet is stored in the `BRM_home/wallet/client` directory. If it is stored in a different location, update the `sqlnet.ora` file accordingly.

To set the BRM client wallet location in the **sqlnet.ora** file:

1. Open the **sqlnet.ora** file on the BRM machine. The file is located in the directory specified by \$TNS_ADMIN (typically **\$ORACLE_HOME/network/admin**).
2. Add these entries:

```
SQLNET.WALLET_OVERRIDE = TRUE
WALLET_LOCATION= (
  SOURCE= (METHOD=FILE)
    (METHOD_DATA= (DIRECTORY=brm_wallet_path))
)
```

where *brm_wallet_path* is the path to the directory in which the BRM client wallet is stored.

3. Save and close the file.

5

Installing BRM

Learn about installing the Oracle Communications Billing and Revenue Management (BRM) software on Linux.

Topics in this document:

- [About the BRM Installation Package](#)
- [Installing BRM: Task List](#)
- [Downloading the BRM Software](#)
- [Installing BRM in GUI Mode](#)
- [Installing BRM in Silent Mode](#)
- [Completing the Installation](#)

This chapter is for network administrators, database administrators, and engineers who install and configure the BRM software. The person installing the software should be familiar with the following topics:

- Linux administration commands and the Linux operating system
- Database configuration
- Network system management

About the BRM Installation Package

The BRM installation package includes the BRM server and BRM client packages. The BRM server package includes all the required and optional BRM server components and applications. You can use the Installer to install one or more of the following individual BRM server components:

- Typical BRM server components. The following are the most commonly used BRM server components:
 - Connection Manager (CM)
 - Oracle Data Manager (DM)
 - Batch Controller
 - Billing and Invoicing utilities
- Connection Manager (CM) Proxy
- Connection Manager (CM) Master Process (CMMP)
- Invoice Data Manager

Before you install the Invoice Data Manager, make sure you have a separate database schema installed and available to use for storing invoices.

- Kafka Data Manager
- Provisioning Data Manager
- Email Data Manager

- BRM Optional Managers

You can install BRM with the following optional managers:

 **Note:**

You must install the CM and DM before or at the same time as installing the optional managers. Also, make sure that you install the optional managers on the same machine where the CM is installed.

- Account Migration Manager (AMM)
- BRM Services Framework Manager
- BRM SDK

You can install BRM SDK independent of the BRM server, making it possible to isolate development activities from production servers. For example, you can install BRM SDK on each of the computers used by BRM developers at your site. These developers can share access to test and production BRM servers. However, there are some advantages of installing the BRM SDK on BRM servers. For example, installing the SDK on your BRM server gives you access to sample applications that are not included in the server installation.

- Conversion Manager
- Collections Manager

The BRM Collections Manager server components include opcodes, utilities, and storable classes.

- Content Manager
- EAI Manager

To ensure proper load balancing on your BRM system, you can install EAI Manager on a different machine. However, you must install this on the same machine where the CM is installed.

- Event Extraction Manager
- GPRS Manager
- GSM Manager
- Inventory Manager
- IP Address Manager
- JCA Resource Adapter
- LDAP Manager
- MultiDB manager
- Number Manager
- Paymentech Manager
- Partition Upgrade Manager
- Performance Manager
- Revenue Assurance Manager
- Rated Event Loader

- SIM Manager
- Roaming Settlement Package
- Suspense Manager
- Vertex Manager
- Voucher Manager
- Web Services Manager

Oracle recommends that you install Web Services Manager on the machine on which the typical BRM server components are installed. You must also increase the heap size used by the Java Virtual Machine (JVM) before installing Web Services Manager to avoid "Out of Memory" error messages in the log file.

- BRM Reports
- BRM Reports Optional Managers

You can install BRM Reports with the following optional managers:

- MultiDB Reports
- Collections Reports
- Content Manager Reports
- GPRS Reports
- Number Manager Reports
- Revenue Assurance Reports
- Roaming Reports
- SIM Card Manager Reports
- SMS Reports
- Suspense Reports
- Voucher Reports

- BRM Invoices
- Pipeline Manager
- Pipeline Manager Optional Managers

You can install Pipeline Manager with the following optional managers:

- CIBER Roaming Manager
- Interconnect Manager
- Pipeline Configuration Manager
- Pipeline PDK Manager
- TAP Roaming Manager

For information on the BRM client application package, see "[Installing BRM Thick Clients](#)".

Installing BRM: Task List

BRM installation must be performed by a user who has permissions to write to the **oralInventory** directory.

To install the BRM software:

1. Download the BRM package and extract its contents. See "[Downloading the BRM Software](#)".
2. Install the BRM software in either GUI mode or silent mode. Installing BRM in silent mode lets you perform a non-interactive installation of BRM. You can use silent mode to install BRM quickly.
 - [Installing BRM in GUI Mode](#)
 - [Installing BRM in Silent Mode](#)
3. Check your configuration entries and Oracle wallet. See "[Completing the Installation](#)".

Downloading the BRM Software

You can download the BRM software from one of the following locations:

- For BRM 15.0.0 or any 15.0.x maintenance release: From the Oracle software delivery website (<https://edelivery.oracle.com>)
- For any 15.0.x.y patch set release: From the Oracle support website (<https://support.oracle.com>)

Search for and download the **Oracle Communications Billing and Revenue Management 15.0.x.y.0** software, where *x* refers to the maintenance release and *y* refers to the patch set release of BRM that you are installing.

The Zip archive includes the installer: **brmsvr_15.0.x.y.0_linux_generic_full.jar**

Installing BRM in GUI Mode

For information about installing BRM in GUI mode, please see the following topics:

- [Starting the BRM GUI Installer](#): All users should read this section.
- [Installing a Typical BRM System](#): Read this section if you want to install only the default BRM components (**Typical** installation type. Recommended for non-production systems).
- [Installing All BRM Components](#): Read this section if you want to install all BRM components (**Complete** installation type).
- [Installing Individual BRM Components](#): Read this section if you want to select the BRM components to install (**Custom** installation type). "[Installing CM and DM on Separate Machines](#)" describes a special case of this type of installation.

Note:

If you are installing BRM to replace an identical release (for example, to restore a clean version of the package), you must first uninstall the existing installation. See "[Uninstalling BRM](#)".

Starting the BRM GUI Installer

To start the BRM GUI installer, go to the directory where you downloaded the BRM software and run the following command:

```
Java_home/bin/java -jar jarFile[ -invPtrLoc invPath/oraInst.loc][ -record -  
destinationFile respPath]
```

where:

- *Java_home* is the directory in which you installed the latest compatible Java version.
- *jarFile* is the BRM installer file. For example:
`brmserver_15.0.0.0.0_linux_generic_full.jar`
- **-invPtrLoc** starts an optional clause to use if you want to use an **oraInventory** directory that already exists in a different location from the one specified in the **etc/oraInst.loc** file.
- *invPath* is the path to the directory in which the **oraInst.loc** file is located.
- **-record** starts an optional clause to use if you want to create a silent installer response file during the installation.
- *respPath* is the absolute path to the response file.

For example:

```
/tools/Linux/jdk/bin/java -jar brmserver_15.0.0.0.0_linux_generic_full.jar
```

or

```
/tools/Linux/jdk/bin/java -jar brmserver_15.0.0.0.0_linux_generic_full.jar -invPtrLoc /  
support/oraInventory/oraInst.loc
```

or

```
/tools/Linux/jdk/bin/java -jar brmserver_15.0.0.0.0_linux_generic_full.jar -record -  
destinationFile /brm15/silent/InstComp.txt
```

or

```
/tools/Linux/jdk/bin/java -jar brmserver_15.0.0.0.0_linux_generic_full.jar -invPtrLoc /  
support/oraInventory/oraInst.loc -record -destinationFile /brm15/silent/InstComp.txt
```

After the GUI installer starts, the steps for installing BRM depend on the BRM server components you choose to install:

- To install only the default BRM server components, select the **Typical** installation option.
This option installs the most common BRM server components that are required by default. Use this option for evaluation, demonstration, and functional testing.
See "[Installing a Typical BRM System](#)" for more information.
- To install all BRM server components, select the **Complete** installation option.
See "[Installing All BRM Components](#)" for more information.
This option installs all the BRM server components. Use this option for development and production systems.
- To choose one or more BRM server components to install each time you run the installer, select the **Custom** installation option.
This option installs a subset of BRM server components that you select. Recommended for advanced users. Use this option for production systems.
See "[Installing Individual BRM Components](#)" for more information.
For an overview of the different ways to set up a production system, see "[Types of BRM Systems](#)".

Installing a Typical BRM System

The instructions in this section assume that you are installing all of the required BRM server components, including the database, on a single computer.

A Typical BRM system is a self-contained version of BRM that contains only the most typically used BRM components. Use this option for evaluation and demonstration systems.

To install a Typical BRM system, launch the installer and then answer the window prompts:

1. In the Welcome window, click **Next**.
2. If the **oralnst.loc** file is corrupt or not present, the Specify Inventory Directory and Credentials window appears next. Otherwise, go to step 3. In the Specify Inventory Directory and Credentials window, enter the details listed in [Table 5-1](#) and then click **Next**.

Table 5-1 Specify Inventory Directory and Credentials

Field	Description
Inventory Directory	The full path to the inventory directory. This should be an absolute path, not containing environment variables. Do not include the name of the oralnst.loc file. The directory and oralnst.loc file will be created if they do not already exist. The default location of the oralInventory directory is recorded in the /etc/oralnst.loc file.
Operating System Group Name	The name of the operating system group that has write permission to the inventory directory.

3. In the Installation Location window, enter the full path or browse to the directory in which to install BRM. This should be an absolute path, not containing environment variables. Click **Next**.
4. In the Installation Type window, select **Typical**. The lower part of the window displays the components that are included in the Typical installation. Click **Next**.
5. In the Specify Prerequisite Libraries Location window, enter the details listed in [Table 5-2](#) and then click **Next**.

Table 5-2 Specify Prerequisite Libraries Location

Field	Description
Prerequisite Libraries	The full path to the directory in which the ojdbc8.jar file is stored. See " Downloading the ojdbc8.jar File " for more information.
Enable SSL	Do one of the following: <ul style="list-style-type: none"> • To enable secure communication between BRM server components, select the Enable SSL check box. • To not use SSL between BRM server components, deselect the check box.

6. In the Specify Wallet Details window, enter the details listed in [Table 5-3](#) and then click **Next**.

Table 5-3 Specify Wallet Details

Field	Description
Client Wallet Password	The password for the client Oracle wallet
Confirm Client Password	The client Oracle wallet password again
Root Wallet Password	The password for the root Oracle wallet
Confirm Root Password	The root Oracle wallet password again
Server Wallet Password	The password for the server Oracle wallet
Confirm Server Password	The server Oracle wallet password again

7. In the Specify BRM Log Location window, enter the full path to the directory in which to store BRM log files and then click **Next**.
8. In the Database SSL Options window, select one of the following:
 - If your database uses one-way SSL, select **Yes One Way**, click **Next**, and go to the next step.
 - If your database uses two-way SSL, select **Yes Two Way**, click **Next**, and go to the next step.
 - If your database does not use SSL, select **No**, click **Next**, and go to step 10.
9. In the Database SSL Information window, enter the details listed in [Table 5-4](#) and then click **Next**.

Table 5-4 Database SSL Information

Field	Description
Truststore Type	The type of TrustStore file for the SSL connection: SSO or PKCS12
Truststore Location	The directory in which the TrustStore file is located
Truststore Password	The password required to access the certificates from the TrustStore
Keystore Type	The type of KeyStore file that is used for the SSL connection: SSO or PKCS12
Keystore Location	The directory in which your KeyStore file is located
Keystore Password	The password required to access the certificates from the KeyStore

10. In the Create BRM Database Schema User window, do one of the following and then click **Next**.
 - If you want to create a BRM database schema user during installation, select **Yes**.
 - If you do not want to create the BRM database schema user during installation, select **No** and go to step 12.
11. In the BRM Database System User Details window, enter the details listed in [Table 5-5](#) for connecting to the BRM database and then click **Next**.

Table 5-5 BRM Database System User Details

Field	Description
Host Name	The host name or IP address of the machine on which the BRM database is installed
Port Number	The port number assigned to the BRM database service

Table 5-5 (Cont.) BRM Database System User Details

Field	Description
Database Name	The BRM database alias, for example, pindb.example.com
User Name	The name of the BRM database system user This user should have the following capabilities on the BRM database: create user, grant any role, grant any privilege, select any table.
Password	The BRM database system user password

 **Note:**

Ensure that the Oracle Database server is in **Running** state. The Installer connects to the Oracle Database server to verify that the information you entered is valid.

- In the BRM Database Connection Details window, enter the details listed in [Table 5-6](#) and then click **Next**.

Table 5-6 BRM Database Connection Details

Field	Description
Host Name	The host name or IP address of the machine on which the BRM database is installed
Port Number	The port number assigned to the BRM database service
Database Name	The BRM database alias, for example, pindb.example.com
User Name	The BRM database schema user name
Password	The BRM database schema user password
Confirm Password	The BRM database schema user password again This is enabled only if you selected to create a BRM database schema user.

- In the BRM Root User Details window, enter the details listed in [Table 5-7](#) and then click **Next**. This user has all of the permissions in BRM.

Table 5-7 BRM Root User Details

Field	Description
Root Password	The password for the BRM root user
Confirm Root Password	The BRM root user password again

- In the BRM User Details window, enter the details listed in [Table 5-8](#) and then click **Next**. This password will be used for all of the default BRM users except the root user. You should update these passwords after the install.

Table 5-8 BRM User Details

Field	Description
User Password	The password for the non-root default BRM users
Confirm user Password	The non-root BRM user password again

15. In the BRM Connection Manager (CM) Details window, enter the details listed in [Table 5-9](#) for connecting to the CM and then click **Next**.

Table 5-9 BRM Connection Manager (CM) Details

Field	Description
Host Name	The host name or IP address of your CM machine
Port Number	The port number for your CM

16. In the Enterprise Application Integration (EAI) Framework Details window, enter the port number for your EAI Manager and then click **Next**.
17. In the Oracle Data Manager (DM) Details window, enter the details listed in [Table 5-10](#) for connecting to the DM database and then click **Next**.

Table 5-10 Oracle Data Manager (DM) Details

Field	Description
Database Number	The DM database number. The default value is 0.0.0.1 . Note: In BRM 15.0, you can use only the default Database Number for the primary schema.
Port Number	The port number to connect to your DM.
Is Primary DB?	Do one of the following: <ul style="list-style-type: none"> Select Yes if the DM is being installed in the primary schema and go to step 19. Select No if the DM is not being installed in the primary schema.

18. In the Primary DB details window, enter the details listed in [Table 5-11](#) for the primary database and then click **Next**.

Table 5-11 Oracle Primary DB Details

Field	Description
Database Name	The alias for the primary database
User Name	The user name for the primary database
Password	The password for the primary database user

19. In the Select BRM Data Storage Model window, set the size of your database and then click **Next**.
- For test or demonstration databases smaller than 700 MB, select **Test**.
 - For demonstration databases smaller than 1.5 GB, select **Small**.
 - For production databases smaller than 30 GB, select **Medium**.
 - For production databases larger than 30 GB, select **Large**.

20. In the BRM Table and Index Tablespace Details window, enter the details listed in [Table 5-12](#) and then click **Next**. If you elected to create the BRM schema user, these tablespaces will be created. Otherwise, the tablespaces should already exist.

Table 5-12 BRM Table and Index Tablespace Details

Field	Description
Table Tablespace	The name of your data tablespace
Index Tablespace	The name of your index tablespace

21. In the Select Drop BRM Database Tables window, do one of the following and then click **Next**.
 - To drop the BRM database tables and reinitialize the database, select **Yes**. Select this option for test systems, for example where an unsuccessful previous installation might have left some tables in the database.

 **Note:**

If you select **Yes**, the Installer drops all of the existing BRM database tables on your system. This results in irrecoverable loss of data. Ensure that you have backed up all of your existing data before selecting this option.

This does not impact the Pipeline Manager database tables.

- To retain the BRM database tables, select **No**.
The Installer uses your existing BRM database tables.
22. In the Select BRM Database Partitions window, do one of the following and then click **Next**.
If you are installing the BRM server for evaluation or demonstration, you can select **No** to disable partitioning of the database and you need not install Oracle Partitioning. For a production system, however, you must install Oracle Partitioning.

 **Caution:**

To partition tables, you must have Oracle Partitioning installed. If you select **Yes** but do not have Oracle Partitioning installed, the BRM setup program fails when it tries to create partitions. See "[Database Requirements](#)" for more information.

- To enable partitioning for all event tables in your database, select **Yes**.
If you select **Yes**, the following classes are automatically enabled for partitioning: event, journal, journal master, newsfeed, and user activity.
This sets the \$ENABLE_PARTITION parameter to **Yes** in the `pin_setup.values` file.
If you plan to use Rated Event (RE) Loader to load rated events, you must partition your event tables.
- If you do not want to enable partitioning during installation, select **No** and go to step [24](#).

You can also enable partitioning after installation. See the discussion about converting nonpartitioned classes to partitioned classes in *BRM System Administrator's Guide*.

23. In the BRM Database Partition Details window, do one of the following and then click **Next**.
 - To add 12 monthly partitions, a historic partition, and a last partition to your event tables, select **Monthly (12 partitions)**.

 **Note:**

This sets the `$SETUP_CREATE_PARTITIONS` parameter to **Yes** in the `pin_setup.values` file.

In the **Non-event tables** field, add the class names for partitioning your non-event tables.

- To add only a historic partition and a last partition to the event tables, select **Default (2 partitions)**.

You can use this partitioning layout for a simple test or demonstration system. For a production system, however, you must add purgeable partitions after installation is complete and before the system generates events.

24. In the Select Running the `pin_setup` Script window, do one of the following and then click **Next**.
 - To run the `pin_setup` script during installation, select **Yes**. Running this script installs the database components.
 - To prevent the `pin_setup` from running during installation, select **No**. Do this if you want to modify the database configuration before installing.

 **Note:**

If `pin_setup` fails due to invalid database alias or service name, see "[Problem: An Error Occurred When pin_setup is Run During Installation](#)".

25. In the Installation Summary window, review your selections and then click **Install**.

 **Note:**

After the installation begins, you cannot stop or cancel the installation.

The Installation Progress window appears, and the installation begins.

If the BRM database and Pipeline Manager database are installed on different machines, the Pipeline Manager database details will not appear in the installation summary.

The installer checks for all required software and displays errors if it detects any missing or unavailable components or if any connectivity issues occur.

For information about BRM installer logs, see "[Troubleshooting the BRM Installation](#)".

26. When the installation is done, click **Next**.

27. In the Installation Complete window, click **Finish**.

Installing All BRM Components

For a production system, you optimize BRM performance and availability by installing and running the BRM database on its own computer and the various processes on separate computers.

Note:

If you are installing the Oracle DM and your database on separate machines, you must install a database client. For information, see "[Installing the Database and Oracle DM on Separate Machines](#)".

To install all BRM components, launch the installer and then answer the window prompts:

1. In the Welcome window, click **Next**.
2. If the **oralnst.loc** file is corrupt or not present, the Specify Inventory Directory and Credentials window appears next. Otherwise, go to step 3. In the Specify Inventory Directory and Credentials window, enter the details listed in [Table 5-13](#) and then click **Next**.

Table 5-13 Specify Inventory Directory and Credentials

Field	Description
Inventory Directory	The full path to the inventory directory. This should be an absolute path, not containing environment variables. Do not include the name of the oralnst.loc file. The directory and oralnst.loc file will be created if they do not already exist. The default location of the oralInventory directory is recorded in the /etc/oralnst.loc file.
Operating System Group Name	The name of the operating system group that has write permission to the inventory directory.

3. In the Installation Location window, enter the full path or browse to the directory in which to install BRM. This should be an absolute path, not containing environment variables. Click **Next**.
4. In the Installation Type window, select **Complete**. The lower part of the window displays the components that are included in the Complete installation. Click **Next**.
5. In the Specify Prerequisite Libraries Location window, enter the details listed in [Table 5-14](#) and then click **Next**.

Table 5-14 Specify Prerequisite Libraries Location

Field	Description
Prerequisite Libraries	The full path to the directory in which the ojdbc8.jar file is stored. See " Downloading the ojdbc8.jar File " for more information.

Table 5-14 (Cont.) Specify Prerequisite Libraries Location

Field	Description
Enable SSL	Do one of the following: <ul style="list-style-type: none"> To enable secure communication between BRM server components, select the Enable SSL check box. To not use SSL between BRM server components, deselect the check box.

- In the Specify Wallet Details window, enter the details listed in [Table 5-15](#) and then click **Next**.

Table 5-15 Specify Wallet Details

Field	Description
Client Wallet Password	The password for the client Oracle wallet
Confirm Client Password	The client Oracle wallet password again
Root Wallet Password	The password for the root Oracle wallet
Confirm Root Password	The root Oracle wallet password again
Server Wallet Password	The password for the server Oracle wallet
Confirm Server Password	The server Oracle wallet password again

- In the Specify BRM Log Location window, enter the full path to the directory in which to store BRM log files and then click **Next**.
- In the Database SSL Options window, select one of the following:
 - If your database uses one-way SSL, select **Yes One Way**, click **Next**, and go to the next step.
 - If your database uses two-way SSL, select **Yes Two Way**, click **Next**, and go to the next step.
 - If SSL is disabled in your database, select **No**, click **Next**, and go to step [10](#).
- In the Database SSL Information window, enter the details listed in [Table 5-16](#) and then click **Next**.

Table 5-16 Database SSL Information

Field	Description
Truststore Type	The type of TrustStore file for the SSL connection: SSO or PKCS12
Truststore Location	The directory in which the TrustStore file is located
Truststore Password	The password required to access the certificates from the TrustStore
Keystore Type	The type of KeyStore file that is used for the SSL connection: SSO or PKCS12
Keystore Location	The directory in which your KeyStore file is located
Keystore Password	The password required to access the certificates from the KeyStore

- In the Create BRM Database Schema User window, do one of the following and then click **Next**.
 - If you want to create a BRM database schema user during installation, select **Yes**.

- If you do not want to create the BRM database schema user during installation, select **No** and go to step 12.
11. In the BRM Database System User Details window, enter the details listed in [Table 5-17](#) for connecting to the BRM database and then click **Next**.

Table 5-17 BRM Database System User Details

Field	Description
Host Name	The host name or IP address of the machine on which the BRM database is installed
Port Number	The port number assigned to the BRM database service
Database Name	The BRM database alias
User Name	The name of the BRM database system user This user should have the following capabilities on the BRM database: create user, grant any role, grant any privilege, and select any table.
Password	The BRM database system user password

 **Note:**

Ensure that the Oracle Database server is in **Running** state. The Installer connects to the Oracle Database server to verify that the information you entered is valid.

12. In the BRM Database Connection Details window, enter the details listed in [Table 5-18](#) and then click **Next**.

Table 5-18 BRM Database Connection Details

Field	Description
Host Name	The host name or IP address of the machine on which the BRM database is installed
Port Number	The port number assigned to the BRM database service
Database Name	The BRM database alias
User Name	The BRM database schema user name
Password	The BRM database schema user password
Confirm Password	The BRM database schema user password again This is enabled only if you selected to create a BRM database schema user.

13. In the BRM Root User Details window, enter the details listed in [Table 5-19](#) and then click **Next**.

Table 5-19 BRM Root User Details

Field	Description
Root Password	The password for the BRM root user

Table 5-19 (Cont.) BRM Root User Details

Field	Description
Confirm Root Password	The BRM root user password again

14. In the BRM User Details window, enter the details listed in [Table 5-20](#) and then click **Next**. This password will be used for all of the default BRM users. You should update these passwords after the install.

Table 5-20 BRM User Details

Field	Description
User Password	The password for the non-root default BRM users
Confirm user Password	The non-root BRM user password again

15. In the BRM Connection Manager (CM) Details window, enter the details listed in [Table 5-21](#) for connecting to the CM and then click **Next**.

Table 5-21 BRM Connection Manager (CM) Details

Field	Description
Host Name	The host name or IP address of your CM machine
Port Number	The port number for your CM

16. In the Enterprise Application Integration (EAI) Framework Details window, enter the port number for your EAI Manager and then click **Next**.
17. In the Oracle Connection Manager Proxy Details window, enter the port number for your CM Proxy and then click **Next**.
18. In the Oracle Connection Manager Master Process Details window, enter the port number for your CM Master Process (CMMP) and then click **Next**.
19. In the Oracle Data Manager (DM) Details window, enter the details listed in [Table 5-22](#) for connecting to the DM database and then click **Next**.

Table 5-22 Oracle Data Manager (DM) Details

Field	Description
Database Number	The DM database number. The default value is 0.0.0.1 . Note: In BRM 15.0, you can use only the default Database Number for the primary schema.
Port Number	The port number to connect to your DM.
Is Primary DB?	Do one of the following: <ul style="list-style-type: none"> Select Yes if the DM is being installed in the primary schema and go to step 21. Select No if the DM is not being installed in the primary schema.

20. In the Primary DB details window, enter the details listed in [Table 5-23](#) for the primary database and then click **Next**.

Table 5-23 Oracle Primary DB Details

Field	Description
Database Name	The alias for the primary database
User Name	The user name for the primary database
Password	The password for the primary database user

21. In the Select BRM Data Storage Model window, set the size of your database and then click **Next**.
 - For test or demonstration databases smaller than 700 MB, select **Test**.
 - For demonstration databases smaller than 1.5 GB, select **Small**.
 - For production databases smaller than 30 GB, select **Medium**.
 - For production databases larger than 30 GB, select **Large**.
22. In the BRM Table and Index Tablespace Details window, enter the details listed in [Table 5-24](#) and then click **Next**. If you elected to create the BRM schema user, these tablespaces will be created. Otherwise, the tablespaces should already exist.

Table 5-24 BRM Table and Index Tablespace Details

Field	Description
Table Tablespace	The name of your data tablespace
Index Tablespace	The name of your index tablespace

23. In the Select Drop BRM Database Tables window, do one of the following and then click **Next**.
 - To drop the BRM database tables and reinitialize the database, select **Yes**. Select this option for test systems, for example where an unsuccessful previous installation might have left some tables in the database.

 **Note:**

If you select **Yes**, the Installer drops all of the existing BRM database tables on your system. This results in irrecoverable loss of data. Ensure that you have backed up all of your existing data before selecting this option.

This does not impact the Pipeline Manager database tables.

- To retain the BRM database tables, select **No**.
The Installer uses your existing BRM database tables.
24. In the Select BRM Database Partitions window, do one of the following and then click **Next**.

If you are installing the BRM server for evaluation or demonstration, you can select **No** to disable partitioning of the database and you need not install Oracle Partitioning. For a production system, however, you must install Oracle Partitioning.

 **Caution:**

To partition tables, you must have Oracle Partitioning installed. If you select **Yes** but do not have Oracle Partitioning installed, the BRM setup program fails when it tries to create partitions. See "[Database Requirements](#)" for more information.

- To enable partitioning for all event tables in your database, select **Yes**.

If you select **Yes**, the following classes are automatically enabled for partitioning: event, journal, journal master, newsfeed, and user activity.

This sets the \$ENABLE_PARTITION parameter to **Yes** in the **pin_setup.values** file.

If you plan to use Rated Event (RE) Loader to load rated events, you must partition your event tables.

- If you do not want to enable partitioning during installation, select **No** and go to step 26.

You can also enable partitioning after installation. See the discussion about converting nonpartitioned classes to partitioned classes in *BRM System Administrator's Guide*.

25. In the BRM Database Partition Details window, do one of the following and then click **Next**.

- To add 12 monthly partitions, a historic partition, and a last partition to your event tables, select **Monthly (12 partitions)**.

 **Note:**

This sets the \$SETUP_CREATE_PARTITIONS parameter to **Yes** in the **pin_setup.values** file.

In the **Non-event tables** field, add the class names for partitioning your non-event tables.

- To add only a historic partition and a last partition to the event tables, select **Default (2 partitions)**.

You can use this partitioning layout for a simple test or demonstration system. For a production system, however, you must add purgeable partitions after installation is complete and before the system generates events.

In the **Non-Event Tables** field, add the class names for partitioning your non-event tables and then click **Next**.

26. In the Oracle Data Manager (DM) Email window, enter the port number for the email DM and then click **Next**.

27. In the Oracle Data Manager (DM) Invoice window, enter the port number for the invoice DM and then click **Next**.

28. In the Sample Pricing Data window, do one of the following and then click **Next**.

- If you want to load the sample pricing data during installation, select **Yes**.
- If you do not want to load the sample pricing data during installation, select **No**.

29. In the Select Running the pin_setup Script window, do one of the following and click **Next**.

- To run the **pin_setup** script during installation, select **Yes**. Running this script installs the database components.
- To prevent the **pin_setup** from running during installation, select **No**. Do this if you want to modify the database configuration before installing.

 **Note:**

If **pin_setup** fails due to invalid database alias or service name, see "[Problem: An Error Occurred When pin_setup is Run During Installation](#)".

30. In the Create Pipeline Schema User window, do one of the following and then click **Next**.
 - If you want to create a pipeline schema user during installation, select **Yes**. Skip step [34](#) when you get to it.
 - If you already have a pipeline schema user, select **No**. Skip step [33](#) when you get to it.
31. In the Pipeline Database System User Details window, enter the details listed in [Table 5-25](#) for connecting to the pipeline database and then click **Next**.

Table 5-25 Pipeline Database System User Details

Field	Description
Host Name	The host name or IP address of the machine on which the Pipeline Manager database is installed
Port Number	The port number assigned to the Pipeline Manager database service
Database Name	The Pipeline Manager database alias
User Name	The name of the Pipeline Manager database system user This user should have the following capabilities on the Pipeline Manager database: create user, grant any role, grant any privileges, select any table.
Password	The Pipeline Manager database system user password

 **Note:**

Ensure that the Oracle Database server is in **Running** state. The Installer connects to the Oracle Database server to verify that the information you entered is valid.

32. In the BRM Database System User Details window, enter the details listed in [Table 5-26](#) for connecting to the BRM database and then click **Next**.

Table 5-26 BRM Database System User Details

Field	Description
Host Name	The host name or IP address of the machine on which the BRM database is installed This field may be prepopulated with information you provided earlier in the installation.

Table 5-26 (Cont.) BRM Database System User Details

Field	Description
Port Number	The port number assigned to the BRM database service This field may be prepopulated with information you provided earlier in the installation.
Database Name	The BRM database alias This field may be prepopulated with information you provided earlier in the installation.
User Name	The name of the BRM database system user This user should have the following capabilities on the BRM database: create user, grant any role, grant any privileges, select any table. This field may be prepopulated with information you provided earlier in the installation.
Password	The BRM database system user password

 **Note:**

Ensure that the Oracle Database server is in **Running** state. The Installer connects to the Oracle Database server to verify that the information you entered is valid.

- In the Pipeline Schema User Details window, enter the details listed in [Table 5-27](#) to create a pipeline schema user and click **Next**:

Table 5-27 Pipeline Schema User Details

Field	Description
Host Name	The host name or IP address of the machine on which the Pipeline Manager database is installed
Port Number	The port number assigned to the Pipeline Manager database service
Database Name	The Pipeline Manager database alias
User Name	A pipeline schema user name
Password	The password for the pipeline schema user
Confirm Password	The password for the pipeline schema user again
Table Tablespace	The name of the data tablespace for the pipeline schema
Index Tablespace	The name of the index tablespace for the pipeline schema

- In the Pipeline Schema User Details window, enter the details listed in [Table 5-28](#) to connect to the existing pipeline schema and click **Next**:

Table 5-28 Pipeline Schema User Details

Field	Description
Host Name	The host name or IP address of the machine on which the Pipeline Manager database is installed

Table 5-28 (Cont.) Pipeline Schema User Details

Field	Description
Port Number	The port number assigned to the Pipeline Manager database service
Database Name	The Pipeline Manager database alias
User Name	The pipeline schema user name
Password	The password for the pipeline schema user
Table Tablespace	The name of the data tablespace for the pipeline schema
Index Tablespace	The name of the index tablespace for the pipeline schema

35. In the BRM Schema User Details window, enter the details listed in [Table 5-29](#) to connect to the existing BRM database schema and click **Next**:

Table 5-29 BRM Schema User Details

Field	Description
User Name	The BRM schema user name This field may be prepopulated with information you provided earlier in the installation.
Password	The BRM for the pipeline schema user
Table Tablespace	The name of the data tablespace for the BRM schema This may be prepopulated with information you provided earlier in the installation.
Index Tablespace	The name of the index tablespace for the BRM schema This may be prepopulated with information you provided earlier in the installation.

36. In the Installation Summary window, review your selections and then click **Install**.

 **Note:**

After the installation begins, you cannot stop or cancel the installation.

The Installation Progress window appears, and the installation begins.

If the BRM database and Pipeline Manager database are installed on different machines, the Pipeline Manager database details will not appear in the installation summary.

The installer checks for all required software and displays errors if it detects any missing or unavailable components or if any connectivity issues occur.

For information about BRM installer logs, see "[Troubleshooting the BRM Installation](#)".

37. When the installation is done, click **Next**.
38. In the Installation Complete window, click **Finish**.

Installing Individual BRM Components

Note:

If you already installed a component, you must uninstall its features before reinstalling them.

You can install a subset of BRM components, such as the CM and DM, on a single machine to save disk space.

Note:

- If you are installing the CM and DM on separate machines, see "[Installing CM and DM on Separate Machines](#)" for instructions.
- If you are installing additional BRM instances with Pipeline Manager for configuring high availability, ensure that you also select the **Upgrade Manager Framework** in the Available Product Components window. This ensures that a separate Pipeline Manager schema is not created and allows you to use the Pipeline Manager schema of the primary instance.

After installing the additional BRM instance, you can remove the upgrade files in the *BRM_home* directory.

To install individual BRM components, launch the installer and then answer the window prompts:

1. In the Welcome window, click **Next**.
2. If the **oralnst.loc** file is corrupt or not present, the Specify Inventory Directory and Credentials window appears next. Otherwise, go to step 3. In the Specify Inventory Directory and Credentials window, enter the details listed in [Table 5-30](#) and then click **Next**.

Table 5-30 Specify Inventory Directory and Credentials

Field	Description
Inventory Directory	The full path to the inventory directory. This should be an absolute path, not containing environment variables. Do not include the name of the oralnst.loc file. The directory and oralnst.loc file will be created if they do not already exist. The default location of the oralInventory directory is recorded in the /etc/oralnst.loc file.
Operating System Group Name	The name of the operating system group that has write permission to the inventory directory.

3. In the Installation Location window, enter the full path or browse to the directory in which to install BRM. This should be an absolute path, not containing environment variables. Click **Next**.

4. In the Installation Type window, select **Custom**. The lower part of the window displays the components that are included in the Complete installation, and you can choose which of them to install in the next window. Click **Next**.
5. In the Available Product Components window, select the components to install, and deselect any other components that you do not want to install. Click **Next**.

 **Note:**

You cannot deselect a component if it is required to install any of the selected components.

6. If a window other than the Summary window appears, provide the requested information and then click **Next**.

For the description of the fields displayed, see "[Installing All BRM Components](#)". Continue moving through the windows until the Summary window appears.

Your responses are written to the *BRM_home/setup/pin_setup.values* file.

7. When the Installation Summary window appears, review your selections and then click **Install**.
8. The Installation Progress window appears. When installation completes, click **Next**.

 **Note:**

After the installation begins, you cannot stop or cancel the installation.

If the BRM database and Pipeline Manager database are installed on different machines, the Pipeline Manager database details will not appear in the installation summary.

9. The Installation Complete window appears. The installer checks for all required software and displays errors if it detects any missing or unavailable components or if any connectivity issues occur.

For information about BRM installer logs, see "[Troubleshooting the BRM Installation](#)".

10. Click **Finish** to complete the installation.

Installing CM and DM on Separate Machines

To install CM and DM on separate machines:

1. Install DM. For instructions, see "[Installing Individual BRM Components](#)".
2. If you enabled SSL for the DM, do the following:
 - a. Open the DM configuration file (*BRM_home/sys/dm/pin.conf*) file in a text editor.
 - b. Search for **enable_ssl** entry:

```
- dm enable_ssl 1
```
 - c. Set the **enable_ssl** entry to **0**:

```
- dm enable_ssl 0
```
 - d. Save and close the file.

3. Start all the DMs installed. See "Starting and Stopping the BRM System" in *BRM System Administrator's Guide*.
4. Install CM with SSL enabled. For instructions, see "[Installing Individual BRM Components](#)".
5. On the machine on which you installed the DM in step 1, do the following:
 - a. Open the DM configuration file (*BRM_home/sys/dm/pin.conf*) file in a text editor.
 - b. Search for **enable_ssl** entry:

```
- dm enable_ssl 0
```
 - c. Set the **enable_ssl** entry to **1**:

```
- dm enable_ssl 1
```
 - d. Save and close the file.
6. Start the DM processes.
7. On the machine on which you installed the CM in step 4, start the CM processes.

For instructions on starting the DM and CM processes, see "Starting and Stopping the BRM System" in *BRM System Administrator's Guide*.

Installing BRM in Silent Mode

The silent installation uses a response file in which you have set installation information. To obtain the response file, you run the GUI installer for the first install. The GUI installer generates a response file that contains the key-value pairs based on the values that you specify during the GUI installation. You can then copy and edit the response file to create additional response files for installing the BRM server on different machines.

Note:

If you are installing BRM to replace an identical release (for example, to restore a clean version of the package), you must first uninstall the existing installation. See "[Uninstalling BRM](#)".

Creating a Response File

To create a response file:

1. Create the response file by doing one of the following:
 - Create a copy of the response file that was generated during the GUI installation. See "[Installing a Typical BRM System](#)" for more information.

Note:

The GUI Installer does not store passwords provided during installation in the response file. You must manually add the passwords after creating a copy of the response file.

- Create a response file using the template by running the following command:

```
Java_home/bin/java -jar jarFile -getResponseFileTemplates
```

where:

- *Java_home* is the directory in which you installed the latest compatible Java version.
- *jarFile* is the BRM installer file. For example:
`brmsrver_15.0.0.0.0_linux_generic_full.jar`

A response file is created with the default values.

You can create as many response files as needed.

2. Open the file in a text editor.
3. Modify the response file you copied by specifying the key-value information for the parameters you want in your installation.

Note:

- The response file template contains guidelines and examples on how to enter the values in the parameters.
- The Installer treats incorrect context, format, and type values in a response file as if no value were specified.

4. Save and close the response file.

Performing a Silent Installation

To perform a silent installation:

1. Create a response file. See "[Creating a Response File](#)".
2. Copy the response file you created to the machine on which you are running the silent installation.
3. On the machine on which you are running the silent installation, go to the directory where you downloaded the BRM software, and run the following command:

```
Java_home/bin/java -jar jarFile -debug -invPtrLoc Inventory_home/oraInventory/  
oraInst.loc [parameter=value] -responseFile path -silent
```

where:

- *Java_home* is the location of the compatible version of Java.
- *jarFile* is the BRM installer file. For example:
`brmsrver_15.0.0.0.0_linux_generic_full.jar`
- *Inventory_home* is the location of the Oracle inventory.
- *parameter* is the name of an installation parameter.
- *value* is the value of the installation parameter.
- *path* is the absolute path to the response file.

For example:

```
$JAVA_HOME/bin/java -jar brmsserver_15.0.0.0.0_linux_generic_full.jar -debug -  
invPtrLoc Inventory_home/oraInventory/oraInst.loc INSTALL_TYPE=Complete -  
responseFile /tmp/brm_complete.rsp -silent
```

The installation runs silently in the background.

 **Note:**

For a complete list of the available parameters for the `[parameter=value]` clause, and for information about optional debugging parameters, run the following command:

```
Java_home/bin/java -jar jarFile -help
```

The Installer checks for all required software and writes errors to a log file if it detects any missing or unavailable components or if any connectivity issues occur.

For information about BRM installer logs, see "[Troubleshooting the BRM Installation](#)".

Completing the Installation

After BRM has been installed on each machine, check the configuration entries and the BRM root key stored in the client wallet. You can verify the entries by doing the following:

1. Go to the directory in which you installed the BRM server, and source the **source.me** file:

Bash shell:

```
source source.me.sh
```

C shell:

```
source source.me.csh
```

2. Run the following command:

```
orapki wallet display -wallet client
```

The entries stored in the client wallet appear.

If the entries do not appear, you must store the entries manually in the client wallet by using the **pin_crypt_app** utility.

3. Verify the following entries:
 - The **dm_pointer** entry is stored for each DM in your system and they contain the DM machine's host name or IP address. Any additional **dm_pointer** entries include the correct host name.
 - The DM (**sm_database**) points to the correct database.

Installation is now complete. If you encountered installation problems, verify that the settings in the **pin_setup.values** file on each computer point to the correct CM and DM.

6

BRM Postinstallation Tasks

Learn how to perform postinstallation tasks, such as changing your database partitions and running the **pin_setup** script, after installing the Oracle Communications Billing and Revenue Management (BRM) software.

Topics in this document:

- [Scheduling Backups](#)
- [Referencing Environment Variables in pin.conf Files](#)
- [Postinstallation Tasks for a BRM Non-Production System](#)
- [Postinstallation Tasks for a BRM Production Installation](#)
- [What's Next?](#)

Scheduling Backups

You should back up the database every night. You can choose a backup solution from your database manufacturer or from a third party. To keep your database always running, ready to respond to online events, use the database online backup utilities for routine backups.

You should also back up your system files (programs, scripts, source code, and documentation) and your data files and keep the backups in a secure, off-site location. To be safe, you should keep at least three iterations of your system backups and at least one month's worth of daily backups. Storage media are usually less expensive than customer problems.

Verify the data and system backup files to ensure that you can recover the data. At times, this secondary system can also serve as a fully functional test system. If BRM releases a patch that can significantly affect your installation, it is important to try it on a test system before installing it in your production system.

Note:

The only way to verify the data and system backup files is to restore them to another location to ensure that there are no errors in reading, writing, or formatting.

Referencing Environment Variables in pin.conf Files

To prepare for migrating **pin.conf** files to other systems at a future time, you can reference certain environment variables from within the **pin.conf** files, as in this example:

```
- cm fm_module ${PIN_HOME}/lib/fm_utils/$  
{LIBRARYEXTENSION} fm_utils_config fm_utils_init pin
```

For more information, see "Preparing for Platform Migration by Using Variables in pin.conf Files" in *BRM System Administrator's Guide*.

Postinstallation Tasks for a BRM Non-Production System

After installing the BRM server, if you have not performed the following tasks during installation, do the following and then run the **pin_setup** script. See ["Running the pin_setup Script"](#) for more information.

- (Optional) To further configure BRM, you can edit the *BRM_home/setup/pin_setup.values* file. See ["Editing the pin_setup.values File"](#) for more information.

Do the following *after* running the **pin_setup** script:

- (Optional) Change your database partitions as required. See ["Changing Your Database Partitions "](#) for more information.
- If you installed BRM server and Pipeline Manager on separate machines or directories, set the BRM_WALLET and PIN_HOME variables in the BRM server to point to the client wallet and **JARs** in the *Pipeline_home* directory, where *Pipeline_home* is the directory in which Pipeline Manager is installed. See ["Setting Environment Variables for Pipeline Manager"](#) for more information.
- If you installed BRM server and Pipeline Manager on separate machines, update the configuration entries for Pipeline Manager in the client wallet manually. See ["Updating Client Wallet for Pipeline Manager"](#) for more information.
- Copy the makefiles required for compiling the Connection Manager and Facilities Module instances. See ["Copying Files for Compiling CM and FM Modules"](#) for more information.
- Edit and load the event notification list. See ["Editing and Loading the Event Notification List"](#) for more information.
- Load the tailor-made stored procedure to create a tailor-made plan. See ["Loading the Tailor-Made Stored Procedure"](#) for more information.

Editing the pin_setup.values File

To further configure BRM, such as by changing the default currency and country, you edit the *BRM_home/setup/pin_setup.values* file. This file stores the information you provided to the installer and a number of database and add-on component parameters.

The entries you need to edit in the **pin_setup.values** file depend on which components you install on the current machine. For example, if you are installing the Email DM on the current machine, edit the **\$DM_EMAIL** entries.

The following examples show the important entries to check in three configurations:

- The Connection Manager (CM) and Data Manager (DM) reside on separate machines.
- The system contains multiple Oracle DMs connected to one database.
- Invoices are stored in a separate database schema.

Example 6-1 The CM and DM Reside on Separate Machines

Machines that contain a CM must include the correct port number and host name of each DM in the system. This is especially critical when DMs reside on separate machines from the CM.

For example, you might install the Oracle DM and Email DM on a separate machine from the CM. In this case, you must modify the parameters in the CM machine's **pin_setup.values** file as shown in [Table 6-1](#).

Table 6-1 CM Machine's pin_setup Values

Entry	Description
\$DM_ORACLE{'port'}	Must contain the port number of the Oracle DM.
\$DM_ORACLE{'hostname'}	Must contain the host name of the machine running the Oracle DM.
\$DM_EMAIL{'port'}	Must contain the port number of the Email DM.
\$DM_EMAIL{'hostname'}	Must contain the host name of the machine running the Email DM.

Example 6-2 The System Contains Multiple Oracle DMs Connected to One Database

When your system contains multiple Oracle DMs connected to one database, if not already performed during the BRM server installation, you must initialize the database and drop the tablespaces. You can perform this by modifying each DM machine's **pin_setup.values** file as shown in [Table 6-2](#).



Note:

You can initialize the database and drop the tablespaces only *once*.

Table 6-2 DM Machine's pin_setup Values

Entry	Description
\$SETUP_INIT_DB	Must be set to Yes on the primary Oracle DM machine; on all other machines containing an Oracle DM, set to No .
\$SETUP_DROP_ALL_TABLES	Must be set to Yes on the primary Oracle DM machine; on all other machines containing an Oracle DM, set to No .

Example 6-3 Invoices Are Stored in a Separate Database Schema

Storing invoices in their own database schemas speeds up the invoicing process; enables you to store a large number of invoices; and enables you to view, email, and print invoices without affecting the performance of the main BRM schema.

If you are storing invoices in their own schemas, you must update the **pin_setup.values** file to include the correct pointers to the invoice schema. Therefore, you must modify the parameters listed in [Table 6-3](#) on the machine containing the Invoice DM.



Note:

The Invoice DM is supported only on Oracle databases.

Table 6-3 Invoice DM Machine's pin_setup Values

Entry	Description
\$INVOICE_DB{'user'}	Must contain the user name to log in to your invoice schema. This user name must be different from the one used for the main BRM schema.

Table 6-3 (Cont.) Invoice DM Machine's pin_setup Values

Entry	Description
<code>\$INVOICE_DB{'alias'}</code>	Must contain the database alias of the invoice schema.
<code>\$INVOICE_DB{'Host'}</code>	Must contain the host name of the machine running the invoice schema.
<code>\$INVOICE_DB{'tables_group'}</code>	Must contain the name of the data tablespace.
<code>\$INVOICE_DB{'indexes_group'}</code>	Must contain the name of the index tablespace.
<code>\$DM_INVOICE{'port'}</code>	Must contain the port number of the Invoice DM. For guidelines, see "Guidelines for Database and Port-Number Entries" in <i>BRM System Administrator's Guide</i> .
<code>\$DM_INVOICE{'db_num'}</code>	Must contain the database number for the invoice schema.

Running the pin_setup Script

The `pin_setup` script reads the `pin_setup.values` and `pin_tables.values` files and configures BRM by:

- Configuring your various configuration (`pin.conf`) files.
- Setting up database tables and indexes.

To run the `pin_setup` script:

1. Go to the `BRM_home/setup` directory and enter the following command:

```
% ./pin_setup
```

2. If you install a DM component on a separate machine from the CM component, you receive the following notification:

```
Warning: File not found: BRM_home/sys/cm/pin.conf
To complete the install, append the following
file to the sys/cm/pin.conf file and then restart the CM
process:
"BRM_home/append_to_cm_pin_conf"
```

If you receive this notification:

- a. Append the lines from the `BRM_home/append_to_cm_pin_conf` file to the CM machine's `BRM_home/sys/cm/pin.conf` file.
 - b. Stop and restart the CM process.
3. Check the `pin_setup.log` file for status and errors.

Note:

After you run `pin_setup`, the `cm.pinlog` file erroneously contains several `PIN_ERROC_FLIST` and `PIN_ERRCLASS_SYSTEM_DETERMINATE` error messages. You can safely ignore these messages.

By default, the `pin_setup` script configures only the last installed product by reading the `pin_setup.values` file. You can also do the following:

- Use the **-all** parameter to configure BRM and all the optional components present in the **@COMPONENTS** section of **pin_setup.values**. Before using the **-all** parameter to configure BRM, ensure that the following entry is commented:

```
#@COMPONENTS
```

For example, go to the *BRM_home/setup* directory and enter the following command:

```
pin_setup -all
```

To configure an additional set of components using the **-all** parameter, add the **@COMPONENT_LIST= (" ");** entry in the **pin_setup.values** file.

Changing Your Database Partitions

If you *did not* enable partitioning during installation, skip this section.

If you *did* enable partitioning for one or more storable classes during installation, the tables for those storable classes are now divided into the following partitions:

- **Event tables**
 - If you chose to add 12 fixed partitions to your event tables, those tables were divided into 12 monthly partitions, a historic partition, and a last partition. See "About the Default Partitioning Scheme" in *BRM System Administrator's Guide*.
 - If you chose *not* to add 12 fixed partitions to your event tables, those tables were divided into a historic partition and a last partition (which stores *all* purgeable objects for the table). This partitioning scheme is sufficient for a test or demonstration system. For a production system, however, you must create purgeable partitions.
- **Item tables**

Tables for item storable classes were divided into a historic partition and a last partition.
- **Tables for all other storable classes in @CLASSES_TO_BE_PARTITIONED**

Tables for all storable classes listed in the **pin_setup.values** file's **@CLASSES_TO_BE_PARTITIONED** entry *except* the item storable class were given only one partition, **partition_last**. See "About Objects Stored in partition_last and partition_last_pin" in *BRM System Administrator's Guide*. For a production system, you must create purgeable partitions.

Note:

- To test partitioning, you must add at least one purgeable partition.
- To change your partitioning scheme (for example, by adding purgeable partitions), do so *before* any objects are stored in the partitions you want to modify. *Do not modify a partition after BRM adds objects to the partition.*

For information about changing your partitioning scheme, see "Partitioning Tables" in *BRM System Administrator's Guide*.

Setting Environment Variables for Pipeline Manager

If you installed BRM server and Pipeline Manager on separate machines or directories, on the machine on which you installed the BRM server, set the environment variables to point to the

client wallet and JAR files in the *Pipeline_home* directory (where *Pipeline_home* is the directory in which Pipeline Manager is installed) by running the following command:

```
setenv BRM_WALLET Pipeline_home/wallet/client
setenv PIN_HOME Pipeline_home/jars
```

Updating Client Wallet for Pipeline Manager

If you installed BRM server and Pipeline Manager on separate machines, on the machine on which you installed the BRM server, update the values for the following configuration entries in the client wallet manually:

- **oracle.security.client.connect_string***n*
- **oracle.security.client.username***n*
- **oracle.security.client.password***n*

where *n* is the database or database schema number. For example:
oracle.security.client.connect_string1.

To update configuration entries in the client wallet, see "About Oracle Wallet" in *BRM System Administrator's Guide*.

Copying Files for Compiling CM and FM Modules

To copy the required files for compiling CM and FM modules:

1. Copy the following files from the *BRM_home/lib* directory to the *BRM_home/PortalDevKit/source/sys/cm* directory:
 - **libcmpin.so**
 - **libdmpin.so**
2. Copy the **cm.cpp** file from the *BRM_home/source/sys/cm* directory to the *BRM_home/PortalDevKit/source/sys/cm* directory.
3. Copy the contents from the *BRM_home/PortalDevKit/include* directory to the *BRM_home/include* directory.
4. Open the *BRM_home/PortalDevKit/source/samples/env.unix* file in a text editor.
5. Add or modify the following environment variables:

```
LIBDIR = BRM_home/PortalDevKit/lib
RW_INCDIR = PortalDevKit_hostname/rwWorkspace
INCDIR = BRM_home/PortalDevKit/include
PCM_JAR = BRM_home/jars/pcm.jar
JDK_HOME = jdk_path
PCMEXT_JAR = BRM_home/jars/pcmext.jar
```

where:

- *hostname* is the name of the machine on which the BRM server is installed.
 - *jdk_path* is the path to the directory in which the latest version of JRE certified with BRM is installed.
6. Save and close the file.

Editing and Loading the Event Notification List

To edit and load the event notification list:

1. Open the BRM event notification file (*BRM_home/sys/data/config/pin_notify*) in a text editor.
2. Search for the following entries and remove them:
3. Save and close the file.
4. Load the updated file into the database by running the **load_pin_notify** utility:

```
2354 0 /event/billing/settlement/notify
2355 0 /event/billing/dispute/notify
```

```
load_pin_notify -v event_notification_file
```

where *event_notification_file* is the path to the BRM event notification file.

See "Loading the Event Notification List" in *BRM Developer's Guide* for more information.

Loading the Tailor-Made Stored Procedure

If you use the Tailor-Made Plan feature, you must load its stored procedure.

To load the stored procedure:

1. Ensure the following:
 - BRM and Pipeline Manager are installed.
 - The BRM schema and the Pipeline Manager schema reside on the same database.
2. Connect to the Oracle database with SQL*Plus:

```
% sqlplus system@databaseAlias
Enter password: password
```

3. Grant access of the pipeline schema to the BRM database user (for example, **pin**) by doing the following:
 - a. Grant permissions to select, update, insert, and delete command on the Pipeline Manager tables listed below. For example:

```
SQL> grant select, update, insert, delete on tableName to pin_user;
```

where *tableName* is the name of the Pipeline Manager table and *pin-user* is the BRM database user. Run the command for the following tables:

- ifw_rateplan
- ifw_rateplan_cnf
- ifw_rateplan_ver
- ifw_model_selector
- ifw_selector_detail
- ifw_selector_rule
- ifw_selector_rule_Ink
- ifw_selector_ruleset
- ifw_pricemodel

- ifw_pricemdl_step
- b. Grant select permission on the Pipeline Manager tables and sequences listed below. For example:

```
SQL> grant select on tableOrSequenceName to pin_user;
```

where *tableOrSequenceName* is the name of the Pipeline Manager table or sequence and *pin-user* is the BRM database user. Run the command on the following tables and sequences:

- ifw_service
 - ifw_timezone
 - ifw_timemodel
 - ifw_impact_cat
 - ifw_zonemodel
 - ifw_calendar
 - ifw_seq_selectordetail
 - ifw_seq_selectorrule
 - ifw_seq_modelselector
 - ifw_seq_pricemodel
 - ifw_seq_rateplan
4. Type **exit** to exit SQL*Plus.
5. Go to the *Pipeline_home/database/Oracle/Scripts* directory, where *Pipeline_home* is the directory in which Pipeline Manager is installed.
6. Enter the following command to open SQL*Plus:
- ```
% sqlplus pin_user@databaseAlias
Enter password: password
```
- where *pin\_user* is the BRM database user and *databaseAlias* is the service name or database alias of the Oracle database.
7. Enter the following command to load the stored procedure:
- ```
SQL>@create_pricing_tailormadeplan_procedures.plb
```
8. Type **exit** to exit SQL*Plus.

Postinstallation Tasks for a BRM Production Installation

After installing the BRM server, if you have not performed the following tasks during installation, do the following and then run the **pin_setup** script. See "[Running the pin_setup Script](#)" for more information.

- (Optional) To further configure BRM, you can edit the *BRM_home/setup/pin_setup.values* file. See "[Editing the pin_setup.values File](#)" for more information.
- (Optional) If you did not create multiple tablespaces during the BRM server installation, create additional tablespaces and map the BRM tables to the tablespaces. See "[Editing the pin_tables.values File](#)" for more information.
- (Optional) If you enabled partitioning during BRM installation, the following classes are automatically partitioned: journal, journal master, newsfeed, and user activity. However,

you can change the classes that are partitioned. See "[Enabling Different Classes for Partitioning during Installation](#)" for more information. This task is common to both typical and complete BRM server installations.

Do the following *after* running the **pin_setup** script:

- (Optional) Change your database partitions as required. See "[Changing Your Database Partitions](#)" for more information.
- If you installed the BRM server and Pipeline Manager on separate machines or directories, set the BRM_WALLET and PIN_HOME variables in the BRM server to point to the client wallet and JAR files in the *Pipeline_home* directory, where *Pipeline_home* is the directory in which Pipeline Manager is installed. See "[Setting Environment Variables for Pipeline Manager](#)" for more information.
- If you have installed the BRM server and Pipeline Manager on separate machines, update the configuration entries for Pipeline Manager in the client wallet manually. See "[Updating Client Wallet for Pipeline Manager](#)" for more information.
- If you installed any optional components on a separate machine from the CM, edit the optional component's configuration entries. See "[Editing Optional Components Configuration Entries](#)" for more information.
- Copy the makefiles required for compiling the Connection Manager instances. See "[Copying Files for Compiling CM and FM Modules](#)" for more information.
- Edit and load the event notification list. See "[Editing and Loading the Event Notification List](#)" for more information.
- Load the tailor-made stored procedure to create a tailor-made plan. See "[Loading the Tailor-Made Stored Procedure](#)" for more information.

Editing the pin_tables.values File

If you install BRM with the default settings, BRM data is stored in a single tablespace (**pin00**), and BRM indexes are stored in a second tablespace (**pinx00**). Although you can run and test BRM with just these tablespaces, you need multiple tablespaces for optimal performance on a production system.

If your BRM database contains multiple tablespaces, you must use the *BRM_home/setup/scripts/pin_tables.values* file to map the BRM tables to the tablespaces you created in Oracle. For information on how to map your tables, see "[Mapping Tablespaces to Logical Devices](#)".

Enabling Different Classes for Partitioning during Installation

To enable partitioning for different storable classes, you must edit the **pin_setup.values** file and then run the **pin_setup** script.

To enable different storable classes for partitioning during installation:

1. Open the *BRM_home/setup/pin_setup.values* file.
2. Ensure that the \$ENABLE_PARTITION parameter is set to **Yes**.
3. In the @CLASSES_TO_BE_PARTITIONED entry, add or remove storable classes. The default list is shown below:

```
@CLASSES_TO_BE_PARTITIONED = ("/journal:local","/journal master:local", "/newsfeed:local","/sepa:local","/user_activity:local");
```

To add classes for partitioning, use the following format:

```
"/class_name:index_type"
```

where:

- *class_name* is the name of a base storable class. Add only base storable classes to the list.

The event storable class is never added to the list. If partitioning is enabled (`$ENABLE_PARTITION = Yes`), the event tables are always partitioned.

- *index_type* is one of the following index types available for non-event partitions (all event indexes are local):
 - **:local** — Maintenance can be done without shutting down BRM, but performance may suffer. Search operations are more time consuming because searches must hit every local index.
 - **:global** — Search operations are fast, but BRM services must be shut down before adding or dropping partitions. Tables with global indexes require the indexes to be rebuilt.

 **Note:**

When **pin_setup** is run, the tables of storable classes enabled for partitioning get an initial partition. Because BRM does not provide a tool to revert partitioned tables to nonpartitioned tables, these partitions cannot easily be removed after data starts being stored in them.

4. Save and close the file.

Editing Optional Components Configuration Entries

If you install any optional components on a separate machine from your CM, manually edit the component's configuration entries to include the following:

- The correct CM port number.
- The correct host name for the CM machine.
- Any component-specific Facilities Module (FM) entries. For information, see "Syntax for Facilities Module Entries" in *BRM System Administrator's Guide*.

For updating the configuration entries in the Oracle wallet, see "About Oracle Wallet" in *BRM System Administrator's Guide*.

Maintaining a BRM Database

You monitor and maintain the BRM database with standard database tools. For example, you can set up your database software to generate log files. For more information, see the documentation for your database software.

You can also use the **sar** utility to monitor performance.

**Note:**

Do not use SQL statements to insert, delete, or update BRM tables or objects. Always use the Portal Communications Module (PCM) interface, which guarantees the integrity of the BRM database.

For information about managing a multischema system, see "Managing a Multischema System" in *BRM System Administrator's Guide*.

Maintaining the Connection to the Database

If the connection to the database fails, BRM automatically attempts to reconnect using the database name listed in the DM configuration file. If BRM can reestablish the connection, BRM generally restarts the operation. If BRM is in the middle of a transaction, BRM reports a **PIN_ERR_STORAGE** error in the DM log file. If BRM cannot reestablish the connection, it reports a **PIN_ERR_STORAGE_DISCONNECT** error.

For more information about failure recovery, see "Four-Tier Architecture and Failure Recovery" in *BRM Concepts*.

Monitoring Database Space

Before you installed BRM, you set up your database based on estimates of the size of tables for your business activity. The planning process also included forecasts of how fast the tables would grow. You should monitor the growth of tables not only to ensure you maintain enough space on your system, but also to check for unexpected growth that would indicate some problem.

On a typical production system, you should check tables monthly. As part of this audit, you should match rows in each of the tables against the expected rows. If you spot discrepancies, checking the individual tables shows where the unexpected growth is coming from. For a list of the BRM tables, see "Storable Class-to-SQL Mapping" in *BRM Developer's Reference*.

If you have a multischema system, you can use growth information to revise your scheme for distributing accounts among your various schemas. See "Setting Database Schema Priorities" in *BRM System Administrator's Guide*.

Monitoring Oracle Tablespace Usage

You should monitor the growth of tables so that you can add more extents or data files before the tablespaces are filled. To find information about the available blocks and bytes for each tablespace, run the following command:

```
SQL> select * from user_free_space;
```

Your database administrator should provide a maximum value to look for. If a tablespace grows past that maximum, you (or an automated script) should notify the database administrator to take appropriate action.

Monitoring SQL Statements

You can collect debugging information by gathering the SQL statements generated by **dm_oracle** processes. The statements appear in the DM log file, not the DM **pinlog** file.

To get the SQL statements for a specific operation or sequence of events:

1. In the environment from which **dm_oracle** will be started, set the environment variable **DM_DEBUG3** to **0xFFFF003F**.

Using the c-shell (**cs**):

```
setenv DM_DEBUG3 0xFFFF003F
```

Using the bash or Korn shell (**sh/ksh**):

```
export DM_DEBUG3=0xFFFF003F
```

2. Clear the old log file.
3. Start the Oracle DM.
4. Run the DM operation you are debugging to generate SQL statements.
5. Stop the Oracle DM.
6. Use the **grep** command on the Oracle DM log file for the "SQL_STMT" string.
7. Unset the **DM_DEBUG3** environment variable. Otherwise, subsequent DM operations will generate huge log files.

Using the c-shell (**cs**):

```
unsetenv DM_DEBUG3
```

Using the bash or Korn shell (**sh/ksh**):

```
unset DM_DEBUG3
```

Rebuilding Indexes

The structure of indexes influences the speed at which BRM can find records in the database. While you are using BRM in a production environment, especially when there is intensive inserting in the database, these indexes can become unbalanced, impeding access to BRM records. For best efficiency, rebuild the indexes frequently. For example, if you have a heavily used production system, you might want to rebuild the indexes weekly.

Note:

Do *not* delete any of the standard BRM indexes without first consulting Oracle. Removing an index can lead to serious performance problems. Also, do *not* delete or change any of the standard stored procedures. Otherwise, the DM might malfunction.

What's Next?

After completing the postinstallation tasks, set up your product offerings, business policies, and customer accounts in BRM. To do so, you must install the BRM client applications, including the BRM web-based client applications, such as Billing Care, Business Operations Center, and Pricing Design Center (PDC):

- To set up BRM, install core BRM client applications. See "[Installing BRM Thick Clients](#)" for more information.
- To create and manage customer accounts, install the Billing Care application. See *Billing Care Installation Guide* for more information.

- To create, schedule, and view the results of business operations, install the Business Operations Center application. See *Business Operations Center Installation Guide* for more information.
- To create product offerings, install PDC. See *PDC Installation Guide* for more information.

For a production installation, to implement BRM with the required software products for charging, billing, and revenue management, you must install and configure the required software products before you implement BRM.

See the product documentation of the required software products for instructions on installing and configuring those products. For example, if you are using Elastic Charging Engine (ECE) for usage charging, install ECE. See *ECE Installation Guide* for more information.

7

Installing a Multischema System

Learn how to install Oracle Communications Billing and Revenue Management (BRM) in a multischema system.

Topics in this document:

- [Before Installing a Multischema System](#)
- [Multischema Installation Overview](#)
- [Installing a Multischema System: Task List](#)
- [What's Next?](#)

Before Installing a Multischema System

Before you install a multischema system, verify the following:

- Your system meets the minimum hardware and software requirements.
See "[System Requirements](#)".
- You have all the software required to run BRM with an Oracle database in an Oracle Real Application Clusters (Oracle RAC) system.
See "[Database Requirements](#)".
- All database schemas in your system use the following:
 - A unique schema name
 - The same tablespace names

Multischema Installation Overview

You can distribute BRM data among multiple database schemas to increase scalability and availability. For more information about multischema systems, see "[A BRM Multischema Production System](#)".

Typically, a multischema system includes one or more database schema machines and several machines running BRM. You configure the additional BRM machines so that each Oracle Data Manager (DM) process communicates with one particular schema across the network.

For example, [Figure 7-1](#) shows a multischema system with two BRM installation machines and two schemas.

Figure 7-1 Two-Schema BRM Multischema Environment

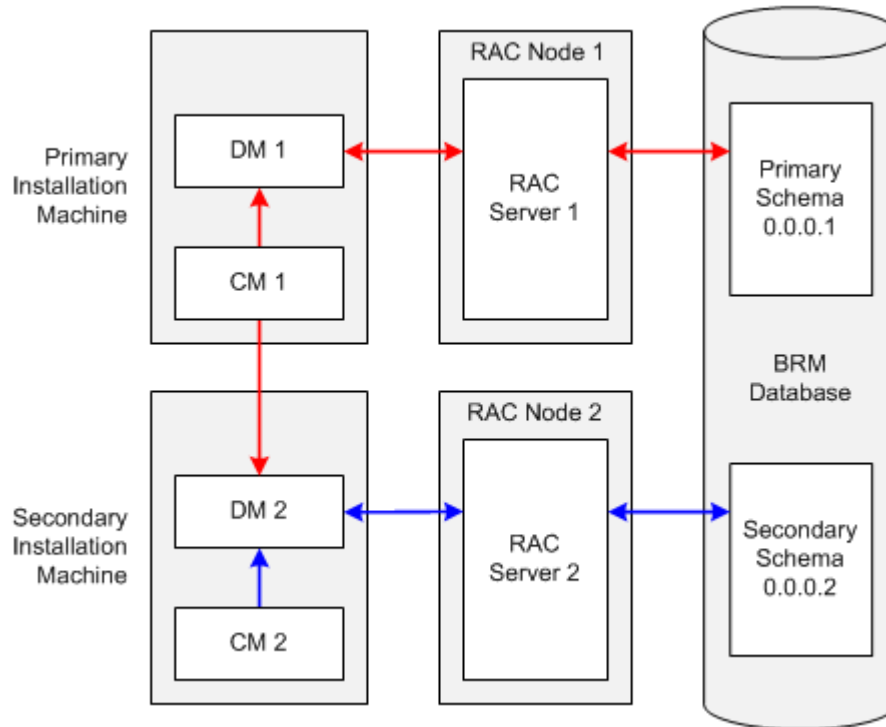

In a multischema system:

- The *primary installation machine* must contain, at a minimum, the primary Connection Manager (CM), the primary Oracle DM, and a database client. The primary CM communicates with both primary and secondary Oracle DMs, and the primary DM is dedicated to the primary database schema.
- The *secondary installation machine* must contain, at a minimum, a secondary DM and a database client. In figure [Figure 7-1](#), it also contains a secondary CM. The secondary CM communicates with the secondary DM, and the secondary DM is dedicated to the secondary database schema. Although the secondary CM is not required, it enables you to perform dedicated operations, such as billing, on the secondary database schema.
- The *primary database schema* contains all the configuration, pricing, audit trail, and uniqueness objects. Modifications to configuration, pricing, and audit trail objects are always performed by the primary DM in the primary database schema. Secondary DMs can modify uniqueness objects in the primary database schema by using schema qualifications. The primary database schema also contains subscriber data, such as events and account objects.
- The *secondary database schema* contains subscriber data. Each secondary database schema also has access to the configuration, pricing, audit trail, and uniqueness objects stored in the primary database schema.

Installing a Multischema System: Task List

This section provides an overview of the tasks you must perform to install and configure a multischema system.

1. Install an Oracle database across all the servers in your Oracle RAC system.

For more information, see the following:

- [BRM Preinstallation Tasks](#)
 - [Setting Up Oracle RAC](#)
 - Oracle RAC documentation
2. Through one Oracle RAC node, create the primary database schema.
See "[Creating and Configuring pin_user](#)".

 **Note:**

The term "BRM user" is synonymous with the term "database schema."

3. Through each of the other Oracle RAC nodes, create a secondary database schema.
See "[Creating and Configuring pin_user](#)".
4. Configure each database schema in your system to connect to all the other database schemas, and verify that the connections work.

 **Note:**

This enables the database links created when you run the **pin_multidb.pl** script (see step 17) to work across the schemas.

For information, see your Oracle database documentation.

5. For each database schema, grant execute permission for **dbms_lock**.
See "[Creating and Configuring pin_user](#)".
6. On your primary installation machine, install the PERL libraries and the JRE required to install BRM components.
7. On each of your secondary installation machines, install the PERL libraries and the JRE required to install BRM components.
8. On your primary installation machine, install BRM.
See "[Installing BRM on the Primary Installation Machine](#)".
9. On your secondary installation machines, install BRM.
See "[Installing BRM on a Secondary Installation Machine](#)".
10. Verify that the BRM installation machines can connect to all the schemas.
See "[Verifying That the Installation Machines Connect to All Schemas](#)".
11. Install Multidatabase Manager on the primary installation machine.
See "[Installing and Configuring Multidatabase Manager on the Primary Installation Machine](#)".
12. (Optional) Disable the creation of uniqueness objects.
See "[Disabling Creation of Uniqueness Objects](#)".
13. Edit the **pin_multidb.conf** file on the primary installation machine.

- See "[Configuring pin_multidb.conf on the Primary Installation Machine](#)".
14. Edit the client wallet on the primary installation machine.
See "[Configuring Client Wallet on the Primary Installation Machine](#)".
 15. If your system includes an SSL-enabled Oracle database, edit the SSL database wallet on the primary installation machine. See "[Connecting to SSL-Enabled Oracle Database](#)".
 16. Grant Oracle database system privileges to each database schema in your system.
See "[Granting System Privileges to Each Database Schema](#)".
 17. Run the **pin_multidb.pl** script on the primary installation machine.
See "[Running pin_multidb.pl on the Primary Installation Machine](#)".
 18. (Optional) Make custom tables available to all the schemas in your system.
See "Creating Custom Tables That Are Available to All Database Schemas" in *BRM System Administrator's Guide*.
 19. (Optional) Configure BRM to enforce the creation of unique account numbers.
See "[Enforcing the Creation of Unique Account Numbers](#)".
 20. Create schema qualifications that connect each secondary database schema to the primary database schema.
See "[Setting Up Schema Qualifications](#)".

Installing BRM on the Primary Installation Machine

The primary installation machine must contain, at a minimum, the primary CM, the primary Oracle DM, and a database client.



Note:

The database client is required because the primary Oracle DM and the primary database schema are installed on different machines.

To set up the primary installation machine:

1. Install BRM. See "[Installing BRM](#)".
2. Connect the Oracle DM to the primary Oracle RAC instance:
 - a. Open the Oracle DM configuration file in a text editor:
BRM_home/sys/dm_oracle/pin.conf
 - b. Set the **sm_database** entry to the connect descriptor configured for the primary Oracle RAC instance:

```
- dm sm_database connectionString
```

connectionString must match the *connectionString* entry for the primary Oracle RAC instance in the **tnsnames.ora** file.

- c. Add the following entry:

```
- dm sm_svcname serviceName
```

serviceName must match the **SERVICE_NAME** entry in the connect descriptor specified in the preceding step.

- d. Save and close the file.
 - e. Stop and restart the Oracle DM.
3. Configure the primary database client to connect to each secondary database schema. For information, see "[Installing the Database and Oracle DM on Separate Machines](#)".
 4. Install the optional components you purchased that might add tables to your database.

 **Note:**

You must install optional components *before* you run the **pin_multidb.pl** script to ensure that configuration objects from your optional component tables are made available to your secondary database schemas. See "[Running pin_multidb.pl on the Primary Installation Machine](#)".

Installing BRM on a Secondary Installation Machine

A secondary installation machine must contain, at a minimum, an Oracle DM and a database client.

 **Note:**

- The database client is required because a secondary installation machine and its corresponding secondary database schema machine (which is in an Oracle RAC system) are different machines.
- You must install all of the BRM software on all machines that run a BRM process, even if you run only a CM or a DM on a particular machine.

To set up a secondary installation machine:

1. Copy the BRM wallet from your primary installation machine to your secondary installation machine.
2. Set the **BRM_WALLET** and **BRM_CONF_WALLET** environment variables to the location of your BRM wallet on the secondary installation machine:

```
setenv BRM_WALLET BRM_home/wallet/client
setenv BRM_CONF_WALLET BRM_home/wallet/client
```

3. Install BRM. See "[Installing BRM](#)".
4. Connect the Oracle DM to a secondary Oracle RAC instance:
 - a. Open the Oracle DM configuration file (*BRM_home/sys/dm_oracle/pin.conf*) in a text editor.
 - b. Set the **sm_database** entry to the connect descriptor configured for a secondary Oracle RAC instance:

```
- dm sm_database connectionString
```

connectionString must match the *connectionString* entry for a secondary Oracle RAC instance in the **tnsnames.ora** file.

- c. Add the following entry:

```
- dm sm_svcname serviceName
```

serviceName must match the **SERVICE_NAME** entry in the connect descriptor specified in the preceding step.

- d. Save and close the file.
- e. Stop and restart the Oracle DM.
5. Configure the secondary database client to connect to the primary database schema. For information, see "[Installing the Database and Oracle DM on Separate Machines](#)".
6. Install the same optional components that you installed on the primary installation machine.
7. On the primary installation machine, generate the root key by running the following command:

```
pin_crypt_app -genrootkey
```

The root key is generated.

8. On both primary and secondary installation machines, set the generated primary root key in the Oracle DM configuration file (*BRM_home/sys/dm_oracle/pin.conf*).

Verifying That the Installation Machines Connect to All Schemas

Verify that BRM was installed and set up properly on your installation machines by connecting to the primary and secondary database schemas.

Using testnap to Verify Access to Your Schemas

The BRM **testnap** utility tests your installation machine's connection to the database schema by establishing a Portal Communications Module (PCM) connection with the CM and executing PCM opcodes using that connection. For more information, see "testnap" in *BRM Developer's Reference*.

Verifying Access between Primary Installation Machine and Primary Schema

Perform the following procedure on the primary installation machine to verify that it can connect to the primary database schema:

1. Log in as user **pin**, go to the *BRM_home/sys/test* directory, and open the **pin.conf** file in a text editor such as **vi**:

```
su - pin
cd BRM_home/sys/test
vi pin.conf
```

2. Modify the following entries in the **pin.conf** file:

```
- nap cm_ptr ip primary_hostname port_number
- nap login_name login_name
```

where:

- *primary_hostname* is the host name of the primary installation machine.

- *port_number* is the port number of the primary CM.
 - *login_name* is the login for the primary CM (the default is **root.0.0.0.1**).
3. Run the **testnap** utility from the *BRM_home/sys/test* directory, and check for connection errors:

```
testnap
====>database 0.0.0.1 from pin.conf "userid"
q
```

Verifying Access between Secondary Installation Machines and Secondary Schemas

Perform the following procedure on each secondary installation machine to verify that it can connect to its secondary database schema:

1. Log in as user **pin**, go to the *BRM_home/sys/test* directory, and open the **pin.conf** file in a text editor such as **vi**:

```
cd BRM_home/sys/test
vi pin.conf
```

2. Modify the following entries in the **pin.conf** file:

```
- nap cm_ptr ip secondary_hostname port_number
- nap login_name login_name
```

where:

- *secondary_hostname* is the host name of the secondary installation machine.
 - *port_number* is the port number of the secondary CM.
 - *login_name* is the login for the secondary CM (the default is **root.0.0.0.2**).
3. Run the **testnap** utility from the *BRM_home/sys/test* directory, and check for connection errors:

```
testnap
====>database 0.0.0.2 from pin.conf "userid"
q
```

Installing and Configuring Multidatabase Manager on the Primary Installation Machine

To install and configure Multidatabase Manager, perform the following procedure on the primary installation machine:

1. Stop all BRM processes if running. See "Starting and Stopping the BRM System" in *BRM System Administrator's Guide*.
2. Install Multidatabase Manager. See "[Installing Individual BRM Components](#)".
3. Go to the *BRM_home/setup* directory, and run the **pin_setup** script.
4. Log in as user **pin** and copy the Multidatabase Manager configuration file (*BRM_home/apps/multi_db/pin.conf*) to the *BRM_home/setup/scripts* directory:

```
su - pin
cp BRM_home/apps/multi_db/pin.conf BRM_home/setup/scripts
```

5. Go to the *BRM_home/setup/scripts* directory, and open the **pin.conf** file in a text editor such as **vi**:

```
cd BRM_home/setup/scripts
vi pin.conf
```

6. Modify the following entries in the **pin.conf** file:

```
- nap cm_ptr ip primary_hostname port_number
- nap login_name login_name
```

where:

- *primary_hostname* is the host name of the primary installation machine.
- *port_number* is the port number of the primary CM.
- *login_name* is the login for the primary CM (the default is **root.0.0.0.1**).

7. Start the CM and Oracle DM processes.

See "Starting and Stopping the BRM System" in *BRM System Administrator's Guide*.

8. Run the **testnap** utility from the *BRM_home/setup/scripts* directory, and check for connection errors:

```
testnap
====>database 0.0.0.1 from pin.conf "userid"
q
```

Disabling Creation of Uniqueness Objects

BRM requires unique service login names. The **/uniqueness** objects maintain a list of unique login names across multiple database schemas. The list is used during authentication. You can disable creation of **/uniqueness** objects. For example, you might want to disable creation of **/uniqueness** objects if you use your own authentication software.

To disable creation of **/uniqueness** objects:

1. Open the CM configuration file (*BRM_home/sys/cm/pin.conf*).
2. Edit the following entry:

```
-cm uniqueness_login 1
```

where:

- **0** does not create uniqueness objects.
- **1** creates uniqueness objects. This is the default.

3. Save the file.
4. Stop and restart the CM.

Configuring pin_multidb.conf on the Primary Installation Machine

You must enter configuration parameters for your multischema setup in the **pin_multidb.conf** file.

 **Note:**

This file is accessible only if you installed Multidatabase Manager for the appropriate platform. See "[Installing and Configuring Multidatabase Manager on the Primary Installation Machine](#)".

To configure a BRM multischema system:

1. Open the `BRM_home/setup/scripts/pin_multidb.conf` file in a text editor such as `vi`:

```
vi BRM_home/setup/scripts/pin_multidb.conf
```

2. Modify the configuration entries listed in [Table 7-1](#).

 **Note:**

Include a set of `$PIN_MD_SECONDARY*[x]` entries for each secondary database schema in your system. For example, if your system contains three secondary database schemas, the file should contain a set of `$PIN_MD_SECONDARY*` entries ending in `[0]`, a set ending in `[1]`, and a set ending in `[2]`.

In prior versions, you needed to set the `$PIN_MD_PRIMARY_DBNO`, `$PIN_MD_PRIMARY_OWNER`, `$PIN_MD_PRIMARY_DBNAME`, `$PIN_MD_PRIMARY_HOSTNAME`, and `$PIN_MD_PRIMARY_PORT` parameters. It is no longer necessary to set them, because they are set automatically.

Table 7-1 pin_multidb.conf File Entries

Entry	Description
<code>\$JDBC_JAR_FILE</code>	Specify the location of the JDBC Library (<code>ojdbc8.jar</code>).
<code>\$PIN_MD_SQL_PLATFORM</code>	Specify the database software your multischema system uses. Enter <code>'Oracle'</code> .
<code>\$PIN_MD_SQL_BASE</code>	Set this to <code>\$ORACLE_HOME</code> .
<code>\$PIN_MD_INFRANET_BASE</code>	Specify the directory in which you installed BRM on your primary installation machine. You must change this value if you installed BRM in a directory other than the default directory.
<code>\$PIN_MD_CM_HOST</code>	Enter the machine name where the primary CM is running.
<code>\$PIN_MD_CM_PORT</code>	Enter the port number for the primary CM. The default is 11960 . Check the port number by looking in the <code>BRM_home/sys/cm/pin.conf</code> file.

Table 7-1 (Cont.) pin_multidb.conf File Entries

Entry	Description
\$PIN_MD_SECONDARY_START_INST	<p>Specify the \$PIN_MD_SECONDARY*[x] array number for the first secondary database schema to add to your system, where x is the array number.</p> <p>For example:</p> <ul style="list-style-type: none"> When initially setting up a multischema system containing three secondary database schemas, set this entry to "0" and set \$PIN_MD_SECONDARY_STOP_INST to "2". This tells the pin_multidb.pl script to configure secondary database schemas based on arrays 0, 1, and 2. When adding secondary database schemas to an existing multischema system, enter the \$PIN_MD_SECONDARY*[x] array number for the first schema being added to the system. For example, if your system contains three secondary database schemas (0, 1, and 2) and you are adding two more schemas, set this entry to "3" and set \$PIN_MD_SECONDARY_STOP_INST to "4". This tells the pin_multidb.pl script to configure secondary database schemas based only on arrays 3 and 4 and to ignore arrays 0, 1, and 2. <p>Note: You must include a set of \$PIN_MD_SECONDARY*[x] entries for each secondary database schema in your system. For example, if your system contains three secondary database schemas, the pin_multidb.conf file should contain a set of \$PIN_MD_SECONDARY* entries ending in [0], a set ending in [1], and a set ending in [2].</p> <p>The default is "0".</p>
\$PIN_MD_SECONDARY_END_INST	<p>Specify the \$PIN_MD_SECONDARY*[x] array number for the last secondary database schema to add to your system, where x is the array number.</p> <p>For example, when you initially set up a multischema system containing three secondary database schemas, enter "2".</p> <p>When adding secondary database schemas to an existing multischema system, enter the \$PIN_MD_SECONDARY*[x] array number for the last schema being added to the system. For example, if your system contains three secondary database schemas (corresponding to arrays 0, 1, and 2) and you are adding two more schemas, enter "4".</p> <p>The default is "0".</p>
\$PIN_MD_SECONDARY_DBNO [x]	Enter the secondary database number. The default is "0.0.0.2".
\$PIN_MD_SECONDARY_OWNER [x]	Enter your user name for the secondary database schema. The default is "PINB".
\$PIN_MD_SECONDARY_DBNAME [x]	<p>Enter the database alias for the secondary database schema.</p> <p>Note: Ensure that you enter a unique database alias for each secondary database schema.</p>
\$PIN_MD_SECONDARY_HOSTNAME [x]	Enter the machine name where the secondary Oracle DM is running.
\$PIN_MD_SECONDARY_PORT [x]	Enter the DM port number for the secondary database schema.
\$PIN_MD_SECONDARY_PARENT_DBNO [x]	Enter the database number of the primary database schema. The default is "0.0.0.1".
\$PIN_MD_SECONDARY_PARENT_SCHEMA [x]	<p>Enter the name of the primary database schema.</p> <p>This value must match the \$PIN_MD_PRIMARY_OWNER [x] value.</p>

Configuring Client Wallet on the Primary Installation Machine

On your primary installation machine, enter the configuration parameters for your multischema setup in the client wallet by using the **pin_crypt_app** utility. See "pin_crypt_app" in *BRM Developer's Guide* for more information about the utility's syntax and parameters.

To configure the client wallet, perform the following on the primary installation machine for each secondary database schema:

1. Go to the *BRM_home/bin* directory.
2. Add or modify the values in the client wallet by running the following command:

```
pin_crypt_app -setconf -wallet clientWalletLocation -parameter configEntry -value value
```

where:

- *clientWalletLocation* is the path to the client wallet.
- *configEntry* is the configuration entry in the client wallet. See [Table 7-2](#) for the entries to be added or modified.
- *value* is the value of the configuration entry to store in the client wallet.

 **Note:**

Ensure that you add or modify the entries listed in [Table 7-2](#) for each secondary schema.

Table 7-2 Client Wallet Entries

Entry	Description
oracle.security.client.connect_stringx where x is the array number of the secondary database schema. For example, if your system contains three secondary database schemas, the client wallet should contain a set of schema entries ending in [0] , a set ending in [1] , and a set ending in [2] .	Enter the database alias for the secondary database schema. Note: Ensure that you enter a unique database alias for each secondary database schema.
oracle.security.client.usernamex	Enter your user name for the secondary database schema. The default is " PINB ".
oracle.security.client.passwordx	Enter your password for the secondary database schema.
0.0.0.x_user_password	Enter the database password.

The configuration entries are stored in the client wallet.

Connecting to SSL-Enabled Oracle Database

You connect your BRM multischema system to an SSL-enabled Oracle database by updating the SSL database wallet. To do so, you use the **pin_crypt_app** utility to add the following configuration entries to the SSL database wallet:

- **oracle.security.client.connect_stringX**: Specifies the database alias for a secondary database schema.
- **oracle.security.client.usernameX**: Specifies the user name for a secondary database schema.
- **oracle.security.client.passwordX**: Specifies the password for the secondary database schema.

where *X* is the secondary database schema number. That is, **1** for the first secondary database schema, **2** for the second secondary database, and so on.

For example, if your multischema system contains a primary database schema and two secondary database schemas, you would add the following configuration entries:

```
oracle.security.client.connect_string1
oracle.security.client.username1
oracle.security.client.password1
oracle.security.client.connect_string2
oracle.security.client.username2
oracle.security.client.password2
```

To add configuration entries to the SSL database wallet, do the following:

1. Go to the *BRM_home/bin* directory.
2. Run the following command for each configuration entry:

```
pin_crypt_app -setconf -wallet DBWalletLocation -parameter configEntry -value value
```

where:

- *DBWalletLocation* is the path and file name of the SSL database wallet.
- *configEntry* is the name of the configuration entry.
- *value* is the value of the configuration entry.

When the prompt appears, enter the password for the wallet.

Granting System Privileges to Each Database Schema

You must grant Oracle database system privileges to the primary database schema and each secondary database schema in your system.

To grant system privileges to each database schema, perform the following on the primary BRM installation machine:

1. Log in to your database as user **sysdba**:

```
% sqlplus system@databaseAlias as sysdba
Enter password: password
```

where:

- *password* is the Oracle system database user password.
 - *databaseAlias* is the Oracle system database alias.
2. Grant system privileges by running the following command separately for each database schema:

```
SQL> grant create table, create view, create trigger to schemaUserName identified by schemaPassword;
```

```
Grant succeeded.
```

```
SQL> commit;
```

```
Commit complete.
```

where:

- *schemaUserName* is the user name for the schema to which you are granting privileges.
- *schemaPassword* is the password for the specified schema user name.

Running pin_multidb.pl on the Primary Installation Machine

The **pin_multidb.pl** script initializes and configures your primary and secondary database schemas.

Running pin_multidb.pl -i

Running the **pin_multidb.pl** script with the **-i** parameter initializes the primary and secondary database schemas. See "pin_multidb" in *BRM System Administrator's Guide*.

To run **pin_multidb -i**, perform the following procedure on the primary installation machine:

1. Log in as user **pin**, go to the *BRM_home/apps/multi_db* directory, and open the **config_dist.conf** file in a text editor such as **vi**:

```
su - pin
cd BRM_home/apps/multi_db
vi config_dist.conf
```

2. Change the status of all secondary database schemas to **OPEN**.

Note:

If your system contains multiple secondary database schemas, create a new set of entries for each additional secondary database schema.

```
DB_NO = "0.0.0.1" ;           # 1st database config block.
PRIORITY = 1 ;
MAX_ACCOUNT_SIZE = 100000 ;
STATUS = "OPEN" ;
SCHEMA_NAME = "pin111x" ;

DB_NO = "0.0.0.2" ;           # 2nd database config block.
PRIORITY = 1 ;
```

```
MAX_ACCOUNT_SIZE = 100000 ;
STATUS = "OPEN" ;
SCHEMA_NAME = "pin112x" ;
```

3. Go to the *BRM_home/setup/scripts* directory, and run **pin_multidb.pl -i**:

```
cd BRM_home/setup/scripts
perl pin_multidb.pl -i
```

This starts a series of interactive prompts. Follow the instructions on the window.

 **Note:**

When a prompt instructs you to set up schema qualifications, see "[Setting Up Schema Qualifications](#)" for more information.

4. At the command prompt, enter the BRM wallet password.
5. Verify that **pin_multidb.pl** created the MD_PRIMARY database link between the primary database schema and each secondary database schema by performing the following procedure on *each* secondary database schema:

- a. Log in to the secondary database schema:

```
% sqlplus schema_user_name@database_alias
Enter password: password
```

where:

- *schema_user_name* is the user name for the secondary database schema.
- *password* is the password for the specified schema user name.
- *database_alias* is the BRM database alias of the secondary database schema.

- b. Enter the following SQL command:

```
SQL> select poid_id0 from uniqueness_t@MD_PRIMARY where poid_id0=1;
```

If the command is successful, the following lines are returned:

```
poid_id0
-----
1
```

If an error is returned, recreate the MD_PRIMARY database link and then rerun the SQL query:

- i. Log in to the secondary database schema:

```
% sqlplus schema_user_name@database_alias
Enter password: password
```

where:

- *schema_user_name* is the user name for the secondary database schema.
- *password* is the password for the specified schema user name.
- *database_alias* is the BRM database alias of the secondary database schema.

- ii. Enter the following SQL command to create the database link:

```
SQL> CREATE DATABASE LINK MD_PRIMARY CONNECT TO $PIN_MD_PRIMARY_OWNER
IDENTIFIED by $PIN_MD_PRIMARY_PASSWD USING '$PIN_MD_PRIMARY_DBNAME';
```

For information about the \$ entries, see [Table 7-1](#).

- iii. Enter the following SQL command to verify that the link was created:

```
SQL> select * from all_db_links;
```

If the command is successful, the MD_PRIMARY database link and any other database links created in the database are returned.

If the command fails, consult your Oracle systems administrator.

6. Check the primary CM's configuration file (*BRM_home/sys/cm/pin.conf*):
 - a. In the following line, verify that *DM_machine* represents the host name of the primary installation machine:

```
- cm dm_pointer 0.0.0.1 ip DM_machine 12950
```

- b. In the following line at the end of the file, verify that *DM_machine* represents the host name of the secondary installation machine:

```
- cm primary_db 0.0.0.1 / 0
- cm dm_attributes 0.0.0.2 scoped,assign_account_obj,searchable
- cm dm_pointer 0.0.0.2 ip DM_machine 12950
```

Note:

Your **pin.conf** file must contain a **dm_pointer** entry for each secondary DM in your system. Verify that any additional **dm_pointer** entries include the correct host name.

Running pin_multidb.pl -f

Note:

Complete all on-screen instructions for **pin_multidb.pl -i** before running **pin_multidb.pl -f**.

Running the **pin_multidb.pl** script with the **-f** parameter completes the multischema installation process. It starts the **pin_config_distribution** process, which runs at the frequency you specify.

To complete the multischema installation:

1. On *each* secondary installation machine, do the following:
 - a. Open the Oracle DM configuration file (*BRM_home/sys/dm_oracle/pin.conf*) in a text editor such as **vi**.
 - b. Make the data dictionary objects writable by setting the following entries to **1**:

```
- dm dd_write_enable_fields 1
- dm dd_write_enable_objects 1
- dm dd_write_enable_portal_objects 1
```
2. On the primary installation machine, go to the *BRM_home/setup/scripts* directory, and run the following command:

```
cd BRM_home/setup/scripts
perl pin_multidb.pl -f
```

This starts a series of interactive prompts. Follow the instructions in the window.

3. Verify that the **pin_config_distribution** process is running. See "pin_config_distribution" in *BRM System Administrator's Guide*.
4. Check the **pin_multidb.log** file for errors.
5. Verify that the following entries are in the configuration file (*BRM_home/sys/cm/pin.conf*) of each secondary CM that needs access to all the schemas in your system.

If they are not in the configuration file, add them to it.

```
- cm primary_db 0.0.0.1 / 0
- cm dm_attributes 0.0.0.1 scoped,assign_account_obj,searchable
- cm dm_pointer 0.0.0.1 ip DM_primary_machine 12950
- cm dm_pointer 0.0.0.x ip DM_secondary_machine 12950
```

where:

- *DM_primary_machine* represents the host name of the primary installation machine.
- *DM_secondary_machine* represents the host name of a secondary installation machine other than the one on which the CM you are configuring resides.



Note:

Your **pin.conf** file must contain a **dm_pointer** entry for each secondary DM in your system. Verify that any additional **dm_pointer** entries include the correct host name.

All BRM applications now have multischema capability.

Enforcing the Creation of Unique Account Numbers

You can configure BRM to enforce the creation of unique account numbers. Similar to the **/uniqueness** object, the **/unique_account_no** object maintains a list of unique account numbers across all BRM database schemas.

To enforce the creation of unique account numbers, perform the following procedure for each CM that you want to have access to all schemas in your system:

1. Open the CM configuration file (*BRM_home/sys/cm/pin.conf*).
2. Edit the following entry:

```
-cm uniqueness_account_no 0
```

where:

- **0** does not enforce unique account numbers. This is the default.
 - **1** enforces unique account numbers.
3. Save the file.
 4. Stop and restart the CM.

Setting Up Schema Qualifications

To set up a multischema system, create schema qualifications that connect each secondary database schema to the primary database schema.



Note:

Multidatabase Manager still creates database links between the schemas, but they are used only by the **pin_multidb** utility.

To set up schema qualifications:

1. On the primary Oracle DM machine:
 - a. Open the Oracle DM configuration file (*BRM_home/sys/dm_oracle/pin.conf*) in a text editor.
 - b. For each secondary database schema in your system, add the following entry:

```
- dm schema db_no schema_name
```

where *db_no* is the database number of the schema, and *schema_name* is the name of the schema.

For example, if your system has two secondary database schemas named **pin02** and **pin03**, add the following entries:

```
- dm schema 0.0.0.2 pin02  
- dm schema 0.0.0.3 pin03
```

- c. Save and close the file.
- d. Go to the *BRM_home/sys/dm_oracle/data* directory and run the following commands:

```
sqlplus login@ORACLE_SID  
Enter password: password  
  
SQL>create_procedures_character_set.plb  
SQL>grant_permissions_oracle.plb  
SQL>call grant_permissions('secondary_schema_name');
```

where:

- *login* is the user name for the primary database schema.
- *password* is the password for the specified user name.
- *ORACLE_SID* is the BRM database alias of the primary database schema.
- *character_set* specifies the database character set of either **UTF8** or **AL32UTF8**.
- *secondary_schema_name* is the name of the secondary database schema to which you are granting permissions.

 **Note:**

Execute **call grant_permissions('secondary_schema_name')** separately for each secondary database schema in your system.

For example, if your system has primary database schema **pin01** and two secondary database schemas named **pin02** and **pin03**, log in to schema **pin01**, and execute the **call** command twice: once for **pin02** and once for **pin03**.

- e. Stop and restart the primary DM.
2. On *each* secondary Oracle DM machine:
 - a. Open the Oracle DM configuration file (*BRM_home/sys/dm_oracle/pin.conf*) in a text editor.
 - b. For the primary database schema and each of the other secondary database schemas in your system, add the following entry:

```
- dm schema db_no schema_name
```

where *db_no* is the database number of the schema, and *schema_name* is the name of the schema.

For example, if your system has schemas named **pin01** (primary), **pin02** (secondary), and **pin03** (secondary), add the following entries:

In the schema pin02 DM configuration file:

```
- dm schema 0.0.0.1 pin01
- dm schema 0.0.0.3 pin03
```

In the schema pin03 DM configuration file:

```
- dm schema 0.0.0.1 pin01
- dm schema 0.0.0.3 pin02
```

- c. Delete or comment out any **db_link** entries to the primary database schema. For example:

```
# - dm db_link MD_PRIMARY
```

 **Note:**

A secondary DM cannot access the primary database schema by using both a schema qualification and a database link. If both entries are set, the DM reports an invalid configuration error.

- d. Save and close the file.
- e. Run the **grant_permissions_oracle.plb** script from the Linux prompt:

```
cd BRM_home/sys/dm_oracle/data
sqlplus login/password@ORACLE_SID < grant_permissions_oracle.plb
call grant_permissions('schema_name');
```

where:

- *login* is the user name for the secondary database schema associated with the DM you are configuring.
- *password* is the password for the specified user name.
- *ORACLE_SID* is the unique BRM database alias of the secondary database schema.
- *schema_name* is the name of the schema to which you are granting permissions.

 **Note:**

Execute **call grant_permissions('schema_name')** separately for the primary database schema and for each of the other secondary database schemas in your system.

For example, if your system has schemas named **pin01** (primary), **pin02** (secondary), and **pin03** (secondary), do the following:

- Log in to **pin01**, and run the call command for **pin02** and then for **pin03**.
- Log in to **pin02**, and run the call command for **pin01** and then for **pin03**.
- Log in to **pin03**, and run the call command for **pin01** and then for **pin02**.

- f. Stop and restart the secondary DM.
3. Using SQL*Plus, grant each database schema the privilege to insert and update tables on the other schemas:

- a. Connect to the BRM database with SQL*Plus as **sysdba**:

```
sqlplus system@databaseAlias as sysdba
Enter password: password
```

where:

- *databaseAlias* is the Oracle system database alias.
- *password* is the Oracle system database user password.

- b. From the primary database schema, enter the following:

```
SQL> GRANT INSERT ANY TABLE TO SecondarySchema;
SQL> GRANT UPDATE ANY TABLE TO SecondarySchema;
```

where *SecondarySchema* is the name of the secondary schema.

- c. From each secondary database schema, enter the following:

```
SQL> GRANT INSERT ANY TABLE TO PrimarySchema;
SQL> GRANT UPDATE ANY TABLE TO PrimarySchema;
```

where *PrimarySchema* is the name of the primary schema.

What's Next?

Your BRM system now has multischema capability. You can install the BRM client applications and start creating your accounts. See "[Installing BRM Thick Clients](#)".

For information on how to manage your multischema system, such as setting database schema priority and status, see "Managing a Multischema System" in *BRM System Administrator's Guide*.

8

Installing BRM Thick Clients

Learn how to install applications that provide graphical user interfaces to the data in the Oracle Communications Billing and Revenue Management (BRM) database.

Topics in this document:

- [About Installing BRM Clients](#)
- [About BRM Client Package](#)
- [Installing Self-Care Manager](#)
- [Installing Customer Center](#)
- [Installing Pricing Center](#)
- [Installing Suspense Management Center](#)
- [Downloading the BRM Client Software](#)
- [Installing BRM Clients in GUI Mode](#)
- [Installing BRM Clients in Silent Mode](#)
- [Configuring the Localization SDK on Windows](#)
- [Granting Administrative Privileges to Pricing Center Users](#)
- [Starting a BRM Client Application on Linux](#)
- [Starting a BRM Client Application on Windows](#)
- [Starting a BRM Client Application from Java Web Start](#)
- [Problems Installing BRM Client Applications](#)
- [What's Next?](#)

Note:

- Before installing BRM thick clients, you must first install BRM. See "[Installing BRM](#)".
- Localized versions of BRM thick clients are supported by BRM. The following languages are supported: French, Italian, Spanish, Japanese, Korean, Chinese Simplified, Chinese Traditional, Russian, and Portuguese Brazilian.

About Installing BRM Clients

You can install the BRM clients in GUI mode or in silent mode. Installing the BRM clients in silent mode lets you perform a noninteractive installation of BRM. You can use silent mode to install the clients quickly.

BRM clients installation must be performed by a user who has permissions to write to the **oralInventory** directory.

For installation instructions, see the following sections:

- [Installing BRM Clients in GUI Mode](#)
- [Installing BRM Clients in Silent Mode](#)

About BRM Client Package

The BRM Install Package includes the BRM server and BRM client packages. The BRM client package includes all the BRM client applications. You can use the Installer to install one or more of the following individual BRM client applications:

- Revenue Assurance Center
- Developer Center
- Customer Center (including GSM Manager: Customer Center Extension)

GSM Manager: Customer Center Extension enables support for assigning SIM cards and telephone numbers in Customer Center. See the discussion about setting up GSM services in Customer Center Help.

 **Note:**

You must install the GSM Manager Customer Center Extension on a system on which Customer Center is installed.

- Customer Center SDK

You can use JBuilder (for example, Borland JBuilder) for various tasks such as creating WAR files for Self-Care Manager and custom pages for Customer Center.

- Collection Center
- Collections Configuration Center
- IP Address Administration Center
- Number Administration Center
- Permissioning Center
- Payment Center
- Pricing Center

 **Note:**

When you install Pricing Center, you automatically install the Resource Editor and the Zone Mapper.

- Self-Care Manager
- SIM Administration Center
- Voucher Administration Center
- Suspense Management Center
- Localization (L10N) SDK

For installing Customer Center, Pricing Center, Self-Care Manager, or Suspense Management Center, see:

- [Installing Customer Center](#)
- [Installing Pricing Center](#)
- [Installing Self-Care Manager](#)
- [Installing Suspense Management Center](#)

For installing other BRM client applications, see "[Installing BRM Clients in GUI Mode](#)".

Installing Self-Care Manager

To use Self-Care Manager, you must install a third-party application server before installing Self-Care Manager. Supported application servers include Tomcat and WebLogic. For more information, see the vendor installation instructions for the application server you are using.

Note:

You must install the application server and Self-Care Manager on the same system. The Connection Manager (CM) can be on the same system as Self-Care Manager or on a different system.

For instructions on installing Self-Care Manager, see "[Installing Individual BRM Clients](#)". After installing Self-Care Manager, configure the application server to work with Self-Care Manager.

Installing Customer Center

You must install Customer Center on a system that includes the following:

- A third-party Web server. BRM currently supports Apache Tomcat. For supported versions, see "Additional BRM Software Requirements" in *BRM Compatibility Matrix*.
- Java Web Start technology with SSL enabled. See "Enabling SSL for Web Start Deployment" in *BRM System Administrator's Guide*.

You then use the Web server and Java Web Start technology to distribute Customer Center to your CSRs.

To use Customer Center, CSRs download it from the Web server to their Windows client systems. When CSRs run Customer Center, they run their local versions that communicate directly with the BRM database.

Each time a CSR runs Customer Center, the application uses Java Web Start to check the Web server for updates and automatically download new versions.

Note:

You can *install* Customer Center on either a Linux or Windows system, but Customer Center can be *run* only on a Windows system.

Install Customer Center on the directory on which Apache Tomcat is installed; for example, `Tomcat_home\webapps\ROOT`. For instructions on installing Customer Center, see "[Installing Individual BRM Clients](#)". After installing Customer Center, configure the application server to work with Customer Center.

Installing Pricing Center

Pricing Center can be installed as a standalone application or on a system with a Web server.

- If you will use Pricing Center as a standalone application on a single system, install the standalone version.
- If you are installing with a Web server, you use the Web server and Java Web Start technology to distribute Pricing Center to your CSRs. You must install the third-party application server (Apache Tomcat) before installing Pricing Center. You must also enable SSL for Java Web Start. See "Enabling SSL for Web Start Deployment" in *BRM System Administrator's Guide*.

To use Pricing Center, CSRs download it from the Web server to their Windows client systems. When CSRs run Pricing Center, they run their local versions that communicate directly with the BRM database.

Each time CSRs run Pricing Center, the application uses Java Web Start to check the Web server for updates and to automatically download any new versions it finds.

Install Pricing Center on the directory on which Apache Tomcat is installed; for example, `Tomcat_home\webapps\ROOT`. For instructions on installing Pricing Center, see "[Installing Individual BRM Clients](#)". After installing Pricing Center, configure the application server to work with Pricing Center.

Installing Suspense Management Center

Suspense Management Center can be installed as a standalone application or on a system with a Web server.

- If you will use Suspense Management Center as a standalone application on a single system, install the standalone version.
- If you are installing with a Web server, you use the Web server and Java Web Start technology to distribute Suspense Management Center to your CSRs. You must install the third-party application server (Apache Tomcat) before installing Suspense Management Center. You must also enable SSL for Java Web Start. See "Enabling SSL for Web Start Deployment" in *BRM System Administrator's Guide*.

To use Suspense Management Center, CSRs download it from the Web server to their Windows client systems. When CSRs run Suspense Management Center, they run their local versions that communicate directly with the BRM database.

Each time a CSR runs Suspense Management Center, the application uses Java Web Start to check the Web server for updates and automatically download new versions.

Install Suspense Management Center on the directory on which Apache Tomcat is installed; for example, `Tomcat_home\webapps\ROOT`. For instructions on installing Suspense Management Center, see "[Installing Individual BRM Clients](#)". After installing Suspense Management Center, configure the application server to work with Suspense Management Center.

Downloading the BRM Client Software

You can download the BRM software from one of the following locations:

- For BRM 15.0.0 or any 15.0.x maintenance release: From the Oracle software delivery website (<https://edelivery.oracle.com>)
- For any 15.0.x.y patch set release: From the Oracle support website (<https://support.oracle.com>)

Search for and download the **Oracle Communications Billing and Revenue Management 15.0.x.y.0** software, where *x* refers to the maintenance release and *y* refers to the patch set release of BRM that you are installing.

The Zip archive includes one of these JAR files for installing BRM clients:

- **brmclients_15.0.x.y.0_generic.jar** contains the client software in English.
- **brmclients_all_15.0.x.y.0_generic.jar** contains the localized version of the client software.

Installing BRM Clients in GUI Mode

The steps for installing BRM clients in GUI mode depend on the clients you choose to install:

- To install *all* BRM clients, select the **Complete** installation option.
See "[Installing All BRM Clients](#)" for more information.
- To choose one or more BRM clients to install each time you run the installer, select the **Custom** installation option.

This option installs only the clients that you select. This option is recommended for advanced users.

See "[Installing Individual BRM Clients](#)" for more information.

Installing All BRM Clients

You can install Developer Center and Self Care Manager on Linux, and the other BRM clients on Windows.

To install all BRM clients:

1. Obtain the BRM clients software. See "[Downloading the BRM Client Software](#)".
2. Go to the *temp_dir* directory, do one of the following:

On Linux, run one of the following commands:

- To start the GUI installer:

```
Java_home/bin/java -jar jarFile
```

where:

- *Java_home* is the directory in which you installed the latest compatible Java version.
- *jarFile* is the BRM installer file. For example:

```
brmclients_15.0.0.0.0_generic.jar
```

- To start the GUI installer and install the application using the **oralInventory** directory in a different location:

```
Java_home/bin/java -jar jarFile -invPtrLoc FilePath/oraInst.loc
```

where *FilePath* is the path to the directory in which the **oralnst.loc** file is located.

- To start the GUI installer and create a silent installer response file during the installation:

```
Java_home/bin/java -jar jarFile -record -destinationFile path
```

where *path* is the response file location and name.

On Windows, run one of the following commands:

- To start the GUI installer:

```
Java_home/bin/java -jar jarFile
```

where:

- *Java_home* is the directory in which you installed the latest compatible Java version.
- *jarFile* is the BRM installer file. For example:

```
brmclients_15.0.0.0.0_generic.jar
```

- To start the GUI installer and install the application using the **oralInventory** directory in a different location:

```
Java_home/bin/java jarFile FilePath/oraInst.loc
```

where *FilePath* is the path to the directory in which the **oralnst.loc** file is located.

- To start the GUI installer and create a silent installer response file during the installation:

```
Java_home/bin/java -jar jarFile -record -destinationFile path
```

where *path* is the absolute path to the response file.

The Welcome window appears.

3. Click **Next**.

The Installation Location window appears.

4. Enter the full path or browse to the directory in which to install BRM.
5. Click **Next**.

If the Language Selection window appears, ensure that the default language (English) is selected and click **Next**.

 **Note:**

If the "Select at least one language" error appears, click **OK** and then proceed to next step.

The Installation Type window appears.

6. Select **Complete**, and click **Next**.

7. In the Customer Center Installation Type window, select the standalone or Web server installation option and click **Next**.
The Customer Center Web Server window appears.
8. In the **Web Server URL** field, enter the complete URL of the Customer Center Web server and click **Next**.
The Pricing Center Installation Type window appears.
9. Select the standalone or Web server installation option and click **Next**.
The Pricing Center Web Server window appears.
10. In the **Web Server URL** field, enter the complete URL of the Pricing Center Web server and click **Next**.
The Suspense Management Center Installation Type window appears.
11. Select the standalone or Web server installation option and click **Next**.
The Suspense Manager Web Server window appears.
12. In the **Web Server URL** field, enter the complete URL of the Suspense Management Web server and click **Next**.
The SSL Authentication window appears.
13. Do one of the following:
 - If you do not want to enable secure communication for BRM clients, deselect the **Enable SSL** check box.
 - To enable secure communication for BRM clients, leave the **Enable SSL** check box selected.
14. In the **Oracle Client Wallet Password** field, enter a password for the Oracle client wallet.
15. In the **Confirm Wallet Password** field, enter the Oracle client wallet password again.
16. Enter the client wallet password again.
17. Click **Next**.
The Installation Summary window appears.
18. Review your selections, and click **Install**.
The Installation Progress window appears, and the installation begins.

 **Note:**

After the installation begins, you cannot stop or cancel the installation.

When the installation is done, click **Next**, the Installation Complete window appears.

The installer checks for all required software and displays errors if it detects any missing or unavailable components or if any connectivity issues occur.

See "[Troubleshooting the BRM Installation](#)" for information about BRM installer logs.

Installing Individual BRM Clients

You can install a subset of BRM client applications (for example, Developer Center and Revenue Assurance Center) on Linux or Windows.

**Note:**

If you already have a client application installed, you must uninstall it before installing the new version.

To install individual BRM clients:

1. Obtain the BRM clients software. See "[Downloading the BRM Client Software](#)".
2. Go to the *temp_dir* directory, do one of the following:

On Linux, run one of the following commands:

- To start the GUI installer:

```
Java_home/bin/java -jar jarFile
```

where:

- *Java_home* is the directory in which you installed the latest compatible Java version.
- *jarFile* is the BRM installer file. For example:

```
brmclients_15.0.0.0.0_generic.jar
```

- To start the GUI installer and install the application using the **oralInventory** directory in a different location:

```
Java_home/bin/java -jar jarFile -invPtrLoc FilePath/oraInst.loc
```

where *FilePath* is the path to the directory in which the **oralnst.loc** file is located.

- To start the GUI installer and create a silent installer response file during the installation:

```
Java_home/bin/java -jar jarFile -record -destinationFile path
```

where *path* is the response file location and name.

On Windows, run one of the following commands:

- To start the GUI installer:

```
Java_home/bin/java -jar jarFile
```

where:

- *Java_home* is the directory in which you installed the latest compatible Java version.
- *jarFile* is the BRM installer file. For example:

```
brmclients_15.0.0.0.0_generic.jar
```

- To start the GUI installer and install the application using the **oralInventory** directory in a different location:

```
Java_home/bin/java jarFile FilePath/oraInst.loc
```

where *FilePath* is the path to the directory in which the **oralnst.loc** file is located.

- To start the GUI installer and create a silent installer response file during the installation:

```
Java_home/bin/java -jar jarFile -record -destinationFile path
```

where *path* is the absolute path to the response file.

The Welcome window appears.

3. Click **Next**.

The Installation Location window appears.

4. Enter the full path or browse to the directory in which to install the BRM clients.

 **Note:**

If you already have a client application installed and installing a new client application, enter the full path or browse to the directory in which the existing client application is installed.

5. Click **Next**.

If the Language Selection window appears, ensure that the default language (English) is selected and click **Next**.

 **Note:**

If the "Select at least one language" error appears, click **OK** and then proceed to next step.

The Installation Type window appears.

6. Select **Custom**, and click **Next**.

The Feature Sets Selection window appears.

7. From the clients list, select the clients to install.

8. Click **Next**.

The corresponding Installation Type window appears. For example, if you selected to install Customer Center, the Customer Center Installation Type window appears.

9. Select the standalone or Web Server installation option and click **Next**.

The corresponding Web Server window appears.

10. In the Web Server URL field, enter the complete URL of the client's Web server and click **Next**.

The SSL Authentication window appears.

11. Do one of the following:

- If you do not want to enable secure communication for BRM clients, deselect the **Enable SSL** check box.
- To enable secure communication for BRM clients, leave the **Enable SSL** check box selected.

12. In the **Client Wallet Password** field, enter a password for the client Oracle wallet.

13. Click **Next**.

The Installation Summary window appears.

14. Review your selections, and click **Install**.

The Installation Progress window appears, and the installation begins.

 **Note:**

After the installation begins, you cannot stop or cancel the installation.

When the installation is done, click **Next**, the Installation Complete window appears.

The installer checks for all required software and displays errors if it detects any missing or unavailable components or if any connectivity issues occur.

See "[Troubleshooting the BRM Installation](#)" for information about BRM installer logs.

Installing BRM Clients in Silent Mode

The silent installation uses a response file in which you have set installation information. To obtain the response file, you run the GUI installer for the first install. The GUI installer generates a response file that contains the key-value pairs based on the values that you specify during the GUI installation. You can then copy and edit the response file to create additional response files for installing the BRM client applications on different machines.

Creating a Response File

To create a response file:

1. Create the response file by doing one of the following:
 - Create a copy of the response file that was generated during the GUI installation. See "[Installing BRM Clients in GUI Mode](#)" for more information.

 **Note:**

The GUI Installer does not save passwords provided during installation in the response file. You must manually add the passwords after creating a copy of the response file.

- Go to the *temp_dir* directory in which you downloaded the BRM client software pack, and create a response file by doing one of the following:

- On Linux, run the following command:

```
Java_home/bin/java -jar jarFile -record -destinationFile path/  
SilentInstall.rsp
```

where:

- * *Java_home* is the directory in which you installed the latest compatible Java version.
- * *jarFile* is the BRM installer file. For example:

```
brmclients_15.0.0.0.0_generic.jar
```

- On Windows, run the following command:

```
java -jar jarFile -getResponseFileTemplates -destinationFile path/  
SilentInstall.rsp
```

where *jarFile* is the BRM installer file. For example:

```
brmclients_15.0.0.0.0_generic.jar
```

A response file is created with the default values. You can create as many response files as needed.

2. Open the file in a text editor.
3. Modify the response file you copied by specifying the key-value information for the parameters you want in your installation. In addition to any other parameters you wish to change, make sure you change/validate the following parameters:

```
ORACLE_HOME  
CLIENT_WALLET_PASSWD  
CONFIRM_CLIENT_WALLET_PASSWD
```

4. Save and close the response file.

Performing a Silent Installation

To perform a silent installation:

1. Create a response file. See "[Creating a Response File](#)".
2. Copy the response file you created to the machine on which you will run the silent installation.
3. On the machine on which you will run the silent installation, go to the *temp_dir* directory in which you downloaded the BRM client software pack, and do one of the following:
 - On Linux, run the following command:

```
Java_home/bin/java -jar jarFile -debug -invPtrLoc Inventory_home/oraInventory/  
oraInst.loc [parameter=value] -responseFile path -silent
```

where:

- *Java_home* is the directory in which you installed the latest supported Java version.
- *jarFile* is the BRM installer file. For example:

```
brmclients_15.0.0.0.0_generic.jar
```
- *Inventory_home* is the location of the Oracle inventory.
- *path* is the location and name of your response file.
- *parameter* is the name of an installation parameter.
- *value* is the value of the installation parameter.

For example:

```
Java_home/bin/java -jar brmclients_15.0.0.0.0_generic.jar -debug -invPtrLoc Ora/  
oraInventory/oraInst.loc INSTALL_TYPE=Complete -responseFile /tmp/  
brm_complete.rsp -responseFile path -silent
```

The installation runs silently in the background.

- On Windows, run the following command:

```
java -jar jarFile -debug -invPtrLoc Inventory_home/oraInventory/oraInst.loc  
[parameter=value] -responseFile path -silent
```

where:

- *jarFile* is the BRM installer file. For example:
`brmclients_15.0.0.0.0_generic.jar`
- *Inventory_home* is the location of the Oracle inventory.
- *parameter* is the name of an installation parameter.
- *value* is the value of the installation parameter.
- *path* is the location and name of your response file.

For example:

```
java -jar brmclients_15.0.0.0.0_generic.jar -debug -invPtrLoc Ora/oraInventory/  
oraInst.loc INSTALL_TYPE=Complete -responseFile /BRM_clients/SilentInstall.rsp -  
silent
```

The installation runs silently in the background.

The Installer checks for all required software and writes errors to a log file if it detects any missing or unavailable components or if any connectivity issues occur.

For information about BRM installer logs, see "[Troubleshooting the BRM Installation](#)".

Configuring the Localization SDK on Windows

After installing the localization (L10N) SDK, you must configure the SDK on Windows. See "[Installing Individual BRM Clients](#)" for installing the Localization SDK.

To configure the localization SDK on Windows, in a command window, use the **subst** command to substitute the drive letter for the build tree directory of the SDK.

If you installed the SDK in the default location, enter the command as follows:

```
subst W: "C:\Oracle_Home\LocalizationSDK"
```

Granting Administrative Privileges to Pricing Center Users

You use the **pricing_admin.pl** script to grant administrative privileges to Pricing Center users. Users with administrative privileges are called pricing admins.

To grant administrative privileges to Pricing Center users, perform the procedures in the following sections:

1. [Modifying the Database Configuration File](#)
2. [Modifying the pricing_admin.pl Script Configuration File](#)
3. [Setting Up the Database Server for the Pipeline Manager Administrator](#)
4. [Initializing the Pricing Admin Configuration Object](#)
5. [Specifying Administrative Privileges for Pipeline Manager Users](#)
6. [Removing Pricing Admins](#)

Modifying the Database Configuration File

1. Go to the DM directory:

```
cd BRM_home/sys/dm_oracle
```

2. Back up the database configuration file (**pin.conf**).

Note:

You will be restoring the **pin.conf** file later in the procedure.

3. Open the **pin.conf** file with a text editor.
4. If the **dd_write_enable_objects** entry is set to **0**, set the entry to **1**.
5. If the **crypt** entry is commented out, uncomment it and configure it according to the notes that precede this entry:

```
- crypt Encrypt_method| BRM_home/lib/Encryption_library "Secret_key"
```

where:

- *Encrypt_method* is the type of encryption method, which is either **aes** or **ozt**.
- *Encryption_library* is the path and filename of the encryption library. The prefix for the library is **lib** for Linux, or **null ""** for Windows. The extension for the library is **.so** for Linux, and **.dll** for Windows.
- *Secret_key* is your encrypted AES or OZT key.

For more information, see "Configuring the Data Manager for AES Encryption" or "Configuring the Data Manager for Oracle ZT PKI Encryption" in *BRM Developer's Guide*.

6. Save and close the file.
7. Stop and restart the DM and CM. See "Starting and Stopping the BRM System" in *BRM System Administrator's Guide*.

Modifying the pricing_admin.pl Script Configuration File

1. Go to the *BRM_Home\setup\scripts* directory.
2. Open the setup configuration file (**pin.conf**) file with a text editor.
3. Check that the following entries are specified in the **pin.conf** file:

```
- nap login_type 1
- - userid 0.0.0.1 /service/admin_client 1
```

4. Specify appropriate values for the **login_name** and parameters:

```
- nap login_name login_name
- nap login_pw password
```

For example:

```
- nap login_name integrate
- nap login_pw integrate
```

5. Enter the host name and port number of your server in the **cm_ptr** entry:

```
- nap cm_ptr ip host_name port_number
```

6. If you are using Pipeline Manager, specify values for the entries described in [Table 8-1](#). These entries specify Pipeline Manager configuration data used by the **pricing_admin.pl** script to set up and maintain pricing admins and the Pipeline Manager database for Pricing Center.

Table 8-1 Pipeline Manager Configuration Data

Entry	Description
default_table_space_name	The tablespace that newly created Oracle users are assigned to. The default is INTEGRATE_TS_1_DAT . If the default tablespace is not available in the Pipeline Manager database, use an available existing tablespace or create a new one. Important: You must specify a value for default_table_space_name before you run the pricing_admin.pl script with the -set parameter.
database_role_name	The role that provides select, insert, delete, and update privileges on IFW_* and JSA_* tables. The default is INTEGRATE_ROLE_ALL . If the default role is not available in the Pipeline Manager database, use an existing role that provides these privileges or create a new role. If you use the -init parameter, the entry is optional.
host	The host name for the server where the Pipeline Manager database is located and running.
port	The port number used by the Pipeline Manager database listener.
db	The name of the Pipeline Manager database instance. Note: You must set the db value to the ORACLE_SID value. If you set the db value to the SERVICE_NAME value, BRM does not generate an error when creating the /config/ pricing_admin object; however, you cannot connect to the Pipeline Manager database from Pricing Center.
db_type	The name of the database vendor. The value should be one of the system database driver groups of entries in the jsaconf.properties file, for example, oracle .
login_name	The default Pipeline Manager database user name. Important: You must specify a value for login_name before you run the pricing_admin.pl script with the -init parameter.
login_pw	The password of the default Pipeline Manager database user. Important: You must specify a value for login_pw before you run the pricing_admin.pl script with the -init parameter.
admin	The DBA on the Pipeline Manager database that has user creation privileges.

Table 8-1 (Cont.) Pipeline Manager Configuration Data

Entry	Description
admin_pw	The password of the DBA account.
db_alias	The alias used to log in to the Pipeline Manager database. Important: Ensure that the tnsnames.ora file also contains an entry with this alias.

Following is a sample **pin.conf** entry value:

```
- pipeline default_table_space_name    INTEGRATE_TS_1_DAT
- pipeline database_role_name         INTEGRATE_ROLE_ALL
- pipeline host                        ttal-013
- pipeline port                        1521
- pipeline db                          pindb
- pipeline db_type                     oracle
- pipeline login_name                  integrate
- pipeline login_pw                    integrate
- pipeline admin                       system
- pipeline admin_pw                    manager
- pipeline db_alias                    ttal
```

 **Note:**

To ensure that Pricing Center can connect to the server, add the name and IP address of the Pipeline Manager host system to the host file of each machine running Pricing Center.

7. Save and close the file.

Setting Up the Database Server for the Pipeline Manager Administrator

To set up an Oracle database server for the Pipeline Manager administrator:

1. Edit the **tnsnames.ora** file to specify **HOST**, **PORT**, and **SERVICE_NAME** values. Use the same values that you used for the **host**, **port**, and **db** entries in the setup configuration file (*BRM_home\setup\scripts\pin.conf*).

The following is the required name entry in the **tnsnames.ora** file that corresponds to the sample **pin.conf** file shown in "[Modifying the pricing_admin.pl Script Configuration File](#)".

 **Note:**

The database alias in the following example is **ttal-013**, the port name is **1521**, and the Pipeline Manager database name (**SERVICE_NAME**) is **pindb**. Be sure to change these values to match your environment.

```
TTAL-013 =
  (DESCRIPTION =
    (ADDRESS_LIST =
```

```
(ADDRESS = (PROTOCOL = TCP) (HOST = ttal_013) (PORT = 1521) )
)
(CONNECT_DATA =
(SERVICE_NAME = pindb)
)
)
```

2. To ensure that the **pin.conf** entries for **admin**, **admin_pw**, **db_alias**, and **host** are correct, try connecting to the Pipeline Manager database using the following command:

```
sqlplus admin/admin_pw@db_alias
```

Initializing the Pricing Admin Configuration Object

Initialize the pricing admin configuration object by running the **pricing_admin.pl** script:

1. Go to the *BRM_home\setup\scripts* directory.
2. Run the **pricing_admin.pl** script with the **-init** parameter:

```
perl pricing_admin.pl -init
```

If initialization is successful, the system returns this line:

```
Initialized config object for pricing admin.
```

3. Restore the original database configuration file (**pin.conf**) that you backed up in "[Modifying the Database Configuration File](#)".
4. Stop and restart the DM to apply the new settings. See "Starting and Stopping the BRM System" in *BRM System Administrator's Guide*.

Specifying Administrative Privileges for Pipeline Manager Users

To specify administrative privileges for Pipeline Manager users:

1. Ensure that every Pipeline Manager user who will be a pricing admin has a CSR account in BRM (an account using the **admin_client** service). You create CSR accounts in Customer Center by using the CSR Plan. See information about the Account Creation wizard's Contact page in Customer Center Help.
2. Create a text file that has the user name and password (in that order) of each pricing admin on a separate line. User names and passwords must be separated by a space. For example:

```
john_jones password
mary_allen password
```

Note:

BRM user names (login names) are case sensitive, but Pipeline Manager user names are not. Therefore, type the names exactly as specified in Customer Center, but avoid using names that are too similar. For example, do not create two accounts with the user names "Smith" and "smith" because they will both be logged in to Pipeline Manager as "SMITH."

3. Go to the *BRM_home\setup\scripts* directory.
4. Run the **pricing_admin.pl** script with the **-set** parameter:

```
perl pricing_admin.pl -set < text_file
```

where *text_file* is the name of the file you created in Step 2.

5. Delete the text file if security is a concern.

Removing Pricing Admins

This section describes how to remove single and multiple users from the Pipeline Manager database.

Removing One Pricing Admin

To remove one pricing admin from the database:

1. Go to the *BRM_home\setup\scripts* directory.
2. Run the **pricing_admin.pl** script with the **-remove** parameter:

```
perl pricing_admin.pl -remove
```

3. When prompted, enter the user name to be deleted.

For each pricing admin removed, the system responds with this line:

```
Removed pricing admin user_name
```

4. Repeat Step 3 until all appropriate user names are removed.

Removing Multiple Pricing Admins

To remove multiple pricing admins from the database:

1. Go to the *BRM_home\setup\scripts* directory.
2. Create a text file (*text_file*) containing only the user names that you want to remove. Put each user name on a separate line, as in this example:

```
john_jones  
mary_allen
```

3. Run the **pricing_admin.pl** script with the **-remove** and *text_file* parameters:

```
perl pricing_admin.pl -remove < text_file
```

Starting a BRM Client Application on Linux

You can install Developer Center and Self Care Manager on Linux only.

To start a BRM client application on Linux:

1. Go to the *install_dir* directory, where *install_dir* is the directory in which you installed the BRM clients.
2. Grant permissions for the BRM client application by running the following command:

```
chmod 755 applicationName.sh
```

where *applicationName* is the name of the BRM client application you want to start.

3. Run the following command:

```
./applicationName.sh
```

Starting a BRM Client Application on Windows

To start a BRM client application on Windows:

1. From the start options, choose *ProductName*, where *ProductName* is the name of the BRM client application you want to start.
The Login dialog box appears.
2. Enter your login name and password.
For information about login names and passwords for client applications, see "Implementing System Security" in *BRM System Administrator's Guide*.
3. To connect to a database other than the one specified during installation, click **Connection Info** and enter the host name and port number.
4. Click **OK**.

Starting a BRM Client Application from Java Web Start

To start Customer Center, Pricing Center, or Suspense Management Center from the Java Web Start Application Manager:

1. Start Java Web Start from the start options.
2. If you do not see Customer Center listed in the Application Manager, choose **View - Downloaded Applications**.
3. Select Customer Center and click **Start**.

Problems Installing BRM Client Applications

This section describes problems you might encounter when installing BRM client applications and their solutions.

Problem: Cannot Start a Client Application after Installation

You cannot start one of the client applications, even though the installation appeared to be successful.

Possible Cause

BRM could not add the client application to your Windows path because the path is too long. Therefore, Windows cannot find it.

Solution

Review your path statement and delete references to obsolete programs. For more information, see your Windows documentation. Reboot the system before you try restarting the client application.

What's Next?

After installing the BRM client applications, you can test BRM with your business models:

- For an overview of setting up product offerings, see "About Creating Product Offerings" in *BRM Creating Product Offerings*.
- For an overview of setting up billing, see "Configuring Billing" in *BRM Configuring and Running Billing*.
- For an overview of setting up customer account creation and managing customer accounts, see "Customizing Account Creation" in *BRM Managing Customers*.

9

Installing Pipeline Configuration Center

Learn how to install Pipeline Configuration Center (PCC), which is a Web-based application that serves as the user interface for Pipeline Manager, on top of the Oracle Communications Billing and Revenue Management (BRM) software.

Note:

Localized versions of PCC are supported by BRM. The following languages are supported: French, Italian, Spanish, Japanese, Korean, Chinese Simplified, Chinese Traditional, and Portuguese Brazilian.

Topics in this document:

- [PCC Installation Overview](#)
- [PCC System Requirements](#)
- [Overview of Preinstallation Tasks](#)
- [Installing PCC](#)
- [PCC Postinstallation Tasks](#)
- [Verifying the PCC Installation](#)
- [Uninstalling PCC](#)
- [Administering PCC](#)
- [Troubleshooting PCC](#)
- [Secure Deployment Checklist](#)

PCC Installation Overview

PCC installation should be performed only by experienced system administrators. You must be familiar with the following before you begin the installation:

- Linux operating system
- Oracle WebLogic Server administration
- Oracle Database administration

Additionally, you should have experience installing Java-related packages.

To learn more about PCC installation, see the following:

- [About the PCC Architecture](#)
- [Overview of the PCC Installation Procedure](#)
- [Performing a Secure PCC Installation](#)
- [Ensuring a Successful PCC Installation](#)

About the PCC Architecture

PCC is a Web-based BRM application that serves as the user interface for Pipeline Manager.

PCC runs on a managed server in an Oracle WebLogic Server domain. To interact with PCC, users access the PCC login page URL in a browser and then enter their PCC user name and password in the login page. After a user is authenticated, the PCC home page appears in the browser.

Figure 9-1 shows how PCC and Pipeline Manager are integrated.

Figure 9-1 PCC and Pipeline Manager Integrated Architecture

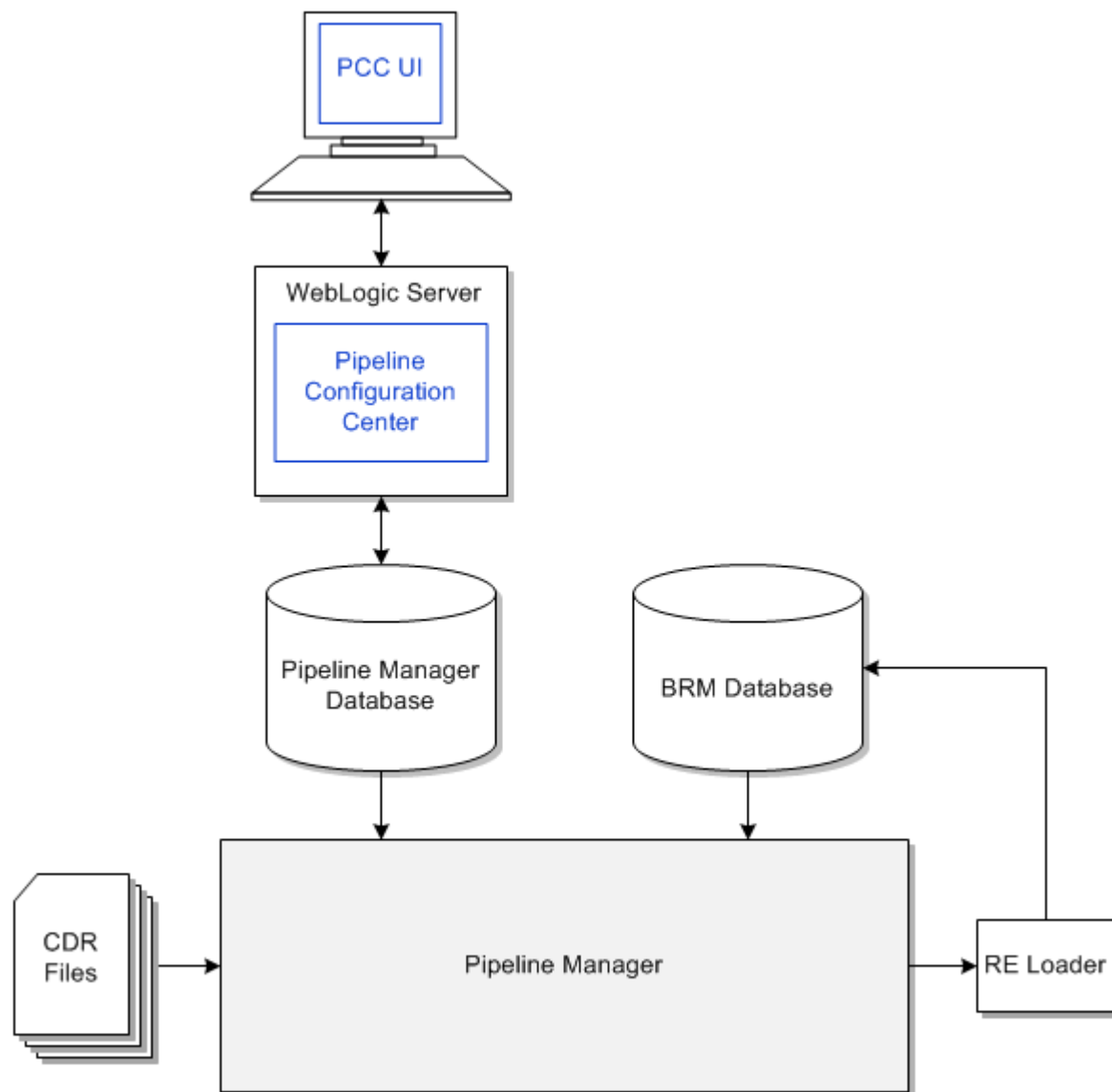

Overview of the PCC Installation Procedure

The following is an overview of the PCC installation procedure:

1. Plan your installation. Planning an installation involves the following:
 - Determining the scale of your implementation. For example, is it a small test system or a large production system?
 - Assessing how many physical computers you need and which software components to install on which computers.
2. Review system requirements.
3. Perform the following preinstallation tasks:
 - Install and configure Oracle WebLogic Server.
 - Set the JAVA_HOME environment variable.
 - Install and configure BRM.
 - Configure Oracle Database advanced security encryption and integrity algorithms for a secure connection from the installer.
4. Install PCC.
5. Perform the postinstallation configuration tasks.
6. Verify the installation.

Performing a Secure PCC Installation

You can install PCC in the following modes:

- GUI mode
- Silent mode

Oracle recommends that you install PCC using Secure Sockets Layer (SSL) in a production environment. See "[Installing PCC](#)" for more information.

The silent mode installation is not meant for production environments. It should be used only in test environments and only for setting up quickly or backing up the properties for later use in another test environment.

See "[Secure Deployment Checklist](#)" for information about the checklist to deploy PCC securely.

Ensuring a Successful PCC Installation

To ensure that the PCC installation is successful, follow these guidelines:

- As you install each component (for example, the WebLogic Server), verify that the component is installed successfully before continuing the installation process.
- Pay close attention to the system requirements.

Before you begin installing the application, ensure that your system has the required software. In addition, ensure that you know all the required configuration values, such as host names and port numbers.

- Make a note of any new configuration values as you create them.

You will be required to enter configuration values later.

PCC System Requirements

Before you install and run PCC, ensure that you have installed and configured the required external software, hardware, server, and database systems:

- [Software Requirements](#)
- [Hardware Requirements](#)

Software Requirements

You must install and connect all required software for optimal performance. For the list of supported software versions, see "Additional Billing Care, Business Operations Center & Pipeline Configuration Center Software Requirement" in *BRM Compatibility Matrix*.

Hardware Requirements

The number and configuration of the computers that you employ for your PCC installation depend on the scale and the kind of deployment you have planned.

[Table 9-1](#) provides the minimum hardware requirements for PCC installed on a single managed server in a domain.

Table 9-1 PCC Minimum Hardware Requirements

Component	Requirement
Hard disk	1.5 GB of free disk space. Note: A minimum of 1.5 GB should be free in the domain home.
Processor	Oracle recommends using twin cores, each running at 1.5 GHz CPU.
Memory	A minimum of 4 GB physical memory and 4 GB swap. If you plan to install the database on the same server as PCC, the minimum memory requirements increase to 6 GB physical memory and 6 GB swap.

Overview of Preinstallation Tasks

Perform the following tasks before installing PCC:

1. Install and configure Oracle WebLogic Server. See "[Installing and Configuring Oracle WebLogic Server](#)".
 - Enable SSL for the target Oracle WebLogic Server server domain, configure the server KeyStore certificate, and get the client KeyStore trusted certificate (**.p12** [recommended] or **.jks** file).
 - If SSL is enabled, ensure that the KeyStore file is created in a secure drive and access is strictly limited to the user account.
2. Set the JAVA_HOME environment variable. See "[Setting the JAVA_HOME Environment Variable](#)".
3. Download and save the **ojdbc8.jar** file to your PCC system. See "[Downloading the ojdbc8.jar File for PCC](#)".
4. Install and configure BRM. See "[Installing and Configuring BRM](#)".

5. Configure Oracle Database advanced security encryption and integrity algorithms for a secure connection from the installer. See the Oracle Database documentation for advanced security configuration parameters. This is required for the PCC installer to make a secured (encrypted) database connection over the network.
6. Download the PCC software. See "[Downloading the PCC Software](#)".

Installing and Configuring Oracle WebLogic Server

This section describes procedures related to installing Oracle WebLogic Server and configuring the Oracle WebLogic Server domain on which you will deploy PCC.

See the information in the following sections:

1. [Installing Oracle WebLogic Server](#)
2. [Installing and Configuring Oracle Application Development Runtime](#)
3. [Creating an Oracle WebLogic Server Domain](#)
4. [Configuring SSL for the Oracle WebLogic Server Domain](#)

Installing Oracle WebLogic Server

Oracle WebLogic Server is available as a component of the Oracle Fusion Middleware software. For more information on supported versions, see *BRM Compatibility Matrix*.

Download Oracle WebLogic Server from the Oracle software delivery website (<https://edelivery.oracle.com>).

See [Installing and Configuring Oracle WebLogic Server and Coherence](#) for information about installing WebLogic Server.

Installing and Configuring Oracle Application Development Runtime

Oracle Application Development Runtime must be installed on the computer on which you install PCC. You can download Oracle Application Development Runtime from the Oracle software delivery website:

<http://edelivery.oracle.com>

For information on installing Oracle Application Development Runtime, see the Oracle Application Development Runtime documentation.

Note:

The Oracle Fusion Middleware Application Developer installer installs both Oracle Application Development Runtime and Oracle Enterprise Manager.

See *Oracle Fusion Middleware Fusion Developer's Guide for Oracle Application Development Framework* for more information on Application Development Framework.

Creating an Oracle WebLogic Server Domain

To create a domain on which to deploy PCC, see the Oracle WebLogic Server documentation.

You must create the domain with at least one managed server and one administration server. Oracle recommends that you deploy PCC on a managed server in a production environment.

[Table 9-2](#) shows the values to choose when creating the domain for PCC.

Table 9-2 Oracle WebLogic Server Domain Configuration Values

Configuration Value	Description
Domain Source	Select Generate a domain configured automatically to support the following BEA products. From the list, select Oracle JRF - 12.2.1 [oracle_common] .
Domain Mode Configuration	Select Production Mode.
Optional Configuration	Select Administration Server, Managed Servers, Clusters and Machines and Deployments and Services.
Administration Server Listen Address	Use a listen address that is equal to a resolvable DNS host or IP address. Do not use localhost or 127.0.0.1 . Those addresses interfere with clustered servers.
Managed Server Listen Address	Enter a listen address that is equal to a resolvable DNS host or IP address.
Target Deployments to Clusters or Servers	Add all libraries to both the managed server target and the Administration Server.
Target Services to Clusters or Servers	Add all services to the managed server target.

See *Oracle Fusion Middleware Installation Guide for Oracle Enterprise Content Management Suite* for more information on Oracle WebLogic Server domains.

You can now start the domain administration server manually and log in to WebLogic Server Administration Console.

Configuring SSL for the Oracle WebLogic Server Domain

To enable secure communication for PCC, you must configure secure socket layer (SSL) for the domain on which you want to deploy PCC.

For more information about configuring SSL in WebLogic Server, see "[Configuring SSL](#)" in *Administering Security for Oracle WebLogic Server*.

Pipeline Configuration Center supports TLS versions 1.2 and 1.3. For information about setting the protocol version, see "[Specifying the SSL/TLS Protocol Version](#)" in *Administering Security for Oracle WebLogic Server*.

Setting the JAVA_HOME Environment Variable

You must set the JAVA_HOME environment variable to your version of Java on the PCC machine and for the WebLogic Server domain.

See "BRM Software Compatibility" in *BRM Compatibility Matrix* for the compatible version of Java.

To set the JAVA_HOME environment variable on the machine on which you want to deploy PCC:

1. On the machine on which you want to deploy PCC, set the `JAVA_HOME` environment variable to the directory in which the JRE/JDK is installed.

2. Verify the Java version by running the following command:

```
$JAVA_HOME/bin/java -version
```

The Java version is displayed.

To set the `JAVA_HOME` environment variable for the WebLogic Server domain:

1. On the machine on which Oracle WebLogic Server is installed, go to the `WebLogic_home/user_projects/domains/Domain_Name/bin` directory.

where:

- `WebLogic_home` is the directory in which you installed the WebLogic Server.
- `Domain_Name` is the domain directory in which PCC will be deployed.

2. Open the `setDomain.sh` file in a text editor.

3. Add or modify the following entries before the `EXTRA_JAVA_PROPERTIES` entry:

```
JAVA_HOME="{JAVA_HOME}"  
export JAVA_HOME
```

4. Save and close the file.

5. Restart Oracle WebLogic Server. See the Oracle WebLogic Server documentation for more information.

6. Verify the Java version used by Oracle WebLogic Server. The Java version is displayed when the WebLogic server is started.

Downloading the ojdbc8.jar File for PCC

Download the **ojdbc8.jar** file and save it in a directory on the machine on which you want to install PCC. Note the path to this directory; you are required to specify this path in the Specify Prerequisite Libraries Location window during the PCC installation.

You can download the **ojdbc8.jar** file from the following location:

<https://www.oracle.com/database/technologies/appdev/jdbc-downloads.html>

Installing and Configuring BRM

To install and configure BRM:

1. Install BRM. See "[Installing BRM](#)" for more information.
2. Set the `PriceDesignCenterInst` business parameter. See "[Setting Up the Business Parameter](#)" for more information.

Setting Up the Business Parameter

To use PCC with PDC, you must set up the `PriceDesignCenterInst` business parameter.

To set up `PriceDesignCenterInst`:

1. Go to `BRM_home/sys/data/config` and run the following command, which creates an editable XML file from the pricing instance of the `/config/business_params` object.

```
pin_bus_params -r BusParamsPricing bus_params_pricing.xml
```

This directory includes the support files used by the `pin_bus_params` utility.

This command creates the XML file named `bus_params_pricing.xml.out` in your working directory. If you do not want this file in your working directory, specify the path as part of the file name.

2. Search for the following line in the XML file:

```
<PriceDesignCenterInst>disabled</PriceDesignCenterInst>
```

By default, `PriceDesignCenterInst` is set to `disabled`.

3. Change `disabled` to `enabled`.
4. Save the file as `bus_params_pricing.xml`.
5. Use the following command to load this updated file into the `/config/business_params` object:

```
pin_bus_params bus_params_pricing.xml
```

6. Read the object with the `testnap` utility or Object Browser to verify that all fields are correct.

Downloading the PCC Software

You can download and install full versions of the PCC software from one of the following locations:

- For BRM 15.0.0 or any 15.0.x maintenance release: From the Oracle software delivery website (<https://edelivery.oracle.com>)
- For any 15.0.x.y patch set release: From the Oracle support website (<https://support.oracle.com>)

Search for and download the **Oracle Communications Billing and Revenue Management 15.0.x.y.0** software, where *x* refers to the maintenance release and *y* refers to the patch set release of BRM that you are installing.

The Zip archive includes the PCC installer:

PipelineConfigurationCenter_15.0.x.y.0_generic.jar

Installing PCC

Before installing PCC, read the following:

- [PCC Installation Overview](#)
- [PCC System Requirements](#)
- [Overview of Preinstallation Tasks](#)

You can install PCC in the following modes:

- **GUI mode:** Use GUI mode when you want to interact with the PCC installer GUI during installation. See "[Installing PCC in GUI Mode](#)".
- **Silent mode:** Use silent mode when you install PCC using the same configuration repeatedly. Silent install mode does not use the GUI, and it runs in the background. See "[Installing PCC in Silent Mode](#)".

The PCC installer must be launched from the computer hosting the Oracle WebLogic Server domain. PCC installation must be performed by a user who has permissions to write to the

Oracle Inventory (**oralInventory**) directory and the *WebLogic_home/user_projects/domains* directory, where *WebLogic_home* is the directory in which you installed the WebLogic Server.

For more information about the **oralInventory** directory, see the Oracle documentation:

<http://docs.oracle.com>

Installing PCC in GUI Mode

To install PCC in GUI mode:

1. Ensure that the Pipeline Manager database server is running.
2. Start the Oracle WebLogic Server domain administration server and managed server on which you want to deploy PCC.
3. Obtain the PCC software. See "[Downloading the PCC Software](#)".
4. To start the PCC GUI installer, go to the directory where you downloaded the PCC software and run the following command:

```
Java_home/bin/java -jar jarFile[ -invPtrLoc invPath/oraInst.loc][ -record -  
destinationFile respPath]
```

where:

- *Java_home* is the directory in which you installed the latest compatible Java version.
- *jarFile* is the BRM installer file. For example:

`PipelineConfigurationCenter_15.0.0.0.0_generic.jar`
- **-invPtrLoc** starts an optional clause to use if you want to use an **oralInventory** directory that already exists in a different location from the one specified in the **/etc/oraInst.loc** file.
- *invPath* is the path to the directory in which the **oraInst.loc** file is located.
- **-record** starts an optional clause to use if you want to create a silent installer response file during the installation.
- *respPath* is the absolute path to the response file.

For example:

```
/tools/Linux/jdk/bin/java -jar PipelineConfigurationCenter_15.0.0.0.0_generic.jar
```

or

```
/tools/Linux/jdk/bin/java -jar PipelineConfigurationCenter_15.0.0.0.0_generic.jar -  
invPtrLoc /support/oraInventory/oraInst.loc
```

or

```
/tools/Linux/jdk/bin/java -jar PipelineConfigurationCenter_15.0.0.0.0_generic.jar -  
record -destinationFile /brm15/silent/InstComp.txt
```

or

```
/tools/Linux/jdk/bin/java -jar PipelineConfigurationCenter_15.0.0.0.0_generic.jar -  
invPtrLoc /support/oraInventory/oraInst.loc -record -destinationFile /brm15/silent/  
InstComp.txt
```

5. In the Welcome window, click **Next**.

6. If the **oralnst.loc** file is corrupt or not present, the Specify Inventory Directory and Credentials window appears next. Otherwise, go to step 7. In the Specify Inventory Directory and Credentials window, enter the details listed in [Table 9-3](#) and then click **Next**.

Table 9-3 Specify Inventory Directory and Credentials

Field	Description
Inventory Directory	The full path to the inventory directory. This should be an absolute path, not containing environment variables. Do not include the name of the oralnst.loc file. The directory and oralnst.loc file will be created if they do not already exist. The default location of the oralInventory directory is recorded in the /etc/oralnst.loc file.
Operating System Group Name	The name of the operating system group that has write permission to the inventory directory.

7. In the Installation Location window, enter the full path or browse to the directory in which to install PCC and click **Next**.
8. In the Feature Sets Selection window, select **Pipeline Configuration Center** and click **Next**.
9. In the Prerequisite Libraries Location window, enter the full path or browse to the directory in which the **ojdbc8.jar** file is located. Click **Next**.
10. In the WebLogic Server Details window, enter the details listed in [Table 9-4](#) for the domain on which you want to deploy PCC. Click **Next**.

Table 9-4 WebLogic Server Details window

Field Name	Description
Host Name	Enter the IP address or the host name of the computer on which the domain is configured.
Port Number	Enter the port number assigned to the domain administration server.
Username	Enter the domain administrator user name.
Password	Enter the password for the domain administrator user.
WebLogic Home	Enter the path of the directory where the Oracle WebLogic Server software is installed. <div style="border-left: 2px solid #0070C0; border-right: 2px solid #0070C0; border-bottom: 2px solid #0070C0; padding: 10px; margin-top: 10px;"> <p> Note:</p> <p>The PCC installer does not proceed until it verifies with the running instance of Oracle WebLogic Server that the domain administration server information you entered is valid.</p> </div>

Table 9-4 (Cont.) WebLogic Server Details window

Field Name	Description
Use SSL?	Do one of the following: <ul style="list-style-type: none"> If the WebLogic server does not support SSL, deselect the Use SSL? check box. If the server supports SSL, leave the Use SSL? check box selected. When the check box is selected, the Keystore Type, Keystore Location, and Keystore Password fields are mandatory. See " Configuring SSL for the Oracle WebLogic Server Domain " for more information.
Keystore Type	Select the KeyStore certificate type: PKCS12 or JKS .
Keystore Location	Enter or browse to the directory of your client-side KeyStore certificate file, which was generated from the exported public certificate using the keytool utility.
Keystore Password	Enter the password for the KeyStore file.

- In the Target Server window, select the domain administration server or managed server on which you want to deploy PCC. Click **Next**.

 **Note:**

Oracle recommends deploying PCC on a managed server. If you select a managed server, ensure that the managed server and the node manager are running.

- In the Pipeline Manager Database Connection window, enter the details listed in [Table 9-5](#) for connecting to the Pipeline Manager database. Click **Next**.

Table 9-5 Pipeline Manager Database Connection window

Field Name	Description
Host Name	Enter the IP address or the host name of the computer on which the Pipeline Manager database is configured.
Port Number	Enter the port number assigned to the Pipeline Manager database service.
User Name	Enter the user name of the Pipeline Manager database user.
Password	Enter the password of the Pipeline Manager database user.
Service Name	Enter the name of the Pipeline Manager database service. <div data-bbox="764 1665 894 1705" data-label="Section-Header">  Note: </div> <div data-bbox="812 1719 1435 1810" data-label="Text"> <p>The PCC installer will not proceed until it verifies with the running instance of the Pipeline Manager database server that the database information you entered is valid.</p> </div>

Table 9-5 (Cont.) Pipeline Manager Database Connection window

Field Name	Description
SSL Enabled	Select the type of connection required to connect to the database: <ul style="list-style-type: none"> • Yes-One Way: One-way SSL authentication is required. • Yes-Two Way: Two-way SSL authentication is required. • No: SSL authentication is not required, and the remaining fields are not needed.
Store Type	Select the type of TrustStore and KeyStore file that is used for the SSL connection: SSO or PKCS12 .
Truststore Location	Enter or browse to the directory in which your TrustStore file is located. This file is used for authentication through SSL.
Truststore Password	Enter the password required to access the certificates from the TrustStore.
Keystore Location	Enter or browse to the directory in which your KeyStore file is located. This file is used for authentication through SSL.
Keystore Password	Enter the password required to access the certificates from the KeyStore.

13. In the BRM Connection Details window, enter the details listed in [Table 9-6](#) for connecting to the BRM server. Click **Next**.

Table 9-6 BRM Connection Details window

Field Name	Description
User Name	Enter the user name for connecting to BRM.
Password	Enter the BRM user's password.
Host Name	Enter the IP address or the host name of the machine on which the primary BRM Connection Manager (CM) or CM Master Process (CMMP) is running.
Port Number	Enter the TCP port number of the CM or CMMP on the host computer. The default value is 11960 .
Service Type	Enter the BRM service type. The default value is /service/admin_client .
Service POID ID	Enter the POID of the BRM service. The default value is 1 .
Use SSL?	Do one of the following: <ul style="list-style-type: none"> • If you have not enabled SSL for BRM, deselect the Use SSL? check box. • If you have enabled SSL for BRM, leave the Use SSL? check box selected.
Wallet Password	Enter the password for the PCC wallet.
Confirm Wallet Password	Enter the password for the PCC wallet again.

14. In the Pipeline Configuration Center User window, enter the details listed in [Table 9-7](#) for creating a PCC user. Click **Next**.

 **Note:**

Entering information in this window is optional. You do not have to create a PCC user now.

Table 9-7 Pipeline Configuration Center User window

Field Name	Description
Username	Enter the name for the PCC user.
Password	Enter a password for the PCC user. Note: The PCC user password can contain up to 12 characters and should contain at least one character that is not a letter. In addition, the user name must not be a part of the password.
Confirm Password	Enter the password again.

15. In the Installation Summary window, review the selections you made in the preceding windows, and then click **Install**.
16. The Installation Progress window appears. When installation completes, click **Next**.

 **Note:**

After the installation begins, if you click **Stop installation**, the installation process stops, but the files that are already copied are not removed.

17. The Installation Complete window appears. Record PCC URL. You use this URL to access PCC.

 **Note:**

If the WebLogic server supports SSL, the secure connection is established for PCC even if you deselect the **Use SSL?** check box in the WebLogic Administration Server Connection window. In this case, two connection URLs are displayed:

- A secured connection URL with SSL listen port and the HTTPS schema
- An unsecured connection URL with the HTTP schema

18. Click **Finish**.

The PCC installer exits.

If you did not create a PCC user during installation, you must create one after the installation is complete. See "[PCC Postinstallation Tasks](#)" for more information.

See "[Verifying the PCC Installation](#)" for information about verifying the successful installation of PCC.

See "[About Installation Logs](#)" for information about PCC installer logs.

Installing PCC in Silent Mode

Silent-mode installation enables you to set installation configurations only once and then use those configurations to duplicate the installation on many machines. In this mode, you use a response file template that contains a predefined set of values to install PCC.

Note:

The silent installation is not meant for production environments, and it should be used only in development, demonstration, and test environments for setting up quickly or backing up the properties for later use in another non-production environment.

About the Response File Template

The PCC installer includes a response file template, *temp_dir/pcc/Disk1/stage/Response/oracle.communications.pcc.Complete.rsp*, where *temp_dir* is the directory in which you unzipped the PCC software.

This response file template contains all the parameters that the PCC installer requires during the silent, unattended installation, but it does not contain the parameter values. You must update the response file template per your installation requirements before starting the silent installation.

Creating a Response File

To create a response file:

1. Create the response file by doing one of the following:
 - Create a copy of the response file that was generated during the GUI installation. See "Installing PCC" for more information.

Note:

The GUI Installer does not store passwords provided during installation in the response file. You must manually add the passwords after creating a copy of the response file.

- Create a response file using the template by running the following command:

```
Java_home/bin/java -jar jarFile -getResponseFileTemplates
```

where:

- *Java_home* is the directory in which you installed the latest supported Java version.
- *jarFile* is the BRM installer file. For example:

```
PipelineConfigurationCenter_15.0.0.0.0_generic.jar
```

A response file is created with the default values.

You can create as many response files as needed.

2. Open the response file in a text editor.
3. Modify the response file you copied by specifying the key-value information for the parameters you want in your installation.

 **Note:**

- The response file template contains guidelines and examples on how to enter the values in the parameters.
- The PCC installer treats incorrect context, format, and type values in a response file as if no value were specified.

4. Save and close the response file.

Installing PCC in Silent Mode

To install PCC in silent mode:

1. Create a response file. See "[Creating a Response File](#)".
2. Copy the response file you created to the machine on which you are running the silent installation.
3. On the machine on which you are running the silent installation, go to the directory where you downloaded the PCC software, and run the following command:

```
Java_home/bin/java -jar jarFile -debug -invPtrLoc Inventory_home/oraInventory/  
oraInst.loc [parameter=value] -responseFile path -silent
```

where:

- *Java_home* is the location of the compatible version of Java.
- *jarFile* is the BRM installer file. For example:
`PipelineConfigurationCenter_15.0.0.0.0_generic.jar`
- *path* is the absolute path to the response file.
- *parameter* is the name of an installation parameter.
- *value* is the value of the installation parameter.

For example:

```
Java_home/bin/java -jar PipelineConfigurationCenter_15.0.0.0.0_generic.jar -debug -  
invPtrLoc Inventory_home/oraInventory/oraInst.loc INSTALL_TYPE=Complete -  
responseFile /response_files/myresponsefile.rsp -silent
```

The installation runs silently in the background.

4. Open the *PCC_Home/install/readme.txt* file, where *PCC_Home* is the directory in which you installed PCC.
5. Copy the URL and paste it in your browser's address field.
You can now access the PCC application.

See "[Verifying the PCC Installation](#)" for information on how to verify that the PCC installation was successful.

See "[About Installation Logs](#)" for information on the PCC installer logs.

About Installation Logs

The PCC Installer logs can be found in the **oralInventory/logs** directory.

Use the following log files to monitor installations and postinstallation tasks:

- **installActionTimeStamp.log**
- **oralInstallTimeStamp.err**
- **oralInstallTimeStamp.out**
- **silentInstallTimeStamp.log** (for silent mode installation)

where *TimeStamp* is the date and time the log file was created.

PCC Postinstallation Tasks

After you install PCC, perform the following postinstallation tasks:

1. [Creating a PCC User after Installing PCC](#)
2. [Using Secure Cookies](#)
3. [Configuring the Session Timeout](#)

Note:

During installation, the PCC installer copies the PCC **Infranet.properties** file to the WebLogic Server *domain_home* directory. You can update the **Infranet.properties** file in that directory.

Creating a PCC User after Installing PCC

During the PCC installation, the installer creates the **Config Admin** Oracle WebLogic Server group. Users belonging to this group have read and write access to perform all the tasks in PCC.

You can create a PCC user during or after the installation. When you create a user during the installation, the installer automatically adds it to the **Config Admin** group.

To create a PCC user after installing PCC, use WebLogic Server Administration Console to create a user and to add the user to the **Config Admin** group.

Note:

Do not use your browser's remember password feature for the WebLogic Server Administration Console URL. As a precaution, always enter the WebLogic server user name and password manually.

To create a PCC user after installing PCC:

1. Log in to WebLogic Server Administration Console.

2. In the **Domain Structure** panel, click the **Security Realms** link.
The **Summary of Security Realms** page appears.
3. Click the **myrealm** link.
The **Settings for myrealm** page appears.
4. Click the **Users and Groups** tab.
5. Click the **Users** subtab.
6. Click **New**.
The **Create a New User** page appears.
7. Do the following:
 - a. In the **Name** field, enter a name for the PCC user.
 - b. (Optional) In the **Description** field, enter a brief description for the PCC user.
 - c. In the **Password** field, enter a password for the PCC user.

 **Note:**

The PCC user password can contain up to 12 characters and should contain at least one nonalphabetic character. In addition, the user name must not be a part of the password.

- d. In the **Confirm Password** field, enter the password again to confirm it.
8. Click **OK**.
The user name appears in the User table.
9. Click the *user* link, where *user* is the PCC user that you created.
The **Settings for user** page appears.
10. Click the **Groups** tab.
11. In the **Parent Groups** section's **Available** list, select **Config Admin**.
12. Move **Config Admin** to the **Chosen** list.
13. Click **Save**.

Using Secure Cookies

Oracle recommends deploying PCC only on SSL, which encrypts sensitive data, thus eliminating problems like session stealing.

WebLogic Server enables a user to securely access HTTPS resources in a session that was initiated using HTTP, without loss of session data.

To use secure cookies:

1. Open the *WebLogic_home/user_projects/domains/Domain_Name/config/config.xml* file.
where:
 - *WebLogic_home* is the directory in which you installed WebLogic Server.
 - *Domain_Name* is the name of the domain you are configuring.

2. Add **AuthCookieEnabled="true"** to the **<WebServer>** element:

```
<WebServer Name="myserver" AuthCookieEnabled="true"/>.
```

 **Note:**

By default, **AuthCookieEnabled** is set to **true**. The secured cookies are enabled by default even if the **config.xml** file does not contain this entry. You can set **AuthCookieEnabled** to **false** to disable secured cookies. However, Oracle recommends not disabling it.

You can also set this entry by using WebLogic Server Administration Console:

1. Log in to WebLogic Server Administration Console.
The home page appears.
2. In the **Domain Configurations** section, under **Domain**, click **Domain**.
The **Settings for Domain_Name** page appears.
3. Click the **Web Applications** tab.
4. Verify that the **Auth Cookie Enabled** check box is selected.
5. Click **Save**.

By default, the **Auth Cookie Enabled** check box is selected, but it is not present in the **config.xml** file. If you deselect it, the **<AuthCookieEnabled>** element is added to the **config.xml** file.

Setting **AuthCookieEnabled** to **true**, the default setting, causes the WebLogic Server instance to send a new secure cookie, **_WL_AUTHCOOKIE_JSESSIONID**, to the browser when authenticating through an HTTPS connection. After the secure cookie is set, the session is allowed to access other security-constrained HTTPS resources only if the cookie is sent from the browser.

For more information, see the discussion about using secure cookies to prevent session stealing in *Oracle Fusion Middleware Developing Applications with the WebLogic Security Service*.

Oracle recommends keeping cookie settings enabled in the browser. Disabling cookies in the browser disables several features, such as Help.

Configuring the Session Timeout

The default session timeout in PCC is 600 seconds. The WebLogic Server administrator can change this value as follows:

1. Log in to WebLogic Server Administration Console.
2. In the **Domain Structure** panel, click **Deployments**.
The **Summary of Deployments** page appears.
3. In the Deployments table, click **PipelineConfigurationCenter**.
The **Settings for PipelineConfigurationCenter** page appears.
4. Click the **Configuration** tab.
5. In the **Session Timeout (in seconds)** field, enter a new timeout value in seconds.

6. Click the **Overview** tab.
7. In the Modules and Components table, click **PCC-PCCViewController-context-root**.
8. Click the **Configuration** tab.
9. In the **Session Timeout (in seconds)** field, enter the same timeout value, in seconds, that you entered in step 5.
10. Click **Save**.

If no deployment plan is created, WebLogic Server creates one with the preceding changes and prompts you to save the deployment plan. Provide the name and path for the deployment plan, and click **OK**.
11. In the **Domain Structure** panel, click **Deployments**.
12. Select the **PipelineConfigurationCenter** check box.
13. Click **Update**.

The Update Application Assistant starts.
14. Select the **Update this application in place with new deployment plan changes** option.
15. Set **Deployment plan path** to the deployment plan created in step 10. Use the **Change Path** button to browse to the file.
16. Click **Next**.
17. Click **Finish**.
18. Restart WebLogic Server.
19. Verify your changes by doing the following:
 - a. Log in to WebLogic Server Administration Console.
 - b. In the **Domain Structure** panel, click **Deployments**.
 - c. Click **PipelineConfigurationCenter**.

The **Settings for PipelineConfigurationCenter** page appears.
 - d. Click the **Configuration** tab.
 - e. Verify that **Session Timeout (in seconds)** is set to the value you specified.

For more information, see the discussion about configuring applications for production deployment in *Oracle Fusion Middleware Deploying Applications to Oracle WebLogic Server*.

Verifying the PCC Installation

Verify whether PCC was installed successfully by doing the following:

- [Checking the State of the Installed Components](#)
- [Logging In to PCC](#)
- [About File Permissions](#)

Checking the State of the Installed Components

You can verify that PCC is installed correctly by checking the state of the installed components.

To check the state of the installed components:

1. Log in to the PCC domain in WebLogic Server Administration Console.

2. In the **Domain Structure** panel, click **Deployments**.
The **Summary of Deployments** page appears.
3. In the **Control** tab, if PCC is installed correctly, the deployed **PipelineConfigurationCenter** application appears in the **Active** state.

Logging In to PCC

You can log in to PCC to verify that PCC is installed.

To log in to PCC:

1. In a supported browser, navigate to the URL provided by the PCC installer at the end of the installation.

The PCC login page appears.

Note:

The URL to access PCC is also available in the *PCC_Home/install/readme.txt* file, where *PCC_Home* is the directory in which you installed PCC.

2. Enter the user name and password in the login window for PCC.
3. Click **Login**.

The PCC home page appears, verifying that PCC is successfully installed.

About File Permissions

- The following default permissions are set for the installed files:
 - `rw----- 600` (for all non-executable files)
 - `rwX----- 700` (for all executable files)

Permissions are set to the most restrictive level, and the WebLogic Server administrator can add or revoke permissions. Oracle recommends keeping the permissions as restrictive as possible.

- Protect the WebLogic configuration (JMS, JDBC, and so on) file, **config.xml**, in the domain's **config** directory with proper permissions.

Verifying Configuration Entries

The installer stores the configuration entries in the PCC wallet. These entries are used to control the connections from Java applications to BRM.

After PCC has been installed on each machine, check the configuration entries stored in the PCC wallet. You can verify the entries by doing the following:

 **Note:**

If PCC and the BRM server are installed on separate machines, copy the PCC wallet to the machine in which the BRM server is installed and perform the following procedure on the machine in which the BRM server is installed.

1. Go to the directory in which you installed PCC, and source the **source.me** file:

Bash shell:

```
source source.me.sh
```

C shell:

```
source source.me.csh
```

2. Run the following command:

```
orapki wallet display -wallet PCC_Wallet_Path
```

where *PCC_Wallet_Path* is the path to the PCC wallet.

The entries stored in the client wallet appear.

If the entries do not appear, you must store the entries manually in the PCC wallet by using the **pin_crypt_app** utility.

To secure this connection information, encrypt the password by using the **pin_crypt_app** utility. See "About Encrypting Passwords" in *BRM Developer's Guide*.

Uninstalling PCC

 **Note:**

After uninstalling PCC, you must manually undeploy the PCC application deployed on the WebLogic server domain. See the discussion about undeploying applications in the Oracle WebLogic Server documentation.

To uninstall PCC:

1. Go to the *PCC_home/oui/bin* directory.
2. Run the following command from a GUI (for example, VNC server):

```
./deinstall.sh
```

The Distribution to Uninstall window appears.

3. Select the components you want to uninstall.
4. Click **Uninstall**.

The Welcome window appears.

5. Click **Next**.

The Uninstallation Summary window appears.

6. Click Uninstall.

The Uninstallation Progress window appears.

7. Click Next.

The Uninstallation Complete window appears.

8. Click Finish.

The PCC installer removes all files except log files. You must delete the log files manually. The log files are in the **oralInventory/logs** directory.

Uninstalling PCC in Silent Mode

To uninstall PCC in silent mode:

1. Go to the *PCC_home/oui/bin* directory.**2. Run the following command:**

```
./deinstall.sh -responseFile path -silent
```

where *path* is the absolute path to the response file.

A message indicating that PCC has been uninstalled successfully appears.

Deleting Files after Uninstalling PCC

The following files remain in the system after PCC is uninstalled:

- Install logs

The log files are in the **oralInventory/logs** directory.

- *PCC_home/oui/data.properties*

This file is used to auto-populate the data during reinstalls.

Delete these files manually if you do not need them, or protect them appropriately if they are required for further installations.

By default, these files are created with the file-level permission 640 (owner can read/write; group members can read; others cannot do anything).

Administering PCC

A PCC administrator is responsible for the day-to-day tasks of maintaining and managing PCC and its users. You perform the following tasks as a PCC administrator:

- [Managing PCC Security](#)

- [Monitoring PCC](#)

- [Managing PCC](#)

Managing PCC Security

Oracle WebLogic Server includes a security architecture that provides a secure foundation for applications. PCC depends on the WebLogic Server security framework to secure its resources and servers. Managing PCC security involves the following:

- Managing security realms: Configuring new security realms, changing the default security realm, and deleting security realms
- Managing users and groups: Defining users and assigning them to a group that can be authenticated in a security realm
- Managing security providers: Managing security providers that provide security services to applications to protect WebLogic Server resources

See the Oracle WebLogic Server Administration Console Help for more information on managing security realms, managing users and groups, and managing security providers.

Monitoring PCC

Regularly monitoring your system ensures fast recognition and resolution of problems or issues. You can use WebLogic Server Administration Console to monitor the following:

- PCC domain
- PCC administration server and managed servers

See the Oracle WebLogic Server Administration Console Help for more information.

Managing PCC

You manage PCC by managing the WebLogic server on which PCC is installed. This includes starting and stopping the PCC administration server and managed servers.

See the Oracle WebLogic Server Administration Console Help for more information.

Troubleshooting PCC

Although PCC installation is designed to be trouble free, you might encounter a problem. You can troubleshoot PCC installation problems using information in the following sections:

- [Troubleshooting Checklist](#)
- [Using Error Logs to Troubleshoot PCC](#)
- [Diagnosing PCC Problems](#)
- [Getting Help for PCC Problems](#)

Troubleshooting Checklist

When problems occur, it is best to do some troubleshooting before you contact Oracle support:

- You know your installation better than Oracle support does. You know whether anything in the system has been changed, so you are more likely to know where to look first.
- Troubleshooting skills are important. Relying on Oracle support to research and solve all your problems prevents you from being in full control of your system.

If you have a problem with your PCC system, ask yourself the following questions because Oracle support will ask them:

- What exactly is the problem? Can you isolate it?
Oracle support needs a clear and concise description of the problem, including when it began to occur.
- What do the log files say?

This is the first thing that Oracle support asks for. Check the error log for the PCC component you are having problems with.

- Has anything changed in the system? Did you install any new hardware or new software? Did the network change in any way? Does the problem resemble another one you had previously? Has your system usage recently jumped significantly?
- Is the system otherwise operating normally? Has response time or the level of system resources changed? Are users complaining about additional or different problems?

Using Error Logs to Troubleshoot PCC

PCC error log files provide detailed information about system problems. If you are having a problem with PCC, look in the log files.

PCC records information about actions performed in the PCC GUI in Oracle WebLogic Server log files. See the Oracle WebLogic Server Administration Console Help for more information.

Diagnosing PCC Problems

PCC problems can be diagnosed using the Oracle WebLogic Server Diagnostic Framework, which enables you to collect, archive, and access diagnostic information about applications hosted on the WebLogic server. See the Oracle WebLogic Server Administration Console Help for more information.

This section lists some common PCC problems and describes how to diagnose the error messages and resolve the problems.

Refreshing the Browser

Do not refresh your browser.

Refreshing the browser causes unpredictable problems in PCC.

Unable to Perform Any Task after Logging In

After you log in to PCC, the links in the navigation pane are not displayed, and you cannot perform any task.

This means that you are not in the **Config Admin** WebLogic Server group. Contact your system administrator, and request to be added to that group.

Getting Help for PCC Problems

If you cannot resolve a PCC problem, contact Oracle support.

Before you contact Oracle support, try to resolve the problem with the information in the log files. See "[Using Error Logs to Troubleshoot PCC](#)" for more information. If this does not help resolve the problem, gather the following information:

- A clear and concise description of the problem, including when it began to occur.
- Relevant portions of the relevant log files.
- Relevant configuration files.
- Recent changes in your system after which the problem occurred, even if you do not think they are relevant.

- A list of all PCC components and patches installed on your system.

When you are ready, report the problem to Oracle support.

Secure Deployment Checklist

To deploy PCC securely, follow this checklist:

1. Preinstallation steps:
 - a. Enable SSL for the target Oracle WebLogic Server domain.
 - b. Configure the server KeyStore certificate, and get the client KeyStore trusted certificate.
 - c. Configure Oracle Database advanced security encryption and integrity algorithms for a secure connection from the installer.
 - d. Verify that you have the correct version of the JDK with the latest security update installed and configured with your PCC/WebLogic Server installation.
2. Installation steps:
 - a. Select the SSL mode, select the KeyStore type, and provide the client KeyStore certificate (**.p12** [recommended] or **.jks** file) for connecting to a WebLogic server over SSL.
3. Postinstallation steps:
 - a. If you do not need the installation log files, delete them.
 - b. The WebLogic Server administrator must create PCC users based on the roles and privileges.
 - c. Do not use your browser's remember password feature for the WebLogic Server Administration Console URL.
 - d. Enable secure cookies.
 - e. Verify that file permissions for the installed files are 600 for all files that are not executable and 700 for all executable files.
4. Uninstallation steps:
 - a. Delete the log files in the **oralInventory/logs** directory manually if you do not need them, or protect them appropriately if they are required for further installations.

10

Installing BRM REST Services Manager

Learn how to use the Oracle Communications Billing and Revenue Manager (BRM) REST Services Manager package to install both the BRM REST Services Manager API and the BRM REST Services Manager SDK on your system.

Topics in this document:

- [Downloading the BRM REST Services Manager Package](#)
- [Generating an SSL Certificate for BRM REST Services Manager](#)
- [Installing BRM REST Services Manager](#)
- [BRM REST Services Manager Postinstallation Tasks](#)
- [Troubleshooting SSL Connection Errors](#)

For more information about the BRM REST Services Manager API and SDK, see *REST Services Manager API for Billing and Revenue Management*.

Downloading the BRM REST Services Manager Package

You can download and install the BRM REST Services Manager software from one of the following locations:

- For BRM 15.0.0 or any 15.0.x maintenance release: From the Oracle software delivery website (<https://edelivery.oracle.com>)
- For any 15.0.x.y patch set release: From the Oracle support website (<https://support.oracle.com>)

Search for and download the **Oracle Communications Billing and Revenue Management 15.0.x.y.0** software, where *x* refers to the maintenance release and *y* refers to the patch set release of BRM that you are installing.

The Zip archive includes the BRM REST Services Manager installer:
BRM_REST_Services_Manager-15.0.x.y.0.jar

Generating an SSL Certificate for BRM REST Services Manager

The following shows the steps for generating a sample SSL certificate:

1. Create a directory named **rsm_keystore** under the **oc-cn-helm-chart/rsm** directory.
2. Generate an SSL certificate. For example:

```
openssl req -x509 -newkey rsa:4096 -keyout openSSLKey.pem -out cert.pem -days 365 -nodes
```

3. Generate a **PKCS12** KeyStore file. For example, this creates a KeyStore file named **keystore.p12**:

```
openssl pkcs12 -export -out keyStore.p12 -inkey openSSLKey.pem -in cert.pem
```

4. Copy your SSL certificate file to the **oc-cn-helm-chart/rsm/rsm_keystore** directory.

Installing BRM REST Services Manager

The BRM REST Services Manager package installs both the BRM REST Services Manager API and the BRM REST Services Manager SDK on your system.

You can install BRM REST Services Manager in the following modes:

- **GUI mode:** Use GUI mode when you want to interact with the BRM REST Services Manager installer GUI during installation. See "[Installing BRM REST Services Manager in GUI Mode](#)".
- **Silent mode:** Use silent mode when you install BRM REST Services Manager using the same configuration repeatedly. Silent install mode does not use the GUI, and it runs in the background. See "[Installing BRM REST Services Manager in Silent Mode](#)".

Installing BRM REST Services Manager in GUI Mode

To install BRM REST Services Manager in GUI mode:

1. Go to the *temp_dir* directory and run one of these commands:

- To start the GUI installer:

```
Java_home/bin/java -jar jarFile
```

where:

- *Java_home* is the directory in which you installed the latest compatible Java version.
- *jarFile* is the BRM installer file. For example:

```
BRM_REST_Services_Manager-15.0.0.0.0.jar
```

- To start the GUI installer and install BRM REST Services Manager using the **oralInventory** directory in a different location:

```
Java_home/bin/java -jar jarFile -invPtrLoc FilePath/oraInst.loc
```

where *FilePath* is the path to the directory in which the **oralInst.loc** file is located.

- To start the GUI installer and create a silent installer response file during the installation:

```
Java_home/bin/java -jar jarFile -record -destinationFile path
```

where *path* is the absolute path to the response file.



Tip:

You can run the following command to get more details about the options.

```
Java_home/bin/java -jar jarFile -help
```

2. In the Welcome window, click **Next**.

 **Note:**

If the **oralnst.loc** file is corrupt or not present, the Specify Inventory Directory and Credentials window appears next. Otherwise, the Installation Location window appears.

- (Optional) In the Specify Inventory Directory and Credentials window, enter the details listed in [Table 10-1](#) and then click **Next**.

Table 10-1 Specify Inventory Directory and Credentials

Field	Description
Inventory Directory	The full path of the inventory directory. The default oralinventory directory is located in the /etc/oralnst.loc (Linux) file.
Operating System Group Name	The name of the operating system group that has write permission to the inventory directory.

- In the Installation Location window, enter the full path or browse to the directory in which you want to install BRM REST Services Manager and then click **Next**.
- In the Feature Sets Selection window, select the feature set options that you want to install and then click **Next**.
- In the Server Details window, enter the details listed in [Table 10-2](#) for the server on which you want to deploy BRM REST Services Manager and then click **Next**.

Table 10-2 Server Details

Field	Description
Host Name	The host name of the computer on which the server is configured.
Port Number	The port number available on the host.
SSL Port Number	The SSL port number on which you want to install BRM REST Services Manager.
KeyStore Location	The path of the client-side KeyStore file you generated in " Generating an SSL Certificate for BRM REST Services Manager ".
KeyStore Password	The password used for accessing the KeyStore file.

- In the Base URL Details window, enter the base URL to include in the response of BRM REST Services Manager requests. Click **Next**.
- In the BRM Connection Details window, enter the details listed in [Table 10-3](#) for connecting to the BRM server and then click **Next**.

Table 10-3 BRM Connection Details

Field	Description
User Name	The user name for connecting to BRM.
Password	The password of the BRM user.

Table 10-3 (Cont.) BRM Connection Details

Field	Description
Host Name	The host name of the computer on which the primary BRM Connection Manager (CM) or CM Master Process (CMMP) is running.
Port Number	The TCP port number of the CM or CMMP on the host computer. The default value is 11960 .
Service Type	The BRM service type. The default value is /service/pcm_client .
Service POID Id	The POID of the BRM service. The default value is 1 .
Use SSL?	Do one of the following: <ul style="list-style-type: none"> • If you have not enabled SSL for BRM, deselect this check box. • If you have enabled SSL for BRM, select this check box.
Wallet Password	The password for the BRM wallet.
Confirm Wallet Password	Enter the password for the BRM wallet again.

- In the Security Details window, do one of the following for the **Configure Security** option and then click **Next**.
 - If you want to configure BRM REST Services Manager securely, select **Yes**, select the **IDCS** or **OAM** option based on your security requirements, and then click **Next**. If you select **IDCS**, the IDCS Details window appears. Enter the following details for authorizing with Oracle Identity Cloud Service (IDCS):
 - **Client ID**: The client ID of the application.
 - **Client Secret**: The client secret of the application.
 - **Identity URL**: The base URL of the IDCS server. For example, `https://tenant-base-url`.
 - **Scope Audience**: The primary audience registered for the application which is appended for scopes.
 - **Audience**: The primary audience registered for the application.

If you select **OAM**, the OAM Details window appears. Enter the following details for authorizing with Oracle Access Management:

 - **OAuth Identity Domain Name**: The OAuth identity domain name hosting artifacts such as the resource server and client.
 - **OAuth Resource Server Name**: The OAuth server name hosting protected resources.
 - **OAuth Token Introspection Endpoint**: The OAuth REST endpoint that validates the access token.
 - **ODD Host Name**: The host name where the Oracle Unified Directory server is installed.
 - **ODD Root User DN**: The **root** user assigned with read and write access to all data in the server. For example: `cn=Directory Manager`.
 - **ODD Root user password**: The password for the **root** user.
 - **ODD HTTP Port**: The HTTP port where Oracle Unified Directory is configured to listen. This port hosts the Oracle Unified Directory REST endpoints.

- **OID HTTPS Port:** The HTTPS port where Oracle Unified Directory is configured to listen. This port hosts the Oracle Unified Directory REST endpoints with HTTPS protocol.
 - **OID users directory base DN:** The base directory name where users are created in Oracle Unified Directory. Example: ou=people,dc=tmf,dc=com.
 - **OID groups directory base DN:** The base directory name where roles or groups are created in Oracle Unified Directory. For example: ou=Groups,dc=tmf,dc=com.
- If you want to configure BRM REST Services Manager in a test installation mode, select **No**.
10. In the Installation Summary window, review the selections you made in the preceding windows and then click **Install**.
 11. The Installation Progress window appears. When the installation completes, click **Next**.

 **Note:**

After the installation begins, you cannot stop or cancel the installation.

12. The Installation Complete window appears. Make note of the BRM REST Services Manager base URL. You use this URL to access BRM REST Services Manager.

 **Note:**

You can find the BRM REST Services Manager logs in the *REST_home/logs* directory, where *REST_home* is the BRM REST Services Manager installation directory.

13. Click **Finish** to complete the installation.
The BRM REST Services Manager installer exits.

Installing BRM REST Services Manager in Silent Mode

The silent installation uses a response file in which you have set installation information. To obtain the response file, you run the GUI installer for the first install. The GUI installer generates a response file that contains the key-value pairs based on the values that you specify during the GUI installation. You can then copy and edit the response file to create additional response files for installing the BRM REST Services Manager on different machines.

Creating a Response File

To create a response file:

1. Create a copy of the response file that was generated during the GUI installation. See "[Installing BRM REST Services Manager in GUI Mode](#)" for more information.

 **Note:**

A response file was created only if you ran the GUI installer with this command:

```
Java_home/bin/java -jar jarFile -record -destinationFile path
```

2. Open the response file in a text editor.
3. Manually add all passwords to the response file. The GUI Installer does not store the passwords that you provided during installation in the response file.
4. Modify the key-value information for the parameters you want in your installation.

 **Note:**

The Installer treats incorrect context, format, and type values in a response file as if no value were specified.

5. Save and close the response file.

Installing BRM REST Services Manager in Silent Mode

To install BRM REST Services Manager in silent mode:

1. Create a response file. See "[Creating a Response File](#)".
2. Copy the response file you created to the machine on which you run the silent installation.
3. On the machine on which you run the silent installation, go to the *temp_dir* directory and run the following command:

```
Java_home/bin/java -jar jarFile -debug -invPtrLoc Inventory_home/oraInventory/  
oraInst.loc [parameter=value] -responseFile path -silent
```

where:

- *Java_home* is the directory in which you installed the latest supported Java version.
- *jarFile* is the BRM installer file. For example:
`BRM_REST_Services_Manager-15.0.0.0.0.jar`
- *parameter* refers to the installation parameters in the response file. You can override these parameters with any of the available parameters in the response file. For example, **INSTALL_TYPE**.
- *value* is the value of the installation parameter. The value allows to override the response file entries at run time. For example, you can set **INSTALL_TYPE=Custom**. This value overrides the existing value in the response file for the same parameter.
- *path* is the absolute path to the response file.

For example:

```
Java_home/bin/java -jar BRM_REST_Services_Manager-15.0.0.0.0.jar -debug -invPtrLoc  
Inventory_home/oraInventory/oraInst.loc INSTALL_TYPE=Complete -responseFile /tmp/  
BRM_REST_Services_Manager.rsp -silent
```

The installation runs silently in the background.

 **Tip:**

You can run the following command to get more details about the options.

```
Java_home/bin/java -jar jarFile -help
```

4. Open the `REST_home/install/readme.txt` file, where `REST_home` is the directory in which you installed BRM REST Services Manager.
5. Copy the URL and paste it in your browser's address field.
You can now access the BRM REST Services Manager.

BRM REST Services Manager Postinstallation Tasks

After you install BRM REST Services Manager, perform these postinstallation tasks:

1. [Excluding the BRM REST Services Manager SDK](#)
2. [Importing Java KeyStore Certificates](#)
3. [Updating BRM Connection Details](#)
4. [Updating the Base URL](#)
5. [Modifying BRM REST Services Manager Properties](#)
6. [Setting Up Zipkin Tracing in BRM REST Services Manager](#)
7. [Connecting BRM REST Services Manager to Oracle Analytics Publisher](#)
8. [Configuring BRM REST Services Manager for High Availability](#)
9. [Allowing the Use of Deprecated Cyphers](#)

Excluding the BRM REST Services Manager SDK

The BRM REST Services Manager package installs both the BRM REST Services Manager API and the BRM REST Services Manager SDK on your system.

If you do not want to include the BRM REST Services Manager SDK in your deployment, remove this entry from the `REST_home/scripts/brm_rsm.properties` file:
EXTENSION_LIB_PATH.

Importing Java KeyStore Certificates

When installing BRM REST Services Manager, if you select **OLD HTTPS Port**, you must import the Java KeyStore certificates in the Java KeyStore for a secure connection to Oracle Unified Directory.

To import the Java KeyStore certificates into the Java KeyStore:

1. Log on to the machine where you have installed BRM REST Services Manager.
2. Go to the `Java_home/bin` directory, where `Java_home` is the directory in which you installed the latest supported Java version.
3. Run the following command:

```
keytool -import -alias AliasName -file CertificateFileLocation -keystore cacerts
```

where:

- *AliasName* is a unique name of an entity.
- *CertificateFileLocation* is the path where you have stored the Oracle Unified Directory SSL Certificate.

The **keytool** command prompts you for a Java KeyStore password. When prompted whether to trust the certificate, enter **yes**.

The Java KeyStore certificates are imported into the default Java KeyStore.

Updating BRM Connection Details

By default, the BRM REST Services Manager installer stores sensitive information such as passwords in the Oracle wallet, and BRM REST Services Manager retrieves the passwords from the Oracle wallet. However, you can update this sensitive information after the installation.

To update the BRM connection details:

1. Navigate to the *REST_home/Wallet* directory, where *REST_home* is the BRM REST Services Manager installation directory.
2. Run the following command to update the BRM connection details:

```
java -cp
";oraclepkijarLocation;osdtcertjarlocation;osdtcorejarLocation;cetjarLocation
com.portal.cet.ConfigEditor -setconf -wallet clientWalletLocation -
parameter configEntry -value value
```

where:

- *clientWalletLocation* is the path to the client wallet.
 - *configEntry* is the configuration entry in the client wallet.
 - *value* is the appropriate value for the respective entry in the client wallet.
3. Stop BRM REST Services Manager using this command:
`REST_home/scripts/stop_brm_rsm.sh`
 4. Start BRM REST Services Manager using this command:
`REST_home/scripts/start_brm_rsm.sh`

Updating the Base URL

After installation, you can update the base URL with the resource details to return in the response of BRM REST Services Manager requests. To do so, edit the *BRM_home/scripts/app_external.properties* file.



Note:

You don't need to restart the BRM REST Services Manager server after editing the **app_external.properties** file.

Modifying BRM REST Services Manager Properties

To modify the BRM REST Services Manager properties:

1. Stop BRM REST Services Manager using this command:

```
REST_home/scripts/stop_brm_rsm.sh
```

2. Open the *REST_home*/scripts/**brm_rsm.properties** file in a text editor.
3. Modify the properties based on your requirements. For example, changing the port number and log level.
4. Save the **brm_rsm.properties** file.
5. Start BRM REST Services Manager using this command:

```
REST_home/scripts/start_brm_rsm.sh
```

Setting Up Zipkin Tracing in BRM REST Services Manager

You can trace the flow of API calls made to BRM REST Services Manager by using Zipkin, which is an open-source tracing system. For more information, see the Zipkin website: <https://zipkin.io/>.

To set up Zipkin tracing for BRM REST Services Manager:

1. Install Zipkin. See the Zipkin Quickstart documentation: <https://zipkin.io/pages/quickstart.html>.
2. (Optional) To use secure SSL Zipkin, perform these steps:
 - a. Generate a client SSL Certificate for connecting BRM REST Services Manager to Zipkin.
 - b. Use the client SSL Certificate to create a PKCS12 TrustStore file.
 - c. Go to the *REST_home*/**Wallet** directory, where *REST_home* is the BRM REST Services Manager installation directory.
 - d. To use secure Zipkin, pass the TrustStore file you created with the `TRUST_STORE_FILE_PATH` key and set the password in your client wallet:

```
java -cp '.:oraclepki.jar:osdt_cert.jar:osdt_core.jar:cet.jar'  
com.portal.cet.ConfigEditor -setconf -wallet clientWalletLocation/  
wallet -parameter TRUST_STORE_PASSPHRASE -value password
```

where:

- *clientWalletLocation* is the path to the client wallet.
- *password* is the TrustStore password in Base64 format.

3. Stop BRM REST Services Manager using this command:

```
REST_home/scripts/stop_brm_rsm.sh
```

4. Open the *REST_home*/scripts/**brm_rsm.properties** file in a text editor.
5. Enable tracing in BRM REST Services Manager by setting the following parameter:

```
TRACING_ENABLED=true
```

6. Set the following parameters to the host name and port number of the machine on which Zipkin tracing collector is installed:

```
ZIPKIN_HOST_NAME=hostname  
ZIPKIN_PORT=portNumber
```

7. Set the following parameter to the protocol of the Zipkin tracing collector, which is either HTTP or HTTPS:

```
ZIPKIN_PROTOCOL=HTTPS
```

8. Save the **brm_rsm.properties** file.
9. Start BRM REST Services Manager using this command:

```
REST_home/scripts/start_brm_rsm.sh
```

Afterward, you can start tracing the flow of API calls to BRM REST Services Manager by using the Zipkin UI or Zipkin API.

Connecting BRM REST Services Manager to Oracle Analytics Publisher

To enable BRM REST Services Manager to retrieve PDF invoices generated by Oracle Analytics Publisher, do one of the following:

- Create an **Infranet.properties** file in your user's home directory (*User_home*) and then add these parameters:
 - **BIP_USERID**: Set this to the Oracle Analytics Publisher user that has web access.
 - **BIP_PASSWORD**: Set this to the password for the Oracle Analytics Publisher user password.
 - **BIP_URL**: Set this to the URL for accessing the Oracle Analytics Publisher instance. For example: **http://hostname:port/xmlpserver/services/PublicReportService_v11**.
- Update the Oracle Analytics Publisher connection details in the BRM REST Services Manager wallet. For more information, see the *REST_home/Wallet/README* file.

Configuring BRM REST Services Manager for High Availability

You can optionally configure BRM REST Services Manager for high availability.

Because BRM REST Services Manager is a relatively simple API service, you can support high availability by using the open-source load balancer of your choice, such as Apache HTTP Server or HAProxy. The load balancer automatically routes requests to whichever server is available, which enables greater scalability by sharing the traffic among servers, and also lets processing continue if an instance is down.

The basic steps for configuring BRM REST Services Manager for high availability are:

1. Install and configure BRM REST Services Manager. You can install multiple instances on the same server by using a different port, or install different instances on different servers.
2. Install a load balancer. You can install the load balancer on the same server as one of your BRM REST Services Manager instances, or a different server with access to the BRM REST Services Manager servers.
3. Add the details of the BRM REST Services Manager servers to the load balancer, using a proxy to pass traffic to the group of servers.

Allowing the Use of Deprecated Cyphers

According to security best practices, by default BRM Rest Services Manager restricts less-secure cyphers from being used. These restricted cyphers are listed in *REST_home/scripts/security.properties*. You can change this configuration if you are willing to take the risk of allowing less-secure cyphers.

To allow individual restricted cyphers:

1. Stop BRM REST Services Manager using this command:

```
REST_home/scripts/stop_brm_rsm.sh
```

2. Back up the *REST_home/scripts/security.properties* file.
3. Open the *REST_home/scripts/security.properties* file in a text editor.
4. Remove the names of any cyphers you would like to allow.
5. Save the *security.properties* file.
6. Start BRM REST Services Manager using this command:

```
REST_home/scripts/start_brm_rsm.sh
```

To remove all cypher restrictions:

1. Stop BRM REST Services Manager using this command:

```
REST_home/scripts/stop_brm_rsm.sh
```

2. Open the *REST_home/scripts/brm_rsm.properties* file in a text editor.
3. Set the value of the **OVERRIDE_SECURITY_PROPERTIES** property to **false**.
4. Save the *brm_rsm.properties* file.
5. Start BRM REST Services Manager using this command:

```
REST_home/scripts/start_brm_rsm.sh
```

Troubleshooting SSL Connection Errors

BRM REST Services Manager can use SSL connections for invoking OAuth Token Introspection Endpoint and Oracle Unified Directory REST APIs. [Table 10-4](#) describes the possible SSL connection errors and solutions.

Table 10-4 SSL Connection Errors and Solutions

SSL Connection Errors	Solutions
javax.net.ssl.SSLHandshakeException: java.security.cert.CertificateException: No name matching hostname found	Ensure that the Common Name (CN) in the SSL certificate is the fully qualified domain name of the server where endpoints are hosted.
javax.net.ssl.SSLHandshakeException: sun.security.validator.ValidatorException: PKIX path building failed: sun.security.provider.certpath.SunCertPathBuilder Exception: unable to find valid certification path to requested target	Ensure that the SSL certificate of the endpoint is imported into the Java KeyStore. See " Importing Java KeyStore Certificates " for more information.

11

Troubleshooting the BRM Installation

Learn how to solve problems that may occur in your Oracle Communications Billing and Revenue Management (BRM) system.

Topics in this document:

- [Problems Installing the Database](#)
- [Problems Installing BRM](#)
- [Problems Connecting to the Database](#)

For more information, see "Reference Guide to BRM Error Codes" and "Resolving Problems in Your BRM System" in *BRM System Administrator's Guide*.

Problems Installing the Database

For more information on errors that can occur when installing your database, see your database documentation.

Problem: Cannot Start the Oracle Listener

When you try to start the Oracle Listener, you get a "permission denied" error.

Possible Cause

The path points to a directory for which you do not have access.

Solution

Change the permissions to the directory where the **listener.ora** and **listener.log** files are stored.

Problem: Cannot Connect to the Oracle Database as the System User

You cannot connect to the database as the **system** user with SQL.

Possible Causes

- The Oracle Listener is not running.
- Oracle cannot find a **tnsnames.ora** file.
- The **tnsnames.ora** file does not point to a valid database.

Solution

1. Start the Oracle Listener.
2. Make sure the **tnsnames.ora** file points to your database on the specific host machine.

3. Make sure the Oracle user's path contains the correct path to your **tnsnames.ora** file.

Problems Installing BRM

If you have a problem installing the BRM software or its optional components, first check the **pin_setup.log** file, and then the Data Manager (DM) and Connection Manager (CM) **log** files for possible reasons for the failure.

Problem: An Error Occurred When pin_setup is Run During Installation

When you run the **pin_setup** script of BRM during installation, error occurs if the database alias is incorrect.

Possible Cause

The database alias is incorrect, so the **pin_setup** script cannot finish executing.

Solution

In single-schema environments, make sure you do the following and then continue the BRM installation:

1. Set the **\$TNS_SERVICE_NAME** environment variable to point to the database service name.
2. Open the **tnsnames.ora** file in a text editor.
By default, that file is in the *Oracle_home/network/admin/* directory.
3. Set **SERVICE_NAME** as the database alias in the connect descriptor:

For example:

```
pindb.example.com=(DESCRIPTION=(ADDRESS_LIST=(ADDRESS=(PROTOCOL=) (HOST=) (PORT=))) (CONNECT_DATA=(SERVICE_NAME=pindb.example.com)))
```

4. Save and close the file.

In multischema environments, make sure you do the following after installing BRM:

1. Specify the correct database alias in the Oracle wallet.
For updating the configuration entries in the Oracle wallet, see "About Oracle Wallet" in *BRM System Administrator's Guide*.
2. Update the **\$MAIN_DB{alias}** entry in the *BRM_home/setup/pin_setup.values* file to point to the correct database alias.
3. Run the **pin_setup** script. See "[Running the pin_setup Script](#)".

Problem: An Error Occurred during the Move Data Process

You receive the error "An error occurred during the move data process -132."

Possible Cause

A BRM process is running, so the **pin_setup** script cannot finish executing.

Solution

Make sure you stop all existing BRM processes, and then run the **pin_setup** script again.

Problem: Errors Are Recorded in the Log File When dm_oracle Starts

After you install BRM and while running the **pin_setup** script of BRM, when the Oracle DM starts, errors are recorded in the **dm_oracle.pinlog** file.

Possible Cause

Cannot find the ACCOUNT_T table, as this gets created later on.

Solution

There is no solution; the error does not impact any functionality and can be ignored.

Problem: An Error Occurs in the dm_fusa.pinlog file during pin_setup of Paymentech Manager

Errors occur while running the **pin_setup** script of Paymentech Manager in the **dm_fusa.pinlog** file.

Possible Cause

The simulator is not started.

Solution

After the **pin_setup** of Paymentech Manager is complete, start the answer simulator to remove the errors. The simulators are in *BRM_home/bin*. You start the simulator through the command line:

```
start_answer
```

Problems Connecting to the Database

Conflicting settings in the **pin_setup.values** configuration file often cause database connection failures.

Problem: Pointer to the Wrong Database Name

The **pin_setup** script cannot connect to the database, and the error message in the DM log file shows that the DM is trying to connect to the incorrect database.

Possible Cause

The **\$MAIN_DB{alias}** entry in the **pin_setup.values** file does not match the database alias.

Solution

Enter the correct name for your database; for example, **pin***dbhostname*, in the **\$MAIN_DB{alias}** entry of the **pin_setup.values** file. Re-run the **pin_setup** script.

Problem: Cannot Log In to the Database

The **pin_setup** script cannot log in to the BRM database. The error message indicates an invalid user name or password.

Possible Cause

The **\$MAIN_DB{user}** and **\$MAIN_DB{password}** entries in the **pin_setup.values** file do not specify the correct user name and password for the BRM database.

Solution

First, verify that you can connect to the BRM database by using the user name and password you want. If you cannot connect:

1. Use SQL statements to set up the user and password for the BRM database.
2. Enter the correct user name and password for the BRM database in the **\$MAIN_DB{user}** and **\$MAIN_DB{password}** entries in the **pin_setup.values** file.
3. Re-run the **pin_setup** script.

Problem: Out of Memory on Linux

The **pin_setup** script cannot start the DM, and the error log file for the DM refers to “bad shmget”, “bad shmat”, or another error related to memory.

Possible Cause

There is not enough shared memory on the database server.

Solution

Increase the shared memory value in the **/etc/sysctl.conf** file. Perform these steps in a text editor:

1. Log on as root.
2. Open the **/etc/sysctl.conf** file.
3. Add the following lines to the end of the file, or modify the values if these lines are already present:

```
kernel.shmmax = 536870912  
kernel.shmall = 536870912
```
4. Save and close the file.
5. Run **sysctl -p** from the Linux prompt.

12

Installing Multiple BRM Instances on One System for Testing

Learn how to help your developers test their system by installing and setting up multiple Oracle Communications Billing and Revenue Management (BRM) instances.

Topics in this document:

- [Installing and Configuring Multiple Instances of BRM on One Machine](#)
- [Reinitializing the Database](#)
- [Removing BRM Data from the Database](#)

Installing and Configuring Multiple Instances of BRM on One Machine

You can install multiple instances of BRM on one machine to reduce the amount of hardware needed to test the BRM software. To set up multiple instances of BRM on one machine, perform the following steps:

1. [Creating Multiple Users](#)
2. [Installing and Configuring the Oracle Database for Multiple Instances](#)
3. [Installing Multiple Instances of BRM](#)
4. [Configuring Each BRM Instance](#)

Creating Multiple Users

Create a user for each instance of BRM you want to install. For example, to install four instances of BRM, create users **pin1**, **pin2**, **pin3**, and **pin4**.

To create multiple users:

1. Log in as **root**:

```
% su - root
```
2. Create a group. For example, run the following command to create the group **pin**:

```
# groupadd -g 9500 pin
```
3. Create each user. For example, run the following commands to create four users:

```
# useradd -g pin -s /bin/csh -d BRM_home/pin1 pin1  
# useradd -g pin -s /bin/csh -d BRM_home/pin2 pin2  
# useradd -g pin -s /bin/csh -d BRM_home/pin3 pin3  
# useradd -g pin -s /bin/csh -d BRM_home/pin4 pin4
```
4. Create a password for each user.

Installing and Configuring the Oracle Database for Multiple Instances

Before you install BRM, you must install the Oracle database and configure it for multiple instances of BRM. Install and configure the Oracle database according to the instructions in "[BRM Preinstallation Tasks](#)", except create your BRM tablespaces and BRM users as described in this section. You can also create the BRM tablespaces and BRM users during the BRM server installation.

(Optional) Creating Tablespaces for Each User

You can create unique data, index, and temporary tablespaces for each instance of BRM you install. The examples in this document use the following tablespaces:

- **pinN00** (for data)
 - **pinxN00** (for indexes)
 - **PINTEMPN** (for a temporary tablespace)
1. Create a directory for the tablespaces, such as **/u02/oradata/pindb**. This directory is referred to as *table_location*.
 2. Connect to the Oracle database by using SQL*Plus:

```
% sqlplus system@databaseAlias
Enter password: password
```

3. Create a data, index, and temporary tablespace for each BRM user. Repeat the following commands for each BRM instance:

```
SQL> create tablespace pin00 datafile 'table_location/pin00.dbf'
      size 600M reuse autoextend on extent management
      local uniform size 64K segment space management
      auto;
```

Tablespace created.

```
SQL> create tablespace pinx00 datafile 'table_location/pinx00.dbf'
      size 400M reuse autoextend on extent management
      local uniform size 64K segment space management
      auto;
```

Tablespace created.

```
SQL> create temporary tablespace pintemp tempfile
      'table_location/PINTEMP.dbf' size 100M reuse autoextend on;
```

Tablespace created.

(Optional) Creating Multiple BRM Users

Create the BRM users who can access the Oracle database. The examples in this document use **pinN**, but you can use another naming scheme.

1. Connect to the Oracle database by using SQL*Plus:

```
% sqlplus system@databaseAlias
Enter password: password
```

2. Perform the following for each instance of BRM you will install:

```
SQL> create user pinN identified by password;

User created.

SQL> grant resource, connect to pinN;

Grant succeeded.

SQL> alter user pin default tablespace pinN00;

User altered.

SQL> alter tablespace PINTEMP temporary;

Tablespace altered.

SQL> alter user pin temporary tablespace PINTEMP;

User altered.
```

3. Type **exit** to exit SQL*Plus.

Installing Multiple Instances of BRM

Note:

If you already installed the product, you must uninstall its features before reinstalling them.

To install multiple instances of BRM on one machine:

1. Install the PERL libraries and the JRE required to install BRM components.
2. Log in as user **pinN**.

```
% su - pinN
```
3. Go to the directory in which you installed the PERL libraries and JRE, and then source the **source.me** file.

Caution:

You must source the **source.me** file to proceed with installation. Otherwise, "suitable JVM not found" and other error messages appear.

Bash shell:

```
source source.me.sh
```

C shell:

```
source source.me.csh
```

4. Stop all BRM processes. See "Starting and Stopping the BRM System" in *BRM System Administrator's Guide*.
5. Install BRM in each instance. See "Installing BRM".

 **Note:**

You must log in separately for each instance of BRM that you need to install. For example, log in as **pin1** and install the first instance of BRM. Then, log in as **pin2** and install the second instance of BRM, and so on.

6. Go to the directory in which you installed the BRM software, and then source the **source.me** file:

Bash shell:

```
source source.me.sh
```

C shell:

```
source source.me.csh
```

7. To further configure BRM, such as by changing the default currency and country, edit the *BRM_home/setup/pin_setup.values* file.

This file stores the information you provided to the installer and a number of database and add-on component parameters.

Each instance of BRM is installed in the *BRM_home/pinN* directory, where *N* represents the instance number. For example, the installation program copies BRM to the following directories when you install four instances of BRM in the default BRM directory, */opt/portal/15.0.0.0*:

```
/opt/portal/15.0.0.0/pin1
/opt/portal/15.0.0.0/pin2
/opt/portal/15.0.0.0/pin3
/opt/portal/15.0.0.0/pin4
```

Configuring Each BRM Instance

Follow these steps for each instance of BRM you want to install on your machine:

1. Log in as **root** and change the permissions for the *BRM_home/pinN* directory and its contents from **pin** to **pinN**:

```
% su - root
# cd BRM_home
# chown -R pin pinN
```

2. Edit the **pin_setup** file.

- a. Go to the *BRM_home/pinN/setup* directory, change permissions for the **pin_setup** file, and then open the file in a text editor such as **vi**:

```
% cd BRM_home/setup
% chmod 120000 pin_setup
% vi pin_setup
```

- b. Save and close the file.

3. Go to the *BRM_home/setup* directory and run the **pin_setup** script:

```
% cd BRM_home/setup
% ./pin_setup
```

4. Check the **pin_setup.log** file for status and errors.
5. Verify that BRM was installed and set up correctly by creating an account with Billing Care.
6. Repeat steps 1 through 5 for each instance of BRM you installed on your machine.

Reinitializing the Database

You can reinitialize the BRM database, including tables, indexes, and triggers, and return it to its original condition. You might do this, for example, to clean out a test database.

Note:

When you reinitialize a database, you completely remove existing data from the database. When the data is removed, you cannot restore it. Perform this task only if you are certain you will not need to access any data in the database or you have backed up the data and have confirmed that you can restore it.

Reinitializing BRM Server and Optional Component Data

To reinitialize all BRM data, including data in your core BRM tables and optional component tables, do the following:

1. Stop all BRM processes. See "Starting and Stopping the BRM System" in *BRM System Administrator's Guide*.
2. Edit the **pin_setup.values** file.
 - a. Log in as **pin**, go to the *BRM_home/setup* directory, and open the **pin_setup.values** file in a text editor such as **vi**:

```
% su - pin
% cd BRM_home/setup
% vi pin_setup.values
```

- b. Change the **\$SETUP_DROP_ALL_TABLES** and **\$SETUP_INIT_DB** entries to **YES**:

```
$SETUP_DROP_ALL_TABLES = "YES";
$SETUP_INIT_DB = "YES";
```

- c. Save and close the file.

3. Run the **pin_setup** script:

```
% cd BRM_home/setup
% ./pin_setup
```

4. Drop the optional component tables from your database.
5. Using SQL*Plus, log in to your database as the SYSTEM user and run the following command using the information in [Table 12-1](#):

```
SQL> @path/file_name
```

Table 12-1 Optional Component Drop Source File Location and Name

Optional Component	Path	File Name
GPRS Manager	<i>BRM_home/sys/dd/data</i>	drop_tables_gprs_oracle.source
GSM Manager	<i>BRM_home/sys/dd/data</i>	drop_tables_service_order_oracle.source drop_tables_settlement_oracle.source
Invoice DM	<i>BRM_home/sys/dm_invoice/data</i>	drop_tables.source
Number Manager	<i>BRM_home/sys/dd/data</i>	drop_tables_num_oracle.source
Rated Event Loader	<i>BRM_home/sys/dd/data</i>	drop_tables_rel_oracle.source
SIM Manager	<i>BRM_home/sys/dd/data</i>	drop_tables_sim_oracle.source
Vertex Manager	<i>BRM_home/sys/dd/data</i>	drop_tables_telephony_oracle.source
Suspense Manager	<i>BRM_home/sys/dd/data</i>	drop_tables_suspense_oracle.source
Services Framework Manager	<i>BRM_home/sys/dd/data</i>	drop_tables_telco_oracle.source drop_tables_config_accountera_oracle.source
IP Address Manager	<i>BRM_home/sys/dd/data</i>	drop_tables_ip_oracle.source drop_tables_apn_oracle.source

6. Start all BRM processes.

See "Starting and Stopping the BRM System" in *BRM System Administrator's Guide*.

All core BRM tables and optional component tables have been dropped from your system. You can start adding test accounts to your database and continue testing.

Reinitializing Optional Component Data Only

To reinitialize data from your optional component tables, but keep the data in your core BRM tables:

1. Stop the CM and DM processes.
2. Enable writing of the data dictionary objects in your Oracle DM configuration file:
 - a. Open your Oracle DM configuration file (*BRM_home/sys/dm_oracle/pin.conf*).
 - b. Make sure the following entries are set to **1**:

```

- dm dd_write_enable_objects 1
- dm dd_write_enable_fields 1
- dm dd_write_enable_BRM_objects 1

```
 - c. Save and close the file.
3. Stop and restart the CM and Oracle DM processes.
4. Delete the BRM data dictionary objects for each optional component.

You can find the data dictionary objects for each component in the files listed in [Table 12-2](#).

Table 12-2 Optional Component Data Dictionary Drop Source File Location and Name

Optional Component	Path and File Name
GPRS Manager	<i>BRM_home/sys/dd/data/dd_objects_gprs.source</i>

Table 12-2 (Cont.) Optional Component Data Dictionary Drop Source File Location and Name

Optional Component	Path and File Name
GSM Manager	<i>BRM_home/sys/dd/data/dd_objects_service_order.source</i> <i>BRM_home/sys/dd/data/dd_objects_telco_gsm.source</i> <i>BRM_home/sys/dd/data/dd_objects_settlement.source</i> <i>BRM_home/sys/dd/data/dd_objects_telco.source</i> <i>BRM_home/sys/dd/data/dd_objects_config_accountera.source</i>
Invoice DM	<i>BRM_home/sys/dm_invoice/data/dd_objects.source</i>
Number Manager	<i>BRM_home/sys/dd/data/dd_objects_num.source</i>
Rated Event Loader	<i>BRM_home/sys/dd/data/dd_objects_rel.source</i>
SIM Manager	<i>BRM_home/sys/dd/data/dd_objects_sim.source</i>
Vertex Manager	<i>BRM_home/sys/dd/data/dd_objects_telephony.source</i>
Suspense Manager	<i>BRM_home/sys/dd/data/dd_objects_suspense.source</i>
IP Address Manager	<i>BRM_home/sys/dd/data/dd_objects_ip.source</i> <i>BRM_home/sys/dd/data/dd_objects_apn.source</i>

- a. Create an flist that contains the POID of the objects you want to delete.
See "Understanding flists and Storable Classes" in *BRM Developer's Guide*.
 - b. Run the PCM_OP_SDK_DEL_OBJ_SPECS opcode with the input flist you created.
For more information, see "Deleting Storable Class Specifications" in *BRM Developer's Guide*.
5. Stop the CM and Oracle DM processes.
See "Starting and Stopping the BRM System" in *BRM System Administrator's Guide*.
 6. Drop the optional component tables from your database.
 7. Using SQL*Plus, log in to your database as the SYSTEM user and run the following command using the values in [Table 12-3](#):

```
SQL> @path/file_name
```

Table 12-3 Optional Component Drop Source File Location and Name

Optional Component	Path	File Name
GPRS Manager	<i>BRM_home/sys/dd/data</i>	<i>drop_tables_gprs_oracle.source</i>
GSM Manager	<i>BRM_home/sys/dd/data</i>	<i>drop_tables_service_order_oracle.source</i> <i>drop_tables_settlement_oracle.source</i>
Invoice DM	<i>BRM_home/sys/dm_invoice/data</i>	<i>drop_tables.source</i>
Number Manager	<i>BRM_home/sys/dd/data</i>	<i>drop_tables_num_oracle.source</i>
Rated Event Loader	<i>BRM_home/sys/dd/data</i>	<i>drop_tables_rel_oracle.source</i>
SIM Manager	<i>BRM_home/sys/dd/data</i>	<i>drop_tables_sim_oracle.source</i>
Vertex Manager	<i>BRM_home/sys/dd/data</i>	<i>drop_tables_telephony_oracle.source</i>
Suspense Manager	<i>BRM_home/sys/dd/data</i>	<i>drop_tables_suspense_oracle.source</i>
Services Framework Manager	<i>BRM_home/sys/dd/data</i>	<i>drop_tables_telco_oracle.source</i> <i>drop_tables_config_accountera_oracle.sourc e</i>

Table 12-3 (Cont.) Optional Component Drop Source File Location and Name

Optional Component	Path	File Name
IP Address Manager	<i>BRM_home/sys/dd/data</i>	drop_tables_ip_oracle.source drop_tables_apn_oracle.source

8. Restore the entries in your Oracle DM configuration file to their original value.
 - a. Open your Oracle DM configuration file (*BRM_home/sys/dm_oracle/pin.conf*).
 - b. Return the following entries to their original value:
 - dm dd_write_enable_objects 0
 - dm dd_write_enable_fields 0
 - dm dd_write_enable_BRM_objects 0
 - c. Save and close the file.
9. Stop and restart the CM and Oracle DM processes.

All optional component tables have been dropped from your system. You can start adding test accounts to your database and continue testing.

Removing BRM Data from the Database

To completely remove BRM data, including tables, indexes, and triggers, from the Oracle database:



Note:

After you remove the data, you cannot restore it. Perform this task only if you are certain you will not need to access any data in the database or if you have backed up the data and have confirmed that you can restore it.

1. Use SQL to connect to the database as the **system** user:

```
% sqlplus system@databaseAlias
Enter password: password
```
2. Stop all BRM processes.

See "Starting and Stopping the BRM System" in *BRM System Administrator's Guide*.
3. Enter the following command, replacing *pin_user* with the user you created for BRM, such as **pin**:

```
SQL> DROP USER pin_user CASCADE;
```
4. Log in to the database server as *pin_user*.

If you receive an error indicating an invalid user name, the operation was successful.

13

Uninstalling BRM

Learn how to uninstall the Oracle Communications Billing and Revenue Management (BRM) software, its server components, and its client applications from your computer.

For details on how to uninstall or reinstall the Oracle database, see the database vendor's documentation for your platform.

Topics in this document:

- [Uninstalling the BRM Software](#)
- [Uninstalling BRM in Silent Mode](#)

Uninstalling the BRM Software

You can use Oracle Universal Installer to uninstall the BRM software.

Uninstalling the BRM software requires three tasks:

1. [Uninstalling Optional Components](#)
2. [Uninstalling BRM](#)
3. [Uninstalling BRM Client Applications](#)

For uninstalling BRM server or client applications in silent mode, see "[Uninstalling BRM in Silent Mode](#)".



Note:

Uninstalling BRM does not uninstall the configuration files generated during the BRM installation. You must remove these files manually.

Uninstalling Optional Components

To uninstall optional components:



Note:

- Optional components must be uninstalled before uninstalling BRM.
- If you are uninstalling Oracle Analytics Publisher reports, you must uninstall all of the Oracle Analytics Publisher reports installed. You cannot uninstall individual reports in the BRM-Oracle Analytics Publisher invoicing integration package.

1. Back up the BRM database.

See "[Maintaining a BRM Database](#)".

2. Stop all BRM daemons, processes, and managers.

See "Starting and Stopping the BRM System" in *BRM System Administrator's Guide*.

3. Log in as user **pin**.
4. Go to the *BRM_home/oui/bin* directory, where *BRM_home* is the directory in which you installed BRM.
5. Run the following command from a GUI (for example, VNC Server):

```
./deinstall.sh
```

If multiple products are installed in the same location, you can run the following command:

```
./deinstall.sh -paramFile../inventory/inis/  
distribution_name_distribution_version.ini
```

where:

- *distribution_name* is the name of the distribution for the optional components installed.
- *distribution_version* is the version number of the distribution for the optional components installed.

The Distribution to Uninstall window appears.

6. Select the components you want to uninstall.

 **Note:**

You must uninstall the dependent components before uninstalling the required components. For example, you can uninstall EAI Manager only after you uninstall the dependent optional components, such as Account Synchronization Manager.

7. Click **Uninstall**.

The Welcome window appears.

8. Click **Next**.

The Uninstallation Summary window appears.

9. Click **Uninstall**.

The Uninstallation Progress window appears.

10. Click **Next**.

The Uninstallation Complete window appears.

11. Click **Finish**.

Uninstalling BRM

To uninstall BRM:

1. Back up the BRM database.

See "[Maintaining a BRM Database](#)".

2. Stop all BRM daemons, processes, and managers. See "Starting and Stopping the BRM System" in *BRM System Administrator's Guide*.

3. Log in as user **pin**.
4. Go to the *BRM_home/oui/bin* directory, where *BRM_home* is the directory in which you installed BRM.
5. Run the following command:

```
./deinstall.sh
```

The Distribution to Uninstall window appears.

6. Select the components you want to uninstall.

 **Note:**

Dependent components must be uninstalled before uninstalling the required components. For example, you can uninstall EAI Manager only after you uninstall the dependent optional components, such as Account Synchronization Manager.

7. Click **Uninstall**.
The Welcome window appears.
8. Click **Next**.
The Uninstallation Summary window appears.
9. Click **Uninstall**.
The Uninstallation Progress window appears.
10. Click **Next**.
The Uninstallation Complete window appears.
11. Click **Finish**.

Uninstalling BRM Client Applications

This section describes how to uninstall BRM client applications on Linux and Windows.

Uninstalling BRM Client Applications on Linux

To uninstall BRM client applications on Linux:

1. Back up the BRM database.
See "[Maintaining a BRM Database](#)".
2. Go to the *BRM_client_home/oui/bin* directory, where *BRM_client_home* is the directory in which the BRM client applications are installed.

3. Run the following command:

```
./deinstall.sh
```

The Distribution to Uninstall window appears.

4. Select the client applications you want to uninstall.
5. Click **Next**.
The Welcome window appears.

6. Click **Next**.
The Uninstallation Summary window appears.
7. Click **Uninstall**.
The Uninstallation Progress window appears.
8. Click **Next**.
The Uninstallation Complete window appears.
9. Click **Finish**.

Uninstalling BRM Client Applications on Windows

To uninstall BRM client applications on Windows:

1. Ensure that 64-bit JDK is installed on your Windows system. It is required by the BRM OUI uninstaller.

For the latest support version of JDK, see "Additional BRM Software Requirements" in *BRM Compatibility Matrix*.
2. Back up the BRM database.
See "[Maintaining a BRM Database](#)".
3. Do one of the following to start the uninstaller:
 - (Windows 8.1 and Windows 10) Use the Windows uninstall feature.
 - (Other Windows versions) Do one of the following:
 - Run the **deinstall.cmd** script from the *BRM_client_home\oui\bin* directory.
 - Use the Windows uninstall feature.
The Distribution to Uninstall window appears.
4. Select the client applications you want to uninstall.
5. Click **Uninstall**.
The Welcome window appears.
6. Click **Next**.
The Uninstallation Summary window appears.
7. Click **Uninstall**.
The Uninstallation Progress window appears.
8. Click **Next**.
The Uninstallation Complete window appears.
9. Click **Finish**.

Uninstalling BRM in Silent Mode



Note:

You can uninstall individual BRM components only using GUI mode.

To uninstall BRM (server or client applications) in silent mode:

1. Go to the `BRM_home/oui/bin` directory.
2. Run the following command:

```
./deinstall.sh -responseFile path -silent -uninstall
```

where *path* is the absolute path to the response file that you created in the root directory during the GUI installation of BRM or the BRM client applications.

Part III

Upgrading BRM

This part contains a general overview about upgrading your Oracle Communications Billing and Revenue Management (BRM) software.

This part contains the following chapters:

- [About Upgrading from BRM 12.0 to BRM 15.0](#)
- [Upgrading BRM and Pipeline Manager from BRM 12.0 to BRM 15.0](#)
- [Upgrading BRM 15.0 to a Later Release of BRM 15.0](#)

About Upgrading from BRM 12.0 to BRM 15.0

Learn general information on how to upgrade your existing system to the latest Oracle Communications Billing and Revenue Management (BRM) release.

Topics in this document:

- [About Upgrading BRM to a New Release](#)
- [Planning Your Upgrade](#)
- [Updating Your System Environment](#)
- [Creating Test Environments](#)
- [Transferring Customizations to the New Release](#)
- [Testing Your Upgraded System](#)
- [Preparing for the Production System Upgrade](#)
- [Upgrading Your Production System](#)

In this document, the BRM release running on your production system is called the *old* release. The release you are upgrading to is called the *new* release. For example, if you are upgrading from BRM 12.0 to BRM 15.0, BRM 12.0 is the old release and BRM 15.0 is the new release.

Note:

- A direct upgrade from the BRM 7.5 release is not supported. If you are upgrading from BRM 7.5, you must upgrade your system to BRM 12.0 first. See *Compatibility Matrix* for BRM 12.0 for information about supported BRM 7.5-to-BRM 12.0 upgrades.
- For information about the BRM 12.0 releases from which you can directly upgrade to BRM 15.0, see "Supported BRM Upgrades" in *BRM Compatibility Matrix*. For releases where you cannot directly upgrade to the desired 15.0 release from your BRM 12.0 release, upgrade to a later 12.0 patch set and then upgrade from that patch set to BRM 15.0.

About Upgrading BRM to a New Release

Upgrading to a new release is a four-part process:

1. Plan the upgrade process.
2. Implement and test the upgrade on a test system.
3. Prepare to upgrade your production system.
4. Implement and test the upgrade on the production system.

The upgrade process includes these tasks:

- **Install BRM 15.0** (without installing the database schema).

- **Update the BRM database.** The new BRM release includes an updated database schema with new tables and indexes. You use upgrade scripts to update your BRM database to the new schema.
- **Reimplement customizations.**
 - Source code for policy opcodes can change in a new release. You must merge your old release customizations into the new policy source code and recompile the policy Foams.
 - To support new functionality, the new software includes new configuration files. You must update those files to include the customizations made to your old system.
 - Other customizations in your system; such as customized invoicing, reports, general ledger reporting, and client applications; might need to be updated to work with the new BRM software.
- **Implement new features.** You can implement new BRM functionality to improve your BRM system. See *BRM Release Notes*.

The basic steps for upgrading are:

1. Back up files.
2. Turn off service authentication and authorization.
3. Shut down the old release.
4. Back up your the old release's database.
5. Install BRM 15.0 (without installing the database schema).
6. Upgrade the BRM database schema.
7. Install BRM 15.0 client applications and optional components.
8. Add customizations.
9. Restore service authentication.

 **Note:**

There are additional steps if you use a multischema system, and optional steps for loading data.

Considerations for Upgrading to BRM 15.0

There are some changes specific to BRM 15.0 that might have some impact on your upgrade:

- 64-bit support:
 - All of the BRM libraries are built in a 64-bit environment. Because of this, the 64 suffix is removed from all of the libraries.
 - A new field, PIN_FLDT_INT64 has been added. This enables the storage of large numbers.
 - Consult *BRM Compatibility Matrix* to ensure that you are using the supported version s of compilers and libraries.
 - See "[Migrating Custom Code to a 64-bit Environment](#)" for information about the upgrade impacts from this change.

- CM Authorization:
 - BRM 15.0 provides fine-grained authorization for pcm_client and thick client applications. This is implemented using the new storable class **/config/role** and the following new opcodes:
 - * PCM_OP_CUST_CREATE_ROLE
 - * PCM_OP_CUST_ASSOCIATE_ROLE
 - * PCM_OP_CUST_UPDATE_ROLE
 - * PCM_OP_CUST_DELETE_ROLE
 - You can configure whether to use this new authorization method by setting the new system business parameter, **CMAuthorization**. This parameter is enabled by default.
 - For more information about the default roles and the implementation of this feature, see *System Administrator's Guide*. For more information about the new opcodes, see *Opcode Guide*.
- Merging **dm_ifw_sync** and **dm_aq** with **dm_oracle**:
 - The **dm_ifw_sync** and **dm_aq** queues were previously used for Advanced Queuing in BRM. However, the Account Sync Manager (dm_ifw_sync) and the Queue Manager (dm_aq) components have been deprecated in BRM 15.0. Their functionality has been moved to **dm_oracle**, which has been enhanced to enqueue these messages going forward.
 - See "[Updating Queue Handling](#)" for information about the upgrade impacts from this change.

Planning Your Upgrade

To plan your upgrade, you can perform the following tasks:

1. [Identifying Your Upgrade Team](#)
2. [Identifying Who Is Affected by the Upgrade](#)
3. [Collecting Information about Your System](#)
4. [Determining the Impact of New Features](#)
5. [Estimating How Long the Upgrade Will Take](#)

Identifying Your Upgrade Team

Your upgrade team should include the following team members:

- A database administrator to manage the database upgrade and tune the database.
- A system administrator to manage the hardware and system architecture.
- A business analyst to make business decisions about changes to your BRM implementation.
- A customer service representative (CSR) supervisor to assess the impact on CSRs.

Identifying Who Is Affected by the Upgrade

You should identify who might be affected by the upgrade. For example:

- You might need to give your customers advance notice of any system downtime.

- Tell your system administrators in advance about any changes to the system architecture.
- Notify Oracle so that we can help you anticipate and avoid problems. Technical support might have additional information about upgrading BRM or information specific to your implementation.

Collecting Information about Your System

When you upgrade, you must know all the customizations you implemented in the old release. To prepare for the upgrade, find or create the following documents:

- **Implementation design documents.** When you first implemented BRM, you should have created documents that explained your business requirements and the customizations you made to meet those requirements. These documents help you create a list of customized components. You can also compare these documents with the documentation on new BRM features to find out whether any of your customizations can now be implemented by using standard BRM functionality.
- **List of customized components.** This should list every file created or modified for the original implementation. You need this list to know which files must be checked against the new release for changes.

Customizations might include the following:

- Additional Data Managers (DMs)
- Custom Facility Modules (FMs)
- Custom client applications
- Custom DLLs
- Custom reports
- Merging container **DESC.dsc** files
- Modified storable classes
- Additional storable classes
- Custom table indexes
- Modified configuration, properties, and **INI** files
- Custom Web pages
- A gateway service that provides access to a legacy system

Determining the Impact of New Features

You might need to make changes to your current system to accommodate new functionality in the new release. For example, if the new release changes how balance impact rounding works, you might need to modify your pricing components to support the new rounding method.

The following features are typically affected by new releases:

- Product offerings (rating)
- Billing and invoicing
- General ledger (G/L IDs)
- Web pages
- BRM reports

- Client applications used by CSRs
- Components that integrate credit card processors and tax software
- Discount balancing

In addition, new features might include default functionality that you implemented as a customization. In that case, it is best to replace your customizations with the new feature.

Estimating How Long the Upgrade Will Take

When estimating the time it will take to upgrade, consider the following:

- [How Long Will It Take to Run the Database Upgrade Scripts?](#)
- [How Long Will It Take to Plan, Prepare for, Test, and Perform the Upgrade?](#)

How Long Will It Take to Run the Database Upgrade Scripts?

This is an important consideration because services might be suspended and authentication and authorization might be unavailable while you upgrade the database.

The best way to determine how long the database upgrade will take is to run the upgrade scripts on a test system that duplicates the data in your production system (see "[Creating Test Environments](#)").

In general, it takes longer to upgrade large databases with large tables. A large database can take from 8 to 48 hours to upgrade.

Reducing BRM System Downtime by Purging or Archiving Old Data

The upgrade scripts convert your old release data to the new release format. The time required to complete an upgrade is directly proportional to the size of your database. To save time, purge or archive data that is no longer required before you shut down your production system to perform the upgrade.

Because event tables consume most of the space in a database, you can significantly reduce the size of the database by purging unneeded event objects. If you cannot purge event objects, archive those that are no longer needed.

How Long Will It Take to Plan, Prepare for, Test, and Perform the Upgrade?

Depending on the size and complexity of your BRM implementation, the entire upgrade process can take several months. If your system architecture and customization documentation is complete and up-to-date, the time is significantly shorter.

For help with your upgrade, contact Oracle Support.

Updating Your System Environment

Before upgrading, prepare your system environment:

- Install the latest releases.

Install the latest BRM-supported release of your operating system and database software. Include the latest patches. If you are not running the latest supported release of the database, you might need to upgrade your database software before upgrading BRM. For more information, see the following:

- See "[System Requirements](#)" for a list of hardware and software supported by BRM.
- See "[Planning Your Database Configuration](#)" for general database information.
- Check disk space and memory.

Ensure that your test environments and production system include the disk space and memory required for the new BRM release. The requirements might differ from the requirements for the old release. For more information, see the following:

- See "[System Requirements](#)" for disk space requirements.
- See "Improving BRM Performance" in *BRM System Administrator's Guide* for information on memory configuration.
- Tune your system.

Upgrading is faster and easier if you *first* tune your system for optimal performance. For assistance with estimating the hardware and storage requirements for your BRM system, contact Oracle Support for more information.

Creating Test Environments

To test your upgrade, create the environments described in this section. You use these environments to do the following:

- Compare the default behavior of the old and new releases.
- Determine what customizations you made in the old release.
- Test the upgrade process and its results.

Tip:

- You can install multiple BRM instances on a single Linux machine. See "[Installing and Configuring Multiple Instances of BRM on One Machine](#)" for more information.
- If you install BRM on multiple systems, you can save time by compressing and moving folders and files instead of running the BRM installer on each system. When you copy the files to other systems, you might need to change some configuration file values, such as port numbers, manually if you do not use the automated installer.

Old Baseline Release

Your *old baseline release* system should run the old BRM release with the latest patches but without any customizations. Use this system to do the following:

- Determine what default behavior in the old release has changed in the new release by comparing the old baseline release with the "[New Baseline Release](#)".
- Determine what customizations you made in the old release by comparing the old baseline release with your existing system, which this document calls the "[Old Customized Release](#)".

Old Customized Release

Your *old customized release* system should run the old BRM release with your customizations. This system should be identical to your current production system. To ensure that your test upgrade ("[New Customized Release \(Test System\)](#)") is working properly, compare the behavior of the new customized release with the old customized release.

New Baseline Release

Your *new baseline release* system should run the new BRM release without any customizations. Use this system to find out how the latest BRM release works.

New Customized Release (Test System)

Your *new customized release* (or test) system should run the new BRM release with your customizations and an upgraded BRM database. Use this system to test the following aspects of the upgrade:

- **The upgrade process.** The procedures used to create this system should be as close as possible to the procedures used to upgrade your production system. This ensures that you test such tasks as turning authentication on and off and copying over configuration files.

For information on the standard procedure for upgrading a production system, see "[Upgrading Your Production System](#)".



Tip:

To create this system, perform a test upgrade on your "[Old Customized Release](#)".

- **The upgrade results.** To test the outcome of your upgrade process, run all tests on this system. See "[Testing Your Upgraded System](#)".



Tip:

This system's database should include the same data as your "[Old Customized Release](#)" database. That way, you can run tests on the same data and compare the results

Transferring Customizations to the New Release

This section explains how to transfer customizations from the old release to the new release:

- [Upgrading Customized Policy Source Files](#)
- [Updating Configuration Files](#)
- [Updating Database Customizations](#)
- [Updating Custom Reports](#)
- [Updating Custom Applications](#)

 **Tip:**

When you upgrade to a new BRM release, you first install the default BRM server configuration, and you then install your customized files. To ensure that you add all your customized files to the new release, create a package that includes all your customized files.

Upgrading Customized Policy Source Files

New releases often include changes to policy opcodes. If you customized your policy opcodes, you might need to re-create your customizations after you install the new BRM release:

1. See your internal documentation to find out what customizations were made to policy source files. If the customizations were not documented, use a diff tool to compare the source code in the "Old Baseline Release" with the source code in your "Old Customized Release". Source code is stored in the `BRM_home/source` folder.
2. When you know what your customizations are, use a diff tool to compare your customized source code with the source code in the "New Baseline Release".
3. Determine whether new features implement any of your customizations or make them irrelevant.
4. Merge the policy source file customizations that you still need into the new release source code. As you do so, find any changes to input and output flists. It is common for fields to change or to change from required to optional (or vice versa).
5. Using the libraries in the new release, recompile your custom code in the new release.
6. Test the new source code by using the functionality that it customizes.

Updating Configuration Files

When you install a new BRM release, you install new configuration files, such as the Connection Manager (CM) `pin.conf` file. You must update these files to include the customizations you made to them in your old system. For more information, see "Using Configuration Files" in *BRM System Administrator's Guide*.

Updating Database Customizations

If you added custom storable classes to your old release, corresponding custom tables were added to your BRM database, and corresponding custom definitions were added to your BRM data dictionary. These customizations are *not* modified by the database upgrade scripts.

Modifying the Content of Custom Tables

Depending on how the new release differs from the old release, you *might* need to modify the old data in your custom tables to accommodate the new release. For example, a custom table might store phone numbers in the following format: 408-555-1212. Opcodes in the new release, however, might need a different format, such as 1-408-555-1212.

 **Note:**

To upgrade the old data to the new format, you should create custom SQL scripts and incorporate them into the upgrade configuration file, **upgrade.cfg**, *before running the database upgrade scripts*.

Modifying the Structure of Custom Tables

Depending on the changes introduced by the new release, you *might* need to modify the structure of your custom database tables. For example, you might need to add, delete, or change the size of a column. To make such changes, use either Developer Center or the **pin_deploy** utility after running the database upgrade scripts. Those tools will automatically update your new database schema and data dictionary.

 **Note:**

To identify undocumented database customizations in your old release, compare the database schema in the "[Old Baseline Release](#)" with the database schema in your "[Old Customized Release](#)".

Fixing Standard Database Objects with Nonstandard Object IDs

When you run the database upgrade scripts, the scripts overwrite standard database objects. If you deleted standard objects and re-created them with nonstandard object IDs when customizing BRM, the upgrade scripts delete those objects.

To drop a standard object from the upgraded database and re-create the object with a nonstandard ID, use the **testnap create 1 poid** command. This command enables you to use the POID in the input file to re-create the object instead of using a value from the POID sequence.

Updating Custom Reports

Since BRM reports read data stored in objects, changes to the database schema often require changes to reports. Sometimes it is easier to design new reports to work with the new database schema than to update old reports, especially when there are large-scale schema changes.

For more information, see "About BRM Reports" in *BRM Reports*.

Updating Custom Applications

Use your "[New Customized Release \(Test System\)](#)" to test all custom applications that call opcodes or manipulate data in the database. Changes to storable classes and opcodes in the new release might make such applications function differently.



Note:

You must recompile your custom applications with the new BRM libraries.

Testing Your Upgraded System

To test your "[New Customized Release \(Test System\)](#)", perform the tests listed in "[Testing Checklist](#)". When testing, cover all aspects of the system, including CSR activity, customer logins and service usage, and billing.



Note:

Create an upgrade process document that includes a checklist of the upgrade tasks. Part of your test is to ensure that the checklist is complete because you will use it when upgrading your production system.

When you have completed all your tests without finding any errors, run all the tests again, *twice*. You should run through the tests twice without error before considering the test cycle complete.

If you find any problems that indicate a BRM problem, submit it to Oracle.



Note:

Document all customizations you make during the upgrade. You will need to know about them the next time you upgrade.

Running Old and New Versions in Parallel

A good way to test your upgraded BRM implementation is to run the old release and the new release in parallel. To do so, run the old system as your production system, and import all your data into the new system. You can then run billing and perform other tasks on both systems and compare the results.

Testing the BRM Database

When you install a new BRM release, you run upgrade scripts to update the database schema. The scripts update the database tables and fields, including the BRM database definition. The scripts modify only default BRM objects and do not affect custom objects.

You should load actual production data into the test environment to run the database upgrade scripts with your real information. If you do not have enough hardware to load the entire database, include at least some account information.

When running the upgrade scripts on your test system, look for the following:

- Data errors in your current database

- Custom tables and fields that are not being used

Troubleshooting Your Upgraded System

For information about BRM error messages and other problems that you encounter in your upgraded system, see the following documents:

- "Reference Guide to BRM Error Codes" in *BRM System Administrator's Guide*
- "Resolving Problems in Your BRM System" in *BRM System Administrator's Guide*

Upgrading BRM can expose implementation problems. While running tests, some problems you find might be caused in part by the following:

- **Missing data.** If your initial BRM implementation included the conversion and migration of legacy data, the conversion might not have created all necessary objects or fully populated all fields. In addition, data is sometimes mistakenly deleted. The missing data might not affect the existing BRM implementation, but later versions of BRM might need it.
- **Undocumented customizations.** If you find what appears to be an undocumented customization, compare the "[Old Baseline Release](#)" with your "[Old Customized Release](#)". If you find an undocumented customization, be sure to document it.
- **New functionality.** BRM functionality changes between releases. These changes might enable or require you to get rid of or change some of your customizations.

Testing Checklist

You should have a list of tests that were performed during your initial BRM implementation. In addition to running all those tests, you might run new tests to cover new functionality.

 **Note:**

Before running tests in a *production* environment, ensure that all entries for the **pin_virtual_time** utility were removed from configuration files. If you are running in a *test* environment, it is not necessary to remove entries for the **pin_virtual_time** utility.

These are the basic tests you should perform on your test system:

- Create accounts using the client applications.
- Generate and rate usage events.
- Run billing, including requesting and receiving payments. Check all log files and invoices after running billing.
- Run the **/pin_ledger_report** utility on your "[Old Customized Release](#)" and your test system, and compare the results. If the database on both systems includes the same data, the results should be the same.
- Run all the client applications that your implementation uses.
- Test your product offerings by committing them to the database and purchasing every package and bundle.
- Test all your optional components, such as LDAP Manager and GSM Manager.
- Test credit card processing, including a live connection to the credit card processor.
- Test tax calculation.

- Test all functionality that involves multiple currencies.
- Run all BRM reports that you use. If possible, run the reports against the same data in your "Old Customized Release" and your test system.
- Review all log files for warnings and errors.
- Test all interfaces to external systems.
- Develop and test a fallback plan in case you run into problems during the production system upgrade. For example, after you shut down your production system, you should create a full backup of the system in case you need to restore it.

Preparing for the Production System Upgrade

Before you upgrade your production system, do the following:

- Make a backup of the data in your production system.

Caution:

Do not begin your upgrade until you have backed up your production system.

- Ensure that all files required for customizing the system are available and ready to be copied to the upgraded system. This might include configuration files and Facility Modules (FMs). Test the procedure for copying these files to the upgraded system.
- Be prepared to run a full integration test on your production system after the upgrade scripts have run. Prepare any test scripts and test them before shutting down BRM.
- Inform anyone who needs to know about the upgrade. See "[Identifying Who Is Affected by the Upgrade](#)".
- Create a checklist for the upgrade procedure. (You should have created one while testing the upgrade. See "[Testing Checklist](#)".)
- Prepare a production staging system. This system includes the "[New Baseline Release](#)" with your customized files. You build this system after testing is complete. It serves as a clean system from which to copy files to your production system. To avoid resource contention, run this system on its own dedicated hardware to simulate production performance more accurately. If you have limited resources, you can use your "[New Customized Release \(Test System\)](#)" system as the production staging system.

Upgrading Your Production System

The procedures used to upgrade your production system should be almost identical to the procedures used to create your "[New Customized Release \(Test System\)](#)".

15

Upgrading BRM and Pipeline Manager from BRM 12.0 to BRM 15.0

Learn about the procedures required to upgrade Oracle Communications Billing and Revenue Management (BRM).

Topics in this document:

- [About the Upgrade](#)
- [Tasks Involved in the Upgrade Process](#)
- [Preparing for the Upgrade](#)
- [Creating a Complete Backup of Your BRM 12.0 Data](#)
- [Creating Your BRM 15.0 Database](#)
- [Upgrading to BRM 15.0](#)
- [Upgrading Your Data to BRM 15.0](#)
- [Completing the Upgrade](#)
- [Post-Upgrade Procedures](#)

Note:

- A direct upgrade from the BRM 7.5 release is not supported. If you are upgrading from BRM 7.5, you must upgrade your system to BRM 12.0 first.
- For information about the BRM 12.0 releases from which you can directly upgrade to BRM 15.0, see "Supported BRM Upgrades" in *BRM Compatibility Matrix*.

Before performing this upgrade, see "[About Upgrading from BRM 12.0 to BRM 15.0](#)" for information on how to plan, prepare for, and test your upgrade.

About the Upgrade

To upgrade from BRM 12.0 to BRM 15.0, upgrade the following components:

- BRM
- BRM software Development Kit (BRM SDK)
- Pipeline Manager
- Pipeline Portal Development Kit (Pipeline PDK)

Tasks Involved in the Upgrade Process

This section provides a list of tasks required to upgrade from BRM 12.0 to BRM 15.0. Some tasks are optional or apply only to certain system configurations. Be sure to check whether a task is required for your system.

Caution:

When upgrading a *multischema* system, pay close attention to the system on which each task is performed.

Complete these tasks to upgrade your BRM system:

1. Shut down the current instance of BRM. See "[Shutting Down the Current Instance](#)".
2. Turn off service authentication and authorization. See "[Turning Off BRM Service Authentication and Authorization](#)".
3. Create a complete backup of your BRM 12.0 data. See "[Creating a Complete Backup of Your BRM 12.0 Data](#)".
4. Create a new schema in BRM 15.0. See "[Creating Your BRM 15.0 Database](#)".
5. Import your data BRM 12.0 data. See "[Importing Your BRM 12.0 Data](#)".
6. Install Java. See "[Installing Java](#)".
7. Install Perl. See "[Installing Perl](#)".
8. Obtain the **ojdbc8.jar** jar file. See "[Downloading the ojdbc8.jar File](#)".
9. Set the environment variables. See "[Setting the Environment Variables for Upgrade](#)".
10. Set the BRM wallet location in **sqlnet.ora**. See "[Setting BRM Wallet Location in sqlnet.ora](#)".
11. Obtain the BRM software. See "[Downloading the BRM Software](#)".
12. Install the upgrade package. See "[Installing BRM and Pipeline Manager for Upgrade](#)".
13. Point your BRM 15.0 installation to the new database schema. See "[Pointing the BRM 15.0 Installation to the Database Schema](#)".
14. Upgrade the BRM database schema to the BRM 15.0 schema. See "[Upgrading the BRM Database Schema to the BRM 15.0 Schema](#)".
15. Upgrade the Pipeline Manager database schema to the BRM 15.0 schema. See "[Upgrading the Pipeline Manager Database Schema to the BRM 15.0 Schema](#)".
16. Install BRM 15.0 client applications. See "[Installing the BRM 15.0 Client Applications](#)".
17. Add optional components. See "[Adding Optional Components](#)".
18. Check other database configurations. See "[Updating Configurations](#)".
19. Upgrade Account Migration Manager for multischema systems. See "[Upgrading AMM in a Multischema System](#)".
20. Restore customizations in BRM 15.0. See "[Restoring Customizations](#)".

Preparing for the Upgrade

This section describes the steps you must complete before starting the upgrade.

Shutting Down the Current Instance



Note:

On multischema systems, first perform this task on the primary system, and then on the secondary systems.

To shut down BRM 12.0:

1. Ensure that no users are logged in.
Users include customers, client applications, customer service representatives (CSRs), and so on.
2. Stop all BRM 12.0 processes. For more information, see "Starting and Stopping the BRM System" in *BRM System Administrator's Guide*.

Only the database instances should be running during the installation.

Turning Off BRM Service Authentication and Authorization



Note:

On multischema systems, first perform this task on the primary system, and then on the secondary systems.

To maintain a controlled environment for pre-upgrade testing, cut off interaction between your BRM system and your customers.

Creating a Complete Backup of Your BRM 12.0 Data

Creating a complete backup of the data in your BRM 12.0 environment requires the following actions to be performed in your BRM 12.0 environment:

1. [Backing Up BRM Files](#)
2. [Backing Up Your BRM and Pipeline Manager 12.0 Databases](#)

Backing Up BRM Files

Back up your BRM 12.0 files.

 **Note:**

If you are performing the upgrade on systems with distributed or HA architecture, back up the files on every node.

In particular, ensure that you back up the following files:

- All files customized for BRM 12.0 including any associated source code
- Registry files
- Policy files
- **pin.conf**
- **pin_setup.values**
- **Infranet.properties**
- All other files that contain any customizations used in BRM 12.0

 **Note:**

Back up all customized load utility files to a different location. The data in these files is used to transfer and restore your customizations after upgrading to BRM 15.0.

For more information, see "[Transferring Customizations to the New Release](#)".

Backing Up Your BRM and Pipeline Manager 12.0 Databases

 **Note:**

- On multischema systems, perform this task first on the primary database schema and then on the secondary database schemas.
- Additionally, record the system time of each backup file so that you can match that time entry to import the backup data into the appropriate system in BRM 15.0.

Make a complete offline backup of your BRM database and, if you are using Pipeline Manager, also the Pipeline Manager database. Make the backup using the appropriate backup tools for your database version and ensure that the backup is completely valid and usable. The backup must contain both the database definition and all the database contents. See your database software documentation for more information on performing full database backups.

In addition to the backup, use the Oracle export **exp** or **expdb** utility to export all BRM 12.0 tables. This helps to restore individual tables, if necessary. For more information about the **exp** and **expdb** utilities, see the discussion on export and import utilities in the appropriate version of the *Oracle Database Utilities* document.



Note:

Store this backup in a safe location. The data in these files will become necessary if you encounter any issues in the upgrade process.

Creating Your BRM 15.0 Database



Note:

On multischema systems, perform this task first on the primary database schema and then on the secondary database schemas.

Create a blank BRM database into which you will import the backup you created.

Upgrading to BRM 15.0

This section describes the steps necessary to upgrade to BRM 15.0.

Importing Your BRM 12.0 Data



Note:

On multischema systems, perform this task first on the primary database schema and then on the secondary database schemas.

After you have successfully created a new schema, create a BRM database user (which is the same as the database user in BRM 12.0), and then import the backup data you created in "[Backing Up Your BRM and Pipeline Manager 12.0 Databases](#)". When you import the backup data, check the system time of each backup file to ensure that the data is imported into the appropriate system in BRM 15.0.

Use the **imp** or **impdb** utility to import the backup data. For more information about the **imp** and **impdb** utilities, see the discussion on export and import utilities in the appropriate version of the *Oracle Database Utilities* document.

After you complete the import process, make sure that there are no invalid objects in the database schema. If there are any invalid objects, try to compile them.

Setting the Environment Variables for Upgrade

Before installing the upgrade, ensure that the environment variables are set correctly. For information about the latest compatible versions of Java, Perl, and Kafka, see "BRM Software Compatibility" in *BRM Compatibility Matrix*.

To set the environment variables, perform the following for all users you are going to use to install or run the BRM server:

1. Set the `JAVA_HOME` environment variable to the directory in which the latest version of Java certified with BRM is installed by running the following command:

```
setenv JAVA_HOME java_path
```

where `java_path` is the path to the directory in which the latest version of Java certified with BRM is installed; for example, `/Linux/x86_64/packages/jdk/jdk1.8.0_381`.

2. Verify the Java version by running the following command:

```
java -version
```

The Java version is displayed.

If the latest version of Java certified with BRM is not displayed, the latest Java version is not installed in the directory specified by `JAVA_HOME`.

3. Set the `PERL_HOME` environment variable to the directory in which the latest version of Perl certified with BRM is installed by running the following command:

```
setenv PERL_HOME Perl_path
```

where `Perl_path` is the path to the directory in which the latest version of Perl certified with BRM is installed; for example, `/perl_5_38_0/linux`.

4. Set the `PATH` environment variable by running the following command:

```
setenv PATH $JAVA_HOME/bin:$PERL_HOME/bin:${PATH}
```

5. If your BRM client wallet is not stored in the default location, set the `BRM_CONF_WALLET` and `BRM_WALLET` environment variables to point to the directory in which the BRM client wallet is stored:

```
setenv BRM_CONF_WALLET brm_wallet_path  
setenv BRM_WALLET brm_wallet_path
```

6. Set the `TNS_SERVICE_NAME` environment variable to the service name for your primary database:

```
setenv TNS_SERVICE_NAME service_name
```

7. Set the `HOSTNAME` environment variable by running the following command:

```
setenv HOSTNAME hostName
```

where `hostName` is the fully qualified host name of the machine on which your current instance of BRM is installed.

8. If you will be using the Kafka Data Manager (DM), set the Kafka environment variables:

 **Note:**

The Kafka DM is supported in BRM 12.0 Patch Set 4 and later releases.

```
setenv KAFKA_HOME Kafka_path  
setenv KAFKA_BOOTSTRAP_SERVER_LIST KafkaHost1:port1,KafkaHost2:port2
```

where:

- *Kafka_path* is the path to the directory in which the Kafka library JARs are installed.
- *KafkaHost1:port1,KafkaHost2:port2* are the hosts and ports that the Kafka client will connect to in a bootstrap Kafka cluster the first time it starts. You can specify any number of hosts and ports in this list.
You can alternatively set this list in the **dm_kafka_config.xml** file. See "Mapping Business Events to Kafka Topics" in *BRM Developer's Guide*.

Installing BRM and Pipeline Manager for Upgrade

To install BRM and Pipeline Manager for upgrade:

1. Download the BRM software. See "[Downloading the BRM Software](#)".
2. Go to the directory where you downloaded the BRM installer, and start the installer. See "[Starting the BRM GUI Installer](#)".

The Welcome window appears.

3. Click **Next**.

The Installation Location window appears.

4. Enter the full path or browse to the directory in which BRM 15.0 is going to be installed. Click **Next**.

Caution:

Install BRM 15.0 in a different location from BRM 12.0 to avoid many upgrade problems.

The Installation Type window appears.

5. Select **Custom**, and then click **Next**.

The Feature Sets Selection window appears.

6. From the components list, select **Upgrade Manager Framework** and then select the components that you already installed in BRM 12.0. Click **Next**.

Upgrade Manager Framework contains the BRM server upgrade and the Pipeline Manager upgrade.

 **Note:**

- Ensure that you select the components in **Upgrade Manager Framework (Portalbase Upgrade for BRM and Pipeline Upgrade for Pipeline Manager)** that correspond to the components already installed in your BRM 12.0 or BRM 12.0 patch set environment. In the rest of the list, you must also select the same components that are already installed in your BRM 12.0 or BRM 12.0 patch set environment. You can install any additional optional component after completing the BRM 15.0 upgrade. See "[Adding Optional Components](#)" for instructions on installing the optional components.
- If the existing BRM components are installed on separate machines, install the respective 15.0 component on the machine on which the existing component is installed. For example, if the BRM server and Pipeline Manager are installed on separate machines, install the BRM 15.0 server on the machine on which the existing BRM server is installed and BRM 15.0 Pipeline Manager on the machine on which existing Pipeline Manager is installed.

If you selected only the components in **Upgrade Manager Framework**, proceed to step [10](#).

If you selected the components in **Upgrade Manager Framework** and other components from the components list, the Specify Prerequisite Libraries Location window appears.

7. Specify the information in [Table 15-1](#), and then click **Next**.

Table 15-1 Specify Prerequisite Libraries Location

Field	Description
Prerequisite Libraries	Enter the full path or browse to the directory in which the prerequisite libraries are stored.
Enable SSL for BRM server	If you do not want to enable secure communication between BRM server components, deselect the Enable SSL for BRM server check box. To enable secure communication between BRM server components, leave the Enable SSL for BRM server check box selected.

The Oracle Wallet Details window appears.

8. Enter the information in [Table 15-2](#), and then click **Next**.

Table 15-2 Oracle Wallet Details

Field	Description
Wallet Password	Enter the password for the BRM 12.0 client wallet.

Table 15-2 (Cont.) Oracle Wallet Details

Field	Description
Wallet Location	For a standalone instance or a primary instance, enter the full path or browse to the directory in which the BRM client wallet for your 12.0 installation is located, for example, <i>BRM12_home/wallet/client</i> . For a secondary instance, enter the full path or browse to the directory in which the BRM client wallet or your primary instance is located, for example, <i>BRM15_home/wallet/client</i> .

- In the Specify Wallet Details window, enter the details listed in [Table 15-3](#) and then click **Next**.

Table 15-3 Specify Wallet Details

Field	Description
Client Wallet Password	The password for the client Oracle wallet. Use the same password used for 12.0. In a multischema system, this should be the same wallet password used in the primary schema for 12.0.
Confirm Client Password	This field is inactive for upgrade, since the password should be the same as the one for 12.0.
Root Wallet Password	The password for the root Oracle wallet
Confirm Root Password	The root Oracle wallet password again
Server Wallet Password	The password for the server Oracle wallet
Confirm Server Password	The server Oracle wallet password again

- In the following windows, provide the requested information, and then click **Next**, with the following considerations for upgrade:
 - In the BRM Root User Details window, in the **Root Password** field, ensure that you enter the existing BRM root password that you provided during the BRM 12.0 installation.
 - In the Select Running the pin_setup Script window, select **Yes**. This will create the appropriate pin.conf files for your 15.0 environment. Because you selected upgrade packages to install, this will not initialize the database.
 - Although it is recommended that you stop all services before running the upgrade, you can have the BRM 12.0 environment running during the installation of BRM 15.0. If this is the case, or if the two environments are ever going to be running at the same time, ensure that you provide different port numbers for the feature sets than the ones used for BRM 12.0 to avoid port conflict.

See "[Installing All BRM Components](#)" for descriptions of the fields displayed. Continue moving through the windows until the Installation Summary window appears.

Your responses are written to the *BRM_home/setup/pin_setup.values* file, where *BRM_home* is the directory in which the BRM 15.0 server software is installed.

- In the Installation Summary window, review your selections, and then click **Install**.
The Installation Progress window appears, and the installation begins.

 **Note:**

After the installation begins, you cannot stop or cancel the installation.

12. When the installation is done, click **Next**.

The Installation Complete window appears.

The installer checks for all required software and displays errors if it detects any missing or unavailable components or if any connectivity issues occur.

13. Click **Finish** to exit the installer.
14. Proceed to "[Upgrading Your Data to BRM 15.0](#)".

Upgrading Your Data to BRM 15.0

This section describes the tasks to be completed to upgrade your data to BRM 15.0.

Pointing the BRM 15.0 Installation to the Database Schema

 **Note:**

On multischema systems, first perform this task on the primary system and then on the secondary systems.

Before you run the BRM database upgrade script, verify that the Oracle Data Manager (DM) is configured correctly as this DM provides the interface to the BRM 15.0 database. The Oracle DM should point to the BRM 15.0 database in which you imported your BRM 12.0 backup data, as described in "[Importing Your BRM 12.0 Data](#)".

Verify that Oracle DM is configured properly by starting **dm_oracle**. You should ensure that Oracle DM starts and stops correctly because upgrade scripts start and stop Oracle DM while making changes to the database schema.

Upgrading the BRM Database Schema to the BRM 15.0 Schema

 **Note:**

On multischema systems, first perform this task on the primary system and then on the secondary systems.

To upgrade the BRM 12.0 database schema to a BRM 15.0 database schema, complete the appropriate steps in this section.

Upgrading the Schema on Single-Schema Systems

To upgrade the BRM schema on single-schema systems:

1. Grant additional permission to the BRM database user:
 - a. Connect to the primary database instance using SQL*Plus:

```
% sqlplus system@databaseAlias as sysdba
```

- b. Run the following command:

```
SQL> GRANT SELECT ON V_$SESSION TO BRM_user;  
Grant succeeded.  
SQL> commit;  
Commit complete.
```

- c. Exit SQL*Plus.

2. Edit the *BRM_home/setup/scripts/pin_setup.values* file and ensure that the following values are set:

```
$SETUP_INIT_DB=YES  
$SETUP_DROP_ALL_TABLES=NO  
$CREATE_DATABASE_TABLES=NO
```

Also set/verify the following values:

- (Optional) Set PIN_TEMP_DIR to the directory in which you want to create the temporary files. Ensure that the directory is set with full write permissions.
- (Optional) Set PIN_LOG_DIR to the directory in which you want to create the BRM log files.
- Validate the other information in the file, especially the information about the database.

3. Save and close the file.
4. Edit the *BRM_home/setup/pin_tables.values* file and set the following values:

```
$PIN_CONF_PARTITION_IND = "local";  
$PIN_CONF_NON_EVENT_PARTITION_IND = "local";
```

5. Save and close the file.
6. Run the **source** command on the **source.me** file:

- For Bash Shell:

```
source source.me.sh
```

- For C shell:

```
source source.me.csh
```

7. Go to the *BRM_home/setup/scripts* directory and run the following command:

 **Note:**

- Ensure that you do not run the upgrade script in the background.
- Ensure that the `WALLET_FILE_STORAGE_T` table is present in the database before running this script.

`perl script`

where `script` is either `pin_upgrade_15.pl` for BRM 15.0.0 or `pin_upgrade_15ps x .pl` for a maintenance release with x as the maintenance release, such as 1 for BRM 15.0.1, 2 for BRM 15.0.2, and so on. For example, if you are upgrading to BRM 15.0.1, run the following command:

`perl pin_upgrade_15ps1.pl`

This script runs a series of scripts that upgrade the BRM data from BRM 12.0 to BRM 15.0.x.

 **Note:**

Do not press any button until the command prompt asks for the BRM wallet password in the next step. Otherwise, the script will consider whatever key you have pressed to be the BRM wallet password.

8. At the "Enter Password for the wallet" prompt, enter the BRM client wallet password (which should be the same for both 12.0 and 15.0) and wait for the script to finish.
9. Merge the contents of the backed up `pin_ctl.conf` file into the new `pin_ctl.conf` file.

Upgrading the Schema on Multischema Systems

To upgrade the schema on multischema systems, you upgrade the primary database schema and then the secondary database schemas.

To upgrade the primary database schema, perform the tasks in "[Upgrading the Schema on Single-Schema Systems](#)" on your primary schema.

To upgrade *each* secondary database schema, perform the following on *each* secondary BRM installation machine:

1. Grant an additional permission to the BRM database user:
 - a. Connect to the primary database instance using SQL*Plus:

```
% sqlplus system@databaseAlias as sysdba
```

- b. Run the following command:

```
SQL> GRANT SELECT ON V_$SESSION TO BRM_user;
Grant succeeded.
SQL> commit;
Commit complete.
```

- c. Exit SQL*Plus.
2. Before you upgrade the secondary schema, set the BRM_WALLET environment variable to the BRM wallet in the primary schema:

```
setenv BRM_WALLET BRM_home/wallet/client
```

3. Perform the tasks in ["Upgrading the Schema on Single-Schema Systems"](#) on your secondary schema.

To configure your entire multischema system, perform the following on the appropriate BRM instances:

1. On the primary BRM instance, edit the *BRM_home/apps/multi_db/config_dist.conf* file and add a line specifying the schema name at the end of each block in the file. For example, if you have two database schemas, your file might look like this:

```
DB_NO = "0.0.0.1" ;           # 1st database config block.
PRIORITY = 1 ;
MAX_ACCOUNT_SIZE = 100000 ;
STATUS = "OPEN" ;

DB_NO = "0.0.0.2" ;           # 2nd database config block.
PRIORITY = 1 ;
MAX_ACCOUNT_SIZE = 100000 ;
STATUS = "OPEN" ;
```

Update the file to look more like the following:

```
DB_NO = "0.0.0.1" ;           # 1st database config block.
PRIORITY = 1 ;
MAX_ACCOUNT_SIZE = 100000 ;
STATUS = "OPEN" ;
SCHEMA_NAME = "pin01" ;

DB_NO = "0.0.0.2" ;           # 2nd database config block.
PRIORITY = 1 ;
MAX_ACCOUNT_SIZE = 100000 ;
STATUS = "OPEN" ;
SCHEMA_NAME = "pin02" ;
```

using the correct schema names for your environment.

2. Edit the *BRM_home/setup/scripts/pin_multidb.conf* file in the primary BRM instance and set the following values for each secondary database:

```
#-----
# Secondary db information
#-----

$PIN_MD_SECONDARY_DBNO      [0] = "db_no";
$PIN_MD_SECONDARY_OWNER    [0] = "sec_owner";
#$PIN_MD_SECONDARY_PASSWD  [0] = "pinb";
$PIN_MD_SECONDARY_DBNAME   [0] = "sec_db";
$PIN_MD_SECONDARY_SQLHOST  [0] = "";
```

```
$PIN_MD_SECONDARY_HOSTNAME [0] = "sec_hostname";
$PIN_MD_SECONDARY_PORT     [0] = "dm_port";      # dm port
```

where:

- *db_no* is the database number of the secondary schema, for example **0.0.0.2**.
 - *sec_owner* is the owner of the secondary database.
 - *sec_db* secondary database name.
 - *dm_port* port for the DM.
3. Go to the *BRM_home\setup\scripts* directory in the primary BRM instance and run the following command:

```
pin_multidb.pl -i
```

- a. At the following prompt, enter **y**, which begins the configuration:

```
Do you want to start the configuration now? (y/n):  y
```

- b. At the following prompt, enter **2**, which initializes the primary database:

```
Please enter the starting step (0-8). If you don't know, enter 0:  2
```

- c. Follow the instructions displayed and exit the **pin_multidb.pl** script.

At the prompt to enter the wallet password, enter the wallet password for the primary schema.

4. Restart the Connection Manager (CM) and DM of your primary BRM instance. Ensure that the **testnap** utility works.
5. Run the following command in the primary BRM instance:

```
pin_multidb.pl -f
```

6. Edit the DM **pin.conf** file on the primary BRM instance and set the following value for each secondary schema:

```
- dm schema db_no sec_owner
```

where:

- *db_no* is the database number of the secondary schema, for example **0.0.0.2**.
 - *sec_owner* is the owner of the secondary database.
7. Edit the DM **pin.conf** file on each secondary BRM instance and set the following values for the primary schema:

```
- dm schema 0.0.0.1 prim_owner
```

where:

- *prim_owner* is the owner of the primary database.
8. Stop and restart all of the services on the primary BRM instance and all secondary instances.

9. On the primary BRM instance, connect to SQL*Plus and run the following scripts:

```
@create_procedures_character_set.plb
grant_permissions_oracle.plb
grant_permissions('sec_owner')
```

where:

- *character_set* specifies the database character set, either **UTF8** or **AL32UTF8**.
- *sec_owner* is the owner of the secondary schema.

Run the last command for the owner of each secondary schema.

10. On each secondary BRM instance, connect to SQL*Plus and run the following scripts:

```
@create_procedures_character_set.plb
grant_permissions_oracle.plb
grant_permissions('prim_owner')
```

where:

- *character_set* specifies the database character set, either **UTF8** or **AL32UTF8**.
- *prim_owner* is the owner of the primary schema.

11. On the primary BRM instance, do the following for *each* secondary schema:
 - a. Edit the *BRM_home/sys/dd/data/device_framework_primary_schema_75ps4.sql* script and update all instances of **SEC_SCHEMA_NAME** to the name of the secondary database schema owner.
 - b. Connect to the primary database schema and run the edited script in SQL*Plus.
12. On *each* secondary BRM instance, connect to the secondary database schema and run the *BRM_home/sys/dd/data/device_framework_secondary_schema_75ps4.sql* script in SQL*Plus.

Upgrading the Pipeline Manager Database Schema to the BRM 15.0 Schema



Note:

Run the database upgrade script on the primary schema and then on the secondary schemas.

To upgrade the Pipeline Manager database schema:

1. Create a temporary directory for use during the upgrade by going to *Pipeline_home/upgrade* and creating the *Pipeline_home/upgrade/tmp* directory.

2. Update the `Pipeline_home/upgrade/pipeline_upgrade.cfg` file and set the following values:

```
$PIN_TEMP_DIR = "temp_path"  
$MAIN_DB{'user'} = "db_user";  
$PIPELINE_TBSLSPACE = "tablespace pipeline_tablespace";
```

where:

- `temp_path` is the directory you just created.
- `db_user` is the primary database user.
- `pipeline_tablespace` is the tablespace containing pipeline data.

Ensure that you also update the database information as appropriate.

3. Grant the required access to the user **pin** on the Pipeline Manager tables and sequences, if you have not already done so. See "[Loading the Tailor-Made Stored Procedure](#)" for more information about the Pipeline Manager tables and sequences that you should grant user **pin** access to.
4. Go to the `Pipeline_home/setup/scripts` directory and run the following command:

 **Note:**

- Ensure that you do not run the upgrade script in the background.
- Ensure that the `WALLET_FILE_STORAGE_T` table is present in the database before running this script.

`perl script`

where `script` is either `pin_upgrade_15.pl` for BRM 15.0.0 or `pin_upgrade_15ps x .pl` for a maintenance release with x as the maintenance release, such as 1 for BRM 15.0.1, 2 for BRM 15.0.2, and so on. For example, if you are upgrading to BRM 15.0.1, run the following command:

```
perl pin_upgrade_15ps1.pl
```

This script runs a series of scripts that upgrade Pipeline Manager data from 12.0 to 15.0.x. The log files will be located in the temporary directory you created.

5. In SQL*Plus, run the `Pipeline_home/database/Oracle/Scripts/create_pricing_discountmodel_procedures.plb` script in the Pipeline schema.

Completing the Upgrade

This section describes the tasks required to complete the upgrade process.

Creating Large Indexes

For performance reasons, you must create two indexes manually after the upgrade.

To create the indexes in the default tablespace, use the following commands:

```
CREATE INDEX i_event_item_tr_arbill__id ON event_item_transfer_t
(ar_bill_obj_id0);
CREATE INDEX i_event_session_obj__id ON event_t (session_obj_id0);
```

To create the indexes in another tablespace (for example, the index tablespace), use the following commands:

```
CREATE INDEX i_event_item_tr_arbill__id ON event_item_transfer_t
(ar_bill_obj_id0) tablespace tablespace_name;
CREATE INDEX i_event_session_obj__id ON event_t (session_obj_id0) tablespace
tablespace_name;
```

where *tablespace_name* is the name of the tablespace that should contain the indexes.

Installing the BRM 15.0 Client Applications

When you install client applications, be sure to update the BRM 15.0 **Infranet.properties** and **INI** files with any 15.0 customizations. See "[Installing BRM Thick Clients](#)" for more instructions.

Note:

You must upgrade *all* existing client applications and optional components to BRM 15.0 before you install additional client applications and optional components in BRM 15.0.

To upgrade *custom* client applications, recompile them with BRM 15.0 libraries. See "[Updating Custom Applications](#)" for more information.

Adding Optional Components

At this point, add the optional components that you plan to use in BRM 15.0. See "[Installing Individual BRM Components](#)" for instructions.

Note:

Before you install a new optional component, in case you changed the database password after the previous installation, ensure that the database password is the same in all configuration entries in the Oracle wallet. To change the database password in the configuration entries, see "About Oracle Wallet" in *BRM System Administrator's Guide* for more information.

Updating Configurations

Complete the steps in this section that are appropriate for your BRM 15.0 environment.

Update the Default Settings for the `pin_rel` Utility

If you use Rated Event (RE) Loader, ensure that the database configurations settings are updated.

To update the default settings for the `pin_rel` utility:

1. Go to the `BRM_home/apps/pin_rel` directory.
2. Open the `Infranet.properties` file.
3. Check and, if necessary, update the entries for the following:

```
infranet.rel.dbname = DATABASE_NAME  
infranet.rel.userid = USERNAME
```

4. Save and close the file.

Updating the Settings for the `pin_virtual_time` Utility

If you are testing the upgrade on a test system, ensure that you uncomment all entries for the `pin_virtual_time` utility in the configuration files associated with your BRM test system.

If you are upgrading your production system, ensure that you remove all entries for the `pin_virtual_time` utility from the configuration files associated with your BRM production system.

Upgrading AMM in a Multischema System

If you have a multischema system and it includes Account Migration Manager (AMM), run the AMM installation scripts to upgrade your multischema system.

To upgrade AMM in a multischema system:

1. Log in as user `pin` and go to the `BRM_home/setup/scripts` directory.
2. Run the `pin_amt_install` script:

```
perl pin_amt_install.pl
```

Restoring Customizations

Note:

You must first incorporate customizations on the primary schema and then on the secondary schemas.

Incorporate any customizations you made to your Release 12.0 policy source code, configuration files, invoicing, reports, and general ledger reporting. See "[Transferring Customizations to the New Release](#)" for more information.

Post-Upgrade Procedures

This section provides a list of post-upgrade tasks. Some tasks are optional or apply only to certain platforms or system configurations. Be sure to check whether a task is required for your system.

Perform these tasks after you upgrade your BRM system:

1. [Loading the pin_notify File](#)
2. [Copying Files for Compiling CMs](#)
3. [Migrating Custom Code to a 64-bit Environment](#)
4. [Updating Queue Handling](#)
5. [Setting the Environment Variables for Pipeline Manager](#)
6. [Configuring SSL for the BRM Database](#)
7. [Removing Invalid Objects from the Database](#)
8. [Modifying the Root Encryption Key](#)
9. [Setting the Bill State for Preexisting Bills](#)
10. [Migrating Tax Codes](#)
11. [Updating pin_inv_doc_gen Infranet.properties](#)

Loading the pin_notify File

**Note:**

On multischema systems, first perform this task on the primary system and then on the secondary systems.

If your system includes Pipeline Manager, reload the event notification configuration file, **pin_notify**, in the BRM database. For more information, see "About the Event Notification List" in *BRM Developer's Guide*.

To load the **pin_notify** file:

1. Go to the `BRM_home/sys/data/config` directory.
2. Run the following command:

```
load_pin_notify pin_notify
```

If you do not run the utility from the directory in which the configuration file is located, include the complete path to the file.

3. Stop and restart the Connection Manager (CM).

Copying Files for Compiling CMs

You must copy some files required for building versions of the CM.

To copy the required files for compiling CMs:

1. Copy the following files from the *BRM_home/lib* directory to the *BRM_home/PortalDevKit/source/sys/cm* directory:
 - **libcmpin.so**
 - **libdmpin.so**
2. Copy the **cm.cpp** file from the *BRM_home/source/sys/cm* directory to the *BRM_home/PortalDevKit/source/sys/cm* directory.
3. Open the *BRM_home/PortalDevKit/source/samples/env.unix* file in a text editor.
4. Add or modify the following environment variables:

```
LIBDIR = BRM_home/PortalDevKit/lib
RW_INCDIR = PortalDevKit_hostname/rwWorkspace
INCDIR = BRM_home/PortalDevKit/include
PCM_JAR = BRM_home/jars/pcm.jar
JDK_HOME = jdk_path
PCMEXT_JAR = BRM_home/jars/pcmext.jar
```

where:

- *hostname* is the name of the machine on which the BRM server is installed.
 - *jdk_path* is the path to the directory in which the latest version of JRE certified with BRM is installed, such as */Linux/x86_64/packages/jdk/jdk1.8.0_381*.
5. Save and close the file.

Migrating Custom Code to a 64-bit Environment

To migrate the code for your policy opcodes to 64-bit.

1. If you are using custom makefiles, make the following changes in each:
 - If the makefile contains **-m32**, remove it.
 - Remove **elf_i386** from the file, or replace it with **elf_x86_64**.
 - Update the dynamic linking path for 64-bit. For example, change **-shared -L/usr/lib** to **-shared -L/usr/lib64**
2. Change the format specifiers for variables whose sizes are different for 64-bit. For specifics, see [Table 15-4](#).

Table 15-4 Changes in Data Type Format Between 32-bit and 64-bit

Data type	32-bit Length	64-bit Length
time_t	4 bytes	8 bytes
Pointer	4 bytes	8 bytes
long	4 bytes	8 bytes
wchar_t	2 bytes	4 bytes
size_t	4 bytes	8 bytes

Note:

The `int` and `int32` data types remain 4 bytes, and the `int64` data type remains 8 bytes.

3. Make specific changes relating to time/date formats, to allow for dates beyond the year 2038.
 - If your code ever uses the `int` data type for a date, change the type to `time_t`. While the `int` data type remains at 4 bytes, the `time_t` data type has increased to 8 bytes.
 - When your code calls any PCM library function, such as `PIN_FLIST_FLD_SET` or `PIN_FLIST_FLD_GET`, use variables of type `time_t` or `pin_fld_tstamp_t` for any `PIN_FLDT_TSTAMP` fields.
4. Enable the `-Wconversion` flag during compilation so that it will report any warnings related to implicit type conversions. Solve all of those errors. In particular, make sure you solve any `Wpointer-to-int-cast` warnings. These might be generated by pointers that assume the old data type sizes.
5. Be aware of the magic numbers and any Bit Shifting Operations being used in the code. These may need to be changed. For example, some issues with magic numbers are:

```
longvar = 0xffffffff; //-1 in 32-bit environment
longvar = 0xffffffff; //4294967295 in 64-bit environment
longvar = 0xffffffffffffffff; //-1 in 64-bit environment
```

Updating Queue Handling

The `dm_ifw_sync` and `dm_aq` queues were previously used for Advanced Queuing in BRM. However, the Account Sync Manager (`dm_ifw_sync`) and the Queue Manager (`dm_aq`) components have been deprecated in BRM 15.0. Their functionality has been moved to `dm_oracle`, which has been enhanced to enqueue these messages going forward.

The `BRM_home/apps/pin_ifw_sync/` and `BRM_home/apps/pin_aq/` directories are not present in BRM 15.0. They have been replaced by a new directory, `BRM_home/apps/pin_publish_aq/`. This directory contains the `pin_publish_oracle.pl` utility, which is used to maintain Advanced Queues meant to publish messages for enterprise integration and the Pipeline Rating Engine.

To update your system for this change:

1. Update the payload configuration XML files located in `BRM_home/sys/leai_js` to change the publisher database number. Change the numbers **0.0.9.7** (`dm_aq`) and **0.0.9.9** (`dm_ifw_sync`) to **0.0.0.0**. This will route the events to `dm_oracle`.
2. Update the business event queue mapping by updating the `BRM_home/sys/dm_oracle/aq_event_map` file with the information that was previously directed to `dm_ifw_sync` and `dm_aq`. This file is equivalent to the previous `ifw_sync_queuenames` file.

The DM pin.conf file has been updated to contain the following parameter:

```
- dm_aq_event_map_file ./aq_event_map
```

You can use this parameter to change the name of the queue file according to your requirements.

Setting the Environment Variables for Pipeline Manager

If your system includes Pipeline Manager and if you have the Oracle ZT PKI Encryption enabled in BRM 12.0, you must set some environment variables for Pipeline Manager.

On the machine on which you installed the BRM 15.0 server, set the `BRM_WALLET` environment variable for pipelines by running the following command:

```
setenv BRM_WALLET Pipeline_home/wallet/client
```

Configuring SSL for the BRM Database

You can configure secure sockets layer (SSL) for the BRM database by creating wallets for storing certificates and then modifying the following configuration files in the `Oracle_home/network/admin` directory, where `Oracle_home` is the directory in which the Oracle database is installed, to point to the appropriate wallet:

- `sqlnet.ora`
- `tnsnames.ora`
- `listener.ora`

You can use the **Orapki** utility to create the wallets.

For information about configuring SSL for the Oracle database, see the Oracle Database documentation.

Removing Invalid Objects from the Database

After installing the new version of BRM, run the `create_procedures` script to remove any invalid objects in the BRM database.

In a multischema system, perform this task on the primary Oracle DM machine.

To run the `create_procedures` script:

1. Go to the `BRM_home/sys/dm_oracle/data` directory.
2. Run the following command, which opens SQL*Plus:

```
sqlplus login@ORACLE_SID  
Enter password: password
```

where:

- `login` is the user name for the BRM database schema.
 - `password` is the password for the specified user name.
 - `ORACLE_SID` is the database alias of the BRM database schema.
3. Run the following command:

```
@create_procedures_character_set.plb
```

where `character_set` specifies the database character set of either **UTF8** or **AL32UTF8**.

Modifying the Root Encryption Key

To enhance security, you should modify the root encryption key on a regular basis.

See the appropriate section for more information:

- [Modifying the Root Encryption Key on Single-Schema Systems](#)

- [Modifying the Root Encryption Key on Multischema Systems](#)

Modifying the Root Encryption Key on Single-Schema Systems

To modify the root encryption key on single-schema systems:

1. Back up the `CRYPTKEY_T` and `WALLET_FILE_STORAGE_T` tables in the BRM database. See your database documentation for more information on performing database table and view backups.

Note:

Store the backup in a safe location. The data in the backed up `CRYPTKEY_T` table and the root key wallet will become necessary if you encounter any issues in modifying the root encryption key.

2. Go to the directory in which you installed the BRM server, and edit the appropriate `source.me` file:
 - a. For Bash shell, edit the `source.me.sh` file and look for the following text:

```
export BRM_WALLET
```

Update the wallet location to read:

```
export BRM_WALLET=$PIN_HOME/wallet/
```

- b. For C shell, edit the `source.me.csh` file and look for the following text:

```
setenv BRM_WALLET
```

Update the wallet location to read:

```
setenv BRM_WALLET $PIN_HOME/wallet/
```

3. Source the file you just edited:
 - a. Bash shell:

```
source source.me.sh
```
 - b. C shell:

```
source source.me.csh
```
4. Run the following command from the `BRM_home/sys/test` directory.

```
pin_crypt_app -genrootkey
```
5. Ensure that the `testnap` utility works.
6. Run the following command from the `BRM_home/sys/test` directory.

```
pin_crypt_app -useZT -genkey -update_dm_conf
```
7. Restart the CM and DM and ensure that the `testnap` utility works.

Modifying the Root Encryption Key on Multischema Systems

To modify the root encryption key on multischema systems:

1. Back up the `CRYPTKEY_T` and `WALLET_FILE_STORAGE_T` tables in the BRM database in the primary schema and the `CRYPTKEY_T` table and `WALLET_FILE_STORAGE_T` view in all of the secondary schemas. See your database documentation for more information on performing database table and view backups.

 **Note:**

Store the backup in a safe location. The data in the backed up `CRYPTKEY_T` table and the root key wallet will become necessary if you encounter any issues in modifying the root encryption key.

2. Go to the directory in which you installed the BRM server on the primary and all secondary instances, and edit the appropriate `source.me` file:

- a. For Bash shell, edit the `source.me.sh` file and look for the following text:

```
export BRM_WALLET
```

Update the wallet location to read:

```
export BRM_WALLET=$PIN_HOME/wallet/
```

- b. For C shell, edit the `source.me.csh` file and look for the following text:

```
setenv BRM_WALLET
```

Update the wallet location to read:

```
setenv BRM_WALLET $PIN_HOME/wallet/
```

3. Source the file you just edited:

- a. Bash shell:

```
source source.me.sh
```

- b. C shell:

```
source source.me.csh
```

4. Verify that the key value in `CRYPTKEY_T` is the same for both the primary and secondary schemas. If it is not:

- a. Copy the value of `pin_crypt_aes4dm` from `BRM_home/sys/dm_oracle/pin.conf` to the same location on all of the secondary instances.

- b. Restart the BRM services on the primary and secondary BRM instances.

- c. Run the following command from the `BRM_home/sys/test` directory in the primary instance:

```
pin_crypt_app -useZT -genkey -update_dm_conf
```

- d. Copy the value of `pin_crypt_aes4dm` from `BRM_home/sys/dm_oracle/pin.conf` to the same location on all of the secondary instances.

- e. Restart the BRM services on the primary and secondary BRM instances.

- f. Run the following command from the `BRM_home/apps/pin_crypt` directory in the primary instance:

```
pin_crypt_upgrade -a
```

- g. Ensure that the **testnap** utility works.
5. If the key value is the same for both the primary and secondary schemas, update the root key by doing the following:
 - a. Run the following command from the *BRM_home/sys/test* directory:

```
pin_crypt_app -genrootkey
```
 - b. Ensure that the **testnap** utility works.
 - c. Run the following command from the *BRM_home/sys/test* directory:

```
pin_crypt_app -useZT -genkey -update_dm_conf
```
 - d. Restart the CM and DM in the primary instance and ensure that the **testnap** utility works.
 - e. Copy the value of **pin_crypt_aes4dm** from *BRM_home/sys/dm_oracle/pin.conf* to the same location on all of the secondary instances.
 - f. Verify that the key value in CRYPTKEY_T is the same for both the primary and secondary schemas.
 - g. Restart the CM and DM in the secondary instances.
 - h. Ensure that the **testnap** utility works.

Setting the Bill State for Preexisting Bills

If you are upgrading from BRM 12.0 Patch Set 4 or earlier, after the upgrade any new **/bill** objects include the PIN_FLD_STATE field set to the appropriate value. For all **/bill** objects that existed in the system before applying the BRM patch set, this field will be set to UNDEFINED.

You can optionally run a stored procedure to update the value of PIN_FLD_STATE on preexisting bills. This has no impact on functionality but can be done for consistency.

To run the stored procedure:

1. Go to the *BRM_home/sys/dd/data* directory.
2. Connect to the Oracle database with SQL*Plus:

```
% sqlplus login@ORACLE_SID
Enter password: password
```

where:

- *login* is the user name for the BRM database schema.
- *password* is the password for the specified user name.
- *ORACLE_SID* is the database alias of the BRM database schema.

3. Run this command:

```
SQL> @update_bill_state_12PS5.source
```

The value is set according to the following conditions:

Condition	PIN_FLD_STATE Value
The value of PIN_FLD_END_T is 0	INPROGRESS
The value of PIN_FLD_DUE is not zero and is greater than or equal to the value of PIN_FLD_CURRENT_TOTAL	NEW

Condition	PIN_FLD_STATE Value
The value of PIN_FLD_DUE is not zero and is less than the value of PIN_FLD_CURRENT_TOTAL	PARTIALLYPAID
The value of PIN_FLD_DUE is zero.	SETTLED

See "About Bill States" in *BRM Concepts* for more information about these bill states.

Migrating Tax Codes

If you are upgrading from BRM 12.0 Patch Set 4 or earlier, after the upgrade tax codes are stored in the `/config/taxcodes_map` object rather than in the `taxcodes_map` file.

If you are upgrading from BRM 12.0 Patch Set 4 or earlier, the Patch Set installer loads the `/config/taxcodes_map` object with default values. You must migrate any existing tax codes from the `taxcodes_map` file to the `/config/taxcodes_map` object.

To migrate your existing tax codes to so, perform the following steps:

1. If your existing BRM system contains multiple `taxcodes_map` files, collate them into a single file.
2. Run the `convert_taxcode.pl` script to convert your existing tax codes into XML format:

```
perl BRM_home/setup/scripts/convert_taxcode.pl inputFile [outputFile]
```

where:

- `inputFile` is the name and location of the file that contains your tax code configurations from Patch Set 4 or earlier. By default, these tax codes are stored in the `BRM_home/sys/cm/taxcodes_map` file.
 - `outputFile` is the name of the output file to generate. This file will contain your tax codes converted into XML format. If not provided, the output file will be named `config_taxcodes_map.xml`.
3. Copy the generated `config_taxcodes_map.xml` file to the `BRM_home/sys/data/config` directory.
 4. Load the `config_taxcodes_map.xml` file into the BRM database:

```
BRM_home/apps/load_config/load_config -M BRM_home/sys/data/config/  
config_taxcodes_map.xml
```

See "load_config" in *BRM Developer's Guide* for information about the utility's syntax and parameters.

Your tax codes have been loaded into the `/config/taxcodes_map` object.

Updating pin_inv_doc_gen Infranet.properties

If you are upgrading from BRM 12.0 Patch Set 4 or earlier, after the upgrade entries in the `pin_inv_doc_gen Infranet.properties` file have changed.

Copy the changes from the `BRM_home/apps/pin_inv_doc_gen/Infranet.properties.sample` file to your `BRM_home/apps/pin_inv_doc_gen/Infranet.properties` file, and then set the following new entries:

- **infranet.schedulerdb.url**: Specifies the scheduler database URL in the following format:

```
jdbc:oracle:thin:hostname:port/service
```

where *hostname* is the hostname of the scheduler database, *port* is the port number for the scheduler database, and *service* is the service name of the scheduler database.

- **infranet.schedulerdb.user**: Specifies the user name for the scheduler database.
- **infranet.schedulerdb.credentials**: Specifies the security credentials for connecting to the scheduler database.
- **infranet.jdbcpool.size**: Specifies the initial number of connections maintained in the pool. The default is set to the same as **burst.threadpool.size**.
- **infranet.jdbcpool.maxsize**: Specifies the maximum number of connections that can be created. The default is set to the same as **burst.threadpool.maxsize**.

Upgrading BRM 15.0 to a Later Release of BRM 15.0

Learn how to upgrade an Oracle Communications Billing and Revenue Management (BRM) 15.0 release to a later BRM 15.0 release and to roll back the upgrade.

Topics in this document:

- [About Installing the Later Release](#)
- [Performing a Zero Downtime Upgrade](#)
- [Tasks Involved in the Upgrade Process for a New Release](#)
- [Preparing for the Upgrade to the New Release](#)
- [Upgrading to the New Release](#)
- [Post-Upgrade Procedures for the New Release](#)
- [Installing Optional Components After the Release Upgrade](#)
- [Rolling Back the New BRM Release](#)

Note:

- To upgrade an existing BRM 12.0 or 12.0 patch set installation to a BRM 15.0 release, see "[About Upgrading from BRM 12.0 to BRM 15.0](#)". For information on the supported upgrades, see "BRM Upgrade" in *BRM Compatibility Matrix*.
- To do a full installation of a BRM 15.0 release, see "[Installing BRM](#)".

About Installing the Later Release

Note:

Test the later release on a non-production system before you deploy it on a production system.

The BRM installer allows you to upgrade from BRM 15.0 or a later BRM 15.0 release to the latest release. For example, you could upgrade a BRM 15.0.0 system to BRM 15.0.1.

When you do an upgrade, only files that have been changed are updated. The installer makes a backup of any file it updates. You use the backup files to merge your customizations and to uninstall the later release. The pre-upgrade version of each updated file is stored with the extensions GA and TGA and is left in its original directory. For example, when you install BRM 15.0.1 to upgrade Pipeline Manager, the existing **sample.reg** file is renamed to **sample.reg.TGA**.

The installer contains multiple packages to upgrade different BRM and Pipeline Manager components. You can install or upgrade these components by installing their corresponding packages:

- BRM
- BRM SDK
- Pipeline Manager

Performing a Zero Downtime Upgrade

Note:

- If you perform the zero downtime upgrade, billing might fail for some accounts. In that case, rerun billing for the failed bill units by running the billing utility with the **-retry** option.
- If your upgrade fails due to resource busy or timeout errors in the database, consult your DBA about increasing the value of the `DDL_LOCK_TIMEOUT` parameter for your database.

You can use the zero downtime upgrade method to upgrade your existing BRM installation with very minimal disruption to your existing installation and the services that are provided to your customers.

Before you perform the zero downtime upgrade, ensure the following:

- You have two instances of the existing BRM 15.0 release on your system; for example, two instances of BRM 15.0.0.
- Both BRM instances are currently running. This includes the primary and secondary instances and all the applications in the components connected to your BRM system.
- Both BRM instances are connected to the same BRM and Pipeline Manager database schemas.

To perform the zero downtime upgrade:

Note:

Do not shut down the applications in the components connected to your BRM system while the upgrade is running.

1. Route all the traffic (for example, phone calls or data usage) from the primary instance to the secondary instance.
2. Upgrade the *primary* instance and the BRM database schema to the new release of BRM 15.0; for example, BRM 15.0.1. See "[Upgrading to the New Release](#)" for instructions.
3. Start the *primary* instance. See "Starting and Stopping the BRM System" in *BRM System Administrator's Guide* for instructions.
4. Reroute all traffic from the secondary instance to the primary instance.

 **Caution:**

During the database upgrade on the *primary* instance, ensure that the services or operations in the *secondary* instance are running until all of the requests are rerouted to the *primary* instance.

5. Upgrade the *secondary* instance to the new release. See "[Upgrading to the New Release](#)" for instructions.

 **Note:**

Because you have already upgraded the BRM database schema during the *primary* instance upgrade, you can skip "[Upgrading the BRM Database Schema to the New Release](#)".

6. Perform post-upgrade tasks on both *primary* and *secondary* instances. See "[Post-Upgrade Procedures for the New Release](#)" for instructions.

 **Note:**

Batch operations, such as billing, might fail for a few accounts during the upgrade. You must restart the applications to complete your batch operations.

Tasks Involved in the Upgrade Process for a New Release

This section provides a list of tasks required to upgrade from BRM 15.0 to a new release of BRM 15.0. Some tasks are optional or apply only to certain system configurations. Be sure to check whether a task is required for your system.

 **Caution:**

When upgrading a *multischema* system, pay close attention to the system on which each task is performed.

Complete these tasks before upgrading your BRM system. See "[Preparing for the Upgrade to the New Release](#)" for more information.

1. Shut down the current instance of BRM.
2. Turn off service authentication and authorization.
3. Create a complete backup of your BRM data.
4. Install the latest compatible version of Java if it is different from the one for your current release.
5. Install the latest compatible version of Perl if it is different from the one for your current release.

6. Install any optional components you want to add to the old release. It is recommended to add any optional components to the instance you are upgrading from before the upgrade, because you cannot add them while you are doing the upgrade.

Perform the following tasks to upgrade to the new release. See "[Upgrading to the New Release](#)" for more information.

1. Set the environment variables, for example setting the variables for Java and Perl variables to the latest compatible version.
2. Verify that the BRM wallet location in **sqlnet.ora** is correct.
3. Obtain the BRM software.
4. Install the upgrade package.
5. Upgrade Business Operations Center.
6. Upgrade the BRM database schema to the schema for the new release.
7. If you are using Pipeline Manager, upgrade the Pipeline Manager database schema for the new release.
8. Install BRM client applications.
9. Add customizations.

After you upgrade to the new release of BRM 15.0, perform the following post-upgrade tasks. See "[Post-Upgrade Procedures for the New Release](#)" for more information.

1. Configure SSL for the BRM Database.
2. Remove invalid objects from the database.

Preparing for the Upgrade to the New Release

Complete these tasks before upgrading your BRM system:

1. Shut down the current instance of BRM. See "[Shutting Down the Current Instance](#)" for instructions.
2. Create a complete backup of your BRM data. See "[Backing Up Your BRM and Pipeline Manager Databases](#)" for instructions.
3. Install the latest compatible version of Java if it is different from the one for your current release. See "[Installing Java](#)" for instructions.
4. Install the latest compatible version of Perl if it is different from the one for your current release. See "[Installing Perl](#)" for instructions.
5. Install any optional components you want to add to the old release. See "[Installing Optional Components](#)" for instructions.

Shutting Down the Current Instance

Note:

On multischema systems, first perform this task on the primary system, and then on the secondary systems.

To shut down the existing BRM instance:

1. Ensure that no users are logged in.
Users include customers, client applications, customer service representatives (CSRs), and so on.
2. Stop all BRM processes. For more information, see "Starting and Stopping the BRM System" in *BRM System Administrator's Guide*.
Only the database instances should be running during the upgrade.

Backing Up Files

Note:

In multischema systems, perform this task first on the primary BRM installation machine and then on the secondary BRM installation machines.

In particular, ensure that you back up the following files:

- All customized files, including any associated source code
- Registry files
- Policy files
- **start_all**
- **pin.conf**
- **pin_ctl.conf**
- **pin_setup.values**
- **Infranet.properties**
- All other files that contain any customizations used in your system

If any libraries that were used in a previous release are no longer needed for a later release, these libraries will be moved automatically to *BRM_home/deleted_files* for reference, so you do not need to back them up manually.

Backing Up Your BRM and Pipeline Manager Databases

Note:

In multischema systems, perform this task first on the primary database schema and then on the secondary database schemas.

Make a complete offline backup of your BRM database and, if you are using Pipeline Manager, also the Pipeline Manager database. Make the backup using the appropriate backup tools for your database version and ensure that the backup is completely valid and usable. The backup must contain both the database definition and all the database contents. See your database software documentation for more information on performing full database backups.

 **Note:**

Store this backup in a safe location. The data in these files will become necessary if you encounter any issues in the upgrade process.

Installing Optional Components

 **Note:**

In multischema systems, perform this task first on the primary BRM installation machine and then on the secondary BRM installation machines.

Before upgrading the BRM 15.0 release, install any optional components that you want to add to your BRM system. For example, if you want to add Collections Manager to your BRM system, install Collections Manager in your old release before you install the latest BRM 15.0 release.

See "[Installing Individual BRM Components](#)" for more information.

Upgrading to the New Release

Perform the following tasks to upgrade to the new release:

 **Caution:**

When upgrading a multischema system, pay close attention to the system on which each task is performed.

1. Set the environment variables, for example setting the variables for Java and Perl variables to the latest compatible version. See "[Setting the Environment Variables for Upgrade](#)" for instructions.
2. Verify that the BRM wallet location in `sqlnet.ora` is correct. See "[Setting BRM Wallet Location in sqlnet.ora](#)" for instructions for updating this value.
3. Obtain the BRM software. See "[Downloading the BRM Software](#)" for instructions.
4. Install the upgrade package. See "[Upgrading BRM for the New Release](#)" or "[Upgrading BRM for the New Release in Silent Mode](#)" for instructions.
5. Upgrade the BRM database schema to the BRM 15.0 schema. See "[Upgrading the BRM Database Schema to the New Release](#)" for instructions.
6. Upgrade the Pipeline Manager database schema to the BRM 15.0 schema. See "[Upgrading the Pipeline Manager Database Schema to the New Release](#)" for instructions.
7. Upgrade Business Operations Center. See "Upgrading Business Operations Center" in *Business Operations Center Installation Guide* for instructions.
8. Install BRM 15.0 client applications. See "[Installing the BRM 15.0 Client Applications](#)" for instructions.

9. Add customizations. See "[Adding Customizations](#)" for instructions.

Upgrading BRM for the New Release

Note:

In multischema systems, perform this task first on the primary BRM installation machine and then on the secondary BRM installation machines.

To upgrade to the new release:

1. Go to the directory where you downloaded the BRM installer, and start the installer. See "[Starting the BRM GUI Installer](#)".
2. In the Welcome window, click **Next**.
3. In the Installation Location window, enter the full path or browse to the directory in which you installed BRM 15.0 and then click **Next**.
4. In the Specify Prerequisite Libraries Location window, specify the following library information and then click **Next**.

Field	Description
Prerequisite Libraries	Enter the full path or browse to the directory in which the prerequisite libraries are stored.
Enable SSL for BRM server	You must set this to the same value used for the instance you are upgrading from.

5. In the Oracle Wallet Details window, enter the following information for accessing the Oracle wallets in BRM and then click **Next**.

Field	Description
Wallet Password	Enter the password for the client Oracle wallet for the existing 15.0 installation.
Wallet Location	Enter the path or browse to the directory in which the client Oracle wallet for the existing 15.0 installation is located.

6. In the Database SSL Options window, select the same value (**Yes One Way**, **Yes Two Way**, or **No**) that was used for the instance you are upgrading from.
7. In the following windows, provide the requested information, and then click **Next**.
8. In the Installation Summary window, review the selections you have made in the preceding windows and then click **Install**.

The Installation Progress window appears.

 **Note:**

After installation begins, clicking **Cancel** stops the installation process, but the files that are already copied are not removed. You must manually remove the files. For instructions, see the steps to remove the files in "[Rolling Back the New BRM Release](#)".

9. When the installation is done, click **Next**. The Installation Complete window appears. Note the provided URL. You will use this URL to access BRM.
10. Click **Finish** to complete and exit.

Upgrading BRM for the New Release in Silent Mode

If you want to upgrade the BRM release, using the same configuration, in multiple environments. Silent install mode does not use the GUI and it runs in the background.

In this mode, you use a response file template that contains a predefined set of values to upgrade BRM to the new release. You can generate a response file that contains the parameters and values during the GUI installation.

Creating a Response File

To create a response file:

1. Create the response file by doing one of these:
 - Create a copy of the response file that was generated during the GUI upgrade. See "[Upgrading BRM for the New Release](#)" for more information.

 **Note:**

The GUI Installer does not store passwords provided during installation in the response file. You must manually add the passwords after creating a copy of the response file.

- Create a response file using the template by running the following command:

```
Java_home/bin/java -jar jarFile -getResponseFileTemplates
```

where:

- *Java_home* is the directory in which you installed the latest compatible Java version.
- *jarFile* is the BRM installer file. For example:

```
brmsserver_15.0.0.0.0_linux_generic_full.jar
```

A response file is created with the default values.

You can create as many response files as needed.

2. Open the file in a text editor.
3. Modify the response file you copied by specifying the key-value information for the parameters you want in your installation.

 **Note:**

- The response file template contains guidelines and examples on how to enter the values in the parameters.
- The Installer treats incorrect context, format, and type values in a response file as if no value were specified.

4. Save and close the response file.

Upgrading the Release in Silent Mode

To upgrade the BRM release in silent mode:

1. Create the response file. See "[Creating a Response File](#)".
2. Copy the response file you created to the machine on which you run the silent installation.
3. On the machine on which you are running the silent installation, go to the directory where you downloaded the BRM software, and run the following command:

```
Java_home/bin/java -jar jarFile -debug -invPtrLoc Inventory_home/oraInventory/  
oraInst.loc [parameter=value] -responseFile path -silent
```

where:

- *Java_home* is the location of the compatible version of Java.
- *jarFile* is the BRM installer file. For example:
`brmsrver_15.0.0.0.0_linux_generic_full.jar`
- *Inventory_home* is the location of the Oracle inventory.
- *parameter* is the name of an installation parameter.
- *value* is the value of the installation parameter.
- *path* is the absolute path to the response file.

For example:

```
$JAVA_HOME/bin/java -jar brmsrver_15.0.0.0.0_linux_generic_full.jar -debug -  
invPtrLoc Inventory_home/oraInventory/oraInst.loc INSTALL_TYPE=Complete -  
responseFile /tmp/brm_complete.rsp -silent
```

The installation runs silently in the background.

 **Note:**

For a complete list of the available parameters for the `[parameter=value]` clause, and for information about optional debugging parameters, run the following command:

```
Java_home/bin/java -jar jarFile -help
```

Upgrading the BRM Database Schema to the New Release

The database objects associated with the optional components that are not already installed are not created or updated. To upgrade the BRM database schema, perform one of these procedures:

- [Upgrading the Schema on Single-Schema Systems](#)
- [Upgrading the Schema on Multischema Systems](#)

Upgrading the Schema on Single-Schema Systems

To upgrade the schema on single-schema systems:

1. Grant an additional permission to the BRM database user:
 - a. Connect to the primary database instance using SQL*Plus:

```
% sqlplus system@databaseAlias as sysdba
```

- b. Run the following command:

```
SQL> GRANT SELECT ON V_$SESSION TO BRM_user;  
Grant succeeded.  
SQL> commit;  
Commit complete.
```

- c. Exit SQL*Plus.

2. Open the *BRM_home/setup/scripts/pin_tables.values* file in a text editor.
3. Set these parameters to **local**:

```
# For indexes on event tables  
$PIN_CONF_PARTITION_IND = "local";  
# For indexes on non event tables  
$PIN_CONF_NON_EVENT_PARTITION_IND = "local";
```

4. Save and close the file.
5. Go to *BRM_home* and source the **source.me** file:

- Bash shell:

```
source source.me.sh
```

- C shell:

```
source source.me.csh
```

6. Go to the *BRM_home/setup/scripts* directory and run this script:

 **Note:**

Ensure that you do not run the upgrade script in the background.

```
perl script
```

where *script* is either `pin_upgrade_15.pl` for BRM 15.0.0 or `pin_upgrade_15ps x .pl` for a maintenance release with x as the maintenance release, such as 1 for BRM 15.0.1, 2 for BRM 15.0.2, and so on. For example, if you are upgrading to BRM 15.0.1, run the following command:

```
perl pin_upgrade_15ps1.pl
```

This script runs a series of scripts that upgrade the BRM data to the new release.

7. Merge the contents of the backed up `pin_ctl.conf` file into the new `pin_ctl.conf` file.

Upgrading the Schema on Multischema Systems

To upgrade the schema on multischema systems:

1. On the primary BRM installation machine, do this:
 - a. Grant an additional permission to the BRM database user:
 - i. Connect to the primary database instance using SQL*Plus:

```
% sqlplus system@databaseAlias as sysdba
```
 - ii. Run the following command:

```
SQL> GRANT SELECT ON V_$SESSION TO BRM_user;
Grant succeeded.
SQL> commit;
Commit complete.
```
 - iii. Exit SQL*Plus.
 - b. Ensure that the DMs in your secondary BRM installation machines are up and running.
 - c. Ensure that the `PERL_VERSION` environment variable is set to the latest version of Perl certified with BRM.
 - d. Open the `BRM_home/setup/pin_setup.values` file in a text editor.
 - e. Set these parameters:

```
$SETUP_DROP_ALL_TABLES = "NO";
$SETUP_INIT_DB = "YES";
$SETUP_CONFIGURE = "YES";
$SETUP_DATABASE_TABLES = "NO";
```
 - f. Save and close the file.
 - g. Open the `BRM_home/setup/scripts/pin_tables.values` file in a text editor.
 - h. Set these parameters to **local**:

```
# For indexes on event tables
$PIN_CONF_PARTITION_IND = "local";
# For indexes on non event tables
$PIN_CONF_NON_EVENT_PARTITION_IND = "local";
```
 - i. Save and close the file.
 - j. Go to `BRM_home` and source the `source.me` file:

Bash shell:

```
source source.me.sh
```

C shell:

```
source source.me.csh
```

- k. Go to the `BRM_home/apps/multi_db` directory and run this script:

```
./install.sh
```

Follow the on-screen instructions, entering this information for the primary schema and for each secondary schema when requested:

- Schema user name
- Schema password
- Schema SID (the BRM database alias of the schema)

 **Note:**

Repeat the "Do you have secondary schema to process" step for each secondary schema in your system.

The install script fixes any data errors caused by conflicting storable class IDs. The errors might have occurred during extended architecture (XA) transactions involving multiple schemas or when accounts were migrated from one schema to another.

 **Note:**

As the install script runs, it generates the `BRM_home/apps/multi_db/fix_multi_schema.log` file. To view the progress of the script, display the log file in a different console window.

- i. Go to the `BRM_home/setup/scripts` directory and run this script:

 **Note:**

Ensure that you do not run the upgrade script in the background.

```
perl script
```

where *script* is either `pin_upgrade_15.pl` for BRM 15.0.0 or `pin_upgrade_15ps x .pl` for a maintenance release with x as the maintenance release, such as 1 for BRM 15.0.1, 2 for BRM 15.0.2, and so on. For example, if you are upgrading to BRM 15.0.1, run the following command:

```
perl pin_upgrade_15ps1.pl
```

This script runs a series of scripts that upgrade the BRM data from BRM 12.0 to BRM 15.0.x.

- m. Merge the contents of the backed up `pin_ctl.conf` file into the new `pin_ctl.conf` file.

- n. Ensure that the BRM processes are not running.
2. On each secondary BRM installation machine, do this:
 - a. Grant an additional permission to the BRM database user:
 - i. Connect to the primary database instance using SQL*Plus:

```
% sqlplus system@databaseAlias as sysdba
```
 - ii. Run the following command:

```
SQL> GRANT SELECT ON V_$SESSION TO BRM_user;
Grant succeeded.
SQL> commit;
Commit complete.
```
 - iii. Exit SQL*Plus.
 - b. Ensure that the BRM processes are not running.
 - c. Open the *BRM_home/setup/scripts/pin_tables.values* file in a text editor.
 - d. Set these parameters to **local**:

```
# For indexes on event tables
$PIN_CONF_PARTITION_IND          = "local";
# For indexes on non event tables
$PIN_CONF_NON_EVENT_PARTITION_IND = "local";
```
 - e. Save and close the file.
 - f. Go to *BRM_home* and source the **source.me** file:

Bash shell:

```
source source.me.sh
```

C shell:

```
source source.me.csh
```
 - g. Copy the *BRM_home/setup/scripts/pin_multidb.conf* file from the primary environment to the same location in the secondary environment.

 **Note:**

After you copy this file manually to the secondary environment, the upgrade script will refresh the views by reading the copied file.

- h. Go to the *BRM_home/setup/scripts* directory and run this script:

 **Note:**

Ensure that you do not run the upgrade script in the background.

```
perl script
```

where *script* is either `pin_upgrade_15.pl` for BRM 15.0.0 or `pin_upgrade_15ps x .pl` for a maintenance release with x as the maintenance release, such as 1 for BRM 15.0.1, 2 for BRM 15.0.2, and so on. For example, if you are upgrading to BRM 15.0.1, run the following command:

```
perl pin_upgrade_15ps1.pl
```

This script runs a series of scripts that upgrade the BRM data to the new release.

- i. Merge the contents of the backed up `pin_ctl.conf` file into the new `pin_ctl.conf` file.
3. On the primary BRM installation machine, do this:
 - a. Go to the `BRM_home/apps/multi_db` directory and open the `config_dist.conf` file in a text editor.
 - b. Add a line specifying the schema name at the end of each block in the file. For example, if you have two database schemas, your file might look like this:

```
DB_NO = "0.0.0.1" ;           # 1st database config block.
PRIORITY = 1 ;
MAX_ACCOUNT_SIZE = 100000 ;
STATUS = "OPEN" ;

DB_NO = "0.0.0.2" ;           # 2nd database config block.
PRIORITY = 1 ;
MAX_ACCOUNT_SIZE = 100000 ;
STATUS = "OPEN" ;
```

Update the file to look more like the following:

```
DB_NO = "0.0.0.1" ;           # 1st database config block.
PRIORITY = 1 ;
MAX_ACCOUNT_SIZE = 100000 ;
STATUS = "OPEN" ;
SCHEMA_NAME = "pin01" ;

DB_NO = "0.0.0.2" ;           # 2nd database config block.
PRIORITY = 1 ;
MAX_ACCOUNT_SIZE = 100000 ;
STATUS = "OPEN" ;
SCHEMA_NAME = "pin02" ;
```

using the correct schema names for your environment.

- c. Save and exit the `config_dist.conf` file.
- d. Go to the `BRM_home/setup/scripts` directory and run this command:

```
pin_multidb.pl -i
```
- e. At this prompt, enter `y`, which begins the configuration:

```
Do you want to start the configuration now? (y/n): y
```
- f. At this prompt, enter `2`, which initializes the primary database:

```
Please enter the starting step (0-8). If you don't know, enter 0: 2
```
- g. Follow the instructions displayed and exit the `pin_multidb.pl` script.

The refresh groups are recreated in the primary database.

- h. Run this command:

```
pin_multidb.pl -R all
```

The Connection Managers (CMs) in your secondary BRM installation machines are now started. The views, based on the information in the refresh groups, are re-created in the secondary databases.

Upgrading the Pipeline Manager Database Schema to the New Release

Note:

In multischema systems, run the database upgrade script on the primary schema and then on the secondary schemas.

To upgrade your Pipeline Manager database schema:

1. Open the *Pipeline_home/upgrade/pipeline_upgrade.cfg* file in a text editor, where *Pipeline_home* is the directory in which Pipeline Manager is installed.
2. Set the values of the following parameters:
 - Set **PIN_TEMP_DIR** to the directory in which you want to create the temporary files.
 - Set the **\$PIPELINE_TBLSPACE** environment variable to the tablespace where you want to create pipeline database objects.
 - In the **Information about the databases** section, configure the following database settings as required:

```
$MAIN_DB{'vendor'} = "oracle";
$MAIN_DB{'alias'} = ( $ENV{'ORACLE_SID_PIN'} or $ENV{'ORACLE_SID'} );
$MAIN_DB{'user'} = "USERNAME";
$MAIN_DB{'Database'} = "DATABASE_NAME";
$MAIN_DB{'Host'} = ( $ENV{'ORACLE_SID_PIN'} or $ENV{'ORACLE_SID'} );
```

3. Save and close the file.
4. Grant the required access to user **pin** on the Pipeline Manager tables and sequences, if you have not already done so.

See "Loading the Tailor-Made Stored Procedure" in *BRM Installation Guide* for more information about the Pipeline Manager tables and sequences that you should grant user **pin** access to.

5. Go to the *Pipeline_home/setup/scripts* directory and run the following command:

```
perl script
```

where *script* is either **pin_upgrade_15.pl** for BRM 15.0.0 or **pin_upgrade_15psx.pl** for a maintenance release with *x* as the maintenance release, such as 1 for BRM 15.0.1, 2 for

BRM 15.0.2, and so on. For example, if you are upgrading to BRM 15.0.1, run the following command:

```
perl pin_upgrade_15ps1.pl
```

This script runs a series of scripts that upgrade Pipeline Manager data to the new release.

Adding Customizations

Note:

In multischema systems, incorporate customizations first on the secondary BRM installation machines and then on the primary BRM installation machine.

Incorporate any customizations you made, including source code, policy, **pin.conf**, **pin_ctl.conf**, **pin_setup.values**, and **Infranet.properties** files, if you have not already incorporated them.

(Production system only) Remove all entries for the **pin_virtual_time** utility from the configuration files.

Post-Upgrade Procedures for the New Release

After you install the new release of BRM 15.0, perform the following postinstallation tasks:

1. Configure SSL for the BRM Database. See "[Configuring SSL for the BRM Database](#)" for instructions.
2. Remove invalid objects from the database. See "[Removing Invalid Objects from the Database](#)" for instructions.

Installing Optional Components After the Release Upgrade

Typically, you install optional components before installing the new release. However, if you have already installed the new BRM release and you want to install any optional components:

1. Set the PERL_HOME environment variable to the directory in which Perl is installed by running this command:

```
setenv PERL_HOME Perl_path
```

where *Perl_path* is the path to the directory in which Perl is installed, for example **/perl_5_36.0/linux**.

For the compatible Perl version, see "Additional Software Requirements (BRM)" in *BRM Compatibility Matrix*.

2. Install the required optional components. See "[Installing Optional Components](#)".
3. Unset the PERL5LIB environment variable.
4. Go to the **BRM_home/setup** directory and run this command:

```
./pin_setup -GA
```

5. Upgrade the optional component to the BRM 15.0 release you want to install. See "[Upgrading to the New Release](#)".
6. Set the PERL5LIB environment variable to the directory in which Perl is installed.

Rolling Back the New BRM Release

To roll back the BRM release upgrade:

1. Ensure that you take an offline backup of the data and customizations added after the new release installation.
2. Stop all BRM daemons, processes, and managers.
See "Starting and Stopping the BRM System" in *BRM System Administrator's Guide*.

3. Log in as user **pin**.

4. Run this command:

```
./deinstall.sh
```

The Distribution to Uninstall window appears.

5. Select the release and the components that you want to uninstall.

Note:

Do not use the **Select All** option to select the release or components. If you use this option, the initial release and the new release are selected for uninstallation. Ensure that you have selected only the components for the new release that you want to uninstall.

6. Click **Uninstall**.

The Welcome window appears.

Note:

The Welcome window displays the uninstaller version as **15.0.0.0.0**. You can ignore the version displayed in this window.

7. Click **Next**.

The Uninstallation Summary window appears.

8. Click **Uninstall**.

The Uninstallation Progress window appears.

9. Click **Next**.

The Uninstallation Complete window appears.

10. Click **Finish**.

The new release is uninstalled and the backup files are stored in the system with the **.GA** extension.

11. To remove the backup files, run this command:

```
BRM_home/setup/scripts/RevertMe.pl 0 0 Oracle_home
```

where *Oracle_home* is the directory in which the Oracle database is installed.

12. If BRM and Pipeline Manager are installed on separate locations, run this command from the location in which Pipeline Manager is installed:

```
IFW_home/setup/scripts/RevertMe.pl 0 0 Oracle_home
```

where *IFW_home* is the directory in which Pipeline Manager is installed.

The backup files are removed and the BRM release is rolled back. The rollback process removes the new BRM release and reverts the BRM software to the previous version. However, this process does not affect the database. To return the database schema to the previous version, restore the database using the backup you took at the beginning of the upgrade.