

Oracle® Database Appliance

X11 Deployment and User's Guide



Release 19.26 for Linux x86-64

G20413-01

February 2025

The Oracle logo, consisting of a solid red square with the word "ORACLE" in white, uppercase, sans-serif font centered within it.

ORACLE®

Copyright © 2022, 2025, Oracle and/or its affiliates.

Primary Author: Aparna Kamath

This software and related documentation are provided under a license agreement containing restrictions on use and disclosure and are protected by intellectual property laws. Except as expressly permitted in your license agreement or allowed by law, you may not use, copy, reproduce, translate, broadcast, modify, license, transmit, distribute, exhibit, perform, publish, or display any part, in any form, or by any means. Reverse engineering, disassembly, or decompilation of this software, unless required by law for interoperability, is prohibited.

The information contained herein is subject to change without notice and is not warranted to be error-free. If you find any errors, please report them to us in writing.

If this is software, software documentation, data (as defined in the Federal Acquisition Regulation), or related documentation that is delivered to the U.S. Government or anyone licensing it on behalf of the U.S. Government, then the following notice is applicable:

U.S. GOVERNMENT END USERS: Oracle programs (including any operating system, integrated software, any programs embedded, installed, or activated on delivered hardware, and modifications of such programs) and Oracle computer documentation or other Oracle data delivered to or accessed by U.S. Government end users are "commercial computer software," "commercial computer software documentation," or "limited rights data" pursuant to the applicable Federal Acquisition Regulation and agency-specific supplemental regulations. As such, the use, reproduction, duplication, release, display, disclosure, modification, preparation of derivative works, and/or adaptation of i) Oracle programs (including any operating system, integrated software, any programs embedded, installed, or activated on delivered hardware, and modifications of such programs), ii) Oracle computer documentation and/or iii) other Oracle data, is subject to the rights and limitations specified in the license contained in the applicable contract. The terms governing the U.S. Government's use of Oracle cloud services are defined by the applicable contract for such services. No other rights are granted to the U.S. Government.

This software or hardware is developed for general use in a variety of information management applications. It is not developed or intended for use in any inherently dangerous applications, including applications that may create a risk of personal injury. If you use this software or hardware in dangerous applications, then you shall be responsible to take all appropriate fail-safe, backup, redundancy, and other measures to ensure its safe use. Oracle Corporation and its affiliates disclaim any liability for any damages caused by use of this software or hardware in dangerous applications.

Oracle®, Java, MySQL, and NetSuite are registered trademarks of Oracle and/or its affiliates. Other names may be trademarks of their respective owners.

Intel and Intel Inside are trademarks or registered trademarks of Intel Corporation. All SPARC trademarks are used under license and are trademarks or registered trademarks of SPARC International, Inc. AMD, Epyc, and the AMD logo are trademarks or registered trademarks of Advanced Micro Devices. UNIX is a registered trademark of The Open Group.

This software or hardware and documentation may provide access to or information about content, products, and services from third parties. Oracle Corporation and its affiliates are not responsible for and expressly disclaim all warranties of any kind with respect to third-party content, products, and services unless otherwise set forth in an applicable agreement between you and Oracle. Oracle Corporation and its affiliates will not be responsible for any loss, costs, or damages incurred due to your access to or use of third-party content, products, or services, except as set forth in an applicable agreement between you and Oracle.

Contents

Preface

| | |
|-----------------------------|-----|
| Audience | xix |
| Documentation Accessibility | xix |
| Related Documents | xix |
| Conventions | xx |

1 Oracle Database Appliance Checklists

| | |
|---|-----|
| Checklist for System Requirements | 1-1 |
| Deployment Checklist for Oracle Database Appliance Bare Metal Systems | 1-6 |
| Checklist for Custom Network Address Configuration | 1-8 |

2 Introduction to Oracle Database Appliance

| | |
|--|-----|
| About Oracle Database Appliance | 2-1 |
| Oracle Database Appliance Software Terminology | 2-3 |
| About the Browser User Interface | 2-4 |

3 Readyng Oracle Database Appliance for Deployment

| | |
|--|------|
| Attaching Storage Cables to Oracle Database Appliance X11-HA | 3-1 |
| Attaching Network Cables to Oracle Database Appliance X11-HA | 3-4 |
| Attaching Network Cables to Oracle Database Appliance X11-S or X11-L | 3-6 |
| Attaching Power Cords and Initializing Components | 3-9 |
| Configuring Oracle Integrated Lights Out Manager | 3-9 |
| Powering On Oracle Database Appliance the First Time | 3-11 |

4 Provisioning Oracle Database Appliance Bare Metal System

| | |
|--|-----|
| Verifying Cabling and Network Connections | 4-1 |
| Plumbing the Network | 4-4 |
| Downloading Oracle Database Appliance Software | 4-6 |
| Installing Oracle Database Appliance Software | 4-7 |
| Creating the Appliance | 4-9 |

| | |
|--|------|
| About Enabling Oracle ASMFD on Oracle Database Appliance | 4-15 |
|--|------|

5 Implementing Multi-User Access on Oracle Database Appliance

| | |
|--|------|
| About Multi-User Access on Oracle Database Appliance | 5-2 |
| About Users, Roles, Entitlements, and Operations on a Multi-User Access Enabled Oracle Database Appliance System | 5-4 |
| About Granting and Revoking Resource Access | 5-5 |
| Using Passwordless Multi-User Access on Oracle Database Appliance | 5-6 |
| About Passwordless Multi-User Access on Oracle Database Appliance | 5-7 |
| Provisioning Oracle Database Appliance with Passwordless Multi-User Access | 5-9 |
| Creating, Viewing, and Deleting Users on Oracle Database Appliance with Passwordless Multi-User Access | 5-10 |
| Changing the Password for a User Account on Oracle Database Appliance with Passwordless Multi-User Access | 5-11 |
| Example JSON Files to Create a Single-Node Passwordless Multi-User Enabled Appliance | 5-12 |
| Example JSON File to Create a High-Availability Passwordless Multi-User Enabled Appliance | 5-17 |
| Example JSON Files to Create a Single-Node Passwordless Multi-User Enabled DB System | 5-21 |
| Example JSON File to Create a High-Availability Passwordless Multi-User Enabled DB System | 5-25 |
| Provisioning Oracle Database Appliance with Multi-User Access | 5-29 |
| Creating, Viewing, and Deleting Users on Oracle Database Appliance with Multi-User Access | 5-32 |
| Activating a New User on Oracle Database Appliance with Multi-User Access | 5-33 |
| Granting and Revoking Resource Access on Oracle Database Appliance with Multi-User Access | 5-34 |
| Viewing Roles, Operations, and Entitlements on Oracle Database Appliance with Multi-User Access | 5-35 |
| Managing Databases and Database Homes on Oracle Database Appliance with Multi-User Access | 5-36 |
| Changing the Password for a User Account on Oracle Database Appliance with Multi-User Access | 5-38 |
| Resetting the Password for a Locked User Account on Oracle Database Appliance with Multi-User Access | 5-38 |

6 Oracle Database Appliance Postinstallation Tasks

| | |
|---|-----|
| Configuring CPU Core Count | 6-1 |
| Modifying Oracle ASM Listener Port After Deployment | 6-2 |
| Securing Oracle ILOM Service Processors | 6-3 |
| Changing Oracle Database Appliance Passwords | 6-3 |

7 Re-imaging Oracle Database Appliance

| | |
|---|-----|
| Uninstalling Oracle Database Appliance Components | 7-1 |
| Reimaging an Oracle Database Appliance Baremetal System | 7-4 |
| Performing Secure Erase of Data on Storage Disks | 7-6 |
| Redeployment of Oracle Database Appliance | 7-7 |

8 Patching Oracle Database Appliance

| | |
|--|------|
| About Patching Oracle Database Appliance | 8-2 |
| About Patching Prechecks | 8-4 |
| About Enabling NUMA on Oracle Database Appliance | 8-6 |
| Minimizing Downtime When Patching Oracle Database Appliance | 8-7 |
| About Updating Databases and Database Homes | 8-8 |
| Updating ESTES-EXT Firmware Before Patching Oracle Database Appliance Server | 8-9 |
| Patching Oracle Database Appliance Bare Metal Systems Using the Command-Line | 8-18 |
| Patching Oracle Database Appliance DB Systems Using the Command-Line | 8-34 |
| Patching Oracle Database Appliance Bare Metal Systems Using the Browser User Interface | 8-40 |
| Patching Oracle Database Appliance DB Systems Using the Browser User Interface | 8-42 |
| Updating Oracle Database Appliance Repository with Database Clone Files For Bare Metal Systems | 8-43 |
| Patching Databases Using ODACLI Commands or the BUI | 8-44 |
| Patching Existing Database Homes Using ODACLI or the BUI | 8-46 |
| Patching Non-Provisioned Oracle Database Appliance Systems | 8-47 |
| Applying Additional Patches and Updates on Bare Metal Systems | 8-48 |
| Enabling Kernel Updates | 8-48 |
| Applying Out-of-Cycle Database Patches | 8-49 |
| Cleaning Up the Patch Repository | 8-50 |
| About Upgrading to a Different Database Home | 8-51 |
| Setting Dynamic Default Parameters | 8-52 |

9 Managing Oracle Databases

| | |
|--|------|
| About Administrative Groups and Users on Oracle Database Appliance | 9-2 |
| About Data Migration Options for Oracle Database Appliance | 9-3 |
| About Creating Database Homes on Oracle ACFS Storage | 9-3 |
| About Standard Edition High Availability for Oracle Database Appliance | 9-5 |
| About Enterprise Edition High Availability for Oracle Database Appliance | 9-6 |
| About Transparent Database Encryption (TDE) in Oracle Database Appliance | 9-7 |
| Storing Transparent Database Encryption Keys on Oracle Key Vault Server | 9-9 |
| About Oracle Key Vault | 9-10 |

| | |
|--|-------|
| Creating TDE-Enabled Databases With User Credentials | 9-12 |
| Creating TDE-Enabled Databases Using Oracle Key Vault With Endpoints in Oracle Key Vault | 9-16 |
| Managing Oracle Key Vault Server Configuration Operations Using ODACLI Commands | 9-22 |
| Managing Database Operations on TDE-enabled Databases with TDE keys stored on Oracle Key Vault | 9-24 |
| Changing the Password for TDE-enabled Databases | 9-24 |
| Re-keying TDE Master Encryption Key for TDE-Enabled Databases | 9-26 |
| Performing Backup and Recovery of TDE-enabled Databases | 9-27 |
| Restoring TDE-Enabled Databases Using Oracle Key Vault User Credentials | 9-32 |
| Restoring TDE-Enabled Databases With Endpoints and Wallet Manually Created in Oracle Key Vault | 9-40 |
| Deleting TDE-enabled Databases | 9-50 |
| Creating an Oracle Key Vault User Using BUI | 9-52 |
| Creating Oracle Key Vault Server Configuration Object Using the BUI | 9-52 |
| Granting and Revoking Access on Oracle Key Vault Server Configuration Using BUI | 9-53 |
| Managing Oracle Key Vault Server Configuration Operations Using BUI | 9-53 |
| Manual Migration and Encryption of Data into TDE-Enabled Database | 9-54 |
| Migrating Tablespaces from Non-TDE Oracle ACFS Database to Oracle ACFS Database on Oracle Database Appliance | 9-54 |
| Migrating Tablespaces from Non-TDE Oracle ASM Database to Oracle ASM Database on Oracle Database Appliance | 9-60 |
| Migrating Tablespaces from Non-TDE Oracle ASM Database to Oracle ASM CDB Database on Oracle Database Appliance | 9-67 |
| Migrating Tablespaces from Non-TDE Oracle ACFS Database to Oracle ACFS CDB Database on Oracle Database Appliance | 9-74 |
| Working with Databases | 9-82 |
| Viewing Databases | 9-83 |
| Creating a Database Using the Browser User Interface | 9-83 |
| Managing Database Homes on Oracle ACFS Storage | 9-86 |
| Creating a Database Using ODACLI Commands | 9-87 |
| Cloning a Database from Backup | 9-88 |
| Cloning an Oracle ACFS Database | 9-90 |
| Modifying a Database | 9-92 |
| Moving a Database from One Oracle Home to Another | 9-93 |
| Upgrading a Database | 9-94 |
| Upgrading a Database Manually Using AutoUpgrade | 9-95 |
| Deleting a Database | 9-102 |
| Working with Database Homes | 9-102 |
| About Managing Multiple Oracle Homes on Oracle Database Appliance | 9-103 |
| Viewing Database Homes | 9-104 |
| Creating a Database Home | 9-104 |
| Deleting a Database Home | 9-104 |
| Migrating Databases | 9-104 |

| | |
|--|-------|
| About Migrating Databases | 9-105 |
| Configuring a Static Listener | 9-106 |
| Migrating a Database | 9-107 |
| Registering a Database | 9-108 |
| About Registering a TDE-Enabled Database | 9-109 |
| About Managing Multiple Database Instances Using Instance Caging | 9-115 |
| Oracle EM Express and DB Console | 9-115 |

10 Managing Storage

| | |
|--|-------|
| About Managing Storage | 10-1 |
| About Managing Oracle ASM Disks | 10-1 |
| Managing Storage on Single-Node Systems | 10-2 |
| About Storage on Oracle Database Appliance X11-S and X11-L | 10-2 |
| Adding Small Form Factor (SFF) NVMe Storage Disks | 10-3 |
| Adding Add-in-Card (AIC) NVMe Storage Disks | 10-8 |
| Replacing Small Form Factor (SFF) NVMe Storage Disks | 10-21 |
| Managing Storage on High-Availability Systems | 10-22 |
| About Storage Options for Oracle Database Appliance X11-HA | 10-22 |
| Adding Solid-State Drives (SSDs) for Data Storage | 10-24 |
| Adding the Storage Expansion Shelf | 10-30 |

11 Managing Networks

| | |
|---|------|
| About Network Infrastructure and VLANs on Oracle Database Appliance | 11-1 |
| About Oracle Database Appliance X11 Network Interfaces | 11-2 |
| Viewing Configured Networks and Network Interfaces | 11-4 |
| Creating a Network | 11-4 |
| Creating a Physical Network | 11-5 |
| Updating a Network | 11-5 |
| Adding a Network Interface | 11-6 |
| Deleting a Network Interface | 11-6 |
| Deleting a Network Interface Using Browser User Interface | 11-6 |
| Deleting a Network Using the Browser User Interface | 11-7 |

12 Backup, Restore and Recover Databases

| | |
|---|-------|
| About Database Backup and Recovery Options | 12-1 |
| Configuring NFS Backup and Restore on Oracle Database Appliance | 12-9 |
| Configuring an NFS Backup Location | 12-9 |
| Backing Up the Database to NFS Location | 12-12 |
| Restoring the Database from NFS Backup | 12-15 |

| | |
|--|-------|
| Configuring Agent Proxy Settings for Object Store Access | 12-17 |
| Creating a Database Backup Policy | 12-18 |
| Updating a Database with a Backup Policy | 12-19 |
| Updating a Backup Policy | 12-19 |
| Backing Up a Database Using the Browser User Interface | 12-19 |
| Viewing Backup Reports | 12-20 |
| Recovering a Database Using the Browser User Interface | 12-20 |
| Deleting a Backup Using the Browser User Interface | 12-21 |
| Deleting a Backup Policy | 12-21 |
| Using the CLI to Backup, Restore, and Recover | 12-21 |
| Preparing for Database Backup to Disk | 12-22 |
| Preparing for Database Backup to NFS Location | 12-23 |
| Preparing for Database Backup to Oracle Cloud | 12-24 |
| Backing Up a Database with the CLI | 12-25 |
| Recovering a Database with the CLI | 12-26 |
| Restoring a Database with the CLI | 12-28 |
| Restoring Archivelog with the CLI | 12-31 |
| Deleting Backups with the CLI | 12-31 |

13 Using Oracle Data Guard for Disaster Management and Recovery on Oracle Database Appliance

| | |
|--|-------|
| About Oracle Data Guard on Oracle Database Appliance | 13-2 |
| Deploying Multiple Standby Databases with Oracle Data Guard on Oracle Database Appliance | 13-3 |
| Configuring Oracle Data Guard on Oracle Database Appliance | 13-3 |
| Configuring Oracle Data Guard on Oracle Database Appliance Using BUI | 13-26 |
| Viewing Oracle Data Guard Status on Oracle Database Appliance | 13-28 |
| Viewing Oracle Data Guard Status on Oracle Database Appliance Using BUI | 13-29 |
| Performing Oracle Data Guard Operations | 13-29 |
| Performing Oracle Data Guard Operations Using BUI | 13-30 |
| Creating an Oracle Data Guard Network | 13-31 |
| Migrating an Oracle Database from One System to Another Using Integrated Oracle Data Guard | 13-32 |
| Patching Oracle Data Guard Databases on Oracle Database Appliance | 13-38 |
| Enabling Oracle Active Data Guard on Existing Configurations | 13-40 |
| Registering Oracle Data Guard on Oracle Database Appliance Using ODA CLI Commands | 13-40 |
| Registering Oracle Data Guard on Oracle Database Appliance Using BUI | 13-61 |
| Deconfiguring Oracle Data Guard on Oracle Database Appliance | 13-63 |
| Deconfiguring Oracle Data Guard on Oracle Database Appliance Using BUI | 13-67 |

14 Managing CPU Pools on Oracle Database Appliance Bare Metal and KVM Deployments

| | |
|--|------|
| About CPU Pools | 14-1 |
| Creating a CPU Pool in a Bare Metal or KVM Deployment | 14-3 |
| Remapping CPU Pools in a Bare Metal or KVM Deployment | 14-4 |
| Viewing CPU Pools in a Bare Metal or KVM Deployment | 14-5 |
| Modifying a CPU Pool in a Bare Metal or KVM Deployment | 14-6 |
| Deleting a CPU Pool in a Bare Metal or KVM Deployment | 14-6 |
| Viewing CPU Pool Audit Records in a Bare Metal or KVM Deployment | 14-7 |
| About Over-Subscribed CPU Pools | 14-7 |

15 Managing an Oracle Database Appliance KVM Deployment

| | |
|---|-------|
| About Oracle Database Appliance KVM Deployment | 15-2 |
| About Oracle Database Appliance KVM Virtualization Architecture | 15-3 |
| About Virtual Machines and Oracle Database Appliance KVM Deployments | 15-4 |
| About KVM DB Systems on Oracle Database Appliance | 15-7 |
| Deploying Multiple Databases on DB Systems on Oracle Database Appliance | 15-10 |
| Managing DB Systems in KVM Deployment | 15-15 |
| Creating a DB System in a KVM Deployment | 15-16 |
| Listing DB Systems in a KVM Deployment | 15-22 |
| Describing a DB System in a KVM Deployment | 15-23 |
| Modifying a DB System in a KVM Deployment | 15-24 |
| Attaching and Detaching a Network for a DB System in a KVM Deployment | 15-26 |
| Starting a DB System in a KVM Deployment | 15-27 |
| Stopping a DB System in a KVM Deployment | 15-27 |
| Deleting a DB System in a KVM Deployment | 15-28 |
| Managing Backup, Restore, and Recovery on a DB System in a KVM Deployment | 15-29 |
| Managing Shared CPU Pool with DB System in a KVM Deployment | 15-29 |
| Managing Oracle Data Guard on a DB System in a KVM Deployment | 15-32 |
| Setting Up and Configuring a KVM Deployment for Applications | 15-33 |
| Managing VM Storage in KVM Deployment | 15-33 |
| Creating a VM Storage in a KVM Deployment | 15-34 |
| Viewing VM Storage in a KVM Deployment | 15-34 |
| Modifying VM Storage in a KVM Deployment | 15-35 |
| Deleting a VM Storage in a KVM Deployment | 15-36 |
| Managing Virtual Networks in KVM Deployment | 15-36 |
| Creating a Virtual Network in a KVM Deployment | 15-37 |
| Viewing Virtual Networks in a KVM Deployment | 15-38 |
| Starting and Stopping Virtual Networks in a KVM Deployment | 15-38 |
| Modifying a Virtual Network in a KVM Deployment | 15-39 |

| | |
|--|-------|
| Deleting a Virtual Network in a KVM Deployment | 15-39 |
| Managing Virtual Disks in KVM Deployment | 15-40 |
| Creating a Virtual Disk in a KVM Deployment | 15-40 |
| Viewing Virtual Disks in a KVM Deployment | 15-42 |
| Cloning a Virtual Disk in a KVM Deployment | 15-42 |
| Modifying a Virtual Disk in a KVM Deployment | 15-43 |
| Deleting a Virtual Disk in a KVM Deployment | 15-44 |
| Managing Virtual Machines in KVM Deployment | 15-44 |
| Creating a Virtual Machine in a KVM Deployment | 15-45 |
| Cloning a Virtual Machine in a KVM Deployment | 15-48 |
| Modifying a Virtual Machine in a KVM Deployment | 15-49 |
| Viewing Virtual Machines in a KVM Deployment | 15-50 |
| Starting and Stopping Virtual Machines in a KVM Deployment | 15-51 |
| Deleting a Virtual Machine in a KVM Deployment | 15-51 |
| About Overcommitting Memory or CPUs in an Oracle Database Appliance KVM System | 15-52 |
| Example JSON File to Create a Single-Node DB System | 15-52 |
| Example JSON File to Create a High-Availability DB System | 15-62 |

16 Oracle Database Appliance Command-Line Interface

| | |
|--|-------|
| About Oracle Database Appliance Command-Line Interface | 16-2 |
| Managing ODACLI Privileges and Security with SUDO | 16-4 |
| ODACLI Command Changes with Multi-User Access on Oracle Database Appliance | 16-6 |
| odacli Network Commands | 16-13 |
| odacli configure-firstnet | 16-13 |
| odacli create-network | 16-16 |
| odacli delete-network | 16-18 |
| odacli delete-networkinterface | 16-19 |
| odacli describe-network | 16-20 |
| odacli describe-networkinterface | 16-22 |
| odacli list-networks | 16-23 |
| odacli list-networkinterfaces | 16-23 |
| odacli modify-network | 16-24 |
| odacli Multi-User Access Commands | 16-26 |
| odacli list-domains | 16-27 |
| odacli describe-domain | 16-28 |
| odacli list-tenants | 16-29 |
| odacli describe-tenant | 16-29 |
| odacli create-user | 16-30 |
| odacli activate-user | 16-31 |
| odacli list-users | 16-32 |
| odacli describe-user | 16-33 |

| | |
|--|--------|
| odacli authorize-user | 16-34 |
| odacli delete-user | 16-35 |
| odacli list-user-roles | 16-36 |
| odacli describe-user-role | 16-37 |
| odacli list-user-entitlements | 16-38 |
| odacli describe-user-entitlement | 16-39 |
| odacli list-user-operations | 16-40 |
| odacli describe-user-operation | 16-40 |
| odacli list-resources-access | 16-41 |
| odacli describe-resource-access | 16-42 |
| odacli grant-resource-access | 16-43 |
| odacli revoke-resource-access | 16-44 |
| odacli reset-password | 16-45 |
| odacli change-password | 16-46 |
| odacli Apply Patch and Update Commands | 16-46 |
| odacli cleanup-patchrepo | 16-48 |
| odacli create-prepatchreport | 16-49 |
| odacli describe-prepatchreport | 16-52 |
| odacli list-prepatchreports | 16-62 |
| odacli delete-prepatchreport | 16-63 |
| odacli list-availablepatches | 16-63 |
| odacli describe-component | 16-65 |
| odacli describe-latestpatch | 16-71 |
| odacli list-agentconfig-parameters | 16-72 |
| odacli modify-agentconfig-parameters | 16-74 |
| odacli delete-agentconfig-parameters | 16-76 |
| odacli update-database | 16-78 |
| odacli update-dbhome | 16-79 |
| odacli update-dcsadmin | 16-81 |
| odacli update-dcsagent | 16-81 |
| odacli update-dcscomponents | 16-82 |
| odacli update-registry | 16-83 |
| odacli update-repository | 16-91 |
| odacli update-server | 16-92 |
| odacli update-storage | 16-94 |
| odacli update-server-postcheck | 16-95 |
| odaadmcli orachk | 16-95 |
| odacli Appliance Commands | 16-96 |
| odaconfigcli collectconfig | 16-97 |
| odacli modify-asmport | 16-98 |
| odacli set-credential | 16-100 |
| odacli create-appliance | 16-101 |

| | |
|---|--------|
| odacli describe-system | 16-102 |
| odacli ping-agent | 16-104 |
| odacli list-nodes | 16-104 |
| odacli list-featuretracking | 16-105 |
| odacli Backup and Recovery Commands | 16-108 |
| odacli create-backup | 16-109 |
| odacli create-backupconfig | 16-111 |
| odacli create-objectstoreswift | 16-113 |
| odacli describe-backupconfig | 16-113 |
| odacli delete-backup | 16-114 |
| odacli delete-backupconfig | 16-115 |
| odacli describe-backupreport | 16-116 |
| odacli describe-objectstoreswift | 16-118 |
| odacli delete-objectstoreswift | 16-119 |
| odacli describe-schedule | 16-119 |
| odacli irestore-database | 16-120 |
| odacli list-backupconfigs | 16-126 |
| odacli list-backupreports | 16-126 |
| odacli list-objectstoreswifts | 16-127 |
| odacli list-schedules | 16-127 |
| odacli list-tdebackupreports | 16-129 |
| odacli recover-database | 16-129 |
| odacli restore-archivelog | 16-132 |
| odacli restore-tdewallet | 16-132 |
| odacli modify-backupconfig | 16-133 |
| odacli modify-objectstoreswift | 16-135 |
| odacli modify-schedule | 16-136 |
| odacli Oracle Data Guard Commands | 16-137 |
| odacli configure-dataguard | 16-137 |
| odacli deconfigure-dataguard | 16-149 |
| odacli describe-dataguardstatus | 16-151 |
| odacli failover-dataguard | 16-153 |
| odacli list-dataguardstatus | 16-154 |
| odacli reinstate-dataguard | 16-155 |
| odacli register-dataguard | 16-155 |
| odacli switchover-dataguard | 16-156 |
| odacli CPU Core Commands | 16-156 |
| odacli list-cpucores | 16-157 |
| odacli describe-cpucore | 16-157 |
| odacli modify-cpucore | 16-158 |
| odacli CPU Pool Commands for Bare Metal and KVM | 16-159 |
| odacli create-cpupool | 16-160 |

| | |
|--|--------|
| odacli remap-cpupools | 16-161 |
| odacli list-cpupools | 16-162 |
| odacli describe-cpupool | 16-163 |
| odacli modify-cpupool | 16-163 |
| odacli delete-cpupool | 16-164 |
| odacli list-auditrecords | 16-164 |
| odacli describe-auditrecord | 16-165 |
| odacli Database Commands | 16-166 |
| odacli clone-database | 16-166 |
| odacli create-database | 16-176 |
| odacli delete-database | 16-182 |
| odacli describe-database | 16-184 |
| odacli list-databases | 16-185 |
| odacli modify-database | 16-186 |
| odacli move-database | 16-190 |
| odacli register-database | 16-190 |
| odacli upgrade-database | 16-193 |
| odacli DBHome Commands | 16-195 |
| odacli configure-dbhome-storage | 16-196 |
| odacli list-dbhome-storages | 16-197 |
| odacli describe-dbhome-storage | 16-198 |
| odacli modify-dbhome-storage | 16-199 |
| odacli create-dbhome | 16-200 |
| odacli delete-dbhome | 16-200 |
| odacli describe-dbhome | 16-201 |
| odacli list-dbhomes | 16-202 |
| odacli Database Storage Commands | 16-203 |
| odacli create-dbstorage | 16-203 |
| odacli delete-dbstorage | 16-205 |
| odacli describe-dbstorage | 16-205 |
| odacli describe-dgstorage | 16-207 |
| odacli list-dbstorages | 16-209 |
| odacli list-dgstorages | 16-209 |
| odacli modify-dbstorage | 16-210 |
| odacli modify-dgstorage | 16-212 |
| odacli Diagnostics Collection Commands | 16-213 |
| odacli create-diagcollection | 16-213 |
| odacli describe-diagcollection | 16-214 |
| odacli list-diagcollections | 16-215 |
| odacli delete-diagcollection | 16-215 |
| odacli Job Commands | 16-216 |
| odacli create-jobdata-retention-policy | 16-217 |

| | |
|---|--------|
| odacli create-purge-jobdata-job | 16-218 |
| odacli delete-jobdata-retention-policy | 16-222 |
| odacli describe-job | 16-223 |
| odacli list-jobs | 16-225 |
| odacli list-pendingjobs | 16-229 |
| odacli list-jobdata-retention-policy | 16-229 |
| odacli list-purge-jobdata-jobs | 16-230 |
| odacli list-scheduled-executions | 16-231 |
| odacli Oracle Key Vault Server Configuration Commands | 16-232 |
| odacli create-okvserverconfig | 16-233 |
| odacli copy-okvtdewallet | 16-233 |
| odacli delete-okvserverconfig | 16-236 |
| odacli describe-okvserverconfig | 16-237 |
| odacli list-okvserverconfigs | 16-238 |
| Log Commands | 16-239 |
| odaadmcli manage diagcollect | 16-240 |
| odacli create-auto-logclean-policy | 16-241 |
| odacli delete-auto-logclean-policy | 16-242 |
| odacli create-logcleanjob | 16-243 |
| odacli describe-logcleanjob | 16-244 |
| odacli list-auto-logclean-policy | 16-245 |
| odacli list-logcleanjobs | 16-246 |
| odacli list-logspaceusage | 16-246 |
| odacli Oracle Auto Service Request Commands | 16-247 |
| odacli configure-asr | 16-248 |
| odacli describe-asr | 16-250 |
| odacli delete-asr | 16-250 |
| odacli export-asrconfig | 16-251 |
| odacli modify-asr | 16-252 |
| odacli test-asr | 16-253 |
| Adaptive Classification and Redaction (ACR) Commands | 16-254 |
| odacli describe-acr | 16-254 |
| odacli enable-acr | 16-255 |
| odacli redact-acr | 16-255 |
| odacli list-acr | 16-256 |
| odacli disable-acr | 16-256 |
| odacli OS Commands | 16-257 |
| odacli list-osconfigurations | 16-257 |
| odacli modify-osconfigurations | 16-258 |
| odaadmcli Hardware Monitoring Commands | 16-259 |
| odaadmcli show localdisk | 16-259 |
| odaadmcli show cooling | 16-260 |

| | |
|---------------------------------|--------|
| odaadmcli show env_hw | 16-260 |
| odaadmcli show fs | 16-261 |
| odaadmcli show memory | 16-262 |
| odaadmcli show network | 16-262 |
| odaadmcli show power | 16-263 |
| odaadmcli show processor | 16-264 |
| odaadmcli show server | 16-264 |
| Storage Commands | 16-265 |
| odaadmcli asmops diskgroup | 16-266 |
| odaadmcli expand storage | 16-267 |
| odacli list-dgdisks | 16-267 |
| odacli validate-storagetopology | 16-269 |
| odaadmcli power disk | 16-269 |
| odaadmcli show controller | 16-270 |
| odaadmcli show disk | 16-271 |
| odaadmcli show diskgroup | 16-272 |
| odaadmcli show raidsyncstatus | 16-273 |
| odaadmcli show storage | 16-274 |
| odaadmcli stordiag | 16-275 |

17 Oracle Database Appliance Command-Line Interface for KVM

| | |
|---|-------|
| About Command-Line Interface for Kernel-Based Virtual Machine (KVM) | 17-1 |
| About ODACLI Commands Supported on Oracle KVM Database System | 17-3 |
| odacli DB System Commands for KVM | 17-5 |
| odacli create-dbssystem | 17-6 |
| odacli modify-dbssystem | 17-7 |
| odacli modify-dbfileattributes | 17-10 |
| odacli list-dbssystems | 17-11 |
| odacli describe-dbssystem | 17-12 |
| odacli describe-dbssystem-image | 17-18 |
| odacli start-dbssystem | 17-19 |
| odacli stop-dbssystem | 17-20 |
| odacli delete-dbssystem | 17-21 |
| odacli VM Storage Commands for KVM | 17-23 |
| odacli create-vmstorage | 17-23 |
| odacli list-vmstorages | 17-24 |
| odacli describe-vmstorage | 17-24 |
| odacli modify-vmstorage | 17-25 |
| odacli delete-vmstorage | 17-25 |
| odacli Virtual Disk Commands for Oracle KVM | 17-26 |
| odacli create-vdisk | 17-26 |

| | |
|---|-------|
| odacli list-vdisks | 17-27 |
| odacli describe-vdisk | 17-27 |
| odacli modify-vdisk | 17-28 |
| odacli clone-vdisk | 17-28 |
| odacli delete-vdisk | 17-29 |
| odacli CPU Pool Commands for Bare Metal and KVM | 17-29 |
| odacli create-cpupool | 17-30 |
| odacli remap-cpupools | 17-31 |
| odacli list-cpupools | 17-32 |
| odacli describe-cpupool | 17-33 |
| odacli modify-cpupool | 17-33 |
| odacli delete-cpupool | 17-34 |
| odacli list-auditrecords | 17-34 |
| odacli describe-auditrecord | 17-35 |
| odacli VM Network Commands for KVM | 17-36 |
| odacli create-vnetwork | 17-37 |
| odacli list-vnetworks | 17-37 |
| odacli describe-vnetwork | 17-38 |
| odacli start-vnetwork | 17-38 |
| odacli stop-vnetwork | 17-39 |
| odacli modify-vnetwork | 17-39 |
| odacli delete-vnetwork | 17-40 |
| odacli Virtual Machine Commands for Oracle KVM | 17-40 |
| odacli create-vm | 17-41 |
| odacli list-vm | 17-42 |
| odacli describe-vm | 17-43 |
| odacli modify-vm | 17-43 |
| odacli start-vm | 17-46 |
| odacli stop-vm | 17-46 |
| odacli migrate-vm | 17-47 |
| odacli clone-vm | 17-47 |
| odacli delete-vm | 17-48 |

18 Configuring and Using Oracle Auto Service Request (Oracle ASR)

| | |
|--|-------|
| About Configuring Oracle ASR | 18-1 |
| Configuring Internal Oracle ASR | 18-3 |
| Registering with External Oracle ASR Manager | 18-5 |
| Configuring External Oracle ASR When Oracle ASR Manager Does Not Run on an Oracle Database Appliance | 18-7 |
| Testing Oracle ASR | 18-11 |
| Managing an Oracle ASR Configuration | 18-12 |

19 Troubleshooting Oracle Database Appliance

| | |
|--|-------|
| About Oracle Database Appliance Configuration Collection Utility | 19-2 |
| About Setting Up and Removing SSH Configuration | 19-5 |
| Viewing Oracle Database Appliance Error Correlation Reports | 19-5 |
| About Enabling Linux Kernel Core Extractor for Troubleshooting | 19-6 |
| Viewing Details About DCS Error Messages | 19-8 |
| Collecting Diagnostics Data Using the BUI | 19-9 |
| Resolving Errors When Updating DCS Components During Patching | 19-9 |
| Viewing Component Information on the Appliance | 19-18 |
| Errors When Logging into the Browser User Interface | 19-21 |
| Errors when re-imaging Oracle Database Appliance | 19-22 |
| Using Oracle Autonomous Health Framework for Running Diagnostics | 19-22 |
| About Installing Oracle Autonomous Health Framework | 19-23 |
| Using the Oracle ORAchk Health Check Tool | 19-24 |
| Generating and Viewing Oracle ORAchk Health Check Tool Reports in the Browser User Interface | 19-25 |
| Generating and Viewing Database Security Assessment Reports in the Browser User Interface | 19-25 |
| Running Oracle Trace File Analyzer (TFA) Collector Commands | 19-26 |
| Sanitizing Sensitive Information in Diagnostic Collections | 19-28 |
| Enabling Adaptive Classification and Redaction (ACR) | 19-30 |
| Sanitizing Sensitive Information in Oracle Trace File Analyzer Collections | 19-31 |
| Redacting and Sanitizing Entities in the BUI | 19-31 |
| Sanitizing Sensitive Information in Oracle ORAchk Output | 19-32 |
| Running the Disk Diagnostic Tool | 19-34 |
| Running the Oracle Database Appliance Hardware Monitoring Tool | 19-34 |
| Disabling the Browser User Interface | 19-35 |
| Preparing Log Files for Oracle Support Services | 19-35 |

A Oracle Database Appliance Software Configuration Defaults

| | |
|---|-----|
| Directory Paths for Oracle Database Appliance | A-1 |
| Port Numbers and Protocols of Oracle Database Appliance Components | A-2 |
| Location of Log Files | A-4 |
| Oracle Groups and User Configurations for Oracle Database Appliance | A-5 |

B Oracle Database Appliance Storage Defaults

| | |
|--|-----|
| About Database File Storage | B-1 |
| Oracle ACFS Mount Points and Storage Space | B-2 |

| | |
|---|-----|
| Displaying Mounted Disk Details | B-3 |
| Usable Space on Oracle Database Appliance X11-S and X11-L | B-4 |
| Usable Space on Oracle Database Appliance X11-HA | B-5 |
| Usable Free Space with Oracle ASM | B-6 |

C Creating an Appliance Using JSON File

| | |
|--|-----|
| Loading and Saving Appliance Configurations | C-1 |
| Readme for the Command <code>odacli create-appliance</code> | C-1 |
| Example JSON Files to Create a Single Node Appliance with the CLI | C-2 |
| Example JSON File to Create a High-Availability Appliance with the CLI | C-7 |

D Database Shapes for Oracle Database Appliance

| | |
|---|-----|
| About Database Shapes and Classes | D-1 |
| Database Shapes for the OLTP Class | D-2 |
| Database Shapes for the In-Memory Class | D-4 |
| Database Shapes for the DSS Class | D-6 |

Index

Preface

Oracle Database Appliance is an optimized, prebuilt database system that is easy to deploy, operate, and manage. By integrating hardware and software, Oracle Database Appliance eliminates the complexities of nonintegrated, manually assembled solutions. Oracle Database Appliance reduces the installation and software deployment times from weeks or months to just a few hours while preventing configuration and setup errors that often result in suboptimal, hard-to-manage database environments.

- [Audience](#)
- [Documentation Accessibility](#)
- [Related Documents](#)
- [Conventions](#)

Audience

This guide is intended for anyone who configures, maintains, or uses Oracle Database Appliance:

- System administrators
- Network administrators
- Database administrators
- Application administrators and users

This book does not include information about Oracle Database architecture, tools, management, or application development that is covered in the main body of Oracle Documentation, unless the information provided is specific to Oracle Database Appliance. Users of Oracle Database Appliance software are expected to have the same skills as users of any other Linux-based Oracle Database installations.

Documentation Accessibility

For information about Oracle's commitment to accessibility, visit the Oracle Accessibility Program website at <http://www.oracle.com/pls/topic/lookup?ctx=acc&id=docacc>.

Access to Oracle Support

Oracle customer access to and use of Oracle support services will be pursuant to the terms and conditions specified in their Oracle order for the applicable services.

Related Documents

For more information about Oracle Database Appliance, go to <http://www.oracle.com/goto/oda/docs> and click the appropriate release.

For more information about using Oracle Database, go to <http://docs.oracle.com/database/> and select the database release from the menu.

For more information about Oracle Integrated Lights Out Manager 3.2, see https://docs.oracle.com/cd/E37444_01/.

For more details about other Oracle products that are mentioned in Oracle Database Appliance documentation, see the Oracle Documentation home page at <http://docs.oracle.com>.

Conventions

The following text conventions are used in this document:

| Convention | Meaning |
|-----------------|--|
| boldface | Boldface type indicates graphical user interface elements associated with an action or terms defined in the text. |
| <i>italic</i> | Italic type indicates book titles, emphasis, or placeholder variables for which you supply particular values. |
| monospace | Monospace type indicates commands within a paragraph, URLs, code in examples, text that appears on the screen, or text that you enter. |
| # prompt | The pound (#) prompt indicates a command that is run as the root user. |

1

Oracle Database Appliance Checklists

Use these checklists to ensure you have completed the tasks required for setting up, deploying, and patching Oracle Database Appliance.

- [Checklist for System Requirements](#)
Before you begin the deployment, ensure that you have the system information described in this checklist ready. This checklist applies to baremetal and virtualized platform deployments.
- [Deployment Checklist for Oracle Database Appliance Bare Metal Systems](#)
This checklist provides an overview of the tasks to setup and deploy Oracle Database Appliance bare metal systems for the first time.
- [Checklist for Custom Network Address Configuration](#)
Use the checklist to identify the IP addresses required for Oracle Database Appliance.

Checklist for System Requirements

Before you begin the deployment, ensure that you have the system information described in this checklist ready. This checklist applies to baremetal and virtualized platform deployments.

Table 1-1 Checklist for System Configuration Information for Oracle Database Appliance

| Component | Information Required | Comments |
|-------------|---|---|
| Host Name | The name for the Oracle Database Appliance System. The name must conform with the RFC 952 standard, which allows alphanumeric characters and hyphens (-), but does not allow underscores (_). The name should not begin with a numeral or hyphen and should not end in a hyphen. Oracle recommends that you use all lowercase characters for the host name. | Use this space to note the values for your appliance. Host Name: |
| Domain Name | Your domain name. For example: <code>example.com</code> | Domain Name: |
| Region | The region where you plan to operate the Oracle Database Appliance system. | Region: |
| Timezone | The time zone where you plan to operate the Oracle Database Appliance system. | Timezone: |

Table 1-1 (Cont.) Checklist for System Configuration Information for Oracle Database Appliance

| Component | Information Required | Comments |
|---|---|--|
| Diskgroup Redundancy | Determine the redundancy level for DATA, RECO, and FLASH: If there are up to two disks, then you can select the disk group redundancy as Normal or Flex. If there are more than two disk drives, then you can select the redundancy as Normal (two way mirror), High (three way mirror), or Flex. If you select High redundancy, then DATA, RECO, and FLASH are all High Redundancy. | Use this space to note the values for your appliance. |
| Number of Enabled CPU Cores | Based on your capacity-on-demand (CoD) license, this value specifies the number of enabled CPU cores | Use this space to note the values for your appliance. |
| Backup | Determine the backup location. For external backup, you need an NFS device. | Backup location: |
| Percentage of Storage Reserved for Data | Determine the amount of reserves for DATA storage. The percentage must be a whole number between 10 and 90, and determines how the disks are partitioned between DATA and RECO. For example, if you specify 80, then 80% of storage is reserved for DATA and the remaining 20% is for RECO. | Use this space to note the values for your appliance. |
| System Password | The password set for the root user of the system, operating system users, database users, and pdbname. The password is also used to set the database SYS and SYSTEM passwords. Ensure that the password you provide is in compliance with common security practices. | You must provide a system password when you deploy your appliance. |
| DNS Server | (Optional) DNS server details. If configuring DNS, a minimum of one DNS Server IP is required. | DNS Server details: |
| NTP Server | (Optional) Network Time Protocol (NTP) server details. | NTP Server details: |

Table 1-1 (Cont.) Checklist for System Configuration Information for Oracle Database Appliance

| Component | Information Required | Comments |
|---|---|---|
| Network Information for the client access network | <p>Obtain the following network information:</p> <ul style="list-style-type: none"> • Node 0 Name: such as <code>example0</code> • Node 0 Public IP Address • Node 1 Name (For HA Models): such as <code>example1</code> • Node 1 Public IP Address (For HA Models) • Node 0 Virtual IP Name (For HA Models): for example, <code>example0-vip</code> • Node 0 Public Virtual IP Address (For HA Models) • Node 1 Virtual IP Name (For HA Models): for example, <code>example1-vip</code> • Node 1 Public Virtual IP Address (For HA Models) • SCAN Name (For HA Models): for example, <code>example-scan</code> • SCAN IP Addresses: Two SCAN IP addresses are required • Netmask • Gateway IP <p>The Public and private network must not be in same subnet, they must be in non-related separate subnet.</p> | Use this space to note the values for your appliance. |
| Network Information for the Oracle Integrated Lights Out Manager (ILOM) network | <p>Obtain the following ILOM network information:</p> <ul style="list-style-type: none"> • ILOM host name • ILOM IP address • Subnet mask • Gateway IP • ILOM Password: default is <code>changeme</code>. <p>For HA systems, ensure that you have the information to configure two ILOM networks.</p> | Use this space to note the values for your appliance. |

Table 1-1 (Cont.) Checklist for System Configuration Information for Oracle Database Appliance

| Component | Information Required | Comments |
|----------------------------|---|---|
| User and group information | <p>Determine how you want to configure your users and groups and whether or not you want to allow operating system role separation. The default is two users with six groups.</p> <p>Operating System Role Separation: Yes/No</p> <p>Customization of Users and Groups: Yes/No</p> <p>Groups and IDs:</p> <ul style="list-style-type: none"> • Grid Infrastructure User • Grid Infrastructure User ID • Database User • Database User ID • Install Group • Install Group ID • DBA Operating System Group • DBA Operating System Group ID • ASM Admin Group • ASM Admin Group ID • ASM Operating System Group • ASM Operating System Group ID • ASM DBA Group • ASM DBA Group ID | Use this space to note the values for your appliance. |

Table 1-1 (Cont.) Checklist for System Configuration Information for Oracle Database Appliance

| Component | Information Required | Comments |
|--|--|---|
| Initial Database Details (if you want to create one during deployment) | <p>(Optional) If you choose to create an initial database during deployment, determine the following configuration details:</p> <ul style="list-style-type: none"> • Database name • Database unique name • Database version (based on the database clones that are registered with the Oracle Database Appliance) • Determine the Oracle Database edition licensing that you have, either Enterprise Edition or Standard Edition. You cannot mix editions. • Database deployment, whether Oracle RAC or single-instance database • CDB (Container Database): Yes or No • PDB name • Shape (for example, odb1, odb2, and so on) • Database Class: Enterprise Edition, OLTP, DSS, or IMDB. Standard Edition OLTP only. • Data files on Flash storage: Yes/No • Database file size • Database character set • National character set • Database language • Storage (Oracle ASM or Oracle ACFS). • Database redundancy • Configure Oracle Enterprise Manager console. If you are using Enterprise Manager Cloud Control with this appliance, do not choose this option. • Password for the database <p>The DB Name and DB Unique name can contain alphanumeric characters and must start with an alphabet. It can contain underscores (_), but cannot contain characters such as "!@%^&*()+=\\ `~[{}];:'\",<>/?".</p> | Use this space to note the values for your appliance. |

Table 1-1 (Cont.) Checklist for System Configuration Information for Oracle Database Appliance

| Component | Information Required | Comments |
|--|--|---|
| Oracle Auto Service Request (Oracle ASR) information | <p>(Optional) Do you want to configure and enable Oracle ASR at deployment or later? If required, then ensure that you have the following information.</p> <ul style="list-style-type: none"> ASR Type ASR User Name ASR Password SNMP Version Proxy Server Name Proxy Port Proxy User Name Proxy Password | Oracle Auto Service Request (Oracle ASR) information for your appliance |

Deployment Checklist for Oracle Database Appliance Bare Metal Systems

This checklist provides an overview of the tasks to setup and deploy Oracle Database Appliance bare metal systems for the first time.

Table 1-2 Deployment Checklist for Bare Metal Systems

| Component | Tasks |
|---|---|
| Register your hardware Support Identifier (SI) | Add your hardware Support Identifier (SI) to your My Oracle Support account profile. Your hardware SI is supplied when you purchase Oracle Database Appliance. If you acquire new software licenses, then you must also register your new software SIs. The SI registration process can take up to 24 hours to complete. |
| Plug in the Appliance | <ul style="list-style-type: none"> Plug in all the cables including the power cords, and then wait for the SP OK light to become solid green. Do not power up yet. If there is no video port available on your Oracle Database Appliance hardware model, then use the Server Management Serial Port to connect to a laptop, or determine the DHCP address assigned to it. Note: Serial port must be set to 115200, so make sure the baud rate speed matches. |
| Configure Oracle Integrated Lights Out Manager (Oracle ILOM) on Node0 and Node1 | <p>Before you configure Oracle ILOM:</p> <ul style="list-style-type: none"> Connect an Ethernet cable from the NET MGT port to your site's management network. The NET MGT port is a 1 GbE port for Oracle ILOM and by default, is configured for DHCP. Obtain the Oracle ILOM host name and IP address, the netmask, and the gateway addresses from the DHCP server. Have a new password ready to replace the default Oracle ILOM password <p>Log into the Oracle ILOM console and follow the procedure in the topic <i>Configuring Oracle Integrated Lights Out Manager</i>.</p> |

Table 1-2 (Cont.) Deployment Checklist for Bare Metal Systems

| Component | Tasks |
|---|--|
| Power ON | <ul style="list-style-type: none"> Power on each node and log in as <code>root</code> user with <code>welcome1</code> password. Verify cabling: <code># /opt/oracle/dcs/bin/odacli validate-storagetopology</code> Verify interconnect networking. Run the commands <code># ethtool p1p1</code> and <code># ethtool p1p2</code>. <p>Follow the steps described in the topic <i>Verifying Cabling and Network Connections</i>.</p> |
| Plumb the network | <p>Ensure that you have recorded the IP address and netmask address.</p> <p>Set up a temporary network connection to Oracle Database Appliance. Use the command <code>odacli configure-firstnet</code> on Node0, for both single- and multi-node systems.</p> <p>Log into the Oracle ILOM console and follow the procedure in the topic <i>Plumbing the Network</i>.</p> |
| Download Oracle Database Appliance Software | <p>Log into My Oracle Support and download the software files for deployment. Refer to the <i>Oracle Database Appliance Release Notes</i> for the latest software.</p> |
| Install Oracle Database Appliance | <p>Upload the zip files to a temporary location on Oracle Database Appliance and then update the repository and install the software.</p> <p>Follow the steps and run the commands described in the topic <i>Installing Oracle Database Appliance Software</i>.</p> |
| Create Appliance | <ul style="list-style-type: none"> Set the Browser User Interface password for the <code>oda-admin</code> user. Log into the Browser User Interface and configure system, network, and users and groups. <p>Ensure that you have the information mentioned in <i>Checklist for System Requirements</i> available to you.</p> <p>Follow the steps described in the topic <i>Creating an Appliance</i>.</p> |
| Perform postinstallation tasks | <p>Configure CPU core count.</p> <p>Change the passwords for Browser User Interface, Oracle users and groups, and Oracle ILOM.</p> <p>Follow the steps described in the chapter <i>Oracle Database Appliance Postinstallation Tasks</i>.</p> |
| Cleanup Deployments | <p>If your deployment failed for some reason, then run the cleanup script and redeploy the appliance.</p> <p>For steps to run the cleanup script, see the topic <i>Uninstalling Oracle Database Appliance Components</i>.</p> |

Related Topics

- [Verifying Cabling and Network Connections](#)
After powering on Oracle Database Appliance, verify that the network connections are set up correctly.
- [Configuring Oracle Integrated Lights Out Manager](#)
Configure Oracle Integrated Lights Out Manager (Oracle ILOM) to manage Oracle Database Appliance independent of the operating system.
- [Installing Oracle Database Appliance Software](#)
Install Oracle Database Appliance software, before creating the appliance.

- [Creating the Appliance](#)
Create the appliance using the Browser User Interface or ODA CLI commands.
- [Oracle Database Appliance Postinstallation Tasks](#)
Complete these administrative tasks after you have deployed software, but before the system is operational.
- [Uninstalling Oracle Database Appliance Components](#)
Use the Oracle Database Appliance cleanup deploy utility, `/opt/oracle/oak/onecmd/cleanup.pl` to uninstall Oracle Database Appliance components.

Checklist for Custom Network Address Configuration

Use the checklist to identify the IP addresses required for Oracle Database Appliance.



Note:

Oracle does not recommend changing the default Host Private Address. You cannot change the private network after deploying the appliance.

Table 1-3 Default IP Address Requirements for Oracle Database Appliance

| Type of IP | IP Address Default Values | Your Values As Applicable |
|---|--|---|
| Client Access Network | No default | No default |
| Additional Network | No default | No default |
| Oracle Integrated Lights Out Manager (ILOM) | No default | No default |
| Host Private Addresses | InfiniBand has bonded interface <code>ibbond0</code> . The system configures <code>icbond0</code> on non-InfiniBand High-Availability systems. The subnets <code>192.168.16.0/24</code> and <code>192.168.17.0/24</code> are configured. | Not applicable: the private addresses are defined before deployment and should not be changed |

2

Introduction to Oracle Database Appliance

Oracle Database Appliance saves time and money by simplifying deployment, maintenance, and support of database solutions for organizations of every size. Oracle Database Appliance hardware models are optimized to run Oracle Database Standard Edition and Enterprise Edition.

- [About Oracle Database Appliance](#)
Understand Oracle Database Appliance hardware models, deployment plans, and database options.
- [Oracle Database Appliance Software Terminology](#)
Understand the software patches available for Oracle Database Appliance.
- [About the Browser User Interface](#)
Use the Oracle Appliance Manager Browser User Interface to deploy and manage the appliance, databases, networks, jobs, CPU pools, compute instances, and database systems.

About Oracle Database Appliance

Understand Oracle Database Appliance hardware models, deployment plans, and database options.

About Oracle Database Appliance Hardware Models

Choose the Oracle Database Appliance hardware model that suits your business needs.

| Oracle Database Appliance Hardware Model | Deployment Use Case |
|--|--|
| Oracle Database Appliance X11-S, X11-L, X11-HA | <ul style="list-style-type: none">• Oracle Database Appliance X11-S is a small configuration designed for smaller or entry-level deployments.• Oracle Database Appliance X11-L is a large configuration designed for larger databases.• Oracle Database Appliance X11-HA is a large configuration designed for larger databases and high-availability. |
| Oracle Database Appliance X10-S, X10-L, X10-HA | <ul style="list-style-type: none">• Oracle Database Appliance X10-S is a small configuration designed for smaller or entry-level deployments.• Oracle Database Appliance X10-L is a large configuration designed for larger databases.• Oracle Database Appliance X10-HA is a large configuration designed for larger databases and high-availability. |

| Oracle Database Appliance Hardware Model | Deployment Use Case |
|---|---|
| Oracle Database Appliance X9-2S, X9-2L, X9-2-HA | <ul style="list-style-type: none"> Oracle Database Appliance X9-2S is a small configuration designed for smaller or entry-level deployments. Oracle Database Appliance X9-2L is a large configuration designed for larger databases. Oracle Database Appliance X9-2-HA is a large configuration designed for larger databases and high-availability. |
| Oracle Database Appliance X8-2S, X8-2M, X8-2-HA | <ul style="list-style-type: none"> Oracle Database Appliance X8-2S is a small configuration designed for smaller or entry-level deployments. Oracle Database Appliance X8-2M is a medium-sized configuration designed for performance. Oracle Database Appliance X8-2-HA is a large configuration designed for larger databases and high-availability. |
| Oracle Database Appliance X7-2S, X7-2M, X7-2-HA | <ul style="list-style-type: none"> Oracle Database Appliance X7-2S is a small configuration designed for smaller or entry-level deployments. Oracle Database Appliance X7-2M is a medium-sized configuration designed for performance. Oracle Database Appliance X7-2-HA is a large configuration designed for larger databases and high-availability. |
| Oracle Database Appliance X6-2S, X6-2M, X6-2L | <ul style="list-style-type: none"> Oracle Database Appliance X6-2S is a small configuration designed for smaller or entry-level deployments. Oracle Database Appliance X6-2M is a medium-sized configuration designed for performance. Oracle Database Appliance X6-2L is a large configuration designed for larger databases. |
| Oracle Database Appliance X6-2-HA | Highly-available two-node Oracle RAC clusters that can support both Oracle RAC and single-instance databases. |
| Oracle Database Appliance X5-2 | Highly-available two-node Oracle RAC clusters that can support both Oracle RAC and single-instance databases. |

You cannot expand or reconfigure Oracle Database Appliance to a different configuration. For example, you cannot expand Oracle Database Appliance X7-S to Oracle Database Appliance X7-2M. For Oracle Database Appliance hardware configuration details, see the *Oracle Database Appliance Owner's Guide*.

About Oracle Database Appliance Deployment Plans

Oracle Database Appliance X8-2S and X8-2M are single node systems that you deploy as a bare metal platform.

Oracle Database Appliance X8-2-HA is a two-node system with the option to deploy as a bare metal platform or a virtualized platform.

Oracle Database Appliance X7-2S and X7-2M are single node systems that you deploy as a bare metal platform.

Oracle Database Appliance X7-2-HA is a two-node system with the option to deploy as a bare metal platform or a virtualized platform.

Oracle Database Appliance X6-2S, X6-2M, X6-2L are single node systems that you deploy as a bare metal platform.

Oracle Database Appliance X6-2-HA is a two-node system with the option to deploy as a bare metal platform or a virtualized platform.

Oracle Database Appliance X5-2 is a two-node system with the option to deploy as a bare metal platform or a virtualized platform.

About Database Deployment Options for Oracle Database Appliance

The following Oracle Database editions are available:

| Database Edition | Supported Releases |
|------------------------------------|--|
| Oracle Database Enterprise Edition | Oracle Database release 19c, 18c, 12.2.0.1, and 12.1.0.2 |
| Oracle Database Standard Edition 2 | Oracle Database release 19c, 18c, 12.2.0.1, and 12.1.0.2 |



Note:

It is important to understand your Oracle Database licensing before you create databases. You cannot provision Oracle Database Enterprise Edition and Standard Edition databases in the same bare metal platform, or the same ODA_BASE virtualized deployment, subject to Oracle Database licensing requirements. Review the *Oracle Database Licensing Information User Manual* for the Oracle Database release to review supported options and products.

Oracle Database Appliance Software Terminology

Understand the software patches available for Oracle Database Appliance.

The table describes the Oracle Database Appliance patches that are available for download and the purpose of the patch.



Note:

Some hardware models may not use the patches listed in the table.

Table 2-1 Software for Oracle Database Appliance

| Patch | Description |
|--|---|
| Oracle Database Appliance patch bundle (quarterly patch release) | Use the patch bundle to update to the latest release after Oracle Database Appliance is deployed. The patch updates the Oracle Database Appliance server, storage, and database components. |

Table 2-1 (Cont.) Software for Oracle Database Appliance

| Patch | Description |
|--|--|
| Oracle Database Appliance Grid Infrastructure/Database Clone | Use to perform an initial deployment of Oracle Database Appliance and also to patch your deployment to the latest release. The bundle contains the latest Grid Infrastructure and Database components, Oracle Database Appliance Manager software, Oracle Linux and hardware drivers for deployment on an Oracle Database Appliance that is shipped from factory state. If you reimage Oracle Database Appliance with the Bare Metal ISO Image, download the Grid Infrastructure/Database Clone patch to deploy Oracle Database Appliance. |
| Oracle Database Clone | Use the Database Software Clone files to get the latest Database clone binaries for Oracle Database releases 19c, 12.2.0.1, and 12.1.0.2. The RDBMS clone files are needed to create Oracle databases and database homes. |
| Bare Metal ISO Image | Use to reimage the appliance and reset the system back to the factory configuration. |

 **Note:**

See the *Oracle Database Appliance Release Notes* for the patch numbers and download locations and the component versions available in the patch bundle.

 **Note:**

Starting with Oracle Database 18c, Oracle provides quarterly updates in the form of Release Updates (Updates) and Release Update Revisions (Revisions). Oracle no longer releases patch sets. For more information, see My Oracle Support Note 2285040.1.

Oracle Database releases are of type `version` and `version_full` releases. The `version` release is designated in the form major release version.0.0.0.0. The major release version is based on the last two digits of the year in which an Oracle Database version is released for the first time. The `version_full` release is an update of a version release and is designated based on the major release version, the quarterly release update version (Update), and the quarterly release update revision version (Revision).

Prior to Oracle Database release 18c, changing the first or second digit in the release number was an upgrade, and changing the fourth digit indicated an update. With 18c and later releases, changing the first digit is an upgrade, and changing the second indicates an update.

About the Browser User Interface

Use the Oracle Appliance Manager Browser User Interface to deploy and manage the appliance, databases, networks, jobs, CPU pools, compute instances, and database systems.

The Browser User Interface provides a user-friendly interface to quickly view and perform many of the tasks needed to deploy, patch, and manage your bare metal system. The *Oracle Database Appliance Deployment and User's Guide* for your hardware model describes how to

use the Browser User Interface to perform many of the tasks related to deployment, patching, and management of your appliance.

Use the links in the side navigation to view and manage the following:

- **Appliance**
 - Appliance information
 - System information
 - Disk group information including storage utilization such as free and used space
 - Information about all databases that use a storage disk group
 - All the patches and hardware and software components installed on the appliance
 - List of RPMs and RPM Drift information
 - Oracle ASM port
- **Network**
 - View network details
 - Create, update, and delete networks
 - View interface details
- **Oracle ASR**
 - View Oracle Auto Service Request (Oracle ASR) configuration details
 - Configure, modify, test, and delete Oracle ASR
- **Repository Manager**
 - Update the patch repository with Oracle Database Appliance patches
 - View component details of the patch and versions that are installed on the appliance
 - View component details of the patch and versions that are available, but not yet installed, on the appliance
 - Run patch prechecks before applying the patch
 - Update the server and storage components
- **Compute Instances**
 - Create KVM deployment on Oracle Database Appliance
 - Create view, modify, and, delete virtual storage, virtual network, and virtual disks
 - Create view, modify, and, delete, start, and stop virtual machines
- **DB Systems**
 - Create DB System
 - List and describe DB System
 - Modify, delete, start, and stop DB System
- **CPU Pools**
 - Create view, modify, and, delete CPU pool for bare metal and KVM deployments

Use the links in the top navigation to view and manage the following:

- **Database**
 - Create a database

- View database details
- Apply a backup policy for the database
- Create a manual backup
- Recover a database from a backup
- View and update the database backup schedule and update the archive log backup schedule for the database
- Modify associated networks, database shape and class, and the associated backup policy for a database
- Create, update, and delete backup policies
- Create, update, and delete database homes
- Create and delete database backup
- Clone a database from a database backup or an Oracle ACFS database snapshot
- Patch database homes
- Move databases from one Oracle home to another
- **Credential Store**
 - Create Object Store Credentials for backup and recovery
 - View the details for Object Store Credentials, including the endpoint URL, user name, and tenant
 - Update and delete Object Store Credentials
 - Configure Oracle Key Vault Server
- **Monitoring**
 - View the status of hardware, storage, memory, cooling, networking, and power
 - View monitoring information for each node, in the case of High-Availability deployments
 - View system health status and drilldown to details of incidents
 - Click the hardware image to view details
- **Security**
 - View audit records and create and view database security assessment reports
- **Activity**
 - View a list of jobs, details, and status
 - Click a job description to view job details

Expand **Resources** in the upper right corner of the Browser User Interface to perform the following tasks:

- There are links to access the Oracle Database Appliance blogs, FAQs, and Documentation.
- Click **About** to view the Oracle Database Appliance release that is installed on the appliance.

Expand **Account** in the upper right corner of the Browser User Interface to perform the following tasks:

- Click **ILOM Setting** to change the root password. To enable first-time login and access to Oracle ILOM, a default Administrator (root) account and its password are provided with the system.
- Click **Change Password** to change the `oda-admin` password.
- Click **Sign Out** to sign out of the Browser User Interface. If you do not sign out, the system automatically signs you out after a period of inactivity. A warning will appear 2 minutes before the session expires.

Doc Search

You can access the Oracle Database Appliance documentation set from the Browser User Interface. There is a search box at the top right hand corner on the BUI. Search results are links to documentation pages shown as a new window in the BUI. When you click the **Help** button, links from the documentation relevant to the context of the tab are displayed.

Along with the search results from the Oracle Database Appliance documentation pages, BUI also provides relevant Frequently Asked Questions (FAQs) for the search query. Additionally, you can also search on DCS error codes such as DCS-10001, DCS-10032, and so on in the search box and get the links to documentation pages contains these error codes. When you specify the search query, relevant documentation links, FAQs and DCS error codes links are displayed under separate sections in a new window in the BUI.

For the latest updates to the documentation for a release, see the online Oracle Database Appliance documentation library at <https://docs.oracle.com/en/engineered-systems/oracle-database-appliance/index.html>.

3

Readying Oracle Database Appliance for Deployment

Before deploying Oracle Database Appliance, perform these setup tasks.

- [Attaching Storage Cables to Oracle Database Appliance X11-HA](#)
Connect the storage cables for Oracle Database Appliance X11-HA.
- [Attaching Network Cables to Oracle Database Appliance X11-HA](#)
Connect Oracle Database Appliance X11-HA to either a 10GBase-T (copper) or 25GbE SFP28 (fiber) network.
- [Attaching Network Cables to Oracle Database Appliance X11-S or X11-L](#)
Connect Oracle Database Appliance X11-S or X11-L to either a 10GBase-T (copper) or 25GbE SFP28 (fiber) network.
- [Attaching Power Cords and Initializing Components](#)
Attach power cords for Oracle Database Appliance.
- [Configuring Oracle Integrated Lights Out Manager](#)
Configure Oracle Integrated Lights Out Manager (Oracle ILOM) to manage Oracle Database Appliance independent of the operating system.
- [Powering On Oracle Database Appliance the First Time](#)
Use this procedure the first time you power on Oracle Database Appliance.

Attaching Storage Cables to Oracle Database Appliance X11-HA

Connect the storage cables for Oracle Database Appliance X11-HA.

Cabling the Storage for Oracle Database Appliance X11-HA

Connect the storage cables for Oracle Database Appliance 11-HA.

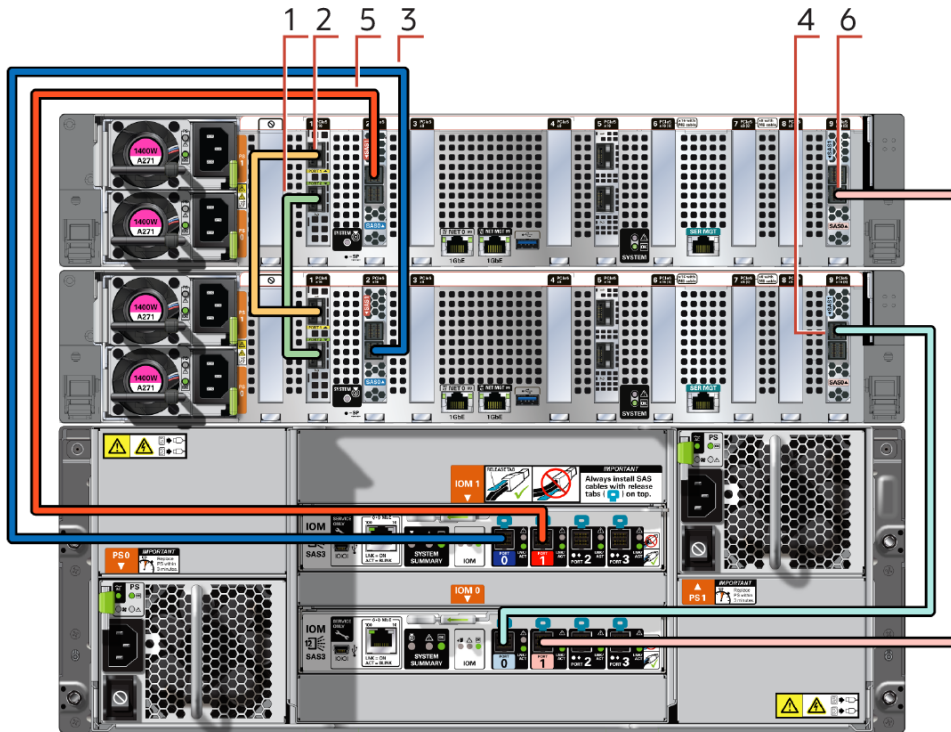

Table 3-1 Storage Cabling for Oracle Database Appliance X11-HA

| Callout Number | Purpose | Start - Compute Node0 | End - Compute Node1 |
|----------------|--|---|---|
| 1 | Connect green SFP28 cable (Interconnect Port 25GbE) | Connect into green port (PORT 2) in PCIe slot 1 | Connect into green port (PORT 2) in PCIe slot 1 |
| 2 | Connect yellow SFP28 cable (Interconnect Port 25GbE) | Connect into yellow port (PORT 1) in PCIe slot 1 | Connect into yellow port (PORT 1) in PCIe slot 1 |
| 3 | Connect dark blue SAS cable | Connect into dark blue port (SAS0) in PCIe slot 2 in Node0 | Connect into dark blue port in top IO Module (PORT 0) |
| 4 | Connect light blue SAS cable | Connect into light blue port (SAS1) in PCIe slot 9 in Node0 | Connect into light blue port in bottom IO Module (PORT 0) |
| 5 | Connect dark red SAS cable | Connect into dark red port (SAS1) in PCIe slot 2 in Node1 | Connect into dark red port in top IO Module (PORT 1) |
| 6 | Connect light red SAS cable | Connect into light red port (SAS0) in PCIe slot 9 in Node1 | Connect into light red port in bottom IO Module (PORT 1) |

Cabling the Storage Expansion Shelf

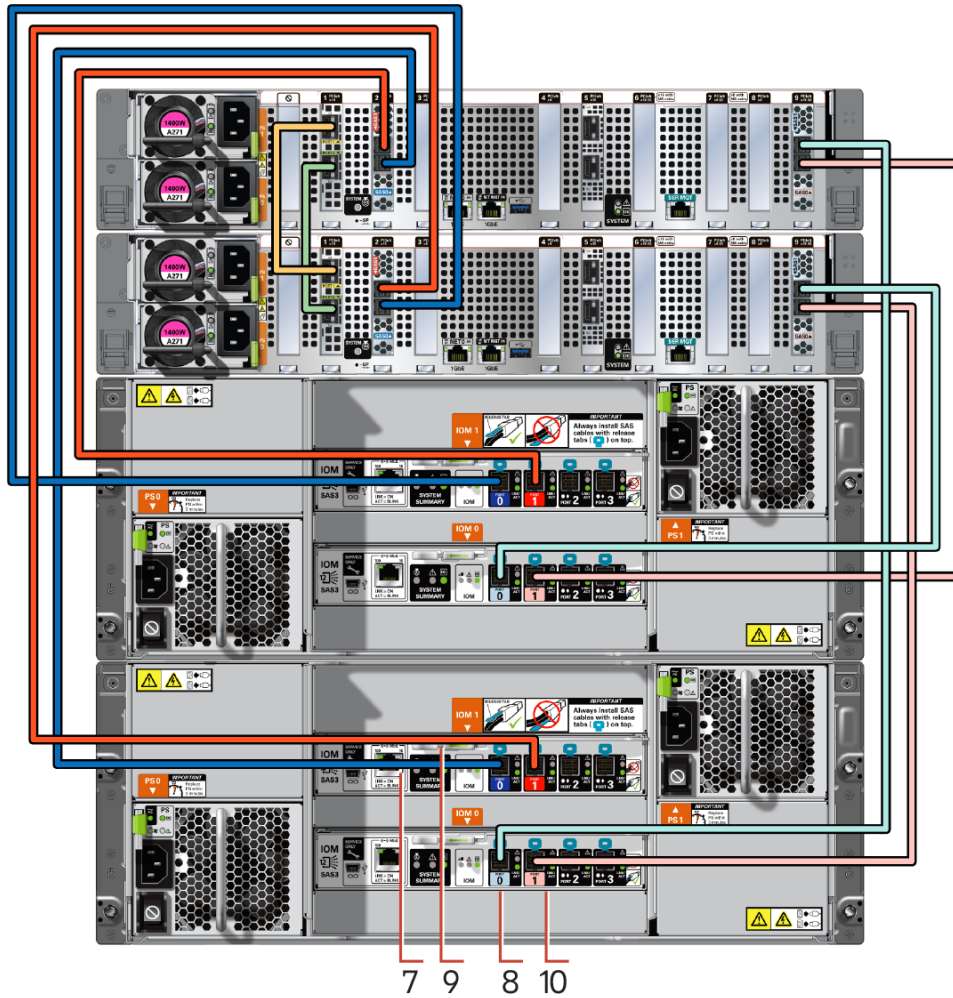

Table 3-2 Cabling the Storage Expansion Shelf for Oracle Database Appliance X11-HA

| Callout Number | Purpose | Start - Compute Nodes | End - Expansion Shelf |
|----------------|------------------------------|---|---|
| 7 | Connect dark blue SAS cable | Connect into dark blue port (SAS0) in PCIe slot 2 in Node1 | Connect into dark blue port in top IO Module (PORT 0) |
| 8 | Connect light blue SAS cable | Connect into light blue port (SAS1) in PCIe slot 9 in Node1 | Connect into light blue port in bottom IO Module (PORT 0) |
| 9 | Connect dark red SAS cable | Connect into dark red port (SAS1) in PCIe slot 2 in Node0 | Connect into dark red port in top IO Module (PORT 1) |
| 10 | Connect light red SAS cable | Connect into light red port (SAS0) in PCIe slot 9 in Node0 | Connect into light red port in bottom IO Module (PORT 1) |

Attaching Network Cables to Oracle Database Appliance X11-HA

Connect Oracle Database Appliance X11-HA to either a 10GBase-T (copper) or 25GbE SFP28 (fiber) network.

The SFP28 ports support 10Gb and 25Gb fibre and twinaxial cable (twinax), depending on the SFP modules used in these ports. For 10GBase-T public networking, use the Cat-6 network cables. To use the SFP28 ports, use the correct transceivers and cables to meet your switch bandwidth. The following sections show the cabling options for 10GBase and 25GbE SFP28 (fiber) network ports.

Connecting the Fiber and Copper Network Cables for Oracle Database Appliance X11-HA

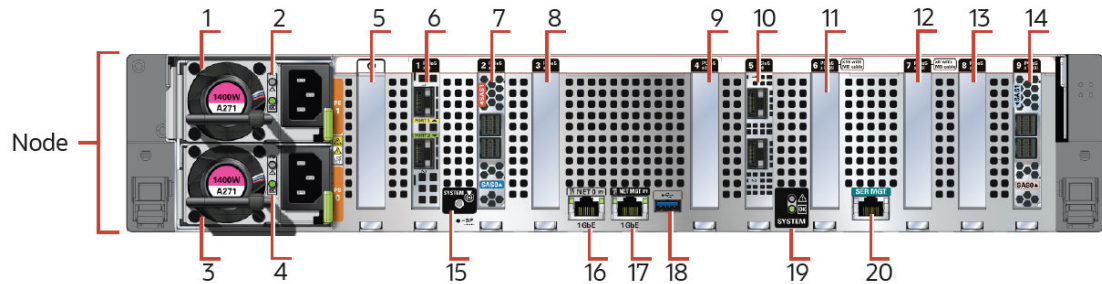

Table 3-3 Network Ports and Power Cabling

| Callout | Description |
|---------|---|
| 1 | Power Supply (PS) 1 with fan module |
| 2 | Power Supply (PS) 1 status indicators: Service Required LED: amber, AC OK LED: green |
| 3 | Power Supply (PS) 0 with fan module |
| 4 | Power Supply (PS) 0 status indicators: Service Required LED: amber, AC OK LED: green |
| 5 | Not used |
| 6 | PCIe card slot 1: Oracle Dual Port 25Gb Ethernet Adapter which provides two ports for a private cluster interconnect between server nodes |
| 7 | PCIe card slot 2: provides two SAS3 connectors used to connect the servers to the storage shelf and the storage expansion shelf |
| 8 | PCIe card slot 3: filler panel |
| 9 | PCIe card slot 4: filler panel, or 2nd optional Oracle Dual Port 25Gb Ethernet Adapter or Oracle Quad Port 10GBase-T Adapter |
| 10 | PCIe card slot 5: 1st Oracle Dual Port 25Gb Ethernet Adapter or Oracle Quad Port 10GBase-T Adapter |
| 11 | PCIe card slot 6: filler panel |
| 12 | PCIe card slot 7: filler panel |
| 13 | PCIe card slot 8: filler panel, or 3rd optional Oracle Dual Port 25Gb Ethernet Adapter or Oracle Quad Port 10GBase-T Adapter |

Table 3-3 (Cont.) Network Ports and Power Cabling

| Callout | Description |
|---------|--|
| 14 | PCIe card slot 9: provides two SAS3 connectors used to connect the servers to the storage shelf and the storage expansion shelf |
| 15 | Locate LED (white) |
| 16 | 100/1000Base-T network interface port with RJ-45 connector: NET 0 |
| 17 | NET MGT port: 10/100/1000Base-T network interface port with RJ-45 connector used to connect to the Oracle ILOM service processor |
| 18 | USB 3.1 connector |
| 19 | System status indicators: Service Required LED (amber), Power/OK LED (green) |
| 20 | SER MGT port: RJ-45 serial port used to connect to the Oracle ILOM service processor |

Fiber Cables

For optical cables, you must purchase either Short Range (SR) or Long Range (LR) SFP transceivers for each of the network ports, and then plug in the appropriate optical cable. Currently, Oracle sells both the SR and LR SFP transceivers. In addition to these transceivers, you must purchase the appropriate LC-LC terminated fiber optic cables from a third-party vendor.

Table 3-4 Transceivers for the SFP Ports - 10Gb/1Gb

| Name | ATO Part Number | x-option Part Number |
|---|-----------------|----------------------|
| SFP+ 10GBase-SR (Short Range Transceiver) | 2129a | X2129A-N |
| SFP+ 10GBase-LR (Long Range Transceiver) | 5562a-z | X5562A-Z |

Table 3-5 Transceivers for the SFP Ports - 25Gb

| Name | ATO Part Number | x-option Part Number |
|---|-----------------|----------------------|
| Oracle 10/25 GbE Dual Rate SFP28 Short Range (SR) Transceiver | 7604269 | 7604270 |
| SFP28 25GBase-LR (Short Range Transceiver) | 7118017 | 7118019 |
| SFP28 25GBase-LR (Long Range Transceiver) | 7118020 | 7118021 |

Copper Cables

You can purchase the following copper cables from Oracle. These cables have built-in SFP connectors.

Table 3-6 Networking Cables for the SFP Ports - 10Gb/1Gb

| Name | Length | ATO Part Number | x-option Part Number |
|--------------------------------------|--------|-----------------|----------------------|
| TwinAx passive copper cable: 1 meter | 1m | 7105137 | X2130A-1M-N |
| TwinAx passive copper cable: 2 meter | 2m | 7105139 | 7105148 |
| TwinAx passive copper cable: 3 meter | 3m | 7105140 | X2130A-3M-N |
| TwinAx passive copper cable: 5 meter | 5m | 7105141 | X2130A-5M-N |

Table 3-7 Networking Cables for the SFP Ports - 25Gb

| Name | Length | ATO Part Number | x-option Part Number |
|--------------------------------------|--------|-----------------|----------------------|
| TwinAx passive copper cable: 1 meter | 1m | 7118359 | 7118367 |
| TwinAx passive copper cable: 2 meter | 2m | 7118360 | 7118368 |
| TwinAx passive copper cable: 3 meter | 3m | 7118361 | 7118369 |
| TwinAx passive copper cable: 5 meter | 5m | 7118362 | 7118370 |

Attaching Network Cables to Oracle Database Appliance X11-S or X11-L

Connect Oracle Database Appliance X11-S or X11-L to either a 10GBase-T (copper) or 25GbE SFP28 (fiber) network.

The SFP28 ports support 10Gb and 25Gb fibre and twinaxial cable (twinax), depending on the SFP modules used in these ports. For 10GBase-T public networking ports that have RJ-45 connectors, use Cat-6 network cables. To use the SFP28 ports, use the correct transceivers and cables to meet your switch bandwidth. The following sections show the cabling options for 10GBase and 25GbE SFP28 (fiber) network ports.

Connecting Network Cables for Oracle Database Appliance X11-S or X11-L

Connect the Fiber and Copper Network Cables for Oracle Database Appliance X11-S or X11-L

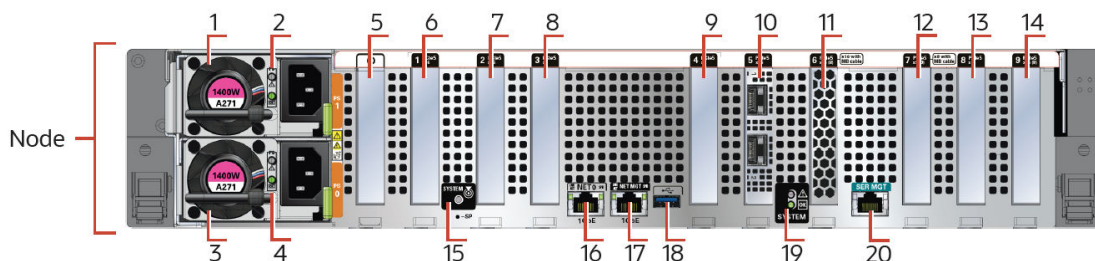

Table 3-8 Network Ports and Power Cabling

| Callout | Description |
|---------|--|
| 1 | Power Supply (PS) 1 with fan module |
| 2 | Power Supply (PS) 1 status indicators: Service Required LED: amber, AC OK LED: green |
| 3 | Power Supply (PS) 0 with fan module |
| 4 | Power Supply (PS) 0 status indicators: Service Required LED: amber, AC OK LED: green |
| 5 | Not used |
| 6 | PCIe card slot 1: <ul style="list-style-type: none"> Oracle Database Appliance X11-S: filler panel Oracle Database Appliance X11-L: filler panel, or 4th optional Oracle Flash Accelerator 680 PCIe Card |
| 7 | PCIe card slot 2: <ul style="list-style-type: none"> Oracle Database Appliance X11-S: filler panel Oracle Database Appliance X11-L: filler panel, or 1st optional Oracle Flash Accelerator 680 PCIe Card |
| 8 | PCIe card slot 3: <ul style="list-style-type: none"> Oracle Database Appliance X11-S: filler panel Oracle Database Appliance X11-L: filler panel, or 2nd optional Oracle Flash Accelerator 680 PCIe Card |
| 9 | PCIe card slot 4: <ul style="list-style-type: none"> Oracle Database Appliance X11-S: filler panel Oracle Database Appliance X11-L: filler panel, or 2nd optional Oracle Flash Accelerator 680 PCIe Card |
| 10 | PCIe card slot 5: 1st Oracle Dual Port 25Gb Ethernet Adapter or Oracle Quad Port 10GBase-T Adapter |
| 11 | PCIe card slot 6: Oracle Retimer PCIe Card |
| 12 | PCIe card slot 7: filler panel |
| 13 | PCIe card slot 8: filler panel, or 3rd optional Oracle Dual Port 25Gb Ethernet Adapter or Oracle Quad Port 10GBase-T Adapter |
| 14 | PCIe card slot 9: <ul style="list-style-type: none"> Oracle Database Appliance X11-S: filler panel, or 2nd optional Oracle Dual Port 25Gb Ethernet Adapter or Oracle Quad Port 10GBase-T Adapter Oracle Database Appliance X11-L: filler panel, or 3rd optional Oracle Flash Accelerator 680 PCIe Card |
| 15 | Locate LED (white) |
| 16 | 100/1000Base-T network interface port with RJ-45 connector: NET 0 |
| 17 | NET MGT port: 10/100/1000Base-T network interface port with RJ-45 connector used to connect to the Oracle ILOM service processor |
| 18 | USB 3.1 connector |

Table 3-8 (Cont.) Network Ports and Power Cabling

| Callout | Description |
|---------|--|
| 19 | System status indicators: Service Required LED (amber), Power/OK LED (green) |
| 20 | SER MGT port: RJ-45 serial port used to connect to the Oracle ILOM service processor |

Fiber Cables

For optical cables, you must purchase either Short Range (SR) or Long Range (LR) SFP transceivers for each of the network ports, and then plug in the appropriate optical cable. Currently, Oracle sells both the SR and LR SFP transceivers. In addition to these transceivers, you must purchase the appropriate LC-LC terminated fiber optic cables from a third-party vendor.

Table 3-9 Transceivers for the SFP Ports - 10Gb/1Gb

| Name | ATO Part Number | x-option Part Number |
|---|-----------------|----------------------|
| SFP+ 10GBase-SR (Short Range Transceiver) | 2129a | X2129A-N |
| SFP+ 10GBase-LR (Long Range Transceiver) | 5562a-z | X5562A-Z |

Table 3-10 Transceivers for the SFP Ports - 25Gb

| Name | ATO Part Number | x-option Part Number |
|---|-----------------|----------------------|
| Oracle 10/25 GbE Dual Rate SFP28 Short Range (SR) Transceiver | 7604269 | 7604270 |
| SFP28 25GBase-LR (Short Range Transceiver) | 7118017 | 7118019 |
| SFP28 25GBase-LR (Long Range Transceiver) | 7118020 | 7118021 |

Copper Cables

You can purchase the following copper cables from Oracle. These cables have built-in SFP connectors:

Table 3-11 Networking Cables for the SFP Ports - 10Gb/1Gb

| Name | Length | ATO Part Number | x-option Part Number |
|--------------------------------------|--------|-----------------|----------------------|
| TwinAx passive copper cable: 1 meter | 1m | 7105137 | X2130A-1M-N |
| TwinAx passive copper cable: 2 meter | 2m | 7105139 | 7105148 |
| TwinAx passive copper cable: 3 meter | 3m | 7105140 | X2130A-3M-N |

Table 3-11 (Cont.) Networking Cables for the SFP Ports - 10Gb/1Gb

| Name | Length | ATO Part Number | x-option Part Number |
|--------------------------------------|--------|-----------------|----------------------|
| TwinAx passive copper cable: 5 meter | 5m | 7105141 | X2130A-5M-N |

Table 3-12 Networking Cables for the SFP Ports - 25Gb

| Name | Length | ATO Part Number | x-option Part Number |
|--------------------------------------|--------|-----------------|----------------------|
| TwinAx passive copper cable: 1 meter | 1m | 7118359 | 7118367 |
| TwinAx passive copper cable: 2 meter | 2m | 7118360 | 7118368 |
| TwinAx passive copper cable: 3 meter | 3m | 7118361 | 7118369 |
| TwinAx passive copper cable: 5 meter | 5m | 7118362 | 7118370 |

Attaching Power Cords and Initializing Components

Attach power cords for Oracle Database Appliance.

Caution:

Before plugging in the power cords, ensure that the electrical outlets providing the power are grounded.

If you use only a single AC circuit, then connect both power cords for each component to that circuit. If you want to maintain N+1 power supply redundancy, then use two separate AC circuits. Connect one power cord from each AC circuit into each component.

For more information about cabling with the supplied Cable Management Arm, refer to *Oracle Database Appliance Owner's Guide*.

Configuring Oracle Integrated Lights Out Manager

Configure Oracle Integrated Lights Out Manager (Oracle ILOM) to manage Oracle Database Appliance independent of the operating system.

Deploying a new Oracle Database Appliance requires a direct connection to the system to configure the Oracle Integrated Lights Out Manager (ILOM) and the first network. If you use the serial port, ensure that the baud rate speeds match. After the first public network interface is configured, you can perform the remaining deployment steps on the Oracle Database Appliance system or from a remote system.

Configuring Oracle ILOM Using IP Address Assigned by DHCP

Ensure that the ILOM NIC is enabled and that `ipv4` is enabled.

1. Using a client system's browser, enter the IP address or host name assigned by DHCP into the browser address field and press **Enter**. For example, `https://129.xxx.xx.xx`.
2. At the login page, enter the default user name, `root` and the default password, `changeme`.
The Oracle ILOM web interface is displayed.

Configuring Oracle ILOM Using Static IP Address

1. Using a client system, establish a secure shell (SSH) connection by entering the following on the command line:

```
ssh -l root sp_ip_address
```

where `sp_ip_address` is the IP address assigned by DHCP.

2. Enter the default user name, `root`, and the default password, `changeme`.

The Oracle ILOM CLI prompt appears. Change the default password to a secure password of your choice.

3. Set the working directory.

```
cd /SP/network
```

4. Specify a static Ethernet configuration as follows:

```
set pendingipaddress=xxx.xxx.xx.xx  
set pendingipnetmask=yyy.yyy.yyy.y  
set pendingipgateway=zzz.zzz.zz.zzz  
set commitpending=true  
set state=enabled
```

`xxx.xxx.xx.xx`, `yyy.yyy.yyy.y` and `zzz.zzz.zz.zzz` are the IP address, netmask, and gateway (respectively) for your ILOM and network configuration.

5. Verify changes and then exit:

```
show /SP/network  
exit
```

Configuring Oracle ILOM Using the IPMI tool

To assign IP addresses to Oracle ILOM manually, follow these steps:

1. Open the IPMI tool.

```
# ipmitool -I open sunoem cli
```

2. Go to `SP/network` and verify that the port is enabled:

```
show /SP/network
```

3. If the port is not enabled, then enable the port.

```
# ipmitool -I open sunoem cli "set /SP/network state=enabled"
```

4. In `SP/network`, verify that `ipv4` is enabled.

5. If `ipv6` is enabled, then disable `ipv6` and enable `ipv4`.

```
# ipmitool -I open sunoem cli "set /SP/network/ipv6 state=disabled"  
# ipmitool -I open sunoem cli "set /SP/network/ipv4 state=enabled"
```

Related Topics

- [Deployment Checklist for Oracle Database Appliance Bare Metal Systems](#)
This checklist provides an overview of the tasks to setup and deploy Oracle Database Appliance bare metal systems for the first time.

See Also:

My Oracle Support Note 1395445.1: "ODA (Oracle Database Appliance) : ILOM configuration via Serial port" at <https://support.oracle.com/rs?type=doc&id=1395445.1>

Powering On Oracle Database Appliance the First Time

Use this procedure the first time you power on Oracle Database Appliance.

When you power on Oracle Database Appliance for the first time, the system automatically defines your public network interface based on which of the public interface ports are connected. For Oracle Database Appliance X11-HA, the dual-port 10/25 GbE SFP28 PCIe adapter is used for the cluster interconnect.

Note:

After you connect power cords, the green SP OK light-emitting diode (LED) lights blink for a few minutes, and then turn to steady ON. The cooling fans also may turn on. However, these events do not indicate that the system is started. You must complete all of the steps in this section to turn on the appliance properly. Read through the entire section to understand the sequence required for initial system startup.

1. (For Oracle Database Appliance X11-HA) Power on the attached storage shelf, or shelves, by plugging in their AC power cords. Do this before powering on the server nodes as it takes a few minutes for a storage shelf to come online.
2. Push the recessed power button to turn on the appliance.

Note:

The fully-initialized state is indicated by the green SP OK LEDs staying steadily lit. If any of the green LED lights on the server are still blinking, then wait for them to complete their initialization steps.

Refer to the figures and to the following callout table to identify the power button and the system initialization status indicator lights.

Figure 3-1 Front of Oracle Database Appliance Power Panel

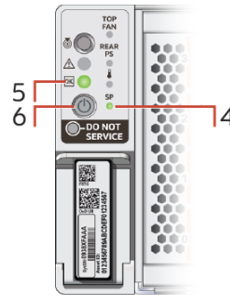

Table 3-13 Description of Callouts for Powering On Oracle Database Appliance

| Callout | Function |
|---------|---|
| 5 | Green Power/OK LED, located on the front panel. The light must be in the steady ON position (Green light does not blink) before you log on to the system. |
| 6 | Recessed ON/OFF power button, which is located on the front panel of the appliance. Push this button only once. Do not repeatedly push the power button. |
| 4 | SP OK LED light, located on the front panel of the appliance. |

Oracle Database Appliance does not use the DO NOT SERVICE indicator.

3. Wait for Oracle Database Appliance to complete startup.

 **Note:**

Do not repeatedly push the power buttons. Startup can take several minutes to complete.

Oracle Database Appliance is ready for use when the green Power/OK LED (callout 1) on the front of the system remains steadily on.

4

Provisioning Oracle Database Appliance Bare Metal System

Understand the process to configure Oracle Database Appliance bare metal system.

The Browser User Interface is the preferred method of deploying your bare metal platform configuration. The Browser User Interface provides all of the fields necessary to provision Oracle Database Appliance, including configuring the system, network, database, and Oracle Auto Service Request (Oracle ASR). If you prefer to use the command-line interface, you must create a JSON file to configure the deployment options.

- [Verifying Cabling and Network Connections](#)
After powering on Oracle Database Appliance, verify that the network connections are set up correctly.
- [Plumbing the Network](#)
Plumb the Oracle Database Appliance network with the public internet protocol (IP) information assigned to a node, to enable provisioning of the Oracle Database Appliance software.
- [Downloading Oracle Database Appliance Software](#)
Download Oracle Database Appliance software and copy to a temporary location before applying updates to your appliance.
- [Installing Oracle Database Appliance Software](#)
Install Oracle Database Appliance software, before creating the appliance.
- [Creating the Appliance](#)
Create the appliance using the Browser User Interface or ODA CLI commands.
- [About Enabling Oracle ASMFD on Oracle Database Appliance](#)
Understand how you can enable Oracle ASMFD on bare metal systems and DB systems on Oracle Database Appliance.

Verifying Cabling and Network Connections

After powering on Oracle Database Appliance, verify that the network connections are set up correctly.

Run the validation scripts only on Oracle Database Appliance HA models.

1. Log into the Oracle Database Appliance console and access the server node with user name as `root` and password `welcome1`.
2. Run validation scripts on both nodes, to verify cabling. For example:

```
# /opt/oracle/dcs/bin/odacli validate-storage topology
INFO : ODA Topology Verification
INFO : Running on Node0
INFO : Check hardware type
SUCCESS : Type of hardware found : X9-2
INFO : Check for Environment
SUCCESS : Type of environment found : Bare Metal
```



```

INFO : Check number of Controllers
SUCCESS : Number of ahci controller found : 1
SUCCESS : Number of External SCSI controllers found : 2
INFO : Check for Controllers correct PCIe slot address
SUCCESS : Internal RAID controller :
SUCCESS : External LSI SAS controller 0 : 31:00.0
SUCCESS : External LSI SAS controller 1 : 9d:00.0
INFO : Check if JBOD powered on
SUCCESS : 2JBOD : Powered-on
INFO : Check for correct number of EBODS(2 or 4)
SUCCESS : EBOD found : 4
INFO : Check for External Controller 0
SUCCESS : Cable check for port 0 on controller 0
SUCCESS : Cable check for port 1 on controller 0
SUCCESS : Overall Cable check for controller 0
INFO : Check for External Controller 1
SUCCESS : Cable check for port 0 on controller 1
SUCCESS : Cable check for port 1 on controller 1
SUCCESS : Overall Cable check for controller 1
INFO : Check for overall status of cable validation on Node0
SUCCESS : Overall Cable Validation on Node0
SUCCESS : JBOD0 Nickname set correctly
SUCCESS : JBOD1 Nickname set correctly

```

3. If there is a storage expansion shelf connected to the appliance, then power it on. Run the `storagetopology` command on both nodes to make sure the cabling is correct. For example:

```

# /opt/oracle/dcs/bin/odacli validate-storagetopology
INFO : ODA Topology Verification
INFO : Running on Node0
INFO : Check hardware type
SUCCESS : Type of hardware found : X9-2
INFO : Check for Environment
SUCCESS : Type of environment found : Bare Metal
INFO : Check number of Controllers
SUCCESS : Number of ahci controller found : 1
SUCCESS : Number of External SCSI controllers found : 2
INFO : Check for Controllers correct PCIe slot address
SUCCESS : Internal RAID controller :
SUCCESS : External LSI SAS controller 0 : 31:00.0
SUCCESS : External LSI SAS controller 1 : 9d:00.0
INFO : Check if JBOD powered on
SUCCESS : 2JBOD : Powered-on
INFO : Check for correct number of EBODS(2 or 4)
SUCCESS : EBOD found : 4
INFO : Check for External Controller 0
SUCCESS : Cable check for port 0 on controller 0
SUCCESS : Cable check for port 1 on controller 0
SUCCESS : Overall Cable check for controller 0
INFO : Check for External Controller 1
SUCCESS : Cable check for port 0 on controller 1
SUCCESS : Cable check for port 1 on controller 1
SUCCESS : Overall Cable check for controller 1
INFO : Check for overall status of cable validation on Node0
SUCCESS : Overall Cable Validation on Node0

```

```
SUCCESS : JBOD0 Nickname set correctly  
SUCCESS : JBOD1 Nickname set correctly
```

4. Verify the interconnect network:

```
# ethtool p1p1  
Settings for p1p1:  
Supported ports: [ FIBRE ]  
Supported link modes: 1000baseT/Full  
Supported pause frame use: Symmetric Receive-only  
Supports auto-negotiation: Yes  
Advertised link modes: 1000baseT/Full  
10000baseT/Full  
Advertised pause frame use: No  
Advertised auto-negotiation: Yes  
Speed: 25000Mb/s <<<<<<<<<<<<<<<<<<<<<<<<<<<<<<<<<<<<<<<<<<<< check speed  
Duplex: Full  
Port: Direct Attach Copper  
PHYAD: 1  
Transceiver: internal  
Auto-negotiation: on  
Current message level: 0x00000000 (0)  
Link detected: yes  
# ethtool p1p2  
Settings for p1p2:  
Supported ports: [ FIBRE ]  
Supported link modes: 1000baseT/Full  
Supported pause frame use: Symmetric Receive-only  
Supports auto-negotiation: Yes  
Advertised link modes: 1000baseT/Full  
10000baseT/Full  
Advertised pause frame use: No  
Advertised auto-negotiation: Yes  
Speed: 25000Mb/s <<<<<<<<<<<<<<<<<<<<<<<<<<<<<<<<<<<<<<<<<<<< check speed  
Duplex: Full  
Port: Direct Attach Copper  
PHYAD: 1  
Transceiver: internal  
Auto-negotiation: on  
Current message level: 0x00000000 (0)  
Link detected: yes
```

Related Topics

- [Deployment Checklist for Oracle Database Appliance Bare Metal Systems](#)
This checklist provides an overview of the tasks to setup and deploy Oracle Database Appliance bare metal systems for the first time.

Plumbing the Network

Plumb the Oracle Database Appliance network with the public internet protocol (IP) information assigned to a node, to enable provisioning of the Oracle Database Appliance software.

Important:

On Oracle Database Appliance X9-2 and X10, the `odacli configure-firstnet` command supports bonding of ports across two supported network PCI cards of the same type.

Caution:

On Oracle Database Appliance X9-2 and X10, you cannot change the network bonding **after** the system is deployed. To change the network bonding, you must reimage and deploy the appliance again.

Note:

If you enable Link Aggregation Control Protocol (LACP) on the bonding interface when you run the `odacli configure-firstnet` command, then `lacp_rate` is set to 1 (fast). You must adjust the switch setting so that it can support this `lacp_rate`.

1. Connect to Oracle ILOM remote console, then log into Oracle Database Appliance as `root`.
2. Run the command `configure-firstnet` on **both** nodes. You can choose to enable Link Aggregation Control Protocol (LACP) on the bonding interface when you run `odacli configure-firstnet`.

```
# /opt/oracle/dcs/bin/odacli configure-firstnet
Use bonding on different network interfaces:
  bonding between ports on the same network card [0]
  bonding between Network Card 1 in slot 6 and Network Card 2 in slot 4
[1]
  bonding between Network Card 1 in slot 6 and Network Card 3 in slot 8
[2]
  bonding between Network Card 2 in slot 4 and Network Card 3 in slot 8
[3]
Please input your selection (0 - 3) [0]:
Select the Interface to configure the network on (btbond1 btbond3 btbond5)
[btbond1]:
Use LACP bonding on btbond1 (yes/no) [no]:
Configure DHCP on btbond1 (yes/no) [no]:
INFO: You have chosen Static configuration
Use VLAN on btbond1 (yes/no) [no]:
```

3. Complete the network configuration as prompted and configure the public network interface. Also provide the netmask and gateway IP address.

You use this network connection to transfer the software to the server node.

Example 4-1 Example of a Bonded Configuration

For a bonded configuration, answer *yes* to using a bonding public interface and configure the first network to use a `btbond3` interface without configuring DHCP.

```
# /opt/oracle/dcs/bin/odacli configure-firstnet
Select the Interface to configure the network on (btbond1 btbond3 btbond4)
[btbond1]:btbond3
Use LCAP bonding on btbond3 (yes/no) [no]:yes
INFO: network interface [btbond3] in LACP mode
Configure DHCP on btbond3 (yes/no) [no]:
INFO: You have chosen Static configuration
Use VLAN on btbond3 (yes/no) [no]:yes
Configure VLAN on btbond3, input VLAN ID [2 - 4094] 119
INFO: using network interface btbond3.119
Enter the IP address to configure : 10.31.129.36
Enter the Netmask address to configure : 255.255.255.240
Enter the Gateway address to configure [10.31.129.33] :
INFO: Restarting the network
Shutting down interface btbond1: [ OK ]
Shutting down interface btbond2: [ OK ]
Shutting down interface p3p1: [ OK ]
Shutting down interface p3p2: [ OK ]
Shutting down interface sfpbond1: [ OK ]
Shutting down loopback interface: [ OK ]
Bringing up loopback interface: [ OK ]
Bringing up interface btbond1: Determining if ip address 10.209.13.109 is
already in use for device btbond1...
[ OK ]
Bringing up interface btbond2: [ OK ]
Bringing up interface sfpbond1: [ OK ]
```

Example 4-2 Example of Configuring VLAN

```
# /opt/oracle/dcs/bin/odacli configure-firstnet
Select the Interface to configure the network on (btbond1 btbond3 btbond4)
[btbond1]:btbond3
Use LCAP bonding on btbond3 (yes/no) [no]:yes
INFO: network interface [btbond3] in LACP mode
Configure DHCP on btbond3 (yes/no) [no]:
INFO: You have chosen Static configuration
Use VLAN on btbond3 (yes/no) [no]:yes
Configure VLAN on btbond3, input VLAN ID [2 - 4094] 119
INFO: using network interface btbond3.119
Enter the IP address to configure : 10.31.129.36
Enter the Netmask address to configure : 255.255.255.240
Enter the Gateway address to configure [10.31.129.33] :
INFO: Restarting the network
Shutting down interface btbond1: [ OK ]
Shutting down interface em1: [ OK ]
Shutting down interface plp1: [ OK ]
Shutting down interface plp2: [ OK ]
```

```
Shutting down loopback interface:           [ OK ]
Bringing up loopback interface:           [ OK ]
Bringing up interface btbond1:
Determining if ip address 192.0.2.24 is already in use for device btbond1...
                                                    [ OK ]
Bringing up interface em1:                 [ OK ]
Bringing up interface plp1:
Determining if ip address 192.0.2.24 is already in use for device
plp1...                                     [ OK ]
Bringing up interface plp2:
Determining if ip address 192.0.2.24 is already in use for device plp2...
                                                    [ OK ]
Bringing up interface btbond1.122:
Determining if ip address 192.0.2.24 is already in use for device
btbond1.122...
                                                    [ OK ]

INFO: Restarting the DCS agent
initdcsagent stop/waiting
initdcsagent start/running, process 32104
```

Configuring LACP after Deployment

Use the `-o` option with the `odacli configure-firstnet` command to enable or disable LACP on a bonding interface.

Enabling LACP on a bonding interface after deployment:

```
# odacli configure-firstnet -o
INFO: Configure network option
Select the Interface to configure the network on (btbond1 btbond3 btbond5)
[btbond1]:btbond3
Use LACP bonding on btbond3 (yes/no) [no]: yes
INFO: network interface [btbond3] setup in LACP mode
```

Disabling LACP on a bonding interface after deployment:

```
# odacli configure-firstnet -o
INFO: Configure network option
Select the Interface to configure the network on (btbond1 btbond3 btbond5)
[btbond1]:btbond3
Use LACP bonding on btbond3 (yes/no) [yes]: no
INFO: network interface [btbond3] setup in active-backup mode
```

Downloading Oracle Database Appliance Software

Download Oracle Database Appliance software and copy to a temporary location before applying updates to your appliance.

1. Download the software files from My Oracle Support to a temporary location on an external client. Refer to the release notes for details about the software for the latest release.

For example, download the Oracle Database Appliance GI Clone for ODACLI/DCS stack (patch 30403673) and Oracle Database Appliance RDBMS Clone for ODACLI/DCS stack (patch 30403662) for 19.26:

```
p30403673_1926000_Linux-x86-64.zip  
p30403662_1926000_Linux-x86-64.zip
```

2. Unzip the software — it contains README.html and one or more zip files for the patch.

```
unzip p30403673_1926000_Linux-x86-64.zip  
unzip p30403662_1926000_Linux-x86-64.zip
```

The GI and RDBMS Clone files for release 19.26 are extracted.

```
odacli-dcs-19.26.0.0.0-date-GI-19.26.0.0.zip  
odacli-dcs-19.26.0.0.0-date-DB-19.26.0.0.zip
```

3. Copy the software files from the external client to Oracle Database Appliance. Use the `scp` or `sftp` protocol to copy the bundle.

Example using `scp` command:

```
scp software_file root@oda_host:/tmp
```

Example using `sftp` command:

```
sftp root@oda_host
```

Enter the `root` password, and then copy the file.

```
put software_file
```

For example, for release 19.26:

```
put odacli-dcs-19.26.0.0.0-date-GI-19.26.0.0.zip  
put odacli-dcs-19.26.0.0.0-date-DB-19.26.0.0.zip
```

The GI and RDBMS Clone files are copied to the temporary location on the appliance. You can update the repository, and create the appliance, as explained in the next topic.

Related Topics

-

Installing Oracle Database Appliance Software

Install Oracle Database Appliance software, before creating the appliance.

Ensure that the Oracle Database Appliance patches are downloaded and available for updating the repository, as described in the topic *Downloading Oracle Database Appliance Software*.

Starting with Oracle Database Appliance release 19.12, the sizes of volumes `/u01` and `/opt` are smaller than the corresponding sizes in earlier releases. The size of `/u01` is now 40GB and

the size of `/opt` is now 30GB. A new ACFS file system, mounted at `/opt/oracle/oak/pkgrepos/orapkg/ clones`, is created during provisioning. The DATA disk group provides space of 150 GB for the file system. The Oracle Grid Infrastructure and Oracle Database clone files are stored on this file system.

Important:

If you want to install third-party software on your Oracle Database Appliance, then ensure that the software does not impact the Oracle Database Appliance software. The version lock on Oracle Database Appliance RPMs displays a warning if the third-party software tries to override Oracle Database Appliance RPMs. You must restore the affected RPMs before patching Oracle Database Appliance so that patching completes successfully.

Important:

To ensure that your deployment has the latest Oracle Database Appliance firmware, download the latest server patch and update the repository. Then, run the `odacli describe-component` command to check whether the firmware is current or out-of-date. If the firmware is not current, then run the `odacli update-server` and `odacli update-storage` commands before you deploy the Oracle Database Appliance software. If the firmware is current, then you can deploy the Oracle Database Appliance software as described in this topic, without updating the server and storage. Before updating the server or storage, ensure that you run the `odacli create-prepatchreport` command to generate the prechecks report, otherwise an error is displayed.

Note:

Public network gateway must be responsive to ping requests. Oracle Clusterware uses the public network gateway as ping target to facilitate the VIP failover in Oracle Database Appliance high-availability environment.

1. Verify the current system version by running the following command on **both** nodes:

```
[root@oda1 opt]# /opt/oracle/dcs/bin/odacli describe-component -v
```

On a single-node Oracle Database Appliance system, run the command `odacli describe-component` without the `-v` option.

```
[root@oda1 opt]# /opt/oracle/dcs/bin/odacli describe-component
```

2. Update the repository with Oracle Grid Infrastructure and Database software only. To prevent space issues in `/opt`, it is recommended that you add other repositories after the bare metal instance is provisioned.

```
[root@oda1 opt]# /opt/oracle/dcs/bin/odacli update-repository -f /tmp/  
GI_clone_file,/tmp/DB_clone_file
```

For example, for release 19.26:

```
[root@oda1 opt]# /opt/oracle/dcs/bin/odacli update-repository -f /tmp/odacli-dcs-19.26.0.0.0-date-DB-19.26.0.0.zip,/tmp/odacli-dcs-19.26.0.0.0-date-GI-19.26.0.0.zip
```

3. Confirm that the repository update is successful:

```
[root@oda1 opt]# /opt/oracle/dcs/bin/odacli describe-job -i job_ID
```

4. Delete the software zip files from the temporary location on the appliance to save space:

```
[root@oda1 opt]# rm software_file  
rm: remove regular file software_file? y
```

You have now updated the repository with the Oracle Database Appliance software, and can create your appliance, as described in the next topic.

Related Topics

- [Deployment Checklist for Oracle Database Appliance Bare Metal Systems](#)
This checklist provides an overview of the tasks to setup and deploy Oracle Database Appliance bare metal systems for the first time.

Creating the Appliance

Create the appliance using the Browser User Interface or ODA CLI commands.

Note:

If you plan to enable multi-user access, then refer to the chapter *Implementing Multi-User Access on Oracle Database Appliance* before you create your appliance.

Creating the Appliance using ODA CLI Commands

You can use the command `odacli create-appliance` and a JSON file that includes your appliance configuration settings to deploy the appliance instead of using the Browser User Interface. Review the readme in the `/opt/oracle/dcs/sample` directory carefully along with the provided JSON example files. Create a JSON file with the necessary changes based on your environment and requirements.

See Also:

Creating an Appliance Using a JSON File in this guide for example JSON files and the procedure to create a JSON file.

 **Note:**

It is important to review the readme and the examples carefully before creating your JSON file. If you do not enter your network and Oracle ILOM information correctly based on your setup, you will lose network access to both the host and Oracle ILOM.

Creating the Appliance using the Browser User Interface (BUI)

Follow these steps to create the appliance using the BUI:

Ensure that ports 7070 and 7093 on the network between Oracle Database Appliance and the client machine, are open.

1. Navigate to the Browser User Interface. You are prompted to set the password for the `oda-admin` user.

```
https://ODA-host-ip-address:7093/mgmt/index.html
```

2. Log into the Browser User Interface with the new password.

When you launch the Browser User Interface on an unconfigured appliance, the Appliance page notifies you that the appliance is not configured and provides a link to the pages needed to configure and create the appliance.

 **Note:**

If you face any issues when logging into the Oracle Database Appliance Browser User Interface, then see the topic *Errors When Logging into the Browser User Interface* in the chapter *Troubleshooting Oracle Database Appliance*.

3. Click **Create Appliance**.
4. In the Create Appliance page, if you want to create the appliance from a saved configuration, click **Browse**, and select the JSON file. The information from the saved configuration file is loaded. You can retain or edit the fields. Otherwise, manually, provide the values to create the appliance.
5. In the System Information tab, specify the values as follows.
 - a. **System Name:** Enter the host name.
The host name can contain alphanumeric characters and dashes (-), but cannot start with a number or dash (-) or end with dash (-). Do not exceed 30 characters.
 - b. **Domain Name:** Enter the domain name.
 - c. **Region:** Select the region of the world where the Oracle Database Appliance is located.
 - d. **Time Zone:** Select the time zone where the Oracle Database Appliance is located.
 - e. (Optional) **DNS Servers:** Enter addresses for one or more DNS servers.
 - f. (Optional) **NTP Servers:** Enter addresses for one or more NTP servers.
 - g. **Diskgroup Redundancy:** If there are two disks, then you can select the disk group redundancy as Normal or Flex. To select the the redundancy as **High**, there must exist more than four disks, and a quorum disk. If five or more disks are configured, then the quorum disk is not required. Select **Normal**, **High**, or **Flex**, as per your deployment requirement.

The Flex parameter defines the disk group redundancy. Flex redundancy requires at least 3 storage devices, including a quorum. For a database to be placed on Oracle ASM, you can set the database redundancy during its creation. For a database to be placed on Oracle ACFS, the database inherits the redundancy of the ACFS file system. You can specify an ACFS file system redundancy during its creation. You can set the disk group redundancy only during appliance creation. The database redundancy can be set anytime you create the database.

The redundancy level for DATA, RECO, and FLASH can be set to Normal, Flex, or High based on whether there are two, four, or more disks.

Note: For Oracle Database Appliance hardware models other than X8-2, the redundancy level for REDO is always High.

- h. Data Storage Percentage:** Enter a whole number between 10 and 90 to define the percentage of storage reserved for DATA, the remainder is reserved for RECO. For example, if you enter 80, then 80% of the storage for DATA and 20% for RECO.
- i. Disk Group for Database Home Storage:** Select the disk group, whether DATA or RECO depending on your hardware model, and specify the size to be allocated. This chooses the disk group from which the ACFS storage required for database homes is allocated.
- j. System Password and Confirm Password:** Enter the system password in both fields.
The system password is the password set for UNIX and `root` users. The password must begin with an alpha character and cannot contain quotation marks. Do not exceed 30 characters.
- k. Specify the DNS Servers and NTP Servers details.**

Starting with Oracle Database Appliance release 19.16, if you specify DNS servers, then ensure that all host names (except SCAN) are resolvable to one and only one IP address through the given domain name and DNS servers. These include Client Access Network Host Name, VIP Name, and ILOM Host Name. This does not apply to SCAN names as they can resolve to multiple IP addresses. If any of the above host names does not resolve to an IP address or resolves to multiple IP addresses, then the the following error is displayed:

```
DCS-10045:Validation error encountered: Hostname 'hostname1' does not  
resolve to a unique IP address.
```

- 6.** In the Network Information tab, configure the primary client access network, virtual networks, and an Oracle Integrated Lights Out Manager (Oracle ILOM) network. You are only required to configure the client access network. The ILOM configuration is optional if you already configured the ILOM for the appliance and you do not need to make changes.

Specify the following, depending on whether it is a single-node or two-node Oracle Database Appliance deployment:

- a. Client Access Network Host Name:** For Node0, enter the host name for the primary client access network.
- b. Client Access Network IP Address:** For Node0, enter the IP address for the primary client access network.
- c. VIP Name for Node0:** Enter the name of the virtual IP network for Node0.
- d. VIP IP Address for Node0:** Enter the virtual IP address that resides on Node0 and is shared between the nodes.
- e. VIP Name for Node1:** Enter the name of the virtual IP network for Node0.

- f. **VIP IP Address for Node1:** Enter the virtual IP address that resides on Node1 and is shared between the nodes.
 - g. (Optional) **ILOM Host Name:** Enter the name of the Oracle ILOM host for Node0 and Node1.
 - h. (Optional) **ILOM Network IP Address:** Enter the IP address for the ILOM for Node0 and Node1.
 - i. (Optional) **ILOM Network Subnet Mask:** Enter the subnet mask address for the ILOM.
 - j. (Optional) **ILOM Network Gateway:** Enter the gateway address for the ILOM.
 - k. **Client Access Network Subnet Mask:** Enter the subnet mask address for the primary client access network.
 - l. **Client Access Network Gateway:** Enter the gateway address for the primary client access network.
 - m. **Client Access Network Interface:** Enter the interface for the primary client access network.
 - n. **SCAN Name:** Specify the Single Client Access Name (SCAN).
 - o. **SCAN IP Address:** Specify the SCAN IP address. You can specify up to three SCAN IP addresses.
- Specify the VIP address and SCAN only for high-availability deployments.
7. Determine how you want to configure your users and groups and whether or not you want to allow operating system role separation:
 - Two users with six groups: Customize Users and Groups, select **No**. Allow OS Role Separation, select **Yes**. This is the default configuration.
 - Two customized users with six customized groups: Customize Users and Groups, select **Yes**. Allow OS Role Separation, select **Yes**.
 - Single user with two groups: Customize Users and Groups, select **No**. Allow OS Role Separation, select **No**.
 - Single user with six groups: Customize Users and Groups, select **Yes**. Allow OS Role Separation, select **No**. SAP deployments use this configuration.
 8. Do you want to create an initial database? Select **Yes** and go to Step 9 or select **No** and go to Step 10.
 9. Enter the following information to configure an initial database:
 - a. **DB Name:** Enter a name for the database.

The name must contain alphanumeric characters and cannot exceed 8 characters.
 - b. (Optional) **DB Unique Name:** Enter a globally unique name for the database.

Databases with the same DB Name within the same domain (for example, copies of a database created for reporting or a physical standby) must have a different DB Unique Name that is unique within the enterprise. The name must contain alphanumeric, underscore (_), dollar (\$), and pound (#) characters, but must begin with an alphabetic character. No other special characters are permitted in a database name. The unique name cannot exceed 30 characters.
 - c. **DB Version:** Select a database bundle patch number.
 - d. **CDB:** Select **Yes** or **No** to specify whether or not you want a Container Database (CDB).
 - e. **PDB Name:** Enter a name for the pluggable database (PDB).

The name must begin with an alphanumeric character. The following characters are valid: alphanumeric characters, and underscore (_).

- f. **PDB Admin User:** Enter an Admin user name for the pluggable database (PDB).
- g. **Database Edition:** Select the Oracle Database edition, either Standard Edition and Enterprise Edition. Your license determines which database edition you are eligible to create in the appliance.

For Oracle Database 19c Standard Edition, you can only create single-instance Oracle Database, with or without high-availability.

- h. **SYS and PDB Admin User Password:** Provide a password for the database.
- i. **Deployment:** Select a deployment type from the list. The options are RAC, RAC-One, or SI (single-instance database). If you select a single instance database, then select the node for the SI database deployment.

For Standard Edition Oracle Database 19c or later, you can choose to enable high availability for single-instance databases. For Standard Edition Oracle Database 19.6 or later, if you choose to create a single-instance database, then the high availability feature is available by default. To disable high-availability, set the value in the **Enable High Availability** field to **No**.

For Enterprise Edition Oracle Database 19.15 or later or Oracle Database 21.6 or later, you can choose to enable high availability for single-instance databases. For Enterprise Edition Oracle Database 19.15 or later or Oracle Database 21.6 or later, if you choose to create a single-instance database, then the high availability feature is disabled by default. To enable high-availability, set the value in the **Enable High Availability** field to **Yes**.

If you select a single instance database, then you have the option to create the database on either Node0 or Node1. The default is Node0.

- j. **Shape:** Select a database shape from the list.
- k. In the **Database Class** field, select a database class from the drop-down list. If an option is not available in the list, it is not supported for the database edition on the Oracle Database Appliance or the version that you selected. The default is OLTP.
- l. In the **Storage** field, select **ACFS** or **ASM** from the drop-down list. The default is Oracle ASM.
- m. If you specified the disk group redundancy as **Flex**, then you can select the **Database Redundancy** value as **Mirror** or **High**.
- n. **Data Files on Flash Storage:** Select **Yes** or **No**.

This option is only available if the HA system has HDD storage drives.

- o. **Configure EM Express:** Select **Yes** or **No**.
Select **Yes** to configure the Oracle Enterprise Manager Database Express (EM Express) console for Oracle Database 12.2.1.0 or 12.1.0.2. Selecting Yes enables you to use the console to manage the database.
- p. **Character set:** Select a character set.
- q. **National Characterset:** Select a national character set.
- r. **Language:** Select the database language.
- s. **Territory:** Select a territory or location from the list.
- t. For Oracle Database Enterprise Edition 19c or later, you can choose to enable Transparent Database Encryption (TDE). Select **Yes** or **No** in the **Enable TDE** option. Specify and confirm the **TDE Password**. By default, the TDE option is disabled.

10. In the Diagnostics Information tab, configure and enable Oracle ASR or choose to enable trace file redaction.

Enable Trace File Redaction: Select **Yes** if you want to redact sensitive information in diagnostics collections.

You can configure and enable Oracle Auto Service Request (Oracle ASR) now or later:

- To not enable Oracle ASR during deployment, select **No** and click **Submit**. After deployment, you can configure an internal Oracle ASR or register with an external Oracle ASR Manager from either the Browser User Interface or command-line interface.
 - Internal Oracle ASR: choose to configure Oracle ASR Manager on Oracle Database Appliance or use Oracle ASR Manager configured on another server in the same network as your appliance.
 - External Oracle ASR: If you already have Oracle ASR Manager configured elsewhere, you can register Oracle Database Appliance with your existing Oracle ASR Manager.
 - To enable Oracle ASR, select **Yes** and complete the fields:
 - a. Select **Internal** or **External** in the **ASR Type** field.
 - b. **ASR User Name:** Enter the e-mail address associated with the My Oracle Support account under which the server is registered.
 - c. **Password:** Enter the password associated with the My Oracle Support account under which the server is registered.
 - d. (Optional) Specify the **HTTPS Port Number** for the ASR manager. The default port number is 16162.
 - e. **HTTP Proxy used for Upload to ASR:** Select **Yes** or **No**.
 - f. **Proxy Server Name:** If you are using a proxy for upload, enter the proxy server name.
 - g. **Proxy Port:** If you are using a proxy for upload, enter the proxy port.
 - h. **(Optional) HTTP Proxy Requires Authentication:** If you are using a proxy for upload, select **Yes** if you require authentication. If you do not require authentication, select **No**.
 - i. **Proxy User Name:** If you are using a proxy for upload, enter the proxy user name.
 - j. **(Optional) Proxy Password:** If you are using a proxy for upload and require authentication, enter the proxy password.
11. Click **Submit**. When prompted, click **Yes** to confirm that you want to start the job to deploy the appliance.
 12. Verify that the appliance is deployed. Run the `odacli describe-system` command. For high-availability deployments, run the command on both nodes.

The job to create the appliance takes time to complete. To monitor the job progress, click the **Activity** tab. Click the job number to view the tasks.

After deployment, the `root` and database users `SYS`, `SYSTEM`, and `PDBADMIN` are set to the system password. The `oracle` and `grid` passwords are set to the default password. Change these passwords to comply with your user security protocols.

Related Topics

- [Errors When Logging into the Browser User Interface](#)
If you have problems logging into the Browser User Interface, then it may be due to your browser or credentials.

Related Topics

- [Deployment Checklist for Oracle Database Appliance Bare Metal Systems](#)
This checklist provides an overview of the tasks to setup and deploy Oracle Database Appliance bare metal systems for the first time.

Related Topics

- [Reimaging an Oracle Database Appliance Baremetal System](#)
Reimage Oracle Database Appliance to perform a bare metal restore of Oracle Database Appliance.

Related Topics

- [Implementing Multi-User Access on Oracle Database Appliance](#)
Understand how multi-user access can be implemented on Oracle Database Appliance, its advantages and restrictions and the associated life cycle management changes for your appliance.
- [odacli Multi-User Access Commands](#)
Use `odacli` commands to enable multi-user access for the appliance.

About Enabling Oracle ASMFD on Oracle Database Appliance

Understand how you can enable Oracle ASMFD on bare metal systems and DB systems on Oracle Database Appliance.

Oracle ASM Filter Driver (Oracle ASMFD) simplifies the configuration and management of disk devices by eliminating the need to rebind disk devices used with Oracle ASM each time the system is restarted.

By default, Oracle ASMFD is enabled on Oracle Database Appliance bare metal systems and DB systems. To disable Oracle ASMFD on Oracle Database Appliance bare metal system and DB system, specify `"enableAFD": "FALSE"` in the JSON file when you provision the bare metal system and DB system. If Oracle ASMFD is not enabled on Oracle Database Appliance bare metal system, then you cannot enable Oracle ASMFD on Oracle Database Appliance DB system. If Oracle ASMFD is enabled on Oracle Database Appliance bare metal system, then you can choose to enable or disable Oracle ASMFD on Oracle Database Appliance DB system by specifying the parameter `"enableAFD": "TRUE"` or `"enableAFD": "FALSE"` in the DB system JSON file during provisioning of the DB system.

For DB systems, if the `"enableAFD"` attribute is not specified in the JSON file during provisioning, then the Oracle ASMFD configuration on the DB system is the same as the bare metal system Oracle ASMFD configuration.

For more information about specifying the `"enableAFD"` attribute in the JSON files when provisioning bare metal and DB systems, see the example JSON files provided in the chapters *Creating an Appliance Using JSON File* and *Managing an Oracle Database Appliance KVM Deployment* in this book.

**Note:**

To identify if Oracle ASMFD is enabled or not, check whether the `/etc/oracleafd.conf` file exists or not. Oracle ASMFD is enabled if this file exists, otherwise, Oracle ASMFD is disabled.

5

Implementing Multi-User Access on Oracle Database Appliance

Understand how multi-user access can be implemented on Oracle Database Appliance, its advantages and restrictions and the associated life cycle management changes for your appliance.

Caution:

You can enable multi-user access **only** at the time of provisioning Oracle Database Appliance on bare metal systems and **cannot** rollback multi-user access after you provision and deploy your appliance. The Oracle Database Appliance administration model changes when you deploy the Multi-User Access feature. Evaluate your role separation requirements before using this feature. Deploying on a test system first can help with the evaluation and assessment of the new administration model.

Note:

You can enable multi-user access on Oracle Database Appliance DB systems when you create the DB system either using ODA CLI commands or Browser User Interface (BUI).

- [About Multi-User Access on Oracle Database Appliance](#)
Before provisioning your appliance, understand how multi-user access can enhance the security of the system and provide an efficient mechanism for role separation.
- [About Users, Roles, Entitlements, and Operations on a Multi-User Access Enabled Oracle Database Appliance System](#)
Understand the users, roles, entitlements, and operations when you provision your appliance with multi-user access enabled.
- [About Granting and Revoking Resource Access](#)
Multi-user access allows exclusive or shared access to resources. Review this example about shared resource access.
- [Using Passwordless Multi-User Access on Oracle Database Appliance](#)
Understand how you can implement passwordless multi-user access on Oracle Database Appliance, its advantages and restrictions, and the associated life cycle management changes for your appliance.
- [Provisioning Oracle Database Appliance with Multi-User Access](#)
You can enable multi-user access **only** when you provision Oracle Database Appliance, using CLI commands or the Browser User Interface.
- [Creating, Viewing, and Deleting Users on Oracle Database Appliance with Multi-User Access](#)
After provisioning the appliance with multi-user access enabled, you can create users with specific entitlements.

- [Activating a New User on Oracle Database Appliance with Multi-User Access](#)
Understand how to activate a new user on multi-user access enabled Oracle Database Appliance.
- [Granting and Revoking Resource Access on Oracle Database Appliance with Multi-User Access](#)
You can grant and revoke resource access on the appliance.
- [Viewing Roles, Operations, and Entitlements on Oracle Database Appliance with Multi-User Access](#)
You can view roles and entitlements on the appliance.
- [Managing Databases and Database Homes on Oracle Database Appliance with Multi-User Access](#)
The custom user created on multi-user access Oracle Database Appliance can deploy and manage databases and database homes.
- [Changing the Password for a User Account on Oracle Database Appliance with Multi-User Access](#)
Understand how to manage passwords on multi-user access Oracle Database Appliance.
- [Resetting the Password for a Locked User Account on Oracle Database Appliance with Multi-User Access](#)
Understand how to reset the password on multi-user access Oracle Database Appliance.

About Multi-User Access on Oracle Database Appliance

Before provisioning your appliance, understand how multi-user access can enhance the security of the system and provide an efficient mechanism for role separation.

Currently, a single Oracle Database Appliance account with user name and password is used to securely connect to the appliance, run ODA CLI commands, or log into BUI. The `root` user performs all administration on an Oracle Database Appliance. With multi-user access, you have the option of providing separate access to database administrators to manage databases. Display of resources within the Browser User Interface are also filtered as per user role. The `root` access is restricted to the Oracle Database Appliance system administrator to access system logs or debug issues that require `root` access.

When you enable multi-user access, you create multiple users with different roles that restrict them from accessing resources created by other users and also restrict the set of operations they can perform using ODA CLI commands or Browser User Interface (BUI). The same user credentials that you set up, can be used for logging into the BUI and running ODA CLI commands. The BUI also displays resources and information based on access to the set of resources. A separate **Multi-User Access Management** tab is available only to the `odaadmin` user to administer the users and resources in the system.



Note:

When you enable multi-user access, the Oracle Database Appliance administrator is `odaadmin`. This user has access to all the resources on the appliance and can run any operations using ODA CLI or the BUI using the same set of credentials. When you do not enable multi-user access, the user name you use to log into BUI is `oda-admin`.

 **Note:**

The authentication token support for ODACLI session management is linked to a multi-user access user account. Since `root` is an operating system administrative user and not a multi-user access user, auth token based session management system is not supported when a user logs in as `root`. Therefore, you must provide an Oracle Database Appliance account user name and password to run any ODACLI command.

Benefits of enabling multi-user access

- Multi-user access feature supports user lifecycle management such as creation, activation, updation, deactivation, deletion, and credential management.
- By using multi-user access, multiple departments such as finance and human resources within the same organization can use Oracle Database Appliance as a consolidation platform for hosting their databases in a secure manner as only the authorized users in the respective departments can access their departmental databases and perform lifecycle management operations on the databases.
- Organizations that have root access policy restrictions can use multi-user access and create separate users with restricted roles.
- Without multi-user access, all databases were created as the default database user chosen during provisioning. Hence, even in a `sudo`-based multi-user environment, the ODA administrator could not track usage of resources. Now such reporting is possible at the database level.
- Multi-user access feature supports token-based session management. A user enters the password only when they run the first `odacli` command. Subsequently, a token is generated and till it expires, the user is not required to enter the password again. Each time an `odacli` command is run, the existing token is refreshed with a new token that has the expiry of 120 mins or the value configured by the `odaadmin` user. This means if the `odacli` session is not idle for the expiry duration, the user does not need to enter the password again.
- Both Basic Auth and mTLS modes of authentication are supported. ODACLI and BUI uses Basic Auth. Users such as `oracle` and `grid` can also run certain operations on the DCS agent using mTLS-based authentication. Basic Auth is a password-based authentication scheme. mTLS is a certificate-based authentication scheme where both the client (user) and the server (DCS agent) mutually present and authenticate each other's certificate before the authentication is deemed complete.
- Multi-user access provides for user account locking on multiple failed login attempts and password expiration. You can also unlock and reset the account in case the password is forgotten.

 **Note:**

You can enable multi-user access **only** at the time of provisioning Oracle Database Appliance and **cannot** rollback multi-user access after you provision and deploy your appliance. Provision the feature on your test system first, and then deploy this feature on your production system.

Related Topics

- [odacli Multi-User Access Commands](#)
Use `odacli` commands to enable multi-user access for the appliance.
- [ODACLI Command Changes with Multi-User Access on Oracle Database Appliance](#)
Understand the ODACLI command changes when you enable multi-user access.

About Users, Roles, Entitlements, and Operations on a Multi-User Access Enabled Oracle Database Appliance System

Understand the users, roles, entitlements, and operations when you provision your appliance with multi-user access enabled.

Note:

Note that in a multi-user access enabled deployment, the `oda-admin` user is not present. The ODA admin user name is `odaadmin`. The first user with administrative privileges is called `odaadmin`. This user can log into the BUI and run ODACLI commands. This user can also create other user accounts with roles and entitlements as required.

About Roles, Entitlements, and Operations

Each user can be assigned one or more roles in a multi-user enabled Oracle Database Appliance system. Each role encompasses a set of entitlements that authorizes a user to perform only a specific set of operations using ODACLI or BUI. Each entitlement in turn, is a group of a similar set of operations. For example, `PROVISIONDB-MGMT` is an entitlement that encompasses provisioning-related operations such as `create-database`, `clone-database`, `delete-database`, `register-database`. Similarly, `BACKUPDB-MGMT` encompasses backup related operations such as `create-backup`, `delete-backup`, `irestore-database`, `recover-database`, and so on. The `ODA-DB` role has access to a collection of entitlements such as `PROVISIONDB-MGMT`, `BACKUPDB-MGMT`, and `PATCHDB-MGMT`. A user with the `ODA-DB` role can perform all the database lifecycle management operations on the databases that they own. Additionally, if a user with the role of `ODA-DB` is granted the `ODA-GRID` role as well, this user can now perform Oracle Grid Infrastructure-related operations.

Roles can be internal or external. Internal roles are assigned to system users and are used internally for the purpose of administration of the Oracle Database Appliance system. For example, the `ODA-ADMINISTRATOR` role is assigned to the Oracle Database Appliance system administrator to manage the appliance or associated entities. Another example is a DB system communicating with the bare metal using a system user with the role of `ODA-DBVMINFRA`.

External roles can be granted to the new users created by `odaadmin`, the Oracle Database Appliance system administrator. For example, the `odaadmin` creates a new user `odadb1` with the role of `ODA-DB`. Now this user `odadb1` is entitled to create databases and perform lifecycle management operations because of the role granted to them. A user can have one or more roles.

The topic *ODACLI Command Changes with Multi-User Access on Oracle Database Appliance* describes the ODACLI commands that have changes for multi-user access and the entitlements required to run the commands.

Multi-User Access User Roles

When you enable multi-user access on Oracle Database Appliance, the following user roles are available:

- **ODA-ADMINISTRATOR:** This is an internal role assigned to the first user (`odaadmin`) created during the provisioning of an Oracle Database Appliance. This role entitles `odaadmin` to run all ODACLI commands or perform all Browser User Interface (BUI) operations. This role cannot be assigned to the new users that `odaadmin` creates. The `odaadmin` account is an administrator role that can run any operation (command) on any resource. For example, user `oda1` creates a database `db1` and user `oda2` creates a database `db2`. Each user can now perform lifecycle management operations on their respective database only. But, `odaadmin` can patch both databases by running `odacli` commands. This allows both DBAs (`oda1` and `oda2`) and an overall administrator (`odaadmin`) to perform functions specific to their role.
- **ODA-DB:** This is an external role available to `odaadmin` to assign to newly-created users. This role entitles the user to perform database management operations such as create, modify, restore, recover, backup, patch, clone, move, register, and delete.
- **ODA-OAKDROOT:** This is an internal role that is assigned to system user `oakdroot` created during provisioning and is used by OAKD to run certain operations such as get-disks and release-disks on the DCS agent. OAKD communicates with DCS through mTLS certificates-based authentication. Hence, this user does not have any password associated with it. Do not use this role to connect by SSH to the appliance or log into the Browser User Interface to run ODACLI commands. None of the password management commands such as change-password apply to this user.
- **ODA-GRID:** This is an internal role assigned to the `grid` user. This role entitles the user to run Oracle Grid Infrastructure-related operations.
- **ODA-DBVMINFRA:** This is an internal role assigned to the DBVM user created on the bare metal system when the DB system is provisioned. This role entitles the user to synchronize metadata between the DB system and the bare metal system.

Related Topics

- [odacli Multi-User Access Commands](#)
Use `odacli` commands to enable multi-user access for the appliance.
- [ODACLI Command Changes with Multi-User Access on Oracle Database Appliance](#)
Understand the ODACLI command changes when you enable multi-user access.

About Granting and Revoking Resource Access

Multi-user access allows exclusive or shared access to resources. Review this example about shared resource access.

Multi-user access allows exclusive or shared access to resources. It is recommended that each user creates their own database home and then creates databases in the home. This provides for an efficient method of separation of duties where each user has exclusive access to their databases. However, in certain exceptional situations, such as lack of disk space, a user can request the administrator `odaadmin` to grant them shared access to a resource owned by another user.

For example, if user `oda1` wants to create a database of version 19c and there is already a database home `DBH2` of the same version created by another user `oda2`. With the consent of user `oda2`, user `oda1` can now request the `odaadmin` user to grant them shared access to

database home `DBH2`. Once the shared access is granted, user `oda1` can now create a database `db1` on the shared database home `DBH2` and manage it. Note that user `oda1` can connect to the database `db1` only through the `SYS` user password and not as a password-less connection based on operating system authentication, as the database home `DBH2` is still owned by user `oda2`. Oracle Database Appliance resources such as database home, database storage, and databases can be shared accross users in a similar fashion on an on-demand basis. However, there are restrictions to the secondary owner managing the shared resource.

Using Passwordless Multi-User Access on Oracle Database Appliance

Understand how you can implement passwordless multi-user access on Oracle Database Appliance, its advantages and restrictions, and the associated life cycle management changes for your appliance.

Caution:

You can enable passwordless multi-user access **only** at the time of provisioning Oracle Database Appliance on bare metal and DB systems and **cannot** rollback multi-user access after you provision and deploy your appliance. The Oracle Database Appliance administration model changes when you deploy the passwordless multi-user access feature. Evaluate your role separation requirements before using this feature. Deploying on a test system first can help with the evaluation and assessment of the new administration model.

Existing bare metal and DB system deployments that do not have multi-user access enabled or have the earlier multi-user access feature which requires a password when you first run an `odacli` command, cannot be converted to a passwordless multi-user access deployment.

Note:

Starting with Oracle Database Appliance release 19.23, a passwordless flavor of the multi-user access feature is also available. You can provision a DB system with either flavor of multi-user access on a bare metal system that does not have multi-user access enabled. On such a bare metal system, you can still use role separation and resource ownership capabilities that multi-user access or multi-user access passwordless provides.

- [About Passwordless Multi-User Access on Oracle Database Appliance](#)
Before provisioning your appliance, understand how passwordless multi-user access can enhance the security of the system and provide an efficient mechanism for role separation.
- [Provisioning Oracle Database Appliance with Passwordless Multi-User Access](#)
You can enable passwordless multi-user access **only** when you provision Oracle Database Appliance using CLI commands. Passwordless multi-user access feature provisioning and management is not supported through the Browser User Interface (BUI).

- [Creating, Viewing, and Deleting Users on Oracle Database Appliance with Passwordless Multi-User Access](#)
After provisioning the appliance with passwordless multi-user access enabled, you can create users with specific entitlements.
- [Changing the Password for a User Account on Oracle Database Appliance with Passwordless Multi-User Access](#)
Understand how to manage passwords on multi-user access Oracle Database Appliance.
- [Example JSON Files to Create a Single-Node Passwordless Multi-User Enabled Appliance](#)
Follow these JSON file examples to create a JSON file to deploy a single node appliance with the command `odacli create-appliance`.
- [Example JSON File to Create a High-Availability Passwordless Multi-User Enabled Appliance](#)
Follow the JSON file example to create a JSON file to deploy a high-availability appliance with the command `odacli create-appliance`.
- [Example JSON Files to Create a Single-Node Passwordless Multi-User Enabled DB System](#)
Follow the JSON file example to create a JSON file to deploy a single-node DB System, with role separation, with the command `odacli create-dbsystem`.
- [Example JSON File to Create a High-Availability Passwordless Multi-User Enabled DB System](#)
Follow the JSON file example to create a JSON file to deploy a two-node DB System, with role separation, with the command `odacli create-dbsystem`.

About Passwordless Multi-User Access on Oracle Database Appliance

Before provisioning your appliance, understand how passwordless multi-user access can enhance the security of the system and provide an efficient mechanism for role separation.

Oracle Database Appliance supports enabling of passwordless multi-user access at the time of provisioning of Oracle Database Appliance, on bare metal systems and DB systems. You must specify the `"isMultiUserAccessPEnabled": true` option in the JSON file used for provisioning bare metal systems and DB systems. For more information, see the example JSON file with this option in this chapter.

When you enable passwordless multi-user access, you create multiple users with different roles that restrict them from accessing resources created by other users and also restrict the set of operations they can perform using ODACLI commands.

Note:

You can enable passwordless multi-user access on Oracle Database Appliance bare metal and DB systems at the time of provisioning using ODACLI commands. You cannot use the Browser User Interface (BUI) to enable passwordless multi-user access on Oracle Database Appliance bare metal systems. However, you can use the BUI on the Oracle Database Appliance bare metal system to enable multi-user access on Oracle Database Appliance DB systems at the time of provisioning.

Benefits of enabling passwordless multi-user access

- If your corporate policies prevent direct usage of Oracle Database Appliance user account passwords by employing tools or software that allow access to Oracle Database Appliance through your corporate credentials, then you can configure passwordless multi-user

access and run commands on your appliance without the need for specifying your Oracle Database Appliance account password when you first run an ODACLI command or when your authentication token expires. This does not compromise the security of the system as all communication to the Oracle Database Appliance server is through a strong and secure system generated password, unique for every user.

- Passwordless multi-user access feature provides role separation and supports user lifecycle management such as creation, deletion, and credential management.
- By using passwordless multi-user access, multiple departments such as finance and human resources within the same organization can use Oracle Database Appliance as a consolidation platform for hosting their databases in a secure manner as only the authorized users in the respective departments can access their departmental databases and perform lifecycle management operations on the databases.
- Organizations that have root access policy restrictions can use passwordless multi-user access and create separate users with restricted roles.
- Without multi-user access, all databases were created as the default database user chosen during provisioning. Hence, even in a `sudo`-based multi-user environment, the ODA administrator could not track usage of resources. Now such reporting is possible at the database level.
- For passwordless multi-user access, you do not have to specify the Oracle Database Appliance account password when you first run an ODACLI command or when the authentication token expires. The Oracle Database Appliance system generates a strong and secure password for every user. This password is internally stored by the system and used when you run `odacli` commands.
- Both Basic Auth and mTLS modes of authentication are supported. ODACLI uses Basic Auth. Users such as `oracle` and `grid` can also run certain operations on the DCS agent using mTLS-based authentication. Basic Auth is a password-based authentication scheme. mTLS is a certificate-based authentication scheme where both the client (user) and the server (DCS agent) mutually present and authenticate each other's certificate before the authentication is deemed complete.

 **Note:**

You can enable passwordless multi-user access **only** at the time of provisioning Oracle Database Appliance and **cannot** rollback passwordless multi-user access after you provision and deploy your appliance. Provision the feature on your test system first, and then deploy this feature on your production system.

Related Topics

- [odacli Multi-User Access Commands](#)
Use `odacli` commands to enable multi-user access for the appliance.
- [ODACLI Command Changes with Multi-User Access on Oracle Database Appliance](#)
Understand the ODACLI command changes when you enable multi-user access.

Provisioning Oracle Database Appliance with Passwordless Multi-User Access

You can enable passwordless multi-user access **only** when you provision Oracle Database Appliance using CLI commands. Passwordless multi-user access feature provisioning and management is not supported through the Browser User Interface (BUI).

Provision your appliance as described in the chapter *Provisioning Oracle Database Appliance Bare Metal System*.

⚠ Caution:

You can enable passwordless multi-user access **only** at the time of provisioning Oracle Database Appliance on bare metal systems and **cannot** rollback multi-user access after you provision and deploy your appliance. The Oracle Database Appliance administration model changes when you deploy the passwordless multi-user access feature. Evaluate your role separation requirements before using this feature. Deploying on a test system first can help with the evaluation and assessment of the new administration model.

Overall Steps in Provisioning Oracle Database Appliance with Passwordless Multi-User Access Enabled

1. Enable passwordless multi-user access.
 - To provision your appliance using a JSON file, add the attribute `"isMultiUserAccessPLEnabled": true` in the `prov_req.json` file. If the attribute is set to `false` or does not exist in the `prov_req.json` file, then passwordless multi-user access is not enabled during provisioning of the appliance. Note that you can set either multi-user access or passwordless multi-user access in the JSON file, **not** both.

```
"isRoleSeparated": true,
  "isMultiUserAccessPLEnabled": true,
  "osUserGroup": {
    "groups": [{
      "groupId": 1001,
      "groupName": "oinstall",
      "groupRole": "oinstall"
    }],
  },
```

...

2. Connect to the Oracle Database Appliance network and run the `odacli configure-firstnet` command using the Oracle ILOM console.
3. Log into Oracle Database Appliance as the root user and run the `odacli create-appliance -r prov.json` command with `"isMultiUserAccessPLEnabled": true` in the `prov.json` file.
4. After the provisioning job is submitted, log out as `root` and log in as the `odaadmin` user using a PAM utility or passwordless SSH and check the status of the provisioning job and ensure that it is successful.

5. The system creates Oracle Database Appliance accounts for `odaadmin`, `oracle`, and `grid` users. These are Oracle Database Appliance system users and their accounts are activated during created. The user `odaadmin` is created with the role of `ODA-ADMINISTRATOR` while the `oracle` and `grid` users are created with the role of `ODA_DB` and `ODA_GRID` respectively.
6. The system configures the multi-user access repository with a list of roles and entitlements, used for assigning to the users in the system.
7. You can now log into the appliance using the PAM utility that is integrated with the appliance. The PAM utility prompts you for your corporate credentials and on successful authentication, logs you into the appliance as an Oracle Database Appliance user as per the mapping defined by the PAM utility administrator. Alternatively, you can set up passwordless SSH to log into the appliance.
8. After the bare metal system is provisioned, log in as the `odaadmin` user and run the `odacli create-dbsystem -p prov.json` command with `"isMultiUserAccessPEnabled": true` in the `prov.json` file.
9. After the DB system is provisioned, log in as the `odaadmin` user through the PAM utility or passwordless SSH and create additional users, if required.
10. Log into the DB system as the `oracle` user through the PAM utility or passwordless SSH and create databases for the `oracle` user.
11. Log into DB system as a custom user through the PAM utility or passwordless SSH and create databases for the custom user.

Related Topics

- [Provisioning Oracle Database Appliance Bare Metal System](#)
Understand the process to configure Oracle Database Appliance bare metal system.
- [odacli Multi-User Access Commands](#)
Use `odacli` commands to enable multi-user access for the appliance.

Creating, Viewing, and Deleting Users on Oracle Database Appliance with Passwordless Multi-User Access

After provisioning the appliance with passwordless multi-user access enabled, you can create users with specific entitlements.

After you provision your appliance with multi-user access enabled, do the following:

Creating, Viewing, and Deleting Users with ODACLI Commands

1. Connect to the appliance as the `odaadmin` user.

```
ssh odaadmin@oda-box hostname/IP
```

2. Run any ODACLI command and provide the `odaadmin` password when prompted.
3. On successful authentication, create a user with the following command:

```
odacli create-user -u username -r comma-separated role names
```

For example, create a user `dbuser1` with lifecycle management privileges for databases:

```
odacli create-user -u dbuser1 -r ODA-DB
```

The `odaadmin` user creates `dbuser1` and assigns a temporary password.

4. After the user is created successfully, the `dbuser1` can log into the appliance with the temporary password.
5. The `dbuser1` is in the `Inactive` state. Activate the user with the following command:

```
odacli activate-user
```

You are prompted to change the password. Enter the temporary password, the new password, and confirm the new password.

6. Use the new password to connect by SSH into the appliance and run ODACLI commands or connect to the Browser User Interface.
7. The `odaadmin` user can view all the users in the system:

```
# odacli list-users
```

8. The `odaadmin` user can view details for a user in the system:

```
# odacli describe-user -u user_id
```

9. Delete a user in the system. Note that only the `odaadmin` user can delete a user in the system.

```
# odacli delete-user -u user_id
```

Related Topics

- [odacli Multi-User Access Commands](#)
Use `odacli` commands to enable multi-user access for the appliance.

Changing the Password for a User Account on Oracle Database Appliance with Passwordless Multi-User Access

Understand how to manage passwords on multi-user access Oracle Database Appliance.

Note:

If your appliance is configured as passwordless multi-user enabled, then all user accounts are preactivated during creation and never get locked because the system internally generates the password for each user and provides it to the DCS agent for authentication when required for running ODACLI commands. For passwordless multi-user enabled systems, do **not** run any scripts for unlocking the `odaadmin` account or the `odacli reset-password` command to reset the password. Run the `odacli change-password` command to change the system generated password for your Oracle Database Appliance account.

Changing the Password on Passwordless Multi-User Access Enabled System Using ODACLI Commands

- You can change password for an Oracle Database Appliance user, whose account is active. This command resets the password of this user account to a new randomly generated password.

```
odacli change-password
```

Related Topics

- [odacli Multi-User Access Commands](#)
Use `odacli` commands to enable multi-user access for the appliance.

Example JSON Files to Create a Single-Node Passwordless Multi-User Enabled Appliance

Follow these JSON file examples to create a JSON file to deploy a single node appliance with the command `odacli create-appliance`.



Note:

If you do not enter your network and Oracle ILOM information correctly based on your setup, then network access is lost to both the host and Oracle ILOM.

When using the example to create your JSON file, change the definitions to match your environment. The password must meet password requirements.

Note: To configure Oracle ASR during provisioning, always specify the `asrType` parameter in the JSON file.

Example 5-1 JSON File to Create a Single Node Oracle Database Appliance with Role Separation and Passwordless Multi-User Access

The following is an example of a JSON file that creates a single node appliance on Oracle Database Appliance. The example uses role separation and enables passwordless multi-user access.

```
{
  "instance" : {
    "name" : "odambox",
    "instanceBaseName" : "odambox-c",
    "dbEdition" : "EE",
    "timeZone" : "UTC",
    "ntpServers" : ["xx.x.x.x"],
    "dnsServers" : ["x.x.x.xx", "xx.x.x.xx", "xx.x.x.xx"],
    "domainName" : "example.com",
    "isRoleSeparated" : true,
    "isMultiUserAccessPLEnabled" : true,
    "osUserGroup" : {
      "groups" : [ {
        "groupId" : 1001,
```

```

        "groupName" : "oinstall",
        "groupRole" : "oinstall"
    }, {
        "groupId" : 1002,
        "groupName" : "dbaoper",
        "groupRole" : "dbaoper"
    }, {
        "groupId" : 1003,
        "groupName" : "dba",
        "groupRole" : "dba"
    }, {
        "groupId" : 1004,
        "groupName" : "asmadmin",
        "groupRole" : "asmadmin"
    }, {
        "groupId" : 1005,
        "groupName" : "asmoper",
        "groupRole" : "asmoper"
    }, {
        "groupId" : 1006,
        "groupName" : "asmdba",
        "groupRole" : "asmdba"
    } ],
    "users" : [ {
        "userId" : 1000,
        "userName" : "oracle",
        "userRole" : "oracleUser"
    }, {
        "userId" : 1001,
        "userName" : "grid",
        "userRole" : "gridUser"
    } ]
}
},
"users": [
    {
        "id": 1000,
        "name": "ugrid",
        "role": "gridUser"
    },
    {
        "id": 1001,
        "name": "uoracle",
        "role": "oracleUser"
    }
]
},
"multiUserAccess": {
    "isMultiUserAccessPLEnabled": true
}
},
"sysOraHomeStorage": {
    "volumeSize": "160",
    "diskgroup": "DATA"
}
"nodes" : [ {

```

```
"nodeNumber" : "0",
"nodeName" : "odambox",
"network" : [ {
  "nicName" : "btbond1",
  "ipAddress" : "xx.x.x.xx",
  "subNetMask" : "xxx.xxx.xxx.x",
  "gateway" : "xx.x.x.x",
  "networkType" : [ "Public" ],
  "isDefaultNetwork" : true
},
],
"ilom" : {
  "ilomName": "odambox-c",
  "ipAddress": "xx.x.x.xx",
  "subNetMask": "xxx.xxx.xx.x",
  "gateway": "xx.x.x.x"
}
} ],
"grid" : {
  "diskGroup" : [ {
    "diskGroupName" : "DATA",
    "redundancy" : "NORMAL",
    "diskPercentage" : 80
  }, {
    "diskGroupName" : "RECO",
    "redundancy" : "NORMAL",
    "diskPercentage" : 20
  } ],
"scan" : null,
"vip": null,
  "language" : "en",
  "enableAFD": "TRUE"
},
"database" : {
  "dbName" : "myTestDb",
  "databaseUniqueName": "myTestDb_sealkj",
  "dbEdition" : "EE",
  "dbVersion" : "19.23.0.0",
  "dbHomeId": null,
  "instanceOnly" : false,
  "isCdb" : true,
  "pdbName" : "pdb1",
  "pdbAdminuserName" : "pdbuser",
  "enableTDE": true,
  "adminPassword" : "password",
  "dbType" : "SI",
  "dbTargetNodeNumber" : null,
  "dbClass" : "OLTP",
  "dbShape" : "odb1",
  "dbStorage" : "ACFS",
  "dbCharacterSet" : {
    "characterSet" : "AL32UTF8",
    "nlsCharacterSet" : "AL16UTF16",
    "dbTerritory" : "AMERICA",
    "dbLanguage" : "AMERICAN"
  }
},
```

```

    "dbConsoleEnable" : false,
    "backupConfigId":null,
    "rmanBkupPassword": null
  },
  "asr" :{
    "asrType": "INTERNAL",
    "userName":"john.smith@example.com",
    "password":"password",
    "proxyServerName":"www-proxy.example.com",
    "proxyPort":"80",
    "proxyUserName":"proxy-user",
    "proxyPassword":"proxy-password",
    "httpsPortNumber":"16163"
  }
}

```

Example 5-2 JSON File to Create a Single Node Oracle Database Appliance without Role Separation and with Passwordless Multi-User Access

The following is an example of a JSON file that creates an Oracle Database Appliance without using role separation and with passwordless multi-user access. This example creates two groups (oinstall and dba) and one user (oracle).

```

{
  "instance" : {
    "name" : "odambox",
    "instanceBaseName" : "odambox-c",
    "dbEdition" : "EE",
    "timeZone" : "UTC",
    "ntpServers" : ["xx.x.x.xx"],
    "dnsServers" : ["xx.x.x.xx", "xx.x.x.xx", "xx.x.x.xx"],
    "domainName" : "example.com",
    "isRoleSeparated" : false,
    "isMultiUserAccessPLEnabled" : true,
    "osUserGroup" : {
      "groups" : [ {
        "groupId" : 1001,
        "groupName" : "oinstall",
        "groupRole" : "oinstall"
      }, {
        "groupId" : 1002,
        "groupName" : "dba",
        "groupRole" : "dba"
      } ],
      "multiUserAccess": {
        "isMultiUserAccessPLEnabled": true
      }
    },
  },
  "nodes" : [ {
    "nodeNumber" : "0",
    "nodeName" : "odambox",
    "network" : [ {
      "nicName" : "btbond1",
      "ipAddress" : "xx.x.x.xx",
      "subNetMask" : "xxx.xxx.xxx.x",
      "gateway" : "xx.x.x.x",
    }
  ]
}

```

```
        "networkType" : [ "Public" ],
        "isDefaultNetwork" : true
    },
],
"ilom" : {
    "ilomName": "odambox-c",
    "ipAddress": "xx.x.x.xx",
    "subNetMask": "xxx.xxx.xxx.x",
    "gateway": "xx.x.x.x"
}
} ],
"grid" : {
    "diskGroup" : [ {
        "diskGroupName" : "DATA",
        "redundancy" : "NORMAL",
        "diskPercentage" : 80
    }, {
        "diskGroupName" : "RECO",
        "redundancy" : "NORMAL",
        "diskPercentage" : 20
    } ],
"scan" : null,
"vip": null,
    "language" : "en",
    "enableAFD": "TRUE"
},
"database" : {
    "dbName" : "myTestDb",
    "databaseUniqueName": "myTestDb_sealkj",
    "dbEdition" : "EE",
    "dbVersion" : "19.21.0.0",
    "dbHomeId": null,
    "instanceOnly" : false,
    "isCdb" : true,
    "pdbName" : "pdb1",
    "pdbAdminuserName" : "pdbuser",
    "enableTDE": true,
    "adminPassword" : "password",
    "dbType" : "SI",
    "dbTargetNodeNumber" : null,
    "dbClass" : "OLTP",
    "dbShape" : "odb1",
    "dbStorage" : "ACFS",
    "dbCharacterSet" : {
        "characterSet" : "AL32UTF8",
        "nlsCharacterSet" : "AL16UTF16",
        "dbTerritory" : "AMERICA",
        "dbLanguage" : "AMERICAN"
    },
    "dbConsoleEnable" : false,
    "backupConfigId": null,
    "rmanBkupPassword": null
},
"asr" : {
    "asrType": "INTERNAL",
    "userName": "john.smith@example.com",
```

```

    "password": "password",
    "proxyServerName": "www-proxy.example.com",
    "proxyPort": "80",
    "proxyUserName": "proxy-user",
    "proxyPassword": "proxy-password",
    "httpsPortNumber": "16163"
  }
}

```

Example JSON File to Create a High-Availability Passwordless Multi-User Enabled Appliance

Follow the JSON file example to create a JSON file to deploy a high-availability appliance with the command `odacli create-appliance`.

Note:

It is important to review the readme and the examples carefully before creating your JSON file. If you do not enter your network and Oracle ILOM information correctly based on your setup, then network access is lost to both the host and Oracle ILOM.

Example 5-3 JSON File to Create a High-Availability Oracle Database Appliance with Role Separation and with Passwordless Multi-User Access

The following is an example of a JSON file that creates a high-availability appliance on Oracle Database Appliance bare metal platform. The example uses role separation and with passwordless multi-user access. When using the example to create your JSON file, change the definitions to match your environment. The password must meet password requirements.

```

{
  "instance": {
    "name": "odahabox",
    "instanceBaseName": "odahabox",
    "dbEdition": "EE",
    "timeZone": "UTC",
    "ntpServers" : ["10.0.3.14"],
    "dnsServers" : ["10.0.4.10", "10.0.4.11", "10.0.4.12"],
    "domainName": "example.com",
    "isRoleSeparated": true,
    "isMultiUserAccessPLEnabled" : true,
    "osUserGroup": {
      "groups": [
        {
          "groupId": 1001,
          "groupName": "oinstall",
          "groupRole": "oinstall"
        },
        {
          "groupId": 1002,
          "groupName": "dbaoper",
          "groupRole": "dbaoper"
        }
      ]
    }
  }
}

```

```

        {
            "groupId":1003,
            "groupName":"dba",
            "groupRole":"dba"
        },
        {
            "groupId":1004,
            "groupName":"asmadmin",
            "groupRole":"asmadmin"
        },
        {
            "groupId":1005,
            "groupName":"asmoper",
            "groupRole":"asmoper"
        },
        {
            "groupId":1006,
            "groupName":"asmdba",
            "groupRole":"asmdba"
        }
    ],
    "users":[
        {
            "userId":101,
            "userName":"grid",
            "userRole":"gridUser"
        },
        {
            "userId":102,
            "userName":"oracle",
            "userRole":"oracleUser"
        }
    ]
},
"users": [
    {
        "id": 1000,
        "name": "ugrid",
        "role": "gridUser"
    },
    {
        "id": 1001,
        "name": "uoracle",
        "role": "oracleUser"
    }
]
},
"multiUserAccess": {
    "isMultiUserAccessPLEnabled": true
}
},
"objectStoreCredentials":null
},
"sysOraHomeStorage": {
    "volumeSize": "160",
    "diskgroup": "DATA"
}

```



```
}
"nodes":[
  {
    "nodeNumber":"0",
    "nodeName":"odahaboxc1n2",
    "network":[
      {
        "nicName":"btbond1",
        "ipAddress":"10.31.98.133",
        "subNetMask":"255.255.240.0",
        "gateway":"10.31.96.1",
        "networkType":[
          "Public"
        ],
        "isDefaultNetwork":true
      }
    ],
    "ilom":{
      "ilomName":"odahabox2-c",
      "ipAddress":"10.31.16.140",
      "subNetMask":"255.255.240.0",
      "gateway":"10.31.16.1"
    }
  },
  {
    "nodeNumber":"1",
    "nodeName":"odahaboxc1n1",
    "network":[
      {
        "nicName":"btbond1",
        "ipAddress":"10.31.98.132",
        "subNetMask":"255.255.240.0",
        "gateway":"10.31.96.1",
        "networkType":[
          "Public"
        ],
        "isDefaultNetwork":true
      }
    ],
    "ilom":{
      "ilomName":"odahabox1-c",
      "ipAddress":"10.31.16.139",
      "subNetMask":"255.255.240.0",
      "gateway":"10.31.16.1"
    }
  }
],
"grid":{
  "diskGroup":[
    {
      "diskGroupName":"DATA",
      "redundancy":"HIGH",
      "diskPercentage":80
    },
    {
      "diskGroupName":"RECO",
```

```
        "redundancy":"HIGH",
        "diskPercentage":20
    },
],
"scan":{
    "scanName":"odahaboxc1-scan",
    "ipAddresses":[
        "10.31.98.182",
        "10.31.98.183"
    ]
},
"vip":[
    {
        "nodeNumber":"0",
        "vipName":"odahaboxc1n2-vip",
        "ipAddress":"10.31.98.159"
    },
    {
        "nodeNumber":"1",
        "vipName":"odahaboxc1n1-vip",
        "ipAddress":"10.31.98.158"
    }
],
"language":"en",
"enableAFD":"TRUE"
},
"database":{
    "dbName":"myTestDb",
    "databaseUniqueName":"myTestDb_sealkj",
    "dbVersion":"19.21.0.0",
    "dbHomeId":null,
    "instanceOnly":false,
    "isCdb":true,
    "pdbName":"pdb1",
    "pdbAdminuserName":"pdbuser",
    "enableTDE":true,
    "adminPassword":"password",
    "dbType":"RAC",
    "dbTargetNodeNumber":null,
    "dbClass":"OLTP",
    "dbShape":"odb1",
    "dbStorage":"ACFS",
    "dbCharacterSet":{
        "characterSet":"AL32UTF8",
        "nlsCharacterSet":"AL16UTF16",
        "dbTerritory":"AMERICA",
        "dbLanguage":"AMERICAN"
    },
    "dbConsoleEnable":false,
    "backupConfigId":null
},
"asr":null
}
```

Example JSON Files to Create a Single-Node Passwordless Multi-User Enabled DB System

Follow the JSON file example to create a JSON file to deploy a single-node DB System, with role separation, with the command `odacli create-dbsystem`.

Use the example JSON file to create a file for your environment.



Note:

It is important to review the readme and the examples carefully before creating your JSON file.

Example 5-4 JSON File to Create a Single-Node Oracle KVM Database System with Role Separation and Passwordless Multi-User Access

The following is an example of a JSON file that creates a single-node Oracle KVM Database System on Oracle Database Appliance bare metal platform. The example uses role separation and passwordless multi-user access. When using the example to create your JSON file, change the definitions to match your environment. The password must meet password requirements.

```
{
  "system": {
    "name": "test_example",
    "shape": "odb2",
    "customMemorySize": "24G",
    "timeZone": "America/Los_Angeles",
    "diskGroup": "DATA",
    "cpuPoolName": "shared_dbsystem_cpupool",
    "enableRoleSeparation": true,
    "customRoleSeparation": {
      "groups": [
        {
          "name": "oinstall",
          "id": 1001,
          "role": "oinstall"
        },
        {
          "name": "dbaoper",
          "id": 1002,
          "role": "dbaoper"
        },
        {
          "name": "dba",
          "id": 1003,
          "role": "dba"
        },
        {
          "name": "asmadmin",
          "id": 1004,
          "role": "asmadmin"
        }
      ]
    }
  }
}
```

```
    },
    {
      "name": "asmoper",
      "id": 1005,
      "role": "asmoper"
    },
    {
      "name": "asmdba",
      "id": 1006,
      "role": "asmdba"
    }
  ],
  "users": [
    {
      "name": "grid",
      "id": 1000,
      "role": "gridUser"
    },
    {
      "name": "oracle",
      "id": 1001,
      "role": "oracleUser"
    }
  ]
}
"users": [
  {
    "id": 1000,
    "name": "ugrid",
    "role": "gridUser"
  },
  {
    "id": 1001,
    "name": "uoracle",
    "role": "oracleUser"
  }
]
},
"multiUserAccess": {
  "isMultiUserAccessPLEnabled": true
}
},
},
"database": {
  "name": "db19",
  "uniqueName": "db19",
  "domainName": "example.com",
  "version": "19.26.0.0.250121",
  "edition": "EE",
  "type": "SI",
  "dbClass": "OLTP",
  "shape": "odb2",
  "role": "PRIMARY",
  "targetNodeNumber": null,
  "enableDbConsole": false,
  "enableFlashStorage": false,
```

```

    "enableFlashCache": false,
    "enableUnifiedAuditing": true,
    "enableEEHA": true,
    "enableSEHA": false,
    "redundancy": null, <<< if diskgroup redundancy is FLEX, then database
redundancy must be set to one of "HIGH" or "MIRROR", otherwise, can be null
    "characterSet": {
        "characterSet": "AL32UTF8",
        "nlsCharacterSet": "AL16UTF16",
        "dbTerritory": "AMERICA",
        "dbLanguage": "ENGLISH"
    },
    "enableTDE": false,
    "isCdb": true,
    "pdbName": "pdb1",
    "pdbAdminUser": "pdbadmin"
},
"network": {
    "domainName": "test_domain",
    "ntpServers": [
        "xx.xxx.xx.xxx"
    ],
    "dnsServers": [
        "xx.xxx.xx.xxx"
    ],
    "nodes": [
        {
            "name": "node1",
            "ipAddress": "xx.xx.xx.xxx",
            "netmask": "xxx.xxx.xxx.x",
            "gateway": "xx.xx.xx.x",
            "number": 0
        }
    ],
    "publicVNetwork": "vnet1"
},
"grid": {
    "language": "en",
    "enableAFD": true
}
}

```

Example 5-5 JSON File to Create a Single-Node Oracle KVM Database System without Role Separation and with Passwordless Multi-User Access

The following is an example of a JSON file that creates a single-node Oracle KVM Database System on Oracle Database Appliance bare metal platform, without role separation and with passwordless multi-user access. When using the example to create your JSON file, change the definitions to match your environment. The password must meet password requirements.

```

{
  "system": {
    "name": "test_example",
    "shape": "odb2",
    "customMemorySize": "24G",
    "timeZone": "America/Los_Angeles",

```

```

        "diskGroup": "DATA",
        "cpuPoolName": "shared_dbssystem_cpupool",
    "database": {
        "name": "db19",
        "uniqueName": "db19",
        "domainName": "example.com",
        "version": "19.26.0.0.250121",
        "edition": "EE",
        "type": "SI",
        "dbClass": "OLTP",
        "shape": "odb4",
        "role": "PRIMARY",
        "targetNodeNumber": null,
        "enableDbConsole": false,
        "enableUnifiedAuditing": true,
        "redundancy": "HIGH",<<< if diskgroup redundancy is FLEX, then
database redundancy must be set to one of "HIGH" or "MIRROR", otherwise, can
be null
        "characterSet": {
            "characterSet": "AL32UTF8",
            "nlsCharacterSet": "AL16UTF16",
            "dbTerritory": "AMERICA",
            "dbLanguage": "ENGLISH"
        },
        "enableTDE": false,
        "isCdb": true,
        "pdbName": "pdb1",
        "pdbAdminUser": "pdbadmin"
    },
    "users": [
        {
            "id": 1000,
            "name": "ugrid",
            "role": "gridUser"
        },
        {
            "id": 1001,
            "name": "uoracle",
            "role": "oracleUser"
        }
    ]
    },
    "multiUserAccess": {
        "isMultiUserAccessPLEnabled": true
    }
},
"network": {
    "domainName": "test_domain",
    "ntpServers": [],
    "dnsServers": [
        "xx.xxx.xx.xxx"
    ],
    "nodes": [
        {
            "name": "node1",
            "ipAddress": "xx.xx.xx.xxx",

```

```

        "netmask": "xxx.xxx.xxx.x",
        "gateway": "xx.xx.xx.x",
        "number": 0
    }
},
"publicVNetwork": "vnet1"
},
"grid": {
    "language": "en",
    "enableAFD": true
}
}

```

Example JSON File to Create a High-Availability Passwordless Multi-User Enabled DB System

Follow the JSON file example to create a JSON file to deploy a two-node DB System, with role separation, with the command `odacli create-dbsystem`.

Use the example JSON file to create a file for your environment.

Example 5-6 JSON File to Create Two-Node Oracle KVM Database System without Role Separation and with Passwordless Multi-User Access

The following is an example of a JSON file that creates two-node Oracle KVM Database System on Oracle Database Appliance bare metal platform, without role separation and with passwordless multi-user access. When using the example to create your JSON file, change the definitions to match your environment. The password must meet password requirements.

```

{
  "system": {
    "name": "test_system",
    "shape": "odb2",
    "customMemorySize": "24G",
    "timeZone": "America/Los_Angeles",
    "diskGroup": "DATA",
    "cpuPoolName": "shared_dbsystem_cpupool",
  },
  "database": {
    "name": "dbtest",
    "uniqueName": "dbtest",
    "domainName": "test_domain",
    "version": "19.26.0.0.250121",
    "edition": "EE",
    "type": "SI",
    "dbClass": "OLTP",
    "shape": "odb2",
    "role": "PRIMARY",
    "targetNodeNumber": "0",
    "enableDbConsole": false,
    "enableUnifiedAuditing": true,
    "enableEEHA": true,
    "redundancy": "MIRROR", <<< if diskgroup redundancy is FLEX, then
database redundancy must be set to one of "HIGH" or "MIRROR", otherwise, can
be null
  }
}

```

```
"characterSet": {
  "characterSet": "AL32UTF8",
  "nlsCharacterSet": "AL16UTF16",
  "dbTerritory": "AMERICA",
  "dbLanguage": "AMERICAN"
},
"enableTDE": false,
"isCdb": true,
"pdbName": "pdb1",
"pdbAdminUser": "pdbadmin"
},
"users": [
  {
    "id": 1000,
    "name": "ugrid",
    "role": "gridUser"
  },
  {
    "id": 1001,
    "name": "uoracle",
    "role": "oracleUser"
  }
]
},
"multiUserAccess": {
  "isMultiUserAccessPLEnabled": true
}
},
"network": {
  "domainName": "test_domain",
  "ntpServers": [],
  "dnsServers": [
    "xx.xxx.xx.xxx"
  ],
  "nodes": [
    {
      "name": "node1",
      "ipAddress": "xx.xx.xxx.xx",
      "netmask": "xxx.xxx.xxx.x",
      "gateway": "xx.xx.xxx.x",
      "number": 0,
      "vipName": "node1-vip",
      "vipAddress": "xx.xx.xxx.xx"
    },
    {
      "name": "node2",
      "ipAddress": "xx.xx.xxx.xx",
      "netmask": "xxx.xxx.xxx.x",
      "gateway": "xx.xx.xxx.x",
      "number": 1,
      "vipName": "node2-vip",
      "vipAddress": "xx.xx.xxx.xx"
    }
  ],
  "publicVNetwork": "vnet1",
  "scanName": "test-scan",
```



```

        "scanIps": [
            "xx.xx.xxx.xx",
            "xx.xx.xxx.xx"
        ]
    },
    "grid": {
        "language": "en",
        "enableAFD": true
    }
}

```

Example 5-7 JSON File to Create Two-Node Oracle KVM Database System with Role Separation and with Passwordless Multi-User Access

The following is an example of a JSON file that creates two-node Oracle KVM Database System on Oracle Database Appliance bare metal platform. The example uses role separation and with passwordless multi-user access. When using the example to create your JSON file, change the definitions to match your environment. The password must meet password requirements.

```

{
  "system": {
    "name": "test_system",
    "shape": "odb2",
    "customMemorySize": "24G",
    "timeZone": "America/Los_Angeles",
    "diskGroup": "DATA",
    "cpuPoolName": "shared_dbssystem_cpupool",
    "enableRoleSeparation": true,
    "customRoleSeparation": {
      "groups": [
        {
          "name": "oinstall",
          "id": 1001,
          "role": "oinstall"
        },
        {
          "name": "dbaoper",
          "id": 1002,
          "role": "dbaoper"
        },
        {
          "name": "dba",
          "id": 1003,
          "role": "dba"
        },
        {
          "name": "asmadmin",
          "id": 1004,
          "role": "asmadmin"
        },
        {
          "name": "asmoper",
          "id": 1005,
          "role": "asmoper"
        }
      ]
    }
  }
}

```

```

        {
            "name": "asmdba",
            "id": 1006,
            "role": "asmdba"
        }
    ],
    "users": [
        {
            "name": "grid",
            "id": 1000,
            "role": "gridUser"
        },
        {
            "name": "oracle",
            "id": 1001,
            "role": "oracleUser"
        }
    ]
}
},
"users": [
    {
        "id": 1000,
        "name": "ugrid",
        "role": "gridUser"
    },
    {
        "id": 1001,
        "name": "uoracle",
        "role": "oracleUser"
    }
]
},
"multiUserAccess": {
    "isMultiUserAccessPLEnabled": true
}
},
"database": {
    "name": "dbtest",
    "uniqueName": "dbtest",
    "domainName": "test_domain",
    "version": "19.26.0.0.250121",
    "edition": "EE",
    "type": "SI",
    "dbClass": "OLTP",
    "shape": "odb2",
    "role": "PRIMARY",
    "targetNodeNumber": "0",
    "enableDbConsole": false,
    "enableUnifiedAuditing": true,
    "enableEEHA": true,
    "redundancy": null, <<< if diskgroup redundancy is FLEX, then
database redundancy must be set to one of "HIGH" or "MIRROR", otherwise, can
be null
    "characterSet": {
        "characterSet": "AL32UTF8",

```

```

        "nlsCharacterSet": "AL16UTF16",
        "dbTerritory": "AMERICA",
        "dbLanguage": "AMERICAN"
    },
    "enableTDE": false,
    "isCdb": true,
    "pdbName": "pdb1",
    "pdbAdminUser": "pdbadmin"
},
"network": {
    "domainName": "test_domain",
    "ntpServers": [],
    "dnsServers": [
        "xx.xxx.xx.xxx"
    ],
    "nodes": [
        {
            "name": "node1",
            "ipAddress": "xx.xx.xxx.xx",
            "netmask": "xxx.xxx.xxx.x",
            "gateway": "xx.xx.xxx.x",
            "number": 0,
            "vipName": "node1-vip",
            "vipAddress": "xx.xx.xxx.xx"
        },
        {
            "name": "node2",
            "ipAddress": "xx.xx.xxx.xx",
            "netmask": "xxx.xxx.xxx.x",
            "gateway": "xx.xx.xxx.x",
            "number": 1,
            "vipName": "node2-vip",
            "vipAddress": "xx.xx.xxx.xx"
        }
    ],
    "publicVNetwork": "vnet1",
    "scanName": "test-scan",
    "scanIps": [
        "xx.xx.xxx.xx",
        "xx.xx.xxx.xx"
    ]
},
"grid": {
    "language": "en",
    "enableAFD": true
}
}

```

Provisioning Oracle Database Appliance with Multi-User Access

You can enable multi-user access **only** when you provision Oracle Database Appliance, using CLI commands or the Browser User Interface.

Provision your appliance as described in the chapter *Provisioning Oracle Database Appliance Bare Metal System*.

▲ Caution:

You can enable multi-user access **only** at the time of provisioning Oracle Database Appliance on bare metal systems and **cannot** rollback multi-user access after you provision and deploy your appliance. The Oracle Database Appliance administration model changes when you deploy the Multi-User Access feature. Evaluate your role separation requirements before using this feature. Deploying on a test system first can help with the evaluation and assessment of the new administration model.

✎ Note:

You can specify the token expiration duration, password expiration duration, maximum failed login attempts, and other details when you provision multi-user access enabled Oracle Database Appliance with JSON file. You can also specify these values as a one-time activity from the Browser User Interface when you configure multi-user access and provision Oracle Database Appliance using the Browser User Interface.

Overall Steps in Provisioning Oracle Database Appliance with Multi-User Access Enabled**1. Enable multi-user access.**

- If you provision your appliance using a JSON file, then add the attribute `"isMultiUserAccessEnabled": true` in the `prov_req.json` file. If the attribute is set to `false` or does not exist in the `prov_req.json` file, then multi-user access is not enabled during provisioning of the appliance.

```
"isRoleSeparated": true,
  "isMultiUserAccessEnabled": true,
  "osUserGroup": {
    "groups": [{
      "groupId": 1001,
      "groupName": "oinstall",
      "groupRole": "oinstall"
    }
  ],
```

...

You can also set the multi-user access attributes by adding the following in the JSON file:

```
},
"asr": null,
"multiUserAccess": {
  "dcsUserPasswdExpDurationInDays": 90,
  "tokenExpirationInMins": 120,
  "maxNumFailedLoginAttempts": 3
}
}
```

The values for these attributes are as follows:

- **Token expiration duration in minutes:** The minimum value you can specify is 10 minutes, the maximum value is 600 minutes, and the default is 120 minutes.
 - **Password expiration duration in days:** The minimum value you can specify is 30 days, the maximum value is 180 days, and the default is 90 days.
 - **Maximum failed login attempts allowed:** The minimum value you can specify is 2, the maximum value is 5, and the default is 3.
 - If you create the appliance using the Browser User Interface (BUI), then select the **Enable Multi-User Access (N/A for DB System)** checkbox in the BUI login page.
2. Provide passwords for `odaadmin`, `oracle`, and `grid` users. These are Oracle Database Appliance system users and their accounts are activated during created. The user `odaadmin` is created with the role of `ODA-ADMINISTRATOR` while the `oracle` and `grid` users are created with the role of `ODA_DB` and `ODA_GRID` respectively.
 3. The system configures the multi-user access repository with a list of roles and entitlements, used for assigning to the users in the system.
 4. You can now log into the appliance with the newly-created user credentials and deploy databases.

Provisioning Oracle Database Appliance Using the Browser User Interface with Multi-User Access Enabled

1. Access the Browser User Interface:

```
https://host-ip-address:7093/mgmt/index.html
```

2. For the first login, since the `odaadmin` role is not configured, you are prompted to provide the ODA password and enable multi-user access.
3. Select **Enable Multi-User Access (N/A for DB System)** and provide a strong password for the ODA user.
4. Click **Configure Multi-User Settings** and then set the **User Password Expiry Duration (In Days)**, **Session Expiration for CLI (minutes)**, and **Maximum Failed Login Attempts**. Click **Save** to save these settings and return to the Login page on the BUI.
5. Click **Submit**. A confirmation message is displayed on successful creation of the user.
6. Click **OK**. You are redirected to the Login page.
7. Specify the **User Name** and **ODA Password** and click **Login**. Note that the ODA admin user name is `odaadmin` if multi-user access is enabled. If multi-user access is not enabled, then the ODA admin user name is `oda-admin`.
8. In the Create Appliance page, specify the details for creating the appliance. See the topic *Creating the Appliance* for detailed information about the information you need to provide.
9. Select **Assign same password for admin, oracle, grid users** if you want to specify the same password for all users. Otherwise, specify different passwords for the `system admin`, `oracle`, and `grid` users.
10. Click **Submit** to create the appliance with multi-user access enabled.
11. The job is submitted and a confirmation page appears with a link to the job. Click the link to view the job progress, tasks, and status. After you close the Job confirmation page, you can click the **Activity** tab to monitor the job progress. Click the job number to view the tasks and status details. Click **Refresh** to refresh the page.

Related Topics

- [Provisioning Oracle Database Appliance Bare Metal System](#)
Understand the process to configure Oracle Database Appliance bare metal system.
- [odacli Multi-User Access Commands](#)
Use `odacli` commands to enable multi-user access for the appliance.

Creating, Viewing, and Deleting Users on Oracle Database Appliance with Multi-User Access

After provisioning the appliance with multi-user access enabled, you can create users with specific entitlements.

After you provision your appliance with multi-user access enabled, do the following:

Creating, Viewing, and Deleting Users with ODACLI Commands

1. Connect to the appliance as the `odaadmin` user.

```
ssh odaadmin@oda-box hostname/IP
```

2. Run any ODACLI command and provide the `odaadmin` password when prompted.
3. On successful authentication, create a user with the following command:

```
odacli create-user -u username -r comma-separated role names
```

For example, create a user `dbuser1` with lifecycle management privileges for databases:

```
odacli create-user -u dbuser1 -r ODA-DB
```

The `odaadmin` user creates `dbuser1` and assigns a temporary password.

4. After the user is created successfully, the `dbuser1` can log into the appliance with the temporary password.
5. The `dbuser1` is in the `Inactive` state. Activate the user with the following command:

```
odacli activate-user
```

You are prompted to change the password. Enter the temporary password, the new password, and confirm the new password.

6. Use the new password to connect by SSH into the appliance and run ODACLI commands or connect to the Browser User Interface.
7. The `odaadmin` user can view all the users in the system:

```
# odacli list-users
```

8. The `odaadmin` user can view details for a user in the system:

```
# odacli describe-user -u user_id
```

9. Delete a user in the system. Note that only the `odaadmin` user can delete a user in the system.

```
# odacli delete-user -u user_id
```

Creating, Viewing, and Deleting Users with Browser User Interface

1. Log into the Browser User Interface as the `odaadmin` user:

```
https://host-ip-address:7093/mgmt/index.html
```

2. Click the **Multi-User Access** tab.
3. Click the **Users** link on the left-hand pane.
4. Click **Create User**.
5. In the **Create User** page, provide the **User ID**, specify the **Role**, and provide the **ODA Password** for this user. Note that the same user credentials work for login for BUI and ODA CLI commands.
6. Optionally, click **Generate mTLS Certificate** to enable mTLS-based authentication.
7. Click **Create**.
8. The job is submitted and a confirmation page appears with a link to the job. Click the link to view the job progress, tasks, and status. After you close the Job confirmation page, you can click the **Activity** tab to monitor the job progress. Click the job number to view the tasks and status details. Click **Refresh** to refresh the page.
9. In the **Multi-User Access** tab, on the **Users** page, click on the link for the user whose details you want to view.
10. To delete a user, log in as the `odaadmin` user. In the **Actions** drop-down list, select **Delete**. Note that only a user of type **Custom** can be deleted.

Related Topics

- [odacli Multi-User Access Commands](#)
Use `odacli` commands to enable multi-user access for the appliance.

Activating a New User on Oracle Database Appliance with Multi-User Access

Understand how to activate a new user on multi-user access enabled Oracle Database Appliance.

Activating the New User on Multi-User Access Enabled System Using ODA CLI Commands

1. After a new user is created by `odaadmin` successfully, the new user, for example, `dbuser1` can log into the appliance with the temporary password.
2. Activate the user with the following command:

```
odacli activate-user
```

You are prompted to change the password. Enter the temporary password, the new password, and confirm the new password.

Activating the New User on Multi-User Access Enabled System Using Browser User Interface

1. After a new user is created by `odaadmin`, log into the Browser User Interface as the new user:

```
https://host-ip-address:7093/mgmt/index.html
```

2. Specify the **User Name** and the temporary password in the **ODA Password** field.
3. Since this is a new account, the Account Status is `Inactive`. You are prompted to specify and confirm a new password.
4. Specify and confirm the **Password** and click **Submit**.
5. On successful password change, log into the Browser User Interface with the new password.

Related Topics

- [odacli Multi-User Access Commands](#)
Use `odacli` commands to enable multi-user access for the appliance.

Granting and Revoking Resource Access on Oracle Database Appliance with Multi-User Access

You can grant and revoke resource access on the appliance.

Granting and Revoking Resource Access with ODACLI Commands

- Grant or revoke access to a resource in a multi-user access enabled system:

```
# odacli grant-resource-access -ri resource_ID -u user_name
# odacli revoke-resource-access -ri resource_ID -u user_name
```

- View access to a DCS resource in a multi-user access system:

```
# odacli describe-resource-access -ri resource_ID
```

- View access to all DCS resources defined in a multi-user access system:

```
# odacli list-resources-access -ao -rn resource_name -rt resource_type
```

Granting and Revoking Resource Access with Browser User Interface

1. Log into the Browser User Interface as `odaadmin`:

```
https://host-ip-address:7093/mgmt/index.html
```

2. Click the **Multi-User Access** tab.
3. Click the **Resources** link on the left-hand pane.
4. Click on a Resource to view more details.

5. For a Resource, in the Actions drop down list, select **Grant Resource Access** to grant the user shared access to a resource. Select the **User Name** from the drop-down list and click **Grant**. Click **Yes** to confirm and submit the job.
6. Select **Revoke Resource Access** to revoke access to a resource from a user. Select the **User Name** from the drop-down list and click **Revoke**. Click **Yes** to confirm and submit the job.

Related Topics

- [odacli Multi-User Access Commands](#)
Use `odacli` commands to enable multi-user access for the appliance.

Viewing Roles, Operations, and Entitlements on Oracle Database Appliance with Multi-User Access

You can view roles and entitlements on the appliance.

Viewing Roles, Operations, and Entitlements with ODACLI Commands



Note:

For Oracle Database Appliance release 19.13, the multi-user access feature is available for standalone Oracle Database Appliance systems. During provisioning, a single domain and tenancy is created by default and all users are created within the default domain and tenancy.

- View all the roles defined in the system:

```
# odacli list-user-roles
```

- View details for a user role in the system:

```
# odacli describe-user-role -n role_name
```

- View all the entitlements defined in the system:

```
# odacli list-user-entitlements
```

- View details for an entitlement in the system:

```
# odacli describe-user-entitlement -n entitlement_name
```

- View all the operations defined in the system:

```
# odacli list-user-operations
```

- View details for an operation in the system:

```
# odacli describe-user-operation -n operation_name
```

- View the domains defined in the system. In this release, this is the default domain.

```
# odacli list-domains
```

- View details for a domain in the system:

```
# odacli describe-domain -dn domain_name
```

- View the tenants in a multi-user access enabled domain. In this release, this is the default tenancy.

```
# odacli list-tenants
```

- View details for a tenant in a multi-user access enabled domain:

```
# odacli describe-tenant -tn tenant_name
```

Viewing Roles, Operations, and Entitlements with Browser User Interface

1. Log into the Browser User Interface as `odaadmin`:

```
https://host-ip-address:7093/mgmt/index.html
```

2. Click the **Multi-User Access** tab.
3. Click the Roles link on the left-hand pane. The roles defined in the system are displayed. These roles cannot be edited or updated.
4. Click on a Role to view more details.
5. Click the Entitlements link on the left-hand pane. The entitlements defined in the system are displayed. These entitlements cannot be edited or updated.
6. Click on an Entitlement to view more details.

Related Topics

- [odacli Multi-User Access Commands](#)
Use `odacli` commands to enable multi-user access for the appliance.

Managing Databases and Database Homes on Oracle Database Appliance with Multi-User Access

The custom user created on multi-user access Oracle Database Appliance can deploy and manage databases and database homes.

After you create a custom `dbuser1` on an Oracle Database Appliance with multi-user access enabled, manage databases as follows:

Creating and Listing Databases and Database Homes Using ODACLI Commands

1. Connect to the appliance as `dbuser1`.

```
ssh dbuser1@oda-box hostname/IP
```

2. Create a database:

```
odacli create-database -n dbName -v dbVersion
```

3. Run the `odacli list-databases` to view the databases owned by `dbuser1`:

```
odacli list-databases
```

Another user with the `ODA-DB` role cannot use the resource owned by `dbuser1` to create a database home, thus ensuring role separation.

4. Use the `-all` option on the appliance when multi-user access is enabled to view all the databases in the system.

```
odacli list-databases -all
```

5. Use the `-all` option on the appliance when multi-user access is enabled to view all the database homes in the system.

```
odacli list-dbhomes -all
```

Creating and Listing Databases and Database Homes Using Browser User Interface

1. Log into the Browser User Interface as `dbuser1`:

```
https://host-ip-address:7093/mgmt/index.html
```

2. Click the **Database** tab.
3. Click **Show All Databases**. A list of all databases in the system is displayed.
 - **View Details:** View the details of the database.
 - **Modify:** Modify the database
 - **Move:** Move the database
 - **Upgrade:** Upgrade the database
 - **Delete:** Delete the database.
 - **Grant Access:** Grant access privilege to the database to a user.
 - **Revoke Access:** Revoke access privilege to the database from a user.
 - **View Pre-patch reports:** View prechecks report for patching.
4. Click the Database Home link on the left hand pane. A list of all database homes in the system is displayed.
5. For a database home, you can click the **Actions** dropdown list, and select from the following options:
 - **View Database:** View the details of the database home.
 - **Delete:** Delete the database.
 - **Grant Access:** Grant access privilege to the database home to a user.
 - **Revoke Access:** Revoke access privilege to the database home from a user.
 - **View Pre-patch reports:** View prechecks report for patching.

Related Topics

- [odacli Multi-User Access Commands](#)
Use `odacli` commands to enable multi-user access for the appliance.

Changing the Password for a User Account on Oracle Database Appliance with Multi-User Access

Understand how to manage passwords on multi-user access Oracle Database Appliance.

Changing the Password on Multi-User Access Enabled System Using ODACLI Commands

- You can change password for an Oracle Database Appliance user, whose account is active:

```
odacli change-password
```

Changing the Password on Multi-User Access Enabled System Using Browser User Interface

1. Log into the Browser User Interface as the user whose password you want to change:

```
https://host-ip-address:7093/mgmt/index.html
```

2. To change the Account password at any time: Click on the Account drop down list in the top right-hand side of Browser User Interface and select **Change Password**.
3. Specify the **Old Password** and also specify and confirm the new **Password** and click **Submit**.

Related Topics

- [odacli Multi-User Access Commands](#)
Use `odacli` commands to enable multi-user access for the appliance.

Resetting the Password for a Locked User Account on Oracle Database Appliance with Multi-User Access

Understand how to reset the password on multi-user access Oracle Database Appliance.

Resetting Password for a Locked User Account on Multi-User Access Enabled System Using ODACLI Commands

Note:

If your appliance is configured as passwordless multi-user enabled, then all user accounts are preactivated during creation and never get locked because the system internally generates the password for each user and provides it to the DCS agent for authentication when required for running ODACLI commands. For passwordless multi-user enabled systems, do **not** run any scripts for unlocking the `odaadmin` account or the `odacli reset-password` command to reset the password. Run the `odacli change-password` command to change the system generated password for your Oracle Database Appliance account.

- Unlock the `odaadmin` user account that is locked due to multiple failed login attempts or password expiry.

1. Log in as `root`.
2. Run the following:

```
/opt/oracle/dcs/bin/resetCredsForOdaAdmin.sh
```

A temporary password is assigned to the `odaadmin` user.

3. Log in as the `odaadmin` user with the temporary password.
4. Run the following command:

```
odacli reset-password
```

You are prompted to provide the temporary password and specify and confirm the new password. After the command runs successfully, the user account is unlocked.

- Unlock any non-admin user account that is locked due to multiple failed login attempts or password expiry.

1. Log in as `odaadmin`.
2. Run the following command:

```
odacli authorize-user
```

After you provide a temporary password, the account is unlocked.

3. Log in as the user whose account was locked, with the temporary password.
4. Run the following command:

```
odacli reset-password
```

You are prompted to provide the old password, the temporary password and specify and confirm the new password. After the command runs successfully, the user account is unlocked and reactivated.

Resetting Password for a Locked User Account on Multi-User Access Enabled System Using Browser User Interface

- Unlock the non-admin user account that is locked due to multiple failed login attempts or password expiry as follows:
 1. Log into the Browser User Interface as the `odaadmin` user:

```
https://host-ip-address:7093/mgmt/index.html
```
 2. In the **Multi-User Access** tab, on the Users page, click on the link for the user whose password you want to reset. Note that you can reset the password for users of type **Custom** only. The Account Status for the user is `LockedFailedLogin`.
 3. In the Actions drop down list, select **Authorize Password Reset**.
 4. In the Authorize Password Reset page, specify the **Old Password**, specify and confirm the **Temporary ODA Password**, and click **Authorize**.
 5. Now, log into the Browser User Interface as the user whose account is being unlocked. Specify the **User Name** and the temporary password in the **ODA Password** field.
 6. Since the account was locked, the Account Status is `CredentialReset`. You are prompted to specify and confirm a new password.
 7. Specify and confirm the **Password** and click **Submit**.
 8. On successful password change, log into the Browser User Interface with the new password.

Related Topics

- [odacli Multi-User Access Commands](#)
Use `odacli` commands to enable multi-user access for the appliance.

6

Oracle Database Appliance Postinstallation Tasks

Complete these administrative tasks after you have deployed software, but before the system is operational.

- [Configuring CPU Core Count](#)
Oracle Database Appliance is delivered with all cores on each server enabled. Follow this procedure to reduce the number of cores, if required.
- [Modifying Oracle ASM Listener Port After Deployment](#)
Understand how you can modify Oracle ASM listener port on Oracle Database Appliance after deployment.
- [Securing Oracle ILOM Service Processors](#)
Change the Oracle ILOM default password after completing Oracle Database Appliance deployment.
- [Changing Oracle Database Appliance Passwords](#)
After deploying your appliance, ensure that you change the following passwords for securing your system.
- [Changing the DNS Server Address on Oracle Database Appliance](#)
If the DNS server in the data center changes, understand how you can update the DNS entries on on Oracle Database Appliance server so that the network functions correctly.

Related Topics

- [Deployment Checklist for Oracle Database Appliance Bare Metal Systems](#)
This checklist provides an overview of the tasks to setup and deploy Oracle Database Appliance bare metal systems for the first time.

Configuring CPU Core Count

Oracle Database Appliance is delivered with all cores on each server enabled. Follow this procedure to reduce the number of cores, if required.

1. To reduce the number of cores, run the following command on Node 0 only:

Set the cores in multiples of 2, for example, 12:

```
[root@oak1 opt]# /opt/oracle/dcs/bin/odacli modify-cpucore --cores 12
```

When you run the command, the nodes are restarted to apply the changes.

2. Check if the job completed successfully:

```
[root@oak1 opt]# /opt/oracle/dcs/bin/odacli describe-job -i job_ID
```

3. Verify that the core count is updated on both nodes:

```
[root@oak1 opt]# /opt/oracle/dcs/bin/odacli describe-cpucore
```

Modifying Oracle ASM Listener Port After Deployment

Understand how you can modify Oracle ASM listener port on Oracle Database Appliance after deployment.

Modifying Oracle ASM listener port using ODACLI commands

In earlier Oracle Database Appliance releases, you provisioned your bare metal system with Oracle ASM listener port 1525 as the default and as the Oracle ASM discovery address port from DB systems. Starting with Oracle Database Appliance release 19.24, you can customize Oracle ASM listener port number as a postinstallation task. All DB systems that you provision after changing the Oracle ASM listener port number use the new Oracle ASM port number.

Use the following command to modify the Oracle ASM listener port number:

```
odacli modify-asmport -p any_unused_port_between_1024_and_65536
```

For example:

```
# odacli modify-asmport -p 1528
```

Note:

You can run the `odacli modify-asmport` command only on deployments where the bare metal system is on Oracle Database Appliance release 19.24 and the DB system is on release 19.24 and you use the DB 23ai clones available with Oracle Database Appliance release 19.24.

Modifying Oracle ASM listener port using BUI

Follow these steps:

1. Log into the Browser User Interface:
`https://host-ip-address:7093/mgmt/index.html`
2. Click **Appliance**.
3. In the Basic Information page, Click **Modify ASM Port** to change the Oracle ASM listener port.
4. In the Modify ASM Port dialog box, specify the **ASM Port** and click **Modify**.
5. Click **Refresh ASM Port** to view the update.

Related Topics

- [Modifying Oracle ASM Listener Port After Deployment](#)
Understand how you can modify Oracle ASM listener port on Oracle Database Appliance after deployment.

Securing Oracle ILOM Service Processors

Change the Oracle ILOM default password after completing Oracle Database Appliance deployment.

Do not change the default password until after you have completed software deployment on the Oracle Database Appliance.

Changing Oracle ILOM Password from the Console

1. In the Oracle ILOM console, from the **Administration** menu, select **User Management**, and then navigate to the **User Accounts** subtab.
2. Select **root** user and click **Edit**.
3. Change the `root` user password.

Changing Oracle ILOM Password Using CLI Commands

1. Connect to the Oracle ILOM service processor (SP) through SSH:

```
# ssh -l root SP-ipaddr
```

2. Set the new password:

```
-> set /SP/users/root password=new_password  
Changing password for user /SP/users/root/password...  
Enter new password again: *****  
New password was successfully set for user /SP/users/root
```

Changing Oracle Database Appliance Passwords

After deploying your appliance, ensure that you change the following passwords for securing your system.

Changing the Oracle Installation Owner Passwords

During deployment, the root and database users SYS, SYSTEM and PDBADMIN are set to the system password. After deployment, the oracle and grid passwords are also set to the system password. Change the passwords to comply with your enterprise user security protocols. Refer to the *Oracle Database Appliance Security Guide* and *Oracle Database Security Guide* for information about the required configuration and best practices to secure database systems.

Changing the oda-admin User Password through the Command-Line

1. Log in to the appliance as `root`.
2. Run the `odacli set-credential` command to reset the password. Enter the new password when prompted.

```
# odacli set-credential --username oda-admin  
Enter 'user' password:  
Retype 'user' password:
```

Changing the the oda-admin User Password through the Browser User Interface

1. Log into the Browser User Interface using the user name `oda-admin`.
2. Click **About**, then **User Settings** in the upper right corner of the Browser User Interface.
3. Enter the password in the Password field and the Password Confirmation field, then click **Submit**.
A confirmation message is displayed.
4. Click **About**, then click **Sign Out**.
5. Log back into the Browser User Interface with the new password.



Note:

The `oda-admin` password expiration period is 90 days.

Changing the DNS Server Address on Oracle Database Appliance

If the DNS server in the data center changes, understand how you can update the DNS entries on on Oracle Database Appliance server so that the network functions correctly.

Follow these steps to change the DNS server address on Oracle Database Appliance:

1. Log in as the `root` user.
2. Open the `/etc/resolv.conf` file in a text editor.
3. Locate the name server setting for the DNS server and change it to the new value. For example:

```
search      example.com
nameserver  10.7.7.3
```

4. Save the file and close the editor.

7

Re-imaging Oracle Database Appliance

Bare metal operating system re-imaging installs Oracle Database Appliance operating system software on the local (boot) drive.

Bare Metal is a non-virtualized Oracle Database Appliance configuration. Oracle Database Appliance ships from the factory with a bare metal configuration, default ISO image and Appliance Manager installed. Use the OS ISO Image to restore the OS to the "shipped from factory" state. Use only when necessary. Reimaging does not patch the firmware or update the component versions; it only re-images the local system disk from an operating system perspective. After imaging is completed, provision the bare metal system.

- [Uninstalling Oracle Database Appliance Components](#)
Use the Oracle Database Appliance cleanup deploy utility, `/opt/oracle/oak/onecmd/cleanup.pl` to uninstall Oracle Database Appliance components.
- [Reimaging an Oracle Database Appliance Baremetal System](#)
Reimage Oracle Database Appliance to perform a bare metal restore of Oracle Database Appliance.
- [Performing Secure Erase of Data on Storage Disks](#)
With this release, you can securely erase data from storage devices. Running the secure erase tool deletes the data on the storage disk permanently.
- [Redeployment of Oracle Database Appliance](#)
Understand the process to redeploy Oracle Database Appliance.

Related Topics

- [Errors when re-imaging Oracle Database Appliance](#)
Understand how to troubleshoot errors that occur when re-imaging Oracle Database Appliance.

Uninstalling Oracle Database Appliance Components

Use the Oracle Database Appliance cleanup deploy utility, `/opt/oracle/oak/onecmd/cleanup.pl` to uninstall Oracle Database Appliance components.

About the Cleanup Utility

Use the cleanup deploy utility to do the following:

- Uninstall Oracle Auto Service Request (Oracle ASR)
- Uninstall Oracle Trace File Analyzer (TFA)
- Uninstall Oracle ORAchk Health Check Tool
- Uninstall Oracle Grid Infrastructure and the Oracle stack
- Reset or delete the Oracle Linux udev rules
- Delete users and groups that were created when the appliance was created.

The script removes the firstnet config and the client access VLAN UNIX_DB, but does not delete any other VLANs. The script also resets any disabled CPU cores and enables all of the cores.

The cleanup utility runs in two modes: default and force mode. In the default mode, the commands used as part of cleanup do not use the force option. The Oracle ASM disk status is changed from MEMBER to FORMER, but ASM header on the disk is not erased. The default mode can be used only for cleaning up or re-provisioning of the same system.



Note:

For High-Availability systems, run the cleanup utility on both nodes sequentially. Ensure that the cleanup utility has completed on the first node, and then start the process on the second node.

Running the Cleanup Utility for a Baremetal Deployment

```
# perl /opt/oracle/oak/onecmd/cleanup.pl [-griduser grid_user] [-dbuser db_user] [-groups comma separated list of groups] [-omausers dbuser1,dbuser2,dbuser3] [-erasedata] [-nodpr] [-nossh] [f]
```

When the *grid_user* and *db_user* are the same (*roleSeparation=false*), you must run the script for each user (*-gridUser* and *-dbUser*).

For example:

```
cleanup.pl -griduser grid -dbuser oracle -omausers dbuser1,dbuser2,dbuser3
```

Table 7-1 Command Options for Cleanup Utility

| Option | Description |
|------------------|--|
| <i>grid_user</i> | Describes the Oracle Grid Infrastructure user name. The default user is <i>grid</i> . |
| <i>db_user</i> | Describes the database user name. The default user is <i>oracle</i> Example with <i>grid</i> and <i>oracle</i> users: cleanup.pl -griduser grid -dbuser oracle |
| <i>groups</i> | Describes the comma-separated list of groups. The default groups are <i>oinstall,dba,dbaoper,asmadmin,asmoper,asmdba</i> . |
| <i>omausers</i> | Describes the comma-separated list of custom users created on a multi-user access enabled Oracle Database Appliance environment. All custom users created after provisioning a multi-user access enabled environment must be removed completely before you re-provision the appliance. |

Table 7-1 (Cont.) Command Options for Cleanup Utility

| Option | Description |
|----------------------------|---|
| erasedata | <p>Completely erases all disks on the Oracle Database system. It is mandatory to run this option if intention of cleanup is to reuse or move these disks on other systems. This option needs to be run on the first node when running on high-availability systems.</p> <p>Example of secure erase:</p> <pre>cleanup.pl -erasedata</pre> |
| cleanDefNet checkHeader | <p>Cleans up the default public network.</p> <p>Checks for OAK/ASM header on disks after successfully running the cleanup script. Use this to validate if the OAK/ASM header was erased by the cleanup script or not.</p> <p>Example of checking disk header:</p> <pre>cleanup.pl -checkHeader</pre> |
| nodpr | <p>Forces regular cleanup even if Data Preserving Reprovisioning environment is detected. Wipes out all data on Oracle ASM disks. You cannot run the command <code>odacli restore-node -g</code> after this operation.</p> <p>On Data Preserving Reprovisioning environments, the default cleanup mode is Data Preserving Reprovisioning mode which cleans the appliance without erasing Oracle SM disks to allow the command <code>odacli restore-node -g</code> to be reattempted. Using the <code>-nodpr</code> option allows you to override this behaviour and force regular cleanup.</p> <p>Example:</p> <pre>cleanup.pl -nodpr</pre> |
| nossh | <p>Does not attempt to set up SSH on high-availability deployments. Use this option in cases such as when the scripts using cleanup.pl are not updated to handle stopping DCS agent, or if you have forgotten the SSH password, or if SSH is not set up on the system.</p> <p>Example:</p> <pre>cleanup.pl -nossh</pre> |

Table 7-1 (Cont.) Command Options for Cleanup Utility

| Option | Description |
|--------|---|
| f | <p>In the force mode, all commands use the force option. The ASM disk header is erased. The oakd header on the disk is erased in both default and force modes.</p> <p>Example of default mode:</p> <pre>cleanup.pl</pre> <p>Example of force mode:</p> <pre>cleanup.pl -f</pre> |

 **Note:**

The cleanup utility for bare metal deployments produces a log file. The utility tries to create the log file at `/opt/oracle/oak/log/hostname/cleanup/cleanup_timestamp.log`. If the log cannot be created in that location, then the log is created at `/tmp/cleanup_timestamp.log`.

Related Topics

- [Deployment Checklist for Oracle Database Appliance Bare Metal Systems](#)
This checklist provides an overview of the tasks to setup and deploy Oracle Database Appliance bare metal systems for the first time.

Reimaging an Oracle Database Appliance Baremetal System

Reimage Oracle Database Appliance to perform a bare metal restore of Oracle Database Appliance.

Bare metal restore uses Oracle Integrated Lights Out Manager (Oracle ILOM) to re-image the Oracle Database Appliance node. The ILOM must be configured before performing a bare metal restore or reimage. Generally, the ILOM is configured as part of readying for deploying Oracle Database Appliance.

Download the Oracle Database Appliance Bare Metal ISO image to your local machine before you launch the Oracle ILOM console.

Follow these steps to reimage your appliance. For Oracle Database Appliance High-Availability deployment, follow these steps on **both** nodes.

1. Open a browser and connect to Oracle Integrated Lights Out Manager (ILOM) on Node 0 as root.
`https://ilom-ip-address`
2. Launch the Remote Console.
 - a. Expand **Remote Control** in the left navigation.

- b. Click the **Redirection** tab.
 - c. Click **Launch** for the Remote Console in the Actions menu.
The state of the system determines what appears on the Console page.
3. Add the image.
 - a. Click the **KVMS** tab, then select **Storage**.
 - b. Click **Add**.
 - c. Browse to the Oracle Database Appliance Bare Metal ISO Image, highlight the image, then click **Select**.
 - d. Click **Connect**.
The mounting of the ISO image is successful when the **Connect** button changes to a **Disconnect** button.
 - e. Click **OK**
The CD-ROM icon in the top right corner is highlighted.
4. Configure the CD-ROM as the next boot device.
 - a. Expand **Host Management** in the left menu of the ILOM Remote Console tab.
 - b. Click **Host Control**.
 - c. Select **CDROM** from the Next Boot Device menu, then click **Save**.
5. Power cycle the node.
 - a. Click **Power Control** in the **Host Management** menu.
 - b. Select **Power Cycle** , then click **Save**.

When the node comes back after the power cycle, re-imaging starts automatically. The Oracle Linux page appears, followed by the Running Post-Install scripts page.

The Running Post-Install scripts page is a static page and might give the impression that the reimaging process is not progressing. The post-install process during re-imaging will wait until the synchronization between the partitions of the two mirrored local hard disks is complete, which can take 15 to 20 minutes to complete.

To check the progress of re-synchronization, press the ALT-F2 key combination to open a second console and enter the following command:

```
# cat /proc/mdstat
```

When the re-synchronization is complete, re-imaging is completed and the machine restarts.

After the machine restarts, the system is ready for you to deploy the Oracle software on the appliance to create an Oracle Database Appliance bare metal platform.

Related Topics

- [Creating the Appliance](#)
Create the appliance using the Browser User Interface or ODA CLI commands.

Performing Secure Erase of Data on Storage Disks

With this release, you can securely erase data from storage devices. Running the secure erase tool deletes the data on the storage disk permanently.

You may want to consolidate storage disks between appliances. For example, you can use X7-2 disks on X6-2 models, and may want to consolidate all X6-2 disks on one system, and use all new X7-2 storage disks on another system. In such cases, use secure erase to erase headers from disks before re-imaging the disks, since the storage disks across the appliances may have different partition ratios.

 **Note:**

The secure erase tool conforms to the NIST 800-88 standard, also called NIST Special Publication 800-88 (NIST SP 800-88), Guidelines for Media Sanitization. Running the secure erase tool removes data from storage disks permanently. If you have any data on the disk, then take a backup of your storage disk before running the secure erase tool.

Follow the steps to run the secure erase tool:

1. Stop `oakd` and the database and Oracle Grid Infrastructure before running the secure erase tool.

On bare metal systems, run the command:

```
# odaadmcli stop oak
```

On Virtualized Platforms:

```
# oakcli stop oak
```

To stop Oracle Clusterware resources:

```
# crsctl stop crs -f
```

2. Run the secure erase tool:

```
# /opt/oracle/oak/bin/odaeraser.py
```

3. You can also run the secure erase tool when running the cleanup tool:

```
# /opt/oracle/oak/onecmd/cleanup.pl -erasedata
```

Example 7-1 Options for the Secure Erase Tool

| Option | Description |
|---------------------------|--|
| -a, --all | Erases all disks. For example: <pre># /opt/oracle/oak/bin/odaeraser.py --all</pre> |
| --disk <i>disk1,disk2</i> | Erases specified disks. For example: <pre># /opt/oracle/oak/bin/odaeraser.py --disk e0_pd_00,e0_pd_01</pre> |
| --dryrun | Runs the tool in the test mode |
| --type HDD SSD NVMe | Erases the type of disk specified |
| -v, --verbose | Displays verbose output |
| -h, --help | Displays all CLI options for the tool |

Redeployment of Oracle Database Appliance

Understand the process to redeploy Oracle Database Appliance.

After cleaning up the system and erasing the header, you can continue deployment of Oracle Database Appliance as follows:

1. Download Oracle Database Appliance software.
2. Install Oracle Database Appliance software.
3. Create the appliance.

For the above steps, run the procedures as described in this guide.

8

Patching Oracle Database Appliance

To keep Oracle Database Appliance running with the latest software, check for and apply Oracle Database Appliance patch bundles when they are released.

- [About Patching Oracle Database Appliance](#)
Use the Oracle Database Appliance Patch Bundle to patch your appliance.
- [About Patching Prechecks](#)
Patching prechecks are designed to detect and flag problems that might be encountered during patching.
- [About Enabling NUMA on Oracle Database Appliance](#)
Understand how you can enable NUMA on bare metal, KVM, and DB Systems on Oracle Database Appliance.
- [Minimizing Downtime When Patching Oracle Database Appliance](#)
Understand best practices to minimize downtime when you apply patches to your Oracle Database Appliance deployment.
- [About Updating Databases and Database Homes](#)
Understand how to update a database and database home using either the Browser User Interface or `odaccli` commands.
- [Updating ESTES-EXT Firmware Before Patching Oracle Database Appliance Server](#)
Update TMT (Task Management Reset Type) for Estes-Ext before you patch the Oracle Database Appliance server.
- [Patching Oracle Database Appliance Bare Metal Systems Using the Command-Line](#)
Follow these steps to apply patches to your Oracle Database Appliance bare metal deployment and existing Oracle Database homes, using CLI commands.
- [Patching Oracle Database Appliance DB Systems Using the Command-Line](#)
Follow these steps to apply patches to your Oracle Database Appliance DB system deployment and existing Oracle Database home in the DB system, using CLI commands.
- [Patching Oracle Database Appliance Bare Metal Systems Using the Browser User Interface](#)
Upload the Oracle Database Appliance Server Patch to the patch repository, deploy the patch bundle using the Browser User Interface, and then update the DCS admin, DCS components, and DCS agent using CLI commands.
- [Patching Oracle Database Appliance DB Systems Using the Browser User Interface](#)
Upload the Oracle Database Appliance Server Patch to the patch repository, deploy the patch bundle using the Browser User Interface, and then update the DCS agent and components using CLI commands.
- [Updating Oracle Database Appliance Repository with Database Clone Files For Bare Metal Systems](#)
Follow these steps to update the Oracle Database Appliance repository with Oracle Database clone files for the latest release using CLI commands.
- [Patching Databases Using ODACLI Commands or the BUI](#)
Use ODACLI commands or the Browser User Interface to patch databases to the latest release in your deployment.

- [Patching Existing Database Homes Using ODACLI or the BUI](#)
Use ODACLI or BUI to patch database homes in your deployment to the latest release.
- [Patching Non-Provisioned Oracle Database Appliance Systems](#)
Oracle Database Appliance supports patching of non-provisioned single-node or high availability systems by running `odacli update-server` command.
- [Applying Additional Patches and Updates on Bare Metal Systems](#)
Configure additional patch repositories and patch your operating system and databases to ensure that your deployment has the latest updates and security fixes.
- [Cleaning Up the Patch Repository](#)
Use the Browser User Interface or Command Line Interface to delete obsolete or old patches from the repository.
- [About Upgrading to a Different Database Home](#)
Understand how to upgrade to a different database home using either the Browser User Interface or `odacli` commands.
- [Setting Dynamic Default Parameters](#)
You can set dynamic default parameters using the BUI.

About Patching Oracle Database Appliance

Use the Oracle Database Appliance Patch Bundle to patch your appliance.

Patches offer new features and may improve the functionality of existing features.

About Out of Place Patching

Starting with Oracle Database Appliance release 19.11, Oracle Database Appliance uses the out-of-place patching model. This means that a new software Oracle home is created when patching an Oracle Grid Infrastructure or Oracle Database home. Starting with Oracle Database Appliance release 19.11, the patches for Oracle Grid Infrastructure and Oracle Database are available as images. All procedures remain the same.

About MySQL Server and DCS Agent

Starting with Oracle Database Appliance release 19.10, DCS Agent uses MySQL server as its metadata store. MySQL server is automatically installed and configured, during provisioning, when creating the appliance. Similarly, during patching, the `odacli update-dcscomponents` command automatically installs and configures MySQL server. MySQL server processes do not run with `root` operating system user account. Instead, MySQL server processes run with a new operating system user account called `odamysql`. Note that the `odamysql` operating system user is created only for ownership purposes and the `odamysql` user account owns only the MySQL directories. The `odamysql` operating system user cannot log into the appliance. The `odamysql` operating system user account for MySQL ensures role separation between the user owning Oracle databases on the appliance and the metadata used for DCS operations.

About Oracle Database Appliance Patch Bundles

The Oracle Database Appliance Patch Bundle contains the latest patches for DCS Admin, DCS Components, OAK, Oracle ILOM, firmware, enhancements, and fixes.

The Oracle Database Appliance Release Notes include information about the latest Oracle Database Appliance patch bundle and a list of component versions in the patch bundle. Oracle recommends updating the appliance with the latest Oracle Database Appliance software version to take advantage of new features, fixes, and the latest supported component versions. See the Oracle Database Appliance Release Notes for the upgrade paths.

▲ Caution:

Do not patch Oracle Database Appliance using generic patches for Oracle Grid Infrastructure or Oracle Linux. Also do not use individual infrastructure patches, such as firmware patches. You must only use Oracle Database Appliance patches. If you use patches that are not intended for Oracle Database Appliance, or if you use OPatch, or a similar patching tool, then the metadata maintained by Oracle Database Appliance is not updated, and you cannot complete future patch updates. If you apply out-of-cycle Oracle Database Release Update (RU), then ensure that you also follow the recommendations described in the Readme for the RU.

The patch bundle provides all relevant patches for the entire system, including the following:

- Oracle Database Appliance server
- BIOS
- Hardware drivers
- Hardware Management Pack (HMP) and firmware drivers for various components
- Oracle Appliance Manager
- Oracle Linux
- Java Runtime Environment (JRE)
- Oracle Integrated Lights Out Manager (Oracle ILOM)
- Oracle Auto Service Request (Oracle ASR)
- Oracle Intelligent Platform Management Interface (Oracle IPMI)
- Network Card Patches for relevant hardware models

About Updating Oracle Linux RPMs

While not recommended, you can update some Oracle Linux RPMs for Oracle Database Appliance. Do not update or customize Oracle Linux kernel, Oracle Optimal Flexible Architecture, Oracle InfiniBand, or related software. Other software may be installed, updated, or customized. However, the Oracle Database Appliance update may not carry newer version dependencies of customized components. Therefore, you might be required to remove and subsequently reapply site-specific changes to successfully update Oracle Database Appliance in the future.

▲ Caution:

For Oracle Database Appliance, do not update the following:

- Oracle Linux Kernel (`kernel`)
- Oracle Optimal Flexible Architecture (`ofa`)
- Oracle RDMA packages (`oracle-rdma-release`)

For storage, do not apply any RPM updates.

About Patching Prechecks

Patching prechecks are designed to detect and flag problems that might be encountered during patching.

The prechecks view the state of the appliance, including the version and hardware specific upgrades, verify that the necessary conditions and checks are complete before attempting an upgrade, and identify conditions that might cause an upgrade to fail. You can avoid potential patching problems by correcting the conditions and resolving the issues before applying the patch.

The prechecks commands are available on Oracle Database Appliance release 12.2.1.2.0 or later. Update the DCS Agent to ensure that the latest updated prechecks are available when you run these commands.

Components Verified by Patching Prechecks

| Check | Component Verified |
|---------------------------------------|---|
| System patching prechecks | Checks that the DCS Agent is online on all nodes Checks that there is sufficient space for the update Validates the minimum agent version and validates the patching tag |
| Validate Nexus Reset Estes-Ext Failed | This server patching precheck is displayed for ORCL-EXT-SAS3 controller with model number 0x0097. This precheck verifies that controllers NVDATA is updated to 0e.01.00.0d version. If Estes-Ext is not updated to I_T Nexus Reset, then an error is displayed. SAS3 controller requires Nexus Reset. DCS-10293: Current System has ORCL-EXT-SAS3 controller which requires the firmware update to enable NEXUS RESET. To perform the firmware update, run <code>/opt/oracle/oak/pkgrepos/firmwarecontroller/lsilogic/0x0097/16.00.08.00/it_nexus_reset.sh</code> on both nodes. |

| Check | Component Verified |
|---------------------------|--|
| Server patching prechecks | <p>For operating system:</p> <ul style="list-style-type: none"> • Validates supported versions • Validates minimum supported versions • Validates patching tag • Validates whether patch location is available • Verifies OS patch • Validates command execution <p>For Oracle ILOM:</p> <ul style="list-style-type: none"> • Validates supported versions • Validates minimum supported versions • Validates patching tag • Validates whether patch location is available • Checks for Oracle ILOM patch version • Validates Patch location • Validates command execution • Validates connectivity to Oracle ILOM <p>For Oracle Grid Infrastructure:</p> <ul style="list-style-type: none"> • Validates supported Oracle Grid Infrastructure versions • Validates available space • Validates whether Oracle Clusterware is running • Validates patching tag • Validates whether system is provisioned • Validates whether Oracle ASM is online • Validates the minimum agent version • Validates the central inventory • Validates patching locks • Validates whether clones location exists • Validates DB start dependencies • Validates DB stop dependencies • Validates command execution <p>For Oracle ORAchk:</p> <ul style="list-style-type: none"> • Runs the ORAchk tool that performs operating system level prechecks. • Validates command execution <p>For server:</p> <ul style="list-style-type: none"> • Validates whether server patching can be performed in local mode or not • Validates command execution <p>Confirms that the bare metal system is upgraded, in the case of DB systems.</p> <p>Verifies and confirms that the database start/stop dependencies are correct.</p> <p>Confirms that patching locks are not present.</p> <p>Verifies that the central inventory is accurate.</p> |

| Check | Component Verified |
|---|--|
| Database home patching prechecks | <p>Confirms that Oracle Grid Infrastructure is installed</p> <p>Confirms that the DCS Agent is at the required version</p> <p>Confirms that Oracle Clusterware is running on all nodes</p> <p>Confirms that Oracle Grid Infrastructure is upgraded</p> <p>Validates that there is sufficient disk space available</p> <p>Checks if the disk group for database homes on Oracle ACFS is configured</p> <p>Checks whether the clone file is present in the repository</p> <p>Checks whether the <code>/u01/app/odaorabase</code> directory exists. If the directory exists, then the check confirms that there is a valid symbolic link.</p> |
| Database home patching with out-of-place patching prechecks | <p>The check creates a database home and verifies that all databases can be moved from the source home to new home.</p> <p>This check validates that the <code>--local</code> option can be used for the database home.</p> |
| Storage prechecks | <p>Validates storage patch location and tag</p> <p>Validates patching location and tag</p> <p>Validates command execution</p> <p>Validates Oracle ASM disk groups status</p> <p>Validates rolling patch (for high-availability deployment)</p> |

About Enabling NUMA on Oracle Database Appliance

Understand how you can enable NUMA on bare metal, KVM, and DB Systems on Oracle Database Appliance.

NUMA (Non-Uniform Memory Access) can help facilitate efficient use of the underlying NUMA hardware. On Oracle Database Appliance, you can enable NUMA for databases on bare metal and DB systems, CPU pools, and for KVM applications.

About Enabling NUMA During Provisioning of Oracle Database Appliance

When you provision Oracle Database Appliance with release 19.26, NUMA is automatically enabled on the database, DB system and CPU pools. Hence, when you create a database, DB system, or CPU pool on an Oracle Database Appliance release 19.26 deployment, NUMA is automatically enabled and no additional configuration is required. NUMA is not enabled by default for application VMs.

About Enabling NUMA After Patching Oracle Database Appliance

NUMA is enabled by default starting with Oracle Database Appliance release 19.12. When you patch to Oracle Database Appliance release 19.26 from 19.11 or earlier, the `odacli update-server` command sets NUMA at the system level. New databases created after patching are NUMA-enabled. For existing databases, enable NUMA by running the command `alter system set "enable_numa_support"=true` on the database.

After patching the bare metal system to release 19.26 from 19.11 or earlier, as a one-time activity, you must run the command `odacli remap-cpupools` to enable NUMA on all existing CPU pools (BM, VM, dbsystem).

For existing DB systems, run the command `odacli modify-dbsystem --enable-numa` to enable NUMA for the dbsystem and the database of the DB system.

NUMA is not enabled by default for application VMs. For new and existing application VMs, run the command `odacli modify-vm --enable-numa` to enable NUMA for the VM configuration. You must also enable NUMA for the components inside the VM such as operating system and application running inside the VM. The command `odacli modify-dbsystem --enable-numa` is only supported on application VMs with even number of CPU cores so that CPU cores can be evenly distributed to NUMA nodes. In Oracle Database Appliance, one CPUcore is equal to 2 vCPU.

See the topic *Patching Oracle Database Appliance Bare Metal Systems Using the Command-Line* for more details about the steps to patch your deployment and enable NUMA.

Related Topics

- [Patching Oracle Database Appliance Bare Metal Systems Using the Command-Line](#)
Follow these steps to apply patches to your Oracle Database Appliance bare metal deployment and existing Oracle Database homes, using CLI commands.
- [Patching Oracle Database Appliance DB Systems Using the Command-Line](#)
Follow these steps to apply patches to your Oracle Database Appliance DB system deployment and existing Oracle Database home in the DB system, using CLI commands.
- [Remapping CPU Pools in a Bare Metal or KVM Deployment](#)
Use ODACLI commands or the Browser User Interface to remap CPU pools in a bare metal or KVM deployment.
- [odacli modify-vm](#)
Use the `odacli modify-vm` command to modify a virtual machine on Oracle Database Appliance Kernel-based Virtual Machine (KVM).
- [odacli remap-cpupools](#)
Use the `odacli remap-cpupools` command to remap CPU pools to NUMA allocation on Oracle Database Appliance Bare Metal or Kernel-based Virtual Machine (KVM) deployment.
- [odacli modify-dbsystem](#)
Use the `odacli modify-dbsystem` command to modify a DB system on Oracle Database Appliance Kernel-based Virtual Machine (KVM).
- [odacli create-cpupool](#)
Use the `odacli create-cpupool` command to create a new CPU pool on Oracle Database Appliance Bare Metal or Kernel-based Virtual Machine (KVM) deployment.

Minimizing Downtime When Patching Oracle Database Appliance

Understand best practices to minimize downtime when you apply patches to your Oracle Database Appliance deployment.

Recommendations for Minimizing Downtime During Patching

- To minimize database patching downtime, it is recommended that you use Oracle RAC or Oracle RAC One Node on an Oracle Database Appliance high-availability system.

- If available, use Oracle Data Guard and patch the standby system first. After you patch the standby system, switch the workload to the standby system, patch the primary system, and then switch the workload back to the primary system. For more information, see *Patching Oracle Data Guard Databases on Oracle Database Appliance* in this guide.
- Always use Oracle Database Appliance Backup and Recovery (ODABR) to back up the system disks to ensure easy restore, if the patching operation fails. ODABR restores the system disk to pre-patching state.
- The `odacli update-storage` command has a `--rolling` option for storage devices (SSD and HDD) to minimize patching downtime. There could be other shared storage component firmware that require a system restart and do not support rolling. Oracle Database Appliance storage patching can be deferred, but it is not recommended. Note that the `--rolling` option cannot be used with the `odacli update-storage` command on single-node Oracle Database Appliance systems.

Minimizing Downtime using the `--local` Option During Patching

To minimize downtime, use the `--local` option with the `odacli update-server` and `odacli update-dbhome` commands. Update the DCS components and then run the `odacli create-prepatchreport` command. There is no downtime during the prepatch process. After analyzing the prepatch report, use the `--local` option to continue patching Oracle Database Appliance.

Note:

Before patching databases, ensure that the server patching operation on both nodes has completed successfully. Do not run the `odacli update-dbhome` and `odacli update-database` commands before the `odacli update-server` operation completes successfully on both nodes.

See Also:

Oracle Database High Availability Overview and Best Practices Guide in the Oracle Database 19c Documentation Library

About Updating Databases and Database Homes

Understand how to update a database and database home using either the Browser User Interface or `odacli` commands.

About Updating Databases and Database Homes

Oracle Database Appliance provides the following options to patch or update databases and database homes:

- **Patch or update each database home.** The database home is patched out-of-place. When patching database home, Oracle Database Appliance automatically provisions a destination database home if needed, records the source database home, target version, and destination database home mapping in the metadata repository, and then moves all databases running in the source database home to the destination database home. Use the `odacli update-dbhome` command or the BUI to patch all databases from a single source database home to a single destination database home. Use this option if there are no constraints on your system for space usage or for provisioning a new database home.

- **Patch or update selected databases in a database home to a specific database home.** You must specify the target database and destination database home when patching. You can use the `odacli update-database` command or the BUI to patch a specific database to a specific database home or to control when and how many database homes are provisioned. Using the update-database workflow also provides an option to run the operation again, if the patching operation failed. The abort and revert options available with the update-database workflow are not supported when the target database is a single-instance database.

Before patching the database or database home, upload the Oracle Database clone files for the database version, to the repository, and then create the database home. See *Patching Oracle Database Appliance Using the CLI* for the procedure to update the repository with the latest Oracle Database clone files.

! Important:

The `odacli update-database` command that enabled association of a backup configuration with database was deprecated in Oracle Database Appliance release 19.6. Starting with Oracle Database Appliance release 19.17, the `odacli update-database` command enables database patching and is similar to the patching functionality that the `odacli update-dbhome` command provides, with a few differences as described in the *Oracle Database Appliance Deployment Guide* for your hardware model.

Before you run the `odacli update-dbhome` command, you must create the prepatch report for the database home by running the command `odacli create-prepatchreport -d`. Similarly, before you run the `odacli update-database` command, you must create the prepatch report either for the source database home or target database by running the command `odacli create-prepatchreport -d` or `odacli create-prepatchreport -db` respectively. The source and destination database homes must be consistent in the prepatch report and when specifying them in the `odacli update-database` command. If you do not create the prepatch report before the patch operation, then the `odacli update-database` and `odacli update-dbhome` commands fail with an error message prompting you to run the patching pre-checks.

For more information about the options for the `update-dbhome` and `odacli update-database` commands, see the chapter *Oracle Database Appliance Command-Line Interface*.

Updating ESTES-EXT Firmware Before Patching Oracle Database Appliance Server

Update TMT (Task Management Reset Type) for Estes-Ext before you patch the Oracle Database Appliance server.

Before you patch your Oracle Database Appliance deployment and your existing database homes to the current release, you must update `I_T Target Reset` of Estes-Ext to `I_T Nexus Reset`. This update is not included in the regular firmware update. Run the `/opt/oracle/oak/pkgrepos/firmwarecontroller/lsilogic/0x0097/16.00.08.00/it_nexus_reset.sh` script to complete this update before you perform server patching. The patching precheck verifies that controllers NVDATA is updated to `0e.01.00.0d` version. If Estes-Ext is not updated to `I_T Nexus Reset`, then an error is displayed.

Follow these steps:

1. Ensure that you update the repository with the server zip file for Oracle Database Appliance release 19.26.
2. Shut down Oracle Grid Infrastructure, Oracle Database, and all applications before you run the update. Ensure that Oracle Clusterware is not running.
3. Before you patch the Oracle Database Appliance server, run the following command:

```
# /opt/oracle/oak/pkgrepos/firmwarecontroller/lsilogic/0x0097/16.00.08.00/
sas3flash -listall
Avago Technologies SAS3 Flash Utility
Version 17.00.00.00 (2018.04.02)
Copyright 2008-2018 Avago Technologies. All rights reserved.
```

```
Adapter Selected is a Avago SAS: SAS3008(C0)
```

| Num | Ctlr | FW Ver | NVDATA | x86-BIOS | PCI Addr |
|-----|-------------|-------------|-------------|-------------|-------------|
| 0 | SAS3008(C0) | 16.00.08.00 | 0e.01.00.0c | 08.37.00.00 | 00:3b:00:00 |
| 1 | SAS3008(C0) | 16.00.08.00 | 0e.01.00.0c | 08.37.00.00 | 00:e3:00:00 |

```
Finished Processing Commands Successfully.
Exiting SAS3Flash.
```

4. If the system is already up-to-date, then the following message is displayed:

```
# /opt/oracle/oak/pkgrepos/firmwarecontroller/lsilogic/
0x0097/16.00.08.00/it_nexus_reset.sh
The I_T Nexus Reset is enabled for the SAS3 controller(s) in this system.
No action required.
```

5. Run the script.

```
# /opt/oracle/oak/pkgrepos/firmwarecontroller/lsilogic/0x0097/16.00.08.00/
it_nexus_reset.sh
```

Use the `-force` option to run the script without being prompted for answers.

6. If Oracle Clusterware is running, then the following error is displayed:

```
# /opt/oracle/oak/pkgrepos/firmwarecontroller/lsilogic/0x0097/16.00.08.00/
it_nexus_reset.sh
CRS status found as up and running in this node, please SHUTDOWN the CRS
and retry running this script
```

7. Shut down Oracle Clusterware and run the script again:

```
# /u01/app/19.26.0.0/grid/bin/crsctl check crs
CRS-4638: Oracle High Availability Services is online
CRS-4537: Cluster Ready Services is online
CRS-4529: Cluster Synchronization Services is online
CRS-4533: Event Manager is online

# /u01/app/19.26.0.0/grid/bin/crsctl stop crs
```

```
...
...
...

# /u01/app/19.26.0.0/grid/bin/crsctl check crs
CRS-4639: Could not contact Oracle High Availability Services

# /opt/oracle/oak/pkgrepos/firmwarecontroller/lsilogic/0x0097/16.00.08.00/
it_nexus_reset.sh
#####
Running it_nexus_reset.sh script is going to perform nexus reset
and does DEEP POWER CYCLE of iLOM
Please enter 'yes' to confirm the Nexus Reset operation,
enter 'no' to cancel.
#####
Do you wish to continue and rest nexus adapter? (yes/no): yes
Trying perform I_T Nexus Reset
Updating Adapter with index: 0
running /opt/oracle/oak/pkgrepos/firmwarecontroller/lsilogic/
0x0097/16.00.08.00/sas3flash -c 0 -f /opt/oracle/oak/pkgrepos/
firmwarecontroller/lsilogic/0x0097/16.00.08.00/
Oracle_SAS9300-8e_it_p_000D_ph16.04_nexus.bin
Avago Technologies SAS3 Flash Utility
Version 17.00.00.00 (2018.04.02)
Copyright 2008-2018 Avago Technologies. All rights reserved.

Adapter Selected is a Avago SAS: SAS3008(C0)

Executing Operation: Flash Firmware Image

Firmware Image has a Valid Checksum.
Firmware Version 16.00.08.00
Firmware Image compatible with Controller.

Valid NVDATA Image found.
NVDATA Major Version 0e.01
Checking for a compatible NVData image...

NVDATA Device ID and Chip Revision match verified.
NVDATA SubSystem Vendor and SubSystem Device ID match
verified.

NVDATA Versions Compatible.
Valid Initialization Image verified.
Valid BootLoader Image verified.

Beginning Firmware Download...
Firmware Download Successful.

Verifying Download...

Firmware Flash Successful.

Resetting Adapter...
Adapter Successfully Reset.

NVDATA Version 0e.01.00.0d
```

```
Finished Processing Commands Successfully.  
Exiting SAS3Flash.  
running /opt/oracle/oak/pkgrepos/firmwarecontroller/lsilogic/  
0x0097/16.00.08.00/sas3flash -c 0 -o -e 3  
Avago Technologies SAS3 Flash Utility  
Version 17.00.00.00 (2018.04.02)  
Copyright 2008-2018 Avago Technologies. All rights reserved.
```

Advanced Mode Set

Adapter Selected is a Avago SAS: SAS3008(C0)

Executing Operation: Erase Flash

Erasing Persistent Configuration Pages Region...

Erase Flash Operation Successful!

```
Finished Processing Commands Successfully.  
Exiting SAS3Flash.  
running /opt/oracle/oak/pkgrepos/firmwarecontroller/lsilogic/  
0x0097/16.00.08.00/sas3flash -c 0 -b /opt/oracle/oak/pkgrepos/  
firmwarecontroller/lsilogic/0x0097/16.00.08.00/mpt3x64.rom  
Avago Technologies SAS3 Flash Utility  
Version 17.00.00.00 (2018.04.02)  
Copyright 2008-2018 Avago Technologies. All rights reserved.
```

Adapter Selected is a Avago SAS: SAS3008(C0)

Executing Operation: Flash BIOS Image

Validating BIOS Image...

BIOS Header Signature is Valid

BIOS Image has a Valid Checksum.

BIOS PCI Structure Signature Valid.

BIOS Image Compatible with the SAS Controller.

Attempting to Flash BIOS Image...

Verifying Download...

Flash BIOS Image Successful.

```
Finished Processing Commands Successfully.  
Exiting SAS3Flash.  
running /opt/oracle/oak/pkgrepos/firmwarecontroller/lsilogic/  
0x0097/16.00.08.00/sas3flash -c 0 -b /opt/oracle/oak/pkgrepos/  
firmwarecontroller/lsilogic/0x0097/16.00.08.00/mptsas3.rom  
Avago Technologies SAS3 Flash Utility  
Version 17.00.00.00 (2018.04.02)  
Copyright 2008-2018 Avago Technologies. All rights reserved.
```

Adapter Selected is a Avago SAS: SAS3008 (C0)

Executing Operation: Flash BIOS Image

Validating BIOS Image...

BIOS Header Signature is Valid

BIOS Image has a Valid Checksum.

BIOS PCI Structure Signature Valid.

BIOS Image Compatible with the SAS Controller.

Attempting to Flash BIOS Image...

Verifying Download...

Flash BIOS Image Successful.

Finished Processing Commands Successfully.

Exiting SAS3Flash.

```
running /opt/oracle/oak/pkgrepos/firmwarecontroller/lsilogic/
0x0097/16.00.08.00/sas3flash -c 0 -b /opt/oracle/oak/pkgrepos/
firmwarecontroller/lsilogic/0x0097/16.00.08.00/lsisas3f.rom
Avago Technologies SAS3 Flash Utility
Version 17.00.00.00 (2018.04.02)
Copyright 2008-2018 Avago Technologies. All rights reserved.
```

Adapter Selected is a Avago SAS: SAS3008 (C0)

Executing Operation: Flash BIOS Image

Validating BIOS Image...

BIOS Header Signature is Valid

BIOS Image has a Valid Checksum.

BIOS PCI Structure Signature Valid.

BIOS Image Compatible with the SAS Controller.

Attempting to Flash BIOS Image...

Verifying Download...

Flash BIOS Image Successful.

Finished Processing Commands Successfully.

Exiting SAS3Flash.

```
Updating Adapter with index: 1
running /opt/oracle/oak/pkgrepos/firmwarecontroller/lsilogic/
0x0097/16.00.08.00/sas3flash -c 1 -f /opt/oracle/oak/pkgrepos/
firmwarecontroller/lsilogic/0x0097/16.00.08.00/
Oracle_SAS9300-8e_it_p_000D_ph16.04_nexus.bin
```

Avago Technologies SAS3 Flash Utility
Version 17.00.00.00 (2018.04.02)
Copyright 2008-2018 Avago Technologies. All rights reserved.

Adapter Selected is a Avago SAS: SAS3008(C0)

Executing Operation: Flash Firmware Image

Firmware Image has a Valid Checksum.
Firmware Version 16.00.08.00
Firmware Image compatible with Controller.

Valid NVDATA Image found.
NVDATA Major Version 0e.01
Checking for a compatible NVData image...

NVDATA Device ID and Chip Revision match verified.
NVDATA SubSystem Vendor and SubSystem Device ID match
verified.

NVDATA Versions Compatible.
Valid Initialization Image verified.
Valid BootLoader Image verified.

Beginning Firmware Download...
Firmware Download Successful.

Verifying Download...

Firmware Flash Successful.

Resetting Adapter...
Adapter Successfully Reset.

NVDATA Version 0e.01.00.0d
Finished Processing Commands Successfully.
Exiting SAS3Flash.

```
running /opt/oracle/oak/pkgrepos/firmwarecontroller/lsilogic/  
0x0097/16.00.08.00/sas3flash -c 1 -o -e 3  
Avago Technologies SAS3 Flash Utility  
Version 17.00.00.00 (2018.04.02)  
Copyright 2008-2018 Avago Technologies. All rights reserved.
```

Advanced Mode Set

Adapter Selected is a Avago SAS: SAS3008(C0)

Executing Operation: Erase Flash

Erasing Persistent Configuration Pages Region...

Erase Flash Operation Successful!

Finished Processing Commands Successfully.
Exiting SAS3Flash.

```
running /opt/oracle/oak/pkgrepos/firmwarecontroller/lsilogic/  
0x0097/16.00.08.00/sas3flash -c 1 -b /opt/oracle/oak/pkgrepos/
```

```
firmwarecontroller/lsilogic/0x0097/16.00.08.00/mpt3x64.rom
Avago Technologies SAS3 Flash Utility
Version 17.00.00.00 (2018.04.02)
Copyright 2008-2018 Avago Technologies. All rights reserved.
```

```
Adapter Selected is a Avago SAS: SAS3008(C0)
```

```
Executing Operation: Flash BIOS Image
```

```
Validating BIOS Image...
```

```
BIOS Header Signature is Valid
```

```
BIOS Image has a Valid Checksum.
```

```
BIOS PCI Structure Signature Valid.
```

```
BIOS Image Compatible with the SAS Controller.
```

```
Attempting to Flash BIOS Image...
```

```
Verifying Download...
```

```
Flash BIOS Image Successful.
```

```
Finished Processing Commands Successfully.
```

```
Exiting SAS3Flash.
```

```
running /opt/oracle/oak/pkgrepos/firmwarecontroller/lsilogic/
0x0097/16.00.08.00/sas3flash -c 1 -b /opt/oracle/oak/pkgrepos/
firmwarecontroller/lsilogic/0x0097/16.00.08.00/mptsas3.rom
Avago Technologies SAS3 Flash Utility
Version 17.00.00.00 (2018.04.02)
Copyright 2008-2018 Avago Technologies. All rights reserved.
```

```
Adapter Selected is a Avago SAS: SAS3008(C0)
```

```
Executing Operation: Flash BIOS Image
```

```
Validating BIOS Image...
```

```
BIOS Header Signature is Valid
```

```
BIOS Image has a Valid Checksum.
```

```
BIOS PCI Structure Signature Valid.
```

```
BIOS Image Compatible with the SAS Controller.
```

```
Attempting to Flash BIOS Image...
```

```
Verifying Download...
```

```
Flash BIOS Image Successful.
```

```
Finished Processing Commands Successfully.
```

```
Exiting SAS3Flash.
```



```
running /opt/oracle/oak/pkgrepos/firmwarecontroller/lsilogic/  
0x0097/16.00.08.00/sas3flash -c 1 -b /opt/oracle/oak/pkgrepos/  
firmwarecontroller/lsilogic/0x0097/16.00.08.00/lsisas3f.rom  
Avago Technologies SAS3 Flash Utility  
Version 17.00.00.00 (2018.04.02)  
Copyright 2008-2018 Avago Technologies. All rights reserved.
```

```
Adapter Selected is a Avago SAS: SAS3008(C0)
```

```
Executing Operation: Flash BIOS Image
```

```
Validating BIOS Image...
```

```
BIOS Header Signature is Valid
```

```
BIOS Image has a Valid Checksum.
```

```
BIOS PCI Structure Signature Valid.
```

```
BIOS Image Compatible with the SAS Controller.
```

```
Attempting to Flash BIOS Image...
```

```
Verifying Download...
```

```
Flash BIOS Image Successful.
```

```
Finished Processing Commands Successfully.
```

```
Exiting SAS3Flash.
```

```
create script for ILOM deep recycle  
chmod 777 /tmp/dcsfiles/  
chmod 700 /tmp/dcsfiles//rebootIloM.sh  
prepare system for ILOM recycle  
Enabling HOST_AUTO_POWER_ON on ILOM  
Connected. Use ^D to exit.  
-> set /SP/policy HOST_AUTO_POWER_ON=enabled  
Set 'HOST_AUTO_POWER_ON' to 'enabled'
```

```
-> Session closed  
Disconnected  
Setting set /System/ deep_power_cycle=true  
Connected. Use ^D to exit.  
-> set /System/ deep_power_cycle=true  
Set 'deep_power_cycle' to 'true'
```

```
-> Session closed  
Disconnected  
Trigger recycle script in background
```

8. Continue patching your server and databases as described in the topic *Patching Oracle Database Appliance Bare Metal Systems Using the Command-Line*.

9. Verify that the updates ran successfully. When the system comes up, verify the NVDATA versions and firmware version.

```
# /opt/oracle/oak/pkgrepos/firmwarecontroller/lsilogic/0x0097/16.00.08.00/
sas3flash -listall
Avago Technologies SAS3 Flash Utility
Version 17.00.00.00 (2018.04.02)
Copyright 2008-2018 Avago Technologies. All rights reserved.

Adapter Selected is a Avago SAS: SAS3008(C0)

Num   Ctlr           FW Ver           NVDATA           x86-BIOS           PCI Addr
-----
-
0   SAS3008(C0)   16.00.08.00     0e.01.00.0d     08.37.00.00       00:3b:00:00
1   SAS3008(C0)   16.00.08.00     0e.01.00.0d     08.37.00.00       00:e3:00:00

Finished Processing Commands Successfully.
Exiting SAS3Flash.
```

Related Topics

- [About Enabling NUMA on Oracle Database Appliance](#)
Understand how you can enable NUMA on bare metal, KVM, and DB Systems on Oracle Database Appliance.
- [Patching Oracle Database Appliance DB Systems Using the Command-Line](#)
Follow these steps to apply patches to your Oracle Database Appliance DB system deployment and existing Oracle Database home in the DB system, using CLI commands.
- [Managing Database Homes on Oracle ACFS Storage](#)
Use the Oracle Appliance Manager Browser User Interface or ODACLI commands to manage database home storage in Oracle Database Appliance.
- [About Creating Database Homes on Oracle ACFS Storage](#)
When you create new Oracle Database homes, they are created on Oracle ACFS file system which are stored on Oracle Database Appliance storage disks. You can create new Oracle Database homes using the `odacli create-database` or `odacli create-dbhome` commands, or when you patch an existing database home.
- [odacli modify-vm](#)
Use the `odacli modify-vm` command to modify a virtual machine on Oracle Database Appliance Kernel-based Virtual Machine (KVM).
- [odacli remap-cpupools](#)
Use the `odacli remap-cpupools` command to remap CPU pools to NUMA allocation on Oracle Database Appliance Bare Metal or Kernel-based Virtual Machine (KVM) deployment.
- [odacli modify-dbsystem](#)
Use the `odacli modify-dbsystem` command to modify a DB system on Oracle Database Appliance Kernel-based Virtual Machine (KVM).
- [odacli create-cpupool](#)
Use the `odacli create-cpupool` command to create a new CPU pool on Oracle Database Appliance Bare Metal or Kernel-based Virtual Machine (KVM) deployment.

Patching Oracle Database Appliance Bare Metal Systems Using the Command-Line

Follow these steps to apply patches to your Oracle Database Appliance bare metal deployment and existing Oracle Database homes, using CLI commands.

To patch your Oracle Database Appliance deployment and your existing database homes to the current release, you must download the Oracle Database Appliance Server patch, Oracle Grid Infrastructure clone files, and Oracle Database clone files and update the repository on the bare metal system.

NOT_SUPPORTED:

When you patch your Oracle Database Appliance deployment to the current release, for ORCL-EXT-SAS3 controller with model number 0x0097, the patching precheck verifies that controllers NVDATA is updated to 0e.01.00.0d version. You must update I_T Target Reset of Estes-Ext to I_T Nexus Reset by running the `/opt/oracle/oak/pkgrepos/firmwarecontroller/lisilogic/0x0097/16.00.08.00/it_nexus_reset.sh` script. For more information, see the topic *Updating ESTES-EXT Firmware Before Patching Oracle Database Appliance Server*.

! Important:

Oracle recommends always patching from within the previous four Oracle Database Appliance releases because these patching paths are tested. If you patch from any earlier Oracle Database Appliance release, then you may encounter errors.

Note:

Run the steps in this procedure in the same order as documented. Run the `odacli update-dcsadmin`, `odacli update-dcscomponents`, and `odacli update-dcsagent` commands before running the `odacli update-server` command.

Note:

Note that for DCS Agent update to be complete, both the `odacli update-dcscomponents` and `odacli update-dcsagent` commands must be run. Ensure that both commands are run in the order specified.

! Important:

Ensure that there is sufficient space on your appliance to download the patches.

 **Important:**

If you want to install third-party software on your Oracle Database Appliance, then ensure that the software does not impact the Oracle Database Appliance software. The version lock on Oracle Database Appliance RPMs displays a warning if the third-party software tries to override Oracle Database Appliance RPMs. You must restore the affected RPMs before patching Oracle Database Appliance so that patching completes successfully.

 **Important:**

If you have configured Oracle ASR and are patching your appliance to Oracle Database Appliance release 19.26, then after updating the DCS agent, delete the existing Oracle ASR configuration and reconfigure it, before you run the `odacli update-server` command to patch your appliance.

 **Note:**

Public network gateway must be responsive to ping requests. Oracle Clusterware uses the public network gateway as ping target to facilitate the VIP failover in Oracle Database Appliance high-availability environment.

 **See Also:**

Enabling Custom SSH Key Management on Oracle Database Appliance in this guide for information on how to manage SSH keys on bare metal systems and DB systems

The Oracle Database Appliance Backup Recovery (ODABR) tool helps recover a system to the pre-patch state, should any potential errors occur during the patching process that may render the system unusable. Download and install the latest version of the Oracle Database Appliance Backup Recovery (ODABR) tool to enable creation of snapshots before patching. See My Oracle Support Note 2466177.1 for the procedure to install ODABR.

<https://support.oracle.com/rs?type=doc&id=2466177.1>

Follow these steps to apply patches to your Oracle Database Appliance and update existing database homes.

1. Download the Oracle Database Appliance Server Patch for the ODACLI/DCS stack (patch 37536686), Oracle Grid Infrastructure clone files (patch 30403673), and Oracle Database clone files (patch 30403662) from My Oracle Support to a temporary location on an external client. Refer to the release notes for details about the patch numbers and software for the latest release.

For example, download the server patch for 19.26:

```
p37536686_1926000_Linux-x86-64.zip
```

2. Unzip the software — it contains README.html and one or more zip files for the patch.

```
unzip p37536686_1926000_Linux-x86-64.zip
```

The zip file contains the following software file:

```
oda-sm-19.26.0.0.0-date-server.zip
```

3. Copy all the software files from the external client to Oracle Database Appliance. For High-Availability deployments, copy the software files to only one node. The software files are copied to the other node during the patching process. Use the `scp` or `sftp` protocol to copy the bundle.

Example using `scp` command:

```
# scp software_file root@oda_host:/tmp
```

Example using `sftp` command:

```
# sftp root@oda_host
```

Enter the `root` password, and copy the files.

```
put software_file
```

4. Update the repository with the server software file:

```
[root@oda1 opt]# /opt/oracle/dcs/bin/odacli update-repository -f /tmp/  
software_file
```

For example, for 19.26:

```
[root@oda1 opt]# /opt/oracle/dcs/bin/odacli update-repository -f /tmp/oda-  
sm-19.26.0.0.0-date-server.zip
```

5. Confirm that the repository update is successful:

```
[root@oda1 opt]# /opt/oracle/dcs/bin/odacli describe-job -i job_ID
```

6. Update DCS admin:

```
[root@oda1 opt]# /opt/oracle/dcs/bin/odacli update-dcsadmin -v 19.26.0.0.0
```

7. Update the DCS components:

```
[root@oda1 opt]# /opt/oracle/dcs/bin/odacli update-dcscomponents -v  
19.26.0.0.0
```

The `odacli update-dcscomponents` command updates the Zookeeper, MySQL, and updates other DCS components such as the DCS Agent, DCS CLI, and DCS Controller on Oracle Database Appliance.

If the DCS components are updated, then the message "status" : "Success" is displayed on the command line. For failed updates, fix the error and then proceed with the update by re-running the `odacli update-dcscomponents` command. See the topic *Resolving Errors When Updating DCS Components During Patching* about more information about DCS components checks errors.

 **Note:**

Note that for DCS Agent update to be complete, both the `odacli update-dcscomponents` and `odacli update-dcsagent` commands must be run. Ensure that both commands are run in the order specified in this procedure.

8. Update the DCS agent:

```
[root@oda1 opt]# /opt/oracle/dcs/bin/odacli update-dcsagent -v 19.26.0.0.0
```

9. Update the repository with the Oracle Grid Infrastructure clone file and the Oracle Database clone file:

```
[root@oda1 opt]# /opt/oracle/dcs/bin/odacli update-repository -f /tmp/software_file
```

For example, for 19.26:

```
[root@oda1 opt]# /opt/oracle/dcs/bin/odacli update-repository -f /tmp/odacli-dcs-19.26.0.0.0-date-GI-19.26.0.0.zip
[root@oda1 opt]# /opt/oracle/dcs/bin/odacli update-repository -f /tmp/odacli-dcs-19.26.0.0.0-date-DB-19.26.0.0.zip
```

- 10. Run patching pre-checks.** You must run the `odacli create-prepatchreport` command before you patch your server; otherwise, the `odacli update-server` command fails with an error message prompting you to run the patching pre-checks. Note that `odacli create-prepatchreport` supports the `-l` option, which runs the prechecks on the local node only. However, to be able to patch the system by running the command `odacli update-server`, the command `odacli create-prepatchreport` must be run without the `-l` option, so that the prechecks can be performed on both nodes before patching is started on any of the two nodes.

Note that there is no downtime when the patching prechecks run.

```
[root@oda1 opt]# /opt/oracle/dcs/bin/odacli create-prepatchreport -s -v version
```

For example, for 19.26:

```
[root@oda1 opt]# /opt/oracle/dcs/bin/odacli create-prepatchreport -s -v 19.26.0.0.0
```

Note that running the `odacli create-prepatchreport` command creates the target Oracle Grid Infrastructure home, which the server patching operation uses.

11. Verify that the patching pre-checks ran successfully:

```
[root@odal1 opt]# /opt/oracle/dcs/bin/odacli describe-prepatchreport
```

For example:

```
[root@odal1 opt]# odacli describe-prepatchreport -i 677d73d2-5eed-46e5-a06f-d5ca2649d36e
```

Patch pre-check report

```
-----
Job ID: 677d73d2-5eed-46e5-a06f-d5ca2649d36e
Description: Patch pre-checks for [OS, ILOM, GI, ORACHKSERVER,
SERVER]
Status: SUCCESS
Created: December 8, 2024 3:37:19 PM CST
Result: All pre-checks succeeded
```

Node Name

```
-----
n1
```

Pre-Check Status Comments

```
-----
__OS__
Validate supported versions Success Validated minimum supported versions.
Validate patching tag Success Validated patching tag: 19.26.0.0.0
Is patch location available Success Patch location is available.
Verify OS patch Success Verified OS patch
Validate command execution Success Validated command execution

__ILOM__
Validate ILOM server reachable Success Successfully connected with ILOM
server using public IP and USB
interconnect
Validate supported versions Success Validated minimum supported versions.
Validate patching tag Success Validated patching tag: 19.26.0.0.0.
Is patch location available Success Patch location is available.
Checking IloM patch Version Success Successfully verified the versions
Patch location validation Success Successfully validated location
Validate command execution Success Validated command execution

__GI__
Validate GI metadata Success Successfully validated GI metadata
Validate supported GI versions Success Validated minimum supported
versions.
Validate available space Success Validated free space under /u01
Is clusterware running Success Clusterware is running
Validate patching tag Success Validated patching tag: 19.26.0.0.0.
Is system provisioned Success Verified system is provisioned
Validate ASM in online Success ASM is online
Validate kernel log level Success Successfully validated the OS log
level
Validate minimum agent version Success GI patching enabled in current
DCSAGENT version
Validate Central Inventory Success oraInventory validation passed
```

```

Validate patching locks Success Validated patching locks
Validate clones location exist Success Validated clones location
Validate DB start dependencies Success DBs START dependency check passed
Validate DB stop dependencies Success DBs STOP dependency check passed
Validate space for clones Success Clones volume is already created
volume
Evaluate GI patching Success Successfully validated GI patching
Validate command execution Success Validated command execution
  __ORACHK__
Running orachk Success Successfully ran Orachk
Validate command execution Success Validated command execution

  __SERVER__
Validate local patching Success Successfully validated server local
                                patching
Validate command execution Success Validated command execution
Node Name
-----
n2

Pre-Check Status Comments
-----
-----

  __OS__
Validate supported versions Success Validated minimum supported versions.
Validate patching tag Success Validated patching tag: 19.26.0.0.0.
Is patch location available Success Patch location is available.
Verify OS patch Success Verified OS patch
Validate command execution Success Validated command execution

  __ILOM__
Validate ILOM server reachable Success Successfully connected with ILOM
                                server using public IP and USB
                                interconnect
Validate supported versions Success Validated minimum supported versions.
Validate patching tag Success Validated patching tag: 19.26.0.0.0.
Is patch location available Success Patch location is available.
Checking IloM patch Version Success Successfully verified the versions
Patch location validation Success Successfully validated location
Validate command execution Success Validated command execution

  __GI__
Validate GI metadata Success Successfully validated GI metadata
Validate supported GI versions Success Validated minimum supported
versions.
Validate available space Success Validated free space under /u01
Is clusterware running Success Clusterware is running
Validate patching tag Success Validated patching tag: 19.26.0.0.0.
Is system provisioned Success Verified system is provisioned
Validate ASM in online Success ASM is online
Validate kernel log level Success Successfully validated the OS log
                                level
Validate minimum agent version Success GI patching enabled in current
                                DCSAGENT version
Validate Central Inventory Success oraInventory validation passed
Validate patching locks Success Validated patching locks
Validate clones location exist Success Validated clones location

```



```

Validate DB start dependencies Success DBs START dependency check passed
Validate DB stop dependencies Success DBs STOP dependency check passed
Validate space for clones Success Clones volume is already created
volume
Evaluate GI patching Success Successfully validated GI patching
Validate command execution Success Validated command execution
__ORACHK__
Running orachk Success Successfully ran Orachk
Validate command execution Success Validated command execution

__SERVER__
Validate local patching Success Successfully validated server local
patching
Validate command execution Success Validated command execution

```

Use the command `odacli describe-prepatchreport` to view details of the pre-patch report. Fix the warnings and errors mentioned in the report and proceed with the server patching.

12. Apply the server update. Note that you can use the `--local` option with the `odacli update-server` command to update the local node.

```
[root@odal1 opt]# /opt/oracle/dcs/bin/odacli update-server -v version
```

For example, for 19.26:

```
[root@odal1 opt]# /opt/oracle/dcs/bin/odacli update-server -v 19.26.0.0.0
```

13. Confirm that the server update is successful:

```
[root@odal1 opt]# /opt/oracle/dcs/bin/odacli describe-job -i job_ID
```

 **Note:**

After successful server update, it is recommended that you delete any ODABR snapshot you created before starting the server update. If you want to retain any ODABR snapshot when you update the storage and other components, then consider that the presence of active ODABR snapshots may affect system performance. See My Oracle Support Note 2466177.1 for the procedure to create and delete ODABR snapshots: <https://support.oracle.com/rs?type=doc&id=2466177.1>

14. Before you update the storage components, run the `odacli create-prepatchreport` command with the `-st` option.

```
[root@odal1 opt]# /opt/oracle/dcs/bin/odacli create-prepatchreport -st -v
version
```

For example, for 19.26:

```
[root@odal1 opt]# /opt/oracle/dcs/bin/odacli create-prepatchreport -st -v
19.26.0.0.0
```

15. Verify that the patching pre-checks ran successfully:

```
[root@oda1 opt]# /opt/oracle/dcs/bin/odacli describe-prepatchreport
```

For example:

```
[root@oda1 opt]# odacli describe-prepatchreport -i 95887f92-7be7-4865-a311-54318ab385f2
```

Patch pre-check report

```
-----
Job ID: 95887f92-7be7-4865-a311-54318ab385f2
Description: Patch pre-checks for [STORAGE]
Status: SUCCESS
Created: December 8, 2024 12:52:37 PM HKT
Result: All pre-checks succeeded
```

Node Name

node1

| Pre-Check | Status | Comments |
|--|---------|-------------------------------|
| ----- | | |
| ----- | | |
| <u>STORAGE</u> | | |
| Validate patching tag 19.26.0.0.0. | Success | Validated patching tag: |
| Patch location validation location | Success | Verified patch |
| Patch tag validation tag | Success | Verified patch |
| Storage patch tag validation location | Success | Verified storage patch |
| Verify ASM disks status online | Success | ASM disks are |
| Validate rolling patch as | Success | Rolling mode patching allowed |
| | | there is no expander and |
| controller | | |

upgrade.

| | | |
|---|---------|-------------------|
| Validate command execution execution | Success | Validated command |
|---|---------|-------------------|

Node Name

node2

| Pre-Check | Status | Comments |
|-----------------------|---------|-------------------------|
| ----- | | |
| ----- | | |
| <u>STORAGE</u> | | |
| Validate patching tag | Success | Validated patching tag: |

```

19.26.0.0.0.
Patch location validation      Success  Verified patch
location
Patch tag validation          Success  Verified patch
tag
Storage patch tag validation  Success  Verified storage patch
location
Verify ASM disks status      Success  ASM disks are
online
Validate rolling patch       Success  Rolling mode patching allowed
as
                                there is no expander and
controller

upgrade.
Validate command execution    Success  Validated command
execution
    
```

Use the command `odacli describe-prepatchreport` to view details of the pre-patch report. The pre-patch report also indicates whether storage patching can be rolling or not, based on whether an Expander or Controller update is also required.

Fix the warnings and errors mentioned in the report and proceed with the storage components patching.

16. Update the storage components.

Specify the `--rolling` option to patch shared disks in a rolling fashion. Note that if you patch from an Oracle Database Appliance release that requires the expander to be patched, then you cannot use the `--rolling` option during storage patching.

```
[root@oda1 opt]# /opt/oracle/dcs/bin/odacli update-storage -v version --rolling
```

For example, for 19.26:

```
[root@oda1 opt]# /opt/oracle/dcs/bin/odacli update-storage -v 19.26.0.0.0 --rolling
```

17. Starting with Oracle Database Appliance release 19.11, Oracle Database homes are not created on the local disk. Oracle Database homes are created on an Oracle ACFS-managed file system. For a database user oracle, the new database homes are created under `/u01/app/odaorahome/oracle/`.

If the database home is not already configured on Oracle ACFS, then before patching the database home, configure the database home storage with the `odacli configure-dbhome-storage` command. For example:

```
[root@oda1 opt]# odacli configure-dbhome-storage -dg DATA
```

The command does not cause storage allocation or creation of volumes or file systems. The command only sets the disk group location in the metadata.

For information about managing database homes on Oracle ACFS, see the topic *Managing Database Home Storage*.

18. To patch existing Oracle Database Homes to release 19.26, ensure that the repository is updated with the Oracle Database clone files. If you have not updated the repository with the Oracle Database clone files, then update the repository. Note that you must update the DCS agent before you update the repository with the Oracle Database clone files.

```
[root@odal opt]# /opt/oracle/dcs/bin/odacli update-repository -f /tmp/  
DB_software_file
```

```
[root@odal opt]# /opt/oracle/dcs/bin/odacli update-repository -f /tmp/  
odacli-dcs-19.26.0.0.0-date-DB-19.26.0.0.zip
```

 **Note:**

You have the option to patch each database home using the `odacli update-dbhome` command or patch selected databases in a database home to a specific database home using the `odacli update-database` command.

19. To patch all databases in a specified database home:

- a. If you want to patch each database home by running the `odacli update-dbhome` command, then create the prepatch report first. Run the patching pre-checks and review the prepatch report. You must run the `odacli create-prepatchreport` command before you patch your Oracle Database homes; otherwise, the `odacli update-dbhome` command fails with an error message prompting you to run the patching pre-checks.

```
[root@odal opt]# /opt/oracle/dcs/bin/odacli create-prepatchreport --  
dbhome --dbhomeid DB_Home_ID -v release_number  
[root@odal opt]# odacli describe-prepatchreport -i Job_ID
```

```
[root@odal opt]# /opt/oracle/dcs/bin/odacli create-prepatchreport --  
dbhome --dbhomeid d03d5187-1c20-470a-9d51-49a0d6f60772 -v 19.26.0.0  
[root@odal opt]# odacli describe-prepatchreport -i 6f040374-d271-4711-  
a7db-e6c04597ad69
```

Patch pre-check report

```
-----  
Job ID: 6f040374-d271-4711-a7db-e6c04597ad69  
Description: Patch pre-checks for [DB, ORACHKDB]: DbHome  
is OraDB19000_home1  
Status: SUCCESS  
Created: December 8, 2024 8:59:48 AM HKT  
Result: All pre-checks succeeded
```

Node Name

```
-----  
node1
```

```
Pre-Check          Status  
Comments
```

```
-----  
-----
```

```

    DB
    Validate DB Home ID                               Success  Validated DB Home
    ID:

    d03d5187-1c20-470a-9d51-49a0d6f60772
    Validate patching tag                             Success  Validated patching tag:
    19.26.0.0.0.
    Is system provisioned                             Success  Verified system is
    provisioned
    Validate minimum agent version                    Success  Validated minimum agent
    version
    Is GI upgraded                                    Success  Validated GI is
    upgraded
    Validate available space for                       Success  Validated free space required
    under
    db                                                /u01/app/
    odaorahome
    Validate dbHomesOnACFS                            Success  User has configured diskgroup
    for
    configured                                       Database homes on
    ACFS
    Validate Oracle base                              Success  Successfully validated Oracle
    Base
    Is DB clone available                             Success  Successfully validated clone
    file

    exists
    Evaluate DBHome patching with                     Success  Successfully validated
    updating
    RHP                                              dbhome with RHP.  and local
    patching                                         is

    possible
    Validate command execution                         Success  Validated command
    execution

    ORACHK
    Running orachk                                    Success  Successfully ran
    Orachk
    Validate command execution                         Success  Validated command
    execution

    Node Name
    -----
    node2

    Pre-Check                                         Status
    Comments
    -----
    -----

    DB
    Validate DB Home ID                               Success  Validated DB Home
    ID:

    d03d5187-1c20-470a-9d51-49a0d6f60772
    Validate patching tag                             Success  Validated patching tag:
    
```

```

19.26.0.0.0.
Is system provisioned          Success  Verified system is
provisioned
Validate minimum agent version Success  Validated minimum agent
version
Is GI upgraded                 Success  Validated GI is
upgraded
Validate available space for   Success  Validated free space required
under
db                             /u01/app/
odaorahome
Validate dbHomesOnACFS        Success  User has configured diskgroup
for
configured                     Database homes on
ACFS
Validate Oracle base          Success  Successfully validated Oracle
Base
Is DB clone available         Success  Successfully validated clone
file

exists
Evaluate DBHome patching with Success  Successfully validated
updating
RHP                             dbhome with
RHP.
Validate command execution     Success  Validated command
execution

__ORACHK__
Running orachk                 Success  Successfully ran
Orachk
Validate command execution     Success  Validated command
execution

```

If the disk group for database homes on Oracle ACFS is not set up as described in step 17, then the prepatch report lists the error `The system is not set up to create database homes on ACFS`. Run the `odacli configure-dbhome-storage` command to configure the disk group for database homes on Oracle ACFS.

Note that running the `odacli create-prepatchreport` command creates the target Oracle Grid Infrastructure home, which the database patching operation uses.

- b. If the pre-patch report does not show any errors, then update the database home to the latest release. You need not use the `-f` option with the `odacli update-dbhome` command. Note that you can use the `--local` option with the `odacli update-dbhome` command to update the local node.

```
[root@oda1 opt]# /opt/oracle/dcs/bin/odacli update-dbhome --id
DB_Home_ID -v release_number
```

For example, for 19.26:

```
[root@oda1 opt]# /opt/oracle/dcs/bin/odacli update-dbhome --id 7c67c5b4-
f585-4ba9-865f-c719c63c0a6e -v 19.26.0.0.0
```

20. To patch a specific database to a specific database home:

- a. If you want patch selected databases in a database home to a specific database home using the `odacli update-database` command, then create the prepatch report first. Run the patching pre-checks and review the prepatch report. You must run the `odacli create-prepatchreport` command before you patch your Oracle database; otherwise, the `odacli update-database` command fails with an error message prompting you to run the patching pre-checks.

```
[root@odal opt]# /opt/oracle/dcs/bin/odacli create-prepatchreport -db -
dbid DATABASE_ID -to a68f9947-DB_HOME_ID
```

For example, for 19.26:

```
[root@odal ~]# odacli describe-prepatchreport -i efa93519-
a365-4e9a-9f25-ad3c653cccef
```

Patch pre-check report

```
-----
                        Job ID: efa93519-a365-4e9a-9f25-ad3c653cccef
                        Description: Patch pre-checks for [SINGLEEDB,
ORACHKSINGLEEDB]: Target DB is db10181, Destination DbHome is
OrADB19000_home8
                        Status: SUCCESS
                        Created: December 8, 2024 11:19:03 AM PDT
                        Result: All pre-checks succeeded
```

Node Name

```
-----
node1
```

Pre-Check Status Comments

```
-----
__SINGLEEDB__
Is system provisioned Success Verified system is provisioned
Validate dbHomesOnACFS Success User has configured disk group for
configured Database homes on ACFS
Validate Oracle base Success Successfully validated Oracle Base
Evaluate DB clone availability Success Successfully validated clone file
exists
Evaluate DB patching with RHP Success Successfully validated patching DB
with RHP.
Validate command execution Success Validated command execution
```

__ORACHK__

```
Running orachk Success Successfully ran Orachk
Validate command execution Success Validated command execution
```

Node Name

```
-----
node2
```

Pre-Check Status Comments

```
-----
-----
```

```

__SINGLEDEB__
Is system provisioned Success Verified system is provisioned
Validate dbHomesOnACFS Success User has configured disk group for
configured Database homes on ACFS
Validate Oracle base Success Successfully validated Oracle Base
Evaluate DB clone availability Success Successfully validated clone file
exists
Evaluate DB patching with RHP Success Successfully validated patching DB
with RHP.
Validate command execution Success Validated command execution

```

```

__ORACHK__
Running orachk Success Successfully ran Orachk
Validate command execution Success Validated command execution

```

- b. If the pre-patch report does not show any errors, then update the databases to the latest release.

```

[root@odal1 opt]# /opt/oracle/dcs/bin/odacli update-database -i
database_ID/-n database_name -to destination_dbhome_ID

```

For example, for 19.26:

```

[root@odal1 opt]# /opt/oracle/dcs/bin/odacli update-database -i
c05458c7-0f1d-4260-8e62-003b3ec26d74/-n db10181 -to dc98eaa9-289c-4710-
a898-ca6287a07a9c
[root@odal1 ~]# odacli describe-job -i
d442a7d4-594f-48e2-8b02-9124811bb7b4

```

Job details

```

-----
ID: d442a7d4-594f-48e2-8b02-9124811bb7b4
Description: DB Patching: database ID is
c05458c7-0f1d-4260-8e62-003b3ec26d74
Status: Success
Created: December 8, 2024 3:23:43 PM PDT
Message:

```

Task Name Node Name Start Time End Time Status

```

-----
-----
Creating wallet for DB Client node1 December 8, 2024 3:24:42 PM PDT
December 8, 2024 3:24:42 PM PDT Success
Patch databases by RHP node1 December 8, 2024 3:24:42 PM PDT December
8, 2024 3:29:34 PM PDT Success
Updating database metadata node2 December 8, 2024 3:29:34 PM PDT
December 8, 2024 3:29:34 PM PDT Success
Set log_archive_dest for Database node1 December 8, 2024 3:29:34 PM PDT
December 8, 2024 3:29:37 PM PDT Success
Generating and saving BOM node1 December 8, 2024 3:29:37 PM PDT
December 8, 2024 3:31:44 PM PDT Success
Generating and saving BOM node2 December 8, 2024 3:29:37 PM PDT
December 8, 2024 3:31:44 PM PDT Success

```



```
TDE parameter update node2 December 8, 2024 3:32:25 PM PDT December 8,  
2024 3:32:25 PM PDT Success
```

21. Confirm that the patch jobs are successful:

```
[root@oda1 opt]# /opt/oracle/dcs/bin/odacli list-jobs
```

- 22. If you are patching your appliance from Oracle Database Appliance release 19.11 or earlier, then run the following steps. You must also run these steps if your appliance was previously patched to Oracle Database Appliance release 19.12 or later, but you did not run these steps when patching to release 19.12.**
- a. After patching the bare metal systems and database homes, enable NUMA (Non-Uniform Memory Access) on existing databases of release 19.12 or earlier, by running the following SQL*Plus command:**

```
SQL> alter system set "_enable_numa_support"=true scope=spfile sid='*';
```

Restart the database after running the command to ensure that the changes take effect.

For more information about enabling NUMA, see the topic *About Enabling NUMA on Oracle Database Appliance*.

- b. If you have deployed DB systems, VMs, or CPU pools, perform the following steps:**
 - i. Run the `odacli remap-cpupools` command:**

```
[root@oda1 opt]# /opt/oracle/dcs/bin/odacli remap-cpupools
```

If the `odacli remap-cpupools` command fails with the error `DCS-10001:Internal error encountered: Not enough physical CPUs available for CPU Pool 'cpupool_name' on node 'node_name'`, run the `odacli remap-cpupools` command again with the `--use_reserved-cores` option. For information about the command options, see the chapter *Oracle Database Appliance Command-Line Interface for KVM*.

- ii. If you have DB systems in your deployment, then run the `odacli modify-dbsystem` command. If you have VMs in your KVM deployment and you want to enable NUMA for the VMs, then run the `odacli modify-vm --enable-numa` command for VMs. That is:**

For DB systems:

```
odacli modify-dbsystem --enable-numa
```

For VMs:

```
odacli modify-vm --enable-numa
```

 **Note:**

For bare metal systems and DB systems on Oracle Database Appliance X7-2S and X8-2S, the database `init.ora` parameter `_enable_numa_support` is set to `FALSE` even when NUMA is enabled. This is expected because these hardware models are single socket systems.

Related Topics

- [Patching Existing Database Homes Using ODACLI or the BUI](#)
Use ODACLI or BUI to patch database homes in your deployment to the latest release.

Related Topics

- [Oracle Database Appliance Release Notes](#)

Related Topics

- [Resolving Errors When Updating DCS Components During Patching](#)
Understand how to troubleshoot errors when updating DCS components during patching.

Related Topics

- [About Enabling NUMA on Oracle Database Appliance](#)
Understand how you can enable NUMA on bare metal, KVM, and DB Systems on Oracle Database Appliance.
- [Patching Oracle Database Appliance DB Systems Using the Command-Line](#)
Follow these steps to apply patches to your Oracle Database Appliance DB system deployment and existing Oracle Database home in the DB system, using CLI commands.
- [Managing Database Homes on Oracle ACFS Storage](#)
Use the Oracle Appliance Manager Browser User Interface or ODACLI commands to manage database home storage in Oracle Database Appliance.
- [About Creating Database Homes on Oracle ACFS Storage](#)
When you create new Oracle Database homes, they are created on Oracle ACFS file system which are stored on Oracle Database Appliance storage disks. You can create new Oracle Database homes using the `odacli create-database` or `odacli create-dbhome` commands, or when you patch an existing database home.
- [odacli modify-vm](#)
Use the `odacli modify-vm` command to modify a virtual machine on Oracle Database Appliance Kernel-based Virtual Machine (KVM).
- [odacli remap-cpupools](#)
Use the `odacli remap-cpupools` command to remap CPU pools to NUMA allocation on Oracle Database Appliance Bare Metal or Kernel-based Virtual Machine (KVM) deployment.
- [odacli modify-dbsystem](#)
Use the `odacli modify-dbsystem` command to modify a DB system on Oracle Database Appliance Kernel-based Virtual Machine (KVM).
- [odacli create-cpupool](#)
Use the `odacli create-cpupool` command to create a new CPU pool on Oracle Database Appliance Bare Metal or Kernel-based Virtual Machine (KVM) deployment.

Patching Oracle Database Appliance DB Systems Using the Command-Line

Follow these steps to apply patches to your Oracle Database Appliance DB system deployment and existing Oracle Database home in the DB system, using CLI commands.

To patch your Oracle Database Appliance DB systems deployment and your existing database homes to the current release, you must download the Oracle Database Appliance Server Patch and update the bare metal system repository.

Note:

Run the commands in this topic in the same order as documented. Run the `odacli update-dcsadmin`, `odacli update-dcscomponents`, and `odacli update-dcsagent` commands before running the `odacli update-server` command.

Note:

Note that for DCS agent update to be complete, both the `odacli update-dcscomponents` and `odacli update-dcsagent` commands must be run. Ensure that both commands are run in the order specified.

Note:

Public network gateway must be responsive to ping requests. Oracle Clusterware uses the public network gateway as ping target to facilitate the VIP failover in Oracle Database Appliance high-availability environment.

Ensure that you have patched your Oracle Database Appliance bare metal deployment to release 19.26 before you patch your DB system.

Follow these steps to apply patches to your Oracle Database Appliance DB system deployment and update the existing database home in the DB system.

1. Ensure that the Oracle Database Appliance Server Patch for the ODACLI/DCS stack, Oracle Grid Infrastructure clone files, and Oracle Database clone files are available in the repository. Run the `odacli list-availablepatches` command in the bare metal system to view whether the clone files are available in the system.

```
[root@oda1 opt]# odacli list-availablepatches
```

2. Connect to the DB system.
3. Update DCS admin:

```
[root@dbsystem1 opt]# /opt/oracle/dcs/bin/odacli update-dcsadmin -v 19.26.0.0.0
```

4. Update the DCS components:

```
[root@dbsystem1 opt]# /opt/oracle/dcs/bin/odacli update-dcscomponents -v
19.26.0.0.0
```

If the DCS components are updated, then the message "status" : "Success" is displayed on the command line. For failed updates, fix the error and then proceed with the update by re-running the `odacli update-dcscomponents` command. See the topic *Resolving Errors When Updating DCS Components During Patching* about more information about DCS components checks errors.

Note:

Note that for DCS agent update to be complete, both the `odacli update-dcscomponents` and `odacli update-dcsagent` commands must be run. Ensure that both commands are run in the order specified.

5. Update the DCS agent:

```
[root@dbsystem1 opt]# /opt/oracle/dcs/bin/odacli update-dcsagent -v
19.26.0.0.0
```

6. Run patching pre-checks. You must run the `odacli create-prepatchreport` command before you patch your server; otherwise, the `odacli update-server` command fails with an error message prompting you to run the patching pre-checks.

```
[root@dbsystem1 opt]# /opt/oracle/dcs/bin/odacli create-prepatchreport -s -
v version
```

For example, for 19.26:

```
[root@dbsystem1 opt]# /opt/oracle/dcs/bin/odacli create-prepatchreport -s -
v 19.26.0.0.0
```

7. Verify that the patching pre-checks ran successfully:

```
[root@dbsystem1 opt]# /opt/oracle/dcs/bin/odacli describe-prepatchreport
```

For example:

```
[root@dbsystem1 ~]# odacli describe-prepatchreport -i
f7e6fb22-1fc0-4aa1-937c-9669dbbb8ae6
```

```
Patch pre-check report
```

```
-----
Job ID: f7e6fb22-1fc0-4aa1-937c-9669dbbb8ae6
Description: Patch pre-checks for [OS, GI, ORACHKSERVER,
SERVER]
Status: SUCCESS
Created: December 8, 2024 3:38:03 PM CET
Result: All pre-checks succeeded
```

```

Node Name
-----
node1

Pre-Check          Status
Comments          -----
-----
  OS
Validate supported versions      Success  Validated minimum supported
versions.
Validate patching tag            Success  Validated patching tag:
19.26.0.0.0.
Is patch location available      Success  Patch location is
available.
Verify OS patch                  Success  Verified OS
patch
Validate command execution       Success  Validated command
execution

  GI
Validate GI metadata             Success  Successfully validated GI
metadata
Validate supported GI versions   Success  Validated minimum supported
versions.
Validate available space         Success  Validated free space
under /u01
Is clusterware running          Success  Clusterware is
running
Validate patching tag            Success  Validated patching tag:
19.26.0.0.0.
Is system provisioned            Success  Verified system is
provisioned
Validate BM versions             Success  Validated BM server
components

versions
Validate kernel log level        Success  Successfully validated the OS
log

level
Validate minimum agent version   Success  GI patching enabled in
current                                     DCSAGENT

version
Validate Central Inventory       Success  oraInventory validation
passed
Validate patching locks          Success  Validated patching
locks
Validate clones location exist   Success  Validated clones
location
Evaluate GI patching             Success  Successfully validated GI
patching
Validate command execution       Success  Validated command
execution

```

```

__ORACHK__
Running orachk                Success    Successfully ran
Orachk
Validate command execution    Success    Validated command
execution

__SERVER__
Validate local patching       Success    Successfully validated server
local

patching
Validate command execution    Success    Validated command
execution

Node Name
-----
node2

Pre-Check                      Status
Comments
-----
-----

__OS__
Validate supported versions    Success    Validated minimum supported
versions.
Validate patching tag         Success    Validated patching tag:
19.26.0.0.0.
Is patch location available    Success    Patch location is
available.
Verify OS patch               Success    Verified OS
patch
Validate command execution     Success    Validated command
execution

__GI__
Validate GI metadata           Success    Successfully validated GI
metadata
Validate supported GI versions Success    Validated minimum supported
versions.
Validate available space       Success    Validated free space
under /u01
Is clusterware running        Success    Clusterware is
running
Validate patching tag         Success    Validated patching tag:
19.26.0.0.0.
Is system provisioned          Success    Verified system is
provisioned
Validate BM versions           Success    Validated BM server
components

versions
Validate kernel log level      Success    Successfully validated the OS
log

level
Validate minimum agent version Success    GI patching enabled in

```

```

current
                                DCSAGENT
version
Validate Central Inventory      Success  oraInventory validation
passed
Validate patching locks         Success  Validated patching
locks
Validate clones location exist  Success  Validated clones
location
Evaluate GI patching            Success  Successfully validated GI
patching
Validate command execution      Success  Validated command
execution

__ORACHK__
Running orachk                  Success  Successfully ran
Orachk
Validate command execution      Success  Validated command
execution

__SERVER__
Validate local patching         Success  Successfully validated server
local

patching
Validate command execution      Success  Validated command
execution

```

Use the command `odacli describe-prepatchreport` to view details of the pre-patch report. Fix the warnings and errors mentioned in the report and proceed with the server patching.

8. Apply the server update. Note that you can use the `--local` option with the `odacli update-server` command to update the local node.

```
[root@dbssystem1 opt]# /opt/oracle/dcs/bin/odacli update-server -v version
```

For example, for 19.26:

```
[root@dbssystem1 opt]# /opt/oracle/dcs/bin/odacli update-server -v
19.26.0.0.0
```

You can use the `-f` option to override precheck failures and complete the server patching.

9. Confirm that the server update is successful:

```
[root@dbssystem1 opt]# /opt/oracle/dcs/bin/odacli describe-job -i job_ID
```

10. To patch existing Oracle Database Homes to release 19.26:

- a. On the bare metal system, run the command `odacli describe-dbssystem-image` to check that the repository is updated with the required Oracle Database clone files. If the database clone file is not displayed in the command output, then run the command

odacli update-repository on the bare metal system to update the repository with the database clone files:

```
[root@odal opt]# /opt/oracle/dcs/bin/odacli update-repository -f /tmp/
DB_software_file
```

```
[root@odal opt]# /opt/oracle/dcs/bin/odacli update-repository -f /tmp/
odacli-dcs-19.26.0.0.0-date-DB-19.26.0.0.zip
```

- b. Run the patching pre-checks and review the prepatch report. You must run the `odacli create-prepatchreport` command before you patch your Oracle Database homes; otherwise, the `odacli update-dbhome` command fails with the error message prompting you to run the patching pre-checks.

```
[root@dbsystem1 opt]# /opt/oracle/dcs/bin/odacli create-prepatchreport
--dbhome --dbhomeid DB_Home_ID -v release_number
[root@dbsystem1 opt]# odacli describe-prepatchreport -i Job_ID
```

```
[root@dbsystem1 opt]# /opt/oracle/dcs/bin/odacli create-prepatchreport
--dbhome --dbhomeid 7c67c5b4-f585-4ba9-865f-c719c63c0a6e -v 19.26.0.0
[root@dbsystem1 opt]# odacli describe-prepatchreport -i
39ef1eeb-70d3-47ad-b3f5-48960ca0607b
```

Alternatively, you can use the `odacli update-database` to update the databases in your deployment:

```
[root@dbsystem1 opt]# odacli create-prepatchreport --database --
database-id database_ID --to-home dest_dbhome_ID
[root@dbsystem1 opt]# odacli update-database --id database_ID --to-home
dest_dbhome_ID
```

- c. If there are no errors, then update the database home to the latest release. You need not use the `-f` option with the `odacli update-dbhome` command. Note that you can use the `--local` option with the `odacli update-dbhome` command to update the local node. You can also use the `--node` option to specify the node containing the database to update.

```
[root@dbsystem1 opt]# /opt/oracle/dcs/bin/odacli update-dbhome --id
DB_Home_ID -v release_number
```

For example, for 19.26:

```
[root@dbsystem1 opt]# /opt/oracle/dcs/bin/odacli update-dbhome --id
7c67c5b4-f585-4ba9-865f-c719c63c0a6e -v 19.26.0.0
```

11. Confirm that the patch jobs are successful:

```
[root@dbsystem1 opt]# /opt/oracle/dcs/bin/odacli list-jobs
```

Related Topics

- [About Enabling NUMA on Oracle Database Appliance](#)
Understand how you can enable NUMA on bare metal, KVM, and DB Systems on Oracle Database Appliance.
- [odacli modify-vm](#)
Use the `odacli modify-vm` command to modify a virtual machine on Oracle Database Appliance Kernel-based Virtual Machine (KVM).
- [odacli remap-cpupools](#)
Use the `odacli remap-cpupools` command to remap CPU pools to NUMA allocation on Oracle Database Appliance Bare Metal or Kernel-based Virtual Machine (KVM) deployment.
- [odacli modify-dbsystem](#)
Use the `odacli modify-dbsystem` command to modify a DB system on Oracle Database Appliance Kernel-based Virtual Machine (KVM).
- [odacli create-cpupool](#)
Use the `odacli create-cpupool` command to create a new CPU pool on Oracle Database Appliance Bare Metal or Kernel-based Virtual Machine (KVM) deployment.
- [odacli describe-dbsystem-image](#)
Use the `odacli describe-dbsystem-image` command to view the supported Oracle Grid Infrastructure and Oracle Database versions and the availability of the clone files and Database System KVM image in the Oracle Database Appliance system.

Patching Oracle Database Appliance Bare Metal Systems Using the Browser User Interface

Upload the Oracle Database Appliance Server Patch to the patch repository, deploy the patch bundle using the Browser User Interface, and then update the DCS admin, DCS components, and DCS agent using CLI commands.

Updating the Patch Repository Using the Browser User Interface

1. Download the Oracle Database Appliance patches from My Oracle Support and save them in a directory on the appliance. See the *Oracle Database Appliance Release Notes* for a list of available patches and links to download the patches.
2. Log into the Browser User Interface.

```
https://Node0-host-ip-address:7093/mgmt/index.html
```

3. Click **Repository Manager**.
4. In the Update Patch Repository page, enter the absolute file path and patch name, then click **Update Repository** to start the update repository job. You can list more than one file to update to the repository with a comma separated list, without spaces, or you can update each file, one at a time.
5. Click **Activity** to monitor the progress. When the job completes successfully, the Patch Repository is updated.

Updating the DCS Admin, DCS Components, and DCS Agent After Updating the Repository and Before Patching

Before patching your appliance using the Browser User Interface, you must update the DCS admin, DCS agent, and DCS components manually through CLI commands.

Follow these steps:

1. In the BUI, click **Appliance** and then click **Infrastructure Patching** on the lefthand pane.
2. Using ODACLI commands, update the DCS admin, DCS components, and DCS agent:

```
[root@oda1 opt]# /opt/oracle/dcs/bin/odacli update-dcsadmin -v 19.26.0.0.0
[root@oda1 opt]# /opt/oracle/dcs/bin/odacli update-dcscomponents -v
19.26.0.0.0
[root@oda1 opt]# /opt/oracle/dcs/bin/odacli update-dcsagent -v 19.26.0.0.0
```

If the DCS components are updated, then the message "status" : "Success" is displayed on the command line. For failed updates, fix the error and then proceed with the update.

Note:

You must log into the Browser User Interface again after running the `odacli update-dcscomponents` command.

Running Patching Prechecks and Patching Server, and Storage Using the Browser User Interface

1. Do not have any jobs running or pending during the update window.
2. In the BUI, click the **Appliance** tab, and then click **Infrastructure Patching** on the lefthand pane.
3. In the SERVER section, view the Component Details. If you just updated the Patch Repository, click **Refresh**.

After the patch is uploaded to the Patch Repository, the Component Details on the page are updated with the Installed Version and Available Version for each component.

4. Click **Precheck** to run patching prechecks. You must run the patching prechecks before updating the server and other components. Click **View Pre-check Reports** to view the patching prechecks report. If there are no errors in the report, then click **Apply Patch** to begin the job to patch the server components. For high-availability systems, when updating the server on the bare metal system, you can select the **Node to Update**. You can choose the node that you want to update or you can choose to update both nodes.

When the job finishes, go to the next step. Click **View Jobs** for the job status.

5. In the STORAGE section, click **Refresh** to refresh the Component Details. Click **Precheck** to run patching prechecks. You must run the patching prechecks before updating the storage components. Click **View Pre-check Reports** to view the patching prechecks report. If there are no errors in the report, then click **Apply Patch** to begin the job to patch the storage components. Click **View Jobs** for the job status.

For high-availability environment, you can select the **Rolling** check box to perform rolling patching of storage components.

All patching-related information is logged in the `dcs-agent` log file at `/opt/oracle/dcs/log/dcs-agent.log`.

Patching Oracle Database Appliance DB Systems Using the Browser User Interface

Upload the Oracle Database Appliance Server Patch to the patch repository, deploy the patch bundle using the Browser User Interface, and then update the DCS agent and components using CLI commands.

Updating the Patch Repository Using the Browser User Interface

1. Download the Oracle Database Appliance patches from My Oracle Support and save them in a directory on the appliance. See the *Oracle Database Appliance Release Notes* for a list of available patches and links to download the patches.
2. Log into the Browser User Interface within the bare metal system, with the `oda-admin` user name and password.

```
https://Node0-host-ip-address:7093/mgmt/index.html
```

3. Click the **Appliance** tab, and then click **Infrastructure Patching** on the lefthand pane.
4. In the **Update Repository** tab, on the Update Patch Repository page, enter the absolute file path and patch name, then click **Update Repository** to start the update repository job. You can list more than one file to update to the repository with a comma separated list, without spaces, or you can update each file, one at a time.
5. Click **Activity** to monitor the progress. When the job completes successfully, the Patch Repository is updated.

Updating the DCS Admin, DCS Components, and DCS Agent After Updating the Repository and Before Patching

Before patching your DB system using the Browser User Interface, you must update the DCS admin, DCS agent, and DCS components manually, through CLI commands.

Follow these steps:

1. In the BUI, click **Appliance** and then click **Infrastructure Patching** on the lefthand pane.
2. Using ODA CLI, update the DCS admin, DCS components, and DCS agent:

```
[root@oda1 opt]# /opt/oracle/dcs/bin/odacli update-dcsadmin -v 19.26.0.0.0
[root@oda1 opt]# /opt/oracle/dcs/bin/odacli update-dcscomponents -v
19.26.0.0.0
[root@oda1 opt]# /opt/oracle/dcs/bin/odacli update-dcsagent -v 19.26.0.0.0
```

If the DCS components are updated, then the message `"status" : "Success"` is displayed on the command line. For failed updates, fix the error and then proceed with the update.

 **Note:**

You must log into the Browser User Interface again after running the `odacli update-dcscomponents` command.

Running Patching Prechecks and Patching Server and Storage Components Using the Browser User Interface

1. Do not have any jobs running or pending during the update window.
2. Log into the Browser User Interface within the DB system with the `oda-admin` user name and password.

```
https://Node0-host-ip-address:7093/mgmt/index.html
```

3. Click the **Appliance** tab, and then click **Infrastructure Patching** on the lefthand pane.
4. In the SERVER section, view the Component Details. If you just updated the Patch Repository, click **Refresh**.

After the patch is uploaded to the Patch Repository, the Component Details on the page are updated with the Installed Version and Available Version for each component.

5. Click **Precheck** to run patching prechecks. You must run the patching prechecks before updating the server and other components. Click **View Pre-check Reports** to view the patching prechecks report. If there are no errors in the report, then click **Apply Patch** to begin the job to patch the server components. For high-availability systems, when updating the server on the bare metal system, you can select the **Node to Update**. You can choose the node that you want to update or you can choose to update both nodes.

When the job finishes, go to the next step. Click **View Jobs** for the job status.

6. In the STORAGE section, click **Refresh** to refresh the Component Details. Click **Precheck** to run patching prechecks. You must run the patching prechecks before updating the storage components. Click **View Pre-check Reports** to view the patching prechecks report. If there are no errors in the report, then click **Apply Patch** to begin the job to patch the storage components. Click **View Jobs** for the job status.

For high-availability environment, you can select the **Rolling** check box to perform rolling patching of storage components.

7. Click **Activity** to monitor the progress, and verify that the job completes successfully.

Updating Oracle Database Appliance Repository with Database Clone Files For Bare Metal Systems

Follow these steps to update the Oracle Database Appliance repository with Oracle Database clone files for the latest release using CLI commands.

To create new databases of a specific release version, you must update the Oracle Database Appliance repository with the Oracle Database clone files for a release. Follow these steps to update the repository with Oracle Database clone files for the latest release.

1. Download the Oracle Database clone software file for a release, for example, `p30403662_1926000_Linux-x86-64.zip`, and extract the Oracle Database clone software:

For example, download the Oracle Database clone software patch for 19.26:

```
unzip /tmp/p30403662_1926000_Linux-x86-64.zip
odacli-dcs-19.26.0.0.0-date-DB-19.26.0.0.zip
```

2. Copy all the software files from the external client to Oracle Database Appliance. For High-Availability deployments, copy the software files to only one node. The software files are copied to the other node during the patching process. Use the `scp` or `sftp` protocol to copy the bundle.

Example using `scp` command:

```
# scp software_file root@oda_host:/tmp
```

Example using `sftp` command:

```
# sftp root@oda_host
```

Enter the `root` password, and copy the files.

```
put software_file
```

3. Update the repository with latest release database software:

```
[root@oda1 opt]# /opt/oracle/dcs/bin/odacli update-repository -f /tmp/
odacli-dcs-db-clone-file.zip/
```

For example, for 19.26:

```
[root@oda1 opt]# /opt/oracle/dcs/bin/odacli update-repository -f /tmp/
odacli-dcs-19.26.0.0.0-date-DB-19.26.0.0.zip
```

Follow the same steps to update the repository with the database clone software for other supported database versions.

4. Confirm that the repository update is successful:

```
[root@oda1 opt]# /opt/oracle/dcs/bin/odacli list-jobs
[root@oda1 opt]# /opt/oracle/dcs/bin/odacli describe-job -i job_ID
```

5. Delete the software zip files from the temporary location on the appliance to save space:

```
[root@oda1 opt]# rm software_file
rm: remove regular file software_file? y
```

Patching Databases Using ODACLI Commands or the BUI

Use ODACLI commands or the Browser User Interface to patch databases to the latest release in your deployment.

Before patching the database home, upload the Oracle Database clone files for the database version, to the repository. See *Updating Oracle Database Appliance Repository with Database*

Clone Files Using the CLI for the procedure to update the repository with the latest Oracle Database clone files.

! Important:

You must run the `odacli create-prepatchreport` command before you patch the Oracle databases; otherwise, the `odacli update-database` command fails with an error message prompting you to run the patching pre-checks.

Patching Databases on Oracle Database Appliance using ODACLI Commands

Run the following command to patch a database using the CLI:

```
odacli update-database [-a] [-dp] [-f] [-i db_id] [-imp] [-l] [-n db_name] [-ni node] [-r] [-to db_home_id] [-j] [-h]
```

For more information about the options for the `update-database` command, see the chapter *Oracle Database Appliance Command-Line Interface*.

Patching Databases on Oracle Database Appliance using BUI

1. Log into the Browser User Interface with the `oda-admin` user name and password.

```
https://Node0-host-ip-address:7093/mgmt/index.html
```

2. Navigate to the **Database** tab.
3. Select the database you want to patch.
4. Click **Update**.
5. If you select **Apply Data Patch**, then the Data Patch for the specified database is applied and you cannot select any other options.
6. On a high-availability system, you can also select the node in the **Select Node to Update** list.
7. Select **Ignore Missing Patches** to ignore missing patches.
8. Select **Force Run** to force the operation to run.
9. Select the destination database home.
10. In the **Patching Options**
 - **Abort**: To abort previously unfinished or failed patching operation.
 - **Revert**: To revert previously unfinished or failed patching operation.
 - **None**: To patch the database.
11. Click **Update**.
12. If you have not run the pre-checks earlier, then an error is displayed when you submit the job to update the database.
13. In the Database page, select the Database and then click **Precheck** to run pre-checks for patching the database.
Click **Activity** for job status.

14. In the Database page, for the database to be patched, click **Actions** and select **View Pre-patch reports** to view the pre-check report. Fix any errors, and then select Action as **Apply** to patch the database.
15. Verify that the patching job completes successfully.

Patching Existing Database Homes Using ODA CLI or the BUI

Use ODA CLI or BUI to patch database homes in your deployment to the latest release.

Before patching the database, upload the Oracle Database clone files for the database version, to the repository. See *Updating Oracle Database Appliance Repository with Database Clone Files Using the CLI* for the procedure to update the repository with the latest Oracle Database clone files.

Patching Database Homes on Oracle Database Appliance using ODA CLI Commands

Run the following command to patch a database home using the CLI:

```
odacli update-dbhome -i dbhome_id -v version [-f] [-imp] [-p] [-l] [-u
node_number] [-j] [-h]
```

For more information about the options for the `update-dbhome` command, see the chapter *Oracle Database Appliance Command-Line Interface*.

Patching Database Homes on Oracle Database Appliance using BUI

1. Log into the Browser User Interface with the `oda-admin` user name and password.

```
https://Node0-host-ip-address:7093/mgmt/index.html
```

2. Navigate to the **Database Home** tab.
3. Select the database home you want to patch.
4. Select the **Patch Version** for the database home.
5. To patch multiple database homes, select each database home to be patched and the patch version for each database home.
6. Select the **Node to Update**. You can choose the node that you want to update or you can choose to update all nodes.
7. Click **Patch**. Select **Precheck** to run pre-checks before patching the database. Click **Activity** for job status.
8. On the Patch page, for the database to be patched, click **Actions** and select **View Pre-patch reports** to view the pre-check report. Fix any errors, and then select Action as **Apply** to patch the database.
9. Select **Ignore Precheck Failures** to ignore failures reported in the prechecks reported. It is recommended that you fix errors reported in the precheck results.
10. Select **Ignore Missing Patches** to ignore missing patches.
11. Verify that the patching job completes successfully.

Related Topics

- [Patching Oracle Database Appliance Bare Metal Systems Using the Command-Line](#)
Follow these steps to apply patches to your Oracle Database Appliance bare metal deployment and existing Oracle Database homes, using CLI commands.

Related Topics

- [Oracle Database Appliance Release Notes](#)

Patching Non-Provisioned Oracle Database Appliance Systems

Oracle Database Appliance supports patching of non-provisioned single-node or high availability systems by running `odacli update-server` command.

A non-provisioned Oracle Database Appliance system does not have Oracle Grid Infrastructure or Oracle Database installed or running on it. You can upgrade Oracle ILOM and storage firmware on an unprovisioned system without running the `odacli create-appliance` command by reimaging the system using the bare metal ISO image of Oracle Database release 19.22 or later. Then patch the system with the server patches of the same release as the bare metal ISO image by running the `odacli update-server` command. When you reimage your system, the DCS infrastructure is updated automatically.

Follow these steps to update the firmware:

1. Reimage the Oracle Database Appliance using the bare metal ISO image for Oracle Database Appliance release 19.22 or later.
2. Update the repository with the server patch for the Oracle Database Appliance release you want to patch to, for example 19.22 or later.
3. For running `odacli update-server` on Oracle Database Appliance imaged with ISO of release 19.22:

```
odacli update-server -v 19.22.0.0.0 -sko -f
```

For Oracle Database Appliance release 19.22, you can use the `-sko` option to skip ORAchk failures and proceed with the server patching, and the `-f` option to override precheck failures and complete the server patching.

4. For running `odacli update-server` on Oracle Database Appliance imaged with ISO of release 19.11 or later, follow these steps:
 - a. Create the pre-patch report for the `odacli update-server` command by specifying the `-s` option.

```
odacli create-prepatchreport -v 19.11.0.0.0 -s
```

Fix the warnings and errors mentioned in the report and proceed with the server patching.

- b. Update the server:

```
odacli update-server -v 19.11.0.0.0 -f
```

For Oracle Database Appliance release 19.11 or later, you can use the `-f` option to override precheck failures and complete the server patching.

Applying Additional Patches and Updates on Bare Metal Systems

Configure additional patch repositories and patch your operating system and databases to ensure that your deployment has the latest updates and security fixes.

- [Enabling Kernel Updates](#)
Oracle Ksplice enables you to update your systems with the latest kernel security and bug fix updates.
- [Applying Out-of-Cycle Database Patches](#)
The out-of-cycle patching feature enables administrators to patch databases in the Oracle Database Appliance deployment with the latest Oracle Database Release Update, outside of the Oracle Database Appliance releases.

Enabling Kernel Updates

Oracle Ksplice enables you to update your systems with the latest kernel security and bug fix updates.

You can download and install the latest Oracle Ksplice updates (uptrack-updates) with either the local ULN repository or ULN channel.

Follow these steps to install Oracle Ksplice:

1. Register your server with Unbreakable Linux Network (ULN). By default, you are registered for the Oracle Linux Latest channel for your operating system and hardware.
2. Log in to Unbreakable Linux Network:
<https://www.oracle.com/in/linux/>
3. Ensure that you have access to the Internet on the server where you want to use Ksplice. For example, if you are using a proxy server, then set the proxy server and port values in the shell with commands similar to the following:

```
# export http_proxy=http://proxy.company.com:port  
# export https_proxy=http://proxy.company.com:port
```

4. Register the server:

```
# uln_register
```

5. Set up the local repository as described in the Oracle Ksplice user documentation. This enables you to download the latest Ksplice update packages at regular intervals without requiring a direct connection to the Oracle Utrack server or to ULN.
6. To update a system to a specific effective kernel version, install the `uptrack-updates` package for the current kernel.

```
yum -y install uptrack-updates-'uname -r'
```

You can also download the `uptrack-updates` RPM from the Ksplice channel and install the RPM manually. For example:

```
# rpm -Uvh uptrack-  
updates-4.14.35-1902.11.3.1.e17uek.x86_64-20200325-0.noarch.rpm
```

 **See Also:**

Oracle Linux Ksplice User's Guide for information about configuring Oracle Ksplice at:
<https://docs.oracle.com/en/operating-systems/oracle-linux/>

Applying Out-of-Cycle Database Patches

The out-of-cycle patching feature enables administrators to patch databases in the Oracle Database Appliance deployment with the latest Oracle Database Release Update, outside of the Oracle Database Appliance releases.

You can apply Oracle Database Release Update (RU) patches manually using OPatch. Refer to the relevant section in this topic to run the OPatch for your database version.

 **Note:**

The OPatch commands and procedures described in this topic are examples, and may need modifications based on a specific Oracle Database Release Update (RU). Always refer to the Readme of the Oracle Database Release Update (RU) for additional commands and steps.

 **Note:**

It is strongly recommended that you patch your deployment through the Oracle Database Appliance releases, whenever possible.

 **Note:**

You can apply out-of-cycle patches to baremetal and DB system deployments using this procedure.

Using OPatchauto to Manually Patch Oracle Database Release 12c and Later

1. Confirm that the `dc-agent` and other components are updated to the latest release.

```
# odacli describe-component  
# odacli list-dbhomes
```

2. Update OPatch to the latest version, if available:

- a. Download the latest OPatch version from My Oracle Support.
- b. Copy the files to the local host and extract them to the `ORACLE_HOME/OPatch` directory.
- c. Update the OPatch tool as oracle user.

```
/bin/rm -rf $ORACLE_HOME/OPatch/
su - oracle -c /usr/bin/unzip -q -o OPatch_zip_location/
p6880880_122010_Linux-x86-64.zip -d $ORACLE_HOME
```

3. Download the latest database patches from My Oracle Support and copy the files to the local host.

```
scp patchfilename root@hostname:directory
```

4. Unzip patches to an empty directory, for example, `/tmp/patchesDir` as oracle user. This creates sub directories under `/tmp/patchesDir` with bug numbers. If the patch you are applying is a Release Update (RU), then the patch directory has multiple sub-directories.

```
/usr/bin/unzip -o location_of_patches/p29301631_180000_Linux-x86-64.zip -
d /tmp/patchesDir
```

5. For Oracle Database Appliance High-Availability deployments, set up SSH Keys for secure connection.
6. Analyze the patches.

```
$ORACLE_HOME/OPatch/patchauto apply directory_with_patches_extracted -
analyze -oh $ORACLE_HOME -log /tmp/patchAutoAnalyzePatch.log
```

7. As root user, apply the patches.

```
$ORACLE_HOME/OPatch/patchauto apply directory_to_extract_patches -
oh $ORACLE_HOME -inplace
```

8. When patching is completed on both nodes, run `utlpr.sql` and `catcon.pl` scripts to recompile invalid objects in the database.
9. Update the registry to ensure that system component values are registered.

```
# odacli update-registry -n dbhome -f
```

Cleaning Up the Patch Repository

Use the Browser User Interface or Command Line Interface to delete obsolete or old patches from the repository.

About Cleaning Up the Patch Repository

After patching Oracle Database Appliance with the latest patches, old unused clone files may remain and consume space in the repository. Cleanup repository deletes the unused clone/patch files to reclaim space. You can clean up the repository using the Browser User Interface or ODACLI commands.

Cleaning Up the Patch Repository Using ODACLI command

```
# odacli cleanup-patchrepo [-cl clones] | [-v version [-comp component]] | [-l local|-n NodeID]
```

Specify the clone file names and the node from which you want to delete the old patches.

For details about the command options, see the chapter *Oracle Database Appliance Command-Line Interface*.

Cleaning Up the Patch Repository Using the Browser User Interface

Follow these steps to clean up the patch repository:

1. In the Browser User Interface, click **Patch Manager**.
2. Click the **Cleanup Repository** tab, and then click **Refresh** to list the available patches in the repository.
3. Select the Components, such as old Oracle Grid Infrastructure or Oracle Database clone files that you want to clean up from the repository, and the Patch Version, for example, an older release of Oracle Database Appliance.
4. Click **Cleanup Clone Files** to clean up clone files for selected components from the repository at `/opt/oracle/oak/pkgrepos/orapkg/ clones/`.
5. Click **Cleanup Repository** to submit the cleanup repository job.
6. Click **Activity** to monitor the progress. When the job completes successfully, the Patch Repository is updated.

Related Topics

- [odacli cleanup-patchrepo](#)
Use the `odacli cleanup-patchrepo` command to delete obsolete or old patches from the repository.

About Upgrading to a Different Database Home

Understand how to upgrade to a different database home using either the Browser User Interface or `odacli` commands.

Prerequisites for Upgrading Database Homes

You can upgrade database homes of the following releases:

- Oracle Database 12.2 to 19c
- Oracle Database 12.1 to 19c

Before upgrading to a different database home, upload the Oracle Database clone files for the database version, to the repository, and then create the database home. See *Patching Oracle Database Appliance Using the CLI* for the procedure to update the repository with the latest Oracle Database clone files.

About Upgrading Database Homes Using the Browser User Interface

Follow these steps to upgrade to a different database home using the Browser User Interface.

1. Log into the Browser User Interface with the `oda-admin` user name and password.

```
https://Node0-host-ip-address:7093/mgmt/index.html
```

2. Click the **Database** tab, and then select a database, click **Actions**, and then click **Upgrade**.
3. Verify that the database upgrade job completes successfully.

About Upgrading Database Homes Using the Command-Line Interface

Run the following command to upgrade to a different database home using the CLI:

```
odacli upgrade-database -i Comma separated list of database ids -from source  
dbhome id -to destination dbhome id [-j] [-h]
```

For more information about the options for the `upgrade-database` command, see the chapter *Oracle Database Appliance Command-Line Interface*.

Setting Dynamic Default Parameters

You can set dynamic default parameters using the BUI.

Setting Dynamic Default Parameters Using the Browser User Interface

Follow these steps:

1. From the Appliance page, click **Parameter Repository**.
2. The Parameter Repository page lists all the parameters in the repository. Currently, parameters of type RDBMS are supported.
3. Select **Update Parameter** to create a new configuration property.
4. In the Update Parameter page, specify the **Parameter Name** and **Value**, and provide an optional **Description**. Specify whether you want to create the parameter for the **Bare Metal** or **DB System**. You can also specify the whether the parameter applies to **All DB Systems** or you can select the DB system for which you want to create the parameter.
5. Click **OK**.
6. Confirm the action to submit the job. Monitor the job progress and check that it completes successfully.
7. To update a parameter, select the **Update** option from the **Actions** menu.
8. You can edit the Value, Description, and select whether the parameter applies to **Bare Metal** or **DB System**. You can also select the DB system for which you want to update the parameter or choose to apply the parameter to **All DB Systems**.
9. Click **Update**.
10. To delete a parameter, select the **Delete** option from the **Actions** menu. You can delete the parameter from the **Bare Metal** or **DB System**. You can also select the DB system for which you want to delete the parameter or choose to delete the parameter from **All DB Systems**.
11. Click **Delete**.

9

Managing Oracle Databases

Manage the Oracle Databases on your Oracle Database Appliance.

- [About Administrative Groups and Users on Oracle Database Appliance](#)
Oracle Database Appliance Browser User Interface deployment creates operating system groups and users whose members are granted system administration privileges on the appliance.
- [About Data Migration Options for Oracle Database Appliance](#)
Oracle Database Appliance supports the use of standard Oracle Database loading and migration tools.
- [About Creating Database Homes on Oracle ACFS Storage](#)
When you create new Oracle Database homes, they are created on Oracle ACFS file system which are stored on Oracle Database Appliance storage disks. You can create new Oracle Database homes using the `odacli create-database` or `odacli create-dbhome` commands, or when you patch an existing database home.
- [About Standard Edition High Availability for Oracle Database Appliance](#)
Oracle Database Appliance supports Standard Edition High Availability solution with Oracle Grid Infrastructure that provides cluster-based failover for Oracle Database 19c Standard Edition.
- [About Enterprise Edition High Availability for Oracle Database Appliance](#)
Oracle Database Appliance supports Enterprise Edition High Availability solution with Oracle Grid Infrastructure that provides cluster-based failover for Oracle Database Enterprise Edition.
- [About Transparent Database Encryption \(TDE\) in Oracle Database Appliance](#)
Transparent Data Encryption (TDE) enables you to encrypt sensitive data that you store in tables and tablespaces.
- [Storing Transparent Database Encryption Keys on Oracle Key Vault Server](#)
Understand how you can create Transparent Database Encryption (TDE) enabled databases on Oracle Database Appliance and store the TDE keys on Oracle Key Vault server.
- [Working with Databases](#)
Use the Browser User Interface to display a list of databases, database details, and create and delete databases. You can use CLI commands to manage your databases.
- [Working with Database Homes](#)
Use the Browser User Interface to display a list of database homes, details, and create and delete database homes.
- [Migrating Databases](#)
Review these topics to learn how to prepare for and migrate an entire database to your Oracle Database Appliance.
- [About Registering a TDE-Enabled Database](#)
Understand the process to register Transparent Data Encryption (TDE) enabled databases.
- [About Managing Multiple Database Instances Using Instance Caging](#)
Use instance caging to manage your system resources on Oracle Database Appliance.

- [Oracle EM Express and DB Console](#)
You can use Oracle Enterprise Manager Database Express (EM Express), or the Database Control Console (DB Console) to manage your database.

About Administrative Groups and Users on Oracle Database Appliance

Oracle Database Appliance Browser User Interface deployment creates operating system groups and users whose members are granted system administration privileges on the appliance.

During configuration, two administrative accounts are created for Oracle Database Appliance: the user `grid`, with a user ID (UID) of 1001, and the user `oracle`, with a UID of 1000. The user `grid` is the Oracle Grid Infrastructure installation owner. The user `oracle` is the Oracle Database installation owner, and the owner of all Oracle Database homes (Oracle homes). By default, these users are members of operating system groups whose members are granted privileges to start up and administer Oracle Database and Oracle Automatic Storage Management.

The following table describes the Oracle system privileges groups, and information about the operating system authentication groups:

Table 9-1 Operating System Groups and Users on Oracle Database Appliance

| Oracle System Privileges | Group Name | Group ID (GID) | <i>grid</i> is a member | <i>oracle</i> is a member |
|-----------------------------------|-----------------------|----------------|-------------------------|---------------------------|
| Oracle Inventory group (OINSTALL) | <code>oinstall</code> | 1001 | yes (primary group) | yes (primary group) |
| OSOPER for dbaoper group | <code>dbaoper</code> | 1002 | yes | yes |
| OSDBA group | <code>dba</code> | 1003 | no | yes |
| OSASM group for Oracle ASM | <code>asmadmin</code> | 1004 | yes | no |
| OSOPER for ASM group | <code>asmoper</code> | 1005 | yes | no |
| OSDBA for ASM group | <code>asmdba</code> | 1006 | yes | yes |

To change the Group Name and GID from the default values on Oracle Database Appliance bare metal platforms, change the default values from the Browser User Interface during the deployment. If you create an initial database during deployment, then the password for the SYS and SYSTEM users is the password that you set in the Browser User Interface.

To change the Group Name and GID from the default values on the Oracle Database Appliance Virtualized Platform, use the `-advance` parameter with the command `oakcli deploy`. If you create an initial database during deployment, then the password for the SYS and SYSTEM users is the ROOT password from the Configurator.

 **Note:**

Change the password for both users as soon as possible after configuration to prevent unauthorized access to your database using these privileged accounts.

About Data Migration Options for Oracle Database Appliance

Oracle Database Appliance supports the use of standard Oracle Database loading and migration tools.

If you are loading data or migrating data from an existing database to Oracle Database Appliance, then you can use the standard Oracle Database loading and migration tools. These tools include the following:

- Oracle GoldenGate
- SQL*Loader
- Oracle Data Pump
- transportable tablespaces
- RMAN

You can also use the RMAN utility to back up and recover databases on Oracle Database Appliance.

About Creating Database Homes on Oracle ACFS Storage

When you create new Oracle Database homes, they are created on Oracle ACFS file system which are stored on Oracle Database Appliance storage disks. You can create new Oracle Database homes using the `odacli create-database` or `odacli create-dbhome` commands, or when you patch an existing database home.

Oracle Database homes are created on an Oracle ACFS-managed file system. For a database user `oracle`, the new database homes are created under `/u01/app/odaorahome/oracle/`.

The mount `/u01/app/odaorahome` is a shared file system for a high-availability system. On a high-availability system, `/u01/app/odaorahome/` is a shared `ORACLE_HOME` between the nodes. Existing database homes continue to remain on the local disks.

The `ORACLE_BASE` location has also changed to an Oracle ACFS-based file system. On high-availability system, the `ORACLE_BASE` is not shared between the nodes. Each node has its own Oracle ACFS file system for `ORACLE_BASE`. The new `ORACLE_BASE` for the database homes are created under the mount `/u01/app/odaorabase/`.

The disk space for the Oracle ACFS file system is located in the `DATA` or `RECO` disk group. You must specify the disk group for the Oracle ACFS file system. For Oracle Database Appliance X8-2 hardware model and single-node systems, the Oracle ACFS file system must be located in the `DATA` disk group. You can specify the initial size of the `ORACLE_HOME` volume. The default value is 80 GB. You can set a value from 25 GB to 1024 GB. The initial volume size for `ORACLE_BASE` is fixed at 10GB. Note that for these volumes, `AUTOEXTEND` is off. You can extend the volume size with the `odacli modify-dbhome-storage` command.

Changes When Provisioning Oracle Database Appliance Release 19.26

As part of the provisioning request, you must specify the disk group and size of the volume in the `json` file in the `sysOraHomeStorage` section.

```
"sysOraHomeStorage" : {  
  "diskgroup" : "DATA",
```



```
"volumeSize" : "80"  
},
```

If you do not specify the values in the json file, then the following error is displayed during provisioning:

```
DCS-10045:Validation error encountered: Missing argument : sysOraHomeStorage
```

If the values are invalid, then the following errors may be displayed during provisioning:

```
DCS-10024:Input parameter 'Disk Group' contains unacceptable value 'DATAL'.  
Allowed values are '[DATA, RECO]'. (case insensitive)  
DCS-10045:Validation error encountered: Required volumeSize value in  
sysOraHomeStorage should be in the range of 25GB to 1024GB.
```

Changes When Patching to Oracle Database Appliance Release 19.26

If you have patched your appliance from Oracle Database Appliance release 19.6 or later to 19.26, then run the `odacli configure-dbhome-storage` command **before** creating a new database home. Otherwise, the following error is displayed when creating a new database home:

```
# odacli create-dbhome -v 19.8.0.0.200714  
DCS-10601:The system is not set up to create database homes on ACFS.
```

Once the disk group for the volumes are setup, new database homes are created on the Oracle ACFS file system.

Related Topics

- [odacli configure-dbhome-storage](#)
Use the `odacli configure-dbhome-storage` command to configure the database home storage.
- [odacli list-dbhome-storages](#)
Use the `odacli list-dbhome-storages` command to view the database home storage resources after the volumes for ORACLE_HOME and ORACLE_BASE are created.
- [odacli describe-dbhome-storage](#)
Use the `odacli describe-dbhome-storage` command to view information such as how much space is available (at a volume or diskgroup level).
- [odacli modify-dbhome-storage](#)
Use the `odacli modify-dbhome-storage` command to modify database home storage and add additional disk space.
- [Managing Database Homes on Oracle ACFS Storage](#)
Use the Oracle Appliance Manager Browser User Interface or ODACLI commands to manage database home storage in Oracle Database Appliance.

About Standard Edition High Availability for Oracle Database Appliance

Oracle Database Appliance supports Standard Edition High Availability solution with Oracle Grid Infrastructure that provides cluster-based failover for Oracle Database 19c Standard Edition.

About Standard Edition High Availability for Oracle Database 19c

With Standard Edition High Availability, when there is an instance or a node failure, the database automatically fails over to the other node, after attempting to restart on the local node. The database is restarted on the surviving node, thereby providing high availability for Oracle Standard Edition databases.

If your Oracle Database deployment contains Standard Edition 2 Oracle Real Application Cluster (Oracle RAC) databases of releases earlier than 19c, then they must be converted to a Standard Edition High Availability configuration as part of the upgrade to Oracle Database 19c.

For more details about this feature, refer to the Oracle Database Documentation Library at <https://docs.oracle.com/en/database/oracle/oracle-database/index.html>.

About Standard Edition High Availability for Oracle Database Appliance Release 19.26

Standard Edition High Availability for Oracle Database 19c is supported on Oracle Database Appliance for high availability deployments, that is, deployments that have two server nodes, shared storage, and server interconnects.

Oracle Database Appliance enables automatic configuration for failover at deployment time for Oracle Database 19c Standard Edition single-instance databases. Both nodes have Oracle Homes for Standard Edition single-instance databases.

Single-instance Oracle Database 19c Standard Edition databases created using the ODA CLI commands or the Browser User Interface (BUI) have Standard Edition High Availability enabled by default. You can also choose to disable the High Availability option. To enable Standard Edition High Availability for existing Standard Edition Oracle RAC databases of releases earlier than 19c, you must convert these Oracle RAC or Oracle One Node databases to single-instance databases, and then upgrade to single-instance Oracle Database 19c Standard Edition database with Standard Edition High Availability enabled by default.

About Provisioning, Upgrading, and Relocating Standard Edition High Availability Oracle Database

To create a single-instance Oracle Database 19c with Standard Edition High Availability, use the following command:

```
odacli create-database -u db_unique_name -n db_name -dh db_home -y SI -g target_node
```

To upgrade a Standard Edition Oracle RAC Database to Oracle Database 19c Standard Edition, convert the Oracle RAC Database to a single-instance Oracle Database:

```
odacli modify-database -in db_name -y single-instance
```

Then, upgrade the single-instance database to Oracle Database 19c with Standard Edition High Availability as follows:

```
odacli upgrade-database -i db_id -to destination_dbhome -ha
```

To relocate a Standard Edition High Availability Oracle Database from one node to another outside of a failover, use the following command, specifying either the target node or the target host in the command:

```
odacli modify-database -in db_name -g target_node
```

or:

```
odacli modify-database -in db_name -th target_host
```

For detailed information about these ODA CLI command options, see the *Oracle Database Appliance Command Line Reference* chapter in this guide.

Related Topics

- [Oracle Database Appliance Command-Line Interface](#)
The command-line interface has different classes of tools to manage Oracle Database Appliance.

About Enterprise Edition High Availability for Oracle Database Appliance

Oracle Database Appliance supports Enterprise Edition High Availability solution with Oracle Grid Infrastructure that provides cluster-based failover for Oracle Database Enterprise Edition.

About Enterprise Edition High Availability for Oracle Database

With Enterprise Edition High Availability, when there is an instance or a node failure, the database automatically fails over to the other node, after attempting to restart on the local node. The database is restarted on the surviving node, thereby providing high availability for Oracle Enterprise Edition databases.

For more details about this feature, refer to the Oracle Database Documentation Library at <https://docs.oracle.com/en/database/oracle/oracle-database/index.html>.

About Enterprise Edition High Availability for Oracle Database Appliance Release 19.26

Enterprise Edition High Availability for Oracle Database 19.26 is supported on Oracle Database Appliance for high availability deployments, that is, deployments that have two server nodes, shared storage, and server interconnects.

Oracle Database Appliance enables automatic configuration for failover at deployment time for Oracle Database 19.26 Enterprise Edition single-instance databases. Both nodes have Oracle Homes for Enterprise Edition single-instance databases.

To enable Enterprise Edition High Availability for existing Enterprise Edition Oracle RAC databases of release 19.26, you must convert these Oracle RAC databases to single-instance databases, and then upgrade to single-instance Oracle Database 19.26 Enterprise Edition database with Enterprise Edition High Availability enabled by default.

About Provisioning, Upgrading, and Relocating Enterprise Edition High Availability Oracle Database

To create a single-instance Oracle Database 19.26 with Enterprise Edition High Availability, use the following command:

```
odacli create-database -u db_unique_name -n db_name -dh db_home -y SI -g target_node -ha
```

To upgrade an Enterprise Edition Oracle RAC Database to Oracle Database 19.26 Enterprise Edition, convert the Oracle RAC Database to a single-instance Oracle Database:

```
odacli modify-database -in db_name -y single-instance
```

Then, upgrade the single-instance database to Oracle Database 19.26 with Enterprise Edition High Availability as follows:

```
odacli upgrade-database -i db_id -to destination_dbhome -ha
```

To relocate an Enterprise Edition High Availability Oracle Database from one node to another outside of a failover, use the following command, specifying either the target node or the target host in the command:

```
odacli modify-database -in db_name -g target_node
```

or:

```
odacli modify-database -in db_name -th target_host
```

For detailed information about these ODA CLI command options, see the *Oracle Database Appliance Command Line Reference* chapter in this guide.

Related Topics

- [Oracle Database Appliance Command-Line Interface](#)
The command-line interface has different classes of tools to manage Oracle Database Appliance.

About Transparent Database Encryption (TDE) in Oracle Database Appliance

Transparent Data Encryption (TDE) enables you to encrypt sensitive data that you store in tables and tablespaces.

After the data is encrypted, this data is transparently decrypted for authorized users or applications when they access this data. TDE helps protect data stored on media (also called data at rest) in the event that the storage media or data file is stolen.

Oracle Database uses authentication, authorization, and auditing mechanisms to secure data in the database, but not in the operating system data files where data is stored. To protect these data files, Oracle Database provides Transparent Data Encryption (TDE).

TDE encrypts sensitive data stored in data files. To prevent unauthorized decryption, TDE stores the encryption keys in a security module external to the database, called a keystore.

Oracle Database Appliance enables creation and lifecycle management of TDE-enabled databases with ODA CLI commands or through the BUI. You can create TDE-enabled single-instance, Oracle RAC or Oracle RAC One Node databases with ODA CLI commands or BUI. You can also change TDE passwords and re-key the database using ODA CLI commands or BUI. When you use software keystore, you can also backup the TDE wallets along with the database. You can also recover the TDE software wallet and restore the database as a new copy with the `odacli irestore-database` command.

Based on the keystore used, TDE on Oracle Database Appliance can be configured as any of the following types:

- **TDE keys stored in software keystore:** In this type of TDE method, the TDE keys are stored in a wallet on Oracle Database Appliance.
- **TDE keys stored in a wallet on Oracle Key Vault:** In this type of TDE method, the TDE keys are stored in a wallet on Oracle Key Vault. Note that if you do not want to provide the credentials of users in Oracle Key Vault, you can use endpoints already created on Oracle Key Vault, and directly specify the endpoints when you create or restore the database on Oracle Database Appliance. Otherwise, you can create Oracle Key Vault server configuration on Oracle Database Appliance with the Oracle Key Vault user details and use these user credentials to create and restore the database on Oracle Database Appliance. You can configure TDE keys with Oracle Key Vault keystore in one of the following ways:
 - **Using credentials of a user in Oracle Key Vault:** In this configuration, the TDE keys are stored in a wallet on Oracle Key Vault and accessed through Oracle Key Vault user credentials.
 - **Using endpoints and wallet already created on Oracle Key Vault:** In this configuration, the TDE keys are stored in a wallet on Oracle Key Vault and accessed through Oracle Key Vault end points.

 **Note:**

To enable Transparent Data Encryption (TDE), you must deploy Oracle Database Enterprise Edition with Oracle Database 19c or later. Transparent Data Encryption (TDE) is an Advanced Security Option (ASO) available with Oracle Database Enterprise Edition.

 **See Also:**

[Using Transparent Data Encryption](#) in the *Oracle Database Advanced Security Guide*

▲ Caution:

When you enable TDE on databases, either with software keystore or with Oracle Key Vault keystore using endpoints and wallet already created on Oracle Key Vault, you are prompted to set a password for the TDE wallet. Provide a strong password for security compliance. Set the password carefully, and ensure that this password is available to you at all times for database management operations. Failure to provide the TDE wallet password when prompted, results in not being able to access the database tables.

Storing Transparent Database Encryption Keys on Oracle Key Vault Server

Understand how you can create Transparent Database Encryption (TDE) enabled databases on Oracle Database Appliance and store the TDE keys on Oracle Key Vault server.

- [About Oracle Key Vault](#)
Oracle Key Vault is a fault-tolerant, highly available, and scalable, secure and standards-compliant key and secrets management appliance, where you can store, manage, and share your security objects.
- [Creating TDE-Enabled Databases With User Credentials](#)
Understand how you can create TDE-enabled databases on Oracle Database Appliance using the credentials of a user in Oracle Key Vault. This method supports creation of TDE-enabled databases on bare metal and DB systems.
- [Creating TDE-Enabled Databases Using Oracle Key Vault With Endpoints in Oracle Key Vault](#)
Understand how you can create TDE-enabled databases on Oracle Database Appliance using endpoints and wallets already in Oracle Key Vault. This method supports creation of TDE-enabled databases on bare metal and DB systems.
- [Managing Oracle Key Vault Server Configuration Operations Using ODA CLI Commands](#)
Understand how you can manage Oracle Key Vault server configuration operations on Oracle Database Appliance on bare metal and DB systems.
- [Managing Database Operations on TDE-enabled Databases with TDE keys stored on Oracle Key Vault](#)
Understand how you can manage TDE-enabled databases with TDE keys stored on Oracle Key Vault on Oracle Database Appliance on bare metal and DB systems.
- [Creating an Oracle Key Vault User Using BUI](#)
Create a user with Oracle Key Vault server configuration entitlement on a multi-user access enabled Oracle Database Appliance.
- [Creating Oracle Key Vault Server Configuration Object Using the BUI](#)
Understand how you can create TDE-enabled database on Oracle Database Appliance with TDE keys stored in Oracle Key Vault on bare metal and DB systems using the BUI.
- [Granting and Revoking Access on Oracle Key Vault Server Configuration Using BUI](#)
Understand how you can grant and revoke access to Oracle Key Vault server configuration on Oracle Database Appliance on bare metal and DB systems using BUI.
- [Managing Oracle Key Vault Server Configuration Operations Using BUI](#)
Understand how you can manage Oracle Key Vault server configuration operations on Oracle Database Appliance on bare metal and DB systems.

- [Manual Migration and Encryption of Data into TDE-Enabled Database](#)
Understand how you can migrate transportable tablespaces to TDE-enabled database on Oracle Database Appliance.

About Oracle Key Vault

Oracle Key Vault is a fault-tolerant, highly available, and scalable, secure and standards-compliant key and secrets management appliance, where you can store, manage, and share your security objects.

For detailed information about Oracle Key Vault, see the Oracle Key Vault documentation at https://docs.oracle.com/en/database/oracle/key-vault/21.10/okvag/okv_intro.html#GUID-1C565FBE-BC21-4E76-B2A6-88A17F6649D7.

Terminology used when storing TDE keys on Oracle Key Vault for TDE-enabled databases on Oracle Database Appliance

Understand these concepts about using Oracle Key Vault server with databases on Oracle Database Appliance:

- **Role separation:** Oracle recommends that you assign different users for database administration and TDE key operations. You must not provide the user who has the database administration role with the credentials of the Oracle Key Vault server. This ensures the database user with data file access cannot open the database without knowing TDE wallet passwords. You can set up this role separation by enabling multi-user access feature on Oracle Database Appliance. For more information about configuring multi-user access, see the topic *Implementing Multi-User Access on Oracle Database Appliance*. On Oracle Database Appliance, the credentials of Oracle Key Vault user need not be shared with the ODA-DB user. The ODA-Administrator grants the resource, that is, the Oracle Key Vault server configuration, access to the intended DB user and the DB user can use the Oracle Key Vault server configuration when creating the TDE-enabled database to store the TDE keys on the Oracle Key Vault server.
- **Oracle Key Vault server configuration:** The term refers to an Oracle Database Appliance resource that stores the metadata of the Oracle Key Vault. The Oracle Key Vault server configuration has details such as the name of the user created to manage the TDE keys on the Oracle Key Vault server and the IP address or host name of the Oracle Key Vault server. The Oracle Key Vault server configuration on Oracle Database Appliance is identified by a name, to differentiate Oracle Key Vault server configurations. This name is unique within the Oracle Database Appliance system and the value is case-sensitive. When creating the Oracle Key Vault server configuration, you must provide the credentials of the user on Oracle Key Vault server. It is recommended that this user is a least privileged user with only `Create Endpoint` privilege. The user name and password you specify when you create the Oracle Key vault server configuration correspond to the user on the Oracle Key vault server. The password you provide during creation of this object is not stored on Oracle Database Appliance. The Oracle Key Vault client auto-login wallet is created using these credentials and all requests to the Oracle Key Vault server use this client auto-login wallet. The database automatically reads the auto-login wallet for the required ADMINISTER KEY MANAGEMENT SQL commands.
- **A user with ODA-DB role:** A user with ODA-DB role in a multi-user access-enabled or multi-user access-enabled passwordless environment can create and maintain the database. This user, is granted the ODA-DB role and is entitled to perform all database related operations such as creation, patching, modification, deletion, backup, and recovery. These operations are restricted to the database that belongs to the user. For more details, see the chapter *Implementing Multi-User Access on Oracle Database Appliance* in this guide.

- **Oracle Key Vault user:** The Oracle Key Vault user name and password that you provide when you create the Oracle Key Vault server configuration must correspond to an existing user and the password on the Oracle Key Vault server. Otherwise, there can be failures in accessing Oracle Key Vault. This user can also perform create, delete, describe, and list operations on the Oracle Key Vault server configuration objects that they create.
- **Virtual Wallet:** A virtual wallet, created on Oracle Key Vault, is a container for objects that must be stored securely. For TDE-enabled databases on Oracle Database Appliance that use Oracle Key Vault as the keystore, the TDE keys of the database are stored inside this virtual wallet.

Requirements for configuring TDE-enabled databases with keys stored in Oracle Key Vault

- The Oracle Key Vault server version must be 21.9.0 or later.
- It is recommended that you set up Network Time Protocol on Oracle Database Appliance. The database operations interacting with Oracle Key Vault fails if the clock on Oracle Database Appliance and Oracle Key Vault server are not synchronized. You must ensure that the time is consistent across the servers or use Network Time Protocol on Oracle Database Appliance.
- You cannot create a starter database with TDE configured using Oracle Key Vault when you provision Oracle Database Appliance on bare metal systems and select to create a starter database. This is because creation of TDE database that uses Oracle Key Vault to store TDE keys requires Oracle Key Vault server configuration to already exist. To create a database with TDE configured using Oracle Key Vault on DB system, first create a DB system without a starter database and then create the database with TDE configured using Oracle Key Vault as described in the topic *Creating TDE-Enabled Database on Oracle Database Appliance Using Oracle Key Vault*.
- For configuring TDE-enabled databases with keys stored in Oracle Key Vault with the credentials of a user in Oracle Key Vault, on multi-user access-enabled systems, you must create a new user with the `ODA-OKVCONFIGADMIN` role which has the entitlements `ODA-OKVCONFIGVIEWMGMT` and `ODA-OKVCONFIGMODIFYMGMT`. The `ODA-OKVCONFIGVIEWMGMT` entitlement enables you to perform operations such as Describe and List on the Oracle Key Vault server configuration object. The `ODA-OKVCONFIGMODIFYMGMT` entitlement enables you to perform operations such as Create and Delete on the Oracle Key Vault server configuration object. The `ODA-OKVCONFIGVIEWMGMT` entitlement is included in the `ODA-DB` role, and any DB user with the `ODA-DB` role can list and describe the Oracle Key Vault server configuration object and select the required Oracle Key Vault server configuration object to create the database. For non-multi user access-enabled systems, there is no need to create a new user.

Related Topics

- [Implementing Multi-User Access on Oracle Database Appliance](#)
Understand how multi-user access can be implemented on Oracle Database Appliance, its advantages and restrictions and the associated life cycle management changes for your appliance.
- [odacli Multi-User Access Commands](#)
Use `odacli` commands to enable multi-user access for the appliance.
- [ODACLI Command Changes with Multi-User Access on Oracle Database Appliance](#)
Understand the ODACLI command changes when you enable multi-user access.

Creating TDE-Enabled Databases With User Credentials

Understand how you can create TDE-enabled databases on Oracle Database Appliance using the credentials of a user in Oracle Key Vault. This method supports creation of TDE-enabled databases on bare metal and DB systems.

Follow these steps to create a TDE-enabled database with TDE keys stored on Oracle Key Vault on Oracle Database Appliance bare metal and DB systems:

Step 1: Create the user on Oracle Database Appliance corresponding to the user on Oracle Key Vault. This step applies to multi-user access-enabled systems only.

If the user with the `ODA-OKVCONFIGADMIN` role does not exist, or if you want to assign a different user for the database you are creating, then create the user.

1. Create a new user with the `ODA-OKVCONFIGADMIN` role. For example:

```
odacli create-user -u okvuser1 -r ODA-OKVCONFIGADMIN
```

The user is created and assigned a temporary password.

2. After the user is created successfully, the `okvuser1` can log into the appliance with the temporary password.
3. The `okvuser1` is in the `Inactive` state. If the appliance is configured with multi-user access enabled, then activate the user with the following command. Note that if the appliance is configured with passwordless multi-user access, then you do not need to activate the user. For more information about configuring multi-user access, the topic *Implementing Multi-User Access on Oracle Database Appliance*.

```
odacli activate-user
```

You are prompted to change the password. Enter the temporary password, the new password, and confirm the new password.

4. Use the new password to connect by SSH into the appliance and run ODACLI commands or connect to the Browser User Interface.

Step 2: Create an Oracle Key Vault server configuration

1. The Oracle Key Vault user that creates the Oracle Key Vault server configuration must be a user with the least privilege of `Create Endpoint` on the Oracle Key Vault server.
2. For multi-user access-enabled systems, log in as the user with the `ODA-OKVCONFIGADMIN` role, for example, the `okvuser1`. For non-multi user access enabled systems, log in as the `root` user.
3. The Oracle Key Vault password prompt displays twice, to accept and confirm the Oracle Key Vault password. Specify the password of the Oracle Key Vault user on the Oracle Key Vault server, which enables the user to log into the Oracle Key Vault server. Specify the user name with the `-u` option in the `odacli create-okvserverconfig` command. The name of the Oracle Key Vault server configuration is case-sensitive and no two Oracle Key

Vault server configurations can have same name on Oracle Database Appliance. The length of the Oracle Key Vault server configuration cannot exceed 128 characters.

```
odacli create-okvserverconfig -n okvobj1 -u epokvusrl -ip xxx.xx.xxx.xxx
Enter OKV user password :
Retype OKV user password :
Job details
```

```
-----
ID: 730d2469-6efa-4ed1-8386-513e97c866ea
Description: Create OKV Server Config: okvobj1
Status: Created
Created: October 20, 2024 11:28:39 AM PDT
Message: Create OKV Server Config.
```

```
Task Name                               Start
Time                                     End
Time                                     Status
-----
-----
-----
```

```
odacli describe-job -i 730d2469-6efa-4ed1-8386-513e97c866ea
```

Job details

```
-----
ID: 730d2469-6efa-4ed1-8386-513e97c866ea
Description: Create OKV Server Config: okvobj1
Status: Success
Created: October 20, 2024 11:28:39 AM PDT
Message: Create OKV Server Config.
```

```
Task Name                               Node Name                               Start
Time                                     End                                       Time
Time                                     Status
-----
-----
-----
OKV Password Store creation              n1                                       October
20, 2024 11:28:39 AM PDT                 October 20, 2024 11:29:04 AM PDT
Success
Download of OKV REST package             n1                                       October
20, 2024 11:28:42 AM PDT                 October 20, 2024 11:28:44 AM PDT
Success
Edit of OKV REST package                 n1                                       October
20, 2024 11:28:44 AM PDT                 October 20, 2024 11:28:45 AM PDT
Success
Generate OKV client wallets              n1                                       October
20, 2024 11:28:45 AM PDT                 October 20, 2024 11:28:47 AM PDT
Success
```

The command creates an Oracle Key Vault server configuration `okvobj1` for the Oracle Key Vault server user `epokvusrl` on the specified server.

Step 3: Share Oracle Key Vault server configuration for multi user access-enabled systems only

1. For multi-user access-enabled systems, the DB user who creates the database using the Oracle Key Vault server configuration must have shared access to the Oracle Key Vault server configuration created by the Oracle Key Vault user. The `odaadmin` user must share the Oracle Key Vault server configuration with the DB user using the `odacli grant-resource-access` command. The DB user can then create the database with the Oracle Key Vault server configuration. An example where the `odaadmin` user shares the `okvobj1` resource with DB user `dbusr1` is as follows:

```
su odaadmin

odacli grant-resource-access -ri d017d35a-0757-460a-98f0-9f8d0944c872 -u
dbusr1
Shared access of resource granted to user successfully...
```

To get the resource ID of the Oracle Key Vault server configuration, run the `odacli list-okvserverconfigs` command. For example:

```
odacli list-okvserverconfigs
```

| ID | Name | IP address | Host Name | Name | User |
|--------------------------------------|---------|---------------|-----------|-------------|--------------------------------|
| | | | | Description | |
| d017d35a-0757-460a-98f0-9f8d0944c872 | epadmin | xxx.xx.xx.xxx | Null | okvobj1 | OKV Server for sales databases |

Step 4: Create the database

For multi-user access-enabled systems, log in as the DB user and use the `odacli create-database` command with the options `-t`, `-osc` and `-kt` to create a database with TDE configured using Oracle Key Vault server. For non-multi user access-enabled systems, you can run the same command as `root` user.

Determine the Oracle Key Vault server you want to store the TDE keys on and provide the value with the `-osc` option in the `odacli create-database` command. The DB user can select the required Oracle Key Vault server configuration from the list of Oracle Key Vault server configurations displayed with the `odacli list-okvserverconfigs` command. For non-multi user access enabled systems, run the `odacli list-okvserverconfigs` command as `root` user.

- The option `-t` indicates that the database must be configured with TDE, using the Oracle Key Vault credentials represented by the Oracle Key Vault server configuration specified using the `-osc` option.
- The option `-kt` specifies the the type of keystore used in TDE configuration. The value of the keystore can be either `software` or `okv`. The default is `software`. The values are case-insensitive. The `OKVServerConfigName` attribute of the database is set to the name of the Oracle Key Vault server configuration specified in the create database request.
- The password for TDE wallet is randomly generated by the system, and you do not need to specify it.

An example to create a database `kokvdb2` which uses Oracle Key Vault credentials represented by Oracle Key Vault server configuration `kovobj1` is as follows:

```
odacli create-database -n kokvdb2 -t -kt OKV -osc kovobj1
Enter SYS and SYSTEM user password:
Retype SYS and SYSTEM user password:
```

Job details

```
-----
ID: 94a51f1a-2d4c-4eac-b0c2-7871d88c0df8
Description: Database service creation with DB name: kokvdb2
Status: Created
Created: July 15, 2024 3:00:53 PM CST
Message:
```

| Task Name | Start Time | End Time | Status |
|-----------|------------|----------|--------|
| ----- | ----- | ----- | ----- |
| ----- | ----- | ----- | ----- |

```
odacli describe-job -i 94a51f1a-2d4c-4eac-b0c2-7871d88c0df8
```

Job details

```
-----
ID: 94a51f1a-2d4c-4eac-b0c2-7871d88c0df8
Description: Database service creation with DB name: kokvdb2
Status: Success
Created: July 15, 2024 3:00:53 PM CST
Message:
```

| Task Name | Start Time | End Time | Status |
|-----------|------------|----------|--------|
| ----- | ----- | ----- | ----- |
| ----- | ----- | ----- | ----- |

| | | | |
|------------------------------------|------------------------------|------------------------------|---------|
| Validating dbHome available space | July 15, 2024 3:01:19 PM CST | July 15, 2024 3:01:19 PM CST | Success |
| ... | | | |
| TDE configuration using OKV | July 15, 2024 3:17:37 PM CST | July 15, 2024 3:20:36 PM CST | Success |
| TDE Wallet directory creation | July 15, 2024 3:17:38 PM CST | July 15, 2024 3:17:46 PM CST | Success |
| Setting Database parameter for OKV | July 15, 2024 3:17:46 PM CST | July 15, 2024 3:19:07 PM CST | Success |
| Auto login TDE Wallet creation | July 15, 2024 3:19:07 PM CST | July 15, 2024 3:19:09 PM CST | Success |
| OKV TDE Wallet creation | July 15, 2024 3:19:09 PM CST | July 15, 2024 3:19:12 PM CST | Success |
| OKV Endpoint configuration | July 15, 2024 3:19:12 PM CST | July 15, 2024 3:19:43 PM CST | Success |
| Setting TDE Master Encryption Key | July 15, 2024 3:19:43 PM CST | July 15, 2024 3:19:43 PM CST | Success |

```
CST          July 15, 2024 3:20:13 PM CST          Success
Create Users tablespace          July 15, 2024 3:20:36 PM
CST          July 15, 2024 3:20:39 PM CST          Success
Clear all listeners from Database July 15, 2024 3:20:39 PM
CST          July 15, 2024 3:20:40 PM CST          Success
Copy Pwfile to Shared Storage    July 15, 2024 3:20:43 PM
CST          July 15, 2024 3:20:47 PM CST          Success
```

On successful database creation, the Oracle Key Vault client software is installed in the `/etc/OKV/db_unique_name/okv` directory. The ownership of all the files is set to `db_user:oinstall` and the permission is set to 750. The autologin TDE wallets are created in the `/etc/OKV/db_unique_name/tde` and `/etc/OKV/db_unique_name/tde_seps` directories. The ownership of these directories is recursively set to `db_user:oinstall` and the permission to 750.

Related Topics

- [Implementing Multi-User Access on Oracle Database Appliance](#)
Understand how multi-user access can be implemented on Oracle Database Appliance, its advantages and restrictions and the associated life cycle management changes for your appliance.
- [odacli Multi-User Access Commands](#)
Use `odacli` commands to enable multi-user access for the appliance.

Creating TDE-Enabled Databases Using Oracle Key Vault With Endpoints in Oracle Key Vault

Understand how you can create TDE-enabled databases on Oracle Database Appliance using endpoints and wallets already in Oracle Key Vault. This method supports creation of TDE-enabled databases on bare metal and DB systems.



Note:

In this Oracle Database Appliance release, this feature is supported on Oracle RAC and Oracle single-instance databases only. This feature is not available with Oracle RAC One Node databases and Oracle single-instance database with high-availability enabled.

To create a TDE-enabled database using Oracle Key Vault with endpoints in Oracle Key Vault, you must complete the following tasks:

1. Log into Oracle Key Vault and create virtual TDE wallet corresponding to a database.
2. Create endpoints corresponding to each instance. For a single instance database, you must create one endpoint and for Oracle RAC database, create two endpoints.
3. Set the default wallet for the created endpoint.
4. Download the `okvclient.jar` file corresponding to each endpoint. For single instance database, download one file, and for Oracle RAC database, there are two files available for download, one per instance..

Step 1: Obtain the `okvclient.jar` file using Oracle Key Vault REST commands

You can create the `okvclient.jar` file either through Oracle Key Vault REST commands or Oracle Key Vault server user interface.

To obtain the `okvclient.jar` file using Oracle Key Vault REST commands, log in as the `oracle` user, and then follow these steps:

1. Create working directories, such as `/tmp/work` and `/tmp/work/client_wallet`. Navigate to the `/tmp/work` directory and download and unzip the RESTful Service utility from the Oracle Key Vault server. When you unzip the utility, you can observe three directories `bin`, `lib`, and `conf`.

```
mkdir /tmp/work/
mkdir /tmp/work/client_wallet
cd /tmp/work
curl -Ok https://okv_server_ip:5695/okvrestclipackage.zip
% Total % Received % Xferd Average Speed Time Time Time Current
          Dload Upload Total Spent Left Speed
100 3750k 100 3750k 0 0 2500k 0 0:00:01 0:00:01 --:--:-- 2500k
```

2. Unzip `okvrestclipackage.zip`. Edit `conf/okvrestcli.ini` and add the Oracle Key Vault server IP address, user name, and path to the directory where the client autologin wallets are created. In the following example, `/tmp/work/client_wallet` is the directory path where client autologin wallets are created.

```
#Provide absolute path for log_property, okv_client_config properties
[Default]
log_property=./conf/okvrestcli_logging.properties
server=okv_server_ip
okv_client_config=./conf/okvclient.ora
user=okv_user
client_wallet=/tmp/work/client_wallet
```

3. Edit the `bin/okv` file and uncomment the line `export OKV_RESTCLI_CONFIG=$OKV_RESTCLI_DIR/conf/okvrestcli.ini` and also set the `JAVA_HOME` variable:

```
#!/bin/bash
export OKV_RESTCLI_DIR=$(dirname "${0}"/..)
export OKV_RESTCLI_CONFIG=$OKV_RESTCLI_DIR/conf/okvrestcli.ini
export JAVA_HOME=/opt/oracle/dcs/java/1.8.0_xxx
if [ -z "$JAVA_HOME" ]
then
    echo "JAVA_HOME environment variable is not set."
    exit 1
fi

if [ -z "$OKV_RESTCLI_CONFIG" ]
then
    echo "OKV_RESTCLI_CONFIG environment variable is not set."
    exit 1
fi
```

```
export OKV_RESTCLI_JAR=$OKV_RESTCLI_DIR/lib/okvrestcli.jar
$JAVA_HOME/bin/java -jar $OKV_RESTCLI_JAR "$@"
```

4. Generate client auto login wallets. You are prompted to provide the Oracle Key Vault user password.

```
/tmp/work/bin/okv admin client-wallet add --client-wallet /tmp/work/
client_wallet --wallet-user okv_user
Password:
```

5. Create the TDE wallet corresponding to the database, if the TDE wallet is not already created using the Oracle Key Vault user interface.

```
/tmp/work/bin/okv manage-access wallet create --wallet wallet_name --
unique FALSE
```

6. Create the endpoint corresponding to the wallet. For Oracle RAC database, create two endpoints. Create the endpoint only if it is not already created using the Oracle Key Vault user interface.

```
/tmp/work/bin/okv admin endpoint create --endpoint endpoint_name --type
ORACLE_DB --platform LINUX64 --strict-ip-check TRUE
```

7. Set the default wallet for the endpoint. For Oracle RAC database, the default wallet for both endpoints must be the same TDE wallet. Set the default wallet only if it is not already set using the Oracle Key Vault user interface.

```
/tmp/work/bin/okv manage-access wallet set-default --wallet wallet_name --
endpoint endpoint_name
```

8. Download the `okvclient.jar` command. For Oracle RAC database, you must download the `okvclient.jar` corresponding to both the endpoints. After the download is complete, copy the `okvclient.jar` corresponding to the remote instance to the remote node.

```
/tmp/work/bin/okv admin endpoint download --endpoint <endpoint_name> --
location <location>
```

9. While downloading the endpoint, if the Endpoint token is already consumed message is observed as below, then re-enroll the endpoint.

```
/tmp/work/bin/okv admin endpoint download --endpoint endpoint_name --
location location
/tmp/work/log/okv0.log.0 (Permission denied)
{
  "result" : "Failure",
  "message" : "Endpoint token is already consumed"
}

/tmp/work/bin/okv admin endpoint re-enroll --endpoint <endpoint_name>
/tmp/work/log/okv0.log.0 (Permission denied)
{
  "result" : "Success"
}
```

Step 2: Create the database

1. For multi user access-enabled and multi user access passwordless systems, log in as the DB user and run the `odacli create-database` command. For non-multi user access-enabled systems, log in as the `root` user and run the `odacli create-database` command. The option `--enable-tde/-t` indicates that the database must be configured with TDE. The option `--keystore-type/-kt` specifies the the type of keystore to use in TDE configuration. The option `--okvclient-path/-ocp` specifies the absolute path to the `okvclient.jar` file corresponding to the endpoint.

For single-instance database, the option `--okvclient-path/-ocp` takes only one value. For Oracle RAC database, the option `--okvclient-path/-ocp` takes two values corresponding to each instance. The values must be comma-separated. The first path corresponds to the local instance whereas the second path corresponds to the remote instance. You are prompted to provide the TDE password.

On successful database creation, the Oracle Key Vault client software is installed in the `/etc/OKV/db_unique_name/okv` directory. The local auto login TDE wallets are created in the `/etc/OKV/db_unique_name/tde` directory. The `okvclient.jar` file in the source location is deleted.

An example to create a single-instance database named `okvdb` without using the Oracle Key Vault server configuration object, is as follows:

```
odacli create-database -n okvdb -y SI -t -kt OKV -ocp /tmp/okvclient.jar
Enter SYS and SYSTEM user password:
Retype SYS and SYSTEM user password:
Enter TDE wallet password:
Retype TDE wallet password:
```

Job details

```
-----
ID: 94a51f1a-2d4c-4eac-b0c2-7871d88c0df8
Description: Database service creation with DB name: okvdb
Status: Created
Created: July 15, 2024 3:00:53 PM CST
Message:
```

```
Task Name          Start
Time              End
Time              Status
-----
-----
-----
```

```
odacli describe-job -i 94a51f1a-2d4c-4eac-b0c2-7871d88c0df8
```

Job details

```
-----
ID: 94a51f1a-2d4c-4eac-b0c2-7871d88c0df8
Description: Database service creation with DB name: okvdb
Status: Success
Created: July 15, 2024 3:00:53 PM CST
Message:
```



```

Task Name                               Start
Time                                     End
Time                                     Status
-----
Validating dbHome available space       July 15, 2024 3:01:19 PM
CST                                     July 15, 2024 3:01:19 PM CST          Success
...
TDE configuration using OKV             July 15, 2024 3:17:37 PM
CST                                     July 15, 2024 3:20:36 PM CST          Success
TDE Wallet directory creation           July 15, 2024 3:17:38 PM
CST                                     July 15, 2024 3:17:46 PM CST          Success
Setting Database parameter for OKV      July 15, 2024 3:17:46 PM
CST                                     July 15, 2024 3:19:07 PM CST          Success
Auto login TDE Wallet creation          July 15, 2024 3:19:07 PM
CST                                     July 15, 2024 3:19:09 PM CST          Success
Installing the OKV client software      July 15, 2024 3:19:09 PM
CST                                     July 15, 2024 3:19:42 PM CST          Success
Setting TDE Master Encryption Key       July 15, 2024 3:19:43 PM
CST                                     July 15, 2024 3:20:13 PM CST          Success
Create Users tablespace                 July 15, 2024 3:20:36 PM
CST                                     July 15, 2024 3:20:39 PM CST          Success
Clear all listeners from Database        July 15, 2024 3:20:39 PM
CST                                     July 15, 2024 3:20:40 PM CST          Success
Copy Pwfile to Shared Storage           July 15, 2024 3:20:43 PM
CST                                     July 15, 2024 3:20:47 PM CST          Success

```

An example to create an Oracle RAC database named `okvdbrac` without using the Oracle Key Vault server configuration object, is as follows. Specify the path to the `okvclient.jar` file for the local database instance first, followed by the path to the `okvclient.jar` file for the remote database instance in the request.

```

odacli create-database -n okvdb -y RAC -t -kt OKV -ocp /tmp/dir1/
okvclient.jar,/tmp/dir2/okvclient.jar
Enter SYS and SYSTEM user password:
Retype SYS and SYSTEM user password:
Enter TDE wallet password:
Retype TDE wallet password:

```

Job details

```

-----
ID:      cb611ec2-ff87-44f9-a79b-3ab1a290644f
Description: Database service creation with DB name: okvdbrac
Status:  Created
Created:  October 20, 2024 6:13:28 AM PDT
Message:

```

```

Task Name                               Start
Time                                     End
Time                                     Status
-----
-----
-----

```

```
odacli describe-job -i cb611ec2-ff87-44f9-a79b-3ab1a290644f
```

Job details

```
-----
                ID:  cb611ec2-ff87-44f9-a79b-3ab1a290644f
      Description:  Database service creation with DB name: okvdrac
        Status:    Success
       Created:    October 20, 2024 6:13:28 AM PDT
       Message:
```

| Task Name | Node Name | Start |
|-----------------------------------|---------------------------------|---------|
| Time | End | |
| Time | Status | |
| ----- | | |
| Validating dbHome available space | n1 | October |
| 20, 2024 6:13:49 AM PDT | October 20, 2024 6:13:49 AM PDT | |
| Success | | |
| Validating dbHome available space | n2 | October |
| 20, 2024 6:13:49 AM PDT | October 20, 2024 6:13:49 AM PDT | |
| Success | | |
| Setting up SSH equivalence | n1 | October |
| 20, 2024 6:13:51 AM PDT | October 20, 2024 6:13:54 AM PDT | |
| Success | | |
| Setting up SSH equivalence | n1 | October |
| 20, 2024 6:13:54 AM PDT | October 20, 2024 6:13:57 AM PDT | |
| Success | | |
| Creating ACFS database home | n1 | October |
| 20, 2024 6:13:58 AM PDT | October 20, 2024 6:13:58 AM PDT | |
| Success | | |
| Validating dbHome available space | n1 | October |
| 20, 2024 6:13:59 AM PDT | October 20, 2024 6:13:59 AM PDT | |
| Success | | |
| . | | |
| . | | |
| . | | |
| Setting TDE Master Encryption Key | n1 | October |
| 20, 2024 6:34:15 AM PDT | October 20, 2024 6:34:56 AM PDT | |
| Success | | |
| Create Users tablespace | n1 | October |
| 20, 2024 6:34:57 AM PDT | October 20, 2024 6:34:59 AM PDT | |
| Success | | |
| Clear all listeners from Database | n1 | October |
| 20, 2024 6:35:00 AM PDT | October 20, 2024 6:35:01 AM PDT | |
| Success | | |
| Deleting OKV Client Software Jar | n1 | October |
| 20, 2024 6:35:03 AM PDT | October 20, 2024 6:35:04 AM PDT | |
| Success | | |
| Deleting OKV Client Software Jar | n2 | October |
| 20, 2024 6:35:04 AM PDT | October 20, 2024 6:35:04 AM PDT | |
| Success | | |
| Encrypt all Tablespaces | n1 | October |

20, 2024 6:35:04 AM PDT
Success

October 20, 2024 6:36:15 AM PDT

Related Topics

- [Implementing Multi-User Access on Oracle Database Appliance](#)
Understand how multi-user access can be implemented on Oracle Database Appliance, its advantages and restrictions and the associated life cycle management changes for your appliance.
- [odacli Multi-User Access Commands](#)
Use `odacli` commands to enable multi-user access for the appliance.

Managing Oracle Key Vault Server Configuration Operations Using ODACLI Commands

Understand how you can manage Oracle Key Vault server configuration operations on Oracle Database Appliance on bare metal and DB systems.

You can create, list, delete, and describe Oracle Key Vault server configuration on Oracle Database Appliance bare metal and DB systems. Note that you run these operations only when you create TDE-enabled databases that allow Oracle Database Appliance to store the user credentials of the Oracle Key Vault user, described in the *Creating TDE-Enabled Databases With User Credentials* topic.

Listing Oracle Key Vault server configurations:

Use the `odacli list-okvserverconfigs` command to view all the Oracle Key Vault server configurations.

```
odacli list-okvserverconfigs
```

| ID | Name | IP address | Host Name | Name | User |
|--------------------------------------|----------|---------------|-----------|-------------|-------------------------------|
| | | | | Description | |
| d017d35a-0757-460a-98f0-9f8d0944c872 | epadmin | xxx.xx.xx.xxx | Null | okvobj1 | OKV server for Sales database |
| b6336173-666b-4d81-88bd-5ae384419114 | epadmin2 | xxx.xx.xx.xxx | Null | okvobj2 | OKV server for Sales database |

Describing an Oracle Key Vault server configuration:

Use the `odacli describe-okvserverconfig` command to view a Oracle Key Vault server configuration.

For example:

```
odacli describe-okvserverconfig -n dokvobj1
OKV Server Config details
```

```
-----
ID: c196bd0a-4a42-43a6-8578-9929ceb28525
Name: dokvobj1
UserName: user1
```

```

IP Address: xxx.xxx.xx.xxx
Host Name:
Description: OKV server config for Sales
CreatedTime: October 4, 2024 9:41:43 AM HKT
UpdatedTime: October 4, 2024 9:42:10 AM HKT
State: CONFIGURED

```

Deleting Oracle Key Vault server configuration:

Use the `odacli delete-okvserverconfig` command to delete Oracle Key Vault server configuration. You can delete the Oracle Key Vault server configuration only if all databases that used the Oracle Key Vault server configuration are already deleted.

```
odacli delete-okvserverconfig -n okvobj1
```

Job details

```

-----
ID: 7446c9b4-a927-431f-8e0b-099eec8116e7
Description: Delete OKV Server Config: dokvobj1
Status: Running
Created: October 4, 2024 9:44:29 AM HKT
Message: Delete OKV Server Config

```

| Task Name | Start Time | End Time | Status |
|-----------------------------|--------------------------------|----------|---------|
| OKV Password Store deletion | October 4, 2024 9:44:29 AM HKT | | Running |

```
odacli describe-job -i 7446c9b4-a927-431f-8e0b-099eec8116e7
```

Job details

```

-----
ID: 7446c9b4-a927-431f-8e0b-099eec8116e7
Description: Delete OKV Server Config: dokvobj1
Status: Success
Created: October 4, 2024 9:44:29 AM HKT
Message: Delete OKV Server Config

```

| Task Name | Node Name | Start Time | End Time | Status |
|--------------------------------------|-----------|--------------------------------|--------------------------------|---------|
| OKV Password Store deletion | oda1 | October 4, 2024 9:44:29 AM HKT | October 4, 2024 9:44:45 AM HKT | Success |
| OKV Server Config directory deletion | oda1 | October 4, 2024 9:44:45 AM HKT | October 4, 2024 9:44:45 AM HKT | Success |
| OKV Server Config deletion | oda1 | October 4, 2024 9:44:45 AM HKT | October 4, 2024 9:44:46 AM HKT | Success |

Related Topics

- [odacli Multi-User Access Commands](#)
Use `odacli` commands to enable multi-user access for the appliance.

Managing Database Operations on TDE-enabled Databases with TDE keys stored on Oracle Key Vault

Understand how you can manage TDE-enabled databases with TDE keys stored on Oracle Key Vault on Oracle Database Appliance on bare metal and DB systems.

You can re-key TDE master encryption key or restore, delete, perform database backup and recovery, and configure Oracle Data Guard on TDE-enabled database on Oracle Key Vault on Oracle Database Appliance bare metal and DB systems.

- [Changing the Password for TDE-enabled Databases](#)
Understand how you can change the password of TDE-enabled database on Oracle Database Appliance on bare metal and DB systems, that uses Oracle Key Vault to store TDE keys.
- [Re-keying TDE Master Encryption Key for TDE-Enabled Databases](#)
Understand how you can re-key TDE master encryption key of TDE-enabled database on Oracle Database Appliance on bare metal and DB systems, that uses Oracle Key Vault to store TDE keys.
- [Performing Backup and Recovery of TDE-enabled Databases](#)
Understand how you can back up and recover TDE-enabled database with TDE keys stored on Oracle Key Vault on Oracle Database Appliance on bare metal and DB systems.
- [Restoring TDE-Enabled Databases Using Oracle Key Vault User Credentials](#)
Understand how you can restore TDE-enabled databases using database backups, on Oracle Database Appliance bare metal and DB systems, with credentials of a user on Oracle Key Vault.
- [Restoring TDE-Enabled Databases With Endpoints and Wallet Manually Created in Oracle Key Vault](#)
Understand how you can restore TDE-enabled databases on Oracle Database Appliance using the endpoints and wallets created manually on Oracle Key Vault. This method supports creation of TDE-enabled databases on bare metal and DB systems.
- [Deleting TDE-enabled Databases](#)
Understand how you can delete a TDE-enabled database on Oracle Database Appliance on bare metal and DB systems, that uses Oracle Key Vault to store TDE keys.

Changing the Password for TDE-enabled Databases

Understand how you can change the password of TDE-enabled database on Oracle Database Appliance on bare metal and DB systems, that uses Oracle Key Vault to store TDE keys.

Changing the password of TDE-enabled databases on Oracle Database Appliance that use the credentials of a user in Oracle Key Vault

Use the `odacli modify-database` command with the option `--change-tde-password, -ctp` for TDE-enabled databases on Oracle Database Appliance that use the credentials of a user in Oracle Key Vault. The new password is randomly generated and stored securely on the Oracle Key Vault server replacing the old TDE password. For example:

```
odacli modify-database -n kokvdb2 -ctp
Job details
```

```

-----
ID: 5d77eb72-909e-42b8-a65a-fcc61689346b
Description: Modify database: db6
Status: Success
Created: January 28, 2025 16:07:01 UTC
Message: Modify database

```

| Task Name | End Time | Node Name | Start Status |
|---|-------------------------------|-----------|---------------------------------------|
| Re-enroll and Provision of Endpoint | January 28, 2025 16:07:05 UTC | n1 | January 28, 2025 16:07:19 UTC Success |
| Save the new TDE password using a temporary custom attribute on OKV | January 28, 2025 16:07:20 UTC | n1 | January 28, 2025 16:07:23 UTC Success |
| Change the TDE password in local wallet | January 28, 2025 16:07:23 UTC | n1 | January 28, 2025 16:07:41 UTC Success |
| Auto login TDE Wallet creation | January 28, 2025 16:07:41 UTC | n1 | January 28, 2025 16:07:45 UTC Success |
| Re-enroll and Provision of Endpoint | January 28, 2025 16:07:45 UTC | n2 | January 28, 2025 16:08:01 UTC Success |
| Change the TDE password in local wallet | January 28, 2025 16:08:01 UTC | n2 | January 28, 2025 16:08:17 UTC Success |
| Auto login TDE Wallet creation | January 28, 2025 16:08:17 UTC | n1 | January 28, 2025 16:08:21 UTC Success |
| Save new TDE password on OKV | January 28, 2025 16:08:22 UTC | n2 | January 28, 2025 16:08:29 UTC Success |
| Delete the temporary custom attribute on OKV | January 28, 2025 16:08:29 UTC | n2 | January 28, 2025 16:08:32 UTC Success |
| Deleting OKV Client Software Jar | January 28, 2025 16:08:32 UTC | n2 | January 28, 2025 16:08:33 UTC Success |

Changing the password of TDE-enabled databases on Oracle Database Appliance that use endpoints and wallets already in Oracle Key Vault

Use the `odacli modify-database` command with the option `--change-tde-password,-ctp`. For TDE-enabled databases on Oracle Database Appliance that use endpoints and wallets

already in Oracle Key Vault, you are prompted to specify the password during the password change operation. For example:

```
odacli modify-database -n kokvdb2 -ctp
Enter the current TDE password:
Enter the new TDE password:
Re-enter the new TDE password:
```

Job details

```
-----
ID: 84633eef-7cf5-474e-aaed-559444d5cb2c
Description: Modify database: db14
Status: Success
Created: January 31, 2025 09:23:39 UTC
Message: Modify database
```

| Task Name | Node Name | Start Time | End Time | Status |
|---|-----------|-------------------------------|-------------------------------|---------|
| Change the TDE password in local wallet | n1 | January 31, 2025 09:23:49 UTC | January 31, 2025 09:23:49 UTC | Success |
| Auto login TDE Wallet creation | n1 | January 31, 2025 09:23:49 UTC | January 31, 2025 09:23:50 UTC | Success |
| Change the TDE password in local wallet | n2 | January 31, 2025 09:23:50 UTC | January 31, 2025 09:23:51 UTC | Success |
| Auto login TDE Wallet creation | n1 | January 31, 2025 09:23:51 UTC | January 31, 2025 09:23:53 UTC | Success |

Related Topics

- [odacli modify-database](#)
Use the `odacli modify-database` command to modify the configuration of a database, such as backup configuration, database class, and database type, and to change TDE wallet management from `EXTERNAL` to `ODA`.

Re-keying TDE Master Encryption Key for TDE-Enabled Databases

Understand how you can re-key TDE master encryption key of TDE-enabled database on Oracle Database Appliance on bare metal and DB systems, that uses Oracle Key Vault to store TDE keys.

Use the `odacli modify-database` command to perform re-key of TDE master encryption key with the option `-rkt`. For TDE configured using Oracle Key Vault, you are prompted to specify the password during the re-key operation. For example:

```
odacli modify-database -n kokvdb2 -rkt
{
  "jobId" : "dbedf89d-b60f-4209-bbcf-0db61e4eb350",
  "status" : "Created",
  "message" : "Modify database",
```

```

"reports" : [ ],
"createTimestamp" : "July 15, 2024 15:56:01 PM CST",
"resourceList" : [ {
  "resourceId" : "7a1c996b-ee8d-49bc-8759-cbbfcee3bcce",
  "resourceType" : null,
  "resourceNewType" : "Db",
  "jobId" : "dbedf89d-b60f-4209-bbcf-0db61e4eb350",
  "updatedAt" : null
} ],
"description" : "Modify database: kokvdb2",
"updatedAt" : "July 15, 2024 15:56:01 PM CST",
"jobType" : null
}

```

```
odacli describe-job -i dbedf89d-b60f-4209-bbcf-0db61e4eb350
```

Job details

```

-----
                ID: dbedf89d-b60f-4209-bbcf-0db61e4eb350
Description:    Modify database: kokvdb2
                Status: Success
Created:       July 15, 2024 3:56:01 PM CST
Message:      Modify database

```

```

Task Name                Start
Time                    End Time
Status
-----
-----
TDE Wallet Re-Key       July 15, 2024 3:56:04 PM
CST                     July 15, 2024 3:56:12 PM CST           Success

```

Related Topics

- [odacli Multi-User Access Commands](#)
Use `odacli` commands to enable multi-user access for the appliance.

Performing Backup and Recovery of TDE-enabled Databases

Understand how you can back up and recover TDE-enabled database with TDE keys stored on Oracle Key Vault on Oracle Database Appliance on bare metal and DB systems.

Performing backup of TDE-enabled database with TDE keys stored on Oracle Key Vault

Use the `odacli create-backup` command to back up TDE-enabled database with TDE keys stored on Oracle Key Vault. The TDE wallet is not present on Oracle Database Appliance, but resides in Oracle Key Vault server, and hence it is not backed up with the database backup. As a result, the value of TDE wallet backup location attribute of the database backup report is set to null.

```
[odaadmin@oda1 bin]$ odacli describe-job -i be94d1f7-ad6e-48a5-94a3-f0a52578048b
```

Job details

```
-----
```



```

ID: be94dlf7-ad6e-48a5-94a3-f0a52578048b
Description: Create Regular-L0 Backup[TAG:auto][Db:db15][NFS:/
nfs_backup/orabackups/dbsfb225975e/database/1851419729/db15]
Status: Success
Created: March 26, 2024 4:14:19 AM PDT
Message:

```

| Task Name | Node Name | Start |
|--|-------------------------------|------------------------|
| Time | End Time | Status |
| Validate backup config | odal | March 26, 2024 4:14:21 |
| AM PDT | March 26, 2024 4:14:21 AM PDT | Success |
| NFS location existence validation | odal | March 26, 2024 4:14:21 |
| AM PDT | March 26, 2024 4:14:22 AM PDT | Success |
| Recovery Window validation | odal | March 26, 2024 4:14:22 |
| AM PDT | March 26, 2024 4:14:24 AM PDT | Success |
| Archivelog deletion policy configuration | odal | March 26, 2024 4:14:24 |
| AM PDT | March 26, 2024 4:14:26 AM PDT | Success |
| Database backup | odal | March 26, 2024 4:14:26 |
| AM PDT | March 26, 2024 4:15:21 AM PDT | Success |

```

[odaadmin@odal bin]$ odacli describe-backupreport -i d2326683-9766-4933-bee1-
a2b59c9d7e9e
{
  "id" : "d2326683-9766-4933-bee1-a2b59c9d7e9e",
  "dbResId" : "96a98156-b657-403e-a87c-357c2069c285",
  "tag" : "auto",
  "dbId" : "1851419729",
  "dbName" : "db15",
  "dbUniqueName" : "db15",
  "backupType" : "Regular-L0",
  "keepDays" : null,
  "backupLocation" : "/nfs_backup/orabackups/dbsfb225975e/database/1851419729/
db15/db",
  "cfBackupHandle" : "/nfs_backup/orabackups/dbsfb225975e/database/1851419729/
db15/db/c-1851419729-20240326-03",
  "spfBackupHandle" : "/nfs_backup/orabackups/dbsfb225975e/database/
1851419729/db15/db/c-1851419729-20240326-03",
  "pitrTimeStamp" : "March 26, 2024 04:15:06 AM PDT",
  "pitrSCN" : "1675444",
  "resetLogsTimeStamp" : "March 26, 2024 03:01:39 AM PDT",
  "resetLogsSCN" : "1575481",
  "oraHomeVersion" : "19.23.0.0.240116",
  "sqlPatches" : "35926646,34774667,35943157",
  "backupLogLoc" : "/nfs_backup/orabackups/dbsfb225975e/database/1851419729/
db15/rmanlog/2024-03-26/rman_backup_auto_2024-03-26_04-14-29.0478.log",
  "tdeWalletLoc" : null,
  "dbConfigLoc" : "/nfs_backup/orabackups/dbsfb225975e/database/1851419729/
db15/dbconfig/2024-03-26/DBCONFIG_auto_2024-03-26_04-15-19.0472.tar.gz",
  "name" : "Backup_Report_db15",
  "createTime" : "March 26, 2024 04:14:26 AM PDT",
  "state" : {
    "status" : "CONFIGURED"
  }
}

```

```

    },
    "updatedAtTime" : "March 26, 2024 04:14:26 AM PDT",
    "backupReportLogDetail" : "/nfs_backup/orabackups/dbsfb225975e/database/
1851419729/db15/rmandetaillogreport/2024-03-26/
rman_list_backup_detail_auto_2024-03-26_04-15-16.0129.log",
    "dbInfo" : {
        "dbClass" : "OLTP",
        "dbType" : "RAC",
        "dbShape" : "odb2",
        "dbEdition" : "EE",
        "dbStorage" : "ASM",
        "dbRedundancy" : null,
        "pdbName" : null,
        "isCdb" : false
    },
    },
    "dbDataSize" : "2441M",
    "dbRedoSize" : "16403M",
    "rmanBackupPieces" : "/nfs_backup/orabackups/dbsfb225975e/database/
1851419729/db15/backuppieces/2024-03-26/backupPieces_auto_96a98156-b657-403e-
a87c-357c2069c285_20240326041518.json",
    "compressionAlgo" : "BASIC",
    "cpuPool" : null,
    "numberOfCores" : null,
    "keystoreType" : "OKV",
}

```

Note that since TDE wallet backup is not supported, if the keystore type is OKV, if you specify the component as `tdewallet` in the `odacli create-backup` command, an error is encountered.

```
[odaadmin@oda1 bin]$ odacli create-backup -n db15 -c tdewallet
DCS-10144:TDE wallet backup operation is not supported for TDE databases with
OKV keystore type.
```

Performing recovery of database with TDE configured using Oracle Key Vault with credentials of Oracle Key Vault user

Use the `odacli recover-database` command to recover a database with TDE configured using Oracle Key Vault. For example, to recover a database `kokvdb2`, run the following command:

```

odacli recover-database -n kokvdb2 -t latest
{
  "jobId" : "8a50d65f-2269-41ff-b030-51fe4ecc82b5",
  "status" : "Created",
  "message" : null,
  "reports" : [ ],
  "createTimestamp" : "July 15, 2024 18:26:26 PM CST",
  "resourceList" : [ ],
  "description" : "Create recovery-latest for DB : kokvdb2",
  "updatedAtTime" : "July 15, 2024 18:26:26 PM CST",
  "jobType" : null
}

odacli describe-job -i 8a50d65f-2269-41ff-b030-51fe4ecc82b5
```

Job details

```

-----
ID: 8a50d65f-2269-41ff-b030-51fe4ecc82b5
Description: Create recovery-latest for DB : kokvdb2
Status: Success
Created: July 15, 2024 6:26:26 PM CST
Message:

```

| Task Name | Start Time | End Time | Status |
|-------------------------------|------------------------------|------------------------------|---------|
| Database recovery validation | July 15, 2024 6:26:30 PM CST | July 15, 2024 6:27:50 PM CST | Success |
| Database recovery | July 15, 2024 6:27:50 PM CST | July 15, 2024 6:30:07 PM CST | Success |
| Enable block change tracking | July 15, 2024 6:30:07 PM CST | July 15, 2024 6:30:12 PM CST | Success |
| Database opening | July 15, 2024 6:30:12 PM CST | July 15, 2024 6:30:15 PM CST | Success |
| Database restart | July 15, 2024 6:30:15 PM CST | July 15, 2024 6:31:31 PM CST | Success |
| Recovery metadata persistence | July 15, 2024 6:31:31 PM CST | July 15, 2024 6:31:31 PM CST | Success |

The TDE wallets are stored on the Oracle Key Vault server and not on Oracle Database Appliance, and so, ODA CLI commands cannot be used for restore and recovery operations. If the keystore type is OKV, and you specify the component as `tdewallet` in the `odacli recover-database` command, an error is encountered.

```

[odaadmin@oda1 bin]$ odacli recover-database -n db15 -tl /nfs_backup/ewallet.p12 -t latest
DCS-10045:Validation error encountered: Usage of TDE wallet related parameters is not allowed for a TDE database with OKV keystore type.

```

```

[odaadmin@oda1 bin]$ odacli restore-tdewallet -n db15
Enter TDE wallet password:
DCS-10144:Restore TDE wallet operation is not supported for TDE databases with OKV keystore type.

```

Performing recovery of database with TDE configured using Oracle Key Vault with endpoints in Oracle Key Vault

The `odacli recover-database` command prompts for the TDE password. Before database recovery, the local auto-login wallet is regenerated using the Administer Key Management command. You must specify the TDE password for database recovery.

```

odacli recover-database -n kokvdb2 -t latest
Enter the TDE password:

```

```

odacli describe-job -i 8a50d65f-2269-41ff-b030-51fe4ecc82b5

```

Job details

```

-----
ID:      8a50d65f-2269-41ff-b030-51fe4ecc82b5
Description: Create recovery-latest for DB : kokvdb2
Status:  Success
Created:  July 15, 2024 6:26:26 PM CST
Message:

```

| Task Name | Start Time | End Time | Status |
|--------------------------------|------------------------------|------------------------------|---------|
| Auto login TDE Wallet creation | July 15, 2024 6:26:30 PM CST | July 15, 2024 6:27:50 PM CST | |
| Database recovery validation | July 15, 2024 6:26:30 PM CST | July 15, 2024 6:27:50 PM CST | Success |
| Database recovery | July 15, 2024 6:27:50 PM CST | July 15, 2024 6:30:07 PM CST | Success |
| Enable block change tracking | July 15, 2024 6:30:07 PM CST | July 15, 2024 6:30:12 PM CST | Success |
| Database opening | July 15, 2024 6:30:12 PM CST | July 15, 2024 6:30:15 PM CST | Success |
| Database restart | July 15, 2024 6:30:15 PM CST | July 15, 2024 6:31:31 PM CST | Success |
| Recovery metadata persistence | July 15, 2024 6:31:31 PM CST | July 15, 2024 6:31:31 PM CST | Success |

Errors during database recovery

The TDE wallets are stored on the Oracle Key Vault server and not on Oracle Database Appliance, and so, ODA CLI commands cannot be used for restore and recovery operations. If the keystore type is OKV, and you specify the component as `tdewallet` in the `odacli recover-database` command, an error is encountered.

```

[odaadmin@oda1 bin]$ odacli recover-database -n db15 -tl /nfs_backup/
ewallet.p12 -t latest
DCS-10045:Validation error encountered: Usage of TDE wallet related
parameters is not allowed for a TDE database with OKV keystore type.

```

```

[odaadmin@oda1 bin]$ odacli restore-tdewallet -n db15
Enter TDE wallet password:
DCS-10144:Restore TDE wallet operation is not supported for TDE databases
with OKV keystore type.

```

Related Topics

- [odacli Multi-User Access Commands](#)
Use `odacli` commands to enable multi-user access for the appliance.

Restoring TDE-Enabled Databases Using Oracle Key Vault User Credentials

Understand how you can restore TDE-enabled databases using database backups, on Oracle Database Appliance bare metal and DB systems, with credentials of a user on Oracle Key Vault.

Prerequisites

- To restore a database with primary role in an Oracle Data Guard configuration, TDE wallet for the target database must be created on the Oracle Key Vault server before you run the restore command. This TDE wallet is a copy of the wallet of the source database.
- To restore a database with a standby role in an Oracle Data Guard configuration, the TDE wallet copy must **not** be created. The TDE wallet of the primary database must be used for the standby database.

Step 1: Create the Oracle Key Vault user. This step applies to multi-user access-enabled systems only.

If the user with the `ODA-OKVCONFIGADMIN` role does not exist, or if you want to assign a different user for the database you are restoring, then create the user.

1. Create a new user with the `ODA-OKVCONFIGADMIN` role. For example:

```
odacli create-user -u okvuser1 -r ODA-OKVCONFIGADMIN
```

The user is created and assigned a temporary password.

2. After the user is created successfully, the `okvuser1` can log into the appliance with the temporary password.
3. The `okvuser1` is in the `Inactive` state. If the appliance is configured with multi-user access enabled, then activate the user with the following command. Note that if the appliance is configured with passwordless multi-user access, then you do not need to activate the user. For more information about configuring multi-user access, the topic *Implementing Multi-User Access on Oracle Database Appliance*.

```
odacli activate-user
```

You are prompted to change the password. Enter the temporary password, the new password, and confirm the new password.

4. Use the new password to connect by SSH into the appliance and run ODACLI commands or connect to the Browser User Interface.

Step 2: Create an Oracle Key Vault server configuration

Create an Oracle Key Vault server configuration for the target database. Create a new Oracle Key Vault server configuration only if an Oracle Key Vault server configuration for the same Oracle Key Vault server does not already exist. If a configuration already exists, then use the existing configuration.

1. The Oracle Key Vault user that creates the Oracle Key Vault server configuration must be a user with atleast the privilege of `Create Endpoint` on the Oracle Key Vault server.

- For multi-user access-enabled systems, log in as the user with the `ODA-OKVCONFIGADMIN` role, for example, the `okvuser1`. For non-multi user access enabled systems, log in as the `root` user.
- Oracle Key Vault password prompt displays twice, to accept and confirm the Oracle Key Vault password. This is the password of the Oracle Key Vault user on the Oracle Key Vault server, which enables the user to log into the Oracle Key Vault server. Specify the user name with the `-u` option in the `odacli create-okvserverconfig` command. The name of the Oracle Key Vault server configuration is case-sensitive and no two Oracle Key Vault server configurations can have same name on Oracle Database Appliance. The length of the Oracle Key Vault server configuration cannot exceed 128 characters.

```
odacli create-okvserverconfig -n okvobj1 -u epokvusrl -ip xxx.xx.xxx.xxx
Enter OKV user password :
Retype OKV user password :
Job details
```

```
-----
ID: 8878fc02-3d64-4519-bf52-fcb50839f89f
Description: Create OKV Server Config: okvcfg5
Status: Success
Created: October 14, 2024 14:04:29 UTC
Message: Create OKV Server Config.
```

| Task Name | Node Name | Start Time | End Time | Status |
|------------------------------|-----------|-------------------------------|-------------------------------|---------|
| OKV Password Store creation | oda1 | October 14, 2024 14:04:29 UTC | October 14, 2024 14:04:56 UTC | Success |
| Download of OKV REST package | oda1 | October 14, 2024 14:04:31 UTC | October 14, 2024 14:04:32 UTC | Success |
| Edit of OKV REST package | oda1 | October 14, 2024 14:04:32 UTC | October 14, 2024 14:04:32 UTC | Success |
| Generate OKV client wallets | oda1 | October 14, 2024 14:04:32 UTC | October 14, 2024 14:04:35 UTC | Success |

The command creates an Oracle Key Vault server configuration `okvobj1` for the Oracle Key Vault server user `epokvusrl` on the specified server.

Step 3: Copy TDE keys from source wallet to target wallet on Oracle Key Vault server using ODACLI commands

Use the `odacli copy-okvtdewallet` command to copy the TDE wallet to the Oracle Key Vault server. Specify the source wallet name (`--source-wallet-name | -swn`), target wallet Oracle Key Vault server configuration object name (`--target-okvserverconfig | -tosc`), and the target wallet name (`--target-wallet-name | -tw`) in the command. A new wallet with the name specified for the target wallet name (`--target-wallet-name | -tw`) parameter is created in the target Oracle Key Vault server. This wallet contains the TDE keys copied from the source wallet.

If the source wallet is on a different Oracle Key Vault server than the target wallet, then specify the source wallet Oracle Key Vault server details such as the host name (`--source-hostname` | `-shn`) or the IP address (`--source-ip` | `-sip`) of the server and the name of the user that owns the wallet on the Oracle Key Vault server (`--source-username` | `-su`). You must provide a password when prompted in this case. This is the password of the Oracle Key Vault user that owns the source wallet on the Oracle Key Vault server. For multi-user access enabled systems, run this command as the Oracle Key Vault user on Oracle Database Appliance.

There are three scenarios when you copy the TDE wallet:

Scenario 1: Copy the TDE wallet on the same Oracle Key Vault server with the same Oracle Key Vault user

In this case, the source TDE wallet and the target TDE wallet are on the same Oracle Key Vault server, and both are owned by the same user on the OKV server. For example:

```
odacli copy-okvtdewallet -swn tdeokv_on_oda8m013-c -tosc okvobj1 -twm tdeokvss
Job details
```

```
-----
ID: 50df7dcc-8e17-48db-9206-879c44e57c20
Description: Copy wallet in OKV server
Status: Success
Created: June 20, 2024 2:56:02 AM CST
Message:
```

```
Task Name                               Start
Time                                     End Time
Status
-----
-----
Creating a TDE wallet copy in the OKV    June 20, 2024 2:56:03 AM
CST                                       June 20, 2024 2:57:17 AM CST      Success
server
```

Scenario 2: Copy the TDE wallet on the same Oracle Key Vault server but using a different Oracle Key Vault user

In this case, the source and the target wallet are on the same Oracle Key Vault server but are owned by different users on the Oracle Key Vault server. The owner of the source wallet in the Oracle Key Vault must provide read and manage access permissions on the wallet to the owner of the target wallet on Oracle Key Vault before running the ODACLI command to copy the wallet.

Follow these steps to provide read and manage wallet permissions to the target wallet Oracle Key Vault user:

1. Log into the Oracle Key Vault server as the source wallet Oracle Key Vault user.
2. Navigate to the **Keys and Wallets** tab. Select the source wallet checkbox and click the Edit icon.
3. Navigate to the **Wallet Access Settings** section and click **Add**.
4. In the dropdown list for **Type**, select **Users**, and then select the checkbox for the target wallet Oracle Key Vault user.
5. In the **Access Level** section, select **Read Only** and **Manage Wallet**.
6. Click **Save**.

After you provide the required permissions to the target wallet user, run the `odacli copy-okvtdewallet` command.

```
odacli copy-okvtdewallet -swn tdeokv_on_oda8m013-c -tosc okvobj2 -twm tdeokvdu
Job details
```

```
-----
ID: 50df7dcc-8e17-48db-9206-879c44e57c20
Description: Copy wallet in OKV server
Status: Success
Created: June 20, 2024 2:56:02 AM CST
Message:
```

| Task Name | Start Time | End Time | Status |
|--|------------------------------|------------------------------|---------|
| Creating a TDE wallet copy in the OKV server | June 20, 2024 2:56:03 AM CST | June 20, 2024 2:57:17 AM CST | Success |

Scenario 3: Copy the TDE wallet to a different Oracle Key Vault server

In this case, the source wallet and the target wallet are on different Oracle Key Vault servers. Specify the source wallet Oracle Key Vault server details in the `odacli copy-okvtdewallet` command. Specify the password of the source wallet Oracle Key Vault user when prompted. For example:

```
odacli copy-okvtdewallet -swn tdeokv_on_oda8m013-c -sip xxx.xx.x.xxx -su
epokvusr1 -tosc okvobj3 -twm tdeokvds
Enter OKV user password:
Retype OKV user password:
```

Job details

```
-----
ID: 50df7dcc-8e17-48db-9206-879c44e57c20
Description: Copy wallet in OKV server
Status: Success
Created: June 20, 2024 2:56:02 AM CST
Message:
```

| Task Name | Start Time | End Time | Status |
|--|------------------------------|------------------------------|---------|
| Creating a TDE wallet copy in the OKV server | June 20, 2024 2:56:03 AM CST | June 20, 2024 2:57:17 AM CST | Success |

Alternate method for Step 3: Copying the TDE keys from the source database wallet to the target database wallet using the Oracle Key Vault user interface

Instead of using ODACLI commands, you can create a new wallet for the target database in the Oracle Key Vault server and copy the TDE keys of the source database to the wallet using the Oracle Key Vault user interface as follows:

1. Log into the Oracle Key Vault server.
2. Navigate to the **Keys & Wallets** tab.
3. The Oracle Key Vault user must be provided read, write, and manage wallet permissions from the **Access Settings** section of the source database wallet.
4. To create a new wallet, click **Create**.
5. Specify the new name for the wallet of the target database.
6. Copy the TDE keys of the source database when creating the new wallet. Search for the name of the source database in the **Add Wallet Contents** section. When the keys are displayed, select all **TDE Master Encryption Key** checkboxes for the database.
7. To save the wallet, click **Save**.
8. Run this step only if the Oracle Key Vault administrator has created the wallet for the Oracle Key Vault user. Ensure that the administrator provides read-write and manage-wallet access for the wallet to the user after creation.
 - a. Log into the Oracle Key Vault server as the Oracle Key Vault administrator.
 - b. In the **Keys & Wallets** tab, select the checkbox for the newly-created wallet and click on the **Edit** option for the wallet.
 - c. In the **Wallet Access Settings**, click **Add**.
 - d. In the **Select Endpoint/User Group** section, select **Users** from the dropdown list.
 - e. Select the checkbox for the Oracle Key Vault user to be provided access to the wallet.
 - f. In the **Access Level** section, select **Read and Modify** and **Manage Wallet** options.
 - g. To save the access settings for the wallet, click **Save**.

Step 4: Restoring TDE-enabled databases with TDE keys stored on Oracle Key Vault

Use the `odacli irestore-database` command to restore a TDE-enabled database with TDE keys stored on Oracle Key Vault. Specify the options `--enable-tde`, `--okv-server-config`, `--okv-wallet-name`, and `keystore-type` in the command.

The option `--enable-tde, -t` indicates that the restored database must be configured with TDE, using the Oracle Key Vault server configuration specified in the `--okv-server-config` option. The keystore of such i restored database is set to OKV. The `okvServerConfigName` attribute of the restored database object is set to the name of the Oracle Key Vault server configuration specified in the `irestore` request. Specify the wallet name for the target database with the `--okv-wallet-name` parameter. This wallet must be present in the Oracle Key Vault server and the TDE keys must be copied to the wallet before running the `irestore` operation.

Since the wallet is already created in the Oracle Key Vault server, specify the name of the wallet, the Oracle Key Vault server configuration where the wallet is created, and the keystore type as OKV in this case in the `odacli irestore-database` command:

```
odacli irestore-database -r /tmp/db1Backupreport.json -t -osc okvobj1 -kt OKV
-own db2_wallet -n okvdb15
```

Enter SYS and SYSTEM user password:

Enter SYS and SYSTEM user password:

Job details

```

-----
                ID: dc44f3f0-5af3-4402-ad23-e923e1446371
Description: Database service recovery with DB name: okvdb15
      Status: Success
      Created: July 5, 2024 6:54:00 AM EDT
      Message:
  
```

| Task Name | Node Name | Start |
|--------------------------------------|-----------------------------|--------------|
| Time | End Time | |
| Status | | |
| Check if cluster ware is running | oda1 | July 5, |
| 2024 6:54:23 AM EDT | July 5, 2024 6:54:23 AM EDT | |
| Success | | |
| Check if cluster ware is running | oda2 | July 5, 2024 |
| 6:54:23 AM EDT | July 5, 2024 6:54:24 AM EDT | |
| Success | | |
| Creating DbStorage for DbRestore | oda1 | July 5, 2024 |
| 6:54:25 AM EDT | July 5, 2024 6:54:42 AM EDT | |
| Success | | |
| Validating DiskSpace for DATA | oda1 | July 5, |
| 2024 6:54:25 AM EDT | July 5, 2024 6:54:27 AM EDT | |
| Success | | |
| Setting up SSH equivalence | oda1 | July 5, |
| 2024 6:54:27 AM EDT | July 5, 2024 6:54:34 AM EDT | |
| Success | | |
| Configuring user access to ACFS | oda1 | July 5, |
| 2024 6:54:38 AM EDT | July 5, 2024 6:54:39 AM EDT | |
| Success | | |
| filesystems for | | |
| okvdb15 | | |
| Audit directory creation | oda1 | July 5, 2024 |
| 6:54:40 AM EDT | July 5, 2024 6:54:40 AM EDT | |
| Success | | |
| Audit directory creation | oda2 | July 5, 2024 |
| 6:54:41 AM EDT | July 5, 2024 6:54:41 AM EDT | |
| Success | | |
| Configure TDE for RestoreDb TaskFlow | oda1 | July 5, 2024 |
| 6:54:46 AM EDT | July 5, 2024 6:56:07 AM EDT | |
| Success | | |
| Auxiliary Instance Creation | oda1 | July 5, 2024 |
| 6:54:50 AM EDT | July 5, 2024 6:55:30 AM EDT | |
| Success | | |
| TDE Wallet directory creation | oda1 | July 5, 2024 |
| 6:55:30 AM EDT | July 5, 2024 6:55:31 AM EDT | |
| Success | | |
| OKV Endpoint configuration | oda1 | July 5, 2024 |
| 6:55:31 AM EDT | July 5, 2024 6:56:02 AM EDT | |
| Success | | |

```

Auto login TDE Wallet creation          odal          July 5, 2024
6:56:02 AM EDT          July 5, 2024 6:56:04 AM EDT
Success
Password based TDE Wallet open          odal          July 5,
2024 6:56:04 AM EDT          July 5, 2024 6:56:07 AM EDT
Success
Create pfile for Auxiliary Instance      odal          July 5,
2024 6:56:07 AM EDT          July 5, 2024 6:56:08 AM EDT
Success
Rman duplicate                          odal          July 5,
2024 6:56:08 AM EDT          July 5, 2024 7:01:22 AM EDT
Success
Creating pfile from spfile              odal          July 5,
2024 7:01:23 AM EDT          July 5, 2024 7:01:24 AM EDT
Success
Set PFile Ownership                    odal          July 5,
2024 7:01:24 AM EDT          July 5, 2024 7:01:24 AM EDT
Success
Customize Db Parameters                 odal          July 5,
2024 7:01:25 AM EDT          July 5, 2024 7:01:36 AM EDT
Success
Shutdown And Start database             odal          July 5,
2024 7:01:36 AM EDT          July 5, 2024 7:06:51 AM EDT
Success
Create spfile for restore db            odal          July 5,
2024 7:06:51 AM EDT          July 5, 2024 7:06:53 AM EDT
Success
Set PFile Ownership                    odal          July 5,
2024 7:06:53 AM EDT          July 5, 2024 7:06:53 AM EDT
Success
Shutdown And Mount database             odal          July 5,
2024 7:06:54 AM EDT          July 5, 2024 7:08:22 AM EDT
Success
Re-Create control file                  odal          July 5,
2024 7:08:23 AM EDT          July 5, 2024 7:09:21 AM EDT
Success
Removing Disabled Redo Threads          odal          July 5,
2024 7:09:21 AM EDT          July 5, 2024 7:09:23 AM EDT
Success
Updating DB attributes                  odal          July 5,
2024 7:09:23 AM EDT          July 5, 2024 7:09:25 AM EDT
Success
Register Database taskflow              odal          July 5,
2024 7:09:30 AM EDT          July 5, 2024 7:14:51 AM EDT
Success
Create SPFile in shared loc             odal          July 5,
2024 7:09:30 AM EDT          July 5, 2024 7:09:40 AM EDT
Success
Delete Local Spfile                    odal          July 5,
2024 7:09:40 AM EDT          July 5, 2024 7:09:41 AM EDT
Success
Register DB with clusterware            odal          July 5,
2024 7:09:41 AM EDT          July 5, 2024 7:11:19 AM EDT
Success
Add Startup Trigger to Open all PDBS    odal          July 5,
2024 7:11:20 AM EDT          July 5, 2024 7:11:20 AM EDT

```

```

Success
Set SysPassword and Create PwFile          oda1          July 5,
2024 7:11:21 AM EDT          July 5, 2024 7:11:24 AM EDT
Success
Enable block change tracking              oda1          July 5,
2024 7:11:25 AM EDT          July 5, 2024 7:11:37 AM EDT
Success
Creating pfile                            oda1          July 5,
2024 7:11:37 AM EDT          July 5, 2024 7:11:39 AM EDT
Success
Updating db env                           oda1          July 5,
2024 7:11:39 AM EDT          July 5, 2024 7:11:40 AM EDT
Success
Enable DbSizing Template                  oda1          July 5,
2024 7:11:40 AM EDT          July 5, 2024 7:13:14 AM EDT
Success
Update Database Global Name                oda1          July 5,
2024 7:13:14 AM EDT          July 5, 2024 7:13:17 AM EDT
Success
Create tns entry                          oda1          July 5,
2024 7:13:18 AM EDT          July 5, 2024 7:13:19 AM EDT
Success
Create tns entry                          oda2          July 5,
2024 7:13:19 AM EDT          July 5, 2024 7:13:21 AM EDT
Success
Running datapatch                          oda1          July 5,
2024 7:13:21 AM EDT          July 5, 2024 7:13:52 AM EDT
Success
Set CPU pool                              oda1          July 5,
2024 7:13:52 AM EDT          July 5, 2024 7:13:52 AM EDT
Success
Reset Associated Networks for Database      oda1          July 5,
2024 7:14:54 AM EDT          July 5, 2024 7:15:00 AM EDT
Success
Reset Associated Networks                  oda2          July 5,
2024 7:15:00 AM EDT          July 5, 2024 7:15:01 AM EDT
Success
Set log_archive_dest for Database          oda1          July 5,
2024 7:15:01 AM EDT          July 5, 2024 7:15:07 AM EDT
Success
Setting Database parameter for OKV        oda1          July 5,
2024 7:15:07 AM EDT          July 5, 2024 7:16:43 AM EDT
Success
Enable New Tablespace Encryption          oda1          July 5,
2024 7:16:45 AM EDT          July 5, 2024 7:16:47 AM EDT
Success
Copy Pwfile to Shared Storage              oda1          July 5,
2024 7:16:47 AM EDT          July 5, 2024 7:16:58 AM EDT
Success
Configure All Candidate Nodes              oda1          July 5,
2024 7:16:58 AM EDT          July 5, 2024 7:17:01 AM EDT
Success

```

Restore the database by copying the wallet using ODA CLI commands and providing the wallet name to the command. After copying the TDE keys of the wallet of the source database with

the `odacli copy-okvtdewallet` command, specify the target Oracle Key Vault wallet name in the `odacli irestore-database` command.

```
odacli irestore-database -r /tmp/db1Backupreport.json -t -osc okvobj1 -kt OKV
-own db2_wallet
Enter SYS and SYSTEM user password:
Enter SYS and SYSTEM user password:
```

Related Topics

- [odacli Multi-User Access Commands](#)
Use `odacli` commands to enable multi-user access for the appliance.

Restoring TDE-Enabled Databases With Endpoints and Wallet Manually Created in Oracle Key Vault

Understand how you can restore TDE-enabled databases on Oracle Database Appliance using the endpoints and wallets created manually on Oracle Key Vault. This method supports creation of TDE-enabled databases on bare metal and DB systems.

Prerequisites

- To restore a database with primary role in an Oracle Data Guard configuration, TDE wallet for the target database must be created on the Oracle Key Vault server before you run the restore command. This TDE wallet is a copy of the wallet of the source database.
- To restore a database with a standby role in an Oracle Data Guard configuration, the TDE wallet copy must **not** be created. The TDE wallet of the primary database must be used for the standby database.
- The TDE wallet created must be set as the default wallet for the endpoints created.
- The `okvclient.jar` file corresponding to each endpoint must be downloaded and copied to the Oracle Database Appliance node on which you submit the database restore request.

Step 1: Copying the TDE keys from the source database wallet to the target database wallet using the Oracle Key Vault user interface

Create a new wallet for the target database in the Oracle Key Vault server and copy the TDE keys of the source database to the wallet as follows:

1. Log into the Oracle Key Vault server.
2. Navigate to the **Keys & Wallets** tab.
3. The Oracle Key Vault user must be provided read, write, and manage wallet permissions from the **Access Settings** section of the source database wallet.
4. To create a new wallet, click **Create**.
5. Specify the new name for the wallet of the target database.
6. Copy the TDE keys of the source database when creating the new wallet. Search for the name of the source database in the **Add Wallet Contents** section. When the keys are displayed, select all **TDE Master Encryption Key** checkboxes for the database.
7. To save the wallet, click **Save**.
8. Run this step only if the Oracle Key Vault administrator has created the wallet for the Oracle Key Vault user. Ensure that the administrator provides read-write and manage-wallet access for the wallet to the user after creation.

- a. Log into the Oracle Key Vault server as the Oracle Key Vault administrator.
- b. In the **Keys & Wallets** tab, select the checkbox for the newly-created wallet and click on the **Edit** option for the wallet.
- c. In the **Wallet Access Settings**, click **Add**.
- d. In the **Select Endpoint/User Group** section, select **Users** from the dropdown list.
- e. Select the checkbox for the Oracle Key Vault user to be provided access to the wallet.
- f. In the **Access Level** section, select **Read and Modify** and **Manage Wallet** options.
- g. To save the access settings for the wallet, click **Save**.

Step 2: Creating endpoints and setting the default wallet

Follow these steps:

1. Create endpoints corresponding to each instance. For Oracle RAC database, create two endpoints corresponding to two instances. For single-instance database, create one endpoint corresponding to one instance.
 - a. In the Oracle Key Vault home page, navigate to the **Endpoints** tab and click **Add**.
 - b. Specify the **Endpoint Name**. Select the **Type** as **Oracle Database**, **Platform** as **Linux**, and click **Register**.

Key Vault 21.7

Home Endpoints Keys & Wallets Reports Users

Last Refreshed Time: 21-AUG-2024 08:10:19 [All times UTC +05:30 hours]

Endpoints

Register Endpoint

Endpoint Name * test

Type * Oracle Database

Platform * Linux

Description

Administrator Email

Cancel Register

2. In the Default Wallet page, click **Choose Wallet** and set the default wallet for the created endpoints.

Key Vault 21.7

Home Endpoints Keys & Wallets Reports Users

Last Refreshed Time: 21-AUG-2024 08:15:10 [All times UTC +05:30 hours]

Endpoints

Add Default Wallet

Select Wallet

| Wallet Name | Description | Creation Time | Creat Node |
|-------------|-------------|----------------------|------------|
| test | | 21-AUG-2024 08:15:01 | - |
| dharmtest | | 30-JUL-2024 10:44:15 | - |

Cancel Select

Step 3: Downloading the TDE wallet to Oracle Key Vault server using Oracle Key Vault commands

For multi user access-enabled and multi user access passwordless systems, log in as the Oracle Key Vault server user. For non-multi user access-enabled systems, log in as the `oracle` user and then follow these steps:

1. Create working directories such as `/tmp/work` and `/tmp/work/client_wallet`. Navigate to the `/tmp/work` directory. Download and extract the RESTful Service Utility from Oracle Key Vault server. You can view three directories `bin`, `lib`, and `conf`.

```
mkdir /tmp/work/
mkdir /tmp/work/client_wallet
cd /tmp/work
curl -Ok https://okv_server_ip:5695/okvrestclipackage.zip
% Total % Received % Xferd Average Speed Time Time Time Current
                        Dload Upload Total Spent Left Speed
100 3750k 100 3750k 0 0 2500k 0 0:00:01 0:00:01 --:--:-- 2500k
```

2. Extract the contents of `okvrestclipackage.zip` file. Edit the `conf/okvrestcli.ini` file and add the Oracle Key Vault server IP address, user name, and path to the directory where the client auto login wallets are created. In the following example, the client auto login wallets are created in the `/tmp/work/client_wallet` directory.

```
#Provide absolute path for log_property, okv_client_config properties
[Default]
log_property=./conf/okvrestcli_logging.properties
server=<okv_server_ip>
okv_client_config=./conf/okvclient.ora
user=<okv_user>
client_wallet=/tmp/work/client_wallet
```

3. Edit the `bin/okv` file and uncomment the line `export OKV_RESTCLI_CONFIG=$OKV_RESTCLI_DIR/conf/okvrestcli.ini` file. Set `JAVA_HOME` as follows:

```
#!/bin/bash
export OKV_RESTCLI_DIR=$(dirname "${0}")/..
export OKV_RESTCLI_CONFIG=$OKV_RESTCLI_DIR/conf/okvrestcli.ini
export JAVA_HOME=/opt/oracle/dcs/java/1.8.0_xxx
if [ -z "$JAVA_HOME" ]
then
echo "JAVA_HOME environment variable is not set."
exit 1
fi

if [ -z "$OKV_RESTCLI_CONFIG" ]
then
echo "OKV_RESTCLI_CONFIG environment variable is not set."
exit 1
fi

export OKV_RESTCLI_JAR=$OKV_RESTCLI_DIR/lib/okvrestcli.jar
$JAVA_HOME/bin/java -jar $OKV_RESTCLI_JAR "$@"
```

4. Generate the client auto login wallets. Specify the Oracle Key Vault password when prompted.

```
/tmp/work/bin/okv admin client-wallet add --client-wallet /tmp/work/
client_wallet --wallet-user okv_user
Password:
```

5. Create the endpoint corresponding to the wallet. For Oracle RAC database, you must create two endpoints specific to each database instance. Run this step only if the endpoints are not already created using the Oracle Key Vault Server user interface.

```
/tmp/work/bin/okv admin endpoint create --endpoint endpoint_name --type
ORACLE_DB --platform LINUX64 --strict-ip-check TRUE
```

6. Set the wallet created in Step 1 as the default wallet for the endpoints. For Oracle RAC database, the default wallet for both the endpoints must be same TDE wallet. Run this step only if the TDE wallet is not already set as the default wallet for the endpoints using the Oracle Key Vault Server user interface.

```
/tmp/work/bin/okv manage-access wallet set-default --wallet <wallet_name>
--endpoint <endpoint_name>
```

7. Download the `okvclient.jar` file. For Oracle RAC database, download the `okvclient.jar` file corresponding to both endpoints. After downloading the files, copy the `okvclient.jar` corresponding to the remote instance to the remote node.

```
/tmp/work/bin/okv admin endpoint download --endpoint <endpoint_name> --
location <location>
```

When you download the endpoints, if you encounter a message such as `Endpoint token is already consumed`, then you must enroll the endpoint again as follows:

```
/tmp/work/bin/okv admin endpoint download --endpoint endpoint_name --
location location
/tmp/work/log/okv0.log.0 (Permission denied)
{
  "result" : "Failure",
  "message" : "Endpoint token is already consumed"
}

/tmp/work/bin/okv admin endpoint re-enroll --endpoint <endpoint_name>
/tmp/work/log/okv0.log.0 (Permission denied)
{
  "result" : "Success"
}
}
```

Step 4: Restoring TDE-enabled databases with TDE keys stored on Oracle Key Vault

For multi-user access-enabled systems, log in as database user. For non-multi user access enabled systems, log in as the `root` user. Use the `odacli irestore-database` command to restore a TDE-enabled database with TDE keys stored on Oracle Key Vault. Specify the options `--enable-tde`, `--okvclient-path`, and `keystore-type` in the command.

The option `--enable-tde,-t` indicates that the restored database must be configured with TDE. Use the option `--keystore-type,-kt` to specify the type of keystore for the TDE configuration. Use the option `--okvclient-path,-ocp` to specify the absolute path to the `okvclient.jar` file corresponding to the database endpoint. For single-instance database, you can specify one value in the `--okvclient-path,-ocp` option, whereas for Oracle RAC database, you can specify two values. Provide the TDE password when you are prompted. After the restore operation of the database is successful, the Oracle Key Vault endpoint software is installed in the `/etc/OKV/db_unique_name/okv` location. The local auto login TDE wallets are created in the `/etc/OKV/db_unique_name/tde` location.

To restore a single-instance database `okvdb` without using the Oracle Key Vault server configuration object, run the `odacli irestore-database` command as follows:

```
odacli irestore-database -r /tmp/bkpreport.json -n okvdb8 -y SI -t -kt OKV -
ocp /tmp/okvclient.jar
Enter SYS and SYSTEM user password:
Retype SYS and SYSTEM user password:
Enter TDE wallet password:
```

Job details

```
-----
ID: dce7bde6-7fc4-48ec-891b-649525f1ce4f
Description: Database service recovery with DB name: okvdb8
Status: Success
Created: August 28, 2024 2:50:46 PM CST
Message:
```

| Task Name | Node Name | Start |
|----------------------------------|--------------------------------|------------|
| Time | End Time | |
| Status | | |
| Restore Database | scaodal0ha13c2n1 | August 28, |
| 2024 2:51:09 PM CST | August 28, 2024 2:58:11 PM CST | |
| Failure | | |
| Restore Database | scaodal0ha13c2n1 | August 28, |
| 2024 2:51:10 PM CST | August 28, 2024 2:58:10 PM CST | |
| Failure | | |
| Check if cluster ware is running | scaodal0ha13c2n1 | August 28, |
| 2024 2:51:14 PM CST | August 28, 2024 2:51:14 PM CST | |
| Success | | |
| Check if cluster ware is running | scaodal0ha13c2n2 | August 28, |
| 2024 2:51:14 PM CST | August 28, 2024 2:51:14 PM CST | |
| Success | | |
| Creating DbStorage for DbRestore | scaodal0ha13c2n1 | August 28, |
| 2024 2:51:14 PM CST | August 28, 2024 2:51:21 PM CST | |
| Success | | |
| Validating DiskSpace for DATA | scaodal0ha13c2n1 | August 28, |
| 2024 2:51:14 PM CST | August 28, 2024 2:51:15 PM CST | |
| Success | | |
| Setting up SSH equivalence | scaodal0ha13c2n1 | August 28, |
| 2024 2:51:15 PM CST | August 28, 2024 2:51:19 PM CST | |
| Success | | |
| Configuring user access to ACFS | scaodal0ha13c2n1 | August 28, |
| 2024 2:51:20 PM CST | August 28, 2024 2:51:20 PM CST | |

```

Success
filesystems for
okvdb8st

Audit directory creation          scaoda10ha13c2n1      August 28,
2024 2:51:20 PM CST              August 28, 2024 2:51:21 PM CST
Success
Audit directory creation          scaoda10ha13c2n2      August 28,
2024 2:51:21 PM CST              August 28, 2024 2:51:21 PM CST
Success
Configure TDE for RestoreDb TaskFlow  scaoda10ha13c2n1      August 28,
2024 2:51:22 PM CST              August 28, 2024 2:51:39 PM CST
Success
Auxiliary Instance Creation        scaoda10ha13c2n2      August 28,
2024 2:51:24 PM CST              August 28, 2024 2:51:36 PM CST
Success
TDE Wallet directory creation      scaoda10ha13c2n1      August 28,
2024 2:51:36 PM CST              August 28, 2024 2:51:36 PM CST
Success
Installing OKV Client Software     scaoda10ha13c2n2      August 28,
2024 2:51:36 PM CST              August 28, 2024 2:51:37 PM CST
Success
Auto login TDE Wallet creation     scaoda10ha13c2n1      August 28,
2024 2:51:37 PM CST              August 28, 2024 2:51:38 PM CST
Success
Password based TDE Wallet open     scaoda10ha13c2n1      August 28,
2024 2:51:38 PM CST              August 28, 2024 2:51:39 PM CST
Success
Install Object Store Swift module   scaoda10ha13c2n2      August 28,
2024 2:51:58 PM CST              August 28, 2024 2:52:16 PM CST
Success
Restoring Spfile From Casper       scaoda10ha13c2n2      August 28,
2024 2:52:16 PM CST              August 28, 2024 2:52:38 PM CST
Success
Customize Db Parameters            scaoda10ha13c2n2      August 28,
2024 2:52:38 PM CST              August 28, 2024 2:52:47 PM CST
Success
Create spfile for restore db       scaoda10ha13c2n2      August 28,
2024 2:52:47 PM CST              August 28, 2024 2:52:48 PM CST
Success
Restoring control file             scaoda10ha13c2n2      August 28,
2024 2:52:48 PM CST              August 28, 2024 2:53:11 PM CST
Success
Mounting db                        scaoda10ha13c2n2      August 28,
2024 2:53:11 PM CST              August 28, 2024 2:53:35 PM CST
Success
Validating backup for RestoreDB    scaoda10ha13c2n2      August 28,
2024 2:53:35 PM CST              August 28, 2024 2:53:41 PM CST
Success
Restoring DB for migration          scaoda10ha13c2n2      August 28,
2024 2:53:41 PM CST              August 28, 2024 2:54:26 PM CST
Success
Change DBID and/or DBName          scaoda10ha13c2n2      August 28,
2024 2:54:27 PM CST              August 28, 2024 2:54:28 PM CST
Success
Register Database taskflow         scaoda10ha13c2n1      August 28,

```

| | | | |
|--|------------|---------------------|------------|
| 2024 2:54:31 PM CST | August 28, | 2024 2:57:08 PM CST | |
| Success | | | |
| Create SPFile in shared loc | | scaoda10ha13c2n2 | August 28, |
| 2024 2:54:31 PM CST | August 28, | 2024 2:54:37 PM CST | |
| Success | | | |
| Delete Local Spfile | | scaoda10ha13c2n2 | August 28, |
| 2024 2:54:37 PM CST | August 28, | 2024 2:54:37 PM CST | |
| Success | | | |
| Register DB with clusterware | | scaoda10ha13c2n2 | August 28, |
| 2024 2:54:37 PM CST | August 28, | 2024 2:55:23 PM CST | |
| Success | | | |
| Set SysPassword and Create PwFile | | scaoda10ha13c2n1 | August 28, |
| 2024 2:55:23 PM CST | August 28, | 2024 2:55:25 PM CST | |
| Success | | | |
| Enable block change tracking | | scaoda10ha13c2n2 | August 28, |
| 2024 2:55:26 PM CST | August 28, | 2024 2:55:28 PM CST | |
| Success | | | |
| Creating pfile | | scaoda10ha13c2n2 | August 28, |
| 2024 2:55:28 PM CST | August 28, | 2024 2:55:29 PM CST | |
| Success | | | |
| Updating db env | | scaoda10ha13c2n2 | August 28, |
| 2024 2:55:29 PM CST | August 28, | 2024 2:55:30 PM CST | |
| Success | | | |
| Enable DbSizing Template | | scaoda10ha13c2n2 | August 28, |
| 2024 2:55:30 PM CST | August 28, | 2024 2:56:20 PM CST | |
| Success | | | |
| Create tns entry | | scaoda10ha13c2n1 | August 28, |
| 2024 2:56:20 PM CST | August 28, | 2024 2:56:21 PM CST | |
| Success | | | |
| Create tns entry | | scaoda10ha13c2n2 | August 28, |
| 2024 2:56:21 PM CST | August 28, | 2024 2:56:22 PM CST | |
| Success | | | |
| Running datapatch | | scaoda10ha13c2n2 | August 28, |
| 2024 2:56:22 PM CST | August 28, | 2024 2:56:23 PM CST | |
| Success | | | |
| Set CPU pool | | scaoda10ha13c2n1 | August 28, |
| 2024 2:56:23 PM CST | August 28, | 2024 2:56:23 PM CST | |
| Success | | | |
| Reset Associated Networks for Database | | scaoda10ha13c2n2 | August 28, |
| 2024 2:57:10 PM CST | August 28, | 2024 2:57:13 PM CST | |
| Success | | | |
| Reset Associated Networks | | scaoda10ha13c2n1 | August 28, |
| 2024 2:57:13 PM CST | August 28, | 2024 2:57:14 PM CST | |
| Success | | | |
| Set log_archive_dest for Database | | scaoda10ha13c2n2 | August 28, |
| 2024 2:57:14 PM CST | August 28, | 2024 2:57:18 PM CST | |
| Success | | | |
| Setting Database parameter for OKV | | scaoda10ha13c2n1 | August 28, |
| 2024 2:57:18 PM CST | August 28, | 2024 2:58:05 PM CST | |
| Success | | | |
| Enable New Tablespace Encryption | | scaoda10ha13c2n2 | August 28, |
| 2024 2:58:07 PM CST | August 28, | 2024 2:58:08 PM CST | |
| Success | | | |
| Deleting OKV Client Software Jar | | scaoda10ha13c2n2 | August 28, |
| 2024 2:58:09 PM CST | August 28, | 2024 2:58:09 PM CST | |
| Success | | | |

```
Copy Pwfile to Shared Storage          scaoda10ha13c2n1          August 28,
2024 2:58:09 PM CST                   August 28, 2024 2:58:10 PM CST          Success
```

To restore an Oracle RAC database, run the `odacli irestore-database` command as follows. Specify the `okvclient.jar` file for the local database instance first, followed by the path to the `okvclient.jar` file for the remote database instance in the request. In the following example, the `okvclient.jar` file in the `/tmp/dir1` location belongs to the local node and the `okvclient.jar` file in the `/tmp/dir2` location belongs to the remote node.

```
odacli irestore-database -r /tmp/bkpreport.json -n okvdb7 -y RAC -t -kt OKV -
ocp /tmp/dir1/okvclient.jar,/tmp/dir2/okvclient.jar
Enter SYS and SYSTEM user password:
Retype SYS and SYSTEM user password:
Enter TDE wallet password:
```

Job details

```
-----
ID: 79b2d96c-0156-444b-b965-185b311f5110
Description: Database service recovery with DB name: okvdb7
Status: Success
Created: August 28, 2024 12:58:39 AM CST
Message:
```

| Task Name | Node Name | Start |
|----------------------------------|---------------------------------|------------|
| Time | End Time | |
| Status | | |
| Check if cluster ware is running | scaoda10ha13c2n1 | August 28, |
| 2024 12:59:07 AM CST | August 28, 2024 12:59:07 AM CST | |
| Success | | |
| Check if cluster ware is running | scaoda10ha13c2n2 | August 28, |
| 2024 12:59:07 AM CST | August 28, 2024 12:59:07 AM CST | |
| Success | | |
| Creating DbStorage for DbRestore | scaoda10ha13c2n1 | August 28, |
| 2024 12:59:07 AM CST | August 28, 2024 12:59:14 AM CST | |
| Success | | |
| Validating DiskSpace for DATA | scaoda10ha13c2n1 | August 28, |
| 2024 12:59:08 AM CST | August 28, 2024 12:59:08 AM CST | |
| Success | | |
| Setting up SSH equivalence | scaoda10ha13c2n1 | August 28, |
| 2024 12:59:09 AM CST | August 28, 2024 12:59:12 AM CST | |
| Success | | |
| Configuring user access to ACFS | scaoda10ha13c2n1 | August 28, |
| 2024 12:59:13 AM CST | August 28, 2024 12:59:13 AM CST | |
| Success | | |
| filesystems for | | |
| okvdb7 | | |
| Audit directory creation | scaoda10ha13c2n1 | August 28, |
| 2024 12:59:14 AM CST | August 28, 2024 12:59:14 AM CST | |
| Success | | |
| Audit directory creation | scaoda10ha13c2n2 | August 28, |
| 2024 12:59:14 AM CST | August 28, 2024 12:59:14 AM CST | |

```

Success
Configure TDE for RestoreDb TaskFlow      scaodal0ha13c2n1      August 28,
2024 12:59:15 AM CST      August 28, 2024 12:59:32 AM CST
Success
Auxiliary Instance Creation                scaodal0ha13c2n1      August 28,
2024 12:59:17 AM CST      August 28, 2024 12:59:28 AM CST
Success
TDE Wallet directory creation              scaodal0ha13c2n1      August 28,
2024 12:59:28 AM CST      August 28, 2024 12:59:28 AM CST
Success
Installing OKV Client Software              scaodal0ha13c2n1      August 28,
2024 12:59:28 AM CST      August 28, 2024 12:59:29 AM CST
Success
Installing OKV Client Software              scaodal0ha13c2n2      August 28,
2024 12:59:30 AM CST      August 28, 2024 12:59:31 AM CST
Success
Auto login TDE Wallet creation              scaodal0ha13c2n1      August 28,
2024 12:59:31 AM CST      August 28, 2024 12:59:32 AM CST
Success
Password based TDE Wallet open              scaodal0ha13c2n1      August 28,
2024 12:59:32 AM CST      August 28, 2024 12:59:32 AM CST
Success
Install Object Store Swift module           scaodal0ha13c2n2      August 28,
2024 12:59:51 AM CST      August 28, 2024 1:00:09 AM CST
Success
Restoring Spfile From Casper                scaodal0ha13c2n1      August 28,
2024 1:00:09 AM CST      August 28, 2024 1:00:28 AM CST
Success
Customize Db Parameters                     scaodal0ha13c2n1      August 28,
2024 1:00:28 AM CST      August 28, 2024 1:00:34 AM CST
Success
Create spfile for restore db                scaodal0ha13c2n1      August 28,
2024 1:00:34 AM CST      August 28, 2024 1:00:35 AM CST
Success
Restoring control file                      scaodal0ha13c2n1      August 28,
2024 1:00:35 AM CST      August 28, 2024 1:00:58 AM CST
Success
Mounting db                                scaodal0ha13c2n1      August 28,
2024 1:00:58 AM CST      August 28, 2024 1:01:23 AM CST
Success
Validating backup for RestoreDB             scaodal0ha13c2n1      August 28,
2024 1:01:23 AM CST      August 28, 2024 1:01:29 AM CST
Success
Restoring DB for migration                  scaodal0ha13c2n1      August 28,
2024 1:01:29 AM CST      August 28, 2024 1:10:54 AM CST
Success
Re-Create control file                      scaodal0ha13c2n1      August 28,
2024 1:10:54 AM CST      August 28, 2024 1:11:36 AM CST
Success
Change DBID and/or DBName                  scaodal0ha13c2n1      August 28,
2024 1:11:36 AM CST      August 28, 2024 1:14:34 AM CST
Success
Removing Disabled Redo Threads              scaodal0ha13c2n1      August 28,
2024 1:14:34 AM CST      August 28, 2024 1:14:36 AM CST
Success
Updating DB attributes                       scaodal0ha13c2n1      August 28,

```

| | | | |
|---------------------------------------|------------|---------------------|------------|
| 2024 1:14:36 AM CST | August 28, | 2024 1:14:37 AM CST | |
| Success | | | |
| Customize DB for Type RAC/RacOne | | scaoda10ha13c2n1 | August 28, |
| 2024 1:14:37 AM CST | August 28, | 2024 1:14:44 AM CST | |
| Success | | | |
| Enable cluster ware for rac/racone db | | scaoda10ha13c2n1 | August 28, |
| 2024 1:14:45 AM CST | August 28, | 2024 1:14:45 AM CST | |
| Success | | | |
| Building Cluster DB Views for Rac and | | scaoda10ha13c2n1 | August 28, |
| 2024 1:14:45 AM CST | August 28, | 2024 1:14:56 AM CST | |
| Success | | | |
| RacOne | | | |
| Register Database taskflow | | scaoda10ha13c2n1 | August 28, |
| 2024 1:14:58 AM CST | August 28, | 2024 1:20:24 AM CST | |
| Success | | | |
| Create SPFile in shared loc | | scaoda10ha13c2n1 | August 28, |
| 2024 1:14:59 AM CST | August 28, | 2024 1:15:05 AM CST | |
| Success | | | |
| Delete Local Spfile | | scaoda10ha13c2n1 | August 28, |
| 2024 1:15:05 AM CST | August 28, | 2024 1:15:05 AM CST | |
| Success | | | |
| Register DB with clusterware | | scaoda10ha13c2n1 | August 28, |
| 2024 1:15:05 AM CST | August 28, | 2024 1:16:33 AM CST | |
| Success | | | |
| Add Startup Trigger to Open all PDBS | | scaoda10ha13c2n1 | August 28, |
| 2024 1:16:33 AM CST | August 28, | 2024 1:16:33 AM CST | |
| Success | | | |
| Set SysPassword and Create PwFile | | scaoda10ha13c2n1 | August 28, |
| 2024 1:16:34 AM CST | August 28, | 2024 1:16:38 AM CST | |
| Success | | | |
| Enable block change tracking | | scaoda10ha13c2n1 | August 28, |
| 2024 1:16:38 AM CST | August 28, | 2024 1:16:54 AM CST | |
| Success | | | |
| Creating pfile | | scaoda10ha13c2n1 | August 28, |
| 2024 1:16:55 AM CST | August 28, | 2024 1:16:56 AM CST | |
| Success | | | |
| Updating db env | | scaoda10ha13c2n1 | August 28, |
| 2024 1:16:56 AM CST | August 28, | 2024 1:16:56 AM CST | |
| Success | | | |
| Enable DbSizing Template | | scaoda10ha13c2n1 | August 28, |
| 2024 1:16:56 AM CST | August 28, | 2024 1:18:38 AM CST | |
| Success | | | |
| Update Database Global Name | | scaoda10ha13c2n1 | August 28, |
| 2024 1:18:39 AM CST | August 28, | 2024 1:18:40 AM CST | |
| Success | | | |
| Create tns entry | | scaoda10ha13c2n1 | August 28, |
| 2024 1:18:40 AM CST | August 28, | 2024 1:18:42 AM CST | |
| Success | | | |
| Create tns entry | | scaoda10ha13c2n2 | August 28, |
| 2024 1:18:42 AM CST | August 28, | 2024 1:18:43 AM CST | |
| Success | | | |
| Running datapatch | | scaoda10ha13c2n1 | August 28, |
| 2024 1:18:43 AM CST | August 28, | 2024 1:19:19 AM CST | |
| Success | | | |

```

Set CPU pool                                scaoda10ha13c2n1      August 28,
2024 1:19:19 AM CST                        August 28, 2024 1:19:19 AM CST
Success
Reset Associated Networks for Database       scaoda10ha13c2n1      August 28,
2024 1:20:26 AM CST                        August 28, 2024 1:20:30 AM CST
Success
Reset Associated Networks                   scaoda10ha13c2n2      August 28,
2024 1:20:30 AM CST                        August 28, 2024 1:20:31 AM CST
Success
Set log_archive_dest for Database          scaoda10ha13c2n1      August 28,
2024 1:20:31 AM CST                        August 28, 2024 1:20:34 AM CST
Success
Auto login TDE Wallet creation              scaoda10ha13c2n1      August 28,
2024 1:20:34 AM CST                        August 28, 2024 1:20:36 AM CST
Success
Setting Database parameter for OKV         scaoda10ha13c2n1      August 28,
2024 1:20:36 AM CST                        August 28, 2024 1:22:17 AM CST
Success
Enable New Tablespace Encryption           scaoda10ha13c2n1      August 28,
2024 1:22:19 AM CST                        August 28, 2024 1:22:20 AM CST
Success
Deleting OKV Client Software Jar           scaoda10ha13c2n1      August 28,
2024 1:22:20 AM CST                        August 28, 2024 1:22:20 AM CST
Success
Deleting OKV Client Software Jar           scaoda10ha13c2n2      August 28,
2024 1:22:20 AM CST                        August 28, 2024 1:22:20 AM CST
Success

```

Related Topics

- [odacli Multi-User Access Commands](#)
Use `odacli` commands to enable multi-user access for the appliance.

Deleting TDE-enabled Databases

Understand how you can delete a TDE-enabled database on Oracle Database Appliance on bare metal and DB systems, that uses Oracle Key Vault to store TDE keys.

Use the `odacli delete-database` command to delete TDE-enabled database with TDE keys stored on Oracle Key Vault. Use the `-n` option to specify the name of the database to be deleted.

```

odacli delete-database -n kokvdb1
{
  "jobId" : "6f001840-5002-43ee-9067-e22930e36d58",
  "status" : "Running",
  "message" : null,
  "reports" : [ {
    "taskId" : "TaskDcsJsonRpcExt_2259",
    "taskName" : "Validate DB 9aeceb5f-afc5-4051-8bd1-00c62048ca01 for
deletion",
    "nodeName" : "scaoda6m006",
    "taskResult" : "",
    "startTime" : "July 15, 2024 15:40:50 PM CST",
    "endTime" : "July 15, 2024 15:40:50 PM CST",
    "duration" : "00:00:00.13",
    "status" : "Success",

```

```

    "taskDescription" : null,
    "parentTaskId" : "TaskSequential_2257",
    "jobId" : "6f001840-5002-43ee-9067-e22930e36d58",
    "tags" : [ ],
    "reportLevel" : "Info",
    "updatedAt" : "July 15, 2024 15:40:50 PM CST"
  } ],
  "createTimestamp" : "July 15, 2024 15:40:49 PM CST",
  "resourceList" : [ ],
  "description" : "Database service deletion with DB name: kokvdb1 with ID :
9aeeeb5f-afc5-4051-8bd1-00c62048ca01",
  "updatedAt" : "July 15, 2024 15:40:50 PM CST",
  "jobType" : null
}

```

```
odacli describe-job -i 6f001840-5002-43ee-9067-e22930e36d58
```

Job details

```

-----
ID: 6f001840-5002-43ee-9067-e22930e36d58
Description: Database service deletion with DB name: kokvdb1
with ID : 9aeeeb5f-afc5-4051-8bd1-00c62048ca01
Status: Success
Created: July 15, 2024 3:40:49 PM CST
Message:

```

| Task Name | Start |
|-----------------------------|--------------------------|
| Time | End Time |
| Status | |
| ----- | ----- |
| ----- | ----- |
| ----- | ----- |
| Validate DB | July 15, 2024 3:40:50 PM |
| CST | Success |
| 9aeeeb5f- | |
| afc5-4051-8bd1-00c62048ca01 | |

for
deletion

| | |
|----------------------------|--------------------------|
| Deleting the RMAN logs | July 15, 2024 3:40:50 PM |
| CST | Success |
| OKV Endpoint deletion | July 15, 2024 3:40:51 PM |
| CST | Success |
| OKV Wallet deletion | July 15, 2024 3:40:56 PM |
| CST | Success |
| OKV Files deletion | July 15, 2024 3:41:05 PM |
| CST | Success |
| Database Deletion By RHP | July 15, 2024 3:41:05 PM |
| CST | Success |
| Unregister DB From Cluster | July 15, 2024 3:42:37 PM |
| CST | Success |
| Kill PMON Process | July 15, 2024 3:42:37 PM |
| CST | Success |
| Database Files Deletion | July 15, 2024 3:42:37 PM |
| CST | Success |

Delete File Groups of Database kokvdb1 July 15, 2024 3:42:49 PM
CST July 15, 2024 3:42:58 PM CST Success

Related Topics

- [odacli Multi-User Access Commands](#)
Use `odacli` commands to enable multi-user access for the appliance.

Creating an Oracle Key Vault User Using BUI

Create a user with Oracle Key Vault server configuration entitlement on a multi-user access enabled Oracle Database Appliance.

Creating an Oracle Key Vault User with Browser User Interface

1. Log into the Browser User Interface as the `odaadmin` user:

```
https://host-ip-address:7093/mgmt/index.html
```

2. Click the **Multi-User Access** tab.
3. Click the Users link on the left-hand pane.
4. Click **Create User**.
5. In the Create User page, provide the **User ID**, specify the **Role** as `ODA-OKVCONFIGADMIN`, and provide the **ODA Password** for this user. Note that the same user credentials work for login for BUI and ODACLI commands.
6. Click **Create**.
7. The job is submitted and a confirmation page appears with a link to the job. Click the link to view the job progress, tasks, and status. After you close the Job confirmation page, you can click the **Activity** tab to monitor the job progress. Click the job number to view the tasks and status details. Click **Refresh** to refresh the page.
8. The account is created with Inactive state. Log into the BUI with the user credentials. You are prompted to change the password. Change the password and log into the BUI with the new password.

Related Topics

- [odacli Multi-User Access Commands](#)
Use `odacli` commands to enable multi-user access for the appliance.

Creating Oracle Key Vault Server Configuration Object Using the BUI

Understand how you can create TDE-enabled database on Oracle Database Appliance with TDE keys stored in Oracle Key Vault on bare metal and DB systems using the BUI.

Follow these steps to create a TDE-enabled database with TDE keys stored on Oracle Key Vault on Oracle Database Appliance bare metal and DB systems:

1. Log into the Browser User Interface:

```
https://host-ip-address:7093/mgmt/index.html
```
2. Click **Credential Store**, then click **Oracle Key Vault Server Config**.
3. The existing Oracle Key Vault server configurations are displayed.
4. Click **Create** and create an Oracle Key Vault server configuration.

5. In the Create OKV Server Config page, specify the **OKV Server Config Name**, **OKV Server Host**, **OKV Server IP address**, **OKV User Name**, and **Password**.
6. Click **Create**.
7. Confirm the creation request job and verify that the job completed successfully.

Related Topics

- [odacli Multi-User Access Commands](#)
Use `odacli` commands to enable multi-user access for the appliance.

Granting and Revoking Access on Oracle Key Vault Server Configuration Using BUI

Understand how you can grant and revoke access to Oracle Key Vault server configuration on Oracle Database Appliance on bare metal and DB systems using BUI.

Granting and Revoking Access to Oracle Key Vault server configurations

Follow these steps:

1. Log into the Browser User Interface:
`https://host-ip-address:7093/mgmt/index.html`
2. Click **Credential Store**, then click **Oracle Key Vault Server Config**.
3. You can view all existing Oracle Key Vault server configurations.
4. To grant access to an existing Oracle Key Vault server configuration, select the Oracle Key Vault server configuration, and from the **Actions** drop-down list, select **Grant Access**.
5. In the Grant Resource Access page, select the **User Name** to whom you want to grant access to the resource.
6. Click **Grant**.
7. Click **Yes** to confirm the action.
8. To revoke access to an existing Oracle Key Vault server configuration, select the Oracle Key Vault server configuration, and from the **Actions** drop-down list, select **Revoke Access**.
9. In the Revoke Resource Access page, select the **User Name** from whom you want to revoke access to the resource.
10. Click **Revoke**.
11. Click **Yes** to confirm the action.

Related Topics

- [odacli Multi-User Access Commands](#)
Use `odacli` commands to enable multi-user access for the appliance.

Managing Oracle Key Vault Server Configuration Operations Using BUI

Understand how you can manage Oracle Key Vault server configuration operations on Oracle Database Appliance on bare metal and DB systems.

You can create, list, delete, and describe Oracle Key Vault server configuration on Oracle Database Appliance bare metal and DB systems using the Browser User Interface (BUI).

Listing and Deleting Oracle Key Vault server configurations:

Follow these steps:

1. Log into the Browser User Interface:
`https://host-ip-address:7093/mgmt/index.html`
2. Click **Credential Store**, then click **Oracle Key Vault Tasks**.
3. You can view all existing Oracle Key Vault server configurations.
4. To delete an existing Oracle Key Vault server configuration, select the Oracle Key Vault server configuration, and from the **Actions** drop-down list, select **Delete**.

Related Topics

- [odacli Multi-User Access Commands](#)
Use `odacli` commands to enable multi-user access for the appliance.

Manual Migration and Encryption of Data into TDE-Enabled Database

Understand how you can migrate transportable tablespaces to TDE-enabled database on Oracle Database Appliance.

- [Migrating Tablespaces from Non-TDE Oracle ACFS Database to Oracle ACFS Database on Oracle Database Appliance](#)
Understand how you can migrate tablespaces from non-TDE Oracle ACFS database to Oracle ACFS database with Oracle Key Vault enabled on Oracle Database Appliance.
- [Migrating Tablespaces from Non-TDE Oracle ASM Database to Oracle ASM Database on Oracle Database Appliance](#)
Understand how you can migrate tablespaces from non-TDE Oracle ASM database to Oracle ASM database with Oracle Key Vault enabled on Oracle Database Appliance.
- [Migrating Tablespaces from Non-TDE Oracle ASM Database to Oracle ASM CDB Database on Oracle Database Appliance](#)
Understand how you can migrate tablespaces from non-TDE Oracle ASM database to Oracle ASM CDB database with Oracle Key Vault enabled on Oracle Database Appliance.
- [Migrating Tablespaces from Non-TDE Oracle ACFS Database to Oracle ACFS CDB Database on Oracle Database Appliance](#)
Understand how you can migrate tablespaces from non-TDE Oracle ACFS database to Oracle ACFS CDB database with Oracle Key Vault enabled on Oracle Database Appliance.

Migrating Tablespaces from Non-TDE Oracle ACFS Database to Oracle ACFS Database on Oracle Database Appliance

Understand how you can migrate tablespaces from non-TDE Oracle ACFS database to Oracle ACFS database with Oracle Key Vault enabled on Oracle Database Appliance.

Ensure that there is a source and destination database. The two databases can be on one Oracle Database Appliance server or on different servers. The source database must be a non TDE-enabled database, either an Oracle Database Appliance database or any Oracle database with compatible Endian. The destination database must be an Oracle Database Appliance database created with ODACLI commands.

Step 1: Export the tablespace from the source database

1. Create a tablespace TBS01 and table TAB1 on source database DBNOTDE Create an extra tablespace TBS01 on the source database, and then, create table TAB1 on the new tablespace.

```
SQL> select TABLESPACE_NAME, ENCRYPTED from dba_tablespaces ;
```

| TABLESPACE_NAME | STATUS | ENC |
|-----------------|--------|-----|
| SYSTEM | ONLINE | NO |
| SYSAUX | ONLINE | NO |
| UNDOTBS1 | ONLINE | NO |
| TEMP | ONLINE | NO |
| USERS | ONLINE | NO |

```
###
```

```
### Checks if a set of tablespaces (to be transported) is self-contained
```

```
###
```

```
SQL> EXECUTE DBMS_TTS.TRANSPORT_SET_CHECK('tbs01',true) ;
```

```
PL/SQL procedure successfully completed.
```

2. Create the database directory in the source database DBNOTDE to be used for the export. Create a database directory object in the destination database to be used by expdp.

```
###
```

```
### login as oracle user
```

```
###
```

```
$ mkdir -pv /u01/app/odaorabase0/oracle/dpdump/ttsps_dir
```

```
mkdir: created directory '/u01/app/odaorabase0/oracle/dpdump/ttsps_dir'
```

```
###
```

```
### Connect to database using SQLPLUS as sysdba user ( sqlplus / as sysdba ) and run the following
```

```
###
```

```
SQL> CREATE DIRECTORY ttsps_dir AS '/u01/app/odaorabase0/oracle/dpdump/ttsps_dir';
```

```
Directory created.
```

```
SQL>
```

3. Export the TBS01 tablespace from source database DBNOTDE. First, set the tablespace to be copied in READ ONLY mode. Next, run expdp on the designated tablespace. Review the log files for expdp stored under the database directory ttsps_dir.

```
###
```

```
### login as oracle user
```

```
### Connect to database using SQLPLUS as sysdba user ( sqlplus / as sysdba ) and run the following
```

```
###
```

```
SQL> ALTER TABLESPACE TBS01 READ ONLY;
```

```
Tablespace altered.
```

```
###
```

```
### Run expdp as SYSTEM user, password for SYSTEM need to be entered when  
prompted
```

```
###
```

```
$ expdp system TRANSPORT_TABLESPACES=TBS01 TRANSPORT_FULL_CHECK=YES  
DIRECTORY=ttsp_dir DUMPFILE=expttps.dmp
```

```
Export: Release 19.0.0.0.0 - Production on Mon Nov 6 12:47:00 2023  
Version 19.25.0.0.0
```

```
Copyright (c) 1982, 2019, Oracle and/or its affiliates. All rights  
reserved.
```

```
Password:
```

```
Connected to: Oracle Database 19c Enterprise Edition Release 19.0.0.0.0 -  
Production
```

```
Starting "SYSTEM"."SYS_EXPORT_TRANSPORTABLE_01": system/*****  
TRANSPORT_TABLESPACES=TBS01 TRANSPORT_FULL_CHECK=YES DIRECTORY=ttsp_dir  
DUMPFILE=expttps.dmp
```

```
Processing object type TRANSPORTABLE_EXPORT/STATISTICS/TABLE_STATISTICS
```

```
Processing object type TRANSPORTABLE_EXPORT/PLUGTS_BLK
```

```
Processing object type TRANSPORTABLE_EXPORT/POST_INSTANCE/PLUGTS_BLK
```

```
Processing object type TRANSPORTABLE_EXPORT/TABLE
```

```
Master table "SYSTEM"."SYS_EXPORT_TRANSPORTABLE_01" successfully loaded/  
unloaded
```

```
*****  
***
```

```
Dump file set for SYSTEM.SYS_EXPORT_TRANSPORTABLE_01 is:
```

```
/u01/app/odaorabase0/oracle/dpdump/ttsp_dir/expttps.dmp
```

```
*****  
***
```

```
Datafiles required for transportable tablespace TBS01:
```

```
/u02/app/oracle/oradata/dbnotde/DBNOTDE/datafile/
```

```
o1_mf_tbs01_lnlgn65j_.dbf
```

```
Job "SYSTEM"."SYS_EXPORT_TRANSPORTABLE_01" successfully completed at Mon  
Nov 6 12:47:19 2023 elapsed 0 00:00:14
```

4. Move data files to the destination database server and edit the status of the data file in the source database DBNOTDE to READ WRITE. Move the data file to the TDE-enabled database server in the location /u02/app/oracle/oradata/dbtde/DBTDE/datafile.

```
###
```

```
### login as oracle user
```

```
###
```

```
$ cp /u02/app/oracle/oradata/dbnotde/DBNOTDE/datafile/
```

```
o1_mf_tbs01_lnlgn65j_.dbf /u02/app/oracle/oradata/dbtde/DBTDE/datafile/
```

```
o1_mf_tbs01_lnlgn65j_.dbf
```

```
###
### In source database, set the tablespace back to read write mode
### Connect to database using SQLPLUS as sysdba user ( sqlplus / as
sysdba ) and run the following
###
```

```
SQL> ALTER TABLESPACE TBS01 READ WRITE;
```

Step 2: Import the tablespaces into a TDE-enabled database

1. Create a TDE-enabled database with Oracle Key Vault, DBTDE as the destination database, as described in the earlier procedure. Copy the data file and tablespace of the source database to this database using `expdp` and `impdp`. Create the database on an Oracle Database Appliance using the Browser User Interface (BUI) or ODACLI commands. For example:

```
# odacli create-database -n dbtde -t -kt okv -osc adminobj1 -dh
e2a65596-6435-4410-9e8d-6b21a6005779 -r ACFS
```

```
# odacli describe-database -n dbtde
Database details
```

```
-----
                ID: e261b9f8-8212-499b-840e-eb6ea3e09447
Description: dbtde
      DB Name: dbtde
      DB Type: SI
         CDB: false
      Storage: ACFS
      Home ID: e2a65596-6435-4410-9e8d-6b21a6005779
TDE Wallet Management: ODA
      TDE Enabled: true
KeystoreType : OKV
```

2. Create the database directory in the Oracle Key Vault-enabled destination database for the import operation. The source database `expdp` dump file and output for `impdp` is stored in the database directory object. Copy the `expdp` dump file from the source database server to this server, and use the `impdp` dump file to add tablespace metadata to destination database.

```
###
### login as sysdba user and run the following:
### Connect to database using SQLPLUS as sysdba user ( sqlplus / as
sysdba ) and run the following
###
```

```
SQL> CREATE DIRECTORY ttsps_dir AS '/u01/app/odaorabase0/oracle/dpdump/
ttsps_dir';
```

```
Directory created.
```

3. Import the TBS01 tablespace to the destination database DBTDE. Copy the `expdp` dump file of the source database to the database directory `ttsps_dir`. The `impdp` uses the dump

file to add tablespace metadata to destination database. TRANSPORT_DATAFILES references the location of the data file in the destination database.

```
###
### Run impdp as SYSTEM user, password for SYSTEM need to be entered when
prompted
###

$ impdp system TRANSPORT_DATAFILES='\u02/app/oracle/oradata/dbtde/DBTDE/
datafile/o1_mf_tbs01_lnlgn65j_.dbf\' DIRECTORY=ttsp_dir
dumpfile=expttps.dmp

Import: Release 19.0.0.0.0 - Production on Mon Nov 6 12:53:37 2023
Version 19.25.0.0.0

Copyright (c) 1982, 2019, Oracle and/or its affiliates. All rights
reserved.
Password:

Connected to: Oracle Database 19c Enterprise Edition Release 19.0.0.0.0 -
Production
Master table "SYSTEM"."SYS_IMPORT_TRANSPORTABLE_01" successfully loaded/
unloaded
Starting "SYSTEM"."SYS_IMPORT_TRANSPORTABLE_01": system/*****
TRANSPORT_DATAFILES='/u02/app/oracle/oradata/dbtde/DBTDE/datafile/
o1_mf_tbs01_lnlgn65j_.dbf' DIRECTORY=ttsp_dir dumpfile=expttps.dmp
Processing object type TRANSPORTABLE_EXPORT/PLUGTS_BLK
Processing object type TRANSPORTABLE_EXPORT/TABLE
Processing object type TRANSPORTABLE_EXPORT/STATISTICS/TABLE_STATISTICS
Processing object type TRANSPORTABLE_EXPORT/POST_INSTANCE/PLUGTS_BLK
Job "SYSTEM"."SYS_IMPORT_TRANSPORTABLE_01" successfully completed at Mon
Nov 6 12:53:46 2023 elapsed 0 00:00:03
```

4. Enable and test encryption on the destination Oracle Key Vault-enabled database.

```
###
### login as oracle user
### Connect to database using SQLPLUS as sysdba user ( sqlplus / as
sysdba ) and run the following
###

SQL> select TABLESPACE_NAME, STATUS , ENCRYPTED from dba_tablespaces ;

TABLESPACE_NAME          STATUS  ENC
-----
SYSTEM                   ONLINE  YES
SYSaux                   ONLINE  YES
UNDOTBS1                 ONLINE  YES
TEMP                     ONLINE  YES
USERS                     ONLINE  YES
TBS01                    READ ONLY NO

SQL> alter tablespace TBS01 read write ;
```

Tablespace altered.

```
SQL> alter tablespace TBS01 encryption online encrypt ;
```

Tablespace altered.

```
SQL> select TABLESPACE_NAME, STATUS , ENCRYPTED from dba_tablespaces ;
```

| TABLESPACE_NAME | STATUS | ENC |
|-----------------|--------|-----|
| SYSTEM | ONLINE | YES |
| SYSAUX | ONLINE | YES |
| UNDOTBS1 | ONLINE | YES |
| TEMP | ONLINE | YES |
| USERS | ONLINE | YES |
| TBS01 | ONLINE | YES |

###

Retrieve the data from TAB1

###

```
SQL> select OWNER, table_name from tab1 where rownum < 3;
```

OWNER

TABLE_NAME

SYS

TS\$

SYS

ICOL\$

###

When the wallet is closed or unavailable, same SQL does not retrieve data

To simulate wallet absence rename the cwallet.sso wallet under <wallet_root>/tde to some other name like cwallet.sso.orig

and close the wallet. To return auto-login wallet , rename file back to cwallet.sso and run the SQL again.

###

```
SQL> show parameter wallet_root
```

| NAME | TYPE | VALUE |
|-------------|--------|----------------|
| wallet_root | string | /etc/OKV/dbtde |

```
SQL> ! mv /etc/OKV/dbtde/tde/cwallet.sso /etc/OKV/dbtde/tde/cwallet.sso.orig
```



```
SQL> ADMINISTER KEY MANAGEMENT SET KEYSTORE CLOSE ;

SQL> select OWNER, table_name from tab1 where rownum < 3;
select OWNER, table_name from tab1 where rownum < 3
*
ERROR at line 1:
ORA-28365: wallet is not open

SQL> ! mv /etc/OKV/dbtde/tde/cwallet.sso.orig /etc/OKV/dbtde/tde/
cwallet.sso

SQL> select OWNER, table_name from tab1 where rownum < 3
2 ;

OWNER
-----
-----
TABLE_NAME
-----
-----
SYS
TS$

SYS
ICOL$
```

Related Topics

- [odacli Multi-User Access Commands](#)
Use `odacli` commands to enable multi-user access for the appliance.

Migrating Tablespaces from Non-TDE Oracle ASM Database to Oracle ASM Database on Oracle Database Appliance

Understand how you can migrate tablespaces from non-TDE Oracle ASM database to Oracle ASM database with Oracle Key Vault enabled on Oracle Database Appliance.

Ensure that there is a source and destination database. The two databases can be on one Oracle Database Appliance server or on different servers. The source database must be a non TDE-enabled database, either an Oracle Database Appliance database or any Oracle database with compatible Endian. The destination database must be an Oracle Database Appliance database created with ODACLI commands and with Oracle Key Vault enabled on it.

Step 1: Export the tablespace from the source database

1. Create a tablespace TBS01 and table TAB1 on source database ASMNOTDE Create an extra tablespace TBS01 on the source database, and then, create table TAB1 on the new tablespace.

```
SQL> select TABLESPACE_NAME, STATUS , ENCRYPTED from dba_tablespaces ;
TABLESPACE_NAME          STATUS      ENC
-----
SYSTEM                   ONLINE     NO
SYSAUX                   ONLINE     NO
UNDOTBS1                  ONLINE     NO
```

```
TEMP                ONLINE    NO
USERS               ONLINE    NO
TBS01               ONLINE    NO
```

```
SQL> SQL> select FILE_NAME from dba_data_files where
TABLESPACE_NAME='TBS01' ;
```

```
FILE_NAME
-----
```

```
+DATA/ASMNOTDE/DATAFILE/tbs01.374.1152267015
```

```
###
```

```
### Checks if a set of tablespaces (to be transported) is self-contained
```

```
###
```

```
SQL> EXECUTE DBMS_TTS.TRANSPORT_SET_CHECK('tbs01',true) ;
```

```
PL/SQL procedure successfully completed.
```

2. Create the database directory in the source database ASMNOTDE to use for the export. Create a database directory object in the destination database for expdp.

```
###
```

```
### login as oracle user
```

```
###
```

```
$ mkdir -pv /u01/app/odaorabase0/oracle/dpdump/ttsp_dir
```

```
mkdir: created directory '/u01/app/odaorabase0/oracle/dpdump/ttsp_dir'
```

```
###
```

```
### Connect to database using SQLPLUS as sysdba user ( sqlplus / as
sysdba ) and run the following
```

```
###
```

```
SQL> CREATE DIRECTORY ttsp_dir AS '/u01/app/odaorabase0/oracle/dpdump/
ttsp_dir';
```

```
Directory created.
```

3. Export the TBS01 tablespace from the source database ASMNOTDE. First, set the tablespace to be copied in READ ONLY mode. Next, run expdp on the designated tablespace. Review the dump files for expdp stored under the database directory ttsp_dir.

```
###
```

```
### Set the tablespaces that you need to be exported in read-only mode
```

```
### login as Oracle user
```

```
### Connect to database using SQLPLUS as sysdba user ( sqlplus / as
sysdba ) and run the following
```

```
SQL> ALTER TABLESPACE TBS01 READ ONLY;
```

```
Tablespace altered.
```

```

SQL>

###
### Run expdp as SYSTEM user, password for SYSTEM need to be entered when
prompted
###

$ expdp system TRANSPORT_TABLESPACES=TBS01 TRANSPORT_FULL_CHECK=YES
DIRECTORY=ttsp_dir DUMPFILE=expttpsasm.dmp

Export: Release 19.0.0.0.0 - Production on Tue Nov 7 10:12:19 2023
Version 19.25.0.0.0

Copyright (c) 1982, 2019, Oracle and/or its affiliates. All rights
reserved.
Password:

Connected to: Oracle Database 19c Enterprise Edition Release 19.0.0.0.0 -
Production
Starting "SYSTEM"."SYS_EXPORT_TRANSPORTABLE_01": system/*****
TRANSPORT_TABLESPACES=TBS01 TRANSPORT_FULL_CHECK=YES DIRECTORY=ttsp_dir
DUMPFILE=expttpsasm.dmp
Processing object type TRANSPORTABLE_EXPORT/STATISTICS/TABLE_STATISTICS
Processing object type TRANSPORTABLE_EXPORT/PLUGTS_BLK
Processing object type TRANSPORTABLE_EXPORT/POST_INSTANCE/PLUGTS_BLK
Processing object type TRANSPORTABLE_EXPORT/TABLE
Master table "SYSTEM"."SYS_EXPORT_TRANSPORTABLE_01" successfully loaded/
unloaded
*****
***
Dump file set for SYSTEM.SYS_EXPORT_TRANSPORTABLE_01 is:
/u01/app/odaorabase0/oracle/dpdump/ttsp_dir/expttpsasm.dmp
*****
***
Datafiles required for transportable tablespace TBS01:
+DATA/ASMNOTDE/DATAFILE/tbs01.374.1152267015
Job "SYSTEM"."SYS_EXPORT_TRANSPORTABLE_01" successfully completed at Tue
Nov 7 10:12:49 2023 elapsed 0 00:00:20

```

4. Move data files to the destination database server and edit the status of the data file in the source database ASMNOTDE to READ WRITE.

```

###
### login to grid user
### Copying datafiles from ASM to filesystem
###

$ asmcmd cp +DATA/ASMNOTDE/DATAFILE/tbs01.295.1165369089 /home/grid/
tbs01.dbf
copying +DATA/ASMNOTDE/DATAFILE/tbs01.295.1165369089 -> /home/grid/
tbs01.dbf

###
### In source database, set the tablespace back to read write mode

```

```
### login as Oracle user
### Connect to database using SQLPLUS as sysdba user ( sqlplus / as
sysdba ) and run the following
###

SQL> ALTER TABLESPACE TBS01 READ WRITE;
```

Step 2: Import the tablespaces into a TDE-enabled database

1. Create a TDE-enabled database with Oracle Key Vault, ASMTDE as the destination database. Copy the data file and tablespace of the source database to this database using expdp and impdp. Create the database on an Oracle Database Appliance using the Browser User Interface (BUI) or ODACLI commands. For example:

```
# odacli create-database -n asmtde -t -kt okv -osc adminobj1 -dh
e2a65596-6435-4410-9e8d-6b21a6005779 -r ASM

# odacli describe-database -n asmtde
Database details
-----
                ID: 5dfa97d9-d774-4a4a-93a2-d21a36faf283
Description: asmtde
      DB Name: asmtde
      DB Type: SI
         CDB: false
      Storage: ASM
      Home ID: e2a65596-6435-4410-9e8d-6b21a6005779
TDE Wallet Management: ODA
      TDE Enabled: true
KeystoreType : OKV
```

2. Copy the data file from file system to the destination Oracle ASM location of ASMTDE.

```
###
### login to grid user
###

$ asmcmd cp /home/grid/tbs01.dbf +DATA/ASMTDE/DATAFILE/tbs01 --dest_dbname
ASMTDE
copying /home/grid/tbs01.dbf -> +DATA/ASMTDE/DATAFILE/tbs01

ASMCMD> ls --permission
User                               Group  Permission  Name
dbusr1@66d5786e6a057fd3bfa6ca745d993aef  rw-----
SYS_AUX.292.1165368127
dbusr1@66d5786e6a057fd3bfa6ca745d993aef  rw-----
SYSTEM.279.1165368093
dbusr1@66d5786e6a057fd3bfa6ca745d993aef  rw-----
UNDOTBS1.290.1165368143
dbusr1@66d5786e6a057fd3bfa6ca745d993aef  rw-----
USERS.288.1165368875
  grid@66d5786e6a057fd3bfa6ca745d993aef  rw-----  tbs01 => +DATA/
ASMTDE/DATAFILE/tbs01.294.1165425531
  grid@66d5786e6a057fd3bfa6ca745d993aef  rw-----
tbs01.294.1165425531
```

```

ASMCMD> chown dbusr1@66d5786e6a057fd3bfa6ca745d993aef tbs01
ASMCMD> ls --permission
User                               Group  Permission  Name
dbusr1@66d5786e6a057fd3bfa6ca745d993aef      rw-----
SYS_AUX.292.1165368127
dbusr1@66d5786e6a057fd3bfa6ca745d993aef      rw-----
SYSTEM.279.1165368093
dbusr1@66d5786e6a057fd3bfa6ca745d993aef      rw-----
UNDOTBS1.290.1165368143
dbusr1@66d5786e6a057fd3bfa6ca745d993aef      rw-----
USERS.288.1165368875
dbusr1@66d5786e6a057fd3bfa6ca745d993aef      rw-----  tbs01 => +DATA/
OKVDB2/DATAFILE/tbs012.294.1165425531
dbusr1@66d5786e6a057fd3bfa6ca745d993aef      rw-----
tbs01.294.1165425531

```

3. Create the database directory in the ASMTDE database for the import.

```

###
### login as oracle user
### Connect to database using SQLPLUS as sysdba user ( sqlplus / as
sysdba ) and run the following
###

SQL> CREATE DIRECTORY ttsps_dir AS '/u01/app/odaoracle0/oracle/dpdump/
ttsps_dir';

```

Directory created.

4. Import the TBS01 tablespace to the destination database ASMTDE. Copy the expdp dump file of the source database to the database directory ttsps_dir. The impdp uses the dump file to add tablespace metadata to destination database. TRANSPORT_DATAFILES references the location of the data file in the destination database.

```

###
### Run impdb as SYSTEM user, password for SYSTEM need to be entered when
prompted
###

$ impdp system TRANSPORT_DATAFILES='/u02/app/oracle/oradata/dbtde/DBTDE/
datafile/o1_mf_tbs01_lnlgn65j_.dbf\' DIRECTORY=ttsps_dir
dumpfile=expttps.dmp

```

```

Import: Release 19.0.0.0.0 - Production on Mon Nov 6 12:53:37 2023
Version 19.25.0.0.0

```

```

Copyright (c) 1982, 2019, Oracle and/or its affiliates. All rights
reserved.
Password:

```

```

Connected to: Oracle Database 19c Enterprise Edition Release 19.0.0.0.0 -
Production
Master table "SYSTEM"."SYS_IMPORT_TRANSPORTABLE_01" successfully loaded/
unloaded
Starting "SYSTEM"."SYS_IMPORT_TRANSPORTABLE_01": system/*****
TRANSPORT_DATAFILES='/u02/app/oracle/oradata/dbtde/DBTDE/datafile/

```

```
o1_mf_tbs01_lnlgn65j_.dbf' DIRECTORY=ttsp_dir dumpfile=expttps.dmp
Processing object type TRANSPORTABLE_EXPORT/PLUGTS_BLK
Processing object type TRANSPORTABLE_EXPORT/TABLE
Processing object type TRANSPORTABLE_EXPORT/STATISTICS/TABLE_STATISTICS
Processing object type TRANSPORTABLE_EXPORT/POST_INSTANCE/PLUGTS_BLK
Job "SYSTEM"."SYS_IMPORT_TRANSPORTABLE_01" successfully completed
```

5. Enable and test encryption on the destination Oracle Key Vault-enabled database.

```
###
### login as oracle user
### Connect to database using SQLPLUS as sysdba user ( sqlplus / as
sysdba ) and run the following
###

SQL> select TABLESPACE_NAME, STATUS , ENCRYPTED from dba_tablespaces ;

TABLESPACE_NAME          STATUS      ENC
-----
SYSTEM                    ONLINE     NO
SYSAUX                   ONLINE     NO
UNDOTBS1                  ONLINE     NO
TEMP                      ONLINE     NO
USERS                     ONLINE     YES
TBS01                     READ ONLY NO

6 rows selected.

SQL> alter tablespace TBS01 read write ;

Tablespace altered.

SQL>      alter tablespace TBS01 encryption online encrypt ;

Tablespace altered.

SQL> select TABLESPACE_NAME, STATUS , ENCRYPTED from dba_tablespaces ;

TABLESPACE_NAME          STATUS      ENC
-----
SYSTEM                    ONLINE     NO
SYSAUX                   ONLINE     NO
UNDOTBS1                  ONLINE     NO
TEMP                      ONLINE     NO
USERS                     ONLINE     YES
TBS01                     ONLINE     YES

6 rows selected.

###
### Retrieve the data from TAB1
###

SQL> select OWNER, table_name from tab1 where rownum < 3

OWNER
```

```

-----
-----
TABLE_NAME
-----
-----
SYS
TS$

SYS
ICOL$

###
### When the wallet is closed or unavailable, same SQL does not retrieve
data
### To simulate wallet absence rename the cwallet.sso wallet under
<wallet_root>/tde to some other name like cwallet.sso.orig
### and close the wallet. To return auto-login wallet , rename file back
to cwallet.sso and run the SQL again.
###

SQL> show parameter wallet_root

NAME                                TYPE      VALUE
-----
wallet_root                          string    /etc/OKV/asmtde

SQL> ! mv /etc/OKV/asmtde/tde/cwallet.sso /etc/OKV/asmtde/tde/
cwallet.sso.orig

SQL> ADMINISTER KEY MANAGEMENT SET KEYSTORE CLOSE ;

SQL> select OWNER, table_name from tab1 where rownum < 3;
select OWNER, table_name from tab1 where rownum < 3
*
ERROR at line 1:
ORA-28365: wallet is not open

SQL> ! mv /etc/OKV/asmtde/tde/cwallet.sso.orig /etc/OKV/asmtde/tde/
cwallet.sso

SQL> select OWNER, table_name from tab1 where rownum < 3
2 ;

OWNER
-----
-----
TABLE_NAME
-----
-----
SYS
TS$

```

```
SYS
ICOL$
```

Related Topics

- [odacli Multi-User Access Commands](#)
Use `odacli` commands to enable multi-user access for the appliance.

Migrating Tablespaces from Non-TDE Oracle ASM Database to Oracle ASM CDB Database on Oracle Database Appliance

Understand how you can migrate tablespaces from non-TDE Oracle ASM database to Oracle ASM CDB database with Oracle Key Vault enabled on Oracle Database Appliance.

Ensure that there is a source and destination database. The two databases can be on one Oracle Database Appliance server or on different servers. The source database must be a non TDE-enabled database, either an Oracle Database Appliance database or any Oracle database with compatible Endian. The destination database must be an Oracle Database Appliance database created with ODACLI commands and with Oracle Key Vault enabled on it.

Step 1: Export the tablespace from the source database

1. Create a tablespace TBS01 and table TAB1 on source database ASMNOTDE Create an extra tablespace TBS01 on the source database, and then, create table TAB1 on the new tablespace.

```
SQL> SQL> select FILE_NAME from dba_data_files where
TABLESPACE_NAME='TBS01' ;
```

```
FILE_NAME
```

```
-----
-----
+DATA/ASMNOTDE/DATAFILE/tbs01.374.1152267015
```

```
###
### Checks if a set of tablespaces (to be transported) is self-contained
###
```

```
SQL> EXECUTE DBMS_TTS.TRANSPORT_SET_CHECK('tbs01',true) ;
```

```
PL/SQL procedure successfully completed.
```

2. Create the database directory in the source database ASMNOTDE to use for the export. Create a database directory object in the destination database for `expdp`.

```
###
### login as oracle user
###
```

```
$ mkdir -pv /u01/app/odaorabase0/oracle/dpdump/ttsps_dir
mkdir: created directory '/u01/app/odaorabase0/oracle/dpdump/ttsps_dir'
```

```
###
### Connect to database using SQLPLUS as sysdba user ( sqlplus / as
sysdba ) and run the following
```

###

```
SQL> CREATE DIRECTORY ttsps_dir AS '/u01/app/odaorabase0/oracle/dpdump/
ttsps_dir';
```

Directory created.

3. Export the TBS01 tablespace from the source database ASMNOTDE. First, set the tablespace to be copied in READ ONLY mode. Next, run `expdp` on the designated tablespace. Review the dump files for `expdp` stored under the database directory `ttsps_dir`.

###

```
### Set the tablespaces that you need to be exported in read-only mode
### login as Oracle user
### Connect to database using SQLPLUS as sysdba user ( sqlplus / as
sysdba ) and run the following
```

```
SQL> ALTER TABLESPACE TBS01 READ ONLY;
```

Tablespace altered.

```
SQL>
```

###

```
### Run expdp as SYSTEM user, password for SYSTEM need to be entered when
prompted
###
```

```
$ expdp system TRANSPORT_TABLESPACES=TBS01 TRANSPORT_FULL_CHECK=YES
DIRECTORY=ttsps_dir DUMPFILE=expttpsasm.dmp
```

```
Export: Release 19.0.0.0.0 - Production on Tue Nov 7 10:12:19 2023
Version 19.25.0.0.0
```

```
Copyright (c) 1982, 2019, Oracle and/or its affiliates. All rights
reserved.
```

```
Password:
```

```
Connected to: Oracle Database 19c Enterprise Edition Release 19.0.0.0.0 -
Production
```

```
Starting "SYSTEM"."SYS_EXPORT_TRANSPORTABLE_01": system/*****
TRANSPORT_TABLESPACES=TBS01 TRANSPORT_FULL_CHECK=YES DIRECTORY=ttsps_dir
DUMPFILE=expttpsasm.dmp
```

```
Processing object type TRANSPORTABLE_EXPORT/STATISTICS/TABLE_STATISTICS
```

```
Processing object type TRANSPORTABLE_EXPORT/PLUGTS_BLK
```

```
Processing object type TRANSPORTABLE_EXPORT/POST_INSTANCE/PLUGTS_BLK
```

```
Processing object type TRANSPORTABLE_EXPORT/TABLE
```

```
Master table "SYSTEM"."SYS_EXPORT_TRANSPORTABLE_01" successfully loaded/
unloaded
```

```
*****
```

```
***
```

```
Dump file set for SYSTEM.SYS_EXPORT_TRANSPORTABLE_01 is:
```

```
/u01/app/odaorabase0/oracle/dpdump/ttsps_dir/expttpsasm.dmp
```

```
*****
```

```
***
```

```
Datafiles required for transportable tablespace TBS01:
+DATA/ASMNOTDE/DATAFILE/tbs01.374.1152267015
Job "SYSTEM"."SYS_EXPORT_TRANSPORTABLE_01" successfully completed at Tue
Nov 7 10:12:49 2023 elapsed 0 00:00:20
```

4. Move data files to the destination database server and edit the status of the data file in the source database ASMNOTDE to READ WRITE.

```
###
### login to grid user
### Copying datafiles from ASM to filesystem
###

$ asmcmd cp +DATA/ASMNOTDE/DATAFILE/tbs01.295.1165369089 /home/grid/
tbs01.dbf
copying +DATA/ASMNOTDE/DATAFILE/tbs01.295.1165369089 -> /home/grid/
tbs01.dbf

###
### In source database, set the tablespace back to read write mode
### login as Oracle user
### Connect to database using SQLPLUS as sysdba user ( sqlplus / as
sysdba ) and run the following
###

SQL> ALTER TABLESPACE TBS01 READ WRITE;
```

Step 2: Import the tablespaces into a TDE-enabled database

1. Create a TDE-enabled database with Oracle Key Vault, ASMTDE as the destination database. Copy the data file and tablespace of the source database to this database using expdp and impdp. Create the database on an Oracle Database Appliance using the Browser User Interface (BUI) or ODACLI commands. For example:

```
# odacli create-database -n asmtde -t -kt okv -osc adminobj1 -dh
e2a65596-6435-4410-9e8d-6b21a6005779 -r ASM --cdb -d pdbadmin -p pdb1

# odacli describe-database -n asmtde
Database details
-----
                ID: 5dfa97d9-d774-4a4a-93a2-d21a36faf283
Description: asmtde
      DB Name: asmtde
      DB Type: SI
           CDB: true
      PDB Name: PDB2
PDB Admin User Name: pdbadmin
      Storage: ASM
      Home ID: e2a65596-6435-4410-9e8d-6b21a6005779
TDE Wallet Management: ODA
           TDE Enabled: true
KeystoreType : OKV
```

```
###
### login as oracle user
### Connect to database using SQLPLUS as sysdba user ( sqlplus / as
sysdba ) and run the following
###
```

```
SQL> col PDB_NAME for a20
SQL> select PDB_NAME,GUID from dba_pdbs ;
```

```
PDB_NAME          GUID
-----
PDB1              1599A96E256A8B99E063BE6B1F0AC02B
PDB$SEED         15998A6665985353E063BE6B1F0A494A
```

2. Copy the data file from file system to the destination Oracle ASM location of ASMTDE. Ensure that you set the relevant permissions after copying the file.

```
###
### login to grid user
###
```

```
$ asmcmd cp /home/grid/tbs01.dbf +DATA/ASMTDE/
1599A96E256A8B99E063BE6B1F0AC02B/DATAFILE/tbs01 --dest_dbname ASMTDE
copying /home/grid/tbs01.dbf -> +DATA/ASMTDE/
1599A96E256A8B99E063BE6B1F0AC02B/DATAFILE/tbs01
```

```
$ asmcmd
```

```
ASMCMD> pwd
+DATA/ASMTDE/1599A96E256A8B99E063BE6B1F0AC02B/DATAFILE
ASMCMD> ls --permission
User                                     Group  Permission  Name
dbusr1@00eea686ffb0ff1bbf28c0b8362cccf6  rw-----
SYSAUX.332.1165769683
dbusr1@00eea686ffb0ff1bbf28c0b8362cccf6  rw-----
SYSTEM.333.1165769683
dbusr1@00eea686ffb0ff1bbf28c0b8362cccf6  rw-----
UNDOTBS1.331.1165769683
dbusr1@00eea686ffb0ff1bbf28c0b8362cccf6  rw-----
USERS.335.1165769685
grid@00eea686ffb0ff1bbf28c0b8362cccf6    rw-----  tbs01 => +DATA/
ASMTDE/DATAFILE/tbs01.338.1165770781
```

```
ASMCMD> chown dbusr1@00eea686ffb0ff1bbf28c0b8362cccf6 tbs01
ASMCMD>
```

```
ASMCMD> ls --permission
User                                     Group  Permission  Name
dbusr1@00eea686ffb0ff1bbf28c0b8362cccf6  rw-----
SYSAUX.332.1165769683
dbusr1@00eea686ffb0ff1bbf28c0b8362cccf6  rw-----
SYSTEM.333.1165769683
dbusr1@00eea686ffb0ff1bbf28c0b8362cccf6  rw-----
UNDOTBS1.331.1165769683
dbusr1@00eea686ffb0ff1bbf28c0b8362cccf6  rw-----
```

```
USERS.335.1165769685
dbusr1@00eea686ffb0ff1bbf28c0b8362ccccf6          rw----- tbs01 => +DATA/
ASMTDE/DATAFILE/tbs01.338.1165770781
```

3. Create tnsnames service for PDB1.

```
###
### Edit the file $ORACLE_HOME/network/admin/tnsnames.ora with the
following content
###

PDB1 =
  (DESCRIPTION =
    (ADDRESS = (PROTOCOL = TCP) (HOST = <server-name>) (PORT = 1521))
    (CONNECT_DATA =
      (SERVER = DEDICATED)
      (SERVICE_NAME = pdb1.test)
```

4. Create the directory in PDB1 for the import.

```
###
### login as oracle user
###

$ mkdir -pv /u01/app/odaorabase0/oracle/dpdump/ttsps_dir
mkdir: created directory '/u01/app/odaorabase0/oracle/dpdump/ttsps_dir'

###
### Connect to database using SQLPLUS as sysdba user ( sqlplus / as
sysdba ) and run the following
###

SQL> ALTER SESSION SET CONTAINER=PDB1 ;
SQL> CREATE DIRECTORY ttsps_dir AS '/u01/app/odaorabase0/oracle/dpdump/
ttsps_dir';

Directory created.

SQL>
```

5. Import the tablespace to PDB1. Copy the expdp dump file of the source database to the database directory ttsps_dir. The impdp uses the dump file to add tablespace metadata to destination database. TRANSPORT_DATAFILES references the location of the data file in the destination database.

```
###
### Run impdp as SYSTEM user, password for SYSTEM need to be entered when
prompted
###

$ impdp system@pdb1 TRANSPORT_DATAFILES='+DATA/ASMTDE/
1599A96E256A8B99E063BE6B1F0AC02B/DATAFILE/tbs01\' DIRECTORY=ttsps_dir
dumpfile=expttpsasm.dmp

Import: Release 19.0.0.0.0 - Production on Mon Apr 8 17:52:09 2024
```

Version 19.23.0.0.0

Copyright (c) 1982, 2019, Oracle and/or its affiliates. All rights reserved.
Password:

```

Connected to: Oracle Database 19c Enterprise Edition Release 19.0.0.0.0 -
Production
Master table "SYSTEM"."SYS_IMPORT_TRANSPORTABLE_01" successfully loaded/
unloaded
Starting "SYSTEM"."SYS_IMPORT_TRANSPORTABLE_01":  system/*****@pdb1
TRANSPORT_DATAFILES='+DATA/ASMTDE/1599A96E256A8B99E063BE6B1F0AC02B/
DATAFILE/tbs01' DIRECTORY=ttsp_dir dumpfile=expttpsasm.dmp
Processing object type TRANSPORTABLE_EXPORT/PLUGTS_BLK
Processing object type TRANSPORTABLE_EXPORT/TABLE
Processing object type TRANSPORTABLE_EXPORT/STATISTICS/TABLE_STATISTICS
Processing object type TRANSPORTABLE_EXPORT/POST_INSTANCE/PLUGTS_BLK
Job "SYSTEM"."SYS_IMPORT_TRANSPORTABLE_01" successfully completed at Mon
Apr 8 17:52:18 2024 elapsed 0 00:00:03
    
```

6. Enable and test encryption on the destination Oracle Key Vault-enabled database PDB1.

```

###
### login as oracle user
### Connect to database using SQLPLUS as sysdba user ( sqlplus / as
sysdba ) and run the following
###

SQL> alter session set container=pdb1 ;

Session altered.

SQL> select TABLESPACE_NAME, STATUS , ENCRYPTED from dba_tablespaces ;

TABLESPACE_NAME          STATUS      ENC
-----
SYSTEM                   ONLINE     NO
SYSAUX                   ONLINE     NO
UNDOTBS1                 ONLINE     NO
TEMP                     ONLINE     NO
USERS                    ONLINE     NO
TBS01                    READ ONLY NO

6 rows selected.

SQL> alter tablespace TBS01 read write ;

Tablespace altered.

SQL>  alter tablespace TBS01 encryption online encrypt ;

Tablespace altered.

SQL> select TABLESPACE_NAME, STATUS , ENCRYPTED from dba_tablespaces ;

TABLESPACE_NAME          STATUS      ENC
-----
    
```

```

-----
SYSTEM                ONLINE    NO
SYS_AUX              ONLINE    NO
UNDOTBS1             ONLINE    NO
TEMP                 ONLINE    NO
USERS                ONLINE    NO
TBS01                ONLINE    YES

```

6 rows selected.

```

###
### Retrieve the data from TAB1
###

```

```

SQL> select OWNER, table_name from tab1 where rownum < 3
      2 ;

```

```

OWNER
-----
TABLE_NAME
-----
SYS
TS$

SYS
ICOL$

```

```

###
### When the wallet is closed or unavailable, same SQL does not retrieve
data
### To simulate wallet absence rename the cwallet.sso wallet under
<wallet_root>/tde to some other name like cwallet.sso.orig
### and close the wallet. To return auto-login wallet , rename file back
to cwallet.sso and run the SQL again.
###

```

```

SQL> show parameter wallet_root

```

```

NAME                TYPE        VALUE
-----
wallet_root          string      /etc/OKV/asmtde

```

```

SQL> ! mv /etc/OKV/asmtde/tde/cwallet.sso /etc/OKV/asmtde/tde/
cwallet.sso.orig

```

```

SQL> ADMINISTER KEY MANAGEMENT SET KEYSTORE CLOSE ;

```

```

SQL> select OWNER, table_name from tab1 where rownum < 3;
select OWNER, table_name from tab1 where rownum < 3
      *

```

ERROR at line 1:

```
ORA-28365: wallet is not open
```

```
SQL> ! mv /etc/OKV/asmtde/tde/cwallet.sso.orig /etc/OKV/asmtde/tde/
cwallet.sso
```

```
SQL> select OWNER, table_name from tab1 where rownum < 3
      2 ;
```

```
OWNER
```

```
-----
```

```
TABLE_NAME
```

```
-----
```

```
SYS
```

```
TS$
```

```
SYS
```

```
ICOL$
```

Related Topics

- [odacli Multi-User Access Commands](#)
Use `odacli` commands to enable multi-user access for the appliance.

Migrating Tablespaces from Non-TDE Oracle ACFS Database to Oracle ACFS CDB Database on Oracle Database Appliance

Understand how you can migrate tablespaces from non-TDE Oracle ACFS database to Oracle ACFS CDB database with Oracle Key Vault enabled on Oracle Database Appliance.

Ensure that there is a source and destination database. The two databases can be on one Oracle Database Appliance server or on different servers. The source database must be a non TDE-enabled database, either an Oracle Database Appliance database or any Oracle database with compatible Endian. The destination database must be an Oracle Database Appliance database created with ODACLI commands and with Oracle Key Vault enabled on it.

Step 1: Export the tablespace from the source database

1. Create a tablespace TBS01 and table TAB1 on source database DBNOTDE Create an extra tablespace TBS01 on the source database, and then, create table TAB1 on the new tablespace.

```
###
### login as Oracle user
### Connect to database using SQLPLUS as sysdba user ( sqlplus / as
sysdba ) and run the following
###
```

```
SQL> select TABLESPACE_NAME, ENCRYPTED from dba_tablespaces ;
```

| TABLESPACE_NAME | STATUS | ENC |
|-----------------|--------|-----|
| SYSTEM | ONLINE | NO |
| SYSAUX | ONLINE | NO |

```

UNDOTBS1          ONLINE    NO
TEMP              ONLINE    NO
USERS             ONLINE    NO

```

```

SQL> create tablespace TBS01 datafile size 10g ;
Tablespace created.

```

```

SQL>
SQL> create table tab1 tablespace TBS01 as select a.* from dba_tables
a ,dba_users b, dba_users c ;
Table created.

```

```

SQL> select count(*) from tab1 ;

```

```

      COUNT(*)
-----
      3028228

```

```

SQL>

```

```

SQL> select TABLESPACE_NAME, ENCRYPTED from dba_tablespaces ;

```

| TABLESPACE_NAME | STATUS | ENC |
|-----------------|--------|-----|
| SYSTEM | ONLINE | NO |
| SYSAUX | ONLINE | NO |
| UNDOTBS1 | ONLINE | NO |
| TEMP | ONLINE | NO |
| USERS | ONLINE | NO |
| TBS01 | ONLINE | NO |

```

SQL> select FILE_NAME from dba_data_files where TABLESPACE_NAME='TBS01' ;

```

```

FILE_NAME
-----
/u02/app/oracle/oradata/dbnotde/DBNOTDE/datafile/o1_mf_tbs01_lnlgn65j_.dbf

```

```

SQL>

```

```

###
### Checks if a set of tablespaces (to be transported) is self-contained
###

```

```

SQL> EXECUTE DBMS_TTS.TRANSPORT_SET_CHECK('tbs01',true) ;

```

```

PL/SQL procedure successfully completed.

```

2. Create the database directory in the source database DBNOTDE to be used for the export. Create a database directory object in the destination database to be used by expdp.

```

###
### login as oracle user

```



```
###

$ mkdir -pv /u01/app/odaorabase0/oracle/dpdump/ttsps_dir
mkdir: created directory '/u01/app/odaorabase0/oracle/dpdump/ttsps_dir'

###
### Connect to database using SQLPLUS as sysdba user ( sqlplus / as
sysdba ) and run the following
###

SQL> CREATE DIRECTORY ttsps_dir AS '/u01/app/odaorabase0/oracle/dpdump/
ttsps_dir';

Directory created.

SQL>
```

3. Export the TBS01 tablespace from source database DBNOTDE. First, set the tablespace to be copied in READ ONLY mode. Next, run `expdp` on the designated tablespace. Review the log files for `expdp` stored under the database directory `ttsps_dir`.

```
###
### login as oracle user
### Connect to database using SQLPLUS as sysdba user ( sqlplus / as
sysdba ) and run the following
###

SQL> ALTER TABLESPACE TBS01 READ ONLY;

Tablespace altered.

###
### Run expdp as SYSTEM user, password for SYSTEM need to be entered when
prompted
###

$ expdp system TRANSPORT_TABLESPACES=TBS01 TRANSPORT_FULL_CHECK=YES
DIRECTORY=ttsps_dir DUMPFILE=expttps.dmp

Export: Release 19.0.0.0.0 - Production on Mon Nov 6 12:47:00 2023
Version 19.25.0.0.0

Copyright (c) 1982, 2019, Oracle and/or its affiliates. All rights
reserved.
Password:

Connected to: Oracle Database 19c Enterprise Edition Release 19.0.0.0.0 -
Production
Starting "SYSTEM"."SYS_EXPORT_TRANSPORTABLE_01": system/*****
TRANSPORT_TABLESPACES=TBS01 TRANSPORT_FULL_CHECK=YES DIRECTORY=ttsps_dir
DUMPFILE=expttps.dmp
Processing object type TRANSPORTABLE_EXPORT/STATISTICS/TABLE_STATISTICS
Processing object type TRANSPORTABLE_EXPORT/PLUGTS_BLK
Processing object type TRANSPORTABLE_EXPORT/POST_INSTANCE/PLUGTS_BLK
```

```
Processing object type TRANSPORTABLE_EXPORT/TABLE
Master table "SYSTEM"."SYS_EXPORT_TRANSPORTABLE_01" successfully loaded/
unloaded
*****
***
Dump file set for SYSTEM.SYS_EXPORT_TRANSPORTABLE_01 is:
/u01/app/odaorabase0/oracle/dpdump/ttsp_dir/expttps.dmp
*****
***
Datafiles required for transportable tablespace TBS01:
/u02/app/oracle/oradata/dbnotde/DBNOTDE/datafile/
o1_mf_tbs01_lnlgn65j_.dbf
Job "SYSTEM"."SYS_EXPORT_TRANSPORTABLE_01" successfully completed at Mon
Nov 6 12:47:19 2023 elapsed 0 00:00:14
```

4. Move data files to the destination database server and edit the status of the data file in the source database DBNOTDE to READ WRITE. Move the data file to the TDE-enabled database server in the PDB2 data files location.

```
###
### login as oracle user
###

$ cp /u02/app/oracle/oradata/dbnotde/DBNOTDE/datafile/
o1_mf_tbs01_lnlgn65j_.dbf /u02/app/oracle/oradata/cdbtde/CDBTDE/
092546916A493FE5E063E730850AF5BE/datafile/

###
### In source database, set the tablespace back to read write mode
### Connect to database using SQLPLUS as sysdba user ( sqlplus / as
sysdba ) and run the following
###

SQL> ALTER TABLESPACE TBS01 READ WRITE;
```

Step 2: Import the tablespaces into a TDE-enabled database

1. Create a TDE-enabled database with Oracle Key Vault, CDBTDE as the destination database. Copy the data file and tablespace of the source database to this database using expdp and impdp. Create the database on an Oracle Database Appliance using the Browser User Interface (BUI) or ODACLI commands. For example:

```
# odacli create-database -n okvdb2 -t -kt okv -osc adminobj1 -dh
e2a65596-6435-4410-9e8d-6b21a6005779 -r ACFS --cdb -d pdbadmin -p pdb2

# odacli describe-database -n cdbtde
Database details
-----
ID: c1ba7c6a-2808-4a20-bf23-e35cb62c3fd0
Description: cdbtde
DB Name: cdbtde
DB Type: SI
CDB: true
PDB Name: PDB2
PDB Admin User Name: pdbadmin
```

```

Storage: ACFS
Home ID: e2a65596-6435-4410-9e8d-6b21a6005779
TDE Wallet Management: ODA
TDE Enabled: true
KeystoreType : OKV

###
### login as oracle user
### Connect to database using SQLPLUS as sysdba user ( sqlplus / as
sysdba ) and run the following
### Take a note of PDB2 GUID which helps to determine the path of PDB2
datafiles
###

SQL> col PDB_NAME for a20
SQL> select PDB_NAME,GUID from dba_pdbs ;

PDB_NAME          GUID
-----
PDB2              092546916A493FE5E063E730850AF5BE
PDB$SEED         15998A6665985353E063BE6B1F0A494A

```

2. Create tnsnames service for PDB2.

```

###
### Edit the file $ORACLE_HOME/network/admin/tnsnames.ora with the
following content
###

PDB2 =
  (DESCRIPTION =
    (ADDRESS = (PROTOCOL = TCP)(HOST = <server-name>)(PORT = 1521))
    (CONNECT_DATA =
      (SERVER = DEDICATED)
      (SERVICE_NAME = pdb2.test)

```

3. Create directory in PDB2 for the import.

```

###
### login as oracle user
###

$ mkdir -pv /u01/app/odaorabase0/oracle/dpdump/ttsp_dir
mkdir: created directory '/u01/app/odaorabase0/oracle/dpdump/ttsp_dir'

###
### Connect to database using SQLPLUS as sysdba user ( sqlplus / as
sysdba ) and run the following
###

SQL> ALTER SESSION SET CONTAINER=PDB2 ;
SQL> CREATE DIRECTORY ttsp_dir AS '/u01/app/odaorabase0/oracle/dpdump/
ttsp_dir';

Directory created.

```

SQL>

4. Import the TBS01 tablespace to the destination database PDB2 container on CDBTDE. Copy the `expdp` dump file of the source database to the database directory `ttsp_dir`. The `impdp` uses the dump file to add tablespace metadata to destination database. `TRANSPORT_DATAFILES` references the location of the data file in the destination database.

```
###
### Run impdp as SYSTEM user, password for SYSTEM need to be entered when
prompted
###

$ impdp system@pdb2 TRANSPORT_DATAFILES='\u02/app/oracle/oradata/cdbtde/
CDBTDE/092546916A493FE5E063E730850AF5BE/datafile/
o1_mf_tbs01_lnlgn65j_.dbf\' DIRECTORY=ttsp_dir dumpfile=exp1.dmp

Import: Release 19.0.0.0.0 - Production on Thu Nov 9 21:42:25 2023
Version 19.25.0.0.0

Copyright (c) 1982, 2019, Oracle and/or its affiliates. All rights
reserved.
Password:

Connected to: Oracle Database 19c Enterprise Edition Release 19.0.0.0.0 -
Production
Master table "SYSTEM"."SYS_IMPORT_TRANSPORTABLE_01" successfully loaded/
unloaded
Starting "SYSTEM"."SYS_IMPORT_TRANSPORTABLE_01": system/*****@pdb2
TRANSPORT_DATAFILES='/u02/app/oracle/oradata/cdbtde/CDBTDE/
092546916A493FE5E063E730850AF5BE/datafile/o1_mf_tbs01_lnlgn65j_.dbf'
DIRECTORY=ttsp_dir dumpfile=exp1.dmp
Processing object type TRANSPORTABLE_EXPORT/PLUGTS_BLK
Processing object type TRANSPORTABLE_EXPORT/TABLE
Processing object type TRANSPORTABLE_EXPORT/STATISTICS/TABLE_STATISTICS
Processing object type TRANSPORTABLE_EXPORT/STATISTICS/MARKER
Processing object type TRANSPORTABLE_EXPORT/POST_INSTANCE/PLUGTS_BLK
Job "SYSTEM"."SYS_IMPORT_TRANSPORTABLE_01" successfully completed at Thu
Nov 9 21:42:52 2023 elapsed 0 00:00:19
```

5. Enable and test encryption on the destination Oracle Key Vault-enabled database PDB1.

```
###
### login as oracle user
### Connect to database using SQLPLUS as sysdba user ( sqlplus / as
sysdba ) and run the following
###

SQL> alter session set container=pdb2 ;

Session altered.

SQL> select TABLESPACE_NAME, STATUS , ENCRYPTED from dba_tablespaces ;

TABLESPACE_NAME          STATUS          ENC
```

```

-----
SYSTEM          ONLINE      NO
SYSAUX          ONLINE      NO
UNDOTBS1        ONLINE      NO
TEMP            ONLINE      NO
USERS           ONLINE      NO
TBS01           READ ONLY  NO

```

```
SQL> alter tablespace TBS01 read write ;
```

Tablespace altered.

```
SQL> alter tablespace TBS01 encryption online encrypt ;
```

Tablespace altered.

```
SQL> select TABLESPACE_NAME, STATUS , ENCRYPTED from dba_tablespaces ;
```

```

TABLESPACE_NAME          STATUS      ENC
-----
SYSTEM                   ONLINE     NO
SYSAUX                   ONLINE     NO
UNDOTBS1                 ONLINE     NO
TEMP                     ONLINE     NO
USERS                    ONLINE     NO
TBS01                    ONLINE     YES

```

```
SQL> select FILE_NAME from dba_data_files where TABLESPACE_NAME='TBS01' ;
```

```

FILE_NAME
-----
/u02/app/oracle/oradata/cdbtde/CDBTDE/092546916A493FE5E063E730850AF5BE/
datafile/
ol_mf_tbs01_lnx8h50f_.dbf

```

```

###
### Retrieve the data from TAB1
###

```

```
SQL> select OWNER, table_name from tab1 where rownum < 3
```

```

OWNER
-----
TABLE_NAME
-----
SYS
TS$

SYS
ICOL$

```

```
###
### When the wallet is closed or unavailable, same SQL does not retrieve
data
### To simulate wallet absence rename the cwallet.sso wallet under
<wallet_root>/tde to some other name like cwallet.sso.orig
### and close the wallet. To return auto-login wallet , rename file back
to cwallet.sso and run the SQL again.
###
```

```
SQL> show parameter wallet_root
```

```
NAME                                TYPE    VALUE
-----                                -
wallet_root                          string  /etc/OKV/cdbtde
```

```
SQL> ! mv /etc/OKV/cdbtde/tde/cwallet.sso /etc/OKV/cdbtde/tde/
cwallet.sso.orig
```

```
SQL> ADMINISTER KEY MANAGEMENT SET KEYSTORE CLOSE ;
```

```
SQL> select OWNER, table_name from tab1 where rownum < 3;
select OWNER, table_name from tab1 where rownum < 3
*

```

```
ERROR at line 1:
ORA-28365: wallet is not open
```

```
SQL> ! mv /etc/OKV/cdbtde/tde/cwallet.sso.orig /etc/OKV/cdbtde/tde/
cwallet.sso
```

```
SQL> select OWNER, table_name from tab1 where rownum < 3
2 ;
```

```
OWNER
-----
TABLE_NAME
-----
SYS
TS$

SYS
ICOL$
```

Related Topics

- [odacli Multi-User Access Commands](#)
Use `odacli` commands to enable multi-user access for the appliance.

Working with Databases

Use the Browser User Interface to display a list of databases, database details, and create and delete databases. You can use CLI commands to manage your databases.

 **Note:**

Oracle Database Appliance enables unified auditing for databases created in new database homes. Unified audit trail captures audit information and places them in one location and in one format. This consolidated view enables auditors to co-relate audit information from different components. Having a single audit trail also improves management and security of the audit trail. For more information about unified audit trail for Oracle Database, see *Oracle Database Security Guide*.

- [Viewing Databases](#)
Use the Oracle Appliance Manager Browser User Interface to display a list of Oracle databases and database details, create, upgrade, and delete a database in Oracle Database Appliance.
- [Creating a Database Using the Browser User Interface](#)
Use the Oracle Appliance Manager Browser User Interface to create a database in Oracle Database Appliance.
- [Managing Database Homes on Oracle ACFS Storage](#)
Use the Oracle Appliance Manager Browser User Interface or ODACLI commands to manage database home storage in Oracle Database Appliance.
- [Creating a Database Using ODACLI Commands](#)
Create a database from the command-line interface.
- [Cloning a Database from Backup](#)
Use the Browser User Interface to clone a database from a backup.
- [Cloning an Oracle ACFS Database](#)
Create a database from an existing Oracle ACFS database using ODACLI commands or BUI.
- [Modifying a Database](#)
Use the Oracle Appliance Manager Browser User Interface or ODACLI commands to modify a database in Oracle Database Appliance.
- [Moving a Database from One Oracle Home to Another](#)
Use the Oracle Appliance Manager Browser User Interface or ODACLI commands to move a database from one Oracle home to another of the same database version.
- [Upgrading a Database](#)
Use the Oracle Appliance Manager Browser User Interface to upgrade an Oracle database to a different database home version.
- [Upgrading a Database Manually Using AutoUpgrade](#)
Use AutoUpgrade to manually upgrade an earlier release of Oracle database on Oracle Database Appliance.
- [Deleting a Database](#)
Use the Oracle Appliance Manager Browser User Interface to delete an Oracle database.

Viewing Databases

Use the Oracle Appliance Manager Browser User Interface to display a list of Oracle databases and database details, create, upgrade, and delete a database in Oracle Database Appliance.

1. Log into the Browser User Interface:

```
https://host name or ip-address:7093/mgmt/index.html
```

2. Click the **Database** tab.
3. (Optional) Click the database name, in blue font, to display more details about the database.
4. (Optional) Click **Actions** next to a database entry to view more details, upgrade or delete the database.

Creating a Database Using the Browser User Interface

Use the Oracle Appliance Manager Browser User Interface to create a database in Oracle Database Appliance.

Ensure that the repository is updated with Oracle RDBMS Clone files for a database version, before creating the database as described in *Updating Oracle Database Appliance Repository with Database Clone Files Using the CLI*.

 **Note:**

For Standard Edition Oracle Database 19c or later, you cannot create Oracle RAC or Oracle RAC One Node Database. You can only create single-instance Oracle Database. For Standard Edition Oracle Database 19.6 or later, you can choose to enable high availability for single-instance database. For Enterprise Edition Oracle Database 19.15 or later or Oracle Database 21.6 or later, you can choose to enable high availability for single-instance databases.

The Browser User Interface provides a quick and easy method of creating new databases. The Create New Database page in the Browser User Interface is populated with default options for most of the configuration options. Drop-down lists enable you to quickly view and select from a list of available options. You can use the drop-down list to create a new database Oracle Database Home (ORACLE_HOME) for the database or select an existing ORACLE_HOME that you created earlier.

Oracle Database 19.26 is supported on both Oracle Automatic Storage Management (Oracle ASM) and Oracle ASM Cluster file system (Oracle ACFS). When databases are created in Oracle ACFS, each database is configured with its own Oracle ACFS file system for the datafiles and uses the following naming convention: `/u02/app/db user/oradata/db unique name`. The default size of this mount point is 100 GB.

The fields in the Browser User Interface adjust, depending on the database version you select. Follow these steps to create a database:

1. Log into the Browser User Interface:

```
https://host-ip-address:7093/mgmt/index.html
```

2. Click the **Database** tab.
3. Click **Create Database** to display the Create Database page.
4. Select **Create Database** on the Create Database page.
5. Enter the following information on the Database Information page to configure the database:
 - a. In the **DB Name** field, enter a name for the database. The name *db1* appears in the field as an example of a database name, but the field is not populated. You must enter a name.

The name must contain lowercase alphanumeric characters and cannot exceed 8 characters. The Oracle system identifier (SID) is always set to the database name.
 - b. (Optional) In the **DB Unique Name** field, enter a name to define a unique name for the database.
 - c. In the **Use Existing DB Home** field, select **Yes** or **No**.
 - d. In the **DB Version** field, select a database bundle patch number from the drop-down list.

Available database versions with available clones appear in the list in descending order. Supported versions that are not available in the repository appear in light gray font at the bottom of the list. Search is available for the list. To add a supported version to the repository, download the RDBMS clone file and update the repository.
 - e. For the **CDB** option on Oracle Database releases later than 12.1, select **Yes** or **No**, depending on whether or not you want the database to be a container database (CDB). The default is **Yes**.
 - f. In the **PDB Name** field, enter a name for the pluggable database (PDB).

Alphanumeric characters and underscore (`_`) are valid. The name must begin with an alphanumeric character and cannot exceed 30 characters. The name *pdb1* appears in the field in italic text as an example, but it is not populated. You must enter a name.
 - g. In the **PDB Admin User** field, enter a name.

The field shows *pdbadmin* as an example, you must enter a name. Alphanumeric characters and underscore (`_`) are valid.
 - h. In the Database Edition field, enter the edition for which you have a license, either **Enterprise Edition** or **Standard Edition**.

For Standard Edition Oracle Database 19c or later, you can only create single-instance Oracle Database. For Standard Edition Oracle Database 19.6 or later, you can choose to enable high availability for single-instance database. For Enterprise Edition Oracle Database 19.15 or later or Oracle Database 21.6 or later, you can choose to enable high availability for single-instance databases.
 - i. For single-instance Oracle Database deployment, specify the **Node**, either Node0 or Node1. The default is Node0. Specify whether you want to **Enable High Availability**.
 - j. In the **Shape** field, select a database shape from the drop-down list. The shape determines the number of cores and total memory allocated to the database. The default is *odb1*.
 - k. In the **Database Class** field, select a database class from the drop-down list. If an option is not available in the list, it is not supported for the database edition on the Oracle Database Appliance or the version that you selected. The default is OLTP.
 - l. In the **Storage** field, select **ACFS** or **ASM** from the drop-down list. The default is Oracle ASM.

- m. If the disk group redundancy was set to **Flex** during the appliance creation, then you can select the **Database Redundancy** value as **Mirror** or **High**.
 - n. Select the **Networks** you want to associate with the database.
 - o. Select the **CPU Pool Name** to associate with the database.
 - p. For the **Configure EM Express** or **Configure EM Console** option, select **Yes** or **No**. The default is **No**.

Select **Yes** to configure the Oracle Enterprise Manager Database Express (EM Express) console for Oracle Database 19.26. Selecting **Yes** enables you to use the console to manage the database.
 - q. In the **SYS and PDB Admin User Password** field, enter the password for the `SYS`, `SYSTEM`, and `PDB Admin`.

The password must begin with an alpha character and cannot exceed 30 characters. Quotation marks are not allowed.
 - r. In the **Confirm Password** field, enter the password again to confirm.
 - s. In the **Characteraset** field, select an option from the drop-down list. The default is `AL32UTF8`.
 - t. In the **National Characterset** field, select an option from the drop-down list. The default is `AL16UTF16`.
 - u. In the **Language** field, select a database language from the drop-down list. The default is American.
 - v. In the **Territory** field, select a territory or location for the database from the drop-down list. The default is America.
6. Click **Next**.
 7. In the TDE Information page, for Oracle Database Enterprise Edition 19c or later, you can choose to enable Transparent Database Encryption (TDE). Select **Yes** or **No** in the **Enable TDE** option. By default, the TDE option is disabled.
 8. If you choose to Enable TDE, then you can choose to configure TDE and store the TDE wallet either on Oracle Database Appliance or on Oracle Key Vault. If you want to store the TDE wallet on Oracle Database Appliance, then specify and confirm the **TDE Wallet Password**.
 9. To specify Oracle Key Vault server configuration, select the **Store TDE Keys on OKV server** option, and then select the **Use OKV Client Path** or **Use OKV Server Config** option.
 10. If you select the **Use OKV Client Path** option, then specify the **OKV Client path**.
 11. If you select the **Use OKV Server Config** option, then select the OKV Server Config from the drop down list.
 12. Click **Create**. When prompted, click **Yes** to confirm that you want to start the job to create the database.

The job is submitted and a confirmation page appears with a link to the job. Click the link to view the job progress, tasks, and status.

After you close the Job confirmation page, you can click the **Activity** tab to monitor the job progress. Click the job number to view the tasks and status details. Click **Refresh** to refresh the page.

Managing Database Homes on Oracle ACFS Storage

Use the Oracle Appliance Manager Browser User Interface or ODACLI commands to manage database home storage in Oracle Database Appliance.

Managing Database Home Storage Using the Browser User Interface

1. Log into the Browser User Interface:
`https://host-ip-address:7093/mgmt/index.html`
2. Click the **Database** tab.
3. Click Database Home Storage on the left pane.
4. If Database Home Storage is not configured, then click on the **Configure Database Home Storage** button.
5. Select the Disk Group Name and specify the Size in GB.
6. Click **Create**. When prompted, click **Yes** to confirm that you want to start the job to configure the database home storage.
7. You can also view a list of all Database Home storages from the Database tab and view details for each database.
8. To modify Database Home Storage, select **Modify** in the **Actions** drop down list.

Managing Database Home Storage Using ODACLI Commands

1. Use the `odacli configure-dbhome-storage` command to configure the database home storage:

```
# odacli configure-dbhome-storage -dg DATA
```

2. Use the `odacli list-dbhome-storages` command to list the database home storages:

```
# odacli list-dbhome-storages
```

3. Use the `odacli describe-dbhome-storages` command to describe a database home storage:

```
odacli describe-dbhome-storage -i 67622ce6-0a00-4fec-b948-7a0ba7922311
```

For more information about these command options, see the *Oracle Database Appliance Command Line Reference* chapter in this guide.

Related Topics

- [odacli configure-dbhome-storage](#)
Use the `odacli configure-dbhome-storage` command to configure the database home storage.
- [odacli list-dbhome-storages](#)
Use the `odacli list-dbhome-storages` command to view the database home storage resources after the volumes for ORACLE_HOME and ORACLE_BASE are created.

- [odacli describe-dbhome-storage](#)
Use the `odacli describe-dbhome-storage` command to view information such as how much space is available (at a volume or diskgroup level).
- [odacli modify-dbhome-storage](#)
Use the `odacli modify-dbhome-storage` command to modify database home storage and add additional disk space.

Creating a Database Using ODACLI Commands

Create a database from the command-line interface.

Note:

If you provisioned the appliance without creating an initial database, then you must create a Oracle home. If the version of the database home is different from the migrated database, create a database home for the migrated database. You might want to create a database home specifically for the migrated database.

Caution:

When you enable Transparent Data Encryption (TDE) on databases, with software keystore or Oracle Key Vault keystore with endpoints in Oracle Key Vault, you are prompted to set a password for the TDE wallet. Provide a strong password for security compliance. Enter this password carefully when setting it for the first time, and ensure that this password is available to you at all times for database management operations. Failure to provide the TDE wallet password when prompted, will cause an error in accessing encrypted data.

This example creates a new database named `PRODDB` with database version 19.26, and a new database home, if a database home does not exist.

1. Use the `odacli list-dbhomes` command to display a list of database homes and verify that a database home exists for the database version.

Note the ID if you want to use an existing database home or if you want to get more details. Use the `odacli describe-dbhomes` command to get more details about a specific database home.

```
# odacli list-dbhomes
ID                               Name                               DB Version
-----
b727bf80-c99e-4846-ac1f-28a81a725df6 OraDB199_home1 19.26.0.0.0

(continued)
Home Location
-----
/u01/app/orauser/product/19.0.0.0/dbhome_1
```

2. Create a database home if a database home does not exist for the database version.

If you want to create a database home for specifically for the migrated database, you can use the `odacli create-dbhome` command, or you can create the database home when

you create the database. The example creates a database home for database version 19.26.0.0.0.

```
# odacli create-dbhome -v 19.26.0.0.0
```

3. Create a database. You can use an existing database home ID or you can create a database home when creating the database.

To create a database named `PRODDB` that uses an existing database home with ID `b727bf80-c99e-4846-ac1f-28a81a725df6`:

```
# odacli create-database -n PRODDB -io -dh b727bf80-c99e-4846-ac1f-28a81a725df6
```

To create a database named `PRODDB` with database version 19.26.0.0.0 and a database home:

```
# odacli create-database -n PRODDB -v 19.26.0.0.0 -io
```

To create a TDE-enabled database named `PRODDB`:

```
# odacli create-database -n PRODDB -t
```

Cloning a Database from Backup

Use the Browser User Interface to clone a database from a backup.

When you backup a database in Oracle Database Appliance, a backup report is created. Save the backup report as a JSON file and you can use the file to create a database on the same appliance, or a different appliance.

The following are the prerequisites to cloning a database from a backup:

1. The source database backup location must be Object Store or External FRA (Network File System).
2. If you use Object Store backup location, then obtain Object Store Credentials for the host.
3. If you use an External FRA (Network File System) backup location, then obtain the Network File System (NFS) mount point location.
4. Create a backup policy using the object store credentials or NFS mount point as the backup destination.
5. Attach the backup policy to the database that you want to backup. If the source database does not have TDE enabled, then providing the Backup Encryption password is mandatory when attaching Objectstore backup policy. However, the Backup Encryption password is optional when attaching the NFS backup policy. If the source database has TDE enabled, then you need not specify the Backup Encryption password, irrespective of backup destination.
6. Create a manual backup of the database and save the backup report generated when the backup completes.

Follow these steps to create a database from backup:

1. Log into the Browser User Interface:

```
https://host-ip-address:7093/mgmt/index.html
```

2. Click the **Database** tab.
3. Click **Create Database** to display the Create Database page.
4. Click **Clone Database from Backup**, then click **Next** to display the Clone Database from Backup page.
5. Select the Backup Destination from which you want to create the database. If your backup destination is Object Store:
 - a. Select Backup Destination as **ObjectStore**.
 - b. Select your **Object Store Credential Name**.
 - c. Enter the password in the **Backup Encryption Passwords** field and the **Confirm Backup Encryption Passwords** field.

If your backup destination is Network File System (NFS):

- a. Select Backup Destination as **External FRA**.
 - b. Enter the password in the **Backup Encryption Passwords** field and the **Confirm Backup Encryption Passwords** field.
6. Click **Browse** and select the backup report from which you want to create the database.

When the backup report is loaded, Database Information and TDE Information steps are displayed on different pages and populated based on the backup report. You can edit some of the fields.

For Standard Edition Oracle Database 19c or later, you cannot clone Oracle RAC or Oracle RAC One Node Database. You can only clone a single-instance Oracle Database. For Standard Edition Oracle Database 19.6 or later, you can choose to enable high-availability for single-instance database. For Enterprise Edition Oracle Database 19.15 or later or Oracle Database 21.6 or later, you can choose to enable high availability for single-instance databases.

7. In the **DB Name** field, enter a name for the database.

The name must contain lowercase alphanumeric characters and cannot exceed 8 characters. The Oracle system identifier (SID) is always set to the database name.
8. Enter the password in the **SYS and PDB Admin User Password** field and the **Confirm Password** field.
9. Specify the Networks.
10. If your source database has Transparent Database Encryption (TDE) enabled, then you can enable TDE on the cloned database. If the source database has TDE enabled, then the backup report has the TDE wallet backup location and the **TDE Wallet Backup Location** field in the BUI displays this value. Specify and confirm the **TDE Password**.
11. You can choose an Oracle Key Vault server configuration from the **Select OKV Server Config** drop-down list, and specify the **OKV Wallet Location**.

12. Click **Create**.
13. Click **Yes** to confirm that you want to clone a database from the selected Object Store or External FRA.

When you submit the job, the job ID and a link to the job appears. Click the link to display the job status and details.

14. Validate that the job completed. You can track the job in the **Activity** tab in the Browser User Interface, or run the command `odacli describe-job` with the job ID.

```
# odacli describe-job -i jobId
```

Cloning an Oracle ACFS Database

Create a database from an existing Oracle ACFS database using ODACLI commands or BUI.

Cloning enables to:

- Create a database from another database without bringing down the source database
- Create multiple databases from a gold image, thus ensuring standardized mass deployments
- Optimize space utilization, by use of Oracle ACFS snapshots in cloning
- Create different types of databases, from a single source database type. For example, you can create single-instance databases, Oracle RAC databases, or Oracle RAC One Node databases from any type of source database
- Depending on the available memory and CPU cores, specify a supported database shape such as `odb1s`, `odb2`, and so on, to create any class of database from any source database.
- Create clone databases on a standby system. Since standby systems are not production systems, they are a better choice for seeding test or development environments.
- Run clone database from a database home that is different from that of the source database.
- Create clone database from a read-only source database.
- Create read-only clone database from any source database.

Following are the prerequisites to clone a database:

- Ensure that Oracle Clusterware is running on all nodes, and the source database is up and running.
- The source database must use Oracle ACFS storage.
- The source database must not be a multitenant container database (CDB).
- The source database must be opened in either read-write mode, or read-only mode if it is a primary database. A standby database can be in mounted or read-only open mode.
- The source database must not be in backup mode.
- The source database must be in archive mode.
- All data files of the source database must be in the same Oracle ACFS directory.

 **Note:**

For Standard Edition Oracle Database 19c or later, you cannot clone Oracle RAC or Oracle RAC One Node Database. You can only clone a single-instance Oracle Database. For Standard Edition Oracle Database 19.6 or later, you can choose to enable high-availability for single-instance database.

Cloning an Oracle ACFS Database Using Command Line Interface

1. Run the `odacli clone-database` command.

```
odacli clone-database --databaseUniqueName --dbname --dbshape --dbtype --
sourcedbname --associated-networks --cpupool --dbhomeid --disable-ha --
enable-ha --newhome --read-only --tdepassword--json
```

For cloning, you can create a new database home or select an existing database home. To create a new database home, specify the `--newhome` option. To use an existing database home, specify the `--dbhomeid`. Specify the unique name of the database, the name for the new database, the database shape, the type of database, and the source database name. For TDE-enabled database, also specify the `--tdepassword` option. The TDE password of the new database must be the same as the TDE password of the source database.

For information about all the command options, see the *ODA CLI Command Reference* chapter.

Cloning an Oracle ACFS Database Using the Browser User Interface

1. Log into the Browser User Interface:

```
https://host-ip-address:7093/mgmt/index.html
```

2. Click the **Database** tab.
3. Click **Create Database** to display the Create Database page.
4. Click **Clone a Database**, then click **Next** to display the Clone Database page.
5. In the Clone Database page, you can create a new database home or select an existing database home.
6. To create a new database home, select the **Create New DB Home** and then provide the values as described in this procedure.
7. To specify an existing database home, select the **Source Database Name** from which you want to create the database and the **DB Home Name**.

For Oracle Database 19c Standard Edition, you can only create single-instance Oracle Database, with or without high-availability. For Standard Edition Oracle Database 19.6 or later, you can choose to enable high-availability for single-instance database. For Enterprise Edition Oracle Database 19.15 or later or Oracle Database 21.6 or later, you can choose to enable high availability for single-instance databases.

8. Select the **Database Shape** (template) for your new database. The database shape you select determines the total memory allocated to the database.
9. In the **DB Name** field, enter a name for the database.
The name must contain lowercase alphanumeric characters and cannot exceed 8 characters. The Oracle system identifier (SID) is always set to the database name.
10. Specify the **DB Unique Name** for the database. If the database unique name is not provided, then the name of the database is set to the database name.
11. Specify the Networks.
12. Enter the password in the **SYS and PDB Admin User Password** field and the **Confirm Password** field. For Transparent Database Encryption (TDE) enabled database, specify the TDE wallet password. The TDE password is the same as the TDE password of the source database.

13. Click **Create**.
14. Click **Yes** to confirm that you want to clone a database from the selected source database.
When you submit the job, the job ID and a link to the job appears. Click the link to display the job status and details.
15. Validate that the job completed. You can track the job in the **Activity** tab in the Browser User Interface, or run the command `odacli describe-job` with the job ID.

```
# odacli describe-job -i jobId
```

Related Topics

- [odacli clone-database](#)
Use the `odacli clone-database` command to clone a new database from a source database.

Modifying a Database

Use the Oracle Appliance Manager Browser User Interface or ODACLI commands to modify a database in Oracle Database Appliance.

Modifying a Database Using the Browser User Interface

1. Log into the Browser User Interface:
`https://host-ip-address:7093/mgmt/index.html`
2. Click the **Database** tab.
3. For the database that you want to modify, select **Modify** in the Actions drop down list.
4. In the Modify Database page, you can attach or detach associated networks and backup policy, and modify database shape and class. You can also change TDE wallet management from `EXTERNAL` to `ODA` for Oracle Database 19c and later databases.
5. To modify the **Database Class** or **Database Shape**, select the new value in the drop down list.
6. To attach or detach networks, modify the values in the **Attach Networks** and **Detach Networks** fields.
7. To remove the associated backup policy from the database, do not select any value in the **Select Back up Policy** drop down list.
8. If you configured Oracle Flex disk group when you created the database, you can also modify the database redundancy. If the database you are modifying is an Oracle ACFS Database, then the database redundancy for all cloned Oracle ACFS databases is modified.
9. You can choose to change the **Backup Encryption Password**. If the database has TDE enabled, then the RMAN Backup Encryption password is not used.
10. Note that if the database uses Oracle Key Vault server configuration, then you cannot modify any TDE options.
11. Select the **Specify TDE Option** to perform these operations:
 - Select **Re-key TDE Master Encryption Key** to re-key the TDE master encryption key of the database. Specify the **Current TDE Wallet** password.
 - Select **Change Password for TDE Wallet** and specify the **Current TDE Password** and the **New TDE Password**.

- If the TDE wallet management is set to `EXTERNAL`, then you can view and select the **Change TDE Wallet Management** option, and set it to `ODA`.
12. For Enterprise Edition Oracle Database 19.15 or later or Oracle Database 21.6 or later, you can choose to **Enable High Availability** for single-instance databases.
 13. For Standard Edition Oracle Database 19.6 or later, you can choose to **Enable High Availability** for single-instance databases.
 14. Click **Modify**. When prompted, click **Yes** to confirm that you want to start the job to modify the database.

Modifying a Database Using ODACLI Commands

1. Use the `odacli modify-database` command to modify the configuration of a database, such as backup configuration, database class, database type, TDE key, or to change the TDE wallet management from `EXTERNAL` to `ODA`.

```
# odacli modify-database -s database_shape -cl database_class -i dbid
```

For example:

```
# odacli modify-database -i 1941d594-c777-4eca-9fce-18b778d5c153 -s odb2 -
cl DSS
```

For example, the following command re-keys the TDE master encryption key of the database after accepting the current TDE Wallet password.

```
# odacli modify-database -n testdb -rkt
Enter TDE wallet password:
```

For more information about the `odacli modify-database` command options, see the *Oracle Database Appliance Command Line Reference* chapter in this guide.

Related Topics

- [odacli modify-database](#)
Use the `odacli modify-database` command to modify the configuration of a database, such as backup configuration, database class, and database type, and to change TDE wallet management from `EXTERNAL` to `ODA`.

Moving a Database from One Oracle Home to Another

Use the Oracle Appliance Manager Browser User Interface or ODACLI commands to move a database from one Oracle home to another of the same database version.

Moving a Database Using the Browser User Interface

1. Log into the Browser User Interface:
`https://host-ip-address:7093/mgmt/index.html`
2. Click the **Database** tab.
3. For the database that you want to modify, select **Move** in the Actions drop down list.
4. Select the **Destination Database Home** where you want to move the database. The destination database home must be of the same base version. Select **Ignore Missing**

Patches to ignore missing patches. For high-availability environment, you can select the **Non-Rolling** check box to perform non-rolling move of the database home.

5. Click **Move**. When prompted, click **Yes** to confirm that you want to start the job to move the database.

Moving a Database Using ODACLI Commands

1. Use the `odacli move-database` command to move a database from one Oracle home to another home of the same database version.

```
# odacli move-database -i database_ID -dh destination_database_home_ID
```

For more information about the `odacli move-database` command options, see the *Oracle Database Appliance Command Line Reference* chapter in this guide.

Related Topics

- [odacli move-database](#)

Use the command `odacli move-database` to move a database from one Oracle home to another home of the same database version.

Upgrading a Database

Use the Oracle Appliance Manager Browser User Interface to upgrade an Oracle database to a different database home version.

Before upgrading to a different database home, you must upload the Oracle RDBMS clone files to the repository and create the database home.

Note:

You cannot upgrade Oracle RAC or Oracle RAC One Node Database to a destination database home of Standard Edition Oracle Database 19c or later. You must first convert Oracle RAC Or Oracle RAC One Node Database to single-instance Oracle Database using the `odacli modify-database` command and then upgrade the single-instance Oracle Database to a destination database home of Standard Edition 19c or later.

1. Log into the Browser User Interface:

```
https://host name or ip-address:7093/mgmt/index.html
```

2. Click the **Database** tab.
3. Click **Actions** next to the database that you want, then select **Upgrade**.
4. Select the destination database home version from the list of available versions for the upgrade.

When upgrading single-instance Standard Edition Oracle Database 18.9 or later to Standard Edition Oracle Database 19c or later, you can also choose to enable or disable High Availability.

When upgrading single-instance Enterprise Edition Oracle Database 19.15 or later or Oracle Database 21.6 or later, you can also choose to enable or disable High Availability.

5. You can also change the TDE wallet management option if TDE is enabled for the source database and the TDE Wallet Management is set to **External**. Select **Change TDE Wallet Management** to set the TDE Wallet Management to **ODA**.
6. Click **Upgrade**.

Upgrading a Database Manually Using AutoUpgrade

Use AutoUpgrade to manually upgrade an earlier release of Oracle database on Oracle Database Appliance.

Starting with Oracle Database Appliance release 19.17, you cannot manage releases of Oracle Database earlier than 19c using ODACLI or BUI. To upgrade Oracle databases of release 12.1, 12.2, and 18c on Oracle Database Appliance, use OPatch to patch the databases or use Oracle Database Upgrade Assistant (DBUA) or AutoUpgrade to upgrade these databases manually with Oracle Database Appliance 19.17 or later.

Ensure the following:

- The Oracle Database Appliance server must be on Oracle Database Appliance release 19.19 or later.
- The repository must be updated with the target database clone version on the source and target Oracle Database Appliance systems.

1. Create the destination DB home for the database:

```
#odacli create-dbhome -v 19.18.0.0.230117

[root@oda1 ~]# odacli list-dbhomes
ID                                     Name                                     DB
Version                               DB Edition Home
Location                               Status
-----
-----
f90adcc1-f64a-41ce-b72d-154db155b1fa  OraDB19000_home1
19.18.0.0.230117                       EE                                     /u01/app/odaorahome/oracle/
product/19.0.0.0/dbhome_1             CONFIGURED
562a7428-9ea7-4878-9005-62c9d732a12b  OraDB12102_home1
12.1.0.2.220719                       EE                                     /u01/app/odaorahome/oracle/
product/12.1.0.2/dbhome_1             CONFIGURED
```

2. Disable SSHCleanerJob and configure SSH user equivalence between both nodes in case of Oracle Database Appliance High-Availability systems.

```
[root@oda1 ~]# odacli list-schedules|grep "Name\|SSH"
ID                                     Name
Description
CronExpression                       Disabled
44ad4fe2-4893-4c7d-a61c-15845cb74aa5  SSHCleanerJob                               SSH
cleaner job to clean up stale SSH keys  0 0/30 * 1/1 * ?
*                                       false

[root@oda1 ~]# odacli modify-schedule -i 44ad4fe2-4893-4c7d-
a61c-15845cb74aa5 -d
Modify job schedule success
```

```
[root@oda1 ~]# odacli list-schedules|grep "Name\|SSH"
ID                                     Name
Description
CronExpression                        Disabled
44ad4fe2-4893-4c7d-a61c-15845cb74aa5  SSHCleanerJob          SSH
cleaner job to clean up stale SSH keys  0 0/30 * 1/1 * ?
*                                     true
```

```
[oracle@oda1 ~]$ /u01/app/odaorahome/oracle/product/19.0.0.0/dbhome_1/
deinstall/sshUserSetup.sh -user oracle -hosts "oda1 oda2" -
noPromptPassphrase
```

3. Create the AutoUpgrade configuration file as the oracle operating system user on the first node.

```
[oracle@oda1 ~]$ cat autoupgrade.conf
global.autoupg_log_dir=/u01/app/odaorabase/oracle/autoupgrade
upg1.dbname=italy
upg1.start_time=NOW
upg1.source_home=/u01/app/odaorahome/oracle/product/12.1.0.2/dbhome_1
upg1.target_home=/u01/app/odaorahome/oracle/product/19.0.0.0/dbhome_1
upg1.sid=italy11
upg1.log_dir=/u01/app/odaorabase/oracle/autoupgrade/italy
upg1.upgrade_node=localhost
upg1.target_version=19
upg1.run_utlpr=yes
upg1.timezone_upg=no
```

4. Change the Fast Recovery Area to Oracle ACFS if the database was created on Oracle ASM.

- a. Verify whether the dbstorage of the database is ACFS or ASM.

```
# odacli list-databases
```

| ID | Version | CDB | Class | DB Name | DB Type | DB Status |
|--------------------------------------|--------------------------------------|------|-------|---------|---------|-----------|
| 5c183783-a198-413e-b96e-2c941fela895 | 12.1.0.2.220719 | true | OLTP | italy | RAC | |
| CONFIGURED | 562a7428-9ea7-4878-9005-62c9d732a12b | | | odb2 | ACFS | |
| 8f90d26d-c17a-45e3-abbc-67c981c24a3f | 19.18.0.0.230117 | true | OLTP | hun | RAC | |
| CONFIGURED | f90adcc1-f64a-41ce-b72d-154db155b1fa | | | EE | odb1 | ASM |

```
[root@oda1 ~]# odacli list-dbhomes
```

| ID | Version | DB Edition | Name | DB |
|--------------------------------------|---------|------------|------------------|----|
| f90adcc1-f64a-41ce-b72d-154db155b1fa | | | OraDB19000_home1 | |

```

19.18.0.0.230117          EE          /u01/app/odaorahome/oracle/
product/19.0.0.0/dbhome_1  CONFIGURED
562a7428-9ea7-4878-9005-62c9d732a12b  OraDB12102_home1
12.1.0.2.220719         EE          /u01/app/odaorahome/oracle/
product/12.1.0.2/dbhome_1  CONFIGURED

[oracle@oda1 ~]$ export ORACLE_HOME=/u01/app/odaorahome/oracle/product/
12.1.0.2/dbhome_1
[oracle@oda1 ~]$ export PATH=$ORACLE_HOME/bin:$PATH
[oracle@oda1 ~]$ export ORACLE_SID=italy1
[oracle@oda1 ~]$ sqlplus / as sysdba

```

```
SQL> show parameter db_recovery_file_dest
```

ACFS:

| NAME | TYPE | VALUE |
|----------------------------|-------------|------------------|
| db_recovery_file_dest | string | /u03/app/oracle/ |
| fast_recovery_area/ | | |
| db_recovery_file_dest_size | big integer | 53862M |

ASM:

| NAME | TYPE | VALUE |
|---------------------------------------|-------------|-------|
| db_recovery_file_dest | string | |
| +RECO (FG\$FILEGROUP_TEMPLATE_MIRROR) | | |
| db_recovery_file_dest_size | big integer | 200G |

- b.** If the dbstorage is ASM, then create a vmstorage temporarily or use an existing one and create with a slightly larger size than db_recovery_file_dest_size.

```

[root@oda1 ~]# odacli create-vmstorage -n tempfra -r mirror -s 250G
[root@oda1 ~]# odacli list-vmstorages
Name          Disk group      Volume name      Volume
device        Size            Used             Used %
Available    Mount Point
Created              Updated
-----
tempfra        DATA           TEMPFRA          /dev/asm/
tempfra-18     250.00 GB      1.09 GB         0.44%         248.91
GB /u05/app/sharedrepo/tempfra          2023-04-18 19:05:55 CEST
2023-04-18 19:05:55 CEST

```

- c.** Create a folder on the vmstorage and change ownership of the folder to oracle:dba.

```

[root@oda1 ~]# mkdir /u05/app/sharedrepo/tempfra/italy
[root@oda1 ~]# chown oracle:dba /u05/app/sharedrepo/tempfra/italy

```

d. Change db_recovery_file_dest to ACFS.

```
SQL> alter system set db_recovery_file_dest='/u05/app/sharedrepo/
tempfra/italy/' scope=both;
```

5. Run prechecks and review the findings.

```
[oracle@oda1 ~]$ /u01/app/odaorahome/oracle/product/19.0.0.0/
dbhome_1/jdk/bin/java -jar /u01/app/odaorahome/oracle/product/19.0.0.0/
dbhome_1/rdbms/admin/autoupgrade.jar -config ~/autoupgrade.conf -mode
analyze
AutoUpgrade 22.4.220712 launched with default internal options
Processing config file ...
+-----+
| Starting AutoUpgrade execution |
+-----+
1 CDB(s) plus 2 PDB(s) will be analyzed
Type 'help' to list console commands
upg> Job 100 completed
----- Final Summary -----
Number of databases          [ 1 ]

Jobs finished                [1]
Jobs failed                  [0]

Please check the summary report at:
/u01/app/odaorabase/oracle/autoupgrade/cfgtoollogs/upgrade/auto/status/
status.html
/u01/app/odaorabase/oracle/autoupgrade/cfgtoollogs/upgrade/auto/status/
status.log
```

6. Run AutoUpgrade in fixup mode to fix issues that could prevent a successful upgrade (if any).

```
[oracle@oda1 ~]$ /u01/app/odaorahome/oracle/product/19.0.0.0/
dbhome_1/jdk/bin/java -jar /u01/app/odaorahome/oracle/product/19.0.0.0/
dbhome_1/rdbms/admin/autoupgrade.jar -config ~/autoupgrade.conf -mode
fixups
AutoUpgrade 22.4.220712 launched with default internal options
Processing config file ...
+-----+
| Starting AutoUpgrade execution |
+-----+
1 CDB(s) plus 2 PDB(s) will be processed
Type 'help' to list console commands
upg> Job 101 completed
----- Final Summary -----
Number of databases          [ 1 ]

Jobs finished                [1]
Jobs failed                  [0]

Please check the summary report at:
/u01/app/odaorabase/oracle/autoupgrade/cfgtoollogs/upgrade/auto/status/
status.html
```

```
/u01/app/odaorabase/oracle/autoupgrade/cfgtoollogs/upgrade/auto/status/  
status.log
```

7. Re-run prechecks and review the findings.

```
[oracle@oda1 ~]$ /u01/app/odaorahome/oracle/product/19.0.0.0/  
dbhome_1/jdk/bin/java -jar /u01/app/odaorahome/oracle/product/19.0.0.0/  
dbhome_1/rdbms/admin/autoupgrade.jar -config ~/autoupgrade.conf -mode  
analyze  
AutoUpgrade 22.4.220712 launched with default internal options  
Processing config file ...  
+-----+  
| Starting AutoUpgrade execution |  
+-----+  
1 CDB(s) plus 2 PDB(s) will be analyzed  
Type 'help' to list console commands  
upg> Job 102 completed  
----- Final Summary -----  
Number of databases          [ 1 ]  
  
Jobs finished                [1]  
Jobs failed                  [0]  
  
Please check the summary report at:  
/u01/app/odaorabase/oracle/autoupgrade/cfgtoollogs/upgrade/auto/status/  
status.html  
/u01/app/odaorabase/oracle/autoupgrade/cfgtoollogs/upgrade/auto/status/  
status.log
```

8. Upgrade the database.

```
[oracle@oda1 ~]$ /u01/app/odaorahome/oracle/product/19.0.0.0/  
dbhome_1/jdk/bin/java -jar /u01/app/odaorahome/oracle/product/19.0.0.0/  
dbhome_1/rdbms/admin/autoupgrade.jar -config ~/autoupgrade.conf -mode  
deploy  
  
AutoUpgrade 22.4.220712 launched with default internal options  
Processing config file ...  
+-----+  
| Starting AutoUpgrade execution |  
+-----+  
1 CDB(s) plus 2 PDB(s) will be processed  
Type 'help' to list console commands  
  
upg> Job 103 completed  
----- Final Summary -----  
Number of databases          [ 1 ]  
  
Jobs finished                [1]  
Jobs failed                  [0]  
Jobs restored                [0]  
Jobs pending                 [0]  
  
---- Drop GRP at your convenience once you consider it is no longer needed  
----  
Drop GRP from italy1: drop restore point AUTOUPGRADE_9212_ROME121020
```

Please check the summary report at:
 /u01/app/odaorabase/oracle/autoupgrade/cfgtoollogs/upgrade/auto/status/
 status.html
 /u01/app/odaorabase/oracle/autoupgrade/cfgtoollogs/upgrade/auto/status/
 status.log

Note: once you confirmed that database was running as expected from all perspective and downgrade surely would not be needed, drop the restore point which was created by AutoUpgrade tool as the output also instructed

```
---- Drop GRP at your convenience once you consider it is no longer needed
----
Drop GRP from italy1: drop restore point AUTOUPGRADE_9212_ROME121020
```

9. Enable SSHCleaner job and remove SSH user equivalence in case of Oracle Database Appliance high-availability system.

```
[root@oda1 ~]# odacli list-schedules|grep "Name\|SSH"
ID                                     Name
Description
CronExpression                        Disabled
44ad4fe2-4893-4c7d-a61c-15845cb74aa5  SSHCleanerJob                SSH
cleaner job to clean up stale SSH keys  0 0/30 * 1/1 * ?
*                                       true
```

```
[root@oda1 ~]# odacli modify-schedule -i 44ad4fe2-4893-4c7d-
a61c-15845cb74aa5 -e
Modify job schedule success
```

```
[root@oda1 ~]# odacli list-schedules|grep "Name\|SSH"
ID                                     Name
Description
CronExpression                        Disabled
44ad4fe2-4893-4c7d-a61c-15845cb74aa5  SSHCleanerJob                SSH
cleaner job to clean up stale SSH keys  0 0/30 * 1/1 * ?
*                                       false
```

Remove local and remote node from /home/oracle/.ssh/authorized_keys files on both nodes as oracle OS user using "vi" command

```
[oracle@oda1 ~]$ vi /home/oracle/.ssh/authorized_keys
[oracle@oda2 ~]$ vi /home/oracle/.ssh/authorized_keys
```

Remove all id* files under /home/oracle/.ssh as oracle OS user on both nodes

```
[oracle@oda1 ~]$ rm /home/oracle/.ssh/id*
[oracle@oda2 ~]$ rm /home/oracle/.ssh/id*
```

10. Sync up the DCS metadata of the database.

```
[root@oda1 ~]# odacli list-dbhomes
ID                                     Name                                     DB
Version                               DB Edition Home
Location                               Status
```

```
-----
-----
-----
f90adcc1-f64a-41ce-b72d-154db155b1fa    OraDB19000_home1
19.18.0.0.230117                          EE          /u01/app/odaorahome/oracle/
product/19.0.0.0/dbhome_1    CONFIGURED
562a7428-9ea7-4878-9005-62c9d732a12b    OraDB12102_home1
12.1.0.2.220719              EE          /u01/app/odaorahome/oracle/
product/12.1.0.2/dbhome_1    CONFIGURED
```

```
[root@oda1 ~]# odacli list-databases
```

```
ID                               DB Name    DB Type  DB
Version                          CDB        Class    Edition Shape    Storage Status
DB Home ID
```

```
-----
-----
222a1d47-24ea-4a00-82f0-20d7fe17f59e    italy      RAC
12.1.0.2.220719                          true      OLTP     EE       odb2     ACFS
CONFIGURED 562a7428-9ea7-4878-9005-62c9d732a12b
```

```
[root@oda1 ~]# odacli describe-dbstorage -n italy|grep DBUnique
```

```
DBUnique Name: rome
```

```
[root@oda1 ~]# odacli update-registry -n db -u rome
```

```
Job details
```

```
-----
ID: fc54b821-c407-4174-8a1a-c90ba66e6cd2
Description: Discover Components : db
Status: Created
Created: April 18, 2023 12:04:55 PM CEST
Message:
```

```
[root@oda1 ~]# odacli describe-job -i fc54b821-c407-4174-8a1a-c90ba66e6cd2
```

```
Job details
```

```
-----
ID: fc54b821-c407-4174-8a1a-c90ba66e6cd2
Description: Discover Components : db
Status: Success
Created: April 18, 2023 12:04:55 PM CEST
Message:
```

```
-----
Task Name                               Node Name                               Start
Time                                   End Time                                Status
-----
Discover DBHome                          oda1                                     April 18,
2023 12:05:01 PM CEST                    April 18, 2023 12:05:04 PM CEST        Success
Discover DBHome                          oda1                                     April 18,
2023 12:05:04 PM CEST                    April 18, 2023 12:05:07 PM CEST        Success
Discover DB: rome                         oda1                                     April 18, 2023
12:05:09 PM CEST                        April 18, 2023 12:05:20 PM CEST        Success
```

```
[root@oda1 ~]# odacli list-databases
ID                               DB Name  DB Type  DB
Version                          CDB      Class   Edition Shape  Storage Status
DB Home ID
-----
-----
222a1d47-24ea-4a00-82f0-20d7fe17f59e  italy    RAC
19.18.0.0.230117      true    OLTP    EE      odb2   ACFS
CONFIGURED  f90adcc1-f64a-41ce-b72d-154db155b1fa
```

11. If you edited `db_recovery_file_dest` in step 4, then revert the change.

```
[oracle@oda1 ~]$ export ORACLE_HOME=/u01/app/odaorahome/oracle/product/
19.0.0.0/dbhome_1
[oracle@oda1 ~]$ export PATH=$ORACLE_HOME/bin:$PATH
[oracle@oda1 ~]$ export ORACLE_SID=italy1
[oracle@oda1 ~]$ sqlplus / as sysdba
```

```
SQL> alter system set
db_recovery_file_dest='+RECO(FG$FILEGROUP_TEMPLATE_MIRROR)' scope=both;
```

12. Take a full backup.

```
[oracle@oda1 ~]# odacli create-backup -n italy -bt Regular-L0
```

13. Remove the temporary vmstorage.

```
[oracle@oda1 ~]# odacli delete-vmstorage -n tempfra
```

Deleting a Database

Use the Oracle Appliance Manager Browser User Interface to delete an Oracle database.

1. Log into the Browser User Interface:
`https://host name or ip-address:7093/mgmt/index.html`
2. Click the **Database** tab.
3. Click **Actions** next to the database that you want, then select **Delete**.
4. In the Confirmation dialog, select **Force Delete** to force the deletion and then click **OK** to confirm the action.

Working with Database Homes

Use the Browser User Interface to display a list of database homes, details, and create and delete database homes.

- [About Managing Multiple Oracle Homes on Oracle Database Appliance](#)
Create and manage one or more Oracle home directories and Oracle databases on Oracle Database Appliance.

- [Viewing Database Homes](#)
Use the Browser User Interface to display a list of database homes and database home details, including databases associated with a DB home.
- [Creating a Database Home](#)
Use the Browser User Interface to create database homes in Oracle Database Appliance.
- [Deleting a Database Home](#)
Use the Browser User Interface to delete an Oracle database home.

About Managing Multiple Oracle Homes on Oracle Database Appliance

Create and manage one or more Oracle home directories and Oracle databases on Oracle Database Appliance.

Oracle home is the directory in which you install Oracle Database binaries, and from which Oracle Database runs. Oracle Database Appliance supports multiple Oracle homes, including support of different release Oracle Database homes. You can create multiple Oracle databases on a given Oracle home. Use Oracle Appliance Manager Browser User Interface to create and manage multiple Oracle homes and databases on Oracle Database Appliance. Oracle Database Appliance Manager automatically creates an Oracle Database Oracle home that is compliant with Oracle's Optimal Flexible Architecture (OFA) standards.

Check the *Oracle Database Appliance Release Notes* to obtain information about the specific Oracle software releases supported for your Oracle Database Appliance platform.

When you use ODA CLI commands to create multiple homes on Oracle Database Appliance, the commands start the Oracle Home cloning process. In Oracle Database Appliance deployments, the user `oracle` is the default software installation owner.

You can use the Browser User Interface or the command-line interface to create and manage databases.

Use ODA CLI commands to create, list, describe, and delete databases on Oracle Database Appliance. The `odacli create-database` command enables you to create a database with minimal user input. When you run this command without any additional options, the command creates a new database home (ORACLE_HOME). You can create a database in an existing home by using the `--dbhomeid` option. To find the `dbhomeid`, use the `odacli list-dbhomes` command.

Alternatively, you can use the Browser User Interface to create list, describe and delete databases and database homes. You can display a list of all Database Homes that includes the database home name, ID, version, the date and time that the database home was created and the location on the same page. You can also create and delete database homes on the Browser User Interface.

Caution:

Do not apply Oracle Database patches directly to Oracle Databases on Oracle Database Appliance. Only use Oracle Database Appliance patch bundles, which are tested to work across the whole software stack. If a one-off database patch is required, it may be applied to the Oracle Home. When you apply the Oracle Database Appliance patch bundle, it may cause a conflict during future patching events and you might need to roll back and then re-apply the patch.

Viewing Database Homes

Use the Browser User Interface to display a list of database homes and database home details, including databases associated with a DB home.

1. Log in to the Browser User Interface:

```
https://ip-address:7093/mgmt/index.html
```

2. Click the **Database** tab.
3. Click **Database Home** on the left menu to view all database homes. The name, ID, version, location and date and time stamp of when the database home was created appears on the page.
4. (Optional) Click **Actions** next to a database home entry, then **View Databases** to see the databases that are associated with the database home.

Creating a Database Home

Use the Browser User Interface to create database homes in Oracle Database Appliance.

Before you can create a database home, the Oracle Database Appliance RDBMS Clone file image must be in the repository. Follow these steps to create a database home:

1. Log in to the Browser User Interface:

```
https://ip-address:7093/mgmt/index.html
```

2. Click the **Database** tab, then click **Database Home**.
3. Click **Create Database Home**.
4. Select a database version from the list of available versions, then select the database edition, either **Enterprise Edition** or **Standard Edition**, per your licensing agreement.
5. Click **Create**. When prompted, click **Yes** to confirm that you want to start the job.

Deleting a Database Home

Use the Browser User Interface to delete an Oracle database home.

You can delete a database home (DB Home) if it is not associated with any databases.

1. Log into the Browser User Interface:

```
https://host name or ip-address:7093/mgmt/index.html
```

2. Click the **Database** tab.
3. Click **Database Home** on the left menu to view all database homes. The name, ID, version, location and date and time stamp of when the database home was created appears on the page.
4. Click **Actions** next to a database home entry, then **Delete**, and then confirm the action to delete a database home.

Migrating Databases

Review these topics to learn how to prepare for and migrate an entire database to your Oracle Database Appliance.

- [About Migrating Databases](#)
You can migrate an entire active container database (CDB) or non-CDB database to an Oracle Database Appliance machine by using the RMAN duplicate command.
- [Configuring a Static Listener](#)
Configure a static listener before you duplicate a database.
- [Migrating a Database](#)
Use the `RMAN Duplicate` command to migrate the entire database to the appliance.
- [Registering a Database](#)
Use the `odacli register-database` command to register the migrated database with the appliance.

About Migrating Databases

You can migrate an entire active container database (CDB) or non-CDB database to an Oracle Database Appliance machine by using the RMAN duplicate command.

When using RMAN Duplicate, ensure to have network connectivity from source and target databases:

- Source database: The existing database to be migrated.
- Target database: The new database created on an Oracle Database Appliance environment.

If you do not have network connectivity between the source and the target environments, you can use the offline migration method. Offline migration uses RMAN backup sets for duplication, which does not require connectivity to the primary database.

At a high level, the procedure involves the following steps:

1. Deploy or update Oracle Database Appliance to the latest version.

Confirm that the provisioning completed successfully. On bare metal systems, use the command `odacli list-jobs` and the command `odacli describe-job` to verify the status.

2. Create an instance only database from the command-line interface.

- On bare metal systems, use the command `odacli create-database` with the `instanceonly` flag on an Oracle Database Appliance machine. The new database is the target database.

Creating an instance only database also creates the following:

- ACFS Filesystem used to store the database files
- Directory structures that are required by the database instance/`rman duplicate` command
- Password file for the SYS user

3. Configure a static listener.

4. Migrate the existing database to the target database using the backup and restore operations.

5. Register the migrated database with the appliance.

 **Note:**

You can only migrate and register a database of the same storage type. For example, to migrate and register an Oracle ACFS database, you must create an Oracle ACFS database and then migrate and register it. Similarly, to migrate an Oracle ASM database, you must create an Oracle ASM database and then migrate it.

Configuring a Static Listener

Configure a static listener before you duplicate a database.

The static listener is only required when using RMAN Duplicate command.

Perform the following steps to manually configure the `listener.ora` file:

1. Log in as a grid user.
2. Navigate to `/u01/app/19.0.0.0/grid/network/admin/` directory.
3. Edit the default `listener.ora` file and append the static database entry.

```
SID_LIST_LISTENER=  
  (SID_LIST=  
    (SID_DESC=  
      (GLOBAL_DBNAME=db_unique_name with domain)  
      (ORACLE_HOME=db home)  
      (SID_NAME=db unique name)  
      (ENVS="TNS_ADMIN=database home/network/admin"))  
    )  
  )
```

For example, the following file is edited for an 19.26.0.0.0 database named `PRODDB` in the `example.com` domain:

```
SID_LIST_LISTENER=  
  (SID_LIST=  
    (SID_DESC=  
      (GLOBAL_DBNAME=PRODDB.example.com)  
      (ORACLE_HOME=/u01/app/oracle/product/19.0.0.0/dbhome_2)  
      (SID_NAME=PRODDB)  
      (ENVS="TNS_ADMIN=/u01/app/oracle/product/19.0.0.0/  
dbhome_2/network/admin"))  
    )  
  )
```

4. Save the file.
5. Restart the listener.

```
srvctl stop listener -l listener  
srvctl start listener -l listener
```

Migrating a Database

Use the `RMAN Duplicate` command to migrate the entire database to the appliance.

Before migrating the database, verify that a network connection exists between the source and destination databases.

1. Verify that the `sysdba` connection to the auxiliary database is working. Use the password that you defined when you created the database with the `--instanceonly` flag.

```
sqlplus sys/password@hostname:PORT/GLOBAL_DBNAME as sysdba << EOF
select 1 from dual;
exit;
EOF
```

The following example uses the `Welcome_12` password for `myhost` on port 1521 for `PRODDB.example.com`.

```
sqlplus sys/Welcome_12@myhost:1521/PRODDB.example.com as sysdba << EOF
select 1 from dual;
exit;
EOF
```

2. As oracle user, set the `ORACLE_HOME` and `ORACLE_SID` environment variables.

```
ORACLE_HOME=path of Oracle Home against which the AUX DB is created
ORACLE_SID=database unique name
```

3. Display a list of all database storage configured on the appliance and database storage identifiers (ID).

Use the `odacli list-dbstorages` to display the storage IDs for all configured filesystems.

```
# odacli list-dbstorages
ID Type                               DBUnique Name          Status
-----
68d13446-f26c-49ee-ab75-a393732aa88a  Asm      rdb1             Configured
ff2023d9-338d-4cff-8bb4-e73a89e32ce4   Acfs     PRODDB           Configured
```

4. Display the database storage details, including the `DATA`, `RECO` and `REDO` locations, for each database storage ID.

For example, use the `odacli describe-dbstorage` command to display information about the ACFS storage for ID `9fe39332-cc1a-4b4b-8393-165524a6ef6b`.

```
# odacli describe-dbstorage -i ff2023d9-338d-4cff-8bb4-e73a89e32ce4
DBStorage details
-----
ID: ff2023d9-338d-4cff-8bb4-e73a89e32ce4
DB Name: PRODDB
DBUnique Name: PRODDB
DB Resource ID: c5b77384-634e-4dc8-b10b-fa2831d2c59b
Storage Type: Acfs
```



```

DATA Location: /u02/app/oracle/oradata/PRODDB
RECO Location: /u03/app/oracle/fast_recovery_area/
REDO Location: /u03/app/oracle/redo/
State: ResourceState(status=Configured)
Created: June 22, 2019 12:07:12 PM SGT
UpdatedTime: June 22, 2019 12:26:39 PM SGT

```

5. Duplicate the database.

Use the RMAN duplicate database command to duplicate the database.

```

rman target sys/Welcome__12@source database hostname:PORT
(Continued)
/Service Name auxiliary sys/Welcome_12@Hostname of the target
database:1521/service name
RUN {
SET NEWNAME FOR DATABASE TO NEW;
duplicate target database to PRODDB from active database
SPFILE
SET cluster_database 'false'
SET audit_file_dest '/u01/app/oracle/admin/PRODDB/adump'
SET db_create_file_dest '/u02/app/oracle/oradata/PRODDB'
SET db_create_online_log_dest_1 '/u03/app/oracle/redo'
SET db_recovery_file_dest '/u03/app/oracle/fast_recovery_area'
SET control_files '/tmp/control_PRODDB.ctl' nofilenamecheck;
}

```

Registering a Database

Use the `odacli register-database` command to register the migrated database with the appliance.

The `dbclass`, `dbshape`, `servicename` and `password` are mandatory for registering the database. The `dbclass` and `dbshape` determine the `sga_target` and `pga_target` settings. The database `init.ora` parameters are reset as part of the `odacli register-database` command. Review the `init.ora` parameters after registration and ensure that the parameters set correctly.

Follow these steps to register a database:

1. Ensure that the `sqlpatches` are in the Oracle Database Appliance environment. If the patches are not in the environment, copy the `$OH/sqlpatch` directories from the source database home to the `$OH` in Oracle Database Appliance before executing the `odacli register-database` command

The `odacli register-database` command invokes the `datapatch` utility for applying the post patch SQLs. If the source database has any `sqlpatches` applied that are not present in the Oracle Database Appliance environment, then the `datapatch` will fail.

2. Register the database with Oracle Database Appliance.

```

# odacli register-database -c OLTP -s odbl -sn example_service
Enter SYS, SYSTEM and PDB Admin user password:
Retype SYS, SYSTEM and PDB Admin user password:
{
  "jobId" : "317b430f-ad5f-42ae-bb07-13f053d266e2",
  "status" : "Created",

```

```

    "message" : null,
    "reports" : [ ],
    "createTimestamp" : "August 08, 2021 05:55:49 AM EDT",
    "description" : "Database service registration with
                    db service name: example_service",
    "updatedAt" : "August 08, 2018 05:55:49 AM EDT"
}
# odacli describe-job -i "317b430f-ad5f-42ae-bb07-13f053d266e2"

```

Job details

```

-----
ID: 317b430f-ad5f-42ae-bb07-13f053d266e2
Description: Database service registration with
             db service name: example_service
Status: Success
Created: August 08, 2018 5:55:49 AM EDT
Message:

```

| Task Name | Start Time |
|-------------------------------|--------------------------------|
| restore control file | August 08, 2018 5:55:49 AM EDT |
| move spfile to right location | August 08, 2018 5:56:08 AM EDT |
| register DB with clusterware | August 08, 2018 5:56:13 AM EDT |
| reset db parameters | August 08, 2018 5:57:05 AM EDT |
| Running DataPatch | August 08, 2018 5:57:36 AM EDT |

(Continued)

| End Time | Status |
|--------------------------------|---------|
| August 08, 2018 5:56:08 AM EDT | Success |
| August 08, 2018 5:56:13 AM EDT | Success |
| August 08, 2018 5:57:05 AM EDT | Success |
| August 08, 2018 5:57:36 AM EDT | Success |
| August 08, 2018 5:57:49 AM EDT | Success |

- Use the `odacli list-databases` command to view the registered database.

About Registering a TDE-Enabled Database

Understand the process to register Transparent Data Encryption (TDE) enabled databases.

Starting with Oracle Database Appliance release 19.12, a new attribute called `TDE Wallet Management` is added to the database. The `TDE Wallet Management` value can be either `EXTERNAL`, which means TDE is not configured by Oracle Database Appliance, or the value can be `ODA`, which means TDE is configured by Oracle Database Appliance. If the database is not TDE-enabled, then the value of the `TDE Wallet Management` attribute is `NULL`. If a database of release 18c or later is registered, then its `TDE wallet management` attribute value is `ODA` by default. If a database of release earlier than 18c is registered, then the `TDE wallet management` attribute value is `EXTERNAL` by default. The examples with sample output are provided at the end of this topic.

For Oracle Database release 19c or later, if the `TDE Wallet Management` value is `EXTERNAL`, then you can change this value to `ODA` using the `--change-tdewallet-mgmt` option in the `odacli modify-database` command. You must provide the TDE password when prompted.

For Oracle Database release 12c, the TDE Wallet Management value can be changed from EXTERNAL to ODA while upgrading the database to 19c or later using the `--change-tdewallet-mgmt` option in the `odacli upgrade-database` command.

 **Note:**

Oracle Database Appliance does not support the conversion of a non-TDE database to a TDE-enabled database.

 **Note:**

In this Oracle Database Appliance release, you cannot register a TDE-enabled database with TDE Keys stored on Oracle Key Vault.

Prerequisites to Register a TDE-Enabled Database

Following are the prerequisites to register a TDE-enabled database:

- You can use either the software keystore or the hardware keystore to configure TDE.
- If TDE is configured using the software keystore, then you must use only the `SQLNET.ENCRYPTION_WALLET_LOCATION` parameter.
- If TDE is configured using the software keystore, then for bare metal deployments, password-protected wallet (`ewallet.p12`) and autologin TDE wallet (`cwallet.sso`) must be available in the location `/opt/oracle/dcs/commonstore/wallets/tde/db_uniquename/`.
- If autologin TDE wallet (`cwallet.sso`) is not present but password-protected wallet (`ewallet.p12`) is present, then TDE password must be provided in the register database request.
- For Oracle Database Appliance DB systems deployments, if TDE is configured using Software keystore, then TDE must be configured using the `WALLET_ROOT` parameter and TDE wallets must be at location `+DATA/DB_UNIQUE_NAME/tde`.
- The instance name of the database being registered must be same as the database name. This condition also applies to the databases that do not have TDE enabled.

When TDE Wallet Management value is EXTERNAL

Following are the restrictions when the TDE Wallet Management value is EXTERNAL:

- TDE wallet re-key using ODA CLI commands is not supported. You can connect to the database and re-key the TDE wallet.

```
# odacli modify-database -in db_name -rkt
Enter TDE wallet password:
DCS-10040:Operation 'Re-Key of TDE wallet' is not supported: TDE wallet
management is not ODA.
```

- TDE wallet password change using ODA CLI commands is not supported.

```
# odacli modify-database -in db_name -ctp
Enter current TDE wallet password:
Enter new TDE wallet password:
```

```
Retype new TDE wallet password:
DCS-10040:Operation 'Password change of TDE wallet' is not supported: TDE
wallet management is not ODA.
```

- TDE wallet backup is not supported.

```
# odacli create-backup -in database_name -c tdewallet
DCS-10040:Operation 'Backup of TDE wallet' is not supported: TDE wallet
management is not ODA.
```

- TDE wallet is not backed up while performing database backup.

```
# odacli create-backup -in database_name -bt regular-10
{
  "jobId" : "49153a90-d4bd-45e7-b3b7-46078621b895",
  "status" : "Created",
  "message" : null,
  "reports" : [ ],
  "createTimestamp" : "August 24, 2021 05:59:53 AM UTC",
  "resourceList" : [ ],
  "description" : "Create regular-10 Backup[TAG:auto][Db:db_name]
[OSS:example]",
  "updatedAt" : "August 24, 2021 05:59:53 AM UTC"
}
```

```
# odacli describe-job -i 49153a90-d4bd-45e7-b3b7-46078621b895
```

Job details

```
-----
ID: 49153a90-d4bd-45e7-b3b7-46078621b895
Description: Create regular-10 Backup[TAG:auto][Db:db_name]
[OSS:example]
Status: Success
Created: August 24, 2021 5:59:53 AM UTC
Message:
```

| Task Name | Start | Status |
|--|--------------------------------|---------|
| Time | End Time | |
| Validate backup config | August 24, 2021 5:59:56 AM | Success |
| UTC | August 24, 2021 5:59:56 AM UTC | |
| Container validation | August 24, 2021 5:59:56 AM | Success |
| UTC | August 24, 2021 5:59:57 AM UTC | |
| libopc existence check | August 24, 2021 5:59:57 AM | Success |
| UTC | August 24, 2021 5:59:57 AM UTC | |
| Backup Validations | August 24, 2021 5:59:57 AM | Success |
| UTC | August 24, 2021 6:00:02 AM UTC | |
| Recovery Window validation | August 24, 2021 6:00:02 AM | Success |
| UTC | August 24, 2021 6:00:05 AM UTC | |
| Archivelog deletion policy configuration | August 24, 2021 6:00:05 AM | Success |
| UTC | August 24, 2021 6:00:08 AM UTC | |
| Database backup | August 24, 2021 6:00:08 AM | Success |
| UTC | August 24, 2021 6:02:06 AM UTC | |

```
# odacli describe-backupreport -i b75c7ffa-68f8-4eea-8f12-bfe30b8c92f7 |
grep -i tde
    "tdeWalletLoc" : null,
```

- Restore of TDE wallet is not supported.

```
# odacli restore-tdewallet -in db_name
Enter TDE wallet password:
DCS-10040:Operation 'Restore of TDE wallet' is not supported: TDE wallet
management is not ODA.
```

- Cloning of TDE-enabled database is not supported.

```
odacli clone-database -n db_name2 -f db_name -u db_name2
Enter SYS user password:
Retype SYS user password:
DCS-10040:Operation 'Cloning of TDE database' is not supported: TDE wallet
management is not ODA.
```

- When you move the database from one database home to another database home, the `SQLNET.ENCRYPTION_WALLET_LOCATION` parameter is updated in the destination database home.
- When you upgrade the database, the `SQLNET.ENCRYPTION_WALLET_LOCATION` parameter is updated in the new database home.
- When you update the database home, the `SQLNET.ENCRYPTION_WALLET_LOCATION` parameter is updated in the new database home.
- When you delete a database, the TDE wallet is not deleted.
- For Oracle Database Appliance DB systems, only databases that have TDE configured using the `WALLET_ROOT` parameter can be registered.

Example 9-1 Sample output of TDE-enabled database registered in bare metal deployments

```
# odacli describe-database -in mydb
Database details
-----
                ID: 47de99d6-62cc-4623-a38c-1ac880e7082c
Description: mydb
      DB Name: mydb
    DB Version: 19.11.0.0.210420
      DB Type: SI
      DB Role: PRIMARY
DB Target Node Name: node1
      DB Edition: EE
          DBID: 2987837625
Instance Only Database: false
                CDB: false
                PDB Name:
      PDB Admin User Name:
High-Availability Enabled: false
                Class: OLTP
                Shape: odb1
                Storage: ASM
          DB Redundancy:
```

```

CharacterSet: AL32UTF8
National CharacterSet: AL16UTF16
Language: AMERICAN
Territory: AMERICA
Home ID: 6717bed4-104a-415b-8d26-c0de634a2c85
Console Enabled: false
TDE Enabled: false
TDE Wallet Management: External
Level 0 Backup Day: Sunday
AutoBackup Enabled: true
Created: May 18, 2021 3:33:13 AM UTC
DB Domain Name: example_domain
Associated Networks: Public-network
CPU Pool Name:

```

Example 9-2 Sample output of TDE-enabled database registered in Oracle Database Appliance DB System deployments

```

# odacli describe-database -in mydb
odacli describe-database -in mydb
Database details
-----
ID: 47de99d6-62cc-4623-a38c-1ac880e7082c
Description: mydb
DB Name: mydb
DB Version: 19.11.0.0.210420
DB Type: SI
DB Role: PRIMARY
DB Target Node Name: node1
DB Edition: EE
DBID: 2987837625
Instance Only Database: false
CDB: false
PDB Name:
PDB Admin User Name:
High-Availability Enabled:false
Class: OLTP
Shape: odb1
Storage: ASM
DB Redundancy:
CharacterSet: AL32UTF8
National CharacterSet: AL16UTF16
Language: AMERICAN
Territory: AMERICA
Home ID: 6717bed4-104a-415b-8d26-c0de634a2c85
Console Enabled: false
TDE Enabled: false
TDE Wallet Management: ODA
Level 0 Backup Day: Sunday
AutoBackup Enabled: true
Created: May 18, 2021 4:33:13 AM UTC
DB Domain Name: example_domain
Associated Networks: Public-network
CPU Pool Name:

```

Example 9-3 Sample output of TDE-enabled database registered in Oracle Database Appliance when password-protected wallet (ewallet.p12) exists but not the autologin TDE wallet (cwallet.sso)

```
# odacli register-database -sn example_service --dbclass OLTP --dbshape odb2
Enter SYS user password:
DCS-10011:Input parameter 'TDE wallet password' cannot be NULL.Required to
generate Autologin wallet at /opt/oracle/dcs/commonstore/wallets/tde/db_name

odacli register-database -sn example_service --dbclass OLTP --dbshape odb2 -
tp
Enter SYS, SYSTEM and PDB Admin user password:
Retype SYS, SYSTEM and PDB Admin user password:
Enter TDE wallet password
Retype TDE wallet password:
{
  "jobId" : "4903b711-f144-4aed-9bf6-31c79dbce261",
  "status" : "Created",
  "message" : null,
  "reports" : [ ],
  "createTimestamp" : "August 25, 2021 05:42:13 AM UTC",
  "resourceList" : [ ],
  "description" : "Database service registration with db service name:
example_service",
  "updatedAt" : "August 25, 2021 05:42:14 AM UTC"
}

# odacli describe-job -i 4903b711-f144-4aed-9bf6-31c79dbce261

Job details
-----
                ID: 4903b711-f144-4aed-9bf6-31c79dbce261
        Description: Database service registration with db service name:
example_service
                Status: Success
                Created: August 25, 2021 5:42:13 AM UTC
                Message:

Task Name                Start Time
End Time                Status
-----
TDE parameter validate at destination    August 25, 2021 5:42:14 AM UTC
August 25, 2021 5:42:14 AM UTC    Success
Enable OMF parameters                August 25, 2021 5:42:17 AM UTC
August 25, 2021 5:42:17 AM UTC    Success
Setting db character set                August 25, 2021 5:42:17 AM UTC
August 25, 2021 5:42:18 AM UTC    Success
Move Spfile to right location                August 25, 2021 5:42:18 AM UTC
August 25, 2021 5:42:24 AM UTC    Success
Enable DbSizing Template                August 25, 2021 5:42:24 AM UTC
August 25, 2021 5:43:15 AM UTC    Success
Copy Pwfile to Shared Storage                August 25, 2021 5:43:16 AM UTC
August 25, 2021 5:43:20 AM UTC    Success
Running DataPatch                August 25, 2021 5:43:20 AM UTC
August 25, 2021 5:43:32 AM UTC    Success
```

| | |
|--------------------------------|--------------------------------|
| configuring TDE | August 25, 2021 5:43:32 AM UTC |
| August 25, 2021 5:44:51 AM UTC | Success |
| Reset Associated Networks | August 25, 2021 5:44:52 AM UTC |
| August 25, 2021 5:44:55 AM UTC | Success |

About Managing Multiple Database Instances Using Instance Caging

Use instance caging to manage your system resources on Oracle Database Appliance.

Oracle Database provides a method for managing CPU allocations on a multi-CPU server that runs multiple database instances. This method is called instance caging. Instance caging uses an initialization parameter to limit the number of CPUs that an instance can use simultaneously.

Instance caging and Oracle Database Resource Manager (the Resource Manager) work together to support your desired service levels across multiple instances. Consolidation can minimize idle resources, maximize efficiency, and lower costs.

Oracle Database Appliance templates are already tuned for the size of each database instance workload. They are designed to run on a specific number of cores. Instance caging ensures that each database workload is restricted to the set of cores allocated by the template, enabling multiple databases to run concurrently with no performance degradation, up to the capacity of Oracle Database Appliance. You can select database template sizes larger than your current needs to provide for planned growth.



Note:

Oracle strongly recommends that you use the Oracle Database Appliance templates, because they implement best practices and are configured specifically for Oracle Database Appliance.

The Oracle Database Appliance Manager interface refers to the database sizing templates as database classes.

By default, instance caging is not enabled on Oracle Database Appliance. To enable instance caging, set the initialization parameter, `RESOURCE_MANAGER_PLAN`, for each database on Oracle Database Appliance. The parameter specifies the plan to be used by the Resource Manager for the current instance. Setting this parameter directs the Resource Manager to allocate core resources among databases. If a plan is not specified with this parameter, then the Resource Manager and instance caging are not enabled.

Instance caging allocation of core resources is enabled in accordance with the Oracle Database Appliance database template size that you select for each database. The `CPU_COUNT` initialization parameter is set in the template. Use the `CPU_COUNT` setting that matches the size of each database to consolidate, and follow the standard instructions for configuring instance caging.

Oracle EM Express and DB Console

You can use Oracle Enterprise Manager Database Express (EM Express), or the Database Control Console (DB Console) to manage your database.

The EM Express console is available for supported releases of Oracle Database. The consoles are web-based tools for managing Oracle Databases.

The EM Express console provides the following features:

- Support for basic administrative tasks, such as storage and user management
- Comprehensive solutions for performance diagnostics and tuning
- Performance advisors in a graphic user interface
- Oracle Database utilities in a graphic user interface, such as SQL*Loader and Oracle Recovery Manager (RMAN)

EM Express is built inside the database server and cannot perform actions outside the database.

10

Managing Storage

Understand the storage options and how to manage storage for your Oracle Database Appliance deployment.

- [About Managing Storage](#)
Understand Oracle Database Appliance storage options.
- [About Managing Oracle ASM Disks](#)
Understand the Oracle ASM disk management features that Oracle Database Appliance supports.
- [Managing Storage on Single-Node Systems](#)
Understand the storage options for your Oracle Database Appliance X11-S and X11-L systems.
- [Managing Storage on High-Availability Systems](#)
Understand the storage for your Oracle Database Appliance X11-HA system.

About Managing Storage

Understand Oracle Database Appliance storage options.

Oracle Database Appliance uses raw storage to protect data in the following ways:

- **Fast Recovery Area (FRA) backup.** FRA is a storage area (directory on disk or Oracle ASM diskgroup) that contains redo logs, control file, archived logs, backup pieces and copies, and flashback logs.
- **Mirroring.** Double or triple mirroring provides protection against mechanical issues.

The amount of available storage is determined by the location of the FRA backup (external or internal) and if double or triple mirroring is used. External NFS storage is supported for online backups, data staging, or additional database files.

Oracle Database Appliance X11-L and X11-HA models provide storage expansion options from the base configuration. In addition, on Oracle Database Appliance X11-HA multi-node platforms, you can add an optional storage expansion shelf.

The redundancy level for FLASH is based on the DATA and RECO selection. If you choose High redundancy (triple mirroring), then FLASH is also High redundancy.

About Managing Oracle ASM Disks

Understand the Oracle ASM disk management features that Oracle Database Appliance supports.

Oracle Database Appliance enables you to manage your Oracle ASM disks.

Bringing Oracle ASM Disk Groups Online Automatically

Oracle Database Appliance periodically checks the status of Oracle ASM disks in disk groups. If any Oracle ASM disk is OFFLINE due to transient disk errors, then Oracle Database Appliance attempts to bring the disk ONLINE.

Optimizing Oracle ASM Disk Group Rebalance Operations

Oracle Database Appliance ensures rebalancing of Oracle ASM disks to complete as quickly as possible, without overloading the system and the disks at the same time. This ensures that the system is in a steady state running with the appropriate redundancy. There are default thresholds for the values for rebalancing operations, and you can also set the custom threshold values. For example:

```
odacli modify-agentconfig-parameters -n ASMRM_CPU_RQ -v 50 -d "CPU RUN QUEUE THRESHOLD" -u
odacli modify-agentconfig-parameters -n ASMRM_MAX_HDD_DISK_RQ -v 2 -d "HDD DISK QUEUE THRESHOLD" -u
odacli modify-agentconfig-parameters -n ASMRM_MAX_SSD_DISK_RQ -v 32 -d "SSD DISK QUEUE THRESHOLD" -u
odacli modify-agentconfig-parameters -n ASMRM_MAX_NVME_DISK_RQ -v 50 -d "NVME DISK QUEUE THRESHOLD" -u
```

The above command options set custom threshold limits for rebalance monitoring of Oracle ASM disks.

You can monitor rebalance operations using the `odacli describe-schedule -i Schedule ID` and `odacli list-scheduled-executions` commands.

Managing Storage on Single-Node Systems

Understand the storage options for your Oracle Database Appliance X11-S and X11-L systems.

- [About Storage on Oracle Database Appliance X11-S and X11-L](#)
Understand the storage for your Oracle Database Appliance single-node system.
- [Adding Small Form Factor \(SFF\) NVMe Storage Disks](#)
Depending on the available drives, you can expand Oracle Database Appliance X11-L storage to add Small Form Factor (SFF) NVMe disks or replace existing NVMe disks.
- [Adding Add-in-Card \(AIC\) NVMe Storage Disks](#)
You can expand Oracle Database Appliance X11-L storage with two or four Add-in-Card (AIC) NVMe disks. Oracle Database Appliance X11-L supports a maximum of four AICs.
- [Replacing Small Form Factor \(SFF\) NVMe Storage Disks](#)
Understand how you can replace existing SFF NVMe disks on Oracle Database Appliance.

About Storage on Oracle Database Appliance X11-S and X11-L

Understand the storage for your Oracle Database Appliance single-node system.

Oracle Database Appliance X11-S has two 6.8TB NVMe disks that host DATA and RECO disk groups. There are ten partitions that you can divide between DATA and RECO for Oracle ASM storage information. By default, DATA has an eight partition configuration and RECO has a two partition configuration. The storage capacity is fixed and cannot be expanded.

Oracle Database Appliance X11-L has two form factor-based NVMe disks namely Small Form Factor (SFF) and AIC (Add-in-Card). Both form factor NVMe disks are of 6.8TB storage capacity. SFF is a single disk of 6.8TB capacity whereas AIC has two NVMe disks each of 3.4TB capacity, with a combined storage capacity of 6.8TB. The default configuration for

Oracle Database Appliance X11-L is two 6.8TB NVMe disks that host DATA and RECO disk groups.

When you first deploy and configure X11-L in this release, you can set the storage on X11-L in multiple of 2 packs of NVMe and AIC drives, such as 2, 4, and 6 disks, up to a maximum of 8 disks.

Oracle Database Appliance X11-L supports four SFF NVMe disks and four AIC NVMe disks. You must populate all four SFF NVMe disks before you add AIC NVMe disks to the system.

The table describes the NVMe storage configurations with expansion memory and storage options for single-node systems.

Table 10-1 Storage Options for Oracle Database Appliance X11-S and X11-L

| Configuration | Oracle Database Appliance X11-S | Oracle Database Appliance X11-L |
|--------------------------|---------------------------------|--|
| Base Configuration | 2 x 6.8 TB NVMe = 13.6 TB NVMe | 2 x 6.8 TB NVMe = 13.6 TB NVMe |
| Storage addition options | None | <p>6x6.8TB NVMe storage drives for total storage of 54.4TB NVMe.</p> <p>You must populate all four SFF NVMe disks before you add AIC NVMe disks to the system.</p> <p>For the additional two SFF NVMe, order the following:</p> <p>Qty:1 (Two 6.8TB 2.5-inch NVMe PCIe SFF SSD with marlin bracket for Oracle Database Appliance X11-L)</p> <p>For the additional four NVMe AIC SSDs (these are PCIe NVMe Flash Cards that require cover removal to install), order the following:</p> <p>Qty:1 for two, Qty:2 for four:</p> <p>Qty:1 - (Two 6.8 TB NVMe PCIe Cards for Oracle Database Appliance X11-L)</p> |

Adding Small Form Factor (SFF) NVMe Storage Disks

Depending on the available drives, you can expand Oracle Database Appliance X11-L storage to add Small Form Factor (SFF) NVMe disks or replace existing NVMe disks.

Use the ODAADMCLI commands to perform appliance storage maintenance tasks, including perform storage diagnostics and collect diagnostic logs for storage components.

Preparing for a Storage Upgrade

Review and perform these best practices before adding storage.

1. Check the disk health of the existing storage disks.

```
# odaadmcli show disk
```

2. Run the `odaadmcli show disk` and `asmcmd lsdsk -p` commands to view and review the storage disk information in OAKD and Oracle Automatic Storage Management (Oracle ASM).

```
# odaadmcli show disk
```

```
# asmcmd lsdsk -p
```

3. Use ORAchk to confirm Oracle ASM and Oracle Clusterware health.

Adding Small Form Factor (SFF) NVMe Storage Disks

The default configuration for Oracle Database Appliance X11-S or X11-L includes two NVMe disks. You cannot expand storage for Oracle Database Appliance X11-S.

For Oracle Database Appliance X11-L, you can expand storage by adding two SFF NVMe disks followed by two or four Add-in-Cards (AIC).

Important:

You must populate all four SFF slots before adding AIC.

WARNING:

Pulling a drive before powering it off will crash the kernel, which can lead to data corruption. Do not pull the drive when the LED is an amber or green color. When you need to replace an NVMe drive, use the software to power off the drive before pulling the drive from the slot. If you have more than one disk to replace, complete the replacement of one disk before starting replacement of the next disk.

Follow **all** these steps to add SFF NVMe disks:

1. Before adding the NVMe disks, ensure that the current disks are online in `oakd` and Oracle ASM. Otherwise, the prechecks fail. For example, for 2-disks expansion to slots 2 and 3, the disks in slots 0 and 1 must be online in Oracle ASM and `oakd`.
2. Insert each disk one at a time in the appropriate slot and wait for the disk to power ON.
3. The disk automatically powers on when you insert the disk in the slot. Wait for one minute and then check disk status. **If the disk is in the ON state, then you need not power on the disk manually.** If the disk state is OFF as per the disk status, and then power on the disk manually, and then check the status again.

```
# odaadmcli power disk status slot_number
```

```
# odaadmcli power disk on slot_number
```

For example, to add two (2) NVMe disks, insert the disks in slots 2 and 3.

```
# odaadmcli power disk status pd_02
# odaadmcli power disk on pd_02

# odaadmcli power disk status pd_03
# odaadmcli power disk on pd_03
```

4. Repeat steps 2 and 3 for each disk to be added.
5. Run the `odaadmcli expand storage` command to add the new storage disks. **Note:** You must run this step to add the storage disk. Otherwise, the newly-added disk is not visible to OAKD and hence does not display when you run the `odaadmcli show disk` or `odaadmcli show storage` commands. The newly-added disk is recognized by OAKD after the `odaadmcli expand storage` command completes running successfully.

```
# odaadmcli expand storage -ndisk number_of_disks
```

For example, to add two (2) NVMe drives:

```
#odaadmcli expand storage -ndisk 2
Running precheck, it may take a few minutes.
Precheck passed.
Check the progress of expansion of storage by executing 'odaadmcli show
disk'
Waiting for expansion to finish. It may take several minutes to complete
depending upon the number of disks being expanded
```

6. Check the status of the new disk in OAKD with the `odaadmcli show disk` command. The disk must have the status `Online` and `Good` in OAKD.

```
# odaadmcli show disk
NAME PATH TYPE STATE STATE_DETAILS

pd_00 /dev/nvme0n1 NVD ONLINE Good
pd_01 /dev/nvme1n1 NVD ONLINE Good
pd_02 /dev/nvme3n1 NVD ONLINE Good
pd_03 /dev/nvme2n1 NVD ONLINE Good
#
```

7. Verify that the disks in slots 2 and 3 are added to Oracle Automatic Storage Management (Oracle ASM) as follows. The new disk in Oracle ASM must be in `CACHED MEMBER ONLINE NORMAL` state.
 - a. Run `asm_script` to verify that the disks in slots 2 and 3 are added to Oracle ASM. Verify that both disks are successfully added (`CACHED` and `MEMBER`). Following is example of default configuration of 80:20 where eight partitions (p1 to p8) are part of the `DATA` disk group and two partitions (p9 and p10) are part of the `RECO` disk group.

```
# su gridUser /opt/oracle/oak/bin/stordiag/asm_script.sh 0 6
# su grid /opt/oracle/oak/bin/stordiag/asm_script.sh 0 6

SQL*Plus: Release 19.0.0.0.0 - Production on Wed Dec 11 08:26:05 2024
Version 19.25.0.0.0
Copyright (c) 1982, 2024, Oracle. All rights reserved.
```

Connected to:
 Oracle Database 19c Enterprise Edition Release 19.0.0.0.0 - Production
 Version 19.25.0.0.0

SQL> SQL> SQL> SQL> SQL>

```

PATH
NAME                                GROUP_NUMBER STATE    MODE_ST
MOUNT_S HEADER_STATU
-----
-----
AFD:NVD_S02_S6UENA0TC001P1
NVD_S02_S6UENA0TC001P1              1 NORMAL  ONLINE
  CACHED MEMBER
AFD:NVD_S02_S6UENA0TC001P10
NVD_S02_S6UENA0TC001P10             2 NORMAL  ONLINE
  CACHED MEMBER
AFD:NVD_S02_S6UENA0TC001P2
NVD_S02_S6UENA0TC001P2              1 NORMAL  ONLINE
  CACHED MEMBER
AFD:NVD_S02_S6UENA0TC001P3
NVD_S02_S6UENA0TC001P3              1 NORMAL  ONLINE
  CACHED MEMBER
AFD:NVD_S02_S6UENA0TC001P4
NVD_S02_S6UENA0TC001P4              1 NORMAL  ONLINE
  CACHED MEMBER
AFD:NVD_S02_S6UENA0TC001P5
NVD_S02_S6UENA0TC001P5              1 NORMAL  ONLINE
  CACHED MEMBER
AFD:NVD_S02_S6UENA0TC001P6
NVD_S02_S6UENA0TC001P6              1 NORMAL  ONLINE
  CACHED MEMBER
AFD:NVD_S02_S6UENA0TC001P7
NVD_S02_S6UENA0TC001P7              1 NORMAL  ONLINE
  CACHED MEMBER
AFD:NVD_S02_S6UENA0TC001P8
NVD_S02_S6UENA0TC001P8              1 NORMAL  ONLINE
  CACHED MEMBER
AFD:NVD_S02_S6UENA0TC001P9
NVD_S02_S6UENA0TC001P9              2 NORMAL  ONLINE
  CACHED MEMBER
AFD:NVD_S03_S6UENA0TC001P1
NVD_S03_S6UENA0TC001P1              1 NORMAL  ONLINE
  CACHED MEMBER
AFD:NVD_S03_S6UENA0TC001P10
NVD_S03_S6UENA0TC001P10             2 NORMAL  ONLINE
  CACHED MEMBER
AFD:NVD_S03_S6UENA0TC001P2
NVD_S03_S6UENA0TC001P2              1 NORMAL  ONLINE
  CACHED MEMBER
AFD:NVD_S03_S6UENA0TC001P3
NVD_S03_S6UENA0TC001P3              1 NORMAL  ONLINE
  CACHED MEMBER
AFD:NVD_S03_S6UENA0TC001P4
NVD_S03_S6UENA0TC001P4              1 NORMAL  ONLINE
  CACHED MEMBER
  
```

```
AFD:NVD_S03_S6UENA0TC001P5
NVD_S03_S6UENA0TC001P5          1 NORMAL ONLINE
  CACHED MEMBER
AFD:NVD_S03_S6UENA0TC001P6
NVD_S03_S6UENA0TC001P6          1 NORMAL ONLINE
  CACHED MEMBER
AFD:NVD_S03_S6UENA0TC001P7
NVD_S03_S6UENA0TC001P7          1 NORMAL ONLINE
  CACHED MEMBER
AFD:NVD_S03_S6UENA0TC001P8
NVD_S03_S6UENA0TC001P8          1 NORMAL ONLINE
  CACHED MEMBER
AFD:NVD_S03_S6UENA0TC001P9
NVD_S03_S6UENA0TC001P9          2 NORMAL ONLINE
  CACHED MEMBER
```

```
SQL> Disconnected from Oracle Database 19c Enterprise Edition Release
19.0.0.0.0 - Production
Version 19.25.0.0.0
[root@node1 ~]#
```

- b. Use the `odaadmcli show validation storage errors` command to view hard storage errors. Hard errors include having the wrong type of disk inserted into a particular slot, an invalid disk model, or an incorrect disk size.

```
# odaadmcli show validation storage errors
```

- c. Use the `odaadmcli show validation storage failures` command to view soft validation errors. A typical soft disk error would be an invalid version of the disk firmware.

```
# odaadmcli show validation storage failures
```

- d. Confirm that the `oak_storage_conf.xml` file shows the number of disks added. For example, if you added 2 disks to the base configuration, then the `oak_storage_conf.xml` file must show `numberOfDisks` as 4.

```
#cat /opt/oracle/oak/conf/oak_storage_conf.xml
<!--
This file is created by the Oracle Database Appliance software as part
of system provisioning based on system provisioning requests.
Values of element nodes can be changed by OAK in response to storage
configuration change operation.
DO NOT EDIT THIS FILE.
-->
<CometConfiguration>
  <OakStorageConfigInfo type="string" dimension="vector"
readonly="true" required="true" default="">
    <!-- Number of disks part of OAK -->
    <numberOfDisks>4</numberOfDisks>
    <!-- Number of partitions per disk part of DATA diskgroup in
multiple partition scheme -->
    <!-- Number of partitions per disk part of RECO diskgroup in
multiple partition scheme -->
    <!-- are derived from number of partitions per disk which are
```



```
part of ASM DATA diskgroup -->
  <numOfDataDiskPartitionInAsm>8</numOfDataDiskPartitionInAsm>
</OakStorageConfigInfo>
</CometConfiguration>
#
```

Adding Add-in-Card (AIC) NVMe Storage Disks

You can expand Oracle Database Appliance X11-L storage with two or four Add-in-Card (AIC) NVMe disks. Oracle Database Appliance X11-L supports a maximum of four AICs.

Use the ODAADMCLI commands to perform appliance storage maintenance tasks, including perform storage diagnostics and collect diagnostic logs for storage components.

Preparing for a Storage Upgrade

Review and perform these best practices before adding storage.

1. Update Oracle Database Appliance to the latest Patch Bundle before expanding storage.

```
# odacli describe-component
```

2. Check the disk health of the existing storage disks.

```
# odaadmcli show disk
```

3. Run the `odaadmcli show diskgroup` command to display and review Oracle Automatic Storage Management (Oracle ASM) disk group information.
4. Use the `asmcmd` command to verify that all the disks for the four SFF slots are part of Oracle ASM.
5. Use Oracle ORAchk to confirm Oracle ASM and Oracle Clusterware health.

Adding Add-in-Cards (AIC) NVMe Storage Disks

For Oracle Database Appliance X11-L, you can expand storage by adding two SFF NVMe disks followed by two or four Add-in-Cards (AIC). You can expand storage by first adding 2 AIC NVMe disks or 4 AIC, up to a maximum of 4 AIC disks. When you expand storage, adding odd numbers of AIC drives is **not** supported.

Important:

You must populate all four SFF slots before adding AIC.

WARNING:

Pulling a drive before powering it off will crash the kernel, which can lead to data corruption. Do not pull the drive when the LED is an amber or green color. When you need to replace an NVMe drive, use the software to power off the drive before pulling the drive from the slot. If you have more than one disk to replace, complete the replacement of one disk before starting replacement of the next disk.

 **See Also:**

Chapter *Installing Oracle Database Appliance Into a Rack* in the *Oracle Database Appliance X11 Owner's Guide* in the Oracle Database Appliance Documentation Library for this release for requirements before adding any optional PCIe add-in card storage

Note that you must install the AIC NVMe disks in the correct slots as described in the *Oracle Database Appliance X11 Owner's Guide* and complete all configuration steps to add the AIC NVMe disks. Following are PCI slot for AIC:

- x16-PCIe slot 2: NVMe AIC (first)
- x8-PCIe slot 3: NVMe AIC (second)
- x8-PCIe slot 9: NVMe AIC (third)
- x16-PCIe slot 1: NVMe AIC (fourth)

Follow these steps to add AIC NVMe disks:

1. On successful installation of AIC, the system restarts. Check that Oracle Clusterware is up and running.

```
crsctl check crs
CRS-4638: Oracle High Availability Services is online
CRS-4537: Cluster Ready Services is online
CRS-4529: Cluster Synchronization Services is online
CRS-4533: Event Manager is online
```

2. Verify that the `oakd` process is running.

```
# odaadmcli show disk
```

If the `oakd` process is not running, then start it:

```
# odaadmcli start oak
```

3. Run the `odaadmcli show disk` command to check that `oakd` has discovered all AIC NVMe disks. For 2 AIC disks, there are four (4) NVMe disks of 3.4TB, and for four AIC disks, there are eight (8) 3.4TB NVMe disks.

For two AIC:

```
# odaadmcli show storage
==== BEGIN STORAGE DUMP =====
Host Description: Oracle Corporation:ORACLE SERVER E6-2L
Total number of controllers: 8

    Id = 0
    Pci Slot = 100
    Serial Num = PHCP4246002S7P6CGN
    Vendor = Solidigm
    Model = SOLIDIGM SB5PH27X076TOC
    FwVers = G70YR112
    strId = nvme:71:00.00
    Pci Address = 71:00.0
```

```
Id = 1
Pci Slot = 101
Serial Num = PHCP4302001Y7P6CGN
Vendor = Solidigm
Model = SOLIDIGM SB5PH27X076TOC
FwVers = G70YR112
strId = nvme:72:00.00
Pci Address = 72:00.0
```

```
Id = 2
Pci Slot = 103
Serial Num = PHCP424400EE7P6CGN
Vendor = Solidigm
Model = SOLIDIGM SB5PH27X076TOC
FwVers = G70YR112
strId = nvme:73:00.00
Pci Address = 73:00.0
```

```
Id = 3
Pci Slot = 102
Serial Num = PHCP424600527P6CGN
Vendor = Solidigm
Model = SOLIDIGM SB5PH27X076TOC
FwVers = G70YR112
strId = nvme:74:00.00
Pci Address = 74:00.0
```

```
Id          = 4
Pci Slot    = 2
Serial Num  = PHAZ2233000R6P4AGN-1
Vendor      = Intel
Model       = INTEL SSDPFCKE064T1S
FwVers      = 9CV1R310
strId       = nvme:c1:00.00
Pci Address = c1:00.0
```

```
Id          = 5
Pci Slot    = 22
Serial Num  = PHAZ2233000R6P4AGN-2
Vendor      = Intel
Model       = INTEL SSDPFCKE064T1S
FwVers      = 9CV1R310
strId       = nvme:c2:00.00
Pci Address = c2:00.0
```

```
Id          = 7
Pci Slot    = 3
Serial Num  = PHAZ2333000R6P4AGN-1
Vendor      = Intel
Model       = INTEL SSDPFCKE064T1S
FwVers      = 9CV1R310
strId       = nvme:e2:00.00
Pci Address = e2:00.0
```

```
Id          = 6
```

```

    Pci Slot      = 23
    Serial Num    = PHAZ2333000R6P4AGN-2
    Vendor        = Intel
    Model         = INTEL SSDPFCKE064T1S
    FwVers        = 9CV1R310
    strId         = nvme:e3:00.00
    Pci Address   = e3:00.0

Total number of expanders: 0
Total number of PDs: 8
    /dev/nvme0n1 Solidigm NVD 6801gb slot: 0 pci-addr : 71 SOLIDIGM
SB5PH27X076TOC SFF
    /dev/nvme1n1 Solidigm NVD 6801gb slot: 1 pci-addr : 72 SOLIDIGM
SB5PH27X076TOC SFF
    /dev/nvme3n1 Solidigm NVD 6801gb slot: 2 pci-addr : 74 SOLIDIGM
SB5PH27X076TOC SFF
    /dev/nvme2n1 Solidigm NVD 6801gb slot: 3 pci-addr : 73 SOLIDIGM
SB5PH27X076TOC SFF
    /dev/nvme8n1 Solidigm NVD 3400gb slot: 4 pci-addr : f1 SOLIDIGM
SB5PHC7E068TON AIC
    /dev/nvme9n1 Solidigm NVD 3400gb slot: 5 pci-addr : f2 SOLIDIGM
SB5PHC7E068TON AIC
    /dev/nvme6n1 Solidigm NVD 3400gb slot: 6 pci-addr : e1 SOLIDIGM
SB5PHC7E068TON AIC
    /dev/nvme7n1 Solidigm NVD 3400gb slot: 7 pci-addr : e2 SOLIDIGM
SB5PHC7E068TON AIC
==== END STORAGE DUMP =====
#
# odaadmcli show disk
      NAME                PATH                TYPE                STATE
STATE_DETAILS
Good    pd_00                /dev/nvme0n1       NVD                 ONLINE
Good    pd_01                /dev/nvme1n1       NVD                 ONLINE
Good    pd_02                /dev/nvme2n1       NVD                 ONLINE
Good    pd_03                /dev/nvme3n1       NVD                 ONLINE
Good    pd_04_c1             /dev/nvme5n1       NVD                 UNKNOWN
NewDiskInserted
      pd_04_c2             /dev/nvme4n1       NVD                 UNKNOWN
NewDiskInserted
      pd_05_c1             /dev/nvme9n1       NVD                 UNKNOWN
NewDiskInserted
      pd_05_c2             /dev/nvme8n1       NVD                 UNKNOWN
NewDiskInserted

For four AIC:

# odaadmcli show storage
==== BEGIN STORAGE DUMP =====
Host Description: Oracle Corporation:ORACLE SERVER E6-2L
Total number of controllers: 12

```

Id = 8
Pci Slot = 9
Serial Num = PHCR429000036P8AGN-1
Vendor = Solidigm
Model = SOLIDIGM SB5PHC7E068TON
FwVers = G79YR112
strId = nvme:61:00.00
Pci Address = 61:00.0

Id = 9
Pci Slot = 29
Serial Num = PHCR429000036P8AGN-2
Vendor = Solidigm
Model = SOLIDIGM SB5PHC7E068TON
FwVers = G79YR112
strId = nvme:62:00.00
Pci Address = 62:00.0

Id = 0
Pci Slot = 100
Serial Num = PHCP430500077P6CGN
Vendor = Solidigm
Model = SOLIDIGM SB5PH27X076TOC
FwVers = G70YR112
strId = nvme:71:00.00
Pci Address = 71:00.0

Id = 5
Pci Slot = 101
Serial Num = PHCP424400JU7P6CGN
Vendor = Solidigm
Model = SOLIDIGM SB5PH27X076TOC
FwVers = G70YR112
strId = nvme:72:00.00
Pci Address = 72:00.0

Id = 6
Pci Slot = 103
Serial Num = PHCP424600977P6CGN
Vendor = Solidigm
Model = SOLIDIGM SB5PH27X076TOC
FwVers = G70YR112
strId = nvme:73:00.00
Pci Address = 73:00.0

Id = 7
Pci Slot = 102
Serial Num = PHCP430500067P6CGN
Vendor = Solidigm
Model = SOLIDIGM SB5PH27X076TOC
FwVers = G70YR112
strId = nvme:74:00.00
Pci Address = 74:00.0

Id = 3
Pci Slot = 1

```

Serial Num = PHCR4286000B6P8AGN-1
Vendor     = Solidigm
Model     = SOLIDIGM SB5PHC7E068TON
FwVers    = G79YR112
strId     = nvme:91:00.00
Pci Address = 91:00.0

Id        = 4
Pci Slot  = 21
Serial Num = PHCR4286000B6P8AGN-2
Vendor     = Solidigm
Model     = SOLIDIGM SB5PHC7E068TON
FwVers    = G79YR112
strId     = nvme:92:00.00
Pci Address = 92:00.0

Id        = 1
Pci Slot  = 2
Serial Num = PHCR4280002W6P8AGN-1
Vendor     = Solidigm
Model     = SOLIDIGM SB5PHC7E068TON
FwVers    = G79YR112
strId     = nvme:e1:00.00
Pci Address = e1:00.0

Id        = 2
Pci Slot  = 22
Serial Num = PHCR4280002W6P8AGN-2
Vendor     = Solidigm
Model     = SOLIDIGM SB5PHC7E068TON
FwVers    = G79YR112
strId     = nvme:e2:00.00
Pci Address = e2:00.0

Id        = 10
Pci Slot  = 3
Serial Num = PHCR4280004S6P8AGN-1
Vendor     = Solidigm
Model     = SOLIDIGM SB5PHC7E068TON
FwVers    = G79YR112
strId     = nvme:f1:00.00
Pci Address = f1:00.0

Id        = 11
Pci Slot  = 23
Serial Num = PHCR4280004S6P8AGN-2
Vendor     = Solidigm
Model     = SOLIDIGM SB5PHC7E068TON
FwVers    = G79YR112
strId     = nvme:f2:00.00
Pci Address = f2:00.0
Total number of expanders: 0
Total number of PDs: 12
    /dev/nvme0n1    Solidigm          NVD  6801gb slot: 0  pci-addr :
71 SOLIDIGM SB5PH27X076TOC          SFF
    /dev/nvme1n1    Solidigm          NVD  6801gb slot: 1  pci-addr :

```

```

72 SOLIDIGM SB5PH27X076TOC          SFF
    /dev/nvme3n1 Solidigm          NVD 6801gb slot: 2 pci-addr :
74 SOLIDIGM SB5PH27X076TOC          SFF
    /dev/nvme2n1 Solidigm          NVD 6801gb slot: 3 pci-addr :
73 SOLIDIGM SB5PH27X076TOC          SFF
    /dev/nvme10n1 Solidigm         NVD 3400gb slot: 4 pci-addr :
e1 SOLIDIGM SB5PHC7E068TON          AIC
    /dev/nvme11n1 Solidigm         NVD 3400gb slot: 5 pci-addr :
e2 SOLIDIGM SB5PHC7E068TON          AIC
    /dev/nvme8n1 Solidigm          NVD 3400gb slot: 6 pci-addr :
f1 SOLIDIGM SB5PHC7E068TON          AIC
    /dev/nvme9n1 Solidigm          NVD 3400gb slot: 7 pci-addr :
f2 SOLIDIGM SB5PHC7E068TON          AIC
    /dev/nvme6n1 Solidigm          NVD 3400gb slot: 8 pci-addr :
61 SOLIDIGM SB5PHC7E068TON          AIC
    /dev/nvme7n1 Solidigm          NVD 3400gb slot: 9 pci-addr :
62 SOLIDIGM SB5PHC7E068TON          AIC
    /dev/nvme12n1 Solidigm         NVD 3400gb slot: 10 pci-addr :
91 SOLIDIGM SB5PHC7E068TON          AIC
    /dev/nvme13n1 Solidigm         NVD 3400gb slot: 11 pci-addr :
92 SOLIDIGM SB5PHC7E068TON          AIC
==== END STORAGE DUMP =====

```

For example, to add two (2) AIC disks, you must specify `ndisk` values as 4 because AIC has two NVMe disks, so the total value of two AIC disks is four NVMe disks.

```

#odaadmcli expand storage -ndisk 4
Running precheck, it may take a few minutes.
Precheck passed.
Check the progress of expansion of storage by executing 'odaadmcli show
disk'
Waiting for expansion to finish. It may take several minutes to complete
depending upon the number of disks being expanded

```

4. Run the `odaadmcli show disk` command to ensure that all disks are listed, are online, and are in a good state.

```

# odaadmcli show disk
NAME PATH TYPE STATE STATE_DETAILS

pd_00 /dev/nvme0n1 NVD ONLINE Good
pd_01 /dev/nvme1n1 NVD ONLINE Good
pd_02 /dev/nvme3n1 NVD ONLINE Good
pd_03 /dev/nvme14n2 NVD ONLINE Good
pd_04_c1 /dev/nvme10n1 NVD ONLINE Good
pd_04_c2 /dev/nvme11n1 NVD ONLINE Good
pd_05_c1 /dev/nvme8n1 NVD ONLINE Good
pd_05_c2 /dev/nvme9n1 NVD ONLINE Good

#

```

5. Verify that the two AIC disks are added to Oracle Automatic Storage Management (Oracle ASM) as follows:
 - a. Run `asm_script` to verify that the disks in slots 3 and 4 are added to Oracle ASM. Verify that both disks are successfully added (CACHED and MEMBER). Following is an example of default configuration of 80:20 where eight partitions (p1 to p8) are part

of the DATA disk group and two partitions (p9 and p10) are part of the RECO diskgroup.

```
# su gridUser /opt/oracle/oak/bin/stordiag/asm_script.sh 0 6
# su grid /opt/oracle/oak/bin/stordiag/asm_script.sh 0 6
```

```
SQL*Plus: Release 19.0.0.0.0 - Production on Tue Dec 10 11:28:07 2024
Version 19.25.0.0.0
Copyright (c) 1982, 2024, Oracle. All rights reserved.
Connected to:
Oracle Database 19c Enterprise Edition Release 19.0.0.0.0 - Production
Version 19.25.0.0.0
```

```
SQL> SQL> SQL> SQL> SQL>
PATH
NAME                                GROUP_NUMBER STATE    MODE_ST
MOUNT_S HEADER_STATU
-----
-----
-----
AFD:NVD_S04_C1_PHAZ22330P1
NVD_S04_C1_PHAZ22330P1                1 NORMAL  ONLINE
  CACHED MEMBER
AFD:NVD_S04_C1_PHAZ22330P2
NVD_S04_C1_PHAZ22330P2                1 NORMAL  ONLINE
  CACHED MEMBER
AFD:NVD_S04_C1_PHAZ22330P3
NVD_S04_C1_PHAZ22330P3                1 NORMAL  ONLINE
  CACHED MEMBER
AFD:NVD_S04_C1_PHAZ22330P4
NVD_S04_C1_PHAZ22330P4                1 NORMAL  ONLINE
  CACHED MEMBER
AFD:NVD_S04_C1_PHAZ22330P5
NVD_S04_C1_PHAZ22330P5                1 NORMAL  ONLINE
  CACHED MEMBER
AFD:NVD_S04_C2_PHAZ22330P10
NVD_S04_C2_PHAZ22330P10              2 NORMAL  ONLINE
  CACHED MEMBER
AFD:NVD_S04_C2_PHAZ22330P6
NVD_S04_C2_PHAZ22330P6                1 NORMAL  ONLINE
  CACHED MEMBER
AFD:NVD_S04_C2_PHAZ22330P7
NVD_S04_C2_PHAZ22330P7                2 NORMAL  ONLINE
  CACHED MEMBER
AFD:NVD_S04_C2_PHAZ22330P8
NVD_S04_C2_PHAZ22330P8                2 NORMAL  ONLINE
  CACHED MEMBER
AFD:NVD_S04_C2_PHAZ22330P9
NVD_S04_C2_PHAZ22330P9                2 NORMAL  ONLINE
  CACHED MEMBER
AFD:NVD_S05_C1_PHAZ23330P1
NVD_S05_C1_PHAZ23330P1                1 NORMAL  ONLINE
  CACHED MEMBER
AFD:NVD_S05_C1_PHAZ23330P2
NVD_S05_C1_PHAZ23330P2                1 NORMAL  ONLINE
  CACHED MEMBER
```



```

AFD:NVD_S05_C1_PHAZ23330P3
NVD_S05_C1_PHAZ23330P3          1 NORMAL ONLINE
  CACHED MEMBER
AFD:NVD_S05_C1_PHAZ23330P4
NVD_S05_C1_PHAZ23330P4          1 NORMAL ONLINE
  CACHED MEMBER
AFD:NVD_S05_C1_PHAZ23330P5
NVD_S05_C1_PHAZ23330P5          1 NORMAL ONLINE
  CACHED MEMBER
AFD:NVD_S05_C2_PHAZ23330P10
NVD_S05_C2_PHAZ23330P10         2 NORMAL ONLINE
  CACHED MEMBER
AFD:NVD_S05_C2_PHAZ23330P6
NVD_S05_C2_PHAZ23330P6          1 NORMAL ONLINE
  CACHED MEMBER
AFD:NVD_S05_C2_PHAZ23330P7
NVD_S05_C2_PHAZ23330P7         2 NORMAL ONLINE
  CACHED MEMBER
AFD:NVD_S05_C2_PHAZ23330P8
NVD_S05_C2_PHAZ23330P8         2 NORMAL ONLINE
  CACHED MEMBER
AFD:NVD_S05_C2_PHAZ23330P9
NVD_S05_C2_PHAZ23330P9         2 NORMAL ONLINE
  CACHED MEMBER
AFD:SSD_QRMDSK_P2
                                0 NORMAL ONLINE CLOSED FORMER
AFD:SSD_QRMDSK_P1
                                0 NORMAL ONLINE CLOSED FORMER
SQL> Disconnected from Oracle Database 19c Enterprise Edition Release
19.0.0.0.0 - Production
Version 19.25.0.0.0

```

- b.** Use the `odaadmcli show validation storage errors` command to view hard storage errors. Hard errors include having the wrong type of disk inserted into a particular slot, an invalid disk model, or an incorrect disk size.

```
# odaadmcli show validation storage errors
```

- c.** Use the `odaadmcli show validation storage failures` command to view soft validation errors. A typical soft disk error would be an invalid version of the disk firmware.

```
# odaadmcli show validation storage failures
```

- d.** Confirm that the `oak_storage_conf.xml` file shows the number of disks added. For example, if you added two AIC to four SFF, then the `oak_storage_conf.xml` file must show `numberOfDisks` as 8.

```

#cat /opt/oracle/oak/conf/oak_storage_conf.xml
<!--
This file is created by the ODA software as part of system provisioning
based on system provisioning requests. Values of element nodes can be
changed by OAK in response to storage configuration change operation.
DO NOT EDIT THIS FILE.
-->

```

```

<CometConfiguration>
  <OakStorageConfigInfo type="string" dimension="vector"
readonly="true" required="true" default="">
  <!-- Number of disks part of OAK -->
  <numberOfDisks>8</numberOfDisks>
  <!-- Number of partitions per disk part of DATA diskgroup in
multiple partition scheme -->
  <!-- Number of partitions per disk part of RECO diskgroup in
multiple partition scheme -->
  <!-- are derived from number of partitions per disk which are
part of ASM DATA diskgroup -->
  <numOfDataDiskPartitionInAsm>8</numOfDataDiskPartitionInAsm>
  </OakStorageConfigInfo>
</CometConfiguration>
#

```

For example, to add four (4) AIC disks, you must specify `ndisk` values as 8 because AIC has two NVMe disks, so the total value of four AIC disks is eight NVMe disks.

```

#odaadmcli expand storage -ndisk 8
Running precheck, it may take a few minutes.
Precheck passed.
Check the progress of expansion of storage by executing 'odaadmcli show
disk'
Waiting for expansion to finish. It may take several minutes to complete
depending upon the number of disks being expanded

```

- e. Run the `odaadmcli show disk` command to ensure that all disks are listed, are online, and are in a good state.

```

# odaadmcli show disk
pd_00 /dev/nvme0n1 NVD ONLINE Good
pd_01 /dev/nvme1n1 NVD ONLINE Good
pd_02 /dev/nvme2n1 NVD ONLINE Good
pd_03 /dev/nvme3n1 NVD ONLINE Good
pd_04_c1 /dev/nvme4n1 NVD ONLINE Good
pd_04_c2 /dev/nvme5n1 NVD ONLINE Good
pd_05_c1 /dev/nvme9n1 NVD ONLINE Good
pd_05_c2 /dev/nvme8n1 NVD ONLINE Good
pd_06_c1 /dev/nvme11n1 NVD ONLINE Good
pd_06_c2 /dev/nvme10n1 NVD ONLINE Good
pd_07_c1 /dev/nvme12n1 NVD ONLINE Good
pd_07_c2 /dev/nvme13n1 NVD ONLINE Good

```

- f. Verify that the disks are added to Oracle Automatic Storage Management (Oracle ASM) as follows:
- i. Run `asm_script` to verify that the AIC disks are added to Oracle ASM. Verify that both disks are successfully added (CACHED and MEMBER). Following is example of default configuration of 80:20 where eight partitions (p1 to p8) are part of the DATA disk group and two partitions (p9 and p10) are part of the RECO diskgroup.

```

# su gridUser /opt/oracle/oak/bin/stordiag/asm_script.sh 0 6
# su grid /opt/oracle/oak/bin/stordiag/asm_script.sh 0 6

```

```
SQL*Plus: Release 19.0.0.0.0 - Production on Tue Dec 10 11:56:05
2024
Version 19.25.0.0.0
Copyright (c) 1982, 2024, Oracle. All rights reserved.
Connected to:
Oracle Database 19c Enterprise Edition Release 19.0.0.0.0 -
Production
Version 19.25.0.0.0
```

```
SQL> SQL> SQL> SQL> SQL>
AFD:NVD_S04_C1_PHCR42800P1
NVD_S04_C1_PHCR42800P1          1 NORMAL ONLINE
  CACHED MEMBER
AFD:NVD_S04_C1_PHCR42800P2
NVD_S04_C1_PHCR42800P2          1 NORMAL ONLINE
  CACHED MEMBER
AFD:NVD_S04_C1_PHCR42800P3
NVD_S04_C1_PHCR42800P3          1 NORMAL ONLINE
  CACHED MEMBER
AFD:NVD_S04_C1_PHCR42800P4
NVD_S04_C1_PHCR42800P4          1 NORMAL ONLINE
  CACHED MEMBER
AFD:NVD_S04_C1_PHCR42800P5
NVD_S04_C1_PHCR42800P5          1 NORMAL ONLINE
  CACHED MEMBER
AFD:NVD_S04_C2_PHCR42800P10
NVD_S04_C2_PHCR42800P10        2 NORMAL ONLINE
  CACHED MEMBER
AFD:NVD_S04_C2_PHCR42800P6
NVD_S04_C2_PHCR42800P6          2 NORMAL ONLINE
  CACHED MEMBER
AFD:NVD_S04_C2_PHCR42800P7
NVD_S04_C2_PHCR42800P7          2 NORMAL ONLINE
  CACHED MEMBER
AFD:NVD_S04_C2_PHCR42800P8
NVD_S04_C2_PHCR42800P8          2 NORMAL ONLINE
  CACHED MEMBER
AFD:NVD_S04_C2_PHCR42800P9
NVD_S04_C2_PHCR42800P9          2 NORMAL ONLINE
  CACHED MEMBER
AFD:NVD_S05_C1_PHCR42800P1
NVD_S05_C1_PHCR42800P1          1 NORMAL ONLINE
  CACHED MEMBER
AFD:NVD_S05_C1_PHCR42800P2
NVD_S05_C1_PHCR42800P2          1 NORMAL ONLINE
  CACHED MEMBER
AFD:NVD_S05_C1_PHCR42800P3
NVD_S05_C1_PHCR42800P3          1 NORMAL ONLINE
  CACHED MEMBER
AFD:NVD_S05_C1_PHCR42800P4
NVD_S05_C1_PHCR42800P4          1 NORMAL ONLINE
  CACHED MEMBER
AFD:NVD_S05_C1_PHCR42800P5
NVD_S05_C1_PHCR42800P5          1 NORMAL ONLINE
  CACHED MEMBER
AFD:NVD_S05_C2_PHCR42800P10
```

| | | | |
|-----------------------------|---|--------|--------|
| NVD_S05_C2_PHCR42800P10 | 2 | NORMAL | ONLINE |
| CACHED MEMBER | | | |
| AFD:NVD_S05_C2_PHCR42800P6 | | | |
| NVD_S05_C2_PHCR42800P6 | 2 | NORMAL | ONLINE |
| CACHED MEMBER | | | |
| AFD:NVD_S05_C2_PHCR42800P7 | | | |
| NVD_S05_C2_PHCR42800P7 | 2 | NORMAL | ONLINE |
| CACHED MEMBER | | | |
| AFD:NVD_S05_C2_PHCR42800P8 | | | |
| NVD_S05_C2_PHCR42800P8 | 2 | NORMAL | ONLINE |
| CACHED MEMBER | | | |
| AFD:NVD_S05_C2_PHCR42800P9 | | | |
| NVD_S05_C2_PHCR42800P9 | 2 | NORMAL | ONLINE |
| CACHED MEMBER | | | |
| AFD:NVD_S06_C1_PHCR42900P1 | | | |
| NVD_S06_C1_PHCR42900P1 | 1 | NORMAL | ONLINE |
| CACHED MEMBER | | | |
| AFD:NVD_S06_C1_PHCR42900P2 | | | |
| NVD_S06_C1_PHCR42900P2 | 1 | NORMAL | ONLINE |
| CACHED MEMBER | | | |
| AFD:NVD_S06_C1_PHCR42900P3 | | | |
| NVD_S06_C1_PHCR42900P3 | 1 | NORMAL | ONLINE |
| CACHED MEMBER | | | |
| AFD:NVD_S06_C1_PHCR42900P4 | | | |
| NVD_S06_C1_PHCR42900P4 | 1 | NORMAL | ONLINE |
| CACHED MEMBER | | | |
| AFD:NVD_S06_C1_PHCR42900P5 | | | |
| NVD_S06_C1_PHCR42900P5 | 1 | NORMAL | ONLINE |
| CACHED MEMBER | | | |
| AFD:NVD_S06_C2_PHCR42900P10 | | | |
| NVD_S06_C2_PHCR42900P10 | 2 | NORMAL | ONLINE |
| CACHED MEMBER | | | |
| AFD:NVD_S06_C2_PHCR42900P6 | | | |
| NVD_S06_C2_PHCR42900P6 | 2 | NORMAL | ONLINE |
| CACHED MEMBER | | | |
| AFD:NVD_S06_C2_PHCR42900P7 | | | |
| NVD_S06_C2_PHCR42900P7 | 2 | NORMAL | ONLINE |
| CACHED MEMBER | | | |
| AFD:NVD_S06_C2_PHCR42900P8 | | | |
| NVD_S06_C2_PHCR42900P8 | 2 | NORMAL | ONLINE |
| CACHED MEMBER | | | |
| AFD:NVD_S06_C2_PHCR42900P9 | | | |
| NVD_S06_C2_PHCR42900P9 | 2 | NORMAL | ONLINE |
| CACHED MEMBER | | | |
| AFD:NVD_S07_C1_PHCR42860P1 | | | |
| NVD_S07_C1_PHCR42860P1 | 1 | NORMAL | ONLINE |
| CACHED MEMBER | | | |
| AFD:NVD_S07_C1_PHCR42860P2 | | | |
| NVD_S07_C1_PHCR42860P2 | 1 | NORMAL | ONLINE |
| CACHED MEMBER | | | |
| AFD:NVD_S07_C1_PHCR42860P3 | | | |
| NVD_S07_C1_PHCR42860P3 | 1 | NORMAL | ONLINE |
| CACHED MEMBER | | | |
| AFD:NVD_S07_C1_PHCR42860P4 | | | |
| NVD_S07_C1_PHCR42860P4 | 1 | NORMAL | ONLINE |
| CACHED MEMBER | | | |

```

AFD:NVD_S07_C1_PHCR42860P5
NVD_S07_C1_PHCR42860P5          1 NORMAL ONLINE
  CACHED MEMBER
AFD:NVD_S07_C2_PHCR42860P10
NVD_S07_C2_PHCR42860P10       2 NORMAL ONLINE
  CACHED MEMBER
AFD:NVD_S07_C2_PHCR42860P6
NVD_S07_C2_PHCR42860P6       2 NORMAL ONLINE
  CACHED MEMBER
AFD:NVD_S07_C2_PHCR42860P7
NVD_S07_C2_PHCR42860P7       2 NORMAL ONLINE
  CACHED MEMBER
AFD:NVD_S07_C2_PHCR42860P8
NVD_S07_C2_PHCR42860P8       2 NORMAL ONLINE
  CACHED MEMBER
AFD:NVD_S07_C2_PHCR42860P9
NVD_S07_C2_PHCR42860P9       2 NORMAL ONLINE
  CACHED MEMBER
AFD:SSD_QRMSDK_P2
                                0 NORMAL ONLINE CLOSED FORMER
AFD:SSD_QRMSDK_P1
                                0 NORMAL ONLINE CLOSED FORMER

```

- ii. Use the `odaadmcli show validation storage errors` command to view hard storage errors. Hard errors include having the wrong type of disk inserted into a particular slot, an invalid disk model, or an incorrect disk size.

```
# odaadmcli show validation storage errors
```

- iii. Use the `odaadmcli show validation storage failures` command to view soft validation errors. A typical soft disk error would be an invalid version of the disk firmware.

```
# odaadmcli show validation storage failures
```

- iv. Confirm that the `oak_storage_conf.xml` file shows the number of disks added. For example, if you added four AIC to four SFF, then the `oak_storage_conf.xml` file must show `numberOfDisks` as 12, that is, four SFF NVME disks and eight NVMe disks for four AIC.

```

#cat /opt/oracle/oak/conf/oak_storage_conf.xml
<!--
This file is created by the ODA software as part of system
provisioning
based on system provisioning requests. Values of element nodes can
be
changed by OAK in response to storage configuration change
operation.
DO NOT EDIT THIS FILE.
-->
<CometConfiguration>
  <OakStorageConfigInfo type="string" dimension="vector"
readonly="true" required="true" default="">
    <!-- Number of disks part of OAK -->
    <numberOfDisks>12</numberOfDisks>

```

```

        <!-- Number of partitions per disk part of DATA diskgroup in
multiple partition scheme -->
        <!-- Number of partitions per disk part of RECO diskgroup in
multiple partition scheme -->
        <!-- are derived from number of partitions per disk which are
part of ASM DATA diskgroup -->
        <numOfDataDiskPartitionInAsm>12</numOfDataDiskPartitionInAsm>
    </OakStorageConfigInfo>
</CometConfiguration>
#

```

Replacing Small Form Factor (SFF) NVMe Storage Disks

Understand how you can replace existing SFF NVMe disks on Oracle Database Appliance.

Preparing for a Storage Upgrade

1. Check the disk health of the existing storage disks.

```
# odaadmcli show disk
```

2. Run the `odaadmcli show disk` and `asmcmd lsdsk -p` commands to view and review the storage disk information in OAKD and Oracle Automatic Storage Management (Oracle ASM).

```
# odaadmcli show disk
```

```
# asmcmd lsdsk -p
```

3. Use `ORAchk` to confirm Oracle ASM and Oracle Clusterware health.

Replacing NVMe Storage Disks

Follow **all** these steps to replace NVMe storage disks:

WARNING:

Pulling a drive before powering it off will crash the kernel, which can lead to data corruption. Do not pull the drive when the LED is an amber or green color. When you need to replace an NVMe drive, use the software to power off the drive before pulling the drive from the slot. If you have more than one disk to replace, complete the replacement of one disk before starting replacement of the next disk.

1. Power OFF the NVMe disk before removing it from the slot.
2. Wait for one minute for OAKD to complete the operation for disk removal.
3. Insert the new disk in the slot.
4. Wait for at least 2-3 minutes between inserting each disk for OAKD to complete the operation to add the disk to Oracle ASM and OAK.

5. Check the status of the new disk in OAKD with the `odaadmcli show disk` command. The disk must have the status `Online` and `Good` in OAKD. Check the status of the new disk in Oracle ASM with the `asmcmd lsdsk -p` command. The disk must be in `CACHED MEMBER ONLINE NORMAL` state.

```
# odaadmcli show disk
```

```
# asmcmd lsdsk -p
```

Managing Storage on High-Availability Systems

Understand the storage for your Oracle Database Appliance X11-HA system.

- [About Storage Options for Oracle Database Appliance X11-HA](#)
Oracle Database Appliance High-Availability systems have options for high performance and high capacity storage configurations.
- [Adding Solid-State Drives \(SSDs\) for Data Storage](#)
Add a pack of solid-state drives (SSDs) for data storage into the existing Oracle Database Appliance X11-HA base configuration to fully populate the base storage shelf.
- [Adding the Storage Expansion Shelf](#)
After the base storage shelf is fully populated, you can add the storage expansion shelf to expand your data storage on your high-availability platform.

About Storage Options for Oracle Database Appliance X11-HA

Oracle Database Appliance High-Availability systems have options for high performance and high capacity storage configurations.

The base configuration of Oracle Database Appliance X11-HA hardware model has six slots (slots 0-5) with 7.68 TB drives of SSD raw storage. If you choose to order and deploy the full storage capacity, then you can fill the remaining 18 slots (slots 6-23) with either SSD or HDD drives. For even more storage, you can add a storage expansion shelf to double the storage capacity of your appliance.

In all configurations, the base storage and the storage expansion shelf each have six SSDs for DATA/RECO in the SSD option or FLASH in the HDD option.

Oracle Database Appliance X11-HA does not allocate dedicated SSD drives for REDO disk groups. Instead, the space for REDO logs is allocated on SSD drives as required.

For Oracle ASM storage, the REDO logs are stored in the available disk group space during database creation, based on the database shape selected. For Oracle ACFS storage, the space for REDO logs is allocated during the database storage creation assuming the minimum db shape (`odb1s`). If you create the database storage without database, then the space allocated for REDO logs is 4 GB, assuming the minimum db shape (`odb1s`). Subsequently, when you create a database with your required database shape on the existing database storage, the REDO logs space is extended based on shape of the database.

On Oracle Database Appliance X11-HA High Performance configurations, with only SSD drives, the DATA and RECO disk groups use all the SSD drives whether 6, 12, 18, 24, or 48 with storage expansion shelf. REDO logs are stored in the RECO disk group.

On Oracle Database Appliance X11-HA High Capacity configurations, with both HDD and SSD drives, the DATA and RECO disk groups use the HDD drives, and the SSD drives store the FLASH disk group. REDO logs are stored in the FLASH disk group.

On both High Performance and High Capacity configurations, REDO logs are always created on SSD drives, similar to earlier Oracle Database Appliance hardware models. REDO logs are always created with high redundancy irrespective of the redundancy level of the disk group, whether RECO or FLASH.

High Performance

A high performance configuration uses solid state drives (SSDs) for DATA and RECO storage. The base configuration has six disks, each with 7.68 TB SSD raw storage for DATA and RECO.

You can add up to three (3) 6-Pack SSDs on the base configuration, for a total of 184.32 TB SSD raw storage. If you need more storage, you can double the capacity by adding an expansion shelf of SSD drives. The expansion shelf provides an additional 24 SSDs, each with 7.68TB raw storage for DATA and RECO, for a total of another 184.32 TB SSD raw storage.

Adding an expansion shelf requires that the base storage shelf and expansion shelf are fully populated with SSD drives. When you expand the storage, there is no downtime.

A system fully configured for high performance has 368.64 TB SSD raw storage for DATA and RECO.

High Capacity

A high capacity configuration uses a combination of SSD and HDD drives.

The base configuration has six disks, each with 7.68 TB SSD raw storage for FLASH.

The following expansion options are available:

- Base shelf: additional 396 TB HDD raw storage for DATA and RECO (18 HDDs, each with 22 TB storage)
- Expansion Storage shelf: additional shelf storage configuration must be identical to the storage configuration of the base shelf.

A system fully configured for high capacity has a total of 884.16 TB raw storage for DATA, RECO, and FLASH, with 92.16 TB SSD and 792 TB HDD.

Table 10-2 Storage Options for Oracle Database Appliance X11-HA

| Configuration | Oracle Database Appliance X11-HA SSD-Only Configuration for High Performance | Oracle Database Appliance X11-HA SSD and HDD Configuration for High Capacity |
|--------------------|---|---|
| Base configuration | <p>Base storage shelf contains 6 SSDs of 7.68 TB.</p> <ul style="list-style-type: none"> • 6 x 7.68 TB SSD = 46 TB SSD | <p>Base storage shelf is fully populated with 6-pack SSDs of 7.68 TB and 18-drives of HDDs with 22 TB.</p> <ul style="list-style-type: none"> • 6 x 7.68 TB SSD = 46 TB SSD • 18 x 22TB HDD = 396 TB HDD • Total storage on the first JBOD = 442 TB, with 46 TB SSD and 396 TB HDD |

Table 10-2 (Cont.) Storage Options for Oracle Database Appliance X11-HA

| Configuration | Oracle Database Appliance X11-HA SSD-Only Configuration for High Performance | Oracle Database Appliance X11-HA SSD and HDD Configuration for High Capacity |
|---------------------------------|---|---|
| Storage addition options | <p>Base shelf contains 6 SSDs. Additional 18 SSDs must be added in packs of 6.</p> <ul style="list-style-type: none"> • Base system: 6 x 7.68 TB SSD = 46 TB SSD • Adding 6 SSDs: 12x 7.68 TB SSD = 92 TB SSD • Adding 12 SSDs: 18 x 7.68 TB SSD = 138 TB SSD • Adding 18 SSDs: 24 x 7.68 TB SSD = 184 TB SSD (full shelf) | Not applicable. Base storage shelf is fully populated. |
| Storage shelf expansion options | <ul style="list-style-type: none"> • The optional expansion storage shelf can only be installed after the base storage shelf is fully populated, and it must have the same configuration as the base storage shelf. • Total storage on the base storage shelf = 184 TB SSD • Storage on the expansion shelf = 24 x 7.68 TB SSD = 184 TB SSD • Total storage including both JBODs = 368.6 TB SSD | <ul style="list-style-type: none"> • The optional expansion storage shelf can only be installed after the base storage shelf is fully populated, and it must have the same configuration as the base storage shelf. • Total storage on the base storage shelf = 442 TB, with 46 TB SSD and 396 TB HDD • Total storage including both JBODs = 884 TB, with 92 TB SSD and 792 TB HDD |

Converting High Performance to High Capacity system

You can order a fully populated base storage shelf of 6 SSD + 18 HDD for high capacity configuration. If you initially ordered only the default 6 SSD base storage shelf and deployed high performance system, then you can later convert this to high capacity system configuration. Order 18 HDD and populate the base storage shelf as follows:

1. Take a backup of your database on the default storage of 6 SSD configuration on the provisioned system.
2. Run the cleanup utility with the `--erasedata` option on both nodes to erase all SSD disks of OAK and Oracle ASM headers. The `--erasedata` option completely erases the SSD disk so any data on the disks is lost and becomes unrecoverable.
3. After cleanup of both nodes, add 18 HDD disks to the base storage shelf. These 18 HDDs must be brand new disks from Oracle without any OAK and Oracle ASM header.
4. Reimage both nodes with the required OAK version.
5. Reprovision the system again.

Adding Solid-State Drives (SSDs) for Data Storage

Add a pack of solid-state drives (SSDs) for data storage into the existing Oracle Database Appliance X11-HA base configuration to fully populate the base storage shelf.

If you need to add storage to the base configuration, you can order one, two, or three 6-pack of SSDs to complete the base configuration on Oracle Database Appliance X11-HA.

You must fully populate the base configuration before you can add an expansion shelf to Oracle Database Appliance X11-HA. If you add an expansion shelf, the shelf must have the same disk storage configuration as the base configuration.

 **Note:**

For a high-performance configuration, you can add SSDs to the base storage shelf or add a storage expansion shelf. For high-capacity base configuration with 6-SSDs, if you want to expand storage to use HDDs, then you must reimage and deploy the appliance.

Before adding the disks to the system, ensure that Oracle Database Appliance is on the latest release.

1. Insert disks one at a time in the slots.

To add one 6-pack of SSDs, insert the disks in slots 6 to 11. To add two 6-pack of SSDs, insert the disks in slots 6 to 17. To add three 6-pack of SSDs, insert the disks in slots 6 to 23.

 **Note:**

Allow at least one minute between inserting each disk.

After all disks are added, go to Step 2.

2. Run the `odaadmcli expand storage` command on any node.

```
# odaadmcli expand storage -ndisk number_of_disks_to_be_added -enclosure  
enclosure_number_of_the_disks_to_be_added
```

The enclosure number is 0 when you add storage disks to the first storage enclosure or JBOD (just a bunch of disks).

For example:

```
# odaadmcli expand storage -ndisk 6 -enclosure 0  
Running precheck, it may take a few minutes.  
Precheck passed.  
Check the progress of expansion of storage by executing 'odaadmcli show  
disk'  
Waiting for expansion to finish. It may take several minutes to complete  
depending upon the number of disks being expanded
```

```
odaadmcli expand storage command completed.  
Check the status of the newly-expanded disk in OAK by running the  
odaadmcli show disk command.  
All disks must be in the ONLINE status. Check the status of the newly-  
expanded disk in Oracle ASM by running the asmcmd lsdsk -p.  
The mount status must be CACHED and the header status must be MEMBER for  
all the newly-added disks.
```

If the status of the newly-added disks in OAK and Oracle ASM are different, then the `odaadmcli expand storage` command failed.

It takes 10 to 12 minutes to add all of the disks to the configuration.

3. Run the `odaadmcli show disk` command to ensure that all disks are listed, are online, and are in a good state.

```
# odaadmcli show disk
```

4. Verify that the disks in slots 6 to 11 are added to Oracle Automatic Storage Management (Oracle ASM).
 - a. Run the `asm_script` to verify that the disks in slots 6 to 11 are added to Oracle Automatic Storage Management (Oracle ASM). If the 6 disks are successfully added (CACHED and MEMBER), then go to Step 7. Following is example of default configuration of 80:20 where eight partitions (p1 to p8) are part of the DATA disk group and two partitions (p9 and p10) are part of the RECO diskgroup.

```
# su gridUser /opt/oracle/oak/bin/stordiag/asm_script.sh 1 6
```

For example:

```
# su gridUser /opt/oracle/oak/bin/stordiag/asm_script.sh 1 6
# su grid /opt/oracle/oak/bin/stordiag/asm_script.sh 1 6
```

```
SQL*Plus: Release 19.0.0.0.0 - Production on Wed Dec 11 09:26:05 2024
Version 19.25.0.0.0
Copyright (c) 1982, 2024, Oracle. All rights reserved.
Connected to:
Oracle Database 19c Enterprise Edition Release 19.0.0.0.0 - Production
Version 19.25.0.0.0
```

```
SQL> SQL> SQL> SQL> SQL>
PATH
NAME                                GROUP_NUMBER STATE    MODE_ST
MOUNT_S HEADER_STATU
-----
-----
-----
AFD:SSD_E0_S06_46724304P1
SSD_E0_S06_46724304P1                1 NORMAL  ONLINE
CACHED MEMBER
AFD:SSD_E0_S06_46724304P10
SSD_E0_S06_46724304P10              2 NORMAL  ONLINE
CACHED MEMBER
AFD:SSD_E0_S06_46724304P2
SSD_E0_S06_46724304P2                1 NORMAL  ONLINE
CACHED MEMBER
AFD:SSD_E0_S06_46724304P3
SSD_E0_S06_46724304P3                1 NORMAL  ONLINE
CACHED MEMBER
AFD:SSD_E0_S06_46724304P4
SSD_E0_S06_46724304P4                1 NORMAL  ONLINE
CACHED MEMBER
AFD:SSD_E0_S06_46724304P5
```

```

SSD_E0_S06_46724304P5                1 NORMAL ONLINE
    CACHED MEMBER
AFD:SSD_E0_S06_46724304P6
SSD_E0_S06_46724304P6                1 NORMAL ONLINE
    CACHED MEMBER
AFD:SSD_E0_S06_46724304P7
SSD_E0_S06_46724304P7                1 NORMAL ONLINE
    CACHED MEMBER
AFD:SSD_E0_S06_46724304P8
SSD_E0_S06_46724304P8                1 NORMAL ONLINE
    CACHED MEMBER
AFD:SSD_E0_S06_46724304P9
SSD_E0_S06_46724304P9                2 NORMAL ONLINE
    CACHED MEMBER
AFD:SSD_E0_S07_47182256P1
SSD_E0_S07_47182256P1                1 NORMAL ONLINE
    CACHED MEMBER
AFD:SSD_E0_S07_47182256P10
SSD_E0_S07_47182256P10              2 NORMAL ONLINE
    CACHED MEMBER
AFD:SSD_E0_S07_47182256P2
SSD_E0_S07_47182256P2                1 NORMAL ONLINE
    CACHED MEMBER
AFD:SSD_E0_S07_47182256P3
SSD_E0_S07_47182256P3                1 NORMAL ONLINE
    CACHED MEMBER
AFD:SSD_E0_S07_47182256P4
SSD_E0_S07_47182256P4                1 NORMAL ONLINE
    CACHED MEMBER
AFD:SSD_E0_S07_47182256P5
SSD_E0_S07_47182256P5                1 NORMAL ONLINE
    CACHED MEMBER
AFD:SSD_E0_S07_47182256P6
SSD_E0_S07_47182256P6                1 NORMAL ONLINE
    CACHED MEMBER
AFD:SSD_E0_S07_47182256P7
SSD_E0_S07_47182256P7                1 NORMAL ONLINE
    CACHED MEMBER
AFD:SSD_E0_S07_47182256P8
SSD_E0_S07_47182256P8                1 NORMAL ONLINE
    CACHED MEMBER
AFD:SSD_E0_S07_47182256P9
SSD_E0_S07_47182256P9                2 NORMAL ONLINE
    CACHED MEMBER
AFD:SSD_E0_S08_46724288P1
SSD_E0_S08_46724288P1                1 NORMAL ONLINE
    CACHED MEMBER
AFD:SSD_E0_S08_46724288P10
SSD_E0_S08_46724288P10              2 NORMAL ONLINE
    CACHED MEMBER
AFD:SSD_E0_S08_46724288P2
SSD_E0_S08_46724288P2                1 NORMAL ONLINE
    CACHED MEMBER
AFD:SSD_E0_S08_46724288P3
SSD_E0_S08_46724288P3                1 NORMAL ONLINE
    CACHED MEMBER
    
```

```

AFD:SSD_E0_S08_46724288P4
SSD_E0_S08_46724288P4          1 NORMAL ONLINE
  CACHED MEMBER
AFD:SSD_E0_S08_46724288P5
SSD_E0_S08_46724288P5          1 NORMAL ONLINE
  CACHED MEMBER
AFD:SSD_E0_S08_46724288P6
SSD_E0_S08_46724288P6          1 NORMAL ONLINE
  CACHED MEMBER
AFD:SSD_E0_S08_46724288P7
SSD_E0_S08_46724288P7          1 NORMAL ONLINE
  CACHED MEMBER
AFD:SSD_E0_S08_46724288P8
SSD_E0_S08_46724288P8          1 NORMAL ONLINE
  CACHED MEMBER
AFD:SSD_E0_S08_46724288P9
SSD_E0_S08_46724288P9          2 NORMAL ONLINE
  CACHED MEMBER
AFD:SSD_E0_S09_47180592P1
SSD_E0_S09_47180592P1          1 NORMAL ONLINE
  CACHED MEMBER
AFD:SSD_E0_S09_47180592P10
SSD_E0_S09_47180592P10         2 NORMAL ONLINE
  CACHED MEMBER
AFD:SSD_E0_S09_47180592P2
SSD_E0_S09_47180592P2          1 NORMAL ONLINE
  CACHED MEMBER
AFD:SSD_E0_S09_47180592P3
SSD_E0_S09_47180592P3          1 NORMAL ONLINE
  CACHED MEMBER
AFD:SSD_E0_S09_47180592P4
SSD_E0_S09_47180592P4          1 NORMAL ONLINE
  CACHED MEMBER
AFD:SSD_E0_S09_47180592P5
SSD_E0_S09_47180592P5          1 NORMAL ONLINE
  CACHED MEMBER
AFD:SSD_E0_S09_47180592P6
SSD_E0_S09_47180592P6          1 NORMAL ONLINE
  CACHED MEMBER
AFD:SSD_E0_S09_47180592P7
SSD_E0_S09_47180592P7          1 NORMAL ONLINE
  CACHED MEMBER
AFD:SSD_E0_S09_47180592P8
SSD_E0_S09_47180592P8          1 NORMAL ONLINE
  CACHED MEMBER
AFD:SSD_E0_S09_47180592P9
SSD_E0_S09_47180592P9          2 NORMAL ONLINE
  CACHED MEMBER
AFD:SSD_E0_S10_47182288P1
SSD_E0_S10_47182288P1          1 NORMAL ONLINE
  CACHED MEMBER
AFD:SSD_E0_S10_47182288P10
SSD_E0_S10_47182288P10         2 NORMAL ONLINE
  CACHED MEMBER
AFD:SSD_E0_S10_47182288P2
SSD_E0_S10_47182288P2          1 NORMAL ONLINE
  
```

```

    CACHED MEMBER
    AFD:SSD_E0_S10_47182288P3
    SSD_E0_S10_47182288P3                1 NORMAL ONLINE
    CACHED MEMBER
    AFD:SSD_E0_S10_47182288P4
    SSD_E0_S10_47182288P4                1 NORMAL ONLINE
    CACHED MEMBER
    AFD:SSD_E0_S10_47182288P5
    SSD_E0_S10_47182288P5                1 NORMAL ONLINE
    CACHED MEMBER
    AFD:SSD_E0_S10_47182288P6
    SSD_E0_S10_47182288P6                1 NORMAL ONLINE
    CACHED MEMBER
    AFD:SSD_E0_S10_47182288P7
    SSD_E0_S10_47182288P7                1 NORMAL ONLINE
    CACHED MEMBER
    AFD:SSD_E0_S10_47182288P8
    SSD_E0_S10_47182288P8                1 NORMAL ONLINE
    CACHED MEMBER
    AFD:SSD_E0_S10_47182288P9
    SSD_E0_S10_47182288P9                2 NORMAL ONLINE
    CACHED MEMBER
    AFD:SSD_E0_S11_46722912P1
    SSD_E0_S11_46722912P1                1 NORMAL ONLINE
    CACHED MEMBER
    AFD:SSD_E0_S11_46722912P10
    SSD_E0_S11_46722912P10              2 NORMAL ONLINE
    CACHED MEMBER
    AFD:SSD_E0_S11_46722912P2
    SSD_E0_S11_46722912P2                1 NORMAL ONLINE
    CACHED MEMBER
    AFD:SSD_E0_S11_46722912P3
    SSD_E0_S11_46722912P3                1 NORMAL ONLINE
    CACHED MEMBER
    AFD:SSD_E0_S11_46722912P4
    SSD_E0_S11_46722912P4                1 NORMAL ONLINE
    CACHED MEMBER
    AFD:SSD_E0_S11_46722912P5
    SSD_E0_S11_46722912P5                1 NORMAL ONLINE
    CACHED MEMBER
    AFD:SSD_E0_S11_46722912P6
    SSD_E0_S11_46722912P6                1 NORMAL ONLINE
    CACHED MEMBER
    AFD:SSD_E0_S11_46722912P7
    SSD_E0_S11_46722912P7                1 NORMAL ONLINE
    CACHED MEMBER
    AFD:SSD_E0_S11_46722912P8
    SSD_E0_S11_46722912P8                1 NORMAL ONLINE
    CACHED MEMBER
    AFD:SSD_E0_S11_46722912P9
    SSD_E0_S11_46722912P9                2 NORMAL ONLINE
    CACHED MEMBER
    
```

```

SQL> Disconnected from Oracle Database 19c Enterprise Edition Release
19.0.0.0.0 - Production
    
```

```
Version 19.25.0.0.0
```

```
#
```

- b. Use the `odaadmcli show validation storage errors` command to view hard storage errors. Hard errors include having the wrong type of disk inserted into a particular slot, an invalid disk model, or an incorrect disk size.

```
# odaadmcli show validation storage errors
```

- c. Use the `odaadmcli show validation storage failures` command to view soft validation errors. A typical soft disk error would be an invalid version of the disk firmware.

```
# odaadmcli show validation storage failures
```

- d. Confirm that the `oak_storage_conf.xml` file shows the number of disks added. For example, if you added 6 disks to the base configuration, then the `oak_storage_conf.xml` file must show `numberOfDisks` as 12. If you added 12 disks to the base configuration, then the `oak_storage_conf.xml` file must show 18.

```
#cat /opt/oracle/oak/conf/oak_storage_conf.xml
```

```
<!--
```

```
This file is created by the ODA software as part of system provisioning based on system provisioning requests. Values of element nodes can be changed by OAK in response to storage configuration change operation. DO NOT EDIT THIS FILE.
```

```
-->
```

```
<CometConfiguration>
```

```
  <OakStorageConfigInfo type="string" dimension="vector"
  readonly="true" required="true" default="">
```

```
    <!-- Number of disks part of OAK -->
```

```
    <numberOfDisks>12</numberOfDisks>
```

```
    <!-- Number of partitions per disk part of DATA diskgroup in multiple partition scheme -->
```

```
    <!-- Number of partitions per disk part of RECO diskgroup in multiple partition scheme -->
```

```
    <!-- are derived from number of partitions per disk which are part of ASM DATA diskgroup -->
```

```
    <numOfDataDiskPartitionInAsm>8</numOfDataDiskPartitionInAsm>
```

```
  </OakStorageConfigInfo>
```

```
</CometConfiguration>
```

```
#
```

Adding the Storage Expansion Shelf

After the base storage shelf is fully populated, you can add the storage expansion shelf to expand your data storage on your high-availability platform.

The expansion shelf is available on Oracle Database Appliance high-availability platforms, such as Oracle Database Appliance X11-HA. The addition of the storage expansion shelf includes checks across both nodes. It is important to confirm that SSH does work across the nodes and all users can connect as expected using their shared password.

You must fully populate the base configuration before you can add an expansion shelf. If you add an expansion shelf, the shelf must have the same disk storage configuration as the base storage shelf.

 **Note:**

Oracle recommends that you add a storage expansion shelf when you have relatively little activity on your databases. When the system discovers the new storage, Oracle Automatic Storage Management (Oracle ASM) automatically rebalances the disk groups. The rebalance operation may degrade database performance until the operation completes.

1. Install and cable the storage expansion shelf, but do **not** power on the expansion shelf.

 **Caution:**

Review cabling instructions carefully to ensure that you have carried out cabling correctly. Incorrect connections can cause data loss when adding a storage expansion shelf to Oracle Database Appliance with existing databases.

2. Verify that both nodes plus the base storage shelf are up and running. Log into each server node and run the `odacli validate-storagetopology` command to confirm that the base configuration cabling is correct.

```
# odacli validate-storagetopology
...
      INFO      : Check if JBOD powered on
SUCCESS      : JBOD : Powered-on
      INFO      : Check for correct number of EBODS(2 or 4)
SUCCESS      : EBOD found :
2

      INFO      : Check for overall status of cable validation
on Node0
SUCCESS      : Overall Cable Validation on Node0
SUCCESS      : JBOD Nickname set correctly : Oracle Database Appliance - E0
```

Run the command to confirm that the two server nodes are properly cabled to the base storage shelf and all disks are online, with a good status, and added to the existing disk groups on both nodes. If there any failures, then fix the cabling before proceeding to the next step.

 **Note:**

If the output shows that `EBOD found` is 2, then you only have the base storage shelf. If `EBOD found` is 4, then you have a base storage shelf and an expansion shelf.

 **Note:**

If you add a new JBOD fresh from the factory, then the output of the `odacli validate-storage-topology` command is:

```
# odacli validate-storage-topology
...
WARNING : JBOD Nickname is incorrectly set to :
```

3. Power on the storage expansion shelf and wait for 20 minutes before issuing the CLI command for storage expansion.
4. Log in to each server node and run the `odacli validate-storage-topology` command to validate the storage cabling and confirm that the new storage shelf is recognized.

```
# odacli validate-storage-topology

INFO      : Check if JBOD powered on
SUCCESS   : 2JBOD : Powered-
on
INFO      : Check for correct number of EBODS(2 or 4)
SUCCESS   : EBOD found :
4
...
...

INFO      : Check for overall status of cable validation on Node0
SUCCESS   : Overall Cable Validation on Node0
SUCCESS   : JBOD0 Nickname set correctly : Oracle Database Appliance - E0
SUCCESS   : JBOD1 Nickname set correctly : Oracle Database Appliance -
E1
```

If you add a new JBOD fresh from the factory, then the output of the `odacli validate-storage-topology` command is:

```
# odacli validate-storage-topology
...
WARNING : JBOD Nickname is incorrectly set to :
```

Look for the following indicators that both storage shelves are recognized:

- When there are two shelves, the JBOD is numbered. For example:

```
SUCCESS : 2JBOD : Powered-on
```

- When both shelves are recognized, the EBOD found value is 4.

```
SUCCESS : EBOD found : 4
```

- When the expansion shelf is cabled properly, the nickname is E1. For example:

```
SUCCESS : JBOD0 Nickname set correctly : Oracle Database
Appliance - E0
SUCCESS : JBOD1 Nickname set correctly : Oracle Database
Appliance - E1
```

Fix any errors before proceeding.

5. Run the `odaadmcli show disk` command to ensure that all disks in the expansion shelf are listed, are online, and are in a good state.

```
# odaadmcli show disk
```

When all disks are online and in a good state, proceed to the next step.

6. Run the `odaadmcli show enclosure` command to check the health of components in expansion shelf.

```
# odaadmcli show enclosure
```

7. Run the `odaadmcli expand storage` command.

```
# odaadmcli expand storage -ndisk 24 -enclosure 1
Running precheck, it may take a few minutes.
Precheck passed.
Check the progress of expansion of storage by executing 'odaadmcli show
disk'
Waiting for expansion to finish. It may take several minutes to complete
depending upon the number of disks being expanded

odaadmcli expand storage command completed.
```

It takes approximately 30 to 40 minutes to add all of the disks to the configuration.

8. Check the status of the newly-expanded disk in OAK by running the `odaadmcli show disk` command. All disks must have status ONLINE. Check the status of the newly-expanded disk in Oracle ASM by running the `asmcmd lsdsk -p` command. The mount status must be CACHED and header status must be MEMBER for all the newly-added disks. If the status of the newly-added disks in OAK and Oracle ASM is different, then the `odaadmcli expand storage` command failed.

Example of an Oracle Database Appliance X11-HA High Capacity System:

```
# odaadmcli show disk
```

| | NAME | PATH | TYPE | STATE |
|---------------|----------|-----------|------|--------|
| STATE_DETAILS | | | | |
| Good | e0_pd_00 | /dev/sda | SSD | ONLINE |
| Good | e0_pd_01 | /dev/sdb | SSD | ONLINE |
| Good | e0_pd_02 | /dev/sdc | SSD | ONLINE |
| Good | e0_pd_03 | /dev/sdab | SSD | ONLINE |

| | | | | |
|------|----------|-----------|-----|--------|
| Good | e0_pd_04 | /dev/sdad | SSD | ONLINE |
| Good | e0_pd_05 | /dev/sdac | SSD | ONLINE |
| Good | e0_pd_06 | /dev/sdae | HDD | ONLINE |
| Good | e0_pd_07 | /dev/sdaf | HDD | ONLINE |
| Good | e0_pd_08 | /dev/sdag | HDD | ONLINE |
| Good | e0_pd_09 | /dev/sdai | HDD | ONLINE |
| Good | e0_pd_10 | /dev/sdah | HDD | ONLINE |
| Good | e0_pd_11 | /dev/sdaj | HDD | ONLINE |
| Good | e0_pd_12 | /dev/sdak | HDD | ONLINE |
| Good | e0_pd_13 | /dev/sdam | HDD | ONLINE |
| Good | e0_pd_14 | /dev/sdal | HDD | ONLINE |
| Good | e0_pd_15 | /dev/sdan | HDD | ONLINE |
| Good | e0_pd_16 | /dev/sdap | HDD | ONLINE |
| Good | e0_pd_17 | /dev/sdar | HDD | ONLINE |
| Good | e0_pd_18 | /dev/sdaq | HDD | ONLINE |
| Good | e0_pd_19 | /dev/sdao | HDD | ONLINE |
| Good | e0_pd_20 | /dev/sdat | HDD | ONLINE |
| Good | e0_pd_21 | /dev/sdas | HDD | ONLINE |
| Good | e0_pd_22 | /dev/sdau | HDD | ONLINE |
| Good | e0_pd_23 | /dev/sdav | HDD | ONLINE |
| Good | e1_pd_00 | /dev/sdaw | SSD | ONLINE |
| Good | e1_pd_01 | /dev/sdax | SSD | ONLINE |
| Good | e1_pd_02 | /dev/sday | SSD | ONLINE |
| Good | e1_pd_03 | /dev/sdaz | SSD | ONLINE |
| Good | e1_pd_04 | /dev/sdba | SSD | ONLINE |
| Good | e1_pd_05 | /dev/sdbb | SSD | ONLINE |
| Good | e1_pd_06 | /dev/sdbc | HDD | ONLINE |
| Good | e1_pd_07 | /dev/sdbd | HDD | ONLINE |

```

Good      e1_pd_08      /dev/sdbe      HDD           ONLINE
Good      e1_pd_09      /dev/sdbf      HDD           ONLINE
Good      e1_pd_10      /dev/sdbg      HDD           ONLINE
Good      e1_pd_11      /dev/sdbh      HDD           ONLINE
Good      e1_pd_12      /dev/sdbi      HDD           ONLINE
Good      e1_pd_13      /dev/sdbj      HDD           ONLINE
Good      e1_pd_14      /dev/sdbk      HDD           ONLINE
Good      e1_pd_15      /dev/sdbl      HDD           ONLINE
Good      e1_pd_16      /dev/sdbm      HDD           ONLINE
Good      e1_pd_17      /dev/sdbn      HDD           ONLINE
Good      e1_pd_18      /dev/sdbo      HDD           ONLINE
Good      e1_pd_19      /dev/sdbp      HDD           ONLINE
Good      e1_pd_20      /dev/sdbq      HDD           ONLINE
Good      e1_pd_21      /dev/sdbr      HDD           ONLINE
Good      e1_pd_22      /dev/sdbs      HDD           ONLINE
Good      e1_pd_23      /dev/sdbt      HDD           ONLINE
Good
#

```

```
# su grid /opt/oracle/oak/bin/stordiag/asm_script.sh 1 6
```

```

SQL*Plus: Release 19.0.0.0.0 - Production on Wed Dec 11 11:28:05 2024
Version 19.25.0.0.0
Copyright (c) 1982, 2024, Oracle. All rights reserved.
Connected to:
Oracle Database 19c Enterprise Edition Release 19.0.0.0.0 - Production
Version 19.25.0.0.0

```

```
SQL> SQL> SQL> SQL> SQL>
```

```

PATH
NAME                                GROUP_NUMBER STATE    MODE_ST MOUNT_S
HEADER_STATU
-----
-----
AFD:HDD_E0_S06_134748696P1
HDD_E0_S06_134748696P1                1 NORMAL  ONLINE  CACHED
MEMBER
AFD:HDD_E0_S06_134748696P10
HDD_E0_S06_134748696P10              2 NORMAL  ONLINE  CACHED
MEMBER

```

```

AFD:HDD_E0_S06_134748696P2
HDD_E0_S06_134748696P2          1 NORMAL ONLINE  CACHED
MEMBER
AFD:HDD_E0_S06_134748696P3
HDD_E0_S06_134748696P3          1 NORMAL ONLINE  CACHED
MEMBER
AFD:HDD_E0_S06_134748696P4
HDD_E0_S06_134748696P4          1 NORMAL ONLINE  CACHED
MEMBER
AFD:HDD_E0_S06_134748696P5
HDD_E0_S06_134748696P5          1 NORMAL ONLINE  CACHED
MEMBER
AFD:HDD_E0_S06_134748696P6
HDD_E0_S06_134748696P6          1 NORMAL ONLINE  CACHED
MEMBER
AFD:HDD_E0_S06_134748696P7
HDD_E0_S06_134748696P7          1 NORMAL ONLINE  CACHED
MEMBER
AFD:HDD_E0_S06_134748696P8
HDD_E0_S06_134748696P8          1 NORMAL ONLINE  CACHED
MEMBER
AFD:HDD_E0_S06_134748696P9
HDD_E0_S06_134748696P9          2 NORMAL ONLINE  CACHED
MEMBER
AFD:HDD_E0_S07_134749392P1
HDD_E0_S07_134749392P1          1 NORMAL ONLINE  CACHED
MEMBER
AFD:HDD_E0_S07_134749392P10
HDD_E0_S07_134749392P10         2 NORMAL ONLINE  CACHED
MEMBER
AFD:HDD_E0_S07_134749392P2
HDD_E0_S07_134749392P2          1 NORMAL ONLINE  CACHED
MEMBER
AFD:HDD_E0_S07_134749392P3
HDD_E0_S07_134749392P3          1 NORMAL ONLINE  CACHED
MEMBER
AFD:HDD_E0_S07_134749392P4
HDD_E0_S07_134749392P4          1 NORMAL ONLINE  CACHED
MEMBER
AFD:HDD_E0_S07_134749392P5
HDD_E0_S07_134749392P5          1 NORMAL ONLINE  CACHED
MEMBER
AFD:HDD_E0_S07_134749392P6
HDD_E0_S07_134749392P6          1 NORMAL ONLINE  CACHED
MEMBER
AFD:HDD_E0_S07_134749392P7
HDD_E0_S07_134749392P7          1 NORMAL ONLINE  CACHED
MEMBER
AFD:HDD_E0_S07_134749392P8
HDD_E0_S07_134749392P8          1 NORMAL ONLINE  CACHED
MEMBER
AFD:HDD_E0_S07_134749392P9
HDD_E0_S07_134749392P9          2 NORMAL ONLINE  CACHED
MEMBER
''
''

```

```

''
SQL> Disconnected from Oracle Database 19c Enterprise Edition Release
19.0.0.0.0 - Production
Version 19.25.0.0.0
#
  
```

Example of an Oracle Database Appliance X11-HA High Performance System:

```

# odaadmcli show disk
          NAME          PATH          TYPE          STATE
STATE_DETAILS
Good      e0_pd_00             /dev/sda      SSD            ONLINE
Good      e0_pd_01             /dev/sdc      SSD            ONLINE
Good      e0_pd_02             /dev/sdaa     SSD            ONLINE
Good      e0_pd_03             /dev/sdab     SSD            ONLINE
Good      e0_pd_04             /dev/sdac     SSD            ONLINE
Good      e0_pd_05             /dev/sdad     SSD            ONLINE
Good      e0_pd_06             /dev/sdag     SSD            ONLINE
Good      e0_pd_07             /dev/sdae     SSD            ONLINE
Good      e0_pd_08             /dev/sdah     SSD            ONLINE
Good      e0_pd_09             /dev/sdaf     SSD            ONLINE
Good      e0_pd_10             /dev/sdai     SSD            ONLINE
Good      e0_pd_11             /dev/sdaj     SSD            ONLINE
Good      e0_pd_12             /dev/sdak     SSD            ONLINE
Good      e0_pd_13             /dev/sdam     SSD            ONLINE
Good      e0_pd_14             /dev/sdal     SSD            ONLINE
Good      e0_pd_15             /dev/sdan     SSD            ONLINE
Good      e0_pd_16             /dev/sdap     SSD            ONLINE
Good      e0_pd_17             /dev/sdao     SSD            ONLINE
Good      e0_pd_18             /dev/sdaq     SSD            ONLINE
Good      e0_pd_19             /dev/sdar     SSD            ONLINE
Good      e0_pd_20             /dev/sdas     SSD            ONLINE
Good      e0_pd_21             /dev/sdau     SSD            ONLINE
  
```

```

Good
    e0_pd_22      /dev/sdat      SSD      ONLINE
Good
    e0_pd_23      /dev/sdav      SSD      ONLINE
Good
    e1_pd_00      /dev/sdaw      SSD      ONLINE
Good
    e1_pd_01      /dev/sdax      SSD      ONLINE
Good
    e1_pd_02      /dev/sday      SSD      ONLINE
Good
    e1_pd_03      /dev/sdaz      SSD      ONLINE
Good
    e1_pd_04      /dev/sdba      SSD      ONLINE
Good
    e1_pd_05      /dev/sdbb      SSD      ONLINE
Good
    e1_pd_06      /dev/sdbc      SSD      ONLINE
Good
    e1_pd_07      /dev/sdbd      SSD      ONLINE
Good
    e1_pd_08      /dev/sdbe      SSD      ONLINE
Good
    e1_pd_09      /dev/sdbf      SSD      ONLINE
Good
    e1_pd_10      /dev/sdbg      SSD      ONLINE
Good
    e1_pd_11      /dev/sdbh      SSD      ONLINE
Good
    e1_pd_12      /dev/sdbi      SSD      ONLINE
Good
    e1_pd_13      /dev/sdbj      SSD      ONLINE
Good
    e1_pd_14      /dev/sdbk      SSD      ONLINE
Good
    e1_pd_15      /dev/sdbl      SSD      ONLINE
Good
    e1_pd_16      /dev/sdbm      SSD      ONLINE
Good
    e1_pd_17      /dev/sdbn      SSD      ONLINE
Good
    e1_pd_18      /dev/sdbo      SSD      ONLINE
Good
    e1_pd_19      /dev/sdbp      SSD      ONLINE
Good
    e1_pd_20      /dev/sdbq      SSD      ONLINE
Good
    e1_pd_21      /dev/sdbr      SSD      ONLINE
Good
    e1_pd_22      /dev/sdbs      SSD      ONLINE
Good
    e1_pd_23      /dev/sdbt      SSD      ONLINE

```

```

Good
#
#su grid /opt/oracle/oak/bin/stordiag/asm_script.sh 1 6

```

```
SQL*Plus: Release 19.0.0.0.0 - Production on Wed Dec 11 11:46:05 2024
Version 19.25.0.0.0
Copyright (c) 1982, 2024, Oracle. All rights reserved.
Connected to:
Oracle Database 19c Enterprise Edition Release 19.0.0.0.0 - Production
Version 19.25.0.0.0
```

```
SQL> SQL> SQL> SQL> SQL>
```

```
PATH
NAME                                GROUP_NUMBER STATE    MODE_ST MOUNT_S
HEADER_STATU
-----
-----
AFD:SSD_E0_S00_51829200P1
SSD_E0_S00_51829200P1                1 NORMAL    ONLINE  CACHED
MEMBER
AFD:SSD_E0_S00_51829200P10
SSD_E0_S00_51829200P10              2 NORMAL    ONLINE  CACHED
MEMBER
AFD:SSD_E0_S00_51829200P2
SSD_E0_S00_51829200P2                1 NORMAL    ONLINE  CACHED
MEMBER
AFD:SSD_E0_S00_51829200P3
SSD_E0_S00_51829200P3                1 NORMAL    ONLINE  CACHED
MEMBER
AFD:SSD_E0_S00_51829200P4
SSD_E0_S00_51829200P4                1 NORMAL    ONLINE  CACHED
MEMBER
AFD:SSD_E0_S00_51829200P5
SSD_E0_S00_51829200P5                1 NORMAL    ONLINE  CACHED
MEMBER
AFD:SSD_E0_S00_51829200P6
SSD_E0_S00_51829200P6                1 NORMAL    ONLINE  CACHED
MEMBER
AFD:SSD_E0_S00_51829200P7
SSD_E0_S00_51829200P7                1 NORMAL    ONLINE  CACHED
MEMBER
AFD:SSD_E0_S00_51829200P8
SSD_E0_S00_51829200P8                1 NORMAL    ONLINE  CACHED
MEMBER
AFD:SSD_E0_S00_51829200P9
SSD_E0_S00_51829200P9                2 NORMAL    ONLINE  CACHED
MEMBER
AFD:SSD_E0_S01_51829664P1
SSD_E0_S01_51829664P1                1 NORMAL    ONLINE  CACHED
MEMBER
AFD:SSD_E0_S01_51829664P10
SSD_E0_S01_51829664P10              2 NORMAL    ONLINE  CACHED
MEMBER
AFD:SSD_E0_S01_51829664P2
SSD_E0_S01_51829664P2                1 NORMAL    ONLINE  CACHED
MEMBER
AFD:SSD_E0_S01_51829664P3
SSD_E0_S01_51829664P3                1 NORMAL    ONLINE  CACHED
MEMBER
```

| | | | | |
|----------------------------|---|--------|--------|--------|
| AFD:SSD_E0_S01_51829664P4 | | | | |
| SSD_E0_S01_51829664P4 | 1 | NORMAL | ONLINE | CACHED |
| MEMBER | | | | |
| AFD:SSD_E0_S01_51829664P5 | | | | |
| SSD_E0_S01_51829664P5 | 1 | NORMAL | ONLINE | CACHED |
| MEMBER | | | | |
| AFD:SSD_E0_S01_51829664P6 | | | | |
| SSD_E0_S01_51829664P6 | 1 | NORMAL | ONLINE | CACHED |
| MEMBER | | | | |
| AFD:SSD_E0_S01_51829664P7 | | | | |
| SSD_E0_S01_51829664P7 | 1 | NORMAL | ONLINE | CACHED |
| MEMBER | | | | |
| AFD:SSD_E0_S01_51829664P8 | | | | |
| SSD_E0_S01_51829664P8 | 1 | NORMAL | ONLINE | CACHED |
| MEMBER | | | | |
| AFD:SSD_E0_S01_51829664P9 | | | | |
| SSD_E0_S01_51829664P9 | 2 | NORMAL | ONLINE | CACHED |
| MEMBER | | | | |
| AFD:SSD_E0_S02_51849168P1 | | | | |
| SSD_E0_S02_51849168P1 | 1 | NORMAL | ONLINE | CACHED |
| MEMBER | | | | |
| AFD:SSD_E0_S02_51849168P10 | | | | |
| SSD_E0_S02_51849168P10 | 2 | NORMAL | ONLINE | CACHED |
| MEMBER | | | | |
| AFD:SSD_E0_S02_51849168P2 | | | | |
| SSD_E0_S02_51849168P2 | 1 | NORMAL | ONLINE | CACHED |
| MEMBER | | | | |
| AFD:SSD_E0_S02_51849168P3 | | | | |
| SSD_E0_S02_51849168P3 | 1 | NORMAL | ONLINE | CACHED |
| MEMBER | | | | |
| AFD:SSD_E0_S02_51849168P4 | | | | |
| SSD_E0_S02_51849168P4 | 1 | NORMAL | ONLINE | CACHED |
| MEMBER | | | | |
| AFD:SSD_E0_S02_51849168P5 | | | | |
| SSD_E0_S02_51849168P5 | 1 | NORMAL | ONLINE | CACHED |
| MEMBER | | | | |
| AFD:SSD_E0_S02_51849168P6 | | | | |
| SSD_E0_S02_51849168P6 | 1 | NORMAL | ONLINE | CACHED |
| MEMBER | | | | |
| AFD:SSD_E0_S02_51849168P7 | | | | |
| SSD_E0_S02_51849168P7 | 1 | NORMAL | ONLINE | CACHED |
| MEMBER | | | | |
| AFD:SSD_E0_S02_51849168P8 | | | | |
| SSD_E0_S02_51849168P8 | 1 | NORMAL | ONLINE | CACHED |
| MEMBER | | | | |
| AFD:SSD_E0_S02_51849168P9 | | | | |
| SSD_E0_S02_51849168P9 | 2 | NORMAL | ONLINE | CACHED |
| MEMBER | | | | |
| AFD:SSD_E0_S03_51828144P1 | | | | |
| SSD_E0_S03_51828144P1 | 1 | NORMAL | ONLINE | CACHED |
| MEMBER | | | | |
| AFD:SSD_E0_S03_51828144P10 | | | | |
| SSD_E0_S03_51828144P10 | 2 | NORMAL | ONLINE | CACHED |
| MEMBER | | | | |
| AFD:SSD_E0_S03_51828144P2 | | | | |
| SSD_E0_S03_51828144P2 | 1 | NORMAL | ONLINE | CACHED |

```

MEMBER
AFD:SSD_E0_S03_51828144P3
SSD_E0_S03_51828144P3          1 NORMAL ONLINE  CACHED
MEMBER
AFD:SSD_E0_S03_51828144P4
SSD_E0_S03_51828144P4          1 NORMAL ONLINE  CACHED
MEMBER
AFD:SSD_E0_S03_51828144P5
SSD_E0_S03_51828144P5          1 NORMAL ONLINE  CACHED
MEMBER
AFD:SSD_E0_S03_51828144P6
SSD_E0_S03_51828144P6          1 NORMAL ONLINE  CACHED
MEMBER
AFD:SSD_E0_S03_51828144P7
SSD_E0_S03_51828144P7          1 NORMAL ONLINE  CACHED
MEMBER
AFD:SSD_E0_S03_51828144P8
SSD_E0_S03_51828144P8          1 NORMAL ONLINE  CACHED
MEMBER
AFD:SSD_E0_S03_51828144P9
SSD_E0_S03_51828144P9          2 NORMAL ONLINE  CACHED
MEMBER
AFD:SSD_E0_S04_51829536P1
SSD_E0_S04_51829536P1          1 NORMAL ONLINE  CACHED
MEMBER
AFD:SSD_E0_S04_51829536P10
SSD_E0_S04_51829536P10         2 NORMAL ONLINE  CACHED
MEMBER
AFD:SSD_E0_S04_51829536P2
SSD_E0_S04_51829536P2          1 NORMAL ONLINE  CACHED
MEMBER
AFD:SSD_E0_S04_51829536P3
SSD_E0_S04_51829536P3          1 NORMAL ONLINE  CACHED
MEMBER
AFD:SSD_E0_S04_51829536P4
SSD_E0_S04_51829536P4          1 NORMAL ONLINE  CACHED
MEMBER
AFD:SSD_E0_S04_51829536P5
SSD_E0_S04_51829536P5          1 NORMAL ONLINE  CACHED
MEMBER
AFD:SSD_E0_S04_51829536P6
SSD_E0_S04_51829536P6          1 NORMAL ONLINE  CACHED
MEMBER
AFD:SSD_E0_S04_51829536P7
SSD_E0_S04_51829536P7          1 NORMAL ONLINE  CACHED
MEMBER
AFD:SSD_E0_S04_51829536P8
SSD_E0_S04_51829536P8          1 NORMAL ONLINE  CACHED
MEMBER
AFD:SSD_E0_S04_51829536P9
SSD_E0_S04_51829536P9          2 NORMAL ONLINE  CACHED
MEMBER
AFD:SSD_E0_S05_51841136P1
SSD_E0_S05_51841136P1          1 NORMAL ONLINE  CACHED
MEMBER
AFD:SSD_E0_S05_51841136P10
    
```

```

SSD_E0_S05_51841136P10          2 NORMAL   ONLINE   CACHED
MEMBER
AFD:SSD_E0_S05_51841136P2
SSD_E0_S05_51841136P2          1 NORMAL   ONLINE   CACHED
MEMBER
AFD:SSD_E1_S23_51847424P9
SSD_E1_S23_51847424P9          2 NORMAL   ONLINE   CACHED
MEMBER
''
''
''

```

```

SQL> Disconnected from Oracle Database 19c Enterprise Edition Release
19.0.0.0.0 - Production
Version 19.25.0.0.0
#

```

9. Use the `odaadmcli show validation storage errors` command to show hard storage errors.

Hard errors include having the wrong type of disk inserted into a particular slot, an invalid disk model, or an incorrect disk size.

```
# odaadmcli show validation storage errors
```

10. Use the `odaadmcli show validation storage failures` command to show soft validation errors.

A typical soft disk error would be an invalid version of the disk firmware.

```
# odaadmcli show validation storage failures
```

11. Run the `odacli describe-component` command to verify that all firmware components in the storage expansion are current.

```
# odacli describe-component
```

12. If needed, update the storage shelf and then run the `odacli describe-component` command to confirm that the firmware is current.

```
# odacli update
# odacli describe-component
```

11

Managing Networks

View the public and private networks that are configured on your Oracle Database Appliance.

- [About Network Infrastructure and VLANs on Oracle Database Appliance](#)
Learn about networks and virtual local area networks (VLANs) on the appliance.
- [About Oracle Database Appliance X11 Network Interfaces](#)
Learn about onboard network interfaces for Oracle Database Appliance.
- [Viewing Configured Networks and Network Interfaces](#)
Use the Browser User Interface to display a list of configured networks, network details, and interfaces.
- [Creating a Network](#)
Understand how you can use the Browser User Interface to create a network for the appliance.
- [Creating a Physical Network](#)
Understand how you can use the Browser User Interface to create a physical network on the unused network interface.
- [Updating a Network](#)
Understand how you can use the Browser User Interface to update a network and revise the IP address, subnet mask, gateway, or type of network.
- [Adding a Network Interface](#)
Understand how you can add a configured network interface.
- [Deleting a Network Interface](#)
Understand how you can delete a configured network interface.
- [Deleting a Network Interface Using Browser User Interface](#)
Understand how you can delete a configured network interface using the Browser User Interface.
- [Deleting a Network Using the Browser User Interface](#)
Understand how you can delete a configured network using the Browser User Interface.

About Network Infrastructure and VLANs on Oracle Database Appliance

Learn about networks and virtual local area networks (VLANs) on the appliance.

Oracle Database Appliance has two dual-port public network interfaces (either copper or fiber), which are bonded. For dual-port networks cards, the bonded network interface used for primary public network is always `btbond1`. You can, optionally, configure upto six bonded interfaces, `btbond1` to `btbond6`. If you use network cards with four ports, then you can select either `btbond1` or `btbond2` as the public network interface.

You can use the Browser User Interface to display all physical and virtual networks. You can use ODA CLI commands or the Browser User Interface to create, update, and deleted networks.

Virtual Local Area Networks (VLANs)

Oracle Database Appliance supports multiple virtual local area networks (VLANs) on the same network port or bond. VLANs are multiple logical networks that are created from a single physical network switch port, providing network security isolation for multiple workloads that share a common network. For example, application, backup, and management networks. Each VLAN acts as an independent logical network operating with other VLANs over the same physical connection. The VLAN tag associated with the data packet and network define the network. You can create a collection of isolated networks to enhance network security and bandwidth and keep data packets separated.

The network interfaces differ, depending on your Oracle Database Appliance hardware. The VLAN is created on `btbond0` in single-node and high-availability platforms. In all cases, connections to user domains are through the selected interfaces. A switch that supports tagged VLANs uses VLAN IDs to identify the packet, including to which network the packet belongs.

 **Note:**

To use VLANs with Oracle Database Appliance, you must configure the VLANs before you deploy the appliance.

The Browser User Interface enables you to create, list, and delete VLANs on the appliance. For high-availability systems, you can use the Browser User Interface to create a VLAN on both nodes of the appliance. To create a VLAN on a specific node, use the command-line interface.

For a bare metal deployment, use the Browser User Interface or `odacli` commands to manage the following types of VLANs:

- Data Guard: For Oracle Data Guard.
- Database: For Oracle Database.
- Backup: For backup operations.
- Management: For management traffic.
- Other: For usage defined by the customer. For example, for applications.

The public VLAN is setup when you configure the first network using the command `odacli configure-firstnet`. You can set up only one public VLAN. Use the command-line interface to create other VLANs. For high-availability systems, the IP addresses for Node 0 and Node 1 cannot be the same. Oracle Database Appliance does not support Dynamic Host Configuration Protocol (DHCP) to provide IP addresses, subnet mask and default gateway.

About Oracle Database Appliance X11 Network Interfaces

Learn about onboard network interfaces for Oracle Database Appliance.

The network interfaces differ, depending on your Oracle Database Appliance hardware. In all cases, connections to user domains are through the selected interfaces. Two ports inside a network card are used to create an active-backup mode bonding interface.

The following table lists the default network interfaces for Oracle Database Appliance bare metal systems on Oracle Database Appliance X11-HA.

Table 11-1 Network Interfaces for Oracle Database Appliance X11-HA Bare Metal Deployment

| PCIe Network Card Slot | PCIe Network Port | Network Interfaces | Network Bonds | IP Addresses |
|-------------------------------------|---|-------------------------|-------------------|---|
| PCIe Slot 1 (Interconnect) | 2 x 10/25GbE SFP28 ports | p1p1, p1p2 | icbond0 | Node 0: 192.168.16.24 Node 1: 192.168.16.25 |
| PCIe Slot 5 (required - first NIC) | 4 x 10GBase-T ports or 2 x 10/25GbE SFP28 ports | p5p1, p5p2 (p5p3, p5p4) | btbond1 (btbond2) | Can be assigned during provisioning or post deployment. |
| PCIe Slot 4 (optional - second NIC) | 4 x 10GBase-T ports or 2 x 10/25GbE SFP28 ports | p4p1, p4p2 (p4p3, p4p4) | btbond3 (btbond4) | Can be assigned during provisioning or post deployment. |
| PCIe Slot 8 (optional - third NIC) | 4 x 10GBase-T ports or 2 x 10/25GbE SFP28 ports | p8p1, p8p2 (p8p3, p8p4) | btbond5 (btbond6) | Can be assigned during provisioning or post deployment. |
| On-board | 1GBase-T | em1 | Not applicable | Assigned post deployment |

The following table lists the default network interfaces for Oracle Database Appliance bare metal systems on Oracle Database Appliance X11-S and X11-L.

Table 11-2 Network Interfaces for Oracle Database Appliance X11-S and X11-L Bare Metal Deployment

| PCIe Network Card Slot | PCIe Network Port | Network Interfaces | Network Bonds | IP Addresses |
|---|---|-------------------------|-------------------|--|
| PCIe Slot 5 (required - first NIC) | 4 x 10GBase-T ports or 2 x 10/25GbE SFP28 ports | p5p1, p5p2 (p5p3, p5p4) | btbond1 (btbond2) | btbond1 and btbond2 can be assigned during deployment. |
| PCIe Slot 4 (optional - second NIC for Oracle Database Appliance X11-L) | 4 x 10GBase-T ports or 2 x 10/25GbE SFP28 ports | p4p1, p4p2 (p4p3, p4p4) | btbond3 (btbond4) | Can be assigned during deployment. If not assigned during deployment, then it can be assigned post deployment. |
| PCIe Slot 9 (optional - second NIC for Oracle Database Appliance X11-S) | 4 x 10GBase-T ports or 2 x 10/25GbE SFP28 ports | p9p1, p9p2 (p9p3, p9p4) | btbond3 (btbond4) | Can be assigned during deployment. If not assigned during deployment, then it can be assigned post deployment. |

Table 11-2 (Cont.) Network Interfaces for Oracle Database Appliance X11-S and X11-L Bare Metal Deployment

| PCIe Network Card Slot | PCIe Network Port | Network Interfaces | Network Bonds | IP Addresses |
|------------------------------------|---|-------------------------|-------------------|--|
| PCIe Slot 8 (optional - third NIC) | 4 x 10GBase-T ports or 2 x 10/25GbE SFP28 ports | p8p1, p8p2 (p8p3, p8p4) | btbond5 (btbond6) | Can be assigned during deployment. If not assigned during deployment, then it can be assigned post deployment. |
| On-board | 1GBase-T | em1 | Not applicable | Assigned post deployment |

Viewing Configured Networks and Network Interfaces

Use the Browser User Interface to display a list of configured networks, network details, and interfaces.

1. Click the **Appliance** tab in the Browser User Interface.
2. Click the **Network** tab in the left navigation to display a list of configured networks and configured databases.

When the appliance is a high-availability system, the network details for **Node0** and **Node1** display on the page.

3. Click **Show Interfaces** in the upper left corner of the Network page to display a list of network interfaces.

If the appliance is a high-availability system, then the network interface details for **Node0** and **Node1** display on the page.

4. Click **Show Networks** to go back to the network view.

Creating a Network

Understand how you can use the Browser User Interface to create a network for the appliance.

When naming a network, you can use alphanumeric characters, dashes (-) and underscores (_). The network name cannot exceed 40 characters and must begin with an alpha character.

1. Click the **Appliance** tab in the Browser User Interface.
2. Click the **Network** tab in the left navigation to display a list of configured networks.
3. If the appliance is a high-availability system, then the Browser User Interface helps you create the network for both nodes at the same time.
4. Click **Create Network** in the upper right corner.
5. Enter the network information in the required fields. The Interface field has a drop-down menu with available choices. The Subnet Mask field has a drop-down menu with available choices and a search box. Optionally, enter a Gateway IP address and select an option from the Network Type list. The network type helps to identify if the network is for backup, database, dataguard, management, private, or other.

If the appliance is a high-availability system, then you must also specify the SCAN (Oracle Single Client Access Name) details such as name and IP address, and VIP (Virtual IP) name and address.

6. Click **Create**.

Creating a Physical Network

Understand how you can use the Browser User Interface to create a physical network on the unused network interface.

1. Click the **Appliance** tab in the Browser User Interface.
2. Click the **Network** tab in the left navigation to display a list of configured networks.
3. If the appliance is a single-node system, then click **Create Network** in the upper right corner. If the appliance is a high-availability system, then go to Step 4.
 - a. Enter the network information in the required fields. The Interface field has a drop-down menu with available choices. The Subnet Mask field has a drop-down menu with available choices and a search box. Optionally, enter a Gateway IP address and select an option from the Network Type list. The network type helps to identify if the network is for backup, database, dataguard, management, private, or other.
 - b. Click **Create**.
4. If the appliance is a high-availability system, then the Browser User Interface helps you create the network for both nodes at the same time. Click **Create Network** in the upper right corner.
 - a. Enter the network information in the required fields. The Interface field has a drop-down menu with available choices. The Subnet Mask field has a drop-down menu with available choices and a search box. Optionally, enter a Gateway IP address and select an option from the Network Type list. The network type helps to identify if the network is for backup, database, dataguard, management, private, or other.
 - b. Click **Create**.

Updating a Network

Understand how you can use the Browser User Interface to update a network and revise the IP address, subnet mask, gateway, or type of network.

1. Click the **Appliance** tab in the Browser User Interface.
2. Click the **Network** tab in the left navigation to display a list of configured networks.

When the appliance is a high-availability system, tabs named **Node0** and **Node1** display in the right corner, below the **Refresh** button. Click a tab to display network details for each node.
3. If the appliance is a high-availability system, click **Node0** or **Node1** to display the node where the network that you want to edit resides.
4. Expand the **Actions** menu, then click **Update** for the network that you want to edit.
5. Update the information in the IP Address, Subnet Mask, and Gateway fields and select a network type from the list, as needed, then click **Update**. For High-Availability deployments, you can also update the Virtual IP Address and Oracle Single Client Access Name (SCAN).

Adding a Network Interface

Understand how you can add a configured network interface.

This procedure explains how to add a network interface card on Oracle Database Appliance.

1. Power off the appliance.
2. Add the network interface card.
3. Power on the appliance.
4. The network configuration files are automatically updated for network bonding and configuration changes.

Deleting a Network Interface

Understand how you can delete a configured network interface.

This procedure explains how to delete a network interface card on Oracle Database Appliance X11. You cannot delete the network interface card in slot 5. You also cannot delete the `btbond1` and `btbond2` networks.

1. Disconnect all networks for the network interface card from all applications on the appliance.
2. Power off the appliance.
3. Remove the network interface card.
4. Power on the appliance.
5. Run the command `odacli delete networkinterface` to clean up the network configuration files.

```
odacli delete networkinterface network_interface_name
```

```
[root@oak ~]# odacli delete-networkinterface btbond3  
Network btbond3 has been deleted successfully
```

```
[root@oak ~]# odacli delete-networkinterface btbond4  
Network btbond4 has been deleted successfully
```

Deleting a Network Interface Using Browser User Interface

Understand how you can delete a configured network interface using the Browser User Interface.

1. Click the **Appliance** tab in the Browser User Interface.
2. Click the **Network** tab in the left navigation to display a list of configured networks.
3. Click the **Show Interfaces** tab in the right navigation to display a list of configured network interfaces.
4. Expand the **Actions** menu, then click **Delete** for the network interface that you want to delete.

5. Confirm the action when prompted.

Deleting a Network Using the Browser User Interface

Understand how you can delete a configured network using the Browser User Interface.

1. Click the **Appliance** tab in the Browser User Interface.
2. Click the **Network** tab in the left navigation to display a list of configured networks.

When the appliance is a high-availability system, tabs named **Node0** and **Node1** display in the right corner, below the **Refresh** button. Click a tab to display network details for each node.

3. If the appliance is a high-availability system, then click **Node0** or **Node1** to display the node where the network that you want to delete resides.
4. Expand the **Actions** menu, then click **Delete** for the network that you want to delete.
5. Confirm the action when prompted.

Backup, Restore and Recover Databases

Review backup, restore, and recovery operations for your databases.

- [About Database Backup and Recovery Options](#)
Backup your databases in Oracle Database Appliance and use the restore and recover features to restore a database to the same or another system or to recover database files.
- [Configuring NFS Backup and Restore on Oracle Database Appliance](#)
To backup databases to Network File System (NFS) location or to restore the database from NFS location, you must configure the NFS backup location to ensure that Oracle Database Appliance can perform read and write operations.
- [Configuring Agent Proxy Settings for Object Store Access](#)
If the Object Store IP address is accessible only through proxy setup by the Oracle Database Appliance server, then define the proxy setting for the agent, so that the agent can access the Object Store.
- [Creating a Database Backup Policy](#)
Understand how to create a policy to backup a database to an internal or external Oracle Fast Recovery Area (FRA) location or to the Object Store using the Browser User Interface.
- [Updating a Database with a Backup Policy](#)
Attach a backup policy to a database to define the database backup attributes and destination.
- [Updating a Backup Policy](#)
Use the Browser User Interface to update the recovery window, change the ObjectStore Credential, or change the crosscheck option for a backup policy.
- [Backing Up a Database Using the Browser User Interface](#)
Apply a backup policy to a database, create a manual backup, update a database backup schedule, or update an archive log backup scheduler.
- [Viewing Backup Reports](#)
Understand how you can use the Browser User Interface to view backup reports.
- [Recovering a Database Using the Browser User Interface](#)
Understand the recovery options available for recovering a database.
- [Deleting a Backup Using the Browser User Interface](#)
Use the Browser User Interface to delete database backups.
- [Deleting a Backup Policy](#)
Use the Browser User Interface to delete a database backup policy.
- [Using the CLI to Backup, Restore, and Recover](#)
Use the command-line interface to backup, restore, and recover databases.

About Database Backup and Recovery Options

Backup your databases in Oracle Database Appliance and use the restore and recover features to restore a database to the same or another system or to recover database files.

It is important to create a backup recovery strategy to protect the databases in Oracle Database Appliance from data loss. A user error or a physical problem with a disk can cause a failure of a read or write operation on a disk file required to run the database. You can create a backup policy in the Browser User Interface or from the command-line interface.

The following backup options are available:

- Backup to an Oracle Fast Recovery Area (FRA) disk (Internal FRA)
- Backup to Oracle Cloud Infrastructure Object Storage (Oracle Object Storage)
- Backup to a Network File System (NFS) location (External FRA)

You can use the backup, restore, and recovery features with databases that have backup policy attached to them in the system. You can choose to manage your backups, and set up your backup, restore, and recovery options.

The backup feature enables you to create a backup policy with your backup parameters, such as backup location, recovery window, enable and disable crosscheck, and ObjectStoreSwift Object details. For new and existing databases, you can create and attach a backup policy to a database to perform backup. After a backup policy is attached to a database, the DCS agent automatically schedules the database backup and archive logs backup, for the database. By default, the frequency of the database backup schedule is once a day and the frequency of archivelog backup schedule is 30 minutes. The database backup scheduler performs level 0 backup every Sunday and a level 1 backup Monday through Saturday. However the level 0 backup day can be changed from the default Sunday to any day of the week. The database backup scheduler and archive logs backup schedulers can be disabled or have their frequencies changed.

The DCS agent generates and saves a backup report for each backup. The backup report contains the metadata required to recover or restore a database.

Oracle Database Appliance uses the Oracle Recovery Manager (RMAN) to recover the database. You can recover from a backup report, a point-in-time (PITR), a System Change Number (SCN), or from the latest backup. When a backup report is used for recovery, it performs an SCN recovery, by reading the SCN value from the backup report. For recovery of data block, tablespaces, data files, PDBs, see the *Oracle Database Backup and Recovery Reference Guide*.

Backup Policy

The backup policy defines the backup details. When you create a backup policy, you define the destination for the database backups, either Internal FRA (Disk) or External FRA (NFS location), or Oracle Object Storage, and you define the recovery window.

If you use the Oracle Object Storage for backup and recovery, you must have an ObjectStore Resource ID or Name.

You can assign the backup policy to the database when you create the database. You can also attach a backup policy to an existing database or update a backup policy.

You can specify compression algorithm while creating the backup policy. The supported compression algorithms are BASIC, LOW, MEDIUM, and HIGH. For Objectstore backup policy, you can specify any compression algorithm. By default, if you do not specify the compression algorithm while creating the Objectstore backup policy, then MEDIUM compression algorithm is used. By default, if you do not specify the compression algorithm while creating the Disk or NFS backup policy, then BASIC compression algorithm is used. Refer to the *Oracle Database Licensing Information User Manual* for license considerations when you use LOW, MEDIUM, or HIGH compression algorithms for Disk or NFS backup policy.

Backup Levels

Specify the backup level when you take a backup. The supported back levels are:

- **Level 0:** This backup captures all blocks in the datafile. By default, level 0 backups occur every Sunday. You can customize your backup settings through the Browser User Interface or the command-line. A level 0 backup is a full backup and is used as the parent for a level 1 backup.
- **Level 1:** This backup is an incremental backup that captures only those blocks that change between backups in each datafile. By default, a level 1 backup occurs daily, Monday through Saturday, and captures images of each block in a datafile that changed. Level 1 backups are differential backups. The Level 1 backup includes blocks that were changed from the most recent level 1 or level 0 backup.
- **LongTerm:** This backup is a long-term, or archival backup. Use LongTerm to create a backup that is all-inclusive and exempt from the backup retention policy. The backup is all-inclusive because every file needed to restore and recover the database is backed up to a single location. The backup is exempt from the retention policy that is defined in the recovery window. For long term backups, you must use External FRA (NFS location) or Objectstore backup policy.
- **Archivelog:** This is a backup of all archive logs not yet backed up to the backup destination, such as Internal FRA, External FRA (NFS location), or Object Store.

When a database is modified with a backup configuration, database backup schedule and archive logs backup schedules are created automatically. Automatic database backup schedule creates a level 0 backup on Level 0 Backup Day, by default, on Sunday, and level 1 on the remaining days of the week. Also, automatic archive logs backup schedules creates archive logs backup for the database with a default frequency of 30 minutes. These backup schedules can be edited to enable or disable or change the frequency using cron expression.

Backup to Disk

When you backup to disk, you are using the Oracle Fast Recovery Area (FRA) of the disk. FRA is a storage directory that allows backup and recovery operations on Oracle databases. The directory contains archived redo logs, backup pieces and copies, and the control file.

Advantages to backing up to disk are as follows:

- Quick recovery from backups stored on disk
- Automate management of recovery related files (like archived logs)

Note:

- When you backup to disk, the data for non-TDE database is not encrypted and RMAN backup encryption are not allowed. In addition, backup to disk requires a lot of disk space (up to two to three times the size of the database).
- If the database is TDE-enabled, then the RMAN backup encryption password is not required, irrespective of the backup destination.

The following is a high-level overview of the workflow for backup and recovery when using a disk:

1. Create a backup policy to define the backup destination (disk) and recovery window for the disk destination.
2. Create a database and attach the backup policy to the database. When the backup policy is associated with a database, archive logs backups and database backups are automatically created.
3. Manage obsolete backups.
4. Recover the database from a backup on the disk.

Backup to External FRA (Network File System)

Specifying a Network File System (NFS) location for backups, enables you to safely and securely store or retrieve a database backup at any time.

The advantages of using NFS backup location are:

- With NFS, you can access remote files, locally, by mounting local file systems on a network.
- Provides a centralized backup location, without requiring manual refresh.
- Supports enhanced security options using firewalls and Kerberos.
- Support for encrypted backups using passwords. You optionally, set the backup password, and provide the same during restore operation.
- The RMAN Backup Encryption password is applicable for databases that do not have TDE enabled. If the database has TDE enabled, then the RMAN backup password is not required, irrespective of the backup destination.

The following is a high-level overview of the workflow for backup and recovery when using an NFS location:

1. Create a mount point for the NFS location.
The mount point must be accessible from both nodes. The `oracle` user must have read/write permissions to the NFS location. If the request is being made to a remote server, ensure that it is running. See *Creating a Mount Point for NFS Backup Location* for the procedure to create a mount point.
2. Create a backup policy specifying the NFS location, and the recovery window for NFS destination.
3. Associate the database with this backup policy, either during database creation, or by updating the backup policy for the database.
4. Backups are automatically scheduled, and you can also run manual backups. You can specify manual backup options in the Browser User Interface or using ODA CLI commands.
5. Manage obsolete backups.
6. Restore from backup. When you save your backups to NFS, you can restore the database to the same system or to a different system.
7. Recover the database from a backup on NFS.

Backup to Oracle Object Storage

Oracle Object Storage is a highly secure, scalable storage platform that enables you to safely and securely store or retrieve a database backup at any time. Data and the associated metadata are stored as an object in a logical container (bucket). Oracle Database Appliance creates a Backup Report and a unique ID to identify each backup.

Oracle Object Storage is tightly integrated with Oracle Cloud Infrastructure Identity and Access Management. The data, user-defined metadata associated with the data, and encryption keys are automatically encrypted using 256-bit Advanced Encryption Standard (AES- 256). The encryption keys are rotated frequently and cannot be disabled. By default, only authenticated users that have explicitly been granted access to specific resources can access data stored in Oracle Object Storage. Data is uploaded and downloaded over SSL endpoints using the HTTPS protocol.

When you backup to Oracle Object Storage, you are using your backup policy and your Oracle ObjectStoreSwift credentials. The credentials are stored in an encrypted Oracle wallet. You can attach the credentials to one or more backup policies.



Note:

Credentials are validated when you create the backup policy that uses Oracle Object Storage. The credentials are not validated against the URL and tenancy.

Advantages to using Oracle Object Storage are as follows:

- Backups are encrypted using the password for non-TDE databases. For TDE-enabled databases, backups are encrypted by default and do not require the RMAN backup encryption password to be specified separately.



Caution:

Save the password that you use during backups in a safe location, you must provide the password during recovery operations.

- Quick recovery from backups. With the Oracle Object Storage, you can safely and securely use the Browser User Interface to store or retrieve data directly from within the cloud platform, at any time.
- Automate management of recovery related files (like archived logs)
- Oracle Object Storage is not directly accessed by the operating system, instead it uses APIs to access the storage at the application level.

The following is a high-level overview of the workflow for backup and recovery when using Oracle Object Storage:

1. Create an Object Store object with your credentials.
2. Create a backup policy to define the backup location (Object Store), Object Store Credentials Name, the container (bucket) name where you want to store backups, and the recovery window.
3. Create a database and attach the backup policy either as a part of creating the database, or update the database with backup policy after creating the database. When the backup policy is associated with a database, backups are automatically created.
4. Manage obsolete backups.
5. Restore from backup. When you save your backups to Oracle Object Storage, you can restore the database to the same system or to a different system.
6. Recover the database from a backup on Oracle Object Storage.

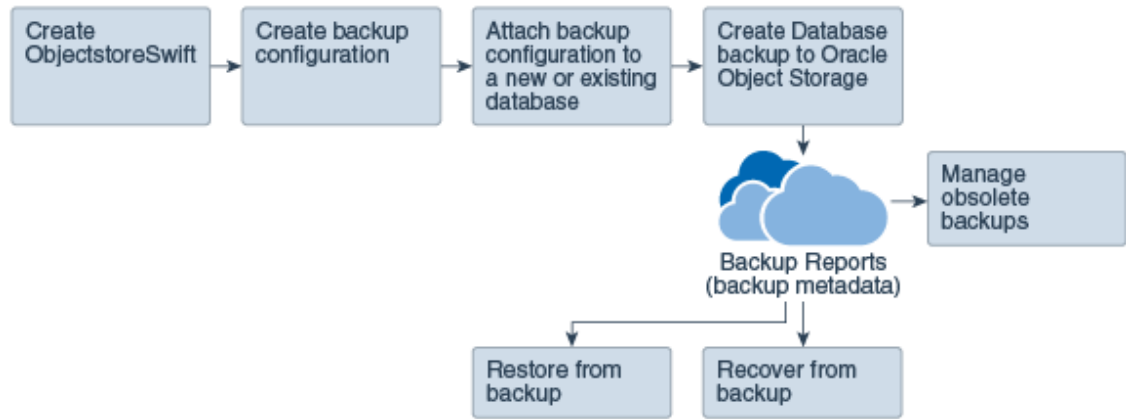

Note:

Before you can use this backup option, you must create an Oracle Cloud Infrastructure Object Storage account. When you create the account, you define the account credentials, end point URL, and bucket. Go to the Oracle Store and sign up for Oracle Cloud Infrastructure Object Storage.

Backup Reports

A backup report is generated for each backup and is similar to, but does not replace, a recovery catalog. The report contains the Oracle Database Appliance information and metadata needed to restore or recover a database. The Backup Report is designed to keep track of all of the information required to restore or recover a database.

The following is an example of a level 1 backup report:

```

{
  "id" : "2d82460c-d648-4e75-8c7d-72cc90bc442a",
  "dbResId" : "b5fc646e-01a6-4c8b-8286-7633346c4329",
  "tag" : null,
  "dbId" : "2717054291",
  "dbName" : "HRDbO",
  "dbUniqueName" : "HRDbOu",
  "backupType" : "REGULAR-L1",
  "keepDays" : null,
  "backupLocation" : "https://swiftobjectstorage.us-phoenix-1.oraclecloud.com/v1/dbaasimage/backupbucket",
  "cfBackupHandle" : "c-2717054291-20171108-04",
  "spfBackupHandle" : "c-2717054291-20171108-04",
  "pitrTimeStamp" : "November 08, 2017 12:43:14 PM UTC",
  "pitrSCN" : "1175058",
  "resetLogsTimeStamp" : "November 08, 2017 09:55:34 AM UTC",
  "resetLogsSCN" : "1112268",
  "oraHomeVersion" : "12.2.0.1.170814 (26723265, 26609817)",
  "sqlPatches" : "25811364,26609817",
  "backupLogLoc" : "https://swiftobjectstorage.us-phoenix-1.oraclecloud.com/v1/dbaasimage/backupbucket/scaoda702c1n1/rmanlog/HRDbOu/2717054291/2017-11-08/rman_backup_2017-11-08_12-42-41.0545.log",
  "tdeWalletLoc" : null,
  "dbConfigLoc" : "https://swiftobjectstorage.us-phoenix-1.oraclecloud.com/v1/dbaasimage/backupbucket/scaoda702c1n1/dbconfig/HRDbOu/2717054291/2017-11-08/DBCONFIG_TAG20171108T124407_2017-11-08_12-44-07.0533.tar.gz",
  "name" : "Backup_Report_HRDbO",
  "createTime" : "November 08, 2017 12:42:08 PM UTC",
  "state" : {
    "status" : "CONFIGURED"
  },
  "updatedTime" : "November 08, 2017 12:44:12 PM UTC",
  "backupReportLogDetail" : "https://swiftobjectstorage.us-phoenix-1.oraclecloud.com/v1/dbaasimage/backupbucket/scaoda702c1n1/rmandetaillogreport/HRDbOu/2717054291/2017-11-08/rman_list_backup_detail_2017-11-08_12-44-04.0362.log",
  "dbInfo" : {
    "dbClass" : "OLTP",
    "dbType" : "RAC",
    "dbShape" : "odbi",
    "dbEdition" : "EE",
    "dbStorage" : "ASM"
  },
  "dbDataSize" : "1542M",
}
  
```



```
"dbRedoSize" : "16403M"  
}
```

About Backup of TDE Wallet

When the database backup is performed, the TDE wallet backup is also taken. The database backup can be of any type like regular-L0, regular-L1, longterm and archivelog. Use the `odacli list-tdebackupreports` command to view the latest TDE wallet backup in a backup destination. For example, if a TDE-enabled database named `tdeddb1` was attached with Disk, and then NFS, and later Oracle Object Storage backup configuration, and the database was backed up to each of these backup destination eventually, then the `odacli list-tdebackupreports` command lists three entries of TDE wallet backup corresponding to Disk, NFS and Oracle Object Storage backup destination, respectively, for the database `tdeddb1`. The reason for selecting the latest copy is that the TDE wallet is a cumulative wallet, that is, all previous changes, such as re-key operation is available in the latest TDE wallet itself.

About Recovery Options

The recovery in Oracle Database Appliance always performs a full database restore or recover. The recovery options are LATEST, PITR, SCN, and BackupReport.

The following types of recovery are available:

- **LATEST:** Performs a complete recovery (valid backups and all required archived logs and online redo logs must be available)
- **PITR:** Point-in-Time Recovery that performs a recovery to a specified timestamp within the current incarnation of database
- **SCN:** SCN-based recovery that performs a recovery is an incomplete recovery to a specified SCN within the current incarnation of database.
- **BackupReport:** Performs a recovery based on the Backup Report SCN. The BackupReport option is similar to SCN, except that the recovery uses the Backup Report SCN instead of a specified SCN.

Point-in-Time Database Recovery

Point-in-Time Recovery (PITR) recovers the database to a specific point-in-time. You must specify the timestamp for this type of recovery.

A point-in-time recovery is often used for the following situations:

- You want to recover the database to an SCN before a user or administrative error.
- Complete database recovery failed because all necessary archived redo logs were not available.
- A database upgrade fails.
- You are creating a test database or a reporting database from production database backups.

System Change Number Recovery

A system change number (SCN) is a stamp that defines a committed version of a database at a point in time. Oracle assigns every committed transaction a unique SCN. You can recover a database to the latest time or to an SCN.

The database is restored from backups created before the target time, and then applies incremental backups and logs to re-create all changes between the time of the data file backups and the end point of recovery. When the end point is specified as an SCN, the

database applies the redo logs and stops after each redo thread or the specified SCN, whichever occurs first. When the end point is specified as a time, the database internally determines a suitable SCN for the specified time and then recovers to this SCN.

SCN is a primary mechanism to maintain data consistency in Oracle database. With each execution, there is an increase in the count of the SCN. The following are some examples of areas that use SCN:

1. Redo records. Every redo record has an SCN version of the redo record in the redo header (redo records can have non-unique SCN). Given redo records from two threads (as in the case of RAC), recovery will order them in SCN order, essentially maintaining a strict sequential order.
2. Data block. Every data block has block SCN (block version). In addition to that, a change vector in a redo record also has expected block SCN. This means that a change vector can be applied to one and only version of the block. Code checks if the target SCN in a change vector is matching with the block SCN before applying the redo record. If there is a mismatch, corruption errors are thrown.
3. Read consistency. Every query has query environment which includes an SCN at the start of the query. A session can see the transactional changes only if that transaction commit SCN is lower than the query environment SCN.
4. Commit. Every commit generates an SCN (commit SCN) that marks a transaction boundary. Group commits are possible too.

Restoring Archive Logs

The database auto backup policies - Regular-L0, and Regular-L1 delete archive log, which could be essential in later process, such as in configuration or reinstate operations for Oracle Data Guard. Oracle Database Appliance supports restore of archive logs for a database. You can choose to restore archive logs from one SCN to another SCN, or from one timestamp to another timestamp.

Run the command `odacli restore-archivelog` specifying the SCN or timestamp period.

Obsolete Database Backups

It is important to remove older backups once they become obsolete. The type of backup and the recovery window that you define in the database backup policy determines when database backups become obsolete.

For level 0, level 1, and archive log backups, run the command `odacli delete-backup` for a given Database Resource Identifier to delete obsolete backups and backup reports based on the defined recovery window.

For Longterm backups, provide the corresponding backup report as an input and use the command `odacli delete-backup` to delete the backups from Oracle Object Storage or NFS backup location and the back report you specify in the command.

Typically, older level 0 and level 1 database backups are considered obsolete based on the defined recovery window and those obsolete backups are deleted when you run the `odacli delete-backup` command. The defined recovery window is as follows:

- Disk: 1-14 days
- Object Storage: 1-30 days

Starting with Oracle Database Appliance release 19.15, on attaching a backup policy to a database, the DCS agent creates a scheduler for deleting the database backup. It deletes the obsolete backups and backup reports for the database. By default, the frequency of this delete

backup scheduler is once a week. It runs on every Monday to delete obsolete backups and backup reports of the database. The delete backup scheduler can be edited to disable it or to change its frequency.

Related Topics

- [Configuring an NFS Backup Location](#)
Configure Network File System (NFS) backup location, to set up the NFS backup and mount the NFS client location on Oracle Database Appliance.

Configuring NFS Backup and Restore on Oracle Database Appliance

To backup databases to Network File System (NFS) location or to restore the database from NFS location, you must configure the NFS backup location to ensure that Oracle Database Appliance can perform read and write operations.

Following are the steps to configure the NFS location, backup database to NFS location, and restore database as a standby database from the NFS backup location.

- [Configuring an NFS Backup Location](#)
Configure Network File System (NFS) backup location, to set up the NFS backup and mount the NFS client location on Oracle Database Appliance.
- [Backing Up the Database to NFS Location](#)
To backup a database to NFS location on Oracle Database Appliance, you must create an NFS backup configuration object and then attach the same to the database.
- [Restoring the Database from NFS Backup](#)
Understand the steps to restore a database from NFS location.

Configuring an NFS Backup Location

Configure Network File System (NFS) backup location, to set up the NFS backup and mount the NFS client location on Oracle Database Appliance.

An NFS setup involves an NFS server location and an NFS client location. While performing database backup operation, it is recommended that you configure the NFS server location on a different system, than the system where the source database, that is, the database to be backed up, is running. This ensures the database backups are not lost, even if the system where the source database is running, is corrupted or lost. However, the NFS client location must be configured on the same machine where the database is running, to perform database backup operation. Also, while performing database restore operation, the NFS client location must be configured on the same system where the database must be restored.

Note:

- An NFS backup configuration object must be created and attached to the database. This NFS backup location is a mandatory parameter to create a NFS backup configuration object.
- For TDE-enabled database, Oracle Database Appliance requires the backup path to be different for database and TDE wallet, as per security guidelines. If the source database is TDE-enabled, then configure another NFS client location following the steps in this topic.

Run the following steps on the NFS server:

1. Create an Oracle ADVM volume and format the volume as Oracle ACFS, on any node, for example, `node0`, of a different Oracle Database Appliance system, as the `grid` operating system user.

```
[root@***** ~]# su - grid

[grid@***** ~]# asmcmd

ASMCMDB> volcreate -G data -s 100G backup

ASMCMDB> volinfo -G data backup
Diskgroup Name: DATA
Volume Name: BACKUP
Volume Device: /dev/asm/backup-322
State: ENABLED
Size (MB): 102400
Resize Unit (MB): 64
Redundancy: HIGH
Stripe Columns: 8
Stripe Width (K): 4096
Usage:
Mountpath:
ASMCMDB> exit
[grid@***** ~]$ mkfs -t acfs /dev/asm/backup-322
mkfs.acfs: version = 19.0.0.0.0
mkfs.acfs: on-disk version = 46.0
mkfs.acfs: volume = /dev/asm/backup-322
mkfs.acfs: volume size = 107374182400 ( 100.00 GB )
mkfs.acfs: Format complete.

[grid@***** ~]$ exit
```

2. Create an operating system directory as the `root` user to export Oracle ACFS volume created in the previous step.

```
[root@***** ~]# mkdir /nfs_backup_server
```

3. Register the file system with Oracle Clusterware and start the file system as the `root` user.

```
[root@***** ~]# /u01/app/19.13.0.0/grid/bin/srvctl add filesystem -
d /dev/asm/backup-322 -path /nfs_backup_server -mountowner oracle -
mountgroup asmadmin
[root@***** ~]# /u01/app/19.13.0.0/grid/bin/srvctl start filesystem -
d /dev/asm/backup-322
```

4. Identify the owner and group of the `DBHOME/bin/oracle` binary of the source database and set the directory ownership to the same owner and group. In the following example, the owner and group of the `DBHOME/bin/oracle` binary are `oracle` and `asmadmin` respectively. Hence, the ownership of NFS server location is set to the same. The permissions of the directory must be set to 750.

```
[root@***** ~]# ls -ltr /u01/app/odaorahome/oracle/product/19.0.0.0/
dbhome_1/bin/oracle
-rwsr-s--x 1 oracle asmadmin 449234896 Sep 21 11:39 /u01/app/
```

```
odaorahome/oracle/product/19.0.0.0/dbhome_1/bin/oracle

[root@***** ~]# chown oracle:asmadmin /nfs_backup_server
[root@***** ~]# chmod 750 /nfs_backup_server
[root@***** ~]# ls -ld /nfs_backup_server
drwxr-x--- 2 oracle asmadmin 4096 Sep 21 12:25 /nfs_backup_server
```

- When NFS server location and NFS client location are on different systems, then there may be cases where the IDs of the `oracle` user and the `asmadmin` group may be different. If the IDs of the `oracle` user and the `asmadmin` group are the same, then do not run step 6. In the following example, the ID of `oracle` user is 1001 on the NFS server system and 1000 on the NFS client system.

Output of the system where the NFS server location is configured:

```
[root@***** ~]# id oracle
uid=1001(oracle) gid=1001(oinstall)
groups=1001(oinstall),1006(asmdba),1003(dba),1002(dbaoper)
```

Output of the system where the NFS client location is configured:

```
[root@***** ~]# id oracle
uid=1000(oracle) gid=1001(oinstall)
groups=1001(oinstall),1006(asmdba),1003(dba),1002(dbaoper)
```

In such a case, the ownership of the NFS server location must be set to the same ID as the `oracle` user on the system where the NFS client location is configured. The ownership of the `/nfs_backup_server` location must be set to 1000 as follows:

```
[root@***** ~]# chown 1000:asmadmin /nfs_backup_server/
```

- Export the NFS server location to the systems where the NFS client location is created.

```
[root@***** ~]# cat /etc/exports
/nfs_backup_server Node0_NFS_Client_Location_IP(rw, sync, no_root_squash)
/nfs_backup_server Node1_NFS_Client_Location_IP(rw, sync, no_root_squash)
```

Note that the NFS mount option must be `(rw, sync, no_root_squash)`. Starting with Oracle Database Appliance release 19.17, there is no dependency on NFS mount option `no_root_squash`, it can then be `(rw, sync)`.

- Restart the NFS server.

Command on Oracle Linux 7 systems:

```
[root@***** ~]# /bin/systemctl restart nfs.service
```

Command on Oracle Linux 8 systems:

```
[root@***** ~]# /bin/systemctl restart nfs-server
```

- Verify the mount point using the `showmount -e` command.

```
[root@***** ~]# showmount -e
Export list for *****:
```

```

/nfs_backup_server
Node0_NFS_Client_Location_IP,Node1_NFS_Client_Location_IP

```

Follow these steps to mount the NFS location on Oracle Database Appliance. If the source database is on an Oracle Database Appliance high-availability system, then run the following steps on both nodes.

1. Create a NFS client location as the `root` user.

```
[root@***** ~]# mkdir /nfs_backup_client
```

2. Mount the NFS client location on to the NFS server location, using the IP address of the system where the NFS server location is configured.

```
[root@***** ~]# mount -t nfs NFS_Server_Location_IP:/nfs_backup_server /
nfs_backup_client
```

Related Topics

- [About Database Backup and Recovery Options](#)
Backup your databases in Oracle Database Appliance and use the restore and recover features to restore a database to the same or another system or to recover database files.

Related Topics

- [Preparing for Database Backup to NFS Location](#)
Use the command-line interface to create a policy to backup a database to an External FRA (NFS Location).

Backing Up the Database to NFS Location

To backup a database to NFS location on Oracle Database Appliance, you must create an NFS backup configuration object and then attach the same to the database.

The relationship between NFS backup configuration object and database is one-to-many, that is, you can attach one NFS backup configuration object to multiple databases. Use the NFS backup location that you configured in the *Configuring an NFS Backup Location* topic to create an NFS backup configuration object.

Follow these steps to backup a database to an NFS location:

1. Create the NFS backup configuration with the NFS backup location using the `odacli create-backupconfig` command. In the following sample output, the NFS backup location, specified using the `-c` option, is `/nfs_backup_client/`, the name of the NFS backup configuration object, specified using the `-n` option is `nfsbcfg`, the destination, specified using the `-d` option is `nfs` and the retention period, specified using the `-w` option is 1 day.

If the source database is TDE-enabled, then along with database backup location, specified using the `-c` option, the TDE wallet location must also be specified using the `-f` option. The TDE backup path must be different from the database backup path and can be configured in the same way as the database backup path.

```

# odacli create-backupconfig -n nfsbcfg -d nfs -c /nfs_backup_client/ -w 1
{
  "jobId" : "0a86bd50-7ac7-4d6d-af4b-1ee2c4d451d5",
  "status" : "Created",
  "message" : "backup config creation",
  "reports" : [ ],

```

```

    "createTimestamp" : "September 21, 2022 17:02:21 PM UTC",
    "resourceList" : [ {
      "resourceId" : "023eb9ac-a4d0-4071-a358-c904791d15d7",
      "resourceType" : null,
      "resourceNewType" : "BackupConfig",
      "jobId" : "0a86bd50-7ac7-4d6d-af4b-1ee2c4d451d5",
      "updatedAt" : null
    } ],
    "description" : "create backup config:nfsbcfg",
    "updatedAt" : "September 21, 2022 17:02:21 PM UTC"
  }
}

# odacli describe-job -i 0a86bd50-7ac7-4d6d-af4b-1ee2c4d451d5

Job details
-----
                ID: 0a86bd50-7ac7-4d6d-af4b-1ee2c4d451d5
Description:    create backup config:nfsbcfg
                Status: Success
Created:       September 21, 2022 5:02:21 PM UTC
Message:      backup config creation

Task Name                Start
Time                    End Time                Status
-----
Backup config metadata persist      September 21, 2022 5:02:21 PM
UTC September 21, 2022 5:02:21 PM UTC Success

```

2. Attach the NFS backup configuration object to the database using the `odacli modify-database` command.

```

# odacli modify-database -n mydb -bin nfsbcfg
{
  "jobId" : "4cd995f1-feb4-413e-a863-71e87cc97cff",
  "status" : "Created",
  "message" : "Modify database",
  "reports" : [ ],
  "createTimestamp" : "September 21, 2022 17:37:13 PM UTC",
  "resourceList" : [ {
    "resourceId" : "09b476c2-8f09-4636-9233-d8789c320b25",
    "resourceType" : "DB",
    "resourceNewType" : null,
    "jobId" : "4cd995f1-feb4-413e-a863-71e87cc97cff",
    "updatedAt" : "September 21, 2022 17:37:13 PM UTC"
  } ],
  "description" : "Modify database : mydb",
  "updatedAt" : "September 21, 2022 17:37:13 PM UTC"
}

# odacli describe-job -i 4cd995f1-feb4-413e-a863-71e87cc97cff

Job details
-----
                ID: 4cd995f1-feb4-413e-a863-71e87cc97cff

```

```

Description: Modify database : mydb
Status: Success
Created: September 21, 2022 5:37:13 PM UTC
Message: Modify database
    
```

| Task Name | Start | Status |
|---|-------------------------------|--------|
| Time | End Time | |
| Validate OMF parameter values | September 21, 2022 5:37:18 PM | |
| UTC September 21, 2022 5:37:19 PM UTC | Success | |
| update db with backupconfig attributes | September 21, 2022 5:37:34 PM | |
| UTC September 21, 2022 5:37:39 PM UTC | Success | |
| Enable Database Autobackup | September 21, 2022 5:37:39 PM | |
| UTC September 21, 2022 5:37:39 PM UTC | Success | |
| Enable Archivelog Autobackup | September 21, 2022 5:37:39 PM | |
| UTC September 21, 2022 5:37:39 PM UTC | Success | |
| Configure Control file Auto Backup Format | September 21, 2022 5:37:39 | |
| PM UTC September 21, 2022 5:37:42 PM UTC | Success | |
| Backup Current Control file | September 21, 2022 5:37:42 PM | |
| UTC September 21, 2022 5:37:50 PM UTC | Success | |
| Update metadata for database:mydb | September 21, 2022 5:37:50 PM | |
| UTC September 21, 2022 5:37:50 PM UTC | Success | |

- Back up the database using the `odacli create-backup` command. For example, you can take a backup type called Regular-L0 with archivelog using the `-ka` option.

Note that you must take the backup with the `-ka` option, if you want to restore the backup as a standby database only for Oracle Database Appliance releases earlier than 19.12. From Oracle Database Appliance release 19.12 and later, the `-ka` option is not mandatory for restoring the database as standby.

```

# odacli create-backup -n mydb -bt regular-l0 -ka
{
  "jobId" : "6dc7ae65-93e3-4dc2-b4a7-563c8f98b01a",
  "status" : "Created",
  "message" : null,
  "reports" : [ ],
  "createTimestamp" : "September 21, 2022 17:39:03 PM UTC",
  "resourceList" : [ ],
  "description" : "Create regular-l0 Backup[TAG:auto][Db:mydb][NFS:/
nfs_backup_client/orabackups/scaoda823-c/database/3031000803/mydb]",
  "updatedAtTime" : "September 21, 2022 17:39:03 PM UTC"
}
    
```

```
# odacli describe-job -i 6dc7ae65-93e3-4dc2-b4a7-563c8f98b01a
```

```

Job details
-----
ID: 6dc7ae65-93e3-4dc2-b4a7-563c8f98b01a
Description: Create regular-l0 Backup[TAG:auto][Db:mydb]
[NFS:/nfs_backup_client/orabackups/scaoda823-c/database/3031000803/mydb]
Status: Success
Created: September 21, 2022 5:39:03 PM UTC
Message:
    
```

| Task Name | Start | Status |
|--|-----------------------------------|---------|
| Time | End Time | |
| Validate backup config | September 21, 2022 5:39:05 PM UTC | Success |
| NFS location existence validation | September 21, 2022 5:39:05 PM UTC | Success |
| Backup Validations | September 21, 2022 5:39:05 PM UTC | Success |
| Recovery Window validation | September 21, 2022 5:39:11 PM UTC | Success |
| Archivelog deletion policy configuration | September 21, 2022 5:39:13 PM UTC | Success |
| Database backup | September 21, 2022 5:39:16 PM UTC | Success |

- Oracle Database Appliance creates a backup report corresponding to each backup. Identify the backup report of the above database backup job using the `odacli list-backupreports` command. Describe the backup using the `odacli describe-backupreport - backupreport_id` command and save its output to a JSON file, as shown in the following example. After the JSON file for the backup report is ready, copy the file to the target system where you want to restore the database backup.

```
# odacli list-backupreports | grep -i mydb
496d6e76-d061-4bc2-ae0a-b3325eaa15fa 09b476c2-8f09-4636-9233-
d8789c320b25 3031000803 mydb mydb regular-10
auto September 21, 2022 5:39:16 PM UTC September 21, 2022
5:39:16 PM UTC Configured
# odacli describe-backupreport -i 496d6e76-d061-4bc2-ae0a-b3325eaa15fa >
mydb.json
```

Restoring the Database from NFS Backup

Understand the steps to restore a database from NFS location.

Follow these steps to restore a database from an NFS location:

- The NFS client location must be created on both the nodes of the Oracle Database Appliance system as the `root` user.

```
[root@***** ~]# mkdir /nfs_backup_client
```

- At the server system, export the NFS server location to the Oracle Database Appliance system using the IP address of the Oracle Database Appliance system.

```
[root@***** ~]# cat /etc/exports
/nfs_backup_server <Node0_target_machine_IP>(rw, sync, no_root_squash)
/nfs_backup_server <Node1_target_machine_IP>(rw, sync, no_root_squash)
```

For Oracle Database Appliance release 19.16 and earlier, you must specify the `no_root_squash` parameter. Starting with Oracle Database Appliance release 19.17, you need not specify the `no_root_squash` parameter.

3. Restart the NFS server on the system with the NFS server location.

Command on Oracle Linux 7 systems:

```
[root@***** ~]# /bin/systemctl restart nfs.service
```

Command on Oracle Linux 8 systems:

```
[root@***** ~]# /bin/systemctl restart nfs-server
```

4. Restore the database.

```
# odacli irestore-database -r mydb.json
Enter SYS user password:
Retype SYS user password:
{
  "jobId" : "85a8792a-ca9b-4a50-8202-11d63949d3f2",
  "status" : "Created",
  "message" : null,
  "reports" : [ ],
  "createTimestamp" : "September 21, 2022 17:43:06",
  "resourceList" : [ ],
  "description" : "Database service recovery with db name: mydb",
  "updatedAtTime" : "September 21, 2022 17:43:06"
}
```

```
# odacli describe-job -i 85a8792a-ca9b-4a50-8202-11d63949d3f2
```

Job details

```
-----
ID: 85a8792a-ca9b-4a50-8202-11d63949d3f2
Description: Database service recovery with db name: mydb
Status: Success
Created: September 21, 2022 5:43:06 PM UTC
Message:
```

| Task Name | Start | Status |
|---------------------------------------|-------------------------------|---------|
| Time | End Time | |
| ----- | | |
| Check if cluster ware is running | September 21, 2022 5:43:30 PM | Success |
| UTC September 21, 2022 5:43:30 PM UTC | | |
| Check if cluster ware is running | September 21, 2022 5:43:30 PM | Success |
| UTC September 21, 2022 5:43:30 PM UTC | | |
| Creating DbStorage for DbRestore | September 21, 2022 5:43:30 PM | Success |
| UTC September 21, 2022 5:48:36 PM UTC | | |
| Validating dbHome available space | September 21, 2022 5:43:30 PM | Success |
| UTC September 21, 2022 5:43:30 PM UTC | | |
| Validating dbHome available space | September 21, 2022 5:43:30 PM | Success |
| UTC September 21, 2022 5:43:30 PM UTC | | |
| Validating DiskSpace for DATA | September 21, 2022 5:43:30 PM | Success |
| UTC September 21, 2022 5:43:31 PM UTC | | |
| Generating SSH key | September 21, 2022 5:43:31 PM | Success |
| UTC September 21, 2022 5:43:31 PM UTC | | |
| . | | |
| . | | |
| . | | |

```

Reset Associated Networks          September 21, 2022 6:30:03 AM
UTC   September 21, 2022 6:30:04 AM UTC   Success
Set log_archive_dest for Database  September 21, 2022 6:30:04 AM
UTC   September 21, 2022 6:30:11 AM UTC   Success

```

Configuring Agent Proxy Settings for Object Store Access

If the Object Store IP address is accessible only through proxy setup by the Oracle Database Appliance server, then define the proxy setting for the agent, so that the agent can access the Object Store.

To create a backup policy that uses Object Store location, the agent must be able to access the Object Store URL.

1. Define the `HttpProxyHost` and `HttpProxyPort` settings in the `modify-agentconfig-parameters` command.

```
# odacli modify-agentconfig-parameters -n HttpProxyHost -v www-
proxy.test.com -n HttpProxyPort -v 80 -u
```

Job details

```

-----
ID: 0b0cbf9b-b0ab-4523-a096-5da4e48fc825
Description: Update agent configuration parameter values [HttpProxyHost,
HttpProxyPort]
Status: Created
Created: October 23, 2023 4:56:53 PM IST
Message:

```

```

Task Name Start Time End Time Status
-----

```

For more information about the `modify-agentconfig-parameters` command usage, see the *Oracle Database Appliance Command-Line Interface*.

2. Verify that the update succeeded:

```
# odacli describe-job -i 0b0cbf9b-b0ab-4523-a096-5da4e48fc825
```

Job details

```

-----
ID: 0b0cbf9b-b0ab-4523-a096-5da4e48fc825
Description: Update agent configuration parameter values [HttpProxyHost,
HttpProxyPort]
Status: Success
Created: October 23, 2023 4:56:53 PM IST
Message:

```

```

Task Name Start Time End Time Status
-----

```

3. Run the `list-agentconfigParameters` command to view the changes in the proxy settings:

```
# odacli list-agentConfigParameters
```

```

Name Value Description Updated
-----
HttpProxyHost www-proxy.test.com October 23, 2023 4:56:53 PM IST
HttpProxyPort 80 October 23, 2018 4:56:53 PM IST
HttpsProxyHost Https proxy server host October 23, 2023 12:23:21 AM IST
HttpsProxyPort Https proxy server port October 23, 2023 12:23:21 AM IST
OSPatchRepos Repo list for OS patching October 23, 2023 12:23:21 AM IST

```

You can now use the Browser User Interface or the command-line interface to create a backup policy to use the ObjectStore location for backup.

Related Topics

- [odacli list-agentconfig-parameters](#)
Use the `odacli list-agentconfig-parameters` command to list configuration variables used by the appliance.

Creating a Database Backup Policy

Understand how to create a policy to backup a database to an internal or external Oracle Fast Recovery Area (FRA) location or to the Object Store using the Browser User Interface.

The backup policy defines the backup, including the location where you want to store the backups and the recovery window. Backup to disk requires a lot of disk space (up to two to three times the size of the database).

Follow these steps to create a backup policy from the Browser User Interface:

1. Click the **Database** tab in the Browser User Interface.
2. Click **Backup Policy** in the left navigation to display a list of backup policies.
3. Click **Create Backup Policy**.
4. Enter a name for the backup policy and select the number of days for the recovery window. Select **Enable Crosscheck** to determine if the files on the disk or in the media management catalog correspond to data in the RMAN repository. The **Enable Compression** checkbox is selected by default. Selecting this option ensures backups are compressed. Select one of the following as the backup destination:
 - To backup to disk, select **Internal FRA** as the backup destination.
 - To backup to the cloud, select **ObjectStore** as the backup destination. If you have more than one Object Store, then select the Object Store Credential Name from the list. Enter a name in the Container Name field.
 - To backup to an NFS location, select **External FRA** as the backup destination, and specify the NFS mount point location.
 - To not define a destination, select **None**.

The Backup Policy name must begin with an alpha character and contain only alphanumeric characters.

5. You must specify the **TDE Wallet Backup Location** to associate the backup configuration to a TDE-enabled database.
6. Click **Create**. Click **Yes** to confirm that you want to create the backup policy.

A link to the job appears. When the job completes successfully, the backup configuration is ready.

Update an existing database to attach the backup configuration to the database using the ID or Name. When you attach the backup configuration to a database, the DCS agent schedules

daily automatic backups for the database and automatic backups for archivelog of the database.

Updating a Database with a Backup Policy

Attach a backup policy to a database to define the database backup attributes and destination.

1. In the Browser User Interface, click the **Database** tab.
2. For the database that you want to modify, select **Modify** in the Actions drop down list.
3. In the Modify Database page, select a backup policy from the **Select Backup Policy** drop down list.
4. Specify and confirm the **Backup Encryption Password**.
5. Click **Modify** to submit the job.
6. Click the **Activity** tab to check the job status.

When the job completes successfully, the backup policy is associated with the database.

Updating a Backup Policy

Use the Browser User Interface to update the recovery window, change the ObjectStore Credential, or change the crosscheck option for a backup policy.

Crosscheck determines if the files on the disk on in the media management catalog correspond to data in the RMAN repository.

1. Click the **Database** tab in the Browser User Interface.
2. Click **Backup Policy** in the left navigation to display a list of backup policies.
3. Expand the **Actions** menu for a backup policy, then click **Update**.
4. To change the recovery window, use the up or down arrow to change the number of days.
5. To enable or disable the crosscheck, select or deselect **Enable Crosscheck**.
6. Click **Update**. Click **Yes** to confirm that you want to update the backup policy.

A link to the job appears. When the job completes successfully, the backup configuration is ready.

Backing Up a Database Using the Browser User Interface

Apply a backup policy to a database, create a manual backup, update a database backup schedule, or update an archive log backup scheduler.

You can use the Browser User Interface or the command-line interface to create a database backup. In the command-line interface, use the command `odacli create-backup` for a specified Database.

Before creating a database backup, you must have a backup policy. The backup policy defines the recovery window and the backup destination. You must associate a backup policy with the database, otherwise you cannot create backups.

Follow these steps to backup a database from the Browser User Interface:

1. In the Browser User Interface, click the **Database** tab.
2. Click a database name to select a database from the list.

3. Review the database information, including the backup policy name and destination details. To select a backup policy for the database, click **Apply Backup Policy**. Select a policy and specify the **Backup Encryption Password**. For TDE-enabled databases, backups are encrypted by default and do not require the RMAN backup encryption password to be specified separately. For databases that do not have TDE enabled, the **Backup Encryption Password** is mandatory for Objectstore backup destination, optional for NFS backup destination and not required for Disk backup destination.
4. Click **Manual Backup, Update Database Backup Schedule** or **Update Archive Log Backup Schedule**.
If the action is disabled, then apply a backup policy.
5. Click **Yes** to confirm the job.
A link to the job appears. When the job completes successfully, the backup is ready. A list of backups appears at the bottom of the page.

Viewing Backup Reports

Understand how you can use the Browser User Interface to view backup reports.

A report is generated when a database backup is performed. The backup report lists the type, location, and date and timestamp of the backup.

1. In the Browser User Interface, click the **Database** tab, then click the database name in the list of databases.
Information about the database appears on the Database Information page.
2. Scroll to the bottom of the page to view a list of Backups.
3. Click the Job ID for a backup to view the Backup Report and more details about the backup.

Recovering a Database Using the Browser User Interface

Understand the recovery options available for recovering a database.

1. In the Browser User Interface, click the **Database** tab, then select a database from the list.
2. On the Database Information page, click **Recover**.
3. On the Recover Database page, select any of the following recovery options:
 - Recover Full Database to the specified Backup:** Select the existing backup from which you want to recover the database
 - Recover Full Database to the Latest:** Select this option to recover the database from the last known good state, with the least possible data loss.
 - Recover Full Database to the specified Timestamp:** Specify the timestamp to recover the database.
 - Recover Full Database to the System Change Number (SCN):** Specify the SCN of the backup from which you want to recover the database.
4. Specify and confirm the **Backup Encryption Password** for databases without Transparent Database Encryption (TDE) enabled.
5. If the database has TDE enabled, then the **TDE Wallet Backup Location** and **TDE Password** fields are displayed.
6. Click the **Activity** tab to check the job status.

When the job completes successfully, the database is recovered as per the specified recovery options.

Deleting a Backup Using the Browser User Interface

Use the Browser User Interface to delete database backups.

You can delete Level-0, Level-1, and Archive Log backups anytime. To delete long term backups, you must check the Backup Report for the database to determine when the backup is obsolete.

1. Click the **Database** tab in the Browser User Interface.
2. Click the database name, in blue font, to display more details about the database for which you want to delete the backup.
3. Click **Delete Backups** .
4. Select the Backup type you want to delete, whether Level-0, Level-1, and Archive Log backup or long Term backup, then click **Start**. Click **Yes** to confirm that you want to delete the backup.

A link to the job appears. When the job completes successfully, the backup is deleted.

Deleting a Backup Policy

Use the Browser User Interface to delete a database backup policy.

1. Click the **Database** tab in the Browser User Interface.
2. Click **Backup Policy** in the left navigation to display a list of backup policies.
3. Expand the **Actions** menu for a backup policy, then click **Delete**. Click **Yes** to confirm that you want to delete the backup policy.

A link to the job appears. When the job completes successfully, the backup policy is deleted.

Using the CLI to Backup, Restore, and Recover

Use the command-line interface to backup, restore, and recover databases.

- [Preparing for Database Backup to Disk](#)
Use the command-line interface to create a policy to backup a database to the Oracle Fast Recovery Area (FRA) of a disk.
- [Preparing for Database Backup to NFS Location](#)
Use the command-line interface to create a policy to backup a database to an External FRA (NFS Location).
- [Preparing for Database Backup to Oracle Cloud](#)
Create a backup configuration to backup a database to Oracle Cloud Infrastructure Object Storage.
- [Backing Up a Database with the CLI](#)
Create a level 0, level 1, LongTerm database backup, or archivelog backup with the command-line interface.

- [Recovering a Database with the CLI](#)
Recover the database to the system using a Backup Report, point-in-time recovery (PITR), a system change number (SCN), or from the latest backup time.
- [Restoring a Database with the CLI](#)
You can restore a database to a system from Oracle Object Storage or NFS backup location using a backup report and the command-line interface.
- [Restoring Archivelog with the CLI](#)
You can restore archivelog from one SCN to another SCN, or from one timestamp to another timestamp using the command-line interface.
- [Deleting Backups with the CLI](#)
Delete older, obsolete level 0, level 1, archive log, and long term backups along with obsolete backup reports.

Preparing for Database Backup to Disk

Use the command-line interface to create a policy to backup a database to the Oracle Fast Recovery Area (FRA) of a disk.

You can create a backup policy using the Browser User Interface or the command-line interface. Most of the backup and recovery commands enable you to provide either a resource name or resource ID to identify the database.

Backup to disk or the **Backup to Internal FRA** option in the Browser User Interface, requires a lot of disk space (up to two to three times the size of the database).

Follow these steps to create a backup policy through the command-line interface:

1. Create a BackupConfig object (backup configuration) using the command `odacli create-backupconfig`.

The backup configuration defines the backup, including the location where you want to store the backups and the recovery window.

The following example creates a backup configuration named `mkgldailydisk` with a backup to `disk` and a 1 day recovery window.

```
# odacli create-backupconfig -d Disk -n mkgldailydisk -w 1
```

2. Check the job status.

```
# odacli describe-job -i job_id_from_step1
```

When the job completes successfully, the backup configuration is ready.

3. Update an existing database to attach the backup configuration to the database using the ID or Name.

When you attach the backup configuration to a database, the DCS agent schedules daily automatic backups for the database and automatic backups for the archivelog.

The following example uses the Database Resource ID and Backup Configuration ID:

```
# odacli modify-database -i d3c4d8f6-5eb7-4f9e-ab27-7bdd5013ac90 -bi  
9d942e0a-ba00-4cbc-9bfb-0de83ed279e5 -bp
```

The following example uses the Database Resource Name, `mydb` and the Backup Configuration Name, `mydb`:

```
# odacli modify-database -n mydb -bin mybcfg
```

Preparing for Database Backup to NFS Location

Use the command-line interface to create a policy to backup a database to an External FRA (NFS Location).

You can create a backup policy using the Browser User Interface or the command-line interface. Most of the backup and recovery commands enable you to provide either a resource name or resource ID to identify the database.

Backup to NFS location or the **Backup to External FRA** option in the Browser User Interface, requires creation of an NFS mount point.

Follow these steps to create a backup policy through the command-line interface:

1. Create a BackupConfig object (backup configuration) using the command `odacli create-backupconfig`.

The backup configuration defines the backup, including the location where you want to store the backups and the recovery window.

The following example creates a backup configuration named `mkgldailynfs` with a backup to disk and a 1 day recovery window.

```
# odacli create-backupconfig -d NFS -n mkgldailynfs -c absolute-path-to-parent-directory-for-NFS-destination -w 1
```

2. Check the job status.

```
# odacli describe-job -i job_id_from_step1
```

When the job completes successfully, the backup configuration is ready.

3. (Optional) Update an existing database to attach the backup configuration to the database using the ID or Name.

When you attach the backup configuration to a database, the DCS agent schedules daily automatic backups for the database and automatic backups for the archivelog.

The following example uses the Database Resource ID and Backup Configuration ID:

```
# odacli modify-database -i d3c4d8f6-5eb7-4f9e-ab27-7bdd5013ac90 -bi 9d942e0a-ba00-4cbc-9bfb-0de83ed279e5 -bp
```

The following example uses the Database Resource Name, `mydb` and the Backup Configuration Name, `mydb`:

```
# odacli modify-database -in mydb -bin mybcfg -bp
```

The `-bp` option to specify the backup password is optional and is not applicable for TDE-enabled databases.

Related Topics

- [Configuring an NFS Backup Location](#)
Configure Network File System (NFS) backup location, to set up the NFS backup and mount the NFS client location on Oracle Database Appliance.

Preparing for Database Backup to Oracle Cloud

Create a backup configuration to backup a database to Oracle Cloud Infrastructure Object Storage.

Before you can backup to Oracle Object Storage, you must sign up for an Oracle Cloud Infrastructure Object Storage account and know your Oracle Object Storage credentials. When you create an Oracle ObjectStoreSwift object, the command creates and stores the credential details in the system and stores the password in an encrypted Oracle wallet. The Oracle wallet contains the Oracle Object Storage password.

Go to the Oracle Store to sign up for Oracle Cloud Infrastructure Object Storage.

1. Create an Oracle ObjectStoreSwift object using the command `create-objectstoreswift`.

```
# odacli create-objectstoreswift -e swift end point URL -n Object Store
Swift name -t Object Store tenant name -u Object Store user name
```

For example:

```
# odacli create-objectstoreswift -e https://
swiftobjectstorage.r1.oracleiaas.com/v1 -n ossn1 -t mytenant -u
user.name@example.com
```

The output includes an objectstoreswift Resource ID to identify an ObjectStoreSwift credential.

2. Create a BackupConfig object (backup configuration) using the command `odacli create-backupconfig`.

The backup configuration defines the backup, including the location (container) where you want to store the backups, the recovery window, and the credentials that are defined in your encrypted Oracle wallet.

The following example creates a backup configuration named `hr_7d_cloud` with a backup to the ObjectStore. The following backup parameters are defined: the container is `hr_bucket`, `crosscheck` is not enabled, the recovery window is 7 days, and the ObjectStoreSwift Resource ID is provided, which attaches the ObjectStoreSwiftObject to the backup configuration.

```
# odacli create-backupconfig -n hr_7d_cloud -d ObjectStore -w 7 -o
b974f006-5503-4949-ab6c-6f1a56e4ac37 -c hr_bucket -no-cr
```

 **Note:**

If the ObjectstoreSwift Object was not created with valid credentials, then creating the backup configuration will fail.

3. Check the job status.

```
odacli describe-job -i job_id_from_step2
```

When the job completes successfully, the backup configuration is ready.

4. Update an existing database to attach the backup configuration to the database.

When you attach the backup configuration to a database, the DCS agent schedules daily automatic backups for the database, automatic backups for the archivelog, and weekly deletion of obsolete backups and backup reports for the database.

```
# odacli modify-database -i e3c4d8f6-5eb7-4f9e-ab27-7bdd5013ac10 -bi  
7d942e0a-ba00-4cbc-9bfb-0de83ed279e5 -bp
```

 **Note:**

When you create a new database, you have the option to associate the database with any type of backup configuration.

Backing Up a Database with the CLI

Create a level 0, level 1, LongTerm database backup, or archivelog backup with the command-line interface.

You can create a database backup in the Browser User Interface or with the command-line interface. When you attach a backup configuration object to a database, the DCS agent automatically schedules daily backups for the database. The day and time are based on the Oracle Database Appliance time zone. The AutoSchedule triggers a level 0 Backup every Sunday, a level 1 the other 6 days of the week, and an archivelog backup every 30 minutes. Use the command `odacli modify-schedule` to disable or change the scheduled backup time.

To create a Long Term database backup, or a level 0 or level 1 backup outside of the automatic backups, use the command `odacli create-backup`.

 **Note:**

To recover a database, there must be a level 0 backup taken, so that the backup report contains information about the base backup. Restoring a database to the same system with a different DB Name and DB Unique Name or to another system does not always require a long term database backup report. You can use archivelog, or level 0, or level 1 backup reports as well. If you use the archivelog backup report, a prior database backup must exist. To restore a database to another system, you must have a long term database backup in Oracle Object Storage.

1. Verify that a backup configuration object is associated with the database.
2. Create a single backup, outside of the automatic backups, using the command `odacli create-backup`.

Use the Database Resource ID or Database Name to identify the database to backup, specify the type of backup, and use a tag to create a name for the backup. You can use up to 30 alphanumeric characters for the backup name tag. For example, create a level 0 backup named 2018Jan02_HRLevel10 for resource ID 20576eb1-bc32-4e34-bf97-fda0b60ca15b

```
# odacli create-backup -i 20576eb1-bc32-4e34-bf97-fda0b60ca15b -bt Regular-
L0 -t 2018Jan02_HRLevel10
```

When the job finishes, a backup report is generated for the backup. The report contains all of the metadata required to recover a database.

3. (Optional) Display a list of backup reports.

```
# odacli list-backupreports
```

Recovering a Database with the CLI

Recover the database to the system using a Backup Report, point-in-time recovery (PITR), a system change number (SCN), or from the latest backup time.

Recovering a database in Oracle Database Appliance is a full RMAN database recovery.

Recovering from a backup report requires JSON input for the backup report.

When recovering a TDE-enabled database, you need not specify the backup password.

1. Display a list of backup reports and locate the latest Backup Report for the database and save the Backup Report ID.

```
# odacli list-backupreports
```

2. Use the Backup Report ID to display the details of the Backup Report. Determine how you want to recover the database: PITR, SCN, or Latest and locate the needed information in the Backup Report.

```
# odacli describe-backupreport -i 7fbb06bf-e3a3-4aed-b617-4d1cd3d33387
{
  "id" : "7fbb06bf-e3a3-4aed-b617-4d1cd3d33387",
  "dbResId" : "4903d18a-6c20-4860-9ed0-d2ea7bd3d7b9",
  "tag" : "auto",
  "dbId" : "3022438697",
  "dbName" : "tdbasml",
  "dbUniqueName" : "tdbasml",
  "backupType" : "regular-l0",
  "keepDays" : null,
  "backupLocation" : "https://swiftobjectstorage.us-
ashburn-1.oraclecloud.com/v1/paasdevdbcssi/Bha_Backups",
  "cfBackupHandle" : "c-3022438697-20201022-03",
  "spfBackupHandle" : "c-3022438697-20201022-03",
  "pitrTimeStamp" : "October 22, 2020 07:51:59 AM UTC",
  "pitrSCN" : "2549429",
  "resetLogsTimeStamp" : "October 22, 2020 05:23:56 AM UTC",
  "resetLogsSCN" : "2510142",
  "oraHomeVersion" : "19.8.0.0.200714",
  "sqlPatches" : "31281355",
```

```

    "backupLogLoc" : "https://swiftobjectstorage.us-
ashburn-1.oraclecloud.com/v1/paasdevdbcssi/Bha_Backups/scaoda8s002-c/
database/3022438697/tdbasml/rmanlog/2020-10-22/
rman_backup_auto_2020-10-22_07-51-06.0546.log",
    "tdeWalletLoc" : "https://swiftobjectstorage.us-
ashburn-1.oraclecloud.com/v1/paasdevdbcssi/TestLtBackupFailur/scaoda8s002-
c/database/3022438697/tdbasml/tdewallet/
ewallet_2020102207525186_tdbasml.p12",
    "dbConfigLoc" : "https://swiftobjectstorage.us-
ashburn-1.oraclecloud.com/v1/paasdevdbcssi/Bha_Backups/scaoda8s002-c/
database/3022438697/tdbasml/dbconfig/2020-10-22/
DBCONFIG_auto_2020-10-22_07-52-43.0230.tar.gz",
    "name" : "Backup_Report_tdbasml",
    "createTime" : "October 22, 2020 07:51:03 AM UTC",
    "state" : {
        "status" : "CONFIGURED"
    },
    "updatedAt" : "October 22, 2020 07:52:55 AM UTC",
    "backupReportLogDetail" : "https://swiftobjectstorage.us-
ashburn-1.oraclecloud.com/v1/paasdevdbcssi/Bha_Backups/scaoda8s002-c/
database/3022438697/tdbasml/rmandetaillogreport/2020-10-22/
rman_list_backup_detail_auto_2020-10-22_07-52-33.0919.log",
    "dbInfo" : {
        "dbClass" : "OLTP",
        "dbType" : "SI",
        "dbShape" : "odbl",
        "dbEdition" : "EE",
        "dbStorage" : "ASM",
        "dbRedundancy" : null,
        "pdbName" : null,
        "isCdb" : false
    },
    "dbDataSize" : "1662M",
    "dbRedoSize" : "12298M",
    "rmanBackupPieces" : "https://swiftobjectstorage.us-
ashburn-1.oraclecloud.com/v1/paasdevdbcssi/Bha_Backups/scaoda8s002-c/
database/3022438697/tdbasml/backuppieces/2020-10-22/
backupPieces_auto_4903d18a-6c20-4860-9ed0-
d2ea7bd3d7b9_20201022075238.json",
    "compressionAlgo" : "MEDIUM",
    "cpuPool" : null,
    "numberOfCores" : null
}

```

3. To recover from a backup report, based on SCN, identify the database ID and the backup report for recovery.

In the following example, the JSON input file for the backup report is `backupreport.json`.

```

# odacli recover-database -i b5fc646e-01a6-4c8b-8286-7633346c4 -br
backupreport.json

```

- To recover based on PITR, identify the database ID and the date and time stamp for recovery.

```
# odacli recover-database -i b5fc646e-01a6-4c8b-8286-7633346c4 -t PITR -r
01/08/2018 12:57:33
```

- To recover based on SCN, identify the database ID and the SCN number.

```
# odacli recover-database -i b5fc646e-01a6-4c8b-8286-7633346c4 -t SCN -s
392375947
```

- To recover based on the latest backup, identify the database ID and use the Latest option.

```
# odacli recover-database -i b5fc646e-01a6-4c8b-8286-7633346c4 -t Latest
```

- Validate that the job completed. You can track the job in the **Activity** tab in the Browser User Interface, or run the command `odacli describe-job` with the job ID.

```
# odacli describe-job -i jobId
```

When the job completes successfully, the recovery is complete.

Note:

Use the `-p` option only if the database backup is encrypted using the RMAN backup password. The `-p` option is not applicable for TDE-enabled databases.

Restoring a Database with the CLI

You can restore a database to a system from Oracle Object Storage or NFS backup location using a backup report and the command-line interface.

When you restore a database, environment and validation checks and setup tasks are performed. Restoring a database requires a number of tasks and configuration details, such as creating database storage, Oracle Home, recreating the control file, registering the database, and establishing RMAN restore and recovery. An Oracle Database Appliance backup report is generated for each backup and contains the metadata required to restore a database. The report is designed to help you to quickly and efficiently restore a database.

You can restore a database from one appliance to another appliance, or to the same appliance when the source database is deleted:

- To restore to a different system, copy the backup report generated by the command `odacli create-backup` to any folder on the other machine and use the command `odacli irestore-database` with the backup report. You must provide the complete location of the backup report when you run the command `odacli irestore-database`.
- To restore to the same system, delete the source database and use the backup report generated by the command `odacli create-backup`.

To restore a database from Object Store backup, the backup report corresponding to that backup must be present in the target system. Also an ObjectStoreSwift object with the credential that can access the Object Store backup must be created and specified while restoring the database.

 **Note:**

For Standard Edition Oracle Database 19c or later, you cannot restore Oracle RAC or Oracle RAC One Node Database.

Follow these steps to restore a database using the command-line (CLI):

1. Display a list of backup reports and locate the latest Backup Report in Oracle Object Storage or NFS for the database and save the Backup Report ID.

```
# odacli list-backupreports
```

2. Use the Backup Report ID to display the details of the latest Backup Report.

```
# odacli describe-backupreport -i 7fbb06bf-e3a3-4aed-b617-4d1cd3d33387
{
  "id" : "7fbb06bf-e3a3-4aed-b617-4d1cd3d33387",
  "dbResId" : "4903d18a-6c20-4860-9ed0-d2ea7bd3d7b9",
  "tag" : "auto",
  "dbId" : "3022438697",
  "dbName" : "tdbasml",
  "dbUniqueName" : "tdbasml",
  "backupType" : "regular-10",
  "keepDays" : null,
  "backupLocation" : "https://swiftobjectstorage.us-ashburn-1.oraclecloud.com/v1/paasdevdbcssi/Bha_Backups",
  "cfBackupHandle" : "c-3022438697-20201022-03",
  "spfBackupHandle" : "c-3022438697-20201022-03",
  "pitrTimeStamp" : "October 22, 2020 07:51:59 AM UTC",
  "pitrSCN" : "2549429",
  "resetLogsTimeStamp" : "October 22, 2020 05:23:56 AM UTC",
  "resetLogsSCN" : "2510142",
  "oraHomeVersion" : "19.8.0.0.200714",
  "sqlPatches" : "31281355",
  "backupLogLoc" : "https://swiftobjectstorage.us-ashburn-1.oraclecloud.com/v1/paasdevdbcssi/Bha_Backups/scaoda8s002-c/database/3022438697/tdbasml/rmanlog/2020-10-22/rman_backup_auto_2020-10-22_07-51-06.0546.log",
  "tdewalletLoc" : "https://swiftobjectstorage.us-ashburn-1.oraclecloud.com/v1/paasdevdbcssi/TestLtBackupFailur/scaoda8s002-c/database/3022438697/tdbasml/tdewallet/ewallet_2020102207525186_tdbasml.p12",
  "dbConfigLoc" : "https://swiftobjectstorage.us-ashburn-1.oraclecloud.com/v1/paasdevdbcssi/Bha_Backups/scaoda8s002-c/database/3022438697/tdbasml/dbconfig/2020-10-22/DBCONFIG_auto_2020-10-22_07-52-43.0230.tar.gz",
  "name" : "Backup_Report_tdbasml",
  "createTime" : "October 22, 2020 07:51:03 AM UTC",
  "state" : {
    "status" : "CONFIGURED"
  },
  "updatedAtTime" : "October 22, 2020 07:52:55 AM UTC",
  "backupReportLogDetail" : "https://swiftobjectstorage.us-ashburn-1.oraclecloud.com/v1/paasdevdbcssi/Bha_Backups/scaoda8s002-c/"
}
```

```

database/3022438697/tdbasml/rmandetaillogreport/2020-10-22/
rman_list_backup_detail_auto_2020-10-22_07-52-33.0919.log",
  "dbInfo" : {
    "dbClass" : "OLTP",
    "dbType" : "SI",
    "dbShape" : "odb1",
    "dbEdition" : "EE",
    "dbStorage" : "ASM",
    "dbRedundancy" : null,
    "pdbName" : null,
    "isCdb" : false
  },
  "dbDataSize" : "1662M",
  "dbRedoSize" : "12298M",
  "rmanBackupPieces" : "https://swiftobjectstorage.us-
ashburn-1.oraclecloud.com/v1/paasdevdbcssi/Bha_Backups/scaoda8s002-c/
database/3022438697/tdbasml/backuppieces/2020-10-22/
backupPieces_auto_4903d18a-6c20-4860-9ed0-
d2ea7bd3d7b9_20201022075238.json",
  "compressionAlgo" : "MEDIUM",
  "cpuPool" : null,
  "numberOfCores" : null
}

```

3. (Optional) If you need to generate a new backup report, use the command `odacli create-backup`.

```
# odacli create-backup
```

4. Locate the Swift Object Store credential ID for the database backup.

```
# odacli list-objectstoreswifts
```

5. Save the backup report from Step 2, as a JSON file in any directory on the appliance. For example, `backupreport.json`.

6. Restore the database to the system using the JSON file in the command `odacli irestore-database`. You must specify the absolute path to the JSON file.

Run the command, then enter the SYS user password when prompted.

```
# odacli irestore-database -r backupreport.json -oid Object Store ID
```

To restore a TDE-enabled database, the TDE wallet password must be provided. You must specify the `-t` option in the command `odacli irestore-database`. If source database is TDE enabled, then the target database which was restored will also have TDE enabled.

7. Validate that the job completed. You can track the job in the **Activity** tab in the Browser User Interface, or run the command `odacli describe-job` with the job ID.

```
# odacli describe-job -i jobId
```

Restoring Archivelog with the CLI

You can restore archivelog from one SCN to another SCN, or from one timestamp to another timestamp using the command-line interface.

Follow these steps to restore archivelog using the command-line (CLI):

- Restore archivelog from one SCN to another SCN, or from one timestamp to another timestamp:

```
# odacli restore-archivelog -fs from_scn -ts to_scn
# odacli restore-archivelog -ft from_timestamp -tt to_timestamp
```

Deleting Backups with the CLI

Delete older, obsolete level 0, level 1, archive log, and long term backups along with obsolete backup reports.

For level 0, level 1, and archive log backups, the recovery window defined in the Backup Configuration determines when the backup is obsolete. The ranges are as follows:

- Backup to disk: between 1 and 14 days
- Backup to the Oracle Object Storage: between 1 and 31 days

For Long Term backups to the Oracle Object Storage or NFS, view the `keepDays` attribute of the Backup Report for a database to determine when the backup is obsolete. To delete Long Term Backup, the Database Resource ID or Database name and the Backup Report are required.

Follow these steps to delete database backups using `odacli` commands:

1. Display a list of all backup reports.

```
# odacli list-backupreports
```

2. Obtain the Database ID and type of backup.

```
# odacli describe-backupreport -i Backup Report ID
```

3. To delete obsolete level 0, level 1, and archivelog backups along with obsolete backup reports, use the Database ID or Database Name to delete the backup.

```
# odacli delete-backup -i 20576eb1-bc32-4e34-bf97-fda0b60ca15b
```

4. To delete Long Term backups, use the Backup Report from the JSON file to delete the backup.

In the following example, the JSON input file for the backup report is `backupreport.json`.

```
# odacli delete-backup -i 20576eb1-bc32-4e34-bf97-fda0b60ca15b -br
backupreport.json
```

13

Using Oracle Data Guard for Disaster Management and Recovery on Oracle Database Appliance

Understand how you can use Oracle Data Guard for disaster management and recovery on Oracle Database Appliance.

- [About Oracle Data Guard on Oracle Database Appliance](#)
Oracle Database Appliance provides client interface through ODA CLI commands and BUI for easy configuration and management of Oracle Data Guard for high availability, data protection, and disaster recovery.
- [Deploying Multiple Standby Databases with Oracle Data Guard on Oracle Database Appliance](#)
In this release, Oracle Database Appliance supports Oracle Data Guard configuration with multiple standby databases.
- [Configuring Oracle Data Guard on Oracle Database Appliance](#)
Oracle Database Appliance enables you to set up Oracle Data Guard using ODA CLI commands.
- [Configuring Oracle Data Guard on Oracle Database Appliance Using BUI](#)
Oracle Database Appliance enables you to set up Oracle Data Guard using BUI.
- [Viewing Oracle Data Guard Status on Oracle Database Appliance](#)
View Oracle Data Guard status using ODA CLI commands.
- [Viewing Oracle Data Guard Status on Oracle Database Appliance Using BUI](#)
View Oracle Data Guard status using BUI.
- [Performing Oracle Data Guard Operations](#)
Perform failover, switchover, and reinstate operations on Oracle Data Guard using ODA CLI commands.
- [Performing Oracle Data Guard Operations Using BUI](#)
Perform failover, switchover, and reinstate operations on Oracle Data Guard using BUI.
- [Creating an Oracle Data Guard Network](#)
Create an Oracle Data Guard network and associate it with a database using ODA CLI commands.
- [Migrating an Oracle Database from One System to Another Using Integrated Oracle Data Guard](#)
Understand how you can use Integrated Oracle Data Guard to migrate an Oracle Database from one system to another.
- [Patching Oracle Data Guard Databases on Oracle Database Appliance](#)
Understand how you can patch primary and standby databases on Oracle Data Guard using ODA CLI commands.
- [Enabling Oracle Active Data Guard on Existing Configurations](#)
Understand how you can enable Oracle Active Data Guard on existing configurations.

- [Registering Oracle Data Guard on Oracle Database Appliance Using ODACL CLI Commands](#)
Oracle Database Appliance enables you to migrate Oracle Data Guard configuration that were manually configured, and register the configuration metadata with Oracle Database Appliance using ODACL CLI commands.
- [Registering Oracle Data Guard on Oracle Database Appliance Using BUI](#)
Oracle Database Appliance enables you to migrate Oracle Data Guard configuration that were manually configured, and register the configuration metadata with Oracle Database Appliance using BUI.
- [Deconfiguring Oracle Data Guard on Oracle Database Appliance](#)
Deconfigure Oracle Data Guard status using ODACL CLI commands.
- [Deconfiguring Oracle Data Guard on Oracle Database Appliance Using BUI](#)
Deconfigure Oracle Data Guard status using BUI.

About Oracle Data Guard on Oracle Database Appliance

Oracle Database Appliance provides client interface through ODACL CLI commands and BUI for easy configuration and management of Oracle Data Guard for high availability, data protection, and disaster recovery.

Oracle Data Guard provides a comprehensive set of services that create, maintain, manage, and monitor one or more standby databases to enable production Oracle databases to survive disasters and data corruptions. Oracle Data Guard maintains these standby databases as copies of the production database. Then, if the production database becomes unavailable because of a planned or an unplanned outage, Oracle Data Guard can switch any standby database to the production role, minimizing the downtime associated with the outage. Oracle Data Guard can be used with traditional backup, restoration, and cluster techniques to provide a high level of data protection and data availability. Oracle Data Guard transport services are also used by other Oracle features such as Oracle Streams and Oracle GoldenGate for efficient and reliable transmission of redo from a source database to one or more remote destinations.

With Oracle Data Guard, administrators can optionally improve production database performance by offloading resource-intensive backup and reporting operations to standby systems.

The ability to create clone databases on a standby system enables you to set up test or development environments based on your standby databases. Since standby systems are not production systems, they are a better choice for seeding test or development environments.



Note:

Oracle Database Enterprise Edition includes Oracle Data Guard.

Deploying Multiple Standby Databases with Oracle Data Guard on Oracle Database Appliance

In this release, Oracle Database Appliance supports Oracle Data Guard configuration with multiple standby databases.

Prerequisites for deploying multiple standby databases with Oracle Data Guard configuration

- Primary and standby databases must be on different Oracle Database Appliance systems.
- For multiple standby configuration, you must deploy three Oracle Database Appliance DB systems.
- You can deploy multiple standby databases by providing the values in the `odacli configure-dataguard` command or through JSON file.

Note:

In this release, you can configure a maximum of two standby databases with Oracle Data Guard configuration.

Note:

You can only configure all standby databases at the time of Oracle Data Guard configuration, that is, when you run the `odacli configure-dataguard` command. You cannot configure additional standby databases later.

Configuring Oracle Data Guard on Oracle Database Appliance

Oracle Database Appliance enables you to set up Oracle Data Guard using ODACLI commands.

Prerequisites for Oracle Database Guard Configuration

Before you begin:

- Oracle recommends running the primary and the standby databases on separate Oracle Database Appliance hardware, so ensure that you have at least two separate Oracle Database Appliance machines.
- Oracle recommends that the primary and standby systems have the same Oracle Database Appliance configuration. The database must have identical configuration for database version and storage, that is, they must have either Oracle ASM or Oracle ACFS storage, to avoid any unpredictability with the database switch roles.
- The primary and standby systems must be the same Oracle Database Appliance release, and must be on Oracle Database Appliance release 19.22 or later.
- If you have customized the operating system, then ensure that environments on the systems are identical.

- Ensure that your deployment follows Oracle Maximum Availability Architecture (MAA) best practices. See the Oracle Maximum Availability Architecture (MAA) page on Oracle Technology Network.
- If you decide to use Oracle ObjectStore for backup and recovery, then you must configure access for the primary and standby systems.

Setting up Backup and Recovery for Oracle Database Guard Configuration

You can use either Object Store or External FRA (NFS) to set up the backup for primary and standby databases when configuring Oracle Data Guard on Oracle Database Appliance. A backup is necessary to instantiate a standby database.

To set up Object Store backup (recommended):

1. Configure the agent proxy settings:

```
# odacli modify-agentconfig-parameters -n HttpProxyHost -v www-  
proxy.test.com -n HttpProxyPort -v 80 -u
```

For more information, see the topic *Configuring Agent Proxy Settings for Object Store Access* in this guide.

2. Create the Object Store credentials on both primary and standby systems:

```
# odacli create-objectstoreswift -e swift_end_point_URL -n Object  
Store_Swift_name -t Object_Store_tenant_name -u Object_Store_user_name
```

For example:

```
# odacli create-objectstoreswift -e https://swiftobjectstorage.us-  
ashburn-1.oraclecloud.com/v1 -n aaa -t test_user -u testuser
```

3. View the Object Store Swift name:

```
# odacli list-objectstoreswifts
```

4. Create the backup configuration:

```
# odacli create-backupconfig -d objectstore -c testuser -on aaa -w 7 -cr -  
n backupConfig7days
```

5. Associate the backup configuration with the database:

```
# odacli modify-database -n test_db -bin backupConfig7days -bp
```

To set up NFS backup:

1. Create the backup configuration. For high-availability deployments, run the command on one node only.

```
# odacli create-backupconfig -n nfsbkup -w 10 -d NFS -c /u01/nfs_backup
```

2. Associate the backup configuration with the database:

```
# odacli modify-database -n test_db -bin nfsbkup
```

Configuring Oracle Data Guard using ODACLI commands

Follow these steps:

1. Take a backup of your primary database to Object Store or External FRA (NFS).

```
# odacli create-backup --backupType Regular-L0 -n primary_DB
```

For example:

```
# odacli create-backup --backupType Regular-L0 -n test_db
```

2. Save the backup report:

```
# odacli describe-backupreport -i eba406c7-ae46-4d1d-a1e5-3e985397b171 >
backup_report_test_db_0620.json
```

The backup report ID is the ID of the backup created in step 1 and can be obtained by running the `odacli list-backupreports` command.

3. Copy the backup report to the standby system and restore the backup to a standby database. Note that to create a database with role as standby in an Oracle Data Guard configuration on Oracle Database Appliance, you do not need to copy the wallet of the primary database when using Oracle Key Vault keystore for TDE-enabled databases. The same wallet can be specified in the `odacli irestore-database` command.

```
# odacli irestore-database -ro STANDBY
```

If you want to use Object Store, then specify the Object Store location:

```
# odacli irestore-database -r backup_report.json -u dbUniqueName -on
objectStoreName -bp -ro STANDBY
Rman Backup Encryption Password(s). Multiple passwords needs to be comma
separated.:
Password for SYS user:
```

In the above command, specify the `dbUniqueName` of the standby system.

```
odacli irestore-database -r backup_report.json -u dbUniqueName -ro STANDBY
Password for SYS user:
```

4. Configure Oracle Data Guard, by running the `odacli configure-dataguard` command on the primary system. Provide the values for your configuration through the interactive command line interface.

In the interactive CLI configuration steps, the parameters are as follows:

- Standby site address is IP address or host name of the standby host. Provide the fully qualified domain name and hostname if the primary and the standby systems are in the same domain and DNS is configured.
- You can specify multiple standby databases.

- For multiple standby databases, on non-multi user access enabled systems, retain the default user name as `oda-admin`. Specify the BUI password for `oda-admin` user and operating system password for the `root` user when prompted.

```
# odacli configure-dataguard
Number of standby databases (enter 1 or 2 | default: 1): 2
Standby 1 site address: standby1
BUI username for Standby site standby. If Multi-user Access/Multi-user
Access Passwordless is not enabled on Standby site standby1, enter
'oda-admin'; otherwise, enter the name of the user who has irestored
the Standby
database (default: oda-admin):
BUI password for Standby site standby1:
Password for root user on Standby site standby1:
Standby 2 site address: standby2
BUI username for Standby site standby2. If Multi-user Access/Multi-user
Access Passwordless is not enabled on Standby site standby2, enter
'oda-admin'; otherwise, enter the name of the user who has irestored
the Standby
database (default: oda-admin):
BUI password for Standby site standby2:
Password for root user on Standby site standby2:
```

- For multiple standby databases, on multi-user access enabled systems, specify the user name who has irestored the standby database. Specify the BUI password of the same user when prompted.

```
# odacli configure-dataguard
Number of standby databases (enter 1 or 2 | default: 1): 2
Standby 1 site address: standby1
BUI username for Standby site standby1. If Multi-user Access/Multi-user
Access
Passwordless is not enabled on Standby site standby1, enter 'oda-
admin'; otherwise, enter the name of the user who has irestored the
Standby database (default: oda-admin): u1
BUI password for Standby site standby1. If Multi-user Access
Passwordless is enabled on
Standby site, copy the cwallet.sso file from Standby site
(/opt/oracle/dcs/conf/dcspublickey_wallet/) to Primary site (/root/).
Rename the file to 'cwallet.sso.standby1', set the file ownership
(root:root) and file permission (0440) and then press enter:
Standby 2 site address: standby2
BUI username for Standby
site standby2. If Multi-user Access/Multi-user Access
Passwordless is not enabled on Standby site standby2, enter 'oda-
admin'; otherwise, enter the name of the user who has irestored the
Standby database (default: oda-admin): usr1
BUI password for Standby
site standby2. If Multi-user Access Passwordless is enabled on
Standby site, copy the cwallet.sso file from Standby site
(/opt/oracle/dcs/conf/dcspublickey_wallet/) to Primary site (/root/).
Rename the file to 'cwallet.sso.standby2', set the file ownership
(root:root) and file permission (0440) and then press enter:
```

- For multiple standby databases, on multi-user access passwordless systems, specify the user name who has restored the standby database. You are prompted to copy the wallet, follow the instructions in the interactive command flow.

```
# odacli configure-dataguard
Number of standby databases (enter 1 or 2 | default: 1): 2
Standby 1 site address: standby1
BUI username for Standby
  site standby1. If Multi-user Access/Multi-user Access
Passwordless is not enabled on Standby site standby1, enter 'oda-
admin'; otherwise, enter the name of the user who has restored the
Standby database (default: oda-admin): ul
BUI password for Standby
  site standby1. If Multi-user Access Passwordless is enabled on
Standby site, copy the cwallet.sso file from Standby site
(/opt/oracle/dcs/conf/dcspublickey_wallet/) to Primary site (/root/).
Rename the file to 'cwallet.sso.standby1', set the file ownership
(root:root) and file permission (0440) and then press enter:
Standby 2 site address: standby2
BUI username for Standby
  site standby2. If Multi-user Access/Multi-user Access
Passwordless is not enabled on Standby site standby2, enter 'oda-
admin'; otherwise, enter the name of the user who has restored the
Standby database (default: oda-admin): usr1
BUI password for Standby
  site standby2. If Multi-user Access Passwordless is enabled on
Standby site, copy the cwallet.sso file from Standby site
(/opt/oracle/dcs/conf/dcspublickey_wallet/) to Primary site (/root/).
Rename the file to 'cwallet.sso.standby2', set the file ownership
(root:root) and file permission (0440) and then press enter:
```

- Select Oracle Data Guard protection modes to meet availability, performance and data protection requirements. Oracle Data Guard Protection Modes are Maximum Availability, Maximum Performance, and Maximum Protection. The log transport modes are ASYNC, SYNC, and FASTSYNC. You can select the following combinations of protection modes and transport types:

Table 13-1 Oracle Data Guard protection modes and transport modes

| Protection Mode \ Transport Type | ASYNC | FASTSYNC** | SYNC |
|----------------------------------|-------|------------|------|
| MAXPERFORMANCE | Y* | Y | Y |
| MAXAVAILABILITY | N | Y | Y* |
| MAXPROTECTION | N | N | Y* |

* in the table indicates the default supported pair and ** FASTSYNC mode is available only in Oracle Database 12.1 or later.

Example with one standby configuration:

```
# odacli configure-dataguard
# /opt/oracle/dcs/bin/odacli configure-dataguard
Number of standby databases (enter 1 or 2 | default: 1):
Standby 1 site address: phxdbfzp04.dev3farm3phx.databasede3phx
BUI username for Standby site host1. If Multi-user Access/Multi-user
```



```

Access Passwordless is not enabled on Standby site
phxdbfzp04.dev3farm3phx.databasede3phx, enter 'oda-admin'; otherwise,
enter the name of the user who has restored the Standby database
(default: oda-admin): oda-admin
BUI password for Standby site host2:
Password for root user on Standby site host2:

*****
*****
Data Guard configuration name: tdb_dg
Database name for Data Guard configuration: tdb
Primary database SYS password:
Protection mode [MAX_PROTECTION, MAX_PERFORMANCE, MAX_AVAILABILITY]
(default: MAX_PERFORMANCE):
Enable Active Data Guard (Y/N, default:N):
*****
*****

Data Guard default settings for standby database - tdbstandby
Primary site network for Data Guard configuration: Public-network
Standby site network for Data Guard configuration: Public-network
Primary database listener port (TCP): 1521
Standby database listener port (TCP): 1521
Transport type: ASYNC
Do you want to edit this Data Guard configuration? (Y/N, default:N): N
*****
*****

Enter Primary database RMAN backup encryption password if any:
Do you want to provide another Primary database RMAN backup encryption
password if any? [y/n] (default 'n'):
Standby database's SYS password will be set to Primary database's after
Data Guard configuration. Ignore warning and proceed with Data Guard
configuration? (Y/N, default:N): Y
{
  "jobId" : "e02cc0b3-bce3-4d6c-alf5-5b121bb7f66a",
  "status" : "Created",
  "message" : "",
  "reports" : [ ],
  "createTimestamp" : "January 23, 2025 03:12:44 AM UTC",
  "resourceList" : [ ],
  "description" : "DG Config service for DB tdb",
  "updatedAt" : "January 23, 2025 03:12:44 AM UTC",
  "jobType" : null,
  "cpsMetadata" : null
}

[root@host1 work]# /opt/oracle/dcs/bin/odacli describe-job -i e02cc0b3-
bce3-4d6c-alf5-5b121bb7f66a

Job details
-----
                ID: e02cc0b3-bce3-4d6c-alf5-5b121bb7f66a
Description:    DG Config service for DB tdb
                Status: Success
                Created: January 23, 2025 03:12:44 UTC
                Message:

```

```

Task Name                               Start
Time                                     End
Time                                     Status
-----
-----
-----
Validate configure primary request       January 23, 2025 03:13:10
UTC                                     January 23, 2025 03:13:21 UTC          Success
(Primary site) (Host:
host1/Job

ID:

901389f5-0cad-4ee6-91be-3f77b85652af)

Validate configure standby request       January 23, 2025 03:13:21
UTC                                     January 23, 2025 03:13:29 UTC          Success
(Standby site)
(Host:

host2/Job
ID:

856d86e4-dd51-41a7-9050-
b0c39ae771f9)

Uploading Primary DB Password File     January 23, 2025 03:13:29
UTC                                     January 23, 2025 03:13:52 UTC          Success
(Standby
site)

Configure primary database (Primary     January 23, 2025 03:13:52
UTC                                     January 23, 2025 03:15:29 UTC          Success
site) (Host: host1/Job
ID:

5dd46e86-
e07f-423f-9ebf-2515b4ac17d5)

Configure standby request (Standby     January 23, 2025 03:15:29
UTC                                     January 23, 2025 03:17:30 UTC          Success
site)
(Host:

host2/Job
ID:

2ab511a2-15c0-4371-
bf30-9b7e27ff5288)

Create archive log restore (Primary     January 23, 2025 03:17:30
UTC                                     January 23, 2025 03:17:52 UTC          Success
site) (Host: host1/Job
ID:

```

96766874-6537-4972-81a9-971440e2acfb)

```
Configure and enable Data Guard          January 23, 2025 03:17:53
UTC          January 23, 2025 03:19:19 UTC          Success
(Primary site) (Host:
host1/Job
```

ID:

7ad65ffa-ea06-479d-bb21-
e0b81fb8c743)

```
Enable Flashback (Standby site) (Host:   January 23, 2025 03:19:19
UTC          January 23, 2025 03:19:38 UTC          Success
host2/Job
```

ID:

a1768703-4dd4-4f1f-
b9a3-9fe0f99615d5)

```
Re-enable Data Guard (Primary site)      January 23, 2025 03:19:38
UTC          January 23, 2025 03:19:44 UTC          Success
(Host: host1/Job
```

ID:

3f6dd276-63e3-4804-a179-
e10052386206)

```
Create Data Guard status (Primary       January 23, 2025 03:19:44
UTC          January 23, 2025 03:19:49 UTC          Success
site) (Host: host1/Job
```

ID:

8a3eb946-3501-4618-9d4a-
ad8a6d298cc8)

```
Create Data Guard status (Standby      January 23, 2025 03:19:49
UTC          January 23, 2025 03:19:57 UTC          Success
site)
```

(Host:

host2/Job

ID:

d9d65942-6284-40d5-a991-b1d21edae96f)

Example with two standby databases configuration:

```
# odacli configure-dataguard
Number of standby databases (enter 1 or 2 | default: 1): 2
Standby 1 site address: standby1
BUI username for Standby site standby1. If Multi-user Access/Multi-user
Access Passwordless is not enabled on Standby site standby1, enter
'oda-admin'; otherwise, enter the name of the user who has restored the
Standby
```

```
database (default: oda-admin):
BUI password for Standby site standby1:
Password for root user on Standby site standby1:
Standby 2 site address: standby2
BUI username for Standby site standby2. If Multi-user Access/Multi-user
Access Passwordless is not enabled on Standby site standby2, enter
'oda-admin'; otherwise, enter the name of the user who has restored the
Standby
database (default: oda-admin):
BUI password for Standby site standby2:
Password for root user on Standby site standby2:

*****
*****

Data Guard configuration name: dgbb
Database name for Data Guard configuration: bb
Primary database SYS password:
Protection mode [MAX_PROTECTION, MAX_PERFORMANCE, MAX_AVAILABILITY]
(default:
MAX_PERFORMANCE):
Enable Active Data Guard (Y/N, default:N):
*****
*****

Data Guard default settings for standby database - bb1
Primary site network for Data Guard configuration: Public-network
Standby site network for Data Guard configuration: Public-network
Primary database listener port (TCP): 1521
Standby database listener port (TCP): 1521
Transport type: ASYNC
Do you want to edit this Data Guard configuration? (Y/N, default:N):

Data Guard default settings for standby database - bb2
Primary site network for Data Guard configuration: Public-network
Standby site network for Data Guard configuration: Public-network
Primary database listener port (TCP): 1521
Standby database listener port (TCP): 1521
Transport type: ASYNC
Do you want to edit this Data Guard configuration? (Y/N, default:N):
Warning: in compliance with Oracle MAA best practices. DbType (RAC) of
Primary
database bb is different from DbType (SI) of Standby database. Ignore
warning
and proceed with Data Guard configuration? (Y/N, default:N): y
Warning: in compliance with Oracle MAA best practices. DbType (RAC) of
Primary
database bb is different from DbType (SI) of Standby database. Ignore
warning
and proceed with Data Guard configuration? (Y/N, default:N): y
*****
*****

Enter Primary database RMAN backup encryption password if any:
Do you want to provide another Primary database RMAN backup encryption
password
if any? [y/n] (default 'n'):
Standby database's SYS password will be set to Primary database's after
```

```
Data
Guard configuration. Ignore warning and proceed with Data Guard
configuration?
```

```
(Y/N, default:N): y
{
  "jobId" : "f1df87d7-221c-4dc3-a15f-fa35d91560f5",
  "status" : "Created",
  "message" : "",
  "reports" : [ ],
  "createTimestamp" : "January 17, 2025 22:57:55 PM UTC",
  "resourceList" : [ ],
  "description" : "DG Config service for DB bb",
  "updatedAt" : "January 17, 2025 22:57:55 PM UTC",
  "jobType" : null,
  "cpsMetadata" : null
}
```

```
[root@host1 ~]# odacli describe-job -i
"f1df87d7-221c-4dc3-a15f-fa35d91560f5"
```

Job details

```
-----
                ID: f1df87d7-221c-4dc3-a15f-fa35d91560f5
Description: DG Config service for DB bb
      Status: Success
      Created: January 17, 2025 22:57:55 UTC
      Message:

Task Name                               Node Name                               Start
Time  End Time                           Status
-----
-----
Validate configure primary request       host1                                     January 17,2025
22:58:38 UTC                             January 17, 2025 22:58:44 UTC             Success

(Primary site) (Host:host1/Job
ID:
eb8bbb43-159c-48e0-8dda-9e2bbd280669)

Validate configure standby request       host1                                     January 17,2025
22:58:44 UTC                             January 17, 2025 22:58:52 UTC             Success
(Standby site) (Host: standby1/Job
ID:
86345f35-500c-4ba8-8ff9-
f97c201ad3c7)

Uploading Primary DB Password File       host1                                     January 17,2025
22:58:52 UTC                             January 17, 2025 22:59:07 UTC             Success
(Standby
site)

Configure primary database (Primary       host1                                     January 17,2025
```

```

22:59:07 UTC          January 17, 2025 22:59:58 UTC          Success
site) (Host: host1/Job ID:
23ee7263-a59e-40bd-
bbec-4c17a5d4ba99)

Configure standby request (Standby      host1      January 17,2025
22:59:58 UTC          January 17, 2025 23:02:00 UTC          Success
site) (Host: standby1/Job
ID:
af543839-85ba-4e83-89d3-
af161d528256)

Create archive log restore (Primary     host1      January 17,2025
23:02:00 UTC          January 17, 2025 23:02:37 UTC          Success
site) (Host: host1/Job ID:
b2940217-cec6-4b22-92d2-
f4ec8f26b8b8)

Configure and enable Data Guard          host1      January 17,2025
23:02:37 UTC          January 17, 2025 23:04:19 UTC          Success
(Primary site)
(Host:
host1/Job ID:
7882e1e5-0d71-48df-bd86-
e79ee6b57a21)

Enable Flashback (Standby site) (Host:  host1      January 17,2025
23:04:19 UTC          January 17, 2025 23:04:37 UTC          Success
standby1/Job
ID:
c2ef962c-
f429-4e97-8bc3-1355cd7d0ca8)

Re-enable Data Guard (Primary site)     host1      January 17,2025
23:04:37 UTC          January 17, 2025 23:04:43 UTC          Success
(Host: host1/Job ID:
fb4a7055-0049-4d44-
a726-0871ed54ca07)

Create Data Guard status (Primary       host1      January 17,2025
23:04:43 UTC          January 17, 2025 23:04:54 UTC          Success
site) (Host: host1/Job ID:
5aca5c16-632f-488b-
aade-1c677030c81d)

Create Data Guard status (Standby       host1      January 17,2025
23:04:54 UTC          January 17, 2025 23:05:07 UTC          Success
site) (Host: standby1/Job
ID:
5f0c5460-4c38-4aed-8a5b-
e70c0ca70df8)

Validate configure primary request      host1      January 17,2025
23:05:07 UTC          January 17, 2025 23:05:13 UTC          Success

```

```

(Primary site) (Host:host1/Job
ID:
5ac64b32-5da6-48df-
b8cc-020853363695)

Validate configure standby request      host1      January 17,2025
23:05:13 UTC      January 17, 2025 23:05:21 UTC      Success
(Standby site) (Host: standby2/Job
ID:

81aa6900-4460-408e-9ab2-
fdcd92c8b7bf)

Uploading Primary DB Password File      host1      January 17,2025
23:05:21 UTC      January 17, 2025 23:05:32 UTC      Success
(Standby
site)

Configure primary database (Primary      host1      January 17,2025
23:05:32 UTC      January 17, 2025 23:06:14 UTC      Success
site) (Host: host1/Job ID:
c78a8072-8023-4278-
bd94-3dd1ef97e066)

Configure standby request (Standby      host1      January 17,2025
23:06:14 UTC      January 17, 2025 23:07:43 UTC      Success
site) (Host: standby2/Job
ID:
46274a35-bb06-43a9-
a8a5-66dc4d163463)

Create archive log restore (Primary      host1      January 17,2025
23:07:43 UTC      January 17, 2025 23:08:15 UTC      Success
site) (Host: host1/Job ID:
2b20aaa2-fcb7-4bc5-
b501-27ad9d45f34b)

Configure standby TNS entry (New      host1      January 17,2025
23:08:15 UTC      January 17, 2025 23:08:24 UTC      Success
standby site) (Host: standby2/Job
ID:

7e32db8c-999c-44fa-
bdf5-3aed77c9590c)

Configure standby TNS entry (Existing      host1      January 17,2025
23:08:24 UTC      January 17, 2025 23:08:28 UTC      Success
standby site) (Host: standby1/Job
ID:

6a44539e-d5b9-4c45-
ad2c-7bff8c871e37)

Add standby database (Primary site)      host1      January 17,2025
23:08:28 UTC      January 17, 2025 23:09:50 UTC      Success
(Host: host1/Job ID:

```

1d7c6c93-bd85-496a-
bb7d-67ae7b224d58)

```
Enable Flashback (Standby site) (Host: host1          January 17,2025
23:09:50 UTC          January 17, 2025 23:10:03 UTC          Success
standby2/Job
ID:
4a6b8623-
efc0-4016-80be-305b0ed56363)
```

```
Re-enable Data Guard (Primary site)          host1          January 17,2025
23:10:03 UTC          January 17, 2025 23:10:09 UTC          Success
(Host: host1/Job ID:
2afea759-752a-42a4-a077-
bd85d4b687a3)
```

```
Update Data Guard status (Primary          host1          January 17,2025
23:10:09 UTC          January 17, 2025 23:10:35 UTC          Success
site) (Host: host1/Job ID:
11d93988-ea4d-4e37-
af30-763c2522693d)
```

```
Create Data Guard status (New standby          host1          January 17,2025
23:10:35 UTC          January 17, 2025 23:10:53 UTC          Success
site) (Host: standby2/Job ID:
aa5b286f-30f1-48d1-8c2d-2490d15ce408)
```

```
Update Data Guard status (Existing host1          January 17,2025 23:10:53
UTC          January 17, 2025 23:11:06 UTC          Success
standby site) (Host: standby1/JobID:
7d8ffa16-6785-468a-bff9-baf8e13b38ec)
```

Example with Oracle Data Guard custom configuration:

```
# odacli configure-dataguard
Number of standby databases (enter 1 or 2 | default: 1): 2
Standby 1 site address: standby1
BUI username for Standby site standby1. If Multi-user Access/Multi-user
Access Passwordless is not enabled on Standby site standby1, enter 'oda-
admin'; otherwise, enter the name of the user who has irestored the
Standby database (default: oda-admin):
BUI password for Standby site standby1:
Password for root user on Standby site standby1:
Standby 2 site address: standby2
BUI username for Standby site standby2. If Multi-user Access/Multi-user
Access Passwordless is not enabled on Standby site standby2, enter 'oda-
admin'; otherwise, enter the name of the user who has irestored the
Standby database (default: oda-admin):
BUI password for Standby site standby2:
Password for root user on Standby site standby2:

Data Guard configuration name: dg6
Database name for Data Guard configuration: db
Primary database SYS password:
```



```

Protection mode [MAX_PROTECTION, MAX_PERFORMANCE, MAX_AVAILABILITY]
(default: MAX_PERFORMANCE): MAX_AVAILABILITY
Enable Active Data Guard? (Y/N, default:N): y
*****
*****
Data Guard default settings for standby database kdb
Primary site network for Data Guard configuration: Public-network
Standby site network for Data Guard configuration: Public-network
Primary database listener port (TCP): 1521
Standby database listener port (TCP): 1521
Transport type: ASYNC
Do you want to edit this Data Guard configuration? (Y/N, default:N): y
*****
*****
Primary site network for Data Guard configuration [Public-network]
(default: Public-network):
Standby site network for Data Guard configuration [Public-network]
(default: Public-network):
Primary database listener port (TCP) (default: 1521):
Standby database listener port (TCP) (default: 1521):
Transport type [ASYNC, FASTSYNC, SYNC] (default: ASYNC): SYNC
*****
*****
Data Guard default settings for standby database ldb
Primary site network for Data Guard configuration: Public-network
Standby site network for Data Guard configuration: Public-network
Primary database listener port (TCP): 1521
Standby database listener port (TCP): 1521
Transport type: ASYNC
Do you want to edit this Data Guard configuration? (Y/N, default:N): y
*****
*****
Primary site network for Data Guard configuration [Public-network]
(default: Public-network):
Standby site network for Data Guard configuration [Public-network]
(default: Public-network):
Primary database listener port (TCP) (default: 1521):
Standby database listener port (TCP) (default: 1521):
Transport type [ASYNC, FASTSYNC, SYNC] (default: ASYNC): SYNC
Enter Primary database RMAN backup encryption password if any:
Do you want to provide another Primary database RMAN backup encryption
password if any? [y/n] (default 'n'):
Standby database's SYS password will be set to Primary database's after
Data Guard configuration. Ignore warning and proceed with Data Guard
configuration? (Y/N, default:N): y
{
  "jobId" : "fcf23de7-3ef0-4dae-9a3c-735abf9bda4a",
  "status" : "Created",
  "message" : "",
  "reports" : [ ],
  "createTimestamp" : "December 13, 2024 01:58:53 AM CET",
  "resourceList" : [ ],
  "description" : "DG Config service for DB db",
  "updatedAt" : "December 13, 2024 01:58:53 AM CET",
  "jobType" : null,
  "cpsMetadata" : null
}
    
```

```

}

[root@test_host ~]# odacli describe-job -i
fcf23de7-3ef0-4dae-9a3c-735abf9bda4a

Job details
-----
                ID: fcf23de7-3ef0-4dae-9a3c-735abf9bda4a
Description:    DG Config service for DB db
                Status: Success
                Created: December 13, 2024 01:58:53 CET
                Message:

Task Name                               Start
Time                                     End
Time                                     Status
-----
-----
Validate configure primary request       December 13, 2024 02:01:18
CET                                     December 13, 2024 02:01:29 CET      Success
(Primary site)
(Host:

test_host/Job
ID:

cce1142e-24e4-4bbc-9d46-
f46f96bf3191)

Validate configure standby request       December 13, 2024 02:01:29
CET                                     December 13, 2024 02:01:45 CET      Success
(Standby site)
(Host:

standby1/Job
ID:

f962f6dc-4eeb-497f-9a0c-
b9387d25318b)

Uploading Primary DB Password File       December 13, 2024 02:01:45
CET                                     December 13, 2024 02:02:16 CET      Success
(Standby
site)

Configure primary database (Primary      December 13, 2024 02:02:16
CET                                     December 13, 2024 02:02:43 CET      Success
site) (Host: test_host/Job
ID:

0d909875-ecec-450a-
a2f9-6c09103d9f26)

Configure standby request (Standby       December 13, 2024 02:02:43
CET                                     December 13, 2024 02:04:11 CET      Success

```

```
site) (Host: standby1/Job
ID:

03ffc6b5-5f45-47af-b96c-
d75b82a09234)

Create archive log restore (Primary      December 13, 2024 02:04:11
CET          December 13, 2024 02:04:47 CET          Success
site) (Host: test_host/Job
ID:

49808676-bd12-4933-8c28-
eef7dee17503)

Configure and enable Data Guard          December 13, 2024 02:04:47
CET          December 13, 2024 02:06:32 CET          Success
(Primary site)
(Host:

test_host/Job
ID:

7ed03a2d-
bb93-4ff7-9e45-0f825c8fff2f)

Enable Flashback (Standby site) (Host:   December 13, 2024 02:06:32
CET          December 13, 2024 02:06:53 CET          Success
standby1/Job
ID:

dalee6fb-cfb3-4f6d-9eaa-
a6c1c8811d0e)

Re-enable Data Guard (Primary site)      December 13, 2024 02:06:53
CET          December 13, 2024 02:06:59 CET          Success
(Host: test_host/Job
ID:

f1b8f204-
da5b-40f4-886f-3dc2d0f71042)

Enable Active Data Guard (Standby        December 13, 2024 02:06:59
CET          December 13, 2024 02:07:26 CET          Success
site) (Host: standby1/Job
ID:

d5982a61-
b48d-4449-8cad-2eb41fc89ff9)

Create Data Guard status (Primary        December 13, 2024 02:07:26
CET          December 13, 2024 02:07:42 CET          Success
site) (Host: test_host/Job
ID:

e7b6448b-301d-45e5-9a90-4388ac6f55f6)
```

```
Create Data Guard status (Standby      December 13, 2024 02:07:42
CET          December 13, 2024 02:07:58 CET          Success
site) (Host: standby1/Job
ID:

b046c3ca-dcae-47c4-
b904-8fe8fb7cd166)

Validate configure primary request      December 13, 2024 02:07:59
CET          December 13, 2024 02:08:10 CET          Success
(Primary site)
(Host:

test_host/Job
ID:

f2cec30f-74ee-44e3-bbbc-
f6bc47bcc781)

Validate configure standby request      December 13, 2024 02:08:10
CET          December 13, 2024 02:08:26 CET          Success
(Standby site)
(Host:

standby2/Job
ID:

f170c64f-347b-4606-af31-
dbb4c0abaccf)

Uploading Primary DB Password File      December 13, 2024 02:08:26
CET          December 13, 2024 02:08:57 CET          Success
(Standby
site)

Configure primary database (Primary      December 13, 2024 02:08:57
CET          December 13, 2024 02:09:23 CET          Success
site) (Host: test_host/Job
ID:

f680835a-3813-433e-
bcc3-8d49ae235833)

Configure standby request (Standby      December 13, 2024 02:09:23
CET          December 13, 2024 02:11:02 CET          Success
site) (Host: standby2/Job
ID:

d66ef480-0810-4219-
a5e1-633be0d6fe9a)

Create archive log restore (Primary      December 13, 2024 02:11:03
CET          December 13, 2024 02:11:36 CET          Success
site) (Host: test_host/Job
ID:
```

ae4e5f3d-6792-44c4-8971-
df41ae212a04)

Configure standby TNS entry (New December 13, 2024 02:11:36
CET December 13, 2024 02:11:54 CET Success
standby site)
(Host:

standby2/Job
ID:

27bbe14a-6f7d-4a7f-
bde9d530327090f)

Configure standby TNS entry (Existing December 13, 2024 02:11:54
CET December 13, 2024 02:12:13 CET Success
standby site)
(Host:

standby1/Job
ID:

dcf53474-
d649-452f-818a-4fe069e9761e)

Add standby database (Primary site) December 13, 2024 02:12:13
CET December 13, 2024 02:13:38 CET Success
(Host: test_host/Job
ID:

2ffb36d8-74a0-4dc4-9f79-
cc74223f1016)

Enable Flashback (Standby site) (Host: December 13, 2024 02:13:38
CET December 13, 2024 02:14:00 CET Success
standby2/Job
ID:

01a23d42-
d49a-4b61-9c28-19e9f7639800)

Re-enable Data Guard (Primary site) December 13, 2024 02:14:00
CET December 13, 2024 02:14:06 CET Success
(Host: test_host/Job
ID:

f416981a-99c1-4c0a-
ab72-2bbb5a0e3a40)

Enable Active Data Guard (Standby December 13, 2024 02:14:06
CET December 13, 2024 02:14:32 CET Success
site) (Host: standby2/Job
ID:

99618fc7-0500-4275-8ea2-
f65a8b4e8f77)

```
Update Data Guard status (Primary      December 13, 2024 02:14:32
CET      December 13, 2024 02:14:48 CET      Success
site) (Host: test_host/Job
ID:
```

```
14b4526c-
eebe-410a-920e-396df5216c93)
```

```
Create Data Guard status (Standby     December 13, 2024 02:14:48
CET      December 13, 2024 02:15:15 CET      Success
site) (Host: standby2/Job
ID:
```

```
090f829d-7f80-4481-800c-
c9c6115a4be2)
```

```
Update Data Guard status (Old Standby  December 13, 2024 02:15:15
CET      December 13, 2024 02:15:31 CET      Success
site) (Host: standby1/Job
ID:
```

```
afc0a2b3-18ad-461c-a13d-ec688427c6e6)
```

You can specify a JSON file to configure Oracle Data Guard. Ensure that you specify the `databaseName` and `standbyEndpoints` options in the JSON file.

```
{
  "name": "tdb_DG",
  "protectionMode": "MAX_PERFORMANCE",
  "enableFlashback": true,
  "enableActiveDg": "false",
  "databaseName": "tdb",           ==> newly added mandatory field
  "replicationGroups": [
    {
      "sourceEndpoints": [
        {
          "endpointType": "PRIMARY",
          "hostName": "host_name",
          "listenerPort": 1521,
          "databaseUniqueName": "tdb",
          "ipAddress": "xx.xx.xx.xx" ==> VIP of the
corresponding network
        }
      ],
      "targetEndpoints": [
        {
          "endpointType": "STANDBY",
          "hostName": "host_name",
          "listenerPort": 1521,
          "databaseUniqueName": "tdbstndby",
          "ipAddress": "xx.xx.xx.xx"
        }
      ],
      "transportType": "SYNC"
```

```

    }
  ],
  "standbyEndpoints": [                               ==> newly added optional field
    {
      "name": "endpoint_test",
      "dcsUserName": "oda-admin"
    }
  ]
}

```

For more information about these command options, see the *Oracle Database Appliance Command Line Reference* chapter in this guide.

Configuring Oracle Data Guard with one standby database on Oracle Database Appliance using JSON file

```

# /opt/oracle/dcs/bin/odacli configure-dataguard --requestjson /mnt/host1/
nfsbackup/dgcmd.json
Number of standby databases (enter 1 or 2 | default: 1):
BUI password for Standby site standby1:
Password for root user on Standby site standby1:
Primary database SYS password:
*****
*****

```

Standby database's SYS password will be set to Primary database's after Data Guard configuration. Ignore warning and proceed with Data Guard configuration? (Y/N, default:N): Y

```

{
  "jobId" : "73adf616-3b6c-452f-bf93-e95abc675cc5",
  "status" : "Created",
  "message" : "",
  "reports" : [ ],
  "createTimestamp" : "January 23, 2025 05:08:50 AM UTC",
  "resourceList" : [ ],
  "description" : "DG Config service for DB tdb",
  "updatedAt" : "January 23, 2025 05:08:50 AM UTC",
  "jobType" : null,
  "cpsMetadata" : null
}

```

```

[root@host1 work]# /opt/oracle/dcs/bin/odacli describe-job -i
73adf616-3b6c-452f-bf93-e95abc675cc5

```

Job details

```

-----
ID: 73adf616-3b6c-452f-bf93-e95abc675cc5
Description: DG Config service for DB tdb
Status: Success
Created: January 23, 2025 05:08:50 UTC
Message:

```

```

Task Name                               Start
Time                                     End Time
Status
-----
-----

```

```
-----  
Validate configure primary request      January 23, 2025 05:09:19  
UTC          January 23, 2025 05:09:30 UTC          Success  
(Primary site) (Host:  
host1/Job  
  
ID:  
  
7bd1a3d5-2f8c-4d9e-  
a381-61d04f01b514)  
  
Validate configure standby request      January 23, 2025 05:09:30  
UTC          January 23, 2025 05:09:43 UTC          Success  
(Standby site)  
(Host:  
  
host2/Job  
ID:  
  
18731cf2-bf42-4a3a-  
b187-17e93cedbb7c)  
  
Uploading Primary DB Password File      January 23, 2025 05:09:43  
UTC          January 23, 2025 05:10:03 UTC          Success  
(Standby  
site)  
  
Configure primary database (Primary      January 23, 2025 05:10:03  
UTC          January 23, 2025 05:11:35 UTC          Success  
site) (Host: host1/Job  
ID:  
  
d3030fe0-8885-42d6-a57f-  
ae38baef54af)  
  
Configure standby request (Standby      January 23, 2025 05:11:35  
UTC          January 23, 2025 05:13:35 UTC          Success  
site)  
(Host:  
  
host2/Job  
ID:  
  
763881f4-ea4d-43bc-8e6a-  
c7f78765c0ff)  
  
Create archive log restore (Primary      January 23, 2025 05:13:35  
UTC          January 23, 2025 05:13:54 UTC          Success  
site) (Host: host1/Job  
ID:  
  
5dfbe653-10c8-420f-  
bada-4c0c8cb6a9e1)  
  
Configure and enable Data Guard          January 23, 2025 05:13:54  
UTC          January 23, 2025 05:15:26 UTC          Success
```



```

(Primary site) (Host:
host1/Job

ID:

137d29a2-9d2c-4ddc-85c8-3a729847e188)

Enable Flashback (Standby site) (Host: January 23, 2025 05:15:26
UTC January 23, 2025 05:15:44 UTC Success
host2/Job
ID:

70306983-40a2-4039-98cb-57ba5e11e9a5)

Re-enable Data Guard (Primary site) January 23, 2025 05:15:44
UTC January 23, 2025 05:15:50 UTC Success
(Host: host1/Job
ID:

4a5fb2aa-1b0b-45c8-
b2f3-95103c9f1f00)

Create Data Guard status (Primary January 23, 2025 05:15:50
UTC January 23, 2025 05:15:56 UTC Success
site) (Host: host1/Job
ID:

6848b9c1-356f-43ff-
b6e0-5e9b1b01fc53)

Create Data Guard status (Standby January 23, 2025 05:15:56
UTC January 23, 2025 05:16:09 UTC Success
site)
(Host:

host2/Job
ID:

3109148f-9ef8-4914-ab43-adab4851e126)

```

Example JSON for configuring Oracle Data Guard with two standby databases on Oracle Database Appliance

To configure two standby databases using JSON file, you must specify two `replicationGroups` sections, where `sourceEndpoints` corresponds to the information about the primary database and `targetEndPoints` in each `replicationGroups` section corresponds to each standby database. For example:

```

{
  "name": "dgname",
  "protectionMode": "MAX_PERFORMANCE",
  "databaseName": "vmdb1",
  "enableActiveDg": false,
  "databaseName": "tdb", ==> newly added field
  "standbyEndpoints": [ ==> newly added field
    {

```

```

        "name": "endpoint_test",
        "dcsUserName": "oda-admin"
    }
]
"replicationGroups": [
{
    "sourceEndPoints": [
        {
            "databaseUniqueName": "vmdb1",
            "ipAddress": "xx.xx.xx.xx",
            "hostName": "host_name",
            "listenerPort": 1521
        }
    ],
    "targetEndPoints": [
        {
            "databaseUniqueName": "bvmdb1",
            "ipAddress": "xx.xx.xx.xx",
            "hostName": "host_name",
            "listenerPort": 1521
        }
    ],
    "transportType": "ASYNC"
},
{
    "sourceEndPoints": [
        {
            "databaseUniqueName": "vmdb1",
            "ipAddress": "xx.xx.xx.xx",
            "hostName": "host_name",
            "listenerPort": 1521
        }
    ],
    "targetEndPoints": [
        {
            "databaseUniqueName": "avmdb1",
            "ipAddress": "xx.xx.xx.xx",
            "hostName": "host_name",
            "listenerPort": 1521
        }
    ],
    "transportType": "ASYNC"
}
]
}
}

```

Related Topics

- [Configuring Agent Proxy Settings for Object Store Access](#)
If the Object Store IP address is accessible only through proxy setup by the Oracle Database Appliance server, then define the proxy setting for the agent, so that the agent can access the Object Store.
- <https://www.oracle.com/in/database/technologies/high-availability/maa.html>

Configuring Oracle Data Guard on Oracle Database Appliance Using BUI

Oracle Database Appliance enables you to set up Oracle Data Guard using BUI.

Prerequisites for Oracle Database Guard Configuration

Before you begin:

- Oracle recommends running the primary and the standby databases on separate Oracle Database Appliance hardware, so ensure that you have at least two separate Oracle Database Appliance machines.
- Oracle recommends that the primary and standby systems have the same Oracle Database Appliance configuration. The database must have identical configuration for database version and storage, that is, they must have either Oracle ASM or Oracle ACFS storage, to avoid any unpredictability with the database switch roles.
- The primary and standby systems must be the same Oracle Database Appliance release, and must be on Oracle Database Appliance release 19.26 or later.
- If you have customized the operating system, then ensure that environments on the systems are identical.
- Ensure that your deployment follows Oracle Maximum Availability Architecture (MAA) best practices. See the Oracle Maximum Availability Architecture (MAA) page on Oracle Technology Network.
- If you decide to use Oracle ObjectStore for backup and recovery, then you must configure access for the primary and standby systems.
- Ensure that the backup for primary and standby databases is set up. You can use either Object Store or External FRA (NFS) to set up the backup for primary and standby databases when configuring Oracle Data Guard on Oracle Database Appliance. A backup is necessary to instantiate a standby database.

Configuring Oracle Data Guard using BUI

Follow these steps:

1. Log into the Browser User Interface:
`https://host-ip-address:7093/mgmt/index.html`
2. Click **Database**.
3. In the Database page, click on the database to view the database details.
4. In the Database details page, click the **Dataguard Associations** tab. The Oracle Data Guard configurations associated with the database are displayed.
5. To configure an Oracle Data Guard configuration, click **Configure**.
6. In the System Information tab, you can use a JSON file to provide the Oracle Data Guard configuration values or specify the values for each field.
7. To configure Oracle Data Guard using JSON file, in the System Information tab, click **Browse** and load the configuration.
8. Or, specify the **Dataguard Configuration Name** and **Select Protection Mode**. The **Database name** field is already populated.
9. Select **Enable Active Dataguard**, if you want to enable Oracle Active Data Guard.

10. In the **Primary Information** tab, specify the **VIP of the Associated Network, Listener Port, Database SYS Password, and Backup Encryption Passwords**. For high-availability systems, specify the **Node 0 VIP of the Associated Network, Node 1 Primary Host Name, and Node 1 VIP of the Associated Network**.
11. In the **Standby Information** tab, specify the **Standby Host Name, VIP of the Associated Network, BUI User, BUI Password, System User, Database Unique Name, Database SYS Password, Listener Port, and Select Transport Type**. For high-availability systems, specify the **Node 0 Standby Host Name, Node 0 VIP of the Associated Network, Node 1 Standby Host Name, and Node 1 VIP of the Associated Network**.
12. You can add multiple standby Oracle Data Guard configurations. Click **Add Standby** to add a new standby Oracle Data Guard configuration. A new **Standby Information** tab is opened for each new standby you add.
13. For each new standby, specify the **Standby Host Name, VIP of the Associated Network, BUI User, BUI Password, System User, Database Unique Name, Database SYS Password, Listener Port, and Select Transport Type**. For high-availability systems, specify the **Node 0 Standby Host Name, Node 0 VIP of the Associated Network, Node 1 Standby Host Name, and Node 1 VIP of the Associated Network**.
14. Click **Save Configuration** if you want to save the configuration as a JSON file.
15. Click **Configure** and click **Yes** to confirm. Verify that the job is submitted and completes successfully.

Example JSON for configuring Oracle Data Guard on Oracle Database Appliance

```
{
  "name": "test1_test7",
  "databaseName": "test",
  "protectionMode": "MAX_PERFORMANCE",
  "enableFlashback": true,
  "enableActiveDg": false,
  "replicationGroups": [
    {
      "sourceEndPoints": [
        {
          "endpointType": "PRIMARY",
          "hostName": "test_domain1",
          "listenerPort": 1521,
          "databaseUniqueName": "test1",
          "ipAddress": "test_IPaddress"
        }
      ],
      {
        "endpointType": "PRIMARY",
        "hostName": "test_domain1",
        "listenerPort": 1521,
        "databaseUniqueName": "test1",
        "ipAddress": "test_IPaddress2"
      }
    ],
    "targetEndPoints": [
      {
        "endpointType": "STANDBY",
        "hostName": "test_domain2",
        "listenerPort": 1521,
        "databaseUniqueName": "test7",

```

```

        "ipAddress": "test_IPAddress3"
    },
    {
        "endpointType": "STANDBY",
        "hostName": "test_domain2",
        "listenerPort": 1521,
        "databaseUniqueName": "test7",
        "ipAddress": "test_IPAddress4"
    }
],
"transportType": "ASYNC"
}
]
}

```

Related Topics

- [Configuring Agent Proxy Settings for Object Store Access](#)
If the Object Store IP address is accessible only through proxy setup by the Oracle Database Appliance server, then define the proxy setting for the agent, so that the agent can access the Object Store.
- <https://www.oracle.com/in/database/technologies/high-availability/maa.html>

Viewing Oracle Data Guard Status on Oracle Database Appliance

View Oracle Data Guard status using ODACLI commands.

Viewing Oracle Data Guard Status using ODACLI commands

Follow these steps:

- To view the status of primary and standby databases in your Oracle Data Guard configuration, use the following command:

```
# odacli list-dataguardstatus
```

- To view the status of your specific Oracle Data Guard configuration, use the following command:

```
# odacli describe-dataguardstatus -i 5f0ed48a-366d-454c-a389-fe367772dbb7
```

For more information about these command options, see the *Oracle Database Appliance Command Line Reference* chapter in this guide.

Related Topics

- [odacli Oracle Data Guard Commands](#)
Use ODACLI commands to configure and manage Oracle Data Guard in your Oracle Database Appliance deployment.

Viewing Oracle Data Guard Status on Oracle Database Appliance Using BUI

View Oracle Data Guard status using BUI.

Listing and Viewing Oracle Data Guard Status using BUI

Follow these steps:

1. Log into the Browser User Interface:
`https://host-ip-address:7093/mgmt/index.html`
2. Click **Database**.
3. In the Database page, click on the database to view the database details.
4. In the Database details page, click the **Dataguard Associations** tab.
The Oracle Data Guard configurations associated with the database are displayed.
5. To view the status of a specific Oracle Data Guard configuration, from the **Actions** drop-down list of the Oracle Data Guard configuration, select **View**.

Related Topics

- [odacli Oracle Data Guard Commands](#)
Use ODACLI commands to configure and manage Oracle Data Guard in your Oracle Database Appliance deployment.

Performing Oracle Data Guard Operations

Perform failover, switchover, and reinstate operations on Oracle Data Guard using ODACLI commands.

Performing Oracle Data Guard operations using ODACLI commands

Follow these steps:

- To switch roles between the primary database and standby database in your Oracle Data Guard configuration, run the following command on the **primary** system. Specify the standby database unique name with the `-u` option.

```
# odacli switchover-dataguard -i dg_ID -u
standby_db_unique_name_to_switchover
```

For example:

```
# odacli switchover-dataguard -i 75f23ce0-006a-4aeb-ba6d-b4b60275c19 -u
test_db2
```

Confirm that the switchover of roles completed successfully:

```
# odacli describe-dataguardstatus -i 75f23ce0-006a-4aeb-ba6d-b4b60275c19
```

- A failover provides for transitioning a standby database in your configuration to take over the primary database role, if all instances of an Oracle RAC primary database fail, or are unreachable.
To failover a standby database to the primary database in your Oracle Data Guard configuration, run the following command on your current **standby** system.

```
# odacli failover-dataguard -i dg_ID -u  
standby_db_unique_name_to_failover_to
```

For example:

```
# odacli failover-dataguard -i 75f23ce0-006a-4aeb-ba6d-b4b60275c19 -u  
test_db2
```

Confirm that the requested database failover to the new primary database has completed successfully:

```
# odacli describe-dataguardstatus -i 75f23ce0-006a-4aeb-ba6d-b4b60275c19
```

- To reinstate a failed primary database after a failover and convert it to a new standby database in your Oracle Data Guard configuration, run the following command on your new **primary** system.

```
# odacli reinstate-dataguard -i dg_ID -u db_unique_name_to_reinstate
```

For example:

```
# odacli reinstate-dataguard -i 75f23ce0-006a-4aeb-ba6d-b4b60275c19 -u  
test_db2
```

Confirm that the requested database is reinstated as a new standby database:

```
# odacli describe-dataguardstatus -i 75f23ce0-006a-4aeb-ba6d-b4b60275c19
```

For more information about these command options, see the *Oracle Database Appliance Command Line Reference* chapter in this guide.

Related Topics

- [odacli Oracle Data Guard Commands](#)
Use ODACLI commands to configure and manage Oracle Data Guard in your Oracle Database Appliance deployment.

Performing Oracle Data Guard Operations Using BUI

Perform failover, switchover, and reinstate operations on Oracle Data Guard using BUI.

Performing switchover, failover, and reinstate Oracle Data Guard operations using BUI

Follow these steps:

1. Log into the Browser User Interface:
<https://host-ip-address:7093/mgmt/index.html>

2. Click **Database**.
3. In the Database page, click on the database to view the database details.
4. In the Database details page, click the **Dataguard Associations** tab. The Oracle Data Guard configurations associated with the database are displayed.
5. You can perform switchover operation only from the primary Oracle Data Guard Association using the BUI. From the **Actions** drop-down list of the Oracle Data Guard configuration, select **Switchover**.
6. In the Confirmation message, verify the **DB Unique Name** and **Target Database Password**, and click **Yes**.
7. You can perform failover operation only from the standby Oracle Data Guard Association using the BUI. From the **Actions** drop-down list of the Oracle Data Guard configuration, select **Failover**.
8. In the Confirmation message, verify the **DB Unique Name** and **Target Database Password**, and click **Yes**.
9. You can perform reinstate operation only from the primary Oracle Data Guard Association using the BUI. To reinstate an Oracle Data Guard configuration, from the **Actions** drop-down list of the Oracle Data Guard configuration, select **Reinstate**.
10. In the Confirmation message, verify the **DB Unique Name** and **Target Database Password**, and click **Yes**.

Related Topics

- [odacli Oracle Data Guard Commands](#)
Use ODACLI commands to configure and manage Oracle Data Guard in your Oracle Database Appliance deployment.

Creating an Oracle Data Guard Network

Create an Oracle Data Guard network and associate it with a database using ODACLI commands.

Configuring an Oracle Data Guard Network using ODACLI commands

You can configure Oracle Data Guard using a network of type Public, Database, or Dataguard.

Follow these steps:

1. Create the network:

```
# odacli create-network -n btbond1 -t VLAN -p 192.209.10.227 -w Dataguard -
no-d -s 255.255.255.240 -v 369 -g 192.209.10.225
```

2. View the new network:

```
# odacli list-networks
```

| ID | Interface Type | Subnet Mask | Name | Gateway | NIC |
|--------------------------------------|----------------|-------------|-----------------|---------|--------------|
| | | | | | VLAN ID Node |
| Networks | | | | | |
| ----- | | | | | |
| ----- | | | | | |
| ----- | | | | | |
| 836cfa4b-5d2c-45e3-a62d-099fc7c57984 | | | Private-network | | priv0 |

```
INTERNAL          255.255.255.240 [ IP Address on node0: 192.168.16.24 ]
1a312239-761d-4321-84d2-8da406f21e5c Public-network      btbond1.359
VLAN              255.255.255.240 10.209.10.65      359 [ IP Address on
node0: 192.209.10.69 ]
f279ac96-5a4a-4b73-86af-1afb6b6ae5d4 vlan369          btbond1.369
VLAN              255.255.255.240 10.209.10.225    369 [ IP Address on
node0: 192.209.10.227]
```

3. To attach a network of type Dataguard to a database:

```
# odacli modify-database -in test_db -an vlan369
```

For more information about these command options, see the *Oracle Database Appliance Command Line Reference* chapter in this guide.

Related Topics

- [odacli Oracle Data Guard Commands](#)
Use ODACLI commands to configure and manage Oracle Data Guard in your Oracle Database Appliance deployment.

Migrating an Oracle Database from One System to Another Using Integrated Oracle Data Guard

Understand how you can use Integrated Oracle Data Guard to migrate an Oracle Database from one system to another.

Migrating Oracle Data Guard Database using ODACLI commands

If your database is on an old Oracle Database Appliance hardware model, and you want to move your deployment to a new Oracle Database Appliance hardware, then you can use your Oracle Data Guard configuration on Oracle Database Appliance to migrate from one system to another. The same steps can also be applied to migrate an Oracle Database from an Oracle Database Appliance bare Metal system to a DB system in a KVM deployment, or from one DB system in a KVM deployment to another DB system.

Before you begin:

- Oracle recommends running the primary and the standby databases on separate Oracle Database Appliance hardware, so ensure that you have at least two separate Oracle Database Appliance machines.
- The primary and standby systems must be the same Oracle Database Appliance release, and must be on Oracle Database Appliance release 19.8 or later. The instances on the primary and standby databases must have similar configuration for database parameter settings including database version, memory, CPU, networking, and storage (Oracle ASM or Oracle ACFS), thus avoiding any unpredictability when the databases switch roles.
- If you have customized the operating system, then ensure that environments on both machines are identical.
- Ensure that your deployment follows Oracle Maximum Availability Architecture (MAA) best practices.

Follow these steps:

1. Take a backup of your primary database to Object Store or External FRA (NFS).

```
# odacli create-backup primary_DB
```

For example:

```
# odacli create-backup --backupType Regular-L0 -in test_db
```

2. Save the backup report:

```
# odacli describe-backupreport -i eba406c7-ae46-4d1d-a1e5-3e985397b171 >
backup_report_test_db_0620.json
```

The backup report ID is the ID of the backup created in step 1 and can be obtained by running the `odacli list-backupreports` command.

3. Copy the backup report to the standby system and restore the backup to a standby database.

```
# odacli irestore-database -ro STANDBY
```

If your backup option is Object Store, then specify the Object Store location:

```
# odacli irestore-database -r backup_report.json -u dbUniqueName -on
objectStoreName -bp -ro STANDBY -dh
Password for SYS user:
Rman Backup Encryption Password(s). Multiple passwords needs to be comma
separated.:
```

If your backup option is NFS, then specify the NFS location:

```
odacli irestore-database -r backup_report.json -u dbUniqueName -ro STANDBY
Password for SYS user:
```

4. Configure Oracle Data Guard, by running the following command on the primary system:

```
# /opt/oracle/dcs/bin/odacli configure-dataguard
Number of standby databases (enter 1 or 2 | default: 1):
Standby 1 site address: standby1
BUI username for Standby site standby1. If Multi-user Access/Multi-user
Access Passwordless is not enabled on Standby site standby1, enter 'oda-
admin'; otherwise, enter the name of the user who has irestored the
Standby database (default: oda-admin): oda-admin
BUI password for Standby site standby1:
Password for root user on Standby site standby1:

*****
*****

Data Guard configuration name: tdb_dg
Database name for Data Guard configuration: tdb
Primary database SYS password:
Protection mode [MAX_PROTECTION, MAX_PERFORMANCE, MAX_AVAILABILITY]
(default: MAX_PERFORMANCE):
```

```

Enable Active Data Guard (Y/N, default:N):
*****
*****

```

```

Data Guard default settings for standby database - tdbstandby
Primary site network for Data Guard configuration: Public-network
Standby site network for Data Guard configuration: Public-network
Primary database listener port (TCP): 1521
Standby database listener port (TCP): 1521
Transport type: ASYNC
Do you want to edit this Data Guard configuration? (Y/N, default:N): N
*****
*****

```

```

Enter Primary database RMAN backup encryption password if any:
Do you want to provide another Primary database RMAN backup encryption
password if any? [y/n] (default 'n'):
Standby database's SYS password will be set to Primary database's after
Data Guard configuration. Ignore warning and proceed with Data Guard
configuration? (Y/N, default:N): Y

```

```

{
  "jobId" : "e02cc0b3-bce3-4d6c-alf5-5b121bb7f66a",
  "status" : "Created",
  "message" : "",
  "reports" : [ ],
  "createTimestamp" : "January 23, 2025 03:12:44 AM UTC",
  "resourceList" : [ ],
  "description" : "DG Config service for DB tdb",
  "updatedAt" : "January 23, 2025 03:12:44 AM UTC",
  "jobType" : null,
  "cpsMetadata" : null
}

```

```

[root@phxdbfzp22 work]# /opt/oracle/dcs/bin/odacli describe-job -i
e02cc0b3-bce3-4d6c-alf5-5b121bb7f66a

```

Job details

```

-----
                ID: e02cc0b3-bce3-4d6c-alf5-5b121bb7f66a
Description: DG Config service for DB tdb
      Status: Success
      Created: January 23, 2025 03:12:44 UTC
      Message:

```

```

Task Name                Start
Time                    End
Time                    Status
-----
-----
Validate configure primary request      January 23, 2025 03:13:10
UTC          January 23, 2025 03:13:21 UTC          Success
(Primary site) (Host:
phxdbfzp22/Job

```

ID:

```

901389f5-0cad-4ee6-91be-3f77b85652af)

Validate configure standby request      January 23, 2025 03:13:21
UTC      January 23, 2025 03:13:29 UTC      Success
(Standby site)
(Host:
                                     host1/Job

ID:

856d86e4-dd51-41a7-9050-
b0c39ae771f9)

Uploading Primary DB Password File     January 23, 2025 03:13:29
UTC      January 23, 2025 03:13:52 UTC      Success
(Standby
site)

Configure primary database (Primary     January 23, 2025 03:13:52
UTC      January 23, 2025 03:15:29 UTC      Success
site) (Host: phxdbfzp22/Job
ID:

5dd46e86-
e07f-423f-9ebf-2515b4ac17d5)

Configure standby request (Standby      January 23, 2025 03:15:29
UTC      January 23, 2025 03:17:30 UTC      Success
site)
(Host:

host1/Job
ID:

2ab511a2-15c0-4371-
bf30-9b7e27ff5288)

Create archive log restore (Primary     January 23, 2025 03:17:30
UTC      January 23, 2025 03:17:52 UTC      Success
site) (Host: phxdbfzp22/Job
ID:

96766874-6537-4972-81a9-971440e2acfb)

Configure and enable Data Guard          January 23, 2025 03:17:53
UTC      January 23, 2025 03:19:19 UTC      Success
(Primary site) (Host:
phxdbfzp22/Job

ID:

7ad65ffa-ea06-479d-bb21-
e0b81fb8c743)

Enable Flashback (Standby site) (Host:  January 23, 2025 03:19:19
UTC      January 23, 2025 03:19:38 UTC      Success
host1/Job

```

ID:

a1768703-4dd4-4f1f-
b9a3-9fe0f99615d5)

Re-enable Data Guard (Primary site) January 23, 2025 03:19:38
UTC January 23, 2025 03:19:44 UTC Success

(Host: phxdbfzp22/Job

ID:

3f6dd276-63e3-4804-a179-
e10052386206)

Create Data Guard status (Primary January 23, 2025 03:19:44
UTC January 23, 2025 03:19:49 UTC Success

site) (Host: phxdbfzp22/Job

ID:

8a3eb946-3501-4618-9d4a-
ad8a6d298cc8)

Create Data Guard status (Standby January 23, 2025 03:19:49
UTC January 23, 2025 03:19:57 UTC Success

site)

(Host:

host1/Job

ID:

d9d65942-6284-40d5-a991-b1d21edae96f)

5. Check the status of Oracle Data Guard and ensure it is working:

```
# odacli describe-dataguardstatus -i dataguard_configuration_ID
```

6. Switch over to the standby database:

```
# odacli switchover-dataguard -i 75f23ce0-006a-4aeb-ba6d-b4b60275c19 -u  
houdg02
```

7. Deconfigure Oracle Data Guard. The process also deletes the standby database on the old Oracle Database Appliance hardware machine.

```
# /opt/oracle/dcs/bin/odacli deconfigure-dataguard --id "ee22f382-  
b04e-4658-a6c7-ab00fc7e3270"
```

Number of standby databases (enter 1 or 2 | default: 1):

Standby 1 site address: standby1

BUI username for Standby site standby1. If Multi-user Access/Multi-user
Access Passwordless is not enabled on Standby site standby1, enter 'oda-
admin'; otherwise, enter the name of the user who has restored the
Standby database (default: oda-admin): oda-admin

BUI password for Standby site standby1:

Password for root user on Standby site standby1:

Standby database will be deleted after Data Guard configuration is
removed. Ignore warning and proceed with Data Guard deconfiguration?

(Y/N): Y

```
{
  "jobId" : "0613c649-3da6-463a-8359-2f6d7d17399b",
  "status" : "Created",
  "message" : "",
  "reports" : [ ],
  "createTimestamp" : "January 23, 2025 03:42:41 AM UTC",
  "resourceList" : [ ],
  "description" : "DG Deconfig service",
  "updatedAtTime" : "January 23, 2025 03:42:41 AM UTC",
  "jobType" : null,
  "cpsMetadata" : null
}
```

```
[root@phxdbfzp22 work]# /opt/oracle/dcs/bin/odacli describe-job -i
0613c649-3da6-463a-8359-2f6d7d17399b
```

Job details

```
-----
                ID: 0613c649-3da6-463a-8359-2f6d7d17399b
Description:    DG Deconfig service
                Status: Success
Created:       January 23, 2025 03:42:41 UTC
Message:

Task Name                               Start
Time                                     End
Time                                     Status
-----
De-configure Dataguard (Primary site)   January 23, 2025 03:42:44
UTC                                       January 23, 2025 03:44:22 UTC          Success
(Host: phxdbfzp22/Job
ID:
93758e42-2cf4-4aa1-949e-
b6018c1c35d7)

Delete Dataguard Status(Primary site)   January 23, 2025 03:44:22
UTC                                       January 23, 2025 03:44:28 UTC          Success
(Host: phxdbfzp22/Job
ID:
e090af71-9c6d-4d14-8e16-3c64c4aa7f14)

Delete Dataguard Status(Standby site)   January 23, 2025 03:44:28
UTC                                       January 23, 2025 03:44:36 UTC          Success
(Host:
host1/Job
ID:
a5bf022a-
c1ca-4c1a-8747-4ff6a0e938c0)

Delete Standby Database (Standby site)   January 23, 2025 03:44:36
```

```

UTC          January 23, 2025 03:46:07 UTC          Success
(Host:

host1/Job
ID:

f93b1f26-69d9-4690-84f9-4c0c9947423a)

```

For more information about these command options, see the *Oracle Database Appliance Command Line Reference* chapter in this guide.

Related Topics

- [odacli Oracle Data Guard Commands](#)
Use ODACLI commands to configure and manage Oracle Data Guard in your Oracle Database Appliance deployment.

Patching Oracle Data Guard Databases on Oracle Database Appliance

Understand how you can patch primary and standby databases on Oracle Data Guard using ODACLI commands.

Prerequisites for patching Oracle Data Guard primary and standby databases using ODACLI commands

Before patching the database homes, upload the Oracle Database clone files for the database version, to the repository. See *Updating Oracle Database Appliance Repository with Database Clone Files Using the CLI* for the procedure to update the repository with the latest Oracle Database clone files. Also ensure that the primary Oracle Database Appliance system and the standby Oracle Database Appliance system are on the same Oracle Database Appliance release. It is recommended that the two systems be on the latest Oracle Database Appliance release. See *Patching Oracle Database Appliance Bare Metal Systems Using the Command-Line* for the procedure to patch your Oracle Database Appliance deployment.

Important:

Patch the standby database on Oracle Database Appliance first, before patching the primary database to ensure that all functions are updated correctly. Patching the standby first may affect Oracle Active Data Guard OJVM functionality. Hence, ensure that you patch the standby system first, and then patch the primary system immediately after that.

Patching Oracle Data Guard primary and standby databases using `odacli update-database` command

You can use the `odacli update-database` command to update the databases in your Oracle Data Guard configuration. Follow these steps for patching databases in your Oracle Data Guard configuration:

Patching workflow with primary database A and standby database B:

1. Create prepatch report for database B:

```
# odacli create-prepatchreport -db -dbid databaseId -to dbhomeid
```

2. Update standby database B:

```
# odacli update-database -i databaseId -to dbhomeId
```

3. Switch roles between the primary database and standby database in your Oracle Data Guard configuration, by running the following command on the primary system:

```
# odacli switchover-dataguard -i dgid -u db_A
```

4. Create prepatch report for database A:

```
# odacli create-prepatchreport -db -dbid databaseId -to dbhomeid
```

5. Update database A:

```
# odacli update-database -i databaseId -to dbhomeid
```

6. Switch roles again between the primary database and standby database in your Oracle Data Guard configuration, by running the following command on the primary system:

```
# odacli switchover-dataguard -i dgid -u db_A
```

7. Create a prepatch report for the datapatch for database A:

```
# odacli create-prepatchreport -dp -dbid databaseId
```

8. Apply datapatch on database A:

```
# odacli update-database -i databaseId -dp
```

For more information about these command options, see the *Oracle Database Appliance Command Line Reference* chapter in this guide.

Patching Oracle Data Guard primary and standby databases using `odacli update-dbhome` command

Follow these steps to patch the databases in your Oracle Data Guard configuration on Oracle Database Appliance:

1. Run the following command on the standby database:

```
# odacli update-dbhome
```

2. After patching job on the standby database is successful, run the following command on the primary database:

```
# odacli update-dbhome
```

3. Confirm that the patching jobs are successful:

```
# /opt/oracle/dcs/bin/odacli list-jobs
```

4. Confirm the existing Data Guard configuration is working properly by running the following command on both primary and standby systems:

```
odacli describe-dataguardstatus -i dgid
```

For more information about these command options, see the *Oracle Database Appliance Command Line Reference* chapter in this guide.

Enabling Oracle Active Data Guard on Existing Configurations

Understand how you can enable Oracle Active Data Guard on existing configurations.

Oracle Active Data Guard is licensed option to the Oracle Database Enterprise Edition and enables advanced capabilities that extend the basic Oracle Data Guard functionality.

Oracle Active Data Guard function requires database to be open as read-only while enabling the *redo log apply* option. Follow these steps to enable Oracle Active Data Guard on existing configurations:

1. Modify database to have read-only start option:

```
srvctl modify database -d standby_db_unique_name -startoption "read only"
srvctl stop database -d standby_db_unique_name
srvctl start database -d standby_db_unique_name
```

To check if Oracle Data Guard has read-only start option set, run the following command:

```
srvctl config database -d standby_db_unique_name | grep "Start options"
```

2. Enable redo log apply by running the following PL/SQL commands:

```
ALTER DATABASE RECOVER MANAGED STANDBY DATABASE CANCEL;
ALTER DATABASE RECOVER MANAGED STANDBY DATABASE DISCONNECT FROM SESSION;
```

Registering Oracle Data Guard on Oracle Database Appliance Using ODACLI Commands

Oracle Database Appliance enables you to migrate Oracle Data Guard configuration that were manually configured, and register the configuration metadata with Oracle Database Appliance using ODACLI commands.

Prerequisites for Oracle Database Guard Registration

Before you begin:

- Oracle recommends running the primary and the standby databases on separate Oracle Database Appliance hardware, so ensure that you have at least two separate Oracle Database Appliance machines.

- Oracle recommends that the primary and standby systems have the same Oracle Database Appliance configuration. The database must have identical configuration for database version and storage, that is, they must have either Oracle ASM or Oracle ACFS storage, to avoid any unpredictability with the database switch roles.
- The primary and standby systems must be the same Oracle Database Appliance release, and must be on Oracle Database Appliance release 19.22 or later.
- If you have customized the operating system, then ensure that environments on the systems are identical.
- Ensure that your deployment follows Oracle Maximum Availability Architecture (MAA) best practices. See the Oracle Maximum Availability Architecture (MAA) page on Oracle Technology Network.

Registering Oracle Data Guard using ODACLI commands

Follow these steps:

1. Register Oracle Data Guard with Oracle Database Appliance, in one of the following ways:
Register Oracle Data Guard using interactive mode:

```
[root@node1 ~]# odacli register-dataguard
Number of standby databases (enter 1 or 2 | default: 1): 2
Standby 1 site address: host2
BUI username for Standby site host2. If Multi-user Access/Multi-user
Access Passwordless is not enabled on Standby site host2, enter 'oda-
admin'; otherwise, enter the name of the user who has irestored the
Standby database (default: oda-admin):
BUI password for Standby site host2:
Password for root user on Standby site host2:
Standby 2 site address: host3
BUI username for Standby site host3. If Multi-user Access/Multi-user
Access Passwordless is not enabled on Standby site host1, enter 'oda-
admin'; otherwise, enter the name of the user who has irestored the
Standby database (default: oda-admin):
BUI password for Standby site host3:
Password for root user on Standby site host3:

*****
*****
Data Guard configuration name: books_dgconf
Database name for Data Guard configuration: books
Primary database SYS password:
Protection mode [MAX_PROTECTION, MAX_PERFORMANCE, MAX_AVAILABILITY]
(default: MAX_PERFORMANCE):
*****
*****

Data Guard default settings for standby database - books_u1
Primary site network for Data Guard configuration: Public-network
Standby site network for Data Guard configuration: Public-network
Primary database listener port (TCP): 1521
Standby database listener port (TCP): 1521
Transport type: ASYNC
For standby 'books_u1', does the above Data Guard configuration match your
actual configuration? (Y/N, default:N): y
```

```
Data Guard default settings for standby database - books_u2
Primary site network for Data Guard configuration: Public-network
Standby site network for Data Guard configuration: Public-network
Primary database listener port (TCP): 1521
Standby database listener port (TCP): 1521
Transport type: ASYNC
For standby 'books_u2', does the above Data Guard configuration match your
actual configuration? (Y/N, default:N): y
{
  "jobId" : "525d4c0d-5d4c-401b-9d7a-add15e1057a5",
  "status" : "Created",
  "message" : "",
  "reports" : [ ],
  "createTimestamp" : "December 15, 2024 03:22:40 AM MSK",
  "resourceList" : [ ],
  "description" : "Register Dataguard service for DB a9cca840-
d5f6-4c52-8136-10668ce88c69",
  "updatedAt" : "December 15, 2024 03:22:40 AM MSK",
  "jobType" : null,
  "cpsMetadata" : null
}
```

```
[root@host1 ~]# odacli describe-job -i 525d4c0d-5d4c-401b-9d7a-add15e1057a5
```

Job details

```
-----
                ID: 525d4c0d-5d4c-401b-9d7a-add15e1057a5
        Description: Register Dataguard service for DB a9cca840-
d5f6-4c52-8136-10668ce88c69
                Status: Success
                Created: December 15, 2024 03:22:40 MSK
                Message:
```

| Task Name | Node Name | Start |
|-----------|-----------|-------|
| Time | End | |
| Time | Status | |

```
-----
Validate register dataguard primary      host1          December 15,
2024 03:23:45 MSK          December 15, 2024 03:24:20 MSK
Success
request (Primary site)
(Host:
```

```
host1/Job
ID:
```

```
e11da95d-
e00e-41b3-9894-8dd7a9ffceb9)
```

```
-----
Validate register dataguard standby      host1          December 15,
2024 03:24:20 MSK          December 15, 2024 03:25:05 MSK
Success
request (Standby site)
```

```
(Host:

host2/Job
ID:

6e566598-700c-4154-8056-853df67d15b3)

Validate register dataguard standby      host1      December 15,
2024 03:25:05 MSK      December 15, 2024 03:25:45 MSK
Success
request (Standby site)
(Host:
```

```
host1/Job
ID:

11330cdd-ccdf-4e05-
acf8-2885418a9efc)

Create Data Guard status (Primary      host1      December 15,
2024 03:25:45 MSK      December 15, 2024 03:26:07 MSK
Success
site) (Host: host1/Job
ID:
```

```
a779a3d6-709a-4a1c-
a649-9fbf373624ed)

Create Data Guard status (Standby      host1      December 15,
2024 03:26:07 MSK      December 15, 2024 03:26:34 MSK
Success
site) (Host: host2/Job
ID:
```

```
9233aea0-021a-4790-
b359-60de42d50526)

Create Data Guard status (Standby      host1      December 15,
2024 03:26:34 MSK      December 15, 2024 03:27:01 MSK
Success
site) (Host: host1/Job
ID:
```

```
79f7ec79-fb43-4f57-8f05-da37afbe275b)
```

Oracle Data Guard status on the primary system:

```
# odacli list-dataguardstatus
Updated about 2 minute(s) ago
It can take up to several minutes to update Data Guard status. You can re-
run the command to obtain the latest status.
```

| ID | Name | Role | Protection Mode | Status |
|-------|------|------|-----------------|--------|
| ----- | | | | |

```

-----
a3543f5a-63a8-42c3-abcc-a8e180a1dd25      books_dgconf
books          PRIMARY      MAX_PERFORMANCE      CONFIGURED
[root@host1_node1 ~]# odacli list-dataguardstatus -j
[ {
  "id" : "a3543f5a-63a8-42c3-abcc-a8e180a1dd25",
  "name" : "books_dgconf",
  "databaseId" : "a9cca840-d5f6-4c52-8136-10668ce88c69",
  "protectionMode" : "MAX_PERFORMANCE",
  "role" : "PRIMARY",
  "replicationGroups" : [ {
    "sourceEndpoints" : [ {
      "endpointType" : "PRIMARY",
      "databaseUniqueName" : "books",
      "ipAddress" : "xx.xx.xx.xx",
      "hostName" : "n1",
      "listenerPort" : 1521,
      "serviceName" : "test_service",
      "sysPassword" : null,
      "openMode" : "READ WRITE",
      "state" : {
        "status" : "ENABLED"
      }
    }
  ], {
    "endpointType" : "PRIMARY",
    "databaseUniqueName" : "books",
    "ipAddress" : "xx.xx.xxx.xxx",
    "hostName" : "host2",
    "listenerPort" : 1521,
    "serviceName" : "test_service",
    "sysPassword" : null,
    "openMode" : "READ WRITE",
    "state" : {
      "status" : "ENABLED"
    }
  }
  ],
  "targetEndpoints" : [ {
    "endpointType" : "STANDBY",
    "databaseUniqueName" : "books_u1",
    "ipAddress" : "xx.xx.xx.xx",
    "hostName" : "n2",
    "listenerPort" : 1521,
    "serviceName" : "test_service",
    "sysPassword" : null,
    "openMode" : null,
    "state" : {
      "status" : "ENABLED"
    }
  }
  ], {
    "endpointType" : "STANDBY",
    "databaseUniqueName" : "books_u1",
    "ipAddress" : "xx.xx.xx.xx",
    "hostName" : "host_name",
    "listenerPort" : 1521,
    "serviceName" : "test_service",
    "sysPassword" : null,
  }
  ]
} ]

```

```

        "openMode" : null,
        "state" : {
            "status" : "ENABLED"
        }
    } ],
    "transportType" : "ASYNC",
    "applyLag" : "0 seconds",
    "transportLag" : "0 seconds",
    "approximateRoleTransitionTime" : "30 seconds",
    "applyRate" : "12.00 KByte/s"
}, {
    "sourceEndPoints" : [ {
        "endpointType" : "PRIMARY",
        "databaseUniqueName" : "books",
        "ipAddress" : "xx.xx.xx.xx",
        "hostName" : "n1",
        "listenerPort" : 1521,
        "serviceName" : "test_service",
        "sysPassword" : null,
        "openMode" : "READ WRITE",
        "state" : {
            "status" : "ENABLED"
        }
    } ],
    {
        "endpointType" : "PRIMARY",
        "databaseUniqueName" : "books",
        "ipAddress" : "xx.x.xx.xxx",
        "hostName" : "host2",
        "listenerPort" : 1521,
        "serviceName" : "test_service",
        "sysPassword" : null,
        "openMode" : "READ WRITE",
        "state" : {
            "status" : "ENABLED"
        }
    } ],
    "targetEndPoints" : [ {
        "endpointType" : "STANDBY",
        "databaseUniqueName" : "books_u2",
        "ipAddress" : "xx.xx.xx.xx",
        "hostName" : "host_name",
        "listenerPort" : 1521,
        "serviceName" : "host1",
        "sysPassword" : null,
        "openMode" : null,
        "state" : {
            "status" : "ENABLED"
        }
    } ],
    {
        "endpointType" : "STANDBY",
        "databaseUniqueName" : "books_u2",
        "ipAddress" : "xx.xx.xx.xx",
        "hostName" : "host_name",
        "listenerPort" : 1521,
        "serviceName" : "host1",
        "sysPassword" : null,
    }
}

```

```

        "openMode" : null,
        "state" : {
            "status" : "ENABLED"
        }
    } ],
    "transportType" : "ASYNC",
    "applyLag" : "0 seconds",
    "transportLag" : "0 seconds",
    "approximateRoleTransitionTime" : "30 seconds",
    "applyRate" : "5.00 KByte/s"
} ],
"observers" : [ ],
"createTime" : "December 15, 2024 03:25:48 AM MSK",
"state" : {
    "status" : "CONFIGURED"
},
"updatedAt" : "December 15, 2024 03:26:06 AM MSK"
} ]

```

```

[root@host1_node2 ~]# odacli list-dataguardstatus -j
[ {
    "id" : "a3543f5a-63a8-42c3-abcc-a8e180a1dd25",
    "name" : "books_dgconf",
    "databaseId" : "a9cca840-d5f6-4c52-8136-10668ce88c69",
    "protectionMode" : "MAX_PERFORMANCE",
    "role" : "PRIMARY",
    "replicationGroups" : [ {
        "sourceEndpoints" : [ {
            "endpointType" : "PRIMARY",
            "databaseUniqueName" : "books",
            "ipAddress" : "xx.xx.xx.xx",
            "hostName" : "n1",
            "listenerPort" : 1521,
            "serviceName" : "test_service",
            "sysPassword" : null,
            "openMode" : "READ WRITE",
            "state" : {
                "status" : "ENABLED"
            }
        }
    ], {
        "endpointType" : "PRIMARY",
        "databaseUniqueName" : "books",
        "ipAddress" : "xx.xx.xx.xx",
        "hostName" : "host2",
        "listenerPort" : 1521,
        "serviceName" : "test_service",
        "sysPassword" : null,
        "openMode" : "READ WRITE",
        "state" : {
            "status" : "ENABLED"
        }
    }
    ],
    "targetEndpoints" : [ {
        "endpointType" : "STANDBY",
        "databaseUniqueName" : "books_u1",
        "ipAddress" : "xx.xx.xx.xx",

```

```

    "hostName" : "n2",
    "listenerPort" : 1521,
    "serviceName" : "test_service",
    "sysPassword" : null,
    "openMode" : null,
    "state" : {
      "status" : "ENABLED"
    }
  }, {
    "endpointType" : "STANDBY",
    "databaseUniqueName" : "books_u1",
    "ipAddress" : "xx.xx.xx.xx",
    "hostName" : "host_name",
    "listenerPort" : 1521,
    "serviceName" : "test_service",
    "sysPassword" : null,
    "openMode" : null,
    "state" : {
      "status" : "ENABLED"
    }
  } ],
  "transportType" : "ASYNC",
  "applyLag" : "0 seconds",
  "transportLag" : "0 seconds",
  "approximateRoleTransitionTime" : "30 seconds",
  "applyRate" : "12.00 KByte/s"
}, {
  "sourceEndPoints" : [ {
    "endpointType" : "PRIMARY",
    "databaseUniqueName" : "books",
    "ipAddress" : "xx.xx.xx.xx",
    "hostName" : "n1",
    "listenerPort" : 1521,
    "serviceName" : "test_service",
    "sysPassword" : null,
    "openMode" : "READ WRITE",
    "state" : {
      "status" : "ENABLED"
    }
  } ],
  {
    "endpointType" : "PRIMARY",
    "databaseUniqueName" : "books",
    "ipAddress" : "xx.xx.xx.xx",
    "hostName" : "host2",
    "listenerPort" : 1521,
    "serviceName" : "test_service",
    "sysPassword" : null,
    "openMode" : "READ WRITE",
    "state" : {
      "status" : "ENABLED"
    }
  } ],
  "targetEndPoints" : [ {
    "endpointType" : "STANDBY",
    "databaseUniqueName" : "books_u2",
    "ipAddress" : "x.xx.xxx.xx",

```



```

        "hostName" : "host_name",
        "listenerPort" : 1521,
        "serviceName" : "host1",
        "sysPassword" : null,
        "openMode" : null,
        "state" : {
            "status" : "ENABLED"
        }
    }, {
        "endpointType" : "STANDBY",
        "databaseUniqueName" : "books_u2",
        "ipAddress" : "xx.xx.xx.xx",
        "hostName" : "host_name",
        "listenerPort" : 1521,
        "serviceName" : "host1",
        "sysPassword" : null,
        "openMode" : null,
        "state" : {
            "status" : "ENABLED"
        }
    } ],
    "transportType" : "ASYNC",
    "applyLag" : "0 seconds",
    "transportLag" : "0 seconds",
    "approximateRoleTransitionTime" : "30 seconds",
    "applyRate" : "5.00 KByte/s"
} ],
"observers" : [ ],
"createTime" : "December 15, 2024 03:25:48 AM MSK",
"state" : {
    "status" : "CONFIGURED"
},
"updateTime" : "December 15, 2024 03:26:06 AM MSK"
} ]

```

Oracle Data Guard status on the first standby system:

```

# odacli list-dataguardstatus
Updated about 3 minute(s) ago
It can take up to several minutes to update Data Guard status. You can re-
run the command to obtain the latest status.
ID                                     Name
Database Name      Role      Protection Mode      Status
-----
a3543f5a-63a8-42c3-abcc-a8e180a1dd25  books_dgconf
books              STANDBY  MAX_PERFORMANCE     CONFIGURED
[root@host2_node1 ~]# odacli list-dataguardstatus -j
[ {
  "id" : "a3543f5a-63a8-42c3-abcc-a8e180a1dd25",
  "name" : "books_dgconf",
  "databaseId" : "d2ccb22b-3e31-47cb-967c-1f1fdefea54e",
  "protectionMode" : "MAX_PERFORMANCE",
  "role" : "STANDBY",
  "replicationGroups" : [ {

```

```

"sourceEndpoints" : [ {
  "endpointType" : "PRIMARY",
  "databaseUniqueName" : "books",
  "ipAddress" : "xx.xx.xx.xx",
  "hostName" : "host_name",
  "listenerPort" : 1521,
  "serviceName" : "service_name",
  "sysPassword" : null,
  "openMode" : null,
  "state" : {
    "status" : "ENABLED"
  }
}, {
  "endpointType" : "PRIMARY",
  "databaseUniqueName" : "books",
  "ipAddress" : "xx.xx.xx.xx",
  "hostName" : "host_name",
  "listenerPort" : 1521,
  "serviceName" : "service_name",
  "sysPassword" : null,
  "openMode" : null,
  "state" : {
    "status" : "ENABLED"
  }
} ],
"targetEndpoints" : [ {
  "endpointType" : "STANDBY",
  "databaseUniqueName" : "books_u1",
  "ipAddress" : "xx.xx.xx.xx",
  "hostName" : "host_name",
  "listenerPort" : 1521,
  "serviceName" : "service_name",
  "sysPassword" : null,
  "openMode" : "MOUNTED",
  "state" : {
    "status" : "ENABLED"
  }
}, {
  "endpointType" : "STANDBY",
  "databaseUniqueName" : "books_u1",
  "ipAddress" : "xx.xx.xx.xx",
  "hostName" : "host_name",
  "listenerPort" : 1521,
  "serviceName" : "service_name",
  "sysPassword" : null,
  "openMode" : "MOUNTED",
  "state" : {
    "status" : "ENABLED"
  }
} ],
"transportType" : "ASYNC",
"applyLag" : "0 seconds",
"transportLag" : "0 seconds",
"approximateRoleTransitionTime" : "30 seconds",
"applyRate" : "11.00 KByte/s"
}, {

```

```

"sourceEndpoints" : [ {
  "endpointType" : "PRIMARY",
  "databaseUniqueName" : "books",
  "ipAddress" : "xx.xx.xx.xx",
  "hostName" : "host_name",
  "listenerPort" : 1521,
  "serviceName" : "service_name",
  "sysPassword" : null,
  "openMode" : null,
  "state" : {
    "status" : "ENABLED"
  }
}, {
  "endpointType" : "PRIMARY",
  "databaseUniqueName" : "books",
  "ipAddress" : "xx.xx.xx.xx",
  "hostName" : "host_name",
  "listenerPort" : 1521,
  "serviceName" : "service_name",
  "sysPassword" : null,
  "openMode" : null,
  "state" : {
    "status" : "ENABLED"
  }
} ],
"targetEndpoints" : [ {
  "endpointType" : "STANDBY",
  "databaseUniqueName" : "books_u2",
  "ipAddress" : "xx.xx.xx.xx",
  "hostName" : "host_name",
  "listenerPort" : 1521,
  "serviceName" : "service_name",
  "sysPassword" : null,
  "openMode" : null,
  "state" : {
    "status" : "ENABLED"
  }
}, {
  "endpointType" : "STANDBY",
  "databaseUniqueName" : "books_u2",
  "ipAddress" : "xx.xx.xx.xx",
  "hostName" : "host_name",
  "listenerPort" : 1521,
  "serviceName" : "service_name",
  "sysPassword" : null,
  "openMode" : null,
  "state" : {
    "status" : "ENABLED"
  }
} ],
"transportType" : "ASYNC",
"applyLag" : "0 seconds",
"transportLag" : "0 seconds",
"approximateRoleTransitionTime" : "30 seconds",
"applyRate" : "5.00 KByte/s"
} ],

```

```

"observers" : [ ],
"createTime" : "December 15, 2024 00:26:21 AM GMT",
"state" : {
  "status" : "CONFIGURED"
},
"updatedAtTime" : "December 15, 2024 00:26:31 AM GMT"
} ]

```

```
[root@host2_node2 bin]# odacli list-dataguardstatus
```

Updated about 5 minute(s) ago

It can take up to several minutes to update Data Guard status. You can re-run the command to obtain the latest status.

| ID | Name | Role | Protection Mode | Status |
|--------------------------------------|--------------|---------|-----------------|------------|
| a3543f5a-63a8-42c3-abcc-a8e180aldd25 | books_dgconf | | | |
| books | | STANDBY | MAX_PERFORMANCE | CONFIGURED |

```
[root@scaoda603c4n2 bin]# odacli list-dataguardstatus -j
```

```

[ {
  "id" : "a3543f5a-63a8-42c3-abcc-a8e180aldd25",
  "name" : "books_dgconf",
  "databaseId" : "d2ccb22b-3e31-47cb-967c-1f1fdefea54e",
  "protectionMode" : "MAX_PERFORMANCE",
  "role" : "STANDBY",
  "replicationGroups" : [ {
    "sourceEndpoints" : [ {
      "endpointType" : "PRIMARY",
      "databaseUniqueName" : "books",
      "ipAddress" : "xx.xx.xx.xx",
      "hostName" : "host_name",
      "listenerPort" : 1521,
      "serviceName" : "service_name",
      "sysPassword" : null,
      "openMode" : null,
      "state" : {
        "status" : "ENABLED"
      }
    }
  ], {
    "endpointType" : "PRIMARY",
    "databaseUniqueName" : "books",
    "ipAddress" : "xx.xx.xx.xx",
    "hostName" : "host_name",
    "listenerPort" : 1521,
    "serviceName" : "service_name",
    "sysPassword" : null,
    "openMode" : null,
    "state" : {
      "status" : "ENABLED"
    }
  }
  ],
  "targetEndpoints" : [ {
    "endpointType" : "STANDBY",
    "databaseUniqueName" : "books_ul",
    "ipAddress" : "xx.xx.xx.xx",
    "hostName" : "host_name",

```

```

        "listenerPort" : 1521,
        "serviceName" : "service_name",
        "sysPassword" : null,
        "openMode" : "MOUNTED",
        "state" : {
            "status" : "ENABLED"
        }
    }, {
        "endpointType" : "STANDBY",
        "databaseUniqueName" : "books_u1",
        "ipAddress" : "10.32.202.58",
        "hostName" : "host_name",
        "listenerPort" : 1521,
        "serviceName" : "service_name",
        "sysPassword" : null,
        "openMode" : "MOUNTED",
        "state" : {
            "status" : "ENABLED"
        }
    } ],
    "transportType" : "ASYNC",
    "applyLag" : "0 seconds",
    "transportLag" : "0 seconds",
    "approximateRoleTransitionTime" : "30 seconds",
    "applyRate" : "11.00 KByte/s"
}, {
    "sourceEndPoints" : [ {
        "endpointType" : "PRIMARY",
        "databaseUniqueName" : "books",
        "ipAddress" : "xx.xx.xx.xx",
        "hostName" : "host_name",
        "listenerPort" : 1521,
        "serviceName" : "service_name",
        "sysPassword" : null,
        "openMode" : null,
        "state" : {
            "status" : "ENABLED"
        }
    } ],
    {
        "endpointType" : "PRIMARY",
        "databaseUniqueName" : "books",
        "ipAddress" : "xx.xx.xx.xx",
        "hostName" : "host_name",
        "listenerPort" : 1521,
        "serviceName" : "service_name",
        "sysPassword" : null,
        "openMode" : null,
        "state" : {
            "status" : "ENABLED"
        }
    } ],
    "targetEndPoints" : [ {
        "endpointType" : "STANDBY",
        "databaseUniqueName" : "books_u2",
        "ipAddress" : "10.32.202.9",
        "hostName" : "host_name",

```

```

        "listenerPort" : 1521,
        "serviceName" : "service_name",
        "sysPassword" : null,
        "openMode" : null,
        "state" : {
            "status" : "ENABLED"
        }
    }, {
        "endpointType" : "STANDBY",
        "databaseUniqueName" : "books_u2",
        "ipAddress" : "xx.xx.xx.xx",
        "hostName" : "host_name",
        "listenerPort" : 1521,
        "serviceName" : "service_name",
        "sysPassword" : null,
        "openMode" : null,
        "state" : {
            "status" : "ENABLED"
        }
    } ],
    "transportType" : "ASYNC",
    "applyLag" : "0 seconds",
    "transportLag" : "0 seconds",
    "approximateRoleTransitionTime" : "30 seconds",
    "applyRate" : "5.00 KByte/s"
} ],
"observers" : [ ],
"createTime" : "December 15, 2024 00:26:21 AM GMT",
"state" : {
    "status" : "CONFIGURED"
},
"updatedAt" : "December 15, 2024 00:26:31 AM GMT"
} ]

```

Oracle Data Guard status on the second standby system:

```

# odacli list-dataguardstatus
Updated about 3 minute(s) ago
It can take up to several minutes to update Data Guard status. You can re-
run the command to obtain the latest status.
ID                                     Name
Database Name           Role           Protection Mode   Status
-----
a3543f5a-63a8-42c3-abcc-a8e180a1dd25  books_dgconf
books                     STANDBY       MAX_PERFORMANCE  CONFIGURED
[root@scaoda603c4n1 ~]# odacli list-dataguardstatus -j
[ {
  "id" : "a3543f5a-63a8-42c3-abcc-a8e180a1dd25",
  "name" : "books_dgconf",
  "databaseId" : "d2ccb22b-3e31-47cb-967c-1f1fdefea54e",
  "protectionMode" : "MAX_PERFORMANCE",
  "role" : "STANDBY",
  "replicationGroups" : [ {
    "sourceEndPoints" : [ {

```

```

    "endpointType" : "PRIMARY",
    "databaseUniqueName" : "books",
    "ipAddress" : "xx.xx.xx.xx",
    "hostName" : "host_name",
    "listenerPort" : 1521,
    "serviceName" : "service_name",
    "sysPassword" : null,
    "openMode" : null,
    "state" : {
        "status" : "ENABLED"
    }
}, {
    "endpointType" : "PRIMARY",
    "databaseUniqueName" : "books",
    "ipAddress" : "xx.xx.xx.xx",
    "hostName" : "host_name",
    "listenerPort" : 1521,
    "serviceName" : "service_name",
    "sysPassword" : null,
    "openMode" : null,
    "state" : {
        "status" : "ENABLED"
    }
} ],
"targetEndPoints" : [ {
    "endpointType" : "STANDBY",
    "databaseUniqueName" : "books_u1",
    "ipAddress" : "xx.xx.xx.xx",
    "hostName" : "host_name",
    "listenerPort" : 1521,
    "serviceName" : "service_name",
    "sysPassword" : null,
    "openMode" : "MOUNTED",
    "state" : {
        "status" : "ENABLED"
    }
}, {
    "endpointType" : "STANDBY",
    "databaseUniqueName" : "books_u1",
    "ipAddress" : "xx.xx.xx.xx",
    "hostName" : "host_name",
    "listenerPort" : 1521,
    "serviceName" : "service_name",
    "sysPassword" : null,
    "openMode" : "MOUNTED",
    "state" : {
        "status" : "ENABLED"
    }
} ],
"transportType" : "ASYNC",
"applyLag" : "0 seconds",
"transportLag" : "0 seconds",
"approximateRoleTransitionTime" : "30 seconds",
"applyRate" : "11.00 KByte/s"
}, {
    "sourceEndPoints" : [ {

```

```

    "endpointType" : "PRIMARY",
    "databaseUniqueName" : "books",
    "ipAddress" : "xx.xx.xx.xx",
    "hostName" : "host_name",
    "listenerPort" : 1521,
    "serviceName" : "service_name",
    "sysPassword" : null,
    "openMode" : null,
    "state" : {
      "status" : "ENABLED"
    }
  }, {
    "endpointType" : "PRIMARY",
    "databaseUniqueName" : "books",
    "ipAddress" : "xx.xx.xx.xx",
    "hostName" : "host_name",
    "listenerPort" : 1521,
    "serviceName" : "service_name",
    "sysPassword" : null,
    "openMode" : null,
    "state" : {
      "status" : "ENABLED"
    }
  } ],
  "targetEndPoints" : [ {
    "endpointType" : "STANDBY",
    "databaseUniqueName" : "books_u2",
    "ipAddress" : "xx.xx.xx.xx",
    "hostName" : "host_name",
    "listenerPort" : 1521,
    "serviceName" : "service_name",
    "sysPassword" : null,
    "openMode" : null,
    "state" : {
      "status" : "ENABLED"
    }
  }, {
    "endpointType" : "STANDBY",
    "databaseUniqueName" : "books_u2",
    "ipAddress" : "xx.xx.xx.xx",
    "hostName" : "host_name",
    "listenerPort" : 1521,
    "serviceName" : "service_name",
    "sysPassword" : null,
    "openMode" : null,
    "state" : {
      "status" : "ENABLED"
    }
  } ],
  "transportType" : "ASYNC",
  "applyLag" : "0 seconds",
  "transportLag" : "0 seconds",
  "approximateRoleTransitionTime" : "30 seconds",
  "applyRate" : "5.00 KByte/s"
} ],
"observers" : [ ],

```



```

    "createTime" : "December 15, 2024 00:26:21 AM GMT",
    "state" : {
      "status" : "CONFIGURED"
    },
    "updatedAtTime" : "December 15, 2024 00:26:31 AM GMT"
  } ]

```

```
[root@host3_node2 bin]# odacli list-dataguardstatus
```

```
Updated about 5 minute(s) ago
```

It can take up to several minutes to update Data Guard status. You can re-run the command to obtain the latest status.

```

ID                                     Name
Database Name           Role           Protection Mode      Status
-----
a3543f5a-63a8-42c3-abcc-a8e180aldd25  books_dgconf
books                       STANDBY       MAX_PERFORMANCE     CONFIGURED

```

```
[root@scaoda603c4n2 bin]# odacli list-dataguardstatus -j
```

```

[ {
  "id" : "a3543f5a-63a8-42c3-abcc-a8e180aldd25",
  "name" : "books_dgconf",
  "databaseId" : "d2ccb22b-3e31-47cb-967c-1f1fdefea54e",
  "protectionMode" : "MAX_PERFORMANCE",
  "role" : "STANDBY",
  "replicationGroups" : [ {
    "sourceEndpoints" : [ {
      "endpointType" : "PRIMARY",
      "databaseUniqueName" : "books",
      "ipAddress" : "xx.xx.xx.xx",
      "hostName" : "host_name",
      "listenerPort" : 1521,
      "serviceName" : "service_name",
      "sysPassword" : null,
      "openMode" : null,
      "state" : {
        "status" : "ENABLED"
      }
    }
  ], {
    "endpointType" : "PRIMARY",
    "databaseUniqueName" : "books",
    "ipAddress" : "xx.xx.xx.xx",
    "hostName" : "host_name",
    "listenerPort" : 1521,
    "serviceName" : "service_name",
    "sysPassword" : null,
    "openMode" : null,
    "state" : {
      "status" : "ENABLED"
    }
  }
  ],
  "targetEndpoints" : [ {
    "endpointType" : "STANDBY",
    "databaseUniqueName" : "books_u1",
    "ipAddress" : "xx.xx.xx.xx",
    "hostName" : "host_name",
    "listenerPort" : 1521,

```

```

    "serviceName" : "service_name",
    "sysPassword" : null,
    "openMode" : "MOUNTED",
    "state" : {
      "status" : "ENABLED"
    }
  }, {
    "endpointType" : "STANDBY",
    "databaseUniqueName" : "books_u1",
    "ipAddress" : "10.32.202.58",
    "hostName" : "host_name",
    "listenerPort" : 1521,
    "serviceName" : "service_name",
    "sysPassword" : null,
    "openMode" : "MOUNTED",
    "state" : {
      "status" : "ENABLED"
    }
  } ],
  "transportType" : "ASYNC",
  "applyLag" : "0 seconds",
  "transportLag" : "0 seconds",
  "approximateRoleTransitionTime" : "30 seconds",
  "applyRate" : "11.00 KByte/s"
}, {
  "sourceEndpoints" : [ {
    "endpointType" : "PRIMARY",
    "databaseUniqueName" : "books",
    "ipAddress" : "xx.xx.xx.xx",
    "hostName" : "host_name",
    "listenerPort" : 1521,
    "serviceName" : "service_name",
    "sysPassword" : null,
    "openMode" : null,
    "state" : {
      "status" : "ENABLED"
    }
  } ],
  {
    "endpointType" : "PRIMARY",
    "databaseUniqueName" : "books",
    "ipAddress" : "xx.xx.xx.xx",
    "hostName" : "host_name",
    "listenerPort" : 1521,
    "serviceName" : "service_name",
    "sysPassword" : null,
    "openMode" : null,
    "state" : {
      "status" : "ENABLED"
    }
  } ],
  "targetEndpoints" : [ {
    "endpointType" : "STANDBY",
    "databaseUniqueName" : "books_u2",
    "ipAddress" : "10.32.202.9",
    "hostName" : "host_name",
    "listenerPort" : 1521,

```

```

        "serviceName" : "service_name",
        "sysPassword" : null,
        "openMode" : null,
        "state" : {
            "status" : "ENABLED"
        }
    }, {
        "endpointType" : "STANDBY",
        "databaseUniqueName" : "books_u2",
        "ipAddress" : "xx.xx.xx.xx",
        "hostName" : "host_name",
        "listenerPort" : 1521,
        "serviceName" : "service_name",
        "sysPassword" : null,
        "openMode" : null,
        "state" : {
            "status" : "ENABLED"
        }
    } ],
    "transportType" : "ASYNC",
    "applyLag" : "0 seconds",
    "transportLag" : "0 seconds",
    "approximateRoleTransitionTime" : "30 seconds",
    "applyRate" : "5.00 KByte/s"
} ],
"observers" : [ ],
"createTime" : "December 15, 2024 00:26:21 AM GMT",
"state" : {
    "status" : "CONFIGURED"
},
"updateTime" : "December 15, 2024 00:26:31 AM GMT"
} ]

```

Register Oracle Data Guard with two standby systems with JSON file:

```

[root@node1 ~]# odacli register-dataguard -r advregdg.json
Number of standby databases (enter 1 or 2 | default: 1): 2
Standby 1 site address: host2
BUI username for Standby site host2. If Multi-user Access/Multi-user
Access Passwordless is not enabled on Standby site host2, enter 'oda-
admin'; otherwise, enter the name of the user who has ired the
Standby database (default: oda-admin): u1
BUI password for Standby site host2. If Multi-user Access Passwordless is
enabled on Standby site, copy the cwallet.sso file from Standby site (/opt/
oracle/dcs/conf/dcspublickey_wallet/) to Primary site (/root/). Rename the
file to 'cwallet.sso.host2', set the file ownership (root:root) and file
permission (0440) and then press enter:
Standby 2 site address: host3
BUI username for Standby site host3. If Multi-user Access/Multi-user
Access Passwordless is not enabled on Standby site host3, enter 'oda-
admin'; otherwise, enter the name of the user who has ired the
Standby database (default: oda-admin): usr1
BUI password for Standby site host3. If Multi-user Access Passwordless is
enabled on Standby site, copy the cwallet.sso file from Standby site (/opt/
oracle/dcs/conf/dcspublickey_wallet/) to Primary site (/root/). Rename the

```

```

file to 'cwallet.sso.host3', set the file ownership (root:root) and file
permission (0440) and then press enter:
Primary database SYS password:
{
  "jobId" : "5c4be2a3-5892-4482-9549-e47005f05548",
  "status" : "Created",
  "message" : "",
  "reports" : [ ],
  "createTimestamp" : "December 19, 2024 01:13:42 AM UYT",
  "resourceList" : [ ],
  "description" : "Register Dataguard service for DB 0f56f07e-ale5-4c88-
a535-4cfc7858a80a",
  "updatedAt" : "December 19, 2024 01:13:42 AM UYT",
  "jobType" : null,
  "cpsMetadata" : null
}
[root@host2 ~]# odacli describe-job -i 5c4be2a3-5892-4482-9549-e47005f05548

```

Job details

```

-----
                        ID: 5c4be2a3-5892-4482-9549-e47005f05548
Description: Register Dataguard service for DB 0f56f07e-
ale5-4c88-a535-4cfc7858a80a
Status: Success
Created: December 19, 2024 01:13:42 UYT
Message:

```

| Task Name | Start Time | End Time | Status |
|---|--------------------------------|--------------------------------|---------|
| Validate register dataguard primary request (Primary site) (Host: host2/Job ID: 6e0cdfbd-69f8-442c-be4a-73937e67b938) | December 19, 2024 01:13:58 UYT | December 19, 2024 01:14:15 UYT | Success |
| Validate register dataguard standby request (Standby site) (Host: host2/Job ID: f505eec8-533d-4a80-9edc-34ec16008167) | December 19, 2024 01:14:15 UYT | December 19, 2024 01:14:35 UYT | Success |
| Validate register dataguard standby request (Standby site) (Host: host2/Job ID: f505eec8-533d-4a80-9edc-34ec16008167) | December 19, 2024 01:14:35 UYT | December 19, 2024 01:15:01 UYT | Success |

```

request (Standby site)
(Host:

host2/Job
ID:

3d8e79e9-15ab-4d7d-
ba92-2f3d0e73852b)

Create Data Guard status (Primary          December 19, 2024 01:15:01
UYT          December 19, 2024 01:15:07 UYT          Success
site) (Host: host2/Job
ID:

87591524-9ec4-42f6-
ae3a-1b5eddf4945d)

Create Data Guard status (Standby          December 19, 2024 01:15:07
UYT          December 19, 2024 01:15:15 UYT          Success
site) (Host: host2/Job
ID:

4705752a-24b7-41b5-
b2e5-2c64f6eac3c4)

Create Data Guard status (Standby          December 19, 2024 01:15:15
UYT          December 19, 2024 01:15:23 UYT          Success
site) (Host: host2/Job
ID:

0c7553ba-0f53-49f3-9f7f-8128f7d47e30)

{
  "name" : "dgconf_c2",
  "protectionMode" : "MAX_AVAILABILITY",
  "replicationGroups" : [ {
    "sourceEndPoints" : [ {
      "endpointType" : "PRIMARY",
      "databaseUniqueName" : "c2",
      "ipAddress" : "xx.xx.xx.xx",
      "hostName" : "host2",
      "listenerPort" : 1521,
      "serviceName" : "c2",
      "sysPassword" : null
    } ],
    "targetEndPoints" : [ {
      "endpointType" : "STANDBY",
      "databaseUniqueName" : "c2t_2",
      "ipAddress" : "xx.xx.xx.xx",
      "hostName" : "c2t_2",
      "listenerPort" : 1521,
      "serviceName" : "c2t_2",
      "sysPassword" : null
    } ],
    "transportType" : "SYNC"
  } ], {

```

```

    "sourceEndpoints" : [ {
      "endpointType" : "PRIMARY",
      "databaseUniqueName" : "c2",
      "ipAddress" : "xx.xx.xx.xx",
      "hostName" : "host2",
      "listenerPort" : 1521,
      "serviceName" : "c2",
      "sysPassword" : null
    } ],
    "targetEndpoints" : [ {
      "endpointType" : "STANDBY",
      "databaseUniqueName" : "c2t_1",
      "ipAddress" : "xx.xx.xx.xx",
      "hostName" : "host2",
      "listenerPort" : 1521,
      "serviceName" : "c2t_1",
      "sysPassword" : null
    } ],
    "transportType" : "FASTSYNC"
  } ]
}

```

For more information about these command options, see the *Oracle Database Appliance Command Line Reference* chapter in this guide.

Related Topics

- <https://www.oracle.com/in/database/technologies/high-availability/maa.html>

Registering Oracle Data Guard on Oracle Database Appliance Using BUI

Oracle Database Appliance enables you to migrate Oracle Data Guard configuration that were manually configured, and register the configuration metadata with Oracle Database Appliance using BUI.

Prerequisites for Oracle Database Guard Registration

Before you begin:

- Oracle recommends running the primary and the standby databases on separate Oracle Database Appliance hardware, so ensure that you have at least two separate Oracle Database Appliance systems.
- Oracle recommends that the primary and standby systems have the same Oracle Database Appliance configuration. The database must have identical configuration for database version and storage, that is, they must have either Oracle ASM or Oracle ACFS storage, to avoid any unpredictability with the database switch roles.
- The primary and standby systems must be the same Oracle Database Appliance release, and must be on Oracle Database Appliance release 19.26 or later.
- If you have customized the operating system, then ensure that environments on the systems are identical.
- Ensure that your deployment follows Oracle Maximum Availability Architecture (MAA) best practices. See the Oracle Maximum Availability Architecture (MAA) page on Oracle Technology Network.

Registering Oracle Data Guard using BUI

Follow these steps:

1. Log into the Browser User Interface:
`https://host-ip-address:7093/mgmt/index.html`
2. Click **Database**.
3. In the Database page, click on the database to view the database details.
4. In the Database details page, click the **Dataguard Associations** tab. The Oracle Data Guard configurations associated with the database are displayed.
5. To register an Oracle Data Guard configuration, click **Register**.
6. In the System Information tab, you can use a JSON file to provide the Oracle Data Guard configuration values or specify the values for each field.
7. To register Oracle Data Guard using JSON file, in the System Information tab, click **Browse** and load the configuration.
8. Or, specify the **Dataguard Configuration Name** and **Select Protection Mode**. The **Database name** field is already populated.
9. Select **Enable Active Dataguard**, if you want to enable Oracle Active Data Guard.
10. In the **Primary Information** tab, specify the **VIP of the Associated Network**, **Listener Port**, **Database SYS Password**, and **Backup Encryption Passwords**. For high-availability systems, specify the **Node 0 VIP of the Associated Network**, **Node 1 Primary Host Name**, and **Node 1 VIP of the Associated Network**.
11. In the Standby Information tab, specify the **Standby Host Name**, **VIP of the Associated Network**, **BUI User**, **BUI Password**, **System User**, **Database Unique Name**, **Database SYS Password**, **Listener Port**, and **Select Transport Type**. For high-availability systems, specify the **Node 0 Standby Host Name**, **Node 0 VIP of the Associated Network**, **Node 1 Standby Host Name**, and **Node 1 VIP of the Associated Network**.
12. You can add multiple standby Oracle Data Guard configurations. Click **Add Standby** to add a new standby Oracle Data Guard configuration. A new **Standby Information** tab is opened for each new standby you add.
13. For each new standby, specify the **Standby Host Name**, **VIP of the Associated Network**, **BUI User**, **BUI Password**, **System User**, **Database Unique Name**, **Database SYS Password**, **Listener Port**, and **Select Transport Type**. For high-availability systems, specify the **Node 0 Standby Host Name**, **Node 0 VIP of the Associated Network**, **Node 1 Standby Host Name**, and **Node 1 VIP of the Associated Network**.
14. Click **Save Configuration** if you want to save the configuration as a JSON file.
15. Click **Register** and click **Yes** to confirm. Verify that the job is submitted and completes successfully.

Example JSON for registering Oracle Data Guard on Oracle Database Appliance

```
[root@node1 ~]# cat dg.json
{
  "name" : "provd1_sprovd1",
  "protectionMode" : "MAX_PERFORMANCE",
  "replicationGroups" : [ {
    "sourceEndpoints" : [ {
      "endpointType" : "PRIMARY",
      "databaseUniqueName" : "provd1",
```

```

        "ipAddress" : "10.32.65.225",
        "hostName" : "host1.domain.com",
        "listenerPort" : 1521,
        "serviceName" : "provdb.domain.com",
        "sysPassword" : null
    } ],
    "targetEndPoints" : [ {
        "endpointType" : "STANDBY",
        "databaseUniqueName" : "sprovdb",
        "ipAddress" : "10.32.65.230",
        "hostName" : "host2.domain.com",
        "listenerPort" : 1521,
        "serviceName" : "sprovdb.domain.com",
        "sysPassword" : null
    } ],
    "transportType" : "ASYNCR"
} ]
}

```

Related Topics

- <https://www.oracle.com/in/database/technologies/high-availability/maa.html>

Deconfiguring Oracle Data Guard on Oracle Database Appliance

Deconfigure Oracle Data Guard status using ODA CLI commands.

Deconfiguring Oracle Data Guard Status using ODA CLI commands

To deconfigure Oracle Data Guard, you must specify the Oracle Data Guard Configuration ID. Run the `odacli list-dataguardstatus` command to find the Oracle Data Guard Configuration ID.

Follow these steps:

- To deconfigure Oracle Data Guard with one standby database, run the following command on the primary system:

```

# /opt/oracle/dcs/bin/odacli deconfigure-dataguard --id "ee22f382-
b04e-4658-a6c7-ab00fc7e3270"
Number of standby databases (enter 1 or 2 | default: 1):
Standby 1 site address: standby1
BUI username for Standby site standby1. If Multi-user Access/Multi-user
Access Passwordless is not enabled on Standby site standby1, enter 'oda-
admin'; otherwise, enter the name of the user who has restored the
Standby database (default: oda-admin): oda-admin
BUI password for Standby site standby1:
Password for root user on Standby site standby1:
Standby database will be deleted after Data Guard configuration is
removed. Ignore warning and proceed with Data Guard deconfiguration?
(Y/N): Y
{
  "jobId" : "0613c649-3da6-463a-8359-2f6d7d17399b",
  "status" : "Created",
  "message" : "",
  "reports" : [ ],

```



```

    "createTimestamp" : "January 23, 2025 03:42:41 AM UTC",
    "resourceList" : [ ],
    "description" : "DG Deconfig service",
    "updatedAt" : "January 23, 2025 03:42:41 AM UTC",
    "jobType" : null,
    "cpsMetadata" : null
}

```

```

[root@nl oda]# /opt/oracle/dcs/bin/odacli describe-job -i
0613c649-3da6-463a-8359-2f6d7d17399b

```

Job details

```

-----
                ID: 0613c649-3da6-463a-8359-2f6d7d17399b
Description:    DG Deconfig service
                Status: Success
                Created: January 23, 2025 03:42:41 UTC
                Message:

Task Name                               Start
Time                                     End
Time                                     Status
-----
De-configure Dataguard (Primary site)    January 23, 2025 03:42:44
UTC                                       January 23, 2025 03:44:22 UTC          Success
(Host: phxdbfzp22/Job
ID:

93758e42-2cf4-4aa1-949e-
b6018c1c35d7)

Delete Dataguard Status(Primary site)    January 23, 2025 03:44:22
UTC                                       January 23, 2025 03:44:28 UTC          Success
(Host: phxdbfzp22/Job
ID:

e090af71-9c6d-4d14-8e16-3c64c4aa7f14)

Delete Dataguard Status(Standby site)    January 23, 2025 03:44:28
UTC                                       January 23, 2025 03:44:36 UTC          Success
(Host:

standby1
/Job
ID:

a5bf022a-
c1ca-4c1a-8747-4ff6a0e938c0)

Delete Standby Database (Standby site)    January 23, 2025 03:44:36
UTC                                       January 23, 2025 03:46:07 UTC          Success
(Host:

standby1

```

```
/Job
ID:

f93b1f26-69d9-4690-84f9-4c0c9947423a)
```

- To deconfigure Oracle Data Guard with two standby databases, run the following command on the primary system:

```
# odacli deconfigure-dataguard -i
281ed08c-302f-4a94-932f-02fabf95e88e
Number of standby databases (enter 1 or 2 | default: 1): 2
Standby 1 site address: standby1
BUI username for Standby site standby1. If Multi-user Access/Multi-user
Access Passwordless is not enabled on Standby site standby1, enter
'oda-admin'; otherwise, enter the name of the user who has irestored the
Standby
database (default: oda-admin):
BUI password for Standby site standby1:
Password for root user on Standby site standby1:
Standby 2 site address: standby2
BUI username for Standby site standby2. If Multi-user Access/Multi-user
Access Passwordless is not enabled on Standby site standby2, enter
'oda-admin'; otherwise, enter the name of the user who has irestored the
Standby
database (default: oda-admin):
BUI password for Standby site standby2:
Password for root user on Standby site standby2:
Standby database will be deleted after Data Guard configuration is removed.
Ignore warning and proceed with Data Guard deconfiguration? (Y/N): y
{
  "jobId" : "e0b74b70-da87-4f46-8950-8cf061a8c576",
  "status" : "Created",
  "message" : "",
  "reports" : [ ],
  "createTimestamp" : "January 17, 2025 21:12:57 PM UTC",
  "resourceList" : [ ],
  "description" : "DG Deconfig service",
  "updatedAt" : "January 17, 2025 21:12:57 PM UTC",
  "jobType" : null,
  "cpsMetadata" : null
}
```

```
[root@nl ~]# odacli describe-job -i "e0b74b70-da87-4f46-8950-8cf061a8c576"
```

```
Job details
```

```
-----
                ID: e0b74b70-da87-4f46-8950-8cf061a8c576
Description:    DG Deconfig service
                Status: Success
                Created: January 17, 2025 21:12:57 UTC
                Message:
```

```
Task Name                Start
Time
End Time                Status
-----
```

```

-----
De-configure Dataguard (Primary site)   January 17, 2025 21:13:02
UTC           January 17, 2025 21:14:14 UTC           Success
(Host: scaoda8m014/Job
ID:

65fbb55a-167d-428b-90ad-72c9e6acd706)

Delete Dataguard Status (Primary site)   January 17, 2025 21:14:14
UTC           January 17, 2025 21:14:20 UTC           Success
(Host: scaoda8m014/Job
ID:
3ade2aa0-6dcf-469a-
a592-61e7111d26c2)

Delete Dataguard Status (Standby site)   January 17, 2025 21:14:20
UTC           January 17, 2025 21:14:29 UTC           Success
(Host: standby1/Job
ID:
9948a60f-119f-4a6d-944f-
fe02741be5b9)

Delete Standby Database (Standby site)   January 17, 2025 21:14:29
UTC           January 17, 2025 21:16:41 UTC           Success
(Host: standby1/Job
ID:
714e53db-3dd6-4a22-
b614-5110a4e98004)

Delete Dataguard Status (Standby site)   January 17, 2025 21:16:41
UTC           January 17, 2025 21:16:49 UTC           Success
(Host: standby2/Job ID:
17958ff9-
c3e3-4ca8-9dc2-975ea2f369cb)

Delete Standby Database (Standby site)   January 17, 2025 21:16:49
UTC           January 17, 2025 21:19:22 UTC           Success
(Host: standby2/Job ID:
c352ea80-6c98-4249-bc7f-2700f1e81fdc)

```

For more information about these command options, see the *Oracle Database Appliance Command Line Reference* chapter in this guide.

Related Topics

- [odacli Oracle Data Guard Commands](#)
Use ODACLI commands to configure and manage Oracle Data Guard in your Oracle Database Appliance deployment.

Deconfiguring Oracle Data Guard on Oracle Database Appliance Using BUI

Deconfigure Oracle Data Guard status using BUI.

Deconfiguring Oracle Data Guard Status using BUI

Follow these steps:

1. Log into the Browser User Interface:
`https://host-ip-address:7093/mgmt/index.html`
2. Click **Database**.
3. In the Database page, click on the database to view the database details.
4. In the Database details page, click the **Dataguard Associations** tab. The Oracle Data Guard configurations associated with the database are displayed.
5. From the **Actions** drop-down list of the Oracle Data Guard configuration, select **Deconfigure**.
6. In the Standby Information tab, specify the **Standby Host Name, VIP of the Associated Network, BUI User, BUI Password, System User, and Database SYS Password**. For high-availability systems, specify the **Node 0 Standby Host Name, Node 0 VIP of the Associated Network, Node 1 Standby Host Name, and Node 1 VIP of the Associated Network**.
7. Select **Force Run** to run the operation.
8. Click **Add Standby** to add another standby for deconfiguration.
9. After adding details of all the standby systems that you want to deconfigure, click **Deconfigure** and confirm the action. Verify that the job is submitted and completes successfully.

Related Topics

- [odacli Oracle Data Guard Commands](#)
Use ODACLI commands to configure and manage Oracle Data Guard in your Oracle Database Appliance deployment.

Managing CPU Pools on Oracle Database Appliance Bare Metal and KVM Deployments

Use CPU pools to manage CPU resources on Oracle Database Appliance bare metal and KVM deployments.

- [About CPU Pools](#)
CPU pools enable management of CPU resources on Oracle Database Appliance on both bare metal and KVM deployments. There are three types of CPU pools, that is, BM, VM, and DB system.
- [Creating a CPU Pool in a Bare Metal or KVM Deployment](#)
Use ODACL commands or the Browser User Interface to create a CPU pool in a bare metal or KVM deployment.
- [Remapping CPU Pools in a Bare Metal or KVM Deployment](#)
Use ODACL commands or the Browser User Interface to remap CPU pools in a bare metal or KVM deployment.
- [Viewing CPU Pools in a Bare Metal or KVM Deployment](#)
Use ODACL commands or the Browser User Interface to view all CPU pools or details about a CPU pool in a bare metal or KVM deployment.
- [Modifying a CPU Pool in a Bare Metal or KVM Deployment](#)
Use ODACL commands or the Browser User Interface to modify a CPU pool in a bare metal or KVM deployment.
- [Deleting a CPU Pool in a Bare Metal or KVM Deployment](#)
Use ODACL commands or the Browser User Interface to delete a CPU pool in a bare metal or KVM deployment.
- [Viewing CPU Pool Audit Records in a Bare Metal or KVM Deployment](#)
Use ODACL commands or the Browser User Interface to delete a CPU pool in a bare metal or KVM deployment.
- [About Over-Subscribed CPU Pools](#)
Configure virtual machines so that they do not subscribe to more CPU resources than the resources available in CPU pools.

About CPU Pools

CPU pools enable management of CPU resources on Oracle Database Appliance on both bare metal and KVM deployments. There are three types of CPU pools, that is, BM, VM, and DB system.

Use the BM CPU pool to ensure that the database on a bare metal host runs exclusively on the CPU lists specified in the CPU pool. All Oracle processes are bound to the CPUs in this CPU pool and run only on these CPUs. The bare metal CPU pool is assigned to database by updating the `init.ora` parameter `processor_group_name`.

Use the VM CPU pools to cage and manage CPU resource allocations to workloads for virtual machines. Workloads are isolated by creating CPU pools and assigning or pinning virtual

machines to a specific CPU pool. When you pin a virtual machine to a CPU pool, you ensure that the virtual machine uses CPUs in only that CPU pool.

The DB system CPU pool is similar to the VM CPU pool, but it only applies to a DB system.

Resources in CPU pools cannot overlap, that is, CPU pools cannot share CPUs. But one CPU pool can be assigned to multiple databases (BM CPU pool), or VMs (VM CPU pools), or DB systems (shared DB system CPU pools).

Oracle Database Appliance provides ODACLI commands to create, update, modify, and delete CPU pools.

By default, the first core of the socket is reserved and cannot be used by the VM and DB system CPU pools for optimal performance. This behavior is available from release 19.12 and later when NUMA is enabled. If you want to use the first core of the socket in your CPU pool, then use the `--use-reserved-cores` option to enable use of the first core of socket for VM and DB system CPU pools.

About Bare Metal CPU Pools

For new databases, you can attach the new CPU pool using the `create-database` command. For existing databases, use the `modify-database` command to attach the CPU pool to the database. Restart the database manually for changes to take effect. Clone, `irestore` and recover database operations will also try to use the same CPU pool if the CPU pool is used by the source database. Specify the `--cpupool` option to use the new CPU pool. The standby database uses the CPU pool configured for the primary database. Specify the `--cpupool` option in the `irestore-database` command when restoring the backup to the standby site if you want to use a separate CPU pool on the standby site. For more details about the command syntax, see the *Oracle Database Appliance Command Line Interface* chapter in this guide.

About VM CPU Pools

For new VMs, you can attach the new CPU pool using the `create-vm` command. For existing VMs, use the `modify-vm` command to attach or update the CPU pool. Use the `--live` option to apply the changes to a running VM, and use the `--config` parameter to persist the change. For more details about the command syntax, see the *Oracle Database Appliance Command Line Interface* chapter in this guide.

About DB System CPU Pools

Creating a DB system automatically creates an internal DB system CPU pool associated with this DB system. The internal DB system CPU pool is created and managed internally. It cannot be created, modified, or deleted manually. Starting with Oracle Database Appliance release 19.11, you can create a new type of shared DB system CPU pool which can be shared among DB systems. For more details, see the topic *Managing Shared CPU Pool with Database System in a KVM Deployment* in this guide.

About Audit Records for CPU Pools

CPU pool operations history are recorded in audit records metadata and system log for audit purposes. The CPU pool changes include create, modify, delete operations, and attach and detach operations from VMs and databases. The CPU pool audit records can be queried using `odacli list-auditrecords` and `odacli describe-auditrecord` commands but they can not be changed or deleted. For more details about the command syntax, see the *Oracle Database Appliance Command Line Interface* chapter in this guide.

Understanding the Effect of Changing the CPU Cores on CPU Pool Allocation

You may have changed the CPU core count on Oracle Database Appliance using the `odacli modify-cpucore` command. You must assign cores in multiples of two, with a minimum of two cores. If you change the CPU core count, then you can subsequently only increase the CPU core count.

If you change the CPU core count in an Oracle Database Appliance environment which has CPU pools, then the following behavior is seen:

- `odacli create-cpupool` and `odacli modify-cpupool` will always select the online CPUs. Therefore, on both bare metal and KVM deployments, any CPU pool created after running the `odacli modify-cpucore` command, will select from the available online CPUs.
- For existing CPU pools on bare metal and KVM deployments, some CPUs can become offline when you run the `odacli modify-cpucore` command. Check the CPU pools for any offline CPUs using the `odacli describe-cpupool` command. You can then update the CPU pool to use available ONLINE CPUs by using the `odacli modify-cpupool` command.
- If the databases use a CPU pool and some CPUs become offline, then use the `odacli modify-cpupool` command to update the CPU pool. Restart the databases to use the updated CPU pool.

Related Topics

- [Managing Shared CPU Pool with DB System in a KVM Deployment](#)
Use ODACLI commands or the Browser User Interface to manage shared CPU pool with DB system in a KVM deployment.
- [Oracle Database Appliance Command-Line Interface](#)
The command-line interface has different classes of tools to manage Oracle Database Appliance.

Creating a CPU Pool in a Bare Metal or KVM Deployment

Use ODACLI commands or the Browser User Interface to create a CPU pool in a bare metal or KVM deployment.

Using ODACLI to Create a CPU Pool

Use the command `odacli create-cpupool` to create a CPU pool.

Create a VM CPU pool named `cpupool1` with 6 cores associated to it.

```
# odacli create-cpupool -n cpupool1 -c 6 -vm
```

Using Browser User Interface to Create a CPU Pool

Follow these steps:

1. Log into the Browser User Interface:

```
https://host-ip-address:7093/mgmt/index.html
```

2. Click the **Appliance** tab.
3. Click **CPU Pool** to display the CPU Pool page.

4. Click **Create CPU Pool**.
5. In the Create CPU Pool page, specify the following:
 - **CPU Pool Name:** Name of the CPU pool
 - **CPU Pool Type:** Specify if the CPU pool is for bare metal or virtual system.
 - **Number of CPU Cores:** Number of CPU cores allocated to the pool
 - **Socket to Use:** Specify the sockets to use for the CPU pool.
 - **Configure on:** For high-availability deployments, select the nodes where you want to configure the CPU pool.
 - **Use Reserved CPU Cores:** Select this option to use reserved CPU cores.
6. Click **Create**.
7. When you submit the job, the job ID and a link to the job appears. Click the link to display the job status and details.
8. Validate that the job completed. You can track the job in the **Activity** tab in the Browser User Interface, or run the command `odacli describe-job` with the job ID.

Related Topics

- [odacli modify-dbsystem](#)
Use the `odacli modify-dbsystem` command to modify a DB system on Oracle Database Appliance Kernel-based Virtual Machine (KVM).
- [odacli modify-vm](#)
Use the `odacli modify-vm` command to modify a virtual machine on Oracle Database Appliance Kernel-based Virtual Machine (KVM).
- [Remapping CPU Pools in a Bare Metal or KVM Deployment](#)
Use ODACLI commands or the Browser User Interface to remap CPU pools in a bare metal or KVM deployment.

Remapping CPU Pools in a Bare Metal or KVM Deployment

Use ODACLI commands or the Browser User Interface to remap CPU pools in a bare metal or KVM deployment.

Using ODACLI to Remap CPU Pools

When you patch the bare metal system to Oracle Database Appliance release 19.12 and later, NUMA is enabled after patching. Then, use the command `odacli remap-cpupools` to remap CPU pools.

See the topic *About Enabling NUMA on Oracle Database Appliance* for more information.

Using Browser User Interface to Remap CPU Pools

Follow these steps:

1. Log into the Browser User Interface:

```
https://host-ip-address:7093/mgmt/index.html
```

2. Click the **Appliance** tab.
3. Click **CPU Pool** to display the CPU Pools page.

4. Click **Remap CPU Pool** on the page. This will remap all CPU pools for NUMA allocation.
5. In the confirmation dialog, select **Force Run** if you want to force the remap operation. Select **Use Reserved CPU Cores** to use reserved CPU cores.
6. Click **Yes** to confirm the action.
7. When you submit the job, the job ID and a link to the job appears. Click the link to display the job status and details.
8. Validate that the job completed. You can track the job in the **Activity** tab in the Browser User Interface, or run the command `odacli describe-job` with the job ID.

Related Topics

- [odacli modify-dbsystem](#)
Use the `odacli modify-dbsystem` command to modify a DB system on Oracle Database Appliance Kernel-based Virtual Machine (KVM).
- [odacli modify-vm](#)
Use the `odacli modify-vm` command to modify a virtual machine on Oracle Database Appliance Kernel-based Virtual Machine (KVM).
- [odacli create-cpupool](#)
Use the `odacli create-cpupool` command to create a new CPU pool on Oracle Database Appliance Bare Metal or Kernel-based Virtual Machine (KVM) deployment.

Viewing CPU Pools in a Bare Metal or KVM Deployment

Use ODACLI commands or the Browser User Interface to view all CPU pools or details about a CPU pool in a bare metal or KVM deployment.

Using ODACLI to View CPU Pools

The command `odacli describe-cpupool` displays details about a CPU pool. Use the command `odacli list-cpupools` to view all CPU pools in the deployment.

```
# odacli list-cpupools
```

```
# odacli describe-cpupool -n cpupool1
```

Using Browser User Interface to View CPU Pools

Follow these steps:

1. Log into the Browser User Interface:

```
https://host-ip-address:7093/mgmt/index.html
```

2. Click the **Appliance** tab.
3. Click **CPU Pool** to display the CPU Pool page.
4. You can view the list of all configured CPU pools.
5. To view the details of a CPU pool, click on the CPU pool or click on the Actions drop down and select View Details.

Modifying a CPU Pool in a Bare Metal or KVM Deployment

Use ODACLI commands or the Browser User Interface to modify a CPU pool in a bare metal or KVM deployment.

Using ODACLI to Modify CPU Pool

Use the command `odacli modify-cpupool` to modify a CPU pool.

```
# odacli modify-cpupool -n cpupool1 -c 10
```

Restart the associated databases to use the updated CPU pool.

Using Browser User Interface to Modify CPU Pool

Follow these steps:

1. Log into the Browser User Interface:

```
https://host-ip-address:7093/mgmt/index.html
```

2. Click the **Appliance** tab.
3. Click **CPU Pool** to display the CPU Pools page.
4. From the Actions drop down list for the CPU pool you want to modify, select **Modify**.
5. In the Modify CPU Pool page, specify any changes in the Number of CPU Cores, and select if you want to apply the changes to running VMs or if you want to force the modify operation. Then click **Modify**.
6. When you submit the job, the job ID and a link to the job appears. Click the link to display the job status and details.
7. Validate that the job completed. You can track the job in the **Activity** tab in the Browser User Interface, or run the command `odacli describe-job` with the job ID.

Deleting a CPU Pool in a Bare Metal or KVM Deployment

Use ODACLI commands or the Browser User Interface to delete a CPU pool in a bare metal or KVM deployment.

Using ODACLI to Delete CPU Pool

Use the command `odacli delete-cpupool` to delete a CPU Pool.

Delete a CPU pool named `cpupool1`.

```
# odacli delete-cpupool -n cpupool1
```

Using Browser User Interface to Delete CPU Pool

Follow these steps:

1. Log into the Browser User Interface:

```
https://host-ip-address:7093/mgmt/index.html
```

2. Click the **Appliance** tab.
3. Click **CPU Pool** to display the CPU Pool page.
4. From the Actions drop down list for the CPU pool you want to delete, select **Delete**.
5. Click Yes to confirm your choice.
6. When you submit the job, the job ID and a link to the job appears. Click the link to display the job status and details.
7. Validate that the job completed. You can track the job in the **Activity** tab in the Browser User Interface, or run the command `odacli describe-job` with the job ID.

Viewing CPU Pool Audit Records in a Bare Metal or KVM Deployment

Use ODACLI commands or the Browser User Interface to delete a CPU pool in a bare metal or KVM deployment.

Using ODACLI to View Audit Record Details for CPU Pools

Use the `odacli list-auditrecords` command to list the audit records for a CPU Pool:

```
# odacli list-auditrecords
```

Use the `odacli describe-auditrecord` command to describe the audit record for a CPU Pool.

```
# odacli describe-auditrecord
```

Using Browser User Interface to View Audit Record Details for CPU Pools

Follow these steps:

1. Log into the Browser User Interface:

```
https://host-ip-address:7093/mgmt/index.html
```

2. Click the **Security** tab.
3. Select **Show Advanced Search** and specify the filters for the CPU audit records details such as the From and To dates, Resource type, Resource name, DCS user name, Operation type, and the number of records to display the CPU Pool details.
4. From the list of audit records displayed, click on the audit record ID for which you to drill down for more details.

About Over-Subscribed CPU Pools

Configure virtual machines so that they do not subscribe to more CPU resources than the resources available in CPU pools.

A CPU resource can belong to one, and only one, CPU pool. You can assign multiple virtual machines to a CPU pool. A CPU pool becomes oversubscribed when the virtual machines that are active in the pool require more CPUs than you configured for the pool. For example, if a CPU pool has four CPUs, then you can start two virtual machines that are defined to use four CPUs each. In this case, the CPU pool is oversubscribed, because each of the four CPUs is supporting two virtual machines.

If you stop one of those virtual machines, but start another one that requires two CPUs, then the CPU pool is still oversubscribed. This is because two of the CPUs are supporting both virtual machines. When oversubscribing a CPU pool, assess the performance of the virtual machines in that pool. Reassign one or more virtual machines to a different CPU pool if sharing an oversubscribed pool degrades performance to unacceptable levels.

Managing an Oracle Database Appliance KVM Deployment

KVM virtualization uses a kernel-based virtual machine (KVM) to create a virtualized environment for your Linux applications.

Understand the Oracle Database Appliance KVM architecture, and procedures to deploy a guest virtual machine, manage high availability, manage CPU pools, and configure network settings for Oracle Database Appliance KVM deployment.

- [About Oracle Database Appliance KVM Deployment](#)
You can use Oracle KVM to optimize your system resource use for databases and applications.
- [About Oracle Database Appliance KVM Virtualization Architecture](#)
Review this topic to understand how Oracle Database Appliance KVM deployment works with Oracle Database Appliance hardware.
- [About Virtual Machines and Oracle Database Appliance KVM Deployments](#)
Oracle Database Appliance KVM deployment is designed to run and deploy virtual machines to manage system resources.
- [About KVM DB Systems on Oracle Database Appliance](#)
Understand how you can deploy KVM-based DB systems on Oracle Database Appliance to run your Oracle Database environments.
- [Deploying Multiple Databases on DB Systems on Oracle Database Appliance](#)
Understand the guidelines and procedure to deploy multiple databases on a DB system on Oracle Database Appliance.
- [Managing DB Systems in KVM Deployment](#)
Use ODACLI to create, list, describe, start, stop, and delete DB systems in an Oracle Database Appliance KVM deployment.
- [Setting Up and Configuring a KVM Deployment for Applications](#)
Understand the steps to set up and configure KVM deployment for applications.
- [Managing VM Storage in KVM Deployment](#)
Use ODACLI to create, view, modify, and delete VM storage in an Oracle Database Appliance KVM deployment.
- [Managing Virtual Networks in KVM Deployment](#)
Use ODACLI to create, view, start, stop, and delete virtual networks in an Oracle Database Appliance KVM deployment.
- [Managing Virtual Disks in KVM Deployment](#)
Use ODACLI to create, view, clone, modify, and delete virtual disks on Oracle Database Appliance KVM deployment.
- [Managing Virtual Machines in KVM Deployment](#)
Use ODACLI to create, view, clone, modify, start, stop, and delete virtual machines in an Oracle Database Appliance KVM deployment.
- [About Overcommitting Memory or CPUs in an Oracle Database Appliance KVM System](#)
Understand performance and other considerations before overcommitting CPU and memory for application KVM.

- [Example JSON File to Create a Single-Node DB System](#)
Follow the JSON file example to create a JSON file to deploy a single-node DB System, with role separation, with the command `odacli create-dbsystem`.
- [Example JSON File to Create a High-Availability DB System](#)
Follow the JSON file example to create a JSON file to deploy a High-Availability DB system, with role separation, with the command `odacli create-dbsystem`.

About Oracle Database Appliance KVM Deployment

You can use Oracle KVM to optimize your system resource use for databases and applications.

You can deploy a Kernel-based Virtual Machine (KVM) virtual platform on Oracle Database Appliance. With Oracle Database Appliance KVM deployments, you can use the capabilities of Oracle KVM to effectively allocate resources to databases and applications running on the same physical Oracle Database Appliance. Rather than simply disabling unnecessary server cores, you can use the excess capacity to host other workloads. This enables consolidation of both databases and applications, while retaining the ease of deployment and management associated with Oracle Database Appliance.

See Also:

For more information about supported operating systems, see the *Oracle Linux KVM User's Guide*: <https://docs.oracle.com/en/operating-systems/oracle-linux/kvm-user/index.html>

The KVM feature provides a set of modules that enable you to use the Oracle Linux kernel as a hypervisor. KVM supports x86_64 processor architecture. By default, KVM is built into the Unbreakable Enterprise Kernel (UEK) release. KVM features are actively developed and may vary depending on platform and kernel release. If you are using Unbreakable Enterprise Kernel, you should refer to the release notes for the kernel release of your Oracle Database Appliance to obtain information about features and any known issues or limitations that may apply. KVM is supported on Oracle Linux 7.

What are the differences between KVM and Oracle VM Virtualization?

Oracle KVM makes it easy to setup and manage the virtualized environment with little virtualization expertise. With the KVM deployment, you can consolidate entire multi-tier environments within a single Oracle Database Appliance system.

The following are some of the advantages of deploying Oracle Database Appliance with the KVM option:

- Deploy database and applications in a single hardware environment.
- Use your CPU cores (and memory) efficiently.
- Use virtual local area networks (VLANs) to provide separate networks to different virtual machines.
- Use VM storage to grow storage for the virtual machine repository.
- Enables easy resource management per VM and maintenance of quality of service (QoS)
- Provides solution-in-a-box with application, middleware, and databases.

- Improves data center efficiency by increasing space utilization and reducing energy consumption and cooling costs.
- Oracle KVM virtualization is available on bare metal deployments of Oracle Database Appliance, whereas Oracle VM virtualization on Oracle Database Appliance requires Virtualized Platform setup.
- Oracle Database Appliance supports KVM on all hardware models, whereas Virtualized Platform deployments using Oracle VM are supported on only Oracle Database Appliance High-Availability models.
- Oracle Database Appliance KVM deployments use Type 2 host operating system-based hypervisor, whereas Oracle Database Appliance Virtualized Platform deployments use Type 1 bare metal hypervisor.
- KVM is the virtualization technology used in Oracle Cloud Infrastructure (OCI), where as Oracle Database Appliance Virtualized Platform is based on Xen technology.

About Oracle Database Appliance KVM Virtualization Architecture

Review this topic to understand how Oracle Database Appliance KVM deployment works with Oracle Database Appliance hardware.

Oracle Database Appliance KVM deployment provides virtualization technology that enables multiple applications to share the same physical server. The Oracle Database Appliance KVM architecture is engineered specifically to leverage the Oracle Database Appliance hardware capabilities. Oracle Database Appliance KVM stack is integrated with Oracle Clusterware. The KVM resources such as VM storages and Virtual Machines are registered as CRS resources and are automatically managed by CRS for high availability.

The Oracle Database Appliance KVM virtualization architecture uses the virtual machine components shown in the following illustration:

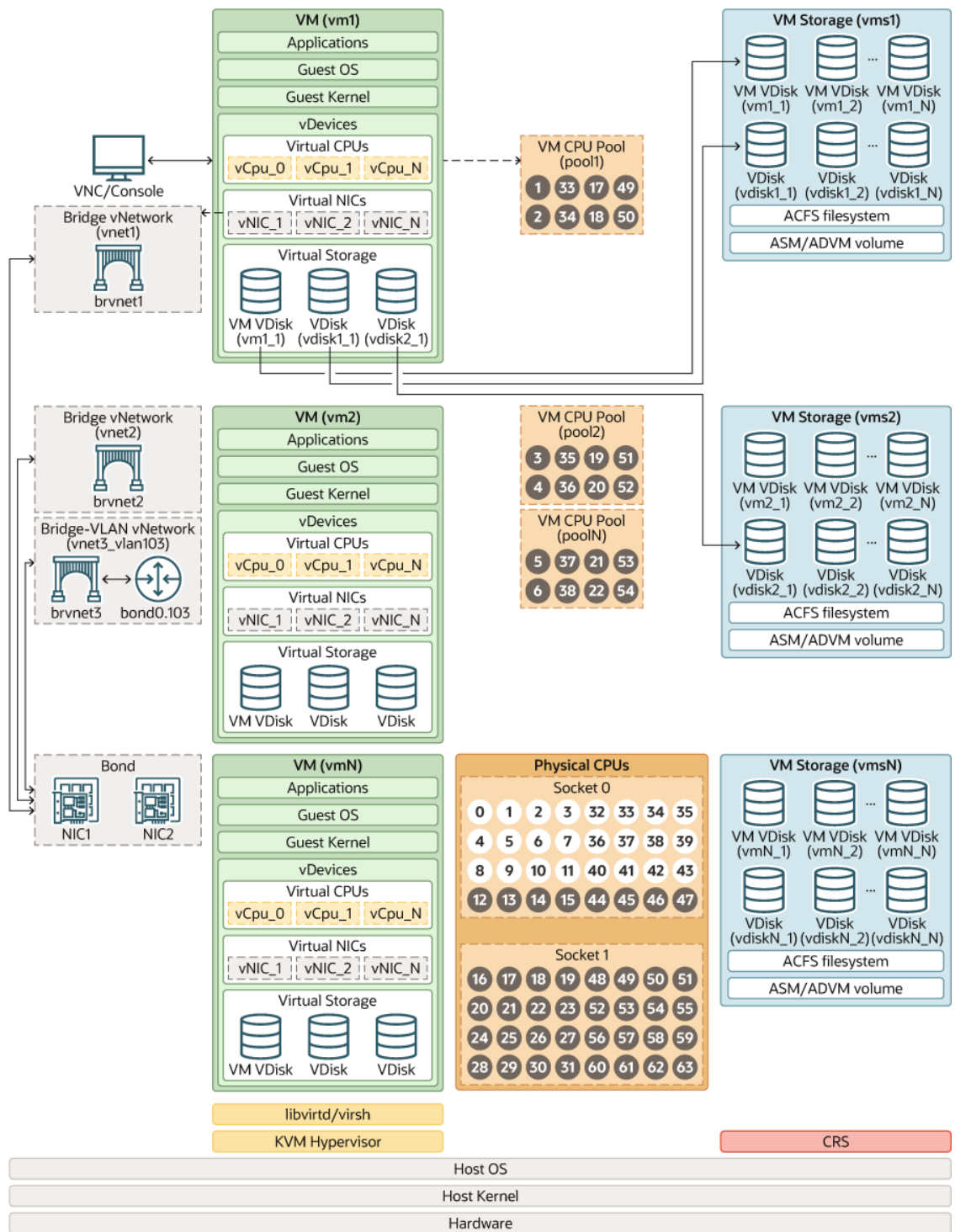

About Virtual Machines and Oracle Database Appliance KVM Deployments

Oracle Database Appliance KVM deployment is designed to run and deploy virtual machines to manage system resources.

Configure virtual machines on Oracle Database Appliance KVM deployment to manage the use of resources, such as the CPU pool, memory, and other shared resources by your application.

Understand the terminology of the various components you need to set up for an Oracle Database Appliance KVM deployment. The ODA CLI tooling handles all the required configuration for your Oracle Database Appliance KVM deployment.

VM Storage

A VM storage is a central location for storing resources that are essential to creating and managing virtual machines. These resources include ISO files (virtual DVD images), virtual machine configuration files, and virtual disks. The VM storage is configured on an Oracle Automatic Storage Management Cluster File System (Oracle ACFS). Oracle Database Appliance KVM uses VM storage to optimize available disk space usage in the environment, and for easy reallocation of virtual machines if a physical server fails. The virtual machine files can be stored on shared disks, providing shared storage for the virtual machines. You can:

- Create one or more virtual machines on the VM storage.
- Use ODA CLI commands to create and manage VM storage, virtual disks, and their virtual machines, and the underlying architecture shown in the illustration.

Virtual Networks

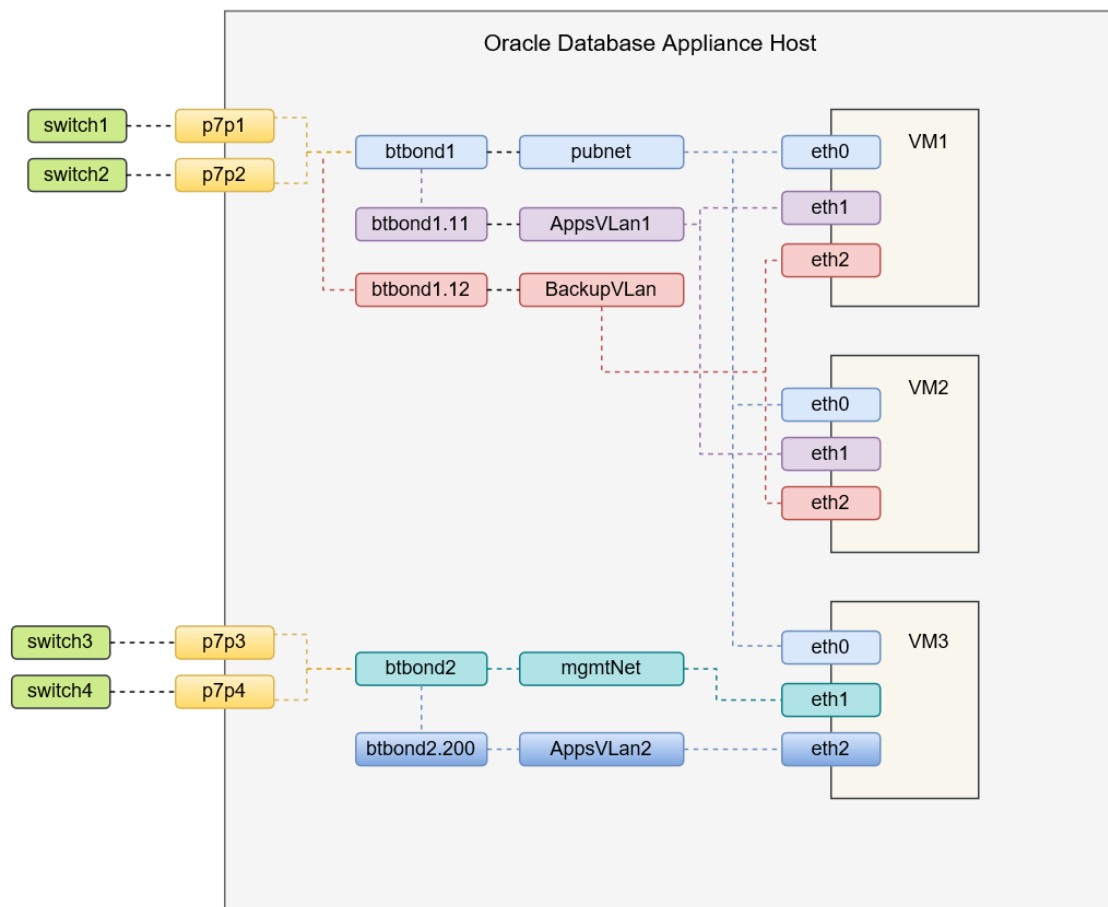

Oracle Database Appliance KVM virtual network supports two type of networks, bridged and bridged-vlan. The above figure is an example of the KVM virtual network on Oracle Database Appliance X8-2 hardware models.

In a bridged network, a Linux bridge is created and the network interface or bond interface, is attached to the bridge. A default bridge network named `pubnet` is created on the public network selected during the appliance deployment. Any VM that wants to access this public network can be attached to this `pubnet` vnetwork. This `pubnet` vnetwork cannot be modified or deleted. In the above diagram, `btbond1` is used for the public network, and default vnetwork `pubnet` is created with `btbond1.eth0` of VMs are attached to this `pubnet` vnetwork. Except for the default `pubnet` bridge, no other bridged network is allowed to be created on this public network interface. Additional bridged vnetwork can be created on other interfaces that are not used for the public network. In the above diagram, the `mgmtNet` bridged network is created with `btbond2.eth1` of VM3 is attached to this `mgmtNet` vnetwork.

For example:

```
odacli create-vnetwork --name mgmtNet --bridge mgmtNet --type bridged --  
interface btbond2 --ip ip_address --gateway gateway --netmask netmask
```

In a bridged-vlan network, VLAN can be created on all available public interfaces, including the interface where public network is already configured. For example, you can create a VLAN on both `btbond1` and `btbond2`. Follow proper procedures to configure the VLAN on the switch before creating the bridged-vlan network. In the figure above, `backupVlan` and `AppsVlan1` are created from `btbond1` and attached to `eth1` and `eth2` of VM1 and VM2 respectively.

For example:

```
odacli create-vnetwork --name backupvlan --bridge backupvlan --type bridged-  
vlan --vlan-id 12 --interface btbond1 --ip ip_address --gateway gateway --  
netmask netmask
```

vnetwork is not supported on private interfaces and secondary interfaces of the bond interface.

Virtual Disks

In addition to virtual machines, you can create virtual disks in VM storage. Virtual disks provide additional storage options for virtual machines by enabling you to attach additional block storage to your virtual machines. Similarly, you can detach the disk if you no longer need the additional space. You can use virtual disks to expand existing file system storage inside the virtual machine by adding the new virtual disk to an existing logical volume, or by creating a new file system on a virtual disk. Virtual disks can optionally be attached to multiple virtual machines.

Virtual Machines

A *virtual machine* is granted virtual resources, and can be started, stopped, cloned, and restarted independently. By default, virtual machines are created with `autostart` and `failover` enabled for high-availability models. During failover, the VM is automatically started, and there will be attempt to restart once before failing over to a different node on high-availability models. You can enable or disable `autostart` and `failover` using the `odacli modify-vm` command options. The option to `autostart` is also available on single-node Oracle Database Appliance models.

About KVM DB Systems on Oracle Database Appliance

Understand how you can deploy KVM-based DB systems on Oracle Database Appliance to run your Oracle Database environments.

About KVM DB Systems

KVM DB systems enable hard partitioning for Oracle Database licensing, where each KVM DB system has its own CPU pool that is automatically assigned during KVM DB system creation. Oracle Database Appliance simplifies the management of KVM DB systems with the built-in Browser User Interface (BUI) or ODA CLI Command Line Interface (ODACLI).

About KVM DB System Architecture

You can provision and configure a DB system on an Oracle KVM. The database can be a single-instance Oracle Database or an Oracle RAC Database with two instances. You can create multiple databases in each DB system.

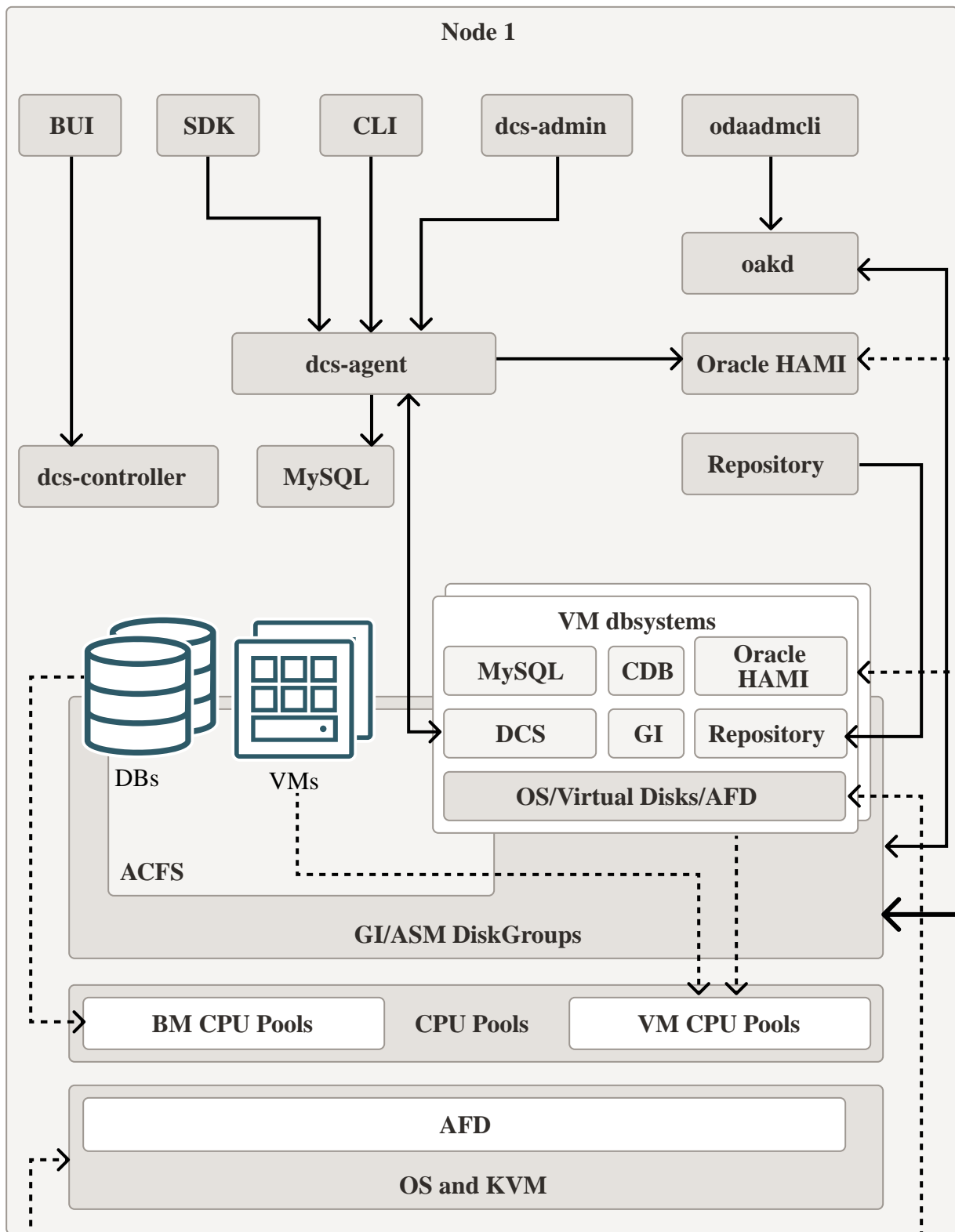

About KVM DB System Networks

Each Oracle Database Appliance DB system on KVM has the following networks created by default:

- Public network:** The default vnetwork pubnet is created on the bare metal system, based on the public interface you select for Oracle Grid Infrastructure provisioning. When you create a DB system, the public network of the DB system is attached to the pubnet vnetwork created on the bare metal system. The pubnet network is selected by default as the public network of the DB system. You can also create a different vnetwork and use it as public network for the dbsystem.
- Oracle ASM network:** Oracle Database Appliance DB system uses Oracle ASM to manage the database storage. The Oracle ASM instance runs on bare metal systems, but not on the DB system. The database on the DB System uses the Oracle ASM listener running on the bare metal system to communicate with Oracle ASM. The Oracle ASM network for example, privasm in the network diagram below, is created to facilitate this communication between the database on the DB system and the Oracle ASM listener on the bare metal system. This network is also used for communications between the DCS agent on the DB system and DCS agent on the bare metal system, and for enabling sharing of the central repository on bare metal system with the DB systems.
- DB system cluster interconnect network:** When DB system is created as a two-node cluster on high-availability model, a cluster interconnect network is created automatically and it is deleted when the DB system is deleted. Each cluster owns its cluster interconnect. Different DB system cannots communicate with each other using cluster interconnect network. 192.168.16.0/24 and 192.168.17.0/24 are reserved for the use of these two internal networks. So, ensure that the IP CIDR 192.168.16.0/24 and 192.168.17.0/24 are available for use by Oracle Database Appliance DB system on KVM.
- Starting with Oracle Database Appliance release 19.12, you can create a vnetwork, either a bridged or bridged-vlan vnetwork, such as vnet2 in the image below, and then use the `odacli modify-dbsystem` command to attach the vnetwork to the dbsystem.

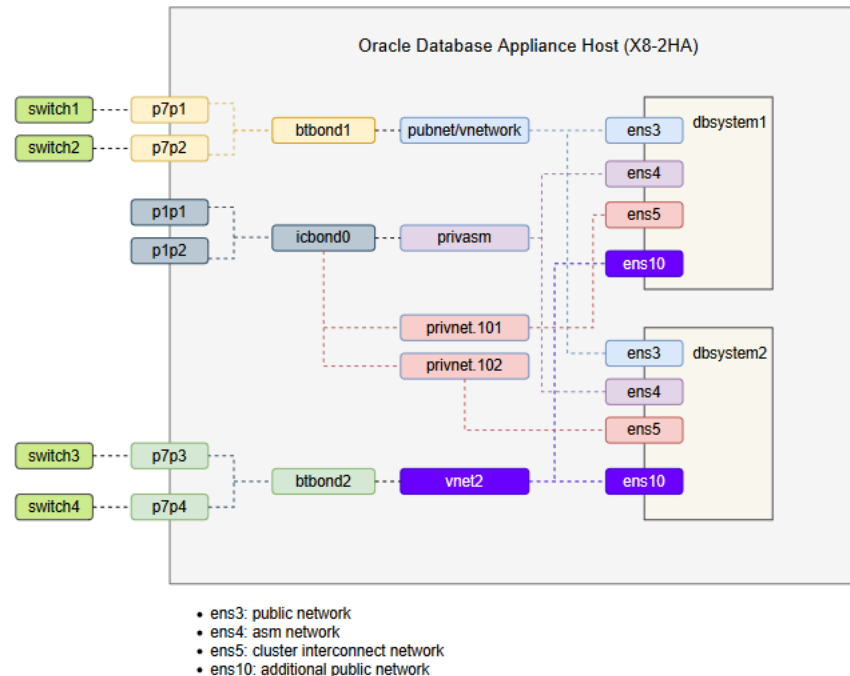

Restrictions When Deploying KVM DB System

The following restrictions apply when you deploy KVM DB system on Oracle Database Appliance:

- You cannot use Oracle ACFS for storage within the DB system. The database running inside the dbssystem uses Oracle ASM storage. The VM is created on Oracle ACFS based storage.
- On Oracle Database Appliance DB systems, the Oracle Grid Infrastructure software installed is of the same version as the Oracle Database version you install. The version is specified in the DB system JSON payload, with the attribute `version` for `database`.
- You cannot configure CPU pools or run VM commands within the DB system.

Deploying Multiple Databases on DB Systems on Oracle Database Appliance

Understand the guidelines and procedure to deploy multiple databases on a DB system on Oracle Database Appliance.

Supported DB System Shapes

In earlier releases of Oracle Database Appliance, where the DB system supported creation of only one database, the DB system shape was the same as the database shape. Starting with Oracle Database Appliance release 19.23, you can create multiple databases on the DB system, with a separate DB system shape `dbsx`, where X is the number of CPU cores on the DB system VM. X is an even number that ranges from 2 to N-2 where N is the maximum number of CPU cores on the bare metal system. You can view the value of N with the `odacli list-cpucores` command on the bare metal system. The default memory of the DB system is eight times that of the CPU cores of the DB system. You can create the DB system with custom memory size that is larger than the default memory size by specifying the memory size in the JSON file or BUI when you create the DB system.

Restrictions and Guidelines for Deploying Multiple Databases on DB Systems

You can provision and configure a DB system on an Oracle KVM. The database can be a single-instance Oracle Database or an Oracle RAC Database with two instances. Starting with Oracle Database Appliance release 19.23, you can create multiple databases in each DB system. For an existing appliance, after you patch the bare metal system to Oracle Database Appliance release 19.23, you can create new DB systems that support multiple databases. For existing DB systems to support multiple databases, you must patch them to Oracle Database Appliance release 19.23 first. To check whether a DB system supports multiple databases, run the `odacli list-dbsystems` command and verify that the shape of the DB system is `dbsx`.

- You can create multiple databases on DB systems with Oracle Database release 19c version, but cannot create different major version databases within a DB system. To create a DB system that supports 19c database, specify a 19c starter database during the DB system creation. If no starter database is specified in the DB system creation payload, a DB system that supports 19c database is created.
- You can use the `odacli create-database` command to create the first database if you did not choose to create a starter database, or additional databases in the DB system. The Oracle Grid Infrastructure home and database home are configured on the local file system `/u01` of the DB system.

- When you create a database in DB system with the `odacli create-database` command, the default database shape is `odb1`.
- DB system must be sized properly based on the sizing requirement of databases running in the DB system. Taken together, the shapes of databases running in a DB system must be no greater than the shape of the DB system, for example, databases `odbA`, `odbB`, ..., `odbN` running in the DB system shape `dbsX`, then $A+B+\dots+N$ must be less than or equal to `X`. You can change the DB system shapes to meet the sizing requirement of the databases in the DB system.
- When you create a DB system, if you specify the starter database, then Oracle Grid Infrastructure of the same release as the database is installed. If you do not specify a starter database when you create a DB system, then Oracle Grid Infrastructure of the same release as the Oracle Database Appliance is installed.
- When you delete a DB system, and you use the `--force` option with the `odacli delete-dbsystem` command, all database data files in the DB system are deleted.
- You can move databases in the DB system across different database homes using the `odacli move-database` command.
- You can restore databases with the `odacli irestore-database` command to a DB system with support for multiple databases. This may result in multiple databases running in the DB system. Make sure the DB system shape supports the additional databases restored. If not, change the DB system shape to accommodate additional databases.
- Starting with Oracle Database Appliance release 19.23, the `odacli modify-dbsystem --shape` command only changes the shape of the DB system; it does not change the shapes of the database inside the DB system any more. You must modify database shapes accordingly based on the new shape of the DB system. Ensure that you scale up database shapes after the DB system shape is scaled up. Similarly, scale down database shapes before DB system shape is scaled down, otherwise databases could fail to start because of reduced DB system memory.

Creating Multiple Databases on DB Systems

You can create databases on the DB system in one of the following ways:

- When you create the DB system using the `odacli create-dbsystem` command, you can optionally choose to create the starter database. The Oracle Grid Infrastructure software is installed and the started database is created. You specify the starter database details in the JSON file.
- If you do not specify the starter database details in the JSON file when you create the DB system, then only Oracle Grid Infrastructure is installed, but a database is not created. After the `odacli create-dbsystem` command completes successfully, you can then create multiple databases using the `odacli create-database` command.

Example JSON files to create databases on DB systems

Example JSON file to create DB system with starter database:

```
{
  "system": {
    "name": "dbsystem1",
    "diskGroup": "DATA",
    "systemPassword": "password",
    "timeZone": "Pacific/Majuro",
    "enableRoleSeparation": false,
    "shape": "dbs4",
```

```

"customRoleSeparation": {
  "users": [
    {
      "name": "oracle",
      "id": 1618,
      "role": "oracleUser"
    }
  ],
  "groups": [
    {
      "name": "oinstall",
      "id": 1018,
      "role": "oinstall"
    },
    {
      "name": "dbaoper",
      "id": 1019,
      "role": "dbaoper"
    },
    {
      "name": "dba",
      "id": 1020,
      "role": "dba"
    },
    {
      "name": "asmadmin",
      "id": 1021,
      "role": "asmadmin"
    },
    {
      "name": "asmoper",
      "id": 1022,
      "role": "asmoper"
    },
    {
      "name": "asmdba",
      "id": 1023,
      "role": "asmdba"
    }
  ]
},
"network": {
  "domainName": "us.oracle.com",
  "ntpServers": [
    "xx.xx.xxx.xx"
  ],
  "dnsServers": [
    "xxx.xxx.xx.x",
    "xxx.xx.xxx.xx"
  ],
  "scanName": "dbssystem1-scan",
  "scanIps": [
    "xx.xx.xxx.xxx",
    "xx.xx.xxx.xxx"
  ],

```



```

"nodes": [
  {
    "name": "node1",
    "ipAddress": "xx.xx.xx.xxx",
    "netmask": "xxx.xxx.xxx.x",
    "gateway": "xx.xx.xxx.x",
    "number": 0,
    "vipName": "node1-vip",
    "vipAddress": "xx.xx.xxx.xxx"
  },
  {
    "name": "node2",
    "ipAddress": "xx.xx.xxx.xxx",
    "netmask": "xxx.xxx.xxx.0",
    "gateway": "xx.xx.xxx.x",
    "number": 1,
    "vipName": "node2-vip",
    "vipAddress": "xx.xx.xxx.xxx"
  }
],
"grid": {
  "language": "en",
  "enableAFD": false
},
"database": {
  "name": "rZWuZTw4",
  "uniqueName": "rZWuZTw4U",
  "domainName": "test_domain",
  "adminPassword": "password",
  "version": "19.26.0.0.250121",
  "edition": "EE",
  "type": "RAC",
  "dbClass": "IMDB",
  "shape": "odb2",
  "role": "PRIMARY",
  "targetNodeNumber": null,
  "enableDbConsole": false,
  "enableUnifiedAuditing": true,
  "redundancy": null,
  "characterSet": {
    "characterSet": "AL32UTF8",
    "nlsCharacterSet": "AL16UTF16",
    "dbTerritory": "AMERICA",
    "dbLanguage": "AMERICAN"
  },
  "rmanBackupPassword": null,
  "level0BackupDay": null,
  "enableTDE": false,
  "tdePassword": null,
  "isCdb": true,
  "pdbName": "test_pdb",
  "pdbAdminUser": "test_pdb_admin"
}
}

```

Example JSON file to create DB system without starter database:

```
{
  "system": {
    "name": "dbsystem1",
    "diskGroup": "DATA",
    "systemPassword": "password",
    "timeZone": "Pacific/Majuro",
    "enableRoleSeparation": false,
    "shape": "dbs4",
    "customRoleSeparation": {
      "users": [
        {
          "name": "oracle",
          "id": 1618,
          "role": "oracleUser"
        }
      ],
      "groups": [
        {
          "name": "oinstall",
          "id": 1018,
          "role": "oinstall"
        },
        {
          "name": "dbaoper",
          "id": 1019,
          "role": "dbaoper"
        },
        {
          "name": "dba",
          "id": 1020,
          "role": "dba"
        },
        {
          "name": "asmadmin",
          "id": 1021,
          "role": "asmadmin"
        },
        {
          "name": "asmoper",
          "id": 1022,
          "role": "asmoper"
        },
        {
          "name": "asmdba",
          "id": 1023,
          "role": "asmdba"
        }
      ]
    }
  },
  "network": {
    "domainName": "testdomain",
    "ntpServers": [
      "xx.xx.xxx.xx"
    ]
  }
}
```

```

    ],
    "dnsServers": [
        "xxx.xxx.xx.x",
        "xx.xx.xxx.xx"
    ],
    "scanName": "dbssystem1-scan",
    "scanIps": [
        "xx.xx.xxx.xxx",
        "xx.xx.xxx.xxx"
    ],
    "nodes": [
        {
            "name": "node1",
            "ipAddress": "xx.xx.xx.xx",
            "netmask": "xxx.xxx.xxx.x",
            "gateway": "xx.xx.xxx.x",
            "number": 0,
            "vipName": "node1-vip",
            "vipAddress": "xx.xx.xxx.xxx"
        },
        {
            "name": "node2",
            "ipAddress": "xx.xx.xx.xx",
            "netmask": "xxx.xxx.xxx.x",
            "gateway": "xx.xx.xxx.x",
            "number": 1,
            "vipName": "node2-vip",
            "vipAddress": "xx.xx.xxx.xxx"
        }
    ]
},
"grid": {
    "language": "en",
    "enableAFD": false
},
"database": null
}

```

Managing DB Systems in KVM Deployment

Use ODACLI to create, list, describe, start, stop, and delete DB systems in an Oracle Database Appliance KVM deployment.

- [Creating a DB System in a KVM Deployment](#)
Use ODACLI commands or the Browser User Interface to create a DB system in a KVM deployment.
- [Listing DB Systems in a KVM Deployment](#)
Use ODACLI commands or the Browser User Interface to list DB systems in a KVM deployment.
- [Describing a DB System in a KVM Deployment](#)
Use ODACLI commands or the Browser User Interface to describe a DB system in a KVM deployment.

- [Modifying a DB System in a KVM Deployment](#)
Use ODACLI commands or the Browser User Interface to modify a DB system in a KVM deployment.
- [Attaching and Detaching a Network for a DB System in a KVM Deployment](#)
Use ODACLI commands to attach or detach networks for DB system in a KVM deployment.
- [Starting a DB System in a KVM Deployment](#)
Use ODACLI commands or the Browser User Interface to start a DB system in a KVM deployment.
- [Stopping a DB System in a KVM Deployment](#)
Use ODACLI commands or the Browser User Interface to stop a DB system in a KVM deployment.
- [Deleting a DB System in a KVM Deployment](#)
Use ODACLI commands or the Browser User Interface to delete a DB system in a KVM deployment.
- [Managing Backup, Restore, and Recovery on a DB System in a KVM Deployment](#)
Understand the backup, restore, and recovery operations supported on a DB system in a KVM deployment.
- [Managing Shared CPU Pool with DB System in a KVM Deployment](#)
Use ODACLI commands or the Browser User Interface to manage shared CPU pool with DB system in a KVM deployment.
- [Managing Oracle Data Guard on a DB System in a KVM Deployment](#)
Understand the Oracle Data Guard operations supported on a DB system in a KVM deployment.

Creating a DB System in a KVM Deployment

Use ODACLI commands or the Browser User Interface to create a DB system in a KVM deployment.

Important:

Oracle Grid Infrastructure of the same version as the database version is installed in the DB system. Use the command `odacli describe-dbsystem-image` to check the supported database versions for the DB system. Oracle Database Appliance release 19.26 supports creation of 23ai DB system that runs Oracle Grid Infrastructure 23ai and Oracle Database 23ai. To create 23ai DB system, download and update the repository with DBVM 23ai template (patch 36524660), Oracle Grid Infrastructure 23ai clone (patch 36524627), and Oracle Database 23ai clones (patch 36524642). Specify the starter Oracle Database 23ai version in the create-dbsystem JSON file. Use the `odacli describe-dbsystem-image` command to check the exact Oracle Database 23ai version. The 23ai DB system supports running only Oracle Database 23ai database.

NOT_SUPPORTED:

To create the DB system, access control must be enabled in Oracle ASM running on bare metal system. When the bare metal system is newly provisioned or patched to Oracle Database Appliance release 19.26, access control is already enabled, which is a prerequisite for setting appropriate file ownerships for all the files created in DB systems and on the bare metal system. Before you create the DB system, the files on Oracle ASM disk groups that do not have file ownership must be set up with ownership. If ownership is not set, then creation of DB system fails. Use the `odacli modify-dbfileattributes` command to set up the file ownerships.

Using ODACLI to Create a KVM DB System

Use the command `odacli create-dbsystem` to create a KVM DB system.

Follow these steps:

1. Download the Oracle Database Appliance KVM DB System Image from My Oracle Support to a temporary location on an external client. Refer to the release notes for details about the software for the latest release.
For example, to create a 23ai DB system, use patch number 36524660. For 19c DB system, use patch number 32451228.

```
patch_number_1926000_Linux-x86-64.zip
```

2. Unzip the software — it contains README.html and one or more zip files for the patch.

```
unzip patch_number_1926000_Linux-x86-64.zip
odacli-dcs-19.26.0.0.0-date-ODAVM-19.26.0.0.zip
```

3. Update the repository with the image.

```
# /opt/oracle/dcs/bin/odacli update-repository -f /tmp/odacli-
dcs-19.26.0.0.0-date-ODAVM-19.26.0.0.zip
```

4. Run the `odacli describe-dbsystem-image` command to query the supported Oracle Grid Infrastructure and Oracle Database versions for this DB system KVM image. The Oracle Grid Infrastructure version that supports the Oracle Database version is installed.

```
# odacli describe-dbsystem-image
DB System Image details
-----
-----
Component Name Supported Versions Available Versions
-----
DBVM 23.5.0.1.0 23.5.0.1.0
GI 23.5.0.24.07 23.5.0.24.07
   23.5.0.24.07 23.5.0.24.07
DB 23.5.0.24.07 23.5.0.24.07
   23.5.0.24.07 23.5.0.24.07
DBVM 19.24.0.0.0 19.24.0.0.0
   GI 19.24.0.0.240716 19.24.0.0.240716
                               19.23.0.0.240416 not-available
                               19.22.0.0.240116 not-available
```

```

19.21.0.0.231017 not-available
19.20.0.0.230718 not-available
19.19.0.0.230418 not-available
19.18.0.0.230117 not-available
19.17.0.0.221018 not-available
19.16.0.0.220719 not-available
19.15.0.0.220419 not-available
19.14.0.0.220118 not-available
19.13.0.0.211019 not-available
19.12.0.0.210720 not-available
19.11.0.0.210420 not-available
21.8.0.0.221018 not-available
21.7.0.0.220719 not-available
21.6.0.0.220419 not-available
21.5.0.0.220118 not-available
21.4.0.0.211019 not-available
21.3.0.0.210720 not-available
DB 19.24.0.0.240716 19.24.0.0.240716
19.23.0.0.240416 not-available
19.22.0.0.240116 not-available
19.21.0.0.231017 not-available
19.20.0.0.230718 not-available
19.19.0.0.230418 not-available
19.18.0.0.230117 not-available
19.17.0.0.221018 not-available
19.16.0.0.220719 not-available
19.15.0.0.220419 not-available
19.14.0.0.220118 not-available
19.13.0.0.211019 not-available
19.12.0.0.210720 not-available
19.11.0.0.210420 not-available
21.8.0.0.221018 not-available
21.7.0.0.220719 not-available
21.6.0.0.220419 not-available
21.5.0.0.220118 not-available
21.4.0.0.211019 not-available
21.3.0.0.210720 not-available

```

5. If the `odacli describe-dbsystem-image` command output shows any component as `not-available` on the system, then download the component with supported versions and run the `odacli update-repository` to import the component to the repository. To deploy Oracle Database release 19.26, deploy Oracle Grid Infrastructure release 19.26. To deploy 23ai DB system, ensure that the DBVM 23.4.x, Oracle Grid Infrastructure 23.4.x, and Oracle Database 23.4.x clones are shown available in the `odacli describe-dbsystem-image` command output.
6. Create the `prov.json` file as per examples provided in this chapter. Oracle Database 21c and later supports only Container Databases (CDB). Ensure that you set the parameter `"isCdb": true`, and provide both the `pdbName` and `pdbAdminUser` in the JSON file if provisioning an Oracle Database 21c or later DB system.
7. Run the `odacli create-dbsystem` command with the `prov.json` file on the host.

```
# odacli create-dbsystem -p prov.json
```

8. If the `odacli create-dbsystem` command displays the message `ASM ACL setup is not completed`, please run `'odacli modify-dbfileattributes'` command, then run the `odacli modify-dbfileattributes` command, and make sure the job finishes successfully before running the `odacli create-dbsystem` command.
9. If the `odacli create-dbsystem` command displays the message `css_critical` configuration should be different on both nodes on a high-availability environment, then follow the instructions below to set `css_critical` and ensure that the DB system functions properly when interconnect fails.
 - a. Run `crsctl set server css_critical yes` on the first bare metal host. You must restart the Oracle Clusterware stack on the node for the values to take effect.
 - b. Run `crsctl set server css_critical no` on the second bare metal host. You must restart the Oracle Clusterware stack on the node for the values to take effect.
 - c. Run `crsctl get server css_critical` to verify the value.
Refer to *Oracle Clusterware Administration and Deployment Guide* for more details about setting `css_critical`.

Using Browser User Interface to Create a KVM DB System

Follow these steps:

1. Log into the Browser User Interface:

```
https://host-ip-address:7093/mgmt/index.html
```

2. Click the **Appliance** tab.
3. Click **DB Systems** to display the DB Systems page.
4. In the page, click **Create DB System**.
5. In the Create DB System page, provide the DB system values.
6. If you want to use an existing configuration file, click **Browse** and select the configuration file. The system information from the file is populated in the relevant fields.
7. In the System Information tab, specify the values as follows.
 - **DB System Name:** Enter the DB System name. The name cannot end with a dash (-). Do not exceed 15 characters.
 - **Domain Name:** Enter the domain name.
 - **Region:** Select the region of the world where the Oracle Database Appliance is located.
 - **Time Zone:** Select the time zone where the Oracle Database Appliance is located.
 - Select **Specify Multi-User Access Option** to enable multi-user access on the DB system. You can choose either the **Enable Multi-User Access** or **Enable Passwordless Multi-User Access** option. For more information about these features, see the chapter *Implementing Multi-User Access on Oracle Database Appliance* in this guide.
 - If you choose to enable multi-user access, then specify and confirm the **ODA Administrator User Password**, **Oracle User Password**, and **Grid User Password**. Click **Configure Multi-User Access Settings** and set the **User Password Expiry Duration**, **Session Expiration for CLI**, and **Maximum Failed Login Attempts**.

- If you choose to enable passwordless multi-user access, then you do not need to specify any of the above passwords.
 - **System Password and Confirm Password:** Enter the system password in both fields. The system password is the password set for UNIX and `root` users. The password must contain at least two characters each from: uppercase letters, lowercase letters, numbers (0-9), and allowed special characters #, - or `_`. The password must have a minimum of 9 characters and a maximum of 30 characters. Select the **Assign same password for admin, oracle, and grid users** option if you want to keep the same password for all users.
 - **Disk Group for VM Storage:** Select the disk group that is used for hosting the KVM storage. Note that this is different from the database file storage for the database that runs in the KVM, which is displayed automatically from the correct Oracle ASM disk group based on the database file type.
 - **CPU Pool Name:** Select the CPU pool to be associated with the DB system.
 - Select **Force Run** if you want to allow the DB system to use this CPU pool even if selecting the CPU pool leads to oversubscription of the CPU pool. Select **Use Reserved CPU Cores** to use reserved CPU cores.
 - **Memory Size:** Specify the memory to be allocated to the DB system. The memory size can be in KB, MB, GB, or TB. The default is GB.
 - **VM Storage Redundancy:** Specify the redundancy for the VM storage, either **Mirror** or **High**.
 - (Optional) **DNS Servers:** Enter addresses for one or more DNS servers.
 - (Optional) **NTP Servers:** Enter addresses for one or more NTP servers.
 - **Public Network:** Select from the existing virtual networks.
8. In the Network Information tab, specify the client access network details.
- **Node Name:** For Node0, enter the host name for the primary client access network.
 - **IP Address:** Enter the virtual IP address that is shared between the nodes.
 - **Subnet Mask:** Enter the subnet mask address for the primary client access network.
 - **Gateway:** Enter the gateway address for the primary client access network.
- For two-node deployments, provide the above values for both nodes. In addition, you must also specify the following:
- **VIP Name and VIP Address:** Specify the Virtual IP name and address.
 - **SCAN Name and SCAN IP Address:** Specify the Single Client Access Name (SCAN) and SCAN IP address.
9. In the User and Group Selection tab, configure your users and groups and specify whether or not you want to allow operating system role separation:
- Two users with six groups: Customize Users and Groups, select **No**. Allow OS Role Separation, select **Yes**. This is the default configuration.
 - Two customized users with six customized groups: Customize Users and Groups, select **Yes**. Allow OS Role Separation, select **Yes**.
 - Single user with two groups: Customize Users and Groups, select **No**. Allow OS Role Separation, select **No**.
 - Single user with six groups: Customize Users and Groups, select **Yes**. Allow OS Role Separation, select **No**.

- Specify the **GI User**, **DB User**, **Install Group**, **DBA Oper Group**, **DBA Group**, **ASM Admin Group**, **ASM Oper Group**, **ASM DBA Group**, and the User and Group IDs.
10. In the Database Information tab, specify the following information to configure the database:
- **DB Name:** Enter a name for the database. The name must contain alphanumeric characters and cannot exceed 8 characters.
 - **DB Version:** Specify the database version.
 - (Optional) **DB Unique Name:** Enter a globally unique name for the database. Databases with the same DB Name within the same domain (for example, copies of a database created for reporting or a physical standby) must have a different DB Unique Name that is unique within the enterprise. The name must begin with a lowercase or uppercase letter, and contain only alphanumeric characters and underscores(_). The name must not contain dollar (\$), and pound (#) characters. The name cannot exceed 30 characters.
 - **CDB:** Select **Yes** or **No** to specify whether or not you want a Container Database (CDB).
 - **PDB Name:** Enter a name for the pluggable database (PDB).
 - **PDB Admin User:** Enter an Admin user name for the pluggable database (PDB). The name must begin with an alphanumeric character. You can specify alphanumeric characters and underscore (_) in the name.
 - **Database Edition:** Select the Oracle Database edition, either Standard Edition and Enterprise Edition. Your license determines which database edition you are eligible to create in the DB System.
 - **Deployment:** Select the type of Deployment, whether **RAC**, **RAC One**, or **SI**. For Standard Edition Oracle Database 19c or later, you can only create single-instance Oracle Database. For Standard Edition Oracle Database 19.6 or later, you can choose to enable high availability for single-instance database.

For Enterprise Edition Oracle Database 19.15 or later or Oracle Database 21.6 or later, you can choose to enable high availability for single-instance databases. For Enterprise Edition Oracle Database 19.15 or later or Oracle Database 21.6 or later, if you choose to create a single-instance database, then the high availability feature is disabled by default. To enable high-availability, set the value in the **Enable High Availability** field to **Yes**.
 - **Sys and PDB Admin User Password and Confirm Password:** Provide a password for the database.
 - **Shape:** Select a database shape from the list.
 - **Database Redundancy:** If disk group redundancy is FLEX, then select **HIGH** or **MIRROR** from the drop down list for database redundancy. If the disk group redundancy is not FLEX, then the database redundancy field is not available and is set to the same as the disk group redundancy internally.
 - In the **Database Class** field, select a database class from the drop-down list. If an option is not available in the list, it is not supported for the database edition on the Oracle Database Appliance or the version that you selected. The default is OLTP.
 - **Configure EM Express:** Select **Yes** or **No**. Select **Yes** to configure the Oracle Enterprise Manager Database Express (EM Express) console.
 - **Character set:** Select a character set.
 - **National Characterset:** Select a national character set.

- **Language:** Select the database language.
 - **Territory:** Select a territory or location from the list.
 - For Oracle Database Enterprise Edition 19c or later, you can choose to enable Transparent Database Encryption (TDE). Select **Yes** or **No** in the **Enable TDE** option. Specify and confirm the **TDE Password**. By default, the TDE option is disabled.
 - **Data Files on Flash Storage:** Select **Yes** or **No**. This option is only available if the high-availability system has HDD storage drives.
11. Click **Create**.
 12. When you submit the job, the job ID and a link to the job appears. Click the link to display the job status and details.
 13. Validate that the job completed. You can track the job in the **Activity** tab in the Browser User Interface, or run the command `odacli describe-job` with the job ID.

Related Topics

- [Implementing Multi-User Access on Oracle Database Appliance](#)
Understand how multi-user access can be implemented on Oracle Database Appliance, its advantages and restrictions and the associated life cycle management changes for your appliance.
- [Example JSON File to Create a High-Availability DB System](#)
Follow the JSON file example to create a JSON file to deploy a High-Availability DB system, with role separation, with the command `odacli create-dbsystem`.
- [Example JSON File to Create a Single-Node DB System](#)
Follow the JSON file example to create a JSON file to deploy a single-node DB System, with role separation, with the command `odacli create-dbsystem`.
- [odacli describe-dbsystem-image](#)
Use the `odacli describe-dbsystem-image` command to view the supported Oracle Grid Infrastructure and Oracle Database versions and the availability of the clone files and Database System KVM image in the Oracle Database Appliance system.
- [odacli modify-dbfileattributes](#)
Use the `odacli modify-dbfileattributes` command to properly set the file attributes (permissions and ownership) of files on Oracle ASM disk group on a bare metal host to support a dbsystem. Only run this command if prompted by the `odacli create-dbsystem` command.

Listing DB Systems in a KVM Deployment

Use ODACLI commands or the Browser User Interface to list DB systems in a KVM deployment.

Using ODACLI to List DB Systems

Use the command `odacli list-dbsystems` to list DB systems.

```
# odacli list-dbsystems
```

Using Browser User Interface to List DB Systems

Follow these steps:

1. Log into the Browser User Interface:

```
https://host-ip-address:7093/mgmt/index.html
```

2. Click the **Appliance** tab.
3. Click **DB Systems** to display the DB Systems page.
4. In the page, click on the DB system for which you want to view details.

Related Topics

- [odacli list-dbsystems](#)
Use the `odacli list-dbsystems` command to view the database systems on Oracle Database Appliance Kernel-based Virtual Machine (KVM).

Describing a DB System in a KVM Deployment

Use ODACLI commands or the Browser User Interface to describe a DB system in a KVM deployment.

Using ODACLI to Describe a DB System

Use the command `odacli describe-dbsystem` to describe a DB system.

```
# odacli describe-dbsystem -n dbsystem_name
```

Using Browser User Interface to Describe a DB System

Follow these steps:

1. Log into the Browser User Interface:

```
https://host-ip-address:7093/mgmt/index.html
```

2. Click the **Appliance** tab.
3. Click **DB Systems** to display the DB Systems page.
4. In the page, click on the DB System for which you want to view details or click on the **Actions** drop down and select **View Details** to view the DB System details.
5. Click on the System Information tab for the DB System details, associated CPU Pool, Storage details, and associated VMs.
6. Click on the Database Information tab to view the associated database details.
7. Click on the Network Information tab to view the network details for single node or high-availability deployments.

Related Topics

- [odacli describe-dbsystem](#)
Use the `odacli describe-dbsystem` command to describe a database system on Oracle Database Appliance Kernel-based Virtual Machine (KVM).

Modifying a DB System in a KVM Deployment

Use ODACLI commands or the Browser User Interface to modify a DB system in a KVM deployment.

Using ODACLI to Modify a DB System

Use the command `odacli modify-dbsystem --shape` to change shape of the DB system. Starting with Oracle Database Appliance release 19.23, the `odacli modify-dbsystem --shape` command only changes the shape of the DB system; it does not change the shapes of the database inside the DB system any more. You must modify database shapes accordingly based on the new shape of the DB system. Ensure that you scale up database shapes after the DB system shape is scaled up. Similarly, scale down database shapes before DB system shape is scaled down; otherwise databases could fail to start because of reduced DB system memory.

```
# odacli modify-dbsystem -n dbsystem_name -s dbs4 [-dvn v_networks_to_detach]  
[-en] [-gw gateway] [-ip ip_address] [-nm netmask] [-sip scan_ip_address] [-  
sn scan_name] [-s shape] [-vips vip_address] [-vt v_network_type] [-m  
custom_memory_size]
```

You can attach a CPU pool to the DB system, or remove the CPU pool from the DB system.

Use the command `odacli modify-dbsystem -m` to increase the DB system memory. This does not change the database memory configuration. You must manually update the database memory configuration such as SGA, PGA, and others to utilize the increased memory. The command does not support reducing DB system memory. Changing the shape of the DB system after you change the DB system memory resets the memory of the DB system.

You can increase the DB system memory with the `odacli modify-dbsystem` command using the `-m` option.

```
# odacli modify-dbsystem -n dbsystem_name -m 24G
```

To reduce the DB system memory, use the `--shape` option with the command `odacli modify-dbsystem`. The DB system is automatically restarted for the new shape to take effect.

```
# odacli modify-dbsystem --name dbsystem1 --shape dbs2
```

Use the command `odacli modify-dbsystem` to attach or detach a new network to the DB system. This new network can be used for database backup, Oracle Data Guard setup or other purposes in the DB system.

You can use `odacli modify-dbsystem` to attach or detach the shared DB system CPU pool. Attaching a shared DB system CPU pool removes the internal CPU pool that was created at DB system creation time. When detaching shared CPU pool from the DB system, an internal CPU pool is automatically created and attached to the DB system. One shared DB system CPU pool can be attached to multiple DB systems. Oversubscribing to shared DB system CPU pool is allowed, but there could be potential performance impact if shared CPU pool is oversubscribed.

 **Note:**

The `odacli modify-dbsystem -s shape` command only works on Oracle Database Appliance release 19.13 and later DB systems. The CPU pool commands are available on Oracle Database Appliance release 19.11 and later DB systems. In Oracle Database Appliance release 19.23 and later, the `odacli modify-dbsystem -s shape` command changes the DB system shape only; it does not modify the database shape. Run the `odacli modify-database` command in the DB system to change the database shape in the DB system.

Using Browser User Interface to Modify a KVM DB System

Follow these steps:

1. Log into the Browser User Interface:

```
https://host-ip-address:7093/mgmt/index.html
```

2. Click the **Appliance** tab.
3. Click **DB Systems** to display the DB Systems page.
4. In the page, click on the DB System for which you want to view details or click on the **Actions** drop down and select **Modify** to change the following:
 - DB System shape
 - Attach or detach CPU pool for the DB system
 - Attach or detach networks
 - Enable or disable NUMA for the DB system
 - Memory size allocated to the DB system
 - VM storage redundancy (either Mirror or High)
5. Select the new shape and CPU pool and click **Modify**.
6. Click **Enable NUMA** to set NUMA capabilities, and click **Modify**.
7. Click the Detach Networks field to view the networks, select the network you want to detach, and click **Modify**.
8. To attach a network, specify the **Name**, **IP Address**, **Subnet Mask**, **Gateway**, **Network Type**, **Default Network**, and click **Modify**.
9. Confirm your action to submit the job to modify the DB System. You can manually run the `odacli modify-database` command inside the DB system to change the database shape.

Related Topics

- [odacli modify-dbsystem](#)
Use the `odacli modify-dbsystem` command to modify a DB system on Oracle Database Appliance Kernel-based Virtual Machine (KVM).
- [odacli modify-vm](#)
Use the `odacli modify-vm` command to modify a virtual machine on Oracle Database Appliance Kernel-based Virtual Machine (KVM).

- [odacli remap-cpupools](#)
Use the `odacli remap-cpupools` command to remap CPU pools to NUMA allocation on Oracle Database Appliance Bare Metal or Kernel-based Virtual Machine (KVM) deployment.
- [odacli create-cpupool](#)
Use the `odacli create-cpupool` command to create a new CPU pool on Oracle Database Appliance Bare Metal or Kernel-based Virtual Machine (KVM) deployment.

Attaching and Detaching a Network for a DB System in a KVM Deployment

Use ODACLI commands to attach or detach networks for DB system in a KVM deployment.

Using ODACLI to Attach or Detach a Network to a DB System

You can attach a new vnetwork to the DB system and use it for database backup, Oracle Data Guard configuration, and other options. Use the `odacli modify-dbsystem` to attach or detach network for a DB system in a KVM deployment. The vnetwork must exist before you can attach it to the dbsystem.

Follow these steps to attach a vnetwork to a DB system:

1. Identify the name of vnetwork bridge to attach to the DB system using the `odacli list-vnetworks` and `odacli describe-vnetwork -n vnetwork_name` commands.
2. Use the `odacli modify-dbsystem` command to attach vnetwork to DB system:

```
# odacli modify-dbsystem -n dbsystem1 -avn vnet2 -t Dataguard -ip
192.168.10.119,192.168.10.120 -nm 255.255.240.0 -gw 192.168.10.1 -sn scan1
-sip 192.168.10.30,192.168.10.31 -vips
vip1:0:192.168.15.57,vip2:1:192.168.15.58
```

The IP address, netmask (nm) and gateway (gw) values are used to configure the new interface of the DB system. The SCAN name (sn), SCAN IP address (sip) and Virtual IP address (vip) are used when the vnetwork type is `database` or `dataguard`.

To detach a vnetwork in the DB system, run the following command:

```
# odacli modify-dbsystem -n name -dvn vnetwork_name
```

Using Browser User Interface to Modify a DB System

Follow these steps:

1. Log into the Browser User Interface:

```
https://host-ip-address:7093/mgmt/index.html
```

2. Click the **Appliance** tab.
3. Click **DB Systems** to display the DB Systems page.
4. In the page, click on the DB System for which you want to view details or click on the **Actions** drop down and select **Modify** to attach or detach vnetworks for the DB system.
5. Click the Detach Networks field to view the vnetworks, select the vnetwork you want to detach, and click `Modify`.

6. To attach a network, specify the **Name, IP Address, Subnet Mask, Gateway, Network Type, Default Network**, and click `Modify`.
7. Confirm your action to submit the job to modify the DB system.

Starting a DB System in a KVM Deployment

Use ODACLI commands or the Browser User Interface to start a DB system in a KVM deployment.

Using ODACLI to start a DB System

Use the command `odacli start-dbssystem` to start a DB system.

```
# odacli start-dbssystem -n dbssystem_name
```

Using Browser User Interface to Start a DB System

Follow these steps:

1. Log into the Browser User Interface:

```
https://host-ip-address:7093/mgmt/index.html
```

2. Click the **Appliance** tab.
3. Click **DB Systems** to display the DB Systems page.
4. In the page, click on the DB System which you want to start.
5. Click on the System Information tab and then click **Start**.
6. For high-availability deployments, select the node on which you want to start the DB System. Click **Yes**.
7. When you submit the job, the job ID and a link to the job appears. Click the link to display the job status and details.
8. Validate that the job completed. You can track the job in the **Activity** tab in the Browser User Interface, or run the command `odacli describe-job` with the job ID.
9. When the DB System starts, the state displays as ONLINE.

Related Topics

- [odacli start-dbssystem](#)
Use the `odacli start-dbssystem` command to start a database system on Oracle Database Appliance Kernel-based Virtual Machine (KVM).

Stopping a DB System in a KVM Deployment

Use ODACLI commands or the Browser User Interface to stop a DB system in a KVM deployment.

Using ODACLI to Stop a DB System

Use the command `odacli stop-dbssystem` to stop a DB system.

```
# odacli stop-dbssystem -n dbssystem_name
```

Using Browser User Interface to Stop a DB System

Follow these steps:

1. Log into the Browser User Interface:

```
https://host-ip-address:7093/mgmt/index.html
```

2. Click the **Appliance** tab.
3. Click **DB Systems** to display the DB Systems page.
4. In the page, click on the DB System which you want to stop.
5. Click on the System Information tab and then click **Stop**.
6. For high-availability deployments, select the node on which you want to stop the DB System. Click **Yes**.
7. When you submit the job, the job ID and a link to the job appears. Click the link to display the job status and details.
8. Validate that the job completed. You can track the job in the **Activity** tab in the Browser User Interface, or run the command `odacli describe-job` with the job ID.
9. When the DB system stops, the state displays as OFFLINE.

Related Topics

- [odacli stop-dbsystem](#)
Use the `odacli stop-dbsystem` command to stop a database system on Oracle Database Appliance Kernel-based Virtual Machine (KVM).

Deleting a DB System in a KVM Deployment

Use ODA CLI commands or the Browser User Interface to delete a DB system in a KVM deployment.

Using ODA CLI to Delete a KVM DB System

Use the command `odacli delete-dbsystem` to delete a KVM DB system.

```
# odacli delete-dbsystem -n dbsystem_name -f
```

If you do not specify the `-f` option, then the operation deletes the DB system and Oracle Clusterware files, and retains the database files. With the `-f` option, the operation deletes the DB system, Oracle Clusterware files, and the database files.

Using Browser User Interface to Delete a KVM DB System

Follow these steps:

1. Log into the Browser User Interface:

```
https://host-ip-address:7093/mgmt/index.html
```

2. Click the **Appliance** tab.
3. Click **DB Systems** to display the DB Systems page.

4. In the page, for DB System which you want to delete, click on the **Actions** drop down list and select **Delete**.
5. Confirm that you want to delete the DB System. Select **Force Delete** if you want to delete the DB system, Oracle Clusterware files, and the database files during the delete operation. Click **Yes**.
6. When you submit the job, the job ID and a link to the job appears. Click the link to display the job status and details.
7. Validate that the job completed. You can track the job in the **Activity** tab in the Browser User Interface, or run the command `odacli describe-job` with the job ID.

Related Topics

- [odacli delete-dbsystem](#)
Use the `odacli delete-dbsystem` command to delete a DB system on Oracle Database Appliance Kernel-based Virtual Machine (KVM).

Managing Backup, Restore, and Recovery on a DB System in a KVM Deployment

Understand the backup, restore, and recovery operations supported on a DB system in a KVM deployment.

About Backup, Restore, and Recovery on a DB System

Similar to the bare metal systems, you can use ODACLI commands to configure and perform backup, restore, and recovery operations on DB systems. For information about backup, restore, and recovery on Oracle Database Appliance, see the chapter *Backup, Recover and Restore* in this guide.

Related Topics

- [Backup, Restore and Recover Databases](#)
Review backup, restore, and recovery operations for your databases.

Managing Shared CPU Pool with DB System in a KVM Deployment

Use ODACLI commands or the Browser User Interface to manage shared CPU pool with DB system in a KVM deployment.

Using ODACLI to Manage Shared CPU Pool with DB system

Creating a DB system automatically creates an internal DB system CPU pool associated with this DB system. This DB system pool is managed internally and cannot be created, modified, or deleted manually. You can create a new type of shared CPU pool using the `odacli create-cpupool --dbsystem/-dbs -n cores` command. Similarly to VM and BM types, this CPU pool must not overlap with other CPU pools. In high-availability environments, the DB system CPU pool cannot be local, it must exist on both nodes always.

Associating Shared DB System CPU Pool

A shared DB system CPU pool can be associated to a new DB system or existing DB system. To create a new DB system with shared DB system CPU pool, add the "cpuPoolName" parameter in the `create-dbsystem json` file. The associated internal CPU pool is automatically

deleted after a shared CPU pool is attached to a DB system. Use the `odacli modify-dbsystem` command to associate the CPU pool to an existing DB system.

```
# odacli modify-dbsystem -n dbsystem_name -cp dbspool1
```

The cores of the DB System (based on its shape) must fit into the shared DB System CPU pool. Associating a shared DB system CPU pool to an existing DB system removes the internal CPU pool associated to the DB system. A single shared DB System CPU pool can be shared by multiple DB Systems. Oversubscription to the DB system CPU pool is allowed, but performance may be impacted if the CPU pool is oversubscribed. The list of associated DB systems can be queried using `odacli list-cpupool` or `odacli describe-cpupool` commands.

Use `odacli describe-dbsystem` to check the details of the CPU pool associated to the DB system:

```
# odacli describe-dbsystem -n dbs4e912c
CPU Pool
-----
                Name: ce3f42bb28
    Number of cores: 2

                Host: n1
    Effective CPU set: 9-10,29-30
        Online CPUs: 9, 10, 29, 30
        Offline CPUs: NONE

                Host: n2
    Effective CPU set: 9-10,29-30
        Online CPUs: 9, 10, 29, 30
        Offline CPUs: NONE
```

Use `odacli list-cpupools` to view the DB system CPU pool type and associated DB systems. The internal DB system CPU pool has type "DB_SYSTEM" and shared DB system CPU pool has type "DB_SYSTEM_SHARED".

```
# odacli list-cpupools
Name                Type                Configured on        Cores
Associated resources Created
Updated
-----
-----
-----
bmpool1             BM                n1,                  2
NONE                2021-03-30 17:54:59 UTC 2021-03-30 17:55:00
UTC

n2

vmpool1             VM                n1,                  2
NONE                2021-03-30 17:54:48 UTC 2021-03-30 17:54:49
UTC

n2
```

```

dbspool1          DB_SYSTEM_SHARED  n1,          4
NONE              2021-03-30 17:55:11 UTC 2021-03-30 17:55:11
UTC

n2

ce3f42bb28       DB_SYSTEM        n1,          2
dbs4e912c        2021-03-30 17:57:43 UTC 2021-03-30 18:01:27
UTC

n2

```

Use `odacli describe-cpupool` to find out more details about DB system CPU pool:

```
# odacli describe-cpupool -n ce3f42bb28
```

```
CPU Pool
details
```

```
-----
--
```

```

                                ID: 8e62933b-b394-4bcf-9c32-6a4cea2e0360
                                Name: ce3f42bb28
                                Created: 2021-03-30 17:57:43 UTC
                                Updated: 2021-03-30 18:01:27 UTC
                                Type: DB_SYSTEM
                                Number of cores: 2
                                Associated resources: dbs4e912c

```

```
CPU Allocations
```

```
-----
                                Node: n1
                                Effective CPU set: 9-10,29-30
                                Online CPUs: 9, 10, 29, 30
                                Offline CPUs: NONE

                                Node: n2
                                Effective CPU set: 9-10,29-30
                                Online CPUs: 9, 10, 29, 30
                                Offline CPUs: NONE

```

Dissociating Shared DB System CPU Pool

A DB System with a shared DB System CPU pool could have the shared CPU pool detached from it and an internal DB System CPU Pool is created. If the internal DB system CPU pool cannot be created, then the `odacli modify-dbsystem` command fails.

Dissociating shared DB System CPU Pool:

```
# odacli modify-dbsystem -n dbs4e912c -no-cp
```

Modifying Shared DB System CPU Pool

A shared DB system CPU pool could be resized if all the associated DB systems shapes still fit into the cores of the pool (CPU pool size \geq individual DB system size) The change is effective immediately on running DB system VMs.

Modifying a DB System Associated with a Shared DB System CPU Pool

If a DB System is associated with a shared DB System CPU Pool and its shape is modified with the `odacli modify-dbsystem` command, then the new shape of the DB system must fit into the cores of the pool.

Deleting Shared DB System CPU Pool

A shared DB system CPU Pool can be deleted using the `odacli delete-cpupool` command only if it has no associated DB systems.

Related Topics

- Oracle Database Appliance KVM Hard Partitioning Compliance
- [odacli modify-dbsystem](#)
Use the `odacli modify-dbsystem` command to modify a DB system on Oracle Database Appliance Kernel-based Virtual Machine (KVM).
- [Remapping CPU Pools in a Bare Metal or KVM Deployment](#)
Use ODACLI commands or the Browser User Interface to remap CPU pools in a bare metal or KVM deployment.
- [odacli modify-vm](#)
Use the `odacli modify-vm` command to modify a virtual machine on Oracle Database Appliance Kernel-based Virtual Machine (KVM).
- [odacli remap-cpupools](#)
Use the `odacli remap-cpupools` command to remap CPU pools to NUMA allocation on Oracle Database Appliance Bare Metal or Kernel-based Virtual Machine (KVM) deployment.
- [odacli create-cpupool](#)
Use the `odacli create-cpupool` command to create a new CPU pool on Oracle Database Appliance Bare Metal or Kernel-based Virtual Machine (KVM) deployment.

Managing Oracle Data Guard on a DB System in a KVM Deployment

Understand the Oracle Data Guard operations supported on a DB system in a KVM deployment.

About Using Oracle Data Guard on a DB System

Similar to the bare metal systems, you can configure and use Oracle Data Guard on DB systems using ODACLI commands. You can set up Oracle Data Guard between the bare metal system and DB system, or between two DB systems. Integrated Oracle Data Guard can also be used for migrating from bare metal system to DB system, or between two DB systems. For information about Oracle Data Guard on Oracle Database Appliance, see the chapter *Using Oracle Data Guard for Disaster Management and Recovery on Oracle Database Appliance* in this guide.

Related Topics

- [Using Oracle Data Guard for Disaster Management and Recovery on Oracle Database Appliance](#)
Understand how you can use Oracle Data Guard for disaster management and recovery on Oracle Database Appliance.

Setting Up and Configuring a KVM Deployment for Applications

Understand the steps to set up and configure KVM deployment for applications.

Follow these steps to set up a KVM deployment on Oracle Database Appliance

1. Create a VM storage.
2. Create a virtual network.
3. Create virtual disks.
4. Create virtual machines.

The following links provide information about performing these steps:

Related Topics

- [Creating a VM Storage in a KVM Deployment](#)
Use ODACLI commands or the Browser User Interface to create a VM storage in a KVM deployment.
- [Creating a Virtual Network in a KVM Deployment](#)
Use ODACLI commands or the Browser User Interface to create a virtual network in a KVM deployment.
- [Creating a Virtual Disk in a KVM Deployment](#)
Use ODACLI commands or the Browser User Interface to create a virtual disk in a KVM deployment.
- [Creating a Virtual Machine in a KVM Deployment](#)
Use ODACLI commands or the Browser User Interface to create a virtual machine in a KVM deployment.

Managing VM Storage in KVM Deployment

Use ODACLI to create, view, modify, and delete VM storage in an Oracle Database Appliance KVM deployment.

- [Creating a VM Storage in a KVM Deployment](#)
Use ODACLI commands or the Browser User Interface to create a VM storage in a KVM deployment.
- [Viewing VM Storage in a KVM Deployment](#)
Use ODACLI commands or the Browser User Interface to view all VM storage or details about a VM storage in a KVM deployment.
- [Modifying VM Storage in a KVM Deployment](#)
Use ODACLI commands or the Browser User Interface to modify VM storage in a KVM deployment.
- [Deleting a VM Storage in a KVM Deployment](#)
Use ODACLI commands or the Browser User Interface to delete a VM storage in a KVM deployment.

Creating a VM Storage in a KVM Deployment

Use ODACLI commands or the Browser User Interface to create a VM storage in a KVM deployment.

Using ODACLI to Create VM Storage

Use the command `odacli create-vmstorage` to create a VM Storage.

Create a VM storage named `share1` of 8 GB.

```
# odacli create-vmstorage -n share1 -s 8G
```

Using Browser User Interface to Create VM Storage

Follow these steps:

1. Log into the Browser User Interface:

```
https://host-ip-address:7093/mgmt/index.html
```

2. Click the **Appliance** tab.
3. Click **Show VM Instances** to display the VM Instances page.
4. In the page, select the **Create VM Storage** option and click **Next**.
5. In the Create VM Storage page, specify the following:
 - **Storage Name:** Name of the VM storage
 - **Storage Size:** Size of the storage to be allocated
 - **ASM Disk group:** Select the Oracle ASM disk group
 - **Redundancy:** Select the VM storage redundancy, either Mirror or High
6. Click **Create**.
7. When you submit the job, the job ID and a link to the job appears. Click the link to display the job status and details.
8. Validate that the job completed. You can track the job in the **Activity** tab in the Browser User Interface, or run the command `odacli describe-job` with the job ID.

Viewing VM Storage in a KVM Deployment

Use ODACLI commands or the Browser User Interface to view all VM storage or details about a VM storage in a KVM deployment.

Using ODACLI to View VM Storage

The command `odacli describe-vmstorage` displays details about VM storage. Use the command `odacli list-vmstorages` to view all VM storages in the deployment.

```
# odacli list-vmstorages
```

```
# odacli describe-vmstorage
```

Using Browser User Interface to View VM Storage

Follow these steps:

1. Log into the Browser User Interface:

```
https://host-ip-address:7093/mgmt/index.html
```

2. Click the **Appliance** tab.
3. Click **VM Instances** to display the VM Details page.
4. Click the **Show VM Storage** tab to view the list of all configured VM storages.
5. Click on a VM Storage to view the details of the VM storage.

Modifying VM Storage in a KVM Deployment

Use ODACLI commands or the Browser User Interface to modify VM storage in a KVM deployment.

Using ODACLI to Modify VM Storages

Use the command `odacli modify-vmstorage` to modify VM storage.

Increase the size of a VM storage named `share1` by 10 gigabytes.

```
# odacli modify-vmstorage -n share1 -i 10G
```

Decrease the size of a VM storage named `share1` by 5 gigabytes.

```
# odacli modify-vmstorage -n share1 -s 5G
```

Using Browser User Interface to Modify VM Storage

Follow these steps:

1. Log into the Browser User Interface:

```
https://host-ip-address:7093/mgmt/index.html
```

2. Click the **Appliance** tab.
3. Click **VM Instances** to display the VM Details page.
4. Click the **Show VM Storage** tab.
5. In the page, select a VM Storage, select the **Modify** option and click **Next**.
6. In the Modify VM Storage page, specify **Increment** in size, the VM storage **Redundancy** as either **Mirror** or **High**, and click **Modify**.
7. When you submit the job, the job ID and a link to the job appears. Click the link to display the job status and details.
8. Validate that the job completed. You can track the job in the **Activity** tab in the Browser User Interface, or run the command `odacli describe-job` with the job ID.

Deleting a VM Storage in a KVM Deployment

Use ODACLI commands or the Browser User Interface to delete a VM storage in a KVM deployment.

Using ODACLI to Delete VM Storage

Use the command `odacli delete-vmstorage` to delete a VM storage.

Delete a VM storage named `vs1`.

```
# odacli delete-vmstorage -n vs1
```

Using Browser User Interface to Modify VM Storage

Follow these steps:

1. Log into the Browser User Interface:

```
https://host-ip-address:7093/mgmt/index.html
```

2. Click the **Appliance** tab.
3. Click **VM Instances** to display the VM Details page.
4. Click the **Show VM Storage** tab.
5. In the page, select a VM Storage, select the **Delete** option.
6. Click Yes to confirm your choice.
7. When you submit the job, the job ID and a link to the job appears. Click the link to display the job status and details.
8. Validate that the job completed. You can track the job in the **Activity** tab in the Browser User Interface, or run the command `odacli describe-job` with the job ID.

Managing Virtual Networks in KVM Deployment

Use ODACLI to create, view, start, stop, and delete virtual networks in an Oracle Database Appliance KVM deployment.

- [Creating a Virtual Network in a KVM Deployment](#)
Use ODACLI commands or the Browser User Interface to create a virtual network in a KVM deployment.
- [Viewing Virtual Networks in a KVM Deployment](#)
Use ODACLI commands or the Browser User Interface to view all virtual networks or details about a virtual network in a KVM deployment.
- [Starting and Stopping Virtual Networks in a KVM Deployment](#)
Use ODACLI commands or the Browser User Interface to start or stop virtual networks in a KVM deployment.
- [Modifying a Virtual Network in a KVM Deployment](#)
Use ODACLI commands or the Browser User Interface to modify a virtual network in a KVM deployment.

- [Deleting a Virtual Network in a KVM Deployment](#)
Use ODACLI commands or the Browser User Interface to delete a virtual network in a KVM deployment.

Creating a Virtual Network in a KVM Deployment

Use ODACLI commands or the Browser User Interface to create a virtual network in a KVM deployment.

Using ODACLI to Create Virtual Network

Use the command `odacli create-vnetwork` to create a virtual network.

Create a VM network of type `bridged` using the interface `btbond2`.

```
# odacli create-vnetwork --name mgmtNet --bridge mgmtNet --type bridged --  
interface btbond2 --ip 192.168.120.26 --gateway 192.168.120.1 --netmask  
255.255.255.0
```

Create a VM network of type `bridged-vlan` using the interface `btbond1`.

```
# odacli create-vnetwork --name backupvlan --bridge backupvlan --type bridged-  
vlan --vlan-id 12 --interface btbond1 --ip 192.168.100.10 --gateway  
192.168.100.1 --netmask 255.255.255.0
```

Using Browser User Interface to Create Virtual Network

Follow these steps:

1. Log into the Browser User Interface:

```
https://host-ip-address:7093/mgmt/index.html
```

2. Click the **Appliance** tab.
3. Click **Show VM Instances** to display the VM Instances page.
4. In the page, select the **Create Virtual Network** option and click **Next**.
5. In the Create Virtual Network page, specify the following:
 - Name: Name of the virtual network
 - IP Address: Virtual network IP address
 - Subnet Mask and Gateway: Virtual network subnet mask and gateway
 - Network Type: Virtual network type
 - Interface: Virtual network interface
 - Bridge Name: Name of the network bridge
 - VLAN ID: ID of the VLAN network
6. Click **Create**.
7. When you submit the job, the job ID and a link to the job appears. Click the link to display the job status and details.

8. Validate that the job completed. You can track the job in the **Activity** tab in the Browser User Interface, or run the command `odacli describe-job` with the job ID.

Viewing Virtual Networks in a KVM Deployment

Use ODACLI commands or the Browser User Interface to view all virtual networks or details about a virtual network in a KVM deployment.

Using ODACLI to View Virtual Networks

The command `odacli describe-vnetwork` displays details about a virtual network. Use the command `odacli list-vnetworks` to view all virtual networks in the deployment.

```
# odacli list-vnetworks
```

```
# odacli describe-vnetwork -n vnet1
```

Using Browser User Interface to Create Virtual Networks

Follow these steps:

1. Log into the Browser User Interface:

```
https://host-ip-address:7093/mgmt/index.html
```

2. Click the **Appliance** tab.
3. Click **VM Instances** to display the VM Details page.
4. Click the **Show Virtual Networks** tab to view the list of all configured virtual networks.
5. Click on a Virtual Network to view the details of the virtual network.

Starting and Stopping Virtual Networks in a KVM Deployment

Use ODACLI commands or the Browser User Interface to start or stop virtual networks in a KVM deployment.

Using ODACLI to Start and Stop Virtual Networks

The command `odacli start-vnetwork` starts a virtual network. Use the command `odacli stop-vnetwork` to stop a virtual network in the deployment.

```
# odacli start-vnetwork -n vnet1
```

```
# odacli stop-vnetwork -n vnet1
```

Using Browser User Interface to Start and Stop Virtual Networks

Follow these steps:

1. Log into the Browser User Interface:

```
https://host-ip-address:7093/mgmt/index.html
```

2. Click the **Appliance** tab.
3. Click **VM Instances** to display the VM Details page.
4. Click the **Show Virtual Networks** tab to view the list of all configured virtual networks.
5. To start a virtual network, click on a Virtual Network, and then click **Start**.
6. To stop a virtual network, click on a virtual network, and then click **Stop**.

Modifying a Virtual Network in a KVM Deployment

Use ODACLI commands or the Browser User Interface to modify a virtual network in a KVM deployment.

Using ODACLI to Modify Virtual Network

Use the command `odacli modify-vnetwork` to modify a virtual network.

```
# odacli modify-vnetwork -n vnet1 -g 10.11.44.41
```

Using Browser User Interface to Modify Virtual Network

Follow these steps:

1. Log into the Browser User Interface:

```
https://host-ip-address:7093/mgmt/index.html
```

2. Click the **Appliance** tab.
3. Click **VM Instances** to display the VM Details page.
4. Click the **Show Virtual Networks** tab.
5. In the page, select a Virtual Network, select the **Modify** option and click **Next**.
6. In the Modify Virtual Network page, specify any changes in the Subnet Mask, Gateway, or IP Address, and click **Modify**.
7. When you submit the job, the job ID and a link to the job appears. Click the link to display the job status and details.
8. Validate that the job completed. You can track the job in the **Activity** tab in the Browser User Interface, or run the command `odacli describe-job` with the job ID.

Deleting a Virtual Network in a KVM Deployment

Use ODACLI commands or the Browser User Interface to delete a virtual network in a KVM deployment.

Using ODACLI to Delete Virtual Networks

Use the command `odacli delete-vnetwork` to delete a virtual network.

Delete a virtual network named `vnet1`.

```
# odacli delete-vnetwork -n vnet1
```

Using Browser User Interface to Modify Virtual Networks

Follow these steps:

1. Log into the Browser User Interface:

```
https://host-ip-address:7093/mgmt/index.html
```

2. Click the **Appliance** tab.
3. Click **VM Instances** to display the VM Details page.
4. Click the **Show Virtual Networks** tab.
5. In the page, select a virtual network, select the **Delete** option.
6. Click Yes to confirm your choice.
7. When you submit the job, the job ID and a link to the job appears. Click the link to display the job status and details.
8. Validate that the job completed. You can track the job in the **Activity** tab in the Browser User Interface, or run the command `odacli describe-job` with the job ID.

Managing Virtual Disks in KVM Deployment

Use ODA CLI to create, view, clone, modify, and delete virtual disks on Oracle Database Appliance KVM deployment.

- [Creating a Virtual Disk in a KVM Deployment](#)
Use ODA CLI commands or the Browser User Interface to create a virtual disk in a KVM deployment.
- [Viewing Virtual Disks in a KVM Deployment](#)
Use ODA CLI commands or the Browser User Interface to view all virtual disks or details about a virtual disk in a KVM deployment.
- [Cloning a Virtual Disk in a KVM Deployment](#)
Use ODA CLI commands or the Browser User Interface to clone a virtual disk in a KVM deployment.
- [Modifying a Virtual Disk in a KVM Deployment](#)
Use ODA CLI commands or the Browser User Interface to modify a virtual disk in a KVM deployment.
- [Deleting a Virtual Disk in a KVM Deployment](#)
Use ODA CLI commands or the Browser User Interface to delete a virtual disk in a KVM deployment.

Creating a Virtual Disk in a KVM Deployment

Use ODA CLI commands or the Browser User Interface to create a virtual disk in a KVM deployment.

Ensure that a VM storage exists before you create a virtual disk.

Using ODA CLI to Create Virtual Disks

Use the command `odacli create-vdisk` to create a virtual disk.

Specify the name of the virtual disk in the command `odacli create-vdisk -n name`. Identify the storage in which you create the virtual disk by using the `-st storage` option. Use the option `-s size` to specify the virtual disk size. If you want to configure the virtual disk as a shared disk, then use the option `-sh`.

The vdisk name must start with a letter followed by underscores, hyphens, or alphanumeric characters and can have a maximum length of 30 characters.

Create a 2 GB non-sparse and shareable virtual disk named `vdisk1` inside the VM storage `vms1`.

```
odacli create-vdisk -n vdisk1 -st vms1 -s 2G -sh
```

Using Browser User Interface to Create Virtual Disks

Follow these steps:

1. Log into the Browser User Interface:

```
https://host-ip-address:7093/mgmt/index.html
```

2. Click the **Appliance** tab.
3. Click **VM Instances** to display the Virtual Disk page.
4. Click **Create Virtual Disk**.
5. In the page, select the **Create Virtual Disk** option and click **Next**.
6. In the Create Virtual Disk page, specify the following:
 - **Virtual Disk Name:** Name assigned to the virtual disk that is unique within the name repository
 - **VM Storage Name:** Name of the VM storage where the virtual disk will be created
 - **Disk Size:** Size of the virtual disk
 - **Shared:** Specify if you want to share the virtual disk
 - **Sparse or Non-Sparse:** Specify if the virtual disk is sparse
7. Click **Create**.
8. When you submit the job, the job ID and a link to the job appears. Click the link to display the job status and details.
9. Validate that the job completed. You can track the job in the **Activity** tab in the Browser User Interface, or run the command `odacli describe-job` with the job ID.

Viewing Virtual Disks in a KVM Deployment

Use ODACLI commands or the Browser User Interface to view all virtual disks or details about a virtual disk in a KVM deployment.

Using ODACLI to View Virtual Disks

The command `odacli describe-vdisk` displays details about a virtual disk. Use the command `odacli list-vdisks` to view all virtual disks in the deployment.

```
# odacli list-vdisks
```

```
# odacli describe-vdisk -n vdisk_name
```

Using Browser User Interface to Create Virtual Disks

Follow these steps:

1. Log into the Browser User Interface:

```
https://host-ip-address:7093/mgmt/index.html
```

2. Click the **Appliance** tab.
3. Click **VM Instances** to display the VM Details page.
4. Click the **Show Virtual Disks** tab to view the list of all configured virtual disks.
5. Click on a virtual disk to view the details of the virtual disk.

Cloning a Virtual Disk in a KVM Deployment

Use ODACLI commands or the Browser User Interface to clone a virtual disk in a KVM deployment.

Using ODACLI to Clone Virtual Disks

Use the command `odacli clone-vdisk` to clone an existing virtual disk.

Specify the source vdisk from which you want to clone with the `-n` option, and specify the name of the cloned virtual disk with the `-cn` option.

Create a clone of a virtual disk named `vdisk1`, with the name `vdisk1_clone`. The cloned disk is created on the same storage as `vdisk1`.

```
# odacli clone-vdisk -n vdisk1 -cn vdisk1_clone
```

Using Browser User Interface to Create Virtual Disks

Follow these steps:

1. Log into the Browser User Interface:

```
https://host-ip-address:7093/mgmt/index.html
```

2. Click the **Appliance** tab.

3. Click **VM Instances** to display the Virtual Disk page.
4. Click **Create Virtual Disk**.
5. In the page, select the **Clone Virtual Disk** option and click **Next**.
6. In the Clone Virtual Disk page, specify the following:
 - Select the source virtual disk you want to clone
 - Specify the name of the cloned virtual disk
7. Click **Create**.
8. When you submit the job, the job ID and a link to the job appears. Click the link to display the job status and details.
9. Validate that the job completed. You can track the job in the **Activity** tab in the Browser User Interface, or run the command `odacli describe-job` with the job ID.

Modifying a Virtual Disk in a KVM Deployment

Use ODACLI commands or the Browser User Interface to modify a virtual disk in a KVM deployment.

Using ODACLI to Modify Virtual Disks

Use the command `odacli modify-vdisk` to increase the size of a virtual disk.

Increase the size of a virtual disk named `vdisk1` by 4 gigabytes.

```
# odacli modify-vdisk -n vdisk1 -i 4G
```

Using Browser User Interface to Modify Virtual Disks

Follow these steps:

1. Log into the Browser User Interface:

```
https://host-ip-address:7093/mgmt/index.html
```

2. Click the **Appliance** tab.
3. Click **VM Instances** to display the VM Details page.
4. Click the **Show Virtual Disks** tab.
5. In the page, select a Virtual Disk, select the **Modify Virtual Disk** option and click **Next**.
6. In the Modify Virtual Disk page, specify Increment in size and if you want to share the virtual disk.
7. Click **Modify**.
8. When you submit the job, the job ID and a link to the job appears. Click the link to display the job status and details.
9. Validate that the job completed. You can track the job in the **Activity** tab in the Browser User Interface, or run the command `odacli describe-job` with the job ID.

Deleting a Virtual Disk in a KVM Deployment

Use ODACLI commands or the Browser User Interface to delete a virtual disk in a KVM deployment.

Using ODACLI to Delete Virtual Disks

Use the command `odacli delete-vdisk` to delete a virtual disk.

Delete a virtual disk named `vdisk1`.

```
# odacli delete-vdisk -n vdisk1
```

Using Browser User Interface to Modify Virtual Disks

Follow these steps:

1. Log into the Browser User Interface:

```
https://host-ip-address:7093/mgmt/index.html
```

2. Click the **Appliance** tab.
3. Click **VM Instances** to display the VM Details page.
4. Click the **Show Virtual Disks** tab.
5. In the page, select a Virtual Disk, select the **Delete** option.
6. Click Yes to confirm your choice.
7. When you submit the job, the job ID and a link to the job appears. Click the link to display the job status and details.
8. Validate that the job completed. You can track the job in the **Activity** tab in the Browser User Interface, or run the command `odacli describe-job` with the job ID.

Managing Virtual Machines in KVM Deployment

Use ODACLI to create, view, clone, modify, start, stop, and delete virtual machines in an Oracle Database Appliance KVM deployment.

- [Creating a Virtual Machine in a KVM Deployment](#)
Use ODACLI commands or the Browser User Interface to create a virtual machine in a KVM deployment.
- [Cloning a Virtual Machine in a KVM Deployment](#)
Use ODACLI commands or the Browser User Interface to clone a virtual machine instance in a KVM deployment.
- [Modifying a Virtual Machine in a KVM Deployment](#)
Use ODACLI commands or the Browser User Interface to modify a virtual machine in a KVM deployment.
- [Viewing Virtual Machines in a KVM Deployment](#)
Use ODACLI commands or the Browser User Interface to view all virtual machines or details about a virtual machine in a KVM deployment.

- [Starting and Stopping Virtual Machines in a KVM Deployment](#)
Use ODACLI commands or the Browser User Interface to start or stop virtual machines in a KVM deployment.
- [Deleting a Virtual Machine in a KVM Deployment](#)
Use ODACLI commands or the Browser User Interface to delete a virtual machine in a KVM deployment.

Creating a Virtual Machine in a KVM Deployment

Use ODACLI commands or the Browser User Interface to create a virtual machine in a KVM deployment.

Ensure that a VM storage exists before you create a VM instance.

Using ODACLI to Create Virtual Machine Instance

Use the command `odacli create-vm` to create a VM instance. Specify the preferred node on which to start the virtual machine after creation (`-pn` option).

Following is an example command to create a VM named `vm1` with 8 vcpus and 8 GB memory. A VM disk of size 10 GB is created automatically as `/dev/vda` inside the VM for the operating system installation. The VM disk is stored in the VM storage `vms1`. The source used for the installation is located on `/u01/OL7.iso`. If you want to attach an additional virtual disk to the VM, you can specify `--vdisks vdisk_name`, where `vdisk_name` is an existing virtual disk. This virtual disk when attached, is shown as `/dev/vdb` inside the VM.

```
# odacli create-vm -n vm1 -vc 8 -m 8G -vms vms1 -src /u01/OL7.iso -size 10G
```

To use a kickstart configuration file to create the VM instance, include the file in the `--extra-args` parameter. Create a kickstart configuration file, including the network configuration for the guest VM. Ensure that you specify the network details in the `--extra-args` parameter so that the VM bootstrap can use it to access the kickstart configuration file in this format `"dns=dns ip ip=ip::gateway:netmask:hostname:interface:none"`. The IP must belong to the vnetwork to be attached to the VM, and the kickstart configuration must be available over this vnetwork.

For example:

```
odacli create-vm --name odaksvm --vnetwork pubnet --memory 4G --  
source /u01/kvm/images/OL77_x86_64.iso --vmstorage myvms --size 10G --vcpus 2  
--extra-args "dns=dns_IP ip=vm_IP::gateway_IP:netmask:vm_hostname:eth0:none  
console=tty0 console=ttyS0,115200 ks=http://Webserver_IP:portnumber/ks.txt"
```

If you do not use a kickstart configuration file to create the VM instance, then complete the VM instance creation as follows:

1. Run the `odacli create-vm` command and check that it completes successfully.
2. Use the `odacli describe-vm` command to check the VNC port.
3. Log in to the VM instance using the VNC port: `host:vncport`. See the section *Connecting to the VM instance Using VNC* for the steps to connect to the VM instance using VNC.
4. Complete the installation process by providing your values for the installation screens.
5. Log in again to the VM instance using the VNC port: `host:vncport`. See the section *Connecting to the VM instance Using VNC* for the steps to connect to the VM instance using VNC.

6. If you specified `--vnetwork` in the `odacli create-vm` command, then you can run `ifconfig -a` to view the network interface in the VM. Configure the network as you would on a Linux system.
7. After the network is configured, log into the VM using the network and customize the VM instance.
8. If you did not specify `--vnetwork` in the `odacli create-vm` command, then the VM network is created using the default Network Address Translation (NAT) based KVM bridge `virbr0`. `eth0` is configured as DHCP inside the VM.

Connecting to the VM instance Using VNC: Method 1

1. Find out the VNC display port of the VM from the command `odacli describe-vm -n vm_name: 127.0.0.1:1`

```
# odacli describe-vm -n vm1
VM details
```

```
-----
-----
```

```
                ID: c280af13-997c-49b1-97ce-0617610535f1
                Name: vm1
```

```
...
```

```
Graphics settings: vnc,listen=127.0.0.1
                  Display Port: 127.0.0.1:1 <<<<
```

```
...
```

2. Run `vncserver` on the Oracle Database Appliance host. Note down the `vncserver` address `odahost:11`.

```
# vncserver
New 'odahost:11 (root)' desktop is odahost:11
```

3. Launch `vncviewer` from your desktop, login to the Oracle Database Appliance host using the `vncserver` address created in step 2: `odahost:11`. This launches a `vncviewer` that logs into the Oracle Database Appliance host.
4. From `vncviewer` launched in step 3, run the `vncviewer` command with the display port from the `odacli describe-vm` output. For example, in the previous step, the `odacli describe-vm` command shows the display port is `127.0.0.1:1`, so type `vncviewer 127.0.0.1:1`.

Connecting to the VM instance Using VNC: Method 2

1. Find out the VNC display port of the VM from the command `odacli describe-vm`. For example, the Display Port is `Display Port: 127.0.0.1:1`, and the current node `myodahost1`.

```
# odacli describe-vm -n vm1
VM details
```

```
-----
-----
```

```
                ID: c280af13-997c-49b1-97ce-0617610535f1
                Name: vm1
```

```
...
```

```
Graphics settings: vnc,listen=127.0.0.1
                  Display Port: 127.0.0.1:1 <<<<
```

```
...
```

```

Status
-----
Current node: myodahost1 <<<
Current state: ONLINE
Target state: ONLINE

```

2. On Linux or macOS operating systems where you want to launch the vncviewer, use the following command to create the SSH tunnel:

```
ssh -L localport:127.0.0.1:vncport root@odahost
```

where localport is an available port number greater than 1024 on your local machine (for example, 12345) where vnc viewer is launched. vncport is the VNC port displayed in the `odacli describe-vm` command plus 5900. For example, if `odacli describe-vm` returns the display port as `127.0.0.1:1`, then use 5901 as the VNC port. `odahost1` is the host name of the Oracle Database Appliance host where the VM is running. `127.0.0.1` is the address where vnc server is listening at. Do not change the `127.0.0.1` address. For example:

```
ssh -L 12345:127.0.0.1:5901 root@odahost1
```

On Windows, use PuTTY to create the SSH tunnel.

3. Launch vncviewer from your desktop, enter VNC server address as `localhost:localport`, where localport is one used in the SSH tunnel in step 2 (such as 12345). For example:

```
vncserver: localhost:12345
```

How to find VM network interface attached to the vnetwork

If you specified `--vnetwork` in the `odacli create-vm` command, then you can run `ifconfig -a` to view the network interface in the VM. Find out the VM network interface name that is attached to the vnetwork by matching the interface MAC address to the MAC address displayed in the `odacli describe-vm` command.

For example:

```

# odacli describe-vm -n vm1
VM details
-----
--
                                ID: c280af13-997c-49b1-97ce-0617610535f1
                                Name: vm1
...
Parameters
-----
...
                                Config Live
                                -----
-----
                                Memory: 2.00 GB 2.00 GB
                                Max Memory: 2.00 GB 2.00 GB
...
                                vNetworks: pubnet:52:54:00:15:b5:c4 pubnet:52:54:00:15:b5:c4
<<<<

```

Run "ip link show" inside the VM, find the interface name whose MAC address (the link/ether field in the ip command output: link/ether 52:54:00:15:b5:c4) that matches the vnetwork MAC address in the describe-vm output "pubnet:52:54:00:15:b5:c4", in this case it is eth0. So eth0 is the interface attached to the vnetwork "pubnet".

```
# ip link show
...
3: eth0: <BROADCAST,MULTICAST,UP,LOWER_UP> mtu 1500 qdisc fq_codel state UP
mode DEFAULT group default qlen 1000
    link/ether 52:54:00:15:b5:c4 brd ff:ff:ff:ff:ff:ff
```

Configure the network interface eth0 as you would on a Linux system.

Using Browser User Interface to Create Virtual Machine Instance

Follow these steps:

1. Log into the Browser User Interface:

```
https://host-ip-address:7093/mgmt/index.html
```

2. Click the **Appliance** tab.
3. Click **Show VM Instances** to display the VM Instances page.
4. In the page, select the **Create VM Instance** option and click **Next**.
5. In the Create Virtual VM page, specify the following:
 - VM Name: Name assigned to the VM instance that is unique within the name repository
 - VM Storage Name: Name of the VM storage where the VM instance will be created
 - Source Installation: The source from which you want to create the VM
 - Preferred Node: Node where you want to run the VM instance
 - Memory Size: Size of the memory to be allocated
 - CPU Pool Name: Select the CPU Pool
 - Number of vCPUs to Use: Number of virtual CPUs to be allocated
6. Click **Create**.
7. When you submit the job, the job ID and a link to the job appears. Click the link to display the job status and details.
8. Validate that the job completed. You can track the job in the **Activity** tab in the Browser User Interface, or run the command `odacli describe-job` with the job ID.

Cloning a Virtual Machine in a KVM Deployment

Use ODA CLI commands or the Browser User Interface to clone a virtual machine instance in a KVM deployment.

Using ODA CLI to Clone Virtual Machine Instance

Use the command `odacli clone-vm` to clone an existing virtual machine.

The name of the VM you create is defined by the command `odacli clone-vm -cn name`. Specify the source VM from which you want to clone.

Create a clone of a virtual machine named `vm1`, with the name `vm1_clone`. The cloned VM is created on the same storage as `vm1`.

```
# odacli clone-vm -n vm1 -cn vm1_clone
```

Using Browser User Interface to Clone Virtual Machine Instance

Follow these steps:

1. Log into the Browser User Interface:

```
https://host-ip-address:7093/mgmt/index.html
```

2. Click the **Appliance** tab.
3. Click **VM Instances** to display the VM Instance page.
4. Click **Create VM Instance**.
5. In the page, select the **Clone VM Instance** option and click **Next**.
6. In the Clone VM Instance page, specify the following:
 - Select the Source VM you want to clone
 - Specify the name and description of the cloned VM instance
7. Click **Create**.
8. When you submit the job, the job ID and a link to the job appears. Click the link to display the job status and details.
9. Validate that the job completed. You can track the job in the **Activity** tab in the Browser User Interface, or run the command `odacli describe-job` with the job ID.

Modifying a Virtual Machine in a KVM Deployment

Use ODA CLI commands or the Browser User Interface to modify a virtual machine in a KVM deployment.

Using ODA CLI to Modify Virtual Machines

Use the command `odacli modify-vm` to modify a virtual machine.

Update the configuration of a VM named `vm1`, setting the CPU count to 6 and the maximum memory to 6 gigabytes on both the running VM and subsequent boots.

```
# odacli modify-vm -n vm1 -c 6 -mm 6G --live --config
```

Modify a VM to attach a vnetwork:

```
# odacli modify-vm -n vm_name -avn vnetwork_name
```

- When an application VM is created, a default network interface is created by default in the VM. This interface is attached to the default kvm bridge (`virbr0`) at the host. This interface is intended for convenient communication between the host and VM. This interface does not attach to any physical network interface at the host. Do not configure this interface to use for any external communication.

- You must create a vnetwork using the command `odacli create-vnetwork` and attach the vnetwork (`odacli modify-vm -avn`) to the VM. This creates a second interface in the VM. Configure this network interface for your network requirement.
- The network interface name in the VM depends on the operating system.

Using Browser User Interface to Modify Virtual Machines

Follow these steps:

1. Log into the Browser User Interface:

```
https://host-ip-address:7093/mgmt/index.html
```

2. Click the **Appliance** tab.
3. Click **VM Instances** to display the VM Details page.
4. Click the **Show VM Instances** tab.
5. In the page, select a Virtual Machine, select the **Modify** option and click **Next**.
6. In the Modify VM page, specify Increment in size, and if you want to Auto Start, Set Failover, or Enable NUMA.
7. You can also modify the CPU Pool, Number of vCPUs to use, Memory Size, and attach and detach virtual disks and virtual networks.
8. Select if you want to save the configuration or apply the configuration to the running VM.
9. Click **Modify**.
10. When you submit the job, the job ID and a link to the job appears. Click the link to display the job status and details.
11. Validate that the job completed. You can track the job in the **Activity** tab in the Browser User Interface, or run the command `odacli describe-job` with the job ID.

Viewing Virtual Machines in a KVM Deployment

Use ODA CLI commands or the Browser User Interface to view all virtual machines or details about a virtual machine in a KVM deployment.

Using ODA CLI to View Virtual Machines

The command `odacli describe-vm` displays details about a virtual machine. Use the command `odacli list-vms` to view all virtual machines in the deployment.

```
# odacli list-vms
```

```
# odacli describe-vm -n vm_name
```

Using Browser User Interface to Create Virtual Machines

Follow these steps:

1. Log into the Browser User Interface:

```
https://host-ip-address:7093/mgmt/index.html
```

2. Click the **Appliance** tab.
3. Click **VM Instances** to display the VM Details page.
4. Click the **Show VM Instances** tab to view the list of all configured virtual machines.
5. Click on a VM Instance to view the details of the virtual machine.

Starting and Stopping Virtual Machines in a KVM Deployment

Use ODACLI commands or the Browser User Interface to start or stop virtual machines in a KVM deployment.

Using ODACLI to Start and Stop Virtual Machines

The command `odacli start-vm` starts a virtual machine. Use the command `odacli stop-vm` to stop a virtual machine in the deployment.

If `pref-node` is defined for the VM, then the VM starts on the `pref-node`. If `pref-node` is not defined for the VM, then the VM can start on any node, in a high-availability deployment. However, if you specify the node name `-n`, then the VM starts on the specified node, even if the preferred node is defined.

```
# odacli start-vm -n vm1
```

```
# odacli stop-vm -n vm1
```

Using Browser User Interface to Start and Stop Virtual Machines

Follow these steps:

1. Log into the Browser User Interface:

```
https://host-ip-address:7093/mgmt/index.html
```

2. Click the **Appliance** tab.
3. Click **VM Instances** to display the VM Details page.
4. Click the **Show VM Instances** tab to view the list of all configured virtual machines.
5. To start a virtual machine, click on a VM Instance, and then click **Start** and select the node to start the virtual machine.
6. To stop a virtual machine, click on a VM Instance, and then click **Stop** to stop the virtual machine. Click **Force Stop** to close all running processes and stop the virtual machine.

Deleting a Virtual Machine in a KVM Deployment

Use ODACLI commands or the Browser User Interface to delete a virtual machine in a KVM deployment.

Using ODACLI to Delete Virtual Machines

Use the command `odacli delete-vm` to delete a virtual machine.

Delete a virtual machine named `vm1`.

```
# odacli delete-vm -n vm1
```

Using Browser User Interface to Modify Virtual Machines

Follow these steps:

1. Log into the Browser User Interface:

```
https://host-ip-address:7093/mgmt/index.html
```

2. Click the **Appliance** tab.
3. Click **VM Instances** to display the VM Details page.
4. Click the **Show VM Instances** tab.
5. In the page, select a VM Instance, select the **Delete** option.
6. Click Yes to confirm your choice.
7. When you submit the job, the job ID and a link to the job appears. Click the link to display the job status and details.
8. Validate that the job completed. You can track the job in the **Activity** tab in the Browser User Interface, or run the command `odacli describe-job` with the job ID.

About Overcommitting Memory or CPUs in an Oracle Database Appliance KVM System

Understand performance and other considerations before overcommitting CPU and memory for application KVM.

Oracle Database Appliance does not restrict overcommitting of CPU and memory for application KVM. However, it is not recommended to overcommit CPU or memory. Overcommitting CPU can lead to slow performance of the VMs and the host. Overcommitting memory can cause the system to run out of memory (OOM), which may lead to the Linux kernel shutting down important system processes. Before you decide to overcommit CPU or memory, ensure that you test your systems. When sizing the application VMs, it is recommended to reserve at least 24 GB memory and 2 CPU cores for bare metal system KVM host when there is no database running on the bare metal system host.

Oracle Database Appliance validates oversubscription of shared CPU pools for DB systems as well as memory associated with DB systems. Starting with Oracle Database Appliance release 19.15, the commands `odacli start-dbsystem`, `odacli modify-dbsystem`, `odacli create-dbsystem`, and `odacli modify-cpupool` display errors if the operations result in overcommitting of the CPU pool or memory for the DB system. You can use the `--force/-f` option to allow overcommit of resources for DB systems. This check applies to DB systems only, not for application VMs.

Example JSON File to Create a Single-Node DB System

Follow the JSON file example to create a JSON file to deploy a single-node DB System, with role separation, with the command `odacli create-dbsystem`.

Use the example JSON file to create a file for your environment.

 **Note:**

It is important to review the readme and the examples carefully before creating your JSON file.

Example 15-1 JSON File to Create a Single-Node Oracle KVM Database System with Role Separation

The following is an example of a JSON file that creates a single-node DB 23ai DB system on Oracle Database Appliance bare metal system. To create a DB 23ai DB system, use the example JSON, and update the `version` in the `database` section to DB 23ai version. Use the `odacli describe-dbsystem-image` command to view the supported 23ai version. When using the example to create your JSON file, change the definitions to match your environment. The password must meet password requirements.

```
{
  "system": {
    "name": "test_example",
    "shape": "odb2",
    "customMemorySize": "24G",
    "timeZone": "America/Los_Angeles",
    "diskGroup": "DATA",
    "cpuPoolName": "shared_dbsystem_cpupool",
    "clusterName": "cl-test",
    "enableRoleSeparation": true,
    "customRoleSeparation": {
      "groups": [
        {
          "name": "oinstall",
          "id": 1001,
          "role": "oinstall"
        },
        {
          "name": "dbaoper",
          "id": 1002,
          "role": "dbaoper"
        },
        {
          "name": "dba",
          "id": 1003,
          "role": "dba"
        },
        {
          "name": "asmadmin",
          "id": 1004,
          "role": "asmadmin"
        },
        {
          "name": "asmoper",
          "id": 1005,
          "role": "asmoper"
        },
        {
          "name": "asmdba",
```

```

        "id": 1006,
        "role": "asmdba"
      }
    ],
    "users": [
      {
        "name": "grid",
        "id": 1000,
        "role": "gridUser"
      },
      {
        "name": "oracle",
        "id": 1001,
        "role": "oracleUser"
      }
    ]
  ]
},
"database": {
  "name": "db19",
  "uniqueName": "db19",
  "domainName": "example.com",
  "version": "23.5.0.24.07",
  "edition": "EE",
  "type": "SI",
  "dbClass": "OLTP",
  "shape": "odb2",
  "role": "PRIMARY",
  "targetNodeNumber": null,
  "enableDbConsole": false,
  "enableFlashStorage": false,
  "enableFlashCache": false,
  "enableUnifiedAuditing": true,
  "enableEEHA": true,
  "enableSEHA": false,
  "redundancy": null, <<< if diskgroup redundancy is FLEX, then database
redundancy must be set to one of "HIGH" or "MIRROR", otherwise, can be null
  "characterSet": {
    "characterSet": "AL32UTF8",
    "nlsCharacterSet": "AL16UTF16",
    "dbTerritory": "AMERICA",
    "dbLanguage": "ENGLISH"
  },
  "enableTDE": false,
  "isCdb": true,
  "pdbName": "pdb1",
  "pdbAdminUser": "pdbadmin"
},
"network": {
  "domainName": "test_domain",
  "ntpServers": [
    "xx.xxx.xx.xxx"
  ],
  "dnsServers": [
    "xx.xxx.xx.xxx"
  ]
},

```

```

    "nodes": [
      {
        "name": "node1",
        "ipAddress": "xx.xx.xx.xxx",
        "netmask": "xxx.xxx.xxx.x",
        "gateway": "xx.xx.xx.x",
        "number": 0
      }
    ],
    "publicVNetwork": "vnet1"
  },
  "grid": {
    "language": "en",
    "enableAFD": true
  }
}

```

Example 15-2 JSON File to Create a Single-Node Oracle KVM Database System without Role Separation

The following is an example of a JSON file that creates a single-node Oracle KVM Database System on Oracle Database Appliance bare metal platform, without role separation. When using the example to create your JSON file, change the definitions to match your environment. The password must meet password requirements.

```

{
  "system": {
    "name": "test_example",
    "shape": "odb2",
    "customMemorySize": "24G",
    "timeZone": "America/Los_Angeles",
    "diskGroup": "DATA",
    "cpuPoolName": "shared_dbssystem_cpupool",
    "clusterName": "cl-test",
    "enableRoleSeparation": true,
    "customRoleSeparation": {
      "groups": [
        {
          "name": "oinstall",
          "id": 1001,
          "role": "oinstall"
        },
        {
          "name": "dbaoper",
          "id": 1002,
          "role": "dbaoper"
        },
        {
          "name": "dba",
          "id": 1003,
          "role": "dba"
        },
        {
          "name": "asmadmin",
          "id": 1004,
          "role": "asmadmin"
        }
      ]
    }
  }
}

```

```

    },
    {
      "name": "asmoper",
      "id": 1005,
      "role": "asmoper"
    },
    {
      "name": "asmdba",
      "id": 1006,
      "role": "asmdba"
    }
  ],
  "users": [
    {
      "name": "grid",
      "id": 1000,
      "role": "gridUser"
    },
    {
      "name": "oracle",
      "id": 1001,
      "role": "oracleUser"
    }
  ]
}
},
"database": {
  "name": "db19",
  "uniqueName": "db19",
  "domainName": "example.com",
  "version": "19.26.0.0.250121",
  "edition": "EE",
  "type": "SI",
  "dbClass": "OLTP",
  "shape": "odb4",
  "role": "PRIMARY",
  "targetNodeNumber": null,
  "enableDbConsole": false,
  "enableUnifiedAuditing": true,
  "redundancy": "HIGH", <<< if diskgroup redundancy is FLEX, then
database redundancy must be set to one of "HIGH" or "MIRROR", otherwise, can
be null
  "characterSet": {
    "characterSet": "AL32UTF8",
    "nlsCharacterSet": "AL16UTF16",
    "dbTerritory": "AMERICA",
    "dbLanguage": "ENGLISH"
  },
  "enableTDE": false,
  "isCdb": true,
  "pdbName": "pdb1",
  "pdbAdminUser": "pdbadmin"
},
"network": {
  "domainName": "test_domain",
  "ntpServers": [],

```

```

    "dnsServers": [
      "xx.xxx.xx.xxx"
    ],
    "nodes": [
      {
        "name": "node1",
        "ipAddress": "xx.xx.xx.xxx",
        "netmask": "xxx.xxx.xxx.x",
        "gateway": "xx.xx.xx.x",
        "number": 0
      }
    ],
    "publicVNetwork": "vnet1"
  },
  "grid": {
    "language": "en",
    "enableAFD": true
  }
}

```

Example 15-3 JSON File to Create a Single-Node Oracle KVM Database System with the `--template/-t` option

The following is an example of a JSON file template sample that creates a single-node Oracle KVM Database System on Oracle Database Appliance bare metal platform. This template sample is generated when you run the `odacli create-dbsystem` command with the `--template/-t` option. When using the example to create your JSON file, change the definitions to match your environment. The password must meet password requirements.

```

{
  "system": {
    "name": "test_dbsystem",
    "shape": "dbs2",
    "customMemorySize": "24G",
    "timeZone": "America/Los_Angeles",
    "diskGroup": "DATA",
    "cpuPoolName": "shared_dbsystem_cpupool",
    "enableRoleSeparation": true,
    "clusterName": "clus-test",
    "customRoleSeparation": {
      "groups": [
        {
          "name": "oinstall",
          "id": 1001,
          "role": "oinstall"
        }
      ],
      "users": [
        {
          "name": "grid",
          "id": 1000,
          "role": "gridUser"
        },
        {
          "name": "oracle",

```

```

        "id": 1001,
        "role": "oracleUser"
      }
    ]
  },
  "database": {
    "name": "dbtest",
    "uniqueName": "dbtest",
    "domainName": "example.com",
    "version": "19.16.0.0.220719",
    "edition": "EE",
    "type": "SI",
    "dbClass": "OLTP",
    "shape": "odb2",
    "role": "PRIMARY",
    "targetNodeNumber": "0",
    "enableDbConsole": false,
    "enableFlashStorage": false,
    "enableFlashCache": false,
    "enableUnifiedAuditing": true,
    "enableEEHA": true,
    "enableSEHA": false,
    "redundancy": "MIRROR",
    "characterSet": {
      "characterSet": "AL32UTF8",
      "nlsCharacterSet": "AL16UTF16",
      "dbTerritory": "AMERICA",
      "dbLanguage": "ENGLISH"
    },
    "enableTDE": false,
    "isCdb": true,
    "pdbName": "pdb1",
    "pdbAdminUser": "pdbadmin"
  },
  "network": {
    "domainName": "example.com",
    "ntpServers": [
      "xxx.xxx.xxx.xxx"
    ],
    "dnsServers": [
      "xxx.xxx.xxx.xxx"
    ],
    "nodes": [
      {
        "name": "node1",
        "ipAddress": "xxx.xxx.xxx.xxx",
        "netmask": "xxx.xxx.xxx.xxx",
        "gateway": "xxx.xxx.xxx.xxx",
        "number": 0
      }
    ],
    "publicVNetwork": "vnet1"
  },
  "grid": {
    "language": "en",

```

```

    "enableAFD": true
  }
}

```

Example 15-4 JSON File to Create a Single-Node Oracle KVM Database System with the `--template-annotated/-ta` option

The following is an example of a JSON file that creates a single-node Oracle KVM Database System on Oracle Database Appliance bare metal platform with the `--template-annotated/-ta` option. When using the example to create your JSON file, change the definitions to match your environment. The password must meet password requirements.

```

{
  "system" : {
    "name" : "test_dbssystem",          ---> The name for the
DB System
    "shape" : "dbs2",                 ---> The shape for the
DB System
    "customMemorySize" : "24G",       ---> The memory size
for the DB System
    "timeZone" : "America/Los_Angeles", ---> The timezone for
the DB System
    "diskGroup" : "DATA",             ---> The ASM disk
group to be used for the DB System volumes. Allowed options: <DATA>, <RECO>,
<REDO>
    "cpuPoolName" : "shared_dbssystem_cpupool", ---> The CPU Pool for
the DB System
    "enableRoleSeparation" : true,     ---> Whether or not to
enable Role Separation. If true, need to specify 6 groups and two users.
'groupName' and 'userName' can be customized. If false, need to specify 2
groups and one user. 'groupName' and 'userName' can be customized. Allowed
options: <true>, <false>
    "customRoleSeparation" : {
      "groups" : [
        {
          "name" : "oinstall",         ---> Name of the group
to create, must be unique
          "id" : 1001,                 ---> ID of the group
to create, must be unique
          "role" : "oinstall",         ---> Role of the
group
        }
      ],
      "users" : [
        {
          "name" : "grid",             ---> Name of the user
to create, must be unique
          "id" : 1000,                 ---> ID of the user to
create, must be unique
          "role" : "gridUser",        ---> Role of the
user
        },
        {
          "name" : "oracle",           ---> Name of the user
to create, must be unique
          "id" : 1001,                 ---> ID of the user to

```

```

create, must be unique
        "role" : "oracleUser",           ---> Role of the
user
    }
  ]
},
  "database" : {
    "name" : "dbtest",                  ---> Name for the DB
System database
    "uniqueName" : "dbtest",            ---> The unique name
for the DB System database
    "domainName" : "example.com",       ---> The domain name
that the DB System database will have
    "version" : "19.26.0.0.250121",     ---> The version for the
DB System database. Execute 'odacli describe-dbsystem-image' to get the
supported version
    "edition" : "EE",                  ---> Enter 'EE' for
Enterprise Edition, or 'SE' for Standard Edition
    "type" : "SI",                      ---> Enter a database
deployment type. Allowed options: <RAC>, <RACOne>, <SI> (single instance
database)
    "dbClass" : "OLTP",                 ---> The class for the
DB System database. Standard Edition only supports OLTP. Allowed options:
<OLT>, <DSS>, <IMDB>
    "shape" : "odb2",                  ---> The DB System
database shape, it must be same as the DB System shape
    "role" : "PRIMARY",                 ---> The role for the
DB System database. Allowed options: <PRIMARY>, <STANDBY>
    "targetNodeNumber" : "0",          ---> Use '0' for Node0
and '1' for Node1. For RAC or RACOne use null. The default is '0' for
Node0
    "enableDbConsole" : false,          ---> Whether or not to
create dbconsole or EM express. By default, dbconsole is disabled. Allowed
options: <true>, <false>
    "enableFlashStorage" : false,      ---> Whether or not to
enable the flash storage for the DB System database. Allowed options: <true>,
<false>
    "enableFlashCache" : false,        ---> Whether or not to
enable the flash cache for the DB System database. Allowed options: <true>,
<false>
    "enableUnifiedAuditing" : true,     ---> Whether or not to
enable unified auditing for the DB System database. Allowed options: <true>,
<false>
    "enableEEHA" : true,               ---> Whether or not to
enable HA for EE SI database. enableEEHA is only valid when the edition is
EE. Allowed options: <true>, <false>
    "enableSEHA" : false,              ---> Whether or not to
enable HA for SE SI database. enableSEHA is only valid when the edition is
SE. Allowed options: <true>, <false>
    "redundancy" : "MIRROR",           ---> If diskgroup
redundancy is FLEX, then database redundancy must be set to one of 'HIGH' or
'MIRROR', otherwise, can be null
    "characterSet" : {
      "characterSet" : "AL32UTF8",      ---> The character set
for the DB System database

```



```

    "nlsCharacterSet" : "AL16UTF16",          ---> The NLS character
set for the DB System database
    "dbTerritory" : "AMERICA",              ---> The territory for
the DB System database
    "dbLanguage" : "ENGLISH",              ---> The language for
the DB System database
  },
  "enableTDE" : false,                      ---> Whether or not to
enable TDE. Allowed options: <true>, <false>
  "isCdb" : true,                           ---> Enter 'true' if
this database is container DB. For 21c and above, cdb must be true. Enter
'false' if this is non-cdb. Allowed options: <true>, <false>
  "pdbName" : "pdb1",                       ---> Enter pdbName if
isCdb parameter is 'true', use 'null' if isCdb is 'false'
  "pdbAdminUser" : "pdbadmin",             ---> Enter PDB admin
user name, use 'null' if isCdb parameter is 'false'
},
"network" : {
  "domainName" : "example.com",            ---> The domain name
for the DB System network
  "ntpServers" : [
    "xxx.xxx.xxx.xxx"
  ],
  "dnsServers" : [
    "xxx.xxx.xxx.xxx"
  ],
  "nodes" : [
    {
      "name" : "node1",                    ---> The name used to
configure the hostname
      "ipAddress" : "xxx.xxx.xxx.xxx",      ---> The IP address
for this node
      "netmask" : "xxx.xxx.xxx.xxx",        ---> The mask of the
network for this node
      "gateway" : "xxx.xxx.xxx.xxx",        ---> The gateway
address for this node
      "number" : 0,                         ---> 0 (Use 0 for the
first node of the DB System instance)
    }
  ],
  "publicVNetwork" : "vnet1",              ---> The name of the
public virtual network. The ipAddress, vipAddress and scanIps must be on this
publicVNetwork
},
"grid" : {
  "language" : "en",                       ---> The language used
for GI (Grid Infrastructure) installation
  "enableAFD" : true,                       ---> Whether or not to
enable ASM Filter Driver, enabled by default. Allowed options: <true>,
<false>
}
}

```

Example JSON File to Create a High-Availability DB System

Follow the JSON file example to create a JSON file to deploy a High-Availability DB system, with role separation, with the command `odacli create-dbsystem`.

Use the example JSON file to create a file for your environment.

Example 15-5 JSON File to Create a High-Availability DB system without Role Separation

The following is an example of a JSON file that creates a High-Availability DB system on Oracle Database Appliance bare metal platform, without role separation. When using the example to create your JSON file, change the definitions to match your environment. The password must meet password requirements.

```
{
  "system": {
    "name": "test_example",
    "shape": "odb2",
    "customMemorySize": "24G",
    "timeZone": "America/Los_Angeles",
    "diskGroup": "DATA",
    "cpuPoolName": "shared_dbsystem_cpupool",
    "clusterName": "cl-test",
    "enableRoleSeparation": true,
    "customRoleSeparation": {
      "groups": [
        {
          "name": "oinstall",
          "id": 1001,
          "role": "oinstall"
        },
        {
          "name": "dbaoper",
          "id": 1002,
          "role": "dbaoper"
        },
        {
          "name": "dba",
          "id": 1003,
          "role": "dba"
        },
        {
          "name": "asmadmin",
          "id": 1004,
          "role": "asmadmin"
        },
        {
          "name": "asmoper",
          "id": 1005,
          "role": "asmoper"
        },
        {
          "name": "asmdba",
          "id": 1006,
```

```

        "role": "asmdba"
    }
],
"users": [
    {
        "name": "grid",
        "id": 1000,
        "role": "gridUser"
    },
    {
        "name": "oracle",
        "id": 1001,
        "role": "oracleUser"
    }
]
}
},
"database": {
    "name": "dbtest",
    "uniqueName": "dbtest",
    "domainName": "test_domain",
    "version": "19.26.0.0.250121",
    "edition": "EE",
    "type": "SI",
    "dbClass": "OLTP",
    "shape": "odb2",
    "role": "PRIMARY",
    "targetNodeNumber": "0",
    "enableDbConsole": false,
    "enableUnifiedAuditing": true,
    "enableEEHA": true,
    "redundancy": "MIRROR", <<< if diskgroup redundancy is FLEX, then
database redundancy must be set to one of "HIGH" or "MIRROR", otherwise, can
be null
    "characterSet": {
        "characterSet": "AL32UTF8",
        "nlsCharacterSet": "AL16UTF16",
        "dbTerritory": "AMERICA",
        "dbLanguage": "AMERICAN"
    },
    "enableTDE": false,
    "isCdb": true,
    "pdbName": "pdb1",
    "pdbAdminUser": "pdbadmin"
},
"network": {
    "domainName": "test_domain",
    "ntpServers": [],
    "dnsServers": [
        "xx.xxx.xx.xxx"
    ],
    "nodes": [
        {
            "name": "node1",
            "ipAddress": "xx.xx.xxx.xx",
            "netmask": "xxx.xxx.xxx.x",

```

```

        "gateway": "xx.xx.xxx.x",
        "number": 0,
        "vipName": "node1-vip",
        "vipAddress": "xx.xx.xxx.xx"
    },
    {
        "name": "node2",
        "ipAddress": "xx.xx.xxx.xx",
        "netmask": "xxx.xxx.xxx.x",
        "gateway": "xx.xx.xxx.x",
        "number": 1,
        "vipName": "node2-vip",
        "vipAddress": "xx.xx.xxx.xx"
    }
],
"publicVNetwork": "vnet1",
"scanName": "test-scan",
"scanIps": [
    "xx.xx.xxx.xx",
    "xx.xx.xxx.xx"
]
},
"grid": {
    "language": "en",
    "enableAFD": true
}
}

```

Example 15-6 JSON File to Create a High-Availability DB system with Role Separation

The following is an example of a JSON file that creates a High-Availability DB system on Oracle Database Appliance bare metal platform. The example uses role separation. When using the example to create your JSON file, change the definitions to match your environment. The password must meet password requirements.

```

{
  "system": {
    "name": "test_system",
    "shape": "dbs2",
    "customMemorySize": "24G",
    "timeZone": "America/Los_Angeles",
    "diskGroup": "DATA",
    "cpuPoolName": "shared_dbssystem_cpupool",
    "enableRoleSeparation": true,
    "customRoleSeparation": {
      "groups": [
        {
          "name": "oinstall",
          "id": 1001,
          "role": "oinstall"
        },
        {
          "name": "dbaoper",
          "id": 1002,
          "role": "dbaoper"
        }
      ]
    }
  }
}

```

```

        {
            "name": "dba",
            "id": 1003,
            "role": "dba"
        },
        {
            "name": "asmadmin",
            "id": 1004,
            "role": "asmadmin"
        },
        {
            "name": "asmoper",
            "id": 1005,
            "role": "asmoper"
        },
        {
            "name": "asmdba",
            "id": 1006,
            "role": "asmdba"
        }
    ],
    "users": [
        {
            "name": "grid",
            "id": 1000,
            "role": "gridUser"
        },
        {
            "name": "oracle",
            "id": 1001,
            "role": "oracleUser"
        }
    ]
}
},
"database": {
    "name": "dbtest",
    "uniqueName": "dbtest",
    "domainName": "test_domain",
    "version": "23.5.0.24.07",
    "edition": "EE",
    "type": "SI",
    "dbClass": "OLTP",
    "shape": "odb2",
    "role": "PRIMARY",
    "targetNodeNumber": "0",
    "enableDbConsole": false,
    "enableUnifiedAuditing": true,
    "enableEEHA": true,
    "redundancy": null, <<< if diskgroup redundancy is FLEX, then
database redundancy must be set to one of "HIGH" or "MIRROR", otherwise, can
be null
    "characterSet": {
        "characterSet": "AL32UTF8",
        "nlsCharacterSet": "AL16UTF16",
        "dbTerritory": "AMERICA",

```

```

        "dbLanguage": "AMERICAN"
    },
    "enableTDE": false,
    "isCdb": true,
    "pdbName": "pdb1",
    "pdbAdminUser": "pdbadmin"
},
"network": {
    "domainName": "test_domain",
    "ntpServers": [],
    "dnsServers": [
        "xx.xxx.xx.xxx"
    ],
    "nodes": [
        {
            "name": "node1",
            "ipAddress": "xx.xx.xxx.xx",
            "netmask": "xxx.xxx.xxx.x",
            "gateway": "xx.xx.xxx.x",
            "number": 0,
            "vipName": "node1-vip",
            "vipAddress": "xx.xx.xxx.xx"
        },
        {
            "name": "node2",
            "ipAddress": "xx.xx.xxx.xx",
            "netmask": "xxx.xxx.xxx.x",
            "gateway": "xx.xx.xxx.x",
            "number": 1,
            "vipName": "node2-vip",
            "vipAddress": "xx.xx.xxx.xx"
        }
    ],
    "publicVNetwork": "vnet1",
    "scanName": "test-scan",
    "scanIps": [
        "xx.xx.xxx.xx",
        "xx.xx.xxx.xx"
    ]
},
"grid": {
    "language": "en",
    "enableAFD": true
}
}

```

Example 15-7 JSON File to Create a High-Availability DB system with Standard Edition High-Availability Enabled

The following is an example of a JSON file that creates a High-Availability DB system on Oracle Database Appliance bare metal platform. When using the example to create your JSON file, change the definitions to match your environment. The password must meet password requirements.

```

{
    "system": {

```

```

"name": "test_example",
"shape": "odb2",
"customMemorySize": "24G",
"timeZone": "America/Los_Angeles",
"diskGroup": "DATA",
"cpuPoolName": "shared_dbssystem_cpupool",
"enableRoleSeparation": true,
"customRoleSeparation": {
  "groups": [
    {
      "name": "oinstall",
      "id": 1001,
      "role": "oinstall"
    },
    {
      "name": "dbaoper",
      "id": 1002,
      "role": "dbaoper"
    },
    {
      "name": "dba",
      "id": 1003,
      "role": "dba"
    },
    {
      "name": "asmadmin",
      "id": 1004,
      "role": "asmadmin"
    },
    {
      "name": "asmoper",
      "id": 1005,
      "role": "asmoper"
    },
    {
      "name": "asmdba",
      "id": 1006,
      "role": "asmdba"
    }
  ],
  "users": [
    {
      "name": "grid",
      "id": 1000,
      "role": "gridUser"
    },
    {
      "name": "oracle",
      "id": 1001,
      "role": "oracleUser"
    }
  ]
}
},
"database": {
  "name": "dbtest",

```

```

    "uniqueName": "dbtest",
    "domainName": "test_domain",
    "version": "19.26.0.0.250121",
    "edition": "SE",
    "type": "SI",
    "dbClass": "OLTP",
    "shape": "odb2",
    "role": "PRIMARY",
    "targetNodeNumber": "0",
    "enableDbConsole": false,
    "enableUnifiedAuditing": true,
    "enableSEHA": true,
    "redundancy": "MIRROR", <<< if diskgroup redundancy is FLEX, then
database redundancy must be set to one of "HIGH" or "MIRROR", otherwise, can
be null
    "characterSet": {
        "characterSet": "AL32UTF8",
        "nlsCharacterSet": "AL16UTF16",
        "dbTerritory": "AMERICA",
        "dbLanguage": "AMERICAN"
    },
    "enableTDE": false,
    "isCdb": true,
    "pdbName": "pdb1",
    "pdbAdminUser": "pdbadmin"
},
"network": {
    "domainName": "test_domain",
    "ntpServers": [],
    "dnsServers": [
        "xx.xxx.xx.xxx"
    ],
    "nodes": [
        {
            "name": "node1",
            "ipAddress": "xx.xx.xxx.xx",
            "netmask": "xxx.xxx.xxx.x",
            "gateway": "xx.xx.xxx.x",
            "number": 0,
            "vipName": "node1-vip",
            "vipAddress": "xx.xx.xxx.xx"
        },
        {
            "name": "node2",
            "ipAddress": "xx.xx.xxx.xx",
            "netmask": "xxx.xxx.xxx.x",
            "gateway": "xx.xx.xxx.x",
            "number": 1,
            "vipName": "node2-vip",
            "vipAddress": "xx.xx.xxx.xx"
        }
    ],
    "publicVNetwork": "vnet1",
    "scanName": "test-scan",
    "scanIps": [
        "xx.xx.xxx.xx",

```



```

        "xx.xx.xxx.xx"
    ]
},
"grid": {
    "language": "en"
    "enableAFD": true
}
}

```

Example 15-8 JSON File to Create a High-Availability DB system with Oracle RAC Database

The following is an example of a JSON file that creates a High-Availability DB system on Oracle Database Appliance bare metal platform. When using the example to create your JSON file, change the definitions to match your environment. The password must meet password requirements.

```

{
  "system": {
    "name": "test_example",
    "shape": "odb2",
    "customMemorySize": "24G",
    "timeZone": "America/Los_Angeles",
    "diskGroup": "DATA",
    "cpuPoolName": "shared_dbssystem_cpupool",
    "enableRoleSeparation": true,
    "customRoleSeparation": {
      "groups": [
        {
          "name": "oinstall",
          "id": 1001,
          "role": "oinstall"
        },
        {
          "name": "dbaoper",
          "id": 1002,
          "role": "dbaoper"
        },
        {
          "name": "dba",
          "id": 1003,
          "role": "dba"
        },
        {
          "name": "asmadmin",
          "id": 1004,
          "role": "asmadmin"
        },
        {
          "name": "asmoper",
          "id": 1005,
          "role": "asmoper"
        },
        {
          "name": "asmdba",
          "id": 1006,

```

```

        "role": "asmdba"
      }
    ],
    "users": [
      {
        "name": "grid",
        "id": 1000,
        "role": "gridUser"
      },
      {
        "name": "oracle",
        "id": 1001,
        "role": "oracleUser"
      }
    ]
  }
},
"database": {
  "name": "dbtest",
  "uniqueName": "dbtest",
  "domainName": "test_domain",
  "version": "19.26.0.0.250121",
  "edition": "EE",
  "type": "RAC",
  "dbClass": "OLTP",
  "shape": "odb2",
  "role": "PRIMARY",
  "targetNodeNumber": "0",
  "enableDbConsole": false,
  "enableUnifiedAuditing": true,
  "redundancy": "MIRROR", <<< if diskgroup redundancy is FLEX, then
database redundancy must be set to one of "HIGH" or "MIRROR", otherwise, can
be null
  "characterSet": {
    "characterSet": "AL32UTF8",
    "nlsCharacterSet": "AL16UTF16",
    "dbTerritory": "AMERICA",
    "dbLanguage": "AMERICAN"
  },
  "enableTDE": false,
  "isCdb": true,
  "pdbName": "pdb1",
  "pdbAdminUser": "pdbadmin"
},
"network": {
  "domainName": "test_domain",
  "ntpServers": [],
  "dnsServers": [
    "xx.xxx.xx.xxx"
  ],
  "nodes": [
    {
      "name": "node1",
      "ipAddress": "xx.xx.xxx.xx",
      "netmask": "xxx.xxx.xxx.x",
      "gateway": "xx.xx.xxx.x",

```

```

        "number": 0,
        "vipName": "node1-vip",
        "vipAddress": "xx.xx.xxx.xx"
    },
    {
        "name": "node2",
        "ipAddress": "xx.xx.xxx.xx",
        "netmask": "xxx.xxx.xxx.x",
        "gateway": "xx.xx.xxx.x",
        "number": 1,
        "vipName": "node2-vip",
        "vipAddress": "xx.xx.xxx.xx"
    }
],
"publicVNetwork": "vnet1",
"scanName": "test-scan",
"scanIps": [
    "xx.xx.xxx.xx",
    "xx.xx.xxx.xx"
]
},
"grid": {
    "language": "en"
    "enableAFD": true
}
}

```

Example 15-9 JSON File to Create a High-Availability DB system with the `--template/-t` option

The following is an example of a JSON file that creates a High-Availability DB system on Oracle Database Appliance bare metal platform. This template sample is generated when you run the `odacli create-dbsystem` command with the `--template/-t` option. When using the example to create your JSON file, change the definitions to match your environment. The password must meet password requirements.

```

{
  "system": {
    "name": "test_dbsystem",
    "shape": "dbs2",
    "customMemorySize": "24G",
    "timeZone": "America/Los_Angeles",
    "diskGroup": "DATA",
    "cpuPoolName": "shared_dbsystem_cpupool",
    "enableRoleSeparation": true,
    "customRoleSeparation": {
      "groups": [
        {
          "name": "oinstall",
          "id": 1001,
          "role": "oinstall"
        }
      ],
      "users": [
        {
          "name": "grid",

```

```

        "id": 1000,
        "role": "gridUser"
    },
    {
        "name": "oracle",
        "id": 1001,
        "role": "oracleUser"
    }
]
}
},
"database": {
    "name": "dbtest",
    "uniqueName": "dbtest",
    "domainName": "example.com",
    "version": "19.26.0.0.250121",
    "edition": "EE",
    "type": "SI",
    "dbClass": "OLTP",
    "shape": "odb2",
    "role": "PRIMARY",
    "targetNodeNumber": "0",
    "enableDbConsole": false,
    "enableFlashStorage": false,
    "enableFlashCache": false,
    "enableUnifiedAuditing": true,
    "enableEEHA": true,
    "enableSEHA": false,
    "redundancy": "MIRROR",
    "characterSet": {
        "characterSet": "AL32UTF8",
        "nlsCharacterSet": "AL16UTF16",
        "dbTerritory": "AMERICA",
        "dbLanguage": "AMERICAN"
    },
    "enableTDE": false,
    "isCdb": true,
    "pdbName": "pdb1",
    "pdbAdminUser": "pdbadmin"
},
"network": {
    "domainName": "example.com",
    "ntpServers": [
        "xxx.xxx.xxx.xxx"
    ],
    "dnsServers": [
        "xxx.xxx.xxx.xxx"
    ],
    "nodes": [
        {
            "name": "node1",
            "ipAddress": "xxx.xxx.xxx.xxx",
            "netmask": "xxx.xxx.xxx.xxx",
            "gateway": "xxx.xxx.xxx.xxx",
            "number": 0,
            "vipName": "node1-vip",

```

```

        "vipAddress": "xxx.xxx.xxx.xxx"
    },
    {
        "name": "node2",
        "ipAddress": "xxx.xxx.xxx.xxx",
        "netmask": "xxx.xxx.xxx.xxx",
        "gateway": "xxx.xxx.xxx.xxx",
        "number": 1,
        "vipName": "node2-vip",
        "vipAddress": "xxx.xxx.xxx.xxx"
    }
],
"publicVNetwork": "vnet1",
"scanName": "dbtest-scan",
"scanIps": [
    "xxx.xxx.xxx.xxx",
    "xxx.xxx.xxx.xxx"
]
},
"grid": {
    "language": "en",
    "enableAFD": true
}
}

```

Example 15-10 JSON File to Create a High-Availability DB system with the --template/-t option

The following is an example of a JSON file that creates a High-Availability DB system on Oracle Database Appliance bare metal platform. This template sample is generated when you run the `odacli create-dbsystem` command with the `--template/t` option. When using the example to create your JSON file, change the definitions to match your environment. The password must meet password requirements.

```

{
  "system": {
    "name": "test_dbsystem",
    "shape": "dbs2",
    "customMemorySize": "24G",
    "timeZone": "America/Los_Angeles",
    "diskGroup": "DATA",
    "cpuPoolName": "shared_dbsystem_cpupool",
    "enableRoleSeparation": true,
    "customRoleSeparation": {
      "groups": [
        {
          "name": "oinstall",
          "id": 1001,
          "role": "oinstall"
        }
      ],
      "users": [
        {
          "name": "grid",
          "id": 1000,
          "role": "gridUser"
        }
      ]
    }
  }
}

```

```

        },
        {
            "name": "oracle",
            "id": 1001,
            "role": "oracleUser"
        }
    ]
}
},
"database": {
    "name": "dbtest",
    "uniqueName": "dbtest",
    "domainName": "example.com",
    "version": "19.26.0.0.250121",
    "edition": "EE",
    "type": "SI",
    "dbClass": "OLTP",
    "shape": "odb2",
    "role": "PRIMARY",
    "targetNodeNumber": "0",
    "enableDbConsole": false,
    "enableFlashStorage": false,
    "enableFlashCache": false,
    "enableUnifiedAuditing": true,
    "enableEEHA": true,
    "enableSEHA": false,
    "redundancy": "MIRROR",
    "characterSet": {
        "characterSet": "AL32UTF8",
        "nlsCharacterSet": "AL16UTF16",
        "dbTerritory": "AMERICA",
        "dbLanguage": "AMERICAN"
    },
    "enableTDE": false,
    "isCdb": true,
    "pdbName": "pdb1",
    "pdbAdminUser": "pdbadmin"
},
"network": {
    "domainName": "example.com",
    "ntpServers": [
        "xxx.xxx.xxx.xxx"
    ],
    "dnsServers": [
        "xxx.xxx.xxx.xxx"
    ],
    "nodes": [
        {
            "name": "node1",
            "ipAddress": "xxx.xxx.xxx.xxx",
            "netmask": "xxx.xxx.xxx.xxx",
            "gateway": "xxx.xxx.xxx.xxx",
            "number": 0,
            "vipName": "node1-vip",
            "vipAddress": "xxx.xxx.xxx.xxx"
        }
    ],

```

```

    {
      "name": "node2",
      "ipAddress": "xxx.xxx.xxx.xxx",
      "netmask": "xxx.xxx.xxx.xxx",
      "gateway": "xxx.xxx.xxx.xxx",
      "number": 1,
      "vipName": "node2-vip",
      "vipAddress": "xxx.xxx.xxx.xxx"
    }
  ],
  "publicVNetwork": "vnet1",
  "scanName": "dbtest-scan",
  "scanIps": [
    "xxx.xxx.xxx.xxx",
    "xxx.xxx.xxx.xxx"
  ]
},
"grid": {
  "language": "en",
  "enableAFD": true
}
}

```

Example 15-11 JSON File to Create a High-Availability DB system with the `--template-annotated/-ta` option

The following is an example of a JSON file that creates a High-Availability DB system on Oracle Database Appliance bare metal platform. This template sample is generated when you run the `odacli create-dbsystem` command with the `--template-annotated/-ta` option. When using the example to create your JSON file, change the definitions to match your environment. The password must meet password requirements.

```

{
  "system" : {
    "name" : "test_dbsystem",          ---> The name for the
DB System
    "shape" : "dbs2",                 ---> The shape for the
DB System
    "customMemorySize" : "24G",       ---> The memory size
for the DB System
    "timeZone" : "America/Los_Angeles", ---> The timezone for
the DB System
    "diskGroup" : "DATA",             ---> The ASM disk
group to be used for the DB System volumes. Allowed options: <DATA>, <RECO>,
<REDO>
    "cpuPoolName" : "shared_dbsystem_cpupool", ---> The CPU Pool for
the DB System
    "useReservedCores" : false,       ---> Whether or not to
use reserved CPU cores. Allowed options: <true>, <false>
    "enableRoleSeparation" : true,    ---> Whether or not to
enable Role Separation. If true, need to specify 6 groups and two users.
'groupName' and 'userName' can be customized. If false, need to specify 2
groups and one user. 'groupName' and 'userName' can be customized. Allowed
options: <true>, <false>
    "customRoleSeparation" : {
      "groups" : [

```

```

        {
            "name" : "oinstall",           ---> Name of the group
to create, must be unique
            "id" : 1001,                 ---> ID of the group
to create, must be unique
group
            "role" : "oinstall",        ---> Role of the
        }
    ],
    "users" : [
        {
            "name" : "grid",           ---> Name of the user
to create, must be unique
            "id" : 1000,                 ---> ID of the user to
create, must be unique
            "role" : "gridUser",        ---> Role of the
user
        },
        {
            "name" : "oracle",         ---> Name of the user
to create, must be unique
            "id" : 1001,                 ---> ID of the user to
create, must be unique
            "role" : "oracleUser",      ---> Role of the
user
        }
    ]
}
},
"database" : {
    "name" : "dbtest",                ---> Name for the DB
System database
    "uniqueName" : "dbtest",          ---> The unique name
for the DB System database
    "domainName" : "example.com",     ---> The domain name
that the DB System database will have
    "version" : "19.26.0.0.250121",   ---> The version for
the DB System database. Execute 'odacli describe-dbsystem-image' to get the
supported version
    "edition" : "EE",                 ---> Enter 'EE' for
Enterprise Edition, or 'SE' for Standard Edition
    "type" : "SI",                     ---> Enter a database
deployment type. Allowed options: <RAC>, <RACOne>, <SI> (single instance
database)
    "dbClass" : "OLTP",                ---> The class for the
DB System database. Standard Edition only supports OLTP. Allowed options:
<OLT>, <DSS>, <IMDB>
    "shape" : "odb2",                 ---> The DB System
database shape, it must be same as the DB System shape
    "role" : "PRIMARY",                ---> The role for the
DB System database. Allowed options: <PRIMARY>, <STANDBY>
    "dbStorage" : "ASM",               ---> Storage type of
the DB System database. The default value is ASM. Allowed options: <ASM>,
<PMEM>
    "level0BackupDay" : "wednesday",  ---> Backup day of the
DB System database. Allowed options: <monday>, <tuesday>, <wednesday>,

```



```

<thursday>, <friday>, <saturday>, <sunday>
    "targetNodeNumber" : "0",          ---> Use '0' for Node0
and '1' for Node1. For RAC or RACOne use null. The default is '0' for
Node0
    "enableDbConsole" : false,         ---> Whether or not to
create dbconsole or EM express. By default, dbconsole is disabled. Allowed
options: <true>, <false>
    "enableFlashStorage" : false,     ---> Whether or not to
enable the flash storage for the DB System database. Allowed options: <true>,
<false>
    "enableFlashCache" : false,       ---> Whether or not to
enable the flash cache for the DB System database. Allowed options: <true>,
<false>
    "enableUnifiedAuditing" : true,    ---> Whether or not to
enable unified auditing for the DB System database. Allowed options: <true>,
<false>
    "enableEEHA" : true,              ---> Whether or not to
enable HA for EE SI database. enableEEHA is only valid when the edition is
EE. Allowed options: <true>, <false>
    "enableSEHA" : false,             ---> Whether or not to
enable HA for SE SI database. enableSEHA is only valid when the edition is
SE. Allowed options: <true>, <false>
    "redundancy" : "MIRROR",          ---> If diskgroup
redundancy is FLEX, then database redundancy must be set to one of 'HIGH' or
'MIRROR', otherwise, can be null
    "characterSet" : {
        "characterSet" : "AL32UTF8",   ---> The character set
for the DB System database
        "nlsCharacterSet" : "AL16UTF16", ---> The NLS character
set for the DB System database
        "dbTerritory" : "AMERICA",    ---> The territory for
the DB System database
        "dbLanguage" : "AMERICAN",    ---> The language for
the DB System database
    },
    "enableTDE" : false,              ---> Whether or not to
enable TDE. Allowed options: <true>, <false>
    "isCdb" : true,                   ---> Enter 'true' if
this database is container DB. For 21c and above, cdb must be true. Enter
'false' if this is non-cdb. Allowed options: <true>, <false>
    "pdbName" : "pdb1",               ---> Enter pdbName if
isCdb parameter is 'true', use 'null' if isCdb is 'false'
    "pdbAdminUser" : "pdbadmin",      ---> Enter PDB admin
user name, use 'null' if isCdb parameter is 'false'
    },
    "network" : {
        "domainName" : "example.com", ---> The domain name
for the DB System network
        "ntpServers" : [
            "xxx.xxx.xxx.xxx"
        ],
        "dnsServers" : [
            "xxx.xxx.xxx.xxx"
        ],
        "nodes" : [
            {

```

```

        "name" : "node1",          ---> The name used to
configure the hostname
        "ipAddress" : "xxx.xxx.xxx.xxx", ---> The IP address
for this node
        "netmask" : "xxx.xxx.xxx.xxx", ---> The mask of the
network for this node
        "gateway" : "xxx.xxx.xxx.xxx", ---> The gateway
address for this node
        "number" : 0,            ---> 0 (Use 0 for the
first node of the DB System instance)
        "vipName" : "node1-vip", ---> The VIP name for
this first node, only for HA case
        "vipAddress" : "xxx.xxx.xxx.xxx", ---> The VIP address
for this first node, only for HA case
    },
    {
        "name" : "node2",          ---> The name used to
configure the hostname
        "ipAddress" : "xxx.xxx.xxx.xxx", ---> The IP address
for this node
        "netmask" : "xxx.xxx.xxx.xxx", ---> The mask of the
network for this node
        "gateway" : "xxx.xxx.xxx.xxx", ---> The gateway
address for this node
        "number" : 1,            ---> 1 (Use 1 for the
second node of the DB System instance)
        "vipName" : "node2-vip", ---> The VIP name for
this second node, only for HA case
        "vipAddress" : "xxx.xxx.xxx.xxx", ---> The VIP address
for this second node, only for HA case
    }
],
    "publicVNetwork" : "vnet1",    ---> The name of the
public virtual network. The ipAddress, vipAddress and scanIps must be on this
publicVNetwork
    "scanName" : "dbtest-scan",    ---> The scan name of
the DB System. It should resolve to the IPs defined in the scanIps. Only for
HA case
    "scanIps" : [
        "xxx.xxx.xxx.xxx",
        "xxx.xxx.xxx.xxx"
    ]
},
    "grid" : {
        "language" : "en",        ---> The language used
for GI (Grid Infrastructure) installation
        "enableAFD" : true,       ---> Whether or not to
enable ASM Filter Driver, enabled by default. Allowed options: <true>,
<false>
    }
}

```

16

Oracle Database Appliance Command-Line Interface

The command-line interface has different classes of tools to manage Oracle Database Appliance.

- [About Oracle Database Appliance Command-Line Interface](#)
Three classes of tools are available to perform deployment, lifecycle management, and system administration on Oracle Database Appliance.
- [Managing ODACLI Privileges and Security with SUDO](#)
Oracle Appliance Manager command-line utility requires `root` system privileges for most administration actions. You may want to use SUDO as part of your system auditing and security policy.
- [ODACLI Command Changes with Multi-User Access on Oracle Database Appliance](#)
Understand the ODACLI command changes when you enable multi-user access.
- [odacli Network Commands](#)
Use the `odacli network` commands to list and describe network interfaces.
- [odacli Multi-User Access Commands](#)
Use `odacli` commands to enable multi-user access for the appliance.
- [odacli Apply Patch and Update Commands](#)
Use the commands `odacli update` and `apply patch` to apply patches and update the appliance.
- [odacli Appliance Commands](#)
Use the `odacli appliance` commands to perform lifecycle activities for the appliance.
- [odacli Backup and Recovery Commands](#)
Use the `odacli backup` and `recover` commands to backup to and restore from Oracle Cloud Infrastructure Object Storage or disk or NFS.
- [odacli Oracle Data Guard Commands](#)
Use ODACLI commands to configure and manage Oracle Data Guard in your Oracle Database Appliance deployment.
- [odacli CPU Core Commands](#)
Use the CPU Core commands to enable CPU cores and display current and historical CPU core configurations.
- [odacli CPU Pool Commands for Bare Metal and KVM](#)
Use `odacli` commands to manage resource allocations on Oracle Database Appliance for bare metal and KVM deployments.
- [odacli Database Commands](#)
Use the `odacli database` commands to perform database lifecycle operations.
- [odacli DBHome Commands](#)
Use the `odacli DBHome` commands to manage database Home operations.
- [odacli Database Storage Commands](#)
Use the Database Storage commands to list, describe, create, and delete Oracle database storage.

- [odacli Diagnostics Collection Commands](#)
Use the diagnostics collection commands to display diagnostics details.
- [odacli Job Commands](#)
Use the `odacli list-jobs` and `odacli describe-job` commands to display job details.
- [odacli Oracle Key Vault Server Configuration Commands](#)
Use `odacli` commands to manage Oracle Key Vault server configuration for databases on Oracle Database Appliance.
- [Log Commands](#)
Use the `odacli log` commands to specify the options to collect and delete logs.
- [odacli Oracle Auto Service Request Commands](#)
Use the Oracle Auto Service Request (Oracle ASR) commands to configure, update, test, and delete Oracle ASR on the system.
- [Adaptive Classification and Redaction \(ACR\) Commands](#)
Understand Adaptive Classification and Redaction (ACR) commands.
- [odacli OS Commands](#)
Use the `odacli OS` commands to list and update operating system (OS) parameters.
- [odaadmcli Hardware Monitoring Commands](#)
Use the `hardware monitoring` commands to display hardware configurations.
- [Storage Commands](#)
Understand the commands to perform storage operations and diagnostics.

About Oracle Database Appliance Command-Line Interface

Three classes of tools are available to perform deployment, lifecycle management, and system administration on Oracle Database Appliance.

The command-line interface (CLI) is an alternative to Oracle Database Appliance Browser User Interface for some appliance configuration and patching tasks, database management, and job activity.

Oracle Database Appliance uses a role-based command-line interface. Use the `odacli` commands to perform lifecycle management tasks and the `odaadmcli` commands to perform storage and hardware monitoring maintenance. Many tasks related to managing Oracle Databases are also required with databases on Oracle Database Appliance. Tasks common to Oracle Database generally are described in the Oracle Database documentation library. However, to simplify tasks, use the Oracle Database Appliance command-line interface. The `odacli` and `odaadmcli` utilities combine the capabilities of the `sys` database administrator role and the operating system Superuser (`root` user). Always perform administrative tasks using the Oracle Database Appliance Browser User Interface or CLI utilities.

The following classes of commands are available:

- **Deployment and Configuration:** Use the deployment and configuration commands as part of the initial deployment of the appliance and to configure CPU cores.
- **Lifecycle management:** Use `odacli` commands to perform database and system administration tasks for the appliance. The `odacli` commands are the primary interface to perform life cycle activities for the appliance.
- **Administration:** Use `odaadmcli` commands to perform hardware administration tasks for the appliance. The `odaadmcli` commands are the interface for infrequent administration activities needed to manage appliance hardware components, storage, and VLAN.

You can perform the following deployment and configuration tasks:

- Configure the first network in the appliance
- Unzip and copy the Oracle Database Appliance software to the correct locations
- Set the number of CPU Cores for the system

You can perform the following appliance lifecycle tasks with `odacli` commands:

- Create and describe the appliance
- Create, list, describe, and delete databases
- Create, list, describe, and delete Oracle Database Homes
- Create, list, and describe the networks
- List and describe the jobs

You can perform the following appliance administration tasks with `odaadmcli` commands:

- Show storage, disks, disk groups, and controllers
- Display storage diagnostics for disks and NVM Express (NVMe)s
- Show server, memory, processor, power, cooling, and network details

Depending on your version of Oracle Appliance Manager and your hardware, some of the `odacli` commands may not be available to you. To see which commands are supported on your version of Oracle Appliance Manager and your hardware, run the `odacli help` command:

```
odacli -h.
```

Command-Line Interface Syntax

The command-line interface commands and parameters are case-sensitive.

An `odacli` or `odaadmcli` command uses the following command syntax:

```
odacli command [options]
```

- *command* is an action you want to perform on the appliance. For example: `odacli list-networks` or `odacli describe-jobs`.
- *options* are optional parts of the `odacli` command. Options can consist of one or more options that extend the use of the `odacli` command carried out on an object. Options include additional information about the action that you want to perform on the object. Option names are preceded with a dash. Some options require the name of an object for the command to perform the action that you want to carry out. If an option is preceded with an * (asterisk), this information is required to submit the command. When appending `-j` to the `odacli` command, the output is returned in JSON format. The help option (`-h`) is an option that is available with almost all commands. When you include the `-h` option, you can obtain additional information about the command that you want to perform.

Oracle Database Appliance Manager Command-Line Interface Help

Run the `-h` command to see the usage information for all commands available for your Oracle Database Appliance. For example:

```
odacli -h
```

Run `odacli command -h` to see detailed help about a specific command. For example, to see detailed help for the `odacli describe-dbhome` command, use the following:

```
odacli describe-dbhome -h
```

Managing ODACLI Privileges and Security with SUDO

Oracle Appliance Manager command-line utility requires `root` system privileges for most administration actions. You may want to use SUDO as part of your system auditing and security policy.

For most tasks, Oracle recommends that you log in as `root` to use the Oracle Appliance Manager command-line interface on Oracle Database Appliance. If you are not logged in as `root`, then you cannot carry out most actions on the appliance. For example, if you are not logged in as `root`, then you can view storage information, but you cannot modify the storage.

Allowing Root User Access Using SUDO

In environments where system administration is handled by a different group than database administration, or where security is a significant concern, you may want to limit access to the `root` user account and password. SUDO enables system administrators to grant certain users (or groups of users) the ability to run commands as `root`, while logging all commands and arguments as part of your security and compliance protocol.

A SUDO security policy is configured by using the file `/etc/sudoers`. Within the `sudoers` file, you can configure groups of users and sets of commands to simplify and audit server administration with SUDO commands.

Caution:

Configuring SUDO to allow a user to perform any operation is equivalent to giving that user `root` privileges. Consider carefully if this is appropriate for your security needs.

Example 16-1 SUDO Example 1: Allow a User to Perform Any ODACLI Operation

This example shows how to configure SUDO to enable a user to perform any ODACLI operation. You do this by adding lines to the commands section in the `/etc/sudoers` file:

```
## The commands section may have other options added to it.
##
Cmd_Alias ODACLI_CMDS=/opt/oracle/dcs/bin/odacli *
jdoe ALL = ODACLI_CMDS
```

In this example, the user name is `jdoe`. The file parameter setting `ALL= ODACLI_CMDS` grants the user `jdoe` permission to run all `odacli` commands that are defined by the command alias `ODACLI_CMDS`. After configuration, you can copy one `sudoers` file to multiple hosts. You can also create different rules on each host.

 **Note:**

Before database creation, you must set up user equivalency with SSH for the root user on each server. If you do not set up user equivalency and configure SSH on each server, then you are prompted to provide the root password for each server during database creation.

After you configure the `sudoer` file with the user, the user `jdoh` can run the set of `odacli` commands configured with the command alias `ODACLICMDS`. For example:

```
odacli create-database --dbname newdb
Enter new 'SYS, SYSTEM and PDB Admin user' password:
Confirm 'SYS, SYSTEM and PDB Admin user' password:

Job details
-----
                ID: 1bc31577-f910-4d3f-b6ff-8e3fccd30141
Description: Database service creation with db name: newdb
      Status: Created
      Created: November 30, 2018 9:23:57 AM PST
      Message:
```

```
Task Name Start Time End Time Status
-----
```

Example 16-2 SUDO Example 2: Allow a User to Perform Only Selected ODACLI Operations

To configure SUDO to allow a user to perform only selected ODACLI operations, add lines to the commands section in the `/etc/sudoers` file as follows:

```
## DCS commands for oracle user
Cmnd_Alias DCSCMDS = /opt/oracle/dcs/bin/odacli describe-appliance
oracle ALL=          DCSCMDS
```

```
$ sudo /opt/oracle/dcs/bin/odacli describe-appliance
```

```
Appliance Information
-----
                ID: a977bb04-6cf0-4c07-8e0c-91a8c7e7ebb8
      Platform: OdaliteL
Data Disk Count: 6
      CPU Core Count: 20
      Created: October 24, 2017 6:51:52 AM HDT
```

```
System Information
-----
                Name: system1001
      Domain Name: example.com
      Time Zone: America/Adak
      DB Edition: EE
      DNS Servers: 10.200.76.198 10.200.76.199 192.0.2.254
```

```
NTP Servers: 10.200.0.1 10.200.0.2
```

```
Disk Group Information
```

```
-----
DG Name                Redundancy                Percentage
-----
Data                   Normal                    90
Reco                   Normal                    10
```

In this example, the user `jdoue2` tries to run the `sudo odacli list-databases` command, which is not part of the set of commands that is configured for that user. SUDO prevents `jdoue2` from running the command.

```
[jdoue2@servernode1 ~]$ sudo /opt/oracle/dcs/bin/odacli list-databases
```

```
Sorry, user jdoue2 is not allowed to execute '/opt/oracle/dcs/bin/odacli list-
databases' as root on servernode1.
```

ODACLI Command Changes with Multi-User Access on Oracle Database Appliance

Understand the ODACLI command changes when you enable multi-user access.

About the `odacli-view` command

In a multi-user access-enabled environment, to run automated scripts, that is, to generate a system report based on the output of `odacli` commands, you may need to provide the user credentials when prompted by the system. In such cases, the automation of scripts may fail. In such cases, use the `odacli-view` command instead of the `odacli` command. The `odacli-view` command allows you to run read-only `odacli` commands as root user without providing user credentials. Read-only `odacli` commands include commands to list, describe, get, read, or ping.

However, the security of the system is not compromised because the user credentials of a securely-generated internal user are used for this purpose. The `odacli-view` command can be used in Oracle Database Appliance deployments with or without multi-user access. In an Oracle Database Appliance environment where multi-user access is not enabled, `odacli-view` has the same functionality as `odacli`. In a multi-user access-enabled environment, `odacli-view` provides the information about all the resources in a system. For example, `odacli-view list-databases` command lists all the databases in the system.

Usage:

```
/opt/oracle/dcs/bin/odacli-view command_name
```

For example:

```
/opt/oracle/dcs/bin/odacli-view list-dbhomes
/opt/oracle/dcs/bin/odacli-view list-databases
/opt/oracle/dcs/bin/odacli-view list-users
```

ODACLI Command Usage and Entitlement Requirements When Multi-User Access is Enabled

 **Note:**

If you have enabled multi-user access, then you can run all supported ODACLI commands on KVM and DB systems, after logging in as `odaadmin`.

 **Note:**

The authentication token support for ODACLI session management is linked to a multi-user access user account. Since `root` is an operating system administrative user and not a multi-user access user, auth token based session management system is not supported when a user logs in as `root`. Therefore, you must provide an Oracle Database Appliance account user name and password to run any ODACLI command.

The following table describes the ODACLI commands that have changes for multi-user access and the entitlements required to run the commands.

| ODACLI Command | Roles Required | Changes in command option |
|---|---------------------------|---------------------------|
| <code>odacli configure-firstnet</code> | ODA-ADMINISTRATOR | No change |
| <code>odacli create-network</code> | ODA-ADMINISTRATOR | No change |
| <code>odacli delete-network</code> | ODA-ADMINISTRATOR | No change |
| <code>odacli delete-networkinterface</code> | ODA-ADMINISTRATOR | No change |
| <code>odacli describe-network</code> | ODA-ADMINISTRATOR, ODA-DB | No change |
| <code>odacli describe-networkinterface</code> | ODA-ADMINISTRATOR, ODA-DB | No change |
| <code>odacli list-networks</code> | ODA-ADMINISTRATOR, ODA-DB | No change |
| <code>odacli list-networkinterfaces</code> | ODA-ADMINISTRATOR, ODA-DB | No change |
| <code>odacli modify-network</code> | ODA-ADMINISTRATOR | No change |
| <code>odacli cleanup-patchrepo</code> | ODA-ADMINISTRATOR, ODA-DB | No change |
| <code>odacli create-prepatchreport</code> | ODA-ADMINISTRATOR, ODA-DB | No change |
| <code>odacli describe-prepatchreport</code> | ODA-ADMINISTRATOR, ODA-DB | No change |
| <code>odacli list-prepatchreports</code> | ODA-ADMINISTRATOR, ODA-DB | No change |
| <code>odacli delete-prepatchreport</code> | ODA-ADMINISTRATOR, ODA-DB | No change |
| <code>odacli list-availablepatches</code> | ODA-ADMINISTRATOR, ODA-DB | No change |
| <code>odacli describe-component</code> | ODA-ADMINISTRATOR, ODA-DB | No change |
| <code>odacli describe-latestpatch</code> | ODA-ADMINISTRATOR, ODA-DB | No change |
| <code>odacli list-agentconfig-parameters</code> | ODA-ADMINISTRATOR | No change |
| <code>odacli modify-agentconfig-parameters</code> | ODA-ADMINISTRATOR | No change |
| <code>odacli delete-agentconfig-parameters</code> | ODA-ADMINISTRATOR | No change |

| ODACLI Command | Roles Required | Changes in command option |
|--------------------------------|---------------------------|---|
| odacli update-dbhome | ODA-ADMINISTRATOR, ODA-DB | User odaadmin with the role of ODA-ADMINISTRATOR can update any database home. A custom user with the role of ODA-DB can only update a database home that they have primary access (as the creator) or shared access (as a user who is granted access by odaadmin). |
| odacli update-dcsadmin | ODA-ADMINISTRATOR | No change |
| odacli update-dcsagent | ODA-ADMINISTRATOR | No change |
| odacli update-dcscomponents | ODA-ADMINISTRATOR | No change |
| odacli update-registry | User with any role | No change |
| odacli update-repository | ODA-ADMINISTRATOR, ODA-DB | No change |
| odacli update-server | ODA-ADMINISTRATOR | No change |
| odacli update-storage | ODA-ADMINISTRATOR | No change |
| odaadmcli orachk | ODA-ADMINISTRATOR | No change |
| odacli set-credential | ODA-ADMINISTRATOR, ODA-DB | Not supported when multi-user access is enabled. When multi-user access is enabled, log in as a custom user and use odacli change-password instead. |
| odacli create-appliance | ODA-ADMINISTRATOR | Add an attribute called "isMultiUserAccessEnabled": true in the provision.json file. When you run the command, you are prompted to enter and confirm passwords for odaadmin, oracle and grid users and the provisioning job is submitted. |
| odacli describe-system | User with any role | No change |
| odacli list-featuretracking | ODA-ADMINISTRATOR | No change |
| odacli create-backup | ODA-ADMINISTRATOR, ODA-DB | Must have primary or shared access |
| odacli create-backupconfig | ODA-ADMINISTRATOR, ODA-DB | If creating backupconfig based on ObjectStoreSwift, user must be the creator of the ObjectStoreSwift. |
| odacli create-objectstoreswift | ODA-ADMINISTRATOR, ODA-DB | No change |
| odacli delete-backup | ODA-ADMINISTRATOR, ODA-DB | User must have primary (creator of that database) or shared access (granted by odaadmin) on the database whose backup is being deleted. |
| odacli delete-backupconfig | ODA-ADMINISTRATOR, ODA-DB | Must have primary or shared access |
| odacli describe-backupreport | ODA-ADMINISTRATOR, ODA-DB | Must have primary or shared access |
| odacli delete-objectstoreswift | ODA-ADMINISTRATOR, ODA-DB | Must have primary or shared access |

| ODACLI Command | Roles Required | Changes in command option |
|---------------------------------|---------------------------|--|
| odacli describe-schedule | ODA-ADMINISTRATOR, ODA-DB | Must have primary or shared access |
| odacli irestore-database | ODA-ADMINISTRATOR, ODA-DB | Must have primary or shared access |
| odacli list-backupconfigs | ODA-ADMINISTRATOR, ODA-DB | Must have primary or shared access |
| odacli list-backupreports | ODA-ADMINISTRATOR, ODA-DB | Must have primary or shared access |
| odacli list-objectstoreswifts | ODA-ADMINISTRATOR, ODA-DB | Must have primary or shared access |
| odacli list-schedules | ODA-ADMINISTRATOR, ODA-DB | No changes |
| odacli list-tdebackupreports | ODA-ADMINISTRATOR, ODA-DB | Must have primary or shared access |
| odacli recover-database | ODA-ADMINISTRATOR, ODA-DB | Must have primary or shared access |
| odacli restore-archivelog | ODA-ADMINISTRATOR, ODA-DB | Must have primary or shared access |
| odacli restore-tdewallet | ODA-ADMINISTRATOR, ODA-DB | Must have primary or shared access |
| odacli modify-backupconfig | ODA-ADMINISTRATOR, ODA-DB | Must have primary or shared access |
| odacli modify-schedule | ODA-ADMINISTRATOR, ODA-DB | No change |
| odacli configure-dataguard | ODA-ADMINISTRATOR, ODA-DB | The creator of the primary database and the standby database could be the same or different users. The default is oda-admin. |
| odacli deconfigure-dataguard | ODA-ADMINISTRATOR, ODA-DB | The creator of the primary database and the standby database could be the same or different users. The default is oda-admin. |
| odacli describe-dataguardstatus | ODA-ADMINISTRATOR, ODA-DB | No change |
| odacli failover-dataguard | ODA-ADMINISTRATOR, ODA-DB | No change |
| odacli list-dataguardstatus | ODA-ADMINISTRATOR, ODA-DB | No change |
| odacli reinstate-dataguard | ODA-ADMINISTRATOR, ODA-DB | No change |
| odacli switchover-dataguard | ODA-ADMINISTRATOR, ODA-DB | No change |
| odacli list-cpucores | ODA-ADMINISTRATOR | No change |
| odacli describe-cpucore | ODA-ADMINISTRATOR | No change |
| odacli modify-cpucore | ODA-ADMINISTRATOR | No change |
| odacli create-cpupool | ODA-ADMINISTRATOR | Only odaadmin can create it but a non-admin user with role of ODA-DB can use them. |
| odacli remap-cpupools | ODA-ADMINISTRATOR | No change |
| odacli list-cpupools | ODA-ADMINISTRATOR, ODA-DB | A non-admin user with the role of ODA-DB can run the odacli list-cpupools command to view all available CPU pools. |

| ODACLI Command | Roles Required | Changes in command option |
|-----------------------------|---------------------------|--|
| odacli describe-cpupool | ODA-ADMINISTRATOR, ODA-DB | A non-admin user with the role of ODA-DB can run the <code>odacli describe-cpupool</code> command to view details of the CPU pool. |
| odacli modify-cpupool | ODA-ADMINISTRATOR | No change |
| odacli delete-cpupool | ODA-ADMINISTRATOR | No change |
| odacli list-auditrecords | ODA-ADMINISTRATOR | No change |
| odacli describe-auditrecord | ODA-ADMINISTRATOR | No change |
| odacli clone-database | ODA-ADMINISTRATOR, ODA-DB | User must have primary or shared access to the database home and the source database being cloned. A user with shared access to source database gets only shared access to the cloned database. Hence, the primary owner of the source database remains the primary owner of the cloned database in this case. |
| odacli create-database | ODA-ADMINISTRATOR, ODA-DB | For database creation in an existing database home, the user must have primary or shared access to the database home. A user with shared access to the database home gets only shared access to the new database, whose primary owner remains the primary owner of the database home. When using existing database storage for the new database, the user must have primary or shared access to that database storage. |
| odacli delete-database | ODA-ADMINISTRATOR, ODA-DB | Can access only those databases where the user has primary or shared access |
| odacli describe-database | ODA-ADMINISTRATOR, ODA-DB | Can access only those databases where the user has primary or shared access |
| odacli list-databases | ODA-ADMINISTRATOR, ODA-DB | User can only view listing of the databases for which they have primary or shared access. Use the <code>-all</code> option to view all databases and request access. |
| odacli modify-database | ODA-ADMINISTRATOR, ODA-DB | User should have primary or shared access to the database and the backupconfig being attached. Additionally, the primary owner (creator) of the database and backupconfig should be the same. |

| ODACLI Command | Roles Required | Changes in command option |
|---------------------------------|---------------------------|---|
| odacli move-database | ODA-ADMINISTRATOR, ODA-DB | User must have primary or shared access to the source database that is being moved and the target database home. Additionally, the primary owner of the source and target database home must be the same. |
| odacli register-database | ODA-ADMINISTRATOR, ODA-DB | User must be the primary owner (creator) of the database home on which this database is to be registered. |
| odacli upgrade-database | ODA-ADMINISTRATOR, ODA-DB | User must have primary or shared access to the source database (the database being upgraded) and the target database home. Additionally, the owner of the source and target database home must be the same. |
| odacli update-database | ODA-ADMINISTRATOR, ODA-DB | User must have primary or shared access to the source database (the database being updated) and the target database home. Additionally, the owner of the source and target database home must be the same. |
| odacli configure-dbhome-storage | ODA-ADMINISTRATOR | No change |
| odacli list-dbhome-storages | ODA-ADMINISTRATOR | No change |
| odacli describe-dbhome-storage | ODA-ADMINISTRATOR | No change |
| odacli modify-dbhome-storage | ODA-ADMINISTRATOR | No change |
| odacli create-dbhome | ODA-ADMINISTRATOR, ODA-DB | Can access only those database homes where the user has primary or shared access. |
| odacli delete-dbhome | ODA-ADMINISTRATOR, ODA-DB | Can access only those database homes where the user has primary or shared access. |
| odacli describe-dbhome | ODA-ADMINISTRATOR, ODA-DB | Can access only those database homes where the user has primary or shared access. |
| odacli list-dbhomes | ODA-ADMINISTRATOR, ODA-DB | Can access only those database homes where the user has primary or shared access. Use the <code>-all</code> option to view all database homes and request access. |
| odacli create-dbstorage | ODA-ADMINISTRATOR | Can access only those dbstorages where the user has primary or shared access. |
| odacli delete-dbstorage | ODA-ADMINISTRATOR | Can access only those dbstorages where the user has primary or shared access. |
| odacli describe-dbstorage | ODA-ADMINISTRATOR | Can access only those dbstorages where the user has primary or shared access. |

| ODACLI Command | Roles Required | Changes in command option |
|--|---------------------------|---|
| odacli list-dbstorages | ODA-ADMINISTRATOR | Can access only those dbstorages where the user has primary or shared access. |
| odacli modify-dbstorage | ODA-ADMINISTRATOR | Can access only those dbstorages where the user has primary or shared access. |
| odacli modify-dgstorage | ODA-ADMINISTRATOR | No change |
| odacli create-jobdata-retention-policy | ODA-ADMINISTRATOR | No change |
| odacli create-purge-jobdata-job | ODA-ADMINISTRATOR | No change |
| odacli delete-jobdata-retention-policy | ODA-ADMINISTRATOR | No change |
| odacli describe-job | User with any role | No change |
| odacli list-jobs | User with any role | No change |
| odacli list-jobdata-retention-policy | ODA-ADMINISTRATOR | No change |
| odacli list-purge-jobdata-job | ODA-ADMINISTRATOR | No change |
| odacli list-scheduled-executions | ODA-ADMINISTRATOR | No change |
| odaadmcli manage diagcollect | ODA-ADMINISTRATOR | No change |
| odacli create-auto-logclean-policy | ODA-ADMINISTRATOR | No change |
| odacli create-logcleanjob | ODA-ADMINISTRATOR | No change |
| odacli describe-logcleanjob | ODA-ADMINISTRATOR | No change |
| odacli list-auto-logclean-policy | ODA-ADMINISTRATOR | No change |
| odacli list-logcleanjobs | ODA-ADMINISTRATOR | No change |
| odacli list-logspaceusage | ODA-ADMINISTRATOR | No change |
| odacli configure-asr | ODA-ADMINISTRATOR | No change |
| odacli delete-asr | ODA-ADMINISTRATOR | No change |
| odacli describe-asr | ODA-ADMINISTRATOR | No change |
| odacli test-asr | ODA-ADMINISTRATOR | No change |
| odacli modify-asr | ODA-ADMINISTRATOR | No change |
| odacli list-osconfigurations | ODA-ADMINISTRATOR | No change |
| odacli modify-osconfigurations | ODA-ADMINISTRATOR | No change |
| odaadmcli show cooling | root | No change |
| odaadmcli show env_hw | root | No change |
| odaadmcli show fs | root | No change |
| odaadmcli show memory | root | No change |
| odaadmcli show network | root | No change |
| odaadmcli show power | root | No change |
| odaadmcli show processor | root | No change |
| odaadmcli show server | root | No change |
| odaadmcli asmops diskgroup | root | No change |
| odaadmcli expand storage | root | No change |
| odacli list-dgdisks | ODA-ADMINISTRATOR, ODA-DB | No change |
| odacli validate-storagetopology | ODA-ADMINISTRATOR | No change |
| odaadmcli power disk | root | No change |

| ODACLI Command | Roles Required | Changes in command option |
|-------------------------------|----------------|---------------------------|
| odaadmcli show controller | root | No change |
| odaadmcli show disk | root | No change |
| odaadmcli show diskgroup | root | No change |
| odaadmcli show raidsyncstatus | root | No change |
| odaadmcli show storage | root | No change |
| odaadmcli stordiag | root | No change |

odacli Network Commands

Use the `odacli network` commands to list and describe network interfaces.

- [odacli configure-firstnet](#)
Use the command `odacli configure-firstnet` to configure the first network in the appliance after racking and connecting the power and network cables.
- [odacli create-network](#)
Use the `odacli create-network` command to create a network.
- [odacli delete-network](#)
Use the command `odacli delete-network` to delete a network.
- [odacli delete-networkinterface](#)
Use the command `odacli delete-networkinterface` to delete a network interface on Oracle Database Appliance X8-2 hardware models.
- [odacli describe-network](#)
Use the `odacli describe-network` command to display the details of a specific network.
- [odacli describe-networkinterface](#)
Use the `odacli describe-networkinterface` command to display the details of any network interface.
- [odacli list-networks](#)
Use the `odacli list-networks` command to display networks.
- [odacli list-networkinterfaces](#)
Use the `odacli list-networkinterfaces` command to display network interfaces.
- [odacli modify-network](#)
Use the `odacli modify-network` command to update an existing network configuration.

odacli configure-firstnet

Use the command `odacli configure-firstnet` to configure the first network in the appliance after racking and connecting the power and network cables.

File Path

`/opt/oracle/dcs/bin/odacli`

Syntax

```
# /opt/oracle/dcs/bin/odacli configure-firstnet
```

Usage Notes

This command ensures that the system is available in the network, enabling you to manage the deployment through the Oracle Appliance Manager Browser User Interface.

- Bonded network configuration: Bonded dual-ported interface. With the bonded configuration, you can only enable one of the interfaces. The bonded configuration supports VLANs. The bonded network configuration uses `btbond1` on Oracle Database Appliance hardware models other than X8-2. On Oracle Database Appliance X8-2, the bonded network configuration uses `btbond1` to `btbond6`. This is the default setting.
- Non-bonded network configuration (on Oracle Database Appliance hardware models other than X8-2): Two separate physical network interfaces, this configuration does not support VLANs. The non-bonded network configuration uses `em2` and `em3` as public interfaces. Note that Oracle Database Appliance X8-2 does not support non-bonded network configuration.
- To change a non-bonded network configuration to a bonded configuration, run the Oracle Database Appliance Cleanup Script and redeploy the appliance.
- You can choose to enable Link Aggregation Control Protocol (LACP) on the bonding interface when you run `odacli configure-firstnet`.
- You can use the `-o` option with the `odacli configure-firstnet` command to configure the network speed for Oracle Dual Port 25 Gb Ethernet Adapter.
- You can also use the `-o` option with the `odacli configure-firstnet` command to enable or disable LACP on a bonding interface after deployment.

Enabling LACP on a bonding interface after deployment:

```
# odacli configure-firstnet -o
INFO: Configure network option
Select the Interface to configure the network on (btbond1 btbond3 btbond5)
[btbond1]:btbond3
Use LACP bonding on btbond3 (yes/no) [no]: yes
INFO: network interface [btbond3] setup in LACP mode
```

Disabling LACP on a bonding interface after deployment:

```
# odacli configure-firstnet -o
INFO: Configure network option
Select the Interface to configure the network on (btbond1 btbond3 btbond5)
[btbond1]:btbond3
Use LACP bonding on btbond3 (yes/no) [yes]: no
INFO: network interface [btbond3] setup in active-backup mode
```

Example 16-3 Configuring the First Network as a Bonded Network

Configure the first network to use a `btbond1` interface without configuring DHCP. Complete the IP address, netmask address, and gateway address.

Values that you need to provide are shown in *italic font*, with the exception of the net1 gateway address; the program obtains the gateway IP address. The program derives this gateway address using the network information you provided for the other IP addresses. Accept this value, unless your network administrator provides an alternative gateway address that is different from the default that the appliance command-line interface detects.

The following is an example of the command on a single node platform:

```
# /opt/oracle/dcs/bin/odacli configure-firstnet

Select the Interface to configure the network on (btbond1): btbond1
Configure DHCP on btbond1 (yes/no): no
INFO: You have chosen Static configuration
Enter the IP address to configure: 10.1.10.2
Enter the Netmask address to configure: 255.255.255.0
Enter the Gateway address to configure: 10.1.10.1
INFO: Plumbing the IPs now
INFO: Restarting the network
Shutting down interface btbond1: bonding: btbond1: Removing slave em2.
bonding: btbond1: releasing active interface em2
bonding: btbond1: making interface em3 the new active one.
bonding: btbond1: Removing slave em3.
bonding: btbond1: releasing active interface em3
:~::~~::~~::
```

Example 16-4 Configuring the First Network as a Non-Bonded Network

The following is an example of a non-bonded configuration. For a non-bonded configuration, answer `no` to using a bonding public interface. Note that Oracle Database Appliance X8-2 does not support non-bonded network configuration.

```
# /opt/oracle/dcs/bin/odacli configure-firstnet
Using bonding public interface (yes/no) [yes]: no
INFO: Breaking the bonding on btbond1
INFO: remove bonding module: rmmod bonding
INFO: remove slave setup in /etc/sysconfig/network-scripts/ifcfg-em2
INFO: remove slave setup in /etc/sysconfig/network-scripts/ifcfg-em3
INFO: Restarting the network
Shutting down interface em1: [ OK ]
Shutting down loopback interface: [ OK ]
Bringing up loopback interface: [ OK ]
Bringing up interface em1: [ OK ]
Bringing up interface em2: [ OK ]
Bringing up interface em3: [ OK ]
INFO: Restarting the DCS agent
initdcsagent stop/waiting
initdcsagent start/running, process 57629
Select the Interface to configure the network on (em2 em3) [em2]:
Configure DHCP on em2 (yes/no) [no]:
INFO: You have chosen Static configuration
Enter the IP address to configure : 10.31.102.101
Enter the Netmask address to configure : 255.255.240.0
Enter the Gateway address to configure[10.31.96.1] :
INFO: Plumbing the IPs now
INFO: Restarting the network
Shutting down interface em1: [ OK ]
```

```

Shutting down interface em2: [ OK ]
Shutting down interface em3: [ OK ]
Shutting down loopback interface: [ OK ]
Bringing up loopback interface: [ OK ]
Bringing up interface em1: [ OK ]
Bringing up interface em2: Determining if ip address 10.31.102.101 is already
in use for device em2...
[ OK ]
Bringing up interface em3: [ OK ]

```

Example 16-5 Configuring the Speed of the Network Interface

The following is an example of setting the speed of the network card manually.

```

# odacli configure-firstnet -o
INFO: Configure network option
Select the Interface to configure the network on (btbond1 btbond2 btbond3)
[btbond1]:btbond3

Use LACP bonding on btbond3 (yes/no) [no]:
Set the network speed on btbond3 to 1) AUTO, 2) 1G, 3) 10G, 4) 25G [AUTO]: 3
INFO: The speed of the network port is set to '10G'
INFO: Please set the speed for the connected ports in the switch
INFO: stop the network 'btbond3'
INFO: start the network 'btbond3'
INFO: Network interface btbond3 (p2p1, p2p2) has been set to using speed '10G'

```

odacli create-network

Use the `odacli create-network` command to create a network.

File Path

```
/opt/oracle/dcs/bin/odacli
```

Syntax

```

odacli create-network [-d|-no-d] -n name [-nn nodeName] [-lp listener_ports]
[-sp scan_ports] [-f interface] [-p ipaddress] [-w {Public|Dataguard|
Database|Management|Backup|Other}] [-s subnetmask] [-g gateway] [-h] [-sip] [-
sn] [-vs] [-j]

```

Parameters

| Parameter | Description |
|-----------------------------------|---|
| <code>--defaultnetwork, -d</code> | (Optional) Identifies the default network. |
| <code>--gateway, -g</code> | (Optional) Defines the network gateway. The gateway is required for the default network. |
| <code>--help, -h</code> | (Optional) Displays help for using the command. |
| <code>--interface, -f</code> | (Optional) Defines the name of the network interface. |
| <code>--interfacetype, -t</code> | (Optional) Defines the network interface type {BOND PHYSICAL VLAN INTERNAL} (non case-sensitive). |

| Parameter | Description |
|--|---|
| <code>--ipaddress, -p</code> | (Optional) Defines the network IP address. This can be specified in the format <code>IPAddress</code> or <code>nodeNumber0:IPAddress0,nodeNumber1:IPAddress1,...</code> |
| <code>--listener-ports, -lp</code> | (Optional) Specifies the comma-separated list of listener ports. The default value is 1521. |
| <code>--scan-ports, -sp</code> | (Optional) Specifies the comma-separated list of SCAN listener ports. The default value is 1521. |
| <code>--json, -j</code> | (Optional) Displays JSON output. |
| <code>--networktype, -w</code> | (Optional) Defines the type of network. Options are: {Public Dataguard Database Management Backup Other}. The default is Other. |
| <code>--name, -n</code> | (Mandatory) Name of the network. |
| <code>--no-defaultnetwork, no-d</code> | (Optional) Identifies a network as not the default network. Use <code>--defaultnetwork -d</code> to identify a default network. |
| <code>--subnetmask, -s</code> | (Optional) Defines the Network Subnet Mask. |
| <code>--scanips, -sip</code> | (Optional) Defines the SCAN IP addresses (in the format <code>scanip0,scanip1,...</code>) |
| <code>--scanname, -sn</code> | (Optional) Defines the SCAN name. |
| <code>--nodeName, -nn</code> | (Optional) Defines the node name for High-Availability deployments. |
| <code>--vips, -vs</code> | (Optional) List of virtual IP addresses. They can be specified in the format <code>vipname0:nodeNumber0:vip0,vipname1:nodenumber1:vip1,..</code> |
| <code>--vlanid, -v</code> | (Optional) Add VLAN as a new network. This option is available for for High-Availability deployments. |

Usage Notes

- Network of `public` type can only be defined when deploying the appliance or when running `odacli configure-firstnet` during initial provisioning.
- Use this command to create an additional network not done in `create-appliance`.
- You are only allowed to create a network on the bond interface.
- On Oracle Database Appliance non-High Availability systems, you cannot specify Virtual IP addresses. The Virtual IP address is set to the same value as the IP address.
- Single Client Access Name (SCAN) cannot be set up on Oracle Database Appliance non-High Availability systems.

Example 16-6 Creating a Network

The following example creates a new network, `sfpbond1`, with IP address `192.0.2.15`. The network is an additional network that uses subnet mask `255.255.255.0` and is not a default network.

```
# odacli create-network -n network1 -f sfpbond1 -p 192.0.2.15 -w Backup -s
255.255.255.0 -no-d
```

Example 16-7 Creating a VLAN Network

```
odacli create-network -g 10.31.131.129 -f btbond1 -t VLAN -p
0:10.31.131.132,1:10.31.131.133 -nn vlan150 -w Database -no-d -sip
10.31.131.134,10.31.131.135 -sn scaoda702c1-vlan150-scan -s 255.255.255.128 -
vs n1-vlan150-vip:0:10.31.131.136,n2-vlan150-vip:1:10.31.131.137 -v 150
```

odacli delete-network

Use the command `odacli delete-network` to delete a network.

File Path

```
/opt/oracle/dcs/bin/odacli
```

Syntax

To delete a network:

```
odacli delete-network -i id [-n] [-h] [-j]
```

Parameters

| Parameter | Description |
|------------|---|
| --id, -i | Defines the network identity. |
| --name, -n | Specifies the network name. |
| --json, -j | (Optional) Displays JSON output. |
| --help, -h | (Optional) Displays help for using the command. |

Usage Notes

You cannot delete the Public-network or Private-network after the system is deployed.

On High-Availability systems, if the node number is not specified in the `odacli delete-network` command, then the network on both nodes is deleted.

Example 16-8 Deleting a Network

The following example deletes a backup network with a network ID of 55db39db-d95c-42c5-abbd-b88eb99b83ec.

```
# odacli delete-network -i 55db39db-d95c-42c5-abbd-b88eb99b83ec
```

```
"jobId" : "c26d217e-419b-4a91-8680-7b06bcfe9828",
"status" : "Running",
"message" : null,
"reports" : [ {
  "taskId" : "TaskSequential_137",
  "taskName" : "deleting network",
  "taskResult" : "Running",
  "startTime" : "December 8, 2024 23:14:32 PM EDT",
  "endTime" : "December 8, 2024 23:14:32 PM EDT",
```

```

        "status" : "Running",
        "taskDescription" : null,
        "parentTaskId" : "TaskSequential_135",
        "jobId" : "c26d217e-419b-4a91-8680-7b06bcfe9828",
        "tags" : [ ],
        "reportLevel" : "Info",
        "updateTime" : "December 8, 2024 23:14:32 PM EDT"
    },{
        "taskId" : "TaskZJsonRpcExt_142",
        "taskName" : "Setting up Network",
        "taskResult" : "Network setup success",
        "startTime" : "December 8, 2024 23:14:32 PM EDT",
        "endTime" : "December 8, 2024 23:14:32 PM EDT",
        "status" : "Success",
        "taskDescription" : null,
        "parentTaskId" : "TaskParallel_141",
        "jobId" : "c26d217e-419b-4a91-8680-7b06bcfe9828",
        "tags" : [ ],
        "reportLevel" : "Info",
        "updateTime" : "December 8, 2024 23:14:32 PM EDT" } ],
    "createTimestamp" : "December 8, 2024 23:14:32 PM EDT",
    "description" : "Network service delete",
    "updateTime" : "December 8, 2024 23:14:32 PM EDT"
}

```

odacli delete-networkinterface

Use the command `odacli delete-networkinterface` to delete a network interface on Oracle Database Appliance X8-2 hardware models.

File Path

```
/opt/oracle/dcs/bin/odacli
```

Syntax

To delete a network interface:

```
odacli delete-networkinterface [-i id] [-n name] [-h] [-j]
```

Parameters

| Parameter | Description |
|-------------------------|---|
| <code>--id, -i</code> | Defines the network interface ID. |
| <code>--name, -n</code> | Defines the network interface name. |
| <code>--help, -h</code> | (Optional) Displays help for using the command. |
| <code>--json, -j</code> | (Optional) Displays JSON output. |

Usage Notes

You cannot delete the network interface card in slot 7.

Example 16-9 Deleting a Network Interface

```
[root@oak ~]/opt/oracle/dcs/bin/odacli delete-networkinterface -n btbond4
{
  "jobId" : "a81066e2-417e-4df6-b810-08df24c646c1",
  "status" : "Running",
  "message" : null,
  "reports" : ,
  "createTimestamp" : "December 8, 2024 00:01:09 AM UTC",
  "resourceList" : ,
  "description" : "Network Interface Deletion with name btbond4",
  "updatedAt" : "December 8, 2024 00:01:09 AM UTC"
}
```

Example 16-10 Deleting btbond1 Network Interface is Not Allowed

```
[root@oak ~]# /opt/oracle/dcs/bin/odacli delete-networkinterface -n btbond1
DCS-10001:Internal error encountered: Delete operation is not allowed on
network interface : btbond1.
```

Example 16-11 Deleting Network Interface When Network Exists is Not Allowed

```
[root@oak ~]# opt/oracle/dcs/bin/odacli delete-networkinterface -n btbond3
DCS-10001:Internal error encountered: Delete operation is not allowed -
networks {[Public-network]} found on interface btbond3. Please delete the
network first.
```

odacli describe-network

Use the `odacli describe-network` command to display the details of a specific network.

File Path

```
/opt/oracle/dcs/bin/odacli
```

Syntax

To display the details of a specific network:

```
odacli describe-network [-i id] [-nn node_name] [-n name] [-j][-h]
```

Parameters

| Parameter | Description |
|-------------------------------|--|
| <code>--id, -i</code> | Identifies the network ID. Use the <code>odacli list-networks</code> command to obtain the <code>id</code> . |
| <code>--json, -j</code> | (Optional) Displays JSON output. |
| <code>--help, -h</code> | (Optional) Displays help for using the command. |
| <code>--name, -n</code> | Specifies the network name. |
| <code>--node-name, -nn</code> | (Optional) Displays the network interface information for the specified node name. |

Example 16-12 Displaying Network Details

Enter the following command to display the details of the public network:

```
# odacli describe-network -n Public-network

Network details
-----
                ID:  a11573f1-cad4-41fc-9dd0-3ba958b605f8
                Name:  Public-network
                NIC:   btbond1
Interface Type: BOND
Subnet Mask:   255.255.255.0
Gateway:      10.31.116.1
VLAN ID:
                Type:  Public
                Default: true
                Created: March 30, 2020 8:37:00 AM PDT
                Updated: March 30, 2023 10:25:27 AM PDT
                Status: Configured
Node Networks: [IP Address on node0: 10.31.117.60, IP Address on
node1: 10.31.117.62]
                Scan Name:  oda1-scan
                Scan Ips:   10.31.117.64 10.31.117.65
                Vips:       [oda1-vip on node0: 10.31.116.61, oda2-vip on
node1: 10.31.116.63]
                Associated Databases: odacn db122a db122b db122c db122d
```

Example 16-13 Displaying Network Details

Enter the following command to display the details of network ID 93c07043-3002-494a-8fa0-f3ae932fb4c5:

```
# odacli describe-network -i 93c07043-3002-494a-8fa0-f3ae932fb4c5 -nn oda1

Network details
-----
                ID:  93c07043-3002-494a-8fa0-f3ae932fb4c5
                Name:  Private-network
                NIC:   ibbond0
InterfaceType: BOND
IP Address:    192.168.16.25
Subnet Mask:   255.255.255.0
Gateway:
VlanId:
                Type:  Private
                Default: false
                Created: November 18, 2023 10:54:16 PM PST
```

odacli describe-networkinterface

Use the `odacli describe-networkinterface` command to display the details of any network interface.

File Path

```
/opt/oracle/dcs/bin/odacli
```

Syntax

To display the details of a specific network interface:

```
odacli describe-networkinterface -i id -n name [-nn node_name] [-j][-h]
```

Parameters

| Parameter | Description |
|-------------------------------|--|
| <code>--id, -i</code> | Identifies the network interface ID. Use the <code>odacli list-networks</code> command to obtain the id. |
| <code>--name, -n</code> | Specifies the network interface name. |
| <code>--json, -j</code> | (Optional) Displays JSON output. |
| <code>--help, -h</code> | (Optional) Displays help for using the command. |
| <code>--node-name, -nn</code> | (Optional) Displays the network interface information for the specified node name. |

Usage Notes

By default, this command always displays the network interface description of the local node. To display the description of another node, specify the node name option (`-nn`).

Example 16-14 Displaying Network Details

Enter the following command to display the details of network interface with ID `fe1bf0a7-f56e-44cd-9a84-f374c0aa4b61`:

```
# /opt/oracle/dcs/bin/odacli describe-networkinterface
-i fe1bf0a7-f56e-44cd-9a84-f374c0aa4b61 -nn odal

Network Interface details
-----
                ID: fe1bf0a7-f56e-44cd-9a84-f374c0aa4b61
                Name: eth2
                NIC: eth2
                Type: PHYSICAL
                Members: eth2
Slave Interface: true
                Created: October 16, 2023 1:16:59 PM PDT
```

odacli list-networks

Use the `odacli list-networks` command to display networks.

File Path

```
/opt/oracle/dcs/bin/odacli
```

Syntax

```
odacli list-networks [-nn node_name] [-j] [-h]
```

Parameters

| Parameter | Description |
|-------------------------------|--|
| <code>--json, -j</code> | (Optional) Displays JSON output. |
| <code>--help, -h</code> | (Optional) Displays help for using the command. |
| <code>--node-name, -nn</code> | (Optional) Displays the network interface information for the specified node name. |

Example 16-15 Displaying a List of Networks

Use the `odacli list-networks` command to display a list of networks:

```
# odacli list-networks
ID Name NIC Interface Type Subnet Mask Gateway VLAN ID Node Networks
-----
-----
-----
30012eeb-1205-4cb6-9fc0-488972b2e420 Private-network priv0 INTERNAL
255.255.255.240 [IP Address on node0: 192.168.16.24]
75d01d4f-e940-4d0f-a4fe-ee04f5a90c73 Public-network btbond1.370 VLAN
255.255.255.0 10.209.10.241 370 [IP Address on node0: 10.209.10.244]
```

odacli list-networkinterfaces

Use the `odacli list-networkinterfaces` command to display network interfaces.

File Path

```
/opt/oracle/dcs/bin/odacli
```

Syntax

```
odacli list-networkinterfaces [-nn node_name] [-j] [-h]
```

Parameters

| Parameter | Description |
|-------------------------|----------------------------------|
| <code>--json, -j</code> | (Optional) Displays JSON output. |

| Parameter | Description |
|------------------|--|
| --help, -h | (Optional) Displays help for using the command. |
| --node-name, -nn | (Optional) Displays the network interface information for the specified node name. |

Example 16-16 Displaying a List of Network Interfaces

Use the `odacli list-networkinterfaces` command to display a list of network interfaces:

```
# odacli list-networkinterfaces -nn odal
ID                               Name                               NIC
Type
-----
d5907a23-1c5d-48c7-8d47-2c188ed43ddd  bond0                               bond0
BOND
4f7ea558-9a43-42a9-8e08-6bfd3a33229  bond1                               bond1
BOND
743ced8d-bbe5-4987-b316-5fdf95d5e60b  eth0                                eth0
PHYSICAL
a4121f9e-e694-4852-a521-44efc6ef3fde  eth1                                eth1
PHYSICAL
c62c5f04-aa93-4783-a3a7-275bf9fab2d9  eth2                                eth2
PHYSICAL
bda21dad-5c1c-4073-89e5-798b8fce8533  eth3                                eth3
PHYSICAL
0141f1ac-5c34-4393-8b99-76094b6f795c  ib0                                  ib0
PHYSICAL
e8cb138a-087f-4739-bb8d-90b1d903aeb6  ib1                                  ib1
PHYSICAL
a31cfd63-fb90-4cbb-a2fb-382c5e33983b  ibbond0                              ibbond0
BOND
```

odacli modify-network

Use the `odacli modify-network` command to update an existing network configuration.

File Path

```
/opt/oracle/dcs/bin/odacli
```

Syntax

To update a network:

```
odacli modify-network -i id -n name [-p IP address] [-lp listener_ports] [-sp scan_ports] [-w {Public|Dataguard|Database|Management|Backup|Other} ] [-s network subnet mask] [-g network gateway] [-sip] [-sn] [-vs] [-j] [-h]
```

Parameters

| Parameter | Description |
|------------------------------------|---|
| <code>--id, -i</code> | Defines the network identity. |
| <code>--name, -n</code> | Defines the network name. |
| <code>--gateway, -g</code> | (Optional) Defines the network gateway. |
| <code>--ipaddress, -p</code> | (Optional) Defines the network IP address. This can be specified in the format IPAddress or nodeNumber0:IPAddress0,nodeNumber1:IPAddress1,... |
| <code>--networktype, -w</code> | (Optional) Defines the type of network. {Public Dataguard Database Management Backup Other} |
| <code>--scanips, -sip</code> | Defines the SCAN IP addresses (in the format scanip0,scanip1,...) |
| <code>--scanname, -sn</code> | Defines the SCAN name. |
| <code>--listener-ports, -lp</code> | (Optional) Specifies the comma-separated list of listener ports. The default value is 1521. |
| <code>--scan-ports, -sp</code> | (Optional) Specifies the comma-separated list of SCAN listener ports. The default value is 1521. |
| <code>--subnetmask, -s</code> | (Optional) Defines the Network Subnet Mask. |
| <code>--vips, -vs</code> | List of virtual IP addresses. They can be specified in the format vipname0:nodeNumber0:vip0,vipname1:nodenumber1:vip1,... |
| <code>--help, -h</code> | (Optional) Displays help for using the command. |
| <code>--json, -j</code> | (Optional) Displays JSON output. |

Usage Notes

- You cannot modify the Public and Private-interfaces after the system is deployed.
- On Oracle Database Appliance non-High Availability systems, you cannot update Virtual IP addresses. The Virtual IP address is set to the same value as the IP address.
- Single Client Access Name (SCAN) cannot be set up on Oracle Database Appliance non-High Availability systems.
- On Oracle Database Appliance High Availability systems, you cannot update network of type Database to other types of network (such as backup, management and so on). You can, however, update IP address, Virtual IP address, Gateway, and Subnet mask for all network types.
- The system has both SFP+ and 10GBaseT bonded pairs, which means that one of them is used for the public, and you can configure the other after deployment if you want additional connectivity. For example, if you want a backup network.

Example 16-17 Modifying a Network

The following example updates the network ID 192.0.0.2 and designates the network as a backup network:

```
# odacli modify-network -i 192.0.0.2 -w Backup
```

odacli Multi-User Access Commands

Use `odacli` commands to enable multi-user access for the appliance.

 **Note:**

The multi-user access feature is available for standalone Oracle Database Appliance systems. During provisioning, a single domain and tenancy is created by default and all users are created within the default domain and tenancy.

- [odacli list-domains](#)
Use the `odacli list-domains` command to list all multi-user access domains.
- [odacli describe-domain](#)
Use the `odacli describe-domain` command to describes a multi-user access domain.
- [odacli list-tenants](#)
Use the `odacli list-tenants` command to list all tenants in a multi-user access domain.
- [odacli describe-tenant](#)
Use the `odacli describe-tenant` command to describe a tenant in a multi-user access domain.
- [odacli create-user](#)
Use the `odacli create-user` command to create a user in a multi-user access system.
- [odacli activate-user](#)
Use the `odacli activate-user` command to activate a user in a multi-user access system.
- [odacli list-users](#)
Use the `odacli list-users` command to list all users in a multi-user access system.
- [odacli describe-user](#)
Use the `odacli describe-user` command to describe a user in a multi-user access system.
- [odacli authorize-user](#)
Use the `odacli authorize-user` command in a multi-user access system to unlock a user account that is locked due to multiple failed login attempts or where the password has expired, and authorize the user to reset their password to reactivate their account.
- [odacli delete-user](#)
Use the `odacli delete-user` command in a multi-user access system to delete a user account.
- [odacli list-user-roles](#)
Use the `odacli list-user-roles` command to list user roles in a multi-user access system.
- [odacli describe-user-role](#)
Use the `odacli describe-user-role` command to describe a user role in a multi-user access system.

- [odacli list-user-entitlements](#)
Use the `odacli list-user-entitlements` command to list all entitlements in a multi-user access system.
- [odacli describe-user-entitlement](#)
Use the `odacli describe-user-entitlement` command to describe an entitlement in a multi-user access system.
- [odacli list-user-operations](#)
Use the `odacli list-user-operations` command to list all operations in a multi-user access system.
- [odacli describe-user-operation](#)
Use the `odacli describe-user-operation` command to describe an operation in a multi-user access system.
- [odacli list-resources-access](#)
Use the `odacli list-resources-access` command to list access to DCS resources in a multi-user access system.
- [odacli describe-resource-access](#)
Use the `odacli describe-resource-access` command to describe access to a DCS resource in a multi-user access system.
- [odacli grant-resource-access](#)
Use the `odacli grant-resource-access` command to grant shared access to a DCS resource in a multi-user access system.
- [odacli revoke-resource-access](#)
Use the `odacli revoke-resource-access` command to revoke access to a DCS resource in a multi-user access system.
- [odacli reset-password](#)
Use the `odacli reset-password` command to reset the password for a user, after it is unlocked, in a multi-user access system.
- [odacli change-password](#)
Use the `odacli change-password` command to change the password for a user in a multi-user access system.

odacli list-domains

Use the `odacli list-domains` command to list all multi-user access domains.

File Path

```
/opt/oracle/dcs/bin/odacli
```

Syntax

```
odacli list-domains [-j] [-h]
```

Parameters

| Parameter | Description |
|-------------------------|---|
| <code>--help, -h</code> | (Optional) Displays help for using the command. |
| <code>--json, -j</code> | (Optional) Displays JSON output. |

Usage Notes

- The `odaadmin` user can run this command to view all the multi-user access domains.

Example 16-18

```
[odaadmin@odal bin]$ odacli list-domains
ID                               Name           Description    Is Active
-----
811f176a-26c9-4480-afb3-2c735d565d91 odalocal.com Default domain true
```

odacli describe-domain

Use the `odacli describe-domain` command to describes a multi-user access domain.

File Path

```
/opt/oracle/dcs/bin/odacli
```

Syntax

```
odacli describe-domain -dn domain_name [-j] [-h]
```

Parameters

| Parameter | Description |
|---------------------------------|--|
| <code>--domain-name, -dn</code> | (Required) Specifies the multi-user access domain. |
| <code>--help, -h</code> | (Optional) Displays help for using the command. |
| <code>--json, -j</code> | (Optional) Displays JSON output. |

Usage Notes

- The `odaadmin` user can run this command to view details of the multi-user access domain.

Example 16-19

```
# odacli describe-domain -dn odalocal.com
Domain details
-----
                ID: 811f176a-26c9-4480-afb3-2c735d565d91
                Name: odalocal.com
Description: Default domain
Is Active: true
Created: November 22, 2021 7:39:50 PM UTC
Last Updated: November 22, 2021 7:39:50 PM UTC
```

odacli list-tenants

Use the `odacli list-tenants` command to list all tenants in a multi-user access domain.

File Path

```
/opt/oracle/dcs/bin/odacli
```

Syntax

```
odacli list-tenants -dn domain_name [-j] [-h]
```

Parameters

| Parameter | Description |
|---------------------------------|---|
| <code>--domain-name, -dn</code> | (Optional) Specifies the multi-user access domain name. |
| <code>--help, -h</code> | (Optional) Displays help for using the command. |
| <code>--json, -j</code> | (Optional) Displays JSON output. |

Usage Notes

- The `odaadmin` user can run this command to view the tenants in a multi-user access domain.

Example 16-20

```
[odaadmin@oda1 bin]$ odacli list-tenants
ID Domain Name          Tenant Name  Tenant  Description  Is
Active
-----
1656723b-f614-4539-9634-d9013e611015 odalocal.com odalocal Default tenant true
```

odacli describe-tenant

Use the `odacli describe-tenant` command to describe a tenant in a multi-user access domain.

File Path

```
/opt/oracle/dcs/bin/odacli
```

Syntax

```
odacli describe-tenant -tn tenant_name -dn domain_name [-j] [-h]
```

Parameters

| Parameter | Description |
|---------------------------------|---|
| <code>--tenant-name, -tn</code> | (Required) Specifies the multi-user access tenant name. |

| Parameter | Description |
|---------------------------------|---|
| <code>--domain-name, -dn</code> | (Optional) Specifies the multi-user access domain name. |
| <code>--help, -h</code> | (Optional) Displays help for using the command. |
| <code>--json, -j</code> | (Optional) Displays JSON output. |

Usage Notes

- The `odaadmin` user can run this command to view the tenant details in a multi-user access domain.

Example 16-21

```
[odaadmin@odal bin]$ odacli describe-tenant -tn odalocal
Tenant details
-----
                ID: 1656723b-f614-4539-9634-d9013e611015
    Domain Name: odalocal.com
    Tenant Name: odalocal
Tenant Description: Default tenant
      Is Active: true
        Created: November 22, 2021 7:39:50 PM UTC
    Last Updated: November 22, 2021 7:39:50 PM UTC
```

odacli create-user

Use the `odacli create-user` command to create a user in a multi-user access system.

File Path

```
/opt/oracle/dcs/bin/odacli
```

Syntax

```
odacli create-user -u user_id -r roles [-gc] [-j] [-h]
```

Parameters

| Parameter | Description |
|-----------------------------------|---|
| <code>--user-id, -u</code> | (Required) Specifies the user whose details are being created. |
| <code>--user-roles, -r</code> | (Required) Specifies the role to be assigned to the user. Use commas to specify multiple roles. |
| <code>--generate-cert, -gc</code> | (Optional) This option generates and registers a pair of certificates, one for the client and the other for the server (DCS agent). After these certificates are mutually exchanged and authenticated, the client and server can communicate with each other using mTLS (mutual Transport Layer Security). This attribute is optional and must be enabled only when you need to connect to the DCS agent with mTLS in addition to Basic Authentication. |
| <code>--help, -h</code> | (Optional) Displays help for using the command. |

| Parameter | Description |
|-------------------------|----------------------------------|
| <code>--json, -j</code> | (Optional) Displays JSON output. |

Usage Notes

- Use the command to create a user in a multi-user access system. After `odaadmin` creates a user and generates temporary login credentials, the new user must activate their account by connecting to the appliance with the temporary password. Run the `odacli activate-user` command and provide the temporary password and then specify the new password. You can also activate the user from the Browser User Interface.

Example 16-22

```
[odaadmin@oda1 bin]$ odacli create-user -u dcsdb2 -r ODA-DB
Enter ODA account password for user 'dcsdb2':
Retype ODA account password for user 'dcsdb2':
```

Job details

```
-----
ID: 856b3d79-8ae1-427c-a77a-8893254a451f
Description: User creation(dcsdb2)
Status: Running
Created: November 29, 2023 7:01:54 AM UTC
Message:
```

```
Task Name Start Time End Time Status
-----
```

```
[odaadmin@oda1 bin]$ odacli describe-job -i 856b3d79-8ae1-427c-
a77a-8893254a451f
```

Job details

```
-----
ID: 856b3d79-8ae1-427c-a77a-8893254a451f
Description: User creation(dcsdb2)
Status: Success
Created: November 29, 2023 7:01:54 AM UTC
Message:
```

```
Task Name Start Time End Time Status
-----
```

odacli activate-user

Use the `odacli activate-user` command to activate a user in a multi-user access system.

File Path

```
/opt/oracle/dcs/bin/odacli
```

Syntax

```
odacli activate-user [-j] [-h]
```

Parameters

| Parameter | Description |
|-------------------|---|
| --domain-name, -d | (Optional) Specifies the name of the domain in which the user exists. |
| --tenant-name, -t | (Optional) Specifies the tenancy in which the user exists. |
| --help, -h | (Optional) Displays help for using the command. |
| --json, -j | (Optional) Displays JSON output. |

Usage Notes

- Use the command to activate a user in a multi-user access system. To activate a user, the user to be activated must connect to the Oracle Database Appliance system through SSH and then run the command.

Example 16-23

```
[dcsdb2@oda1 bin]$ odacli activate-user
Enter your ODA account password:
Enter new password for your ODA account:
Retype new password for your ODA account:
User 'dcsdb2' activated successfully.
```

odacli list-users

Use the `odacli list-users` command to list all users in a multi-user access system.

File Path

```
/opt/oracle/dcs/bin/odacli
```

Syntax

```
odacli list-users [-d domain_name] [-t tenant_name] [-u user_id] [-j] [-h]
```

Parameters

| Parameter | Description |
|-------------------|---|
| --domain-name, -d | (Optional) Specifies the name of the domain in which the user exists. |
| --tenant-name, -t | (Optional) Specifies the tenancy in which the user exists. |
| --user-id, -u | (Optional) Specifies the user for whom the list is being generated. |
| --help, -h | (Optional) Displays help for using the command. |
| --json, -j | (Optional) Displays JSON output. |

Usage Notes

- The `odaadmin` user can run this command to view all the users in a multi-user access system.

Example 16-24

```
[odaadmin@odal bin]$ odacli list-users
```

```

ID                               DCS User Name  OS User Name
Role(s)                          Account Status  User Type
-----
-----
13b64a36-23f8-4ba2-9af3-e0a17a16b376 dcsdb2         dcsdb2       ODA-
DB                                Active         Custom
5006da5b-0fc0-4d6f-9115-17d89ad235e4 oakdroot       oakdroot     ODA-
OAKDROOT                          Active         System
7af066af-55bd-48a9-8db5-c0d3049a1541 ugrid          ugrid        ODA-
GRID                                Active         System
8361ca4b-8747-4687-9459-799c6a17d1b1 uoracle        uoracle      ODA-
DB                                Active         System
a205ce98-2675-49a2-81e2-4e1c7540f023 odaadmin       odaadmin     ODA-
ADMINISTRATOR Active         System

```

odacli describe-user

Use the `odacli describe-user` command to describe a user in a multi-user access system.

File Path

```
/opt/oracle/dcs/bin/odacli
```

Syntax

```
odacli describe-user [-u user_id] [-d domain_name] [-rd] [-t tenant_name] [-j] [-h]
```

Parameters

| Parameter | Description |
|----------------------------------|---|
| <code>--user-id, -u</code> | (Required) Specifies the user whose details are being viewed. |
| <code>--domain-name, -d</code> | (Optional) Specifies the name of the domain in which the user exists. |
| <code>--role-details, -rd</code> | (Optional) Specifies the entitlements and operations associated with the user role. |
| <code>--tenant-name, -t</code> | (Optional) Specifies the tenancy in which the user exists. |
| <code>--help, -h</code> | (Optional) Displays help for using the command. |
| <code>--json, -j</code> | (Optional) Displays JSON output. |

Usage Notes

- Use the command to view details about a user in a multi-user access system.

Example 16-25

```
[odaadmin@oda1 bin]$ odacli describe-user -u dcsdb1

User details
-----
                ID: be3182b4-9933-44a8-89b8-02b883db9d30
      DCS User ID: dcsdb1
      OS User ID: dcsdb1
  Primary OS Group: uoinstall
Secondary OS Groups: uasmdba, dcsdb1_dba, dcsdb1_dbaoper, dcsdb1, dcsagent
      Role(s): ODA-DB
  Account Status: Active
  Account Status: Custom
      Created: November 25, 2021 12:21:16 PM UTC
  Last Updated: November 25, 2021 12:27:31 PM UTC
```

odacli authorize-user

Use the `odacli authorize-user` command in a multi-user access system to unlock a user account that is locked due to multiple failed login attempts or where the password has expired, and authorize the user to reset their password to reactivate their account.

File Path

```
/opt/oracle/dcs/bin/odacli
```

Syntax

```
odacli authorize-user -u user_id [-d domain_name] [-t tenant_name] [-j] [-h]
```

Parameters

| Parameter | Description |
|--------------------------------|---|
| <code>--user-id, -u</code> | (Required) Specifies the user whose account is locked. |
| <code>--domain-name, -d</code> | (Optional) Specifies the name of the domain in which the user exists. |
| <code>--tenant-name, -t</code> | (Optional) Specifies the tenancy in which the user exists. |
| <code>--help, -h</code> | (Optional) Displays help for using the command. |
| <code>--json, -j</code> | (Optional) Displays JSON output. |

Usage Notes

- Use the command to authorize a user in a multi-user access system. Only the system administrator `odaadmin` has the necessary privileges to run this command.

Example 16-26

```
[odaadmin@oda1 bin]$ odacli authorize-user -u dcsdb2
Enter your ODA account password:
Enter new password for user 'dcsdb2':
Retype new password for user 'dcsdb2':
User 'dcsdb2' authorized successfully.
User can now login with the temporary password assigned to them by the system
administrator
and reset their password by executing 'odacli reset-password' command or via
BUI.
```

odacli delete-user

Use the `odacli delete-user` command in a multi-user access system to delete a user account.

File Path

```
/opt/oracle/dcs/bin/odacli
```

Syntax

```
odacli delete-user -u user_id [-d domain_name] [-t tenant_name] [-j] [-h]
```

Parameters

| Parameter | Description |
|--------------------------------|---|
| <code>--user-id, -u</code> | (Required) Specifies the user account to be deleted. |
| <code>--domain-name, -d</code> | (Optional) Specifies the name of the domain in which the user exists. |
| <code>--tenant-name, -t</code> | (Optional) Specifies the tenancy in which the user exists. |
| <code>--help, -h</code> | (Optional) Displays help for using the command. |
| <code>--json, -j</code> | (Optional) Displays JSON output. |

Usage Notes

- Use the command to delete a user in a multi-user access system. Only the system administrator `odaadmin` has the necessary privileges to run this command.
- The user can be deleted only if there are no resources currently being held in their name.

Example 16-27

```
[odaadmin@oda1 bin]$ odacli delete-user -u dcsdb2
```

```
Job details
```

```
-----
ID: a8724a04-3225-43b3-9484-a949bce1c5c0
Description: User deletion(dcsdb2)
Status: Success
Created: November 19, 2021 11:44:35 AM UTC
Message:
```

```

Task Name Start Time End Time Status dcs
-----
-----

[odaadmin@oda1 bin]$ odacli describe-job -i a8724a04-3225-43b3-9484-
a949bce1c5c0

Job details
-----
                ID: a8724a04-3225-43b3-9484-a949bce1c5c0
Description: User deletion(dcsdb2)
      Status: Success
    Created: November 19, 2021 11:44:35 AM UTC
    Message:

Task Name Start Time End Time Status
-----
-----

```

odacli list-user-roles

Use the `odacli list-user-roles` command to list user roles in a multi-user access system.

File Path

```
/opt/oracle/dcs/bin/odacli
```

Syntax

```
odacli list-user-roles [-n role_name] [-j] [-h]
```

Parameters

| Parameter | Description |
|------------------------------|--|
| <code>--role-name, -n</code> | (Optional) Displays the list for the specified role. |
| <code>--help, -h</code> | (Optional) Displays help for using the command. |
| <code>--json, -j</code> | (Optional) Displays JSON output. |

Usage Notes

- Use the command to view all the roles in a multi-user access system. Only the system administrator `odaadmin` has the necessary privileges to run this command.

Example 16-28

```

[odaadmin@oda1 bin]$ odacli list-user-roles

Role Name          Role Description          Is Admin
Role Is Internal  Is Active
-----
-----

```

```

-----
ODA-DB          Role with DB provisioning related entitlements
false          false          true
ODA-GRID        Role with GRID provisioning related entitlements
false          true           true
ODA-DBVMINFRA   Role with DBVM user related entitlements false
true          true
ODA-ADMINISTRATOR System Administrator role with all entitlements
true          true           true
ODA-OAKDROOT    Role with OAKD related entitlements
false          true           true

```

odacli describe-user-role

Use the `odacli describe-user-role` command to describe a user role in a multi-user access system.

File Path

```
/opt/oracle/dcs/bin/odacli
```

Syntax

```
odacli describe-user-role [-n role_name] [-j] [-h]
```

Parameters

| Parameter | Description |
|------------------------------|--|
| <code>--role-name, -n</code> | (Required) Specifies the user role for which you want to list the details. |
| <code>--help, -h</code> | (Optional) Displays help for using the command. |
| <code>--json, -j</code> | (Optional) Displays JSON output. |

Usage Notes

- Use the command to describe a user role in a multi-user access system. Only the system administrator `odaadmin` has the necessary privileges to run this command.

Example 16-29

```

[odaadmin@odal bin]$ odacli describe-user-role -n ODA-DB
Role details
-----
                Name: ODA-DB
                Description: Role with DB provisioning related entitlements
                Is Admin Role: false
                Is Internal: false
                Is Active: true
                Mapped Entitlement(s): PROVISIONDB-MGMT, BACKUPDB-MGMT, PATCHDB-
MGMT, DATAGUARD-MGMT, DBSTORAGE-MGMT, OBJSTORESWIFT-MGMT, RMANREPORT-
MGMT, SCHEDULE-MGMT, ORACHK-MGMT, ASM-RDBMS-INSTANCE-MGMT, CPUPOOLVIEW-
MGMT, COMMON-ALL

```

odacli list-user-entitlements

Use the `odacli list-user-entitlements` command to list all entitlements in a multi-user access system.

File Path

`/opt/oracle/dcs/bin/odacli`

Syntax

```
odacli list-user-entitlements [-ao] [-n entitlement_name] [-j] [-h]
```

Parameters

| Parameter | Description |
|-------------------------------------|---|
| <code>--active-only, -ao</code> | (Optional) Lists the active entitlements. |
| <code>--entitlement-name, -n</code> | (Optional) Displays the list for the specified entitlement. |
| <code>--help, -h</code> | (Optional) Displays help for using the command. |
| <code>--json, -j</code> | (Optional) Displays JSON output. |

Usage Notes

- Use the command to view all entitlements in a multi-user access system. Only the system administrator `odaadmin` has the necessary privileges to run this command.

Example 16-30

```
[odaadmin@odal bin]$ odacli list-user-entitlements
```

```
Entitlement Name      Entitlement
Description                                     Is Active
-----
TOKEN-MGMT           Entitlement for performing user token management
operations           true
OSCONFIGS-MGMT       Entitlement for performing os configurations related
operations           true
FEATURETOGGLE-MGMT   Entitlement for performing feature enable/disable
management operations true
SERVER-MGMT          Entitlement for performing server related
operations           true
HAT-MGMT             Entitlement for performing HAT Administrative
operations           true
ASM-RDBMS-INSTANCE-MGMT Entitlement for performing ASM/RDBMS instance related
operations           true
RMANREPORT-MGMT      Entitlement for performing RMAN report(s) related
operations           true
DBHOME-MGMT          Entitlement for performing DBHomes (on ACFS) related
operations           true
DCSCOMPS-MGMT        Entitlement for performing DCS component related
operations           true
```



```
KVM-MGMT-INTERNAL      Entitlement for performing blackbox KVM related
internal operations    true
...
```

odacli describe-user-entitlement

Use the `odacli describe-user-entitlement` command to describe an entitlement in a multi-user access system.

File Path

```
/opt/oracle/dcs/bin/odacli
```

Syntax

```
odacli describe-user-entitlement -n entitlement_name [-j] [-h]
```

Parameters

| Parameter | Description |
|-------------------------------------|--|
| <code>--entitlement-name, -n</code> | (Required) Displays the details for the specified entitlement. |
| <code>--help, -h</code> | (Optional) Displays help for using the command. |
| <code>--json, -j</code> | (Optional) Displays JSON output. |

Usage Notes

- Use the command to view an entitlement in a multi-user access system. Only the system administrator `odaadmin` has the necessary privileges to run this command.

Example 16-31

```
[odaadmin@oda1 bin]$ odacli describe-user-entitlement -n PROVISIONDB-MGMT
```

```
Entitlement details
```

```
-----
                Name: PROVISIONDB-MGMT
            Description: Entitlement for performing DB provision related
operations
                Is Active: true
            Mapped Operation(s): clone-database,create-database,delete-
database,describe-database,list-databases,modify-database,move-
database,register-database,update-database,upgrade-database,create-
dbhome,delete-dbhome,describe-dbhome,list-dbhomes,describe-netsecurity,update-
netsecurity,list-supported-dbversions,get-db-shapes,restore-
archivelog,restore-tdewallet,modify-dbfileattributes
```

odacli list-user-operations

Use the `odacli list-user-operations` command to list all operations in a multi-user access system.

File Path

```
/opt/oracle/dcs/bin/odacli
```

Syntax

```
odacli list-user-operations [-ao] [-n operations_name] [-j] [-h]
```

Parameters

| Parameter | Description |
|-----------------------------------|---|
| <code>--active-only, -ao</code> | (Optional) Lists the active multi-user access operations. |
| <code>--operation-name, -n</code> | (Optional) Displays the list for the specified operation. |
| <code>--help, -h</code> | (Optional) Displays help for using the command. |
| <code>--json, -j</code> | (Optional) Displays JSON output. |

Usage Notes

- Use the command to view operations in a multi-user access system. Only the system administrator `odaadmin` has the necessary privileges to run this command.

Example 16-32

```
[odaadmin@odal bin]$ odacli list-user-operations
```

```

Operation Name           Operation Description      Is Active
-----
-----
list-orachkreports      List orachkreports        true
list-osconfigurations   List os configurations     true
describe-database       Describe database          true
retrieveall-resources   Retrieve all resources     true
modify-dbsystem-vm      Modify DB System VMs      true
list-backupconfigs      List backup configurations true

```

odacli describe-user-operation

Use the `odacli describe-user-operation` command to describe an operation in a multi-user access system.

File Path

```
/opt/oracle/dcs/bin/odacli
```

Syntax

```
odacli describe-user-operation [-n operation_name] [-j] [-h]
```

Parameters

| Parameter | Description |
|----------------------|--|
| --operation-name, -n | (Optional) Displays the details for the specified operation. |
| --help, -h | (Optional) Displays help for using the command. |
| --json, -j | (Optional) Displays JSON output. |

Usage Notes

- Use the command to view an operation in a multi-user access system. Only the system administrator `odaadmin` has the necessary privileges to run this command.

Example 16-33

```
[odaadmin@odal bin]$ odacli describe-user-operation -n create-database
Operation details
-----
                Name: create-database
        Description: Create database
                Is Active: true
```

odacli list-resources-access

Use the `odacli list-resources-access` command to list access to DCS resources in a multi-user access system.

File Path

```
/opt/oracle/dcs/bin/odacli
```

Syntax

```
odacli list-resources-access [-ao] [-rn resource_name] [-rt resource_type] [-j] [-h]
```

Parameters

| Parameter | Description |
|----------------------|--|
| --active-only, -ao | (Optional) Lists the active resources. |
| --resource-name, -rn | (Optional) Displays the list by resource name. |
| --resource-type, -rt | (Optional) Displays the list for the specified resource type, for example, <code>oda_dbhome</code> , <code>oda_db</code> , <code>oda_dbstorage</code> , <code>oda_objstoreswift</code> , and <code>oda_backupconfig</code> . |
| --help, -h | (Optional) Displays help for using the command. |
| --json, -j | (Optional) Displays JSON output. |

Usage Notes

- Use the command to view access to resources in a multi-user access system. Only the system administrator `odaadmin` has the necessary privileges to run this command.

Example 16-34

```
[odaadmin@odal bin]$ odacli list-resources-access
```

```
Resource ID                               Resource Name   Resource
Location                                  Resource Type   Primary
Owner Shared Access Is Active
-----
-----
cfc65e00-5d9e-4c00-a7a0-f7ea37884e06 asmtde1        53f434fe-598e-46a0-bbdc-
a456404da0c9          ODA_DB        odadb1
odaadmin      true
1dd795e1-b582-49f1-b1fb-eb3d77eb158b bkpcfg_o1
ObjectStore                                  ODA_BACKUPCONFIG
odadb1      odaadmin      true
06682f78-8f5f-4dd2-a918-7935e00bf0c4 o1             https://
swiftobjectstorage.us-phoenix-1.oraclecloud.com/v1 ODA_OBJSTORESWIFT
odadb1      odaadmin      true
53f434fe-598e-46a0-bbdc-a456404da0c9 OraDB19000_home1 /u01/app/odaorahome/
odadb1/product/19.0.0.0/dbhome_1          ODA_DBHOME        odadb1
odaadmin      true
abc9a670-493e-4226-b186-6bc91ea48b9a default
Disk                                          ODA_BACKUPCONFIG
uoracle      odaadmin      true
2360eebc-8899-471c-828f-c008e56fefea asmtde1
DATA,RECO,RECO                                  ODA_DBSTORAGE
odadb1      odaadmin      true
```

odacli describe-resource-access

Use the `odacli describe-resource-access` command to describe access to a DCS resource in a multi-user access system.

File Path

```
/opt/oracle/dcs/bin/odacli
```

Syntax

```
odacli describe-resource-access [-ri resource_ID] [-j] [-h]
```

Parameters

| Parameter | Description |
|---------------------------------|---|
| <code>--resource-ID, -ri</code> | (Required) Specifies the resource ID. |
| <code>--help, -h</code> | (Optional) Displays help for using the command. |

| Parameter | Description |
|-------------------------|----------------------------------|
| <code>--json, -j</code> | (Optional) Displays JSON output. |

Usage Notes

- Use the command to view access to a resource in a multi-user access system. Only the system administrator `odaadmin` has the necessary privileges to run this command.

Example 16-35

```
[odaadmin@odal bin]$ odacli describe-resource-access -ri cfc65e00-5d9e-4c00-a7a0-f7ea37884e06
```

```
Resource Access details
```

```
-----
Resource ID: cfc65e00-5d9e-4c00-a7a0-f7ea37884e06
Resource Name: asmtde1
Resource Location: 53f434fe-598e-46a0-bbdc-a456404da0c9
Resource Type: ODA_DB
Primary Owner: odadb1
Shared Access: odaadmin
Is Active: true
Created: November 17, 2021 1:31:55 PM UTC
Last Updated: November 17, 2021 1:31:55 PM UTC
```

odacli grant-resource-access

Use the `odacli grant-resource-access` command to grant shared access to a DCS resource in a multi-user access system.

File Path

```
/opt/oracle/dcs/bin/odacli
```

Syntax

```
odacli grant-resource-access [-ri resource_ID] [-u user_ID] [-j] [-h]
```

Parameters

| Parameter | Description |
|---------------------------------|---|
| <code>--resource-ID, -ri</code> | (Required) Specifies the resource ID. |
| <code>--user-ID, -u</code> | (Required) Specifies the user name to be granted shared access. |
| <code>--help, -h</code> | (Optional) Displays help for using the command. |
| <code>--json, -j</code> | (Optional) Displays JSON output. |

Usage Notes

- Use the command to grant access to a resource in a multi-user access system. Only the system administrator `odaadmin` has the necessary privileges to run this command.

Example 16-36

```
[odaadmin@oda1 bin]$ odacli grant-resource-access -ri cfc65e00-5d9e-4c00-a7a0-
f7ea37884e06 -u odadb2
Shared access of resource granted to user successfully...
[odaadmin@oda1 bin]$ odacli describe-resource-access -ri cfc65e00-5d9e-4c00-
a7a0-f7ea37884e06
Resource Access details
-----
Resource ID: cfc65e00-5d9e-4c00-a7a0-f7ea37884e06
Resource Name: asmtde1
Resource Location: 53f434fe-598e-46a0-bbdc-a456404da0c9
Resource Type: ODA_DB
Primary Owner: odadb1
Shared Access: odaadmin,odadb2
Is Active: true
Created: November 17, 2021 1:31:55 PM UTC
Last Updated: November 19, 2021 12:46:55 PM UTC
```

odacli revoke-resource-access

Use the `odacli revoke-resource-access` command to revoke access to a DCS resource in a multi-user access system.

File Path

`/opt/oracle/dcs/bin/odacli`

Syntax

```
odacli revoke-resource-access [-ri resource_ID] [-u user_ID] [-j] [-h]
```

Parameters

| Parameter | Description |
|---------------------------------|--|
| <code>--resource-ID, -ri</code> | (Required) Specifies the resource ID. |
| <code>--user-ID, -u</code> | (Required) Specifies the user name whose shared access is to be revoked. |
| <code>--help, -h</code> | (Optional) Displays help for using the command. |
| <code>--json, -j</code> | (Optional) Displays JSON output. |

Usage Notes

- Use the command to revoke access to a resource in a multi-user access system. Only the system administrator `odaadmin` has the necessary privileges to run this command.

Example 16-37

```
[odaadmin@oda1 bin]$ odacli revoke-resource-access -ri cfc65e00-5d9e-4c00-
a7a0-f7ea37884e06 -u dcsdb2
Shared access of resource to the user revoked successfully...
[odaadmin@oda1 bin]$ odacli describe-resource-access -ri cfc65e00-5d9e-4c00-
a7a0-f7ea37884e06
```

Resource Access details

```

-----
Resource ID: cfc65e00-5d9e-4c00-a7a0-f7ea37884e06
Resource Name: asmtde1
Resource Location: 53f434fe-598e-46a0-bbdc-a456404da0c9
Resource Type: ODA_DB
Primary Owner: odadb1
Shared Access: odaadmin
Is Active: true
Created: November 17, 2021 1:31:55 PM UTC
Last Updated: November 19, 2021 12:53:43 PM UTC

```

odacli reset-password

Use the `odacli reset-password` command to reset the password for a user, after it is unlocked, in a multi-user access system.

File Path

```
/opt/oracle/dcs/bin/odacli
```

Syntax

```
odacli reset-password [-d domain_name] [-t tenant_name] [-j] [-h]
```

Parameters

| Parameter | Description |
|--------------------------------|---|
| <code>--domain-name, -d</code> | (Optional) Specifies the name of the domain in which the user exists. |
| <code>--tenant-name, -t</code> | (Optional) Specifies the tenancy in which the user exists. |
| <code>--help, -h</code> | (Optional) Displays help for using the command. |
| <code>--json, -j</code> | (Optional) Displays JSON output. |

Usage Notes

- Use the command to reset the password for a user in a multi-user access system. The password of a user must be reset either when the user account is locked due to multiple failed login attempts or if the password has expired. The `odaadmin` must first unlock the user account by running the `odacli authorize-user` command. The user can then log in with the temporary password assigned by `odaadmin`, run the `odacli reset-password` command, provide the temporary password, and then specify the new password. You can also reset the password from the Browser User Interface.

Example 16-38

```

[dcldb2@oda1 bin]$ odacli reset-password
Enter your ODA account password:
Enter new password for your ODA account:
Retype new password for your ODA account:
Password reset for user 'dcldb2' successful...

```

odacli change-password

Use the `odacli change-password` command to change the password for a user in a multi-user access system.

File Path

```
/opt/oracle/dcs/bin/odacli
```

Syntax

```
odacli change-password [-d domain_name] [-t tenant_name] [-j] [-h]
```

Parameters

| Parameter | Description |
|--------------------------------|---|
| <code>--domain-name, -d</code> | (Optional) Specifies the name of the domain in which the user exists. |
| <code>--tenant-name, -t</code> | (Optional) Specifies the tenancy in which the user exists. |
| <code>--help, -h</code> | (Optional) Displays help for using the command. |
| <code>--json, -j</code> | (Optional) Displays JSON output. |

Usage Notes

- This command must be run by the active user who wants to change the password. To reset the password of a locked or expired account, use the `odacli reset-password` command.

Example 16-39

```
[dcsdb2@oda1 bin]$ odacli reset-password
Enter your ODA account password:
Enter new password for your ODA account:
Retype new password for your ODA account:
Password reset for user 'dcsdb2' successful...
```

odacli Apply Patch and Update Commands

Use the commands `odacli update` and `apply patch` to apply patches and update the appliance.

- [odacli cleanup-patchrepo](#)
Use the `odacli cleanup-patchrepo` command to delete obsolete or old patches from the repository.
- [odacli create-prepatchreport](#)
Use the `odacli create-prepatchreport` command to run pre-checks for patching.
- [odacli describe-prepatchreport](#)
Use the `odacli describe-prepatchreport` command to display the pre-check report, with a list of pre-checks run with status and comments.

- [odacli list-prepatchreports](#)
Use the `odacli list-prepatchreports` command to display all pre-check reports, with a list of pre-checks run with status and comments.
- [odacli delete-prepatchreport](#)
Use the `odacli delete-prepatchreport` command to delete any pre-check report.
- [odacli list-availablepatches](#)
Use the `odacli list-availablepatches` command to display all available patches for Oracle Database Appliance.
- [odacli describe-component](#)
Use the `odacli describe-component` command to display the installed version and the latest available version for each component.
- [odacli describe-latestpatch](#)
Use the `odacli describe-latestpatch` command to display a list of the latest supported patch versions for each component.
- [odacli list-agentconfig-parameters](#)
Use the `odacli list-agentconfig-parameters` command to list configuration variables used by the appliance.
- [odacli modify-agentconfig-parameters](#)
Use the `odacli modify-agentconfig-parameters` command to modify configuration variables used by the appliance.
- [odacli delete-agentconfig-parameters](#)
Use the `odacli delete-agentconfig-parameters` command to delete configuration variables used by the appliance.
- [odacli update-database](#)
Use the `odacli update-database` command to update a database to a specific database home with later version, and within the same major release.
- [odacli update-dbhome](#)
Use the `odacli update-dbhome` command to update a specific database home to the latest patch bundle version.
- [odacli update-dcsadmin](#)
Use the `odacli update-dcsadmin` command to update the DCS admin for DCS components upgrade.
- [odacli update-dcsagent](#)
Use the `odacli update-dcsagent` command to update the agent.
- [odacli update-dcscomponents](#)
Use the `odacli update-dcscomponents` command to update the DCS components such as the DCS agent, CLI, and controller.
- [odacli update-registry](#)
Use the `odacli update-registry` command to update the metadata for the components that are already present in the registry. For database home and grid home, this command updates the patch information, when you apply patches manually.
- [odacli update-repository](#)
Use the `odacli update-repository` command to update the repository with the new Oracle Database Appliance software.
- [odacli update-server](#)
Use the `odacli update-server` command to update the operating system, firmware, Oracle Appliance Kit, Oracle Clusterware, and all other infrastructure components.

- [odacli update-storage](#)
Use the `odacli update-storage` command to update the storage.
- [odacli update-server-postcheck](#)
Use the `odacli update-server-postcheck` command to perform deployment health checks after upgrading the operating system from Oracle Linux 6 to Oracle Linux 7.
- [odaadmcli orachk](#)
Use the `odaadmcli orachk` command to check configuration settings for Oracle Database Appliance components.

odacli cleanup-patchrepo

Use the `odacli cleanup-patchrepo` command to delete obsolete or old patches from the repository.

File Path

`/opt/oracle/dcs/bin/odacli`

Syntax

```
odacli cleanup-patchrepo [-nn node_name] [-cl clones] [-v version [-comp component]] [-l local]
```

Parameters

| Parameter | Description |
|---------------------------------|--|
| <code>--clones, -cl</code> | Specifies the option to clean up clone files (DB and GI) from the repository <code>/opt/oracle/oak/pkgrepos/orapkgs/clones/</code> . |
| <code>--version, -v</code> | Defines the Oracle Database Appliance release you want to delete. You cannot delete the initial or current release files. For example, 12.2.1.4.0. |
| <code>--component, -comp</code> | A comma-separated list of components as {DB, GI} to cleanup for a specific Oracle Database Appliance patch version. The default is both {DB, GI}. |
| <code>--local, -l</code> | (Optional) Cleans up the repository on the local node. |
| <code>--node-name, -nn</code> | (Optional) Cleans up the repository on the specified node names. |
| <code>--help, -h</code> | (Optional) Displays help for using the command. |
| <code>--json, -j</code> | (Optional) Displays JSON output. |

Usage Notes

- Use the command to free up space in the patch repository.
- This command does not delete the current patches or latest installed patch repository.

Example 16-40 Deleting RDBMS and GI components for a specific release

```
# odacli cleanup-patchrepo -cl -comp db,gi -v 12.2.1.4.0
{
  "jobId" : "d915ffc0-c7f6-49cf-8ddd-ab5d2ad9072f",
  "status" : "Created",
```

```
"message" : null,
"reports" : ,
"createTimestamp" : "April 17, 2024 06:44:28 AM UTC",
"resourceList" : ,
"description" : "Cleanup patchrepos",
"updatedAt" : "April 17, 2024 06:44:28 AM UTC"
```

Example 16-41 Deleting Clone Files

```
# odacli cleanup-patchrepo -cl
{
"jobId" : "5d8549a2-1a5e-4b4f-9867-c1f671c659c4",
"status" : "Created",
"message" : null,
"reports" : ,
"createTimestamp" : "April 17, 2024 06:43:45 AM UTC",
"resourceList" : ,
"description" : "Cleanup patchrepos",
"updatedAt" : "April 17, 2024 06:43:45 AM UTC"
}
```

odacli create-prepatchreport

Use the `odacli create-prepatchreport` command to run pre-checks for patching.

Patching pre-checks help identify and remedy any problems before patching is attempted, and ensure all components are ready for updates.

File Path

`/opt/oracle/dcs/bin/odacli`

Syntax

```
odacli create-prepatchreport [-db] [-dbid database_id] [-dp] [-d] [-i
dbhome_id] [-f files] [-l] [-nn node_name] [-os] [-r] [-s] [-sko] [-st] [-to
dest_db_home_id] [-v version] [-j] [-h]
```

Parameters

| Parameter | Description |
|----------------------------------|---|
| <code>--database, -db</code> | (Optional) Specifies the database component for running the pre-checks. This option cannot be used with the <code>-dp</code> and <code>-d</code> options. |
| <code>--databaseid, -dbid</code> | (Optional) Specifies the ID of the database to be updated and for which you want to run the pre-checks. |
| <code>--datapatch, -dp</code> | (Optional) Specifies the datapatch component for running the pre-checks. This option cannot be used with the <code>-db</code> and <code>-d</code> options. |
| <code>--dbhome, -d</code> | (Optional) Specifies the database home component for running the pre-checks. This option cannot be used with the <code>-dp</code> and <code>-db</code> options. |
| <code>--dbhomeid, -i</code> | (Optional) Specifies the IDs of the database homes to be updated and for which you want to run the pre-checks. |

| Parameter | Description |
|--------------------------------------|---|
| <code>--files, -f</code> | (Optional) Specifies files required to update repository, comma-separated if multiple files are required. |
| <code>--operating-system, -os</code> | (Optional) Specifies the operating system components. Use this option to run operating system upgrade. If you specify <code>-c</code> , then the only option is <code>os</code> . If you specify <code>-c os</code> , then you can also specify <code>-local</code> (optional). |
| <code>--node-name, -nn</code> | (Optional) Runs patch pre-checks on specified node names. |
| <code>--local, -l</code> | (Optional) Runs patch pre-checks on local node only. |
| <code>--operating-system, -os</code> | (Optional) Specify this option to run the patch pre-checks for the operating system components. |
| <code>--repo, -r</code> | (Optional) Specify this option to run the patch pre-checks for the repository components. |
| <code>--server, -s</code> | (Optional) Specify this option to run the patch pre-checks for the server components. |
| <code>--storage, -st</code> | (Optional) Specify this option to run the patch pre-checks for the storage components. |
| <code>--version, -v</code> | (Optional) Specifies the version for running the pre-checks. |
| <code>--to-home, -to</code> | (Optional) Specifies the destination Oracle Database Home on the target database for the update. Note that you must use this option with the <code>-db</code> option. |
| <code>--help, -h</code> | (Optional) Displays help for using the command. |
| <code>--json, -j</code> | (Optional) Displays JSON output. The default is false. |

Usage Notes

Use the `odacli create-prepatchreport` command to generate a pre-check report. Use the `--node` or `--local` option to run the patch pre-checks on specific nodes or the local node.

Example 16-42 Creating Pre-Check Report

```
# odacli create-prepatchreport -v 19.26.0.0.0 -s

Job details
-----
                ID: e07993d5-0a06-44e7-819a-36d708c52bb6
Description: Patch pre-checks for [OS, ILOM, GI, ORACHKSERVER]
      Status: Created
      Created: September 20, 2023 1:01:59 AM PDT
      Message: Use 'odacli describe-prepatchreport -i
e07993d5-0a06-44e7-819a-36d708c52bb6' to check details of results

Task Name Start Time End Time Status
-----
```

Example 16-43 Creating Pre-Check Report for Updating Database and Applying Datapatch

```
# odacli describe-prepatchreport -i efa93519-a365-4e9a-9f25-ad3c653cccef
```

```
Patch pre-check report
```

```
-----  
Job ID: efa93519-a365-4e9a-9f25-ad3c653cccef  
Description: Patch pre-checks for [SINGLEDB, ORACHKSINGLEDB]:  
Target DB is db10181, Destination DbHome is OraDB19000_home8  
Status: SUCCESS  
Created: October 18, 2023 11:19:03 AM PDT  
Result: All pre-checks succeeded
```

```
Node Name
```

```
-----
```

```
node1
```

```
Pre-Check Status Comments
```

```
-----
```

```
__SINGLEDB__
```

```
Is system provisioned Success Verified system is provisioned  
Validate dbHomesOnACFS Success User has configured disk group for  
configured Database homes on ACFS  
Validate Oracle base Success Successfully validated Oracle Base  
Evaluate DB clone availability Success Successfully validated clone file  
exists  
Evaluate DB patching with RHP Success Successfully validated patching DB  
with RHP.  
Validate command execution Success Validated command execution
```

```
__ORACHK__
```

```
Running orachk Success Successfully ran Orachk  
Validate command execution Success Validated command execution  
wandli: Node Name
```

```
-----
```

```
node2
```

```
Pre-Check Status Comments
```

```
-----
```

```
__SINGLEDB__
```

```
Is system provisioned Success Verified system is provisioned  
Validate dbHomesOnACFS Success User has configured disk group for  
configured Database homes on ACFS  
Validate Oracle base Success Successfully validated Oracle Base  
Evaluate DB clone availability Success Successfully validated clone file  
exists  
Evaluate DB patching with RHP Success Successfully validated patching DB  
with RHP.  
Validate command execution Success Validated command execution
```

```
__ORACHK__
```

```
Running orachk Success Successfully ran Orachk  
Validate command execution Success Validated command execution  
wandli: example for applying datapatch,
```

```
[root@oda1 ~]# odacli describe-prepatchreport -i 2cdb0b6e-
ce24-4857-86ab-91480a2ac4e8

Patch pre-check report
-----
                Job ID: 2cdb0b6e-ce24-4857-86ab-91480a2ac4e8
                Description: Patch pre-checks for [SINGLEEDB, ORACHKSINGLEEDB]:
Target DB is season, Destination DbHome is OraDB19000_home6
                Status: SUCCESS
                Created: September 16, 2023 10:38:58 PM UTC
                Result: All pre-checks succeeded

Node Name
-----
oda1

Pre-Check Status Comments
-----
__SINGLEEDB__
Is system provisioned Success Verified system is provisioned
Validate dbHomesOnACFS Success User has configured disk group for
configured Database homes on ACFS
Validate Oracle base Success Successfully validated Oracle Base
Evaluate DB clone availability Success Successfully validated clone file
exists
Evaluate DB patching with RHP Success Successfully validated patching DB
with RHP.
Validate command execution Success Validated command execution

__ORACHK__
Running orachk Success Successfully ran Orachk
Validate command execution Success Validated command execution
```

odacli describe-prepatchreport

Use the `odacli describe-prepatchreport` command to display the pre-check report, with a list of pre-checks run with status and comments.

Patching pre-checks help identify and remedy any problems before attempting to patch, and ensure all components are ready for updates.

File Path

`/opt/oracle/dcs/bin/odacli`

Syntax

`odacli describe-prepatchreport -i ID [-j] [-h]`

Parameters

| Parameter | Description |
|-----------------------|--|
| <code>--id, -i</code> | Specifies the Job ID for the pre-check report. |

| Parameter | Description |
|------------|--|
| --help, -h | (Optional) Displays help for using the command. |
| --json, -j | (Optional) Displays JSON output. The default is false. |

Usage Notes

Use the `odacli describe-prepatchreport` command to display the pre-check report.

The pre-checks report indicates whether the server patching can be rolling or not.

Example 16-44 Patch pre-checks report with rolling mode patching supported when Expander or Controller upgrade is not required

```
[root@node1 bin]# odacli describe-prepatchreport -i 83e41cc6-bd0e-4c53-a9fe-c3f6b7ecd47b
```

Patch pre-check report

```
-----
Job ID: 83e41cc6-bd0e-4c53-a9fe-c3f6b7ecd47b
Description: Patch pre-checks for [STORAGE]
Status: SUCCESS
Created: September 3, 2021 2:51:29 PM UTC
Result: All pre-checks succeeded
```

Node Name

node1

| Pre-Check | Status | Comments |
|---------------------------------------|---------|----------------------------------|
| ----- | | |
| __STORAGE__ | | |
| Validate patching tag 19.12.0.0.0. | Success | Validated patching tag: |
| Patch location validation location | Success | Verified patch location |
| Patch tag validation tag | Success | Verified patch tag |
| Storage patch tag validation location | Success | Verified storage patch location |
| Verify ASM disks status online | Success | ASM disks are online |
| Validate rolling patch as | Success | Rolling mode patching allowed as |
| controller | | there is no expander and |
| upgrade. | | |
| Validate command execution execution | Success | Validated command execution |

Node Name

```
node2

Pre-Check                               Status  Comments
-----
__STORAGE__
Validate patching tag                    Success  Validated patching tag:
19.12.0.0.0.
Patch location validation                Success  Verified patch
location
Patch tag validation                     Success  Verified patch
tag
Storage patch tag validation            Success  Verified storage patch
location
Verify ASM disks status                  Success  ASM disks are
online
Validate rolling patch                   Success  Rolling mode patching allowed
as
                                         there is no expander and
controller

upgrade.
Validate command execution                Success  Validated command execution
```

Example 16-45 Patch pre-checks report with rolling mode patching not supported when Expander or Controller upgrade is required

```
[root@node1 bin]# odacli describe-prepatchreport -i 4a3bef2b-687e-41f2-b3d7-cbda79e63877
```

```
Patch pre-check report
-----
                Job ID: 4a3bef2b-687e-41f2-b3d7-cbda79e63877
Description:    Patch pre-checks for [STORAGE]
Status:        SUCCESS
Created:       September 7, 2021 12:30:57 PM UTC
Result:       All pre-checks succeeded
```

```
Node Name
-----
node1

Pre-Check                               Status  Comments
-----
__STORAGE__
Validate patching tag                    Success  Validated patching tag:
19.12.0.0.0.
Patch location validation                Success  Verified patch
location
Patch tag validation                     Success  Verified patch
tag
Storage patch tag validation            Success  Verified storage patch
location
```



```

Verify ASM disks status      Success  ASM disks are
online
Validate rolling patch      Alert   Rolling mode patching not allowed
as
                                there is expander and controller

upgrade.
Validate command execution  Success Validated command
execution

Node Name
-----
node2

Pre-Check                    Status  Comments
-----
-----
  STORAGE
Validate patching tag      Success Validated patching tag:
19.12.0.0.0.
Patch location validation  Success Verified patch
location
Patch tag validation       Success Verified patch
tag
Storage patch tag validation Success Verified storage patch
location
Verify ASM disks status    Success ASM disks are
online
Validate rolling patch      Alert   Rolling mode patching not allowed
as
                                there is expander and controller

upgrade.
Validate command execution  Success Validated command
execution

```

Example 16-46 Displaying the Patch Pre-Checks Report for Operating System, Oracle Grid Infrastructure, and ORAchk

```

[root@oda1 opt]# odacli describe-prepatchreport -i 20d59005-f7f1-421d-bbb1-
bfc4b5a26293
Patch pre-check report
-----
                Job ID: 20d59005-f7f1-421d-bbb1-bfc4b5a26293
Description: Patch pre-checks for [OS, ILOM, GI, ORACHKSERVER,
SERVER]
                Status: SUCCESS
Created: May 13, 2022 7:31:24 AM HKT
                Result: All pre-checks succeeded

Node Name
-----
node1

Pre-Check                    Status  Comments
-----
-----

```

```

-----
-----
OS
Validate supported versions      Success  Validated minimum supported
versions.
Validate patching tag           Success  Validated patching tag:
19.15.0.0.0.
Is patch location available     Success  Patch location is
available.
Verify OS patch                 Success  Verified OS
patch
Validate command execution      Success  Validated command
execution

ILOM
Validate ILOM server reachable  Success  Successfully connected with
ILOM                                     server using public IP and
USB

interconnect
Validate supported versions      Success  Validated minimum supported
versions.
Validate patching tag           Success  Validated patching tag:
19.15.0.0.0.
Is patch location available     Success  Patch location is
available.
Checking IloM patch Version     Success  Successfully verified the
versions
Patch location validation       Success  Successfully validated
location
Validate command execution      Success  Validated command
execution

GI
Validate GI metadata            Success  Successfully validated GI
metadata
Validate supported GI versions  Success  Validated minimum supported
versions.
Validate available space        Success  Validated free space
under /u01
Is clusterware running         Success  Clusterware is
running
Validate patching tag           Success  Validated patching tag:
19.15.0.0.0.
Is system provisioned           Success  Verified system is
provisioned
Validate ASM in online          Success  ASM is
online
Validate kernel log level       Success  Successfully validated the OS
log
level
Validate minimum agent version  Success  GI patching enabled in
current                                  DCSAGENT

```

```

version
Validate Central Inventory      Success  oraInventory validation
passed
Validate patching locks        Success  Validated patching
locks
Validate clones location exist  Success  Validated clones
location
Validate DB start dependencies  Success  DBs START dependency check
passed
Validate DB stop dependencies   Success  DBs STOP dependency check
passed
Evaluate GI patching           Success  Successfully validated GI
patching
Validate command execution      Success  Validated command
execution

__ORACHK__
Running orachk                 Success  Successfully ran
Orachk
Validate command execution      Success  Validated command
execution

__SERVER__
Validate local patching in     Alert   Rolling patching is not possible:
                                     IB enabled
environments
Validate command execution      Success  Validated command
execution

Node Name
-----
node2

Pre-Check                      Status  Comments
-----
__OS__
Validate supported versions    Success  Validated minimum supported
versions.
Validate patching tag          Success  Validated patching tag:
19.15.0.0.0.
Is patch location available    Success  Patch location is
available.
Verify OS patch                Success  Verified OS
patch
Validate command execution      Success  Validated command
execution

__ILOM__
Validate ILOM server reachable  Success  Successfully connected with
ILOM                                     server using public IP and
USB
interconnect

```

| | | |
|---|---------|--|
| Validate supported versions versions. | Success | Validated minimum supported |
| Validate patching tag 19.15.0.0.0. | Success | Validated patching tag: |
| Is patch location available available. | Success | Patch location is |
| Checking Ilom patch Version versions | Success | Successfully verified the |
| Patch location validation location | Success | Successfully validated |
| Validate command execution execution | Success | Validated command |
| <u>GI</u> | | |
| Validate GI metadata metadata | Success | Successfully validated GI |
| Validate supported GI versions versions. | Success | Validated minimum supported |
| Validate available space under /u01 | Success | Validated free space |
| Is clusterware running running | Success | Clusterware is |
| Validate patching tag 19.15.0.0.0. | Success | Validated patching tag: |
| Is system provisioned provisioned | Success | Verified system is |
| Validate ASM in online online | Success | ASM is |
| Validate kernel log level log | Success | Successfully validated the OS |
| level | | |
| Validate minimum agent version current | Success | GI patching enabled in DCSAGENT |
| version | | |
| Validate Central Inventory passed | Success | oraInventory validation |
| Validate patching locks locks | Success | Validated patching |
| Validate clones location exist location | Success | Validated clones |
| Validate DB start dependencies passed | Success | DBs START dependency check |
| Validate DB stop dependencies passed | Success | DBs STOP dependency check |
| Evaluate GI patching patching | Success | Successfully validated GI |
| Validate command execution execution | Success | Validated command |
| <u>ORACHK</u> | | |
| Running orachk Orachk | Success | Successfully ran |
| Validate command execution execution | Success | Validated command |

```

__SERVER__
Validate local patching      Alert      Rolling patching is not possible:
in
                                     IB enabled
environments
Validate command execution  Success   Validated command execution
  
```

Example 16-47 Pre-checks report for storage

```
# odacli describe-prepatchreport -i 95887f92-7be7-4865-a311-54318ab385f2
```

```
Patch pre-check report
```

```

-----
                Job ID: 95887f92-7be7-4865-a311-54318ab385f2
Description: Patch pre-checks for [STORAGE]
Status: SUCCESS
Created: May 13, 2022 12:52:37 PM HKT
Result: All pre-checks succeeded
  
```

```

Node Name
-----
node1
  
```

| Pre-Check | Status | Comments |
|------------------------------|---------|-------------------------------|
| ----- | | |
| __STORAGE__ | | |
| Validate patching tag | Success | Validated patching tag: |
| 19.15.0.0.0. | | |
| Patch location validation | Success | Verified patch |
| location | | |
| Patch tag validation | Success | Verified patch |
| tag | | |
| Storage patch tag validation | Success | Verified storage patch |
| location | | |
| Verify ASM disks status | Success | ASM disks are |
| online | | |
| Validate rolling patch | Success | Rolling mode patching allowed |
| as | | |
| | | there is no expander and |
| controller | | |
| upgrade. | | |
| Validate command execution | Success | Validated command |
| execution | | |

```

Node Name
-----
node2
  
```

| Pre-Check | Status | Comments |
|-------------|--------|----------|
| ----- | | |
| __STORAGE__ | | |

```

Validate patching tag          Success  Validated patching tag:
19.15.0.0.0.
Patch location validation     Success  Verified patch
location
Patch tag validation          Success  Verified patch
tag
Storage patch tag validation  Success  Verified storage patch
location
Verify ASM disks status      Success  ASM disks are
online
Validate rolling patch        Success  Rolling mode patching allowed
as
                                there is no expander and
controller
upgrade.
Validate command execution    Success  Validated command execution

```

Example 16-48 Pre-checks report for updating database home

```
# odacli describe-prepatchreport -i 6f040374-d271-4711-a7db-e6c04597ad69
```

```
Patch pre-check report
```

```

-----
                Job ID: 6f040374-d271-4711-a7db-e6c04597ad69
        Description: Patch pre-checks for [DB, ORACHKDB]: DbHome is
OraDB19000_home1
                Status: SUCCESS
                Created: May 13, 2022 8:59:48 AM HKT
                Result: All pre-checks succeeded

```

```

Node Name
-----
node1

```

```

Pre-Check          Status  Comments
-----
__DB__
Validate DB Home ID          Success  Validated DB Home
ID:
d03d5187-1c20-470a-9d51-49a0d6f60772
Validate patching tag        Success  Validated patching tag:
19.15.0.0.0.
Is system provisioned        Success  Verified system is
provisioned
Validate minimum agent version Success  Validated minimum agent
version
Is GI upgraded                Success  Validated GI is
upgraded
Validate available space for  Success  Validated free space required
under
db                            /u01/app/
odaorahome

```

```

Validate dbHomesOnACFS          Success  User has configured diskgroup
for
configured                      Database homes on
ACFS
Validate Oracle base           Success  Successfully validated Oracle
Base
Is DB clone available          Success  Successfully validated clone
file
exists
Evaluate DBHome patching with  Success  Successfully validated
updating
RHP                              dbhome with RHP.  and local
patching                          is
possible
Validate command execution      Success  Validated command
execution

__ORACHK__
Running orachk                 Success  Successfully ran
Orachk
Validate command execution      Success  Validated command
execution

Node Name
-----
node2

Pre-Check                      Status  Comments
-----
__DB__
Validate DB Home ID            Success  Validated DB Home
ID:
d03d5187-1c20-470a-9d51-49a0d6f60772
Validate patching tag          Success  Validated patching tag:
19.15.0.0.0.
Is system provisioned          Success  Verified system is
provisioned
Validate minimum agent version Success  Validated minimum agent
version
Is GI upgraded                  Success  Validated GI is
upgraded
Validate available space for    Success  Validated free space required
under
db                              /u01/app/
odaorahome
Validate dbHomesOnACFS          Success  User has configured diskgroup
for
configured                      Database homes on
ACFS
Validate Oracle base           Success  Successfully validated Oracle
Base
Is DB clone available          Success  Successfully validated clone

```

```

file

exists
Evaluate DBHome patching with      Success    Successfully validated
updating
RHP                                 dbhome with
RHP.
Validate command execution          Success    Validated command
execution

__ORACHK__
Running orachk                      Success    Successfully ran
Orachk
Validate command execution          Success    Validated command
execution

```

odacli list-prepatchreports

Use the `odacli list-prepatchreports` command to display all pre-check reports, with a list of pre-checks run with status and comments.

Patching pre-checks help identify and remedy any problems before attempting to patch, and ensure all components are ready for updates.

File Path

```
/opt/oracle/dcs/bin/odacli
```

Syntax

```
odacli list-prepatchreports [-h] [-j]
```

Parameters

| Parameter | Description |
|-------------------------|--|
| <code>--help, -h</code> | (Optional) Displays help for using the command. |
| <code>--json, -j</code> | (Optional) Displays JSON output. The default is false. |

Usage Notes

Use the `odacli list-prepatchreports` command to display all pre-check reports.

Example 16-49 Displaying All Patch Pre-Checks Reports

```

# odacli list-prepatchreports
ID      Description      Created              Status
-----
8a8a14b5-1b5e-4eeb-8ba9-c8136fb4eea1      Patch pre-checks for [DB]: DbHome is
OraDB12102_home1
May 16, 2018 7:00:56 PM PDT                Running
2c9a747d-a452-4e48-bcab-9c7cd9f5f35b      Patch pre-checks for [STORAGE]

```



```

May 16, 2018 6:53:23 PM PDT          Success
f3b9c7c1-3061-4577-848d-645669d71f72  Patch pre-checks for [OS, ILOM, GI]
May 16, 2018 7:00:56 PM PDT          Running

```

odacli delete-prepatchreport

Use the `odacli delete-prepatchreport` command to delete any pre-check report.

File Path

```
/opt/oracle/dcs/bin/odacli
```

Syntax

```
odacli delete-prepatchreport -i Report_ID
```

Parameters

| Parameter | Description |
|-------------------------|---|
| <code>--id, -i</code> | Describes the ID of the report to be deleted. |
| <code>--help, -h</code> | (Optional) Displays help for using the command. |

Usage Notes

Use the `odacli delete-prepatchreport` command to delete pre-check reports.

Example 16-50 Deleting A Patch Pre-Checks Report

```
# odacli delete-prepatchreport -i 741f635b-7c75-4832-8813-782367f1e6fd
```

odacli list-availablepatches

Use the `odacli list-availablepatches` command to display all available patches for Oracle Database Appliance.

File Path

```
/opt/oracle/dcs/bin/odacli
```

Syntax

```
odacli list-availablepatches [-h] [-j]
```

Parameters

| Parameter | Description |
|-------------------------|--|
| <code>--help, -h</code> | (Optional) Displays help for using the command. |
| <code>--json, -j</code> | (Optional) Displays JSON output. The default is false. |

Usage Notes

Use the `odacli list-availablepatches` command to display all available patches for Oracle Database Appliance.

Example 16-51 Displaying All Available Patches on Bare Metal System

```
# odacli list-availablepatches
-----
ODA Release Version  Supported DB Versions  Available DB Versions
Supported Platforms
-----
19.14.0.0.0          21.5.0.0.220118        21.5.0.0.220118      DB
System
Metal, DB System    19.14.0.0.220118        19.14.0.0.220118      Bare
Metal               12.2.0.1.220118        12.2.0.1.220118      Bare
Metal               12.1.0.2.220118        12.1.0.2.220118      Bare
Metal
19.11.0.0.0          19.11.0.0.210420       19.11.0.0.210420     Bare
Metal, DB System    18.14.0.0.210420       18.14.0.0.210420     Bare
Metal               12.2.0.1.210420       12.2.0.1.210420     Bare
Metal               12.1.0.2.210420       12.1.0.2.210420     Bare
Metal
```

Example 16-52 Displaying All Available Patches on DB System

```
# odacli list-availablepatches
-----
ODA Release Version  Supported DB Versions  Available DB Versions
Supported Platforms
-----
19.14.0.0.0          21.5.0.0.220118        21.5.0.0.220118      DB
System
Metal, DB System    19.14.0.0.220118        19.14.0.0.220118      Bare
Metal               12.2.0.1.220118        12.2.0.1.220118      Bare
Metal               12.1.0.2.220118        12.1.0.2.220118      Bare
Metal
19.11.0.0.0          19.11.0.0.210420       19.11.0.0.210420     Bare
Metal, DB System    18.14.0.0.210420       18.14.0.0.210420     Bare
Metal               12.2.0.1.210420       12.2.0.1.210420     Bare
```

| | | | |
|-------|-----------------|-----------------|------|
| Metal | 12.1.0.2.210420 | 12.1.0.2.210420 | Bare |
| Metal | | | |

odacli describe-component

Use the `odacli describe-component` command to display the installed version and the latest available version for each component.

If there are multiple DB homes installed on Oracle Database Appliance, then the output displays the version details for each of the installed homes and the databases in each database home. You can use this command to check the component version after applying a patch.

File Path

`/opt/oracle/dcs/bin/odacli`

Syntax

```
odacli describe-component [-d] [-j] [-h] [-s] [-v] [-l] [-nn node_name]
```

Parameters

| Parameter | Description |
|----------------------------------|---|
| <code>--dbhomes, -d</code> | (Optional) Lists the database home versions and available versions. |
| <code>--help, -h</code> | (Optional) Displays help for using the command. |
| <code>--json, -j</code> | (Optional) Displays JSON output. The default is false. |
| <code>--local, -l</code> | (Optional) Describes the components for the local node. Use to display details on the local node of multi-node high availability (HA) systems. This option is not needed to display component details on single-node systems. |
| <code>--node-name, -nn</code> | (Optional) Describes the components for a specific node name on high availability (HA) systems. This option is not needed to display component details on single node systems. |
| <code>--server, -s</code> | (Optional) Lists the server components and versions and the available versions to which you can patch them. |
| <code>--systemversion, -v</code> | (Optional) Displays only the system version. This option is available only on high-availability systems. |

Usage Notes

Use the `odacli describe-component` command to get component details. On a multi-node environment, the command provides details across all nodes. Use the `--node` or `--local` option to get component details for a specific node.

The `odacli describe-component` command displays the local and shared storage components and the updates required for them separately.

Example 16-53 Displaying patch details for components for High-Availability Oracle Database Appliance Systems for a release

```
# odacli describe-component
System Version
-----
23.5.0.0.0

System Node Name
-----
oak0

Local System Version
-----
23.5.0.0.0

Component Installed Version Available Version
-----
-----
OAK 23.5.0.0.0 up-to-date

DCSCONTROLLER 23.5.0.0.0 up-to-date

DCSCLI 23.5.0.0.0 up-to-date

DCSAGENT 23.5.0.0.0 up-to-date

DCSADMIN 23.5.0.0.0 up-to-date

OS 8.10 up-to-date

ILOM 5.1.4.20.r157857 up-to-date

BIOS 84060600 up-to-date

LOCAL CONTROLLER FIRMWARE {
    [c0, c1] E2MU200 up-to-date

    [c4, c5, c6] 26.33.1048 26.37.1014
}

SHARED CONTROLLER FIRMWARE {
    [c2, c3] 23.00.01.00 up-to-date
}

FIRMWAREEXPANDER {
    [c2x0, c3x0] 0310 up-to-date
}

SHARED DISK FIRMWARE {
    [c2d0, c2d1, c2d2, RXA0 up-to-date
    c2d3, c2d4, c2d5,
    c3d0, c3d1, c3d2,
    c3d3, c3d4, c3d5]

    [c2d6, c2d7, c2d8, A7B0 up-to-date
    c2d9, c2d10,
```

```

    c2d11, c2d12,
    c2d13, c2d14,
    c2d15, c2d16,
    c2d17, c2d18,
    c2d19, c2d20,
    c2d21, c2d22,
    c2d23, c3d6, c3d7,
    c3d8, c3d9, c3d10,
    c3d11, c3d12,
    c3d13, c3d14,
    c3d15, c3d16,
    c3d17, c3d18,
    c3d19, c3d20,
    c3d21, c3d22, c3d23]
}

HMP 2.4.9.2.600 up-to-date

System Node Name
-----
oak1

Local System Version
-----
23.5.0.0.0
Component Installed Version Available Version
-----
OAK 23.5.0.0.0 up-to-date

DCSCONTROLLER 23.5.0.0.0 up-to-date

DCSCLI 23.5.0.0.0 up-to-date

DCSAGENT 23.5.0.0.0 up-to-date

DCSADMIN 23.5.0.0.0 up-to-date

OS 8.10 up-to-date

ILOM 5.1.4.20.r157857 up-to-date

BIOS 84060600 up-to-date

LOCAL CONTROLLER FIRMWARE {
    [c0, c1] E2MU200 up-to-date

    [c4, c5, c6] 26.33.1048 26.37.1014
}

SHARED CONTROLLER FIRMWARE {
    [c2, c3] 23.00.01.00 up-to-date
}

FIRMWAREEXPANDER {
    [c2x0, c3x0] 0310 up-to-date

```

```
}  
SHARED DISK FIRMWARE {  
    [c2d0, c2d1, c2d2, RXA0 up-to-date  
    c2d3, c2d4, c2d5,  
    c3d0, c3d1, c3d2,  
    c3d3, c3d4, c3d5]  
  
    [c2d6, c2d7, c2d8, A7B0 up-to-date  
    c2d9, c2d10,  
    c2d11, c2d12,  
    c2d13, c2d14,  
    c2d15, c2d16,  
    c2d17, c2d18,  
    c2d19, c2d20,  
    c2d21, c2d22,  
    c2d23, c3d6, c3d7,  
    c3d8, c3d9, c3d10,  
    c3d11, c3d12,  
    c3d13, c3d14,  
    c3d15, c3d16,  
    c3d17, c3d18,  
    c3d19, c3d20,  
    c3d21, c3d22, c3d23]  
}  
  
HMP 2.4.9.2.600 up-to-date
```

Example 16-54 List DB Home Details

```
# odacli describe-component -d
```

```
System Version
```

```
-----
```

```
23.5.0.0.0
```

```
System Node Name
```

```
-----
```

```
oak0
```

```
Local System Version
```

```
-----
```

```
23.5.0.0.0
```

```
System Node Name
```

```
-----
```

```
oak1
```

```
Local System Version
```

```
-----
```

```
23.5.0.0.0
```

Example 16-55 List the Server Components and Versions

```
# odacli describe-component -s  
[root@oak0 ~]# odacli describe-component -s
```

```

System Version
-----
23.5.0.0.0

System Node Name
-----
oak0

Local System Version
-----
23.5.0.0.0

Component Installed Version Available Version
-----
-----
OAK 23.5.0.0.0 up-to-date

DCSCONTROLLER 23.5.0.0.0 up-to-date

OS 8.10 up-to-date

DCSCLI 23.5.0.0.0 up-to-date

DCSADMIN 23.5.0.0.0 up-to-date

ILOM 5.1.4.20.r157857 up-to-date

BIOS 84060600 up-to-date
LOCAL CONTROLLER FIRMWARE {
    [c0, c1] E2MU200 up-to-date

    [c4, c5, c6] 26.33.1048 26.37.1014
}

SHARED CONTROLLER FIRMWARE {
    [c2, c3] 23.00.01.00 up-to-date
}

FIRMWAREEXPANDER {
    [c2x0, c3x0] 0310 up-to-date
}

SHARED DISK FIRMWARE {
    [c2d0, c2d1, c2d2, RXA0 up-to-date
    c2d3, c2d4, c2d5,
    c3d0, c3d1, c3d2,
    c3d3, c3d4, c3d5]

    [c2d6, c2d7, c2d8, A7B0 up-to-date
    c2d9, c2d10,
    c2d11, c2d12,
    c2d13, c2d14,
    c2d15, c2d16,
    c2d17, c2d18,
    c2d19, c2d20,
    c2d21, c2d22,

```

```

    c2d23, c3d6, c3d7,
    c3d8, c3d9, c3d10,
    c3d11, c3d12,
    c3d13, c3d14,
    c3d15, c3d16,
    c3d17, c3d18,
    c3d19, c3d20,
    c3d21, c3d22, c3d23]
}
System Node Name
-----
oak1

Local System Version
-----
23.5.0.0.0

Component Installed Version Available Version
-----
OAK 23.5.0.0.0 up-to-date

DCSCONTROLLER 23.5.0.0.0 up-to-date

OS 8.10 up-to-date

DCSCLI 23.5.0.0.0 up-to-date

DCSADMIN 23.5.0.0.0 up-to-date

ILOM 5.1.4.20.r157857 up-to-date

BIOS 84060600 up-to-date

LOCAL CONTROLLER FIRMWARE {
    [c0, c1] E2MU200 up-to-date

    [c4, c5, c6] 26.33.1048 26.37.1014
}

SHARED CONTROLLER FIRMWARE {
    [c2, c3] 23.00.01.00 up-to-date
}

FIRMWAREEXPANDER {
    [c2x0, c3x0] 0310 up-to-date
}

SHARED DISK FIRMWARE {
    [c2d0, c2d1, c2d2, RXA0 up-to-date
    c2d3, c2d4, c2d5,
    c3d0, c3d1, c3d2,
    c3d3, c3d4, c3d5]

    [c2d6, c2d7, c2d8, A7B0 up-to-date
    c2d9, c2d10,
    c2d11, c2d12,
```



```

        c2d13, c2d14,
        c2d15, c2d16,
        c2d17, c2d18,
        c2d19, c2d20,
        c2d21, c2d22,
        c2d23, c3d6, c3d7,
        c3d8, c3d9, c3d10,
        c3d11, c3d12,
        c3d13, c3d14,
        c3d15, c3d16,
        c3d17, c3d18,
        c3d19, c3d20,
        c3d21, c3d22, c3d23]
    }

```

odacli describe-latestpatch

Use the `odacli describe-latestpatch` command to display a list of the latest supported patch versions for each component.

File Path

`$ORACLE_HOME/opt/oracle/dcs/bin/odacli`

Syntax

```
odacli describe-latestpatch [-h]
```

Parameters

| Parameter | Description |
|-------------------------|--|
| <code>--help, -h</code> | (Optional) Displays help for using the command. |
| <code>--json, -j</code> | (Optional) Displays JSON output. The default is false. |

Example 16-56 Listing the Latest Supported Versions

```

# odacli describe-latestpatch

ComponentType  availableVersion
-----
gi              18.7.0.0.190716
db              18.7.0.0.190716
db              12.2.0.1.190716
db              12.1.0.2.190716
oak             18.7.0.0.0
asr             18.3.1
ilom            3.0.16.22.f.r100119
ilom            4.0.2.31.r126282
ilom            4.0.4.41.r130359
ilom            4.0.4.37.r130617
ilom            4.0.0.24.r121140
ilom            4.0.4.40.r130348
ilom            4.0.4.38.r130206

```

```
os                6.10
bios              17140300
bios              30150300
bios              25080100
bios              41060300
bios              38130200
bios              39090000
bios              52010400
firmwareexpander 0342
firmwareexpander 001e
firmwareexpander 0306
firmwaredisk     a901
firmwaredisk     0r3q
firmwaredisk     a29a
firmwarecontroller 11.05.03.00
firmwarecontroller qdv1rf30
firmwarecontroller vdv1ry03
firmwarecontroller 20.08.01.14
firmwarecontroller 2.11.1280
firmwarecontroller 13.00.00.00
firmwarecontroller 4.650.00-7176
firmwarecontroller kpyair3q
dcsagent         18.7.0.0.0
firmwaredisk     a7e0
firmwaredisk     a4c0
firmwaredisk     a72a
firmwaredisk     a880
firmwaredisk     a122
firmwaredisk     a38k
firmwaredisk     c122
firmwaredisk     944a
firmwaredisk     9440
firmwaredisk     e12b
firmwaredisk     5g08
firmwaredisk     a902
firmwaredisk     a140
firmwaredisk     sa03
firmwaredisk     0b25
firmwaredisk     sf04
firmwaredisk     c38k
firmwaredisk     a3a0
firmwaredisk     pd51
firmwaredisk     m554
firmwaredisk     0121
firmwaredisk     xc311102
```

odacli list-agentconfig-parameters

Use the `odacli list-agentconfig-parameters` command to list configuration variables used by the appliance.

File Path

```
/opt/oracle/dcs/bin/odacli
```

Syntax

```
odacli list-agentconfig-parameters [-h] [-j] [-n] [-t]
```

Parameters

| Parameter | Description |
|------------|---|
| --help, -h | (Optional) Displays help for using the command. |
| --json, -j | (Optional) Displays JSON output. The default is false. |
| --name, -n | Specifies the name of the parameter. |
| --type, -t | (Optional) Specifies the configuration value for the given type. The default value is PUBLIC. |

Usage Notes

Use the `odacli list-agentconfig-parameters` command to list configuration variables used by the appliance.

Example 16-57 Displaying the HttpProxyPort

```
./odacli list-agentconfig-parameters -n HttpProxyPort
```

```
Name      Value      Description      Updated
-----
HttpProxyPort  Http proxy server port  December 8, 2024 4:14:10 AM UTC
```

Example 16-58 Displaying the agent configuration

```
# odacli list-agentconfig-parameters
```

```
Name      Value      Description      Updated
-----
HttpProxyHost  Http proxy server host  December 8, 2024 4:14:10 AM UTC
HttpProxyPort  Http proxy server port  December 8, 2024 4:14:10 AM
UTC
HttpsProxyHost  Https proxy server host  December 8, 2024 4:14:10 AM
UTC
HttpsProxyPort  Https proxy server port  December 8, 2024 4:14:10 AM
UTC
```

Example 16-59 Displaying Oracle ASM configuration

```
# odacli list-agentconfig-parameters -t ASM
Name      Value      Description      Updated
-----
-----
```

```
-----  
-----  
asm_power_limit          4  June 22, 2021 12:13:10 AM UTC
```

Related Topics

- [Configuring Agent Proxy Settings for Object Store Access](#)
If the Object Store IP address is accessible only through proxy setup by the Oracle Database Appliance server, then define the proxy setting for the agent, so that the agent can access the Object Store.

odacli modify-agentconfig-parameters

Use the `odacli modify-agentconfig-parameters` command to modify configuration variables used by the appliance.

File Path

```
/opt/oracle/dcs/bin/odacli
```

Syntax

```
odacli modify-agentconfig-parameters -n name_param [-adbs] [-a] [-bm] [-c  
comment_param] [-dbs dbsys_param] [-d description_param] [-r] [-t type_param]  
[-u] [-v value_param] [-j] [-h]
```

Parameters

| Parameter | Description |
|-------------------------------------|--|
| <code>--append, -a</code> | (Optional) Appends the parameter values. For example, <code>-n p1 -v v1 -n p2 -v v2 -a</code> . |
| <code>--all-dbsystems, -adbs</code> | (Optional) Dynamic parameter update for all DB systems. |
| <code>--bm-only, -bm</code> | (Optional) Dynamic parameter update for bare metal systems only. |
| <code>--comment, -c</code> | (Optional) Specifies the comment for the parameter. |
| <code>--dbsystem, -dbs</code> | (Optional) DB system name for dynamic parameter update. |
| <code>--description, -d</code> | (Optional) Specifies the description of the parameter. |
| <code>--name, -n</code> | Specifies the name of the parameter. Provide multiple parameter values in the format <code>-n p1 -v v1 -n p2 -v v2</code> . |
| <code>--reset, -r</code> | Resets the parameter to the default value. For example: <code>-n p1 -n p2 -r</code> . |
| <code>--update, -u</code> | Replaces the parameter with the specified value. For example: <code>-n p1 -v v1 -n p2 -v v2 -u</code> . |
| <code>--value, -v</code> | Specifies the value of the parameter. Provide multiple parameter values in the format <code>-n p1 -v v1 -n p2 -v v2</code> . |

| Parameter | Description |
|------------|--|
| --type, -t | (Optional) Specifies the type of the parameter. |
| --json, -j | (Optional) Displays JSON output. The default is false. |
| --help, -h | (Optional) Displays help for using the command. |

Usage Notes

Use the `odacli modify-agentconfig-parameters` command to modify configuration variables used by the appliance. The supported configuration parameters are `HttpsProxyHost` and `HttpsProxyPort`.

Multiple values can be specified. For High-Availability models, the command sets the parameter values on both nodes in the cluster.

For a DB system, dynamic parameter value specified using the `-dbs` flag has more priority than the parameter value specified using the `-adbs` flag, which in turn has a higher priority than the case where the parameter was updated without using any flag from the bare metal system.

Example 16-60 Setting Multiple Parameters

```
# odacli modify-agentconfig-parameters -n HttpsProxyPort -v 80 -d "Http proxy
port"
-n HttpsProxyPort -v 80 -d "Https proxy port" -u

modify-agentconfig-parameters -n HttpsProxyPort -n HttpProxyPort -r

modify-agentconfig-parameters -n HttpsProxyHost -v 90 -a

modify-agentconfig-parameters -n OSPatchRepos -v
```

Example 16-61 Setting Oracle RDBMS Parameters

```
# odacli modify-agentconfig-parameters -t RDBMS -n processes -v 300 -u
The value of processes will be set to 300 in BM and all the DBVMs.
```

```
# odacli list-agentconfig-parameters -t RDBMS -n processes
```

```
Name           Value      Description
Updated
-----
-
processes      300              December 8, 2024 5:24:45 PM UTC
```

Example 16-62 Updating the RDBMS Parameter for all DB systems in the Bare Metal System

```
# odacli modify-agentconfig-parameters -t RDBMS -n processes -v 400 -u -adbs
```

In the bare metal system, the value of the `processes` parameter is not changed:

```
# odacli list-agentconfig-parameters -t RDBMS -n processes
```

| Name | Value | Description |
|-----------|-------|----------------------------------|
| Updated | | |
| processes | 300 | December 8, 2024 12:08:15 AM UTC |

In all DB systems, the value of `processes` is changed:

```
# odacli list-agentconfig-parameters -t RDBMS -n processes
```

| Name | Value | Description |
|-----------|-------|----------------------------------|
| Updated | | |
| processes | 400 | December 8, 2024 12:08:15 AM UTC |

You can set the value for a specific DB system:

```
# odacli modify-agentconfig-parameters -t RDBMS -n processes -v 700 -u -dbs DBSYSTEM1
```

Value is changed on `DBSYSTEM1`:

```
# odacli list-agentconfig-parameters -t RDBMS -n processes
```

| Name | Value | Description |
|-----------|-------|----------------------------------|
| Updated | | |
| processes | 700 | December 8, 2024 12:08:15 AM UTC |

odacli delete-agentconfig-parameters

Use the `odacli delete-agentconfig-parameters` command to delete configuration variables used by the appliance.

File Path

```
/opt/oracle/dcs/bin/odacli
```

Syntax

```
odacli delete-agentconfig-parameters -n name_param [-adbs] [-bm] [-dbs db_param] [-t type_param] [-j] [-h]
```

Parameters

| Parameter | Description |
|-------------------------------------|--|
| <code>--help, -h</code> | (Optional) Displays help for using the command. |
| <code>--json, -j</code> | (Optional) Displays JSON output. The default is false. |
| <code>--name, -n</code> | (Mandatory) Specifies the name of the parameter. |
| <code>--type, -t</code> | (Optional) Deletes the configuration value for the given type. |
| <code>--all-dbsystems, -adbs</code> | (Optional) Deletes the dynamic parameter updated for DB systems, using the <code>-ad</code> option in the <code>odacli modify-agentconfig-parameters</code> command. |
| <code>--bm-only, -bm</code> | (Optional) Deletes the dynamic parameter only from the bare metal systems. |
| <code>--dbssystem, -dbs</code> | (Optional) Deletes the dynamic parameter for a specific DB system. |

Usage Notes

Use the `odacli delete-agentconfig-parameters` command to delete configuration values. For High-Availability models, the command deletes the parameter values on both nodes in the cluster.

Example 16-63 Deleting configuration parameters

```
# odacli delete-agentconfig-parameters -n HttpProxyHost
```

Job details

```
-----
ID: c6e123c6-1b76-48f8-973d-63c8dab65545
Description: delete configuration parameter HttpProxyHost
Status: Running
Created: December 8, 2024 9:45:39 AM PDT
Message:
```

```
Task Name          Start Time
End Time          Status
-----
```

Example 16-64 Deleting processes configuration parameter

```
# odacli delete-agentconfig-parameters -t rdbms -n processes
odacli list-agentconfig-parameters -t RDBMS -n processes
No result found
```

Note: Parameters updated using `-adbs`, `-dbs` flags should be deleted using the same corresponding flags.

```
# odacli delete-agentconfig-parameters -t rdbms -n processes -dbs DBSYSTEM1
```

```
# odacli delete-agentconfig-parameters -t rdbms -n processes -adbs
```

odacli update-database

Use the `odacli update-database` command to update a database to a specific database home with later version, and within the same major release.

File Path

```
/opt/oracle/dcs/bin/odacli
```

Syntax

```
odacli update-database [-a] [-dp] [-f] [-i db_id] [-imp] [-l] [-n db_name] [-nn node_name] [-r] [-to db_home_id] [-j] [-h]
```

Parameters

| Parameter | Description |
|---|--|
| <code>--to-home, -to</code> | (Optional) Specifies the destination Oracle Database Home ID. The <code>-to</code> option is not a mandatory option if you want to apply datapatch using the <code>odacli update-database</code> command. The <code>-to</code> option is only required when you want to use the <code>odacli update-database</code> command to patch a specific database to a specific database home. |
| <code>--abort, -a</code> | (Optional) Aborts the unfinished or failed patching operation. |
| <code>--name, -n</code> | (Optional) Specifies the database name the patch. |
| <code>--ignore-missing-patch, -imp</code> | (Optional) Ignores all missing patches and forces the operation. |
| <code>--force, -f</code> | (Optional) Ignores precheck error and forces the operation. |
| <code>--local, -l</code> | (Optional) Updates the database locally. |
| <code>--node-name, -nn</code> | (Optional) Specifies the node name to be updated. |
| <code>--id, -i</code> | (Optional) Specifies the database ID to be patched. |
| <code>--datapatch, -dp</code> | (Optional) Applies only the datapatch. |
| <code>--revert, -r</code> | (Optional) Reverts the unfinished or failed patching operation. |
| <code>--help, -h</code> | (Optional) Displays help for using the command. |
| <code>--json, -j</code> | (Optional) Displays JSON output. The default is false. |

Usage Notes

- You must run the patching pre-checks at least once before running the `odacli update-database` command. Analyze any failed pre-checks, fix them, and rerun pre-checks. If any

of the failed pre-checks can be ignored, only then run the `odacli update-database` command with the `-f` option.

- The `update-database` command patches a database to a specific database home with later version, and within the same major release.
- To patch a database to a specific database home, the database must be running.
- To patch a database, it must have the status `Configured`. Use the `odacli list-database` command to see a list of configured databases. Patch requests for target databases in any other status are rejected during patching.
- You can patch only the database homes in the `Configured` status. Use the `odacli list-dbhomes` command to see a list of configured database homes. Patch requests for target database homes in any other status are rejected during patching.
- The `--datapatch` option applies the `datapatch` to the specific database. This option is helpful for databases that have moved to a destination database home without the `datapatch`. Examples of using the `--datapatch` option are as follows:
 - When you patch the database as a standby database and then switch the database as the primary database.
 - When you must apply additional or one-off data patches after patching your Oracle Database Appliance deployment.

Example 16-65 Updating an Oracle Database

To patch a specific database to a specific database home:

```
# odacli update-database -i e5b60db5-2ee9-4cfc-93ee-179302ee6ebc -to
dc98eaa9-289c-4710-a898-ca6287a07a9c
```

When the database home version is earlier than the target database version, an error is encountered:

```
# odacli update-database -i c05458c7-0f1d-4260-8e62-003b3ec26d74 -to
7ef2449d-3583-47fd-a57a-6ba3fd224119
DCS-10045:Validation error encountered: Target database's version is higher
than destination dbhome, no need to patch.
```

odacli update-dbhome

Use the `odacli update-dbhome` command to update a specific database home to the latest patch bundle version.

File Path

```
/opt/oracle/dcs/bin/odacli
```

Syntax

```
odacli update-dbhome -i dbhome_id -v version [-f] [-imp] [-p] [-l] [-nn
node_name] [-j] [-h]
```

Parameters

| Parameter | Description |
|---|--|
| <code>--id, -i</code> | Defines the Oracle Database Home to update. |
| <code>--help-h</code> | (Optional) Displays help for using the command. |
| <code>--json, -j</code> | (Optional) Displays JSON output. |
| <code>--precheck, -p</code> | (Optional) Analyzes the patch. |
| <code>--force, -f</code> | (Optional) Ignores precheck error and forces the operation. |
| <code>--local, -l</code> | (Optional) Updates the Database Home locally. |
| <code>--node-name, -n</code> | (Optional) Specifies the node name to be updated. |
| <code>--version, -v</code> | Defines the Oracle Database Appliance version to update. For example, 19.23.0.0.0. |
| <code>--ignore-missing-patch, -imp</code> | (Optional) Ignores missing patch error and forces the operation. |

Usage Notes

- You must run the patching pre-checks at least once before running the `odacli update-dbhome` command. Analyze any failed pre-checks, fix them, and rerun pre-checks. If any of the pre-checks fail, then run the `odacli update-dbhome` command with the `-f` option.
- The `update-dbhome` command applies the latest release update (RU) for Oracle Database home.
- To be updated with the latest patches, the database must be running.
- Only databases in the `Configured` status are updated. Use the `odacli list-database` command to see a list of configured databases. Databases in any other status are skipped during the update.
- When you use the `--local` option, you can patch in the following way. Note that you can patch the nodes in any order, for example, you can patch the instance on `node1` first, and then the instance on `node0`.
 - Run `--local/--node 0` on `node0`, then `--node 1` on `node0`.
 - Or, run `--local/--node 0` on `node0`, then `-local/--node 1` on `node1`.
 - Or, run `--local/--node` on either of the nodes, and then update the database home without using the `--local/--node` on either of the nodes.

Example 16-66 Updating an Oracle Database Home

To apply the latest patch bundle to update an Oracle Database:

```
# odacli update-dbhome -i ad6c7326-e460-411e-94df-230dedbef743 -v 19.26.0.0.0
```

odacli update-dcsadmin

Use the `odacli update-dcsadmin` command to update the DCS admin for DCS components upgrade.

File Path

```
/opt/oracle/dcs/bin/odacli
```

Syntax

```
odacli update-dcsadmin -v version [-j] [-h]
```

Parameters

| Parameter | Description |
|----------------------------|---|
| <code>--version, -v</code> | Defines the Oracle Database Appliance version after update. |
| <code>--help, -h</code> | (Optional) Displays help for using the command. |
| <code>--json, -j</code> | (Optional) Displays JSON output. |

Usage Notes

The `update-dcsadmin` command sets up the `dcsadmin` and other components. Run the `update-dcsadmin` command only after you update the DCS agent.

Example 16-67 Updating DCS Admin

```
# odacli update-dcsadmin -v 19.26.0.0.0
{
  "jobId" : "4c238b93-e641-4f9d-9f86-93d0574dd234",
  "status" : "Created",
  "message" : null,
  "reports" : [ ],
  "createTimestamp" : "December 8, 2024 03:11:53 AM UTC",
  "resourceList" : [ ],
  "description" : "DcsAdmin patching",
  "updatedAt" : "December 8, 2024 03:11:53 AM UTC"
}
```

odacli update-dcsagent

Use the `odacli update-dcsagent` command to update the agent.

File Path

```
/opt/oracle/dcs/bin/odacli
```

Syntax

```
odacli update-dcsagent -v version [-j] [-h]
```

Parameters

| Parameter | Description |
|----------------------------|---|
| <code>--version, -v</code> | Defines the Oracle Database Appliance version after update. |
| <code>--help, -h</code> | (Optional) Displays help for using the command. |
| <code>--json, -j</code> | (Optional) Displays JSON output. |

Usage Notes

The `update dcsagent` command updates the `dcs-agent` to the RPM package that is located in the *location* and restarts the `dcs-agent`. After the update is applied, the agent automatically restarts. It will take a few minutes to reconnect to the `dcs-agent`. Wait until the agent shuts down and completes restarting before performing any tasks.



Note:

Before updating the agent, ensure that you do not have any jobs running or pending during the update window.

Example 16-68 Updating the Agent

To update the `dcs-agent` to version 19.26:

```
# odacli update-dcsagent -v 19.26
{
  "jobId" : "77e454d3-eb68-4130-a247-7633f8d6192b",
  "status" : "Created",
  "message" : null,
  "reports" : [ ],
  "createTimestamp" : "December 8, 2024 14:09:24 PM CST",
  "description" : "DcsAgent patching",
  "updatedAtTime" : "December 8, 2024 14:09:24 PM CST"
}
```

odacli update-dcscomponents

Use the `odacli update-dcscomponents` command to update the DCS components such as the DCS agent, CLI, and controller.

File Path

```
/opt/oracle/dcs/bin/odacli
```

Syntax

```
odacli update-dcscomponents -v version [-j] [-h]
```

Parameters

| Parameter | Description |
|----------------------------|---|
| <code>--version, -v</code> | Defines the Oracle Database Appliance version after update. |
| <code>--help, -h</code> | (Optional) Displays help for using the command. |
| <code>--json, -j</code> | (Optional) Displays JSON output. |

Usage Notes

The `update-dcscomponents` command sets up the `dcscomponents` such as the DCS agent, CLI, and controller.

Example 16-69 Updating DCS Components

```
# odacli update-dcscomponents -v 19.26.0.0.0
{
  "jobId" : "4c238b93-e641-4f9d-9f86-93d0574dd234",
  "status" : "Created",
  "message" : null,
  "reports" : [ ],
  "createTimestamp" : "December 8, 2024 03:11:53 AM UTC",
  "resourceList" : [ ],
  "description" : "DcsComponents patching",
  "updatedAt" : "December 8, 2024 03:11:53 AM UTC"
}
```

odacli update-registry

Use the `odacli update-registry` command to update the metadata for the components that are already present in the registry. For database home and grid home, this command updates the patch information, when you apply patches manually.

File Path

```
/opt/oracle/dcs/bin/odacli
```

Syntax

```
odacli update-registry -n component [-u db_unique_name] [-f] [-j] [-h]
```

Parameters

| Parameter | Description |
|-----------------------------------|--|
| <code>--component, -n</code> | Defines the Oracle Database Appliance component for the registry update. When you specify <code>system</code> , then the components discovered include <code>gihome</code> , <code>dbnode</code> , <code>sysinstance</code> . When you specify <code>all</code> , then the components discovered include <code>dbhome</code> , <code>db</code> , <code>dbstorage</code> , <code>asr</code> . You can also specify the individual component to be refreshed. The individual options include <code>gihome</code> , <code>dbnode</code> , <code>sysinstance</code> , <code>dbhome</code> , <code>DB</code> , <code>dbstorage</code> , <code>ASR</code> . |
| <code>--db-unique-name, -u</code> | (Optional) Specifies the global unique name for the database. This option is only applicable for components <code>DB</code> or <code>dbstorage</code> . |
| <code>--force, -f</code> | This option is deprecated. |
| <code>--help, -h</code> | (Optional) Displays help for using the command. |
| <code>--json, -j</code> | (Optional) Displays JSON output. |

Usage Notes

- Starting with Oracle Database Appliance release 19.18, the `odacli update-registry` command does not require the `-force` option for metadata refresh of a component that already exists in the registry metadata. If the metadata for the component to be updated already exists in the appliance registry metadata, then the command rediscovers the attributes from the environment and updates the system registry.
- The following attribute cannot be discovered with the `odacli update-registry` command:
 - DB component:** `rmanBkupPassword`, `enableEEHA`, `isBcfgInSync`, `dbConsoleEnable`, `cpupool`, `dbClass`, `backupConfigId`, `cloudStorageContainer`, `isAutoBackupDisabled`, `registerOnly`, `entitySource`, `instanceOnly`, `dbShape`, `enableSEHA`.
- Use the `--db-unique-name, -u` option to update the appliance registry metadata for a specific database or `dbstorage`. The `odacli update-registry` command then modifies only the registry metadata for the database or `dbstorage` associated with the database unique name. For example:

```
odacli update-registry -n db -u db_unique_name
odacli update-registry -n dbstorage -u db_unique_name
```

- The `odacli update-registry` command discovers and updates the metadata in the registry only for databases created using ODACLI commands or the Browser User Interface (BUI). An error is displayed when you run the `odacli update-registry` command to update the metadata for databases that were not created using ODACLI commands or BUI. Hence, for database migration cases, do not use the `odacli update-registry` command. Instead, use the `odacli register-database` command. For example:

```
# odacli update-registry -n db -u provdb
DCS-10131: Database 'provdb' cannot discover because metadata does not exist

# dcserr 10131
```

```
10131, Discover_New_Database_Not_Supported, "Database '{0}' cannot
discover because metadata does not exist."
// *Cause: The database did not support discovery of new entities.
// *Action: Use the 'odacli register-database' command.
```

- Similarly, if you run the `odacli update-registry -n dbstorage` command to update the metadata for databases or dbstorage that were not created using ODA CLI commands or BUI, then an error is displayed. While migrating a database, if the database runs on the appliance and dbstorage also exists, but the corresponding appliance registry metadata does not exist, then you cannot run the `odacli update-registry -n dbstorage` command to discover the registry metadata. Instead, use the `odacli create-dbstorage` command.

```
# odacli update-registry -n dbstorage -u newstorage
DCS-10132: Dbstorage 'newstorage' cannot discover because metadata does
not exist
```

```
# dcserr 10132
10132, Discover_New_Dbstorage_Not_Supported, "Dbstorage '{0}' cannot
discover because metadata does not exist."
// *Cause: The database storage did not support discovery of new entities.
// *Action: Use the 'odacli create-dbstorage' command.
```

- The `odacli update-registry` command rediscovers only the following DCS components:
 - System resources : Oracle Grid Infrastructure (`gihome`), Oracle Database node (`dbnode`), System instance (`sysinstance`)
 - Database Home (`dbhome`)
 - Database (`db`)
 - Database storage (`dbstorage`)
 - Oracle ASR (`asr`)

The `odacli update-registry` command does not rediscover any other components not mentioned in the above list.

- If a TDE database is created without using Oracle Database Appliance tooling and the registry is updated for database components, then this database is added to the DCS metadata. If the TDE Wallet Management of the database is ODA, then the TDE password of the database must be updated in the DCS metadata by modifying the database with the same option you use to change the TDE password. You can specify the same password for both the current and new TDE password to ensure that the TDE password is updated in the DCS metadata.
- A report is generated after the `odacli update-registry` command completes running. This report displays the values present before the command was run and the updated values. The report is saved in the location `/opt/oracle/dcs/logs/discoveryReport.txt`. If the command is run again, then the new report is appended to the same file along with the timestamp of the latest run of the command.

Example 16-70 Update Registry Report

```
# odacli update-registry -n system
-----Begin Discovery at 2023-01-24_12-06-28.0666-----
*****
Database Storage Discovery
```

```

*****
*****
DbStorage Details : Vredf
*****
=====
=====
=====
Value      Parameter Name      Old
Value
Value
=====
=====
Database Unique Name
Vredf
Vredf
Name
Vredf
Vredf
State
CONFIGURED
CONFIGURED
Entity Source
null
null
Volume Name1
datvredf
datvredf
Volume Type1
Data
Data
Volume Disk Group1
data
data
Volume File System1      /u02/app/oracle/oradata/
Vredf                    /u02/app/oracle/oradata/
Vredf
Volume Initial Size1
102400
102400
Volume Name2
oraohome_sh
oraohome_sh
Volume Type2
Redo
Redo
Volume Disk Group2
data
data
Volume File System2      /u01/app/
odaorahome              /u01/app/
odaorahome
Volume Initial Size2
204800
204800
Volume Name3

```



```

reco
reco
      Volume Type3
Reco
Reco
      Volume Disk Group3
reco
reco
      Volume File System3           /u03/app/
oracle/                               /u03/app/
oracle/
      Volume Initial Size3
3050496
3050496

```

```

=====
=====

```

```

*****
DbStorage Location : Vredf
*****

```

```

=====
=====

```

| Value | Parameter Name | Old | New |
|-------|----------------|-----|-----|
| Value | | | |

```

=====
=====

```

| | | | |
|-------|------------------|--------------------------|--------------------------|
| Vredf | DATA Destination | /u02/app/oracle/oradata/ | /u02/app/oracle/oradata/ |
|-------|------------------|--------------------------|--------------------------|

| | | | |
|-------|----------------------|--|--|
| Vredf | Database Unique Name | | |
|-------|----------------------|--|--|

| | | | |
|--------------|-------------|--------------------------|--------------------------|
| Vredf | Database Id | 6909f458-9bc4-5d7d-7606- | 6909f458-9bc4-5d7d-7606- |
| c765cd20b823 | | | |
| c765cd20b823 | | | |

| | | | |
|------|-----------------------|--|--|
| Acfs | Database Storage Type | | |
|------|-----------------------|--|--|

| | | | |
|------|-------------------------|--|--|
| null | Flash Cache Destination | | |
|------|-------------------------|--|--|

| | | | |
|---------------------|------------------|------------------|------------------|
| fast_recovery_area/ | Reco Destination | /u03/app/oracle/ | /u03/app/oracle/ |
|---------------------|------------------|------------------|------------------|

| | | | |
|-------|------------------|------------------|------------------|
| redo/ | Redo Destination | /u04/app/oracle/ | /u04/app/oracle/ |
|-------|------------------|------------------|------------------|

| | | | |
|-------|------|--|--|
| Vredf | Name | | |
|-------|------|--|--|

| | | | |
|------------|-------|--|--|
| CONFIGURED | State | | |
|------------|-------|--|--|

CONFIGURED

```
=====
=====
=====
=====
```

-----Begin Discovery at 2023-01-24_12-43-48.0876-----

```
*****
Database Home : OraDB19000_home1
*****
```

```
=====
=====
```

| Value | Parameter Name | Old | New Value |
|-------------------|------------------------|---|--|
| EE | Database Edition | | EE |
| 19.0.0.0/dbhome_1 | Database Home Location | /u01/app/odaorahome/oracle/product/dbhome_1 | /u01/app/odaorahome/oracle/product/19.0.0.0/dbhome_1 |
| 19.18.0.0.230118 | Database Version | | 19.18.0.0.230118 |

| Value | Parameter Name | Old | New Value |
|--|------------------|--|-------------------------|
| null | Entity Source | | null |
| x7ws-391b6agb4d4c a40d-080f24d68faf | Id | 976643xf-6fa9-7466-5bb324e4-361e-4f76- | |
| OraDB19000_home1 | Name | | OraDB19000_home1 |
| CONFIGURED | State | | CONFIGURED |
| 03:33:31.65 2023 | Updated Time | 2023-01-24 | Tue Jan 24 12:43:41 UTC |
| TRUE | Unified Auditing | | TRUE |

```
=====
=====
```

```
*****
Database Home : OraDB19000_home2
*****
```

```
=====
=====
```

| Value | Parameter Name | Old | New Value |
|-------|----------------|-----|-----------|
|-------|----------------|-----|-----------|

```

=====
Database Edition
EE
Database Home Location /u01/app/odaorahome/oracle/product/
19.0.0.0/dbhome_2 /u01/app/odaorahome/oracle/product/19.0.0.0/
dbhome_2
Database Version
19.18.0.0.230118 19.18.0.0.230118
Entity Source
null null
Id
5f3595fa-3509-49a1-8507-36441e12ba46
b790a5f9-9792-421b-931a-fea341384f58
Name
OraDB19000_home2 OraDB19000_home2
State
CONFIGURED CONFIGURED
Updated Time 2023-01-24 Tue Jan 24 12:44:10 UTC
08:21:30.65
2023
Unified Auditing
TRUE TRUE

```

```

=====
=====

```

```

*****
Database : oneDb
*****
=====

```

```

=====
=====
Parameter Name Old New Value
Value
=====
=====
Id 24d62501-0b3e-44e5-
bd09-0e49f57560c6 e3c522ae-7d89-49cc-
bd3c-291cef8fb606
dbName
oneDb oneDb
State
CONFIGURED CONFIGURED
BackupConfigId
null null
CloudStorageContainer
null null
CpuPool
null null
dbUniqueName
oneDb0 oneDb0
Db Character Set
AL32UTF8 AL32UTF8
DbLanguage
AMERICAN AMERICAN

```

| | | |
|--------------------------|---------------------|------------------|
| DbTerritory | | |
| AMERICA | | AMERICA |
| NlsCharacterSet | | |
| AL16UTF16 | | AL16UTF16 |
| DbClass | | |
| Oltpl | | Oltpl |
| DbConsoleEnable | | |
| false | | false |
| DbDomainName | | |
| null | | us.oracle.com |
| DbEdition | | |
| EE | | EE |
| DbHomeId | 976643xf-6fa9-7466- | |
| x7ws-391b6agb4d4c | 976643xf-6fa9-7466- | |
| x7ws-391b6agb4d4c | | |
| DBId | | |
| 3409102472 | | 3409102472 |
| isCdb | | |
| true | | true |
| DbOnFlashStorage | | |
| null | | false |
| DbRedundancy | | |
| null | | null |
| DbRole | | |
| PRIMARY | | PRIMARY |
| DbShape | | |
| Odb1 | | Odb1 |
| DbStorage | | |
| ACFS | | ACFS |
| DbTargetNodeName() | | |
| null | | null |
| DbTargetNodeNumber() | | |
| 0 | | 0 |
| pdbName | | |
| PDB1 | | PDB1 |
| pdbUserName | | |
| null | | PDBADMIN |
| Database Type | | |
| Si | | Si |
| DbVersion | | |
| 19.18.0.0.230118 | | 19.18.0.0.230118 |
| enableEEHA | | |
| false | | false |
| enableSEHA | | |
| false | | false |
| enableTDE | | |
| false | | false |
| InstanceOnly | | |
| false | | false |
| isAutoBackupDisabled | | |
| true | | true |
| IsBcfgInSync | | |
| null | | null |
| IsFileConversionComplete | | |
| null | | null |
| Level0BackupDay | | |

```

null                                     null
    RegisterOnly
null                                     null
    RmanBkupPassword
null                                     null
    TdePassword
null                                     null
    TdeWalletManagement
null                                     null

=====
=====

```

odacli update-repository

Use the `odacli update-repository` command to update the repository with the new Oracle Database Appliance software.

Prerequisites

Before updating the repository, you must upload the Oracle Database Appliance software to the appliance. If the patch contains more than one zip file, then extract and concatenate the zip files before updating the repository.

File Path

```
/opt/oracle/dcs/bin/odacli
```

Syntax

To unpack and copy the patch bundle to the correct locations in the file system:

```
odacli update-repository -f filename [-j] [-h]
```

Parameters

| Parameter | Description |
|-----------------------------|--|
| <code>--filename, -f</code> | Defines the zip filename of patch bundle or RDBMS clones downloaded from My Oracle Support. Provide a comma-separated list of absolute file paths of the end user and patch bundles. |
| <code>--json, -j</code> | (Optional) Displays JSON output. The default is false. |
| <code>--help, -h</code> | (Optional) Displays help for using the command. |

Usage Notes

- Before updating the repository, ensure that you do not have any jobs running or pending during the update window.
- Upload the patches to `dom0` on Node0. On multi-node systems, the DCS-Agent copies the patch to Node1 and updates the patch repository on both nodes.

- Starting with Oracle Database Appliance release 19.12, a new Oracle ACFS file system is created to store the Oracle Database and Oracle Grid Infrastructure clone files. The DATA disk group provides a space of 150 GB for the file system. When provisioning a system with Oracle Database Appliance release 19.12, the file system is created after Oracle Grid Infrastructure software is configured. When patching a system with Oracle Database Appliance release 19.12, the file system is created when you run the `odacli update-server` command. If you run the command `odacli update-repository` after this file system is configured during provisioning or patching, then the `odacli update-repository` command fails if Oracle Clusterware is not running. The following error is displayed:

```
DCS-10626:Cannot update the repository as the Clusterware is down. Some files need to be stored on an ACFS file system.
```

Example 16-71 Updating the Repository

The server patch zip file is located in the `/u01/tmpdir` directory. The following example updates the repository with the latest server patch and then lists the job to verify that the update is successful:

```
# /opt/oracle/dcs/bin/odacli update-repository -f /tmp/oda-sm-19.26.0.0.0-
date-server.zip,/tmp/oda-sm-19.26.0.0.0-date-server.zip
{
  "jobId" : "d3510276-da05-447b-990e-6d30964f8f79",
  "status" : "Created",
  "message" : "/u01/tmpdir/oda-sm-12.2.1.1.0-171031-server.zip",
  "reports" : [ ],
  "createTimestamp" : "December 8, 2024 14:13:45 AM CST",
  "description" : "Repository Update",
  "updatedAt" : "December 8, 2024 14:13:45 AM CST"
}
[root@oak1 tmpdir]# ./odacli list-jobs
# odacli list-jobs
ID                               Description
Created                           Status
-----
6f27a29a-959f-44e1-b984-7473e3c918ad  Server Patching   December 8, 2024
14:19:05 AM CST      Success
```

odacli update-server

Use the `odacli update-server` command to update the operating system, firmware, Oracle Appliance Kit, Oracle Clusterware, and all other infrastructure components.

File Path

```
/opt/oracle/dcs/bin/odacli
```

Syntax

```
odacli update-server [-c] -v version [-f][-ng] [-l] [-n node_name] [-j] [-h]
```

Parameters

| Parameter | Description |
|-------------------------------|--|
| <code>--version, -v</code> | (Mandatory) Defines the version to update. |
| <code>--component, -c</code> | (Optional) Component that is to be upgraded. Supported value is OS. |
| <code>--force, -f</code> | (Optional) Ignores precheck error and forces the patching operation. |
| <code>--local, -l</code> | (Optional) Updates the server on the local node. |
| <code>--node-name, -nn</code> | (Optional) Specifies the node name to be updated. |
| <code>--json, -j</code> | (Optional) Displays JSON output. The default is false. |
| <code>--help, -h</code> | (Optional) Displays help for using the command. |

Usage Notes

- The `update-server` command applies the patches to various infrastructure components and Oracle Clusterware.
After the update is applied, the agent automatically restarts. It will take a few minutes to reconnect to the server. Wait until the agent shuts down and completes restarting before performing any tasks. Allow at least two (2) minutes before running the next command.
- You must run the patching pre-checks at least once before running the `odacli update-server` command. Analyze any failed pre-checks, fix them, and rerun pre-checks. If any of the pre-checks fail, then run the `odacli update-server` command with the `-f` option.
- When you use the `--local` option, you can patch in the following way. Note that you can patch the nodes in any order, for example, you can patch the instance on `node1` first, and then the instance on `node0`.
 - Run `--local/--node 0` on `node0`, then `--node 1` on `node0`.
 - Or, run `--local/--node 0` on `node0`, then `-local/--node 1` on `node1`.
 - Or, run `--local/--node` on either of the nodes, and then update the server without using the `--local/--node` on either of the nodes.

Note:

Before updating the server, ensure that you do not have any jobs running or pending during the update window. You must run the `odacli create-prepatchreport` command before you patch your server; otherwise, the `odacli update-server` command fails with an error message prompting you to run the patching pre-checks. You can use the `-f` option to override precheck failures and complete the server patching.

Example 16-72 Updating the Server

Run the `odacli update-server` command to update the server to 19.26.0.0.0. On a high-availability system, run the command on one node. The patches are applied automatically to both nodes.

```
# odacli update-server -v 19.26.0.0.0
{
  "jobId" : "6f27a29a-959f-44e1-b984-7473e3c918ad",
  "status" : "Created",
  "message" : "Success of Server Update may trigger reboot of node after 4-5
minutes.
Please wait till node restart",
  "reports" : [ ],
  "createTimestamp" : "December 8, 2024 14:13:45 PM CST",
  "resourceList" : [ ],
  "description" : "Server Patching",
  "updatedAt" : "December 8, 2024 14:13:45 PM CST"
}
```

odacli update-storage

Use the `odacli update-storage` command to update the storage.

File Path

```
/opt/oracle/dcs/bin/odacli
```

Syntax

```
odacli update-storage -v version [-h] [-j] [-r]
```

Parameters

| Parameter | Description |
|----------------------------|---|
| <code>--version, -v</code> | Defines the version to update. |
| <code>--json, -j</code> | (Optional) Displays JSON output. The default is false. |
| <code>--help, -h</code> | (Optional) Displays help for using the command. |
| <code>--rolling, -r</code> | (Optional) Enables to patch shared disks in rolling fashion without stopping Oracle Clusterware. The shared disks must be online. |

Usage Notes

- If the FIRMWAREEXPANDER Installed Version is lower than or equal to the Available Version, then you cannot use rolling mode to update the storage.
- If the FIRMWARECONTROLLER Installed Version is lower than or equal to the Available Version, then you cannot use rolling mode to update the storage.

Example 16-73 Updating the Storage

```
# odacli update-storage -v 19.26.0.0.0
```

odacli update-server-postcheck

Use the `odacli update-server-postcheck` command to perform deployment health checks after upgrading the operating system from Oracle Linux 6 to Oracle Linux 7.

File Path

```
/opt/oracle/dcs/bin/odacli
```

Syntax

```
odacli update-server-postcheck -v version [-j] [-h]
```

Parameters

| Parameter | Description |
|----------------------------|--|
| <code>--version, -v</code> | (Required) Specifies the version to update. |
| <code>--json, -j</code> | (Optional) Displays JSON output. The default is false. |
| <code>--help, -h</code> | (Optional) Displays help for using the command. |

odaadmcli orachk

Use the `odaadmcli orachk` command to check configuration settings for Oracle Database Appliance components.

File Path

```
/opt/oracle/oak/bin/odaadmcli
```

Syntax

To perform diagnostic checks of components:

```
odaadmcli orachk [-h]
```

Parameters

| Parameter | Description |
|--|--|
| <code>--help, -h</code> | (Optional) Displays help for using the command. |
| Components such as <code>-a</code> , <code>-acchk</code> , <code>-applypatch</code> , <code>-autostop</code> | (Optional) Specifies the comma-separated list of components for which you want to collect data. Specify the component to be checked in the command. For example: <pre># odaadmcli orachk -a</pre> |
| <code>--verbose</code> | Displays detailed message. |

Usage Notes

The `odaadmcli orachk` command invokes `orachk` from the directory `opt/oracle.SupportTools/orachk`.

Example 16-74 Running `odaadmcli orachk`

```
[root@oak bin] # ./odaadmcli orachk
INFO: 2019-09-04 16:41:26: Running orachk under /opt/oracle.SupportTools/
orachk
```

Example 16-75 Running `odaadmcli orachk` for a component

```
[root@oak bin] # ./odaadmcli orachk -a
INFO: 2019-09-19 10:45:16: Running orachk under /usr/bin/orachk
Checking ssh user equivalency settings on all nodes in cluster for root
```

odacli Appliance Commands

Use the `odacli appliance` commands to perform lifecycle activities for the appliance.

- [odaconfigcli collectconfig](#)
Use the `odaconfigcli collectconfig` command to collect configuration data from the appliance.
- [odacli modify-asmport](#)
Use the `odacli modify-asmport` command to modify the Oracle ASM listener port number.
- [odacli set-credential](#)
Use the `odacli set-credential` command to change the `oda-admin` or `oda-cliadmin` user credentials on a deployment where multi user access is not enabled.
- [odacli create-appliance](#)
Use the `odacli create-appliance` command in a JSON file format to provision Oracle Database Appliance.
- [odacli describe-system](#)
Use the `odacli describe-system` command to display details about components installed on the system.
- [odacli ping-agent](#)
Use the `odacli ping-agent` command to ping the DCS agent resource.
- [odacli list-nodes](#)
Use the `odacli list-nodes` command to list all nodes in the deployment.
- [odacli list-featuretracking](#)
Use the `odacli list-featuretracking` command to display the latest feature tracking report.

odaconfigcli collectconfig

Use the `odaconfigcli collectconfig` command to collect configuration data from the appliance.

File Path

```
/opt/oracle/odaconfig/bin/odaconfigcli
```

Syntax

To collect Oracle Database Appliance configuration information:

```
# odaconfigcli collectconfig [-loc] [-redact] [-silent]
```

Parameters

| Parameter | Description |
|-----------------------|---|
| <code>--loc</code> | (Optional) Specifies custom results location. The default is <code>/opt/oracle/odaconfig/cnr_data</code> . |
| <code>--redact</code> | (Optional) Redacts sensitive entities in configuration collection. Permitted values are <code>sanitize</code> and <code>mask</code> . <code>sanitize</code> : Sensitive entities are replaced with a substitution string <code>mask</code> : Sensitive entities are replaced with <code>**</code> |
| <code>--silent</code> | (Optional) Suppresses all confirmation prompts. |

Example 16-76 Creating a diagnostics collection

```
# odaconfigcli collectconfig

Oracle Database Appliance system config collection:

-- Performing validations:

-- Collecting configuration from the system test1
The config collection is being created at:
/opt/oracle/odaconfig/cnr_data/odaconfig_test1_23_01_2025_19_38_47

1. Collecting system info
Collecting system details [e.g. version, hardwaretype, etc] ....
Collecting storage details ....
Collecting RPM drift info ....
Collecting AFD state ....
Collecting network info ....

2. Collecting Baremetal database info
Collecting system info ....
Collecting component info ....
Collecting dbstorage info ....
Collecting database info ....
```

```

Collecting dbhome info ....
Collecting backupconfig info ....
Collecting cpupool info ....
Collecting network info ....
Collecting objectstoreswift info ....
Collecting backupreport info ....

3. Processing Odaconfig report. Please note ** it will take few minutes ** to
collect all the command outputs
Collecting ODA stack information
Collecting fixed commands information
Generating html ODAConfig report

4. Setting file protection to the files on config collection.

5. Not redacting the collection

Finished config collection and creating jsons. Following is the collection
summary:
Config collect bundle created at: /opt/oracle/odaconfig/cnr_data/
odaconfig_testoda803c1n1_23_01_2025_19_38_47
HTML ODAConfig report can be found at: /opt/oracle/odaconfig/cnr_data/
odaconfig_testoda803c1n1_23_01_2025_19_38_47/
odaconfig_testoda803c1n1_23_01_2025_19_38_47.html
Logs for this run can be found at : /opt/oracle/odaconfig/cnr_data/
odaconfig_testoda803c1n1_23_01_2025_19_38_47/logs

```

odacli modify-asmport

Use the `odacli modify-asmport` command to modify the Oracle ASM listener port number.

File Path

```
/opt/oracle/dcs/bin/odacli
```

Syntax

```
odacli modify-asmport -p [-j] [-h]
```

Parameters

| Parameter | Description |
|-------------------------|--|
| <code>--p, -p</code> | (Mandatory) Specifies the new port number for the Oracle ASM listener. |
| <code>--help, -h</code> | (Optional) Displays help for using the command. |
| <code>--json, -j</code> | (Optional) Displays JSON output. |

Usage Notes

- You can modify the Oracle ASM listener port number on the bare metal system. All DB systems that you provision after changing the Oracle ASM listener port number use the new Oracle ASM port number.

Example 16-77 Command output details on bare metal system and DB system

```
[root@node1 tmp]# odacli modify-asmport -p 1528

[root@node1 tmp]# odacli describe-job -i 3f182c48-7ff8-4642-af13-e330b668c29e
```

Job details

```
-----
ID: 3f182c48-7ff8-4642-af13-e330b668c29e
Description: Modify ASM listener port
Status: Success
Created: July 18, 2024 4:03:05 PM CST
Message:
```

| Task Name | Start Time | End Time | Status |
|---|------------------------------|------------------------------|---------|
| Stop CRS on DB System(s) | July 18, 2024 4:03:05 PM CST | July 18, 2024 4:14:44 PM CST | Success |
| Modify the ASM listener port on BM | July 18, 2024 4:14:44 PM CST | July 18, 2024 4:14:48 PM CST | Success |
| Change discovery address for DB Systems | July 18, 2024 4:14:48 PM CST | July 18, 2024 4:34:17 PM CST | Success |

After running the command on the bare metal system, the DB system job details are as follows:

```
# Stopping Oracle Clusterware
```

```
[root@node1 ~]# odacli describe-job -i 72ed400c-c8ff-4d82-9d8c-b7561d3f3616
```

Job details

```
-----
ID: 72ed400c-c8ff-4d82-9d8c-b7561d3f3616
Description: Stop Clusterware
Status: Success
Created: July 18, 2024 10:14:12 AM CEST
Message:
```

| Task Name | Start Time | End Time | Status |
|----------------------------|--------------------------------|--------------------------------|---------|
| Stop crs with force option | July 18, 2024 10:14:13 AM CEST | July 18, 2024 10:14:23 AM CEST | Success |

```
# Updating the port
```

```
[root@node1 ~]# odacli describe-job -i b728b936-7426-463f-b6d4-b7ab9ff9f399
```

Job details

```
-----
ID: b728b936-7426-463f-b6d4-b7ab9ff9f399
Description: Modify ASM listener port
Status: Success
Created: July 18, 2024 11:32:42 AM CEST
Message:
```

```
Task Name                               Start
Time                                     End Time
Status
-----
Updating the ASM discovery address in    July 18, 2024 11:32:43 AM
CEST                                     July 18, 2024 11:32:43 AM CEST          Success
OLR

Starting the clusterware                 July 18, 2024 11:32:43 AM
CEST                                     July 18, 2024 11:33:44 AM CEST          Success
Updating the ASM discovery address in    July 18, 2024 11:33:44 AM
CEST                                     July 18, 2024 11:34:44 AM CEST          Success
OCR

Restarting Clusterware                   July 18, 2024 11:34:44 AM
CEST                                     July 18, 2024 11:37:24 AM CEST          Success
```

Related Topics

- [odacli modify-asmport](#)
Use the `odacli modify-asmport` command to modify the Oracle ASM listener port number.

odacli set-credential

Use the `odacli set-credential` command to change the `oda-admin` or `oda-cliadmin` user credentials on a deployment where multi user access is not enabled.

Syntax

To reset the `oda-admin` or `oda-cliadmin` user credentials in interactive mode:

```
odacli set-credential --username username [-j] [-h]
```

Parameters

| Parameter | Description |
|-----------------------------|--|
| <code>--username, -u</code> | User name credentials that you want to reset. The user name can be <code>oda-admin</code> or <code>oda-cliadmin</code> . The <code>oda-admin</code> user credentials allow access to the BUI and the <code>oda-cliadmin</code> user credentials allow ODACLI to communicate with the DCS agent internally. |
| <code>--json, -j</code> | (Optional) Displays JSON output. |

| Parameter | Description |
|-------------------------|---|
| <code>--help, -h</code> | (Optional) Displays help for using the command. |

Usage Notes

Only the `root` user can reset the `oda-admin` or `oda-cliadmin` user credentials.

Example 16-78 Resetting the oda-admin Password in Interactive Mode

To reset the `oda-admin` user password to a new password in interactive mode:

```
# odacli set-credential --username oda-admin
Enter 'user' password:
Retype 'user' password:
```

odacli create-appliance

Use the `odacli create-appliance` command in a JSON file format to provision Oracle Database Appliance.

File Path

```
/opt/oracle/dcs/bin/odacli
```

Syntax

To view help for the `odacli create-appliance` command:

```
odacli create-appliance -r requestjson [-j] [-h]
```

Note:

The `odacli create-appliance` command only supports a JavaScript Object Notation (JSON) file format. An example JSON files and a readme are available in an appendix in this document and in the `/opt/oracle/dcs/sample` directory.

Parameters

| Parameter | Description |
|--------------------------------|---|
| <code>--requestjson, -r</code> | JSON input for appliance creation. |
| <code>--json, -j</code> | (Optional) Displays JSON output. |
| <code>--help, -h</code> | (Optional) Displays help for using the command. |

Usage Notes

For example JSON files, see the chapter *Creating an Appliance Using a JSON File* in this publication.

odacli describe-system

Use the `odacli describe-system` command to display details about components installed on the system.

File Path

```
$ORACLE_HOME/opt/oracle/dcs/bin/odacli
```

Syntax

To list jobs and view job details and status:

```
odacli describe-system [-h] [-b] [-d] [-j]
```

Parameters

| Parameter | Description |
|----------------------------|---|
| <code>--json, -j</code> | (Optional) Displays JSON output. |
| <code>--help, -h</code> | (Optional) Displays help for using the command. |
| <code>--bom, -b</code> | (Optional) Displays the bill of materials for the installed components on the appliance. |
| <code>--details, -d</code> | (Optional) Display on the command-line, the details of all installed components on the appliance. |

Usage Notes

Do not provide both options `-b` and `-d` at the same time, in the command.

Example 16-79 Example Command to View the Bill of Materials from the Command Line for Bare Metal Deployments

```
# odacli describe-system -b
ODA Components Information
-----
Component Name          Component
Details
-----
-----
NODE                    Name : odal
                        Domain Name :
                        Time Stamp : April 29, 2020 7:00:12 PM UTC

RPMS                    Installed RPMS : ac1-2.2.49-7.el6_9.1.x86_64,
                        aide-0.14-11.el6.x86_64,
                        alsa-lib-1.1.0-4.el6.x86_64,
                        at-3.1.10-49.el6.x86_64,
                        atk-1.30.0-1.el6.x86_64,
                        attr-2.4.44-7.el6.x86_64,
                        audit-2.4.5-6.el6.x86_64,
```



```
python-2.4.5-6.el6.x86_64,
libs-1.0.0-10.el6.x86_64,
authconfig-6.1.12-23.el6.x86_64,
libs-0.6.25-17.el6.x86_64,
basesystem-10.0-4.0.1.el6.noarch,

libs-9.8.2-0.62.rc1.el6_9.5.x86_64,
utils-9.8.2-0.62.rc1.el6_9.5.x86_64,
binutils-2.20.51.0.2-5.47.el6_9.1.x86_64,

libs-1.0.5-7.el6_0.x86_64,
certificates-2017.2.14-65.0.1.el6_9.noarch,

checkpolicy-2.0.22-1.el6.x86_64,
chkconfig-1.3.49.5-1.el6.x86_64,
ppl-0.15.7-1.2.el6.x86_64,

+-33-3.2.3-69.el6.x86_64,
readline5-5.2-17.1.el6.x86_64,
+-4.8.2-16.el6.x86_64,

libs-0.4.1-6.el6.x86_64,
x11-0.4.1-6.el6.x86_64,
coreutils-8.4-46.0.1.el6.x86_64,
libs-8.4-46.0.1.el6.x86_64,

audit-libs-2.4.5-6.el6.x86_64,
audit-libs-

augeas-

avahi-

b43-openfwfwf-5.2-10.el6.noarch,

bash-4.1.2-48.el6.x86_64,
bc-1.06.95-1.el6.x86_64,
bind-

bind-

biosdevname-0.7.2-1.el6.x86_64,
bridge-utils-1.2-10.el6.x86_64,
busybox-1.15.1-21.el6_6.x86_64,
bzip2-1.0.5-7.el6_0.x86_64,
bzip2-

ca-

cairo-1.8.8-6.el6_6.x86_64,
celt051-0.5.1.3-0.el6.x86_64,

clog-

compat-libcap1-1.10-1.x86_64,
compat-libstdc+

compat-

compat-sap-c+

ConsoleKit-0.4.1-6.el6.x86_64,
ConsoleKit-

ConsoleKit-

coreutils-

cpio-2.10-13.el6.x86_64,
cpp-4.4.7-18.el6.x86_64,
cpupowerutils-1.3-2.el6.x86_64,
cpuspeed-1.5-22.0.1.el6.x86_64,
```

```

dicts-2.8.16-4.el6.x86_64,
cracklib-2.8.16-4.el6.x86_64,
cracklib-
crash-7.1.4-1.0.1.el6_7.x86_64,
crda-3.13_2015.10.22-3.el6.x86_64,
createrepo-0.9.9-27.el6_9.noarch,
cronie-1.4.4-16.el6_8.2.x86_64,
cronie-
anacron-1.4.4-16.el6_8.2.x86_64,
crontabs-1.10-33.el6.noarch,
cryptsetup-
luks-1.2.0-11.el6.x86_64,
cryptsetup-luks-
libs-1.2.0-11.el6.x86_64,
cups-
libs-1.4.2-78.el6_9.x86_64,
....
....
....

```

odacli ping-agent

Use the `odacli ping-agent` command to ping the DCS agent resource.

File Path

```
/opt/oracle/dcs/bin/odacli
```

Syntax

```
odacli ping-agent [-j] [-h]
```

Parameters

| Parameter | Description |
|-------------------------|---|
| <code>--help, -h</code> | (Optional) Displays help for using the command. |
| <code>--json, -j</code> | (Optional) Displays JSON output. |

Example 16-80

```
# odacli ping-agent
```

odacli list-nodes

Use the `odacli list-nodes` command to list all nodes in the deployment.

File Path

```
/opt/oracle/dcs/bin/odacli
```

Syntax

```
odacli list-nodes [-j] [-h]
```

Parameters

| Parameter | Description |
|------------|---|
| --help, -h | (Optional) Displays help for using the command. |
| --json, -j | (Optional) Displays JSON output. |

Example 16-81

```
# odacli list-nodes
```

odacli list-featuretracking

Use the `odacli list-featuretracking` command to display the latest feature tracking report.

File Path

```
$ORACLE_HOME/opt/oracle/dcs/bin/odacli
```

Syntax

Use the `odacli list-featuretracking` command to display the latest feature tracking report.

```
odacli list-featuretracking [-h] [-j]
```

Parameters

| Parameter | Description |
|------------|---|
| --json, -j | (Optional) Displays JSON output. |
| --help, -h | (Optional) Displays help for using the command. |

Example 16-82 Example Command to View the Features Report from the Command Line

```
# odacli list-featuretracking
                                     DCS Feature Tracking Report

Last collection date: 10/26/18 15:35
Report version:      1.0

-----
DCS Feature Usage Summary

                                     Currently
```

| Detected Feature Name Samples | Total Time | Last Usage | Used | Usages |
|-------------------------------------|---------------|----------------|-------|--------|
| ----- | | | | |
| Object Store | | | TRUE | |
| 12 | 12 | 10/26/18 15:35 | | |
| Automatic Service Request (ASR) | | | FALSE | |
| 0 | 12 | | | |
| Storage Expansion Shelf | | | FALSE | |
| 0 | 12 | | | |

DCS High Water Mark Statistics

| Measured Feature Name Mark Category | High Water |
|---|------------|
| ----- | |
| Maximum usage of CPU % DCS Agent | 8.12 |
| Maximum usage of Memory MB DCS Agent | 437.12 |
| Maximum number of threads 150 DCS Agent | |
| Maximum number of open file descriptors 257 DCS Agent | |
| Maximum number of Databases 1 Database | |
| Maximum number of EE Databases 1 Database | |
| Maximum number of SE Databases 0 Database | |
| Maximum number of CDBs 1 Database | |
| Maximum number of non-CDBs 0 Database | |
| Maximum number of RAC Databases 1 Database | |
| Maximum number of RAC One Databases 0 Database | |
| Maximum number of Single Instance Databases 0 Database | |
| Maximum number of PDBs 0 Database | |
| Maximum number of Datafiles 7 Database | |
| Maximum number of Database Homes 1 Database | |
| Maximum number of Flashback Databases 0 Database | |
| Maximum size of a Database GB Database | 6.40 |
| Minimum Database version 18.0.0.0.0 Database | |
| Maximum Database version 18.0.0.0.0 Database | |

```

Maximum number of Backups
12 Database
Maximum number of NFS Backups
0 Database
Maximum number of Object Store Backups
12 Database
Maximum number of Disk Backups
0 Database
Maximum number of Regular-L0 Backups
0 Database
Maximum number of Regular-L1 Backups
1 Database
Maximum number of ArchiveLog Backups
9 Database
Maximum number of Longterm Backups
2 Database
Maximum interval between Database Backups 0 Day(s),
01:01:06 Database
Maximum number of Object Store tenants
1 Object Store
Maximum number of enabled CPU cores
12 Server
Maximum number of disks
24 Storage
Maximum number of ASM Disks Groups
3 Storage
Maximum size of ASM Disk Groups 11.46
TB Storage
Maximum usage of ASM Disk Groups 1.70
% Storage
Maximum number of ASM Disks Groups with redundancy 'NORMAL'
0 Storage
Maximum number of ASM Disks Groups with redundancy 'HIGH'
3 Storage
Maximum number of ASM Disks Groups with redundancy 'EXTERN'
0 Storage
Maximum number of ASM Disks Groups with redundancy 'FLEX'
0 Storage
Maximum ASM Disk Groups compatibility
18.0.0.0.0 Storage
Minimum ASM Disk Groups compatibility
18.0.0.0.0 Storage
Maximum number of non-ACFS file systems
4 Storage
Maximum size of non-ACFS file systems 98.31
GB Storage
Maximum usage of non-ACFS file systems 82.71
% Storage
Maximum number of ACFS file systems
1 Storage
Maximum size of ACFS file systems 5.00
GB Storage
Maximum usage of ACFS file systems 12.19
% Storage

```

odacli Backup and Recovery Commands

Use the `odacli` backup and recover commands to backup to and restore from Oracle Cloud Infrastructure Object Storage or disk or NFS.

- [odacli create-backup](#)
Use the command `odacli create-backup` to create a Level 0, Level 1, archive log, or Longterm backup.
- [odacli create-backupconfig](#)
Use the command `odacli create-backupconfig` to create a backup configuration.
- [odacli create-objectstoreswift](#)
Use the command `odacli create-objectstoreswift` to create and store the Oracle credential details required to backup to Oracle Object Store.
- [odacli describe-backupconfig](#)
Use the command `odacli describe-backupconfig` to describe a backup configuration.
- [odacli delete-backup](#)
Use the command `odacli delete-backup` to delete obsolete backups and backup reports.
- [odacli delete-backupconfig](#)
Use the command `odacli delete-backupconfig` to delete a backup configuration.
- [odacli describe-backupreport](#)
Use the command `odacli describe-backupreport` to display details of a specific backup report.
- [odacli describe-objectstoreswift](#)
Use the command `describe-objectstoreswift` to describe a Swift ObjectStore.
- [odacli delete-objectstoreswift](#)
Use the command `odacli delete-objectstoreswift` to delete the credentials for the ObjectStore account.
- [odacli describe-schedule](#)
Use the command `odacli describe-schedule` to display details for a specific schedule.
- [odacli irestore-database](#)
Use the command `odacli irestore-database` to restore a database from one system to other system from an external FRA (NFS) or Object Store location based on a backup report.
- [odacli list-backupconfigs](#)
Use the command `odacli list-backupconfigs` to list all backup configurations.
- [odacli list-backupreports](#)
Use the command `odacli list-backupreports` to display a list of all backup reports.
- [odacli list-objectstoreswifts](#)
Use the command `odacli list-objectstoreswifts` to display a list of credentials for the ObjectStore account.
- [odacli list-schedules](#)
Use the command `odacli list-schedules` to display all of the schedules in the system, including database backup schedules and some internal maintenance schedules.

- [odacli list-tdebackupreports](#)
Use the `odacli list-tdebackupreports` command to view TDE Wallet backup reports.
- [odacli recover-database](#)
Use the `odacli recover-database` command to recover or restore a database from backup.
- [odacli restore-archivelog](#)
Use the `odacli restore-archivelog` command to restore archivelog from one SCN to another SCN, or from one timestamp to another timestamp.
- [odacli restore-tdewallet](#)
Use the `odacli restore-tdewallet` command to restore TDE wallet from the backup location.
- [odacli modify-backupconfig](#)
Use the command `odacli modify-backupconfig` to update a backup configuration.
- [odacli modify-objectstoreswift](#)
Use the command `odacli modify-objectstoreswift` to change the credentials for the ObjectStore account.
- [odacli modify-schedule](#)
Use the command `odacli modify-schedule` to update the schedule for a database, or to disable the database backup schedule.

odacli create-backup

Use the command `odacli create-backup` to create a Level 0, Level 1, archivelog, or Longterm backup.

File Path

```
/opt/oracle/dcs/bin/odacli
```

Syntax

```
odacli create-backup [-i Database Resource ID | -n Database Resource Name]
[-h] [-j]
```

Parameters

| Parameter | Description |
|--|---|
| <code>--backupType, -bt {Regular-L0 Regular-L1 Longterm archivelog}</code> | Defines the type of backup. The options are not case sensitive. |
| <code>--component, -c {Database TDEWallet}</code> | (Optional) Defines the component. The supported options are Database and TDE Wallet. The options are not case-sensitive. The default value is Database. If you specify the value as Database, then a backup of both the database and TDE Wallet is taken. |
| <code>--name, -n</code> | Defines the database name. |
| <code>--id, -i</code> | Defines the Database Resource ID. |
| <code>--help, -h</code> | (Optional) Displays help for using the command. |
| <code>--json, -j</code> | (Optional) Displays JSON output. |

| Parameter | Description |
|-------------------------------------|---|
| <code>--keep-archivelog, -ka</code> | Keeps archive logs. |
| <code>--keepDays, -k</code> | Defines the Keep Days. For Longterm Backup Type only. |
| <code>--tag, -t</code> | Defines the name of the backup. A tag is alphanumeric, up to 30 characters. Required for Longterm Backup Type. The tag must be wrapped in single quotes when special characters are used. |

Usage Notes

- Use the command `odacli create-backup` for a specified Database Resource ID and provide a tag for the backup name. Use up to 30 alphanumeric characters for the backup name tag. Three types of backups are available:
 - Level 0: An RMAN incremental backup that backs up all data blocks in the data files being backed up. An incremental backup at level 0 is identical in content to a full backup, but unlike a full backup, the level 0 backup is part of an incremental backup strategy.
 - Level 1: An RMAN incremental backup that includes only those blocks that have been changed since the "parent" backup was taken. A parent backup can be either a level 0 or a level 1 backup.
 - Longterm: Longterm backups are available when backing up to NFS (External FRA) or Oracle Cloud Infrastructure Object Storage (Oracle Object Storage).
 - Archivelog: This option is used to perform backup of all archivelogs not yet backed up to the backup destination, such as Internal FRA, External FRA (NFS location), or Object Store.
- For TDE-enabled databases with TDE keys stored in Oracle Key Vault, the TDE wallet of the database is not backed up because the wallet is stored outside Oracle Database Appliance.
- The Backup Type must be specified in most cases, when you run the `odacli create-backup` command. If the Backup Component is TDE Wallet, then you need not specify the Backup Type.
- This command creates a Backup Report with a Resource ID. To get the ID, use the command `odacli describe-job -i job_id -j` and look for the `resourceId` attribute in `resourceList`.

Example 16-83 Create a Manual Database Backup

Create a long term backup that is kept for 90 days and named q12018HR.

```
# odacli create-backup -i Database Resource ID -bt Longterm -c database -k
90 -t q12018HR
```

Example 16-84 Create a Level 0 Database Backup

Create a Level 0 backup named 2017Dec22ProductionLevel0 for resource ID 20576eb1-bc32-4e34-bf97-fda0b60ca15b

```
# odacli create-backup -i 20576eb1-bc32-4e34-bf97-fda0b60ca15b -bt Regular-L0
-t 2017Dec22ProductionLevel0
```

Example 16-85 Create a Backup of only the TDE Wallet

```
# odacli create-backup -n testdb -c TDEWallet
```

Example 16-86 Create a Backup of the database and TDE Wallet

```
# odacli create-backup -n testdb -bt regular-10
```

odacli create-backupconfig

Use the command `odacli create-backupconfig` to create a backup configuration.

File Path

```
/opt/oracle/dcs/bin/odacli
```

Syntax

```
odacli create-backupconfig -n backup configuration name -d backup destination{Disk|ObjectStore|NFS|None} [-c] [-cr] [-h] [-j] [-no-cr] [-o] [-w] [-f] [-ca] [-dc] [-ec] [-on]
```

Parameters

| Parameter | Description |
|---|--|
| <code>--backupdestination, -d {Disk ObjectStore NFS None}</code> | Defines the backup destination. The options are not case sensitive. |
| <code>--container, -c</code> | (Optional) Defines the object store container. |
| <code>--crosscheck, -cr</code> | (Optional) Enable crosscheck. |
| <code>--help, -h</code> | (Optional) Displays help for using the command. |
| <code>--json, -j</code> | (Optional) Displays JSON output. The default is false. |
| <code>--name, -n</code> | Defines the backup configuration name. |
| <code>--no-crosscheck, -no-cr</code> | (Optional) Disable crosscheck. |
| <code>--objectstoreswiftId, -o</code> | (Optional) Defines the swift object store credential ID. |
| <code>--tde-container, -f</code> | (Optional) Defines the container or backup location to backup the TDE Wallet. Must be the absolute path to the parent directory when the backup target is NFS, and must be the container name when the backup target is Objectstore. |
| <code>--recoverywindow, -wDisk: {1-14} ObjectStore: {1-31}</code> | (Optional) Defines the Recovery Window in days. {1-14} days for Disk and {1-31} days for Object Storage in the cloud. |
| <code>--compression-algo, -ca</code> | (Optional) Defines the compression algorithm {basic low medium high} that RMAN must use. (default: basic(disk/NFS), medium(ObjectStore)) |
| <code>--disable-compression, -dc</code> | (Optional) Disables compression for the backups. Compression is enabled by default. |

| Parameter | Description |
|--|--|
| <code>--enable-compression, -ec</code> | (Optional) Enables compression for the backups. Compression is enabled by default. |
| <code>--objectstoreswiftName, -on</code> | (Optional) Defines the Objectstore Swift resource name. Specify the Objectstore Swift resource name or Objectstore Swift ID. |

Usage Notes

- To backup a TDE-enabled database, backup configuration with separate TDE Wallet backup location and Database backup location is mandatory.
- To backup a non-TDE database, backup configuration with either single database backup location or backup configuration with both database backup location and TDE Wallet backup location can be used.
- For Disk backup configuration, TDE Wallet backup location is by default, Fast Recovery Area (FRA), but in a separate path from the Database backup path within FRA. Hence, TDE Wallet backup location need not be specified when creating the Disk backup configuration.
- The recovery window that is defined in the backup configuration determines when backups are considered obsolete. The following are guidelines:
 - Disk: 1-14 days
 - Object Storage: 1-31 days

Example 16-87 Create a Backup Configuration for disk

Create a backup configuration named `production` that backs up to disk with a 14 day recovery window.

```
# odacli create-backupconfig -d Disk -n production -w 14
```

Example 16-88 Create a Backup Configuration for NFS location

Create a backup configuration that backs up to NFS with a 2 day recovery window.

```
# odacli create-backupconfig -d NFS -n NfsPolicy1 -c /tmp/Nfsbackps -w 2
```

Example 16-89 Create a Backup Configuration with separate backup locations for database backup and TDE Wallet backup

```
# odacli create-backupconfig -n bcfg1 -d Objectstore -w 1 -c location1-on  
oss1 -f location2
```

Example 16-90 Create a Backup Configuration with single backup location for database backup

```
# odacli create-backupconfig -n bcfg2 -d Objectstore -w 1 -c testb2 -on oss2
```

odacli create-objectstoreswift

Use the command `odacli create-objectstoreswift` to create and store the Oracle credential details required to backup to Oracle Object Store.

File Path

```
/opt/oracle/dcs/bin/odacli
```

Syntax

```
# odacli create-objectstoreswift -e swift end point URL [-h] [-j] -n Object Store Swift name -t Object Store tenant name -u Object Store user name
```

Parameters

| Parameter | Description |
|--------------------------------|--|
| <code>--endpointurl, -e</code> | Defines the swift end point URL. |
| <code>--help, -h</code> | (Optional) Displays help for using the command. |
| <code>--json, -j</code> | (Optional) Displays JSON output. The default is false. |
| <code>--name, -n</code> | Defines the Object Store Swift name. |
| <code>--tenantname, -t</code> | Defines the Object Store Swift tenant name. |
| <code>--username, -u</code> | Defines the Object Store Swift user name. |

Usage Notes

The command creates and stores the Oracle Cloud Infrastructure Object Storage credential details in the system and stores the password in an encrypted Oracle wallet. You can attach the credentials to one or more backup configurations.

The credentials are validated during Object Store backup configuration creation against the endpoint URL and tenancy.

odacli describe-backupconfig

Use the command `odacli describe-backupconfig` to describe a backup configuration.

File Path

```
/opt/oracle/dcs/bin/odacli
```

Syntax

```
odacli describe-backupconfig [-i backup_configuration_id] [-n name] [-h] [-j]
```

Parameters

| Parameter | Description |
|-------------------------|---|
| <code>--id, -i</code> | Specifies the backup configuration identifier (ID). |
| <code>--name, -n</code> | Specifies the backup configuration name. |
| <code>--help, -h</code> | (Optional) Displays help for using the command. |
| <code>--json, -j</code> | (Optional) Displays JSON output. |

Example 16-91 Describing a Backup Configuration

Describe a backup configuration named `production`

```
# odacli describe-backupconfig -n production
```

odacli delete-backup

Use the command `odacli delete-backup` to delete obsolete backups and backup reports.

File Path

```
/opt/oracle/dcs/bin/odacli
```

Syntax

```
odacli delete-backup -i Database Resource ID -n name [-br] [-h] [-j]
```

Parameters

| Parameter | Description |
|----------------------------------|--|
| <code>--backupreport, -br</code> | (Optional) Defines the backup report. To delete a Long Term backup, use a JSON input file for the backupreport. |
| <code>--id, -i</code> | Defines the Database Resource Identifier (ID). To delete obsolete level 0, level 1 and archive log backups and backup reports, use the database resource ID. |
| <code>--name, -n</code> | Defines the Database resource name. |
| <code>--help, -h</code> | (Optional) Displays help for using the command. |
| <code>--json, -j</code> | (Optional) Displays JSON output. The default is false. |

Usage Notes

- Delete older, obsolete level 0 and level 1, archive log backups and backup reports with the Database Resource ID. The recovery window that is defined in the backup configuration determines when backups are considered obsolete.
- Delete long term backups and backup report from Oracle Object Storage or NFS backup location using a JSON file with the `--backupreport` option.

- To locate the database ID, view the databases in the Browser User Interface or use the command `odacli list-databases`.

Example 16-92 Delete a Level 0 or Level 1 Backup

```
# odacli delete-backup -i 20576eb1-bc32-4e34-bf97-fda0b60ca15b
```

Example 16-93 Delete a Long Term Backup Report

Delete a Long Term backup using a JSON input file for the Backup Report. In this example, `backupreport.json` is the JSON input for the backupreport.

```
# odacli delete-backup -i 20576eb1-bc32-4e34-bf97-fda0b60ca15b -br
backupreport.json
```

odacli delete-backupconfig

Use the command `odacli delete-backupconfig` to delete a backup configuration.

File Path

```
/opt/oracle/dcs/bin/odacli
```

Syntax

```
odacli delete-backupconfig -n name -i backup configuration id [-h] [-j]
```

Parameters

| Parameter | Description |
|-------------------------|--|
| <code>--help, -h</code> | (Optional) Displays help for using the command. |
| <code>--id, -i</code> | Defines the Backup Config identifier (ID). |
| <code>--name, -n</code> | Defines the Backup Config name. |
| <code>--json, -j</code> | (Optional) Displays JSON output. The default is false. |

Usage Notes

You cannot delete a backup configuration if it is attached to a database.

Example 16-94 Deleting a Backup Configuration

Delete a backup configuration named `production`

```
# odacli delete-backupconfig -n production
```

odacli describe-backupreport

Use the command `odacli describe-backupreport` to display details of a specific backup report.

File Path

```
$ORACLE_HOME/opt/oracle/dcs/bin/odacli
```

Syntax

```
odacli describe-backupreport [-h] [-j] [-i]
```

Parameters

| Parameter | Description |
|-------------------------|--|
| <code>--help, -h</code> | (Optional) Displays help for using the command. |
| <code>--json, -j</code> | (Optional) Displays JSON output. The default is false. |
| <code>--id, -i</code> | Defines the backup report ID. |

Example 16-95 Backup report for a TDE-enabled database (contains a `keystoreType` attribute)

```
odacli describe-backupreport -i d2326683-9766-4933-bee1-a2b59c9d7e9e
{
  "id" : "d2326683-9766-4933-bee1-a2b59c9d7e9e",
  "dbResId" : "96a98156-b657-403e-a87c-357c2069c285",
  "tag" : "auto",
  "dbId" : "1851419729",
  "dbName" : "db15",
  "dbUniqueName" : "db15",
  "backupType" : "Regular-L0",
  "keepDays" : null,
  "backupLocation" : "/nfs_backup/orabackups/dbsfb225975e/database/1851419729/db15/db",
  "cfBackupHandle" : "/nfs_backup/orabackups/dbsfb225975e/database/1851419729/db15/db/c-1851419729-20240326-03",
  "spfBackupHandle" : "/nfs_backup/orabackups/dbsfb225975e/database/1851419729/db15/db/c-1851419729-20240326-03",
  "pitrTimeStamp" : "March 26, 2024 04:15:06 AM PDT",
  "pitrSCN" : "1675444",
  "resetLogsTimeStamp" : "March 26, 2024 03:01:39 AM PDT",
  "resetLogsSCN" : "1575481",
  "oraHomeVersion" : "19.22.0.0.240116",
  "sqlPatches" : "35926646,34774667,35943157",
  "backupLogLoc" : "/nfs_backup/orabackups/dbsfb225975e/database/1851419729/db15/rmanlog/2024-03-26/rman_backup_auto_2024-03-26_04-14-29.0478.log",
  "tdeWalletLoc" : null,
  "dbConfigLoc" : "/nfs_backup/orabackups/dbsfb225975e/database/1851419729/db15/dbconfig/2024-03-26/DBCONFIG_auto_2024-03-26_04-15-19.0472.tar.gz",
  "name" : "Backup_Report_db15",
  "createTime" : "March 26, 2024 04:14:26 AM PDT",
```

```

"state" : {
  "status" : "CONFIGURED"
},
"updatedAt" : "March 26, 2024 04:14:26 AM PDT",
"backupReportLogDetail" : "/nfs_backup/orabackups/dbsfb225975e/database/
1851419729/db15/rmandetaillogreport/2024-03-26/
rman_list_backup_detail_auto_2024-03-26_04-15-16.0129.log",
"dbInfo" : {
  "dbClass" : "OLTP",
  "dbType" : "RAC",
  "dbShape" : "odb2",
  "dbEdition" : "EE",
  "dbStorage" : "ASM",
  "dbRedundancy" : null,
  "pdbName" : null,
  "isCdb" : false
},
"dbDataSize" : "2441M",
"dbRedoSize" : "16403M",
"rmanBackupPieces" : "/nfs_backup/orabackups/dbsfb225975e/database/
1851419729/db15/backuppieces/2024-03-26/backupPieces_auto_96a98156-b657-403e-
a87c-357c2069c285_20240326041518.json",
"compressionAlgo" : "BASIC",
"cpuPool" : null,
"numberOfCores" : null,
"keystoreType" : "OKV" <<<< HERE
}

```

Example 16-96 Display Details of a Specific Backup Report

```

# odacli describe-backupreport -i 2d82460c-d648-4e75-8c7d-72cc90bc442a
{
  "id" : "2d82460c-d648-4e75-8c7d-72cc90bc442a",
  "dbResId" : "b5fc646e-01a6-4c8b-8286-7633346c4329",
  "tag" : null,
  "dbId" : "2717054291",
  "dbName" : "ExampleDB",
  "dbUniqueName" : "ExampleDBu",
  "backupType" : "REGULAR-L1",
  "keepDays" : null,
  "backupLocation" : "https://swiftobjectstorage.example.com/v1/dbaasimage/
backupbucket",
  "cfBackupHandle" : "c-2717054291-20180108-04",
  "spfBackupHandle" : "c-2717054291-20180108-04",
  "pitrTimeStamp" : "September 08, 2024 12:43:14 PM UTC",
  "pitrSCN" : "1175058",
  "resetLogsTimeStamp" : "September 08, 2024 09:55:34 AM UTC",
  "resetLogsSCN" : "1112268",
  "oraHomeVersion" : "12.2.0.1.170814 (26723265, 26609817)",
  "sqlPatches" : "25811364,26609817",
  "backupLogLoc" : "https://swiftobjectstorage.example.com/v1/dbaasimage/
backupbucket/scaoda702cin1/rmanlog/ExampleDBu/2717054291/2018-01-08/
rman_backup_2018-01-08_12-42-41.0545.log",
  "tdeWalletLoc" : null,
  "dbConfigLoc" : "https://swiftobjectstorage.example.com/v1/dbaasimage/

```

```

backupbucket/scaoda702c1n1/dbconfig/ExampleDBu/2717054291/2018-01-08/
DBCONFIG_TAG20180108T124407_2018-01-08_12-44-07.0533.tar.gz",
  "name" : "Backup_Report_ExampleDB",
  "createTime" : "January 08, 2018 12:42:08 PM UTC",
  "state" : {
    "status" : "CONFIGURED"
  },
  "updatedAtTime" : "January 08, 2018 12:44:12 PM UTC",
  "backupReportLogDetail" : "https://swiftobjectstorage.example.com/v1/
dbaasimage/backupbucket/scaoda702c1n1/rmandetaillogreport/ExampleDBu/
2717054291/2018-01-08/rman_list_backup_detail_2018-01-08_12-44-04.0362.log",
  "dbInfo" : {
    "dbClass" : "OLTP",
    "dbType" : "RAC",
    "dbShape" : "odbl",
    "dbEdition" : "EE",
    "dbStorage" : "ASM"
  },
  "dbDataSize" : "1542M",
  "dbRedoSize" : "16403M"
}

```

odacli describe-objectstoreswift

Use the command `describe-objectstoreswift` to describe a Swift ObjectStore.

File Path

```
/opt/oracle/dcs/bin/odacli
```

Syntax

```
# odacli describe-objectstoreswift -i Object Store_Swift_id -n Object
Store_Swift_name [-h] [-j]
```

Parameters

| Parameter | Description |
|-------------------------|--|
| <code>--id, -i</code> | Specifies the Object Store Swift identifier (ID). |
| <code>--name, -n</code> | Specifies the Object Store Swift name. |
| <code>--help, -h</code> | (Optional) Displays help for using the command. |
| <code>--json, -j</code> | (Optional) Displays JSON output. The default is false. |

Example 16-97 Describing the Swift Object Store

```
# odacli describe-objectstoreswift -i Object Store Swift id
```

odacli delete-objectstoreswift

Use the command `odacli delete-objectstoreswift` to delete the credentials for the ObjectStore account.

File Path

```
/opt/oracle/dcs/bin/odacli
```

Syntax

```
# odacli delete-objectstoreswift -i Object Store Swift id -n Object Store Swift name [-h] [-j]
```

Parameters

| Parameter | Description |
|-------------------------|--|
| <code>--help, -h</code> | (Optional) Displays help for using the command. |
| <code>--json, -j</code> | (Optional) Displays JSON output. The default is false. |
| <code>--id, -i</code> | Defines the Object Store Swift identifier (ID). |
| <code>--name, -n</code> | Defines the Object Store Swift name. |

Usage Notes

You cannot delete the Object Store credentials if they are attached to a backup configuration.

Example 16-98 Deleting the Oracle Object Store Credentials

```
# odacli delete-objectstoreswift -i Object Store Swift id
```

odacli describe-schedule

Use the command `odacli describe-schedule` to display details for a specific schedule.

File Path

```
/opt/oracle/dcs/bin/odacli
```

Syntax

```
# odacli describe-schedule [-h] [-j] [-i]
```

Parameters

| Parameter | Description |
|-------------------------|--|
| <code>--help, -h</code> | (Optional) Displays help for using the command. |
| <code>--json, -j</code> | (Optional) Displays JSON output. The default is false. |

| Parameter | Description |
|-----------------------|---|
| <code>--id, -i</code> | Defines the schedule with an identifier (ID). |

Example 16-99 Display Schedule Details

```
# odacli describe-schedule -i scheduleid
```

odacli irestore-database

Use the command `odacli irestore-database` to restore a database from one system to other system from an external FRA (NFS) or Object Store location based on a backup report.

File Path

```
/opt/oracle/dcs/bin/odacli
```

Syntax

```
odacli irestore-database -r [-tn] [-n] [-bp] [-cl] [-nn] [-co] [-s] [-ro] [-dr] [-y] [-c] [-oid] [-tf] [-bl] [-t] [-kt] [-ocp] [-tl] [-cp] [-dh] [-dn] [-de] [-f] [-rd] [-on] [-ha|no-ha] [-own] [-osc] [-h] [-j]
```

Parameters

| Parameter | Description |
|---|---|
| <code>--backupPassword(s), -bp</code> | (Optional) Defines the RMAN password for recovery. You can provide more than one password, but the passwords must be separated by a comma(,). |
| <code>--backupReport, -r</code> | JSON input for a backup report. |
| <code>--enable-tde, -t</code> | Specifies whether to enable Transparent Data Encryption (TDE) which uses software keystore. |
| <code>--keystore-type, -kt</code> | Specifies the type of keystore which stores the TDE master encryption key. The value can be <code>software</code> or <code>okv</code> . The default is <code>software</code> . |
| <code>--okvclient-path, -ocp</code> | Specifies the absolute path to the <code>okvclient.jar</code> file. Multiple values must be comma-separated. Cannot be used with the <code>--okv-server-config, -osc</code> option. |
| <code>--dbClass, -cl {EE: OLTP/DSS/IMDB, SE: OLTP}</code> | (Optional) Defines the Database class. |
| <code>--dbConsoleEnable, -co</code> | (Optional) Enables the Database Console. |
| <code>--dbShape, -s {odb1,odb2, and so on}</code> | (Optional) Defines the database shape. |
| <code>--dbStorage, -dr {ACFS ASM}</code> | (Optional) Defines the database storage. Database Storage {ACFS ASM} (non case-sensitive). The default is ASM. |
| <code>--dbType, -y</code> | (Optional) Defines the type of database. For high-availability deployments, the values can be <code>RAC RACOne SI</code> , with the default as <code>RAC</code> . For single-node deployments, the value is <code>SI</code> . |
| <code>--dbEdition, -de</code> | (Optional) Defines the Database Edition (SE or EE). |
| <code>--databaseHome, -dh</code> | (Optional) Defines the database home. |
| <code>--dbName, -n</code> | (Optional) Defines the database name. |

| Parameter | Description |
|----------------------------|--|
| --dbUniqueName, -u | (Optional) Defines the database unique name. |
| --dbDomainName, -dn | Defines the database domain name. |
| --dbrole, -ro | Defines the database role for Oracle Data Guard operations. The options are PRIMARY STANDBY. |
| --help, -h | (Optional) Displays help for using the command. |
| --json, -j | (Optional) Displays JSON output. The default is false. |
| --node-name, -tn | (Optional) Specifies the target host name (applicable only for Oracle RAC One Node Database and single-instance Oracle Database, where supported). This option is available for Oracle Database Appliance high-availability deployments. |
| --enable-tde, -t | (Optional) Specifies whether you want to enable TDE on the target database. |
| --tde-backup-location, -tl | (Optional) Specifies the backup location for TDE wallet. |
| --keystore-type, -kt | Specifies the type of keystore which stores the TDE master encryption key. The value can be software or okv. The default is software. |
| --okv-server-config, -osc | Specifies the name of the Oracle Key Vault server configuration object which serves as the metadata of the Oracle Key Vault user credentials used by the target database. |
| --okv-wallet-name, -own | Specifies the name of the wallet of the target database on the Oracle Key Vault server. Use this option only if the wallet is manually created on the Oracle Key Vault server. |
| --noOfRmanChannels, -c | (Optional) Defines the number of RMAN channels (parallelism) Default: SE Edition: 1, Other Enterprise Editions: 5 |
| --objectStoreId, -oid | Defines the Swift Object Store credential ID. |
| --objectStoreName, -on | Defines the Swift Object Store resource name. |
| --backuplocation, -bl | (Optional) Specifies the NFS or local directory path where backups are available. |
| --dbRedundancy, -rd | Specifies the database redundancy value, that is, {HIGH MIRROR}. To specify the dbRedundancy option for an Oracle ASM or ACFS storage-based database, at least one disk group of FLEX redundancy must exist. To specify the dbRedundancy option for an Oracle ASM storage database, the dbVersion or dbHomeVersion must be 12.2 or later. The precedence logic for setting the dbRedundancy is: <ol style="list-style-type: none"> 1. dbRedundancy that is specified in the irestore-database command. 2. dbRedundancy in the backup report. 3. If the disk group redundancy is FLEX, then the default dbRedundancy value is MIRROR. |
| --associated-networks, -nn | Specifies the associated network names (in the format networkName1,networkName2,...). |
| --dbOnFlashStorage, -f | (Optional) Specifies whether to enable data on Flash storage. |

| Parameter | Description |
|---|--|
| <code>--no-dbOnFlashStorage, -no-f</code> | (Optional) Specifies whether to disable data on Flash storage. |
| <code>--disable-ha, -no-ha</code> | (Optional) Disables High Availability for single-instance Oracle Database 19c and later. |
| <code>--enable-ha, -ha</code> | (Optional) Enables High Availability for single-instance Oracle Database 19c and later. |

Usage Notes

Caution:

When you create a database with Transparent Data Encryption (TDE) enabled, with TDE keys stored in software keystore, you are prompted to set a password for the TDE wallet. Provide a strong password for security compliance. Set the password carefully, and ensure that this password is available to you at all times for database management operations. Failure to provide the TDE wallet password when prompted, will cause an error in accessing encrypted data.

- The command `odacli irestore-database` restores a database to a system using the Backup Report that is in the Oracle Object Store or External FRA (NFS) location. You can restore a database from one appliance to another appliance, or to the same appliance after the source database is deleted.
- An Oracle wallet (ObjectStoreSwift credentials) must be created to access the backups in Oracle Object Store. This command performs the environment checks, validation checks, and tasks needed to restore a database to an Oracle Database Appliance system.
- If `-cp` parameter is provided as part of the command, the database is associated with the particular CPU pool.
- If `-cp` parameter is not provided as part of the command, and if the backup report has information about the associated CPU pool, then the command validates the CPU pool specified in the backup report. If the validation fails, then an error message is displayed.
- If the backup report does not have information about any associated CPU pool, then the database is created without being associated with any CPU pool.
- To restore a TDE-enabled database, the TDE wallet password must be provided.
- If source database is TDE enabled, then the target database which was restored will also have TDE enabled.
- Specify the TDE wallet location if the backup report does not have TDE wallet location or if the backup report is inaccessible or unavailable.
- To create a database with role as standby in an Oracle Data Guard configuration on Oracle Database Appliance, you do not need to copy the wallet of the primary database when using Oracle Key Vault keystore for TDE-enabled databases. The same wallet can be specified in the `odacli irestore-database` command.

Example 16-100 Restoring a Database to the Same System

Run the command `odacli irestore-database` with the backup report. Enter the SYS user password when prompted.

```
# odacli irestore-database -r backupreport.json -oid Object Store ID
```

Example 16-101 Restoring a Database to a Different System

To restore to a different system, copy the backup report to the other machine's `\bin` folder (or provide the complete path to the backup report), then run the command `odacli irestore-database` with the backup report. Enter the SYS user password when prompted.

```
# odacli irestore-database -r backupreport.json -oid Object Store ID
```

Example 16-102 Restoring a Database with TDE Wallet backup from a backup report

```
# odacli irestore-database -r backupreport.json -on oss1 -t
Enter SYS user password:
Retype SYS user password:
Enter TDE wallet password:
```

Example 16-103 Restoring a Database with TDE Wallet backup specified on the CLI

```
# odacli irestore-database -r backupreport.json -tl https://
swiftobjectstorage.us-ashburn-1.oraclecloud.com/v1/paas_test/tde_Backups/
test2-c/database/91276171/tdbacf2/tdewallet/ewallet_2020021714442745.p12 -on
oss2 -p -m
Enter SYS user password:
Retype SYS user password:
Enter TDE wallet password:
```

Example 16-104 Restoring to a standby database when Oracle Data Guard is configured

```
# odacli irestore-database -r backup_report.json -u dbUniqueName -ro STANDBY
```

Example 16-105 Recovering a Database that was associated with a CPU Pool

```
# odacli irestore-database -n irmendb3 -r dbcupllong.json -on ostore -bp -dh
45156cc5-e768-4817-8b52-2a0a482be18f
Enter SYS user password:
Retype SYS user password:
Enter RMAN backup encryption password:
Do you want to provide another RMAN backup encryption password? [y/n]
(default 'n'): n
{
  "jobId" : "31af6cc8-5e04-459b-8017-271c55b8c99b",
  "status" : "Created",
  "message" : null,
  "reports" : [ ],
  "createTimestamp" : "August 10, 2024 11:20:08 AM UTC",
  "resourceList" : [ ],
```

```
"description" : "Database service recovery with db name: irmendb3",
"updatedAt" : "August 10, 2024 11:20:08 AM UTC"
}
```

Example 16-106 Recovering a Database that was associated with a CPU Pool

Restore an Oracle single-instance database okvdb without using the Oracle Key Vault server configuration object as follows:

```
odacli irestore-database -r /tmp/bkpreport.json -n okvdb8 -y SI -t -kt OKV -
ocp /tmp/okvclient.jar
Enter SYS and SYSTEM user password:
Retype SYS and SYSTEM user password:
Enter TDE wallet password:
```

Job details

```
-----
ID: dce7bde6-7fc4-48ec-891b-649525f1ce4f
Description: Database service recovery with DB name: okvdb8
Status: Success
Created: August 28, 2024 2:50:46 PM CST
Message:

Task Name                               Node Name                               Start
Time                                     End Time                                 Status
-----
Restore Database                         n1                                     August 28, 2024 2:51:09
PM CST August 28, 2024 2:58:11 PM CST Failure
Restore Database                         n1                                     August 28, 2024 2:51:10
PM CST August 28, 2024 2:58:10 PM CST Failure
Check if cluster ware is running         n1                                     August 28, 2024 2:51:14
PM CST August 28, 2024 2:51:14 PM CST Success
Check if cluster ware is running         n2                                     August 28, 2024 2:51:14
PM CST August 28, 2024 2:51:14 PM CST Success
Creating DbStorage for DbRestore         n1                                     August 28, 2024 2:51:14
PM CST August 28, 2024 2:51:21 PM CST Success
Validating DiskSpace for DATA           n1                                     August 28, 2024 2:51:14
PM CST August 28, 2024 2:51:15 PM CST Success
Setting up SSH equivalence               n1                                     August 28, 2024 2:51:15
PM CST August 28, 2024 2:51:19 PM CST Success
Configuring user access to ACFS          n1                                     August 28, 2024 2:51:20
PM CST August 28, 2024 2:51:20 PM CST Success
filesystems for
okvdb8st

Audit directory creation                 n1                                     August 28, 2024 2:51:20
PM CST August 28, 2024 2:51:21 PM CST Success
Audit directory creation                 n2                                     August 28, 2024 2:51:21
PM CST August 28, 2024 2:51:21 PM CST Success
Configure TDE for RestoreDb TaskFlow     n1                                     August 28, 2024 2:51:22
PM CST August 28, 2024 2:51:39 PM CST Success
Auxiliary Instance Creation              n2                                     August 28, 2024 2:51:24
PM CST August 28, 2024 2:51:36 PM CST Success
```

| | | |
|--|-------------------------|-------------------------|
| TDE Wallet directory creation | n1 | August 28, 2024 2:51:36 |
| PM CST | August 28, 2024 2:51:36 | PM CST Success |
| Installing OKV Client Software | n2 | August 28, 2024 2:51:36 |
| PM CST | August 28, 2024 2:51:37 | PM CST Success |
| Auto login TDE Wallet creation | n1 | August 28, 2024 2:51:37 |
| PM CST | August 28, 2024 2:51:38 | PM CST Success |
| Password based TDE Wallet open | n1 | August 28, 2024 2:51:38 |
| PM CST | August 28, 2024 2:51:39 | PM CST Success |
| Install Object Store Swift module | n2 | August 28, 2024 2:51:58 |
| PM CST | August 28, 2024 2:52:16 | PM CST Success |
| Restoring Spfile From Casper | n2 | August 28, 2024 2:52:16 |
| PM CST | August 28, 2024 2:52:38 | PM CST Success |
| Customize Db Parameters | n2 | August 28, 2024 2:52:38 |
| PM CST | August 28, 2024 2:52:47 | PM CST Success |
| Create spfile for restore db | n2 | August 28, 2024 2:52:47 |
| PM CST | August 28, 2024 2:52:48 | PM CST Success |
| Restoring control file | n2 | August 28, 2024 2:52:48 |
| PM CST | August 28, 2024 2:53:11 | PM CST Success |
| Mounting db | n2 | August 28, 2024 2:53:11 |
| PM CST | August 28, 2024 2:53:35 | PM CST Success |
| Validating backup for RestoreDB | n2 | August 28, 2024 2:53:35 |
| PM CST | August 28, 2024 2:53:41 | PM CST Success |
| Restoring DB for migration | n2 | August 28, 2024 2:53:41 |
| PM CST | August 28, 2024 2:54:26 | PM CST Success |
| Change DBID and/or DBName | n2 | August 28, 2024 2:54:27 |
| PM CST | August 28, 2024 2:54:28 | PM CST Success |
| Register Database taskflow | n1 | August 28, 2024 2:54:31 |
| PM CST | August 28, 2024 2:57:08 | PM CST Success |
| Create SPFile in shared loc | n2 | August 28, 2024 2:54:31 |
| PM CST | August 28, 2024 2:54:37 | PM CST Success |
| Delete Local Spfile | n2 | August 28, 2024 2:54:37 |
| PM CST | August 28, 2024 2:54:37 | PM CST Success |
| Register DB with clusterware | n2 | August 28, 2024 2:54:37 |
| PM CST | August 28, 2024 2:55:23 | PM CST Success |
| Set SysPassword and Create PwFile | n1 | August 28, 2024 2:55:23 |
| PM CST | August 28, 2024 2:55:25 | PM CST Success |
| Enable block change tracking | n2 | August 28, 2024 2:55:26 |
| PM CST | August 28, 2024 2:55:28 | PM CST Success |
| Creating pfile | n2 | August 28, 2024 2:55:28 |
| PM CST | August 28, 2024 2:55:29 | PM CST Success |
| Updating db env | n2 | August 28, 2024 2:55:29 |
| PM CST | August 28, 2024 2:55:30 | PM CST Success |
| Enable DbSizing Template | n2 | August 28, 2024 2:55:30 |
| PM CST | August 28, 2024 2:56:20 | PM CST Success |
| Create tns entry | n1 | August 28, 2024 2:56:20 |
| PM CST | August 28, 2024 2:56:21 | PM CST Success |
| Create tns entry | n2 | August 28, 2024 2:56:21 |
| PM CST | August 28, 2024 2:56:22 | PM CST Success |
| Running datapatch | n2 | August 28, 2024 2:56:22 |
| PM CST | August 28, 2024 2:56:23 | PM CST Success |
| Set CPU pool | n1 | August 28, 2024 2:56:23 |
| PM CST | August 28, 2024 2:56:23 | PM CST Success |
| Reset Associated Networks for Database | n2 | August 28, 2024 2:57:10 |
| PM CST | August 28, 2024 2:57:13 | PM CST Success |
| Reset Associated Networks | n1 | August 28, 2024 2:57:13 |
| PM CST | August 28, 2024 2:57:14 | PM CST Success |

```

Set log_archive_dest for Database          n2          August 28, 2024 2:57:14
PM CST                                     August 28, 2024 2:57:18 PM CST          Success
Setting Database parameter for OKV        n1          August 28, 2024 2:57:18
PM CST                                     August 28, 2024 2:58:05 PM CST          Success
Enable New Tablespace Encryption          n2          August 28, 2024 2:58:07
PM CST                                     August 28, 2024 2:58:08 PM CST          Success
Deleting OKV Client Software Jar          n2          August 28, 2024 2:58:09
PM CST                                     August 28, 2024 2:58:09 PM CST          Success
Copy Pwfile to Shared Storage             n1          August 28, 2024 2:58:09
PM CST                                     August 28, 2024 2:58:10 PM CST          Success

```

odacli list-backupconfigs

Use the command `odacli list-backupconfigs` to list all backup configurations.

File Path

```
/opt/oracle/dcs/bin/odacli
```

Syntax

```
odacli list-backupconfigs [-h] [-j]
```

Parameters

| Parameter | Description |
|-------------------------|--|
| <code>--help, -h</code> | (Optional) Displays help for using the command. |
| <code>--json, -j</code> | (Optional) Displays JSON output. The default is false. |

Example 16-107 Displaying a List of Backup Configuration

Display a list of backup configurations.

```
# odacli list-backupconfigs
```

odacli list-backupreports

Use the command `odacli list-backupreports` to display a list of all backup reports.

File Path

```
$ORACLE_HOME/opt/oracle/dcs/bin/odacli
```

Syntax

```
# odacli list-backupreports [-h] [-j]
```

Parameters

| Parameter | Description |
|-------------------------|--|
| <code>--help, -h</code> | (Optional) Displays help for using the command. |
| <code>--json, -j</code> | (Optional) Displays JSON output. The default is false. |

Usage Notes

Displays a list of all database backup reports generated from the command `odacli create-backup`.

Example 16-108 Display a List of all Backup Reports

```
# odacli list-backupreports
```

odacli list-objectstoreswifts

Use the command `odacli list-objectstoreswifts` to display a list of credentials for the ObjectStore account.

File Path

```
$ORACLE_HOME/opt/oracle/dcs/bin/odacli
```

Syntax

```
# odacli list-objectstoreswifts [-h] [-j]
```

Parameters

| Parameter | Description |
|-------------------------|--|
| <code>--help, -h</code> | (Optional) Displays help for using the command. |
| <code>--json, -j</code> | (Optional) Displays JSON output. The default is false. |

Example 16-109 Displaying a List of ObjectStore Swift Credentials

```
# odacli list-objectstoreswifts
```

odacli list-schedules

Use the command `odacli list-schedules` to display all of the schedules in the system, including database backup schedules and some internal maintenance schedules.

File Path

```
/opt/oracle/dcs/bin/odacli
```

Syntax

```
# odacli list-schedules [-h] [-j]
```

Parameters

| Parameter | Description |
|------------|--|
| --help, -h | (Optional) Displays help for using the command. |
| --json, -j | (Optional) Displays JSON output. The default is false. |

Usage Notes

The command lists all of the schedules in the system, including database backup schedules and some internal maintenance schedules.

Starting with Oracle Database Appliance release 19.16, DCS software provides a cron job for cleaning up SSH equivalence that was set up by DCS. The SSH cleaner job runs every 30 minutes. If the SSH cleaner job finds that there are currently no DCS jobs which use SSH, then it cleans up SSH keys, and removes passwordless SSH equivalence across the Oracle Database Appliance nodes on high-availability systems. It also deletes any SSH keys (`id_rsa` and `id_rsa.pub`) present in the `/root/.ssh` and `/home/operating_system_user/.ssh` directories. The SSH cleaner job ensures that DCS jobs are thread safe because jobs (threads) do not interleave while operating on shared resources, such as SSH. To retain the SSH equivalence, or the SSH keys, you can disable the SSH cleaner job using the `odacli modify-schedule` command.

Example 16-110 Display a List of Scheduled Database Backups

Display a list of all scheduled database backups and details.

```
# odacli list-schedules
```

```

ID                                     Name
Description
CronExpression                         Disabled
-----
-----
072dceea-9f09-4c1c-a155-6aa4e3d64669   AgentState metastore cleanup
internal agentstateentry metastore maintenance    0 0 0 1/1 * ?
*                                           false
76e530bf-50db-4598-8b9b-6aa89e58b7d7   bom maintenance                               bom
reports generation                          0 0 1 ? * SUN *
false
7b2a8981-fb88-480f-8280-90d463fcbff8   feature_tracking_job                           Feature
tracking job                                0 0 20 ? * WED *
false
af5bc954-c867-4ba4-b587-c9d527cbe07b   Log files Cleanup                               Auto
log file purge bases on policy              0 0 3 1/1 * ? *
false
c4b14c87-e975-43ba-adf3-cb54c72c9cf0   Rebalance Monitoring
Rebalance poll and Power modification        0 0/5 * 1/1 * ?
*                                           true

```

```
d21ccf0d-3341-4030-b204-f3eed892e443      SSHCleanerJob      SSH
cleaner job to clean up stale SSH keys      0 0/30 * 1/1 * ? *
false
```

odacli list-tdebackupreports

Use the `odacli list-tdebackupreports` command to view TDE Wallet backup reports.

File Path

```
/opt/oracle/dcs/bin/odacli
```

Syntax

```
odacli list-tdebackupreports [-h] [-j]
```

Parameters

| Parameter | Description |
|-------------------------|--|
| <code>--help, -h</code> | (Optional) Displays help for using the command. |
| <code>--json, -j</code> | (Optional) Displays JSON output. The default is false. |

Usage Notes

The TDE backup report saves the latest TDE Wallet backup location of a TDE-enabled database, when a database backup or a TDE Wallet backup is taken for that database.

Example 16-111 Viewing the TDE backup report

```
# odacli list-tdebackupreports
DbResID                               OraDbId
BackupLocation
-----
49772c1b-e4e4-401b-a5f0-16c7992d6766  1080131389      https://
swiftobjectstorage.us-ashburn-1.oraclecloud.com/v1/paastest/
TestLtBackupFailur/test2-c/database/1080131389/tddb3/tdewallet/
ewallet_2020053120350968.p12
f1043fa4-b1ee-461b-84d6-8541e4f6f053  1052183392      /u01/NFS_TDE/
orabackups/test2-c/database/1052183392/tddb4/tdewallet/
ewallet_2020060102471941.p12
944a5613-2a1f-41fb-b7b1-91d35e3e8530  1002460890      /u03/app/oracle/
fast_recovery_area/TDDb5/tdewallet/ewallet_2020060103125231.
```

odacli recover-database

Use the `odacli recover-database` command to recover or restore a database from backup.

File Path

```
/opt/oracle/dcs/bin/odacli
```

Syntax

```
odacli recover-database [-i] [-br] [-h] [-j] [-r] [-t] [-p] [-s] [-n] [-tp] [-tl] [-tz] [-cp]
```

Parameters

| Parameter | Description |
|---|---|
| --backupReport, -br{Regular-L0 Regular-L1 Longterm} | (Optional) JSON input for a backup report. |
| --name, -n | Defines the database name. |
| --id, -i | Defines the Database Resource ID. |
| --help, -h | (Optional) Displays help for using the command. |
| --json, -j | (Optional) Displays JSON output. The default is false. |
| --tde-backup-location, -tl | (Optional) Specifies the backup location for TDE wallet. If not specified, the latest known TDE backup location is used. |
| --recoveryTimeStamp, -r | (Optional) Defines the date and time of the backup. The Recovery Timestamp (in format mm/dd/yyyy hh:mm:ss) is required when the recovery is a point in time recovery (PITR). |
| --recoverytype, -t {Latest PITR SCN} | (Optional) Defines the recovery type. Do not provide the recovery type if you define the Backup Report. |
| --rmanrecoverypassword(s), -p | (Optional) Defines the password for recovery. You can provide more than one password, but the passwords must be within single quote separated by comma(,). |
| --scn, -s | (Optional) Defines the SCN recovery type. Required when the RecoveryType is SCN. |
| --cpupool, -cp | (Optional) Specifies the CPU pool name. |
| --timeZone, -tz | (Optional) Specifies the recovery time zone, in a format similar to {area}/{city} such as america/los_angeles. This option is required when the recovery type is a point in time recovery (PITR). |

Usage Notes

Recovers a database to the latest, a point in time recovery (PITR), or System Change Number (SCN) as input. You can also recover a database from a Backup Report provided as JSON input file.

This command performs various environment and validation checks in order to attempt to ensure that recovery of database is successful. If non-TDE database backups are in ObjectStore, the RMAN recovery passwords are needed to recover the database. This includes RMAN restore and recovery.

This command always performs a full RMAN database restore and recovery. This command is most useful when there is a complete database loss or when the majority of the database files are lost. If you do not require a full RMAN restore, you can perform a manual recovery. For example, a single data file loss or control file loss.

- If `-cp` parameter is provided as part of the command, recovered database is associated with the particular CPU pool.

- If `-cp` parameter is not provided as part of the command, and if the backup report has information about the associated CPU pool, then the recovered database is also associated with the same CPU pool.
- If the original database does not have any associated CPU pool, then the recovered database is also not associated with any CPU pool.

Example 16-112 Recovering a Database to a Point-in-Time

```
# odacli recover-database -i b5fc646e-01a6-4c8b-8286-7633346c4 -t PITR -r
11/08/2017 12:57:33 -p
```

Example 16-113 Recovering a Database to the latest

```
# odacli recover-database -i b5fc646e-01a6-4c8b-8286-7633346c4 -t Latest -p
```

Example 16-114 Recovering a Database to an SCN

```
# odacli recover-database -i b5fc646e-01a6-4c8b-8286-7633346c4 -t SCN -s
392375947
```

Example 16-115 Restoring a TDE wallet when performing database recovery is not supported for TDE-enabled databases with TDE keys stored in Oracle Key Vault

The following error is displayed:

```
# odacli recover-database -n db15 -tl /nfs_backup/ewallet.p12 -t latest
DCS-10045:Validation error encountered: Usage of TDE wallet related
parameters is not allowed for a TDE database with OKV keystore type.
```

Example 16-116 Restoring the TDE Wallet while performing database recovery, if TDE wallets are lost

```
# odacli recover-database -n db1 -t latest -tp -tl /u01/NFS_TDE/testbackups/
test2-c/database/91276171/tdbacf2/tdewallet/ewallet_2020021714442745.p12
Enter TDE wallet password:
```

Example 16-117 Recovering a Database that was associated with a CPU Pool

```
# odacli recover-database -t latest -n irmendb4 -cp testcpupool3
{
  "jobId" : "b09f2d3f-2b01-4dbb-9797-122ba786e0e4",
  "status" : "Created",
  "message" : null,
  "reports" : [ ],
  "createTimestamp" : "May 10, 2023 14:56:57 PM UTC",
  "resourceList" : [ ],
  "description" : "Create recovery-latest for db : irmendb4",
  "updatedAt" : "May 10, 2023 14:56:57 PM UTC"
}
```

odacli restore-archivelog

Use the `odacli restore-archivelog` command to restore archivelog from one SCN to another SCN, or from one timestamp to another timestamp.

File Path

```
/opt/oracle/dcs/bin/odacli
```

Syntax

```
odacli restore-archivelog -n database_name -i DB_ID -fs from_scn -ts to_scn  
-ft from_timestamp -tt to_timestamp [-h] [-j]
```

Parameters

| Parameter | Description |
|------------------------------------|--|
| <code>--name, -n</code> | Specifies the Database Name. |
| <code>--id, -i</code> | (Optional) Specifies the Database resource ID. |
| <code>--from-scn, -fs</code> | (Optional) Specifies the start SCN of archivelog restore. |
| <code>--from-timestamp, -ft</code> | (Optional) Specifies the start time of archivelog restore (in the format mm/dd/yyyy hh:mi:ss). |
| <code>--to-scn, -ts</code> | (Optional) Specifies the end SCN of archivelog restore. |
| <code>--to-timestamp, -tt</code> | (Optional) Specifies the end time of archivelog restore (in the format mm/dd/yyyy hh:mi:ss). |
| <code>--help, -h</code> | (Optional) Displays help for using the command. |
| <code>--json, -j</code> | (Optional) Displays JSON output. The default is false. |

Usage Notes

You can restore archivelog for all supported database versions and database types for an Oracle Database Appliance release.

Example 16-118 Restoring archivelog

```
# odacli restore-archivelog -fs from_scn -ts to_scn  
# odacli restore-archivelog -ft from_timestamp -tt to_timestamp
```

odacli restore-tdewallet

Use the `odacli restore-tdewallet` command to restore TDE wallet from the backup location.

File Path

```
/opt/oracle/dcs/bin/odacli
```

Syntax

```
odacli restore-tdewallet [-i] [-n] [-tl] [-h] [-j]
```

Parameters

| Parameter | Description |
|----------------------------|--|
| --name, -n | Specifies the Database Name. |
| --id, -i | Specifies the Database ID. |
| --tde-backup-location, -tl | (Optional) Specifies the backup location for TDE wallet. |
| --help, -h | (Optional) Displays help for using the command. |
| --json, -j | (Optional) Displays JSON output. The default is false. |

Usage Notes

⚠ Caution:

When you create a database with Transparent Data Encryption (TDE) enabled, you are prompted to set a password for the TDE wallet. Provide a strong password for security compliance. Set the password carefully, and ensure that this password is available to you at all times for database management operations. Failure to provide the TDE wallet password when prompted, will cause an error in accessing encrypted data.

- This command prompts for TDE wallet password. When prompted, enter the password of the TDE wallet. This password is the one you created or last updated using the modify-database command.
- TDE Wallet backup location is optional. If no TDE Wallet backup location is provided, then the latest TDE Wallet backup of the database known to the system is used for restoring the TDE Wallet.
- This command is not supported for the TDE-enabled databases with TDE keys stored in Oracle Key Vault. The following error is displayed:

```
# odacli restore-tdewallet -n db15
Enter TDE wallet password:
DCS-10144:Restore TDE wallet operation is not supported for TDE databases
with OKV keystore type.
```

Example 16-119 Restoring TDE wallet for a database from a backup location

```
# odacli restore-tdewallet -n testdb -tl /u01/NFS_TDE/testbackups/test2-c/
database/91276171/tdbacf2/tdewallet/ewallet_2020021714442745.p12
Enter TDE wallet password:
```

odacli modify-backupconfig

Use the command `odacli modify-backupconfig` to update a backup configuration.

File Path

```
/opt/oracle/dcs/bin/odacli
```

Syntax

```
odacli modify-backupconfig [-i] [-n] [-ca] -d backup destination{Disk|ObjectStore|None} [-c] [-cr][no-cr] [-dc] [-ec] [-o][w] [-h] [-j]
```

Parameters

| Parameter | Description |
|---|---|
| --id, -i | Defines the Backup Config ID. |
| --name, -n | Defines the Backup Config name. |
| --backupdestination, -d{Disk ObjectStore None} | Defines the backup destination. The options are not case sensitive. Applicable to System type backup config. |
| --compression-algo, -ca{BASIC LOW MEDIUM HIGH} | Defines the Compression Algorithm that RMAN must use. The default is BASIC for Disk and NFS backup and MEDIUM for ObjectStore backup. |
| --container, -c | (Optional) Defines the object store container or absolute path to the parent directory of NFS destination for backups. |
| --crosscheck, -cr | (Optional) Enable Crosscheck. Applicable to Database type backup config. |
| --name, -n | Defines the backup configuration name. |
| --no-crosscheck, -no-cr | (Optional) Disable crosscheck. |
| --objectstoreswiftid, -o | (Optional) Defines the swift object store credential ID. |
| --recoverywindow, -w Disk: {1-14} ObjectStore: {1-30} | (Optional) Defines the Recovery Window in days. {1-14} days for Disk and {1-30} days for Object store. Applicable to Database type backup config. |
| --disable-compression, -dc | (Optional) Disables compression for the backups. |
| --enable-compression, -ec | (Optional) Enables compression for the backups. |
| --objectstoreswiftname, -on | (Optional) Describes the Swift Object Store credential name. |
| --help, -h | (Optional) Displays help for using the command. |
| --json, -j | (Optional) Displays JSON output. The default is false. |

Usage Notes

- The recovery window that is defined in the backup configuration determines when backups are considered obsolete. The following are guidelines:
 - Disk: 1-14 days
 - ObjectStore in Casper: 1-30 days

Example 16-120 Revise a Backup Configuration for Disk

Create a backup configuration named `production` that backs up to disk with a 14 day recovery window.

```
# odacli modify-backupconfig -d Disk -n production -w 14
```

odacli modify-objectstoreswift

Use the command `odacli modify-objectstoreswift` to change the credentials for the ObjectStore account.

File Path

```
/opt/oracle/dcs/bin/odacli
```

Syntax

```
# odacli modify-objectstoreswift [-n name] [-i id] [-p swiftpassword] [-u Object Store user name] [-h] [-j]
```

Parameters

| Parameter | Description |
|----------------------------------|--|
| <code>--id, -i</code> | Defines the Object Store Swift identifier (ID). |
| <code>--name, -n</code> | Defines the Object Store Swift name. |
| <code>--swiftpassword, -p</code> | (Optional) Defines the Object Store Swift password. |
| <code>--username, -u</code> | (Optional) Defines the Object Store Swift user name. |
| <code>--help, -h</code> | (Optional) Displays help for using the command. |
| <code>--json, -j</code> | (Optional) Displays JSON output. The default is false. |

Usage Notes

Use this command to update the password when it is changed for an ObjectStore account. The command updates the Oracle ObjectStore credential details in the system and stores the password in an encrypted Oracle wallet.

The credentials are validated during the command `odacli modify-backupconfig` with `objectstore` as the destination. The credentials are not validated against endpoint URL and tenancy.

Example 16-121 Changing the Oracle Casper ObjectStore Password

```
# odacli modify-objectstoreswift -i Object Store Swift id -p
```

Example 16-122 Changing the Oracle ObjectStore User Name

```
# odacli modify-objectstoreswift -i Object Store Swift id -u Object Store
user name
```

odacli modify-schedule

Use the command `odacli modify-schedule` to update the schedule for a database, or to disable the database backup schedule.

File Path

```
/opt/oracle/dcs/bin/odacli
```

Syntax

```
# odacli modify-schedule [-i] [-x cronExpression] [-t description] [-d] [-e] [-h] [-j]
```

Parameters

| Parameter | Description |
|-----------------------------------|--|
| <code>--scheduleid, -i</code> | Defines the schedule with an identifier (ID). |
| <code>--cronExpression, -x</code> | (Optional) Specifies the cron expression. Use 5 fields or 6 fields cron expression only. |
| <code>--description, -t</code> | (Optional) Provides a description for the update schedule. |
| <code>--disable, -d</code> | (Optional) Disables the schedule. |
| <code>--enable, -e</code> | (Optional) Enables a disabled schedule. |
| <code>--help, -h</code> | (Optional) Displays help for using the command. |
| <code>--json, -j</code> | (Optional) Displays JSON output. The default is false. |

Usage Notes

Backups incur overhead on the system. When possible, do not schedule backups to run when users are trying to access data.

Starting with Oracle Database Appliance release 19.20, the DCS agent supports only 5 fields cron expressions or 6 fields cron expressions by default, in job schedules. When you patch your deployment from Oracle Database Appliance release 19.19 or earlier, the DCS agent automatically converts all 7 fields cron expression from existing job schedules into an equivalent 6 fields cron expression.

Example 16-123 Modify the Time the Backup Occurs

Edit the cron expression to change the time of scheduled backups for a given schedule ID.

```
# odacli modify-schedule -i scheduleid -x "0 0 13 1/1 * *" -e
```

Example 16-124 Disable Scheduled Database Backups

```
# odacli modify-schedule -i scheduleid -d
```

odacli Oracle Data Guard Commands

Use ODACLI commands to configure and manage Oracle Data Guard in your Oracle Database Appliance deployment.

- [odacli configure-dataguard](#)
Use the command `odacli configure-dataguard` to configure Oracle Data Guard on Oracle Database Appliance.
- [odacli deconfigure-dataguard](#)
Use the command `odacli deconfigure-dataguard` to deconfigure Oracle Data Guard on Oracle Database Appliance.
- [odacli describe-dataguardstatus](#)
Use the command `odacli describe-dataguardstatus` to view Oracle Data Guard status on Oracle Database Appliance.
- [odacli failover-dataguard](#)
Use the command `odacli failover-dataguard` on the standby system to failover the Oracle Data Guard primary database to the standby database.
- [odacli list-dataguardstatus](#)
Use the command `odacli list-dataguardstatus` to verify Oracle Data Guard status on both primary and standby databases.
- [odacli reinstate-dataguard](#)
Use the command `odacli reinstate-dataguard` on the new primary system to reinstate a failed primary database after a failover and convert it to a new standby database.
- [odacli register-dataguard](#)
Use the command `odacli register-dataguard` to register Oracle Data Guard with Oracle Database Appliance.
- [odacli switchover-dataguard](#)
Use the command `odacli switchover-dataguard` on the primary system to reverse the Oracle Data Guard primary and standby database roles on Oracle Database Appliance.

odacli configure-dataguard

Use the command `odacli configure-dataguard` to configure Oracle Data Guard on Oracle Database Appliance.

File Path

```
/opt/oracle/dcs/bin/odacli
```

Syntax

```
# odacli configure-dataguard [-h] [-j] [-i] [-r] [-s]
```

Parameters

| Parameter | Description |
|--------------------------|---|
| --help, -h | (Optional) Displays help for using the command. |
| --json, -j | (Optional) Displays JSON output. The default is false. |
| --requestjson, -r | (Optional) Specifies the JSON file for creating the appliance. |
| --skip-password-copy, -s | (Optional) Specifies that step to copy the password from primary database to standby database can be skipped. |

Usage Notes

If the database orapwd file is not in the typical location, then an error may occur in the configuration process. In such a case, manually copy the orapwd file from the primary database to the standby database in advance, and configure Oracle Data Guard with the --skip-password-copy option.

Example 16-125 Configuring Oracle Data Guard interactively on the command line

Example with one standby configuration:

```
# odacli configure-dataguard
# /opt/oracle/dcs/bin/odacli configure-dataguard
Number of standby databases (enter 1 or 2 | default: 1):
Standby 1 site address: phxdbfzp04.dev3farm3phx.databasede3phx
BUI username for Standby site host1. If Multi-user Access/Multi-user Access
Passwordless is not enabled on Standby site
phxdbfzp04.dev3farm3phx.databasede3phx, enter 'oda-admin'; otherwise, enter
the name of the user who has irestored the Standby database (default: oda-
admin): oda-admin
BUI password for Standby site host2:
Password for root user on Standby site host2:

*****
*****
Data Guard configuration name: tdb_dg
Database name for Data Guard configuration: tdb
Primary database SYS password:
Protection mode [MAX_PROTECTION, MAX_PERFORMANCE, MAX_AVAILABILITY] (default:
MAX_PERFORMANCE):
Enable Active Data Guard (Y/N, default:N):
*****
*****

Data Guard default settings for standby database - tdbstandby
Primary site network for Data Guard configuration: Public-network
Standby site network for Data Guard configuration: Public-network
Primary database listener port (TCP): 1521
Standby database listener port (TCP): 1521
Transport type: ASYNC
Do you want to edit this Data Guard configuration? (Y/N, default:N): N
*****
*****
```

```
*****
Enter Primary database RMAN backup encryption password if any:
Do you want to provide another Primary database RMAN backup encryption
password if any? [y/n] (default 'n'):
Standby database's SYS password will be set to Primary database's after Data
Guard configuration. Ignore warning and proceed with Data Guard
configuration? (Y/N, default:N): Y
```

```
{
  "jobId" : "e02cc0b3-bce3-4d6c-alf5-5b121bb7f66a",
  "status" : "Created",
  "message" : "",
  "reports" : [ ],
  "createTimestamp" : "January 23, 2025 03:12:44 AM UTC",
  "resourceList" : [ ],
  "description" : "DG Config service for DB tdb",
  "updatedAtTime" : "January 23, 2025 03:12:44 AM UTC",
  "jobType" : null,
  "cpsMetadata" : null
}
```

```
[root@host1 work]# /opt/oracle/dcs/bin/odacli describe-job -i e02cc0b3-
bce3-4d6c-alf5-5b121bb7f66a
```

Job details

```
-----
                        ID: e02cc0b3-bce3-4d6c-alf5-5b121bb7f66a
Description: DG Config service for DB tdb
Status: Success
Created: January 23, 2025 03:12:44 UTC
Message:
```

| Task Name | Start Time | End Time | Status |
|------------------------------------|-------------------------------|-------------------------------|---------|
| Validate configure primary request | January 23, 2025 03:13:10 UTC | January 23, 2025 03:13:21 UTC | Success |
| (Primary site) (Host: host1/Job) | | | |

```
ID:
901389f5-0cad-4ee6-91be-3f77b85652af)
```

| | | | |
|------------------------------------|-------------------------------|-------------------------------|---------|
| Validate configure standby request | January 23, 2025 03:13:21 UTC | January 23, 2025 03:13:29 UTC | Success |
| (Standby site) (Host: host2/Job) | | | |

```
ID:
856d86e4-dd51-41a7-9050-
b0c39ae771f9)
```

Uploading Primary DB Password File January 23, 2025 03:13:29
UTC January 23, 2025 03:13:52 UTC Success
(Standby
site)

Configure primary database (Primary January 23, 2025 03:13:52
UTC January 23, 2025 03:15:29 UTC Success
site) (Host: host1/Job
ID:

5dd46e86-
e07f-423f-9ebf-2515b4ac17d5)

Configure standby request (Standby January 23, 2025 03:15:29
UTC January 23, 2025 03:17:30 UTC Success
site)
(Host:

host2/Job
ID:

2ab511a2-15c0-4371-
bf30-9b7e27ff5288)

Create archive log restore (Primary January 23, 2025 03:17:30
UTC January 23, 2025 03:17:52 UTC Success
site) (Host: host1/Job
ID:

96766874-6537-4972-81a9-971440e2acfb)

Configure and enable Data Guard January 23, 2025 03:17:53
UTC January 23, 2025 03:19:19 UTC Success
(Primary site) (Host:
host1/Job

ID:

7ad65ffa-ea06-479d-bb21-
e0b81fb8c743)

Enable Flashback (Standby site) (Host: January 23, 2025 03:19:19
UTC January 23, 2025 03:19:38 UTC Success
host2/Job
ID:

a1768703-4dd4-4f1f-
b9a3-9fe0f99615d5)

Re-enable Data Guard (Primary site) January 23, 2025 03:19:38
UTC January 23, 2025 03:19:44 UTC Success
(Host: host1/Job
ID:

3f6dd276-63e3-4804-a179-

```
e10052386206)

Create Data Guard status (Primary          January 23, 2025 03:19:44
UTC          January 23, 2025 03:19:49 UTC          Success
site) (Host: host1/Job
ID:

8a3eb946-3501-4618-9d4a-
ad8a6d298cc8)

Create Data Guard status (Standby         January 23, 2025 03:19:49
UTC          January 23, 2025 03:19:57 UTC          Success
site)
(Host:

host2/Job
ID:

d9d65942-6284-40d5-a991-b1d21edae96f)
```

Example 16-126 Configuring Oracle Data Guard with two standby configurations

Example with two standby databases configuration:

```
# odacli configure-dataguard
Number of standby databases (enter 1 or 2 | default: 1): 2
Standby 1 site address: standby1
BUI username for Standby site standby1. If Multi-user Access/Multi-user
Access Passwordless is not enabled on Standby site standby1, enter
'oda-admin'; otherwise, enter the name of the user who has irestored the
Standby
database (default: oda-admin):
BUI password for Standby site standby1:
Password for root user on Standby site standby1:
Standby 2 site address: standby2
BUI username for Standby site standby2. If Multi-user Access/Multi-user
Access Passwordless is not enabled on Standby site standby2, enter
'oda-admin'; otherwise, enter the name of the user who has irestored the
Standby
database (default: oda-admin):
BUI password for Standby site standby2:
Password for root user on Standby site standby2:

*****
*****
Data Guard configuration name: dgbb
Database name for Data Guard configuration: bb
Primary database SYS password:
Protection mode [MAX_PROTECTION, MAX_PERFORMANCE, MAX_AVAILABILITY] (default:
MAX_PERFORMANCE):
Enable Active Data Guard (Y/N, default:N):
*****
*****

Data Guard default settings for standby database - bb1
Primary site network for Data Guard configuration: Public-network
```

```

Standby site network for Data Guard configuration: Public-network
Primary database listener port (TCP): 1521
Standby database listener port (TCP): 1521
Transport type: ASYNC
Do you want to edit this Data Guard configuration? (Y/N, default:N):

Data Guard default settings for standby database - bb2
Primary site network for Data Guard configuration: Public-network
Standby site network for Data Guard configuration: Public-network
Primary database listener port (TCP): 1521
Standby database listener port (TCP): 1521
Transport type: ASYNC
Do you want to edit this Data Guard configuration? (Y/N, default:N):
Warning: in compliance with Oracle MAA best practices. DbType (RAC) of Primary
database bb is different from DbType (SI) of Standby database. Ignore warning
and proceed with Data Guard configuration? (Y/N, default:N): y
Warning: in compliance with Oracle MAA best practices. DbType (RAC) of Primary
database bb is different from DbType (SI) of Standby database. Ignore warning
and proceed with Data Guard configuration? (Y/N, default:N): y
*****
*****
Enter Primary database RMAN backup encryption password if any:
Do you want to provide another Primary database RMAN backup encryption
password
if any? [y/n] (default 'n'):
Standby database's SYS password will be set to Primary database's after Data
Guard configuration. Ignore warning and proceed with Data Guard configuration?
(Y/N, default:N): y
{
  "jobId" : "f1df87d7-221c-4dc3-a15f-fa35d91560f5",
  "status" : "Created",
  "message" : "",
  "reports" : [ ],
  "createTimestamp" : "January 17, 2025 22:57:55 PM UTC",
  "resourceList" : [ ],
  "description" : "DG Config service for DB bb",
  "updatedAt" : "January 17, 2025 22:57:55 PM UTC",
  "jobType" : null,
  "cpsMetadata" : null
}

[root@host1 ~]# odacli describe-job -i
"f1df87d7-221c-4dc3-a15f-fa35d91560f5"

Job details
-----
                ID: f1df87d7-221c-4dc3-a15f-fa35d91560f5
Description:    DG Config service for DB bb
                Status: Success
                Created: January 17, 2025 22:57:55 UTC
                Message:

Task Name                               Node Name                               Start
Time  End Time                           Status
-----

```



```

-----
-----
Validate configure primary request          host1          January 17,2025
22:58:38 UTC          January 17, 2025 22:58:44 UTC          Success

(Primary site) (Host:host1/Job
ID:
eb8bbb43-159c-48e0-8dda-9e2bbd280669)

Validate configure standby request         host1          January 17,2025
22:58:44 UTC          January 17, 2025 22:58:52 UTC          Success
(Standby site) (Host: standby1/Job
ID:

86345f35-500c-4ba8-8ff9-
f97c201ad3c7)

Uploading Primary DB Password File        host1          January 17,2025
22:58:52 UTC          January 17, 2025 22:59:07 UTC          Success
(Standby
site)

Configure primary database (Primary        host1          January 17,2025
22:59:07 UTC          January 17, 2025 22:59:58 UTC          Success
site) (Host: host1/Job ID:
23ee7263-a59e-40bd-
bbec-4c17a5d4ba99)

Configure standby request (Standby        host1          January 17,2025
22:59:58 UTC          January 17, 2025 23:02:00 UTC          Success
site) (Host: standby1/Job ID:
af543839-85ba-4e83-89d3-
af161d528256)

Create archive log restore (Primary        host1          January 17,2025
23:02:00 UTC          January 17, 2025 23:02:37 UTC          Success
site) (Host: host1/Job ID:
b2940217-cec6-4b22-92d2-
f4ec8f26b8b8)

Configure and enable Data Guard            host1          January 17,2025
23:02:37 UTC          January 17, 2025 23:04:19 UTC          Success
(Primary site)
(Host:
host1/Job ID:
7882e1e5-0d71-48df-bd86-
e79ee6b57a21)

Enable Flashback (Standby site) (Host:    host1          January 17,2025
23:04:19 UTC          January 17, 2025 23:04:37 UTC          Success
standby1/Job ID:
c2ef962c-
f429-4e97-8bc3-1355cd7d0ca8)

```

```

Re-enable Data Guard (Primary site)          host1          January 17,2025
23:04:37 UTC                               January 17, 2025 23:04:43 UTC          Success
(Host: host1/Job ID:
fb4a7055-0049-4d44-
a726-0871ed54ca07)

Create Data Guard status (Primary           host1          January 17,2025
23:04:43 UTC                               January 17, 2025 23:04:54 UTC          Success
site) (Host: host1/Job ID:
5aca5c16-632f-488b-
aade-1c677030c81d)

Create Data Guard status (Standby          host1          January 17,2025
23:04:54 UTC                               January 17, 2025 23:05:07 UTC          Success
site) (Host: standby1/Job ID:
5f0c5460-4c38-4aed-8a5b-
e70c0ca70df8)

Validate configure primary request          host1          January 17,2025
23:05:07 UTC                               January 17, 2025 23:05:13 UTC          Success
(Primary site) (Host:host1/Job
ID:
5ac64b32-5da6-48df-
b8cc-020853363695)

Validate configure standby request          host1          January 17,2025
23:05:13 UTC                               January 17, 2025 23:05:21 UTC          Success
(Standby site) (Host: standby2/Job
ID:
81aa6900-4460-408e-9ab2-
fdcd92c8b7bf)

Uploading Primary DB Password File          host1          January 17,2025
23:05:21 UTC                               January 17, 2025 23:05:32 UTC          Success
(Standby
site)

Configure primary database (Primary         host1          January 17,2025
23:05:32 UTC                               January 17, 2025 23:06:14 UTC          Success
site) (Host: host1/Job ID:
c78a8072-8023-4278-
bd94-3dd1ef97e066)

Configure standby request (Standby         host1          January 17,2025
23:06:14 UTC                               January 17, 2025 23:07:43 UTC          Success
site) (Host: standby2/Job ID:
46274a35-bb06-43a9-
a8a5-66dc4d163463)

Create archive log restore (Primary        host1          January 17,2025
23:07:43 UTC                               January 17, 2025 23:08:15 UTC          Success
site) (Host: host1/Job ID:
2b20aaa2-fcb7-4bc5-
b501-27ad9d45f34b)

```

```

Configure standby TNS entry (New          host1          January 17,2025
23:08:15 UTC          January 17, 2025 23:08:24 UTC          Success
standby site) (Host: standby2/Job
ID:

7e32db8c-999c-44fa-
bdf5-3aed77c9590c)

Configure standby TNS entry (Existing     host1          January 17,2025
23:08:24 UTC          January 17, 2025 23:08:28 UTC          Success
standby site) (Host: standby1/Job
ID:

6a44539e-d5b9-4c45-
ad2c-7bff8c871e37)

Add standby database (Primary site)       host1          January 17,2025
23:08:28 UTC          January 17, 2025 23:09:50 UTC          Success
(Host: host1/Job ID:
1d7c6c93-bd85-496a-
bb7d-67ae7b224d58)

Enable Flashback (Standby site) (Host:   host1          January 17,2025
23:09:50 UTC          January 17, 2025 23:10:03 UTC          Success
standby2/Job ID:
4a6b8623-
efc0-4016-80be-305b0ed56363)

Re-enable Data Guard (Primary site)       host1          January 17,2025
23:10:03 UTC          January 17, 2025 23:10:09 UTC          Success
(Host: host1/Job ID:
2afea759-752a-42a4-a077-
bd85d4b687a3)

Update Data Guard status (Primary         host1          January 17,2025
23:10:09 UTC          January 17, 2025 23:10:35 UTC          Success
site) (Host: host1/Job ID:
11d93988-ea4d-4e37-
af30-763c2522693d)

Create Data Guard status (New standby     host1          January 17,2025
23:10:35 UTC          January 17, 2025 23:10:53 UTC          Success
site) (Host: standby2/Job ID:
aa5b286f-30f1-48d1-8c2d-2490d15ce408)

Update Data Guard status (Existing host1   January 17,2025 23:10:53
UTC          January 17, 2025 23:11:06 UTC          Success
standby site) (Host: standby1/JobID:
7d8ffa16-6785-468a-bff9-baf8e13b38ec)

```

Example 16-127 Configuring Oracle Data Guard using JSON file

```
# /opt/oracle/dcs/bin/odacli configure-dataguard --requestjson /mnt/host1/
nfsbackup/dgcmd.json
Number of standby databases (enter 1 or 2 | default: 1):
BUI password for Standby site standby1:
Password for root user on Standby site standby1:
Primary database SYS password:
*****
*****
Standby database's SYS password will be set to Primary database's after Data
Guard configuration. Ignore warning and proceed with Data Guard
configuration? (Y/N, default:N): Y
{
  "jobId" : "73adf616-3b6c-452f-bf93-e95abc675cc5",
  "status" : "Created",
  "message" : "",
  "reports" : [ ],
  "createTimestamp" : "January 23, 2025 05:08:50 AM UTC",
  "resourceList" : [ ],
  "description" : "DG Config service for DB tdb",
  "updatedAt" : "January 23, 2025 05:08:50 AM UTC",
  "jobType" : null,
  "cpsMetadata" : null
}

[root@host1 work]# /opt/oracle/dcs/bin/odacli describe-job -i
73adf616-3b6c-452f-bf93-e95abc675cc5

Job details
-----
                ID: 73adf616-3b6c-452f-bf93-e95abc675cc5
Description:    DG Config service for DB tdb
                Status: Success
                Created: January 23, 2025 05:08:50 UTC
                Message:

Task Name                               Start
Time                                     End Time
Status
-----
-----
Validate configure primary request       January 23, 2025 05:09:19
UTC                                       January 23, 2025 05:09:30 UTC      Success
(Primary site) (Host:
host1/Job

ID:

7bd1a3d5-2f8c-4d9e-
a381-61d04f01b514)

Validate configure standby request       January 23, 2025 05:09:30
UTC                                       January 23, 2025 05:09:43 UTC      Success
(Standby site)
```

```

(Host:

host2/Job
ID:

18731cf2-bf42-4a3a-
b187-17e93cedbb7c)

Uploading Primary DB Password File      January 23, 2025 05:09:43
UTC      January 23, 2025 05:10:03 UTC      Success
(Standby
site)

Configure primary database (Primary      January 23, 2025 05:10:03
UTC      January 23, 2025 05:11:35 UTC      Success
site) (Host: host1/Job
ID:

d3030fe0-8885-42d6-a57f-
ae38baef54af)

Configure standby request (Standby      January 23, 2025 05:11:35
UTC      January 23, 2025 05:13:35 UTC      Success
site)
(Host:

host2/Job
ID:

763881f4-ea4d-43bc-8e6a-
c7f78765c0ff)

Create archive log restore (Primary      January 23, 2025 05:13:35
UTC      January 23, 2025 05:13:54 UTC      Success
site) (Host: host1/Job
ID:

5dfbe653-10c8-420f-
bada-4c0c8cb6a9e1)

Configure and enable Data Guard          January 23, 2025 05:13:54
UTC      January 23, 2025 05:15:26 UTC      Success
(Primary site) (Host:
host1/Job

ID:

137d29a2-9d2c-4ddc-85c8-3a729847e188)

Enable Flashback (Standby site) (Host:  January 23, 2025 05:15:26
UTC      January 23, 2025 05:15:44 UTC      Success
host2/Job
ID:

70306983-40a2-4039-98cb-57ba5e11e9a5)

```

```

Re-enable Data Guard (Primary site)      January 23, 2025 05:15:44
UTC          January 23, 2025 05:15:50 UTC          Success
(Host: host1/Job
ID:

4a5fb2aa-1b0b-45c8-
b2f3-95103c9f1f00)

Create Data Guard status (Primary          January 23, 2025 05:15:50
UTC          January 23, 2025 05:15:56 UTC          Success
site) (Host: host1/Job
ID:

6848b9c1-356f-43ff-
b6e0-5e9b1b01fc53)

Create Data Guard status (Standby          January 23, 2025 05:15:56
UTC          January 23, 2025 05:16:09 UTC          Success
site) (Host:

host2/Job
ID:

3109148f-9ef8-4914-ab43-adab4851e126)

```

Example 16-128 Sample JSON for configuring Oracle Data Guard with two standby databases

To configure two standby databases using JSON file, you must specify two `replicationGroups` sections, where `sourceEndpoints` corresponds to the information about the primary database and `targetEndPoints` in each `replicationGroups` section corresponds to each standby database. For example:

```

{
  "name": "dgname",
  "protectionMode": "MAX_PERFORMANCE",
  "databaseName": "vmdb1",
  "enableActiveDg": false,
  "databaseName": "tdb", ==> newly added field
  "standbyEndpoints": [ ==> newly added field
    {
      "name": "endpoint_test",
      "dcsUserName": "oda-admin"
    }
  ]
  "replicationGroups": [
    {
      "sourceEndPoints": [
        {
          "databaseUniqueName": "vmdb1",
          "ipAddress": "xx.xx.xx.xx",
          "hostName": "host_name",
          "listenerPort": 1521
        }
      ]
    }
  ],

```

```

    "targetEndPoints": [
      {
        "databaseUniqueName": "bvmdb1",
        "ipAddress": "xx.xx.xx.xx",
        "hostName": "host_name",
        "listenerPort": 1521
      }
    ],
    "transportType": "ASYNC"
  },
  {
    "sourceEndPoints": [
      {
        "databaseUniqueName": "vmdb1",
        "ipAddress": "xx.xx.xx.xx",
        "hostName": "host_name",
        "listenerPort": 1521
      }
    ],
    "targetEndPoints": [
      {
        "databaseUniqueName": "avmdb1",
        "ipAddress": "xx.xx.xx.xx",
        "hostName": "host_name",
        "listenerPort": 1521
      }
    ],
    "transportType": "ASYNC"
  }
]
}

```

odacli deconfigure-dataguard

Use the command `odacli deconfigure-dataguard` to deconfigure Oracle Data Guard on Oracle Database Appliance.

File Path

```
/opt/oracle/dcs/bin/odacli
```

Syntax

```
# odacli deconfigure-dataguard [-h] [-j] -i [-f]
```

Parameters

| Parameter | Description |
|--------------------------|--|
| <code>--help, -h</code> | (Optional) Displays help for using the command. |
| <code>--json, -j</code> | (Optional) Displays JSON output. The default is false. |
| <code>--id, -i</code> | Specifies the Oracle Data Guard Configuration ID. |
| <code>--force, -f</code> | Forces the deconfiguration of Oracle Data Guard. |

Usage Notes

For deconfiguring Oracle Data Guard, you must specify the Oracle Data Guard Configuration ID. Run the `odacli list-dataguardstatus` command to find the Oracle Data Guard Configuration ID.

Example 16-129 Deconfiguring Oracle Data Guard with one standby database

```
# /opt/oracle/dcs/bin/odacli deconfigure-dataguard --id "ee22f382-b04e-4658-
a6c7-ab00fc7e3270"
Number of standby databases (enter 1 or 2 | default: 1):
Standby 1 site address: standby1
BUI username for Standby site standby1. If Multi-user Access/Multi-user
Access Passwordless is not enabled on Standby site standby1, enter 'oda-
admin'; otherwise, enter the name of the user who has irestored the Standby
database (default: oda-admin): oda-admin
BUI password for Standby site standby1:
Password for root user on Standby site standby1:
Standby database will be deleted after Data Guard configuration is removed.
Ignore warning and proceed with Data Guard deconfiguration? (Y/N): Y
{
  "jobId" : "0613c649-3da6-463a-8359-2f6d7d17399b",
  "status" : "Created",
  "message" : "",
  "reports" : [ ],
  "createTimestamp" : "January 23, 2025 03:42:41 AM UTC",
  "resourceList" : [ ],
  "description" : "DG Deconfig service",
  "updatedAt" : "January 23, 2025 03:42:41 AM UTC",
  "jobType" : null,
  "cpsMetadata" : null
}

[root@n1 oda]# /opt/oracle/dcs/bin/odacli describe-job -i
0613c649-3da6-463a-8359-2f6d7d17399b

Job details
-----
                ID: 0613c649-3da6-463a-8359-2f6d7d17399b
Description:    DG Deconfig service
                Status: Success
Created:       January 23, 2025 03:42:41 UTC
Message:

Task Name                               Start
Time                                     End Time
Status
-----
-----
De-configure Dataguard (Primary site)    January 23, 2025 03:42:44
UTC                                       January 23, 2025 03:44:22 UTC      Success
(Host: phxdbfzp22/Job
ID:
93758e42-2cf4-4aa1-949e-
```



```

b6018c1c35d7)

Delete Dataguard Status(Primary site)    January 23, 2025 03:44:22
UTC          January 23, 2025 03:44:28 UTC          Success
(Host: phxdbfzp22/Job
ID:

e090af71-9c6d-4d14-8e16-3c64c4aa7f14)

Delete Dataguard Status(Standby site)    January 23, 2025 03:44:28
UTC          January 23, 2025 03:44:36 UTC          Success
(Host:

standby1
/Job
ID:

a5bf022a-
c1ca-4c1a-8747-4ff6a0e938c0)

Delete Standby Database (Standby site)   January 23, 2025 03:44:36
UTC          January 23, 2025 03:46:07 UTC          Success
(Host:

standby1
/Job
ID:

f93b1f26-69d9-4690-84f9-4c0c9947423a)

```

odacli describe-dataguardstatus

Use the command `odacli describe-dataguardstatus` to view Oracle Data Guard status on Oracle Database Appliance.

File Path

```
/opt/oracle/dcs/bin/odacli
```

Syntax

```
# odacli describe-dataguardstatus -i [-h] [-j] [-s]
```

Parameters

| Parameter | Description |
|--------------------------------|---|
| <code>--id, -i</code> | (Mandatory) Specifies the Oracle Data Guard Status ID. |
| <code>--synchronous, -s</code> | (Optional) Obtains the latest Oracle Data Guard status synchronously. |
| <code>--help, -h</code> | (Optional) Displays help for using the command. |
| <code>--json, -j</code> | (Optional) Displays JSON output. The default is false. |

Usage Notes

Example 16-130 Viewing Oracle Data Guard configuration status

```
# odacli describe-dataguardstatus -i 1b13fddf-1648-44e9-b928-7aa6b36b783f -j
{
  "id" : "1b13fddf-1648-44e9-b928-7aa6b36b783f",
  "name" : "dgname",
  "databaseId" : "216697dd-c590-4807-8e15-98afc8624fa4",
  "protectionMode" : "MAX_PROTECTION",
  "role" : "STANDBY",
  "replicationGroups" : [ {
    "sourceEndPoints" : [ {
      "endpointType" : "PRIMARY",
      "databaseUniqueName" : "ctest",
      "ipAddress" : "xx.xx.xx.xx",
      "hostName" : "n1",
      "listenerPort" : 1521,
      "serviceName" : "serice_name",
      "sysPassword" : null,
      "openMode" : null,
      "state" : {
        "status" : "ENABLED"
      }
    }
  ] ,
  "targetEndPoints" : [ {
    "endpointType" : "STANDBY",
    "databaseUniqueName" : "ptest",
    "ipAddress" : "xx.xx.xx.xx",
    "hostName" : "n2",
    "listenerPort" : 1521,
    "serviceName" : "pservice_name",
    "sysPassword" : null,
    "openMode" : "READ ONLY WITH APPLY",
    "state" : {
      "status" : "ENABLED"
    }
  }
] ,
  "transportType" : "SYNC",
  "applyLag" : "0 seconds",
  "transportLag" : "0 seconds",
  "approximateRoleTransitionTime" : "30 seconds",
  "applyRate" : "3.00 KByte/s"
} , {
  "sourceEndPoints" : [ {
    "endpointType" : "PRIMARY",
    "databaseUniqueName" : "ctest",
    "ipAddress" : "xx.xx.xx.xx",
    "hostName" : "n1",
    "listenerPort" : 1521,
    "serviceName" : "servic_nae",
    "sysPassword" : null,
    "openMode" : null,
    "state" : {
      "status" : "ENABLED"
    }
  }
] ,
```

```

    }
  } ],
  "targetEndpoints" : [ {
    "endpointType" : "STANDBY",
    "databaseUniqueName" : "dtest",
    "ipAddress" : "xx.xx.xx.xx",
    "hostName" : "host_name",
    "listenerPort" : 1521,
    "serviceName" : "service_name",
    "sysPassword" : null,
    "openMode" : null,
    "state" : {
      "status" : "ENABLED"
    }
  }
] ],
"transportType" : "ASYNCR",
"applyLag" : "0 seconds",
"transportLag" : "0 seconds",
"approximateRoleTransitionTime" : "30 seconds",
"applyRate" : "15.00 KByte/s"
} ],
"observers" : [ ],
"createTime" : "November 22, 2024 23:47:13 CET",
"state" : {
  "status" : "CONFIGURED"
},
"updatedTime" : "November 23, 2024 00:12:24 CET"
}

```

odacli failover-dataguard

Use the command `odacli failover-dataguard` on the standby system to failover the Oracle Data Guard primary database to the standby database.

File Path

```
/opt/oracle/dcs/bin/odacli
```

Syntax

```
# odacli failover-dataguard [-h] [-j] [-i] [-u]
```

Parameters

| Parameter | Description |
|---------------------------------------|---|
| <code>--help, -h</code> | (Optional) Displays help for using the command. |
| <code>--json, -j</code> | (Optional) Displays JSON output. The default is false. |
| <code>--id, -i</code> | Specifies the Oracle Data Guard Status ID. |
| <code>--databaseUniqueName, -u</code> | Specifies the unique name of the database to failover to. |

Usage Notes

After performing the failover, view the status with the `odacli list-dataguardstatus` command.

Example 16-131 Performing Failover Oracle Data Guard

```
# odacli failover-dataguard -i 75f23ce0-006a-4aeb-ba6d-b4b60275c19 -u houdg02
```

odacli list-dataguardstatus

Use the command `odacli list-dataguardstatus` to verify Oracle Data Guard status on both primary and standby databases.

File Path

```
/opt/oracle/dcs/bin/odacli
```

Syntax

```
# odacli list-dataguardstatus [-s] [-h] [-j]
```

Parameters

| Parameter | Description |
|--------------------------------|---|
| <code>--synchronous, -s</code> | (Optional) Obtains the latest Oracle Data Guard status synchronously. |
| <code>--help, -h</code> | (Optional) Displays help for using the command. |
| <code>--json, -j</code> | (Optional) Displays JSON output. The default is false. |

Usage Notes

Example 16-132 Viewing Oracle Data Guard status on primary and standby databases

```
# odacli list-dataguardstatus
Updated about 5 second(s) ago
It can take up to several minutes to update Data Guard status. You can re-run
the command to obtain the latest status.
```

| ID | Name | Role | Protection Mode | Status |
|--------------------------------------|--------|---------|-----------------|------------|
| 1b13fddf-1648-44e9-b928-7aa6b36b783f | dgname | PRIMARY | MAX_PROTECTION | CONFIGURED |
| test | | | | |

odacli reinstate-dataguard

Use the command `odacli reinstate-dataguard` on the new primary system to reinstate a failed primary database after a failover and convert it to a new standby database.

File Path

```
/opt/oracle/dcs/bin/odacli
```

Syntax

```
# odacli reinstate-dataguard [-h] [-j] [-i] [-u]
```

Parameters

| Parameter | Description |
|---------------------------------------|--|
| <code>--help, -h</code> | (Optional) Displays help for using the command. |
| <code>--json, -j</code> | (Optional) Displays JSON output. The default is false. |
| <code>--id, -i</code> | Specifies the Oracle Data Guard Status ID. |
| <code>--databaseUniqueName, -u</code> | (Optional) Specifies the unique name of the database to reinstate. |

Usage Notes

After completing the reinstate operation, view the status with the `odacli list-dataguardstatus` command.

Example 16-133 Performing reinstate operation on Oracle Data Guard

```
# odacli reinstate-dataguard -i 75f23ce0-006a-4aeb-ba6d-b4b60275c19 -u houdg02
```

odacli register-dataguard

Use the command `odacli register-dataguard` to register Oracle Data Guard with Oracle Database Appliance.

File Path

```
/opt/oracle/dcs/bin/odacli
```

Syntax

```
# odacli register-dataguard [-h] [-j] [-r json_input_file]
```

Parameters

| Parameter | Description |
|--------------------------------|--|
| <code>--requestjson, -r</code> | Specifies the JSON input for creation of Oracle Data Guard configuration in the advanced option. |

| Parameter | Description |
|-------------------------|--|
| <code>--help, -h</code> | (Optional) Displays help for using the command. |
| <code>--json, -j</code> | (Optional) Displays JSON output. The default is false. |

odacli switchover-dataguard

Use the command `odacli switchover-dataguard` on the primary system to reverse the Oracle Data Guard primary and standby database roles on Oracle Database Appliance.

File Path

```
/opt/oracle/dcs/bin/odacli
```

Syntax

```
# odacli switchover-dataguard [-h] [-j] [-i] [-u]
```

Parameters

| Parameter | Description |
|---------------------------------------|--|
| <code>--help, -h</code> | (Optional) Displays help for using the command. |
| <code>--json, -j</code> | (Optional) Displays JSON output. |
| <code>--id, -i</code> | Specifies the Oracle Data Guard Status ID. |
| <code>--databaseUniqueName, -u</code> | (Optional) Specifies the unique name of the database to switchover to. |

Usage Notes

After performing the switchover, view the status with the `odacli list-dataguardstatus` command.

Example 16-134 Switching over Oracle Data Guard

```
# odacli switchover-dataguard -i 75f23ce0-006a-4aeb-ba6d-b4b60275c19 -u
houdg02
```

odacli CPU Core Commands

Use the CPU Core commands to enable CPU cores and display current and historical CPU core configurations.

- [odacli list-cpucores](#)
Use the `odacli list-cpucores` command lists the history of core configuration changes in the system.
- [odacli describe-cpucore](#)
Use the `odacli describe-cpucore` command to display the current core configuration and the modification date and time.

- [odacli modify-cpucore](#)
Use the `odacli modify-cpucore` command to enable the number of CPU cores in the system.

odacli list-cpucores

Use the `odacli list-cpucores` command lists the history of core configuration changes in the system.

File Path

```
$ORACLE_HOME/opt/oracle/dcs/bin/odacli
```

Syntax

```
odacli list-cpucores [-h]
```

Parameters

| Parameter | Description |
|-------------------------|---|
| <code>--help, -h</code> | (Optional) Displays help for using the command. |

Example 16-135 Displaying a List of Cores

```
# odacli list-cpucores
```

```
Node  Cores  Modified                               Job Status
-----  -----  -----                               -
0      10      July 22, 2016 12:06:08 PM SGT  Configured
0       8      July 25, 2016 9:39:59 AM SGT  Configured
```

odacli describe-cpucore

Use the `odacli describe-cpucore` command to display the current core configuration and the modification date and time.

File Path

```
/opt/oracle/dcs/bin/odacli
```

Syntax

```
odacli describe-cpucore [-h]
```

Parameters

| Parameter | Description |
|-------------------------|---|
| <code>--help, -h</code> | (Optional) Displays help for using the command. |

Example 16-136 Displaying the Current Core Configuration

```
# odacli describe-cpucore

Node  Cores  Modified                               Job Status
-----  -----  -----  -----
0      8      July 25, 2016 9:39:59 AM SGT  Configured
```

odacli modify-cpucore

Use the `odacli modify-cpucore` command to enable the number of CPU cores in the system.

File Path

```
/opt/oracle/dcs/bin/odacli
```

Syntax

```
odacli modify-cpucore -c cores [-j] [-h]
```

Parameters

| Parameter | Description |
|--------------------------|--|
| <code>--cores, -c</code> | Defines the number of cores to be enabled in the system. |
| <code>--help, -h</code> | (Optional) Displays help for using the command. |
| <code>--json, -j</code> | (Optional) Displays JSON output. |

Usage Notes

- The number of cores you enable must be a multiple of 2.
- After the initial configuration, you cannot reduce the number of cores. You can only increase the number of cores.
- When you run the command, you are prompted to confirm the operation with the following message:

```
Modifying the enabled number of CPU requires a reboot of all nodes in the
ODA system. Are you sure you want to proceed with this operation? (Y/N):
```

- Nodes are restarted after modifying the cores in the BIOS. Note this results in database outage as all the nodes in the cluster are restarted at the same time. Once the system is restarted, the system is updated with the correct number of cores.

Example 16-137 Enabling CPU Cores

The following command enables 8 CPU cores.

```
# odacli modify-cpucore -c 32
Modifying the enabled number of CPU requires a reboot of all nodes in the ODA
system. Are you sure you want to proceed with this operation? (Y/N): y
{
```



```
"jobId" : "1a59d182-79f0-4847-81e6-ab3ebf779096",
"status" : "Created",
"message" : null,
"reports" : [ ],
"createTimestamp" : "December 8, 2024 10:29:37 AM UTC",
"resourceList" : [ ],
"description" : "CPU cores service update",
"updatedAt" : "December 8, 2024 10:29:37 AM UTC"
}
```

WARNING: Reducing the number of enabled cores may set offline any of the CPUs used by a CPU Pool. Thus, please review the status of all the CPU Pools after this operation using the 'describe-cpupool' command. In case of any CPU from a CPU Pool was offline please run 'modify-cpupool' to update the list of CPUs and use only online CPUs.

WARNING: All the nodes in this ODA system will reboot after this operation

odacli CPU Pool Commands for Bare Metal and KVM

Use odacli commands to manage resource allocations on Oracle Database Appliance for bare metal and KVM deployments.

CPU pools enable management of CPU resources in both bare metal and KVM environments. There are two types of CPU pools, that is, BM and VM.

Use the BM CPU pool to ensure that the database on a bare metal host runs exclusively on the CPUs specified in the CPU pool.

Use the VM CPU pools to cage and manage CPU resource allocations to workloads for virtual machines. Workloads are isolated by creating CPU pools and assigning or pinning virtual machines to a specific CPU pool. When you pin a virtual machine to a CPU pool, you ensure that the virtual machine uses CPUs in only that CPU pool.

Resources in CPU pools cannot overlap, that is, CPU pools cannot share CPUs.

- [odacli create-cpupool](#)
Use the `odacli create-cpupool` command to create a new CPU pool on Oracle Database Appliance Bare Metal or Kernel-based Virtual Machine (KVM) deployment.
- [odacli remap-cpupools](#)
Use the `odacli remap-cpupools` command to remap CPU pools to NUMA allocation on Oracle Database Appliance Bare Metal or Kernel-based Virtual Machine (KVM) deployment.
- [odacli list-cpupools](#)
Use the `odacli list-cpupools` command to list all CPU Pools on Oracle Database Appliance Bare Metal or Kernel-based Virtual Machine (KVM) deployment.
- [odacli describe-cpupool](#)
Use the `odacli describe-cpupool` command to describe CPU Pools on Oracle Database Appliance Bare Metal or Kernel-based Virtual Machine (KVM) deployment.
- [odacli modify-cpupool](#)
Use the `odacli modify-cpupool` command to modify a CPU Pool configuration on Oracle Database Appliance Bare Metal or Kernel-based Virtual Machine (KVM) deployment.
- [odacli delete-cpupool](#)
Use the `odacli delete-cpupool` command to delete a CPU Pool configuration on Oracle Database Appliance Kernel-based Virtual Machine (KVM).

- [odacli list-auditrecords](#)
Use the `odacli list-auditrecords` command to list the audit records for a CPU Pool on Oracle Database Appliance Bare Metal or Kernel-based Virtual Machine (KVM) deployment.
- [odacli describe-auditrecord](#)
Use the `odacli describe-auditrecord` command to describe the audit record for a CPU Pool on Oracle Database Appliance Bare Metal or Kernel-based Virtual Machine (KVM) deployment.

odacli create-cpupool

Use the `odacli create-cpupool` command to create a new CPU pool on Oracle Database Appliance Bare Metal or Kernel-based Virtual Machine (KVM) deployment.

Syntax

```
odacli create-cpupool -n name -c number_of_cores {-bm|-vm} [-nn node_name] [-s socket]
[-dbs] [-urc] [-j] [-h]
```

Parameters

| Parameter | Description |
|---|---|
| <code>--name, -n</code> | Specifies the CPU Pool name. |
| <code>--cores, -c</code> | Specifies the CPU Pool cores. |
| <code>--bm, -bm</code> | (Optional) Specifies the CPU Pool as Bare Metal. |
| <code>--vm, -vm</code> | (Optional) Specifies the CPU Pool as Virtual Machine. |
| <code>--dbsystem, -dbs</code> | (Optional) Specifies the CPU Pool type as DB System. |
| <code>--socket, -s</code> | (Optional) Specifies the socket to use. If not specified, then use all available sockets. |
| <code>--use-reserved-cores, -urc</code> | (Optional) Specifies to use reserved CPU cores. |
| <code>--node-name, -nn</code> | (Optional) Specifies the node where the CPU Pool will be created. On High-Availability deployment, if this option is not specified, then the CPU pool is created on both nodes. |
| <code>--json, -j</code> | (Optional) Displays output in JSON format. |
| <code>--help, -h</code> | (Optional) Displays help for using the command. |

Usage Notes

- Attach the BM CPU pool to databases. Bare metal CPU pools can be assigned to multiple databases.
- Attach VM CPU pool VM to guest machines. VM CPU pools can be assigned to multiple VMs.
- Attach dbsystem CPU pool to DB systems. dbsystem CPU pool can be assigned to multiple DB systems. After you create a dbsystem CPU pool, you can create a new DB system with this CPU pool by adding the new CPU pool parameter in the create-dbsystem json file, or modify-dbsystem to attach CPU pool to an existing DB system.
- Resources in CPU pools cannot overlap, that is, CPU pools cannot share CPUs.

- After you create a BM CPU pool, you can associate this CPU pool to a database using the `create-database` or `modify-database` command.
- After you create a VM CPU pool, you can associate this CPU pool to a VM using the `create-vm` or `modify-vm` command.
- Number of cores must be an even number between 2 and the total number of available cores on the system.
- By default, a CPU in the CPU pool is allocated across two sockets in release 19.12 and later. Optionally, you can choose to allocate the CPU based on the socket number (0 or 1). This is especially useful to support Standard Edition licensing. It is recommended that you use the default allocation and do not mix two types of allocation.
- By default, the first core of the socket is reserved and cannot be used by the VM and DB system CPU pools for optimal performance. Use the `--use-reserved-cores` option to enable use of the first core of socket for VM and DB system CPU pools.

Example

Create a BM CPU pool named `cpupool1` with 6 cores associated to it.

```
# odacli create-cpupool -n cpupool1 -c 6 -bm
```

Create a VM CPU pool named `cpupool2` with 6 cores associated to it.

```
# odacli create-cpupool -n cpupool2 -c 6 -vm
```

Create a DB System CPU pool named `cpupool3` with 6 cores associated to it.

```
# odacli create-cpupool -n cpupool3 -c 6 -dbs
```

Create a DB System CPU pool named `cpupool4` with 4 cores of CPUs allocated from socket 0.

```
# odacli create-cpupool -n cpupool4 -dbs -s 0 -c 4
```

odacli remap-cpupools

Use the `odacli remap-cpupools` command to remap CPU pools to NUMA allocation on Oracle Database Appliance Bare Metal or Kernel-based Virtual Machine (KVM) deployment.

Syntax

```
odacli remap-cpupools -f -urc [-j] [-h]
```

Parameters

| Parameter | Description |
|---------------------------------------|---|
| <code>--force, -f</code> | (Optional) Specifies to force the operation. |
| <code>--use-reserved-cores, -j</code> | (Optional) Specifies to use reserved CPU cores. |
| <code>--json, -j</code> | (Optional) Displays output in JSON format. |
| <code>--help, -h</code> | (Optional) Displays help for using the command. |

Usage Notes

If the `odacli remap-cpupools` command fails with the error `DCS-10001:Internal error encountered: Not enough physical CPUs available for CPU Pool 'cpupool_name' on node 'node_name'`, run the `odacli remap-cpupools` command again with the `--use_reserved-cores` option.

Use the `--force` option to remap CPU pools even if the CPU pool is marked as NUMA-enabled. You must use `odacli remap-cpupools` command, after updating the bare metal CPU cores with the command `odacli modify-cpucores` for CPU core number changes.

By default, the first core of the socket is reserved and cannot be used by the VM and DB system CPU pools for optimal performance. Use the `--use-reserved-cores` option to enable use of the first core of socket for VM and DB system CPU pools.

Example

```
# odacli remap-cpupools
```

Related Topics

- [odacli modify-vm](#)
Use the `odacli modify-vm` command to modify a virtual machine on Oracle Database Appliance Kernel-based Virtual Machine (KVM).
- [odacli remap-cpupools](#)
Use the `odacli remap-cpupools` command to remap CPU pools to NUMA allocation on Oracle Database Appliance Bare Metal or Kernel-based Virtual Machine (KVM) deployment.
- [odacli modify-dbsystem](#)
Use the `odacli modify-dbsystem` command to modify a DB system on Oracle Database Appliance Kernel-based Virtual Machine (KVM).
- [odacli create-cpupool](#)
Use the `odacli create-cpupool` command to create a new CPU pool on Oracle Database Appliance Bare Metal or Kernel-based Virtual Machine (KVM) deployment.

odacli list-cpupools

Use the `odacli list-cpupools` command to list all CPU Pools on Oracle Database Appliance Bare Metal or Kernel-based Virtual Machine (KVM) deployment.

Syntax

```
odacli list-cpupools [-j] [-h]
```

Parameters

| Parameter | Description |
|-------------------------|---|
| <code>--json, -j</code> | (Optional) Displays output in JSON format. |
| <code>--help, -h</code> | (Optional) Displays help for using the command. |

Example

```
# odacli list-cpupools
```

odacli describe-cpupool

Use the `odacli describe-cpupool` command to describe CPU Pools on Oracle Database Appliance Bare Metal or Kernel-based Virtual Machine (KVM) deployment.

Syntax

```
odacli describe-cpupool -n name [-j] [-h]
```

Parameters

| Parameter | Description |
|-------------------------|---|
| <code>--name, -n</code> | Specifies the name of the CPU Pool. |
| <code>--json, -j</code> | (Optional) Displays output in JSON format. |
| <code>--help, -h</code> | (Optional) Displays help for using the command. |

Example: Describing a CPU pool named `cpupool1`

```
# odacli describe-cpupool -n cpupool1
```

odacli modify-cpupool

Use the `odacli modify-cpupool` command to modify a CPU Pool configuration on Oracle Database Appliance Bare Metal or Kernel-based Virtual Machine (KVM) deployment.

Syntax

```
odacli modify-cpupool -n name -c cores -f -l [-j] [-h]
```

Parameters

| Parameter | Description |
|--------------------------|---|
| <code>--name, -n</code> | Specifies the CPU Pool name |
| <code>--cores, -c</code> | Specifies the new number of CPU cores |
| <code>--force, -f</code> | (Optional) Forces the operation |
| <code>--live, -l</code> | (Optional) Applies the changes to running VMs |
| <code>--json, -j</code> | (Optional) Displays output in JSON format. |
| <code>--help, -h</code> | (Optional) Displays help for using the command. |

Usage Notes

For VM CPU pool, if `--live` is not specified, then the changes are applied to the VM configuration file and will be activated next time the VM is started. If `--live` is specified, then the changes will be applied to both VM configuration file and to the running VM.

Example

Set the size of a CPU Pool `cpupool1` to 10. If `--live` is not specified, the change is applied to the VM configuration file and will be activated next time the VM is started.

```
# odacli modify-cpupool -n cpupool1 -c 10
```

odacli delete-cpupool

Use the `odacli delete-cpupool` command to delete a CPU Pool configuration on Oracle Database Appliance Kernel-based Virtual Machine (KVM).

Syntax

```
odacli delete-cpupool -n name -f [-j] [-h]
```

Parameters

| Parameter | Description |
|--------------------------|---|
| <code>--name, -n</code> | Specifies the CPU Pool name to be deleted |
| <code>--force, -f</code> | (Optional) Forces deletion. |
| <code>--json, -j</code> | (Optional) Displays output in JSON format. |
| <code>--help, -h</code> | (Optional) Displays help for using the command. |

Example

Delete a CPU pool named `cpupool1`.

```
# odacli delete-cpupool -n cpupool1
```

odacli list-auditrecords

Use the `odacli list-auditrecords` command to list the audit records for a CPU Pool on Oracle Database Appliance Bare Metal or Kernel-based Virtual Machine (KVM) deployment.

Syntax

```
odacli list-auditrecords -du dcs-username -f from_date-range -l latest -nn node_name -ot operation_type -ou OS_username -rn resource_name -rt resource_type -t to_date-range [-j] [-h]
```

Parameters

| Parameter | Description |
|-------------------------------|---|
| <code>--dcs-user, -du</code> | (Optional) Specifies the DCS user name. |
| <code>--from, -f</code> | (Optional) Specifies the <i>from</i> date in the date range for the CPU pool audit records. |
| <code>--latest, -l</code> | (Optional) Specifies the latest number of CPU pool audit records. |
| <code>--node-name, -nn</code> | (Optional) Specifies the node name. |
| <code>--op-type, -ot</code> | (Optional) Specifies the type of operation. |
| <code>--os-user, -ou</code> | (Optional) Specifies the operating system user. |
| <code>--rsc-name, -rn</code> | (Optional) Specifies the resource name. |
| <code>--rsc-type, -rt</code> | (Optional) Specifies the resource type. |
| <code>--to, -t</code> | (Optional) Specifies the <i>to</i> date in the date range for the CPU pool audit records. |
| <code>--json, -j</code> | (Optional) Displays output in JSON format. |

| Parameter | Description |
|------------|---|
| --help, -h | (Optional) Displays help for using the command. |

Example

```
# odacli list-auditrecords
ID                               Resource type      Resource name
Operation type  DCS username      OS username      Timestamp
-----
41295d99-f263-4284-b6d9-2aff1ae0f850  BM_CPU_POOL      testbmpool
CREATE          oda-admin         root             2020-10-08 13:27:05 UTC
0f07a013-5bb4-4cd8-bd49-04dc61fcd454  BM_CPU_POOL      pool_9f74a8e9-
DELETE         oda-admin         root             2020-10-08 12:26:30 UTC
d858269b-6c28-4bc2-af71-79004f3561e6  BM_CPU_POOL      pool_9f74a8e9-
CREATE          oda-admin         root             2020-10-08 12:24:36 UTC
9d7852c1-93fb-410e-9e0c-8c0a95ed3f0c  VM_CPU_POOL      pool_d48e81e4-
DELETE         oda-admin         root             2020-10-08 12:06:45 UTC
0235cc84-9345-40bc-ac4f-7de3f63202e2  VM_CPU_POOL      pool_4fe0b4f4-
DELETE         oda-admin         root             2020-10-08 12:06:45 UTC
762f7263-7bd9-4b12-b891-48305165bf36  VM_CPU_POOL      pool_4fe0b4f4-
MODIFY         oda-admin         root             2020-10-08 12:06:22 UTC
0bd2a25d-2327-4918-bd47-8c00f7406f92  VM_CPU_POOL      pool_4fe0b4f4-
MODIFY
```

odacli describe-auditrecord

Use the `odacli describe-auditrecord` command to describe the audit record for a CPU Pool on Oracle Database Appliance Bare Metal or Kernel-based Virtual Machine (KVM) deployment.

Syntax

```
odacli describe-auditrecord -i [-j] [-h]
```

Parameters

| Parameter | Description |
|------------|---|
| --id, -i | Describes the ID of the audit record. |
| --json, -j | (Optional) Displays output in JSON format. |
| --help, -h | (Optional) Displays help for using the command. |

Example

```
# odacli describe-auditrecord -i 41295d99-f263-4284-b6d9-2aff1ae0f850
Audit Record details
```

```
-----
Event details
```

```
-----
Record ID: 41295d99-f263-4284-b6d9-2aff1ae0f850
Record timestamp: 2020-10-08 13:27:05 UTC
DCS username: oda-admin
OS username: root
Cluster ID: test_cluster-c
Node ID: test_cluster
```

```
Resource/Operation
```

```

-----
Resource type: BM_CPU_POOL
Resource ID: b17cb623-bf79-491f-86d8-d8502987e26c
Resource name: testbmpool
Operation type: CREATE
Operation description: Created with '2' cores and allocation
'test_cluster:1-2,17-18'

```

odacli Database Commands

Use the `odacli` database commands to perform database lifecycle operations.

- [odacli clone-database](#)
Use the `odacli clone-database` command to clone a new database from a source database.
- [odacli create-database](#)
Use the `odacli create-database` command to create a new database.
- [odacli delete-database](#)
Use the `odacli delete-database` command to delete a database.
- [odacli describe-database](#)
Use the `odacli describe-database` command to display database details.
- [odacli list-databases](#)
Use the `odacli list-databases` command to list all databases on the appliance.
- [odacli modify-database](#)
Use the `odacli modify-database` command to modify the configuration of a database, such as backup configuration, database class, and database type, and to change TDE wallet management from `EXTERNAL` to `ODA`.
- [odacli move-database](#)
Use the command `odacli move-database` to move a database from one Oracle home to another home of the same database version.
- [odacli register-database](#)
Use the `odacli register-database` command to register a migrated database with the appliance.
- [odacli upgrade-database](#)
You can use the `odacli upgrade-database` command to upgrade a database from a supported release.

odacli clone-database

Use the `odacli clone-database` command to clone a new database from a source database.

File Path

```
/opt/oracle/dcs/bin/odacli
```

Syntax

```
odacli clone-database [-u] [-n] [-dh] [-nh] [-ro] [-s] [-t] [-j] [-f] [-nn] [-p] [-h] [-ha|-no-ha] [-cp]
```

Parameters

| Parameter | Description |
|---|---|
| <code>--databaseUniqueName, -u</code> | Defines a unique name for the database. |
| <code>--dbname, -n</code> | Defines the name given to the new database (<code>dbname</code> .) |
| <code>--dbhomeid, -dh</code> | Specifies the database home ID of the new database. |
| <code>--newhome, -nh</code> | Specifies that a new database home must be created. |
| <code>--readonly, -ro</code> | (Optional) Specifies to open the database in read-only mode. |
| <code>--dbshape, -s</code> | (Optional) Identifies the database shape (template) and determines the total memory allocated to the database. For example, <code>odb1</code> and <code>odb2</code> . The default is <code>odb1</code> . |
| <code>--dbtype, -t [RAC RACOne SI]</code> | (Optional) Defines the database type. The default database type is the source database type, if the option is not specified. For high-availability deployments, the values can be <code>RAC RACOne SI</code> , with the default as <code>RAC</code> . For single-node deployments, the value is <code>SI</code> . |
| <code>--help, -h</code> | (Optional) Displays help for using the command. |
| <code>--json, -j</code> | (Optional) Displays JSON output. |
| <code>--sourcedbname, -f</code> | Specifies the name of the source database |
| <code>--associated-networks, -nn</code> | (Optional) Specifies the associated network names (in the format <code>networkName1,networkName2,...</code>). |
| <code>--disable-ha, -no-ha</code> | (Optional) Disables High Availability for single-instance Oracle Database 19c and later. |
| <code>--enable-ha, -ha</code> | (Optional) Enables High Availability for single-instance Oracle Database 19c and later. |
| <code>--cpupool, -cp</code> | (Optional) Specifies the CPU pool name. |
| <code>--tdepassword, -p</code> | (Optional) Specifies the TDE password of the source database. |

Usage Notes

- The source database must be up and running.
- The source database must be opened in either read-write mode, or read-only mode if it is a primary database. A standby database can be in mounted or read-only open mode.
- The source database must use Oracle ACFS storage.
- The source database must not be a multitenant container database (CDB)
- If `-cp` parameter is provided as part of the command, cloned database is associated with the particular CPU pool.
- If `-cp` parameter is not provided as part of the command, and if the parent database has an associated CPU pool, then the cloned database is also associated with the same CPU pool as that of parent database.
- If `-cp` parameter is not provided as part of the command, and if the parent database does not have any associated CPU pool, then the cloned database is also not associated with any CPU pool.
- All data files of the source database must be in the same Oracle ACFS directory.

Example 16-138 Cloning a Database in a new database home

```
# odacli list-databases
```

| ID | DB Name | DB Type | DB |
|--------------------------------------|---------|---------|------------|
| Version | Shape | Storage | Status |
| CDB | Class | | |
| DbHomeID | | | |
| bb06935b-384d-482f-b494-45d368d2122a | mydb | SI | |
| 19.16.0.0.220719 | odb1 | ACFS | CONFIGURED |
| 542032e5-a76c-4d66-92e1-bb297ec6192d | primary | SI | |
| a03b5971-bee5-4d9a-b003-009df6f018f6 | odb1 | ACFS | CONFIGURED |
| 618b26d7-a49b-452f-a14b-cfc2c79d0555 | chome1 | SI | |
| a5173f68-6b5c-491f-b8b4-05bce0e7ec20 | odb1 | ACFS | CONFIGURED |
| 6339e2fc-7ae7-4de2-ac3c-9f5b2eaec131 | | | |

```
# odacli list-dbhomes
```

| ID | Name | DB |
|--------------------------------------|-------------------------------------|----|
| Version | Home | |
| Location | Status | |
| 542032e5-a76c-4d66-92e1-bb297ec6192d | OraDB19000_home1 | |
| 19.16.0.0.220719 | /u01/app/odaorahome/oracle/product/ | |
| 19.0.0.0/dbhome_1 | CONFIGURED | |
| 6339e2fc-7ae7-4de2-ac3c-9f5b2eaec131 | OraDB19000_home2 | |
| 19.16.0.0.220719 | /u01/app/odaorahome/oracle/product/ | |
| 19.0.0.0/dbhome_2 | CONFIGURED | |
| 618b26d7-a49b-452f-a14b-cfc2c79d0555 | OraDB19000_home3 | |
| 19.16.0.0.220719 | /u01/app/odaorahome/oracle/product/ | |
| 19.0.0.0/dbhome_3 | CONFIGURED | |

```
# odacli clone-database -n chome4 -u chome4 -f primary -nh
Enter SYS user password:
Retype SYS user password:
```

```
Job details
```

```
-----
ID: f3052b47-e9b6-4825-bef3-91635db4f255
Description: Snap Database service creation with db name: chome4
Status: Created
Created: August 4, 2022 12:23:41 PM UTC
Message:
```

| Task Name | Start Time |
|-----------|------------|
| End Time | Status |
| | |

```
# odacli describe-job -i f3052b47-e9b6-4825-bef3-91635db4f255
```

Job details

```

-----
ID: f3052b47-e9b6-4825-bef3-91635db4f255
Description: Snap Database service creation with db name: chome4
Status: Success
Created: August 4, 2022 12:23:41 PM UTC
Message:

```

| Task Name | Start Time |
|--|--------------------------------|
| End Time | Status |
| ----- | |
| Validate HugeSpaces | August 4, 2022 12:24:00 PM UTC |
| August 4, 2022 12:24:00 PM UTC | Success |
| Validate source database | August 4, 2022 12:24:00 PM UTC |
| August 4, 2022 12:24:11 PM UTC | Success |
| Setting up ssh equivalance | August 4, 2022 12:24:11 PM UTC |
| August 4, 2022 12:24:12 PM UTC | Success |
| Creating volume rdochome4 | August 4, 2022 12:24:12 PM UTC |
| August 4, 2022 12:24:28 PM UTC | Success |
| Creating ACFS filesystem for RECO | August 4, 2022 12:24:28 PM UTC |
| August 4, 2022 12:24:46 PM UTC | Success |
| Database home creation | August 4, 2022 12:24:46 PM UTC |
| August 4, 2022 12:28:06 PM UTC | Success <===== New task |
| Creating ACFS database home | August 4, 2022 12:24:46 PM UTC |
| August 4, 2022 12:24:46 PM UTC | Success <===== New task |
| Validating dbHome available space | August 4, 2022 12:24:46 PM UTC |
| August 4, 2022 12:24:46 PM UTC | Success <===== New task |
| Creating DbHome Directory | August 4, 2022 12:24:46 PM UTC |
| August 4, 2022 12:24:46 PM UTC | Success <===== New task |
| Create required directories | August 4, 2022 12:24:46 PM UTC |
| August 4, 2022 12:24:46 PM UTC | Success <===== New task |
| Extract DB clone | August 4, 2022 12:24:46 PM UTC |
| August 4, 2022 12:26:14 PM UTC | Success <===== New task |
| ProvDbHome by using RHP | August 4, 2022 12:26:14 PM UTC |
| August 4, 2022 12:27:43 PM UTC | Success <===== New task |
| Enable DB options | August 4, 2022 12:27:43 PM UTC |
| August 4, 2022 12:28:02 PM UTC | Success <===== New task |
| Creating wallet for DB Client | August 4, 2022 12:28:06 PM UTC |
| August 4, 2022 12:28:06 PM UTC | Success <===== New task |
| Audit directory creation | August 4, 2022 12:28:06 PM UTC |
| August 4, 2022 12:28:06 PM UTC | Success <===== New task |
| Creation of snapshot database | August 4, 2022 12:28:06 PM UTC |
| August 4, 2022 12:32:46 PM UTC | Success |
| Removing Disabled Redo Threads | August 4, 2022 12:32:46 PM UTC |
| August 4, 2022 12:32:47 PM UTC | Success |
| Creation of SPFile for Shared location | August 4, 2022 12:32:50 PM UTC |
| August 4, 2022 12:32:56 PM UTC | Success |
| Delete SPFile from local location | August 4, 2022 12:32:56 PM UTC |
| August 4, 2022 12:32:56 PM UTC | Success |
| Register DB with clusterware | August 4, 2022 12:32:56 PM UTC |
| August 4, 2022 12:34:23 PM UTC | Success |
| Set SysPassword and Create PwFile | August 4, 2022 12:34:23 PM UTC |
| August 4, 2022 12:34:27 PM UTC | Success |
| Creating pfile | August 4, 2022 12:34:27 PM UTC |

```

August 4, 2022 12:34:28 PM UTC      Success
Disabling external references      August 4, 2022 12:34:28 PM UTC
August 4, 2022 12:34:29 PM UTC      Success
Set CPU pool                        August 4, 2022 12:34:29 PM UTC
August 4, 2022 12:34:29 PM UTC      Success
Enabling supplemental log data     August 4, 2022 12:35:45 PM UTC
August 4, 2022 12:35:46 PM UTC      Success
Enabling blockchange tracking       August 4, 2022 12:35:46 PM UTC
August 4, 2022 12:35:47 PM UTC      Success
Enabling flashback                  August 4, 2022 12:35:47 PM UTC
August 4, 2022 12:35:48 PM UTC      Success
Copy Pwfile to Shared Storage      August 4, 2022 12:35:48 PM UTC
August 4, 2022 12:35:51 PM UTC      Success
Create tns entry                    August 4, 2022 12:35:51 PM UTC
August 4, 2022 12:35:52 PM UTC      Success
Reset Associated Networks           August 4, 2022 12:35:52 PM UTC
August 4, 2022 12:35:55 PM UTC      Success
Set log_archive_dest for Database   August 4, 2022 12:35:55 PM UTC
August 4, 2022 12:35:58 PM UTC      Success

```

```
# odacli list-databases
```

| ID | DB Name | DB Type | DB |
|--------------------------------------|---------|---------|------------|
| Version | Shape | Storage | Status |
| CDB | Class | | |
| DbHomeID | | | |
| bb06935b-384d-482f-b494-45d368d2122a | mydb | SI | |
| 19.16.0.0.220719 | odb1 | ACFS | CONFIGURED |
| 542032e5-a76c-4d66-92e1-bb297ec6192d | | | |
| a03b5971-bee5-4d9a-b003-009df6f018f6 | primary | SI | |
| 19.16.0.0.220719 | odb1 | ACFS | CONFIGURED |
| 618b26d7-a49b-452f-a14b-cfc2c79d0555 | | | |
| a5173f68-6b5c-491f-b8b4-05bce0e7ec20 | chome1 | SI | |
| 19.16.0.0.220719 | odb1 | ACFS | CONFIGURED |
| 6339e2fc-7ae7-4de2-ac3c-9f5b2eaec131 | | | |
| 6bf06951-d89f-4acb-bb93-39ebdfcec4d7 | chome4 | SI | |
| 19.16.0.0.220719 | odb1 | ACFS | CONFIGURED |
| 31693275-85f5-4932-8ad6-8abe8c93ce46 | | | |

```
# odacli list-dbhomes
```

| ID | Name | DB |
|--------------------------------------|-------------------------------------|----|
| Version | Home | |
| Location | Status | |
| 542032e5-a76c-4d66-92e1-bb297ec6192d | OraDB19000_home1 | |
| 19.16.0.0.220719 | /u01/app/odaorahome/oracle/product/ | |
| 19.0.0.0/dbhome_1 | CONFIGURED | |
| 6339e2fc-7ae7-4de2-ac3c-9f5b2eaec131 | OraDB19000_home2 | |
| 19.16.0.0.220719 | /u01/app/odaorahome/oracle/product/ | |
| 19.0.0.0/dbhome_2 | CONFIGURED | |
| 618b26d7-a49b-452f-a14b-cfc2c79d0555 | OraDB19000_home3 | |

```
19.16.0.0.220719 /u01/app/odaorahome/oracle/product/
19.0.0.0/dbhome_3 CONFIGURED
31693275-85f5-4932-8ad6-8abe8c93ce46 OraDB19000_home4
19.16.0.0.220719 /u01/app/odaorahome/oracle/product/
19.0.0.0/dbhome_4 CONFIGURED <=== New DB Home
```

```
# odacli describe-database -n chome4
```

```
Database details
```

```
-----
ID: 6bf06951-d89f-4acb-bb93-39ebdfcec4d7
Description: chome4
DB Name: chome4
DB Version: 19.16.0.0.220719
DB Type: SI
DB Role: PRIMARY
DB Target Node Name: scaoda8m002
DB Edition: EE
DBID: 2169245064
Instance Only Database: false
CDB: false
PDB Name:
PDB Admin User Name:
High Availability: false
Class: OLTP
Shape: odb1
Storage: ACFS
DB Redundancy:
CharacterSet: AL32UTF8
National CharacterSet: AL16UTF16
Language: AMERICAN
Territory: AMERICA
Home ID: 31693275-85f5-4932-8ad6-8abe8c93ce46
<===== OraDB19000_home4
Console Enabled: false
TDE Wallet Management:
TDE Enabled: false
Level 0 Backup Day:
AutoBackup Enabled: false
Created: August 4, 2022 12:23:41 PM UTC
DB Domain Name: example.com
Associated Networks: Public-network
CPU Pool Name:
```

Example 16-139 Cloning a Database in an existing database home

```
# odacli list-dbhomes
```

```
ID Name DB
Version Home
Location Status
-----
-----
542032e5-a76c-4d66-92e1-bb297ec6192d OraDB19000_home1
```

```
19.16.0.0.220719 /u01/app/odaorahome/oracle/product/
19.0.0.0/dbhome_1 CONFIGURED
```

```
# odacli create-dbhome -v 19.16.0.0.220719
```

```
# odacli describe-job -i e2e73a4a-cb54-4bef-90ba-e6d6aeff594a
```

```
Job details
```

```
-----
ID: e2e73a4a-cb54-4bef-90ba-e6d6aeff594a
Description: Database Home OraDB19000_home2 creation with
version :19.16.0.0.220719
Status: Success
Created: August 4, 2022 11:00:48 AM UTC
Message: Create Database Home
```

| Task Name | Start Time | End Time | Status |
|-----------------------------------|--------------------------------|--------------------------------|---------|
| Setting up ssh equivalance | August 4, 2022 11:01:04 AM UTC | August 4, 2022 11:01:05 AM UTC | Success |
| Setting up ssh equivalance | August 4, 2022 11:01:05 AM UTC | August 4, 2022 11:01:06 AM UTC | Success |
| Creating ACFS database home | August 4, 2022 11:01:06 AM UTC | August 4, 2022 11:01:06 AM UTC | Success |
| Validating dbHome available space | August 4, 2022 11:01:06 AM UTC | August 4, 2022 11:01:06 AM UTC | Success |
| Creating DbHome Directory | August 4, 2022 11:01:06 AM UTC | August 4, 2022 11:01:06 AM UTC | Success |
| Create required directories | August 4, 2022 11:01:06 AM UTC | August 4, 2022 11:01:06 AM UTC | Success |
| Extract DB clone | August 4, 2022 11:01:06 AM UTC | August 4, 2022 11:02:35 AM UTC | Success |
| ProvDbHome by using RHP | August 4, 2022 11:02:35 AM UTC | August 4, 2022 11:04:06 AM UTC | Success |
| Enable DB options | August 4, 2022 11:04:06 AM UTC | August 4, 2022 11:04:25 AM UTC | Success |
| Creating wallet for DB Client | August 4, 2022 11:04:29 AM UTC | August 4, 2022 11:04:29 AM UTC | Success |

```
# odacli list-dbhomes
```

| ID | Name | DB |
|--------------------------------------|-------------------------------------|----|
| Version | Home | |
| Location | Status | |
| 542032e5-a76c-4d66-92e1-bb297ec6192d | OraDB19000_home1 | |
| 19.16.0.0.220719 | /u01/app/odaorahome/oracle/product/ | |
| 19.0.0.0/dbhome_1 CONFIGURED | | |
| 6339e2fc-7ae7-4de2-ac3c-9f5b2eaec131 | OraDB19000_home2 | |
| 19.16.0.0.220719 | /u01/app/odaorahome/oracle/product/ | |
| 19.0.0.0/dbhome_2 CONFIGURED | | |

```
# odacli clone-database -n chome1 -u chome1 -f primary -dh 6339e2fc-7ae7-4de2-
ac3c-9f5b2eaec131 <===== New DB Home OraDB19000_home2 [root@scaoda8m002
bin]# odacli describe-job -i ed76ad28-aff6-47c7-9233-6ef2f7c3e8cd
```

Job details

```
-----
ID: ed76ad28-aff6-47c7-9233-6ef2f7c3e8cd
Description: Snap Database service creation with db name: chome1
Status: Success
Created: August 4, 2022 12:02:54 PM UTC
Message:
```

| Task Name | Start Time |
|--|--------------------------------|
| End Time | Status |
| ----- | |
| Validate HugeSpaces | August 4, 2022 12:02:59 PM UTC |
| August 4, 2022 12:03:00 PM UTC | Success |
| Validate source database | August 4, 2022 12:03:00 PM UTC |
| August 4, 2022 12:03:11 PM UTC | Success |
| Setting up ssh equivalance | August 4, 2022 12:03:11 PM UTC |
| August 4, 2022 12:03:11 PM UTC | Success |
| Creating volume rdochome1 | August 4, 2022 12:03:11 PM UTC |
| August 4, 2022 12:03:27 PM UTC | Success |
| Creating ACFS filesystem for RECO | August 4, 2022 12:03:27 PM UTC |
| August 4, 2022 12:03:45 PM UTC | Success |
| Audit directory creation | August 4, 2022 12:03:45 PM UTC |
| August 4, 2022 12:03:45 PM UTC | Success |
| Creation of snapshot database | August 4, 2022 12:03:45 PM UTC |
| August 4, 2022 12:08:25 PM UTC | Success |
| Removing Disabled Redo Threads | August 4, 2022 12:08:25 PM UTC |
| August 4, 2022 12:08:26 PM UTC | Success |
| Creation of SPFile for Shared location | August 4, 2022 12:08:28 PM UTC |
| August 4, 2022 12:08:35 PM UTC | Success |
| Delete SPFile from local location | August 4, 2022 12:08:35 PM UTC |
| August 4, 2022 12:08:35 PM UTC | Success |
| Register DB with clusterware | August 4, 2022 12:08:35 PM UTC |
| August 4, 2022 12:10:00 PM UTC | Success |
| Set SysPassword and Create PwFile | August 4, 2022 12:10:00 PM UTC |
| August 4, 2022 12:10:03 PM UTC | Success |
| Creating pfile | August 4, 2022 12:10:03 PM UTC |
| August 4, 2022 12:10:04 PM UTC | Success |
| Disabling external references | August 4, 2022 12:10:04 PM UTC |
| August 4, 2022 12:10:06 PM UTC | Success |
| Set CPU pool | August 4, 2022 12:10:06 PM UTC |
| August 4, 2022 12:10:06 PM UTC | Success |
| Enabling supplemental log data | August 4, 2022 12:11:18 PM UTC |
| August 4, 2022 12:11:20 PM UTC | Success |
| Enabling blockchange tracking | August 4, 2022 12:11:20 PM UTC |
| August 4, 2022 12:11:21 PM UTC | Success |
| Enabling flashback | August 4, 2022 12:11:21 PM UTC |
| August 4, 2022 12:11:22 PM UTC | Success |
| Copy Pwfile to Shared Storage | August 4, 2022 12:11:22 PM UTC |
| August 4, 2022 12:11:25 PM UTC | Success |
| Create tns entry | August 4, 2022 12:11:25 PM UTC |

```
August 4, 2022 12:11:26 PM UTC      Success
Reset Associated Networks           August 4, 2022 12:11:26 PM UTC
August 4, 2022 12:11:29 PM UTC      Success
Set log_archive_dest for Database   August 4, 2022 12:11:29 PM UTC
August 4, 2022 12:11:32 PM UTC      Success
```

```
# odacli list-databases
```

| ID | DB Name | DB Type | DB |
|--------------------------------------|--------------------------------------|---------|------------|
| Version | Shape | Storage | Status |
| CDB | Class | | |
| DbHomeID | | | |
| bb06935b-384d-482f-b494-45d368d2122a | mydb | SI | |
| 19.16.0.0.220719 | odb1 | ACFS | CONFIGURED |
| 542032e5-a76c-4d66-92e1-bb297ec6192d | | | |
| a03b5971-bee5-4d9a-b003-009df6f018f6 | primary | SI | |
| 19.16.0.0.220719 | odb1 | ACFS | CONFIGURED |
| 618b26d7-a49b-452f-a14b-cfc2c79d0555 | | | |
| a5173f68-6b5c-491f-b8b4-05bce0e7ec20 | chome1 | SI | |
| 19.16.0.0.220719 | odb1 | ACFS | CONFIGURED |
| 6339e2fc-7ae7-4de2-ac3c-9f5b2eaec131 | <===== CLONE DB CREATED SUCCESSFULLY | | |

```
# odacli describe-database -n chome1
```

```
Database details
```

```
-----
ID: a5173f68-6b5c-491f-b8b4-05bce0e7ec20
Description: chome1
DB Name: chome1
DB Version: 19.16.0.0.220719
DB Type: SI
DB Role: PRIMARY
DB Target Node Name: scaoda8m002
DB Edition: EE
DBID: 2639447957
Instance Only Database: false
CDB: false
PDB Name:
PDB Admin User Name:
High Availability: false
Class: OLTP
Shape: odb1
Storage: ACFS
DB Redundancy:
CharacterSet: AL32UTF8
National CharacterSet: AL16UTF16
Language: AMERICAN
Territory: AMERICA
Home ID: 6339e2fc-7ae7-4de2-ac3c-9f5b2eaec131
Console Enabled: false
TDE Wallet Management:
TDE Enabled: false
Level 0 Backup Day:
AutoBackup Enabled: false
```



```

Created: August 4, 2022 12:02:54 PM UTC
DB Domain Name: example.com
Associated Networks: Public-network
CPU Pool Name:

```

Example 16-140 Cloning a Database and associating it with the same CPU Pool as the parent database

```

# odacli clone-database -f dbcpupin -n dbclone -u dbcloneUnique
Enter SYS user password:
Retype SYS user password:

```

Job details

```

-----
ID: 74a80586-3523-4367-93a0-38401647c5a0
Description: Snap Database service creation with db name: dbclone
Status: Created
Created: August 09, 2022 10:25:40 AM UTC
Message:

```

| Task Name | Start Time |
|-----------|------------|
| End Time | Status |
| ----- | |
| ----- | |

Example 16-141 Cloning a Database and associating it with a different CPU pool

```

# odacli clone-database -f dbcpupin -n db1clone -u db1cloneUnique -cp
testdbcpupool2
Enter SYS user password:
Retype SYS user password:

```

Job details

```

-----
ID: 2fe285b5-2e3b-4e80-9121-e7c8380952b3
Description: Snap Database service creation with db name:
db1clone
Status: Created
Created: August 09, 2022 10:36:55 AM UTC
Message:

```

| Task Name | Start Time |
|-----------|------------|
| End Time | Status |
| ----- | |
| ----- | |

Example 16-142 Cloning a TDE-enabled database

```

# odacli clone-database --sourcedbname tdbacf2 --dbname tdbacf2c --
databaseUniqueName tdacf2cu -p
Enter SYS user password:
Retype SYS user password:
Enter TDE wallet password of source database:

```

Example 16-143 Cloning a database and opening the clone in read only mode

```
# odacli clone-database -n clonedb -u clonedb -f sourcedb -ro
Enter SYS user password:
Retype SYS user password:
```

The task `Open Clone DB in READ ONLY mode` is displayed as the last task in the description of the above job.

Related Topics

- [Cloning an Oracle ACFS Database](#)
Create a database from an existing Oracle ACFS database using ODACLI commands or BUI.

odacli create-database

Use the `odacli create-database` command to create a new database.

File Path

```
/opt/oracle/dcs/bin/odacli
```

Syntax

```
odacli create-database -n database_name -cs characterset -cl {OLTP|DSS|IMDB}-
l dblanguage -s dbshape -r {ACFS|ASM} -dt dbterritory -y dbtype -ns
nationalcharacterstet -d pdbadmin -p pdbname -v version [-u
databaseUniqueName] [-dh Database Home ID] [-c|-no-c] [-co|-no-co] [-bi
backupconfigid] [-io] [-dn] [-j] [-nn] [-tn node_name] [-h] [-rd] [-ha|-no-
ha] [-t] [-cp] [-osc] [-kt] [-ocp]
```

Parameters

| Parameter | Description |
|---|--|
| <code>--backupconfigid, -bi</code> | (Optional) Defines the backup configuration identifier for future use. |
| <code>--cdb, -c</code> | (Optional) Creates the database as a container database. Use the <code>-c</code> flag to create a container database and use the <code>-no-c</code> flag to create a non-CDB database. The default is <code>-no-c</code> . |
| <code>--characterstet, -cs</code> | Defines the character set. The default is AL32UTF8. |
| <code>--databaseUniqueName, -u</code> | (Optional) Defines a unique name for the database. |
| <code>--dbdomainname, -dn</code> | Defines the database domain name. |
| <code>--cpupool, -cp</code> | Defines the CPU pool name. The CPU pool must be of type bare metal (BM). |
| <code>--dbEdition, -de</code> | Defines the Database Edition. |
| <code>--dbclass, -cl {OLTP DSS IMDB}</code> | Defines the database class. The default is OLTP. The options are as follows: <ul style="list-style-type: none"> • Enterprise Edition: OLTP, DSS, or IMDB. • Standard Edition: OLTP |

| Parameter | Description |
|---|---|
| <code>--dbconsole, -co</code> | (Optional) Enables the Database Console. Use the <code>-no-co</code> flag to disable the Database Console. If not selected, the default is no database console. |
| <code>--dbhomeid, -dh</code> | (Optional) Identifies the existing Database Home ID. |
| <code>--dblanguage, -l</code> | Defines the database language. The default language is AMERICAN. |
| <code>--dbname, -n</code> | Defines the name given to the new database (<code>dbname.</code>) |
| <code>--dbshape, -s</code> | Identifies the database shape (template) and determines the total memory allocated to the database. For example, <code>odb1</code> and <code>odb2</code> . The default is <code>odb1</code> . You cannot specify the database shape when you create a instance-only database. |
| <code>--dbstorage, -r{ACFS ASM}</code> | Defines the Database Storage, either Oracle ACFS or Oracle ASM. The default value is Oracle ASM. |
| <code>--dbterritory, -dt</code> | Defines the database territory. The default territory is AMERICA. |
| <code>--dbtype, -y [RAC RACOne SI]</code> | Defines the database type. For high-availability deployments, the values can be <code>RAC RACOne SI</code> , with the default as <code>RAC</code> . For single-node deployments, the value is <code>SI</code> . |
| <code>--help, -h</code> | (Optional) Displays help for using the command. |
| <code>--instanceonly, -io</code> | (Optional) Creates a database instance, password file and also the underlying Oracle ACFS mount point. You can use the instance as an auxiliary instance for RMAN duplicate. |
| <code>--json, -j</code> | (Optional) Displays JSON output. |
| <code>--nationalscharacterst, -ns</code> | Defines the NLS National Character Set. The default is AL16UTF16. |
| <code>--no-cdb, -no-c</code> | (Optional) Creates a database that is <i>not</i> a container database. Use this flag when you want to create a non-CDB database. Use the <code>-c</code> flag to create a container database. |
| <code>--no-dbconsole, -no-co</code> | (Optional) Disables Database Console. Use the <code>-co</code> flag to enable Database Console. |
| <code>--pdbadmin, -d</code> | Defines the Pluggable Database (PDB) Admin User. |
| <code>--pdbname, -p</code> | Defines the Pluggable Database (PDB) name. The default value is <code>pdb1</code> . |
| <code>--version, -v</code> | Defines the database bundle patch number. To install the latest bundle patch for a release, specify the release version. To specify a specific supported bundle, use the 5 digit format. |
| <code>--dbRedundancy, -rd</code> | Specifies the database redundancy value, that is, <code>{HIGH MIRROR}</code> . To specify the <code>dbRedundancy</code> option for an Oracle ASM or ACFS storage-based database, all disk groups must have FLEX redundancy. To specify the <code>dbRedundancy</code> option for an Oracle ASM storage database, the <code>dbVersion</code> or <code>dbHomeVersion</code> must be 12.2 or later. |
| <code>--associated-networks, -nn</code> | Specifies the associated network names (in the format <code>networkName1,networkName2,...</code>). |
| <code>--enable-tde, -t</code> | Specifies whether to enable Transparent Data Encryption (TDE) which uses software keystore. |

| Parameter | Description |
|--|---|
| <code>--keystore-type, -kt</code> | Specifies the type of keystore which stores the TDE master encryption key. The value can be <code>software</code> or <code>okv</code> . The default is <code>software</code> . |
| <code>--okv-server-config, -osc</code> | Specifies the name of the Oracle Key Vault server configuration which serves as the metadata of the Oracle Key Vault user credentials. This option must be provided only when the <code>--keystore-type, -kt</code> option is specified.. |
| <code>--okvclient-path, -ocp</code> | Specifies the absolute path to the <code>okvclient.jar</code> file. Multiple values must be comma-separated. Cannot be used with the <code>--okv-server-config, -osc</code> option. |
| <code>--target-node, -tn</code> | (Optional) Specifies the target node name (applicable only for Oracle RAC One Node Database and single-instance Oracle Database, where supported). |
| <code>--levelzerobackupday, -lb</code> | (Optional) Specifies the level zero backup day. The values can be <code>Monday Tuesday Wednesday... Sunday</code> . The default is <code>Sunday</code> . |
| <code>--backupconfigname, -bn</code> | (Optional) Specifies the name of the backup configuration. |
| <code>--bkuppassword, -bp</code> | (Optional) Specifies the RMAN backup encryption password. |
| <code>--enableFlashCache, -fc</code> | (Optional) Specifies whether to enable Flash Cache. |
| <code>--no-enableFlashCache, -no-fc</code> | (Optional) Specifies whether to disable Flash Cache. |
| <code>--dbOnFlashStorage, -f</code> | (Optional) Specifies whether to enable data on Flash storage. |
| <code>--no-dbOnFlashStorage, -no-f</code> | (Optional) Specifies whether to disable data on Flash storage. |
| <code>--disable-ha, -no-ha</code> | (Optional) Disables High Availability for single-instance Oracle Database 19c and later. |
| <code>--enable-ha, -ha</code> | (Optional) Enables High Availability for single-instance Oracle Database 19c and later. The <code>--enable-ha, -ha</code> option is the default for single-instance databases on high availability deployments. |

Usage Notes

- If the disk group redundancy is `FLEX`, then the default `dbRedundancy` value is `MIRROR`.
- Flash cache is disabled by default.
- You cannot mix Oracle Database Standard Edition and Enterprise Edition databases on the same appliance.
- For Standard Edition Oracle Database 19c or later, you cannot create Oracle RAC Or Oracle RAC One Node Database. For Standard Edition, you can only deploy single-instance Oracle Database with or without high-availability enabled.
- Transparent Data Encryption (TDE) is an Advanced Security Option (ASO) available with Oracle Database Enterprise Edition.
- TDE is not configured by default during database creation.
- The `dbname` and `databaseUniqueName` can contain underscores (`-`), lowercase and uppercase alphabet (`a-zA-Z`, and numeric characters (`0-9`), must start with an alphabet, and must not exceed 8 characters in length. Underscores are not permitted only if the `--dbname` is set to `RACOne`, as it is used as a delimiter to identify the database instance. The `dbname` and `databaseUniqueName` must not also be an Oracle reserved key word.

- Use the `--cdb` or `--no-cdb` flag to indicate whether or not the database is a container database. When neither flag is specified, the default database created is a non-CDB database.
- When `--dbhomeid` is not provided, the `create-database` command creates a new Oracle Database Home.
- When `--dbhomeid` is provided, the `create-database` command creates the database using the existing Oracle Home. Use the `odacli list-dbhomes` command to obtain the `dbhomeid`.
- When you use the command to create an instance-only database, then you cannot specify the database shape (template).
- When you specify both the `--version` and the `--dbhomeid`, the version is ignored and the database is created against the existing database home.
- Oracle Database 19c and later is supported on both Oracle Automatic Storage Management (Oracle ASM) and Oracle ASM Cluster file system (ACFS). The default is Oracle ASM.
- When databases are created on Oracle ACFS, each database is configured with its own Oracle ACFS file system for the datafiles and uses the following naming convention: `/u02/app/db user/oradata/db unique name`. The default size of this mount point is 100 GB.

 **Note:**

Oracle recommends not sharing the mount point across different databases.

- Online logs are stored in the `/u03/app/db user/redo/` directory.
- Oracle Fast Recovery Area (FRA) is located in the `/u03/app/db user/fast_recovery_area` directory.
- For the version, you can specify the database version, for example, 19.24.0.0, or you can use a 5 digit format to specify a specific patch bundle version. If you use the database version without specifying the bundle patch number, the latest bundle patch is used.
- You must specify either the Oracle Key Vault server configuration or the absolute path of the `okvclient.jar` file.
- You cannot configure Oracle Key Vault on Oracle RAC One database and single-instance database with high-availability enabled.
- For Oracle Key Vault configuration, you must specify one `okvclient.jar` file path for single-instance database. For Oracle RAC database, you must specify multiple `okvclient.jar` file path.
- For TDE-enabled database configuration, if the keystore type is not specified, then, by default, the keystore is software keystore.

▲ Caution:

When you create a database with Transparent Data Encryption (TDE) enabled, you are prompted to set a password for the TDE wallet. Provide a strong password for security compliance. Set the password carefully, and ensure that this password is available to you at all times for database management operations. Failure to provide the TDE wallet password when prompted, will cause an error in accessing encrypted data.

Example 16-144 Creating a TDE-Enabled Database with Software Keystore

```
# odacli create-database -n test -t
Enter new 'SYS, SYSTEM and PDB Admin user' password:
Confirm 'SYS, SYSTEM and PDB Admin user' password:
Enter new 'TDE wallet' password:
Confirm 'TDE wallet' password:
```

Example 16-145 Creating a Database in Interactive Mode

This example creates a 19.26.0.0.0 OLTP container database named `hrdb` with shape `odb2` and enables you to provide the password interactively.

```
# odacli create-database -n hrdb -c -cl OLTP -s odb2 -p pdb1

Enter new 'SYS, SYSTEM and PDB Admin user' password:
Confirm 'SYS, SYSTEM and PDB Admin user' password:
{
  "jobId" : "f12485f2-dcbe-4ddf-aeel-de24d37037b6",
  "status" : "Created",
  "message" : null,
  "reports" : [ ],
  "createTimestamp" : "December 8, 2024 03:54:03 AM EDT",
  "description" : "Database service creation with db name: hrdb",
  "updateTime" : "December 8, 2024 03:54:03 AM EDT"
}
```

Example 16-146 Creating a Database Against a Different Version

Either of the following statements creates a database against a home with Oracle Database Bundle applied:

```
# odacli create-database -n hrmsdb1 -v 19.26.0.0.0
# odacli create-database -n hrmsdb2 -v 19.26.0.0.250121
```

The following statement creates a new database against a home with a specific Oracle Database Bundle:

```
# odacli create-database -n hrmsdb3 -v 19.26.0.0.250121
```

Example 16-147 Creating a Database associated with a CPU Pool

The following command creates a new database associated with a CPU pool:

```
# odacli create-database -j -n dbcpup1 -r ACFS -cp testdbcpupool
```

Example 16-148 Creating a TDE-Enabled Database with Credentials of a User on Oracle Key Vault

An example to create a database `dbokv1` which uses Oracle Key Vault credentials represented by Oracle Key Vault server configuration `okvobj1` is as follows:

```
odacli create-database -n dbokv1 -t -osc okvobj1 -kt OKV
Enter SYS and SYSTEM user password:
Enter SYS and SYSTEM user password:
```

Example 16-149 Creating a TDE-Enabled Database with keys stored in Oracle Key Vault

Create an Oracle RAC database `okvdbrac` without using the Oracle Key Vault server configuration object. Specify the path to the `okvclient.jar` file for the local database instance first, followed by the path to `okvclient.jar` file for the remote database instance in the request.

```
odacli create-database -n okvdbrac -y RAC -t -kt OKV -ocp /tmp/okvrbadb1/
okvclient.jar,/tmp/okvrbadb2/okvclient.jar
Enter SYS and SYSTEM user password:
Retype SYS and SYSTEM user password:
Enter TDE wallet password:
Retype TDE wallet password:
```

Job details

```
-----
ID: cb611ec2-ff87-44f9-a79b-3ab1a290644f
Description: Database service creation with DB name: okvdbrac
Status: Created
Created: October 20, 2024 6:13:28 AM PDT
Message:
```

```
Task Name          Start
Time              End Time
Status
-----
-----
-----
```

```
odacli describe-job -i cb611ec2-ff87-44f9-a79b-3ab1a290644f
```

Job details

```
-----
ID: cb611ec2-ff87-44f9-a79b-3ab1a290644f
Description: Database service creation with DB name: okvdbrac
Status: Success
Created: October 20, 2024 6:13:28 AM PDT
Message:
```

| Task Name | Node Name | Start |
|-----------------------------------|---------------------------------|------------------|
| Time | End Time | |
| Status | | |
| Validating dbHome available space | n1 | October 20, 2024 |
| 6:13:49 AM PDT | October 20, 2024 6:13:49 AM PDT | |
| Success | | |
| Validating dbHome available space | n2 | October 20, 2024 |
| 6:13:49 AM PDT | October 20, 2024 6:13:49 AM PDT | |
| Success | | |
| Setting up SSH equivalence | n1 | October 20, 2024 |
| 6:13:51 AM PDT | October 20, 2024 6:13:54 AM PDT | |
| Success | | |
| Setting up SSH equivalence | n1 | October 20, 2024 |
| 6:13:54 AM PDT | October 20, 2024 6:13:57 AM PDT | |
| Success | | |
| Creating ACFS database home | n1 | October 20, 2024 |
| 6:13:58 AM PDT | October 20, 2024 6:13:58 AM PDT | |
| Success | | |
| Validating dbHome available space | n1 | October 20, 2024 |
| 6:13:59 AM PDT | October 20, 2024 6:13:59 AM PDT | Success |
| . | | |
| . | | |
| . | | |
| Setting TDE Master Encryption Key | n1 | October 20, 2024 |
| 6:34:15 AM PDT | October 20, 2024 6:34:56 AM PDT | |
| Success | | |
| Create Users tablespace | n1 | October 20, 2024 |
| 6:34:57 AM PDT | October 20, 2024 6:34:59 AM PDT | |
| Success | | |
| Clear all listeners from Database | n1 | October 20, 2024 |
| 6:35:00 AM PDT | October 20, 2024 6:35:01 AM PDT | |
| Success | | |
| Deleting OKV Client Software Jar | n1 | October 20, 2024 |
| 6:35:03 AM PDT | October 20, 2024 6:35:04 AM PDT | |
| Success | | |
| Deleting OKV Client Software Jar | n2 | October 20, 2024 |
| 6:35:04 AM PDT | October 20, 2024 6:35:04 AM PDT | |
| Success | | |
| Encrypt all Tablespaces | n1 | October 20, 2024 |
| 6:35:04 AM PDT | October 20, 2024 6:36:15 AM PDT | Success |

odacli delete-database

Use the `odacli delete-database` command to delete a database.

File Path

`/opt/oracle/dcs/bin/odacli`

Syntax

To delete a database:

```
odacli delete-database -i dbid -n name [-h] [-j] [-fd]
```

Parameters

| Parameter | Description |
|---------------------------|--|
| <code>--id, -i</code> | Identifies the database home identifier (ID) to display. Use the <code>odacli list-databases</code> command to obtain the <code>--id</code> . |
| <code>--name, -n</code> | Defines the database name. |
| <code>--force, -fd</code> | (Optional) Forces the delete operation. |
| <code>--help, -h</code> | (Optional) Displays help for using the command. |
| <code>--json, -j</code> | (Optional) Displays JSON output. |

Usage

- When you run the `odacli delete-database` command on a TDE-enabled database that uses software keystore to store TDE keys, the TDE wallet is also deleted.
- When you run the `odacli delete-database` command on a TDE-enabled database that uses Oracle Key Vault to store TDE keys and was created using Oracle Key Vault user credentials, the TDE wallet and the corresponding endpoints in the Oracle Key Vault are also deleted.
- However, when you run the `odacli delete-database` command on a TDE-enabled database that uses Oracle Key Vault to store TDE keys and was created using endpoints in Oracle Key Vault server, the TDE wallet and the corresponding endpoints in the Oracle Key Vault are not deleted automatically. You must manually delete the TDE wallet and the corresponding endpoints in the Oracle Key Vault.
- The `odacli delete-database` command deletes the database, the file system, and the underlying `advm` volumes assigned to the database. For example, deleting a database named `hrdb` also deletes the file system `/u02/app/oracle/oradata/hrdb`. Do not keep any other files on this database file location. If you have manually added static entries for the database you want to delete in your `listener.ora` file, then remove these entries before running the `odacli delete-database` command.
- The `odacli delete-database` command does not delete the database files. This is expected behavior so that you can archive the database files, if required, or manually restore the database with these database files. Use the `--force` option to delete the database files completely.

Example 16-150 Deleting a Database Named `hrmsdb`

In this example we want to delete a database named `hrmsdb`. Before we can delete the database, we need to know the database home identifier (*dbid*). This example shows how to run the `odacli list-databases` command to list the databases and their associated *dbid*, then how to delete database `hrmsdb`.

```
# odacli list-databases
```

| ID | DB Name | DB Version | CDB | Class |
|----|---------|------------|-----|-------|
|----|---------|------------|-----|-------|

```

-----
-----
a3f4a6c0-a0c9-4c79-bad7-898afcf9de46  hrmsdb  19.22.0.0      true  OLTP
7e28bf52-1a09-49fd-9391-841838d2c42f  crmdb  19.22.0.0.      false OLTP

(continued)
Shape      Storage  Status
-----
odb1       ACFS     Configured
odb1       ACFS     Configured

# odacli delete-database -i a3f4a6c0-a0c9-4c79-bad7-898afcf9de46

```

odacli describe-database

Use the `odacli describe-database` command to display database details.

File Path

```
/opt/oracle/dcs/bin/odacli
```

Syntax

To display database details:

```
odacli describe-database -i dbid -n name [-h] [-j]
```

Parameters

| Parameter | Description |
|-------------------------|--|
| <code>--id, -i</code> | Identifies the database home identifier (ID) to display. Use the <code>odacli list-databases</code> command to obtain the <code>--id</code> . |
| <code>--name, -n</code> | Defines the database name. |
| <code>--json, -j</code> | (Optional) Displays JSON output. |
| <code>--help, -h</code> | (Optional) Displays help for using the command. |

Example 16-151

Display information for a database.

```
# odacli describe-database -n odacn
```

```
Database details
```

```

-----
                ID: 896238139
Description: odacn
      DB Name: odacn
    DB Version: 19.6.0.0.200114
      DB Type: Si
      DB Role: PRIMARY
DB Target Node Name: node1
      DB Edition: EE
                DBID: 896238139

```

```

Instance Only Database: false
                      CDB: false
                      PDB Name:
                      PDB Admin User Name:
High Availability Enabled: false
                      Class: Oltp
                      Shape: Odb1
                      Storage: Asm
                      DB Redundancy: MIRROR
                      CharacterSet: AL32UTF8
National CharacterSet: AL16UTF16
                      Language: AMERICAN
                      Territory: AMERICA
                      Home ID: bcc3991a-0ffc-4d29-86ae-40f2b8721dc4
                      Console Enabled: false
                      Level 0 Backup Day: Sunday
                      AutoBackup Enabled: true
                      Created: March 30, 2020 9:33:09 AM PDT
                      DB Domain Name: domain.com
Associated Networks: Public-network

```

Example 16-152 Displaying Database Details

Display information for database named `ac48e0d2-a7b0-4ffd-a27e-f8e42b028c5f` :

```

# odacli describe-database -i ac48e0d2-a7b0-4ffd-a27e-f8e42b028c5f

Database details
-----
ID: ac48e0d2-a7b0-4ffd-a27e-f8e42b028c5f
Description: rdb1
DB Name: rdb1
DB Version: 19.26.0.0.0
DBID: 1339792271
CDB: true
PDB Name: r1pdb1
PDB Admin User Name: pdbadmin
Class: OLTP
Shape: odb2
Storage: ASM
CharacterSet: DbCharacterSet(characterSet=AL32UTF8,
nlsCharacterSet=AL16UTF16, dbTerritory=AMERICA, dbLanguage=AMERICAN)
Home ID: fe87f30c-b810-45d1-8b96-13996ad7a255
Console Enabled: true
Created: December 8, 2024, 2016 6:21:14 PM

```

odacli list-databases

Use the `odacli list-databases` command to list all databases on the appliance.

File Path

```
$ORACLE_HOME/opt/oracle/dcs/bin/odacli
```

Syntax

To display a list of all databases:

```
odacli list-databases [-h]
```

Parameters

| Parameter | Description |
|------------|---|
| --help, -h | (Optional) Displays help for using the command. |
| -all | (Optional) This option is available only when multi-user access is enabled. Provides a read-only view of all the databases in the system. |

Example 16-153 Displaying a List of Databases

Display a list of databases:

```
# odacli list-databases

ID                                     DB Name    DB Version  CDB
-----
ad6c7326-e460-411e-94df-230dedbef743  rdb121a    19.26.0.0.0  true
fb4d02f3-2413-47ca-8584-a768e23ec2e7  ee12db     19.26.0.0.0  false
```

(Continued)

```
Class   Shape   Storage   Status
-----
OLTP    odb1    ACFS      Configured
IMDB    odb1    ASM       Configured
```

odacli modify-database

Use the `odacli modify-database` command to modify the configuration of a database, such as backup configuration, database class, and database type, and to change TDE wallet management from `EXTERNAL` to `ODA`.

File Path

```
/opt/oracle/dcs/bin/odacli
```

Syntax

```
odacli modify-database [-i] [-dn] [-no-ha] [ha] [-lb] [-no-bkp] [-tn
node_name] [-g] [-cl] [-rd] [-s] [-an] [-ctm] [-bi] [-bin] [-bp] [-id] [-n] [-
y] [-cp] [-no-cpupool] [-rkt] [-ctp] [-h] [-j]
```

Parameters

| Parameter | Description |
|------------|---|
| --name, -n | Defines the database name to be updated. Specify either --name or --id. |

| Parameter | Description |
|--|--|
| <code>--id, -i</code> | Defines the database ID to be updated. Specify either <code>--name</code> or <code>--id</code> . |
| <code>--dbRedundancy, -rd</code> | (Optional) Specifies the database redundancy value, that is, <code>{HIGH MIRROR}</code> . To specify the <code>dbRedundancy</code> option for an Oracle ASM or ACFS storage-based database, at least one disk group of FLEX redundancy must exist. To specify the <code>dbRedundancy</code> option for an Oracle ASM storage database, the <code>dbVersion</code> or <code>dbHomeVersion</code> must be 12.2 or later. |
| <code>--levelzerobackupday, -lb</code> | (Optional) Specifies the Level zero Backup Day. For example, <code>Monday Tuesday Wednesday... Sunday</code> |
| <code>--backupconfigid, -bi</code> | (Optional) Defines the backup configuration identifier for future use. |
| <code>--backupconfigname, -bin</code> | (Optional) Specifies the name of the backup configuration. |
| <code>--bkuppassword, -bp</code> | (Optional) Specifies the RMAN backup encryption password. |
| <code>--no-backup, -no-bkp</code> | (Optional) Disables database backups. Specify this option to also remove the database backup and archivelog backup schedulers. To enable database backups again, you must update the database with a backupconfig object. |
| <code>--dbclass, -cl</code> | (Optional) Defines the database class. The default is OLTP. The options are OLTP, DSS, or IMDB. |
| <code>--dbshape, -s</code> | (Optional) Identifies the database shape (template) and determines the total memory allocated to the database. For example, <code>odb1</code> and <code>odb2</code> . The default is <code>odb1</code> . You cannot specify the database shape for an instance-only database. |
| <code>--attachnetworks, -an</code> | (Optional) Specifies the name of the networks to be attached. Specify the networks in the format <code>network_name1, network_name1, network_name1</code> . |
| <code>--detachnetworks, -dn</code> | (Optional) Specifies the name of the networks to be detached. Specify the networks in the format <code>network_name1, network_name1, network_name1</code> . |
| <code>--dbtype, -y</code> | Defines new database type. The only option is SI. The conversion to single-instance database is available only for Oracle Database Standard Edition. |
| <code>--disable-ha, -no-ha</code> | (Optional) Disables High Availability for single-instance Oracle Database 19c and later. |
| <code>--enable-ha, -ha</code> | (Optional) Enables High Availability for single-instance Oracle Database 19c and later. |
| <code>--target-node, -tn</code> | (Optional) Specifies the target node name (applicable only for Oracle RAC One Node Database and single-instance Oracle Database, where supported). |
| <code>--cpupool, -cp</code> | (Optional) Specifies the CPU pool name. Use this option to associate a CPU pool to a database that does not use any CPU pool or to change the existing association of a CPU pool to a new CPU pool for a database. |
| <code>--no-cpupool</code> | (Optional) Removes the attached CPU pool. |

| Parameter | Description |
|---|--|
| <code>--change-tde-password,-ctp</code> | (Optional) When specified, you are prompted for the current and new TDE Wallet password. Note that in this release, you cannot modify the TDE configuration to use Oracle Key Vault. |
| <code>--change-tdewallet-mgmt,-ctm</code> | (Optional) When specified, the TDE wallet is changed from external to ODA. |
| <code>--rekey-tde,-rkt</code> | (Optional) When specified, current TDE Wallet password is prompted to rekey the TDE master encryption key. |
| <code>--help, -h</code> | (Optional) Displays help for using the command. |
| <code>--json, -j</code> | (Optional) Displays JSON output. |

Usage Notes

Caution:

When you change the TDE wallet password for a database with Transparent Data Encryption (TDE) enabled, you are prompted to set a password for the TDE wallet. Provide a strong password for security compliance. Set the password carefully, and ensure that this password is available to you at all times for database management operations. Failure to provide the TDE wallet password when prompted, will cause an error in accessing encrypted data.

Example 16-154 Modifying the Database Shape (Template) and Database Class

```
# odacli modify-database -s database_shape -cl database_class -i dbid
odacli modify-database -i 1941d594-c777-4eca-9fce-18b778d5c153 -s odb2 -cl DSS
{
  "jobId" : "833d43a7-bcc6-48a7-9f98-b42ffdab3fe1",
  "status" : "Created",
  "message" : null,
  "reports" : [ ],
  "createTimestamp" : "May 16, 2023 06:48:58 AM UTC",
  "resourceList" : [ ],
  "description" : "modify-database service with db ids: 1941d594-
c777-4eca-9fce-18b778d5c153",
  "updatedAt" : "May 16, 2023 06:48:58 AM UTC"
}
```

Example 16-155 Converting Oracle RAC or Oracle RAC One Node Database to Single-instance Oracle Database

```
# odacli modify-database -n db18 -y SI
For moving a database between homes please use the command 'move-database'.
{
  "jobId" : "4b548365-dac5-4557-a6a8-2f65c2b725e7",
  "status" : "Created",
  "message" : "Modify database",
  "reports" : [ ],
  "createTimestamp" : "May 21, 2023 00:32:55 AM UTC",
```

```

"resourceList" : [ {
  "resourceId" : "de2a7959-e31b-4dee-b600-6b16dfb78c34",
  "resourceType" : "DB",
  "resourceNewType" : null,
  "jobId" : "4b548365-dac5-4557-a6a8-2f65c2b725e7",
  "updatedAt" : "May 21, 2023 00:32:55 AM UTC"
} ],
"description" : "Modify database : db18",
"updatedAt" : "May 21, 2023 00:32:55 AM UTC"
}

```

Example 16-156 Specifying the target node when converting database

```

# odacli modify-database -n db18 -y SI -g node_number
# odacli modify-database -n db18 -y SI -th node_name

```

Example 16-157 Changing the TDE Wallet Password

```

# odacli modify-database -n testdb -ctp
Enter current 'TDE wallet' password:
Enter new 'TDE wallet' password:
Confirm 'TDE wallet' password:

```

Example 16-158 Re-keying the TDE Master Encryption Password

```

# odacli modify-database -n testdb -rkt
Enter current 'TDE wallet' password:

```

Example 16-159 Removing a CPU pool

```

# odacli modify-database -n dbcpupin -cp testdbcpupool2
DB will be restarted as part of CPU Pool operation. Do you want to continue
[y/n]:y
For moving a database between homes please use the command 'move-database'.
{
  "jobId" : "c1d05fb3-828a-4644-af9a-9d82b4ef5a89",
  "status" : "Created",
  "message" : "Modify database",
  "reports" : [ ],
  "createTimestamp" : "May 09, 2023 16:18:54 PM UTC",
  "resourceList" : [ {
    "resourceId" : "ff9c138b-a003-40cf-b1fc-0b33cd955ebf",
    "resourceType" : "DB",
    "resourceNewType" : null,
    "jobId" : "c1d05fb3-828a-4644-af9a-9d82b4ef5a89",
    "updatedAt" : "May 09, 2023 16:18:54 PM UTC"
  } ],
  "description" : "Modify database : dbcpupin",
  "updatedAt" : "May 09, 2023 16:18:54 PM UTC"
}

```

odacli move-database

Use the command `odacli move-database` to move a database from one Oracle home to another home of the same database version.

File Path

```
/opt/oracle/dcs/bin/odacli
```

Syntax

```
odacli move-database [-i dbid] [-imp] [-nr] [-n dbname] [-dh dest-dbhome-id]  
[-dhn dest-dbhome-name] [-j] [-h]
```

Parameters

| Parameter | Description |
|---|--|
| <code>--id, -i</code> | (Optional) Defines the database ID. |
| <code>--name, -n</code> | (Optional) Defines the database name. |
| <code>--non-rolling, -nr</code> | (Optional) Specifies whether you want to move the target database in non-rolling manner. By default, the value is false and the database is moved in a rolling manner. |
| <code>--ignore-missing-patch, -imp</code> | (Optional) Ignores all missing patches and forces the operation. |
| <code>--dest-db-home-id, -dh</code> | (Optional) Defines the destination database home ID. |
| <code>--dest-dbhome-name, -dhn</code> | (Optional) Defines the destination database home name. |
| <code>--help, -h</code> | (Optional) Displays help for using the command. |
| <code>--json, -j</code> | (Optional) Displays JSON output. The default is false. |

Usage Notes

Starting with Oracle Database Appliance release 19.19, when you run the `odacli move-database`, the database is moved in a rolling manner, unless you specify the `--non-rolling, -nr` option.

Example 16-160 Moving a Database from one Oracle home to another

```
# ./odacli move-database -i database_ID -dh destination_database_home_ID
```

odacli register-database

Use the `odacli register-database` command to register a migrated database with the appliance.

File Path

```
/opt/oracle/dcs/bin/odacli
```

Syntax

```
odacli register-database -c {OLTP|DSS|IMDB} -s dbshape -t dbtype SI|RACOne|
RAC -o hostname -sn servicename [-bi backupconfigid] [-co|-no-co] [-nn] [-tp]
[-ha|-no-ha] [-h] [-j]
```

Parameters

| Parameter | Description |
|-------------------------------|--|
| --backupconfigid, -bi | (Optional) Defines the backup configuration identifier for future use. |
| --dbclass, -c {OLTP DSS IMDB} | Defines the database class. The database class setting determines the database SGA memory and instance PGA memory configuration. The options are as follows: <ul style="list-style-type: none"> Enterprise Edition: OLTP, DSS, or IMDB. Standard Edition: OLTP |
| --dbconsole, -co | (Optional) Enables the Database Console. Use the <code>-no-co</code> flag to disable the Database Console. If not selected, the default is no Database Console. |
| --dbshape, -s | Identifies the database shape (template) and determines the total memory allocated to the database. For example, odb1 and odb2. The default is odb1. |
| --dbtype, -t [SI RACOne RAC] | Defines the type of database. For high-availability deployments, the values can be RAC RACOne SI, with the default as RAC. For single-node deployments, the value is SI. |
| --help, -h | (Optional) Displays help for using the command. |
| --hostname, -o | Defines the host name. Default: local host name |
| --json, -j | (Optional) Displays JSON output. |
| --no-dbconsole, -no-co | (Optional) Disables Database Console. Use the <code>-co</code> flag to enable Database Console. |
| --servicename, -sn | Defines the Database Service Name. Using this service name, the EZCONNECT String is derived for connecting to the database. For example, <code>hostname:port/servicename</code> . The Port number is the port configured for the listener, as part of the deployment. |
| --associated-networks, -nn | Specifies the associated network names (in the format <code>networkName1,networkName2,...</code>). |
| --disable-ha, -no-ha | (Optional) Disables High Availability for single-instance Oracle Database 19c and later. |
| --enable-ha, -ha | (Optional) Enables High Availability for single-instance Oracle Database 19c and later. |
| --tde-wallet-passwd, -tp | Specifies the password for the TDE wallet. |

Usage Notes

Note:

It is a good practice to use Easy Connect (EZCONNECT) to test the database connectivity before registering the database.

Log in as the `sys` user and enter the following command:

```
sqlplus sys/password@//hostname:1521/service name
```

- The `odacli register-database` command is supported on the primary and the standby database. For the standby database, only the database is registered with Oracle Database Appliance. Oracle Data Guard is not registered with Oracle Database Appliance.
- The migrated database is registered with the listener configured during the provisioning of the appliance. The migrated database must be in read-write or read-only mode for the registration to succeed.
- The `register-database` command validates the `datafile` and log file locations and moves the `controlfile` and `spfile` to the correct locations.
- Some `init.ora` parameters are set, or reset, as part of the registration. Review the parameter changes before and after registration.

The following are examples of changes implemented as part of registration:

- The `memory_target` is reset.
- The `sga_target/pga_aggregate_target/log_buffer/inmemory_size` is configured based on the database class and database shape settings used during registration.
- The registration process sets or resets the recommended appliance-specific parameters. The database is restarted as part of the register database operation.
- The database being registered must use Oracle Managed Files and the file location must match the DATA Location, REDO Location and RECO Location of the `odacli describe-dbstorage` command.
- As part of the registration process, the database is registered with Oracle Clusterware. Only the primary database is registered with Oracle Clusterware.
- TDE-enabled database can also be registered. If TDE is configured using software keystore and the database version is 18c and higher, then TDE wallet management is also supported similar to a TDE database created using the Oracle Database Appliance framework.
- In this release, you cannot register a TDE-enabled database that uses Oracle Key Vault to store TDE keys.

Example 16-161 Registering a Migrated Database

The following is the syntax to register a single instance OLTP database that is using shape odb1.

```
odacli register-database -c OLTP -s odb1 -sn crmdb.example.com
Enter new 'SYS user' password:
Confirm 'SYS user' password:
```

```
{
  "jobId" : "317b430f-ad5f-42ae-bb07-13f053d266e2",
  "status" : "Created",
  "message" : null,
  "reports" : [ ],
  "createTimestamp" : "December 8, 2024 05:55:49 AM EDT",
  "description" : "Database service registration with db service name:
  crmdb.example.com",
  "updatedAt" : "December 8, 2024 05:55:49 AM EDT"
}
rpandrap: ]# odacli describe-job -i "317b430f-ad5f-42ae-bb07-13f053d266e2"
```

Job details

```
-----
                        ID: 317b430f-ad5f-42ae-bb07-13f053d266e2
                        Description: Database service registration with db service name:
  crmdb.example.com
                        Status: Success
                        Created: December 8, 2024 5:55:49 AM EDT
                        Message:
```

| Task Name | Start Time |
|-------------------------------|---------------------------------|
| restore control file | December 8, 2024 5:55:49 AM EDT |
| move spfile to right location | December 8, 2024 5:56:08 AM EDT |
| register DB with clusterware | December 8, 2024 5:56:13 AM EDT |
| reset db parameters | December 8, 2024 5:57:05 AM EDT |
| Running DataPatch | December 8, 2024 5:57:36 AM EDT |

(Continued)

| End Time | Status |
|---------------------------------|---------|
| December 8, 2024 5:56:08 AM EDT | Success |
| December 8, 2024 5:56:13 AM EDT | Success |
| December 8, 2024 5:57:05 AM EDT | Success |
| December 8, 2024 5:57:36 AM EDT | Success |
| December 8, 2024 5:57:49 AM EDT | Success |

odacli upgrade-database

You can use the `odacli upgrade-database` command to upgrade a database from a supported release.

File Path

```
/opt/oracle/dcs/bin/odacli
```

Syntax

To upgrade an Oracle Database:

```
odacli upgrade-database -i Comma separated list of database ids -n Comma
separated list of database names -from source dbhome id -to destination
dbhome id | -fn source dbhome name -tn destination dbhome name [-ctm] [-j] [-
h] [-ha|-no-ha]
```

Parameters

| Parameter | Description |
|--|---|
| <code>--ids, -i</code> | (Optional) Defines the Database IDs to upgrade. You can use a comma separated list of database IDs. |
| <code>--names, -n</code> | (Optional) Defines the names of the databases to upgrade. |
| <code>--dest-dbhome-id, -to</code> | The DB HOME ID of the destination database home. |
| <code>--dest-dbhome-name, -tn</code> | The DB HOME name of the destination database home. |
| <code>--source-dbhome-id, -from</code> | The DB HOME ID of the source database home. |
| <code>--source-dbhome-name, -fn</code> | The DB HOME name of the source database home. |
| <code>--change-tdewallet-mgmt, -ctm</code> | (Optional) When specified, the TDE wallet management attribute is changed from External to ODA. |
| <code>--json, -j</code> | (Optional) Displays JSON output. The default is false. |
| <code>--disable-ha, -no-ha</code> | (Optional) Disables High Availability for single-instance Oracle Database 19c and later. |
| <code>--enable-ha, -ha</code> | (Optional) Enables High Availability for single-instance Oracle Database 19c and later. |
| <code>--help, -h</code> | (Optional) Displays help for using the command. |

Usage Notes

You cannot upgrade Oracle RAC or Oracle RAC One Node Database to a destination database home of Standard Edition 19c or later. You must first convert Oracle RAC or Oracle RAC One Node Database to single-instance Oracle Database using the `odacli modify-database` command and then upgrade the single-instance Oracle Database to a destination database home of Standard Edition 19c or later.

You have the following options for defining the databases to upgrade:

- When you define a single database ID, only the database of the source database home is upgraded.
- When you define more than one database ID, only those databases of the source database home are upgraded.
- When you do not define a database ID, all of the databases under the source database home are upgraded.

You can upgrade databases of the following releases:

- Oracle Database 12.2 to 19c
- Oracle Database 12.1 to 19c
- Oracle Database 12.1 to 12.2

Example 16-162 Upgrading an Oracle Database

In this example, a single database is upgraded. Use the command `odacli list-databases` to display the database ID, then use the command `odacli upgrade-databases` to upgrade the database. After the upgrade is complete, you can run the command `odacli list-databases` again to verify the upgrade.

```
# odacli list-databases
```

```

ID                               DB Name   DB Version  CDB
-----
fb4d02f3-2413-47ca-8584-a768e23ec2e7 ee12db    12.1.0.2   false

(Continued)
Class   Shape   Storage  Status
-----
OLTP    odb1     ACFS     Configured
IMDB    odb1     ASM      Configured

# odacli upgrade-database -i ad6c7326-e460-411e-94df-230dedbef743 -from fa4321f5-0543-477d-bb54-
a429dcc8ee8d -to d752df28-ecdd-4af4-9454-38085ea17f8b
{
  "jobId" : "1bbe8boe-acb0-4296--9c8b-473b69da0c18",
  "status" : "Created",
  "message" : null,
  "reports" : [ ],
  "createTimestamp" : "October 24, 2017 03:54:03 AM EDT",
  "description" : "Database service upgrade with db ids: [ad6c7326-e460-411e-94df-230dedbef743]",
  "updatedAt" : "October 24, 2017 03:54:03 AM EDT"
}

# odacli list-databases

ID                               DB Name   DB Version  CDB
-----
ad6c7326-e460-411e-94df-230dedbef743 rdb121a   12.1.0.2   true
fb4d02f3-2413-47ca-8584-a768e23ec2e7 ee12db    12.1.0.2   false

(Continued)
Class   Shape   Storage  Status
-----
OLTP    odb1     ACFS     Configured
IMDB    odb1     ASM      Configured

```

odacli DBHome Commands

Use the `odacli DBHome` commands to manage database Home operations.

- [odacli configure-dbhome-storage](#)
Use the `odacli configure-dbhome-storage` command to configure the database home storage.
- [odacli list-dbhome-storages](#)
Use the `odacli list-dbhome-storages` command to view the database home storage resources after the volumes for `ORACLE_HOME` and `ORACLE_BASE` are created.
- [odacli describe-dbhome-storage](#)
Use the `odacli describe-dbhome-storage` command to view information such as how much space is available (at a volume or diskgroup level).
- [odacli modify-dbhome-storage](#)
Use the `odacli modify-dbhome-storage` command to modify database home storage and add additional disk space.
- [odacli create-dbhome](#)
Use the `odacli create-dbhome` command to create an Oracle Database Home.
- [odacli delete-dbhome](#)
Use the `odacli delete-dbhome` command to delete database home that is not associated with a database.

- [odacli describe-dbhome](#)
Use the `odacli describe-dbhome` command to display Oracle Database Home details.
- [odacli list-dbhomes](#)
Use the `odacli list-dbhomes` command to display a list of Oracle Home directories.

odacli configure-dbhome-storage

Use the `odacli configure-dbhome-storage` command to configure the database home storage.

File Path

```
/opt/oracle/dcs/bin/odacli
```

Syntax

```
odacli configure-dbhome-storage -dg disk_group [-s volume_size] [-j] [-h]
```

Parameters

| Parameter | Description |
|-------------------------------|--|
| <code>--diskgroup, -dg</code> | (Mandatory) Defines the name of the disk group. |
| <code>--size, -s</code> | (Optional) Defines the size, in gigabytes (GB), of the ORACLE_HOME volume. The default is: 80 GB. The minimum value that can be specified is 25GB and the maximum value is 1024GB. |
| <code>--json, -j</code> | (Optional) Displays the output in JSON format. |
| <code>--help, -h</code> | (Optional) Displays help for using the command. |

Usage Notes

- Valid values for the `--diskgroup` option vary depending on the hardware. For the X5-2, X6-2 and X7-2 HA platforms, you can select between the DATA or RECO diskgroup. For all other platforms such as X8-2, you must select only the DATA diskgroup. With later hardware, you must still run the `odacli configure-dbhome-storage` command.
- When you run the command to create a new database home, it also creates the volumes to hold the database homes. Till the volumes are created, you can run the `odacli configure-dbhome-storage` command to change the diskgroup or the initial size of the volume. Once the volumes for this feature are created, running this command results in an error:

```
# odacli configure-dbhome-storage -dg RECO
DCS-10606:Database homes storage has already been created, no changes are
allowed.
```

Example 16-163 Creating Database Home Storage

```
# odacli configure-dbhome-storage -dg DATA
{
  "jobId" : "553bfeb9-0092-4d73-bbd4-43fcb590886f",
  "status" : "Created",
```

```

    "message" : null,
    "reports" : [ ],
    "createTimestamp" : "May 11, 2021 06:48:12 AM GMT",
    "resourceList" : [ ],
    "description" : "Configure database home storage",
    "updatedAt" : "May 11, 2021 06:48:12 AM GMT"
  }

```

odacli list-dbhome-storages

Use the `odacli list-dbhome-storages` command to view the database home storage resources after the volumes for `ORACLE_HOME` and `ORACLE_BASE` are created.

File Path

```
/opt/oracle/dcs/bin/odacli
```

Syntax

```
odacli list-dbhome-storages [-j] [-h]
```

Parameters

| Parameter | Description |
|-------------------------|---|
| <code>--json, -j</code> | (Optional) Displays the output in JSON format. |
| <code>--help, -h</code> | (Optional) Displays help for using the command. |

Usage Notes

- Starting with Oracle Database Appliance release 19.26, Oracle Database homes are no longer created on the local disk. New Oracle Database homes are created on an Oracle ACFS-managed file system. To create an Oracle ACFS file system, ADVN volumes are created.
- The command lists the resource ID, the node on which the volume is created, and the diskgroup on which the volume is created.

Example 16-164 Listing Database Home Storage on a Single-Node System

```
# odacli list-dbhome-storages
```

```

=====
=====
ID                               Node Description          Disk Group
Volume      Size (GB)  Status
-----
6801cabb-4e45-41d7-9f20-c75dc7cf30c2  0  ORACLE_HOME             DATA
orahome_sh  80          CONFIGURED
f5ad1258-a4a1-4cc1-980c-e2eeca738d99  0  ORACLE_BASE             DATA
odabase_n0  80          CONFIGURED
=====
=====

```

Example 16-165 Listing Database Home Storage on a High-Availability System

```
# odacli list-dbhome-storages

=====
=====
ID                               Node Description          Disk Group
Volume      Size (GB)  Status
-----
67622ce6-0a00-4fec-b948-7a0ba7922311  0,1  SHARED ORACLE_HOME  DATA
orahome_sh  200      CONFIGURED
ac813348-2935-4903-b9a6-eb4f0d9637b3  0    ORACLE_BASE          DATA
odabase_n0  80      CONFIGURED
c8153e7b-6ab7-4a55-90ad-20d4196d2ac4  1    ORACLE_BASE          DATA
odabase_n1  80      CONFIGURED
=====
=====
```

odacli describe-dbhome-storage

Use the `odacli describe-dbhome-storage` command to view information such as how much space is available (at a volume or diskgroup level).

File Path

```
/opt/oracle/dcs/bin/odacli
```

Syntax

```
odacli describe-dbhome-storage -i db_home_id [-j] [-h]
```

Parameters

| Parameter | Description |
|-------------------------|---|
| <code>--id, -i</code> | (Mandatory) Specifies the Oracle home storage ID. This is the ID listed in the <code>odacli list-dbhome-storages</code> command output. |
| <code>--json, -j</code> | (Optional) Displays the output in JSON format. |
| <code>--help, -h</code> | (Optional) Displays help for using the command. |

Example 16-166 Describing Database Home Storage

```
odacli describe-dbhome-storage -i 67622ce6-0a00-4fec-b948-7a0ba7922311
ORACLE_HOME storage details:
=====
                ID: 67622ce6-0a00-4fec-b948-7a0ba7922311
                State: CONFIGURED
                Created: February 11, 2021 5:30:10 AM UTC
                Updated: February 18, 2021 4:33:30 PM UTC

Volume Details
-----
```



```

        Name: ORAHOME_SH
        Disk Group: DATA
        Description: SHARED ORACLE_HOME
        Node Number: 0,1
        Allocated Space: 200.0 GB
        Used Space: 12.10 GB
        Free Space: 187.89 GB
        Location: /u01/app/odaorahome

```

DiskGroup Details

```
-----
```

```

        Name: DATA
        Allocated Space: 15.52 TB
        Used Space: 2.69 TB
        Free Space: 12.83 TB

```

```
=====
```

odacli modify-dbhome-storage

Use the `odacli modify-dbhome-storage` command to modify database home storage and add additional disk space.

File Path

```
/opt/oracle/dcs/bin/odacli
```

Syntax

```
odacli modify-dbhome-storage -i db_home_id -s size[-j] [-h]
```

Parameters

| Parameter | Description |
|-------------------------|---|
| <code>--id, -i</code> | (Mandatory) Specifies the Oracle home storage ID. This is the ID listed in the <code>odacli list-dbhome-storages</code> command output. |
| <code>--size, -s</code> | (Mandatory) Specifies the new size in GB. The minimum value that can be specified is 25GB and the maximum value is 1024GB. |
| <code>--json, -j</code> | (Optional) Displays the output in JSON format. |
| <code>--help, -h</code> | (Optional) Displays help for using the command. |

Example 16-167 Modifying Database Home Storage

```

odacli modify-dbhome-storage -i 9b9c9e0f-db04-4985-be48-3f1e263cd73a -s 30
{
  "jobId" : "badfad81-cfc1-4c82-a181-69ebdfb11c22",
  "status" : "Created",
  "message" : null,
  "reports" : [ ],
  "createTimestamp" : "May 11, 2021 14:04:09 PM CST",
  "resourceList" : [ ],
  "description" : "Modify database home storage",

```

```
"updatedAt" : "May 11, 2021 14:04:09 PM CST"
}
```

odacli create-dbhome

Use the `odacli create-dbhome` command to create an Oracle Database Home.

File Path

```
$ORACLE_HOME/opt/oracle/dcs/bin/odacli
```

Syntax

To create an Oracle Database Home:

```
odacli create-dbhome -v version [-j] [-h]
```

Parameters

| Parameter | Description |
|---------------------------------------|---|
| <code>-v <i>version number</i></code> | Defines the database bundle patch number. |
| <code>--json, -j</code> | (Optional) Displays JSON output. |
| <code>--help, -h</code> | (Optional) Displays help for using the command. |

Usage Notes

For the version number, you can specify the database version, such as 18.7.0.0, 18.5.0.0, 12.2.0.1, or 12.1.0.2, or you can use a 5 digit format to specify a specific patch bundle version. For example, 19.26.0.0.250121. If you use the database version without specifying the bundle patch number, then the latest bundle patch is used.

Example 16-168 Creating an Oracle Database Home

The following example creates an Oracle Database Home version 19.26.0.0.250121.

```
# odacli create-dbhome -v 19.26.0.0.250121
```

odacli delete-dbhome

Use the `odacli delete-dbhome` command to delete database home that is not associated with a database.

File Path

```
/opt/oracle/dcs/bin/odacli
```

Syntax

```
odacli delete-dbhome -i db_home_ID | -n db_home_name [-h]
```

Parameters

| Parameter | Description |
|-------------------------|--|
| <code>--id, -i</code> | Identifies the database home using a database identifier (ID). |
| <code>--name, -n</code> | Identifies the database home using a database name. |
| <code>--help, -h</code> | (Optional) Displays help for using the command. |

Usage Notes

- Use the `odacli list-dbhomes` command to locate the identifier.
- To delete, or uninstall, a database home (dbhome), there must not be any associated databases in the dbhome.
- Use the `odacli delete-database` command to delete an existing database.

Example 16-169 Deleting an Empty Database Home

```
# odacli delete-dbhome -i 0ce547ca-3df2-4178-a7e6-eefa613aeab4
```

odacli describe-dbhome

Use the `odacli describe-dbhome` command to display Oracle Database Home details.

File Path

```
/opt/oracle/dcs/bin/odacli
```

Syntax

To display details about Oracle Database Home:

```
odacli describe-dbhome -i dbhomeid -n name [-h] [-j] [-v]
```

Parameters

| Parameter | Description |
|------------------------------|--|
| <code>--id, -i</code> | Identifies the database home ID. Use the <code>odacli list-dbhomes</code> command to get the <i>id</i> . |
| <code>--name, -n</code> | Identifies the database home name. Use the <code>odacli list-dbhomes</code> command to get the database name. |
| <code>--help, -h</code> | (Optional) Displays help for using the command. |
| <code>--json, -j</code> | (Optional) Displays JSON output. The default is <code>false</code> . |
| <code>--dbversion, -v</code> | (Optional) Identifies the Database Home Version. Use the <code>odacli list-dbhomes -v</code> command to get the <i>dbversion</i> . |

Example 16-170 Displaying Oracle Database Home Details

The following output is an example of using the display Oracle Database Home details command:

```
# odacli describe-dbhome -i b727bf80-c99e-4846-ac1f-28a81a725df6

DB Home details
-----
                ID: b727bf80-c99e-4846-ac1f-28a81a725df6
                Name: OraDB19_home1
                Version: 19.19.0.0.0
Home Location: /u01/app/orauser/product/19/dbhome_1
Created: Jun 2, 2023 10:19:23 AM
```

odacli list-dbhomes

Use the `odacli list-dbhomes` command to display a list of Oracle Home directories.

File Path

```
$ORACLE_HOME/opt/oracle/dcs/bin/odacli
```

Syntax

To display a list of Oracle Home directories:

```
odacli list-dbhomes [-h] [-j]
```

Parameters

| Parameter | Description |
|------------------------|--|
| <code>--help,-h</code> | (Optional) Displays help for using the command. |
| <code>--json,-j</code> | (Optional) Displays JSON output. |
| <code>-all</code> | (Optional) This option is available only when multi-user access is enabled. Provides a read-only view of all the database homes in the system. |

Example 16-171 Displaying a List of Oracle Home Directories

Run the following command to display a list of Oracle Home directories:

```
# odacli list-dbhomes

ID                                     Name                                     DB Version
-----
b727bf80-c99e-4846-ac1f-28a81a725df6 OraDB12102_home1 12.1.0.2

(continued)
Home Location
-----
/u01/app/orauser/product/12.1.0.2/dbhome_1
```

odacli Database Storage Commands

Use the Database Storage commands to list, describe, create, and delete Oracle database storage.

- [odacli create-dbstorage](#)
Use the `odacli create-dbstorage` command to create the file system for database migrations.
- [odacli delete-dbstorage](#)
Use the `odacli delete-dbstorage` command to delete database storage that is not associated with a database.
- [odacli describe-dbstorage](#)
Use the `odacli describe-dbstorage` command to display storage configuration details.
- [odacli describe-dgstorage](#)
Use the `odacli describe-dgstorges` command to display the disk group information.
- [odacli list-dbstorages](#)
Use the `odacli list-dbstorages` command to display a list of all of the database storage configured in the appliance.
- [odacli list-dgstorges](#)
Use the `odacli list-dgstorges` command to display the disk group information.
- [odacli modify-dbstorage](#)
Use the `odacli modify-dbstorage` command to resize the database storage.
- [odacli modify-dgstorage](#)
Use the `odacli modify-dgstorage` command to release disks.

odacli create-dbstorage

Use the `odacli create-dbstorage` command to create the file system for database migrations.

File Path

```
/opt/oracle/dcs/bin/odacli
```

Syntax

```
odacli create-dbstorage -n dbname -s dataSize -u databaseUniqueName -r [ASM|ACFS] -rd [high|mirror] [-h]
```

Parameters

| Parameter | Description |
|---------------------------|-----------------------------------|
| <code>--dbname, -n</code> | Defines the name of the database. |

| Parameter | Description |
|---|--|
| <code>--dataSize, -s</code> | (Optional) Defines the size, in gigabytes (GB), of the filesystem for storing database files and temp files. The default is: 100 GB. The minimum size is 10 GB. When entering the size, do not include GB. For example, for 50 GB, use 50. |
| <code>--databaseUniqueName, -u</code> | (Optional) Defines a unique name for the database. Specify only if the database unique name is different than the database name. The command creates the following mount point: <code>/u02/app/oracle/oradata/db unique name</code> |
| <code>--dbstorage, -r [ASM ACFS]</code> | (Optional) Defines the type of database storage, either ASM or ACFS. When you select ASM, the command only creates the supporting directory structure for storing non-database files. The default is ASM. |
| <code>--db-redundancy, -rd</code> | (Optional) Defines the database redundancy. The values can be high or mirror. The database redundancy is not applicable to database storages of Oracle ASM type, or database storages on normal or high redundancy disk groups. For database storages of Oracle ACFS type, specifying this option creates volumes of the specified redundancy on Oracle ASM disk groups of flex redundancy. |
| <code>--help, -h</code> | (Optional) Displays help for using the command. |

Usage Notes

- The `odacli create-dbstorage` command registers the storage metadata with the Appliance Manager.
- Oracle Database is supported on both Oracle Automatic Storage Management (Oracle ASM) and Oracle ASM Cluster file system (ACFS). The default is Oracle ASM.
- When you create ACFS database storage, the command creates a separate ACFS file system and creates the directory structure for other database files, such as archives and online logs.
- When you create ASM database storage, the command only creates the corresponding directories for non-database files.

Example 16-172 Creating Database Storage

The following statement creates 50 GB ACFS database storage for the APPSDB database.

```
# odacli create-dbstorage -n APPSDB -s 50 -r ACFS
{
  "jobId" : "fc6bf8fd-60c2-44f3-b8b7-efd0e9a2149f",
  "status" : "Created",
  "message" : null,
  "reports" : [ ],
  "createTimestamp" : "August 09, 2016 06:19:35 AM WSST",
  "description" : "Database storage service creation with db name: APPSDB",
  "updatedAtTime" : "August 09, 2016 06:19:35 AM WSST"
}
```

odacli delete-dbstorage

Use the `odacli delete-dbstorage` command to delete database storage that is not associated with a database.

File Path

```
/opt/oracle/dcs/bin/odacli
```

Syntax

```
odacli delete-dbstorage -i ID -n name [-h] [-j]
```

Parameters

| Parameter | Description |
|------------|---|
| --id, -i | Identifies the database storage using a database identifier (ID). |
| --name, -n | Specifies the database storage name. |
| --help, -h | (Optional) Displays help for using the command. |
| --json, -j | (Optional) Displays JSON output. |

Usage Notes

- You can only use the `delete-dbstorage` when the storage is not associated with any databases.
- Use the `delete-database` command to delete an existing database.
- Use the `list-dbstorages` command to locate the identifier.

Example 16-173 Deleting Empty Database Storage

```
# odacli delete-dbstorage -i 9fe39332-cc1a-4b4b-8393-165524a6ef6b
```

odacli describe-dbstorage

Use the `odacli describe-dbstorage` command to display storage configuration details.

File Path

```
/opt/oracle/dcs/bin/odacli
```

Syntax

```
odacli describe-dbstorage -i ID -n name [-j] [-h]
```

Parameters

| Parameter | Description |
|-----------|------------------------------------|
| --id, -i | Specifies the database storage ID. |

| Parameter | Description |
|------------|--|
| --name, -n | Specifies the database storage name. |
| --json, -j | (Optional) Displays JSON output. The default is false. |
| --help, -h | (Optional) Displays help for using the command. |

Usage Notes

- Use the `odacli list-dbstorages` command to get the database storage identifier (ID).
- The DATA Location corresponds to the `init.ora` parameter `db_create_file_dest`.
- RECO Location corresponds to the `init.ora` parameter `db_recovery_file_dest`
- REDO Location corresponds to the `init.ora` parameter `db_create_online_log_dest_1`

Example 16-174 Displaying Database Oracle ACFS Storage Details

The following example displays Oracle ASM Cluster file system (ACFS) storage details:

```
# odacli describe-dbstorage -i 9fe39332-cc1a-4b4b-8393-165524a6ef6b

DBStorage details
-----
ID: 9fe39332-cc1a-4b4b-8393-165524a6ef6b
DB Name: rdb121a
DBUnique Name: rdb121a
DB Resource ID: ad6c7326-e460-411e-94df-230dedbef743
Storage Type: Acfs
DATA Location: /u02/app/oracle/oradata/rdb121a
RECO Location: /u03/app/oracle/fast_recovery_area/
REDO Location: /u03/app/oracle/redo/
State: ResourceState(status=Configured)
Created: July 22, 2016 12:07:12 PM SGT
UpdatedTime: July 22, 2016 12:26:39 PM SGT
```

Example 16-175 Displaying Database Oracle ASM Storage Details

The following example displays Oracle Automatic Storage Management (Oracle ASM) storage details:

```
# odacli describe-dbstorage -i 4f2a1b59-ca66-4d80-951c-425ab7b0acae

DBStorage details
-----
ID: 4f2a1b59-ca66-4d80-951c-425ab7b0acae
DB Name: ee12db
DBUnique Name: ee12db
DB Resource ID: fb4d02f3-2413-47ca-8584-a768e23ec2e7
Storage Type: Asm
DATA Location: DATA
RECO Location: RECO
REDO Location: RECO
State: ResourceState(status=Configured)
```

Created: July 22, 2016 1:13:51 PM SGT
 UpdatedTime: July 22, 2016 1:13:52 PM SGT

odacli describe-dgstorage

Use the `odacli describe-dgstorages` command to display the disk group information.

File Path

`$ORACLE_HOME/opt/oracle/dcs/bin/odacli`

Syntax

```
odacli describe-dgstorage -d diskgroup -h
```

Parameters

| Parameter | Description |
|------------------------------|--|
| <code>--diskgroup, -d</code> | Specifies the disk group for which information is displayed. |
| <code>--help, -h</code> | (Optional) Displays help for using the command. |

Usage Notes

This command displays the storage information for all the databases backed by a disk group, for each disk group present in the system.

Example 16-176 Displaying Disk Group Storage

```
# odacli list-dgstorages -r redundancy
Diskgroup storage details
```

```
-----
-----
```

```
Diskgroup: DATA
```

```
Redundancy: extern|normal|high|flex
```

```
Physical Free Space: wGB
```

```
Physical Total Space: xGB
```

```
Database Unique Name: rdbx
```

```
Location: /u02/app/test/test1/rdbx
```

```
Used Space: dGB (acfsutil.total -
acfsutil.freespace)
```

```
Free Space: dGB (acfsutil.freespace)
```

```

Database Unique Name: rdby

Location: +DATA/rdby

Used Space: zGB (v$asm_file.bytes)

Free Space: xGB (PhyFree/redundancy)

Physical Space:
vGB(v$asm_diskgroup.total_mb)

Physical Used : wGB (v$asm_file.space)

Physical Free :
uGB(v$asm_diskgroup.free_mb)

Physical Reserved : uGB(Lookup Table)

Diskgroup: RECO

Redundancy: normal|high|flex

Physical Free Space: wGB

Physical Total Space: xGB

Database Unique Name: rdbx

Location: /u02/app/test/fast_recovery_area

Used Space: dGB (acfsutil.total -
acfsutil.freespace)

Free Space: dGB (acfsutil.freespace)

Database Unique Name: rdby

Location: +DATA/rdby

Used Space: zGB (v$asm_file.bytes)

Free Space: xGB (PhyFree/redundancy)

Physical Space:
vGB(v$asm_diskgroup.total_mb)

Physical Used : wGB (v$asm_file.space)

Physical Free :
uGB(v$asm_diskgroup.free_mb)

Physical Reserved : uGB(Lookup Table)

```

odacli list-dbstorages

Use the `odacli list-dbstorages` command to display a list of all of the database storage configured in the appliance.

File Path

```
/opt/oracle/dcs/bin/odacli
```

Syntax

```
# odacli list-dbstorages [-h]
```

Parameters

| Parameter | Description |
|-------------------------|---|
| <code>--help, -h</code> | (Optional) Displays help for using the command. |

Usage Notes

This command displays a list of all of the filesystems that are configured with the `create-database` command and the `create-dbstorage` command.

Example 16-177 Displaying a List of all Database Storage

```
# odacli list-dbstorages
```

| ID Type | DBUnique | Name | Status |
|--------------------------------------|----------|---------|------------|
| 9fe39332-cc1a-4b4b-8393-165524a6ef6b | Acfs | rdb121a | Configured |
| 4f2a1b59-ca66-4d80-951c-425ab7b0acae | Asm | ee12db | Configured |
| 0266edac-c729-4539-861f-3f3d543be9e4 | Acfs | db12SE | Configured |

odacli list-dgstorages

Use the `odacli list-dgstorages` command to display the disk group information.

File Path

```
/opt/oracle/dcs/bin/odacli
```

Syntax

```
odacli list-dgstorages -r redundancy -h
```

Parameters

| Parameter | Description |
|-------------------------------|--|
| <code>--redundancy, -r</code> | Specifies the disk group redundancy for FLEX disk group. |
| <code>--help, -h</code> | (Optional) Displays help for using the command. |

Usage Notes

- The command displays the storage-related information for all the disk groups present in the system.
- The redundancy option is valid only for FLEX disk groups. For all disk groups that are not FLEX, logical free space is calculated using the redundancy obtained from `v$asm_diskgroup` rather than the CLI option.
- Redundancy option can take the values MIRROR | HIGH. Use one of these options to specify the database redundancy for FLEX disk groups.
- In the example below, Physical Total Space is the total space in the disk group. (`V$ASM_DISKGROUP.total_mb`) Physical Reserved Space is the reserved space required to handle disk failures. Physical Free Space is the free space in the disk group. (`V$ASM_DISKGROUP.free_mb`) Logical Free Space is the logical free space in the diskgroup. (`V$ASM_DISKGROUP.free_mb / redundancy`)

This command displays the storage information for all the databases backed by a disk group, for each disk group present in the system.

Example 16-178 Displaying Disk Group Storage

```
# odacli list-dgstorages -r redundancy
Diskgroup Redundancy Physical Total Space Physical Reserved Space
Physical Free Space Logical Free
Space
-----
DATA          FLEX          xGB
yGB          zGB          uGB

REDO          HIGH          xGB
yGB          zGB          uGB

RECO          NORMAL        xGB
yGB          zGB          uGB
```

odacli modify-dbstorage

Use the `odacli modify-dbstorage` command to resize the database storage.

File Path

```
/opt/oracle/dcs/bin/odacli
```

Syntax

```
odacli modify-dbstorage [-ds] [-in] [-fs] [-rcs] [-rds] [-h] [-j]
```

Parameters

| Parameter | Description |
|---------------------------------|--|
| <code>--datasize, -ds</code> | (Optional) Specifies the extendable size in GB for the DATA volume. Specify at least one size from FLASH, RECO, REDO, or DATA volumes. |
| <code>--dbname, -in</code> | Defines the database name on which you want to extend the volumes. |
| <code>--flashsize, -fs</code> | (Optional) Specifies the extendable size in GB for the FLASH volume. |
| <code>--recoresize, -rcs</code> | (Optional) Specifies the extendable size in GB for the RECO volume. |
| <code>--redosize, -rds</code> | (Optional) Specifies the extendable size in GB for the REDO volume. |
| <code>--help, -h</code> | (Optional) Displays help for using the command. |
| <code>--json, -j</code> | (Optional) Displays JSON output. |

Usage Notes

- The command can resize DATA, RECO, REDO, and FLASH volumes.
- Database name is a mandatory parameter. All other parameters are optional, however, one of the volume sizes must be specified. If you only provide the DATA size, then the DCS agent calculates the recommended RECO size for the given DATA size is internally calculated. The storage is then extended with the recommended values.
- The mounted Oracle ACFS and its underlying Oracle ADVM storage is extended by the specified value.
- The maximum resize value that can be specified in the command at a time is 100 GB. To resize with a value greater than 100 GB, run the command multiple times with a maximum value of 100 GB each time. For further resize, ensure that the command completes successfully before you run it again.
- To check the result of the resize operation, use the `odacli list-dbstorages` command.
- After database resize operation is completed, use the `odacli describe-dbstorage` command to display storage configuration details.

Example 16-179 Modifying the Database Storage

```
# odacli modify-dbstorage -ds 10 -rcs 15 -n amdb1
{
  "jobId" : "e6d54155-ed4c-4fd6-a3f6-454120fa5c18",
  "status" : "Created",
  "message" : null,
  "reports" : [ ],
  "createTimestamp" : "June 03, 2019 06:06:42 AM UTC",
  "resourceList" : [ ],
  "description" : "Database storage modify operation",
  "updatedAt" : "June 03, 2019 06:06:42 AM UTC"
}
```

odacli modify-dgstorage

Use the `odacli modify-dgstorage` command to release disks.

File Path

```
/opt/oracle/dcs/bin/odacli
```

Syntax

To release disks:

```
odacli modify-dgstorage [-f] [-rd list] [-j] [-h]
```

Parameters

| Parameter | Description |
|----------------------------------|--|
| <code>--force, -f</code> | (Optional) Forces release of specified disks. When this option is specified, the check to verify that all disk groups are mounted on the current node is skipped. |
| <code>--release-disk, -rd</code> | Specifies the disks to release. Generally, this specifies a single storage device with partitions on different disk groups. You can also specify a comma-separated list of disks to release. |
| <code>--json, -j</code> | (Optional) Displays JSON output. |
| <code>--help, -h</code> | (Optional) Displays help for using the command. |

Usage Notes

- Run the `odacli list-dgdisks` to view details of the disk, before running the `odacli modify-dgstorage` command.
- The `odacli modify-dgstorage` command runs a precheck to ensure all disk groups are mounted on the node. You can use the `-f` option to override the precheck.

Example 16-180 Releasing a physical disk `HDD_E0_S10_577135552` which has two logical partitions on two different disk groups

```
# odacli modify-dgstorage -rd HDD_E0_S10_577135552
```

```
Job details
```

```
-----
ID: 46bc736c-417b-4ac2-826e-aa857db50e29
Description: Release disks: [HDD_E0_S10_577135552]
Status: Running
Created: December 8, 2024 6:24:27 PM PDT
Message: Release ASM disks
```

Verifying the result of the Release Disks operation:

```
# odacli describe-job -i 46bc736c-417b-4ac2-826e-aa857db50e29
```

```
Job details
```

```
-----
ID: 46bc736c-417b-4ac2-826e-aa857db50e29
Description: Release disks: [HDD_E0_S10_577135552]
```

```
Status: Success
Created: December 8, 2024 6:24:27 PM PDT
Message: Release ASM disks
```

odacli Diagnostics Collection Commands

Use the diagnostics collection commands to display diagnostics details.

- [odacli create-diagcollection](#)
Use the `odacli create-diagcollection` command to create diagnostics collection data from the appliance.
- [odacli describe-diagcollection](#)
Use the `odacli describe-diagcollection` command to describe diagnostics collection data from the appliance.
- [odacli list-diagcollections](#)
Use the `odacli list-diagcollections` command to list the diagnostics collections.
- [odacli delete-diagcollection](#)
Use the `odacli delete-diagcollection` command to delete diagnostics collection data from the appliance.

odacli create-diagcollection

Use the `odacli create-diagcollection` command to create diagnostics collection data from the appliance.

File Path

```
/opt/oracle/dcs/bin/odacli
```

Syntax

To create diagnostics collection:

```
odacli create-diagcollection -i id [-d] [-t] [-j] [-h]
```

Parameters

| Parameter | Description |
|--------------------------------|---|
| <code>--id, -i</code> | (Mandatory) Specifies the DCS job ID for the collection. |
| <code>--description, -d</code> | (Optional) Description of the diagnostic collection. |
| <code>--tag, -t</code> | (Optional) Specifies tag name to identify the collection. |
| <code>--json, -j</code> | (Optional) Displays JSON output. |
| <code>--help, -h</code> | (Optional) Displays help for using the command. |

Example 16-181 Creating a diagnostics collection

```
# odacli create-diagcollection -i ID
```

Job details

```

-----
                ID: f840feb8-7712-49a1-a525-1ee911176c50
Description:    Diagnostic collection creation
                Status: Created
                Created: April 11, 2023 7:15:30 PM UTC
                Message:

```

odacli describe-diagcollection

Use the `odacli describe-diagcollection` command to describe diagnostics collection data from the appliance.

File Path

```
/opt/oracle/dcs/bin/odacli
```

Syntax

To describe diagnostics collection:

```
odacli describe-diagcollection -i id [-j] [-h]
```

Parameters

| Parameter | Description |
|-------------------------|--|
| <code>--id, -i</code> | (Mandatory) Specifies the diagnostics collection ID. |
| <code>--json, -j</code> | (Optional) Displays JSON output. |
| <code>--help, -h</code> | (Optional) Displays help for using the command. |

Example 16-182 Describing a diagnostics collection

```
# odacli describe-diagcollection -i ID
```

```
Diagnostic collection
details
-----
```

```

--
                ID: f5c07af8-2635-466d-b487-0f04d15fba79
Requested job ID: 016e74cb-01e0-4812-96ef-94602b5ea2c5
Description: Diagnostic collection for job 'Agent State Update
Job '
Collection file path: /opt/oracle/dcs/commonstore/diag/2023/04/
f5c07af8-2635-466d-b487-0f04d15fba79.tar.gz
Collection size: 91.88 KB
Start time: February 27, 2023 7:58:41 PM UTC
End time: February 27, 2023 7:59:39 PM UTC

```

odacli list-diagcollections

Use the `odacli list-diagcollections` command to list the diagnostics collections.

File Path

```
/opt/oracle/dcs/bin/odacli
```

Syntax

To list all diagnostics collections:

```
odacli list-diagcollections [-j] [-h]
```

Parameters

| Parameter | Description |
|-------------------------|---|
| <code>--json, -j</code> | (Optional) Displays JSON output. |
| <code>--help, -h</code> | (Optional) Displays help for using the command. |

Example 16-183 Listing all diagnostics collections

```

ID
Description
size Start time                               End time                               Collection
-----
-----
3c65bcd3-cd30-4332-88b7-fc25b256db75      Diagnostic collection for job
'DcsAdmin patching'                        8.37 MB                               2023-03-08 15:37:02
UTC                                         2023-03-08 15:38:01 UTC
7dd1d951-056c-47b2-ad78-8614d0b3bbd0      Diagnostic collection for job 'VM
winvml start'                              6.59 MB                               2023-03-08 15:37:02
UTC                                         2023-03-08 15:38:01 UTC

```

odacli delete-diagcollection

Use the `odacli delete-diagcollection` command to delete diagnostics collection data from the appliance.

File Path

```
/opt/oracle/dcs/bin/odacli
```

Syntax

To delete diagnostics collection:

```
odacli delete-diagcollection -i id [-j] [-h]
```

Parameters

| Parameter | Description |
|-------------------------|--|
| <code>--id, -i</code> | (Mandatory) Specifies the diagnostics collection ID to be deleted. |
| <code>--json, -j</code> | (Optional) Displays JSON output. |
| <code>--help, -h</code> | (Optional) Displays help for using the command. |

Example 16-184 Deleting a diagnostics collection

```
# odacli delete-diagcollection -i ID
```

odacli Job Commands

Use the `odacli list-jobs` and `odacli describe-job` commands to display job details.

- [odacli create-jobdata-retention-policy](#)
Use the `odacli create-jobdata-retention-policy` command to create job data retention policy for default DCS jobs and specific auto scheduled jobs.
- [odacli create-purge-jobdata-job](#)
Use the `odacli create-purge-jobdata-job` command to create a job to delete data for default DCS jobs and specific auto scheduled jobs.
- [odacli delete-jobdata-retention-policy](#)
Use the `odacli delete-jobdata-retention-policy` command to delete job data retention for default DCS jobs and specific auto scheduled jobs.
- [odacli describe-job](#)
Use the `odacli describe-job` command to display details about a specific job, including the job ID, status, tasks, and the job created date and time stamp.
- [odacli list-jobs](#)
Use the `odacli list-jobs` command to display a list of jobs, including the job IDs, status, and the job created date and time stamp. The default number of jobs listed is 50 from the earliest to the latest.
- [odacli list-pendingjobs](#)
Use the `odacli list-pendingjobs` command to list all pending jobs.
- [odacli list-jobdata-retention-policy](#)
Use the `odacli list-jobdata-retention-policy` command to list job data retention policy for default DCS jobs and specific auto scheduled jobs.
- [odacli list-purge-jobdata-jobs](#)
Use the `odacli list-purge-jobdata-jobs` command to list purge job data for default DCS jobs and specific auto scheduled jobs.
- [odacli list-scheduled-executions](#)

odacli create-jobdata-retention-policy

Use the `odacli create-jobdata-retention-policy` command to create job data retention policy for default DCS jobs and specific auto scheduled jobs.

File Path

```
/opt/oracle/dcs/bin/odacli
```

Syntax

To create job data retention policy:

```
odacli create-jobdata-retention-policy [-j] [-h] [-w] [-s]
```

Parameters

| Parameter | Description |
|--|---|
| <code>--json, -j</code> | (Optional) Displays JSON output. |
| <code>--help, -h</code> | (Optional) Displays help for using the command. |
| <code>--retentionWindow, -w</code> | (Optional) Describes the time interval to retain the job data. Default is 30 days if not specified. |
| <code>--retentionWindowUnit, -u</code> | (Optional) Describes the unit for the retentionWindow. Possible values are Day Hour Minute. Default is Day if no value is specified. |
| <code>--scheduleIds, -s</code> | (Optional) Specifies the IDs, delimited by commas, of the scheduled jobs similar to the <code>odacli list-schedules</code> result. Use <code>Default</code> for all DCS jobs. |

Usage Notes

- Once a policy is created, an auto scheduled job is created to start purging DCS job records regularly, for example, every day at 4 AM, based on the retention policies you define.

Example 16-185 Creating a default policy to purge all the jobs and scheduled executions older than 30 days

```
# odacli create-jobdata-retention-policy
```

```
Job details
```

```
-----
ID: 36d00489-39b1-425f-81bf-6d6e3bfede8b
Description: set job data retention policy
Status: Created
Created: April 23, 2020 3:32:09 PM PDT
Message:
```

```
Task Name Start Time End Time Status
-----
```

```
-----
[root@oda1]# ./odacli describe-job -i c40c17f0-4185-40fe-a126-30fe1f0e5cdd
```

Job details

```

-----
ID: c40c17f0-4185-40fe-a126-30fe1f0e5cdd
Description: set job data retention policy
Status: Success
Created: April 23, 2020 5:42:28 PM PDT

```

Message:

```
Task Name Start Time End Time Status
-----
```

```

-----
set job data retention policy  April 23, 2020 5:42:28 PM PDT  April 23,
2020 5:42:28 PM PDT  Success
create auto job data schedule  April 23, 2020 5:42:28 PM PDT  April 23,
2020 5:42:28 PM PDT  Success

```

Example 16-186 Set up a retention policy of 10 days for the schedule 'archive_log_backup'

```
# odacli create-jobdata-retention-policy -s 284a22b5-41e6-4be1-
a916-048eac74e076 -w 10 -u Day
```

Job details

```

-----
ID: ea68a90e-a8e2-4fc4-a4f1-75461e12c387
Description: set job data retention policy
Status: Created
Created: April 23, 2020 6:22:14 PM PDT

```

Message:

```
Task Name Start Time End Time Status
-----
```

```
[root@oda1]# ./odacli list-jobdata-retention-policy
```

```

Schedule Id      Retention Window  Unit      Modified
-----
Default         20              Day       April 23, 2020 6:16:59 PM PDT
284a22b5-41e6-4be1-a916-048eac74e076  10 Day       April 23, 2020 6:22:14 PM
PDT

```

odacli create-purge-jobdata-job

Use the `odacli create-purge-jobdata-job` command to create a job to delete data for default DCS jobs and specific auto scheduled jobs.

File Path

```
/opt/oracle/dcs/bin/odacli
```

Syntax

To create job data purge:

```
odacli create-purge-jobdata-job [-j] [-h] [-i] [-o] [-u] [-s]
```

Parameters

| Parameter | Description |
|---------------------|--|
| --json, -j | (Optional) Displays JSON output. |
| --help, -h | (Optional) Displays help for using the command. |
| --jobIds, -i | (Optional) Purges data for given DCS job IDs, delimited by commas. |
| --olderThan, -o | (Optional) Purges job data older than the specified time. If not specified, use the existing retentionWindow value. |
| --olderThanUnit, -u | (Optional) Describes the unit for the OlderThan option. Possible values are Day Hour Minute. If not specified, use the existing retentionWindow value. |
| --scheduleIds, -s | (Optional) Specifies the IDs, delimited by commas, of the scheduled jobs similar to the odacli list-schedules result. |

Example 16-187 Creating a job to purge job data

```
# odacli create-purge-jobdata-job

Job details
-----
ID: e43dbd56-dc7c-4812-b653-0fc3208e0929
Description: purge job data
Status: Created
Created: April 23, 2020 6:27:40 PM PDT

Message:
Task Name Start Time End Time Status
-----
-----

[root@oda1]# odacli describe-job -i e43dbd56-dc7c-4812-b653-0fc3208e0929
Job details
-----
ID: e43dbd56-dc7c-4812-b653-0fc3208e0929
Description: purge job data

Status: Success
Created: April 23, 2020 6:27:40 PM PDT
Message: Purged 21 metadata records and 10 files. Purge policies are:
Purge all jobs and scheduled executions older than 30 Days
Purge scheduled executions for ID:284a22b5-41e6-4be1-a916-048eac74e076 older
than 10 Day
```

```

Task Name      Start Time      End Time      Status
-----
purge job data April 23, 2020 6:27:40 PM PDT  April 23, 2020 6:27:40 PM
PDT      Success

```

Example 16-188 Purging job data older than 5 hours, including all jobs and scheduled executions related records

```

# odacli create-purge-jobdata-job -o 5 -u Hour
Job details
-----
ID: 4d065c96-a8eb-4974-a446-573b5ad3cb95
Description: purge job data
Status: Created
Created: April 23, 2020 1:55:59 PM PDT
Message:
Task Name Start Time End Time Status
-----

[root@odal1]# odacli describe-job -i 4d065c96-a8eb-4974-a446-573b5ad3cb95

Job details
-----
ID: 4d065c96-a8eb-4974-a446-573b5ad3cb95
Description: purge job data
Status: Success
Created: April 23, 2020 1:55:59 PM PDT
Message: Purged 242 metadata records and 0 files. Purge policies are:
Purge all jobs and scheduled executions older than 5 Hour

Task Name Start Time End Time Status
-----
purge job data      April 23, 2020 1:55:59 PM PDT      April 23, 2020
1:55:59 PM PDT      Success

```

Example 16-189 Purging job data for multiple jobs

```

# odacli create-purge-jobdata-job -i 87a926cd-a243-49e0-
ba02-9d8968e1de1e,0e2a38c0-041a-41d8-91ad-7f9f7c646f12

Job details
-----
ID: 217cbdbf-15a5-47d3-9582-3f26d6b5eebf
Description: purge job data
Status: Created
Created: April 23, 2020 2:01:25 PM PDT
Message: Task Name Start Time End Time Status
-----

[root@odal1]# odacli describe-job -i 217cbdbf-15a5-47d3-9582-3f26d6b5eebf
Job details

```

```

-----
ID: 217cbdbf-15a5-47d3-9582-3f26d6b5eebf
Description: purge job data
Status: Success
Created: April 23, 2020 2:01:25 PM PDT
Message: Purged 11 metadata records and 0 files. Purge policies are:
Purge job with ID:87a926cd-a243-49e0-ba02-9d8968e1de1e
Purge job with ID:0e2a38c0-041a-41d8-91ad-7f9f7c646f12

```

```

Task Name Start Time End Time Status
-----
purge job data April 23, 2020 2:01:25 PM PDT April 23, 2020
2:01:25 PM PDT Success

```

Example 16-190 Purging job data for specific job data schedules older than 5 days

```
# odacli create-purge-jobdata-job -s 39cc86d6-30c2-4744-bfbc-
e62535e2aa67,31b3a83b-76ca-44d3-9268-b4dac948e217 -o 5 -u Day
```

Job details

```

-----
ID: be839a81-a79b-43ce-bf70-c8abala9cc91
Description: purge job data
Status: Created
Created: April 23, 2020 2:44:54 PM PDT
Message:

```

```
Task Name Start Time End Time Status
-----
```

```
[root@odal]# ./odacli describe-job -i be839a81-a79b-43ce-bf70-c8abala9cc91
```

Job details

```

-----
ID: be839a81-a79b-43ce-bf70-c8abala9cc91
Description: purge job data
Status: Success
Created: April 23, 2020 2:44:54 PM PDT
Message: Purged 0 metadata records and 0 files. Purge policies are:
Purge scheduled executions for ID:39cc86d6-30c2-4744-bfbc-e62535e2aa67 older
than 5 Day
Purge scheduled executions for ID:31b3a83b-76ca-44d3-9268-b4dac948e217 older
than 5 Day

```

```
Task Name Start Time End Time Status
-----
```

```

-----
purge job data April 23, 2020 2:44:54 PM PDT April 23, 2020 2:44:54 PM PDT
Success

```

odacli delete-jobdata-retention-policy

Use the `odacli delete-jobdata-retention-policy` command to delete job data retention for default DCS jobs and specific auto scheduled jobs.

File Path

```
/opt/oracle/dcs/bin/odacli
```

Syntax

To delete job data retention:

```
odacli delete-jobdata-retention-policy [-j] [-h][-s]
```

Parameters

| Parameter | Description |
|--------------------------------|---|
| <code>--json, -j</code> | (Optional) Displays JSON output. |
| <code>--help, -h</code> | (Optional) Displays help for using the command. |
| <code>--scheduleIds, -s</code> | (Optional) Specifies the IDs applied by the job data retention policy. If not supplied, delete all the existing policies. |

Example 16-191 Deleting the job data retention policies

```
# odacli delete-jobdata-retention-policy

Job details
-----
ID: ab819d57-9e35-4f55-bd5e-d26fc6372448
Description: delete job data retention policy
Status: Running
Created: April 23, 2020 7:34:05 PM PDT

Message:
Task Name Start Time End Time Status
-----
remove job data retention policy entries      April 23, 2020 7:34:05 PM
PDT      April 23, 2020 7:34:05 PM PDT      Running

[root@odal1]# odacli describe-job -i ab819d57-9e35-4f55-bd5e-d26fc6372448

Job details
-----
ID: ab819d57-9e35-4f55-bd5e-d26fc6372448
Description: delete job data retention policy
Status: Success
Created: April 23, 2020 7:34:05 PM PDT
Message:

Task Name Start Time End Time Status
```



```

-----
remove job data retention policy entries      April 23, 2020 7:34:05 PM
PDT      April 23, 2020 7:34:05 PM PDT      Success
remove auto job data schedule                April 23, 2020 7:34:05 PM
PDT      April 23, 2020 7:34:05 PM PDT      Success

```

```
[root@oda1]# odacli list-jobdata-retention-policy
```

```
DCS-10032:Resource JobDataRetentionPolicy is not found.
```

odacli describe-job

Use the `odacli describe-job` command to display details about a specific job, including the job ID, status, tasks, and the job created date and time stamp.

File Path

```
/opt/oracle/dcs/bin/odacli
```

Syntax

To view a specific job, status, and tasks:

```
odacli describe-job -i id [-e] [-n parent_task] [-sd sorted_by_duration] [-s status] [-j] [-h]
```

Parameters

| Parameter | Description |
|-----------------------------------|---|
| <code>--id, -i</code> | (Mandatory) Identifies the job. To get the job identifier (jobid), run the <code>list-jobs</code> command. |
| <code>--ecr, -e</code> | (Optional) Specifies to display the error correlation report. |
| <code>--number, -n</code> | (Optional) Specifies the number of parent tasks. |
| <code>--sort-duration, -sd</code> | (Optional) Sorts tasks by duration, either ascending (<code>asc</code>) or descending (<code>desc</code>). |
| <code>--status, -s</code> | (Optional) Specifies the status of the task, such as <code>running</code> , <code>failure</code> , <code>success</code> . |
| <code>--json, -j</code> | (Optional) Displays JSON output. |
| <code>--help, -h</code> | (Optional) Displays help for using the command. |

Example 16-192 Displaying Details for a Job

To display details of a specific job with job ID `02df22c8-c21f-4162-8265-97f7826c243a`:

```
# odacli describe-job -i 02df22c8-c21f-4162-8265-97f7826c243a
```

Example 16-193 Viewing Error Correlation Report

To view error correlation report using ODACLI command:

```
# odacli describe-job -i cb6faa85-d2b4-441a-864a-17a8532cf78d --ecr
ODA Assistant - Error Correlation report
-----
          Failed job ID: cb6faa85-d2b4-441a-864a-17a8532cf78d
          Description: Database service deletion with DB name: zdjGIEn with
id : 4ab1da3e-3918-4acf-bb7f-5529e750849f
          Start Time: 2023-04-14 07:24:37
          End Time: 2023-04-14 07:26:59
          EC report path:
/opt/oracle/dcs/da/da_repo/0ae47ffd-5641-47ed-b66f-f674a6c1fb1d.json

Failed Task Messages
-----
[Database service deletion with DB name: zdjGIEn with id : 4ab1da3e-3918-4acf-
bb7f-5529e750849f] - DCS-10001:Internal error encountered: Failed to delete:
RECO/ZDJGIENU for the database: zdjGIEn.

oda1 Log Messages
-----
DCS Agent
~~~~~
Error Logs
=====
[Kill Pmon Process] - No process running for database : zdjGIEnU
[Database Files Deletion] - Failed to delete directory RECO/ZDJGIENU due
to error: ORA-29261: bad argument
[Database Files Deletion] - ORA-15178: directory 'ZDJGIENU' is not empty;
cannot drop this directory
[Database Files Deletion] - ORA-15028: ASM file '+RECO.431.1134101713'
not dropped; currently being accessed
[Database Files Deletion] - ORA-06512: at "SYS.X$DBMS_DISKGROUP", line
666
[Database Files Deletion] - ORA-06512: at line 2 (DBD ERROR:
OCISstmtExecute)
[Database Files Deletion] - Failed to delete: RECO/ZDJGIENU for the
database: zdjGIEn
[Database Service deletion for 4ab1da3e-3918-4acf-bb7f-5529e750849f] -
DCS-10001:Internal error encountered: Failed to delete: RECO/ZDJGIENU for the
database: zdjGIEn.
          Error code - DCS-10001
          Cause: An internal error occurred.
          Action: Contact Oracle Support for assistance.

RHP Error Logs
=====
[jobid-cb6faa85-d2b4-441a-864a-17a8532cf78d] -
[BatchMoveOpImpl.getMoveDBStateInfo:9195] attempt to fetch metadata from
repos failed with EntityNotExistsException : PRGR-110 : Repository object
"dbsa03b123e2;;;/u01/app/oracle/product/19.0.0.0/dbhome_1" of type "MOVE"
does not exist.
          Error code - PRGR-110
          Cause: The specified repository object does not exist in the repository
database.
```

```

Action: Specify the correct repository object name.
[jobid-cb6faa85-d2b4-441a-864a-17a8532cf78d] -
[GridHomeFactoryImpl.getTempLocation:1437] Exception node : PRCR-1001 :
Resource ora.rhpserver does not exist
Error code - PRCR-1001
Cause: An attempt was made to operate on a resource that does not
exist.
Action: Check the resource using the command 'srvctl config <object>'
and if the resource does not exist, then create it using the command 'srvctl
add <object>'.

```

Release Notes

No matching results were found.

Documentation

1. Deleting a Database

Abstract - Use the Oracle Appliance Manager Browser User Interface to delete an Oracle database.

Link -

<https://domainname:7093/docs/cmtxn/managing-databases-oda.html#GUID-D85D987A-1D9E-4615-B9DB-65B4B393B1D1>

odacli list-jobs

Use the `odacli list-jobs` command to display a list of jobs, including the job IDs, status, and the job created date and time stamp. The default number of jobs listed is 50 from the earliest to the latest.

File Path

/opt/oracle/dcs/bin/odacli

Syntax

To list jobs and view job details and status:

```

odacli list-jobs [-all] [-d] [-desc description_pattern] [-ec] [-o day]
  [-f from] [-hd head] [-l last] [-msg message_pattern]
  [-ndesc not_match_description_pattern]
  [-nmsg not_match_message_pattern] [-sd sorted_by_duration]
  [-s status] [-tl tail] [-t to] [-j] [-h]

```

Parameters

| Parameter | Description |
|------------------|---|
| --all-jobs, -all | (Optional) Displays jobs created by both DCS and error correlation framework. |
| --ec-jobs, -ec | (Optional) Displays jobs created by the error correlation framework. |

| Parameter | Description |
|-----------------------------------|---|
| <code>--for, -o</code> | <p>(Optional) Describes a job created on a specific date. In the format YYYY-MM-DD, such as 2018-01-01.</p> <p>Example:</p> <pre># odacli list-jobs -o 2018-08-09</pre> |
| <code>--from, -f</code> | <p>(Optional) Describes a job created since a specific date. In the format YYYY-MM-DD or YYYY-MM-DD HH:mm:ss, such as 2018-01-01 or 2018-01-01 01:00:00.</p> <p>Examples:</p> <pre># odacli list-jobs -f 2018-08-27 # odacli list-jobs -f "2018-08-27 03:00:00"</pre> |
| <code>--head, -hd</code> | <p>(Optional) Describes the maximum number of older jobs to be displayed, values can be 1 to 200.</p> <p>Example:</p> <pre>odacli list-jobs -hd 10</pre> |
| <code>--to, -t</code> | <p>(Optional) Describes a job created ahead of a specific date. In the format YYYY-MM-DD or YYYY-MM-DD HH:mm:ss, such as 2018-01-01 or 2018-01-01 01:00:00.</p> <p>Example:</p> <pre># odacli list-jobs -t 2018-08-07</pre> |
| <code>--last, -l</code> | <p>(Optional) Describes jobs created from last 'n' time unit - where n can be any integer and time unit can be d for days, h for hours or m for minutes.</p> |
| <code>--tail, -tl</code> | <p>(Optional) Describes the maximum number of latest jobs to be displayed, values can be 1 to 200.</p> <p>Example:</p> <pre># odacli list-jobs -tl 10</pre> |
| <code>--description, -desc</code> | <p>(Optional) Specifies the pattern to filter jobs based on their description. For example, <code>.*a, b.*, .*a b.*</code></p> |
| <code>--no-desc, -ndesc</code> | <p>(Optional) Specifies the pattern to filter jobs that do not match their description. For example, <code>.*a, b.*, .*a b.*</code></p> |

| Parameter | Description |
|-----------------------------------|---|
| <code>--message, -msg</code> | (Optional) Specifies the pattern to filter jobs based on their message. For example, <code>.*a, b.*, .*a b.*</code> |
| <code>--no-message, -nmsg</code> | (Optional) Specifies the pattern to filter jobs that do not match their message. For example, <code>.*a, b.*, .*a b.*</code> |
| <code>--sort-duration, -sd</code> | (Optional) Specifies to sort jobs by duration, either <code>asc</code> or <code>desc</code> . |
| <code>--status, -s</code> | (Optional) Specifies the status of the job, such as <code>created</code> , <code>scheduled</code> , <code>running</code> , <code>failure</code> , <code>success</code> , <code>internalerror</code> . Example: <code># odacli list-jobs -s success</code> |
| <code>--describe-job, -d</code> | (Optional) Specifies the description of the filtered job, if the filter returns a single job. |
| <code>--json, -j</code> | (Optional) Displays JSON output. |
| <code>--help, -h</code> | (Optional) Displays help for using the command. |

Example 16-194 Displaying a List of Jobs

To display a list of jobs:

```
# odacli list-jobs
```

```
ID                               Description                               Created
-----
a6084067-72a1-4625-bea7-efd      Provisioning service                       creation Jun 2, 2018
10:19:23 AM
```

(Continued)

Status

Success

Example 16-195 Displaying Specified Number of Older Jobs

To display a specified number of older jobs:

```
# odacli list-jobs -hd 5
```

```
ID Description Created Status
```

```
--- --- --
```

```
643c6186-a667-43d7-847f-d756a96fa072 Create detailed Backup Report
```

```
August 5, 2018 12:36:26 AM UTC Success
```

```
f29cb82c-6150-487d-aaff-52d65f6ab972 Create recovery-pitr : time '08/05/2018
```

```
07:16:12'
```

```
for db : igIyoz August 5, 2018 1:01:39 AM UTC Success
```

```
cfe19337-ab2f-4ef3-85b5-24601ba31be2 Create detailed Backup Report
```

```

August 5, 2018 1:17:46 AM UTC Success
3749b5e2-240e-4df5-b3c1-32d345243b25 Create detailed Backup Report
August 5, 2018 2:01:07 AM UTC Success
64828852-bb16-4f06-aca9-4bdf9fe7b6f2 Create regular-5 Backup with TAG-
iD5UNjBZ8HN2FYL
for Db:igIyoz August 5, 2018 2:14:19 AM UTC Success

```

Example 16-196 Displaying Jobs in a Date Range

To display jobs created within a time frame:

```

# ./odacli list-jobs -f 2018-08-07 -t 2018-08-08
ID Description Created Status
--- ---
1fc5ef97-a9db-49b2-9664-7c551bd005f4 Authentication key update for test_user
August 7, 2018 12:56:58 AM UTC Success
e24f86cf-bb2e-4ebe-84e0-da5cedb27ad4 Provisioning service creation August 7,
2018 1:00:54 AM UTC Success
7f67efd6-cce5-47b4-8dc4-fdb732491f99 CPU cores service update August 7, 2018
1:41:05 AM UTC Success
0ae9a312-bac8-43be-8a64-5a12c24c2a02 SSH keys update August 7, 2018 1:42:59
AM UTC Success
af41fdc1-87ff-46cd-bc41-26615e115ae7 SSH key delete August 7, 2018 1:44:56 AM
UTC Success
79e4cbb0-b474-48ab-9e04-d3d602bc0ed2 DcsCli patching August 7, 2018 1:50:18
AM UTC Success
edd55e7d-f81f-4a10-942d-1121aef0bfff3 DcsCli patching August 7, 2018 1:50:32
AM UTC Success
acc22c60-3476-4566-8faa-4d36b116eded create backup
config:aaaaaaaaaaaaaaaaaaaaaaaaaaaaa August 7, 2018 2:01:46 AM UTC Success
d89efedf-9110-429a-a3b2-ccd6a53f8564 Database Home OraDB12201_home2 creation
with version :12.2.0.1 August 7, 2018 2:36:05 AM UTC Success
2a5532ae-41fa-47c2-bc90-010a5f26d6b2 Database service creation with db name:
my122 August 7, 2018 3:52:38 AM UTC Success
c4e533e9-c596-478f-92db-2f11f1384075 Discover Components : all August 7, 2018
4:07:09 AM UTC Success
149e89b5-27d3-4c7c-9c03-f029ca3dd495 Discover Components : all August 7, 2018
4:08:45 AM UTC Success
21d4c37b-49ad-48dd-a1db-1f25d9288312 Database Home OraDB11204_home1 creation
with version :11.2.0.4 August 7, 2018 4:19:32 AM UTC Success
b61dbbca-edc1-4a4a-9db2-82b0bdc64e6 Database service deletion with db name:
myTestDb with id : 6400c81d-5837-480c-b4a1-7c01591ee144 August 7, 2018
4:24:50 AM UTC Success
d4a104df-5796-4e37-9173-82f0e263d642 create backup config:bkfgd August 7,
2018 4:28:54 AM UTC Success
a121d40b-f33b-47a4-8fc6-4e3b84173f44 Database service creation with db name:
my112 August 7, 2018 6:51:13 PM UTC Success
42dd661f-9ba0-4877-ace9-39d3f212c071 Discover Components : all August 7, 2018
7:12:56 PM UTC Success
2f648f5a-c9c5-42ec-adb0-98cf6497c89e Discover System Components : system
August 8, 2018 3:28:12 AM UTC Success
a5755f43-509d-4d4c-b7ef-9f99660c4de7 DB Home Patching: Home Id is
97df26b3-42f2-4189-805b-82d1b38737d0 August 8, 2018 3:52:08 AM UTC Success
79b0e697-065f-4630-a524-8d072a4e139a Database Home OraDB12102_home1 creation
with version :12.1.0.2 August 8, 2018 4:34:30 AM UTC Success
112b75bc-3512-4c28-a479-3e0317eb0dc4 Database service creation with db name:

```

```

mynew121 August 8, 2018 8:02:51 AM UTC Failure
09f56fb0-1e91-4b02-a9b8-5add11a8da32 Database service creation with db name:
my121a August 8, 2018 9:13:01 AM UTC Success
5633ded9-07ea-4bf9-9533-31eb65789fe7 Database service deletion with db name:
mynew121 with id : 24be4362-16c8-476f-903a-f6f2ef59f5e4 August 8, 2018
9:24:31 AM UTC Success
458d1c45-02dc-456c-ae88-5da613faaa66 Database service creation with db name:
mynew121 August 8, 2018 9:27:31 AM UTC Success
f178f378-a9d7-4d5c-b6f5-6f62ea4e05bb Database service deletion with db name:
myTestDb with id : ef50387b-0c62-4446-b210-f8d070e2a043 August 8, 2018
9:40:43 AM UTC Success
7fab740f-a711-466a-ba6d-dd5643374c28 Database service deletion with db name:
myTestDb with id : 6632a083-558a-4eb4-8c2b-af0710179980 August 8, 2018
9:41:04 AM UTC Success
3121529d-2b9d-4bbe-bf58-996c2cf46996 Database service creation with db name:
mydss August 8, 2018 9:42:06 AM UTC Success
3d0a9261-19d7-42bb-8b92-00fcc4f8c41e Discover Components : db August 8, 2018
10:17:22 AM UTC Success

```

odacli list-pendingjobs

Use the `odacli list-pendingjobs` command to list all pending jobs.

File Path

```
/opt/oracle/dcs/bin/odacli
```

Syntax

```
odacli list-pendingjobs [-j] [-h]
```

Parameters

| Parameter | Description |
|------------|---|
| --help, -h | (Optional) Displays help for using the command. |
| --json, -j | (Optional) Displays JSON output. |

Example 16-197

```
# odacli list-pendingjobs
```

odacli list-jobdata-retention-policy

Use the `odacli list-jobdata-retention-policy` command to list job data retention policy for default DCS jobs and specific auto scheduled jobs.

File Path

```
/opt/oracle/dcs/bin/odacli
```

Syntax

To list jobs and view job details and status:

```
odacli list-jobdata-retention-policy [-j] [-h]
```

Parameters

| Parameter | Description |
|------------|---|
| --json, -j | (Optional) Displays JSON output. |
| --help, -h | (Optional) Displays help for using the command. |

Example 16-198 Listing all job retention policies

```
# odacli list-jobdata-retention-policy

Schedule Id Retention Window Unit Modified
-----
Default      30 Days      April 23, 2020 6:16:59 PM PDT
284a22b5-41e6-4be1-a916-048eac74e076  10 Days      April 23, 2020 6:22:14
PM PDT
```

odacli list-purge-jobdata-jobs

Use the `odacli list-purge-jobdata-jobs` command to list purge job data for default DCS jobs and specific auto scheduled jobs.

File Path

```
/opt/oracle/dcs/bin/odacli
```

Syntax

To list job data purge policy:

```
odacli list-purge-jobdata-jobs [-j] [-h]
```

Parameters

| Parameter | Description |
|------------|---|
| --json, -j | (Optional) Displays JSON output. |
| --help, -h | (Optional) Displays help for using the command. |

Usage Notes

The command describes the files that are purged, the purged count, the purged file size, and the time of purge.

Example 16-199 Listing history, statistics, and rules for job data purge jobs

```
# odacli list-purge-jobdata-jobs
```

| Purge By Job Size | Job Type | Purged Time | Purged Object | Count |
|---|-------------|-------------------------------|----------------------|-------|
| 4d065c96-a8eb-4974-a446-573b5ad3cb95 102 | Metadata | April 23, 2020 1:55:59 PM PDT | TaskReport | |
| 4d065c96-a8eb-4974-a446-573b5ad3cb95 24 | Metadata | April 23, 2020 1:55:59 PM PDT | ServiceJobReport | |
| 4d065c96-a8eb-4974-a446-573b5ad3cb95 2 | Metadata | April 23, 2020 1:55:59 PM PDT | LogCleanupSummary | |
| 4d065c96-a8eb-4974-a446-573b5ad3cb95 93 | Metadata | April 23, 2020 1:55:59 PM PDT | JobExecutionResource | |
| 4d065c96-a8eb-4974-a446-573b5ad3cb95 21 | Metadata | April 23, 2020 1:55:59 PM PDT | JobDataPurgeResult | |

odacli list-scheduled-executions

Use the command `odacli list-scheduled-executions` to display a list of jobs that were executed.

File Path

```
$ORACLE_HOME/opt/oracle/dcs/bin/odacli
```

Syntax

```
odacli list-scheduled-executions [-e] [-l] [-j] [-h]
```

Parameters

| Parameter | Description |
|--------------------------------|--|
| <code>--executionid, -e</code> | (Optional) Displays the execution ID. |
| <code>--scheduleid, -i</code> | (Optional) Displays the Schedule ID. |
| <code>--help, -h</code> | (Optional) Displays help for using the command. |
| <code>--json, -j</code> | (Optional) Displays JSON output. The default is false. |

Example 16-200 Displaying a List of Scheduled and Executed Jobs

Display a list of scheduled tasks, the status, and the date and time that the task was executed. In the following example, three (3) scheduled tasks were executed. One task, Schedule ID 04b5750c-0d13-42cf-aba3-85416e8edafb, was executed twice.

```
# odacli list-scheduled-executions
```

| ID JobId | ScheduledId |
|--------------------------------------|--------------------------------------|
| 9890508c-ff6d-4307-972f-7962ec390871 | 04b5750c-0d13-42cf-aba3-85416e8edafb |

```
10a33e08-695c-4d13-b970-7dc7215f3cdd
7ee1e2aa-80a8-4297-97f7-365b84bcce4d
4a9e9796-4bed-4df7-af1e-de49362dda97 04b5750c-0d13-42cf-aba3-85416e8edafb
```

```
(Continued)
Status      Executed Time
-----
Executed    February 4, 2018 12:00:00 AM UTC
Executed    February 4, 2018 12:00:00 AM UTC
Executed    February 5, 2018 12:00:00 AM UTC
```

To learn more about a scheduled backup, run the command `odacli list-schedules`. The output displays the ID, name, description, and schedule for each task.

```
# odacli list-schedules
```

```
ID                                     Name
Description
-----
d136cc72-4a80-4ab8-9f1e-120b995b2794  metastore maintenance
internal metastore maintenance
04b5750c-0d13-42cf-aba3-85416e8edafb  AgentState metastore cleanup
internal agentstateentry metastore maintenance
7ee1e2aa-80a8-4297-97f7-365b84bcce4d  backupreport maintenance      backup
reports deletion
```

```
(Continued)
CronExpression      Disabled
-----
0 0 0 1/1 * ? *      true
0 0 0 1/1 * ? *      false
0 0 0 1/3 * ? *      false
```

odacli Oracle Key Vault Server Configuration Commands

Use `odacli` commands to manage Oracle Key Vault server configuration for databases on Oracle Database Appliance.

- [odacli create-okvserverconfig](#)
Use the command `odacli create-okvserverconfig` to create an Oracle Key Vault server configuration.
- [odacli copy-okvtdewallet](#)
Use the command `odacli copy-okvtdewallet` to copy an Oracle Key Vault TDE wallet.
- [odacli delete-okvserverconfig](#)
Use the command `odacli delete-okvserverconfig` to delete an Oracle Key Vault server configuration.
- [odacli describe-okvserverconfig](#)
Use the command `odacli describe-okvserverconfig` to view the Oracle Key Vault server configuration details.
- [odacli list-okvserverconfigs](#)
Use the command `odacli list-okvserverconfigs` to view all Oracle Key Vault server configurations.

odacli create-okvserverconfig

Use the command `odacli create-okvserverconfig` to create an Oracle Key Vault server configuration.

File Path

```
/opt/oracle/dcs/bin/odacli
```

Syntax

```
# odacli create-okvserverconfig -n name -u okv_user_name [-d okv_description]
[-host okv_host_name] [-ip okv_ip_address] [-h] [-j]
```

Parameters

| Parameter | Description |
|--------------------------------|--|
| <code>--name, -n</code> | (Mandatory) Specifies the name of the Oracle Key Vault server configuration object. |
| <code>--user-name, -u</code> | (Mandatory) Specifies the name of the Oracle Key Vault user on the Oracle Key Vault server. |
| <code>--description, -d</code> | (Optional) Describes the Oracle Key Vault server configuration object. |
| <code>--hostname, -host</code> | (Optional) Specifies the name of the Oracle Key Vault server where the Oracle Key Vault user has an account. |
| <code>--server-ip, -ip</code> | (Optional) Specifies the IP address of the Oracle Key Vault server where the Oracle Key Vault user has an account. |
| <code>--help, -h</code> | (Optional) Displays help for using the command. |
| <code>--json, -j</code> | (Optional) Displays JSON output. The default is false. |

Usage Notes

To create an Oracle Key Vault server configuration `okvobj1` for the Oracle Key Vault server user `epokvusrl` on the specified server:

Example 16-201 Creating an Oracle Key Vault server configuration

```
odacli create-okvserverconfig -n okvobj1 -u epokvusrl -ip xxx.xx.xxx.xxx
Enter OKV user password :
Retype OKV user password :
```

odacli copy-okvtdewallet

Use the command `odacli copy-okvtdewallet` to copy an Oracle Key Vault TDE wallet.

File Path

```
/opt/oracle/dcs/bin/odacli
```

Syntax

```
# odacli copy-okvtdewallet -swn source_wallet_name -tosc
target_okv_server_config -twm target_okv_wallet_name [-shn hostname] [-sip
ip_address] [-su user_name] [-j] [-h]
```

Parameters

| Parameter | Description |
|---------------------------------|---|
| --source-wallet-name, -swn | (Mandatory) Specifies the name of the wallet from which TDE keys must be copied to the target wallet in the Oracle Key Vault server. |
| --target-okvserverconfig, -tosc | (Mandatory) Specifies the name of the Oracle Key Vault server configuration object where the target wallet must be created. |
| --target-wallet-name, -twm | (Mandatory) Specifies the name of the wallet to which the TDE keys must be copied from the source wallet in the Oracle Key Vault server. |
| --source-hostname, -shn | (Optional) Specifies the fully-qualified domain name (FQDN) of the Oracle Key Vault server where the source wallet is created. Specify this value only if the source wallet and the target wallet use different Oracle Key Vault servers. |
| --source-ip, -sip | (Optional) Specifies the IP address of the Oracle Key Vault server where the source wallet is created. Specify this value only if the source wallet and the target wallet use different Oracle Key Vault servers. |
| --source-username, -su | (Optional) Specifies the name of the Oracle Key Vault user who owns the source wallet on the Oracle Key Vault server. Specify this value only if the source wallet and the target wallet use different Oracle Key Vault servers. |
| --help, -h | (Optional) Displays help for using the command. |
| --json, -j | (Optional) Displays JSON output. The default is false. |

Example 16-202 Copying the TDE wallet in the same Oracle Key Vault server and owned by the same Oracle Key Vault user

The source TDE wallet and the target TDE wallet are on the same Oracle Key Vault server, and both are owned by the same user on the Oracle Key Vault server.

```
odacli copy-okvtdewallet -swn tdeokv_on_scaoda8m013-c -tosc okvobj1 -twm
tdeokvss
```

Job details

```
-----
ID: 50df7dcc-8e17-48db-9206-879c44e57c20
Description: Copy wallet in OKV server
Status: Success
Created: June 20, 2024 2:56:02 AM CST
Message:
```

```

Task Name                               Start
Time                                   End Time
Status
-----
-----
-----
Creating a TDE wallet copy in the OKV    June 20, 2024 2:56:03 AM
CST                                     June 20, 2024 2:57:17 AM CST           Success
server

```

Example 16-203 Copying the TDE wallet on the same Oracle Key Vault server but using a different Oracle Key Vault user

The source and the target wallet are on the same Oracle Key Vault server but are owned by different users on the Oracle Key Vault server. In this scenario, the target wallet user must copy the source wallet with the following command. Before running the ODACLI command to copy the wallet, the source wallet Oracle Key Vault user must provide read and manage access permissions on the wallet, to the target wallet Oracle Key Vault user. For more details, see the *Restoring TDE-Enabled Database with TDE Keys Stored on Oracle Key Vault* topic.

```

odacli copy-okvtdewallet -swn tdeokv_on_scaoda8m013-c -tosc okvobj2 -twm
tdeokvdu
Job details

```

```

-----
ID: 50df7dcc-8e17-48db-9206-879c44e57c20
Description: Copy wallet in OKV server
Status: Success
Created: June 20, 2024 2:56:02 AM CST
Message:

```

```

Task Name                               Start
Time                                   End Time
Status
-----
-----
-----
Creating a TDE wallet copy in the OKV    June 20, 2024 2:56:03 AM
CST                                     June 20, 2024 2:57:17 AM CST           Success
server

```

Example 16-204 Copying the TDE wallet to a different Oracle Key Vault server

The source wallet and the target wallet are on different Oracle Key Vault servers. Specify the source wallet Oracle Key Vault server details also must be provided in the ODACLI command. Specify the source wallet Oracle Key Vault user password, when prompted.

```

odacli copy-okvtdewallet -swn tdeokv_on_scaoda8m013-c -sip xxx.xx.x.xxx -su
epokvusrl -tosc okvobj3 -twm tdeokvds
Enter OKV user password:
Retype OKV user password:

```

```

Job details

```

```

-----
ID: 50df7dcc-8e17-48db-9206-879c44e57c20
Description: Copy wallet in OKV server

```

```
Status: Success
Created: June 20, 2024 2:56:02 AM CST
Message:
```

```
Task Name                               Start
Time                                     End Time
Status
-----
-----
-----
Creating a TDE wallet copy in the OKV    June 20, 2024 2:56:03 AM
CST                                       June 20, 2024 2:57:17 AM CST          Success
server
```

odacli delete-okvserverconfig

Use the command `odacli delete-okvserverconfig` to delete an Oracle Key Vault server configuration.

File Path

```
/opt/oracle/dcs/bin/odacli
```

Syntax

```
# odacli delete-okvserverconfig [-n name] [-h] [-j]
```

Parameters

| Parameter | Description |
|-------------------------|--|
| <code>--name, -n</code> | (Mandatory) Specifies the Oracle Key Vault server configuration to delete. |
| <code>--help, -h</code> | (Optional) Displays help for using the command. |
| <code>--json, -j</code> | (Optional) Displays JSON output. The default is false. |

Usage Notes

Use the `odacli delete-okvserverconfig` command to delete Oracle Key Vault server configuration. You can delete the Oracle Key Vault server configuration only if the databases that used the Oracle Key Vault server configuration are already deleted.

Example 16-205 Deleting Oracle Key Vault server configuration

```
odacli delete-okvserverconfig -n okvobj1
```

odacli describe-okvserverconfig

Use the command `odacli describe-okvserverconfig` to view the Oracle Key Vault server configuration details.

File Path

```
/opt/oracle/dcs/bin/odacli
```

Syntax

```
# odacli describe-okvserverconfig [-n name] [-h] [-j]
```

Parameters

| Parameter | Description |
|-------------------------|--|
| <code>--name, -n</code> | (Mandatory) Specifies the Oracle Key Vault server configuration. |
| <code>--help, -h</code> | (Optional) Displays help for using the command. |
| <code>--json, -j</code> | (Optional) Displays JSON output. The default is false. |

Usage Notes

For example, the `odacli describe-okvserverconfig` command in a multi-user access enabled system displays the following:

Example 16-206 Viewing Oracle Key Vault server configuration details in a multi-user access enabled system

```
odacli describe-okvserverconfig -n okvobj1
```

```
OKV Server Config details
```

```
-----
                ID: 441fb120-35f8-4c9a-9a5c-76aebaba1c36
                Name: okvobj1
                OKV User Name: epadmin
                OKV Server IP: xxx.xx.xx.xxx
                Primary owner: okvusrl
                Secondary owners: [odaadmin,dbusr1, dbusr2]
```

```
odacli describe-okvserverconfig -n okvobj1 -j
```

```
{
  "ID" : "441fb120-35f8-4c9a-9a5c-76aebaba1c36",
  "Name" : "okvobj1"
  "Primary owner" : "okvusrl"
  "Secondary Owners" : [ "odaadmin", "dbusr1", "dbusr2" ]
  "createTime" : "January 04, 2024 11:25:04 AM UTC",
  "updatedAt" : "January 04, 2024 11:37:48 AM UTC"
}
```

Example 16-207 Viewing Oracle Key Vault server configuration details in a non-multi user access enabled system

In a non-multi user access enabled system, the primary and secondary owner details are not displayed:

```
odacli describe-okvserverconfig -n okvobj1
```

```
OKV Server Config details
```

```
-----
                ID: 441fb120-35f8-4c9a-9a5c-76aebaba1c36
                Name: okvobj1
                OKV User Name: eadmin
                OKV Server IP: xxx.xxx.xx.xxx
```

```
odacli describe-okvserverconfig -n okvobj1 -j
```

```
{
  "ID" : "441fb120-35f8-4c9a-9a5c-76aebaba1c36",
  "Name" : "okvobj1",
  "OKV User Name" : "eadmin",
  "OKV Server IP": "xxx.xxx.xx.xxx",
  "createTime" : "January 04, 2024 11:25:04 AM UTC",
  "updatedAt" : "January 04, 2024 11:37:48 AM UTC"
}
```

Example 16-208 Viewing Oracle Key Vault server configuration details with the -j option

```
odacli describe-okvserverconfig -n dokvobj1 -j
```

```
{
  "id" : "2348516e-37f4-41a6-b482-c70ce0e53bc8",
  "name" : "dokvobj1",
  "userName" : "user1",
  "hostname" : null,
  "ipAddress" : "xxx.xxx.xx.xxx",
  "description" : null,
  "createTime" : "October 20, 2024 05:49:22 AM PDT",
  "updatedAt" : "October 20, 2024 05:49:47 AM PDT",
  "state" : {
    "status" : "CONFIGURED"
  }
}
```

odacli list-okvserverconfigs

Use the command `odacli list-okvserverconfigs` to view all Oracle Key Vault server configurations.

File Path

```
/opt/oracle/dcs/bin/odacli
```

Syntax

```
# odacli list-okvserverconfigs [-h] [-j]
```

Parameters

| Parameter | Description |
|------------|--|
| --help, -h | (Optional) Displays help for using the command. |
| --json, -j | (Optional) Displays JSON output. The default is false. |

Usage Notes

Example 16-209 Viewing all Oracle Key Vault server configurations

```
odacli list-okvserverconfigs
```

| ID | Name | IP address | Host Name | Name | User |
|--------------------------------------|----------|---------------|-----------|-------------|-------------------|
| | | | | Description | |
| d017d35a-0757-460a-98f0-9f8d0944c872 | epadmin | xxx.xx.xx.xxx | Null | okvobj1 | Brief |
| | | | | description | |
| b6336173-666b-4d81-88bd-5ae384419114 | epadmin2 | xxx.xx.xx.xxx | Null | okvobj2 | Brief description |

Log Commands

Use the `odacli` log commands to specify the options to collect and delete logs.

- [odaadmcli manage diagcollect](#)
Use the `odaadmcli manage diagcollect` command to collect diagnostic logs for Oracle Database Appliance components.
- [odacli create-auto-logclean-policy](#)
Use the `odacli create-auto-logclean-policy` command to create a policy for a job to automatically purge log files for a specified time period when certain criteria are met.
- [odacli delete-auto-logclean-policy](#)
Use the `odacli delete-auto-logclean-policy` command to delete a policy for a job to automatically purge log files for a specified time period when certain criteria are met.
- [odacli create-logcleanjob](#)
Use the `odacli create-logcleanjob` command to create a job to purge log files for a specified time period.
- [odacli describe-logcleanjob](#)
Use the `odacli describe-logcleanjob` command to describe a log cleanup job.
- [odacli list-auto-logclean-policy](#)
Use the `odacli list-auto-logclean-policy` command to list the jobs to purge log files.

- [odacli list-logcleanjobs](#)
Use the `odacli list-logcleanjobs` command to list the jobs to purge log files.
- [odacli list-logspaceusage](#)
Use the `odacli list-logspaceusage` command to display the log file usage.

odaadmcli manage diagcollect

Use the `odaadmcli manage diagcollect` command to collect diagnostic logs for Oracle Database Appliance components.

File Path

```
/opt/oracle/oak/bin/odaadmcli
```

Syntax

To collect diagnostic logs for components:

```
odaadmcli manage diagcollect [-h] [--dataMask] [--dataSanitize] [--fromTime] [--toTime] [--Components]
```

Parameters

| Parameter | Description |
|-----------------------------|--|
| <code>--help, -h</code> | (Optional) Displays help for using the command. |
| <code>--dataMask</code> | (Optional) Masks sensitive data. The default is No. |
| <code>--dataSanitize</code> | (Optional) Sanitizes (redacts) sensitive data. The default is No. |
| <code>--fromTime</code> | (Optional) Specifies the time from when you want to collect data. The timestamp formats can be of the type: <code>mon/dd/yyyy hh:mm:ss</code> , or <code>yyyy-mm-dd hh:mm:ss</code> , or <code>yyyy-mm-ddThh:mm:ss</code> , or <code>yyyy-mm-dd</code> . |
| <code>--toTime</code> | (Optional) Specifies the time till when you want to collect data. The timestamp formats can be of the type: <code>mon/dd/yyyy hh:mm:ss</code> , or <code>yyyy-mm-dd hh:mm:ss</code> , or <code>yyyy-mm-ddThh:mm:ss</code> , or <code>yyyy-mm-dd</code> . |
| <code>--Components</code> | (Optional) Specifies the comma-separated list of components for which you want to collect data. The supported values are: <code>all, ips, oda, odalite, dcs, odabackup, odapatching, odadataguard, odaprovisioning, odaconfig, odasystem, odastorage, database, asm, crsclient, dbclient, dbwlm, tns, rhp, procinfo, afd, crs, cha, wls, emagent, oms, ocm, emplugins, em, acfs, install, cfgtools, os, ashhtml, ashtext, awrhtml, awrtext</code> |
| <code>--verbose</code> | Displays detailed message. |

Usage Notes

The following types of sensitive information can be redacted using the `--dataMask` or the `--dataSanitize` option:

- Host names
- IP addresses
- Database names
- Tablespace names
- Service names
- Ports
- Operating System user names

For example, when the `--dataMask` option is used, all instances of a sensitive name such as a database name called "payrolldb" are replaced with "*****" in the TFA collection.

For example, when the `--dataSanitize` option is used, all instances of a sensitive name such as a database name called "payrolldb" are replaced with another string, such as "oCjIN7F8P", in the TFA collection.

Example 16-210 Masking Sensitive Data in Log Collection

```
# /opt/oracle/oak/bin/odaadmcli manage diagcollect --dataMask
DataMask is set as true
TFACTL command is: /opt/oracle/tfa/tfa_home/bin/tfactl
Data mask is set.
Collect data within last 12 hours as default
Please wait for several minutes for the collection to complete.
```

odacli create-auto-logclean-policy

Use the `odacli create-auto-logclean-policy` command to create a policy for a job to automatically purge log files for a specified time period when certain criteria are met.

File Path

```
/opt/oracle/dcs/bin/odacli
```

Syntax

```
odacli create-auto-logclean-policy [-h] [-c] [-o] [-u] [-uMB] [-f] [-uPer]
```

Parameters

| Parameter | Description |
|-------------------------------|---|
| <code>--help, -h</code> | (Optional) Displays help for using the command. |
| <code>--components, -c</code> | (Optional) Specifies the list of components, separated by comma. The values are <code>gi database dcs</code> For example, <code>gi dcs</code> . |

| Parameter | Description |
|---|---|
| <code>--olderthan, -o</code> | (Optional) Cleans logs older than specified time interval. Default is 30 if it is not specified. |
| <code>--olderThanUnit, -u</code> | (Optional) Unit for the <code>--olderthan</code> parameter. Default is Day if it is not specified. |
| <code>--freeSpaceBelowPercentage, -f</code> | Starts purge when free disk space is below the specified number of percentage of the total partition size. Valid range is 20-50. Default is 20. |
| <code>--usageOverMB, -uMB</code> | Starts purge when log usage is over the specified number of MB. Valid range is 10%-50% of partition size. |
| <code>--usageOverPercentage, -uPer</code> | Starts purge when log usage is over the specified number of percentage of total partition space. Valid range is 10-50. |

Example 16-211 Creating Automatic Jobs to Purge Logs

To create a policy for automatic jobs to purge logs:

```
# odacli create-auto-logclean-policy -c 'dcs' -o 30 -uPer 30
Component UsageOverPercentage freeSpaceBelowPercentage UsageOverMB
OlderThan OlderThanUnit
```

```
-----
-----
dcs          30          20          0
30          Day
```

odacli delete-auto-logclean-policy

Use the `odacli delete-auto-logclean-policy` command to delete a policy for a job to automatically purge log files for a specified time period when certain criteria are met.

File Path

```
/opt/oracle/dcs/bin/odacli
```

Syntax

```
odacli odacli delete-auto-logclean-policy [-c] [-h] [-j]
```

Parameters

| Parameter | Description |
|-------------------------------|---|
| <code>--components, -c</code> | (Optional) Specifies the list of components, separated by comma. The values are <code>gi database dcs</code> . For example, <code>gi dcs</code> . |
| <code>--help, -h</code> | (Optional) Displays help for using the command. |
| <code>--json, -j</code> | (Optional) Displays JSON output. The default is false. |

odacli create-logcleanjob

Use the `odacli create-logcleanjob` command to create a job to purge log files for a specified time period.

File Path

```
$ORACLE_HOME/opt/oracle/dcs/bin/odacli
```

Syntax

To list jobs and view job details and status:

```
odacli create-logcleanjob [-h] [-c] [-o] [-u]
```

Parameters

| Parameter | Description |
|-------------------------------|---|
| <code>--help, -h</code> | (Optional) Displays help for using the command. |
| <code>--components, -c</code> | (Optional) Specifies the list of components, separated by comma. The values are <code>gi database dcs</code> For example, <code>gi,dcs</code> . |
| <code>--olderthan, -o</code> | (Optional) Cleans logs older than specified time interval. Default is 30 if it is not specified. |
| <code>--unit, -u</code> | (Optional) Unit for the <code>--olderthan</code> parameter. Default is <code>Day</code> if it is not specified. |

Example 16-212 Creating Jobs to Purge Logs

To create jobs to purge logs:

```
# odacli create-logcleanjob
Job details
-----
                ID:  e03d90b5-41dd-45e0-8b7a-1480d6d7f86f
Description:  log file cleanup
                Status:  Created
                Created:  July 25, 2018 8:06:56 PM UTC
                Message:

Task Name      Start Time End Time  Status
-----
# ./odacli describe-job -i e03d90b5-41dd-45e0-8b7a-1480d6d7f86f
```

Job details

```

-----
ID: e03d90b5-41dd-45e0-8b7a-1480d6d7f86f
Description: log file cleanup
Status: Success
Created: July 25, 2018 8:06:56 PM UTC
Message:

```

| Task Name | Start Time | End Time | Status |
|----------------|------------------------------|------------------------------|---------|
| Clean TFA logs | July 25, 2018 8:06:56 PM UTC | July 25, 2018 8:06:59 PM UTC | Success |
| Clean DCS logs | July 25, 2018 8:06:56 PM UTC | July 25, 2018 8:06:56 PM UTC | Success |

odacli describe-logcleanjob

Use the `odacli describe-logcleanjob` command to describe a log cleanup job.

File Path

```
$ORACLE_HOME/opt/oracle/dcs/bin/odacli
```

Syntax

To list jobs and view job details and status:

```
odacli describe-logcleanjob -i [-h] [-j]
```

Parameters

| Parameter | Description |
|-------------------------|--|
| <code>--help, -h</code> | (Optional) Displays help for using the command. |
| <code>--json, -j</code> | (Optional) Displays JSON output. |
| <code>--id, -i</code> | Displays the summary of the log cleanup with the specified job ID. |

Example 16-213 Displaying Log Cleanup Jobs

To display log cleanup jobs:

```
# odacli describe-logcleanjob -i e03d90b5-41dd-45e0-8b7a-1480d6d7f86f
JobId      Files Deleted  Size Freed  Component  Top Path
```

```

TimeStamp
-----
-----
e03d90b5-41dd-45e0-8b7a-1480d6d7f86f 0 0 bytes dcs /opt/oracle/dcs/log July
25, 2018 8:06:56 PM UTC

e03d90b5-41dd-45e0-8b7a-1480d6d7f86f 0 0 bytes gi /u01/app/12.2.0.1/grid
July 25, 2018 8:06:59 PM UTC

```

odacli list-auto-logclean-policy

Use the `odacli list-auto-logclean-policy` command to list the jobs to purge log files.

File Path

```
$ORACLE_HOME/opt/oracle/dcs/bin/odacli
```

Syntax

To list jobs and view job details and status:

```
odacli list-auto-logclean-policy [-h] [-c]
```

Parameters

| Parameter | Description |
|-------------------------------|---|
| <code>--help, -h</code> | (Optional) Displays help for using the command. |
| <code>--components, -c</code> | (Optional) Specifies the list of components, separated by comma. The values are <code>gi database dcs</code> For example, <code>gi,dcs</code> . |

Example 16-214 Listing Jobs to Purge Logs

To list jobs to purge logs:

```

# odacli list-auto-logclean-policy
Component UsageOverPercentage freeSpaceBelowPercentage UsageOverMB
OlderThan OlderThanUnit
-----
-----
gi          40                20
0          60                Day
database   40                20
0          60                Day
dcs        30                20
0          30                Day

```

odacli list-logcleanjobs

Use the `odacli list-logcleanjobs` command to list the jobs to purge log files.

File Path

```
$ORACLE_HOME/opt/oracle/dcs/bin/odacli
```

Syntax

To list jobs and view job details and status:

```
odacli list-logcleanjobs [-h]
```

Parameters

| Parameter | Description |
|-------------------------|---|
| <code>--help, -h</code> | (Optional) Displays help for using the command. |

Example 16-215 Listing Jobs to Purge Logs

To list jobs to purge logs:

```
# odacli list-logcleanjobs
JobId   Files Deleted   Size Freed   Component   Top Path   TimeStamp
-----
-----a8ef8315-02e8-4979-ab1f-30251818c6eb
0  0 bytes gi /u01/app/12.2.0.1/grid July 25, 2018 7:45:10 PM UTC

e03d90b5-41dd-45e0-8b7a-1480d6d7f86f 0 0 bytes gi /u01/app/12.2.0.1/grid
July 25, 2018 8:06:59 PM UTC

e03d90b5-41dd-45e0-8b7a-1480d6d7f86f 0 0 bytes dcs /opt/oracle/dcs/log
July 25, 2018 8:06:56 PM UTC
-----
```

odacli list-logspaceusage

Use the `odacli list-logspaceusage` command to display the log file usage.

File Path

```
/opt/oracle/dcs/bin/odacli
```

Syntax

To list jobs and view job details and status:

```
odacli list-logspaceusage [-c] [-h]
```

Parameters

| Parameter | Description |
|------------------|---|
| --components, -c | Describes the list of components delimited by comma. The values can be <code>gi database dcs</code> . For example, <code>gi, dcs</code> . |
| --help, -h | (Optional) Displays help for using the command. |

Example 16-216 Displaying a List of Logs

To display log file space usage for a list of components:

```
root@node1 ~]# odacli list-logspaceusage

                        Timestamp: January 13, 2022 8:38:32 AM UTC
-----

Node : node1
-----
Component Size(MB) Partition                               LogUsagePercentage
PartitionFreePercentage
-----
-----

dcs          685.00 /dev/mapper/VolGroupSys-LogVolOpt 0.76          84.00
gi           2293.76 /dev/mapper/VolGroupSys-LogVolU01 1.63          79.00
database     744.14 /dev/asm/odabase_n0-159          7.27          83.00

Node : node2
-----
Component Size(MB) Partition                               LogUsagePercentage
PartitionFreePercentage
-----
-----

dcs          174.00 /dev/mapper/VolGroupSys-LogVolOpt 0.19          85.00
gi           1863.68 /dev/mapper/VolGroupSys-LogVolU01 1.32          79.00
database     299.36 /dev/asm/odabase_n1-159          2.92          90.00
```

odacli Oracle Auto Service Request Commands

Use the Oracle Auto Service Request (Oracle ASR) commands to configure, update, test, and delete Oracle ASR on the system.

- [odacli configure-asr](#)
Use the `odacli configure-asr` command to configure Oracle Auto Service Request (Oracle ASR) after deploying the appliance.
- [odacli describe-asr](#)
- [odacli delete-asr](#)
- [odacli export-asrconfig](#)
- [odacli modify-asr](#)

- [odacli test-asr](#)

odacli configure-asr

Use the `odacli configure-asr` command to configure Oracle Auto Service Request (Oracle ASR) after deploying the appliance.

File Path

```
/opt/oracle/dcs/bin/odacli
```

Syntax

```
odacli configure-asr -u asr_usr [-i asr_mgr_ip] [-e asr_type] [-p] [-t proxy_port] [-r proxy_server] [-y proxy_usr] [-hp HTTPS_port] [-j] [-h]
```

Parameters

| Parameter | Description |
|--|--|
| <code>--username, -u</code> | Specifies the Oracle ASR user name. The user name is the My Oracle Support user name under which the server is registered. |
| <code>--asrtype, -e {internal external}</code> | Specifies the Oracle ASR Configuration Type. The default is internal. |
| <code>--https-port, -hp</code> | (Optional) Specifies the HTTPS port for Oracle ASR Manager. The default port is 16162. |
| <code>--proxyport, -t</code> | (Optional) Specifies the port on which Oracle ASR must be configured. |
| <code>--proxyserver, -r</code> | (Optional) Specifies the proxy server address that can enable connect to My Oracle Support. |
| <code>--proxyuser, -y</code> | (Optional) Specifies the proxy user name needed to authenticate the proxy server. |
| <code>--help, -h</code> | (Optional) Displays help for using the command. |
| <code>--json, -j</code> | (Optional) Displays JSON output. |

Usage Notes

- All log files for Oracle ASR are located in the `/var/opt/asrmanager/log/` directory.
- To configure an external Oracle ASR Manager, you must define the Oracle ASR Configuration Type as external (`-e external`). For example, `odacli configure-asr -e external`.

Example 16-217 Configuring Oracle ASR with a Proxy Server

This example configures Oracle ASR for user name `user@example.com`. An HTTPS port 16165 is defined.

```
# odacli configure-asr -u user@example.com -hp 16165
Enter ASR user's password:
Retype ASR user's password:
```

Job details

```

-----
                ID: 2e6244e5-41e3-46cf-bd7a-43098dd071d8
Description:    Configure ASR
                Status: Success
                Created: September 5, 2023 2:08:56 PM CST
                Message:

Task Name                               Start Time
End Time                                 Status
-----
Modify JavaExec Path                    September 5, 2023 2:08:57 PM CST
September 5, 2023 2:08:57 PM CST        Success
Install ASR                             September 5, 2023 2:08:57 PM CST
September 5, 2023 2:10:13 PM CST        Success
Registering ASR Manager                 September 5, 2023 2:10:14 PM CST
September 5, 2023 2:10:22 PM CST        Success
Creating ASR configuration folders      September 5, 2023 2:10:22 PM CST
September 5, 2023 2:10:22 PM CST        Success
Enable HTTPS for ASR                   September 5, 2023 2:10:22 PM CST
September 5, 2023 2:10:46 PM CST        Success
Importing ASR certificate into DCS      September 5, 2023 2:10:46 PM CST
September 5, 2023 2:10:48 PM CST        Success
truststore

Registering Asset: ODA Host              September 5, 2023 2:10:48 PM CST
September 5, 2023 2:10:48 PM CST        Success
ASR assets activation                   September 5, 2023 2:10:48 PM CST
September 5, 2023 2:10:49 PM CST        Success
Remove AsrConfBackup File               September 5, 2023 2:10:55 PM CST
September 5, 2023 2:10:55 PM CST        Success

```

Example 16-218 Configuring an External Oracle ASR

This example configures Oracle Database Appliance to use an external Oracle ASR instance.

```
# odacli configure-asr -e External
```

```
Enter ASR user's password:
Retype ASR user's password:
```

Job details

```

-----
                ID: cdd8445f-aefb-4f43-881a-145ea1a1181
Description:    Configure ASR
                Status: Success
                Created: September 5, 2023 1:41:33 PM CST
                Message:

Task Name                               Start Time
End Time                                 Status
-----
Creating ASR configuration folders      September 5, 2023 1:41:37 PM CST
September 5, 2023 1:41:38 PM CST        Success
Importing ASR certificate into DCS      September 5, 2023 1:41:38 PM CST

```

```

September 5, 2023 1:41:39 PM CST    Success
truststore
Registering Asset: ODA Host          September 5, 2023 1:41:39 PM CST
September 5, 2023 1:41:39 PM CST    Success
ASR assets activation               September 5, 2023 1:41:39 PM CST
September 5, 2023 1:41:40 PM CST    Success

```

odacli describe-asr

Use the `odacli describe-asr` command to display Oracle Auto Service Request (Oracle ASR) configuration details.

File Path

```
/opt/oracle/dcs/bin/odacli
```

Syntax

```
describe-asr [-h]
```

Parameters

| Parameter | Description |
|-------------------------|---|
| <code>--help, -h</code> | (Optional) Displays help for using the command. |

Example 16-219 Displaying Oracle ASR Details for ASR Type Internal

```

# odacli describe-asr

ASR details
-----
                ID: e0e31043-c312-4371-8301-e62642ef8a4a
                Name: ASR
                ASR Type: Internal
                ASR Manager IP : 10.32.202.13
                ASR Manager username: username@example.com
                HTTPS port number: 16164
                State: CONFIGURED
                Created: September 3, 2023 4:02:38 AM UTC
                Updated: September 3, 2023 4:03:32 AM UTC

```

odacli delete-asr

Use the `odacli delete-asr` command to remove the Oracle Auto Service Request (Oracle ASR) configuration from the system.

File Path

```
$ORACLE_HOME/opt/oracle/dcs/bin/odacli
```

Syntax

```
# odacli delete-asr [-h]
```

Parameters

| Parameter | Description |
|------------|---|
| --help, -h | (Optional) Displays help for using the command. |

Example 16-220 Deleting Oracle ASR From the System

```
# odacli delete-asr
{
  "jobId" : "5d70bd17-ec4a-48da-8196-1364105db99d",
  "status" : "Running",
  "message" : null,
  "reports" : [ ],
  "createTimestamp" : 1469409622451,
  "description" : "Delete ASR",
  "updatedAtTime" : 1469409622458
}
```

odacli export-asrconfig

Use the `odacli export-asrconfig` command to export the internal Oracle ASR Manager configuration files into a zip. The generated zip file can be used to configure the external Oracle ASR Manager on another Oracle Database Appliance.

File Path

```
/opt/oracle/dcs/bin/odacli
```

Syntax

```
odacli export-asrconfig [-j] [-h]
```

Parameters

| Parameter | Description |
|------------|---|
| --help, -h | (Optional) Displays help for using the command. |
| --json, -j | (Optional) Displays JSON output. |

Example 16-221 Exporting the Internal Oracle ASR Configuration

```
# odacli export-asrconfig
Job details
-----
                ID: 7adb6cdc-31b8-42a4-83ac-a866307329fc
Description: Export ASR Config
                Status: Created
```

Created: September 4, 2023 6:11:14 PM UTC
 Message: Run Update repository with the zip /opt/oracle/asr/asrConfiguration/ASRConfiguration.zip in the External ASR host once the current job is successful

```
Task Name Node Name Start Time End Time Status
-----
```

odacli modify-asr

Use the `odacli modify-asr` command to make changes to Oracle Auto Service Request (Oracle ASR) configuration details after deploying the appliance.

File Path

/opt/oracle/dcs/bin/odacli

Syntax

```
odacli modify-asr -u username [-r proxyserver] [-t proxyport] [-y proxyuser] -
e [internal|external][-hp HTTPS_port] [-j] [-h]
```

Parameters

| Parameter | Description |
|---|--|
| --username, -u | Defines the Oracle ASR user name. The user name is the My Oracle Support user name under which the server is registered. |
| --asrtype, -e [<i>internal</i> <i>external</i>] | Defines the Oracle ASR configuration type. The default is <i>internal</i> . |
| --https-port, -hp | (Optional) Specifies the HTTPS port for Oracle ASR Manager. The default port is 16162. |
| --proxyport, -t | (Optional) Defines the proxy server port. |
| --proxyserver, -r | (Optional) Defines the proxy server address. |
| --proxyuser, -y | (Optional) Defines the proxy user name needed to authenticate the proxy server. |
| --help, -h | (Optional) Displays help for using the command. |
| --json, -j | (Optional) Displays JSON output. |

Usage Notes

- Enter the ASR user password during Oracle ASR configuration.
- All log files for Oracle ASR are located in the `/var/opt/asrmanager/log/` directory.
- You cannot use the `modify-asr` command to change the Oracle ASR type. For example, from *internal* to *external*. To change the Oracle ASR type, delete the existing configuration using the `odacli delete-asr` and then re-configure Oracle ASR using the `odacli configure-asr` command.
- You cannot modify an external Oracle ASR Manager using the `odacli modify-asr` command. To modify external ASR, you must delete the existing Oracle ASR configuration

and reconfigure Oracle ASR using the `odacli configure-asr` command. Before running the `odacli configure-asr` command, you must update the repository with the modified Oracle ASR Manager configuration zip file.

Example 16-222 Modifying Oracle ASR to use a New Proxy Server

This example updates Oracle ASR for user name `scott.tiger@example.com`. The password is not defined in the command-line. You are prompted to enter the password during configuration. The proxy server is updated to `www-proxy2.example.com`.

```
# odacli modify-asr -u scott.tiger@example.com --proxyserver www-
proxy2.example.com --proxyport 80
Enter ASR user's password:
Retype ASR user's password:
```

Job details

```
-----
ID: 79cb2baa-1644-45c5-a004-a303e3111807
Description: Update ASR
Status: Created
Updated: December 8, 2024 9:53:54 AM PST
Message:
```

| Task Name | Start Time | End Time | Status |
|-----------|------------|----------|--------|
| ----- | | | |

odacli test-asr

Use the `odacli test-asr` command to test the Oracle Auto Service Request (Oracle ASR) configuration. When the command is run, an email alert is sent to each host and Oracle ILOM registered with Oracle ASR Manager.

File Path

```
/opt/oracle/dcs/bin/odacli
```

Syntax

```
# odacli test-asr [-h]
```

Parameters

| Parameter | Description |
|-------------------------|---|
| <code>--help, -h</code> | (Optional) Displays help for using the command. |

Example 16-223 Testing the Oracle ASR Configuration

```
# odacli test-asr
```

Job details

```
-----
ID: 51522c07-1b32-4874-9bc7-bbee5885f1e5
Description: Test ASR
Status: Success
```

Created: October 20, 2022 1:02:49 PM UTC
Message:

| Task Name | Start Time | End Time |
|-----------|---------------------------------|---------------------------------|
| Test ASR | October 20, 2022 1:02:50 PM UTC | October 20, 2022 1:02:50 PM UTC |
| Success | | |

Adaptive Classification and Redaction (ACR) Commands

Understand Adaptive Classification and Redaction (ACR) commands.

- [odacli describe-acr](#)
Use the `odacli describe-acr` command to check the status of ACR.
- [odacli enable-acr](#)
Use the `odacli enable-acr` command to enable ACR across all nodes, causing redaction of files during Oracle Trace File Analyzer diagnostic collections to occur.
- [odacli redact-acr](#)
Use the `odacli redact-acr` command to enable ACR across all nodes, causing redaction of files during Oracle Trace File Analyzer diagnostic collections to occur.
- [odacli list-acr](#)
Use the `odacli list-acr` command to print reverse map of sanitized entities.
- [odacli disable-acr](#)
Use the `odacli disable-acr` command to disable ACR across all nodes. Redaction of files during Oracle Trace File Analyzer diagnostic collections, then, does not occur.

odacli describe-acr

Use the `odacli describe-acr` command to check the status of ACR.

File Path

```
/opt/oracle/dcs/bin/odacli
```

Syntax

```
odacli describe-acr [-j] [-h]
```

Parameters

| Parameter | Description |
|-------------------------|---|
| <code>--help, -h</code> | (Optional) Displays help for using the command. |
| <code>--json, -j</code> | (Optional) Displays JSON output. |

Example 16-224

```
# odacli describe-acr
```

odacli enable-acr

Use the `odacli enable-acr` command to enable ACR across all nodes, causing redaction of files during Oracle Trace File Analyzer diagnostic collections to occur.

File Path

```
/opt/oracle/dcs/bin/odacli
```

Syntax

```
odacli enable-acr [-j] [-h]
```

Parameters

| Parameter | Description |
|-------------------------|---|
| <code>--help, -h</code> | (Optional) Displays help for using the command. |
| <code>--json, -j</code> | (Optional) Displays JSON output. |

Example 16-225

```
# odacli enable-acr
```

odacli redact-acr

Use the `odacli redact-acr` command to enable ACR across all nodes, causing redaction of files during Oracle Trace File Analyzer diagnostic collections to occur.

File Path

```
/opt/oracle/dcs/bin/odacli
```

Syntax

```
odacli redact-acr -i path_name -m mode [-j] [-h]
```

Parameters

| Parameter | Description |
|---------------------------|---|
| <code>--inpath, -i</code> | (Required) Specifies the path of input file to be redacted. |
| <code>--mode, -m</code> | (Required) Specifies the redaction mode. The values can be <code>mask</code> or <code>sanitize</code> . |
| <code>--help, -h</code> | (Optional) Displays help for using the command. |
| <code>--json, -j</code> | (Optional) Displays JSON output. |

Example 16-226

```
# odacli redact-acr -i path_name -m sanitize
```

odacli list-acr

Use the `odacli list-acr` command to print reverse map of sanitized entities.

File Path

```
/opt/oracle/dcs/bin/odacli
```

Syntax

```
odacli list-acr -l list [-j] [-h]
```

Parameters

| Parameter | Description |
|-------------------------|--|
| <code>--list, -l</code> | (Required) Specifies the list of sanitized entities. |
| <code>--help, -h</code> | (Optional) Displays help for using the command. |
| <code>--json, -j</code> | (Optional) Displays JSON output. |

Example 16-227

```
# odacli list-acr -l list
```

odacli disable-acr

Use the `odacli disable-acr` command to disable ACR across all nodes. Redaction of files during Oracle Trace File Analyzer diagnostic collections, then, does not occur.

File Path

```
/opt/oracle/dcs/bin/odacli
```

Syntax

```
odacli disable-acr [-j] [-h]
```

Parameters

| Parameter | Description |
|-------------------------|---|
| <code>--help, -h</code> | (Optional) Displays help for using the command. |
| <code>--json, -j</code> | (Optional) Displays JSON output. |

Example 16-228

```
# odacli disable-acr
```

odacli OS Commands

Use the `odacli` OS commands to list and update operating system (OS) parameters.

- [odacli list-osconfigurations](#)
Use the command `odacli list-osconfigurations` to display the current HugePage and memlock values and view suggested values based on the total available space.
- [odacli modify-osconfigurations](#)
Use the command `odacli modify-osconfigurations` to update the HugePage and memlock values.

odacli list-osconfigurations

Use the command `odacli list-osconfigurations` to display the current HugePage and memlock values and view suggested values based on the total available space.

File Path

```
$ORACLE_HOME/opt/oracle/dcs/bin/odacli
```

Syntax

```
odacli list-osconfigurations [-h] [-j]
```

Parameters

| Parameter | Description |
|-------------------------|--|
| <code>--help, -h</code> | (Optional) Displays help for using the command. |
| <code>--json, -j</code> | (Optional) Displays JSON output. The default is false. |

Usage Notes

The command displays the configured values for HugePage and memlock from the `/etc/sysctl.conf` and `/etc/security/limits.conf` files. Based on the total available space, suggested values are calculated for the parameters.

Example 16-229 Displaying a List of Configured and Suggested Memlock and HugePage Configurations

```
# odacli list-osconfigurations
```

| Parameter | User | ConfiguredValue | SuggestedValue |
|-----------|---------|-----------------|----------------|
| Memlock | grid | 295971180KB | 289034355KB |
| Memlock | oracle | 295971180KB | 289034355KB |
| HugeSpace | default | 101430MB | 101161MB |

odacli modify-osconfigurations

Use the command `odacli modify-osconfigurations` to update the HugePage and memlock values.

File Path

```
/opt/oracle/dcs/bin/odacli
```

Syntax

```
odacli modify-osconfigurations [-hs hugepage] [-m memlock] [-nhp
number_of_hugepages] [-j] [-h]
```

Parameters

| Parameter | Description |
|---------------------------------------|--|
| <code>--memlock, -m</code> | (Optional) Updates only the memlock value. |
| <code>--hugepage, -hs</code> | (Optional) Updates only the HugePage value. |
| <code>--number-hugepages, -nhp</code> | (Optional) Updates HugePages value. |
| <code>--json, -j</code> | (Optional) Displays JSON output. The default is false. |
| <code>--help, -h</code> | (Optional) Displays help for using the command. |

Usage Notes

The command updates memlock in the `/etc/security/limits.conf` file and HugePage in the `/etc/sysctl.conf` file with the suggested values.

You can modify memlock or hugepage. If no option is provided, then both parameters are updated to the suggested values.

Example 16-230 Updating the HugePage and Memlock Parameters to the Suggested Values

```
odacli modify-osconfigurations
{
  "jobId" : "954cf7a5-9cad-451c-8820-3140a716af26",
  "status" : "Created",
  "message" : "Successfully submitted a request to configure OS
parameters.",
  "reports" : [ ],
  "createTimestamp" : "December 8, 2024 00:03:51 AM MST",
  "resourceList" : [ ],
  "description" : "Configuring OS Parameter",
  "updatedAt" : "December 8, 2024 00:03:51 AM MST"
}
[root@rwsoda6s002 ~]# odacli describe-job -i
"954cf7a5-9cad-451c-8820-3140a716af26"
Job details
```

```
-----
ID: 954cf7a5-9cad-451c-8820-3140a716af26
Description: Configuring OS Parameter
Status: Success
Created: December 8, 2024 12:03:51 AM MST
Message:
Task Name          Start Time          End Time           Status
-----
```

```
Setting up memlock.  December 8, 2024 12:03:51 AM MST  December 8, 2024 12:03:51 AM MST  Success
Setting up HugeSpace December 8, 2024 12:03:51 AM MST  December 8, 2024 12:03:51 AM MST  Success
```

odaadmcli Hardware Monitoring Commands

Use the hardware monitoring commands to display hardware configurations.

- [odaadmcli show localdisk](#)
Use the `odaadmcli show localdisk` command to show cooling details.
- [odaadmcli show cooling](#)
Use the `odaadmcli show cooling` command to show cooling details.
- [odaadmcli show env_hw](#)
Use the `odaadmcli show env_hw` command to display information about the environment and hardware.
- [odaadmcli show fs](#)
Use the `odaadmcli show fs` command to display filesystem details.
- [odaadmcli show memory](#)
Use the `odaadmcli show memory` command to display memory details.
- [odaadmcli show network](#)
Use the `odaadmcli show network` command to show network details.
- [odaadmcli show power](#)
Use the `odaadmcli show power` command to display power supply details.
- [odaadmcli show processor](#)
Use the `odaadmcli show processor` command to display processor details.
- [odaadmcli show server](#)
Use the `odaadmcli show server` command to display server details.

odaadmcli show localdisk

Use the `odaadmcli show localdisk` command to show cooling details.

File Path

```
/opt/oracle/oak/bin/odaadmcli
```

Syntax

To show cooling details:

```
odaadmcli show localdisk [-h]
```

Parameters

| Parameter | Description |
|-------------------------|---|
| <code>--help, -h</code> | (Optional) Displays help for using the command. |

Example

```
# odaadmcli show localdisk
      NAME          PATH          TYPE
STATUS          STATE_IN_ILOM
      lpd_0         /dev/sda     SSD
PredictiveFailure OK
      lpd_1         /dev/sdb     SSD
OK              OK
```

odaadmcli show cooling

Use the `odaadmcli show cooling` command to show cooling details.

File Path

```
/opt/oracle/oak/bin/odaadmcli
```

Syntax

To show cooling details:

```
odaadmcli show cooling [-h]
```

Parameters

| Parameter | Description |
|------------|---|
| --help, -h | (Optional) Displays help for using the command. |

odaadmcli show env_hw

Use the `odaadmcli show env_hw` command to display information about the environment and hardware.

File Path

```
/opt/oracle/oak/bin/odaadmcli
```

Syntax

To display environment and hardware details:

```
odaadmcli show env_hw [-h]
```

Parameters

| Parameter | Description |
|------------|---|
| --help, -h | (Optional) Displays help for using the command. |

Example 16-231 Displaying Environment and Hardware Details

To display the hardware details, enter the command `odaadmcli show env_hw`. The results show a bare metal Oracle Database Appliance system.

```
# odaadmcli show env_hw

BM X7-2 Medium
```

odaadmcli show fs

Use the `odaadmcli show fs` command to display filesystem details.

File Path

```
/opt/oracle/oak/bin/odaadmcli
```

Syntax

To display filesystem details:

```
odaadmcli show fs [-h]
```

Parameters

| Parameter | Description |
|-------------------------|---|
| <code>--help, -h</code> | (Optional) Displays help for using the command. |

Example 16-232 Displaying Filesystem Details

```
# odaadmcli show fs
```

| Type | Total Space | Free Space | Total DG Space | Free DG Space |
|------|-------------|------------|----------------|---------------|
| ext3 | 30237M | 7763M | - | - |
| ext3 | 484M | 416M | - | - |
| ext3 | 60475M | 38149M | - | - |
| ext3 | 100793M | 22060M | - | - |
| acfs | 102400M | 102158M | 4894016M | 2418668M |
| acfs | 102400M | 100501M | 4894016M | 2418668M |
| acfs | 102400M | 100601M | 4894016M | 2418668M |

(Continued)

| Diskgroup | Mount Point |
|-----------|----------------------------------|
| | / |
| | /boot |
| | /opt |
| | /u01 |
| DATA | /u02/app/oracle/oradata/ACFSDB1 |
| DATA | /u02/app/oracle/oradata/ACFSDB2 |
| DATA | /u02/app/oracle/oradata/EE12NCDB |

odaadmcli show memory

Use the `odaadmcli show memory` command to display memory details.

File Path

```
/opt/oracle/oak/bin/odaadmcli
```

Syntax

To show memory details:

```
odaadmcli show memory [-h]
```

Parameters

| Parameter | Description |
|-------------------------|---|
| <code>--help, -h</code> | (Optional) Displays help for using the command. |

Example 16-233 Display Memory Details

```
# odaadmcli show memory
```

```

NAME      HEALTH HEALTH_DETAILS PART_NO.      SERIAL_NO.
DIMM_0    OK      -              3A4K40BB1-CRC 00CE01154602EADA96
DIMM_11   OK      -              3A4K40BB1-CRC 00CE01154602EADADA
DIMM_3    OK      -              3A4K40BB1-CRC 00CE01154602EADBC7
DIMM_8    OK      -              3A4K40BB1-CRC 00CE01154602EADBA0

```

(Continued)

```

LOCATION  MANUFACTURER MEMORY_SIZE  CURR_CLK_SPEED  ECC_Errors
P0/D0   Samsung      32 GB       2400 MHz        0
P0/D1   Samsung      32 GB       2400 MHz        0
P0/D3   Samsung      32 GB       2400 MHz        0
P0/D8   Samsung      32 GB       2400 MHz        0

```

odaadmcli show network

Use the `odaadmcli show network` command to show network details.

File Path

```
/opt/oracle/oak/bin/odaadmcli
```

Syntax

To show network details:

```
odaadmcli show network [-h]
```

Parameters

| Parameter | Description |
|------------|---|
| --help, -h | (Optional) Displays help for using the command. |

Example 16-234 Showing Network Details

```
# odaadmcli show network
NAME          HEALTH HEALTH_DETAILS LOCATION PART_NO MANUFACTURER
MAC_ADDRESS LINK_DETECTED DIE_TEMP

Ethernet_NIC_0  OK      -                NET0      i210      INTEL
00:10:E0:DD:9D:14 no (em1) N/A

Ethernet_NIC_1  OK      -                NET1      X710/X557-AT Intel
3C:FD:FE:78:93:92 no (p2p3) N/A

Ethernet_NIC_2  OK      -                NET2      X710/X557-AT Intel
3C:FD:FE:78:93:91 yes (p2p2) N/A

Ethernet_NIC_3  OK      -                NET3      X710/X557-AT Intel
3C:FD:FE:78:93:90 yes (p2p1) N/A

Ethernet_NIC_4  OK      -                NET4      BCM57414 Broadcom
B0:26:28:3F:D8:B8 yes (p7p2) N/A

Ethernet_NIC_5  OK      -                NET5      X710/X557-AT Intel
3C:FD:FE:78:93:93 no (p2p4) N/A

Ethernet_NIC_6  OK      -                NET6      BCM57414 Broadcom
B0:26:28:3F:D8:B0 yes (p7p1) N/A
```

odaadmcli show power

Use the `odaadmcli show power` command to display power supply details.

File Path

```
/opt/oracle/oak/bin/odaadmcli
```

Syntax

Run this command on the first node, to display power supply details on Oracle Database Appliance High-Availability (HA) models:

```
odaadmcli show power [-h]
```

Parameters

| Parameter | Description |
|------------|---|
| --help, -h | (Optional) Displays help for using the command. |

Example 16-235 Displaying Power Supply Details

```
# odaadmcli show power

NAME          HEALTH HEALTH_DETAILS PART_NO SERIAL_NO.
Power_Supply_0 OK      -                7079395 476856Z+1514CE056G
```

```
(Continued)
LOCATION      INPUT_POWER  OUTPUT_POWER  INLET_TEMP    EXHAUST_TEMP
PS0         Present     112 watts     28.000 degree C  34.938 degree C
```

odaadmcli show processor

Use the `odaadmcli show processor` command to display processor details.

File Path

```
/opt/oracle/oak/bin/odaadmcli
```

Syntax

To show processor details:

```
odaadmcli show processor [-h]
```

Parameters

| Parameter | Description |
|-------------------------|---|
| <code>--help, -h</code> | (Optional) Displays help for using the command. |

Example 16-236 Displaying Processor Details

```
# odaadmcli show processor

NAME      HEALTH HEALTH_DETAILS  PART_NO.  LOCATION  MODEL
CPU_0     OK      -                060F P0   (CPU 0)   Intel(R) Xeon(R) CPU
E5-2630

(Continued)
MAX_CLK_SPEED  TOTAL_CORES  ENABLED_CORES
2.200 GHz     10           10
```

odaadmcli show server

Use the `odaadmcli show server` command to display server details.

File Path

```
/opt/oracle/oak/bin/odaadmcli
```

Syntax

To show server details:

```
odaadmcli show server [-h]
```

Parameters

| Parameter | Description |
|-------------------------|---|
| <code>--help, -h</code> | (Optional) Displays help for using the command. |

Example 16-237 Displaying Server Details

```
# odaadmcli show server

Power State : On
Open Problems : 0
Model : ORACLE SERVER X7-2
Type : Rack Mount
Part Number : 7320190
Serial Number : 1605NM10JJ
Primary OS : Not Available
ILOM Address : 10.209.8.215
ILOM MAC Address : 00:10:E0:95:98:F0
Description : Oracle Database Appliance X7-2 Small 1606NM1s02
Locator Light : Off
Actual Power Consumption : 135 watts
Ambient Temperature : 24.250 degree C
Open Problems Report : System is healthy
```

Storage Commands

Understand the commands to perform storage operations and diagnostics.

- [odaadmcli asmops diskgroup](#)
Use the `odaadmcli asmops diskgroup` command to manage Oracle ASM disk group.
- [odaadmcli expand storage](#)
Use the `odaadmcli expand storage` command to expand storage.
- [odacli list-dgdisks](#)
Use the `odacli list-dgdisks` command to display details about the available disks.
- [odacli validate-storagetopology](#)
Use the `odacli validate-storagetopology` command to check the cable connections between the system controllers and the storage shelf, as well as the cable connection to the storage expansion shelf (if one is installed).
- [odaadmcli power disk](#)
Use the `odaadmcli power disk` command to power a disk on or off for NVMe drives only.
- [odaadmcli show controller](#)
Use the `odaadmcli show controller` command to display details of the controller.
- [odaadmcli show disk](#)
Use the `odaadmcli show disk` command to display the status of a single disk or of all disks on the system.
- [odaadmcli show diskgroup](#)
Use the `odaadmcli show diskgroup` command to list configured diskgroups or display a specific diskgroup configuration.

- [odaadmcli show raidsyncstatus](#)
Use the `odaadmcli show raidsyncstatus` command to display the RAID SYNC status.
- [odaadmcli show storage](#)
Use the `odaadmcli show storage` command to show the storage controllers, expanders, and disks.
- [odaadmcli stordiag](#)
Use the `odaadmcli stordiag` command to collect detailed information for each disk or NVMe.

odaadmcli asmops diskgroup

Use the `odaadmcli asmops diskgroup` command to manage Oracle ASM disk group.

File Path

`/opt/oracle/oak/bin/odaadmcli`

Syntax

```
odaadmcli asmops diskgroup -G diskgroup_name -o {add|remove|offline|
online} -p path -D disk_name -f -w -t timeout [-h]
```

Parameters

| Parameter | Description |
|------------|---|
| -G | (Mandatory) Specifies the disk group name. |
| -o | (Mandatory) Specifies the operation to be performed on Oracle ASM disk. Add disk to disk group, remove from disk group, offline the disk or online the disk. |
| -p | (Mandatory for addition of disks) Specify the disk path during addition of disk to Oracle disk group. |
| -D | (Mandatory) Specify Oracle ASM disk name or alias. |
| --help, -h | (Optional) Displays help for using the command. |
| -f | (Optional) Specifies if you want to force the operation. |
| -w | (Optional) Specifies if you want to wait for the operation to complete. This option is valid for the disk online operation. |
| -t | (Optional) Specifies the duration after which the disks are dropped by Oracle ASM after a disk offline operation. The time out values can be specified in the format 35m, 2h, and so on. This option is valid for the disk offline operation. |

Usage Notes

Run the command on the Oracle Database Appliance system to manage Oracle ASM disk group.

odaadmcli expand storage

Use the `odaadmcli expand storage` command to expand storage.

File Path

```
/opt/oracle/oak/bin/odaadmcli
```

Syntax

```
odaadmcli expand storage -ndisk number of disks to be added -enclosure {0|1} [-h]
```

Parameters

| Parameter | Description |
|--------------------------------|--|
| <code>--enclosure {0 1}</code> | Defines the JBOD or shelf number. The base storage shelf is 0. The storage expansion shelf is 1. This option is only available for multi-node platforms. It is not supported on Oracle Database Appliance single node platforms. |
| <code>--help, -h</code> | (Optional) Displays help for using the command. |
| <code>-ndisk</code> | Defines the number of disks to be added in the enclosure. |

Usage Notes

On high-availability (HA) Oracle Database Appliance hardware models, run the command only on the first node.

Various storage options are available. On multi-node platforms, the base storage is SSD and you can choose to add either SSD or HDD disks. When adding a storage expansion shelf, all disks must be the same type (you cannot combine SSD and HDD disks).



Note:

In addition to reviewing the `expand storage` command, it is important to follow the procedures for adding storage. Cabling validation and disk placement is important. In some cases, you must move disks to different slots to successfully expand storage.

odacli list-dgdisks

Use the `odacli list-dgdisks` command to display details about the available disks.

File Path

```
/opt/oracle/dcs/bin/odacli
```

Syntax

To list available disk details:

```
odacli list-dgdisks [-h] [-dg] [-dp] [-j]
```

Parameters

| Parameter | Description |
|------------------|---|
| --json, -j | (Optional) Displays JSON output. |
| --help, -h | (Optional) Displays help for using the command. |
| --diskgroup, -dg | (Optional) Displays all disks in the specified disk group. The possible values are: ALL, DATA, RECO, REDO, FLASH. If no value is specified, then ALL disks are displayed. |
| --diskpath, -dp | (Optional) Displays all disks that contains the specified value in the path. If no value is specified, then all disks are displayed. |

Usage Notes

Example 16-238 Listing All Available Disks on the System

```
# odacli list-dgdisks -dg ALL
```

```
Name                               Group Mount St Group Num Mode St State
Redundancy Fail Grp                Path                               Health Inc
-----
HDD_E0_S19_576667504P1             DATA  CACHED  1          ONLINE  NORMAL
UNKNOWN   HDD_E0_S19_576667504P1         AFD:HDD_E0_S19_576667504P1      0        0
HDD_E0_S08_577087696P1             DATA  CACHED  1          ONLINE  NORMAL
UNKNOWN   HDD_E0_S08_577087696P1         AFD:HDD_E0_S08_577087696P1      0        0
HDD_E0_S11_576021940P1             DATA  CACHED  1          ONLINE  NORMAL
UNKNOWN   HDD_E0_S11_576021940P1        AFD:HDD_E0_S11_576021940P1      0        0
HDD_E0_S13_576660012P1             DATA  CACHED  1          ONLINE  NORMAL
UNKNOWN   HDD_E0_S13_576660012P1        AFD:HDD_E0_S13_576660012P1      0        0
HDD_E0_S15_577131668P1             DATA  CACHED  1          ONLINE  NORMAL
UNKNOWN   HDD_E0_S15_577131668P1        AFD:HDD_E0_S15_577131668P1      0        0
HDD_E0_S09_576662448P1             DATA  CACHED  1          ONLINE  NORMAL
UNKNOWN   HDD_E0_S09_576662448P1        AFD:HDD_E0_S09_576662448P1      0        0
HDD_E0_S18_577136300P1             DATA  CACHED  1          ONLINE  NORMAL
UNKNOWN   HDD_E0_S18_577136300P1        AFD:HDD_E0_S18_577136300P1      0        0
```

Example 16-239 Listing Disks with the Specified Disk Path on the System

```
# odacli list-dgdisks -dp HDD_E0_S10_577135552
```

```
Name                               Group Mount St Group Num Mode St State   Redundancy
Fail Grp                Path                               Health Inc
-----
-----
```

```
HDD_E0_S10_577135552P1 DATA  CACHED  1          ONLINE  NORMAL  UNKNOWN
HDD_E0_S10_577135552P1 AFD:HDD_E0_S10_577135552P1 0      0
HDD_E0_S10_577135552P2 RECO  CACHED  2          ONLINE  NORMAL  UNKNOWN
HDD_E0_S10_577135552P2 AFD:HDD_E0_S10_577135552P2 0      0
```

odacli validate-storagetopology

Use the `odacli validate-storagetopology` command to check the cable connections between the system controllers and the storage shelf, as well as the cable connection to the storage expansion shelf (if one is installed).

Oracle recommends that you run the `odacli validate-storagetopology` command before deploying the system to ensure that the cabling is correct. This will avoid and prevent problems during deployment due to incorrect or missing cable connections. If the cabling is not correct, you will see errors in your output.

File Path

```
$ORACLE_HOME/opt/oracle/dcs/bin/odacli
```

Syntax

```
odacli validate-storagetopology [-h]
```

Parameters

| Parameter | Description |
|-------------------------|---|
| <code>--help, -h</code> | (Optional) Displays help for using the command. |

odaadmcli power disk

Use the `odaadmcli power disk` command to power a disk on or off for NVMe drives only.

File Path

```
/opt/oracle/oak/bin/odaadmcli
```

Syntax

To power an NVMe disk on or off:

```
odaadmcli power disk {on|off|status} disk_name [-h]
```

Parameters

| Parameter | Description |
|------------------------------|--|
| <i>disk_name</i> | Defines the disk resource name. The resource name format is <code>pd_[0..3]</code> . |
| <code>{on off status}</code> | Power on a disk, power off a disk, display status. |
| <code>--help, -h</code> | (Optional) Displays help for using the command. |

Example 16-240 Powering a Disk Off

This example shows how to power off a disk.

```
# odaadmcli power disk off pd_00
Disk 'pd_00' is already part of ASM

Are you sure you want to power OFF the disk?: 'pd_00'?
[yes/no]:
yes
Powered OFF pd_00
```

Example 16-241 Checking the Disk Status

This example shows how to get the status of disk pd_00.

```
# odaadmcli power disk status pd_00
The disk is powered ON
```

odaadmcli show controller

Use the `odaadmcli show controller` command to display details of the controller.

File Path

```
/opt/oracle/oak/bin/odaadmcli
```

Syntax

To display details of the controller:

```
odaadmcli show controller id [-h]
```

Parameters

| Parameter | Description |
|--------------------------------|---|
| <code>controller_id, id</code> | Defines the controller. |
| <code>--help, -h</code> | (Optional) Displays help for using the command. |

Example 16-242 Showing Controller Details

```
# odaadmcli show controller 1
Controller [1] information:
sun-controller-id = nvme:1b:00.00
sun-id = nvme:1b:00.00
sun-controller-manufacturer = Samsung
pci-vendor-id = 0x0000144d
sun-controller-model = 0xa821
pci-device-id = 0x0000a821
sun-controller-type = NVMe
sun-card-manufacturer = Sun Microsystems
pci-subvendor-id = 0x0000108e
sun-card-model = 0xa803
```



```
pci-subdevice-id = 0x0000a803
pci-address = 1b:00.0
sun-version-firmware = KPYA7R3Q
sun-serial-number = S2LHNAAH101008
sun-product-name = MS1PC2DD3ORA3.2T
pci-slot-number = 11
nvme-power-control = 1
sun-nac-name = /SYS/DBP/NVME1
```

odaadmcli show disk

Use the `odaadmcli show disk` command to display the status of a single disk or of all disks on the system.

File Path

```
/opt/oracle/oak/bin/odaadmcli
```

Syntax

To display the status of all disks on the system:

```
odaadmcli show disk [-h]
```

To display the status of a single disk:

```
odaadmcli show disk disk_name [-h]
```

Parameters

| Parameter | Description |
|-------------------------|--|
| <i>disk_name</i> | (Optional) Define the disk resource name. The resource name format is <code>pd_[0..3]</code> . |
| <code>--help, -h</code> | (Optional) Displays help for using the command. |

Example 16-243 Displaying the Status of All Disks

To display the status of all the disks on the system:

```
# odaadmcli show disk
NAME          PATH          TYPE    STATE    STATE_DETAILS
pd_00        /dev/nvme0n1 NVD      ONLINE   Good
pd_01        /dev/nvme1n1 NVD      ONLINE   Good
```

Example 16-244 Displaying the Status of a Single Disk

To display the status of a disk named `pd_00`:

```
# odaadmcli show disk pd_00

The Resource is : pd_00
ActionTimeout : 1500
ActivePath : /dev/nvme0n1
```

```
AsmDiskList : |data_00||reco_00|
AutoDiscovery : 1
AutoDiscoveryHi : |data:80:NVD||reco:20:NVD|
CheckInterval : 300
ColNum : 0
CriticalWarning : 0
DependListOpr : add
  Dependency : |0|
DiskId : 360025380144d5332
DiskType : NVD
Enabled : 1
ExpNum : 19
HbaPortNum : 10
IState : 0
Initialized : 0
IsConfigDepende : false
  ModelNum : MS1PC2DD3ORA3.2T
  MonitorFlag : 1
MultiPathList : |/dev/nvme0n1|
Name : pd_00
NewPartAddr : 0
OSUserType : |userType:Multiuser|
PlatformName : X7_1_LITE_S
PrevState : Invalid
PrevUsrDevName :
SectorSize : 512
SerialNum : S2LHNAAH000001
Size : 3200631791616
SlotNum : 0
SmartDiskWarnin : 0
SmartTemperatur : 37
State : Online
StateChangeTs : 1465263789
StateDetails : Good
TotalSectors : 6251233968
TypeName : 0
UsrDevName : NVD_S00_S2LHNAAH101026
VendorName : Samsung
gid : 0
  mode : 660
uid : 0
```

odaadmcli show diskgroup

Use the `odaadmcli show diskgroup` command to list configured diskgroups or display a specific diskgroup configuration.

File Path

```
/opt/oracle/oak/bin/odaadmcli
```

Syntax

To list configured diskgroups:

```
odaadmcli show diskgroup [-h]
```

To display DATA configurations:

```
odaadmcli show diskgroup [DATA] [-h]
```

To display RECO configurations:

```
odaadmcli show diskgroup [RECO] [-h]
```

Parameters

| Parameter | Description |
|------------|--|
| DATA | (Optional) Displays the DATA diskgroup configurations. |
| RECO | (Optional) Displays the RECO diskgroup configurations. |
| --help, -h | (Optional) Displays help for using the command. |

Example 16-245 Listing All Diskgroups

```
# odaadmcli show diskgroup
```

```
DiskGroups
-----
DATA
RECO
```

Example 16-246 Displaying DATA Configurations

```
# odaadmcli show diskgroup DATA
```

```
ASM_DISK  PATH                                DISK  STATE  STATE_DETAILS

data_00   /dev/NVD_S00_S2LHNAAH101026p1  pd_00 ONLINE Good
data_01   /dev/NVD_S01_S2LHNAAH101008p1  pd_01 ONLINE Good
```

odaadmcli show raidsyncstatus

Use the `odaadmcli show raidsyncstatus` command to display the RAID SYNC status.

File Path

```
/opt/oracle/oak/bin/odaadmcli
```

Syntax

To display the status of RAID SYNC:

```
odaadmcli show raidsyncstatus [-h]
```

Parameters

| Parameter | Description |
|------------|---|
| --help, -h | (Optional) Displays help for using the command. |

Example 16-247 Displaying the RAID SYNC Status

To display the RAID SYNC details and status:

```
# odaadmcli show raidsyncstatus

Raid Type   Raid Device   Raid Status   maintainPdFailHistory   Rebuildrate
H/W Raid    /dev/sda      Optimal       ON                       30%
```

odaadmcli show storage

Use the `odaadmcli show storage` command to show the storage controllers, expanders, and disks.

File Path

```
/opt/oracle/oak/bin/odaadmcli
```

Syntax

To display the storage controllers, expanders, and disks:

```
odaadmcli show storage [-h]
```

To show storage errors:

```
odaadmcli show storage -errors [-h]
```

Parameters

| Parameter | Description |
|------------|---|
| --errors | (Optional) Shows storage errors. |
| --help, -h | (Optional) Displays help for using the command. |

Example 16-248 Displaying Storage Devices

The following example displays details about the storage devices on an appliance.

```
# odaadmcli show storage
```

```

==== BEGIN STORAGE DUMP =====
Host Description: Oracle Corporation:ORACLE SERVER X6-2
Total number of controllers: 2
  Id = 0
  Pci Slot = 10
  Serial Num = S2LHNAAH101026
  Vendor = Samsung
  Model = MS1PC2DD3ORA3.2T
  FwVers = KPYA7R3Q
  strId = nvme:19:00.00
  Pci Address = 19:00.0

  Id = 1
  Pci Slot = 11
  Serial Num = S2LHNAAH101008
  Vendor = Samsung
  Model = MS1PC2DD3ORA3.2T
  FwVers = KPYA7R3Q
  strId = nvme:1b:00.00
  Pci Address = 1b:00.0

Total number of expanders: 0
Total number of PDs: 2
  /dev/nvme0n1 Samsung NVD 3200gb slot: 0 pci : 19
  /dev/nvme1n1 Samsung NVD 3200gb slot: 1 pci : 1

==== END STORAGE DUMP =====

```

odaadmcli stordiag

Use the `odaadmcli stordiag` command to collect detailed information for each disk or NVMe.

File Path

```
/opt/oracle/oak/bin/odaadmcli
```

Syntax

To collect storage diagnostics for disks and NVM Express (NVMe):

```
odaadmcli stordiag [-n] [-h]
```

Parameters

| Parameter | Description |
|--------------------------|--|
| <code>-ndisk_name</code> | Defines the disk resource name. The resource name format is <code>pd_[0..3]</code> . |
| <code>--help, -h</code> | (Optional) Displays help for using the command. |

Example 16-249 Displaying NVMe Details

To display detailed information for NVMe `pd_00`:

```
# odaadmcli stordiag pd_00
```

Oracle Database Appliance Command-Line Interface for KVM

Use `odacli` commands to manage Oracle Linux Kernel-based Virtual Machine (KVM) on Oracle Database Appliance.



Note:

If you have enabled multi-user access, then you can run all supported ODACLI commands on KVM and DB systems, after logging in as `odaadmin`.

- [About Command-Line Interface for Kernel-Based Virtual Machine \(KVM\)](#)
The `odacli` commands are the primary method for performing database and system administration on Oracle Database Appliance Kernel-Based Virtual Machine (KVM).
- [About ODACLI Commands Supported on Oracle KVM Database System](#)
Understand the `odacli` commands supported on Oracle Database Appliance Kernel-Based Virtual Machine (KVM) Database System in this release.
- [odacli DB System Commands for KVM](#)
Use the `odacli` DB system commands to manage databases on Oracle Database Appliance for Oracle KVM.
- [odacli VM Storage Commands for KVM](#)
Use the `odacli` virtual machine storage commands to manage storage on Oracle Database Appliance for Oracle KVM.
- [odacli Virtual Disk Commands for Oracle KVM](#)
Use the `odacli` virtual disk commands to manage virtual disks on Oracle Database Appliance for Oracle KVM.
- [odacli CPU Pool Commands for Bare Metal and KVM](#)
Use `odacli` commands to manage resource allocations on Oracle Database Appliance for bare metal and KVM deployments.
- [odacli VM Network Commands for KVM](#)
Use the `odacli` virtual machine network commands to manage network on Oracle Database Appliance for Oracle KVM.
- [odacli Virtual Machine Commands for Oracle KVM](#)
Use the `odacli` virtual machine commands to manage virtual machines on Oracle Database Appliance for Oracle KVM.

About Command-Line Interface for Kernel-Based Virtual Machine (KVM)

The `odacli` commands are the primary method for performing database and system administration on Oracle Database Appliance Kernel-Based Virtual Machine (KVM).

You can perform the following tasks with ODACLI commands on Kernel-Based Virtual Machine (KVM):

- Manage VM instances
- Manage VM storage
- Manage virtual disks
- Manage virtual network
- Manage CPU pools

ODACLI Command Location and Path Configuration

The `odacli` command-line interface is in the following directory:

```
/opt/oracle/dcs/bin/odacli
```

Configure the `root` user account on your Oracle Database Appliance servers to have the `PATH` variable defined to search for `odacli` commands in the path `/opt/oracle/dcs/bin/odacli`.

ODACLI Syntax

Oracle Appliance Manager command-line interface commands and parameters are case-sensitive.

An `odacli` command uses the following command syntax:

```
odacli command object [options]
```

- *command* is an action you want to perform on the appliance. For example: `show`, `locate`, `apply`.
- *object* is the target or object on which the `odacli` command performs the operation. For example, you issue a command to create or configure a virtual disk, or a network, or perform other system or software administration. You can also use object abbreviations.
- *options* are optional parts of the `odacli` command. Options can consist of one or more options that extend the use of the `odacli` command carried out on an object. Options include additional information about the action that you want to perform on the object. Option names are preceded with a dash. Many options require the name of an object for the command to perform the action that you want to carry out. The help option (`-h`) is an option that is available with every command. When you include the `-h` option, you can obtain additional information about the command that you want to perform.

Oracle Appliance Manager Command-Line Interface Help

Run the following command to see the usage information for all `odacli` commands available for your Oracle Database Appliance:

```
odacli -h
```

Run the following command to see detailed help about a specific `odacli` command:

```
odacli command -h
```

Run the following command to see detailed help about a specific `odacli` command carried out on an object, and the options that are available for you to use with that object.

```
odacli command object -h
```

About ODACLI Commands Supported on Oracle KVM Database System

Understand the `odacli` commands supported on Oracle Database Appliance Kernel-Based Virtual Machine (KVM) Database System in this release.

This release of Oracle Database Appliance supports the provisioning of Oracle KVM database system through `odacli create-dbsystem` or the Browser User Interface. The following ODACLI commands are supported on Oracle KVM Database System on Oracle Database Appliance:

- `odacli ping-agent`
- `odacli delete-agentconfig-parameters`
- `odacli list-agentconfig-parameters`
- `odacli modify-agentconfig-parameters`
- `odacli restore-archivelog`
- `odacli create-auto-logclean-policy`
- `odacli delete-auto-logclean-policy`
- `odacli list-auto-logclean-policy`
- `odacli list-availablepatches`
- `odacli create-backup`
- `odacli delete-backup`
- `odacli create-backupconfig`
- `odacli delete-backupconfig`
- `odacli describe-backupconfig`
- `odacli list-backupconfigs`
- `odacli modify-backupconfig`
- `odacli describe-backupreport`
- `odacli describe-component`
- `odacli set-credential`
- `odacli create-database`
- `odacli delete-database`
- `odacli describe-database`
- `odacli irestore-database`
- `odacli list-databases`
- `odacli modify-database`

- `odacli recover-database`
- `odacli register-database`
- `odacli configure-dataguard`
- `odacli deconfigure-dataguard`
- `odacli failover-dataguard`
- `odacli reinstate-dataguard`
- `odacli register-dataguard`
- `odacli switchover-dataguard`
- `odacli describe-dataguardstatus`
- `odacli list-dataguardstatus`
- `odacli create-dbhome`
- `odacli delete-dbhome`
- `odacli describe-dbhome`
- `odacli list-dbhomes`
- `odacli create-dbstorage`
- `odacli delete-dbstorage`
- `odacli describe-dbstorage`
- `odacli list-dbstorages`
- `odacli describe-job`
- `odacli list-jobs`
- `odacli create-jobdata-retention-policy`
- `odacli delete-jobdata-retention-policy`
- `odacli list-jobdata-retention-policy`
- `odacli describe-latestpatch`
- `odacli create-logcleanjob`
- `odacli describe-logcleanjob`
- `odacli list-logcleanjobs`
- `odacli list-logspaceusage`
- `odacli describe-network`
- `odacli list-networks`
- `odacli describe-networkinterface`
- `odacli list-networkinterfaces`
- `odacli list-nodes`
- `odacli create-objectstoreswift`
- `odacli delete-objectstoreswift`
- `odacli describe-objectstoreswift`

- `odacli list-objectstoreswifts`
- `odacli modify-objectstoreswift`
- `odacli list-osconfigurations`
- `odacli modify-osconfigurations`
- `odacli list-pendingjobs`
- `odacli create-prepatchreport`
- `odacli delete-prepatchreport`
- `odacli describe-prepatchreport`
- `odacli list-prepatchreports`
- `odacli create-purge-jobdata-job`
- `odacli list-purge-jobdata-jobs`
- `odacli describe-schedule`
- `odacli list-schedules`
- `odacli modify-schedule`
- `odacli list-scheduled-executions`
- `odacli describe-systemcomponent`
- `odacli list-tdebackupreports`
- `odacli restore-tdewallet`

**Note:**

No other ODACLI commands than the ones above are supported on Oracle Database Appliance KVM Database System, in this release.

odacli DB System Commands for KVM

Use the `odacli` DB system commands to manage databases on Oracle Database Appliance for Oracle KVM.

- **`odacli create-dbsystem`**
Use the `odacli create-dbsystem` command to create a new database system on Oracle Database Appliance Kernel-based Virtual Machine (KVM).
- **`odacli modify-dbsystem`**
Use the `odacli modify-dbsystem` command to modify a DB system on Oracle Database Appliance Kernel-based Virtual Machine (KVM).
- **`odacli modify-dbfileattributes`**
Use the `odacli modify-dbfileattributes` command to properly set the file attributes (permissions and ownership) of files on Oracle ASM disk group on a bare metal host to support a `dbsystem`. Only run this command if prompted by the `odacli create-dbsystem` command.

- [odacli list-dbsystems](#)
Use the `odacli list-dbsystems` command to view the database systems on Oracle Database Appliance Kernel-based Virtual Machine (KVM).
- [odacli describe-dbssystem](#)
Use the `odacli describe-dbssystem` command to describe a database system on Oracle Database Appliance Kernel-based Virtual Machine (KVM).
- [odacli describe-dbssystem-image](#)
Use the `odacli describe-dbssystem-image` command to view the supported Oracle Grid Infrastructure and Oracle Database versions and the availability of the clone files and Database System KVM image in the Oracle Database Appliance system.
- [odacli start-dbssystem](#)
Use the `odacli start-dbssystem` command to start a database system on Oracle Database Appliance Kernel-based Virtual Machine (KVM).
- [odacli stop-dbssystem](#)
Use the `odacli stop-dbssystem` command to stop a database system on Oracle Database Appliance Kernel-based Virtual Machine (KVM).
- [odacli delete-dbssystem](#)
Use the `odacli delete-dbssystem` command to delete a DB system on Oracle Database Appliance Kernel-based Virtual Machine (KVM).

odacli create-dbssystem

Use the `odacli create-dbssystem` command to create a new database system on Oracle Database Appliance Kernel-based Virtual Machine (KVM).

Syntax

```
odacli create-dbssystem [-f] [-p json_payload_path] [-t template] [-ta] [-j] [-h]
```

Parameters

| Parameter | Description |
|--|--|
| <code>--params, -p</code> | (Optional) Specifies the input parameters file path for DB system creation. |
| <code>--force, -f</code> | (Optional) Forces the operation with the specified parameters. |
| <code>--template, -t</code> | (Optional) Specifies the path where the template with sample values will be created. |
| <code>--template-annotated, -ta</code> | (Optional) Displays the DB system template with field descriptions. |
| <code>--json, -j</code> | (Optional) Displays output in JSON format. |
| <code>--help, -h</code> | (Optional) Displays help for using the command. |

Usage Notes

For example JSON files that you can use to create the DB system, see the *Example JSON File to Create a High-Availability DB System* and *Example JSON File to Create a Single-Node DB System* topics in this guide.

Example

Create a KVM database system using a JSON file for input parameters.

```
# odacli create-dbsystem -p example_system.json
```

Job details

```

-----
                ID:  fcf305c-3e75-4af4-8702-992aa15619d0
Description:  DB System example_system creation
                Status:  Created
                Created:  December 8, 2024 9:28:03 AM CST
                Message:

```

```

Task Name                Start Time
End Time                Status
-----
-----

```

Related Topics

- [Example JSON File to Create a High-Availability DB System](#)
Follow the JSON file example to create a JSON file to deploy a High-Availability DB system, with role separation, with the command `odacli create-dbsystem`.
- [Example JSON File to Create a Single-Node DB System](#)
Follow the JSON file example to create a JSON file to deploy a single-node DB System, with role separation, with the command `odacli create-dbsystem`.
- [odacli describe-dbsystem-image](#)
Use the `odacli describe-dbsystem-image` command to view the supported Oracle Grid Infrastructure and Oracle Database versions and the availability of the clone files and Database System KVM image in the Oracle Database Appliance system.

odacli modify-dbsystem

Use the `odacli modify-dbsystem` command to modify a DB system on Oracle Database Appliance Kernel-based Virtual Machine (KVM).

Syntax

```

odacli modify-dbsystem -n name [-cp cpu_pool_name] [-no-cp] [-r]
[-avd v_disk_to_attach] [-avn v_network]
[-dvd v_disk_to_detach] [-dvn v_networks_to_detach] [-en] [-gw gateway]
[-ip ip_address] [-nm netmask] [-tvm vm_name]
[-sip scan_ip_address] [-sn scan_name] [-s shape]
[-vips vip_address] [-vt v_network_type] [-m] [-j] [-h]

```

Parameters

| Parameter | Description |
|-------------------------|--|
| <code>--name, -n</code> | (Mandatory) Describes the name of the DB system. |

| Parameter | Description |
|--------------------------------------|---|
| <code>--redundancy, -r</code> | (Optional) Specifies the VM storage redundancy for a DB system. The value can be HIGH or MIRROR. This option is not supported for DB systems on non-FLEX disk group. The options can be MIRROR or HIGH. The default option is MIRROR. |
| <code>--attach-vdisk, -avd</code> | (Optional) Specifies the vdisk to attach. |
| <code>--attach-vnetwork, -avn</code> | (Optional) Specifies the name of the vnetwork to attach. |
| <code>--cpupool, -cp</code> | (Optional) Specifies the shared DB System CPU Pool name. |
| <code>--detach-vdisk, -dvd</code> | (Optional) Specifies the vdisk to detach. |
| <code>--detach-vnetwork, -dvn</code> | (Optional) Specifies the name of the vnetworks to detach. |
| <code>--enable-numa, -en</code> | (Optional) Enables NUMA configuration for the DB System. |
| <code>--gateway, -gw</code> | (Optional) Specifies the network gateway. |
| <code>--ip, -ip</code> | (Optional) Specifies the network IP address. |
| <code>--netmask, -nm</code> | (Optional) Specifies the netmask of the network. |
| <code>--no-cpupool, -no-cp</code> | (Optional) Specifies to dissociate the current DB System CPU Pool name. |
| <code>--target-vm, -tvm</code> | (Optional) Specifies the DB system host name to attach or detach a vdisk. |
| <code>--scan-ips, -sip</code> | (Optional) Specifies the SCAN IP of the network. |
| <code>--scan-name, -sn</code> | (Optional) Specifies the SCAN of the network. |
| <code>--shape, -s</code> | (Optional) Specifies the new shape. You can specify a higher or lower value than the current shape. This option only changes the shape of the DB system. It does not change the shape of databases in the DB system. |
| <code>--vips, -vips</code> | (Optional) Specifies the virtual IP of the network in the format <code>vip_name_0:0:vip_ip_0,vip_name_1:1:vip_ip_1</code> . |
| <code>--vnetwork-type, -vt</code> | (Optional) Specifies the vnetwork type to attach. |
| <code>--memory, -m</code> | (Optional) Defines the memory size. The format is M G. |
| <code>--json, -j</code> | (Optional) Displays output in JSON format. |
| <code>--help, -h</code> | (Optional) Displays help for using the command. |

Usage Notes

- The `odacli modify-dbsystem` command supports the following use cases:

- attach or detach the shared DB system cpupools.
Attaching a CPU pool:

```
odacli modify-dbsystem --name dbsystem_name -cp cpupool
```

Detaching a CPU pool:

```
odacli modify-dbsystem --name dbsystem_name --no-cp
```

- Change DB system shape, that is, scale up (increase) or scale down (decrease):

```
odacli modify-dbsystem -n dbsystem_name -s new_shape
```

- Enable NUMA for the existing DB system. NUMA is enabled on Oracle Database Appliance release 19.12 and later. For existing DB systems created before release 19.12, use the `odacli modify-dbsystem --enable_numa` command to enable the NUMA for the DB system. This command includes enabling the NUMA for the VM configuration, operation system, and the database inside the DB system.

```
odacli modify-dbsystem --name dbsystem name --enable_numa
```

- Attach or detach new network to the DB system. Before attaching a vnetwork, ensure that the vnetwork exists. You must specify the IP address and netmask to configure the new network interface inside the DB system. If the network type is `database` or `dataguard`, specify the VIPs, SCAN name, and SCAN IPs.

```
odacli modify-dbsystem -n dbsystem1 -avn vnet2 -t Dataguard -ip
192.168.10.119,192.168.10.120 -nm 255.255.240.0 -gw 192.168.10.1 -sn
scan1 -sip 192.168.10.30,192.168.10.31 -vips
vip1:0:192.168.15.57,vip2:1:192.168.15.58
```

To detach a network from DB system:

```
odacli modify-dbsystem -n dbsystem1 -dvn vnet2
```

- Starting with Oracle Database Appliance release 19.23, the `odacli modify-dbsystem --shape` command only changes the shape of the DB system; it does not change the shapes of the database inside the DB system any more. You must modify database shapes accordingly based on the new shape of the DB system. Ensure that you scale up database shapes after the DB system shape is scaled up. Similarly, scale down database shapes before DB system shape is scaled down, otherwise databases could fail to start because of reduced DB system memory.
- To attach a vdisk to a DB system, note the following:
 - The vdisk must already exist.
 - When you attach a vdisk, the vdisk attaches to the DB system and displays in the DBVM operating system as a block device, for example, `/dev/vdc`. You must format and create a file system with the block device and maintain the device in the DB system.
 - For high-availability systems, you must specify the DB system to attach the vdisk, using the `--target-vm` option. Specify the VM host name without the domain name in the `--target-vm` option. You can view the VM host name with the `odacli describe-dbsystem` command.
 - On high-availability systems, the vdisk attached to the two nodes on the DB system is local to the DBVM it is attached to. The vdisk is not shared and cannot be shared between two DBVMs in the DB system.
- To detach a vdisk from a DB system, note the following:
 - Detaching a vdisk from the DB system removes the vdisk from the DBVM. The block device, for example, `/dev/vdc` is removed from the DBVM operating system level. You must ensure that sufficient care is exercised at the operating system level, for example, properly back up the content of the file system, remove the block device from logical volume manager, or remove the block device from `/etc/fstab`, before you detach the vdisk. Without proper handling, the DBVM could fail to restart after running the detach vdisk operation.

- For high-availability systems, you must specify the DB system from which to detach the vdisk, using the `--target-vm` option. Specify the VM host name without the domain name in the `--target-vm` option. You can view the VM host name with the `odacli describe-dbsystem` command.
- If the detach vdisk operation fails, then you can retry the detach operation with the `--force`, `-f` parameter to ensure that the vdisk is detached from the device block list and the metadata as well.
- The attach and detach vdisk operations restart the DB system.

Example: Modify a KVM DB system

```
# odacli modify-dbsystem -n example_system1 -cp example_pool -s new_shape
```

Example: Increase the DB System memory to 24 GB

The command supports increasing the DB system memory. To reduce the DB system memory, use the `--shape` option with the command `odacli modify-dbsystem`.

```
# odacli modify-dbsystem -n dbsystem_name -m 24G
```

Related Topics

- [odacli remap-cpupools](#)
Use the `odacli remap-cpupools` command to remap CPU pools to NUMA allocation on Oracle Database Appliance Bare Metal or Kernel-based Virtual Machine (KVM) deployment.
- [odacli create-cpupool](#)
Use the `odacli create-cpupool` command to create a new CPU pool on Oracle Database Appliance Bare Metal or Kernel-based Virtual Machine (KVM) deployment.

odacli modify-dbfileattributes

Use the `odacli modify-dbfileattributes` command to properly set the file attributes (permissions and ownership) of files on Oracle ASM disk group on a bare metal host to support a dbsystem. Only run this command if prompted by the `odacli create-dbsystem` command.

Syntax

```
odacli modify-dbfileattributes [-in db_name] [-j] [-h]
```

Parameters

| Parameter | Description |
|----------------------------|---|
| <code>--dbname, -in</code> | (Optional) Describes the name of the database for which you want to modify the file attributes. |
| <code>--json, -j</code> | (Optional) Displays output in JSON format. |
| <code>--help, -h</code> | (Optional) Displays help for using the command. |

Usage Notes

- To create the database system, access control must be enabled in Oracle ASM running on bare metal system. When the bare metal system is newly provisioned or patched to Oracle

Database Appliance release 19.26, access control is already enabled. This helps you set appropriate file ownerships for all the files created in DB systems and on bare metal.

- Before you create the database system, the files on Oracle ASM disk groups that do not have file ownership must be set up with ownership. The creation of dbssystem fails, and you are prompted to run the `odacli modify-dbfileattributes` command to set up the file ownership and permission. Since there can be many files on Oracle ASM disk group, the user can run this step at their own convenience. Use the `odacli modify-dbfileattributes` command to set up the file ownerships.
- This command sets the file attributes (permissions and ownership) of all files on Oracle ASM disk group. The files include database files and also Oracle Clusterware files such as OCR (Oracle Clusterware Registry). Before creating the first DB system, set up attributes for files owned by both Oracle Grid Infrastructure and Oracle Database by running the `odacli modify-dbfileattributes` command with no arguments.
- If the overall operation was successful for many files, but failed for some files, then you can run the command again by specifying the database names.

Example

Modify the file attributes of the databases.

```
# odacli modify-dbfileattributes -in example_db_name
```

odacli list-dbsystems

Use the `odacli list-dbsystems` command to view the database systems on Oracle Database Appliance Kernel-based Virtual Machine (KVM).

Syntax

```
odacli list-dbsystems [-j] [-h]
```

Parameters

| Parameter | Description |
|-------------------------|---|
| <code>--json, -j</code> | (Optional) Displays output in JSON format. |
| <code>--help, -h</code> | (Optional) Displays help for using the command. |

Example

List the KVM database systems.

```
# odacli list-dbsystems
Name                Shape      Cores  Memory   Status
Created             Updated
-----
-----
dbssystem1          odb4       4      32.00 GB CONFIGURED 2020-12-08
17:39:00 CST 2020-12-08 17:39:00 CST
dbssystem2          odb2       2      16.00 GB CREATING  2020-12-16
09:28:03 CST 2020-12-16 09:28:03 CST
```

odacli describe-dbsystem

Use the `odacli describe-dbsystem` command to describe a database system on Oracle Database Appliance Kernel-based Virtual Machine (KVM).

Syntax

```
odacli describe-dbsystem -n db_system_name [-p payload] [-j] [-h]
```

Parameters

| Parameter | Description |
|----------------------------|---|
| <code>--name, -n</code> | (Mandatory) Describes the name of the DB system. |
| <code>--payload, -p</code> | (Optional) Displays the payload describing the specified DB system. The option that can be specified is <code>COPY</code> . |
| <code>--json, -j</code> | (Optional) Displays output in JSON format. |
| <code>--help, -h</code> | (Optional) Displays help for using the command. |

Usage Notes

Image version is the version which the DB System was created from. Current version is the current version of the DB system. For instance, if the DB System was created on 19.25 and it was patched to 19.26, the output is as follows:

```
Image version: 19.25.0.0.0
Current version: 19.26.0.0.0
```

Example

View details of a KVM database system on a single-node system.

```
# odacli describe-dbsystem -n example_system1
```

```
DB System details
```

```
-----
```

```
--
```

```

                ID: 04f718f8-ddc9-4b45-8e8e-07d14165eb9c
                Name: example_system2
Image version: 19.26.0.0.0
Current version: 19.26.0.0.0
                Shape: odb2
                Cluster name: dbsa4b75be52
                Grid version: 19.26.0.0.250121
                Memory: 16.00 GB
                NUMA enabled: YES
                Status: CONFIGURED
                Created: 2023-04-19 10:00:08 UTC
                Updated: 2023-04-19 10:04:02 UTC
```

```
CPU Pool
```

```
-----
```

```
                Name: c4bfa26faa
                Number of cores: 2
```

```
Host: n1
Effective CPU set: 0-1,20-21
Online CPUs: 0, 1, 20, 21
Offline CPUs: NONE
```

```
Host: n2
Effective CPU set: 0-1,20-21
Online CPUs: 0, 1, 20, 21
Offline CPUs: NONE
```

VM Storage

```
-----
Disk group: DATA
Volume name: S4BFA26FAA
Volume device: /dev/asm/s4bfa26faa-497
Size: 400.00 GB
Mount Point: /u05/app/sharedrepo/example_system
```

VMs

```
-----
Host: host1
VM Name: x4bfa26faa
VM Host Name: example_domain1
VM image path: /vm_image_path1
Target State: ONLINE
Current State: ONLINE
```

```
Host: host2
VM Name: y4bfa26faa
VM Host Name: example_domain2
VM image path: /vm_image_path2
Target State: ONLINE
Current State: ONLINE
```

VNetworks

```
-----
Host: example_domain1
VM Name: x4bfa26faa
Public: xxx.xxx.xxx.xxx / xxx.xxx.xxx.xxx / ens3 /
BRIDGE (pubnet)
ASM: xxx.xxx.xxx.xxx / xxx.xxx.xxx.xxx / ens4 /
BRIDGE (privasm) VLAN (icbond0.100)
Interconnect: xxx.xxx.xxx.xxx / xxx.xxx.xxx.xxx / ens5 /
```

```
Host: example_domain2
VM Name: y4bfa26faa
Public: xxx.xxx.xxx.xxx / xxx.xxx.xxx.xxx / ens3 /
BRIDGE (pubnet)
ASM: xxx.xxx.xxx.xxx / xxx.xxx.xxx.xxx / ens4 /
BRIDGE (privasm) VLAN (icbond0.100)
Interconnect: xxx.xxx.xxx.xxx / xxx.xxx.xxx.xxx / ens5 /
```

Databases

```

-----
Name: flashvm
Resource ID: 350b72f7-2351-49e7-ada3-4051af9594f0
Unique name: flashvmU
Database ID:
Domain name: domain_name
DB Home ID: 617664f6-0a16-4922-8346-9eeb3d7256ee
Shape: odb2
Version: 19.0.0.0
Edition: EE
Type: SI
Role: PRIMARY
Class: OLTP
Storage: ASM
Redundancy:
Target node name:
Character set: AL32UTF8
NLS character set:
Language: AMERICAN
Territory: AMERICA
Console enabled: false
SEHA enabled: false
Associated networks: NONE
Backup config ID:
Level 0 Backup Day: sunday
Autobackup enabled: true
TDE enabled: true
CDB type: false
PDB name:
PDB admin user:

```

View details of a KVM database system on a High Availability system, with InfiniBand.

```

# odacli describe-dbsystem -n example_system3
DB System details

```

```

-----
--
ID: 0c5280a1-3ee1-438e-ad11-1cee23de17fd
Name: example_system3
Image version: 19.16.0.0.0
Current version: 19.16.0.0.0
Shape: odb2
Cluster name: dbsa4b75be52
Grid version: 19.26.0.0.250121
Memory: 16.00 GB
NUMA enabled: YES
Status: CONFIGURED
Created: 2020-12-10 02:11:11 UTC
Updated: 2020-12-10 02:11:11 UTC

```

CPU Pool

```

-----
Name: ce2ab55255
Number of cores: 2
Host: node1

```

Effective CPU set: 4-5,24-25
 Online CPUs: 4, 5, 24, 25
 Offline CPUs: NONE

Host: node2
 Effective CPU set: 4-5,24-25
 Online CPUs: 4, 5, 24, 25
 Offline CPUs: NONE

VM Storage

 Disk group: DATA
 Volume name: SE2AB55255
 Volume device: /dev/asm/se2ab55255-187
 Size: 400.00 GB
 Mount Point: /u05/app/sharedrepo/example_system

VMs

 Host: host1
 VM Name: xe2ab55255
 VM Host Name: host_name1
 VM image path: /vm_image_path1
 Target State: ONLINE
 Current State: ONLINE

Host: host2
 VM Name: ye2ab55255
 VM Host Name: host_name2
 VM image path: /vm_image_path2
 Target State: ONLINE
 Current State: ONLINE

VNetworks

 Host: node1
 VM Name: xe2ab55255
 Public: xxx.xxx.xxx.xxx /xxx.xxx.xxx.xxx / ens3 /
 BRIDGE (pubnet)
 ASM: xxx.xxx.xxx.xxx / xxx.xxx.xxx.xxx / ibbond0 /
 VF (90:03.5)
 Interconnect: xxx.xxx.xxx.xxx / xxx.xxx.xxx.xxx / ibbond1 /
 VF (90:01.7)

Host: node2
 VM Name: ye2ab55255
 Public: xxx.xxx.xxx.xxx / xxx.xxx.xxx.xxx / ens3 /
 BRIDGE (pubnet)
 ASM: xxx.xxx.xxx.xxx / xxx.xxx.xxx.xxx / ibbond0 /
 VF (90:01.0)
 Interconnect: xxx.xxx.xxx.xxx / xxx.xxx.xxx.xxx / ibbond1 /
 VF (90:01.6)

Databases

```

-----
Name: datavm
Resource ID: 6aac341a-3c73-46eb-af2a-1eada9b57661
Unique name: datavmU
Database ID: 3806144946
Domain name: domain_name
DB Home ID: dcc928f1-5eb3-477b-875d-050640b7f68c
Shape: odb2
Version: 19.26.0.0.250121
Edition: EE
Type: RAC
Role: PRIMARY
Class: OLTP
Storage: ASM
Redundancy:
Target node name:
Character set: AL32UTF8
NLS character set:
Language: AMERICAN
Territory: AMERICA
Console enabled: false
SEHA enabled: false
Associated networks: NONE
Backup config ID:
Level 0 Backup Day: sunday
Autobackup enabled: true
TDE enabled: true
CDB type: false
PDB name:
PDB admin user:

```

View details of a DB system in the JSON file format

```

# odacli describe-dbsystem -n scaoda815c2 -p
{
  "forced" : null,
  "system" : {
    "name" : "scaoda815c2",
    "shape" : "odb4",
    "customMemorySize" : "32.00 GB",
    "cpuPoolName" : "c519cd5314",
    "useReservedCores" : false,
    "diskGroup" : "DATA",
    "systemPassword" : null,
    "timeZone" : "UTC",
    "enableRoleSeparation" : true,
    "singleNode" : null,
    "failOver" : false,
    "customRoleSeparation" : {
      "groups" : [ {
        "id" : 1001,
        "name" : "oinstall",
        "role" : "oinstall"
      }, {
        "id" : 1002,

```

```
        "name" : "dbaoper",
        "role" : "dbaoper"
    }, {
        "id" : 1003,
        "name" : "dba",
        "role" : "dba"
    }, {
        "id" : 1004,
        "name" : "asmadmin",
        "role" : "asmadmin"
    }, {
        "id" : 1005,
        "name" : "asmoper",
        "role" : "asmoper"
    }, {
        "id" : 1006,
        "name" : "asmdba",
        "role" : "asmdba"
    } ],
    "users" : [ {
        "id" : 1000,
        "name" : "grid",
        "role" : "gridUser"
    }, {
        "id" : 1001,
        "name" : "oracle",
        "role" : "oracleUser"
    } ]
},
"redundancy" : "MIRROR"
},
"network" : {
    "domainName" : "us.oracle.com",
    "ntpServers" : [ ],
    "dnsServers" : [ "10.209.76.198" ],
    "scanName" : "scaoda815c2-scan",
    "scanIps" : [ "10.32.68.17", "10.32.70.94" ],
    "nodes" : [ {
        "number" : 1,
        "name" : "scaoda815c2n2",
        "ipAddress" : "10.32.68.20",
        "netmask" : "255.255.248.0",
        "gateway" : "10.32.64.1",
        "vipName" : "scaoda815c2n2-vip",
        "vipAddress" : "10.32.68.21"
    }, {
        "number" : 0,
        "name" : "n1",
        "ipAddress" : "10.32.68.18",
        "netmask" : "255.255.248.0",
        "gateway" : "10.32.64.1",
        "vipName" : "n1-vip",
        "vipAddress" : "10.32.68.19"
    } ],
    "publicVNetwork" : null,
    "clusterInterconnect" : null
}
```

```

    },
    "grid" : {
      "language" : "en",
      "enableAFD" : false
    },
  },
  "database" : {
    "name" : "mydb2",
    "uniqueName" : "mydb2u",
    "domainName" : "domainname",
    "adminPassword" : null,
    "version" : "19.17.0.0.221018",
    "edition" : "EE",
    "type" : "RAC",
    "dbClass" : "OLTP",
    "shape" : "odb4",
    "role" : "PRIMARY",
    "redundancy" : "MIRROR",
    "characterSet" : {
      "characterSet" : "AL32UTF8",
      "nlsCharacterSet" : "AL16UTF16",
      "dbTerritory" : "AMERICA",
      "dbLanguage" : "AMERICAN"
    },
    "enableDbConsole" : false,
    "enableSEHA" : false,
    "enableEEHA" : false,
    "enableFlashStorage" : false,
    "rmanBackupPassword" : null,
    "level0BackupDay" : "sunday",
    "enableTDE" : false,
    "tdePassword" : null,
    "enableUnifiedAuditing" : false,
    "isCdb" : true,
    "pdbName" : "pdb1",
    "pdbAdminUser" : "pdbadmin",
    "targetNodeNumber" : 0,
    "dbStorage" : "ASM"
  }
}
}

```

odacli describe-dbsystem-image

Use the `odacli describe-dbsystem-image` command to view the supported Oracle Grid Infrastructure and Oracle Database versions and the availability of the clone files and Database System KVM image in the Oracle Database Appliance system.

Syntax

```
odacli describe-dbsystem-image [-j] [-h]
```

Parameters

| Parameter | Description |
|-------------------------|--|
| <code>--json, -j</code> | (Optional) Displays output in JSON format. |

| Parameter | Description |
|-------------------------|---|
| <code>--help, -h</code> | (Optional) Displays help for using the command. |

Example

View details of a KVM database system image

```
# odacli describe-dbsystem-image
DB System Image details
-----
--
Component Name Supported Versions Available Versions
-----
DBVM           19.10.0.0.0      19.10.0.0.0
GI             19.10.0.0.210119 19.10.0.0.210119
DB            19.10.0.0.210119 19.10.0.0.210119
```

View details of a system where KVM database system image is not available

```
# odacli describe-dbsystem-image
DB System Image details
-----
--
Component Name Supported Versions Available Versions
-----
DBVM           19.10.0.0.0      not-available
GI             19.10.0.0.210119 19.10.0.0.210119
DB            19.10.0.0.210119 19.10.0.0.210119
```

The output shows that the KVM Database System image is not yet available on the system. Download the image and run the `odacli update-repository` to import the image to the repository. The output shows that the Oracle Grid Infrastructure and Oracle Database clones are already available on the system.

odacli start-dbsystem

Use the `odacli start-dbsystem` command to start a database system on Oracle Database Appliance Kernel-based Virtual Machine (KVM).

Syntax

```
odacli start-dbsystem -n dbsystem_name [-nn node_name] [-j] [-h]
```

Parameters

| Parameter | Description |
|-------------------------------|--|
| <code>--name, -n</code> | (Mandatory) Describes the name of the DB system. |
| <code>--node-name, -nn</code> | (Optional) Specifies the bare metal system node name on which to start the DB system VM. |
| <code>--json, -j</code> | (Optional) Displays output in JSON format. |

| Parameter | Description |
|-------------------------|---|
| <code>--help, -h</code> | (Optional) Displays help for using the command. |

Example

Start a KVM database system.

```
# odacli start-dbsystem -n example_system
```

Job details

```
-----
ID: 68044afa-d3cc-4024-9dc8-50fcf847642c
Description: DB System scaoda8s008c4 start
Status: Success
Created: December 16, 2020 9:12:51 AM UTC
Message:

Task Name                               Start Time
End Time                                 Status
-----
Start DB System                          December 16, 2020 9:12:51 AM UTC
December 16, 2020 9:12:52 AM UTC         Success
```

odacli stop-dbsystem

Use the `odacli stop-dbsystem` command to stop a database system on Oracle Database Appliance Kernel-based Virtual Machine (KVM).

Syntax

```
odacli stop-dbsystem -n dbsystem_name [-nn node_name] [-f] [-j] [-h]
```

Parameters

| Parameter | Description |
|-------------------------------|---|
| <code>--name, -n</code> | (Mandatory) Describes the name of the DB system. |
| <code>--force, -f</code> | (Optional) Forces the operation to stop the DB system. |
| <code>--node-name, -nn</code> | (Optional) Specifies the bare metal system node name on which to stop the DB system VM. |
| <code>--json, -j</code> | (Optional) Displays output in JSON format. |
| <code>--help, -h</code> | (Optional) Displays help for using the command. |

Example

Stop a KVM database system.

```
# odacli stop-dbsystem -n example_system
```

Job details

```
-----
ID: 68044afa-d3cc-4024-9dc8-50fcf847642c
```

```

Description: DB System scaoda8s008c4 start
Status: Success
Created: December 16, 2020 9:12:51 AM UTC
Message:

Task Name                               Start Time
End Time                                 Status
-----
Stop DB System                           December 16, 2020 9:12:51 AM UTC
December 16, 2020 9:12:52 AM UTC         Success

```

odacli delete-dbsystem

Use the `odacli delete-dbsystem` command to delete a DB system on Oracle Database Appliance Kernel-based Virtual Machine (KVM).

Syntax

```
odacli delete-dbsystem -n dbsystem_name [-f] [-j] [-h]
```

Parameters

| Parameter | Description |
|--------------------------|--|
| <code>--name, -n</code> | (Mandatory) Describes the name of the DB system. |
| <code>--force, -f</code> | (Optional) If specified, then the operation deletes the database system, Oracle Clusterware files, and the database files. |
| <code>--json, -j</code> | (Optional) Displays output in JSON format. |
| <code>--help, -h</code> | (Optional) Displays help for using the command. |

Usage Notes

- If you do not specify the `-f` option, then the delete DB system operation validates that the DB system does not contain any database. If there are any databases within the DB system, then the following error message is displayed:

```
DB System 'name' must not have any database in order to be deleted, found
following databases: list_of_databases
```

- Specify the `-f` option to delete the DB system, the Oracle Clusterware files, and the database files.
- The `odacli delete-dbsystem` command does not delete the database files. This is expected behavior so that you can archive the database files, if required, or manually restore the database with these database files. Use the `--force` option to delete the database files completely.

Example

Delete a DB system.

```
[root@node1ha17c1n1 log]# odacli delete-dbsystem -n dbsfe0bd8
WARNING: Use --force option to delete the database and datafiles.
Do you confirm delete DB System 'dbsfe0bd8'? (Options: y/n, default: n): y
DCS-10045:Validation error encountered: DB System 'dbsfe0bd8' must not have
```

any database in order to be deleted, found following databases: dbb34f97.

```
[root@node1ha17c1n1 log]# odacli describe-job -i 41de9e46-e1d4-44c0-b0ab-c6049579e9f8
```

Job details

```
-----
ID: 41de9e46-e1d4-44c0-b0ab-c6049579e9f8
Description: DB System dbs7283a3 deletion [Forced]
Status: Success
Created: June 13, 2024 8:14:08 PM UTC
Message:
```

| Task Name | Node Name | Start |
|-----------------------------------|------------------------------|---------------|
| Time | End Time | |
| Status | | |
| ----- | | |
| Delete database | node1ha17c1n1 | June 13, 2024 |
| 8:14:08 PM UTC | June 13, 2024 8:14:09 PM UTC | |
| Success | | |
| Remove DB System from Clusterware | node1ha17c1n1 | June 13, 2024 |
| 8:14:09 PM UTC | June 13, 2024 8:14:09 PM UTC | |
| Success | | |
| Delete ASM client cluster config | node1ha17c1n1 | June 13, 2024 |
| 8:14:09 PM UTC | June 13, 2024 8:14:09 PM UTC | |
| Success | | |
| Deprovision DB System VM(s) | node1ha17c1n1 | June 13, 2024 |
| 8:14:09 PM UTC | June 13, 2024 8:14:10 PM UTC | |
| Success | | |
| Delete DB System ACFS filesystem | node1ha17c1n1 | June 13, 2024 |
| 8:14:10 PM UTC | June 13, 2024 8:14:11 PM UTC | |
| Success | | |
| Delete DB System ACFS mount point | node1ha17c1n1 | June 13, 2024 |
| 8:14:11 PM UTC | June 13, 2024 8:14:11 PM UTC | |
| Success | | |
| Delete DB System ASM volume | node1ha17c1n1 | June 13, 2024 |
| 8:14:11 PM UTC | June 13, 2024 8:14:12 PM UTC | |
| Success | | |
| Delete DB System Networks | node1ha17c1n1 | June 13, 2024 |
| 8:14:12 PM UTC | June 13, 2024 8:14:12 PM UTC | |
| Success | | |
| Remove unused network interfaces | node1ha17c1n1 | June 13, 2024 |
| 8:14:12 PM UTC | June 13, 2024 8:14:12 PM UTC | |
| Success | | |
| Delete imported certificates | node1ha17c1n1 | June 13, 2024 |
| 8:14:12 PM UTC | June 13, 2024 8:14:13 PM UTC | |
| Success | | |
| Delete DB System metadata | node1ha17c1n1 | June 13, 2024 |
| 8:14:13 PM UTC | June 13, 2024 8:14:13 PM UTC | Success |

odacli VM Storage Commands for KVM

Use the `odacli` virtual machine storage commands to manage storage on Oracle Database Appliance for Oracle KVM.

- [odacli create-vmstorage](#)
Use the `odacli create-vmstorage` command to create a new VM storage on Oracle Database Appliance Kernel-based Virtual Machine (KVM).
- [odacli list-vmstorages](#)
Use the `odacli list-vmstorages` command to list all VM storages on Oracle Database Appliance Kernel-based Virtual Machine (KVM).
- [odacli describe-vmstorage](#)
Use the `odacli describe-vmstorage` command to describe VM storage on Oracle Database Appliance Kernel-based Virtual Machine (KVM).
- [odacli modify-vmstorage](#)
Use the `odacli modify-vmstorage` command to modify VM storage configuration on Oracle Database Appliance Kernel-based Virtual Machine (KVM).
- [odacli delete-vmstorage](#)
Use the `odacli delete-vmstorage` command to delete a vmstorage configuration on Oracle Database Appliance Kernel-based Virtual Machine (KVM).

odacli create-vmstorage

Use the `odacli create-vmstorage` command to create a new VM storage on Oracle Database Appliance Kernel-based Virtual Machine (KVM).

Syntax

```
odacli create-vmstorage -n name -s size -dg disk_group [-r {MIRROR|HIGH}] [-j] [-h]
```

Parameters

| Parameter | Description |
|-------------------------------|---|
| <code>--name, -n</code> | Name assigned to the VM storage. |
| <code>--size, -s</code> | Specifies the storage size. Format is K M G T. Minimum Size is 1024M (1G) |
| <code>--diskgroup, -dg</code> | (Optional) Defines the ASM disk group of the VM storage (Default: DATA). |
| <code>--redundancy, -r</code> | (Optional) Specifies the VM storage redundancy for a DB system. The value can be HIGH or MIRROR. This option is not supported for DB systems on non-FLEX disk group. The options can be MIRROR or HIGH. The default option is MIRROR. |
| <code>--json, -j</code> | (Optional) Displays output in JSON format. |
| <code>--help, -h</code> | (Optional) Displays help for using the command. |

Example

Create a VM storage named `share1` of 8 GB.

```
# odacli create-vmstorage -n share1 -s 8G
```

odacli list-vmstorages

Use the `odacli list-vmstorages` command to list all VM storages on Oracle Database Appliance Kernel-based Virtual Machine (KVM).

Syntax

```
odacli list-vmstorages [-j] [-h]
```

Parameters

| Parameter | Description |
|-------------------------|---|
| <code>--json, -j</code> | (Optional) Displays output in JSON format. |
| <code>--help, -h</code> | (Optional) Displays help for using the command. |

Example

```
# odacli list-vmstorages
```

odacli describe-vmstorage

Use the `odacli describe-vmstorage` command to describe VM storage on Oracle Database Appliance Kernel-based Virtual Machine (KVM).

Syntax

```
odacli describe-vmstorage -n name [-j] [-h]
```

Parameters

| Parameter | Description |
|-------------------------|---|
| <code>--name, -n</code> | Specifies the name of the VM storage. |
| <code>--json, -j</code> | (Optional) Displays output in JSON format. |
| <code>--help, -h</code> | (Optional) Displays help for using the command. |

Example: Describing a VM Storage named `share1`

```
# odacli describe-vmstorage -n share1
```

odacli modify-vmstorage

Use the `odacli modify-vmstorage` command to modify VM storage configuration on Oracle Database Appliance Kernel-based Virtual Machine (KVM).

Syntax

```
odacli modify-vmstorage -n name -i increment [-r {MIRROR|HIGH}] [-s decrement] [-j] [-h]
```

Parameters

| Parameter | Description |
|-------------------------------|---|
| <code>--name, -n</code> | Specifies the VM storage name |
| <code>--increment, -i</code> | (Optional) Defines the size to grow the VM storage. Format is K M G T |
| <code>--shrink, -s</code> | (Optional) Defines the size to shrink the VM storage. Format is K M G T |
| <code>--redundancy, -r</code> | (Optional) Specifies the VM storage redundancy for a DB system. The value can be HIGH or MIRROR. This option is not supported for DB systems on non-FLEX disk group. The options can be MIRROR or HIGH. The default option is MIRROR. |
| <code>--json, -j</code> | (Optional) Displays output in JSON format. |
| <code>--help, -h</code> | (Optional) Displays help for using the command. |

Example

Increase the size of a VM storage named `share1` by 10 gigabytes.

```
# odacli modify-vmstorage -n share1 -i 10G
```

odacli delete-vmstorage

Use the `odacli delete-vmstorage` command to delete a vmstorage configuration on Oracle Database Appliance Kernel-based Virtual Machine (KVM).

Syntax

```
odacli delete-vmstorage -n name [-f] [-j] [-h]
```

Parameters

| Parameter | Description |
|--------------------------|---|
| <code>--name, -n</code> | Specifies the vmstorage name to be deleted |
| <code>--force, -f</code> | (Optional) Specifies the force option |
| <code>--json, -j</code> | (Optional) Displays output in JSON format. |
| <code>--help, -h</code> | (Optional) Displays help for using the command. |

Example

Delete a VM storage named `share1`.

```
odacli delete-vmstorage -n share1
```

odacli Virtual Disk Commands for Oracle KVM

Use the odacli virtual disk commands to manage virtual disks on Oracle Database Appliance for Oracle KVM.

- [odacli create-vdisk](#)
Use the `odacli create-vdisk` command to create a new virtual disk in a VM storage on Oracle Database Appliance Kernel-based Virtual Machine (KVM).
- [odacli list-vdisks](#)
Use the `odacli list-vdisks` command to list all virtual disks on Oracle Database Appliance Kernel-based Virtual Machine (KVM).
- [odacli describe-vdisk](#)
Use the `odacli describe-vdisk` command to describe a virtual disk on Oracle Database Appliance Kernel-based Virtual Machine (KVM).
- [odacli modify-vdisk](#)
Use the `odacli modify-vdisk` command to modify a virtual disk on Oracle Database Appliance Kernel-based Virtual Machine (KVM).
- [odacli clone-vdisk](#)
Use the `odacli clone-vdisk` command to clone a virtual disk on Oracle Database Appliance Kernel-based Virtual Machine (KVM).
- [odacli delete-vdisk](#)
Use the `odacli delete-vdisk` command to delete a virtual disk on Oracle Database Appliance Kernel-based Virtual Machine (KVM).

odacli create-vdisk

Use the `odacli create-vdisk` command to create a new virtual disk in a VM storage on Oracle Database Appliance Kernel-based Virtual Machine (KVM).

Syntax

```
odacli create-vdisk -n name -vms vmstorage_name -s size -sh -sp [-j] [-h]
```

Parameters

| Parameter | Description |
|--------------------------------|---|
| <code>--name, -n</code> | Name assigned to the virtual disk that is unique within the name repository |
| <code>--vmstorage, -vms</code> | Name of the VM storage where the virtual disk will be created |
| <code>--size, -s</code> | Amount of storage to be assigned from the shared repository to the shared disk. The default unit is G (for gigabytes) and the minimum size is 500 M (for megabytes). Format is K M G T |
| <code>--shareable, -sh</code> | (Optional) Sets the option of allowing the virtual disk to be shared by more than one virtual machine (<code>shared</code>) |
| <code>--sparse, -sp</code> | (Optional) Creates a sparse vdisk. Use the default option, non-sparse, to pre-allocate the full vdisk size in the vdisk image. Specify <code>sparse vdisk</code> with the <code>--sparse, -sp</code> option when you do not need to pre-allocate the vdisk size in the vdisk image. The image size can increase till it reaches the total current vdisk size. |

| Parameter | Description |
|-------------------------|---|
| <code>--json, -j</code> | (Optional) Displays output in JSON format. |
| <code>--help, -h</code> | (Optional) Displays help for using the command. |

Example

Create a 2 GB non-sparse and shareable Virtual Disk named `vdisk1` inside the VM storage `vms1`.

```
odacli create-vdisk -n vdisk1 -vms vms1 -s 2G -sh
```

odacli list-vdisks

Use the `odacli list-vdisks` command to list all virtual disks on Oracle Database Appliance Kernel-based Virtual Machine (KVM).

Syntax

```
odacli list-vdisks [-j] [-h]
```

Parameters

| Parameter | Description |
|-------------------------|---|
| <code>--json, -j</code> | (Optional) Displays output in JSON format. |
| <code>--help, -h</code> | (Optional) Displays help for using the command. |

Example

```
odacli list-vdisks
```

odacli describe-vdisk

Use the `odacli describe-vdisk` command to describe a virtual disk on Oracle Database Appliance Kernel-based Virtual Machine (KVM).

Syntax

```
odacli describe-vdisk -n name [-j] [-h]
```

Parameters

| Parameter | Description |
|-------------------------|---|
| <code>--name, -n</code> | Specifies the name of the virtual disk. |
| <code>--json, -j</code> | (Optional) Displays output in JSON format. |
| <code>--help, -h</code> | (Optional) Displays help for using the command. |

Example: Describing a Virtual Disk named `vdisk1`

```
odacli describe-vdisk -n vdisk1
```

odacli modify-vdisk

Use the `odacli modify-vdisk` command to modify a virtual disk on Oracle Database Appliance Kernel-based Virtual Machine (KVM).

Syntax

```
odacli modify-vdisk -n name -i [-no-s|-s] [-j] [-h]
```

Parameters

| Parameter | Description |
|------------------------------------|---|
| <code>--name, -n</code> | Specifies the virtual disk name |
| <code>--increment, -i</code> | Defines the size to increase the virtual disk. Format is <i>value units</i> , units are K M G T |
| <code>-no-shareable, --no-s</code> | (Optional) Set the Virtual Disk as non-shareable |
| <code>--shareable, -s</code> | (Optional) Set the Virtual Disk as shareable |
| <code>--json, -j</code> | (Optional) Displays output in JSON format. |
| <code>--help, -h</code> | (Optional) Displays help for using the command. |

Example

Increase the size of a virtual disk named `vdisk1` by 4 gigabytes.

```
# odacli modify-vdisk -n vdisk1 -i 4G
```

odacli clone-vdisk

Use the `odacli clone-vdisk` command to clone a virtual disk on Oracle Database Appliance Kernel-based Virtual Machine (KVM).

Syntax

```
odacli clone-vdisk -n name -cn clone_name [-j] [-h]
```

Parameters

| Parameter | Description |
|--------------------------------|---|
| <code>--name, -n</code> | Specifies the virtual disk name to be cloned |
| <code>--clone-name, -cn</code> | Specifies the name of the cloned virtual disk |
| <code>--json, -j</code> | (Optional) Displays output in JSON format. |
| <code>--help, -h</code> | (Optional) Displays help for using the command. |

Example

Create a clone of a virtual disk named `vdisk1`, with the name `vdisk1_clone`. The cloned disk is created on the same storage as `vdisk1`.

```
# odacli clone-vdisk -n vdisk1 -cn vdisk1_clone
```

odacli delete-vdisk

Use the `odacli delete-vdisk` command to delete a virtual disk on Oracle Database Appliance Kernel-based Virtual Machine (KVM).

Syntax

```
odacli delete-vdisk -n name [-f] [-j] [-h]
```

Parameters

| Parameter | Description |
|--------------------------|---|
| <code>--name, -n</code> | Specifies the virtual disk name to be deleted |
| <code>--force, -f</code> | (Optional) Specifies the force option |
| <code>--json, -j</code> | (Optional) Displays output in JSON format. |
| <code>--help, -h</code> | (Optional) Displays help for using the command. |

Example

Delete a virtual disk named `vdisk1`.

```
# odacli delete-vdisk -n vdisk1
```

odacli CPU Pool Commands for Bare Metal and KVM

Use `odacli` commands to manage resource allocations on Oracle Database Appliance for bare metal and KVM deployments.

CPU pools enable management of CPU resources in both bare metal and KVM environments. There are two types of CPU pools, that is, BM and VM.

Use the BM CPU pool to ensure that the database on a bare metal host runs exclusively on the CPUs specified in the CPU pool.

Use the VM CPU pools to cage and manage CPU resource allocations to workloads for virtual machines. Workloads are isolated by creating CPU pools and assigning or pinning virtual machines to a specific CPU pool. When you pin a virtual machine to a CPU pool, you ensure that the virtual machine uses CPUs in only that CPU pool.

Resources in CPU pools cannot overlap, that is, CPU pools cannot share CPUs.

- [odacli create-cpupool](#)
Use the `odacli create-cpupool` command to create a new CPU pool on Oracle Database Appliance Bare Metal or Kernel-based Virtual Machine (KVM) deployment.
- [odacli remap-cpupools](#)
Use the `odacli remap-cpupools` command to remap CPU pools to NUMA allocation on Oracle Database Appliance Bare Metal or Kernel-based Virtual Machine (KVM) deployment.
- [odacli list-cpupools](#)
Use the `odacli list-cpupools` command to list all CPU Pools on Oracle Database Appliance Bare Metal or Kernel-based Virtual Machine (KVM) deployment.

- [odacli describe-cpupool](#)
Use the `odacli describe-cpupool` command to describe CPU Pools on Oracle Database Appliance Bare Metal or Kernel-based Virtual Machine (KVM) deployment.
- [odacli modify-cpupool](#)
Use the `odacli modify-cpupool` command to modify a CPU Pool configuration on Oracle Database Appliance Bare Metal or Kernel-based Virtual Machine (KVM) deployment.
- [odacli delete-cpupool](#)
Use the `odacli delete-cpupool` command to delete a CPU Pool configuration on Oracle Database Appliance Kernel-based Virtual Machine (KVM).
- [odacli list-auditrecords](#)
Use the `odacli list-auditrecords` command to list the audit records for a CPU Pool on Oracle Database Appliance Bare Metal or Kernel-based Virtual Machine (KVM) deployment.
- [odacli describe-auditrecord](#)
Use the `odacli describe-auditrecord` command to describe the audit record for a CPU Pool on Oracle Database Appliance Bare Metal or Kernel-based Virtual Machine (KVM) deployment.

odacli create-cpupool

Use the `odacli create-cpupool` command to create a new CPU pool on Oracle Database Appliance Bare Metal or Kernel-based Virtual Machine (KVM) deployment.

Syntax

```
odacli create-cpupool -n name -c number_of_cores {-bm|-vm} [-nn node_name] [-s socket]
[-dbs] [-urc] [-j] [-h]
```

Parameters

| Parameter | Description |
|---|---|
| <code>--name, -n</code> | Specifies the CPU Pool name. |
| <code>--cores, -c</code> | Specifies the CPU Pool cores. |
| <code>--bm, -bm</code> | (Optional) Specifies the CPU Pool as Bare Metal. |
| <code>--vm, -vm</code> | (Optional) Specifies the CPU Pool as Virtual Machine. |
| <code>--dbsystem, -dbs</code> | (Optional) Specifies the CPU Pool type as DB System. |
| <code>--socket, -s</code> | (Optional) Specifies the socket to use. If not specified, then use all available sockets. |
| <code>--use-reserved-cores, -urc</code> | (Optional) Specifies to use reserved CPU cores. |
| <code>--node-name, -nn</code> | (Optional) Specifies the node where the CPU Pool will be created. On High-Availability deployment, if this option is not specified, then the CPU pool is created on both nodes. |
| <code>--json, -j</code> | (Optional) Displays output in JSON format. |
| <code>--help, -h</code> | (Optional) Displays help for using the command. |

Usage Notes

- Attach the BM CPU pool to databases. Bare metal CPU pools can be assigned to multiple databases.

- Attach VM CPU pool VM to guest machines. VM CPU pools can be assigned to multiple VMs.
- Attach dbsystem CPU pool to DB systems. dbsystem CPU pool can be assigned to multiple DB systems. After you create a dbsystem CPU pool, you can create a new DB system with this CPU pool by adding the new CPU pool parameter in the create-dbsystem json file, or modify-dbsystem to attach CPU pool to an existing DB system.
- Resources in CPU pools cannot overlap, that is, CPU pools cannot share CPUs.
- After you create a BM CPU pool, you can associate this CPU pool to a database using the create-database or modify-database command.
- After you create a VM CPU pool, you can associate this CPU pool to a VM using the create-vm or modify-vm command.
- Number of cores must be an even number between 2 and the total number of available cores on the system.
- By default, a CPU in the CPU pool is allocated across two sockets in release 19.12 and later. Optionally, you can choose to allocate the CPU based on the socket number (0 or 1). This is especially useful to support Standard Edition licensing. It is recommended that you use the default allocation and do not mix two types of allocation.
- By default, the first core of the socket is reserved and cannot be used by the VM and DB system CPU pools for optimal performance. Use the `--use-reserved-cores` option to enable use of the first core of socket for VM and DB system CPU pools.

Example

Create a BM CPU pool named `cpupool1` with 6 cores associated to it.

```
# odacli create-cpupool -n cpupool1 -c 6 -bm
```

Create a VM CPU pool named `cpupool2` with 6 cores associated to it.

```
# odacli create-cpupool -n cpupool2 -c 6 -vm
```

Create a DB System CPU pool named `cpupool3` with 6 cores associated to it.

```
# odacli create-cpupool -n cpupool3 -c 6 -dbs
```

Create a DB System CPU pool named `cpupool4` with 4 cores of CPUs allocated from socket 0.

```
# odacli create-cpupool -n cpupool4 -dbs -s 0 -c 4
```

odacli remap-cpupools

Use the `odacli remap-cpupools` command to remap CPU pools to NUMA allocation on Oracle Database Appliance Bare Metal or Kernel-based Virtual Machine (KVM) deployment.

Syntax

```
odacli remap-cpupools -f -urc [-j] [-h]
```

Parameters

| Parameter | Description |
|---------------------------------------|---|
| <code>--force, -f</code> | (Optional) Specifies to force the operation. |
| <code>--use-reserved-cores, -j</code> | (Optional) Specifies to use reserved CPU cores. |
| <code>--json, -j</code> | (Optional) Displays output in JSON format. |
| <code>--help, -h</code> | (Optional) Displays help for using the command. |

Usage Notes

If the `odacli remap-cpupools` command fails with the error `DCS-10001:Internal error encountered: Not enough physical CPUs available for CPU Pool 'cpupool_name' on node 'node_name'`, run the `odacli remap-cpupools` command again with the `--use_reserved-cores` option.

Use the `--force` option to remap CPU pools even if the CPU pool is marked as NUMA-enabled. You must use `odacli remap-cpupools` command, after updating the bare metal CPU cores with the command `odacli modify-cpucore`s for CPU core number changes.

By default, the first core of the socket is reserved and cannot be used by the VM and DB system CPU pools for optimal performance. Use the `--use-reserved-cores` option to enable use of the first core of socket for VM and DB system CPU pools.

Example

```
# odacli remap-cpupools
```

Related Topics

- [odacli modify-vm](#)
Use the `odacli modify-vm` command to modify a virtual machine on Oracle Database Appliance Kernel-based Virtual Machine (KVM).
- [odacli remap-cpupools](#)
Use the `odacli remap-cpupools` command to remap CPU pools to NUMA allocation on Oracle Database Appliance Bare Metal or Kernel-based Virtual Machine (KVM) deployment.
- [odacli modify-dbsystem](#)
Use the `odacli modify-dbsystem` command to modify a DB system on Oracle Database Appliance Kernel-based Virtual Machine (KVM).
- [odacli create-cpupool](#)
Use the `odacli create-cpupool` command to create a new CPU pool on Oracle Database Appliance Bare Metal or Kernel-based Virtual Machine (KVM) deployment.

odacli list-cpupools

Use the `odacli list-cpupools` command to list all CPU Pools on Oracle Database Appliance Bare Metal or Kernel-based Virtual Machine (KVM) deployment.

Syntax

```
odacli list-cpupools [-j] [-h]
```

Parameters

| Parameter | Description |
|------------|---|
| --json, -j | (Optional) Displays output in JSON format. |
| --help, -h | (Optional) Displays help for using the command. |

Example

```
# odacli list-cpupools
```

odacli describe-cpupool

Use the `odacli describe-cpupool` command to describe CPU Pools on Oracle Database Appliance Bare Metal or Kernel-based Virtual Machine (KVM) deployment.

Syntax

```
odacli describe-cpupool -n name [-j] [-h]
```

Parameters

| Parameter | Description |
|------------|---|
| --name, -n | Specifies the name of the CPU Pool. |
| --json, -j | (Optional) Displays output in JSON format. |
| --help, -h | (Optional) Displays help for using the command. |

Example: Describing a CPU pool named cpupool1

```
# odacli describe-cpupool -n cpupool1
```

odacli modify-cpupool

Use the `odacli modify-cpupool` command to modify a CPU Pool configuration on Oracle Database Appliance Bare Metal or Kernel-based Virtual Machine (KVM) deployment.

Syntax

```
odacli modify-cpupool -n name -c cores -f -l [-j] [-h]
```

Parameters

| Parameter | Description |
|-------------|---|
| --name, -n | Specifies the CPU Pool name |
| --cores, -c | Specifies the new number of CPU cores |
| --force, -f | (Optional) Forces the operation |
| --live, -l | (Optional) Applies the changes to running VMs |
| --json, -j | (Optional) Displays output in JSON format. |
| --help, -h | (Optional) Displays help for using the command. |

Usage Notes

For VM CPU pool, if `--live` is not specified, then the changes are applied to the VM configuration file and will be activated next time the VM is started. If `--live` is specified, then the changes will be applied to both VM configuration file and to the running VM.

Example

Set the size of a CPU Pool `cpupool1` to 10. If `--live` is not specified, the change is applied to the VM configuration file and will be activated next time the VM is started.

```
# odacli modify-cpupool -n cpupool1 -c 10
```

odacli delete-cpupool

Use the `odacli delete-cpupool` command to delete a CPU Pool configuration on Oracle Database Appliance Kernel-based Virtual Machine (KVM).

Syntax

```
odacli delete-cpupool -n name -f [-j] [-h]
```

Parameters

| Parameter | Description |
|--------------------------|---|
| <code>--name, -n</code> | Specifies the CPU Pool name to be deleted |
| <code>--force, -f</code> | (Optional) Forces deletion. |
| <code>--json, -j</code> | (Optional) Displays output in JSON format. |
| <code>--help, -h</code> | (Optional) Displays help for using the command. |

Example

Delete a CPU pool named `cpupool1`.

```
# odacli delete-cpupool -n cpupool1
```

odacli list-auditrecords

Use the `odacli list-auditrecords` command to list the audit records for a CPU Pool on Oracle Database Appliance Bare Metal or Kernel-based Virtual Machine (KVM) deployment.

Syntax

```
odacli list-auditrecords -du dcx-username -f from_date-range -l latest -nn node_name -ot operation_type -ou OS_username -rn resource_name -rt resource_type -t to_date-range [-j] [-h]
```

Parameters

| Parameter | Description |
|------------------------------|---|
| <code>--dcx-user, -du</code> | (Optional) Specifies the DCS user name. |
| <code>--from, -f</code> | (Optional) Specifies the <i>from</i> date in the date range for the CPU pool audit records. |

| Parameter | Description |
|------------------|---|
| --latest, -l | (Optional) Specifies the latest number of CPU pool audit records. |
| --node-name, -nn | (Optional) Specifies the node name. |
| --op-type, -ot | (Optional) Specifies the type of operation. |
| --os-user, -ou | (Optional) Specifies the operating system user. |
| --rsc-name, -rn | (Optional) Specifies the resource name. |
| --rsc-type, -rt | (Optional) Specifies the resource type. |
| --to, -t | (Optional) Specifies the <i>to</i> date in the date range for the CPU pool audit records. |
| --json, -j | (Optional) Displays output in JSON format. |
| --help, -h | (Optional) Displays help for using the command. |

Example

```
# odacli list-auditrecords
ID                               Resource type   Resource name
Operation type  DCS username   OS username    Timestamp
-----
41295d99-f263-4284-b6d9-2aff1ae0f850  BM_CPU_POOL    testbmpool
CREATE          oda-admin      root           2020-10-08 13:27:05 UTC
0f07a013-5bb4-4cd8-bd49-04dc61fcd454  BM_CPU_POOL    pool_9f74a8e9-
DELETE         oda-admin      root           2020-10-08 12:26:30 UTC
d858269b-6c28-4bc2-af71-79004f3561e6  BM_CPU_POOL    pool_9f74a8e9-
CREATE          oda-admin      root           2020-10-08 12:24:36 UTC
9d7852c1-93fb-410e-9e0c-8c0a95ed3f0c  VM_CPU_POOL    pool_d48e81e4-
DELETE         oda-admin      root           2020-10-08 12:06:45 UTC
0235cc84-9345-40bc-ac4f-7de3f63202e2  VM_CPU_POOL    pool_4fe0b4f4-
DELETE         oda-admin      root           2020-10-08 12:06:45 UTC
762f7263-7bd9-4b12-b891-48305165bf36  VM_CPU_POOL    pool_4fe0b4f4-
MODIFY         oda-admin      root           2020-10-08 12:06:22 UTC
0bd2a25d-2327-4918-bd47-8c00f7406f92  VM_CPU_POOL    pool_4fe0b4f4-
MODIFY
```

odacli describe-auditrecord

Use the `odacli describe-auditrecord` command to describe the audit record for a CPU Pool on Oracle Database Appliance Bare Metal or Kernel-based Virtual Machine (KVM) deployment.

Syntax

```
odacli describe-auditrecord -i [-j] [-h]
```

Parameters

| Parameter | Description |
|------------|---|
| --id, -i | Describes the ID of the audit record. |
| --json, -j | (Optional) Displays output in JSON format. |
| --help, -h | (Optional) Displays help for using the command. |

Example

```
# odacli describe-auditrecord -i 41295d99-f263-4284-b6d9-2aff1ae0f850
Audit Record details
```

```
-----
Event details
-----
      Record ID: 41295d99-f263-4284-b6d9-2aff1ae0f850
Record timestamp: 2020-10-08 13:27:05 UTC
      DCS username: oda-admin
      OS username: root
      Cluster ID: test_cluster-c
      Node ID: test_cluster

Resource/Operation
-----
      Resource type: BM_CPU_POOL
      Resource ID: b17cb623-bf79-491f-86d8-d8502987e26c
      Resource name: testbmpool
      Operation type: CREATE
      Operation description: Created with '2' cores and allocation
'test_cluster:1-2,17-18'
```

odacli VM Network Commands for KVM

Use the `odacli` virtual machine network commands to manage network on Oracle Database Appliance for Oracle KVM.

- [odacli create-vnetwork](#)
Use the `odacli create-vnetwork` command to create a new network on Oracle Database Appliance Kernel-based Virtual Machine (KVM).
- [odacli list-vnetworks](#)
Use the `odacli list-vnetworks` command to list all virtual networks on Oracle Database Appliance Kernel-based Virtual Machine (KVM).
- [odacli describe-vnetwork](#)
Use the `odacli describe-vnetwork` command to describe virtual networks on Oracle Database Appliance Kernel-based Virtual Machine (KVM).
- [odacli start-vnetwork](#)
Use the `odacli start-vnetwork` command to start a virtual network on Oracle Database Appliance Kernel-based Virtual Machine (KVM).
- [odacli stop-vnetwork](#)
Use the `odacli stop-vnetwork` command to stop a virtual network on Oracle Database Appliance Kernel-based Virtual Machine (KVM).
- [odacli modify-vnetwork](#)
Use the `odacli modify-vnetwork` command to modify a network on Oracle Database Appliance Kernel-based Virtual Machine (KVM).
- [odacli delete-vnetwork](#)
Use the `odacli delete-vnetwork` command to delete a virtual network configuration on Oracle Database Appliance Kernel-based Virtual Machine (KVM).

odacli create-vnetwork

Use the `odacli create-vnetwork` command to create a new network on Oracle Database Appliance Kernel-based Virtual Machine (KVM).

Syntax

```
odacli create-vnetwork -n name -if interface-name -t type -br bridge -g gateway -ip IP-address -nm netmask -u uniform -vlan VLAN-network ID [-j] [-h]
```

Parameters

| Parameter | Description |
|------------------------------------|--|
| <code>--name, -n</code> | Specifies the virtual network name. |
| <code>--interface-name, -if</code> | Specifies the the network interface on the host. This can be physical interface or bonded interface. |
| <code>--type, -t</code> | Specifies the virtual network type. Values are bridged or bridged-vlan. |
| <code>--bridge, -br</code> | (Optional) Specifies the name of the bridge. |
| <code>--gateway, -gw</code> | (Optional) Specifies the virtual network gateway |
| <code>--ip, -ip</code> | (Optional) Specifies the virtual network addresses. For more than one address, use the format " <i>node0_ip,node1_ip,...</i> " |
| <code>--netmask, -nm</code> | (Optional) Specifies the virtual network netmask |
| <code>--uniform, -u</code> | (Optional) Specifies whether the virtual network is created on both nodes in a high-availability deployment |
| <code>--vlan-id, -vlan</code> | (Optional) Specifies the VLAN network ID |
| <code>--json, -j</code> | (Optional) Displays output in JSON format. |
| <code>--help, -h</code> | (Optional) Displays help for using the command. |

Usage Notes

If you did not specify the IP address, or netmask, or gateway during vnetwork creation, then you can add them later using the `odacli modify-vnetwork` command.

Example

Create a VM network of type `bridged` using the interface `btbond2`.

```
# odacli create-vnetwork -n vnet1 -if btbond2 -type bridged
```

odacli list-vnetworks

Use the `odacli list-vnetworks` command to list all virtual networks on Oracle Database Appliance Kernel-based Virtual Machine (KVM).

Syntax

```
odacli list-vnetworks [-j] [-h]
```

Parameters

| Parameter | Description |
|------------|---|
| --json, -j | (Optional) Displays output in JSON format. |
| --help, -h | (Optional) Displays help for using the command. |

Example

```
# odacli list-vnetworks
```

odacli describe-vnetwork

Use the `odacli describe-vnetwork` command to describe virtual networks on Oracle Database Appliance Kernel-based Virtual Machine (KVM).

Syntax

```
odacli describe-vnetwork -n [-j] [-h]
```

Parameters

| Parameter | Description |
|------------|---|
| --name, -n | Specifies the name of the virtual network. |
| --json, -j | (Optional) Displays output in JSON format. |
| --help, -h | (Optional) Displays help for using the command. |

Example: Describing a VM Network named `vnet1`

```
# odacli describe-vnetwork -n vnet1
```

odacli start-vnetwork

Use the `odacli start-vnetwork` command to start a virtual network on Oracle Database Appliance Kernel-based Virtual Machine (KVM).

Syntax

```
odacli start-vnetwork -n name [-j] [-h]
```

Parameters

| Parameter | Description |
|------------|--|
| --name, -n | Specifies the virtual machine name to be stopped |
| --json, -j | (Optional) Displays output in JSON format. |
| --help, -h | (Optional) Displays help for using the command. |

Example

Start a virtual network named `vnet1`.

```
# odacli start-vnetwork -n vnet1
```

odacli stop-vnetwork

Use the `odacli stop-vnetwork` command to stop a virtual network on Oracle Database Appliance Kernel-based Virtual Machine (KVM).

Syntax

```
odacli stop-vnetwork -n name [-j] [-h]
```

Parameters

| Parameter | Description |
|-------------------------|---|
| <code>--name, -n</code> | Specifies the virtual network to be stopped |
| <code>--json, -j</code> | (Optional) Displays output in JSON format. |
| <code>--help, -h</code> | (Optional) Displays help for using the command. |

Example

Stop a virtual network named `vnet1`.

```
# odacli stop-vnetwork -n vnet1
```

odacli modify-vnetwork

Use the `odacli modify-vnetwork` command to modify a network on Oracle Database Appliance Kernel-based Virtual Machine (KVM).

Syntax

```
odacli modify-vnetwork -n name -if -t -br -gw -ip -nm -u -vlan [-j] [-h]
```

Parameters

| Parameter | Description |
|-----------------------------|--|
| <code>--name, -n</code> | Specifies the virtual network name. |
| <code>--gateway, -gw</code> | (Optional) Specifies the virtual network gateway |
| <code>--ip, -ip</code> | (Optional) Specifies the virtual network addresses. For more than one address, use the format " <code>node0_ip,node1_ip,...</code> ". Specify the value as <code>none</code> to remove the IP address. |
| <code>--netmask, -nm</code> | (Optional) Specifies the virtual network netmask |
| <code>--json, -j</code> | (Optional) Displays output in JSON format. |
| <code>--help, -h</code> | (Optional) Displays help for using the command. |

Example

Modify a VM network to specify the gateway.

```
# odacli modify-vnetwork -n vnet1 -g 10.11.44.41
```

odacli delete-vnetwork

Use the `odacli delete-vnetwork` command to delete a virtual network configuration on Oracle Database Appliance Kernel-based Virtual Machine (KVM).

Syntax

```
odacli delete-vnetwork -n name [-j] [-h]
```

Parameters

| Parameter | Description |
|-------------------------|---|
| <code>--name, -n</code> | Specifies the vnetwork name to be deleted |
| <code>--json, -j</code> | (Optional) Displays output in JSON format. |
| <code>--help, -h</code> | (Optional) Displays help for using the command. |

Example

Delete a VM network named `vnet1`.

```
# odacli delete-vnetwork -n vnet1
```

odacli Virtual Machine Commands for Oracle KVM

Use the `odacli` virtual machine commands to manage virtual machines on Oracle Database Appliance for Oracle KVM.

- [odacli create-vm](#)
Use the `odacli create-vm` command to create a new virtual machine on Oracle Database Appliance Kernel-based Virtual Machine (KVM).
- [odacli list-vm](#)
Use the `odacli list-vm` command to list all virtual machines on Oracle Database Appliance Kernel-based Virtual Machine (KVM).
- [odacli describe-vm](#)
Use the `odacli describe-vm` command to describe a virtual machine on Oracle Database Appliance Kernel-based Virtual Machine (KVM).
- [odacli modify-vm](#)
Use the `odacli modify-vm` command to modify a virtual machine on Oracle Database Appliance Kernel-based Virtual Machine (KVM).
- [odacli start-vm](#)
Use the `odacli start-vm` command to start a virtual machine on Oracle Database Appliance Kernel-based Virtual Machine (KVM).
- [odacli stop-vm](#)
Use the `odacli stop-vm` command to stop a virtual machine on Oracle Database Appliance Kernel-based Virtual Machine (KVM).
- [odacli migrate-vm](#)
Use the `odacli migrate-vm` command to migrate a virtual machine on Oracle Database Appliance Kernel-based Virtual Machine (KVM).

- [odacli clone-vm](#)
Use the `odacli clone-vm` command to clone a virtual machine configuration on Oracle Database Appliance Kernel-based Virtual Machine (KVM).
- [odacli delete-vm](#)
Use the `odacli delete-vm` command to delete a virtual machine configuration on Oracle Database Appliance Kernel-based Virtual Machine (KVM).

odacli create-vm

Use the `odacli create-vm` command to create a new virtual machine on Oracle Database Appliance Kernel-based Virtual Machine (KVM).

Syntax

```
odacli create-vm -n name -m memory -bo boot_options -src source -vc vcpus -vms
vmstorage -cp cpupool -d description -g graphics
-mm max-mem-size -mvc max-vcpu-count -osv os_variant -pn preferred_node -s disk_size -vd
vdisks
-vn virtual_network_names -ea extra_args -esrc extra_srcs [-j] [-h]
```

Parameters

| Parameter | Description |
|---------------------|---|
| --name, -n | Specifies the VM name |
| --memory, -m | Specifies the size of the VM memory. The format is "value_unit". Unit is M G. |
| --source, -src | Specifies the source installation. If local, it can be an ISO or a bootable disk image. If remote, it can be an URI pointing to an install tree hosted remotely over HTTP, HTTPS, or FTP. |
| --vcpus, -vc | Specifies the number of vCPUs to use. |
| --vmstorage, -vms | Specifies the VM storage name. |
| --boot-options, -bo | Specifies the VM boot options. |
| --cpupool, -cp | (Optional) Specifies the CPU pool name |
| --extra-srcs, -esrc | (Optional) Specifies the extra sources for the guest VM that are mounted as CDROM devices |
| --description, -d | (Optional) Specifies the VM description |
| --extra-args, -ea | (Optional) Specifies the extra arguments for the VM installer. |
| --graphics, -g | (Optional) Specifies the graphics settings for the VM |
| --max-memory, -mm | (Optional) Specifies the maximum size of the VM memory. The format is "value_unit". Unit is M G. |
| --max-vcpus, -mvc | (Optional) Specifies the maximum number of VCPUs |
| --os-variant, -osv | (Optional) Specifies the operating system variant. Use the command <code>osinfo-query os</code> to get the list of the accepted OS variants. |
| --pref-node, -pn | (Optional) Specifies the preferred node to run the VM |
| --size, -s | (Optional) Specifies the size of the VM. The format is "value_unit". Unit is K M G T. |
| --vdisks, -vd | (Optional) Specifies the names of the vdisks to use |
| --vnetworks, -vn | (Optional) Specifies the names of the virtual networks to use |
| --json, -j | (Optional) Displays output in JSON format. |

| Parameter | Description |
|-------------------------|---|
| <code>--help, -h</code> | (Optional) Displays help for using the command. |

Usage Notes

- Use the `--extra-args` parameter to add kickstart configuration file, kernel parameters for example, serial console. For example: `--extra-args "console=tty0 console=ttyS0,115200 ks=http://192.168.122.100:80/ks.txt"`

Example

Create a VM named `vm1` with 8 vcpus and 8 GB memory. The VM is stored in the VM Storage `vms1`. The source used for the installation is located on `/u01/OL7.iso`.

```
# odacli create-vm -n vm1 -vc 8 -m 8G -vms vs1 -src /u01/OL7.iso
```

Example

If the installation source is located through network, the network configuration of the VM must be provided by `--extra-args` so that the network can be setup at the bootstrap of the VM, to reach the installation source over the network. For example, to create a VM from source `https://example.com/iso/OracleLinux/OL7/u9/x86_64/OracleLinux-R7-U9-Server-x86_64-dvd/`:

```
# odacli create-vm -vn pubnet -m 4G -vc 8 -src https://example.com/iso/OracleLinux/OL7/u9/x86_64/OracleLinux-R7-U9-Server-x86_64-dvd/ -vd vmstorage_vdisk2 -vms vmstore -g vnc,listen=0.0.0.0,port=5949 -n vm1 -s 20G --extra-args "dns=<dns_server_ip_addr> ip=<vm1_ip_addr>:<gateway_ip>:<netmask>:<vm1_hostname>:ens3:none"
```

odacli list-vms

Use the `odacli list-vms` command to list all virtual machines on Oracle Database Appliance Kernel-based Virtual Machine (KVM).

Syntax

```
odacli list-vms [-j] [-h]
```

Parameters

| Parameter | Description |
|-------------------------|---|
| <code>--json, -j</code> | (Optional) Displays output in JSON format. |
| <code>--help, -h</code> | (Optional) Displays help for using the command. |

Example

```
# odacli list-vms
```

odacli describe-vm

Use the `odacli describe-vm` command to describe a virtual machine on Oracle Database Appliance Kernel-based Virtual Machine (KVM).

Syntax

```
odacli describe-vm -n name [-j] [-h]
```

Parameters

| Parameter | Description |
|-------------------------|---|
| <code>--name, -n</code> | Specifies the name of the virtual machine. |
| <code>--json, -j</code> | (Optional) Displays output in JSON format. |
| <code>--help, -h</code> | (Optional) Displays help for using the command. |

Example: Describing a Virtual Machine named `vm1`

```
# odacli describe-vm -n vm1
```

odacli modify-vm

Use the `odacli modify-vm` command to modify a virtual machine on Oracle Database Appliance Kernel-based Virtual Machine (KVM).

Syntax

```
odacli modify-vm -n name -as -en -bo boot_options -cfg -avd attach_vdisks -avn attach_vnetworks -dev device -d description -dn -dvd detach-vdisk -dvn detach-vnetworks -mm max-memory -mvc max-vcpus -m memory -no-cp -pn preferred-node -vc vcpu_count -di disk-increment -en -fo -g graphics -l -no-as [-f] [-g] [-j] [-h]
```

Parameters

| Parameter | Description |
|-------------------------------------|--|
| <code>--name, -n</code> | Specifies the VM name |
| <code>--autostart, -as</code> | (Optional) Specifies if the auto-start option must be set for the VM |
| <code>--no-autostart, -no-as</code> | (Optional) Disables the auto-start option for the VM |
| <code>--boot-options, -bo</code> | (Optional) Specifies the boot options to use |
| <code>--config, -cfg</code> | (Optional) Specifies whether the changes persist. |
| <code>--live, -l</code> | (Optional) Indicates whether the specified changes take place live (true) or after the next boot (false). Default is false |
| <code>--enable-numa, -en</code> | (Optional) Enables NUMA configuration for the VM. |
| <code>--disable-numa, -dn</code> | (Optional) Disables NUMA configuration for the VM. |
| <code>--cpu-pool, -cp</code> | (Optional) Specifies the CPU pool name |
| <code>--description, -d</code> | (Optional) Specifies the VM description |
| <code>--failover, -fo</code> | (Optional) Specifies the configuration for the failover |
| <code>--no-failover, -no-fo</code> | (Optional) Specifies the configuration for the failover |

| Parameter | Description |
|--------------------------|--|
| --vcpus, -vc | (Optional) Specifies the number of vCPUs. |
| --memory, -m | (Optional) Specifies the memory size of the VM. The format is "value_unit". Unit is M G. |
| --max-memory, -mm | (Optional) Specifies the maximum memory size of the VM. The format is "value_unit". Unit is M G. |
| --max-vcpus, -mvc | (Optional) Specifies the maximum number of vCPUs. |
| --no-cpupool, -no-cp | (Optional) Dissociates the associated CPU Pool |
| --detach-vdisk, -dvd | (Optional) Specifies the names of the virtual disks to detach |
| --detach-vnetworks, -dvn | (Optional) Specifies the names of the virtual networks to detach |
| --pref-node, -pn | (Optional) Specifies the preferred node to run the VM |
| --disk-increment, -di | Specifies the change in size of the VM. The format is "value_unit". Unit is K M G T. |
| --attach-vdisks, -avd | (Optional) Specifies the names of the vdisks to attach |
| --attach-vnetworks, -avn | (Optional) Specifies the names of the virtual networks to attach |
| --device, -dev | (Optional) Modifies the device as specified in the expression: Where device_expression = [vdisk=vdisk_name,] [bus=bus_type,][target=target_device] vdisk_name: If specified, must refer to an attached vDisk name. Otherwise it refers to the VM image. bus_type: The value can be ide, virtio, scsci, fdc, xen, usb, sata or sd. target_device: Must be a device name compatible with the bus_type. For example: vda, hda, sda. |
| --force, -f | (Optional) Specifies to force the operation. |
| --graphics, -g | (Optional) Defines the graphics settings for the VM. The supported graphics setting is VNC. For example, vnc,listen=127.0.0.1,port=5901. |
| --json, -j | (Optional) Displays output in JSON format. |
| --help, -h | (Optional) Displays help for using the command. |

Usage Tips

- **--live:** The change is applied to the running VM instance, but does not persist after the VM stops.
- **--enable-numa:** Use this option to enable NUMA for an existing VM.
- **--config:** The change persists in the configuration of VM instance and takes effect on subsequent reboots.
- If neither **--live** or **--config** is specified, then the default behavior is **--config**.
- You can specify both the **--live** or **--config** options if you want the modification to take effect immediately and on subsequent boots.
- When an application VM is created, a default network interface is created by default in the VM. This interface is attached to the default kvm bridge (virbr0) at the host. This interface is intended for convenient communication between the host and VM. This interface does not attach to any physical network interface at the host. Do not configure this interface to use for any external communication.

- You must create a vnetwork using the command `odacli create-vnetwork` and attach the vnetwork (`odacli modify-vm -avn`) to the VM. This creates a second interface in the VM. Configure this network interface for your network requirement.
- The network interface name in the VM depends on the operating system.

Modifying CPU Count and Memory for a VM

Update the configuration of a VM named `vm1`, setting the CPU count to 6 and the maximum memory to 6 gigabytes on both the running VM and subsequent boots.

```
# odacli modify-vm -n vm1 -vc 6 -mm 6G --live --config
```

Enabling NUMA

Use `--enable-numa` to enable NUMA for the VM configuration. The command `odacli modify-dbsystem --enable-numa` is only supported on application VMs with even number of CPU cores so that CPU cores can be evenly distributed to NUMA nodes. In Oracle Database Appliance, one CPUcore is equal to 2 vCPU. For more information, see *About Enabling NUMA on Oracle Database Appliance*.

```
# odacli modify-vm --name name --enable-numa
```

Modifying a VM to attach a vnetwork

Modify a VM to attach a vnetwork:

```
# odacli modify-vm -n vm_name -avn vnetwork_name
```

Modifying a VM to change the bus type for the VM image

Modify the bus type for the VM image from `virtio` to `sata`. This is useful when the VM image does not support the `virtio` driver, for example, a Windows VM without `virtio` driver installed:

```
# odacli modify-vm -dev "bus=sata" -n winvm
```

Modifying a VM to change the bus type for a specific vdisk attached to the VM

To modify the bus type for a specific vdisk attached to the VM, run the following command:

```
# odacli modify-vm -dev "vdisk=vdisk_name, bus=sata" -n winvm
```

The command changes the `winvm` bus type of `vdisk_name` to `sata`. If you do not specify the `vdisk` parameter, the command changes the bus type to the vdisk that holds the VM image.

Related Topics

- [odacli remap-cpupools](#)
Use the `odacli remap-cpupools` command to remap CPU pools to NUMA allocation on Oracle Database Appliance Bare Metal or Kernel-based Virtual Machine (KVM) deployment.
- [odacli modify-dbsystem](#)
Use the `odacli modify-dbsystem` command to modify a DB system on Oracle Database Appliance Kernel-based Virtual Machine (KVM).

- [odacli create-cpupool](#)
Use the `odacli create-cpupool` command to create a new CPU pool on Oracle Database Appliance Bare Metal or Kernel-based Virtual Machine (KVM) deployment.

odacli start-vm

Use the `odacli start-vm` command to start a virtual machine on Oracle Database Appliance Kernel-based Virtual Machine (KVM).

Syntax

```
odacli start-vm -n name -nn [-j] [-h]
```

Parameters

| Parameter | Description |
|-------------------------------|--|
| <code>--name, -n</code> | Specifies the virtual machine name to be stopped |
| <code>--node-name, -nn</code> | (Optional) Specifies the node name where the virtual machine will be started |
| <code>--json, -j</code> | (Optional) Displays output in JSON format. |
| <code>--help, -h</code> | (Optional) Displays help for using the command. |

Usage Notes

- If `pref-node` is defined for the VM, then the VM starts on the `pref-node`. If `pref-node` is not defined for the VM, then the VM can start on any node, in a high-availability deployment.
- If you specify the node name `-n`, then the VM starts on the specified node, even if the preferred node is defined.

Example

Start a virtual machine named `vm1`.

```
# odacli start-vm -n vm1
```

odacli stop-vm

Use the `odacli stop-vm` command to stop a virtual machine on Oracle Database Appliance Kernel-based Virtual Machine (KVM).

Syntax

```
odacli stop-vm -n name [-f] [-j] [-h]
```

Parameters

| Parameter | Description |
|--------------------------|--|
| <code>--name, -n</code> | Specifies the virtual machine name to be stopped |
| <code>--force, -f</code> | (Optional) Specifies the force option |
| <code>--json, -j</code> | (Optional) Displays output in JSON format. |
| <code>--help, -h</code> | (Optional) Displays help for using the command. |

Example

Stop a virtual machine named `vm1`.

```
# odacli stop-vm -n vm1
```

odacli migrate-vm

Use the `odacli migrate-vm` command to migrate a virtual machine on Oracle Database Appliance Kernel-based Virtual Machine (KVM).

Syntax

```
odacli migrate-vm -n name -th node_name [-j] [-h]
```

Parameters

| Parameter | Description |
|---------------------------------|--|
| <code>--name, -n</code> | Specifies the virtual machine name to be migrated. |
| <code>--target-node, -th</code> | Specifies the destination node name. |
| <code>--json, -j</code> | (Optional) Displays output in JSON format. |
| <code>--help, -h</code> | (Optional) Displays help for using the command. |

Example

Migrate a virtual machine named `vm1` to node named `oda1`.

```
odacli migrate-vm -n vm1 -th oda1
```

odacli clone-vm

Use the `odacli clone-vm` command to clone a virtual machine configuration on Oracle Database Appliance Kernel-based Virtual Machine (KVM).

Syntax

```
# odacli clone-vm -n name_of_vm_to_clone_from -cn clone_name [-j] [-h]
```

Parameters

| Parameter | Description |
|--------------------------------|---|
| <code>--name, -n</code> | Specifies the virtual machine name to be cloned |
| <code>--clone-name, -cn</code> | Specifies the name of the cloned virtual machine |
| <code>--description, -d</code> | (Optional) Specifies the description of the virtual machine |
| <code>--json, -j</code> | (Optional) Displays output in JSON format. |
| <code>--help, -h</code> | (Optional) Displays help for using the command. |

Example

Create a clone of a virtual machine named `vm1`, with the name `vm1_clone`. The cloned VM is created on the same storage as `vm1`.

```
# odacli clone-vm -n vm1 -cn vm1_clone
```

odacli delete-vm

Use the `odacli delete-vm` command to delete a virtual machine configuration on Oracle Database Appliance Kernel-based Virtual Machine (KVM).

Syntax

```
odacli delete-vm -n name [-f] [-j] [-h]
```

Parameters

| Parameter | Description |
|--------------------------|--|
| <code>--name, -n</code> | Specifies the virtual machine name to be deleted |
| <code>--force, -f</code> | (Optional) Specifies the force option |
| <code>--json, -j</code> | (Optional) Displays output in JSON format. |
| <code>--help, -h</code> | (Optional) Displays help for using the command. |

Example

Delete a virtual machine named `vm1`.

```
odacli delete-vm -n vm1
```

Configuring and Using Oracle Auto Service Request (Oracle ASR)

Configure and use Oracle ASR to automatically generate a service request for specific hardware faults.

- [About Configuring Oracle ASR](#)
Configure Oracle Auto Service Request (Oracle ASR) to automatically generate service requests for specific hardware faults.
- [Configuring Internal Oracle ASR](#)
Use ODACLI commands or the Browser User Interface (BUI) to configure Oracle Auto Service Request (Oracle ASR) in Oracle Database Appliance.
- [Registering with External Oracle ASR Manager](#)
Use ODACLI commands or the Browser User Interface to register Oracle Database Appliance with an external Oracle Auto Service Request (Oracle ASR) Manager.
- [Configuring External Oracle ASR When Oracle ASR Manager Does Not Run on an Oracle Database Appliance](#)
Understand how you can configure Oracle Database Appliance with an external Oracle Auto Service Request (Oracle ASR) Manager.
- [Testing Oracle ASR](#)
Use the `odaccli test-asr` command to confirm that your Oracle ASR configuration is working.
- [Managing an Oracle ASR Configuration](#)
Use the command-line to review an existing configuration, make changes to a configuration, or delete a configuration.
- [Additional Resources for Oracle ASR](#)
Refer to these sections for more information about Oracle ASR.

About Configuring Oracle ASR

Configure Oracle Auto Service Request (Oracle ASR) to automatically generate service requests for specific hardware faults.

Oracle ASR is a secure support feature that can improve system availability through expedited diagnostics and priority service request handling. You can configure Oracle ASR on Oracle Database Appliance to use its own Oracle ASR Manager (**internal Oracle ASR**) or use Oracle ASR Manager configured on another server in the same network as your appliance (**external Oracle ASR**).

Oracle Database Appliance supports two types of Oracle ASR configurations - Internal and External. You can use the `odaccli configure-asr` command to configure both types of Oracle ASR.

- **Internal Oracle ASR:** For this type of configuration, Oracle ASR Manager is installed on the Oracle Database Appliance, where assets need to be monitored. For this type of configuration, Oracle ASR Manager is installed on the Oracle Database Appliance, where

assets need to be monitored. The assets Oracle ILOM and the host are registered with Oracle ASR using an XML payload that is sent to the HTTPS endpoint of Oracle ASR Manager. After successful registration, the alerts are also sent from the assets to the Oracle ASR Manager by composing an XML payload. Once the XML file is sent, an SR is generated based on the alert information present in the XML file.

- **External Oracle ASR:** For this type of configuration, Oracle ASR Manager is not installed on one Oracle Database Appliance. For example, if Oracle ASR manager is not installed on `oda1`, but Oracle ASR Manager is installed on another Oracle Database Appliance, `oda2`, then the assets that belong to `oda2` assets are registered with Oracle ASR Manager installed on `oda1`. To register Oracle Database Appliance assets with an external Oracle ASR Manager, you must first update the repository with Oracle ASR Manager configuration files. After that, configure Oracle ASR as external to register the assets with Oracle ASR Manager.

 **Note:**

With an internal Oracle ASR Manager, an alert is not sent when the server is not running because the Oracle ASR Manager runs on the same server. However, if a critical event occurs on Oracle Database Appliance with an external Oracle ASR Manager, then an alert can still be generated since the Oracle ASR Manager is not running on the same host.

You can configure Oracle ASR as part of deploying the appliance, or you can use the Browser User Interface (BUI) or command-line interface to configure or edit an Oracle ASR after deployment.

Starting with Oracle Database Appliance release 19.21, when you configure Oracle ASR, you specify HTTPS settings and not the SNMP settings. Following are the requirements to configure Oracle ASR:

- Oracle Database Appliance hardware must be associated with a Support Identifier (SI) in My Oracle Support.
- If a proxy server is required for Internet access to Oracle, then you must also provide the name of the proxy server.
- To configure an internal Oracle ASR Manager, you need a My Oracle Support account user name (e-mail address) and password associated with the My Oracle Support account under which the server is registered.
- To register with an external Oracle ASR Manager, use zip file generated by the `odacli export-asrconfig` command when it is run on the appliance where Oracle ASR Manager runs.

Related Topics

- [Configuring Internal Oracle ASR](#)
Use ODA CLI commands or the Browser User Interface (BUI) to configure Oracle Auto Service Request (Oracle ASR) in Oracle Database Appliance.
- [Configuring External Oracle ASR](#)
Use ODA CLI commands or the Browser User Interface to register Oracle Database Appliance with an external Oracle Auto Service Request (Oracle ASR) Manager.
- [odacli configure-asr](#)
Use the `odacli configure-asr` command to configure Oracle Auto Service Request (Oracle ASR) after deploying the appliance.

Configuring Internal Oracle ASR

Use ODACLI commands or the Browser User Interface (BUI) to configure Oracle Auto Service Request (Oracle ASR) in Oracle Database Appliance.

You can register with an internal Oracle ASR Manager at any time, or modify an existing registration. Before configuring, verify that the Oracle Database Appliance hardware is associated with a Support Identifier (SI) in My Oracle Support.

You need the following information to configure Oracle ASR:

- The e-mail address associated with the My Oracle Support account under which the server is registered
- The password associated with the My Oracle Support account under which the server is registered
- If a proxy server is required for Internet access to Oracle, then you must also provide the name of the proxy server

Configuring Internal ASR Using ODACLI Commands

Use the `odacli configure-asr` command to configure Oracle ASR after deploying the appliance.

```
# odacli configure-asr -u user@example.com -hp 16165
```

```
Enter ASR user's password:
Retype ASR user's password:
```

```
Job details
```

```
-----
ID: 1c9f126e-f5d2-4178-9d59-1343314b86ee
Description: Configure ASR
Status: Success
Created: November 29, 2023 4:42:07 PM UTC
Message:
```

```
Task Name                               Start
Time                                     End Time
Status
-----
-----
Setting up SSH equivalence                November 29, 2023 4:42:07 PM
UTC November 29, 2023 4:42:07 PM UTC      Success
Modify JavaExec Path                     November 29, 2023 4:42:08 PM
UTC November 29, 2023 4:42:08 PM UTC      Success
Install ASR                              November 29, 2023 4:42:08 PM
UTC November 29, 2023 4:44:53 PM UTC      Success
Registering ASR Manager                  November 29, 2023 4:45:01 PM
UTC November 29, 2023 4:45:09 PM UTC      Success
Configure ILOM                           November 29, 2023 4:45:09 PM
UTC November 29, 2023 4:45:13 PM UTC      Success
Creating ASR configuration folders        November 29, 2023 4:45:13 PM
UTC November 29, 2023 4:45:13 PM UTC      Success
Setup ASR XML templates                  November 29, 2023 4:45:13 PM
```

```

UTC          November 29, 2023 4:45:13 PM UTC          Success
Enable HTTPS for ASR                               November 29, 2023 4:45:13 PM
UTC          November 29, 2023 4:45:36 PM UTC          Success
Importing ASR certificate into DCS                  November 29, 2023 4:45:36 PM
UTC          November 29, 2023 4:45:38 PM UTC          Success
truststore

Registering Asset: ODA Host                          November 29, 2023 4:45:38 PM
UTC          November 29, 2023 4:45:38 PM UTC          Success
ASR assets activation                              November 29, 2023 4:45:39 PM
UTC          November 29, 2023 4:45:40 PM UTC          Success
Remove AsrConfBackup File                          November 29, 2023 4:45:41 PM
UTC          November 29, 2023 4:45:41 PM UTC          Success

```

After configuring Oracle ASR, check the the asset status for both the host and the Oracle ILOM asset as follows:

```

# /opt/asrmanager/bin/asr list_asset
IP_ADDRESS HOST_NAME SERIAL_NUMBER PARENT_SERIAL ASR ASR_STATUS PROTOCOL
SOURCE LAST_HEARTBEAT PRODUCT_NAME
-----
-----
2213XLA00E oda1-ilom 2213XLA00E Y Active HTTP ILOM_XML 2023-11-30
06:36:11.472 ORACLE SERVER X8-2L
10.133.48.239 oda1 2213XLA00E Y Active HTTP ESSW_XML NA ORACLE SERVER X8-2L

```

Please use My Oracle Support 'http://support.oracle.com' to view the activation status.

To view the latest available asset status in ASR Manager please execute the 'send_asset_status' command.

Configuring Internal ASR Using the BUI

1. Open a browser and enter the following URL to access BUI:

```
https://ip-address:7093/mgmt/index.html
```

2. Login as oda-admin.
3. Click the **Appliance** tab.
4. Click the Oracle ASR menu.
5. If Oracle ASR is already configured, then in the Configure ASR page, provide the Oracle ASR configuration values.
6. Select **Internal** in the **ASR Type** field.
7. In the **ASR User Name** field, enter e-mail address associated with the My Oracle Support account under which the server is registered.
8. In the **ASR Password** field, enter the password associated with the My Oracle Support account under which the server is registered.
9. (Optional) Specify the HTTPS port for the Oracle ASR Manager. The default HTTPS port is 16162.
10. (Optional) If you are using an HTTP Proxy for upload to Oracle ASR, complete the following:
 - a. **HTTP Proxy used for Upload to ASR:** Select **Yes**.

- b. **Proxy User Name:** If you are using a proxy for upload, enter the proxy user name.
- c. **Proxy Port:** If you are using a proxy for upload, enter the proxy port.
- d. **(Optional) HTTP Proxy Requires Authentication:** If you are using a proxy for upload, select **Yes** if you require authentication. If you do not require authentication, select **No**.
- e. **(Optional) Proxy Password:** If you are using a proxy for upload and require authentication, enter the proxy password.

11. Click **Create**.

Registering with External Oracle ASR Manager

Use ODA CLI commands or the Browser User Interface to register Oracle Database Appliance with an external Oracle Auto Service Request (Oracle ASR) Manager.

You can register with an external Oracle ASR Manager at any time.

Before configuring, verify that the Oracle Database Appliance hardware is associated with a Support Identifier (SI) in My Oracle Support.

Before configuring external Oracle ASR on an appliance, ensure that Oracle ASR Manager is configured on another appliance.

Configuring External ASR Using ODA CLI Commands

Run these steps on the appliance where Oracle ASR Manager is configured:

1. Export the internal Oracle ASR Manager configuration files into a zip file:

```
[root@node1 bin]# odacli export-asrconfig

Job details
-----
                ID: 9c9e74d4-d3d8-4f77-9394-42c8eb7bfe1e
Description: Export ASR Config
      Status: Success
      Created: November 30, 2023 7:02:51 AM UTC
      Message: Run update repository with the zip /opt/
oracle/asr/asrConfiguration/ASRConfiguration.zip in the External ASR host
once the current job is successful

Task Name                Start Time
End Time                Status
-----
Creating a zip of ASR config files      November 30, 2023 7:02:52 AM UTC
November 30, 2023 7:02:52 AM UTC Success
```

2. Copy the zip file from the Oracle ASR Manager appliance to the system where the external Oracle ASR Manager must be configured. The zip file path is displayed in the job description in step 1.

```
$ scp zipFilePath user@system_name/IP:destination_path_for_the_zip
```

After copying the Oracle ASR Manager configuration zip file to the external Oracle ASR appliance, run the following steps on the external Oracle ASR appliance:

1. Run the `odacli update-repository` command to extract the zip file on the external Oracle ASR Manager system.

```
[root@node1 bin]# odacli update-repository -f zip_file_path
Job details
-----
                ID: c659b6ee-9f02-4cb4-aba4-4ed8de883e3a
      Description: Repository Update
                Status: Success
                Created: November 30, 2023 3:44:28 PM CST
                Message: /opt/oracle/dcs/bin/ASRConfiguration.zip

Task Name Start Time End Time Status
-----
-----
-----
Unzip bundle November 30, 2023 3:44:28 PM CST November 30, 2023 3:44:28 PM
CST Success
```

2. Configure Oracle ASR Manager as External.

```
[root@node1 bin]# odacli configure-asr -e External

Enter ASR user's password:
Retype ASR user's password:

[root@node1 bin]# odacli describe-job -i cdd8445f-
aefb-4f43-881a-145eaa1a1181

root@scaoda6f001 ~]# odacli describe-job -i 1099eac8-2879-4341-b391-
d56237696395

Job details
-----
                ID: 1099eac8-2879-4341-b391-d56237696395
      Description: Configure ASR
                Status: Success
                Created: November 30, 2023 3:46:50 PM CST
                Message:

Task Name Start Time End Time Status
-----
-----
-----
Setting up SSH equivalence November 30, 2023 3:46:52 PM CST
November 30, 2023 3:46:54 PM CST Success
Creating ASR configuration folders November 30, 2023 3:46:54 PM CST
November 30, 2023 3:46:54 PM CST Success
Setup ASR XML templates November 30, 2023 3:46:54 PM CST
November 30, 2023 3:46:54 PM CST Success
Importing ASR certificate into DCS November 30, 2023 3:46:54 PM CST
November 30, 2023 3:46:56 PM CST Success
truststore
Registering Asset: ODA Host November 30, 2023 3:46:56 PM CST
November 30, 2023 3:46:57 PM CST Success
ASR assets activation November 30, 2023 3:46:57 PM CST
```

```
November 30, 2023 3:46:58 PM CST Success
Configure ILOM November 30, 2023 3:46:58 PM CST
November 30, 2023 3:47:07 PM CST Success
```

3. To verify the successful activation of the assets with the external Oracle ASR Manager, run the command to list assets in the Oracle ASR Manager host as follows:

```
[root@node1 bin]# /opt/asrmanager/bin/asr list_asset
IP_ADDRESS  HOST_NAME      SERIAL_NUMBER PARENT_SERIAL ASR ASR_STATUS
PROTOCOL   SOURCE        LAST_HEARTBEAT PRODUCT_NAME
-----
-----
IP_address_1 oda1          1642NM10D1           Y  Active
HTTP      ESSW_XML      NA                   ORACLE SERVER X7-2
IP_address_2 oda2          1921XLA0AN           Y  Active
HTTP      ILOM_XML      NA                   ORACLE SERVER X8-2L
IP_address_3 oda3          1921XLA0AN           Y  Active
HTTP      ESSW_XML      NA                   ORACLE SERVER X8-2L x86/x64 System
IP_address_4 oda4          1921XLA0AW           Y  Active
HTTP      ILOM_XML      NA                   ORACLE SERVER X8-2L
IP_address_5 oda5          1921XLA0AW           Y  Active
HTTP      ESSW_XML      NA                   ORACLE SERVER X8-2L x86/x64 System
```

Use *My Oracle Support* to view the activation status. To view the latest available asset status in Oracle ASR Manager, run the `send_asset_status` command.

Configuring External Oracle ASR Using the BUI

Ensure that the zip file of Oracle ASR configured externally is imported to the repository using the `odacli update-repository` command, and then run the following steps:

1. Open a browser and enter the following URL to access BUI:

```
https://ip-address:7093/mgmt/index.html
```

2. Login as `oda-admin`.
3. Click the **Appliance** tab.
4. Click the Oracle ASR menu.
5. Select **External** from the ASR Type menu.
6. Click **Create**.

Configuring External Oracle ASR When Oracle ASR Manager Does Not Run on an Oracle Database Appliance

Understand how you can configure Oracle Database Appliance with an external Oracle Auto Service Request (Oracle ASR) Manager.

Prerequisites:

1. Ensure that the ASR manager is installed with version 23.2.0 or above. Run the `/opt/asrmanager/bin/asr show_version` command to view the Oracle ASR version:

```
/opt/asrmanager/bin/asr show_version
```

```

ASR Manager version: 23.2.0

Rules definitions version: 23.2.0.0

Auto Update Statistics
=====
Last Run Time: 2024-02-08 12:19:27.777
Last Run Status: Oracle Automated Service Manager not yet registered.
Next Run Time: 2024-02-09 12:19:27.777

Skipping ASR connectivity tests as ASR Auto Update isn't enabled

Auto Update Status
=====
Auto Update functionality is disabled.
Please refer to the My Oracle Support Doc Id: 1503107.1 for instructions
on Auto Update of ASR Manager software.

ASR Manager Services
-----
ASR Notification Trap is enabled.
Remote Request feature is enabled.

```

2. Ensure that Oracle ASR is enabled to run with HTTPS by running the following commands:

```

/opt/asrmanager/bin/asr https_config
/opt/asrmanager/bin/asr https_enable

```

Ensure that the required setting is present by running the `/opt/asrmanager/bin/asr show_http_receiver` command as follows:

```

/opt/asrmanager/bin/asr show_http_receiver
  HTTP Receiver configuration:

  HTTP Receiver Status: Enabled
  Host Name: xx.xxx.x.xxx
  SFB forward: true
  HTTP Port: 16161
  HTTPS/SSL Port: 16162
  HTTPS/SSL: Enabled
  Jetty HTTP Compliance: Medium - RFC2616
  Enable Jetty Older Ciphers: true

```

The output of the command must display `HTTPS/SSL as Enabled`.

Note that when you run the `/opt/asrmanager/bin/asr https_config` command, and the "What is your first and last name?" question is prompted for the certificate, you must enter the ASR manager IP address and keep the rest of the answers default.

Configuring External ASR Using ODACLI Commands

Run these steps on the appliance where Oracle ASR Manager is configured:

1. Create a directory called `asr` under `/tmp`.

```
mkdir /tmp/asr
```

2. Go to the directory created in step 1.

```
cd /tmp/asr
```

3. Generate the public key with the name `asrHTTPSCertificate.crt` under the directory created in step 1 for Oracle ASR Manager, using its keystore present at `/var/opt/asrmanager/configuration/asrmKeyStore.jks`. The following command creates a certificate `/tmp/asr/asrHTTPSCertificate.crt` for the keystore:

```
jdkbinpath/keytool -exportcert -alias alias set for the keystore -
keystore /var/opt/asrmanager/configuration/asrmKeyStore.jks -file /tmp/asr/
asrHTTPSCertificate.crt -rfc
Enter keystore password: Enter the certificate password provided in "asr
https_config" command
```

4. Create a new JSON file with the name `asrdetails.json` with the following details under `/tmp/asr` and set the values for the following:

- `asrManagerIp`: The IP address of the host where Oracle ASR Manager runs.
- `userName`: The email ID with which Oracle ASR Manager is registered.
- `httpsPortNumber`: The HTTPS port number set for Oracle ASR Manager in the `asr https_config` command.
- `httpsCertAlias`: The certificate ALIAS set when prompted by the `asr https_config` command.

Example of `/tmp/asr/asrdetails.json`:

```
{
  "asrManagerIp" : "xx.xxx.x.xxx",
  "userName" : "test",
  "httpsPortNumber" : 16162,
  "httpsCertAlias" : "oda-asr-client2024-01-31t10:15:52"
}
```

5. Generate a zip file with the files created in step 3 and step 4 `asrHTTPSCertificate.crt` and `asrdetails.json` from the `asr` directory present under `/tmp` directory.

```
cd /tmp
zip ASRConfiguration.zip asr/asrHTTPSCertificate.crt asr/asrdetails.json
```

6. Copy the zip file created in step 5 to the Oracle Database Appliance machine whose assets must be registered with the external Oracle ASR.

```
$ scp /tmp/ASRConfiguration.zip user@machine name/IP:destination path for
the zip
```

After copying the external Oracle ASR Manager configuration zip file to Oracle Database Appliance, run the following steps on the Oracle Database Appliance:

1. Run the `odacli update-repository` command to unzip the zip file created on the external Oracle ASR machine and copied to the appliance.

```
$odacli update-repository -f <zip file path>

odacli describe-job -i c659b6ee-9f02-4cb4-aba4-4ed8de883e3a

Job details
-----
                ID: c659b6ee-9f02-4cb4-aba4-4ed8de883e3a
Description:    Repository Update
                Status: Success
                Created: November 30, 2023 3:44:28 PM CST
                Message: /opt/oracle/dcs/bin/ASRConfiguration.zip

Task Name                Start
Time                    End
Time                    Status
-----
-----
Unzip bundle            November 30, 2023 3:44:28 PM
CST                    November 30, 2023 3:44:28 PM CST    Success
```

2. Configure Oracle ASR Manager as External.

```
$odacli configure-asr -e External

Enter ASR user's password: <SSO password>
Retype ASR user's password:

odacli describe-job -i 1099eac8-2879-4341-b391-d56237696395

Job details
-----
                ID: 1099eac8-2879-4341-b391-d56237696395
Description:    Configure ASR
                Status: Success
                Created: November 30, 2023 3:46:50 PM CST
                Message:

Task Name                Start
Time                    End
Time                    Status
-----
-----
Setting up SSH equivalence    November 30, 2023 3:46:52 PM
CST                          November 30, 2023 3:46:54 PM CST    Success
Creating ASR configuration folders    November 30, 2023 3:46:54 PM
CST                          November 30, 2023 3:46:54 PM CST    Success
Setup ASR XML templates        November 30, 2023 3:46:54 PM
CST                          November 30, 2023 3:46:54 PM CST    Success
Importing ASR certificate into DCS    November 30, 2023 3:46:54 PM
CST                          November 30, 2023 3:46:56 PM CST    Success
truststore
```



```
Registering Asset: ODA Host          November 30, 2023 3:46:56 PM
CST          November 30, 2023 3:46:57 PM CST          Success
ASR assets activation                November 30, 2023 3:46:57 PM
CST          November 30, 2023 3:46:58 PM CST          Success
Configure ILOM                      November 30, 2023 3:46:58 PM
CST          November 30, 2023 3:47:07 PM CST          Success
```

Configuring External ASR Using Browser User Interface (BUI)

After copying the external Oracle ASR Manager configuration zip file to Oracle Database Appliance, follow these steps:

1. Open a browser and enter the following URL to access BUI:

```
https://ip-address:7093/mgmt/index.html
```

2. Login as `oda-admin`.
3. Click the **Appliance** tab.
4. Click the Oracle ASR menu, and then click **Export** on the ASR Information page. **Note:** You must run the export operation from the Oracle Database Appliance on which internal Oracle ASR Manager is configured.
5. After the job completes successfully, a zip file is generated in the location `/opt/oracle/asr/asrConfiguration`.
6. Manually copy the zip file from the appliance with the internal Oracle ASR Manager to the system where the external Oracle ASR Manager must be configured.
7. In the Configure ASR page, select **ASR Type** as **External**.
8. Specify the **Zip File Location** copied in step 6.
9. Click **Update Repository**.
10. After the repository is updated with the zip file, click **Next**.
11. Specify and confirm the **ASR Password**.
12. Click **Configure ASR**.
13. After the job completes successfully, verify the Oracle ASR configuration on the ASR Information page.

Testing Oracle ASR

Use the `odacli test-asr` command to confirm that your Oracle ASR configuration is working.

When you run the command, a test alert is sent to Oracle ASR manager from both Oracle ILOM and the host registered with Oracle ASR. The registered email ID receives an email about the test alert for the registered Oracle ILOM and host.

Attempting to test the configuration outside of the `odacli test-asr` command might not provide the expected test result.

1. Log in as `root` user.

2. Run the `odacli test-asr` command.

```
# odacli test-asr

Job details
-----
                ID: 51522c07-1b32-4874-9bc7-bbee5885f1e5
Description: Test ASR
                Status: Success
                Created: October 20, 2023 1:02:49 PM UTC
                Message:

Task Name Start Time                               End Time
Status
-----
Test ASR October 20, 2023 1:02:50 PM UTC October 20, 2023 1:02:50 PM UTC
Success
```

Managing an Oracle ASR Configuration

Use the command-line to review an existing configuration, make changes to a configuration, or delete a configuration.

You can view and edit the configuration details, but you cannot change the Oracle ASR type. For example, from internal to external. To change the Oracle ASR type, delete the existing configuration and then re-configure Oracle ASR.

All log files for Oracle ASR are located in the `/var/opt/asrmanager/log/` directory.

1. To display Oracle Auto Service Request (Oracle ASR) configuration details, use the `odacli describe-asr` command.

```
# odacli describe-asr

ASR details
-----
                ID: e0e31043-c312-4371-8301-e62642ef8a4a
                Name: ASR
                ASR Type: Internal
                ASR Manager IP : 10.32.202.13
                ASR Manager username: scott.tiger@example.com
                HTTPS port number: 16164
                State: CONFIGURED
                Created: September 3, 2023 4:02:38 AM UTC
                Updated: September 3, 2023 4:03:32 AM UTC
```

2. (Optional) To make changes to Oracle ASR configuration details after deploying the appliance, use the `odacli modify-asr` command.
3. (Optional) To remove the Oracle ASR configuration from the system, use the `odacli delete-asr` command.

```
# odacli delete-asr
{
```

```
"jobId" : "5d70bd17-ec4a-48da-8196-1364105db99d",
"status" : "Running",
"message" : null,
"reports" : [ ],
"createTimestamp" : 1469409622451,
"description" : "Delete ASR",
"updatedAt" : 1469409622458
}
```

Related Topics

- [odacli Oracle Auto Service Request Commands](#)
Use the Oracle Auto Service Request (Oracle ASR) commands to configure, update, test, and delete Oracle ASR on the system.

Additional Resources for Oracle ASR

Refer to these sections for more information about Oracle ASR.

- Oracle ASR product page:
<http://www.oracle.com/asr>
- Oracle Database Appliance products qualified for Oracle ASR:
 - [Oracle ASR Qualified Oracle Database Appliance Products](#)
 - **IMPORTANT:** [Oracle ASR Qualified Product and Fault Rule Coverage Supplement \(Doc ID 2142295.1\)](#)
- Oracle ASR user documentation:
http://docs.oracle.com/cd/E37710_01/index.htm

Troubleshooting Oracle Database Appliance

Understand tools you can use to validate changes and troubleshoot Oracle Database Appliance problems.

- [About Oracle Database Appliance Configuration Collection Utility](#)
Oracle Database Appliance configuration collection collects configuration information for all components in the appliance.
- [About Setting Up and Removing SSH Configuration](#)
Understand how you can set up and remove SSH configuration.
- [Viewing Oracle Database Appliance Error Correlation Reports](#)
Understand how to view Error Correlation Report and how to interpret the report to troubleshoot your appliance.
- [About Enabling Linux Kernel Core Extractor for Troubleshooting](#)
Understand how to manage Linux Kernel Core Extractor to troubleshoot your appliance.
- [Viewing Details About DCS Error Messages](#)
Understand how to view details about DCS errors for troubleshooting them.
- [Collecting Diagnostics Data Using the BUI](#)
Understand how to collect diagnostics data to troubleshoot errors.
- [Resolving Errors When Updating DCS Components During Patching](#)
Understand how to troubleshoot errors when updating DCS components during patching.
- [Viewing Component Information on the Appliance](#)
View details of all the components installed on the appliance, and the RPM drift information.
- [Errors When Logging into the Browser User Interface](#)
If you have problems logging into the Browser User Interface, then it may be due to your browser or credentials.
- [Errors when re-imaging Oracle Database Appliance](#)
Understand how to troubleshoot errors that occur when re-imaging Oracle Database Appliance.
- [Using Oracle Autonomous Health Framework for Running Diagnostics](#)
Oracle Autonomous Health Framework collects and analyzes diagnostic data collected, and proactively identifies issues before they affect the health of your system.
- [Running the Disk Diagnostic Tool](#)
Use the Disk Diagnostic Tool to help identify the cause of disk problems.
- [Running the Oracle Database Appliance Hardware Monitoring Tool](#)
The Oracle Database Appliance Hardware Monitoring Tool displays the status of different hardware components in Oracle Database Appliance server.
- [Disabling the Browser User Interface](#)
You can also disable the Browser User Interface. Disabling the Browser User Interface means you can only manage your appliance through the command-line interface.
- [Preparing Log Files for Oracle Support Services](#)
If you have a system fault that requires help from Oracle Support Services, then you may need to provide log records to help Oracle support diagnose your issue.

About Oracle Database Appliance Configuration Collection Utility

Oracle Database Appliance configuration collection collects configuration information for all components in the appliance.

The utility generates a configuration collection with a specific timestamp that can be utilized by other utilities. The collection contains configuration details for all Oracle Database Appliance components in the form of JSON files and a unified HTML configuration report. Creating a snapshot of the appliance configuration assists in debugging issues on the appliance and provides a comprehensive record of all object versions and configuration details at a specific date and time. Additionally, it serves as a valuable reference for tracking configuration changes over time.

The configuration collection tool obtains and stores details about the following components:

- DCS framework such as DCS controller, DCS agent, DCS admin, etc CPU pools, Oracle Grid Infrastructure, Oracle Database, operating system, Oracle ILOM, BIOS, Oracle ASR, the firmware, Oracle HMP, and so on.
- Operating system, storage, Oracle Clusterware, Oracle KVM, and others.

Use the `odaconfigcli collectconfig [-loc] [-redact] [-silent]` command to run the configuration collection.

```
# odaconfigcli collectconfig
```

```
Oracle Database Appliance system config collection:
```

```
-- Performing validations:
```

```
-- Collecting configuration from the system test1
```

```
The config collection is being created at:
```

```
/opt/oracle/odaconfig/cnr_data/odaconfig_test1_23_01_2025_19_38_47
```

```
1. Collecting system info
```

```
Collecting system details [e.g. version, hardwaretype, etc] ....
```

```
Collecting storage details ....
```

```
Collecting RPM drift info ....
```

```
Collecting AFD state ....
```

```
Collecting network info ....
```

```
2. Collecting Baremetal database info
```

```
Collecting system info ....
```

```
Collecting component info ....
```

```
Collecting dbstorage info ....
```

```
Collecting database info ....
```

```
Collecting dbhome info ....
```

```
Collecting backupconfig info ....
```

```
Collecting cpupool info ....
```

```
Collecting network info ....
```

```
Collecting objectstoreswift info ....
```

```
Collecting backupreport info ....
```

```
3. Processing Odaconfig report. Please note ** it will take few minutes ** to  
collect all the command outputs
```

```
Collecting ODA stack information
```

```
Collecting fixed commands information
Generating html ODAConfig report
```

4. Setting file protection to the files on config collection.

5. Not redacting the collection

Finished config collection and creating jsons. Following is the collection summary:

```
Config collect bundle created at: /opt/oracle/odaconfig/cnr_data/
odaconfig_testoda803c1n1_23_01_2025_19_38_47
HTML ODAConfig report can be found at: /opt/oracle/odaconfig/cnr_data/
odaconfig_testoda803c1n1_23_01_2025_19_38_47/
odaconfig_testoda803c1n1_23_01_2025_19_38_47.html
Logs for this run can be found at : /opt/oracle/odaconfig/cnr_data/
odaconfig_testoda803c1n1_23_01_2025_19_38_47/logs
```

When you run the utility from the bare metal system, the output includes the list of DB systems and their configurations, as this information is available in the bare metal DCS metadata. The collected configuration data is provided in the form of JSON files and a unified HTML report. The CLI offers a redaction option for configuration collection, with two modes: `sanitize` and `mask`. In the `sanitize` mode, sensitive entities such as host name and database name are replaced with alternative strings, while in the `mask` mode, they are replaced with `*`.

Prerequisites to run the utility

- You must run the utility from the bare metal system as the `root` user.
- You can also run the utility on multi-user access enabled systems and multi-user access enabled passwordless systems. Since the utility uses `odacli-view`, no password prompts are required in these environments. If you want to redact the output in a multi-user access enabled environment, ensure that passwordless login for `odacli` from the `odaadmin` user is enabled, eliminating the need for password input.
- The `oakd` service must be running, as the utility uses `odaadmcli` to gather hardware information.
- The system must be provisioned, as there is typically minimal DCS configuration to collect on a new system.

Command and parameters

```
odaconfigcli collectconfig [-loc] [-redact] [-silent]
```

| Parameter | Description |
|-----------------------|---|
| <code>--loc</code> | (Optional) Customizes results location. The default is <code>/opt/oracle/odaconfig/cnr_data</code> . |
| <code>--redact</code> | (Optional) Redacts sensitive entities in configuration collection. Permitted values are <code>sanitize</code> and <code>mask</code> . <code>sanitize</code> : Sensitive entities are replaced with a substitution string <code>mask</code> : Sensitive entities are replaced with <code>**</code> |
| <code>--silent</code> | (Optional) Suppresses all confirmations. |

You can specify custom commands for the tool in a JSON file. For example:

```
# /opt/oracle/odaconfig/customize/commands_output.json:

    "name" : "DCS Extra",
    "commands":
      [
        {
          "command": "rpm -qa | grep -e dcs -e oda-hw-mgmt -e hami -e
mysql",
          "filename": "dcsextra_rpmqadcs.out"
        },
        {
          "command": "/opt/oracle/dcs/bin/odacli list-featuretracking",
          "filename": "dcsextra_listfeaturetracking.out"
        },
        {
          "command": "/opt/oracle/dcs/bin/odacli list-dataguardstatus",
          "filename": "dcsextra_listdataguardstatus.out"
        },
        {
          "command": "/opt/oracle/dcs/bin/odacli list-schedules",
          "filename": "dcsextra_listschedules.out"
        },
        {
          .....
          .....

    "os":
    {
      "name" : "Operating System",
      "commands":
      [
        {
          "command": "lscpu",
          "filename": "os_lscpu.out"
        },
        {
          "command": "free",
          "filename": "os_free.out"
        },
        {
          "command": "top -bn1 | head -n 50",
          "filename": "os_top50.out"
        },
      ],
    }
  ],
}
```

Related Topics

- [odaconfigcli collectconfig](#)
Use the `odaconfigcli collectconfig` command to collect configuration data from the appliance.

About Setting Up and Removing SSH Configuration

Understand how you can set up and remove SSH configuration.

In earlier Oracle Database Appliance releases, the DCS agent used a scheduled SSH cleaner job that ran every 30 minutes, to clean up SSH connections configured in the system. Starting with Oracle Database Appliance release 19.24, the DCS agent does not remove SSH configurations.

The DCS agent has a new `agentconfig` parameter called `ODA_MANAGED_SSH` that you can use to deactivate the `Setup SSH` job on Oracle Database Appliance. You must set up SSH before you run any job that requires SSH configuration between nodes. If you run a job that requires SSH configuration, then the job uses the pre-configured SSH setup. If the SSH keys are present but not functioning or SSH configuration does not exist, the job displays an error. You must set up a working SSH equivalence between nodes before you rerun the job.

Viewing Oracle Database Appliance Error Correlation Reports

Understand how to view Error Correlation Report and how to interpret the report to troubleshoot your appliance.

About Error Correlation Reports

If a DCS job fails, an Error Correlation job is created automatically to generate an Error Correlation report. You can access and review the generated Error Correlation report from the BUI to explore possible ways of error resolution.

The Error Correlation Report contains the following:

- **Log Messages:** Errors, exceptions and warnings from various log files.
- **Failed Task Messages:** Error message displayed when the DCS job failed.
- **Release Notes:** Relevant Known Issues from *Oracle Database Appliance Release Notes* to help resolve the issue.
- **Documentation:** Relevant topics from the Oracle Database Appliance Documentation Library to help resolve the error.

The Error Correlation Report is generated for every failed DCS job and can be accessed from the BUI. On Oracle Database Appliance high-availability deployments, the Error Correlation report contains the error information derived from log files of both the nodes.

Viewing Error Correlation Reports using ODA CLI Commands

You can view the Error Correlation report of a failed DCS job by running the `odacli describe-job -i failed_dcs_job_id --ecr` command. For an example output, see the topic *odacli describe-job* in this guide.

Viewing Error Correlation Reports from the BUI

To view the Error Correlation Report from the Activities page in the BUI:

1. Log into the Browser User Interface:

```
https://host-ip-address:7093/mgmt/index.html
```

2. Click the **Activity** tab.

3. In the Activities page, click the **Failure** or **InternalError** link in the failed DCS job for which you want to view the Error Correlation report. Note that only failed DCS jobs have associated Error Correlation Reports.
4. You can also view the Error Correlation Report for the failed DCS job when you click the **Actions** menu, and select **View Error Correlation Report**.
5. The Error Correlation Report contains the following tabs:
 - **Log Messages:** Displays the logs for DCS agent, DCS admin, Oracle HAMI, MySQL, and Oracle FPP. You can expand each section to view the details. Only components that have logs are displayed. If no errors are found, then the message `No errors or exceptions found in logs` is displayed in the Log Messages section.
 - **Failed Task Messages:** Displays the specific error message displayed when the task failed.
 - **Release Notes:** Displays relevant Known Issues from *Oracle Database Appliance Release Notes* to help resolve the issue. You can click each of these links to view the Release Notes entry. If no relevant Known issues are found, then the message `No matching results were found.` is displayed.
 - **Documentation:** Displays relevant topics from the Oracle Database Appliance Documentation Library to help resolve the error. You can click each of these links to view the documentation topic from the Oracle Database Appliance documentation.

To view the Error Correlation Report from the Diagnostics page in the BUI:

1. In the BUI, click the **Diagnostics** tab.
2. In the Diagnostics page, click **Collect Diagnostic Data** for a failed job.
3. The Collect Diagnostics page displays the Error Correlation Report and Job Details in separate tabs for the failed DCS job. Click the **Report File Name** link to download the Error Correlation Report to your local system.
4. The Job details tab displays the steps in the job and the Error Correlation Report contains the **Log Messages**, **Failed Task Messages**, **Release Notes**, and **Documentation** tabs.

Related Topics

- [odacli describe-job](#)
Use the `odacli describe-job` command to display details about a specific job, including the job ID, status, tasks, and the job created date and time stamp.

About Enabling Linux Kernel Core Extractor for Troubleshooting

Understand how to manage Linux Kernel Core Extractor to troubleshoot your appliance.

About Linux Kernel Core Extractor

A Linux kernel panic can occur due to various reasons such as faulty hardware, driver crashes, or software bugs. To identify the cause of kernel panic, it is essential to collect and analyze the vmcore of the crashed kernel. The kdump service is used to collect the vmcore after the first kernel crash. This process is slow for systems with high memory and often fails to generate vmcore when the available space is not sufficient. When Linux Kernel Core Extractor is enabled on Oracle Database Appliance bare metal systems, the crash utility in the kdump kernel collects useful information for troubleshooting without generating vmcore.

Linux Kernel Core Extractor Commands

List generated crash reports:

```
# /usr/sbin/oled lkce list
Followings are the crash*out found in /var/oled/lkce dir:
/var/oled/lkce/crash_20220307-154542.out
```

Purge existing all but last three crash reports:

```
# /usr/sbin/oled lkce clean
lkce deletes all but last three /var/oled/lkce/crash*out files. do you want
to proceed(yes/no)? [no]:
```

Purge all crash reports:

```
# /usr/sbin/oled lkce clean --all
lkce removes all the files in /var/oled/lkce dir. do you want to proceed(yes/
no)? [no]:
```

By default, the crash report contains output for the following crash commands. You can add other crash commands to the `/etc/oled/lkce/crash_cmds_file`.

```
#
# This is the input file for crash utility. You can edit this manually
# Add your own list of crash commands one per line.
#
bt
bt -a
bt -FF
dev
kmem -s
foreach bt
log
mod
mount
net
ps -m
ps -S
runq
quit
```

By default, vmcore generation is disabled. You can enable vmcore generation as follows:

```
# oled lkce configure --vmcore=yes
Restarting kdump service... done!
lkce: set vmcore to yes
```

For additional Linux Kernel Core Extractor commands, refer to the Linux Kernel Core Extractor help.

```
# oled lkce help
Usage: lkce options
options:
  report report-options -- Generate a report from vmcore
  report-options:
    --vmcore=/path/to/vmcore      - path to vmcore
    [--vmlinux=/path/to/vmlinux]  - path to vmlinux
    [--crash_cmds=cmd1,cmd2,cmd3,..] - crash commands to include
    [--outfile=/path/to/outfile]  - write output to a file

  configure [--default] -- configure lkce with default values
  configure [--show] -- show lkce configuration -- default
  configure [config-options]
  config-options:
    [--vmlinux_path=/path/to/vmlinux] - set vmlinux_path
    [--crash_cmds_file=/path/to/file] - set crash_cmds_file
    [--kdump_report=yes/no]          - set crash report in kdump kernel
    [--vmcore=yes/no]                - set vmcore generation in kdump kernel
    [--max_out_files=<number>]       - set max_out_files

  enable -- enable lkce in kdump kernel
  disable -- disable lkce in kdump kernel
  status -- status of lkce

  clean [--all] -- clear crash report files
  list          -- list crash report files
```

Viewing Details About DCS Error Messages

Understand how to view details about DCS errors for troubleshooting them.

About Viewing Information About DCS Errors

To view more details about any errors during DCS operations, use the command `dc serr error_code`.

```
# /opt/oracle/dcs/bin/dcserr
dc serr error_code

# dcserr 10001
10001, Internal_Error, "Internal error encountered: {0}."
// *Cause: An internal error occurred.
// *Action: Contact Oracle Support Services for assistance.
/
# dcserr 1001
Unknown error code
```

To view more details about DCS errors in the Browser User Interface (BUI), you can provide the DCS error code in the Search box in the BUI. The Search results display the Cause and Action of DCS error codes.

Collecting Diagnostics Data Using the BUI

Understand how to collect diagnostics data to troubleshoot errors.

About Collecting Diagnostics Data

Use the **Diagnostics** tab in the Browser User Interface to view diagnostic information about your deployment and the installed components.

In the Diagnostic Collection page, you can view the available diagnostics collections. Click **Collect Diagnostic Data** to start diagnostics collection. Once the data is collected, click on the collection file path to download the file.

In the Collect Diagnostics page, specify the Job ID for the diagnostics data collection. Optionally, specify a tag and a description for the collection. The details of the Job ID are displayed. Click **Collect** to start the diagnostics data collection.

You can also collect diagnostics from the Activity page, by selecting **Collect Diagnostics** from the **Actions** drop down for a specific job. Click **Collect** to start the diagnostics data collection.

To delete a diagnostic collection, from the Diagnostic Collection page, select the specific collection, and click **Delete**.

This diagnostic collection feature does not replace the `odaadmcli manage diagcollect` command. You can use the `odaadmcli manage diagcollect` command also to enable diagnostics collections, independently of this new feature from the BUI. The `odaadmcli manage diagcollect` command and the diagnostics collection from BUI use the `tfactl` command internally. The diagnostics collection from BUI is aimed to collect other data from DCS metadata that is not collected through `tfactl` and provide greater context for root cause analysis of related DCS jobs failures.

Resolving Errors When Updating DCS Components During Patching

Understand how to troubleshoot errors when updating DCS components during patching.

.

About DCS Components

When you run the `odacli update-dcscomponents` command during patching, pre-checks for MySQL installation are automatically verified before update of Oracle HAMI, MySQL, and DCS components. If any of the pre-checks fail, then the command errors out with a reference to the pre-check report log file location `/opt/oracle/dcs/log/jobfiles/jobId/dcscomponentsPreCheckReport.log`. Review the pre-check report and take corrective actions and then rerun the `odacli update-dcscomponents` command. If there are no pre-check errors, then the patching process proceeds with updating Oracle HAMI, MySQL, and DCS components such as the DCS Agent, DCS CLI, and DCS Controller.

Note:

Run the `odacli update-dcsadmin` command prior to running the `odacli update-dcscomponents` command.

When the `odacli update-dcscomponents` command completes successfully:

The command output is as follows:

```
# ./odacli update-dcscomponents -v 19.26.0.0.0
{
  "jobId" : "3ac3667a-fa22-40b6-a832-504a56aa3fdc",
  "status" : "Success",
  "message" : "Update-dcscomponents is successful on all the node(s):DCS-Agent
shutdown is successful. MySQL upgrade is done before. Metadata migration is
successful. Agent rpm upgrade is successful. DCS-CLI rpm upgrade is
successful.
DCS-Controller rpm upgrade is succ",
  "reports" : null,
  "createTimestamp" : "December 8, 2024 02:37:37 AM CST",
  "description" : "Update-dcscomponents job completed and is not part of Agent
job list",
  "updatedAt" : "December 8, 2024 02:39:10 AM CST"
}
```

The pre-check report log file at the location `/opt/oracle/dcs/log/jobfiles/jobId/dcscomponentsPreCheckReport.log` contains the following:

```
Pre-check Name: Space check
Status: Success
Comments: Required space 3 GB is available in /opt

Pre-check Name: Port check
Status: Success
Comments: Port 3306 is available for running ODA MySQL

Pre-check Name: ODA MySQL rpm installation dry-run check
Status: Success
Comments: ODA MySQL rpm dry-run passed

Pre-check Name: Check for the existence of MySQL connector/J library
Status: Success
Comments: ODA MySQL connector/J library found

Pre-check Name: Check for the existence of Metadata migration utility
Status: Success
Comments: Metadata migration utility found

dcs-admin version:
Pre-check Name: dcs-admin version validation
Status: Success
Comments: dcs-admin is already updated :19.26.0.0.0

Config File Exist dcscontroller:
Pre-check Name: Check DCS config files exists for dcscontroller
Status: Success
Comments: Files /opt/oracle/dcs/conf/dcs-controller.yml and /opt/oracle/dcs/
conf/dcs-controller-logback.xml exist
```

```
Config File Exist dcsagent:
Pre-check Name: Check DCS config files exists for dcsagent
Status: Success
Comments: Files /opt/oracle/dcs/conf/dcs-agent.yml and /opt/oracle/dcs/conf/
dcs-agent-logback.xml exist
```

```
Validate scheduler cron expressions:
Pre-check Name: Validate scheduler cron expressions
Status: Success
Comments: Scheduler cron expressions for existing job schedules are up to date
```

When the `odacli update-dcscomponents` command fails:

On Oracle Database Appliance single-node systems, the command output is as follows:

```
# ./odacli update-dcscomponents -v 19.26.0.0.0

DCS-10008:Failed to update DCscomponents: 19.25.0.0.0
Internal error while patching the DCS components :
DCS-10231:Cannot proceed. Pre-checks for update-dcscomponents failed. Refer to
/opt/oracle/dcs/log/jobfiles/jobId/dcscomponentsPreCheckReport.log
on node 0 for details.
```

On Oracle Database Appliance high-availability systems, the command output is as follows:

```
# ./odacli update-dcscomponents -v 19.26.0.0.0

Internal error while patching the DCS components :
DCS-10231:Cannot proceed. Pre-checks for update-dcscomponents failed. Refer to
/opt/oracle/dcs/log/jobfiles/jobId/dcscomponentsPreCheckReport.log
on node 0 and /opt/oracle/dcs/log/jobfiles/jobId/
dcscomponentsPreCheckReport.log
on node 1 for details.
```

The command runs all pre-checks one by one, and errors out at the end if any of the pre-checks is marked as Failed. When a pre-check fails, the error message is displayed on to the console along with the reference to pre-check report log location. The pre-check report log file is at the location `/opt/oracle/dcs/log/jobfiles/jobId/dcscomponentsPreCheckReport.log`.

```
Pre-check Name: Space check
Status: Failed
Comments: Available space in /opt is 2 GB but minimum required space in /opt
is 3 GB
```

```
Pre-check Name: Port check
Status: Success
Comments: Port 3306 is available for running ODA MySQL
```

```
Pre-check Name: ODA MySQL rpm installation dry-run check
Status: Success
Comments: ODA MySQL rpm dry-run passed
```

```
Pre-check Name: Check for the existence of MySQL connector/J library
Status: Success
```

Comments: ODA MySQL connector/J library found

Pre-check Name: Check for the existence of Metadata migration utility
Status: Success
Comments: Metadata migration utility found

Pre-check Name: dcs-admin version validation
Status: Success
Comments: dcs-admin is already updated :19.20.0.0.0

Config File Exist dcscontroller:
Pre-check Name: Check DCS config files exists for dcscontroller
Status: Success
Comments: Files /opt/oracle/dcs/conf/dcs-controller.yml and /opt/oracle/dcs/conf/dcs-controller-logback.xml exist

Config File Exist dcsagent:
Pre-check Name: Check DCS config files exists for dcsagent
Status: Success
Comments: Files /opt/oracle/dcs/conf/dcs-agent.yml and /opt/oracle/dcs/conf/dcs-agent-logback.xml exist

Validate scheduler cron expressions:
Pre-check Name: Validate scheduler cron expressions
Status: Success
Comments: Scheduler cron expressions for existing job schedules are up to date

When the `odacli update-dcscomponents` command fails due to space check error:

The pre-check report log contains the following:

Pre-check Name: Space check
Status: Failed
Comments: Available space in /opt is 2 GB but minimum required space in /opt is 3 GB

Pre-check Name: Port check
Status: Success
Comments: Port 3306 is available for running ODA MySQL

Pre-check Name: ODA MySQL rpm installation dry-run check
Status: Success
Comments: ODA MySQL rpm dry-run passed

Pre-check Name: Check for the existence of MySQL connector/J library
Status: Success
Comments: ODA MySQL connector/J library found

Pre-check Name: Check for the existence of Metadata migration utility
Status: Success
Comments: Metadata migration utility found

Pre-check Name: dcs-admin version validation
Status: Success
Comments: dcs-admin is already updated :19.20.0.0.0

```

Config File Exist dcscontroller:
Pre-check Name: Check DCS config files exists for dcscontroller
Status: Success
Comments: Files /opt/oracle/dcs/conf/dcs-controller.yml and /opt/oracle/dcs/conf/dcs-controller-logback.xml exist

Config File Exist dcsagent:
Pre-check Name: Check DCS config files exists for dcsagent
Status: Success
Comments: Files /opt/oracle/dcs/conf/dcs-agent.yml and /opt/oracle/dcs/conf/dcs-agent-logback.xml exist

Validate scheduler cron expressions:
Pre-check Name: Validate scheduler cron expressions
Status: Success
Comments: Scheduler cron expressions for existing job schedules are up to date

```

When the `odacli update-dcscomponents` command fails due to port check error:

The pre-check report log contains the following:

```

Pre-check Name: Space check
Status: Success
Comments: Required space 3 GB is available in /opt

Pre-check Name: Port check
Status: Failed
Comments: No port found in the range ( 3306 to 65535 )

Pre-check Name: ODA MySQL rpm installation dry-run check
Status: Success
Comments: ODA MySQL rpm dry-run passed

Pre-check Name: Check for the existence of MySQL connector/J library
Status: Success
Comments: ODA MySQL connector/J library found

Pre-check Name: Check for the existence of Metadata migration utility
Status: Success
Comments: Metadata migration utility found

Pre-check Name: dcs-admin version validation
Status: Success
Comments: dcs-admin is already updated :19.20.0.0.0

Config File Exist dcscontroller:
Pre-check Name: Check DCS config files exists for dcscontroller
Status: Success
Comments: Files /opt/oracle/dcs/conf/dcs-controller.yml and /opt/oracle/dcs/conf/dcs-controller-logback.xml exist

Config File Exist dcsagent:
Pre-check Name: Check DCS config files exists for dcsagent
Status: Success
Comments: Files /opt/oracle/dcs/conf/dcs-agent.yml and /opt/oracle/dcs/conf/dcs-agent-logback.xml exist

```

Validate scheduler cron expressions:
Pre-check Name: Validate scheduler cron expressions
Status: Success
Comments: Scheduler cron expressions for existing job schedules are up to date

When the `odacli update-dcscomponents` command fails due to MySQL RPM installation dry-run check error:

The pre-check report log contains the following:

Pre-check Name: Space check
Status: Success
Comments: Required space 3 GB is available in /opt

Pre-check Name: Port check
Status: Success
Comments: Port 3306 is available for running ODA MySQL

Pre-check Name: ODA MySQL rpm installation dry-run check
Status: Failed
Comments: ODA MySQL rpm dry-run failed. Failed due to the following error :
Exception details are displayed below

Pre-check Name: Check for the existence of MySQL connector/J library
Status: Success
Comments: ODA MySQL connector/J library found

Pre-check Name: Check for the existence of Metadata migration utility
Status: Success
Comments: Metadata migration utility found

Pre-check Name: dcs-admin version validation
Status: Success
Comments: dcs-admin is already updated :19.20.0.0.0

Config File Exist dcscontroller:
Pre-check Name: Check DCS config files exists for dcscontroller
Status: Success
Comments: Files /opt/oracle/dcs/conf/dcs-controller.yml and /opt/oracle/dcs/conf/dcs-controller-logback.xml exist

Config File Exist dcsagent:
Pre-check Name: Check DCS config files exists for dcsagent
Status: Success
Comments: Files /opt/oracle/dcs/conf/dcs-agent.yml and /opt/oracle/dcs/conf/dcs-agent-logback.xml exist

Validate scheduler cron expressions:
Pre-check Name: Validate scheduler cron expressions
Status: Success
Comments: Scheduler cron expressions for existing job schedules are up to date

When the `odacli update-dcscomponents` command fails due to MySQL connector/J library check error:

The pre-check report log contains the following:

```
Pre-check Name: Space check
Status: Success
Comments: Required space 3 GB is available in /opt

Pre-check Name: Port check
Status: Success
Comments: Port 3306 is available for running ODA MySQL

Pre-check Name: ODA MySQL rpm installation dry-run check
Status: Success
Comments: ODA MySQL rpm dry-run passed

Pre-check Name: Check for the existence of MySQL connector/J library
Status: Failed
Comments: MySQL connector/J library does not exist. Ensure update-repository
with latest serverzip bundles ran first without any issues prior to running
update-dcscomponents

Pre-check Name: Check for the existence of Metadata migration utility
Status: Success
Comments: Metadata migration utility found

dcs-admin version:
Pre-check Name: dcs-admin version validation
Status: Success
Comments: dcs-admin is already updated :19.20.0.0.0

Config File Exist dcscontroller:
Pre-check Name: Check DCS config files exists for dcscontroller
Status: Success
Comments: Files /opt/oracle/dcs/conf/dcs-controller.yml and /opt/oracle/dcs/
conf/dcs-controller-logback.xml exist

Config File Exist dcsagent:
Pre-check Name: Check DCS config files exists for dcsagent
Status: Success
Comments: Files /opt/oracle/dcs/conf/dcs-agent.yml and /opt/oracle/dcs/conf/
dcs-agent-logback.xml exist

Validate scheduler cron expressions:
Pre-check Name: Validate scheduler cron expressions
Status: Success
Comments: Scheduler cron expressions for existing job schedules are up to date
```

When the `odacli update-dcscomponents` command fails due to Metadata migration utility check error:

The pre-check report log contains the following:

```
Pre-check Name: Space check
Status: Success
Comments: Required space 3 GB is available in /opt

Pre-check Name: Port check
Status: Success
Comments: Port 3306 is available for running ODA MySQL

Pre-check Name: ODA MySQL rpm installation dry-run check
Status: Success
Comments: ODA MySQL rpm dry-run passed

Pre-check Name: Check for the existence of MySQL connector/J library
Status: Success
Comments: ODA MySQL connector/J library found

Pre-check Name: Check for the existence of Metadata migration utility
Status: Failed
Comments: Metadata migration utility does not exist. Ensure update-repository
with latest serverzip bundles ran first without any issues prior to running
update-dcscomponents.

dcs-admin version:
Pre-check Name: dcs-admin version validation
Status: Success
Comments: dcs-admin is already updated :19.20.0.0.0

Config File Exist dcscontroller:
Pre-check Name: Check DCS config files exists for dcscontroller
Status: Success
Comments: Files /opt/oracle/dcs/conf/dcs-controller.yml and /opt/oracle/dcs/
conf/dcs-controller-logback.xml exist

Config File Exist dcsagent:
Pre-check Name: Check DCS config files exists for dcsagent
Status: Success
Comments: Files /opt/oracle/dcs/conf/dcs-agent.yml and /opt/oracle/dcs/conf/
dcs-agent-logback.xml exist

Validate scheduler cron expressions:
Pre-check Name: Validate scheduler cron expressions
Status: Success
Comments: Scheduler cron expressions for existing job schedules are up to date
```

When the `odacli update-dcscomponents` command displays a warning due to scheduler cron expression:

When patching from Oracle Database Appliance release 19.19 or earlier to the latest release, and you run the `odacli update-dcscomponents` command, there may be a warning in the

precheck report log file if the default cron expressions from the existing list of job schedules are modified. The pre-check report log contains the following:

```
Pre-check Name: Space check
Status: Success
Comments: Required space 3 GB is available in /opt

Pre-check Name: Port check
Status: Success
Comments: Port 3306 is available for running ODA MySQL

Pre-check Name: ODA MySQL rpm installation dry-run check
Status: Success
Comments: ODA MySQL rpm dry-run passed

Pre-check Name: Check for the existence of MySQL connector/J library
Status: Success
Comments: ODA MySQL connector/J library found

Pre-check Name: Check for the existence of Metadata migration utility
Status: Success
Comments: Metadata migration utility found

dcs-admin version:
Pre-check Name: dcs-admin version validation
Status: Success
Comments: dcs-admin is already updated :19.20.0.0.0

Config File Exist dcscontroller:
Pre-check Name: Check DCS config files exists for dcscontroller
Status: Success
Comments: Files /opt/oracle/dcs/conf/dcs-controller.yml and /opt/oracle/dcs/conf/dcs-controller-logback.xml exist

Config File Exist dcsagent:
Pre-check Name: Check DCS config files exists for dcsagent
Status: Success
Comments: Files /opt/oracle/dcs/conf/dcs-agent.yml and /opt/oracle/dcs/conf/dcs-agent-logback.xml exist

Validate scheduler cron expressions:
Pre-check Name: Validate scheduler cron expressions
Status: Warning
Comments: Following cron expressions in the scheduler were modified from their default values. Starting 19.20, DCS Agent converts 7 fields cron expression into 6 fields cron expression. No further action needed.
Schedule ID : 3f671ee7-1a03-43fd-b98b-ce33eb09de08 , Custom cron expression :
10
25 * 1/1 * ? 2023
```

Note that the Status: Warning means the update-dcscomponents pre-check has detected custom cron expressions from the existing list of job schedules. The DCS agent automatically converts from the 7 fields custom cron expression to the equivalent 6 fields cron expression after patching DCS components.

Related Topics

- [Patching Oracle Database Appliance Bare Metal Systems Using the Command-Line](#)
Follow these steps to apply patches to your Oracle Database Appliance bare metal deployment and existing Oracle Database homes, using CLI commands.

Viewing Component Information on the Appliance

View details of all the components installed on the appliance, and the RPM drift information.

Collecting and Viewing the Bill of Materials in the Browser User Interface

Use the Appliance tab in the Browser User Interface to collect and view information about your deployment and the installed components. The Advanced Information tab displays information about the following components:

- Grid Infrastructure Version, and the home directory
- Database Version, Home location, and Edition
- Location and details about the databases configured
- All patches applied to the appliance
- Firmware Controller and Disks
- ILOM information
- BIOS version
- List of RPMs

In the List of RPMs section, click **Show** and then click **RPM Drift** to view the differences between the RPMs installed on the appliance, and the RPMs shipped in the latest Oracle Database Appliance Patch Bundle Update release.

Click **Collect Bill of Materials** to initiate a collection and submit the job. The job ID is displayed. After the collection is complete, click **Refresh** to refresh the information.

Click **Download** to save the components report. You can use this report to help diagnose any deployment issues.

Viewing the Bill of Materials from the Command Line

The bill of materials is also available through the command line for bare metal and virtualized platforms deployments. The information about the installed components is collected according to a set schedule, and stored in the location `/opt/oracle/dcs/Inventory/` for bare metal deployments and in the `/opt/oracle/oak/Inventory/` directory for virtualized platforms. The file is stored in the format `oda_bom_TimeStamp.json`. Use the command `describe-system` to view the bill of materials on the command line. See the *Oracle Database Command-Line Interface* chapter for command options and usage notes.

Example 19-1 Example Command to View the Bill of Materials from the Command Line for Bare Metal Deployments

```
# odacli describe-system -b
ODA Components Information
-----
Component Name          Component
Details
-----
-----
```

```

-----
NODE                                     Name : oda1
                                          Domain Name : testdomain.com
                                          Time Stamp : April 21, 2020 6:21:15 AM UTC

RPMS                                     Installed RPMS : abrt-2.1.11-55.0.1.el7.x86_64,
                                          abrt-addon-
ccpp-2.1.11-55.0.1.el7.x86_64,          abrt-addon-
kerneloops-2.1.11-55.0.1.el7.x86_64,   abrt-addon-
pstoreoops-2.1.11-55.0.1.el7.x86_64,   abrt-addon-
python-2.1.11-55.0.1.el7.x86_64,        abrt-addon-
vmcore-2.1.11-55.0.1.el7.x86_64,        abrt-addon-
xorg-2.1.11-55.0.1.el7.x86_64,          abrt-
cli-2.1.11-55.0.1.el7.x86_64,           abrt-console-
notification-2.1.11-55.0.1.el7.x86_64,  abrt-
dbus-2.1.11-55.0.1.el7.x86_64,          abrt-
libs-2.1.11-55.0.1.el7.x86_64,          abrt-
python-2.1.11-55.0.1.el7.x86_64,        abrt-
tui-2.1.11-55.0.1.el7.x86_64,           acl-2.2.51-14.el7.x86_64,
                                          adwaita-cursor-
theme-3.28.0-1.el7.noarch,               adwaita-icon-
theme-3.28.0-1.el7.noarch,               aic94xx-
firmware-30-6.el7.noarch,                 aide-0.15.1-13.0.1.el7.x86_64,
                                          alsa-
firmware-1.0.28-2.el7.noarch,             alsa-lib-1.1.8-1.el7.x86_64,
                                          alsa-tools-
firmware-1.1.0-1.el7.x86_64,             at-3.1.13-24.el7.x86_64,
                                          at-spi2-
atk-2.26.2-1.el7.x86_64,                 at-spi2-
core-2.28.0-1.el7.x86_64,                atk-2.28.1-1.el7.x86_64,
                                          attr-2.4.46-13.el7.x86_64,
                                          audit-2.8.5-4.el7.x86_64,
                                          audit-libs-2.8.5-4.el7.x86_64,
                                          audit-libs-
python-2.8.5-4.el7.x86_64,               augeas-libs-1.4.0-9.el7.x86_64,

```

```

libopts-5.18-5.el7.x86_64,
libs-0.6.31-19.el7.x86_64,
basesystem-10.0-7.0.1.el7.noarch,
completion-2.1-6.el7.noarch,
libs-9.11.4-9.P2.el7.x86_64,
libs-9.11.4-9.P2.el7.x86_64,
lite-9.11.4-9.P2.el7.x86_64,
license-9.11.4-9.P2.el7.noarch,
utils-9.11.4-9.P2.el7.x86_64,
binutils-2.27-41.base.0.7.el7_7.2.x86_64,
time-1.53.0-27.el7.x86_64,
filesystem-1.53.0-27.el7.x86_64,
iostreams-1.53.0-27.el7.x86_64,
....
....
....
authconfig-6.2.8-30.el7.x86_64,
autogen-
avahi-
bash-4.2.46-33.el7.x86_64,
bash-
bc-1.06.95-13.el7.x86_64,
bind-export-
bind-
bind-libs-
bind-
bind-
biosdevname-0.7.3-2.el7.x86_64,
blktrace-1.0.5-9.el7.x86_64,
bnxtnm-1.40.10-1.x86_64,
boost-date-
boost-
boost-

```

Example 19-2 Example Command to View the Bill of Materials from the Command Line for Virtualized Platforms

```
# oakcli describe-system -b
```

Example 19-3 Example Command to View the Bill of Materials Report from the Stored Location

```
# ls -la /opt/oracle/dcs/Inventory/
total 264
-rw-r--r-- 1 root root 83550 Apr 26 05:41 oda_bom_2018-04-26_05-41-36.json
```

Errors When Logging into the Browser User Interface

If you have problems logging into the Browser User Interface, then it may be due to your browser or credentials.

Note:

Oracle Database Appliance uses self-signed certificates. Your browser determines how you log into the Browser User Interface. Depending on the browser and browser version, you may receive a warning or error that the certificate is invalid or not trusted because it is self-signed, or that the connection is not private. Ensure that you accept the self-signed certificate for the agent and Browser User Interface.

Follow these steps to log into the Browser User Interface:

1. Open a browser window.
2. Go to the following URL: `https://ODA-host-ip-address:7093/mgmt/index.html`
3. Get the security certificate (or certificate), confirm the security exception, and add an exception.
4. Log in with your Oracle Database Appliance credentials.

If you have not already set the `oda-admin` password, then a message is displayed, advising you to change the default password to comply with your system security requirements.

5. If you have not added an exception for the agent security certificate, then a message about accepting agent certificate is displayed.
6. Using a different tab in your browser, go to the following URL: `https://ODA-host-ip-address:7070/login`
7. Get the security certificate (or certificate), confirm the security exception, and add an exception.
8. Refresh the Browser User Interface URL : `https://ODA-host-ip-address:7093/mgmt/index.html`

Note:

If you have any issues logging into the Oracle Database Appliance Browser User Interface on browsers such as macOS Catalina and Google Chrome, then you may need to use any workaround as described on the official site for the product.

Related Topics

- [Creating the Appliance](#)
Create the appliance using the Browser User Interface or ODA CLI commands.
- <http://www.oracle.com/technetwork/indexes/products/browser-policy-2859268.html>

Errors when re-imaging Oracle Database Appliance

Understand how to troubleshoot errors that occur when re-imaging Oracle Database Appliance.

If re-imaging Oracle Database Appliance fails, with old header issues such as errors in storage discovery, or in running GI root scripts, or disk group RECO creation, then use the force mode with `cleanup.pl`.

```
# cleanup.pl -f
```

To ensure that re-imaging is successful, remove the old headers from the storage disks by running the secure erase tool. Verify that the OAK/ASM headers are removed.

```
# cleanup.pl -erasedata  
# cleanup.pl -checkHeader
```

Retry the re-imaging operation.

Related Topics

- [Re-imaging Oracle Database Appliance](#)
Bare metal operating system re-imaging installs Oracle Database Appliance operating system software on the local (boot) drive.

Using Oracle Autonomous Health Framework for Running Diagnostics

Oracle Autonomous Health Framework collects and analyzes diagnostic data collected, and proactively identifies issues before they affect the health of your system.

- [About Installing Oracle Autonomous Health Framework](#)
Oracle Autonomous Health Framework is installed automatically when you provision or patch to Oracle Database Appliance release 19.26.
- [Using the Oracle ORAchk Health Check Tool](#)
Run Oracle ORAchk to audit configuration settings and check system health.
- [Generating and Viewing Oracle ORAchk Health Check Tool Reports in the Browser User Interface](#)
Generate Oracle ORAchk Health Check Tool reports using the Browser User Interface.
- [Generating and Viewing Database Security Assessment Reports in the Browser User Interface](#)
Generate and view Database Security Assessment Reports using the Browser User Interface.
- [Running Oracle Trace File Analyzer \(TFA\) Collector Commands](#)
Understand the installed location of `tfactl` and the options for the command.
- [Sanitizing Sensitive Information in Diagnostic Collections](#)
Oracle Autonomous Health Framework uses Adaptive Classification and Redaction (ACR) to sanitize sensitive data.

- [Enabling Adaptive Classification and Redaction \(ACR\)](#)
Oracle Database Appliance supports Adaptive Classification and Redaction (ACR) to sanitize sensitive data.
- [Sanitizing Sensitive Information in Oracle Trace File Analyzer Collections](#)
You can redact (sanitize or mask) Oracle Trace File Analyzer diagnostic collections.
- [Redacting and Sanitizing Entities in the BUI](#)
Enable and disable trace file redaction, redact files, and show or hide sanitized entities using the Browser User Interface.
- [Sanitizing Sensitive Information in Oracle ORAchk Output](#)
You can sanitize Oracle ORAchk output.

About Installing Oracle Autonomous Health Framework

Oracle Autonomous Health Framework is installed automatically when you provision or patch to Oracle Database Appliance release 19.26.

When you provision or patch your appliance to Oracle Database Appliance release 19.26, Oracle Autonomous Health Framework is installed in the path `/opt/oracle/dcs/oracle.ahf`.

You can verify that Oracle Autonomous Health Framework is installed by running the following command:

```
[root@oak ~]# rpm -q oracle-ahf
oracle-ahf-193000-#####.x86_64
```



Note:

When you provision or patch to Oracle Database Appliance release 19.26, Oracle Autonomous Health Framework automatically provides Oracle ORAchk Health Check Tool and Oracle Trace File Analyzer Collector.

Oracle ORAchk Health Check Tool performs proactive health checks for the Oracle software stack and scans for known problems. Oracle ORAchk Health Check Tool audits important configuration settings for Oracle RAC deployments in the following categories:

- Operating system kernel parameters and packages
- Oracle Database Database parameters, and other database configuration settings
- Oracle Grid Infrastructure, which includes Oracle Clusterware and Oracle Automatic Storage Management

Oracle ORAchk is aware of the entire system. It checks the configuration to indicate if best practices are being followed.

Oracle Trace File Collector provides the following key benefits and options:

- Encapsulation of diagnostic data collection for all Oracle Grid Infrastructure and Oracle RAC components on all cluster nodes into a single command, which you run from a single node
- Option to "trim" diagnostic files during data collection to reduce data upload size
- Options to isolate diagnostic data collection to a given time period, and to a particular product component, such as Oracle ASM, Oracle Database, or Oracle Clusterware

- Centralization of collected diagnostic output to a single node in Oracle Database Appliance, if desired
- On-Demand Scans of all log and trace files for conditions indicating a problem
- Real-Time Scan Alert Logs for conditions indicating a problem (for example, Database Alert Logs, Oracle ASM Alert Logs, and Oracle Clusterware Alert Logs)

Using the Oracle ORAchk Health Check Tool

Run Oracle ORAchk to audit configuration settings and check system health.

Note:

Before running ORAchk, check for the latest version of Oracle Autonomous Health Framework, and download and install it. See My Oracle Support Note 2550798.1 for more information about downloading and installing the latest version of Oracle Autonomous Health Framework.

Running ORAchk on Oracle Database Appliance 19.26 Baremetal Systems for New Installation

When you provision or upgrade to Oracle Database Appliance 19.26, ORAchk is installed using Oracle Autonomous Framework in the directory `/opt/oracle/dcs/oracle.ahf`.

To run `orachk`, use the following command:

```
[root@oak bin]# orachk
```

When all checks are finished, a detailed report is available. The output displays the location of the report in an HTML format and the location of a zip file if you want to upload the report. For example, you can choose the filter to show failed checks only, show checks with a Fail, Warning, Info, or Pass status, or any combination.

Review the Oracle Database Appliance Assessment Report and system health and troubleshoot any issues that are identified. The report includes a summary and filters that enable you to focus on specific areas.

Running ORAchk on Oracle Database Appliance 19.26 Virtualized Platform

When you provision or upgrade to Oracle Database Appliance 19.26, ORAchk is installed using Oracle Autonomous Framework in the directory `/opt/oracle.ahf`.

To run `orachk`, use the following command:

```
[root@oak bin]# oakcli orachk
```

Related Topics

- <https://support.oracle.com/rs?type=doc&id=2550798.1>

Generating and Viewing Oracle ORAchk Health Check Tool Reports in the Browser User Interface

Generate Oracle ORAchk Health Check Tool reports using the Browser User Interface.

1. Log into the Browser User Interface with the `oda-admin` username and password.

`https://Node0-host-ip-address:7093/mgmt/index.html`

2. Click the **Monitoring** tab.
3. In the Monitoring page, on the left navigation pane, click **ORAchk Report**.
On the ORAchk Reports page, a list of all the generated ORAchk reports is displayed.
4. In the Actions menu for the ORAchk report you want to view, click **View**.

The Oracle Database Appliance Assessment Report is displayed. It contains details of the health of your deployment, and lists current risks, recommendations for action, and links for additional information.

5. **To create an on-demand ORAchk report:** On the ORAchk Reports page, click **Create** and then click **Yes** in the confirmation box.

The job to create an ORAchk report is submitted.

6. Click the link to view the status of the job. Once the job completes successfully, you can view the Oracle Database Appliance Assessment Report on the ORAchk Reports page.
7. **To delete an ORAchk report:** In the Actions menu for the ORAchk report you want to delete, click **Delete**.

Generating and Viewing Database Security Assessment Reports in the Browser User Interface

Generate and view Database Security Assessment Reports using the Browser User Interface.

1. Log into the Browser User Interface with the `oda-admin` username and password.

`https://Node0-host-ip-address:7093/mgmt/index.html`

2. Click the **Security** tab.
3. In the Security page, on the left navigation pane, click **DBSAT Reports**.

On the Database Security Assessment Reports page, a list of all the generated DBSAT reports is displayed.

4. In the Actions menu for the ORAchk report you want to view, click **View**.

The Oracle Database Security Assessment Report is displayed. It contains details of the health of your deployment, and lists current risks, recommendations for action, and links for additional information.

5. **To create a DBSAT report:** On the DBSAT Reports page, click **Create** and then click **Yes** in the confirmation box.

The job to create a DBSAT report is submitted.

6. Click the link to view the status of the job. Once the job completes successfully, you can view the Oracle Database Appliance Assessment Report on the DBSAT Reports page.
7. **To delete a DBSAT report:** In the Actions menu for the DBSAT report you want to delete, click **Delete**.

Running Oracle Trace File Analyzer (TFA) Collector Commands

Understand the installed location of `tfactl` and the options for the command.

About Using `tfactl` to Collect Diagnostic Information

When you provision or upgrade to Oracle Database Appliance 19.26, Oracle Trace File Analyzer (TFA) Collector is installed in the directory `/opt/oracle.ahf/bin/tfactl`. You can invoke the command line utility for TFA, `tfactl` from the directory `/opt/oracle.ahf/bin/tfactl`, or simply type `tfactl`.

You can use the following command options to run `tfactl`:

```
/opt/oracle.ahf/bin/tfactl diagcollect -ips|-oda|-odalite|-dcs|-odabackup|
-odapatching|-odadataguard|-odaprovisioning|-odaconfig|-odasystem|-
odastorage|-database|
-asm|-crsclient|-dbclient|-dbwlm|-tns|-rhp|-procinfo|-afd|-crs|-cha|-wls|
-emagent|-oms|-ocm|-emplugins|-em|-acfs|-install|-cfgtools|-os|-ashhtml|-
ashtext|
-awrhtml|-awrtext -mask -sanitize
```

Table 19-1 Command Options for `tfactl` Tool

| Option | Description |
|------------------|--|
| -h | (Optional) Describes all the options for this command. |
| -ips | (Optional) Use this option to view the diagnostic logs for the specified component. |
| -oda | (Optional) Use this option to view the logs for the entire Appliance. |
| -odalite | (Optional) Use this option to view the diagnostic logs for the odalite component. |
| -dcs | (Optional) Use this option to view the DCS log files. |
| -odabackup | (Optional) Use this option to view the diagnostic logs for the backup components for the Appliance. |
| -odapatching | (Optional) Use this option to view the diagnostic logs for patching components of the Appliance. |
| -odadataguard | (Optional) Use this option to view the diagnostic logs for Oracle Data Guard component of the Appliance. |
| -odaprovisioning | (Optional) Use this option to view provisioning logs for the Appliance. |
| -odaconfig | (Optional) Use this option to view configuration-related diagnostic logs. |
| -odasystem | (Optional) Use this option to view system information. |

Table 19-1 (Cont.) Command Options for tfactl Tool

| Option | Description |
|-------------|--|
| -odastorage | (Optional) Use this option to view the diagnostic logs for the Appliance storage. |
| -database | (Optional) Use this option to view database-related log files. |
| -asm | (Optional) Use this option to view the diagnostic logs for the Appliance. |
| -crsclient | (Optional) Use this option to view the diagnostic logs for the Appliance. |
| -dbclient | (Optional) Use this option to view the diagnostic logs for the Appliance. |
| -dbwlm | (Optional) Use this option to view the diagnostic logs for the specified component. |
| -tns | (Optional) Use this option to view the diagnostic logs for TNS. |
| -rhp | (Optional) Use this option to view the diagnostic logs for Rapid Home Provisioning. |
| -afd | (Optional) Use this option to view the diagnostic logs for Oracle ASM Filter Driver. |
| -crs | (Optional) Use this option to view the diagnostic logs for Oracle Clusterware. |
| -cha | (Optional) Use this option to view the diagnostic logs for the Cluster Health Monitor. |
| -wls | (Optional) Use this option to view the diagnostic logs for Oracle WebLogic Server. |
| -emagent | (Optional) Use this option to view the diagnostic logs for the Oracle Enterprise Manager agent. |
| -oms | (Optional) Use this option to view the diagnostic logs for the Oracle Enterprise Manager Management Service. |
| -ocm | (Optional) Use this option to view the diagnostic logs for the specified component. |
| -emplugins | (Optional) Use this option to view the diagnostic logs for Oracle Enterprise Manager plug-ins. |
| -em | (Optional) Use this option to view the diagnostic logs for Oracle Enterprise Manager deployment. |
| -acfs | (Optional) Use this option to view the diagnostic logs for Oracle ACFS storage. |
| -install | (Optional) Use this option to view the diagnostic logs for installation. |
| -cfgtools | (Optional) Use this option to view the diagnostic logs for the configuration tools. |
| -os | (Optional) Use this option to view the diagnostic logs for the operating system. |
| -ashhtml | (Optional) Use this option to view the diagnostic logs for the specified component. |

Table 19-1 (Cont.) Command Options for tfactl Tool

| Option | Description |
|-----------|---|
| -ashtext | (Optional) Use this option to view the diagnostic logs for the Appliance. |
| -awrhtml | (Optional) Use this option to view the diagnostic logs for the Appliance. |
| -awrtext | (Optional) Use this option to view the diagnostic logs for the specified component. |
| -mask | (Optional) Use this option to choose to mask sensitive data in the log collection. |
| -sanitize | (Optional) Use this option to choose to sanitize (redact) sensitive data in the log collection. |

Usage Notes

You can use Trace File Collector (the `tfactl` command) to collect all log files for the Oracle Database Appliance components.

You can also use the command `odaadmcli manage diagcollect`, with similar command options, to collect the same diagnostic information.

For more information about using the `-mask` and `-sanitize` options, see the next topic.

Sanitizing Sensitive Information in Diagnostic Collections

Oracle Autonomous Health Framework uses Adaptive Classification and Redaction (ACR) to sanitize sensitive data.

After collecting copies of diagnostic data, Oracle Trace File Analyzer and Oracle ORAchk use Adaptive Classification and Redaction (ACR) to sanitize sensitive data in the collections. ACR uses a Machine Learning based engine to redact a pre-defined set of entity types in a given set of files. ACR also sanitizes or masks entities that occur in files and directory names. Sanitization replaces a sensitive value with random characters. Masking replaces a sensitive value with a series of asterisks ("*").

ACR currently sanitizes the following entity types:

- Host names
- IP addresses
- MAC addresses
- Oracle Database names
- Tablespace names
- Service names
- Ports
- Operating system user names

ACR also masks user data from the database appearing in block and redo dumps.

Example 19-4 Block dumps before redaction

```
14A533F40 00000000 00000000 00000000 002C0000 [.....,.]
14A533F50 35360C02 30352E30 31322E37 380C3938 [..650.507.2189.8]
14A533F60 31203433 37203332 2C303133 360C0200 [34 123 7310,...6]
```

Example 19-5 Block dumps after redaction

```
14A533F40 ***** ***** ***** ***** [*****]
14A533F50 ***** ***** ***** ***** [*****]
14A533F60 ***** ***** ***** ***** [*****]
```

Example 19-6 Redo dumps before redaction

```
col 74: [ 1] 80
col 75: [ 5] c4 0b 19 01 1f
col 76: [ 7] 78 77 06 16 0c 2f 26
```

Example 19-7 Redo dumps after redaction

```
col 74: [ 1] **
col 75: [ 5] ** ** ** ** ** 
col 76: [ 7] ** ** ** ** ** ** ** ** **
```

Redaction of Literal Values in SQL Statements in AWR, ASH and ADDM Reports

Automatic Workload Repository (AWR), Active Session History (ASH), and Automatic Database Diagnostic Monitor (ADDM) reports are HTML files, which contain sensitive entities such as hostnames, database names, and service names in the form of HTML tables. In addition to these sensitive entities, they also contain SQL statements, that can contain bind variables or literal values from tables. These literal values can be sensitive personal information (PI) stored in databases. ACR processes such reports to identify and redact both usual sensitive entities and literal values present in the SQL statements.

Sanitizing Sensitive Information Using odaadmcli Command

Use the `odaadmcli manage diagcollect` command to collect diagnostic logs for Oracle Database Appliance components. During collection, ACR can be used to redact (sanitize or mask) the diagnostic logs.

```
odaadmcli manage diagcollect [--dataMask|--dataSanitize]
```

In the command, the `--dataMask` option blocks out the sensitive data in all collections, for example, replaces `myhost1` with `*****`. The default is `None`. The `--dataSanitize` option replaces the sensitive data in all collections with random characters, for example, replaces `myhost1` with `orzhmvl`. The default is `None`.

Enabling Adaptive Classification and Redaction (ACR)

Oracle Database Appliance supports Adaptive Classification and Redaction (ACR) to sanitize sensitive data.

After collecting copies of diagnostic data, Oracle Database Appliance use Adaptive Classification and Redaction (ACR) to sanitize sensitive data in the collections. You can use the commands `odacli enable-acr` and `odacli disable-acr` to enable or disable ACR across both nodes, not just on the local node.

See Also:

For more information about setting up the staging server for Adaptive Classification and Redaction (ACR), see My Oracle Support note 2882798.1.

Example 19-8 Describing current status of ACR

```
bash-4.2# odacli describe-acr
Trace File Redaction: Enabled
```

Example 19-9 Enabling ACR:

```
bash-4.2# odacli enable-acr
```

Job details

```
-----
ID: 12bbf784-610a-40a8-b409-e74c58bc35aa
Description: Enable ACR job
Status: Created
Created: April 8, 2021 3:04:13 AM PDT
```

Example 19-10 Disabling ACR

```
bash-4.2# odacli disable-acr
```

Job details

```
-----
ID: 1d69f8b3-3989-4192-bbb9-6518e425061a
Description: Disable ACR job
Status: Created
Created: April 8, 2021 3:04:13 AM PDT
```

Example 19-11 Enabling ACR during provisioning of the appliance

You can enable ACR during provisioning of the appliance by adding the `acr` option to the JSON file used for provisioning. Specify `true` or `false` for the field `acrEnable` in the JSON file. If the `acr` option is not specified, then ACR is disabled.

```
"acr": {  
  "acrEnable": true  
}
```

Related Topics

- <https://support.oracle.com/rs?type=doc&id=2882798.1>

Sanitizing Sensitive Information in Oracle Trace File Analyzer Collections

You can redact (sanitize or mask) Oracle Trace File Analyzer diagnostic collections.

Enabling Automatic Redaction

To enable automatic redaction, use the command:

```
tfactl set redact=[mask|sanitize|none]
```

In the command, the `-mask` option blocks out the sensitive data in all collections, for example, replaces `myhost1` with `*****`. The `-sanitize` option replaces the sensitive data in all collections with random characters, for example, replaces `myhost1` with `orzhmvl`. The `none` option does not mask or sanitize sensitive data in collections. The default is `none`.

Enabling On-Demand Redaction

You can redact collections on-demand, for example, `tfactl diagcollect -srdc ORA-00600 -mask` or `tfactl diagcollect -srdc ORA-00600 -sanitize`.

1. To mask sensitive data in all collections:

```
tfactl set redact=mask
```

2. To sanitize sensitive data in all collections:

```
tfactl set redact=sanitize
```

Example 19-12 Masking or Sanitizing Sensitive Data in a Specific Collection

```
tfactl diagcollect -srdc ORA-00600 -mask  
tfactl diagcollect -srdc ORA-00600 -sanitize
```

Redacting and Sanitizing Entities in the BUI

Enable and disable trace file redaction, redact files, and show or hide sanitized entities using the Browser User Interface.

1. Log into the Browser User Interface with the `oda-admin` username and password.

```
https://Node0-host-ip-address:7093/mgmt/index.html
```

2. Click the **Security** tab.
3. In the Security page, on the left navigation pane, click **Trace File Redaction**.
4. Click the **Trace File Redaction Status** tab.
The current ACR status is displayed.
5. You can enable or disable ACR status based on the current ACR status. For example, if the ACR status is disabled, then click **Enable** to enable ACR. The job to change the ACR status is submitted.
6. Click **Refresh Status** to refresh the ACR status display.
7. Click the **Redact Files** tab.
8. Specify the **Input File Path** of the file to be redacted. The file must be in the `.tar`, or `.gz`, or `.zip` file format.
9. Select either **Sanitize** or **Mask** for the **Redaction Mode**.
10. Click **Redact**. The job to redact files is submitted.
11. Click the **Show Sanitized Entities** tab.
12. Specify the **List of sanitized entities** and click **Show**. The list of sanitized entities are displayed.

Sanitizing Sensitive Information in Oracle ORAchk Output

You can sanitize Oracle ORAchk output.

To sanitize Oracle ORAchk output, include the `-sanitize` option, for example, `orachk -profile asm -sanitize`. You can also sanitize post process by passing in an existing log, HTML report, or a zip file, for example, `orachk -sanitize file_name`.

Example 19-13 Sanitizing Sensitive Information in Specific Collection IDs

```
orachk -sanitize comma_delimited_list_of_collection_IDs
```

Example 19-14 Sanitizing a File with Relative Path

```
orachk -sanitize new/orachk_node061919_053119_001343.zip
orachk is sanitizing
/scratch/testuser/may31/new/orachk_node061919_053119_001343.zip. Please
wait...
```

```
Sanitized collection is:
/scratch/testuser/may31/orachk_aydv061919_053119_001343.zip
orachk -sanitize ../orachk_node061919_053119_001343.zip
orachk is sanitizing
/scratch/testuser/may31/../orachk_node061919_053119_001343.zip. Please wait...
```

```
Sanitized collection is:
/scratch/testuser/may31/orachk_aydv061919_053119_001343.zip
```

Example 19-15 Sanitizing Oracle Autonomous Health Framework Debug Log

```
orachk -sanitize new/orachk_debug_053119_023653.log
orachk is sanitizing /scratch/testuser/may31/new/
orachk_debug_053119_023653.log.
Please wait...
```

```
Sanitized collection is: /scratch/testuser/may31/
orachk_debug_053119_023653.log
```

Example 19-16 Running Full Sanity Check

```
orachk -localonly -profile asm -sanitize -silentforce
```

```
Detailed report (html) -
/scratch/testuser/may31/orachk_node061919_053119_04448/
orachk_node061919_053119_04448.html
```

```
orachk is sanitizing /scratch/testuser/may31/orachk_node061919_053119_04448.
Please wait...
```

```
Sanitized collection is: /scratch/testuser/may31/
orachk_aydv061919_053119_04448
```

```
UPLOAD [if required] - /scratch/testuser/may31/
orachk_node061919_053119_04448.zip
```

To reverse lookup a sanitized value, use the command:

```
orachk -rmap all|comma_delimited_list_of_element_IDs
```

You can also use `orachk -rmap` to lookup a value sanitized by Oracle Trace File Analyzer.

Example 19-17 Printing the Reverse Map of Sanitized Elements

```
orachk -rmap MF_NK1, fcb63u2
```

| Entity Type | Substituted Entity Name | Original Entity Name |
|-------------|-------------------------|----------------------|
| dbname | MF_NK1 | HR_DB1 |
| dbname | fcb63u2 | rac12c2 |

```
orachk -rmap all
```

Running the Disk Diagnostic Tool

Use the Disk Diagnostic Tool to help identify the cause of disk problems.

The tool produces a list of 14 disk checks for each node. To display details, where *n* represents the disk resource name, enter the following command:

```
# odaadmcli storddiag n
```

For example, to display detailed information for NVMe pd_00:

```
# odaadmcli storddiag pd_00
```

Running the Oracle Database Appliance Hardware Monitoring Tool

The Oracle Database Appliance Hardware Monitoring Tool displays the status of different hardware components in Oracle Database Appliance server.

The tool is implemented with the Trace File Analyzer collector. Use the tool both on bare-metal and on virtualized systems. The Oracle Database Appliance Hardware Monitoring Tool reports information only for the node on which you run the command. The information it displays in the output depend on the component that you select to review.

Bare Metal Platform

You can see the list of monitored components by running the command `odaadmcli show -h`

To see information about specific components, use the command syntax `odaadmcli show component`, where *component* is the hardware component that you want to query. For example, the command `odaadmcli show power` shows information specifically about the Oracle Database Appliance power supply:

```
# odaadmcli show power
```

| NAME | HEALTH | HEALTH_DETAILS | PART_NO. | SERIAL_NO. |
|----------------|--------|----------------|----------|--------------------|
| Power_Supply_0 | OK | - | 7079395 | 476856Z+1514CE056G |

(Continued)

| LOCATION | INPUT_POWER | OUTPUT_POWER | INLET_TEMP | EXHAUST_TEMP |
|----------|-------------|--------------|-----------------|-----------------|
| PS0 | Present | 112 watts | 28.000 degree C | 34.938 degree C |

Virtualized Platform

You can see the list of monitored components by running the command `oakcli show -h`

To see information about specific components, use the command syntax `oakcli show component`, where *component* is the hardware component that you want to query. For example,

the command `oakcli show power` shows information specifically about the Oracle Database Appliance power supply:

```
# oakcli show power
```

| NAME | HEALTH | HEALTH_DETAILS | PART_NO. | SERIAL_NO. |
|----------------|--------|----------------|----------|--------------------|
| Power Supply_0 | OK | - | 7047410 | 476856F+1242CE0020 |
| Power Supply_1 | OK | - | 7047410 | 476856F+1242CE004J |

(Continued)

| LOCATION | INPUT_POWER | OUTPUT_POWER | INLET_TEMP | EXHAUST_TEMP |
|----------|-------------|--------------|-----------------|-----------------|
| PS0 | Present | 88 watts | 31.250 degree C | 34.188 degree C |
| PS1 | Present | 66 watts | 31.250 degree C | 34.188 degree C |

Note:

Oracle Database Appliance Server Hardware Monitoring Tool is enabled during initial startup of ODA_BASE on Oracle Database Appliance Virtualized Platform. When it starts, the tool collects base statistics for about 5 minutes. During this time, the tool displays the message "Gathering Statistics..." message.

Disabling the Browser User Interface

You can also disable the Browser User Interface. Disabling the Browser User Interface means you can only manage your appliance through the command-line interface.

1. Log in to the appliance:

```
ssh -l root oda-host-name
```

2. Stop the DCS controller. For High-Availability systems, run the command on both nodes.

```
systemctl stop initdcscontroller
```

Preparing Log Files for Oracle Support Services

If you have a system fault that requires help from Oracle Support Services, then you may need to provide log records to help Oracle support diagnose your issue.

You can collect diagnostic information for your appliance in the following ways:

- Use the Bill Of Materials report saved in the `/opt/oracle/dcs/Inventory/` directory, to enable Oracle Support to help troubleshoot errors, if necessary.
- You can use Trace File Collector (the `tfactl` command) to collect all log files for the Oracle Database Appliance components.
- Use the command `odaadmcli manage diagcollect` to collect diagnostic files to send to Oracle Support Services.
- Use the Error Correlation report available in the `/opt/oracle/dcs/da/da_repo` directory.

The `odaadmcli manage diagcollect` command consolidates information from log files stored on Oracle Database Appliance into a single log file for use by Oracle Support Services. The location of the file is specified in the command output.

Example 19-18 Collecting log file information for a time period, masking sensitive data

```
# odaadmcli manage diagcollect --dataMask --fromTime 2019-08-12 --toTime
2019-08-25
DataMask is set as true
FromTime is set as: 2019-08-12
ToTime is set as: 2019-08-25
TFACTL command is: /opt/oracle/tfa/tfa_home/bin/tfactl
Data mask is set.
Collect data from 2019-08-12
Collect data to 2019-08-25
```

A

Oracle Database Appliance Software Configuration Defaults

Oracle Database Appliance software configuration defaults.

- [Directory Paths for Oracle Database Appliance](#)
Understand the storage and mount configuration file paths for Oracle Database Appliance.
- [Port Numbers and Protocols of Oracle Database Appliance Components](#)
Understand the port numbers and protocols of Oracle Database Appliance components.
- [Location of Log Files](#)
Log files are available for actions performed in the command-line interface and Browser User Interface and are useful when you need to track and debug jobs.
- [Oracle Groups and User Configurations for Oracle Database Appliance](#)
Review the groups and default users created when you deploy the appliance. All passwords are set to the password that you define during deployment.

Directory Paths for Oracle Database Appliance

Understand the storage and mount configuration file paths for Oracle Database Appliance.

Oracle homes on Oracle Database Appliance follow Optimal Flexible Architecture guidelines.

Directory Paths for Oracle Database Appliance

| Item | Directory Path |
|--------------------------------|--|
| Grid home | <code>/u01/app/release-specific_name/gi owner</code> |
| Grid base | <code>/u01/app/gi owner</code> |
| Oracle home | <code>/u01/app/odaorahome/rdbms owner/product/ rdbms_version/ dbhome_home_sequence_number</code> |
| Oracle base | <code>/u01/app/odaorabase/rdbms owner</code> |
| Oracle Inventory | <code>/u01/app/oraInventory</code> |
| Java Runtime Environment (JRE) | <code>/opt/oracle/dcs/java/ release_specific_JRE_version/</code> |
| Java SDK | <code>/opt/oracle/dcs/odajavasdk/</code> |
| Oracle ACFS file system | <code>/opt/oracle/oak/pkgrepos/orapkgs/clones</code> Starting with Oracle Database Appliance release 19.12, a new Oracle ACFS file system is created to store the Oracle Database and Oracle Grid Infrastructure clone files. The DATA disk group provides a space of 150 GB for the file system. |

Port Numbers and Protocols of Oracle Database Appliance Components

Understand the port numbers and protocols of Oracle Database Appliance components.

Table A-1 Port Numbers and Protocols of Oracle Database Appliance Components

| Component | Description | Default Port Number | Protocol | Network |
|-------------|---|---------------------|----------|--------------------|
| BUI | A web-based application to administer and manage the Oracle Database Appliance. | 7093 | TCP | public |
| dcs-agent | The DCS agent is a REST application that performs various operations on the appliance. | 7070, 7071 | TCP | public and private |
| dcs-admin | This application performs lifecycle management operations on the DCS agent, DCS controller, ODA CLI, and other components. | 7060 | TCP | public and private |
| MySQL | The metadata store used by DCS agent. | 3306 | TCP | private |
| Oracle HAMI | Oracle High Availability Metadata Infrastructure service providing distributed services required by DCS including locking and synchronizing configuration details in the cluster. | 22001 | TCP | private |
| oakd | Managing the storage components of Oracle Database Appliance. | Dynamic | TCP | private |

Table A-1 (Cont.) Port Numbers and Protocols of Oracle Database Appliance Components

| Component | Description | Default Port Number | Protocol | Network |
|---------------------------|---|-------------------------------------|--------------|-----------------------|
| Oracle ASR Manager | Oracle Auto Service Request. Refer to Oracle Auto Service Request documentation for other ports used by ASR Manager. | 16161 | TCP | public |
| Oracle ILOM/IPMI | Oracle ILOM for Oracle Database Appliance servers. | 623 | UDP | public |
| Oracle Database listeners | Database listeners, including local listener and SCAN listener. | 1521 | TCP | public |
| Oracle ASM Listener | Oracle ASM listener | 1525 | TCP | private |
| EM Express | Oracle Enterprise Manager Database Express (EM Express). | 5500 and increment one per database | TCP | public |
| ssh | SSH connection to the Oracle Database Appliance servers. | 22 | SSH over TCP | public and private |
| VNC Server | The VNC server created by KVM for KVM virtual guest machines | 5900+ | TCP | localhost (127.0.0.1) |
| NFS | The central repository on bare metal system is shared by the DB Systems using NFS. Refer to the Oracle Linux documentation to identify ports used by NFS. | 2049 - nfs | TCP | private |

Note: IP addresses of the private network that Oracle Database Appliance uses are 192.168.16.0/24 and 192.168.17.0/24.

Related Topics

- [Port Numbers and Protocols of Oracle Components](#)

**See Also:**

Oracle Real Application Clusters Installation Guide for Linux and UNIX for port numbers and protocols used by Oracle Database components

Location of Log Files

Log files are available for actions performed in the command-line interface and Browser User Interface and are useful when you need to track and debug jobs.

You can also use the Oracle Appliance Manager Browser User Interface to view job activity, including the tasks that make up the job. The status of each task appears in the Browser User Interface and you can drill down to get greater details.

If you log a Service Request, upload all of the logs in the `/opt/oracle/dcs/log`, `/opt/oracle/dcs/da/da_repo`, and `/opt/oracle/dcs/dcscli/log` directories.

Patching Log Files

All patching-related information is logged in the `dcs-agent` log in the directory `/opt/oracle/dcs/log/`.

Error Correlation Reports

If a DCS job fails, an Error Correlation report is generated and is available in the `/opt/oracle/dcs/da/da_repo` directory.

DCS Agent Log Directories

Agent-specific activities are logged in the `dcs-agent` log.

The DCS Agent, controller, and command-line interface output are stored in the directory `/opt/oracle/dcs/log/`.

If an error occurs in the command-line interface layer, then the output will show in the `/opt/oracle/dcs/dcscli/log/dcscli.log` file first.

DCS Components Log Directories

The Oracle HAMI logs are stored in the directory `/opt/oracle/hami/base`, `/opt/oracle/hami/obase`, and `/opt/oracle/dcs/hami/log`. The Oracle HAMI logs are `hamiws_pid_n.trc`, `hamictl_timestamp_pid.log`, and `hamiwsmkwallets_pid.trc`.

The MySQL logs are stored in the log `/opt/oracle/dcs/mysql/log/mysql.db.log`. The log contains information about MySQL such as startup, shutdown, connection transaction details, and errors encountered when running MySQL.

Storage Logs

Storage-related activity is logged in the `oakd` log file.

```
/opt/oracle/oak/log/hostname/oak/oakd.log
```

For example, `/opt/oracle/oak/log/myhost/oak/oakd.log`

Use the `odaadmcli manage diagcollect` command to collect diagnostic logs for storage components. The files are saved in the `oakdiag` directory.

```
/opt/oracle/oak/log/hostname/oakdiag/file_name.tar.gz
```

For example, `/opt/oracle/oak/log/myhost/oakdiag/oakStorage-myhost-20161120_2217.tar.gz`

Upgrade using Data Preserving Re provisioning Logs

The `odaupgradeutil` utility logs are stored at `opt/oracle/oak/restore/log`.

Database Logs

Online logs are stored in the `/u03/app/db_user/redo/` directory.

Oracle Fast Recovery Area (FRA) is located in the `/u03/app/db_user/fast_recovery_area` directory.

Database alert logs are stored in the location `$ORACLE_BASE/diag/rdbms/database_unique_name`.

Oracle Auto Service Request (Oracle ASR) Log Files

All log files for Oracle ASR are located in the `/var/opt/asrmanager/log/` directory.

Oracle Groups and User Configurations for Oracle Database Appliance

Review the groups and default users created when you deploy the appliance. All passwords are set to the password that you define during deployment.

Default Operating System Groups and User Configurations

Table A-2 Default Operating System Groups and Users Configuration for Oracle Database Appliance

| Groups and Users | Default Value |
|--|--------------------|
| Oracle Grid Infrastructure installation owner | grid, UID 1001 |
| Oracle Database installation owner | oracle, UID 1000 |
| Oracle Database system administrator | sys |
| Oracle Database generic administrator | system |
| Oracle Inventory system privileges group | oinstall, GID 1001 |
| Oracle ASM Administrators system privileges | asmadmin, GID 1004 |
| Oracle ASM Users system privileges | asmdba, GID 1006 |
| Oracle ASM Operator system privileges | asmoper, GID 1005 |
| Oracle Database Administrators system privileges | dba, GID 1003 |
| Oracle Database Operator system privileges | dbaoper, GID 1002 |

Oracle Groups and User Configurations

You can use the Browser User Interface or the `odacli create-appliance` command and a JSON file to deploy the appliance. The following configurations are supported:

- 2 Users with 6 groups (operating system role separation)
- Single User with 6 groups (no operating system role separation)
- Single user with 2 groups (no operating system role separation)

You can customize `groupname`, `username`, and `UID`.

B

Oracle Database Appliance Storage Defaults

Review this section to understand Oracle Database Appliance storage architecture and options and how to determine usable storage.

- [About Database File Storage](#)
Use Oracle Automatic Storage Management (Oracle ASM) or Oracle Automatic Storage Management Cluster File System (Oracle ACFS) for database files storage.
- [Oracle ACFS Mount Points and Storage Space](#)
Review Oracle ASM Cluster file system (ACFS) mount points for Oracle Database Appliance.
- [Displaying Mounted Disk Details](#)
Use the Oracle Automatic Storage Management `lsdgs` command to display mounted disk groups and their information for Oracle Database Appliance.
- [Usable Space on Oracle Database Appliance X11-S and X11-L](#)
Review the table for the approximate amount of usable space for Oracle Database Appliance X11-S and X11-L.
- [Usable Space on Oracle Database Appliance X11-HA](#)
Review the table for the approximate amount of usable space for high performance and high capacity storage on Oracle Database Appliance X11-HA.
- [Usable Free Space with Oracle ASM](#)
When Oracle ASM calculates usable Free Space, it determines the amount of space to reserve in the case of a disk failure.

About Database File Storage

Use Oracle Automatic Storage Management (Oracle ASM) or Oracle Automatic Storage Management Cluster File System (Oracle ACFS) for database files storage.

Database file systems are used exclusively for storing database files, and they include separate file systems for data files and archive files or backups. You determine the type of database storage when you create the database.

About Oracle ASM Database Storage

With Oracle ASM, database datafiles are stored in DATA disk group. On X8-2, X7-2S, X7-2M, and X6-2 S/M/L systems, which do not have REDO disk group, redo and archive files are stored in RECO disk group. X7-2-HA and other older High-Availability systems have dedicated disks for REDO disk group; redo logs are stored in the REDO disk group.

Reserved storage is the amount of Oracle Automatic Storage Management (Oracle ASM) storage required to restore redundancy in the event of a disk failure. If you use the reserve storage capacity, then the system continues to run, and it is protected through Oracle ASM mirroring. However, in the event of a disk failure, the system is then running in a non-protected and degraded mode. In this event, you must replace disks immediately. If there is no reserved space available, then rebalance cannot restore redundancy after a disk failure.

If you specify mirroring for a file, then Oracle ASM automatically stores redundant copies of the file extents in separate failure groups. Failure groups apply to normal, high, and flex

redundancy disk groups. You can define the failure groups for each disk group when you create or alter the disk group.

 **See Also:**

Oracle Automatic Storage Management Administrator's Guide in the Oracle Database documentation library for information about Oracle ASM Mirroring and Disk Group Redundancy.

About Oracle ACFS Database Storage

With Oracle ACFS, an Oracle ACFS file system is created from DATA disk group for each database to store datafiles, and an Oracle ACFS file system is created from RECO disk group for redo and fast recovery area for all databases.

Each database created under ACFS has its own mount points, `/u02/app/oracle/oradata/dbid`. When you delete a database, you should clean up the files.

Storage Configuration Options

When Oracle Database Appliance is deployed, you can configure how the storage capacity is shared between DATA disk group and RECO disk group. You can choose anywhere from 10% to 90% for DATA and the remainder for RECO. The amount of usable storage is determined by the percentage configured for DATA. You can run the command `asmcmd lsdg` to determine the usable storage on the DATA disk group. You can also run the command `odacli list-dbstorages` command to determine the storage available.

Oracle ACFS Mount Points and Storage Space

Review Oracle ASM Cluster file system (ACFS) mount points for Oracle Database Appliance.

If you select Oracle Automatic Storage Management (Oracle ASM) for database storage when you create a database, then an Oracle ASM Cluster file system (ACFS) is not created. All files are in an Oracle ASM disk group.

If you select Oracle ACFS for database storage, then each database has its own Oracle ACFS mount point:

- DATA disk group: `/u02/app/oracleuser/oradata/db_name`
- RECO disk group: `/u03/app/oracleuser`.
- REDO disk group: `/u04/app/oracleuser/redo/db_name`

With Oracle ACFS, the following are created:

- A 100G ACFS is created from +DATA diskgroup for each database. This Oracle ACFS automatically extends the space on demand.
- A common Oracle ACFS with 25% of +RECO diskgroup is created with auto extension on. This file system is used for fast recovery area.
- For Oracle Database Appliance single-node and High-Availability High Performance systems, the REDO volume is created on the RECO disk group. For Oracle Database Appliance High-Availability High Capacity system, the REDO volume is created on FLASH disk group. The REDO volume stores redo logs.

Table B-1 Oracle ACFS Mount Points and Related Oracle ASM Disk Groups and Volume Information

| File System | Oracle ASM Disk Group | Oracle ASM Dynamic Volume | Mount Point |
|-------------|--|--|---|
| DATA | +DATA | /dev/asm/datdbname- <i>nnn</i> For example: /dev/asm/ datodacn-123 | /u02/app/oracleuser/oradata/ dbname For example: /u02/app/example/ oradata/odacn |
| RECO | +RECO | /dev/asm/reco- <i>nn</i> | /u03/app/oracleuser This mount point is shared by all databases for fast_recovery_area and redo logs. For fast_recovery_area, the path is: /u03/app/oracleuser/ fast_recovery_area/db_name |
| REDO | +RECO/ +FLASH depending on environment type (High Capacity or High Performance) | /dev/asm/rdo/dbName- <i>nnn</i> | /u04/app/oracleuser/redo/db_name For example: /u04/app/oracle/redo/mydb |

Example B-1 Oracle ACFS Storage Space

When the Oracle ACFS file systems are created, they do not initially consume all of the storage in the appliance. Space is preserved for additional repositories, or in some cases, database files stored directly in Oracle ASM. You can check for available storage space in your file systems by running the operating system command `df -k` as shown in the following example.

```
# df -k
Filesystem                1K-blocks  Used    Available  Use%    Mounted on
/dev/mapper/VolGroupSys-LogVolRoot
tmpfs                    65952292    647800    65304492
1% /dev/shm
/dev/sda1                 495844     43872     426372    10%    /boot
/dev/mapper/VolGroupSys-LogVolOpt
/dev/mapper/VolGroupSys-LogVolU01
/dev/asm/reco-62         76546048    1469676    75076372
2% /u03/app/oracle
/dev/asm/datrdb2-268    104857600    3872368    100985232
4% /u02/app/oracle/oradata/rdb2
/dev/asm/datndb11-268    104857600    247160    104610440
1% /u02/app/oracle/oradata/ndb11
/dev/asm/datndb12-268    104857600    247160    104610440
1% /u02/app/oracle/oradata/ndb12
```

Displaying Mounted Disk Details

Use the Oracle Automatic Storage Management `lsdgs` command to display mounted disk groups and their information for Oracle Database Appliance.

To display information about a specific disk group, specify the disk group in the command.

1. Log in as a `grid` user.
2. Run the Oracle Automatic Storage Management `lsdg` command.

Example B-2 Determining Storage on the DATA Disk Group

```
ASMCMD [+] > lsdg data
```

```
State      Type      Rebal  Sector  Block      AU      Total_MB  Free_MB
Req_mir_free_MB  Usable_file_MB
MOUNTED   NORMAL   N           512    4096    4194304    12288     8835
1117                3859
```

(continued)

```
Offline_disks  Voting_files  Name
                0                N  DATA
```

Usable Space on Oracle Database Appliance X11-S and X11-L

Review the table for the approximate amount of usable space for Oracle Database Appliance X11-S and X11-L.

Oracle Database Appliance X11-S and X11-L use 6.8TB NVMe. The storage capacity is the aggregate for DATA and RECO disk groups. The raw storage capacity in the table is based on disk hardware terabytes (based on 1 kilobyte equals 1000 bytes). Approximate usable storage capacity is shown in software storage terabytes (based on 1 kilobyte equals 1024 bytes). Approximate usable storage also accounts for 15% reserved space required to restore full redundancy in case of disk failure (not applicable to the two-drive configuration). The high redundancy values in the table describe the space needed to recover from one failure only.



Note:

The usable storage space described in this topic are approximate values, and may vary as per your deployment.

Table B-2 Usable Disk Capacity on Oracle Database Appliance X11-S and X11-L

| Number of Drives | Raw Storage | Usable Storage with Normal Redundancy (Double Mirroring) | Usable Storage with High Redundancy (Triple Mirroring) |
|------------------------|-------------|--|--|
| X11-S/X11-L (2 drives) | 13.6 TB | 6.2 TB | Not Applicable |
| X11-L (4 drives) | 27.2 TB | 10.5 TB | 7.0 TB |
| X11-L (6 drives) | 40.8 TB | 15.8 TB | 10.5 TB |
| X11-L (8 drives) | 54.4 TB | 21.0 TB | 14.0 TB |

Usable Space on Oracle Database Appliance X11-HA

Review the table for the approximate amount of usable space for high performance and high capacity storage on Oracle Database Appliance X11-HA.

Usable Space for High Performance



Note:

The usable storage space described in this topic are approximate values, and may vary as per your deployment.

Oracle Database Appliance X11-HA with high performance configuration uses 7.68TB solid state drives (SSDs). The storage capacity is the aggregate for DATA and RECO disk groups. The raw storage capacity in the table is based on disk hardware terabytes (based on 1 kilobyte equals 1000 bytes). Approximate usable storage capacity is shown in software storage terabytes (based on 1 kilobyte equals 1024 bytes). Approximate usable storage also accounts for 15% reserved space required to restore full redundancy in case of disk failure. The high redundancy values in the table describe the space needed to recover from one failure only.

Table B-3 Usable Disk Capacity for High Performance on Oracle Database Appliance X11-HA

| Number of Drives | Raw Storage | Usable Storage with Normal Redundancy (Double Mirroring) | Usable Storage with High Redundancy (Triple Mirroring) |
|------------------|-------------|--|--|
| 6 SSD drives | 46 TB | 17.8 TB | 11.9 TB |
| 12 SSD drives | 92 TB | 35.6 TB | 23.7 TB |
| 18 SSD drives | 138 TB | 53.4 TB | 35.6 TB |
| 24 SSD drives | 184 TB | 71.2 TB | 47.5 TB |
| 48 SSD drives | 369 TB | 142.5 TB | 95.0 TB |

Usable Space for High Capacity

Oracle Database Appliance X11-HA with high capacity configuration uses 7.68TB solid state drives (SSDs) and 22TB hard disk drives (HDDs). SSD storage capacity is allocated to the FLASH disk group. HDD storage capacity is the aggregate for DATA and RECO disk groups. The raw storage capacity in the table is based on disk hardware terabytes (based on 1 kilobyte equals 1000 bytes). Approximate usable storage capacity is shown in software storage terabytes (based on 1 kilobyte equals 1024 bytes). Approximate usable storage also accounts for 15% reserved space required to restore full redundancy in case of disk failure. The high redundancy values in the table describe the space needed to recover from one failure only.



Note:

The usable storage space described in this topic are approximate values, and may vary as per your deployment.

Table B-4 Usable Disk Capacity for High Capacity on Oracle Database Appliance X11-HA

| Number of Drives | Raw Storage | Usable Storage with Normal Redundancy (Double Mirroring) | Usable Storage with High Redundancy (Triple Mirroring) |
|---------------------------------|-----------------------------|--|--|
| 6 SSD drives and 18 HDD drives | SSDs: 46 TB HDDs: 396 TB | SSDs: 17.8 TB HDDs: 153.1 TB | SSDs: 11.9 TB HDDs: 102 TB |
| 12 SSD drives and 36 HDD drives | SSDs: 92 TB HDDs: 792 TB | SSDs: 35.6 TB HDDs: 306.1 TB | SSDs: 23.7 TB HDDs: 204.1 TB |

Usable Free Space with Oracle ASM

When Oracle ASM calculates usable Free Space, it determines the amount of space to reserve in the case of a disk failure.

For Oracle Database Appliance with 2 or 4 NVMe drives, this reserved space is not required. When you query Oracle ASM or Oracle Database Appliance commands to view the amount of storage available, the `usable_file_MB` value may report a negative number.

Table B-5 Oracle ASM Calculations

| Number of Drives | Redundancy | Total_MB | Free_MB | Req_mir_free_MB | Usable_file_MB | Name |
|------------------|------------|----------|---------|-----------------|----------------|-------|
| 2 | NORMAL | 4894016 | 4893372 | 0 | 1220644 | RECO/ |
| 4 | NORMAL | 1231176 | 1230996 | 610468 | 305150 | RECO/ |



Note:

Note: 1TB = MB divided by 1024²

How Oracle ASM and Oracle Database Appliance Define Capacity

The following table describes how capacity terms are defined by Oracle ASM and Oracle Database Appliance.

Table B-6 Definition of Terminology

| Term | Oracle ASM Definition | Oracle Database Appliance Definition |
|----------|---|---|
| Total_MB | Size of the disk group in MB | Total usable storage. For example, for 2 NVMe drives, total usable storage is 5.8TB. |
| Free_MB | Free space in the disk group in MB, without regard to redundancy. | Total usable storage after formatting to Oracle ASM disk groups. For example, for 2 NVMe drives, total usable storage is 5.8TB. |

Table B-6 (Cont.) Definition of Terminology

| Term | Oracle ASM Definition | Oracle Database Appliance Definition |
|-----------------|--|---|
| Req_mir_free_MB | Amount of space that must be available in the disk group to restore full redundancy after the worst failure that can be tolerated by the disk group. | Amount of space that must be available in the disk group to restore full redundancy after the most severe failure that can be tolerated by the disk group. This is the <code>REQUIRED_MIRROR_FREE_MB</code> column from the <code>V\$ASM_DISKGROUP</code> view. |
| Usable_file_MB | Amount of free space, adjusted for mirroring, that is available for new files. | Total usable space taking into consideration the mirroring level. Oracle ASM also calculates the amount of space required. |

C

Creating an Appliance Using JSON File

Understand the process to create an appliance using the command `odacli create-appliance` and view an example JSON file.

- [Loading and Saving Appliance Configurations](#)
You can load a saved JSON file and use it to configure your appliance from the Browser User Interface.
- [Readme for the Command `odacli create-appliance`](#)
If you want to create the appliance outside of the Browser User Interface, then review the readme file for details on how to create a JSON file to use with the command-line interface.
- [Example JSON Files to Create a Single Node Appliance with the CLI](#)
Follow these JSON file examples to create a JSON file to deploy a single node appliance with the command `odacli create-appliance`.
- [Example JSON File to Create a High-Availability Appliance with the CLI](#)
Follow the JSON file example to create a JSON file to deploy a high-availability appliance with the command `odacli create-appliance`.

Loading and Saving Appliance Configurations

You can load a saved JSON file and use it to configure your appliance from the Browser User Interface.

Using a Saved Configuration to Create a New Appliance in the Browser User Interface

You can load a saved configuration from your client machine, and create a new appliance.

1. Log into the Browser User Interface.
2. In the Create Appliance page, click **Browse** next to Load Configuration.
3. Select the JSON file from the local machine, being used to access the Browser User Interface.
4. The appliance configuration values from the JSON file are populated in the fields on the Create Appliance page.
5. Make any changes required, and submit the request to create the appliance
Note that for security requirements, you must enter passwords manually.

Readme for the Command `odacli create-appliance`

If you want to create the appliance outside of the Browser User Interface, then review the readme file for details on how to create a JSON file to use with the command-line interface.

You can use the command `odacli create-appliance` and a JSON file that includes your appliance configuration settings to deploy the appliance instead of using the Browser User Interface.

 **Note:**

It is important to review the readme and the examples carefully before creating your JSON file. If you do not enter your network and Oracle ILOM information correctly based on your setup, you will lose network access to both the host and Oracle ILOM.

Readme

The readme is located in the `/opt/oracle/dcs/sample` directory. Review the readme carefully along with the provided JSON example files. Create a JSON file with the necessary changes based on your environment and requirements.

Example JSON Files to Create a Single Node Appliance with the CLI

Follow these JSON file examples to create a JSON file to deploy a single node appliance with the command `odacli create-appliance`.

Use the example JSON files and the information located in the readme as a template to create a file for your environment. Examples and the readme are located in the `/opt/oracle/dcs/sample` directory.

 **Note:**

If you do not enter your network and Oracle ILOM information correctly based on your setup, then network access is lost to both the host and Oracle ILOM.

When using the example to create your JSON file, change the definitions to match your environment. The password must meet password requirements.

Note: To configure Oracle ASR during provisioning, always specify the `asrType` parameter in the JSON file.

Example C-1 JSON File to Create a Single Node Oracle Database Appliance with Role Separation

The following is an example of a JSON file that creates a single node appliance on Oracle Database Appliance. The example uses role separation.

```
{
  "instance" : {
    "name" : "odambox",
    "instanceBaseName" : "odambox-c",
    "dbEdition" : "EE",
    "timeZone" : "UTC",
    "ntpServers" : ["xx.xx.xx.xx"],
    "dnsServers" : ["xx.xx.xx.xx", "xx.xx.xx.xx", "xx.xx.xx.xx"],
    "domainName" : "example.com",
    "isRoleSeparated" : true,
    "osUserGroup" : {
      "groups" : [ {
```

```

        "groupId" : 1001,
        "groupName" : "oinstall",
        "groupRole" : "oinstall"
    }, {
        "groupId" : 1002,
        "groupName" : "dbaoper",
        "groupRole" : "dbaoper"
    }, {
        "groupId" : 1003,
        "groupName" : "dba",
        "groupRole" : "dba"
    }, {
        "groupId" : 1004,
        "groupName" : "asmadmin",
        "groupRole" : "asmadmin"
    }, {
        "groupId" : 1005,
        "groupName" : "asmoper",
        "groupRole" : "asmoper"
    }, {
        "groupId" : 1006,
        "groupName" : "asmdba",
        "groupRole" : "asmdba"
    } ],
    "users" : [ {
        "userId" : 1000,
        "userName" : "oracle",
        "userRole" : "oracleUser"
    }, {
        "userId" : 1001,
        "userName" : "grid",
        "userRole" : "gridUser"
    } ]
}
},
"sysOraHomeStorage": {
    "volumeSize": "160",
    "diskgroup": "DATA"
}
"nodes" : [ {
    "nodeNumber" : "0",
    "nodeName" : "odambox",
    "network" : [ {
        "nicName" : "btbond1",
        "ipAddress" : "xx.xx.xx.xx",
        "subNetMask" : "xx.xx.xx.xx",
        "gateway" : "xx.xx.xx.xx",
        "networkType" : [ "Public" ],
        "isDefaultNetwork" : true
    } ],
},
],
"ilom" : {
    "ilomName": "odambox-c",
    "ipAddress": "xx.xx.xx.xx",
    "subNetMask": "xx.xx.xx.xx",
    "gateway": "xx.xx.xx.xx"
}

```

```

    }
  } ],
  "grid" : {
    "diskGroup" : [ {
      "diskGroupName" : "DATA",
      "redundancy" : "NORMAL",
      "diskPercentage" :80
    }, {
      "diskGroupName" : "RECO",
      "redundancy" : "NORMAL",
      "diskPercentage" :20
    } ],
    "scan" : {
      "scanName":"odambox-scan",
      "ipAddresses":[
        "xx.xx.xx.xx"
      ]
    },
    "vip":[
      {
        "nodeNumber":"0",
        "vipName":"odambox-vip",
        "ipAddress":"xx.xx.xx.xx"
      }
    ],
    "language" : "en",
    "enableAFD":"TRUE"
  },
  "database" : {
    "dbName" : "myTestDb",
    "databaseUniqueName":"myTestDb_sealkj",
    "dbEdition" : "EE",
    "dbVersion" : "19.26.0.0.0",
    "dbHomeId":null,
    "instanceOnly" : false,
    "isCdb" : true,
    "pdbName" : "pdb1",
    "pdbAdminuserName" : "pdbuser",
    "enableTDE":true,
    "adminPassword" : "password",
    "dbType" : "SI",
    "dbTargetNodeNumber" : null,
    "dbClass" : "OLTP",
    "dbShape" : "odb1",
    "dbStorage" : "ACFS",
    "dbCharacterSet" : {
      "characterSet" : "AL32UTF8",
      "nlsCharacterSet" : "AL16UTF16",
      "dbTerritory" : "AMERICA",
      "dbLanguage" : "AMERICAN"
    },
    "dbConsoleEnable" : false,
    "backupConfigId":null,
    "rmanBkupPassword": null
  },
  "asr" :{

```



```

    "asrType": "INTERNAL",
    "userName": "john.smith@example.com",
    "password": "password",
    "proxyServerName": "www-proxy.example.com",
    "proxyPort": "80",
    "proxyUserName": "proxy-user",
    "proxyPassword": "proxy-password",
    "snmpVersion": "v2"
  }
}

```

Example C-2 JSON File to Create a Single Node Oracle Database Appliance without Role Separation

The following is an example of a JSON file that creates an Oracle Database Appliance without using role separation. This example creates two groups (oinstall and dba) and one user ("oracle").

```

{
  "instance" : {
    "name" : "odambox",
    "instanceBaseName" : "odambox-c",
    "dbEdition" : "EE",
    "timeZone" : "UTC",
    "ntpServers" : ["xx.xx.xx.xx"],
    "dnsServers" : ["xx.xx.xx.xx", "xx.xx.xx.xx", "xx.xx.xx.xx"],
    "domainName" : "example.com",
    "isRoleSeparated" : false,
    "osUserGroup" : {
      "groups" : [ {
        "groupId" : 1001,
        "groupName" : "oinstall",
        "groupRole" : "oinstall"
      }, {
        "groupId" : 1002,
        "groupName" : "dba",
        "groupRole" : "dba"
      } ],
      "users" : [ {
        "userId" : 1000,
        "userName" : "oracle",
        "userRole" : "oracleUser"
      } ]
    }
  },
  "nodes" : [ {
    "nodeNumber" : "0",
    "nodeName" : "odambox",
    "network" : [ {
      "nicName" : "btbond1",
      "ipAddress" : "xx.xx.xx.xx",
      "subNetMask" : "xx.xx.xx.xx",
      "gateway" : "xx.xx.xx.xx",
      "networkType" : [ "Public" ],
      "isDefaultNetwork" : true
    } ],
  },

```

```

],
"ilom" : {
  "ilomName": "odambox-c",
  "ipAddress": "xx.xx.xx.xx",
  "subNetMask": "xx.xx.xx.xx",
  "gateway": "xx.xx.xx.xx"
}
} ],
"grid" : {
  "diskGroup" : [ {
    "diskGroupName" : "DATA",
    "redundancy" : "NORMAL",
    "diskPercentage" : 80
  }, {
    "diskGroupName" : "RECO",
    "redundancy" : "NORMAL",
    "diskPercentage" : 20
  } ],
"scan" : {
  "scanName": "odambox-scan",
  "ipAddresses": [
    "xx.xx.xx.xx"
  ]
},
"vip": [
  {
    "nodeNumber": "0",
    "vipName": "odambox-vip",
    "ipAddress": "xx.xx.xx.xx"
  }
],
"language" : "en",
"enableAFD": "TRUE"
},
"database" : {
  "dbName" : "myTestDb",
  "databaseUniqueName": "myTestDb_sealkj",
  "dbEdition" : "EE",
  "dbVersion" : "19.26.0.0.0",
  "dbHomeId": null,
  "instanceOnly" : false,
  "isCdb" : true,
  "pdbName" : "pdb1",
  "pdbAdminuserName" : "pdbuser",
  "enableTDE": true,
  "adminPassword" : "password",
  "dbType" : "SI",
  "dbTargetNodeNumber" : null,
  "dbClass" : "OLTP",
  "dbShape" : "odb1",
  "dbStorage" : "ACFS",
  "dbCharacterSet" : {
    "characterSet" : "AL32UTF8",
    "nlsCharacterSet" : "AL16UTF16",
    "dbTerritory" : "AMERICA",
    "dbLanguage" : "AMERICAN"
  }
}

```

```

    },
    "dbConsoleEnable" : false,
    "backupConfigId":null,
    "rmanBkupPassword": null
  },
  "asr" :{
    "asrType": "INTERNAL",
    "userName":"john.smith@example.com",
    "password":"password",
    "proxyServerName":"www-proxy.example.com",
    "proxyPort":"80",
    "proxyUserName":"proxy-user",
    "proxyPassword":"proxy-password",
    "snmpVersion":"v2"
  }
}

```

Example JSON File to Create a High-Availability Appliance with the CLI

Follow the JSON file example to create a JSON file to deploy a high-availability appliance with the command `odacli create-appliance`.

Use the example JSON files and the information located in the readme as a template to create a file for your environment. Examples and the readme are located in the `/opt/oracle/dcs/sample` directory.

Note:

It is important to review the readme and the examples carefully before creating your JSON file. If you do not enter your network and Oracle ILOM information correctly based on your setup, then network access is lost to both the host and Oracle ILOM.

Example C-3 JSON File to Create a high-availability Oracle Database Appliance with Role Separation

The following is an example of a JSON file that creates a high-availability appliance on Oracle Database Appliance bare metal platform. The example uses role separation. When using the example to create your JSON file, change the definitions to match your environment. The password must meet password requirements.

```

{
  "instance":{
    "name":"odahabox",
    "instanceBaseName":"odahabox",
    "dbEdition":"EE",
    "timeZone":"UTC",
    "ntpServers" : ["10.0.3.14"],
    "dnsServers" : ["xx.xx.xx.xx","xx.xx.xx.xx","xx.xx.xx.xx"],
    "domainName":"example.com",
    "isRoleSeparated":true,
    "osUserGroup":{

```

```

"groups":[
  {
    "groupId":1001,
    "groupName":"oinstall",
    "groupRole":"oinstall"
  },
  {
    "groupId":1002,
    "groupName":"dbaoper",
    "groupRole":"dbaoper"
  },
  {
    "groupId":1003,
    "groupName":"dba",
    "groupRole":"dba"
  },
  {
    "groupId":1004,
    "groupName":"asmadmin",
    "groupRole":"asmadmin"
  },
  {
    "groupId":1005,
    "groupName":"asmoper",
    "groupRole":"asmoper"
  },
  {
    "groupId":1006,
    "groupName":"asmdba",
    "groupRole":"asmdba"
  }
],
"users":[
  {
    "userId":101,
    "userName":"grid",
    "userRole":"gridUser"
  },
  {
    "userId":102,
    "userName":"oracle",
    "userRole":"oracleUser"
  }
]
},
"objectStoreCredentials":null
},
"sysOraHomeStorage": {
  "volumeSize": "160",
  "diskgroup": "DATA"
}
"nodes":[
  {
    "nodeNumber":"0",
    "nodeName":"odahaboxc1n2",
    "network":[

```

```

    {
      "nicName": "btbond1",
      "ipAddress": "xx.xx.xx.xx",
      "subNetMask": "xx.xx.xx.xx",
      "gateway": "xx.xx.xx.xx",
      "networkType": [
        "Public"
      ],
      "isDefaultNetwork": true
    }
  ],
  "ilom": {
    "ilomName": "odahabox2-c",
    "ipAddress": "xx.xx.xx.xx",
    "subNetMask": "xx.xx.xx.xx",
    "gateway": "xx.xx.xx.xx"
  }
},
{
  "nodeNumber": "1",
  "nodeName": "odahaboxc1n1",
  "network": [
    {
      "nicName": "btbond1",
      "ipAddress": "xx.xx.xx.xx",
      "subNetMask": "xx.xx.xx.xx",
      "gateway": "xx.xx.xx.xx",
      "networkType": [
        "Public"
      ],
      "isDefaultNetwork": true
    }
  ],
  "ilom": {
    "ilomName": "odahabox1-c",
    "ipAddress": "xx.xx.xx.xx",
    "subNetMask": "xx.xx.xx.xx",
    "gateway": "xx.xx.xx.xx"
  }
}
],
"grid": {
  "diskGroup": [
    {
      "diskGroupName": "DATA",
      "redundancy": "HIGH",
      "diskPercentage": 80
    },
    {
      "diskGroupName": "RECO",
      "redundancy": "HIGH",
      "diskPercentage": 20
    },
    {
      "diskGroupName": "REDO",
      "redundancy": "HIGH",

```

```

        "diskPercentage":null
    }
],
"scan":{
    "scanName":"odahaboxc1-scan",
    "ipAddresses":[
        "xx.xx.xx.xx",
        "xx.xx.xx.xx"
    ]
},
"vip":[
    {
        "nodeNumber":"0",
        "vipName":"odahaboxc1n2-vip",
        "ipAddress":"xx.xx.xx.xx"
    },
    {
        "nodeNumber":"1",
        "vipName":"odahaboxc1n1-vip",
        "ipAddress":"xx.xx.xx.xx"
    }
],
"language":"en",
"enableAFD":"TRUE"
},
"database":{
    "dbName":"myTestDb",
    "databaseUniqueName":"myTestDb_sealkj",
    "dbVersion":"19.26.0.0.0",
    "dbHomeId":null,
    "instanceOnly":false,
    "isCdb":true,
    "pdbName":"pdb1",
    "pdbAdminuserName":"pdbuser",
    "enableTDE":true,
    "adminPassword":"password",
    "dbType":"RAC",
    "dbTargetNodeNumber":null,
    "dbClass":"OLTP",
    "dbShape":"odb1",
    "dbStorage":"ACFS",
    "dbCharacterSet":{
        "characterSet":"AL32UTF8",
        "nlsCharacterSet":"AL16UTF16",
        "dbTerritory":"AMERICA",
        "dbLanguage":"AMERICAN"
    },
    "dbConsoleEnable":false,
    "backupConfigId":null
},
"asr":null
}

```

Example C-4 JSON File to Create a high-availability Oracle Database Appliance with Enterprise Edition High Availability Enabled

The following is an example of a JSON file that creates a high-availability appliance on Oracle Database Appliance bare metal platform. The example shows enabling of Enterprise Edition High Availability. When using the example to create your JSON file, change the definitions to match your environment. The password must meet password requirements.

```
{
  "instance":{
    "name":"odahabox",
    "instanceBaseName":"odahabox",
    "dbEdition":"EE",
    "timeZone":"UTC",
    "ntpServers" : ["10.0.3.14"],
    "dnsServers" : ["xx.xx.xx.xx", "xx.xx.xx.xx", "xx.xx.xx.xx"],
    "domainName":"example.com",
    "isRoleSeparated":true,
    "osUserGroup":{
      "groups":[
        {
          "groupId":1001,
          "groupName":"oinstall",
          "groupRole":"oinstall"
        },
        {
          "groupId":1002,
          "groupName":"dbaoper",
          "groupRole":"dbaoper"
        },
        {
          "groupId":1003,
          "groupName":"dba",
          "groupRole":"dba"
        },
        {
          "groupId":1004,
          "groupName":"asmadmin",
          "groupRole":"asmadmin"
        },
        {
          "groupId":1005,
          "groupName":"asmoper",
          "groupRole":"asmoper"
        },
        {
          "groupId":1006,
          "groupName":"asmdba",
          "groupRole":"asmdba"
        }
      ],
      "users":[
        {
          "userId":101,
          "userName":"grid",
          "userRole":"gridUser"
        }
      ]
    }
  }
}
```

```

    },
    {
      "userId":102,
      "userName":"oracle",
      "userRole":"oracleUser"
    }
  ]
},
"objectStoreCredentials":null
},
"sysOraHomeStorage": {
  "volumeSize": "160",
  "diskgroup": "DATA"
}
"nodes":[
  {
    "nodeNumber":"0",
    "nodeName":"odahaboxc1n2",
    "network":[
      {
        "nicName":"btbond1",
        "ipAddress":"xx.xx.xx.xx",
        "subNetMask":"xx.xx.xx.xx",
        "gateway":"xx.xx.xx.xx",
        "networkType":[
          "Public"
        ],
        "isDefaultNetwork":true
      }
    ],
    "ilom":{
      "ilomName":"odahabox2-c",
      "ipAddress":"xx.xx.xx.xx",
      "subNetMask":"xx.xx.xx.xx",
      "gateway":"xx.xx.xx.xx"
    }
  },
  {
    "nodeNumber":"1",
    "nodeName":"odahaboxc1n1",
    "network":[
      {
        "nicName":"btbond1",
        "ipAddress":"xx.xx.xx.xx",
        "subNetMask":"xx.xx.xx.xx",
        "gateway":"xx.xx.xx.xx",
        "networkType":[
          "Public"
        ],
        "isDefaultNetwork":true
      }
    ],
    "ilom":{
      "ilomName":"odahabox1-c",
      "ipAddress":"xx.xx.xx.xx",
      "subNetMask":"xx.xx.xx.xx",

```



```

        "gateway": "xx.xx.xx.xx"
    }
}
],
"grid": {
    "diskGroup": [
        {
            "diskGroupName": "DATA",
            "redundancy": "HIGH",
            "diskPercentage": 80
        },
        {
            "diskGroupName": "RECO",
            "redundancy": "HIGH",
            "diskPercentage": 20
        },
        {
            "diskGroupName": "REDO",
            "redundancy": "HIGH",
            "diskPercentage": null
        }
    ],
    "scan": {
        "scanName": "odahaboxc1-scan",
        "ipAddresses": [
            "xx.xx.xx.xx",
            "xx.xx.xx.xx"
        ]
    },
    "vip": [
        {
            "nodeNumber": "0",
            "vipName": "odahaboxc1n2-vip",
            "ipAddress": "xx.xx.xx.xx"
        },
        {
            "nodeNumber": "1",
            "vipName": "odahaboxc1n1-vip",
            "ipAddress": "xx.xx.xx.xx"
        }
    ],
    "language": "en",
    "enableAFD": "TRUE"
},
"database": {
    "dbName": "myTestDb",
    "databaseUniqueName": "myTestDb_sealkj",
    "dbVersion": "19.26.0.0.0",
    "dbHomeId": null,
    "instanceOnly": false,
    "isCdb": true,
    "pdbName": "pdb1",
    "pdbAdminuserName": "pdbuser",
    "enableTDE": true,
    "adminPassword": "password",
    "dbType": "RAC",

```

```

        "dbTargetNodeNumber":null,
        "dbClass":"OLTP",
        "dbShape":"odb1",
        "dbStorage":"ACFS",
        "dbCharacterSet":{
            "characterSet":"AL32UTF8",
            "nlsCharacterSet":"AL16UTF16",
            "dbTerritory":"AMERICA",
            "dbLanguage":"AMERICAN"
        },
        "dbConsoleEnable":false,
        "backupConfigId":null
    },
    "asr":null
}

```

Example C-5 JSON File to Create a high-availability Oracle Database Appliance with Standard Edition High Availability Enabled

The following is an example of a JSON file that creates a high-availability appliance on Oracle Database Appliance bare metal platform. The example shows enabling of Standard Edition High Availability. When using the example to create your JSON file, change the definitions to match your environment. The password must meet password requirements.

```

{
  "instance":{
    "name":"odahabox",
    "instanceBaseName":"odahabox",
    "dbEdition":"SE",
    "timeZone":"UTC",
    "ntpServers" : ["10.0.3.14"],
    "dnsServers" : ["xx.xx.xx.xx","xx.xx.xx.xx","xx.xx.xx.xx"],
    "domainName":"example.com",
    "isRoleSeparated":true,
    "osUserGroup":{
      "groups":[
        {
          "groupId":1001,
          "groupName":"oinstall",
          "groupRole":"oinstall"
        },
        {
          "groupId":1002,
          "groupName":"dbaoper",
          "groupRole":"dbaoper"
        },
        {
          "groupId":1003,
          "groupName":"dba",
          "groupRole":"dba"
        },
        {
          "groupId":1004,
          "groupName":"asmadmin",
          "groupRole":"asmadmin"
        }
      ]
    }
  }
}

```

```

    {
      "groupId":1005,
      "groupName":"asmoper",
      "groupRole":"asmoper"
    },
    {
      "groupId":1006,
      "groupName":"asmdba",
      "groupRole":"asmdba"
    }
  ],
  "users":[
    {
      "userId":101,
      "userName":"grid",
      "userRole":"gridUser"
    },
    {
      "userId":102,
      "userName":"oracle",
      "userRole":"oracleUser"
    }
  ]
},
"objectStoreCredentials":null
},
"sysOraHomeStorage": {
  "volumeSize": "160",
  "diskgroup": "DATA"
}
"nodes":[
  {
    "nodeNumber":"0",
    "nodeName":"odahaboxc1n2",
    "network":[
      {
        "nicName":"btbond1",
        "ipAddress":"xx.xx.xx.xx",
        "subNetMask":"xx.xx.xx.xx",
        "gateway":"xx.xx.xx.xx",
        "networkType":[
          "Public"
        ],
        "isDefaultNetwork":true
      }
    ],
    "ilom":{
      "ilomName":"odahabox2-c",
      "ipAddress":"xx.xx.xx.xx",
      "subNetMask":"xx.xx.xx.xx",
      "gateway":"xx.xx.xx.xx"
    }
  },
  {
    "nodeNumber":"1",
    "nodeName":"odahaboxc1n1",

```

```

"network":[
  {
    "nicName":"btbond1",
    "ipAddress":"xx.xx.xx.xx",
    "subNetMask":"xx.xx.xx.xx",
    "gateway":"xx.xx.xx.xx",
    "networkType":[
      "Public"
    ],
    "isDefaultNetwork":true
  }
],
"ilom":{
  "ilomName":"odahabox1-c",
  "ipAddress":"xx.xx.xx.xx",
  "subNetMask":"xx.xx.xx.xx",
  "gateway":"xx.xx.xx.xx"
}
},
"grid":{
  "diskGroup":[
    {
      "diskGroupName":"DATA",
      "redundancy":"HIGH",
      "diskPercentage":80
    },
    {
      "diskGroupName":"RECO",
      "redundancy":"HIGH",
      "diskPercentage":20
    },
    {
      "diskGroupName":"REDO",
      "redundancy":"HIGH",
      "diskPercentage":null
    }
  ],
  "scan":{
    "scanName":"odahaboxc1-scan",
    "ipAddresses":[
      "xx.xx.xx.xx",
      "xx.xx.xx.xx"
    ]
  },
  "vip":[
    {
      "nodeNumber":"0",
      "vipName":"odahaboxc1n2-vip",
      "ipAddress":"xx.xx.xx.xx"
    },
    {
      "nodeNumber":"1",
      "vipName":"odahaboxc1n1-vip",
      "ipAddress":"xx.xx.xx.xx"
    }
  ]
}

```

```
    ],
    "language": "en",
    "enableAFD": "TRUE"
  },
  "database": {
    "dbName": "myTestDb",
    "databaseUniqueName": "myTestDb_sealkj",
    "dbVersion": "19.26.0.0.0",
    "dbHomeId": null,
    "instanceOnly": false,
    "isCdb": true,
    "pdbName": "pdb1",
    "pdbAdminuserName": "pdbuser",
    "enableTDE": true,
    "adminPassword": "password",
    "dbType": "RAC",
    "dbTargetNodeNumber": null,
    "dbClass": "OLTP",
    "dbShape": "odb1",
    "dbStorage": "ACFS",
    "dbCharacterSet": {
      "characterSet": "AL32UTF8",
      "nlsCharacterSet": "AL16UTF16",
      "dbTerritory": "AMERICA",
      "dbLanguage": "AMERICAN"
    },
    "dbConsoleEnable": false,
    "backupConfigId": null
  },
  "asr": null
}
```

D

Database Shapes for Oracle Database Appliance

Use the information in this appendix to select database shapes, or templates, for your planned databases.

- [About Database Shapes and Classes](#)
Review this information to help determine the database shape (also known as a database template) and class to use based on the common workload your databases perform.
- [Database Shapes for the OLTP Class](#)
Use Oracle Database Appliance OLTP Database Shapes if your database workload is primarily online transaction processing (OLTP).
- [Database Shapes for the In-Memory Class](#)
Use Oracle Database Appliance In-Memory (IMDB) database shapes if your database workload can fit in memory, and can benefit from in-memory performance capabilities.
- [Database Shapes for the DSS Class](#)
Use DSS database shapes if your database workload is primarily decision support services (DSS) or data warehousing.

About Database Shapes and Classes

Review this information to help determine the database shape (also known as a database template) and class to use based on the common workload your databases perform.

Oracle Database Appliance shapes define databases with parameters selected specifically to optimize performance on Oracle Database Appliance. In addition, these shapes help you to set up appropriate instance caging.

Oracle Database Appliance enables you to consolidate many databases into a single system. Consolidation can minimize idle resources, maximize efficiency, and lower costs. By using instance caging in conjunction with Oracle Database Resource Manager (the Resource Manager), you can provide desired levels of service across multiple instances on a single Oracle Database Appliance.

Oracle Database Appliance shapes are already tuned for the size of each database instance workload. They are designed to run on a specific number of cores. Caging ensures that each database workload is restricted to the set of cores allocated by the shape, enabling multiple databases to run concurrently with no performance degradation, up to the capacity of Oracle Database Appliance. You can select database shape sizes larger than your current needs to provide for planned growth, which you accommodate later by adjusting System Global Area (SGA) and Program Global Area (PGA) sizes as well as the number of cores.

 **Note:**

Oracle strongly recommends that you use the Oracle Database Appliance shapes, because they implement best practices and are configured specifically for Oracle Database Appliance.

 **Important:**

Except for the largest database shape, all other database shapes supported on the Oracle Database Appliance bare metal system are also supported on Oracle Database Appliance DB system.

Choosing a Database Shape

Database shapes are configured specifically for the type of database workload that you want to carry out on your databases on Oracle Database Appliance. Choose the shape that best matches the common workload your databases perform (OLTP, DSS, In-Memory).

The database sizing tables provide shape names and sizing based on the number of CPUs and memory attributes for each type of database workload.

Identify the shape type that is appropriate to your database workload and hardware:

- Use Oracle Database Appliance OLTP Database Shapes if your database workload is primarily online transaction processing (OLTP).
- Use Oracle Database Appliance DSS database shapes if your database workload is primarily decision support services (DSS) or data warehousing.
- Use Oracle Database Appliance In-Memory (IMDB) database shapes if your database workload can fit in memory, and can benefit from in-memory performance capabilities.

Use the database shape tables to help select the best shapes for your databases. When using these tables remember the following:

- The information in the tables assumes that you are creating local disk backups. Consider the space requirements for your database and the policy for local disk backups versus external backups. Typically, external backups have more space available for the database than local backups.
- The log file size assumes three (3) REDO log groups for each instance with a log switch every 15 minutes when the system is running at full capacity.

Database Shapes for the OLTP Class

Use Oracle Database Appliance OLTP Database Shapes if your database workload is primarily online transaction processing (OLTP).

The tables list the online transaction processing (OLTP) database shape sizes for Oracle Database Appliance X11-S, X11-L, and X11-HA.

The information in the table assumes the following:

- You are creating local disk backups. Consider the space requirements for your database and the policy for local disk backups versus external backups. Typically, external backups have more space available for the database than local backups.

Table D-1 Oracle Database Appliance X11-S OLTP Database Shapes

| Shape | CPU Cores | SGA (GB) | PGA (GB) | Processes | Redo log file size (GB) | Log buffer (MB) |
|-------|-----------|----------|----------|-----------|-------------------------|-----------------|
| odb1s | 1 | 2 | 1 | 200 | 4 | 32 |
| odb1 | 1 | 4 | 2 | 200 | 4 | 32 |
| odb2 | 2 | 8 | 4 | 400 | 4 | 32 |
| odb4 | 4 | 16 | 8 | 800 | 4 | 64 |
| odb6 | 6 | 24 | 12 | 1200 | 8 | 256 |
| odb08 | 8 | 32 | 16 | 1600 | 8 | 256 |
| odb10 | 10 | 40 | 20 | 2000 | 8 | 256 |
| odb12 | 12 | 48 | 24 | 2400 | 16 | 256 |
| odb16 | 16 | 64 | 32 | 3200 | 16 | 256 |
| odb20 | 20 | 80 | 40 | 4000 | 16 | 256 |
| odb24 | 24 | 96 | 48 | 4800 | 16 | 256 |
| odb28 | 28 | 112 | 56 | 5600 | 16 | 256 |
| odb32 | 32 | 128 | 64 | 6400 | 16 | 256 |

Table D-2 Oracle Database Appliance X11-L and X11-HA OLTP Database Shapes

| Shape | CPU Cores | SGA (GB) | PGA (GB) | Processes | Redo log file size (GB) | Log buffer (MB) |
|-------|-----------|----------|----------|-----------|-------------------------|-----------------|
| odb1s | 1 | 2 | 1 | 200 | 4 | 32 |
| odb1 | 1 | 4 | 2 | 200 | 4 | 32 |
| odb2 | 2 | 8 | 4 | 400 | 4 | 32 |
| odb4 | 4 | 16 | 8 | 800 | 4 | 64 |
| odb6 | 6 | 24 | 12 | 1200 | 8 | 256 |
| odb08 | 8 | 32 | 16 | 1600 | 8 | 256 |
| odb10 | 10 | 40 | 20 | 2000 | 8 | 256 |
| odb12 | 12 | 48 | 24 | 2400 | 16 | 256 |
| odb16 | 16 | 64 | 32 | 3200 | 16 | 256 |
| odb20 | 20 | 80 | 40 | 4000 | 16 | 256 |
| odb24 | 24 | 96 | 48 | 4800 | 16 | 256 |
| odb28 | 28 | 112 | 56 | 5600 | 16 | 256 |
| odb32 | 32 | 128 | 64 | 6400 | 16 | 256 |
| odb36 | 36 | 144 | 72 | 7200 | 32 | 256 |
| odb42 | 42 | 168 | 84 | 8400 | 32 | 256 |
| odb48 | 48 | 192 | 96 | 9600 | 32 | 256 |
| odb56 | 56 | 224 | 112 | 11200 | 32 | 256 |

Table D-2 (Cont.) Oracle Database Appliance X11-L and X11-HA OLTP Database Shapes

| Shape | CPU Cores | SGA (GB) | PGA (GB) | Processes | Redo log file size (GB) | Log buffer (MB) |
|-------|-----------|----------|----------|-----------|-------------------------|-----------------|
| odb64 | 64 | 256 | 128 | 12800 | 32 | 256 |

Database Shapes for the In-Memory Class

Use Oracle Database Appliance In-Memory (IMDB) database shapes if your database workload can fit in memory, and can benefit from in-memory performance capabilities.

The tables list the In-Memory database shape sizes for Oracle Database Appliance X11-2S, X11-2L, and X11-2-HA.

The information in the table assumes the following:

- You are creating local disk backups. Consider the space requirements for your database and the policy for local disk backups versus external backups. Typically, external backups have more space available for the database than local backups.

Table D-3 Oracle Database Appliance X11-S In-Memory Database Shapes

| Shape | CPU Cores | SGA (GB) | PGA (GB) | Processes - M e m o r y | Redo log file size (GB) | Log buffer (MB) |
|-------|-----------|----------|----------|--|-------------------------|-----------------|
| odb1s | 1 | 2 | 1 | 200 | 4 | 32 |
| odb1 | 1 | 4 | 2 | 200 | 4 | 32 |
| odb2 | 2 | 8 | 4 | 400 | 4 | 32 |
| odb4 | 4 | 16 | 8 | 800 | 4 | 64 |
| odb6 | 6 | 24 | 12 | 1200 2 | 8 | 256 |
| odb08 | 8 | 32 | 16 | 1600 6 | 8 | 256 |
| odb10 | 10 | 40 | 20 | 2000 0 | 8 | 256 |
| odb12 | 12 | 48 | 24 | 2400 4 | 16 | 256 |
| odb16 | 16 | 64 | 32 | 3200 2 | 16 | 256 |
| odb20 | 20 | 80 | 40 | 4000 2 | 16 | 256 |
| odb24 | 24 | 96 | 48 | 4800 8 | 16 | 256 |
| odb28 | 28 | 112 | 56 | 5600 6 | 16 | 256 |

Table D-3 (Cont.) Oracle Database Appliance X11-S In-Memory Database Shapes

| Shape | CPU Cores | SGA (GB) | PGA (GB) | Processes - M e m o r y | Redo log file size (GB) | Log buffer (MB) |
|-------|-----------|----------|----------|--|----------------------------|--------------------|
| odb32 | 32 | 128 | 64 | 6400 4 | 16 | 256 |

Table D-4 Oracle Database Appliance X11-L and X11-HA In-Memory Database Shapes

| Shape | CPU Cores | SGA (GB) | PGA (GB) | Processes - M e m o r y | Redo log file size (GB) | Log buffer (MB) |
|-------|-----------|----------|----------|--|----------------------------|--------------------|
| odb1s | 1 | 2 | 1 | 200 | 4 | 32 |
| odb1 | 1 | 4 | 2 | 200 | 4 | 32 |
| odb2 | 2 | 8 | 4 | 400 | 4 | 32 |
| odb4 | 4 | 16 | 8 | 800 | 4 | 64 |
| odb6 | 6 | 24 | 12 | 1200 2 | 8 | 256 |
| odb08 | 8 | 32 | 16 | 1600 6 | 8 | 256 |
| odb10 | 10 | 40 | 20 | 2000 0 | 8 | 256 |
| odb12 | 12 | 48 | 24 | 2400 4 | 16 | 256 |
| odb16 | 16 | 64 | 32 | 3200 2 | 16 | 256 |
| odb20 | 20 | 80 | 40 | 4000 2 | 16 | 256 |
| odb24 | 24 | 96 | 48 | 4800 8 | 16 | 256 |
| odb28 | 28 | 112 | 56 | 5600 6 | 16 | 256 |
| odb32 | 32 | 128 | 64 | 6400 4 | 16 | 256 |
| odb36 | 36 | 144 | 72 | 7200 2 | 32 | 256 |
| odb42 | 42 | 168 | 84 | 8400 4 | 32 | 256 |

Table D-4 (Cont.) Oracle Database Appliance X11-L and X11-HA In-Memory Database Shapes

| Shape | CPU Cores | SGA (GB) | PGA (GB) | Processes - M e m o r y | Redo log file size (GB) | Log buffer (MB) |
|-------|-----------|----------|----------|--|----------------------------|--------------------|
| odb48 | 48 | 192 | 96 | 9600 6 | 32 | 256 |
| odb56 | 56 | 224 | 112 | 11200 1 2 | 32 | 256 |
| odb64 | 64 | 256 | 128 | 12800 2 8 | 32 | 256 |

Database Shapes for the DSS Class

Use DSS database shapes if your database workload is primarily decision support services (DSS) or data warehousing.

The tables list the DSS database shape sizes for Oracle Database Appliance X11-S, X11-L, and X11-HA.

The information in the table assumes the following:

- You are creating local disk backups. Consider the space requirements for your database and the policy for local disk backups versus external backups. Typically, external backups have more space available for the database than local backups.

Table D-5 Oracle Database Appliance X11-S DSS Database Shapes

| Shape | CPU Cores | SGA (GB) | PGA (GB) | Processes | Redo log file size (GB) | Log buffer (MB) |
|-------|-----------|----------|----------|-----------|----------------------------|--------------------|
| odb1s | 1 | 1 | 2 | 200 | 4 | 32 |
| odb1 | 1 | 2 | 4 | 200 | 4 | 32 |
| odb2 | 2 | 4 | 8 | 400 | 4 | 32 |
| odb4 | 4 | 8 | 16 | 800 | 4 | 64 |
| odb6 | 6 | 12 | 24 | 1200 | 8 | 256 |
| odb08 | 8 | 16 | 32 | 1600 | 8 | 256 |
| odb10 | 10 | 20 | 40 | 2000 | 8 | 256 |
| odb12 | 12 | 24 | 48 | 2400 | 16 | 256 |
| odb16 | 16 | 32 | 64 | 3200 | 16 | 256 |
| odb20 | 20 | 40 | 80 | 4000 | 16 | 256 |
| odb24 | 24 | 48 | 96 | 4800 | 16 | 256 |
| odb28 | 28 | 56 | 112 | 5600 | 16 | 256 |

Table D-5 (Cont.) Oracle Database Appliance X11-S DSS Database Shapes

| Shape | CPU Cores | SGA (GB) | PGA (GB) | Processes | Redo log file size (GB) | Log buffer (MB) |
|-------|-----------|----------|----------|-----------|-------------------------|-----------------|
| odb32 | 32 | 64 | 128 | 6400 | 16 | 256 |

Table D-6 Oracle Database Appliance X11-L and X11-HA DSS Database Shapes

| Shape | CPU Cores | SGA (GB) | PGA (GB) | Processes | Redo log file size (GB) | Log buffer (MB) |
|-------|-----------|----------|----------|-----------|-------------------------|-----------------|
| odb1s | 1 | 1 | 2 | 200 | 4 | 32 |
| odb1 | 1 | 2 | 4 | 200 | 4 | 32 |
| odb2 | 2 | 4 | 8 | 400 | 4 | 32 |
| odb4 | 4 | 8 | 16 | 800 | 4 | 64 |
| odb6 | 6 | 12 | 24 | 1200 | 8 | 256 |
| odb08 | 8 | 16 | 32 | 1600 | 8 | 256 |
| odb10 | 10 | 20 | 40 | 2000 | 8 | 256 |
| odb12 | 12 | 24 | 48 | 2400 | 16 | 256 |
| odb16 | 16 | 32 | 64 | 3200 | 16 | 256 |
| odb20 | 20 | 40 | 80 | 4000 | 16 | 256 |
| odb24 | 24 | 48 | 96 | 4800 | 16 | 256 |
| odb28 | 28 | 56 | 112 | 5600 | 16 | 256 |
| odb32 | 32 | 64 | 128 | 6400 | 16 | 256 |
| odb36 | 36 | 72 | 144 | 7200 | 32 | 256 |
| odb42 | 42 | 84 | 168 | 8400 | 32 | 256 |
| odb48 | 48 | 96 | 192 | 9600 | 32 | 256 |
| odb56 | 56 | 112 | 224 | 11200 | 32 | 256 |
| odb64 | 64 | 128 | 256 | 12800 | 32 | 256 |

Glossary

Index

Numerics

10GBase-T (copper) network ports, [3-4](#), [3-6](#)
25GbE SFP28 (fiber) network ports, [3-4](#), [3-6](#)

A

ACFS, [B-1](#), [B-2](#)
ACFS mount points, [B-2](#)
ACR, [19-28](#), [19-30](#)
administrative account users, [9-2](#)
administrative accounts, [9-2](#)
agent
 update, [16-81–16-83](#)
agent proxy setting, [12-17](#)
ASM, [B-1](#)
ASM Cluster File System
 See Oracle ACFS
ASR
 configure, [16-248](#), [16-251](#), [18-3](#), [18-5](#), [18-7](#)
 delete, [16-250](#)
 details, [16-250](#)
 documentation, [18-13](#)
 modify, [16-252](#)
 register, [18-3](#), [18-5](#), [18-7](#)
 test, [16-253](#)
Automatic Storage Management
 See Oracle ASM

B

back up database, [12-19](#)
backup and recovery
 CLI commands, [16-108](#)
 RMAN, [9-3](#)
backup databases, [12-1](#)
backup location
 disk group, [1-1](#)
backup policy, [12-22](#), [12-23](#)
 update, [12-19](#)
backup to external FRA, [12-18](#)
backup to internal FRA, [12-18](#)
backup to NFS location, [12-18](#)
backup to Object Store, [12-18](#)
bare metal patching, [8-9](#), [8-18](#), [8-43](#), [8-47](#)
bill of materials, [19-18](#)

bond
 network interface, [11-1](#), [11-2](#)
bridge
 network interface, [11-1](#)
Browser User Interface, [C-1](#)
 about, [2-4](#)
 actions, [2-4](#)
BUI
 clone vdisk, [15-42](#)
 clone vm, [15-48](#)
 create CPU pool, [14-3](#)
 create dbsystem, [15-16](#)
 create vdisk, [15-40](#)
 create vm, [15-45](#)
 create vmstorage, [15-34](#)
 create vnetwork, [15-37](#)
 delete cpupool, [14-6](#)
 delete dbsystem, [15-28](#)
 delete vdisk, [15-44](#)
 delete vm, [15-51](#)
 delete vnetwork, [15-39](#)
 delete-vmstorage, [15-36](#)
 describe CPU pool, [14-5](#)
 describe dbsystem, [15-23](#)
 describe storage, [15-34](#)
 describe vdisk, [15-42](#)
 describe vm, [15-50](#)
 describe vnetwork, [15-38](#)
 list dbsystems, [15-22](#)
 modify cpupool, [14-6](#)
 modify dbsystem, [15-24](#), [15-26](#), [15-29](#)
 modify vdisk, [15-43](#)
 modify vm, [15-49](#)
 modify vmstorage, [15-35](#)
 modify vnetwork, [15-39](#)
 remap cpupools, [14-4](#)
 start dbsystem, [15-27](#)
 start vm, [15-51](#)
 start vnetwork, [15-38](#)
 stop dbsystem, [15-27](#)

C

cabling, [3-1](#), [3-4](#)
 validate, [16-269](#)
cleanup, [8-50](#)

- cleanup utility, [7-1](#), [7-7](#)
 - cleanup.pl, [7-1](#), [7-7](#), [19-22](#)
 - CLI commands
 - configure, [16-13](#)
 - cloning database, [9-90](#)
 - Configuration Audit Tool (ORAchk), [19-24](#)
 - configure CLI commands
 - configure-firstnet, [16-13](#)
 - configure-firstnet, [4-4](#)
 - CPU
 - commands, [16-156](#)
 - CPU core
 - current configuration, [16-157](#)
 - enable, [16-158](#)
 - CPU cores
 - configuration history, [16-157](#)
 - list, [16-157](#)
 - cpu pool
 - creating, [14-3](#)
 - CPU pool
 - audit record, [14-7](#)
 - deleting, [14-6](#)
 - modifying, [14-6](#)
 - over-subscribed, [14-7](#)
 - remapping, [14-4](#)
 - viewing, [14-5](#)
 - cpu pools
 - about, [14-1](#)
 - cpupool
 - create, [16-160](#), [17-30](#)
 - delete, [16-164](#), [17-34](#)
 - describe, [16-163](#), [17-33](#)
 - modify, [16-163](#), [17-33](#)
 - cpupools
 - auditrecord, [16-164](#), [16-165](#), [17-34](#), [17-35](#)
 - list, [16-162](#), [17-32](#)
 - remap, [16-161](#), [17-31](#)
 - create appliance, [4-9](#)
- ## D
-
- DATA disk group, [B-3](#)
 - database, [1-1](#), [9-103](#), [D-2](#), [D-4](#), [D-6](#)
 - backup policy, [12-19](#)
 - block size, [1-1](#)
 - clone from backup, [9-88](#)
 - create, [9-83](#)
 - delete, [9-102](#), [9-104](#)
 - details, [9-83](#)
 - home, [9-103](#)
 - create multiple, [9-103](#)
 - multiple, [9-103](#)
 - language, [1-1](#)
 - list, [9-83](#)
 - modify, [9-92](#)
 - move, [9-93](#)
 - database (*continued*)
 - register, [16-190](#)
 - template
 - See shape, database
 - territory, [1-1](#)
 - upgrade, [9-94](#), [9-95](#)
 - database backup
 - delete, [12-21](#)
 - database classes, [D-1](#)
 - database home
 - acfs, [9-86](#)
 - create, [9-104](#)
 - details, [9-104](#)
 - display details, [16-200](#)
 - list, [9-104](#)
 - database home storage
 - configure, [16-196](#)
 - describe, [16-198](#)
 - list, [16-197](#)
 - modify, [16-199](#)
 - database homes
 - ACFS, [9-3](#)
 - Database Security Assessment report, [19-25](#)
 - database shapes, [D-1](#), [D-2](#), [D-4](#), [D-6](#)
 - about, [D-1](#)
 - database storage, [B-1](#)
 - commands, [16-203](#)
 - create, [16-203](#)
 - display details, [16-205](#)
 - list, [16-209](#)
 - database, register, [9-108](#), [9-109](#)
 - db system
 - modifying, [15-24](#)
 - DB system
 - backup, restore and recovery, [15-29](#)
 - creating, [15-16](#)
 - delete, [15-28](#)
 - describing, [15-23](#)
 - modifying, [15-29](#)
 - network, [15-26](#)
 - Oracle Data Guard, [15-32](#)
 - start, [15-27](#)
 - stop, [15-27](#)
 - db system patching, [8-34](#)
 - DB systems
 - list, [15-22](#)
 - dbsystem
 - create, [17-6](#)
 - delete, [17-21](#)
 - describe, [17-12](#), [17-18](#)
 - modify, [17-7](#), [17-10](#)
 - start, [17-19](#)
 - stop, [17-20](#)
 - dbsystems
 - list, [17-11](#)
 - dc serr, [19-2](#), [19-8](#)

default groups and users, [A-5](#)
 deleting backups, [12-31](#)
 DHCP (Dynamic Host Configuration Protocol)
 connect to Oracle ILOM, [3-9](#)
 Oracle ILOM configuration, [3-9](#)
 diagnostics, [19-9](#)
 directory paths, [A-1](#)
 disk
 replace, [10-3](#), [10-8](#), [10-21](#)
 disk group redundancy, [B-1](#)
 disk group sizes, [A-5](#)
 disk group storage
 describe, [16-207](#)
 list, [16-209](#)
 domain
 definition, [15-4](#)
 downloading software, [4-6](#)
 DSS
 database shape, [D-6](#)
 dynamic default parameters
 using Browser User Interface, [8-52](#)
 Dynamic Host Configuration Protocol
 See DHCP

E

electrical power cords
 connecting, [3-9](#)
 EM Express, [9-115](#)
 Enterprise Edition High Availability, [9-6](#)
 error correlation report, [19-5](#)
 external FRA, [12-1](#)

F

flex diskgroup, [9-83](#), [9-86](#), [9-92](#)

G

Grid user, [9-2](#)
 groups and users defaults, [A-5](#)
 guest virtual machine
 definition, [15-4](#)

H

Host Public Addresses
 IP address, [1-8](#)

I

IMDB
 database shape, [D-4](#)
 install software, [4-7](#)

installed version
 display, [16-49](#), [16-52](#), [16-62](#), [16-63](#), [16-65](#)
 instance caging, [9-115](#)
 enable, [9-115](#)
 Integrated Lights Out Manager
 See Oracle ILOM
 internal FRA, [12-1](#)

J

JSON file, [5-12](#), [5-17](#), [5-21](#), [5-25](#), [15-52](#), [15-62](#),
[C-1](#), [C-2](#), [C-7](#)

K

key vault
 about, [9-10](#)
 KVM, [17-1](#), [17-3](#)
 definition, [15-3](#)
 deploying, [15-33](#)
 overcommit, [15-52](#)
 KVM commands
 odacli clone-vdisk, [17-28](#)
 odacli clone-vm, [17-47](#)
 odacli create-cpupool, [16-160](#), [17-30](#)
 odacli create-dbsystem, [17-6](#)
 odacli create-vdisk, [17-26](#)
 odacli create-vm, [17-41](#)
 odacli create-vmstorage, [17-23](#)
 odacli create-vnetwork, [17-37](#)
 odacli delete-cpupool, [16-164](#), [17-34](#)
 odacli delete-dbsystem, [17-21](#)
 odacli delete-vdisk, [17-29](#)
 odacli delete-vm, [17-48](#)
 odacli delete-vmstorage, [17-25](#)
 odacli delete-vnetwork, [17-40](#)
 odacli describe-auditrecord, [16-165](#), [17-35](#)
 odacli describe-cpupool, [16-163](#), [17-33](#)
 odacli describe-dbsystem, [17-12](#)
 odacli describe-dbsystem-image, [17-18](#)
 odacli describe-vdisk, [17-27](#)
 odacli describe-vm, [17-43](#)
 odacli describe-vmstorage, [17-24](#)
 odacli describe-vnetwork, [17-38](#)
 odacli list-auditrecords, [16-164](#), [17-34](#)
 odacli list-cpupools, [16-162](#), [17-32](#)
 odacli list-dbsystems, [17-11](#)
 odacli list-vdisks, [17-27](#)
 odacli list-vms, [17-42](#)
 odacli list-vmstorages, [17-24](#)
 odacli list-vnetworks, [17-37](#)
 odacli migrate-vm, [17-47](#)
 odacli modify-cpupool, [16-163](#), [17-33](#)
 odacli modify-dbfileattributes, [17-10](#)
 odacli modify-dbsystem, [17-7](#)
 odacli modify-vdisk, [17-28](#)

KVM commands (*continued*)

- odacli modify-vm, [17-43](#)
- odacli modify-vmstorage, [17-25](#)
- odacli modify-vnetwork, [17-39](#)
- odacli remap-cpupools, [16-161](#), [17-31](#)
- odacli start-dbsystem, [17-19](#)
- odacli start-vm, [17-46](#)
- odacli start-vnetwork, [17-38](#)
- odacli stop-dbsystem, [17-20](#)
- odacli stop-vm, [17-46](#)
- odacli stop-vnetwork, [17-39](#)

L

LED

- status when blinking, [3-11](#)
- status when steady, [3-11](#)
- status when steady on, [3-11](#)

LED indicators

- NVMe, [10-3](#), [10-8](#), [10-21](#)

Linux

- and virtualization, [15-2](#), [15-7](#), [15-10](#)

linux kernel core extractor, [19-6](#)listener.ora, configure, [9-106](#)load configuration, [C-1](#)log files, [A-4](#)

- sending to Oracle Support Services, [19-35](#)

logs

- storage diagnostic, [16-95](#), [16-240](#)

M

migration

- from an existing database, [9-3](#)

multi-node system, [10-22](#)

multi-user access

- appliance, [5-2](#), [5-7](#)
- create user, [5-10](#), [5-32](#), [9-52](#)
- entitlements, [5-35](#)
- manage database, [5-36](#)
- manage database homes, [5-36](#)
- manage password, [5-11](#), [5-38](#)
- odacli commands, [16-6](#)
- passwordless, [5-7](#)
- provisioning, [5-9](#), [5-29](#)
- reset-password, [5-33](#), [5-38](#)
- resources, [5-34](#)
- roles, [5-35](#)
- shared resource, [5-5](#)
- user roles, [5-4](#)

multiple database instances

- instance caging, [9-115](#)

multiple Oracle homes, [9-103](#)

- create, [9-103](#)

My Oracle Support, [19-35](#)

- send log files for troubleshooting, [19-35](#)

N

network

- configure, [16-13](#)
- create, [11-4](#), [11-5](#)
- delete, [11-6](#), [11-7](#)
- interfaces, [11-4](#)
- list, [11-4](#)
- update, [11-5](#)

network cabling, [3-6](#)network infrastructure, [11-1](#), [11-2](#)

network interface

- add, [11-6](#)
- default values, [11-1](#), [11-2](#)
- delete, [11-6](#)

network ports, [3-4](#), [3-6](#)network time protocol service (NTP service), [1-1](#)NFS backup, [12-9](#), [12-12](#), [12-15](#)

NTP service

- See network time protocol service

NVMe

- disk location, [10-3](#), [10-8](#), [10-21](#)
- LED indicators, [10-3](#), [10-8](#), [10-21](#)

O

oakcli commands

- show power
- example, [19-34](#)

Object Store, [12-17](#)

- credentials, [16-113](#), [16-118](#), [16-119](#), [16-127](#), [16-135](#)

odaadmcli commands

- asmops diskgroup, [16-266](#)
- expand storage, [16-267](#)
- hardware configuration, [16-259](#)
- hardware monitoring, [16-259](#)
- manage diagcollect, [16-240](#), [19-35](#)
- orachk, [16-95](#)
- power disk, [16-269](#)
- show controller, [16-270](#)
- show cooling, [16-260](#)
- show disk, [16-271](#)
- show diskgroup, [16-272](#)
- show env_hw, [16-260](#)
- show fs, [16-261](#)
- show localdisk, [16-259](#)
- show memory, [16-262](#)
- show network, [16-262](#)
- show power, [16-263](#)
- show processor, [16-264](#)
- show raidsyncstatus, [16-273](#)
- show server, [16-264](#)
- show storage, [16-274](#)
- storage, [16-265](#)
- stordiag, [16-275](#)

odacli cleanup-patchrepo, 8-50

odacli commands

- acr, 16-254
- appliance, 16-96
- apply patch, 16-46
- backup, 16-108
- cleanup-patchrepo, 16-48
- clone-database, 16-166
- clone-vdisk, 15-42
- clone-vm, 15-48
- configure-asr, 16-248
- configure-dataguard, 16-137
- configure-dbhome-storage, 16-196
- CPU core, 16-156
- cpu pool, 16-159, 17-29
- create database, 9-103
- create vdisk, 15-40
- create-appliance, 16-101
- create-auto-logclean-policy, 16-241
- create-backup, 16-109
- create-backupconfig, 16-111
- create-cpupool, 14-3
- create-database, 16-176
- create-dbhome, 16-200
- create-dbstorage, 16-203
- create-dbsystem, 15-16
- create-diagcollection, 16-213
- create-jobdata-retention-policy, 16-217
- create-logcleanjob, 16-243
- create-network, 16-16
- create-objectstoreswift, 16-113
- create-okvserverconfig, 16-233
- create-prepatchreport, 16-49
- create-purge-jobdata-job, 16-218
- create-vm, 15-45
- create-vmstorage, 15-34
- create-vnetwork, 15-37
- database, 16-166
- database storage, 16-203
- dataguard, 16-137
- DBHome, 16-195
- dbsystem, 17-5
- deconfigure-dataguard, 16-149
- delete-asr, 16-250
- delete-backup, 16-114
- delete-backupconfig, 16-115
- delete-cpupool, 14-6
- delete-database, 16-182
- delete-dbhome, 16-200
- delete-dbstorage, 16-205
- delete-dbsystem, 15-28
- delete-diagcollection, 16-215
- delete-jobdata-retention-policy, 16-222
- delete-network, 16-18
- delete-networkinterface, 16-19
- delete-objectstoreswift, 16-119

odacli commands (*continued*)

- delete-okvserverconfig, 16-236
- delete-prepatchreport, 16-63
- delete-vdisk, 15-44
- delete-vm, 15-51
- delete-vmstorage, 15-36
- delete-vnetwork, 15-39
- describe-asr, 16-250
- describe-backupconfig, 16-113
- describe-backupreport, 16-116
- describe-component, 16-65
- describe-cpucore, 16-157
- describe-cpupool, 14-5
- describe-database, 16-184
- describe-dataguardstatus, 16-151
- describe-dbhome, 16-201
- describe-dbhome-storage, 16-198
- describe-dbstorage, 16-205
- describe-dbsystem, 15-23
- describe-dgstorage, 16-207
- describe-diagcollection, 16-214
- describe-job, 16-223
- describe-latestpatch, 16-71
- describe-logcleanjob, 16-244
- describe-network, 16-20
- describe-networkinterface, 16-22
- describe-objectstoreswift, 16-118
- describe-okvserverconfig, 16-237
- describe-prepatchreport, 16-52
- describe-schedule, 16-119
- describe-system, 16-102
- describe-vdisk, 15-42
- describe-vm, 15-50
- describe-vmstorage, 15-34
- describe-vnetwork, 15-38
- diagnostics, 16-213
- export-asrconfig, 16-251
- failover-dataguard, 16-153
- irestore-database, 16-120
- jobs, 16-216
- key vault, 16-232
- list scheduler jobs, 16-231
- list-auto-logclean-policy, 16-245
- list-backupconfig, 16-126
- list-backupreports, 16-126
- list-cpucores, 16-157
- list-cpupools, 14-5
- list-databases, 16-185
- list-dataguardstatus, 16-154
- list-dbhome-storage, 16-197
- list-dbhomes, 16-202
- list-dbstorages, 16-209
- list-dbsystems, 15-22
- list-dgdisks, 16-267
- list-diagcollections, 16-215
- list-featuretracking, 16-105

odacli commands (*continued*)

- list-jobdata-retention-policy, [16-229](#)
- list-jobs, [16-225](#)
- list-logcleanjobs, [16-246](#)
- list-logspaceusage, [16-246](#)
- list-networkinterfaces, [16-23](#)
- list-networks, [16-23](#)
- list-okvserverconfigs, [16-238](#)
- list-osconfigurations, [16-257](#)
- list-prepatchreports, [16-62](#)
- list-purge-jobdata-jobs, [16-230](#)
- list-scheduled-executions, [16-231](#)
- list-schedules, [16-127](#)
- list-tdebackupreports, [16-129](#)
- list-vdisks, [15-42](#)
- list-vms, [15-50](#)
- list-vmstorages, [15-34](#)
- list-vnetworks, [15-38](#)
- modify-asr, [16-252](#)
- modify-backupconfig, [16-133](#)
- modify-cpupool, [14-6](#), [15-29](#)
- modify-database, [16-186](#)
- modify-dbhome-storage, [16-199](#)
- modify-dbstorage, [16-210](#)
- modify-dbsystem, [15-24](#), [15-26](#)
- modify-dgstorage, [16-212](#)
- modify-network, [16-24](#)
- modify-objectstoreswift, [16-135](#)
- modify-osconfigurations, [16-258](#)
- modify-schedule, [16-136](#)
- modify-vdisk, [15-43](#)
- modify-vm, [15-49](#)
- modify-vmstorage, [15-35](#)
- modify-vnetwork, [15-39](#)
- move-database, [16-190](#)
- multi-user access, [16-26](#)
- network, [16-13](#)
- odacli activate-user, [16-31](#)
- odacli authorize-user, [16-34](#)
- odacli change-password, [16-46](#)
- odacli copy-okvtdewallet, [16-233](#)
- odacli create-appliance, [5-12](#), [5-17](#),
[C-1](#), [C-2](#), [C-7](#)
- odacli create-dbsystem, [5-21](#), [5-25](#),
[15-52](#), [15-62](#)
- odacli create-user, [16-30](#)
- odacli delete-agentconfig-parameters,
[16-76](#)
- odacli delete-auto-logclean-policy,
[16-242](#)
- odacli delete-user, [16-35](#)
- odacli describe-acr, [16-254](#)
- odacli describe-domain, [16-28](#)
- odacli describe-resource-access,
[16-42](#)
- odacli describe-tenant, [16-29](#)

odacli commands (*continued*)

- odacli describe-user, [16-33](#)
- odacli describe-user-entitlement,
[16-39](#)
- odacli describe-user-operation, [16-40](#)
- odacli describe-user-role, [16-37](#)
- odacli disable-acr, [16-256](#)
- odacli enable-acr, [16-255](#)
- odacli grant-resource-access, [16-43](#)
- odacli list-acr, [16-256](#)
- odacli list-agentconfig-parameters,
[16-72](#)
- odacli list-availablepatches, [16-63](#)
- odacli list-dgstorages, [16-209](#)
- odacli list-domains, [16-27](#)
- odacli list-nodes, [16-104](#)
- odacli list-objectstoreswifts, [16-127](#)
- odacli list-pendingjobs, [16-229](#)
- odacli list-resources-access, [16-41](#)
- odacli list-tenants, [16-29](#)
- odacli list-user-entitlements, [16-38](#)
- odacli list-user-operations, [16-40](#)
- odacli list-user-roles, [16-36](#)
- odacli list-users, [16-32](#)
- odacli modify-agentconfig-parameters,
[16-74](#)
- odacli modify-asmport, [16-98](#)
- odacli modify-cpucore, [16-158](#)
- odacli ping-agent, [16-104](#)
- odacli redact-acr, [16-255](#)
- odacli reset-password, [16-45](#)
- odacli revoke-resource-access, [16-44](#)
- odaconfigcli collectconfig, [16-97](#)
- Oracle ASR, [16-247](#)
- OS, [16-257](#)
- recover-database, [16-129](#)
- recovery, [16-108](#)
- register-database, [16-190](#)
- register-dataguard, [16-155](#)
- reinstate-dataguard, [16-155](#)
- remap-cpupools, [14-4](#)
- restore-archivelog, [16-132](#)
- restore-tdewallet, [16-132](#)
- set-credential, [16-100](#)
- show -h
 - with Oracle Database Appliance
Hardware Monitoring Tool,
[19-34](#)
- start-dbsystem, [15-27](#)
- start-vm, [15-51](#)
- start-vnetwork, [15-38](#)
- stop-dbsystem, [15-27](#)
- stop-vm, [15-51](#)
- stop-vnetwork, [15-38](#)
- storage, [16-265](#)
- switchover-dataguard, [16-156](#)

- odacli commands (*continued*)
 - test-asr, [16-253](#)
 - update, [16-46](#)
 - update database, [16-78](#)
 - update database home, [16-79](#)
 - update repository, [16-91](#)
 - update-dcsadmin, [16-81](#)
 - update-dcsagent, [16-81](#)
 - update-dcscomponents, [16-82](#)
 - update-registry, [16-83](#)
 - update-server, [16-92](#)
 - update-server-postcheck, [16-95](#)
 - update-storage, [16-94](#)
 - upgrade-database, [16-193](#)
 - validate storage topology, [16-269](#)
 - validate-storagetopology, [16-269](#)
 - vdisk, [17-26](#)
 - vm, [17-40](#)
 - vmstorage, [17-23](#)
 - vnetwork, [17-36](#)
 - odacli create-appliance
 - example JSON files, [5-12](#), [5-17](#), [C-1](#), [C-2](#), [C-7](#)
 - readme, [C-1](#)
 - odacli create-dbsystem
 - example JSON files, [5-21](#), [5-25](#), [15-52](#), [15-62](#)
 - odaeraser.py, [7-6](#)
 - OINSTALL group, [9-2](#)
 - OLTP
 - database shape, [D-2](#)
 - Optimal Flexible Architecture
 - and Oracle homes, [A-1](#)
 - ORAchk report, [19-25](#)
 - Oracle ACFS, [15-4](#)
 - Oracle ACFS (Oracle Automatic Storage Management Cluster File System)
 - virtual storage, [15-4](#)
 - Oracle ASM, [10-1](#), [A-5](#)
 - Oracle ASM (Oracle Automatic Storage Management)
 - data migration, [9-3](#)
 - user group, [A-5](#)
 - Oracle ASR
 - commands, [16-247](#)
 - configure, [16-248](#), [16-251](#), [18-3](#), [18-5](#), [18-7](#)
 - register, [18-3](#), [18-5](#), [18-7](#)
 - Oracle ASR (Oracle Auto Service Request), [1-1](#)
 - configuring, [18-1](#)
 - Oracle Data Guard, [13-2](#), [13-3](#)
 - active data guard, [13-40](#)
 - CLI commands, [16-137](#)
 - configure, [13-3](#), [13-26](#)
 - deconfigure, [13-63](#), [13-67](#)
 - failover, [13-29](#), [13-30](#)
 - migrating, [13-32](#)
 - network, [13-31](#)
 - patching, [13-38](#)
 - Oracle Data Guard (*continued*)
 - register, [13-40](#), [13-61](#)
 - reinstall, [13-29](#), [13-30](#)
 - status, [13-28](#), [13-29](#)
 - switchover, [13-29](#), [13-30](#)
 - Oracle Database
 - See database
 - Oracle Database Appliance Hardware Monitoring Tool, [19-34](#)
 - Oracle Database Appliance Manager
 - software inventory, [2-3](#)
 - Oracle Database Resource Manager
 - instance caging, [9-115](#)
 - Oracle Enterprise Manager Database Express, [9-115](#)
 - Oracle home
 - multiple, [9-103](#)
 - Oracle ILOM (Oracle Integrated Lights Out Manager), [1-1](#)
 - configure, [3-9](#)
 - Oracle Integrated Lights Out Manager
 - See Oracle ILOM
 - oracle key vault
 - create database, [9-12](#), [9-16](#), [9-52](#)
 - manage database, [9-24](#), [9-26](#), [9-27](#), [9-32](#), [9-40](#), [9-50](#)
 - manage server configuration, [9-22](#), [9-53](#)
 - migrate acfs cdb database, [9-74](#)
 - migrate acfs database, [9-54](#)
 - migrate asm database, [9-60](#), [9-67](#)
 - Oracle Ksplice, [8-48](#)
 - Oracle KVM, [15-2](#), [15-7](#), [15-10](#)
 - Oracle KVM command-line interface
 - alphabetical list of commands, [17-1](#)
 - Oracle ORAchk, [19-32](#)
 - Oracle ORAchk Health Check Tool, [19-24](#)
 - Oracle Support Services
 - See My Oracle Support
 - Oracle Trace File Analyzer Collection, [19-31](#)
 - Oracle user, [9-2](#)
 - OS configuration
 - current, [16-257](#), [16-258](#)
 - suggested, [16-257](#), [16-258](#)
 - OSASM group, [9-2](#)
 - OSDBA, [9-2](#)
 - OSDBA for ASM group, [9-2](#)
 - OSDBA group, [9-2](#)
 - OSOPER groups, [9-2](#)
 - over-subscribed CPU pool, [14-7](#)
- ## P
-
- patches
 - software inventory, [2-3](#)
 - patching
 - appliance, [8-2](#), [8-7](#)

patching (*continued*)
 using Browser User Interface, [8-40](#), [8-42](#),
[8-44](#), [8-46](#)
 patching Oracle Database Appliance, [8-9](#), [8-18](#),
[8-34](#), [8-43](#), [8-47](#)
 performance tuning, [14-7](#)
 plumb network, [4-4](#)
 port numbers, [A-2](#)
 power cords
 connecting, [3-9](#)
 processor_group_name, [14-1](#)
 protocols, [A-2](#)
 proxy setting, [12-17](#)

R

readme, [C-1](#)
 recover database, [12-26](#)
 recovering database, [12-20](#)
 register
 Oracle ASR, [18-3](#), [18-5](#), [18-7](#)
 reimage appliance, [7-4](#)
 resource management
 CPU pools, [14-7](#)
 Oracle KVM, [15-2](#), [15-7](#), [15-10](#)
 supported virtual operating systems, [15-2](#),
[15-7](#), [15-10](#)
 restore archivelog, [12-31](#)
 restore baremetal system, [7-4](#)
 restore database, [12-28](#)
 RMAN (Recovery Manager utility)
 database management, [9-3](#)
 RPM drift, [19-18](#)

S

sanitize diagnostics, [19-28](#), [19-30](#)
 sanitize entities, [19-31](#)
 save configuration, [C-1](#)
 scheduler
 jobs, [16-231](#)
 Scheduling Database Backups, [12-25](#)
 secure erase tool, [7-6](#)
 odaeraser.py, [7-6](#)
 sending log files to Oracle Support Services,
[19-35](#)
 shapes, [D-1](#)
 database
 choosing, [D-1](#)
 OLTP, [D-2](#), [D-4](#), [D-6](#)
 SI (Support Identifier)
 Oracle ASR requirement, [18-1](#)
 space management, [B-2](#)
 SQL*Loader, [9-3](#)
 ssh configuration, [19-5](#)
 Standard Edition High Availability, [9-5](#)

start up the system, [3-11](#)
 static listener, configure, [9-106](#)
 storage, [10-1](#), [10-22](#), [B-3](#)
 expand, [10-3](#), [10-8](#), [10-21](#)
 single-node, [10-2](#)
 storage cables, [3-1](#)
 storage disks
 location, [10-3](#), [10-8](#), [10-21](#)

T

TDE, [9-7](#)
 TFA command, [19-26](#)
 TFA options, [19-26](#)
 Trace File Analyzer (TFA) Collector, [19-26](#)
 trace file redaction, [19-31](#)
 troubleshooting, [19-2](#), [19-5](#), [19-6](#), [19-8](#), [19-9](#),
[19-22](#)
 log files for Oracle Support Services, [19-35](#)
 turning on Oracle Database Appliance, [3-11](#)

U

uninstall, [7-1](#), [7-7](#)
 update
 database, [8-8](#)
 update-dcscomponents, [19-9](#)
 upgrade
 database, [8-51](#)
 usable storage, [B-3](#)

V

viewing backup reports, [12-20](#)
 virtual disk
 clone, [17-28](#)
 cloning, [15-42](#)
 create, [17-26](#)
 creating, [15-40](#)
 delete, [17-29](#)
 deleting, [15-44](#)
 describe, [17-27](#)
 list, [17-27](#)
 modify, [17-28](#)
 modifying, [15-43](#)
 viewing, [15-42](#)
 virtual disks, [15-4](#)
 virtual local area network, [11-1](#), [11-2](#)
 virtual machine
 about, [15-4](#)
 assemblies, [15-4](#)
 clone, [17-47](#)
 cloning, [15-48](#)
 create, [17-41](#)
 creating, [15-45](#)
 delete, [17-48](#)

virtual machine (continued)

- deleting, [15-51](#)
- describe, [17-43](#)
- list, [17-42](#)
- migrate, [17-47](#)
- modify, [17-43](#)
- modifying, [15-49](#)
- start, [15-51](#), [17-46](#)
- stop, [15-51](#), [17-46](#)
- templates, [15-4](#)
- viewing, [15-50](#)

virtual network

- creating, [15-37](#)
- deleting, [15-39](#)
- modifying, [15-39](#)
- start, [15-38](#)
- stop, [15-38](#)
- viewing, [15-38](#)

virtual storage

- about, [15-4](#)

virtualization, [15-2](#), [15-7](#), [15-10](#)

VLAN, [11-1](#)

vm storage

- creating, [15-34](#)
- deleting, [15-36](#)

vm storage (continued)

- modifying, [15-35](#)
- viewing, [15-34](#)

vmstorage

- create, [17-23](#)
- delete, [17-25](#)
- describe, [17-24](#)
- modify, [17-25](#)

vmstorages

- list, [17-24](#)

vnetwork

- create, [17-37](#)
- delete, [17-40](#)
- describe, [17-38](#)
- modify, [17-39](#)
- start, [17-38](#)
- stop, [17-39](#)

vnetworks

- list, [17-37](#)

W**web interface**

- Oracle Enterprise Manager Database Express, [9-115](#)